

MINISTERO DELLA DIFESA  
COSTARMAEREO  
ROMA

AER.1F-104S/ASAM-1

## FLIGHT MANUAL



### F-104S/ASA-M SERIES AIRCRAFT

ALENIA  
(A0019)

**Commanders are responsible for bringing this publication to the attention of all personnel cleared for operation of subject aircraft.**

MINISTERO DELLA DIFESA  
COSTARMAEREO  
ROMA

AER.1F-104S/ASAM-1

# FLIGHT MANUAL



## F-104S/ASA-M SERIES AIRCRAFT

ALENIA  
(A0019)

Commanders are responsible for bringing this publication to the attention of all personnel cleared for operation of subject aircraft.

1 DECEMBER 1996

**LIST OF EFFECTIVE PAGES**

Note: The portion of the text affected by the change is indicated by a vertical line on the outer margin of the page.  
 The portion of illustrations affected by a change is indicated by a vertical line on the outer margin of the page or by a pointing hand or by a shadowed grid.

Dates of issue for original and changed pages are:

Original ..... 0 ..... 1 December 1996

TOTAL NUMBER OF PAGES IN THIS PUBLICATION IS 565 CONSISTING OF THE FOLLOWING:

Page No.	*Change No.	Page No.	*Change No.	Page No.	*Change No.
Title .....	0	4-1 .....	0	Λ4-1 thru Λ4-4 .....	0
Λ .....	0	4-2 blank .....	0	Λ5-1 thru Λ5-4 .....	0
i thru iii .....	0	5-1 thru 5-22 .....	0	Λ6-1 thru Λ6-4 .....	0
iv blank .....	0	6-1 thru 6-30 .....	0	Λ6-5 blank .....	0
v thru ix .....	0	7-1 thru 7-9 .....	0	Λ6-6 thru Λ6-29 .....	0
x blank .....	0	7-10 blank .....	0	Λ6-30 blank .....	0
xi thru xiii .....	0	Λ-1 .....	0	Λ7-1 thru Λ7-4 .....	0
xiv blank .....	0	Λ-2 blank .....	0	Λ8-1 thru Λ8-11 .....	0
xv .....	0	Λ1-1 thru Λ1-21 .....	0	Λ8-12 blank .....	0
xvi blank .....	0	Λ1-22 blank .....	0	Λ9-1 thru Λ9-56 .....	0
1-1 thru 1-160 .....	0	Λ2-1 thru Λ2-24 .....	0	Λ10-1 thru Λ10-12 .....	0
2-1 thru 2-45 .....	0	Λ3-1 thru Λ3-23 .....	0	FO-1 thru FO-15 .....	0
2-46 blank .....	0	Λ3-24 blank .....	0	Index-1 thru Index-8 .....	0
3-1 thru 3-58 .....	0				

**CURRENT FLIGHT CREW CHECKLIST**

AER.1F-104S/ASAM-1CL Issue 1 December 1996

\* Zero in this column indicates an original page

**CAUTION**

- This publication is valid only if it is composed of the above listed pages and duly amended.
- Copies of this publication may be obtained as follows:
  - FA activities, as directed by specification ILA-NL-9004-0001-00B00
  - COSTARMAEREO activities, as directed by specification AER.00-00-8
- Any deficiency and/or mistake in this publication shall be reported as directed by specification AER.00-00-4.



## SCOPE

This manual contains the necessary information for safe and efficient operation of your aircraft. These instructions provide you with a general knowledge of the aircraft and its characteristics and specific normal and emergency procedures. Your experience is recognized; therefore, basic flight principles are avoided. Instructions in this manual are prepared to be understandable by the least experienced crew that may be expected to operate the aircraft.

This manual provides the best possible operating instructions under most circumstances, but it is not a substitute for sound judgment. Multiple emergencies, adverse weather, terrain, etc. may require modification of the procedures.

## PERMISSIBLE OPERATIONS

The flight manual takes a "positive approach" and normally states only what you may do. Unusual operations or configurations are prohibited unless specifically covered herein. Clearance from the using command shall be obtained before any questionable operation, which is not specifically permitted in this manual, is attempted.

## HOW TO BE ASSURED OF HAVING LATEST DATA

Refer to the flight manual cover page and list of effective pages, the title block of each safety and operational supplements, and all status pages attached to formal safety and operational supplements. Clear up all discrepancies before flight.

## ARRANGEMENT

The manual is divided into seven nearly independent sections to simplify its use as a reference manual. Also the Appendix - Performance Data is inserted as separate section.

## SAFETY SUPPLEMENTS

Information involving safety will be promptly forwarded to you in a safety supplement. Urgent information is published in interim safety supplements and transmitted by teletype. Formal supplements are mailed. The supplement title block and status page (published with formal supplement only) should be checked to determine the supplement's effect on the manual and other outstanding supplements.

## OPERATIONAL SUPPLEMENTS

Information involving changes to operating procedures will be forwarded to you by operational supplements.

The procedure for handling operational supplements is the same as for safety supplements.

## CHECKLISTS

The flight manual contains itemized procedures with necessary amplifications. The checklist contains itemized procedures without the amplification. Primary line items in the flight manual and checklist are identical. If a formal safety or operational supplement affects your checklist, the affected checklist page will be attached to the supplement. Cut it out and insert it over the affected page but never discard the checklist page in case the supplement is rescinded and the page is needed.

## HOW TO GET PERSONAL COPIES

Each flight crewmember is entitled to personal copies of the flight manual, safety supplements, operational supplements, and checklist. The required quantities should be ordered before you need them to assure their prompt receipt. Check with your publication distribution officer - it is his job to fulfill your request.

## CHANGE SYMBOL

The change symbol, is illustrated by a black line in the outer margin of the column or page, adjacent to the affected text, like the one printed next to this paragraph. The change symbol indicates text and tabular illustration changes made to the current issue.

Changes to illustrations (except tabular and plotted illustrations) are indicated by a pointing hand or by a shaded area box located at the upper right side of the illustration.

The box is divided into eight equal parts which represent eight proportional areas of the illustration. The shaded area of the box represents the area of the illustration which contains a change.

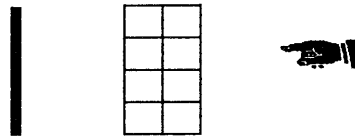

## PUBLICATIONS DEFICIENCY REPORTING

Reporting of deficiencies such as errors or omissions in this manual shall be effected in accordance with AER.00-00-4.

## WARNINGS, CAUTIONS, AND NOTES

The following definitions apply to "Warnings", "Cautions", and "Notes" found throughout the manual.

**WARNING**

OPERATING PROCEDURES, TECHNIQUES, ETC., WHICH COULD RESULT IN PERSONAL INJURY OR LOSS OF LIFE IF NOT CAREFULLY FOLLOWED.

**CAUTION**

OPERATING PROCEDURES, TECHNIQUES, ETC., WHICH COULD RESULT IN DAMAGE TO EQUIPMENT IF NOT CAREFULLY FOLLOWED.

**NOTE**

An operating procedure, technique, etc., which is considered essential to emphasize.

**USE OF WORDS SHALL, WILL, SHOULD AND MAY**

The words shall, will, should and may have the following meanings in this manual:

*Shall* is used to express a provision that is mandatory.

*Will* is used to express a declaration of purpose. It is also used in cases where simple futurity is required.

*Should* and *may* are used to express a non-mandatory provision.

**EFFECTIVITY**

All text and graphics within this manual apply to the F-104S/ASA-M series aircraft.

**YOUR RESPONSIBILITY — TO LET US KNOW**

Every effort is made to keep the flight manual current. Review conferences with operating personnel and a constant review of accident and flight test reports assure inclusion of the latest data in the manual. We shall not correct an error unless we know of its existence. In this regard, it is essential that you do your part.

Comments, corrections, and questions regarding this manual or any phase of the flight manual program are welcomed. These should be forwarded as directed by national procedures and in line with national specifications.

## **IDENTIFICATION OF THE CONFIGURATION STATUS OF THIS MANUAL**

This manual contains information regarding the predicted configuration of the F-104S/ASA-M single seater series aircraft.

**MODIFICATIONS NOT INCORPORATED IN THIS MANUAL**

All modifications which are applicable to this manual, but whose information has not yet been introduced are listed below:

PTD No.	MINISTRY OF DEFENCE DOCUMENT (PTA)	DATE	TITLE
None			



**FURTHER MODIFICATIONS INCORPORATED IN THIS MANUAL**

Further modifications, not yet formally approved at the cut-off date of the Flight Manual current issue, but which for opportunity reasons have been incorporated in the Manual, are identified and temporarily listed below:

PTD No.	TITLE
None	



## LIST OF INCORPORATED PTA

This list contains only the modifications affecting the contents of this manual. Following embodiment of a modification in all effected aircraft, the corresponding number will not be deleted from the list, but the information regarding the pre-modification configuration will be deleted from the manual.

MINISTRY OF DEFENCE DOCUMENT		COMPANY DOCUMENT			
PRESCRIZIONE TECNICA APPLICATIVA (PTA)		PRESCRIZIONE TECNICA DITTA (PTD)			TITLE
No.	DATE	No.	DATE	CLASS	
None					

## LIST OF ABBREVIATIONS

<b>A</b>		CW	Clockwise
A	Ampere		
A/B	Afterburner		<b>D</b>
AC	Alternating Current		
AC	Armament Computer	DC	Direct Current
ADC	Air Data Computer	deg	Degree(s)
ADF	Automatic Direction Finder	DES	Destination
ADJ	Adjustment	DME	Distance Measuring Equipment
AFCC	Automatic Flight Control Computer	DTM	Data Transfer Module
Aft	After	DWP	Destination Waypoint
AGL	Above Ground Level		
Ah	Ampere hour		
AI	Attitude Indicator		<b>E</b>
AIM-7E	Sparrow, Air Intercept Missile		
AIM-9L	Sidewinder, Air Intercept Missile		
ALN	Align	EGT	Exhaust Gas Temperature
ALR	Alarm	ELEC	Electrical
AOA	Angle of Attack	EMER	Emergency
APC	Automatic Pitch Control	ENT	Enter
ASAM	Aggiornamento Sistema d'Arma Modificato	ENG	Engine
ASAP	As Soon As Possible	EPE	Estimated Position Error
ASAS	Aspide/Sparrow Auxiliary System	EPROM	Erasable Programmable Read Only Memory
ASCII	American Standard Code for Information Interchange	EXT	External
ATC	Air Traffic Control	EXT TRAN	External Transfer
AUX	Auxiliary		
AWPT	Absolute Waypoint		<b>F</b>
	<b>B</b>	°F	Fahrenheit Degrees
BIT/AFI	Built In Test/Automatic Fault Isolation	FF	Fixed Frequency
BL	Butt Line	FOD	Foreign Object Damage
BLC	Boundary Layer Control	fpm	Feet per minute
		FREQ	Frequency
		ft/FT	Feet
		FWD	Forward
	<b>C</b>		<b>G</b>
°C	Celsius Degrees	gal/GAL	gallon(s)
C/A	Coarse Acquisition	GC	Gyro Compass
CAL	Calibrate	GC	Generator Contactor
CCW	Counterclockwise	GCA	Ground Controlled Approach
CDP	Compressor Discharge Pressure	GCI	Ground Controlled Intercept
CG	Center of Gravity	GCU	Generator Control Unit
CHG	Change	GD	Guard Frequency
CIT	Compressor Inlet Temperature	GEN	Generator
CLR	Clear	G/g	Gravity (Unit of)
COMP	Compass	GPS	Global Positioning System
CSS	Control Stick Steering	GS	Ground Speed
		GTK	Ground Track

**H**

HQ Have Quick  
 HSI Horizontal Situation Indicator  
 HYD Hydraulic  
 Hz Hertz

**I**

IAS Indicated Airspeed  
 ICAO International Civil Aviation Organization  
 IFF Identification Friend or Foe  
 IGV Inlet Guide Vanes  
 ILS Instrument Landing System  
 IN/CDU Inertial Navigator Control Display Unit  
 INS Inertial Navigation System  
 INU Inertial Navigation Unit  
 IP Initial Position

**K**

KEAS Knots Equivalent Airspeed  
 KIAS Knots Indicated Airspeed  
 Km/km Kilometers  
 KVA/Kva Kilovolt ampere

**L**

LAT Latitude  
 lb/LB Pound(s)  
 lb/hr pounds per hour  
 LDG Landing Gear  
 LE/L.E. Leading Edge  
 LG Landing Gear  
 LONG Longitude  
 LST List

**M**

M Magnetic  
 MAC Mean Aerodynamic Chord  
 mb millibar  
 MFC Main Fuel Control  
 MHz Mega Hertz  
 MRAAM Medium Range Air-to-Air Missile  
 MSL Mean Sea Level  
 MWOD Multiple Word of Day

**N**

NAVSTAR NAVigation System using Time And  
 Racing  
 NET Network  
 NM Nautical Miles  
 NXT Next

**O**

OC Overcurrent  
 OTF On Top Fix(ing)  
 OV Overvoltage

**P**

P code Precision Code  
 PEC Personal Equipment Connector  
 PNEU Pneumatic  
 PP Present Position  
 pph Pounds per hour  
 PP1 No. 1 DC Bus (Primary)  
 PP2 No. 1 DC Bus (Emergency)  
 PP3 No. 2 DC Bus (Emergency)  
 PP4 No. 1 Battery Bus  
 PP5 No. 2 Battery Bus  
 PPS Precise Positioning Service  
 PSI/psi Pounds per square inch  
 PTA Prescrizione Tecnica Applicativa  
 PTD Prescrizione Tecnica Ditta  
 PTT Press To Transmit  
 PWR Power

**Q**

QNH Barometric Pressure at Sea Level  
 QTY Quantity

**R**

RAT Ram Air Turbine  
 RCR Runway Condition Reading  
 RCV Receive  
 RDY Ready  
 RDY NAV Ready Navigation  
 RG Rate Gyro  
 RPM Revolution Per Minute  
 RWPT Relative Waypoint

**S**

sec/Sec Second(s)  
 SIF Selective Identification Feature  
 SYNC Synchronize  
 SLS Side Lobe Suppression  
 SPS Standard Positioning Service  
 STBY Standby  
 STO Stored

**T**

T Time  
 TACAN TACTical Air Navigation  
 TAS True Air Speed  
 TCN TACAN  
 TE/T.E Trailing Edge  
 TOA Time Of Arrival  
 TOD Time Of Day  
 TRU Transformer Rectifier Unit

**U**

UF Under frequency  
 UHF Ultra High Frequency  
 UTC Universal Time Coordinated  
 UV Undervoltage

**V**

V Volt  
 VHF Very High Frequency  
 VOL Volume  
 Vs Versus

**W**

WF Wild Frequency  
 WOD Word of Day  
 WPT Waypoint

**X**

XMT Transmit  
 XP1 No. 1 AC Bus (Primary)  
 XP2 No. 2 AC Bus  
 XP3 No. 3 AC Bus (Secondary)  
 XP4 No. 4 AC Bus (Emergency)  
 XP5 No. 5 AC Bus (Primary Fixed Frequency)  
 XP6 No. 6 AC Bus (Instrument)  
 XP7 No. 7 AC Bus (Secondary Fixed Frequency)

## TABLE OF CONTENTS

<b>Section I</b>	<b>DESCRIPTION AND OPERATION</b>	<b>1-1</b>
<b>Section II</b>	<b>NORMAL PROCEDURES</b>	<b>2-1</b>
<b>Section III</b>	<b>EMERGENCY PROCEDURES</b>	<b>3-1</b>
<b>Section IV</b>	<b>CREW DUTIES</b>	<b>4-1</b>
<b>Section V</b>	<b>OPERATING LIMITATIONS</b>	<b>5-1</b>
<b>Section VI</b>	<b>FLIGHT CHARACTERISTICS</b>	<b>6-1</b>
<b>Section VII</b>	<b>ALL-WEATHER OPERATION</b>	<b>7-1</b>
<b>Appendix -</b>	<b>PERFORMANCE DATA</b>	<b>A-1</b>
<b>Alphabetical Index</b>		<b>Index-1</b>

# SECTION I

## DESCRIPTION AND OPERATION

### TABLE OF CONTENTS

Title	Page
The Aircraft	1-1
Engine	1-2
Fuel Supply System	1-23
External Tip Stores Automatic Drop System	1-30
External Stores Jettison System	1-32
Electrical Power Supply System	1-35
Hydraulic Power Supply Systems	1-40
Flight Control System	1-43
Wing Flap System	1-50
Boundary Layer Control (BLC) System	1-52
Speed Brake System	1-53
Landing Gear System	1-53
Nosewheel Steering System	1-58
Wheel Brake System	1-60
Drag Chute System	1-61
Arresting Hook	1-64
Instruments	1-65
Warning Lights System	1-70
Survival Pack	1-73
Canopy	1-73
Ejection Seat	1-78
Air-Conditioning and Pressurization System	1-83
Defogger and Rain-Remover Systems	1-88
Anti-Icing Systems	1-90
Communications and Navigation Equipment	1-93
Air Data Computer	1-108
Radar Altimeter	1-108
Inertial Navigation System (INS)	1-111
Tactical Air Navigation (TACAN) System	1-117
Global Positioning System (GPS)	1-119
C-2G Directional Gyro System	1-125
Inertial Navigation Control Display Unit (IN/CDU)	1-130
Horizontal Situation Indicator (HSI)	1-138
Navigation Sub-System	1-138
Automatic Flight Control System (AFCS)	1-146
Lighting System	1-151

Oxygen Supply System	1-153
Engine Bleed Air Anti-G Suit System	1-158
Servicing Data	1-159

### THE AIRCRAFT

The single seater F-104S/ASA-M aircraft is a high-performance, all-weather, day and night interceptor powered by an axial-flow, turbojet engine with afterburner. The aircraft, built by ALENIA – STABILIMENTI DI TORINO under Lockheed Aircraft Corporation licence, is designed for high subsonic cruise and high supersonic combat speeds. Notable features of the aircraft include extremely thin flight surfaces, short straight wings with negative dihedral, irreversible-hydraulically-powered flight controls, a controllable horizontal stabilizer mounted at the top of the vertical stabilizer, engine air inlet duct anti-icing, an antiskid brake system, an automatic pitch control system, and a maneuvering automatic pilot.

The wings have leading and trailing edge flaps, and a boundary layer control system which is used in conjunction with the trailing edge flaps to reduce landing speeds. A Martin Baker upward ejection system is used for emergency escape. A drag chute is installed to reduce the landing roll and an arresting hook is available for bringing the aircraft to an emergency stop. Internal fuel cells and external fuel tanks may be serviced through a single-point pressure refueling system.

### NOTE

Refer to Figure FO-1 for aircraft general arrangement and to Figures FO-3 and FO-4 for cockpit and left/right consoles layouts.



## DIMENSIONS

Overall dimensions of the aircraft are as follows:

Wing span (without tip tanks)	22 feet
Length (with boom)	58 ¼ feet
Height (to top of vertical stabilizer)	13 ½ feet
Tread	8 ¾ feet

Refer to Section II "Normal Procedures" for minimum turning radius and ground clearances.

## GROSS WEIGHT

The approximate gross weight of the fully loaded aircraft equipped with ASAS equipment is 21544 lb. The empty weight (zero fuel, no crew) is 14801.

### NOTE

Refer to Appendix - Performance Data - Part 1 Introduction for aircraft weights including wing tip/pylon fuel tanks with or without air-to-air missiles.

## ENGINE

The aircraft powerplant is a General Electric J79-GE-19 turbojet engine (refer to Figure 1-1). Uninstalled engine sea level static thrust rating at military thrust (maximum thrust non-afterburning) is approximately 11870 pounds. Maximum thrust (full afterburning) under the same conditions is approximately 17500 pounds. During engine operation, the 17-stage axial flow compressor is driven by a 3-stage turbine. The turbine is impelled by combustion gases directed against the turbine buckets. Combustion gases after passing through the turbine section, flow around the afterburner spray bars where additional fuel may be introduced to obtain a substantial gain in thrust. The inlet guide vanes and the first six stages of compressor stator vanes are variable to reduce the possibility of compressor stall. The variable stator system automatically positions the vanes to direct the air intake flow in relation to engine speed and compressor inlet temperature (CIT). The aft end of the engine is comprised of a guided expansion variable area nozzle which increases exhaust gas velocity by decreasing the exhaust outlet area. Automatic nozzle area

control is provided to obtain the desired thrust within the safe operating limits of the engine. Mechanical energy to power accessory components is obtained through engine-mounted gearboxes driven by a shaft splined to the compressor rotor.

## ENGINE CONTROL SYSTEM

The engine employs the concept of constant corrected speed control of the rotor, rather than a constant physical speed control, to provide maximum compressor operation efficiency. Engine speed is controlled so that the corrected speed, in general, remains at 100% RPM. Physical engine speed, in other words, is increased as the ambient temperature increases. The maximum engine speed of 105.5% RPM occurs at a CIT of 65° C. At standard day conditions of 15° C, engine speed will be 100%. The engine also incorporates flight idle reset as a function of CIT to prevent duct instability during throttle "chops" at high aircraft speeds. Available thrust is a smoothly increasing function of Mach number. Exhaust gas temperature is controlled as a function of physical engine speed when operating at military or afterburner power settings.

In summary, during military and afterburner operation, the RPM may not be 100% but will vary with CIT. Likewise, exhaust gas temperature will vary with RPM. Refer to Figure 1-2 for RPM and exhaust gas temperature scheduling.

**Tachometer.** The tachometer (refer Figure 1-3), mounted on the right side of the main instrument panel, indicates engine speed in a percentage of the maximum rated speed of 7460 RPM. The instrument is powered by a tachometer generator, which generates a frequency proportional to engine speed.

## ENGINE STARTER AND IGNITION SYSTEMS

### Engine Starter System

The engine starter requires compressed air from a ground turbine source, which is converted to mechanical energy by the starter to rotate the engine. The receptacle for connecting the pressurized air line is located in the right wheel well. An electrical receptacle located adjacent to the air connector permits electrical connection from the cockpit start switches to the electrically controlled air valve on the ground starting unit by means of an auto-start cable. The cable connections should be made to assure pilot control of starting.

## J79-GE-19 TURBOJET ENGINE WITH AFTERBURNER

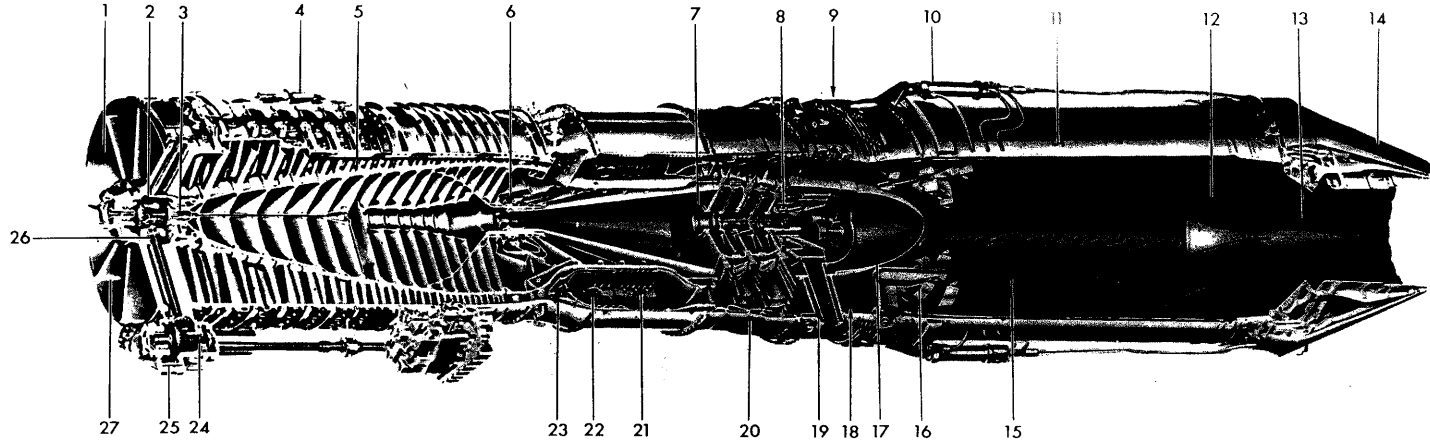
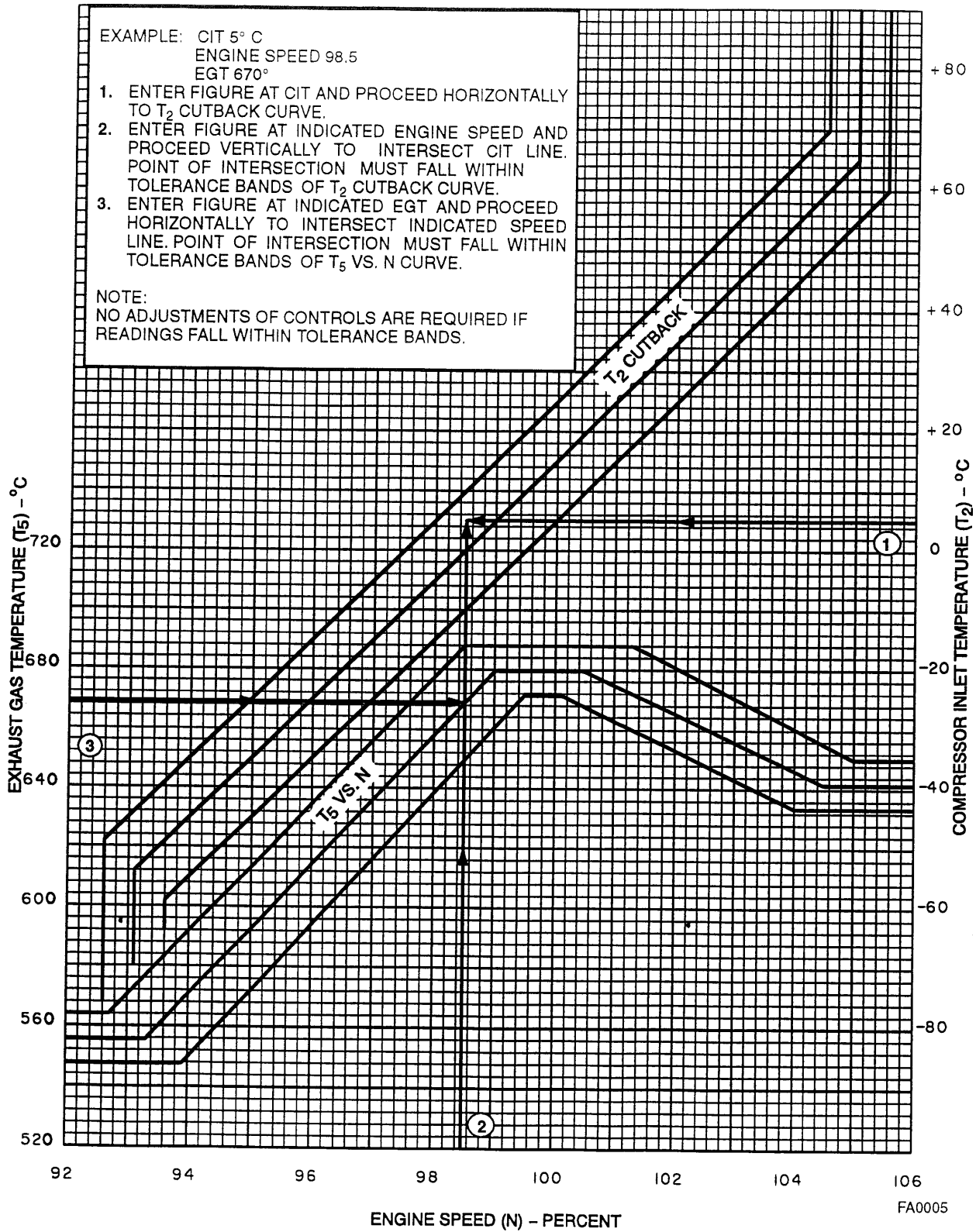

Figure 1-1

- |    |                                |    |                                   |
|----|--------------------------------|----|-----------------------------------|
| 1  | AIR INTAKE                     | 15 | TAILPIPE LINER                    |
| 2  | FRONT GEAR CASE                | 16 | FLAME HOLDER                      |
| 3  | NO. 1 BEARING HOUSING          | 17 | EXHAUST CONE                      |
| 4  | VARIABLE VANE ACTUATOR         | 18 | AFTERBURNER SPRAY BARS            |
| 5  | 17 STAGE COMPRESSOR SECTION    | 19 | TAILPIPE TEMPERATURE THERMOCOUPLE |
| 6  | NO. 2 BEARING HOUSING          | 20 | THREE STAGE TURBINE SECTION       |
| 7  | THREE STAGE TURBINE WHEEL      | 21 | COMBUSTION CHAMBER                |
| 8  | NO. 3 BEARING HOUSING          | 22 | CROSS FIRE DUCT                   |
| 9  | AFTERBURNER FUEL HOUSING       | 23 | FUEL NOZZLE                       |
| 10 | EXHAUST NOZZLE FLAPS ACUTATOR  | 24 | HORIZONTAL ACCESSORY DRIVESHAFT   |
| 11 | TAILPIPE                       | 25 | TRANSFER GEAR CASE                |
| 12 | PRIMARY EXHAUST NOZZLE FLAPS   | 26 | VERTICAL ACCESSORY DRIVESHAFT     |
| 13 | DIVERGENT EXHAUST NOZZLE FLAPS | 27 | COMPRESSOR FRONT FRAME            |
| 14 | SECONDARY OUTER NOZZLE FLASPS  |    |                                   |

**RPM AND EGT SCHEDULE FOR MILITARY  
AND AFTERBURNER POWER 105% MFC  
(POST AER.2J-J79GE19-148)**



NOTE: FOR ENGINES PRE AER.2J-J79GE19-148, THE T<sub>5</sub> VS. N CURVE SHALL BE SHIFTED OF -10° C.

Figure 1-2

A starter centrifugal switch automatically closes the air supply valve to disengage the starter in the range of 42%-47% engine RPM.

**Start Switches.** Two start switches (refer to Figure 1-3) are located on the left forward panel and are marked 1 and 2. The switches have a START, a STOP START, and a center, neutral position. The switches are spring-loaded in the neutral position. By momentarily placing either switch in the START position, battery bus power is supplied to energize the ignition circuit and begin the 45-second ignition cycle.

### NOTE

The "START 1" ignition circuit is electrically powered by the PP4 battery bus while the "START 2" ignition circuit is electrically powered by the PP5 battery bus.

During an ignition cycle, the start switches may be reset to initiate a new 45-second cycle. Placing a start switch in the STOP START position de-energizes the ignition circuits, but will not shut down the engine if combustion has started. With the auto-start cable installed, the start switches are used to open and close the starting air control valve. Both switches are used simultaneously to energize the ignition systems to insure reliability during air starts.

**Engine Motoring Switch.** The engine motoring switch (refer to Figure 1-3), located on the right console, is spring-loaded in the OFF position. The switch is provided to purge the engine by allowing ground turbine air to motor the engine without the ignition system energized. The engine motoring switch receives power from the PP4 battery bus.

### NOTE

Observe the starter RPM and time limits contained in Section II "Normal Procedures" and Section V "Operating Limitations".

## Engine Ignition Systems

Dual ignition systems are provided for air start reliability. Each includes an individual battery and battery bus, a switch, and a spark plug. When energized, the ignition circuit selected fires a spark plug

for 45 seconds unless the start switch is moved to the STOP START position sooner. Ignition is propagated through combustion chamber cross-fire tubes. During missile firing, the ignition circuit is energized when the trigger switch is pressed, and remains energized for 10 to 15 seconds after firing. Activation of the circuit provides standby ignition for immediate engine relight if a flameout occurs.

## Afterburner Ignition System

Afterburner ignition is controlled by a throttle-actuated ignition switch. The afterburner ignition unit receives power from the XP2 AC bus when the throttle is moved to any position in the afterburner range. A spark plug located within the pilot burner operates continuously during afterburning, assuring positive ignition of the pilot burner. Once the system has been actuated, the pilot burner remains lighted as long as the throttle remains in the afterburner range.

## ENGINE FUEL SYSTEM

The engine fuel system (refer to Figure FO-2) pressurizes, meters, atomizes, and injects fuel into the compressor discharge airstream. The system is regulated by the engine fuel control unit as a function of throttle position, engine speed, Compressor Discharge Pressure (CDP) and Compressor Inlet Temperature (CIT). Fuel is supplied to the engine fuel pump by four booster pumps in the main tank. Pressurized fuel enters the engine fuel control unit which, in addition to metering engine fuel, supplies fuel as a hydraulic medium to position the variable stator vanes. From the fuel control unit, fuel is routed through the fuel-oil cooler, the pressurizing and drain valve, and is distributed by fuel manifold to the 10 nozzles, where injection into the airstream occurs.

## Engine Fuel Pump

The engine-driven fuel pump incorporates a centrifugal boost element and two positive displacement, gear-type elements to supply the engine high pressure fuel requirements. The centrifugal boost element supplements the fuel supply system boost pump pressure. Failure of the centrifugal boost element does not affect engine operation except during high fuel consumption operation in low altitude - high Mach number flight. Each gear-type element is capable of supplying sufficient fuel to the engine should one element fail.

## ENGINE CONTROLS AND INDICATORS

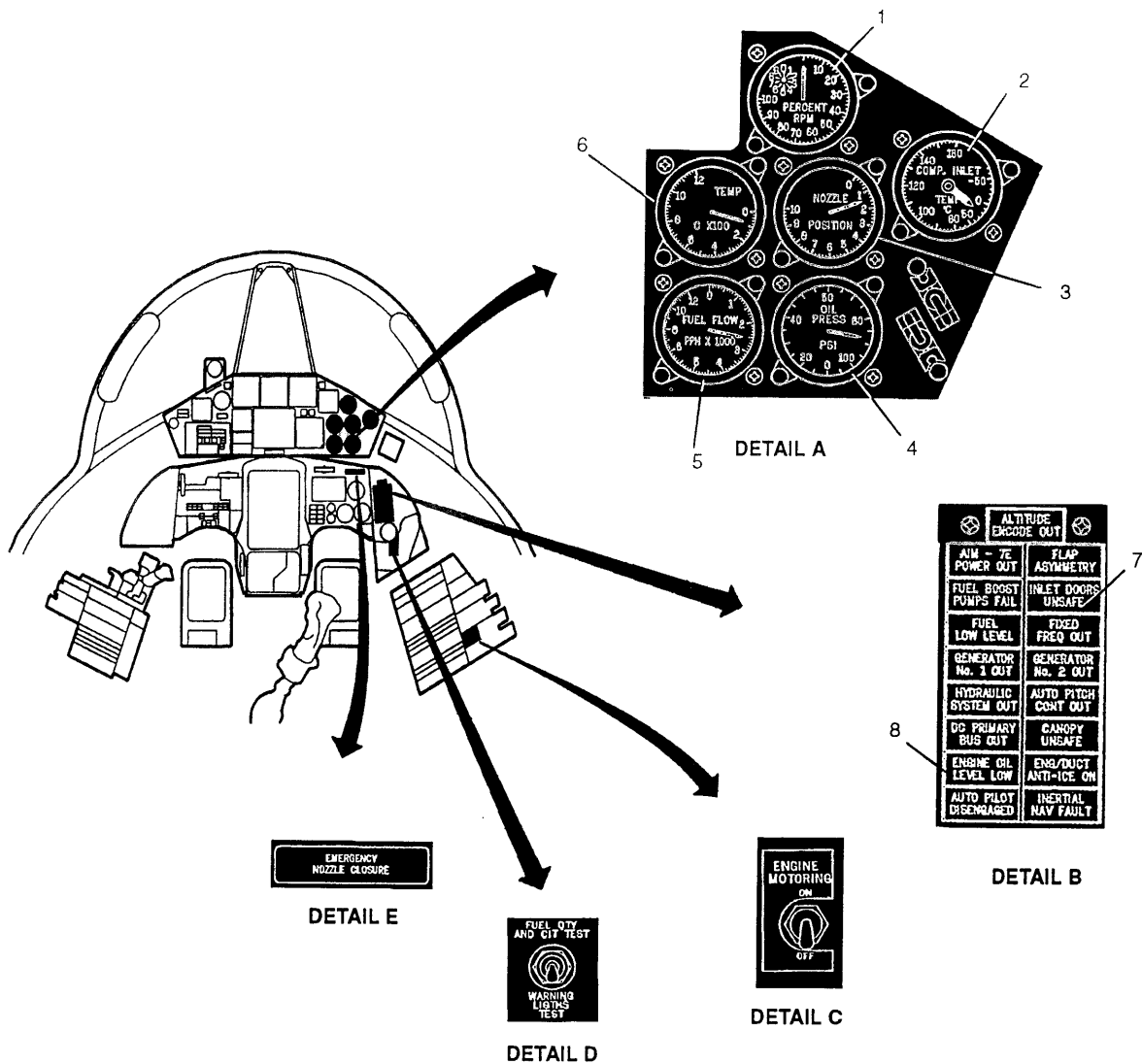

- A - ENGINE INSTRUMENTS**
  - 1 TACHOMETER
  - 2 COMPRESSOR INLET TEMPERATURE GAGE
  - 3 EXHAUST NOZZLE POSITION INDICATOR
  - 4 OIL PRESSURE GAGE
  - 5 FUEL FLOW INDICATOR
  - 6 EXHAUST GAS TEMPERATURE GAGE
- B - WARNING LIGHTS PANEL**
  - 7 INLET DOORS UNSAFE WARNING LIGHT
  - 8 ENGINE OIL LEVEL LOW WARNING LIGHT
- C - ENGINE MOTORING SWITCH**
- D - FUEL QUANTITY AND CIT TEST SWITCH**
- E - EMERGENCY NOZZLE CLOSURE HANDLE**

Figure 1-3 (Sheet 1 of 2)

FA0037

## ENGINE CONTROLS AND INDICATORS

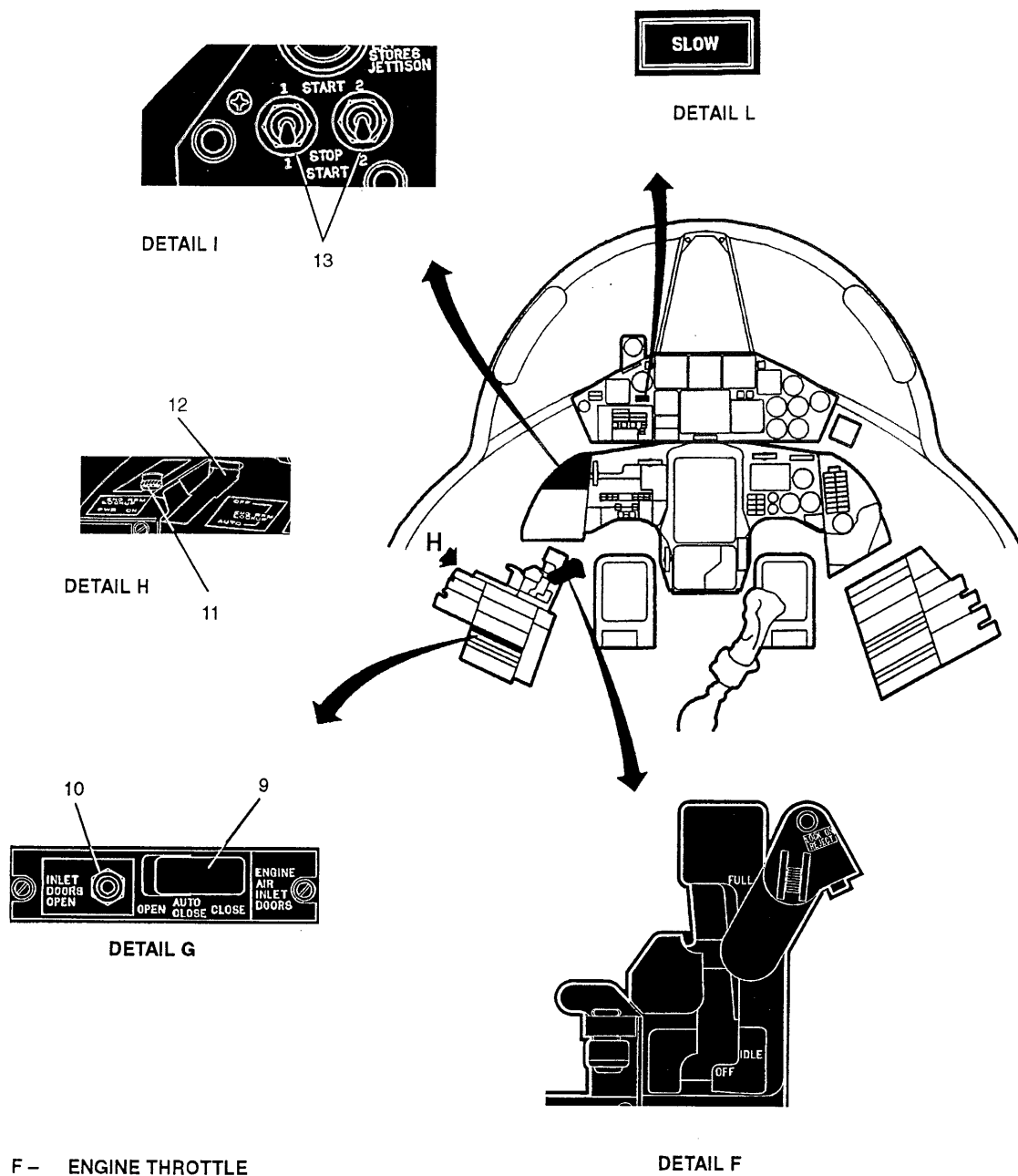

F – ENGINE THROTTLE

G – ENGINE AUXILIARY AIR INLET DOORS CONTROL PANEL

9 ENGINE AUXILIARY AIR INLET DOORS SWITCH

10 ENGINE AUXILIARY AIR INLET DOORS OPEN LIGHT

H – ENGINE RPM LOCK UP

11 RPM LOCK UP POWER ON OVERRIDE LIGHT

12 RPM LOCK UP OVERRIDE SWITCH

I – LEFT FORWARD PANEL

13 START SWITCHES (1 AND 2)

L – SLOW WARNING LIGHT

FA0038

Figure 1-3 (Sheet 2 of 2)

## Engine Fuel Control Unit

The engine fuel control unit meters the fuel flow rate as a function of throttle position, engine speed, CDP, and CIT. A metering valve in the fuel control unit is positioned in response to various internal operating signals and meters fuel to the engine as a function of the integrated signals.

A by-pass valve ports excess fuel back to the fuel pump and a shutoff valve shuts off the fuel supply to the engine burners when the throttle is in the OFF position. In addition to regulating fuel flow, the fuel control unit produces coordinating signals to:

- a. Positively shutoff of engine fuel flow when the throttle is in the OFF position
- b. Maintain minimum fuel flow limit that allows the throttle to be safely retarded at high altitudes
- c. Maintain minimum starting fuel flow
- d. Establish acceleration and deceleration fuel schedules that permit unlimited throttle manipulation without causing compressor stall, combustion blowout, or excessive engine speed instability
- e. Initiate an increase in engine idle speed during conditions of high CIT
- f. Initiate a reduction in maximum engine speed during low CIT operation
- g. Cause a reduction in fuel flow at high compressor discharge pressures
- h. Act as a control of the variable compressor vanes as a function of engine speed and CIT
- i. Provide an afterburner on-off pressure signal scheduled by throttle position and engine speed
- j. Provide regulated servo supply to the nozzle area control
- k. Provide capability of locking the engine speed to maximum during operation above Mach 1.5

### NOTE

Maximum RPM of 105% ( $\pm 0.5$ ) is attained at a CIT of 65° C or greater. Refer to Figure 1-2 for schedule of engine RPM and CIT. Refer also to Appendix for performance data with 105% RPM MFC.

## Fuel Flow Indicating System

A fuel flow transmitter is located on the engine and consists of a movable vane held in place by a calibrated spring, and a transmitter unit. Fuel flow causes the vane position to vary. The vane is magnetically coupled to the transmitter unit, which converts the vane position to an electrical output signal to the cockpit fuel flow indicator.

**Fuel Flow Indicator.** The fuel flow indicator (refer to Figure 1-3), located on the right side of the main instrument panel, indicates the consumption rate in pounds per hour and is graduated from 0 to 12000 pounds. The indicator is powered by the XP6 AC bus through the instrument auto-transformer on the electronic compartment circuit breaker panel. The instrument does not indicate afterburner fuel flow.

## Main Oil Cooler

The main oil cooler reduces engine oil temperature by circulating the oil around tubes containing the cooling fuel flow. The assembly includes an oil temperature control valve, and an oil by-pass valve. The temperature control valve senses oil outlet temperature.

When oil temperature is below 43° C, the valve is open and the oil by-passes the cooler since it does not require additional cooling. When oil temperature, exceeds 68° C, the valve is closed and the oil is routed through the cooler passages.

## Pressurizing And Drain Valve

The pressurizing and drain valve maintains back pressure to the engine fuel control unit to provide an acceptable fuel pressure level for servo operation. The valve permits fuel to flow to the engine when the discharge pressure exceeds a preset value. The drain valve portion of the unit drains the engine fuel manifold when the engine is shut down.

## Fuel Nozzles

The fuel nozzles atomize fuel into the combustion liners in a whirling, conical-shaped spray pattern. The nozzles are located in the compressor rear frame, one extending into the end of each of the 10 combustion liners.

## Throttle

The throttle quadrant (refer to Figure 1-3 and Figure 1-4) is located in the forward portion and left side of the cockpit. In addition to the throttle control lever (which provides a mounting point for the speed brake switch, a microphone button and the lock-on/reject button), the throttle quadrant is the installation panel for the wing flaps lever. A throttle-actuated switch for the landing gear warning signal circuit is also installed in the throttle quadrant. By establishing the fuel flow rate in the engine, the throttle controls engine RPM in non-afterburner positions, and thrust augmentation in afterburner operation.

The throttle quadrant is marked OFF, IDLE and FULL, and the throttle is spring-loaded inboard. Throttle advancement from the OFF position drops the lever into the IDLE position. Full travel from IDLE to the military thrust setting is obtained by a straight, forward motion. During ground starts, the throttle is set in the IDLE position. When combustion has started, throttle advancement increases engine speed until military RPM is reached (refer to Figure 1-9). Afterburning is initiated by moving the throttle outboard and forward into the afterburner slot. The throttle linkage provides adequate friction to prevent lever creepage and eliminates the need for a throttle friction control.

## AFTERBURNER SYSTEM

The afterburner section is located just aft of the turbine section and comprises the tailpipe, guided expansion exhaust nozzle, torch igniter, spray bars, and manifold. The purpose of the afterburner is to provide thrust augmentation by injecting additional fuel into the exhaust gases and igniting the mixture. The turbine exhaust gases are heated and discharged into the jet nozzle. The system provides quick light-off at low afterburner fuel flow with no discernible thrust jump and fully modulated thrust capability to maximum afterburner.

## AFTERBURNER FUEL SYSTEM

Fuel flows from the aircraft tanks through the on-off valve, the afterburner fuel pump, the check-and-vent valve, and the afterburner fuel filter to the afterburner fuel control. The control splits the fuel into "core" and "annulus" flow. Core fuel passes through the oil-cooler to a pressurizing valve. Annulus fuel flows directly to the pressurizing valve. The pressurizing valve then splits both core and

annulus flows into primary and secondary paths to the full-ring manifolds and their respective spray bars.

## Afterburner On-Off Valve

The afterburner on-off valve is an integral part of the afterburner fuel pump, and is located in the pump inlet. The valve allows fuel to enter the afterburner fuel pump when actuated by a high pressure fuel signal from the main fuel control.

## Afterburner Fuel Pump

The afterburner fuel pump is an engine-driven centrifugal pump. The pump rotates continuously, discharging fuel to the afterburner fuel system only when the afterburner on-off valve is open.

## Afterburner Fuel Control

The afterburner fuel control is a hydro-mechanical device which meters total fuel flow as a function of throttle lever position and compressor discharge pressure. The control meters the proper quantity of fuel and directs the flow to the core and annulus manifolds. No flow interruption occurs during the transition from core to core-and-annulus operations. The change from single (core) manifold operation to dual (core plus annulus) manifold operation is accomplished by increasing the throttle lever beyond a predetermined setting. During this throttle advance, the core flow is maintained constant while the annulus flow is increased.

## Afterburner Fuel-Oil Cooler

The afterburner fuel-oil cooler reduces scavenge oil temperature, using afterburner fuel as the coolant. The cooler is similar in operation to the main fuel oil cooler.

## Afterburner Pressurizing Valve

The flow out of the core and annulus discharge ports of the control enter the core and annulus inlet ports of the afterburner pressurizing valve. Four spring-loaded valves in the pressurizing valve split the core and annulus flows into primary and secondary fuel flows as a function of fuel pressure.



## ENGINE THROTTLE QUADRANT

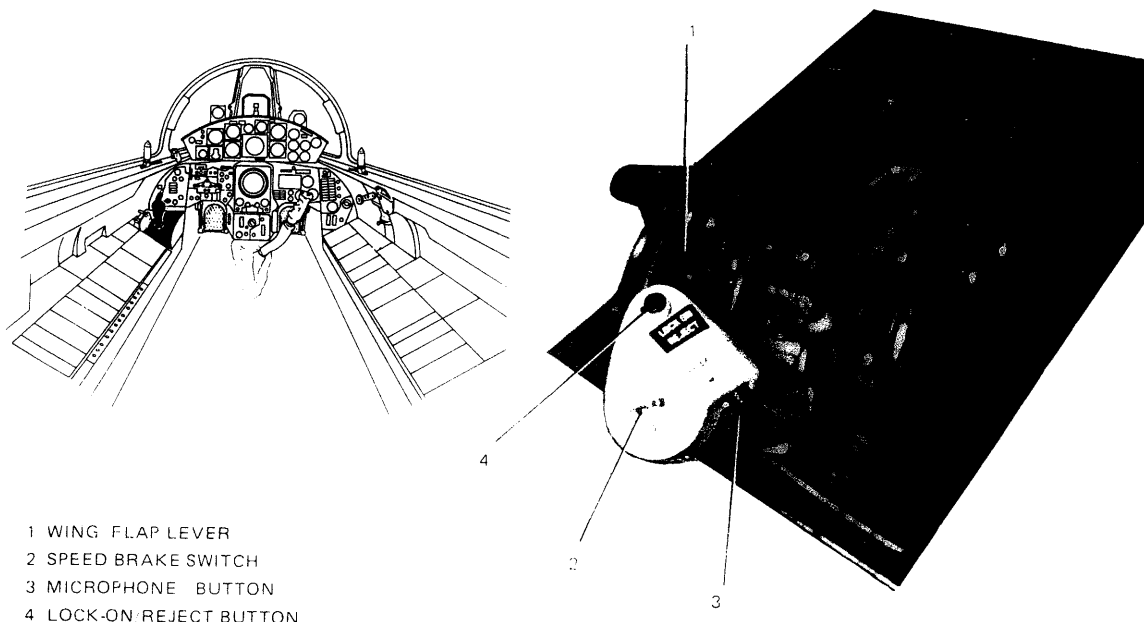

- 1 WING FLAP LEVER
- 2 SPEED BRAKE SWITCH
- 3 MICROPHONE BUTTON
- 4 LOCK-ON REJECT BUTTON

Figure 1-4

**Fuel Manifolds and Spray Bars**

During light-off and low afterburner power settings, fuel is distributed only to the core manifolds and core tubes of the spray bars. This fuel is distributed in the afterburner in a circular area which is approximately 40% of the total afterburner area inside the liners of the duct. Fuel burns in this circular area in the core of the exhaust duct. As the throttle is advanced, fuel flow to the core increases until the core fuel/air ratio reaches a predetermined value. Core fuel flow and fuel/air ratio are then held constant, and increased fuel flow is directed to the annulus manifolds and spray bar tubes. These spray bar tubes distribute fuel to the annular area formed by the outer periphery of the core and exhaust duct liners. This area is approximately 60% of the total area of the afterburner. As fuel flow is increased, the burning in the annulus increases until at maximum power, fuel/air ratio in the annulus is the same as that in the core, and afterburning is uniform.

The use of primary and secondary tubes in the core and annulus provides improved burning at altitude. As altitude increases, air flow decreases and therefore fuel flow decreases. With lower fuel flow in the

secondary tubes, secondary pressures decrease and the possibility of fuel vaporization increases. To prevent such vaporization, fuel flow in the secondary manifolds is restricted at compressor discharge pressure of less than 76 psi. In such cases all fuel is distributed by the primary manifolds, and the primary fuel pressures are sufficient to prevent fuel vaporization at high altitude.

**Core Burner System**

At initiation of afterburning, fuel is introduced at the core of the gas stream (refer to Figure FO-2 and Figure 1-5). As more thrust is demanded, the fuel/air ratio in the core is held constant, and additional fuel is introduced into the annulus surrounding the core until Maximum thrust is achieved. This provides afterburner light-off at low fuel flows with minimal thrust jump, and fully modulated thrust to maximum power.

The system is composed of twenty-one quadruple spray bars which are mounted on the forward exhaust duct and supported by bushings on the inner exhaust cone.

## AFTERBURNER FUEL MANIFOLD

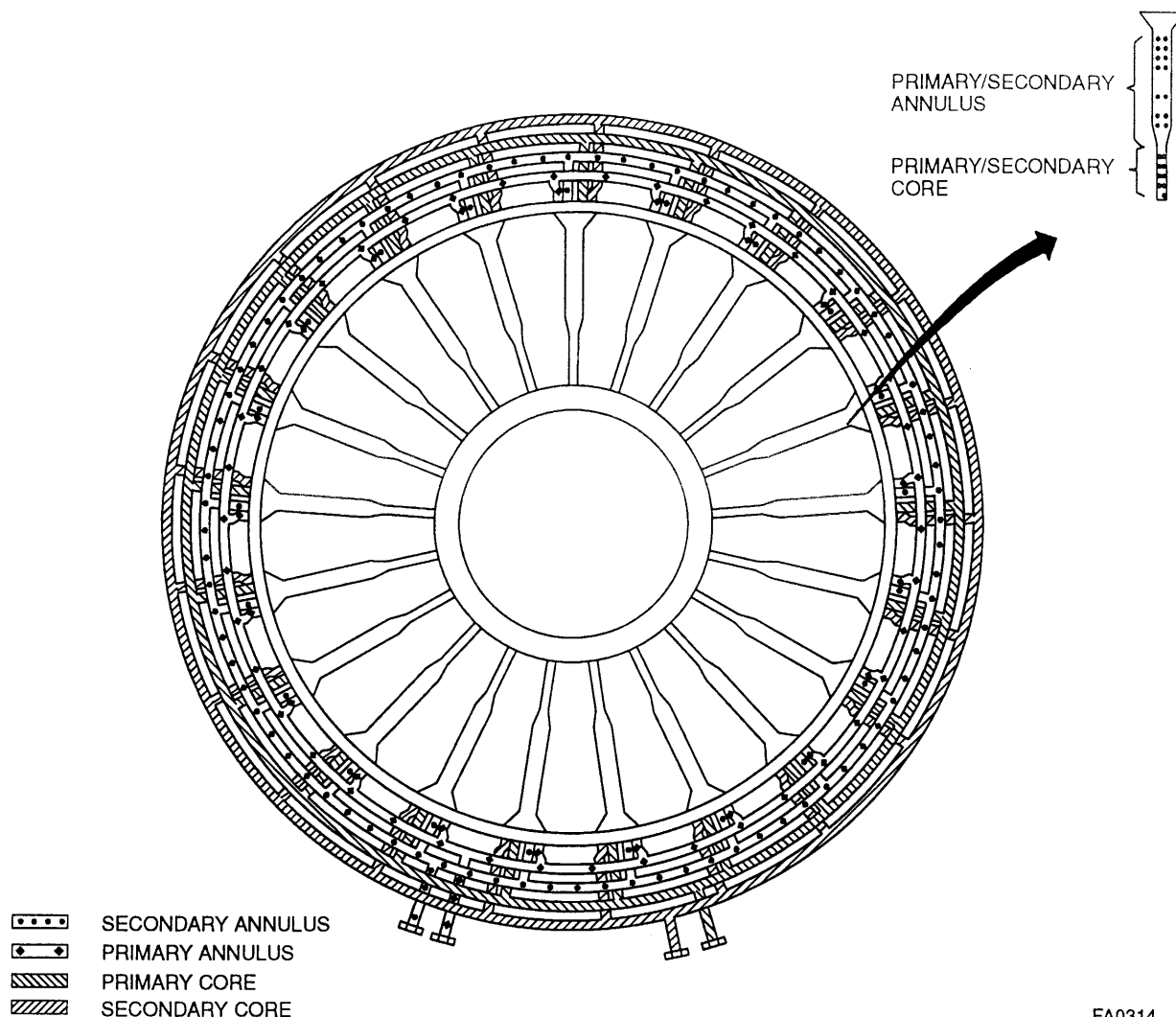

FA0314

Figure 1-5

The spray bars have four tubes each, for primary and secondary flow for the core and the annulus respectively. Fuel flow may be modulated from 2700 pounds per hour to 34000 pounds per hour. Full circle manifolds, with hinge mounts designed to minimize thermal stresses and damp vibratory loads, supply fuel to the spray bars.

### VARIABLE STATOR SYSTEM

The inlet guide vanes and first six stages of compressor stator vanes are variable and are positioned by the variable stator system in relation to engine speed and compressor inlet temperature (also described by the term engine air inlet temperature).

The system allows inlet air to strike the stator blades at the most effective angle for the immediate engine requirement.

The system tends to prevent compressor stall by limiting the inlet air flow angle below the critical angle-of-attack of the airfoil-shaped stator blades.

The system also provides a means of closing the vanes 5° when the trigger is actuated to minimize the inlet distortion effect of forward firing armament on the engine. The system is operated hydraulically, using fuel from the engine fuel control unit as the actuating medium.

The components of the system are: the variable stator actuators, the vane closure valve and the vane closure actuator.

## Variable Stator Actuators

The variable stator actuators are double-acting hydraulic cylinders which position the inlet guide vanes and variable stator vanes.

## Vane Closure Valve

The vane closure valve controls fuel pressure to the variable stator vane feedback actuator, which transmits the vane position to the engine fuel control unit. The vane closure valve also causes the vanes to close 5° upon input of an electrical signal from the control stick-grip trigger switch.

## Vane Closure Actuator

The vane closure actuator is a single-acting hydraulic cylinder which mechanically increases the length of the feedback conduit during missile firing to cause the vanes to close 5°.

## COMPRESSOR INLET TEMPERATURE (CIT) WARNING SYSTEM

The aircraft is equipped with a system to give visual warning in the cockpit when compressor inlet temperature increases to a critical value. The system consists of a temperature-sensing detector located in the right generator cooling duct, a compressor inlet temperature gage and the SLOW warning light.

### Compressor Inlet Temperature Gage

A temperature gage (refer to Figure 1-3) labeled COMP INLET TEMP is located on the upper instrument panel. The instrument is calibrated from -70° C to +160° C.

The SLOW warning light (powered by the PP2 DC bus), located on the left part of the main instrument panel, will illuminate at an indicator temperature of 120° ±1° C when the aircraft is below 40000 feet. Above 40000 feet the SLOW warning light will not illuminate until CIT reaches 153° C.

The system is powered from the XP2 AC bus. A test switch, on the right forward panel, when moved to the FUEL QTY AND CIT TEST position will cause the gage needle to move below -70° C indicating that the system is functioning.

## COMPRESSOR AND VARIABLE STATOR OPERATION

In order to optimize subsonic cruise performance, a high-pressure-ratio compressor is provided. This is accomplished by the variable stator system. The engine was designed for maximum operating efficiency at high RPM settings (refer to Figure 1-6).

The variable IGV and stator system allows stall-free operation throughout the entire speed range. As RPM is reduced from military, the IGV and variable stators (hereafter referred to only as IGV) will start to close and track closed as a function of RPM at any given air inlet temperature. At sea level standard day conditions, the IGV will be fully open above 98.5% RPM; below 98.5% they will track as a function of RPM to the closed position, reaching the closed position at 65.5% RPM.

The IGV track through a total of 37.5° of travel from open to closed. Closing the IGV, avoids the stall area by directing airflow against the compressor blades at an angle below that which is critical as RPM is varied. In addition, total airflow through the compressor is reduced as RPM decreases and the IGV shift toward closed, relieving the load on the rear stages of the compressor, thereby avoiding compressor stalls. The IGV control senses compressor inlet temperature (CIT) and engine RPM. The IGV schedule follows a constant slope as a function of engine RPM; however, the slope is shifted as a result of CIT. At higher CIT values, the IGV will start to close at a higher indicated RPM, and conversely, will start to close at a lower RPM when the CIT is below standard.

### Corrected RPM

The pumping characteristics of the compressor are affected by the temperature of the air entering the compressor, since temperature affects the density. An increase in CIT is effectively the same as a decrease in RPM as far as the compressor is concerned; conversely, a decrease in CIT is effectively the same as an increase in RPM. To maintain a constant mass flow of air through the engine, the RPM shall be varied directly as a function of CIT. As an example, 100% indicated RPM with a 15° C CIT, is a 100% corrected RPM. Indicated RPM of 103%, with a CIT of 95° C corrects to an effective or corrected RPM of 91.2% while 96.2% indicated RPM at -28° C corrects to an RPM of 104.3%.

## ENGINE RPM Vs COMPRESSOR INLET TEMPERATURE

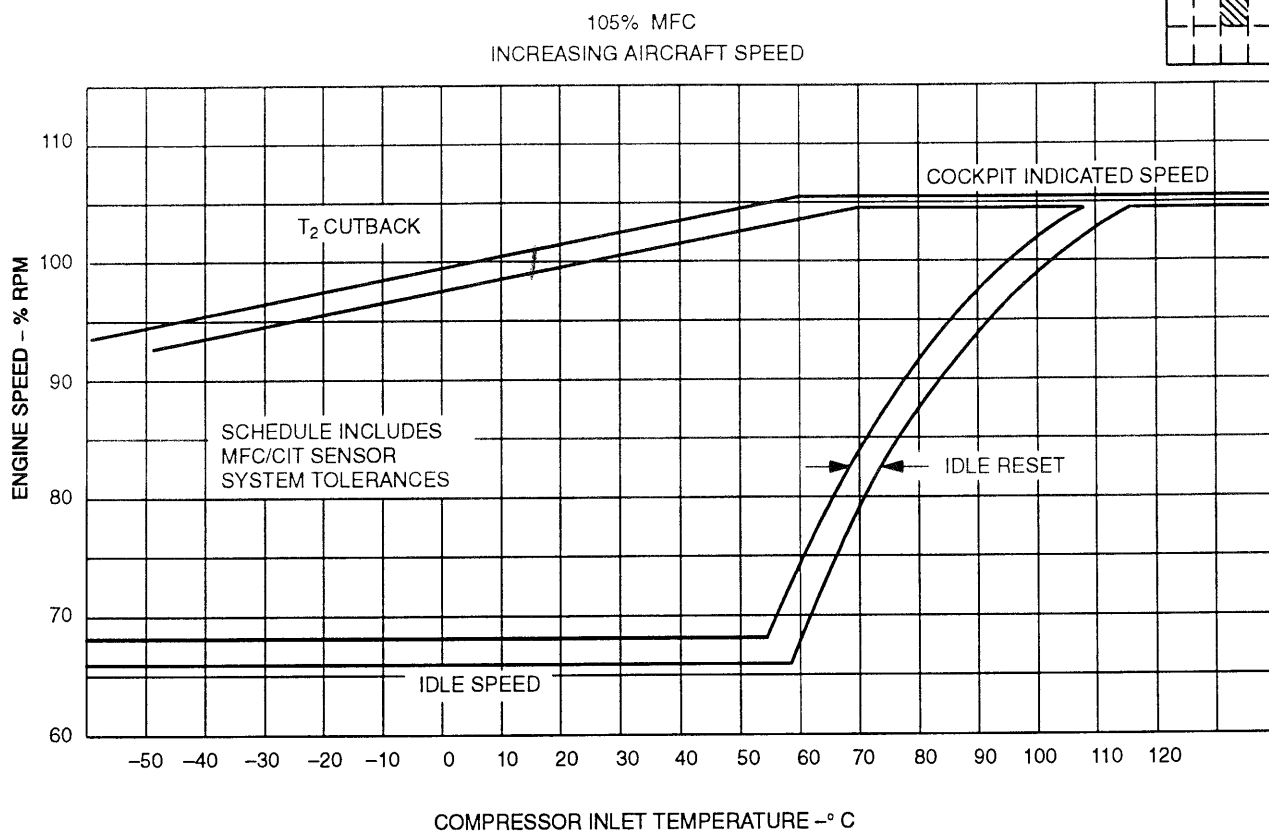

FA0224/1

Figure 1-6

### Engine RPM Control Features

In addition to its normal governing functions, the engine fuel control unit senses and integrates CIT with RPM signals and a corrected RPM is computed mechanically within the unit. This intelligence is used to vary the IGV angle and limit corrected engine RPM to a preset maximum.

### High Corrected RPM and RPM Cutback

With a set engine speed of 103% RPM, corrected speed increases as CIT decreases and at approximately 46° C, 103% indicated RPM is the corrected RPM at 98.1%. At this point the main fuel control schedules reduced engine speed, limiting corrected RPM to a maximum of 105% to insure adequate high corrected speed stall margin.

### Low Corrected RPM (High T<sub>2</sub> Override)

As CIT is increased, corrected RPM decreases to a point where a low corrected-speed stall would be encountered if no compensating action were provided. The IGV schedule is designed to follow corrected engine speed and close to provide a stall margin.

Normal operating engine RPM is 105% above a CIT of approximately 65° C. This speed schedule also provides for engine stall margin.

Flight idle speed schedule is raised to maintain 103% RPM at approximately 113° C CIT. A throttle "chop" below military thrust during flight at a CIT higher than approximately 113° C will not produce an immediate reduction in RPM. This feature is incorporated to reduce the possibility of inlet duct buzz caused by decreased engine air flow requirements at lower RPM for high Mach number conditions.

### CDP Limiter

When maximum airspeed is approached at low altitude, compressor inlet pressure is drastically increased and compressor discharge pressure (CDP) approaches the maximum value permitted by the physical strength of the engine components. A CDP limiter, in the engine fuel control unit, senses CDP and reduces fuel flow to the engine, thus allowing RPM to decrease when the maximum CDP limit is reached.

### CIT Sensor

Compressor inlet temperature is sensed by a capillary tube located in the lower left side of the compressor inlet. This capillary unit transmits a signal to the engine fuel control unit, reacts on internal portions of the fuel control, and modifies IGV and fuel flow schedules as a function of CIT.

### Engine Compressor Stalls

Engine compressor stalls may be caused by various factors, such as engine fuel control malfunction, IGV misrigging, CIT sensor cold shift, afterburner surging or inlet distortion. Regardless of the cause, the result is that the compressor blades stall in much the same manner as the wings of an aircraft. During normal operation, the compressor blades generate axial airflow from the front of the compressor to the rear, at ever-increasing pressure. This pressurized air is delivered to the combustion chamber, where it is heated, and exhausted through the nozzle at a greater velocity than it had at the compressor inlet, thus producing thrust.

A compressor stall occurs whenever this axial airflow is interrupted in its normal rearward travel and slows or stops at some stage of compression, thus stalling the airfoil-shaped compressor blades. Some of the reasons for this airflow interruption are the following:

1. Foreign object damage (FOD) which destroys the airfoil shape of the compressor blades, eliminating their ability to pump air
2. Corrosion on the compressor blades and stators which reduces their capability to pump air at ever-increasing pressure, the same way frost destroys the ability of an aircraft wing to produce lift
3. If the fuel "schedule" during a throttle burst is too high, pressure in the combustion chamber

may increase to the point beyond which the compressor is not able to pump air and the axial velocity of the air slows to the point where the blades stall

4. If the inlet guide vanes are too wide open for a given engine condition, the front of the compressor will pump too much air and overflow the rear of the compressor, resulting in a pile-up of air which decreases the axial airflow velocity, and the compressor will stall

Other factors, such as aircraft "G" load, high angle of attack with its resulting compressor inlet pressure distortion, or operation at high Mach numbers and CIT outside the prescribed limits may also lead to compressor stall.

Primarily, there are two types of engine compressor stalls, both of which are relatively easy to recognize. The first type, most commonly associated with high Mach number flight, is characterized by loud banging and chugging sounds which are definitely noticeable in the cockpit. This type of stall may be eliminated by retarding the throttle below Military thrust. The second type of stall is a loss of thrust and mild rumble which may be felt by the pilot. While these symptoms are usually good indications, they are not always present; when the indications do exist, however, they should always be confirmed by the gages.

The EGT gage should be the first instrument checked when a stall is suspected. If the gage reading is abnormally high, a stall probably exists. In a low-altitude stall, the RPM will also be unwinding or hung up. Combined with the high EGT and unwinding or hung up RPM, will be a wide-open nozzle. The nozzle is not open due to a nozzle malfunction, but because it is attempting to reduce the overtemperature accompanying the stall; therefore, EGT, RPM, and nozzle position shall always be considered to properly diagnose a stall (refer to Section III "Emergency Procedures" for Stall Clearing procedures).

**Subsonic Stall.** Subsonic stall normally begins with a chug or pop, followed by mild vibration. Thrust loss is immediate as evidenced by rapid aircraft deceleration. The engine gages will give the following positive indications of the stall:

1. Usually EGT will be 700° C to 800° C range. However EGT's as low as 600° C may exist. If the stall persists, EGT may increase to above 800° C
2. RPM will decrease and hang up in the 70% to 85% range

3. Nozzle will indicate 9 to 10 units as the nozzle goes to wide open in an attempt to lower EGT

Engine response to throttle manipulation will not be normal. This simultaneous existence of high EGT, low RPM, and wide-open nozzle is conclusive proof that a stall exists. Compressor stall is easily distinguished from open nozzle failure, in which case the open nozzle is accompanied by low EGT and normal RPM response. A high altitude subsonic stall may not be recognized since an immediate flame out usually occurs.

**Engine Stall/Flame Out – High Altitude Subsonic.** High altitude subsonic stall may not be immediately recognized since it is usually accompanied by engine flame-out. This stall will usually occur only if aircraft flight speed is decreased below minimum level-flight speeds at altitude above 40000 feet, and engine transients, such as a throttle burst, afterburner light are made. If the aircraft is operated within the speed limits shown in Figure 6-6, this condition will not occur. When operating near the minimum speed line, use full rather than partial afterburner, since full uniform afterburning will not blow out anywhere in the steady state maximum thrust envelope (refer to Figure 6-6). If partial afterburner is used at extreme high altitudes and low speeds, the afterburner could blow out and the resulting engine transient could cause a stall. Since this stall is usually followed by an engine flame-out, it may be recognized by a slight bump or pop followed by silence and a sinking sensation. Engine speed will be unwinding rapidly and EGT will be low. If an air start procedure is initiated immediately, the engine may be started before the RPM drops below 90%, thus avoiding the discomfort of possible loss of pressurization.

**Supersonic Stall.** Supersonic stall usually occurs only above Mach 1.8. Reasons for this type of stall include a deteriorated compressor, foreign object damage, late T2 reset failure of by-pass flaps to open and exceeding the CIT limit. Distortion of inlet flow, such as that caused by malfunction of the duct secondary air bypass flaps or negative "G", may also reduce stall margin. The supersonic stall is often preceded by an intermittent muffled rumbling and aircraft yawing which coincides with the irregular rumbling. Engine gages will be normal at this time. The actual engine stall is marked by severe loud banging, accompanied by aircraft vibration and deceleration. EGT fluctuation between approximately 550° C to 700° C will occur concurrently with the banging.

**RPM Hangup.** If the RPM decreases below idle before an air start is accomplished, a RPM hangup may occur at approximately 70% to 80% following light off. EGT will be moderate but rising abnormally (a slight high frequency vibration will be felt). Hangup occurs because the engine minimum flow is slightly high for the high altitude and low airspeed existing at light off. FOD or a closed exhaust nozzle will aggravate this condition. Therefore, air starts should be attempted only at lower power setting (refer to Section III "Emergency Procedures" for Air Start/Stall Clearing procedure).

The Ram Air Turbine (RAT) when extended may create a disturbance to inlet duct airflow reducing engine stall margin. Therefore, sudden attitude changes or sudden throttle movements should be avoided during this phase of flight (refer to Section III "Emergency Procedure" - Flight With RAT Extended). In the final analysis of compressor stalls the best protection is summarized as follows:

1. Knowledge of aircraft maneuvers and engine transients which may contribute to compressor stall, and knowledge of the areas of least stall margin in the aircraft envelope
2. Knowledge of the engine symptoms which identify compressor stall
3. Knowledge of correct stall-clearing procedures.

## GUIDED EXPANSION EXHAUST NOZZLE SYSTEM

The exhaust nozzle is a convergent-divergent guided expansion nozzle (refer to Figure 1-7) consisting of primary and secondary nozzle flaps linked to function together. The primary exhaust nozzle flaps, hinged at the aft end of the tailpipe, control the convergent portion of the nozzle. The secondary outer flaps function to introduce secondary airflow to the primary exhaust stream and control the expansion rate of the exhaust gases. The converging portion of the nozzle accelerates the gases to a sonic velocity. The diverging or guided expansion portion of the nozzle permits exit area variation (controlled rate of expansion) thereby accelerating the gases beyond the throat.

The nozzle area is determined by throttle position until the temperature of the exhaust gases reaches the reference temperature schedule of the engine then throttle control of the nozzle is overridden by a temperature limiting system to maintain the exhaust gas temperature according to the reference temperature schedule. The high velocity of the exhaust gases passing from the throat of the nozzle to the exit acts as an aspiration to cause secondary air flow along the outside of the engine. The flaps are

## GUIDED EXPANSION EXHAUST NOZZLE

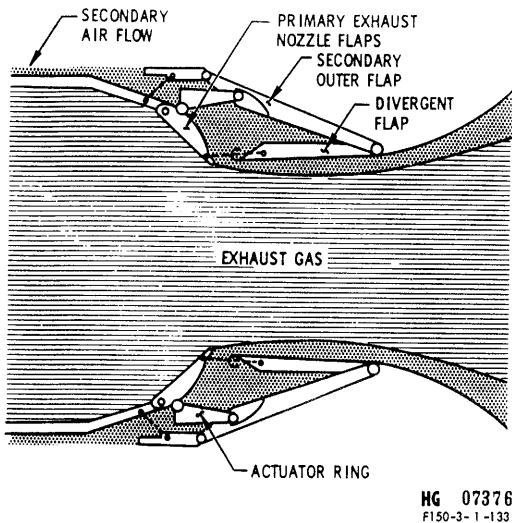

Figure 1-7

positioned automatically according to the schedule of the nozzle area control by four synchronized actuators.

### Secondary Airflow Supply

The engine primary airstream is mainly used to support combustion. A secondary airflow stream, used for engine cooling. For ground running and takeoff, secondary airflow is supplied through eight sets of inward opening (suck-in) doors (spring-loaded to closed) just aft of the firewall.

For moderate and high-speed operating conditions, air from the main ducts is provided for secondary airflow. The air passes through the open area existing between the engine leading edge and the bypass flap assembly.

The bypass flap assembly is installed at the firewall in the forward end of the engine compartment. The assembly consists of ten individual flaps which control the flow of intake duct air to and around the engine. In the closed position, there is a clearance of approximately 0.25 inch between the trailing edge of the flaps and the front face of the engine. This

fixed clearance provides an open area of 25 square inches for the passage of secondary (cooling) air.

Six of these flaps are fixed in the closed position while four of the lower flaps (two A flaps and two B flaps) are operable.

The selector valve for the A flaps is electrically controlled from the right landing gear aft door unlock switch. When the aircraft becomes airborne and the landing gear is retracted, hydraulic pressure is directed to the open side of the A flaps actuators. The open A flaps provide additional bypass area which, together with the fixed clearance, provides a total bypass area of 40 square inches.

### NOTE

During conditions of ground running, takeoff and under certain flight attitudes, airflow through the air bypass flaps is reversed. Engine demand exceeds the supply available through the intake ducts and the necessary additional air is pulled through the ground cooling doors and the engine compartment.

The selector valve for the B flaps is electrically actuated through an air data computer speed sensing Mach switch. The Mach switch causes the B flaps to open at Mach 2.1 ( $\pm 0.05$ ) accelerating and closes the B flaps at Mach 2.0 ( $+ 0.05, - 0.00$ ) decelerating. The open B flaps provide an additional 23 square inches of bypass area which, together with the normal (airborne) bypass area, provides a total of 63 square inches of bypass area. The increase of secondary air through the B flaps has the purpose to provide a larger stall margin for engine operation at high Mach number.

The flap actuators are powered by the No. 2 hydraulic power supply system; both A and B flap selector valves are electrically powered by the PPI DC bus and may be manually operated on the ground by pressing an override button on the valve body. A portion of the intake air is bled from the aft-underside of the engine air intake ducts and is used for cooling the generators.

### Emergency Pressure Relief Door

An emergency pressure relief door installed forward of the hydraulic access door on the fuselage underside is designed to separate from the fuselage when engine compartment pressure is 17 psi greater than the ambient pressure.

## ENGINE AUXILIARY AIR INLET DOORS

An engine auxiliary air inlet door is located on each inlet duct. The doors are opened during takeoff to provide an increased air supply to the engine for added thrust. The doors are electrically controlled by power from the PP2 DC bus and hydraulically actuated by the No. 2 hydraulic system through the priority valve.

**Engine Auxiliary Air Inlet Doors Switch.** A three position guarded switch (refer to Figure 1-3) labeled ENGINE AIR INLET DOORS is located on the left console. The switch is spring-loaded from the OPEN and CLOSE position to the AUTO-CLOSE, guarded position. The switch is used to control hydraulic selector valve in the main landing gear wheelwell. After takeoff and with the inlet doors switch in AUTO-CLOSE, the inlet door circuit is automatically energized by a speed sensing switch and the doors will close as airspeed reaches  $280 \pm 10$  knots. A landing gear ground-air safety interlock switch prevents the doors from being opened in flight; however, if the AUTO-CLOSE system malfunctions, the doors may be closed by placing the switch to the CLOSE position. On the ground, the doors may be used for engine FOD inspection.

**Engine Auxiliary Air Inlet Doors Open Light.** An INLET DOORS OPEN indicator light (refer to Figure 1-3), located adjacent to the inlet doors switch, illuminates to indicate both doors are fully open and ready for flight.

After takeoff, as speed is increased to  $280 \pm 10$  knots, the light will go out as the doors begin closing.

**Engine Auxiliary Air Inlet Doors Unsafe Warning Light.** The engine auxiliary air inlet doors unsafe warning light (refer to Figure 1-3) and the master caution light will illuminate after takeoff when airspeed reaches  $330 \pm 10$  knots if the doors are not closed and latched. This light alerts the pilot to reduce airspeed below 340 KIAS and to close the doors by use of the manual close position of the switch.

## ENGINE RPM LOCKUP SYSTEM

At speeds above Mach 1.5, regardless of throttle position, engine RPM is maintained at a maximum for a given CIT by the engine RPM lockup system. The engine RPM lockup system consists of the air data computer operated speed sensing mach switch, and an electrical circuit connected to the engine fuel control. The system is designed to lock engine speed

at military RPM (regardless the throttle position) at all speeds above Mach 1.5 ( $\pm .05$ ) during acceleration and unlock engine RPM at Mach 1.4 ( $\pm .05$ ) during deceleration. When in lockup, throttle movement will vary engine thrust but not RPM. The engine RPM lockup system provides assurance against engine stall by maintaining an engine airflow compatible with the flight operating conditions.

## ENGINE RPM LOCK UP PWR ON

The aircraft is provided with a bright indication labeled "ENG RPM LOCK UP PWR ON" placed on the left console (refer to Figure 1-3). The system is powered by the PP1 DC bus. When lit, this indicator shows that the system is automatically activated, locking the engine RPM to military. Press the lamp to check its proper functionality.

## RPM Lockup Override Switch

The RPM lockup override switch (refer to Figure 1-3) is a two position guarded toggle switch located on the cockpit left side. The switch is placarded, ENG RPM LOCKUP, and has two marked positions, OFF and AUTO.

In the AUTO position, engine RPM is automatically locked above military RPM at all speeds above Mach 1.5 accelerating, and unlocked at Mach 1.4 and below decelerating. The OFF position is used to override the automatic lockup feature if the pilot so desires.

## NOZZLE AREA CONTROL SYSTEM

The nozzle area control system (refer to Figure 1-8) is an electronic-hydraulic-mechanical computer incorporating an exhaust gas temperature sensing amplifier, nozzle area control unit, and an engine-driven control alternator.

These units function to position the engine exhaust nozzle to conform with engine operating requirements. This feature is effective throughout the entire engine operating range but is primarily important in the military thrust and afterburning regions. There is a mechanical schedule according to which the nozzle area control starts closing the exhaust nozzle immediately following the idle range of throttle position and continuing to the military thrust position (refer to Figure 1-9).

When the nozzle is at its smallest scheduled opening, the temperature control system begins to control the EGT by opening the nozzle above the position called for by the mechanical schedule and



### EXHAUST NOZZLE CONTROL SYSTEM

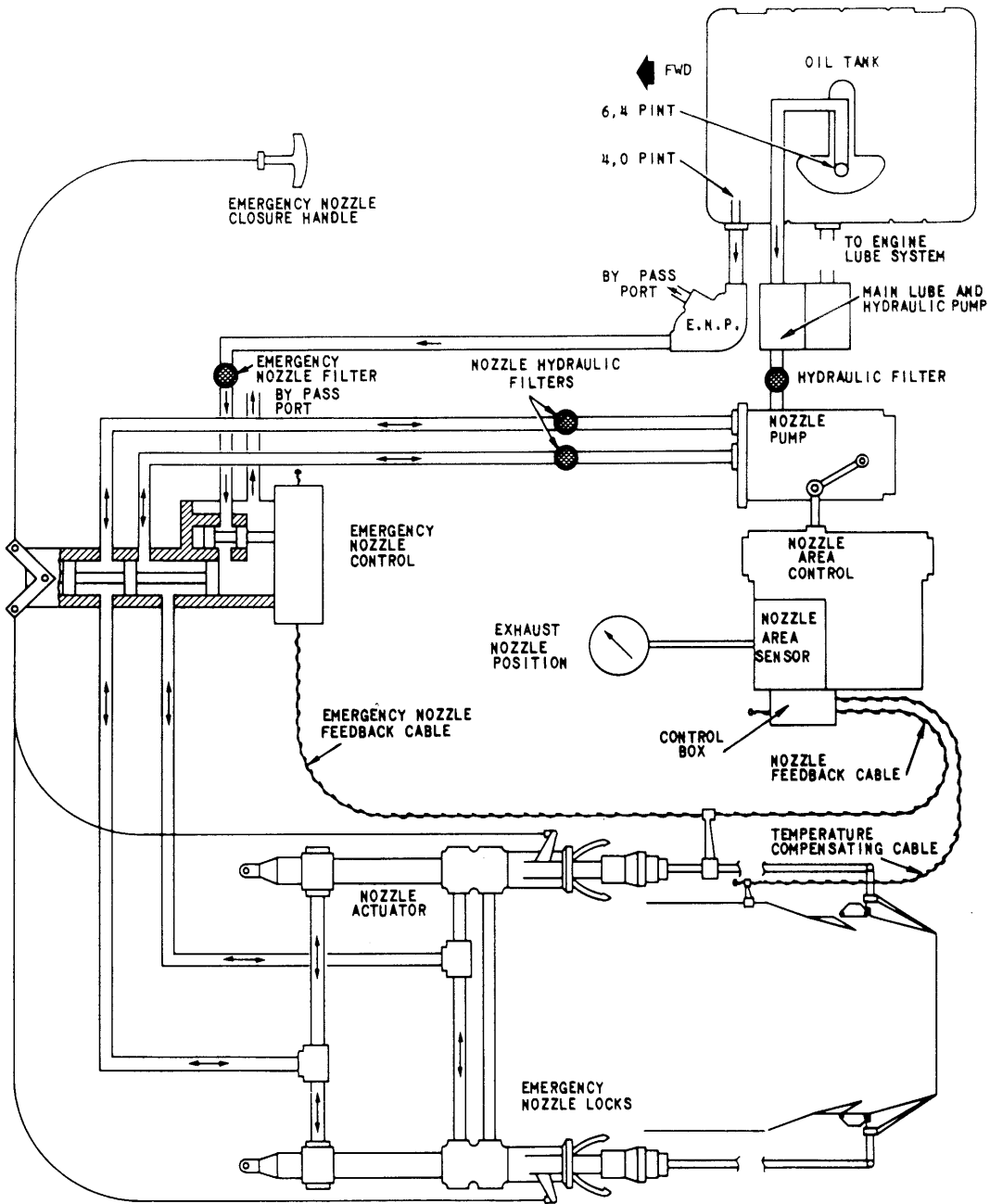

32036

Figure 1-8

## VARIATION OF ENGINE SPEED, TEMPERATURE AND NOZZLE AREA WITH THROTTLE POSITION

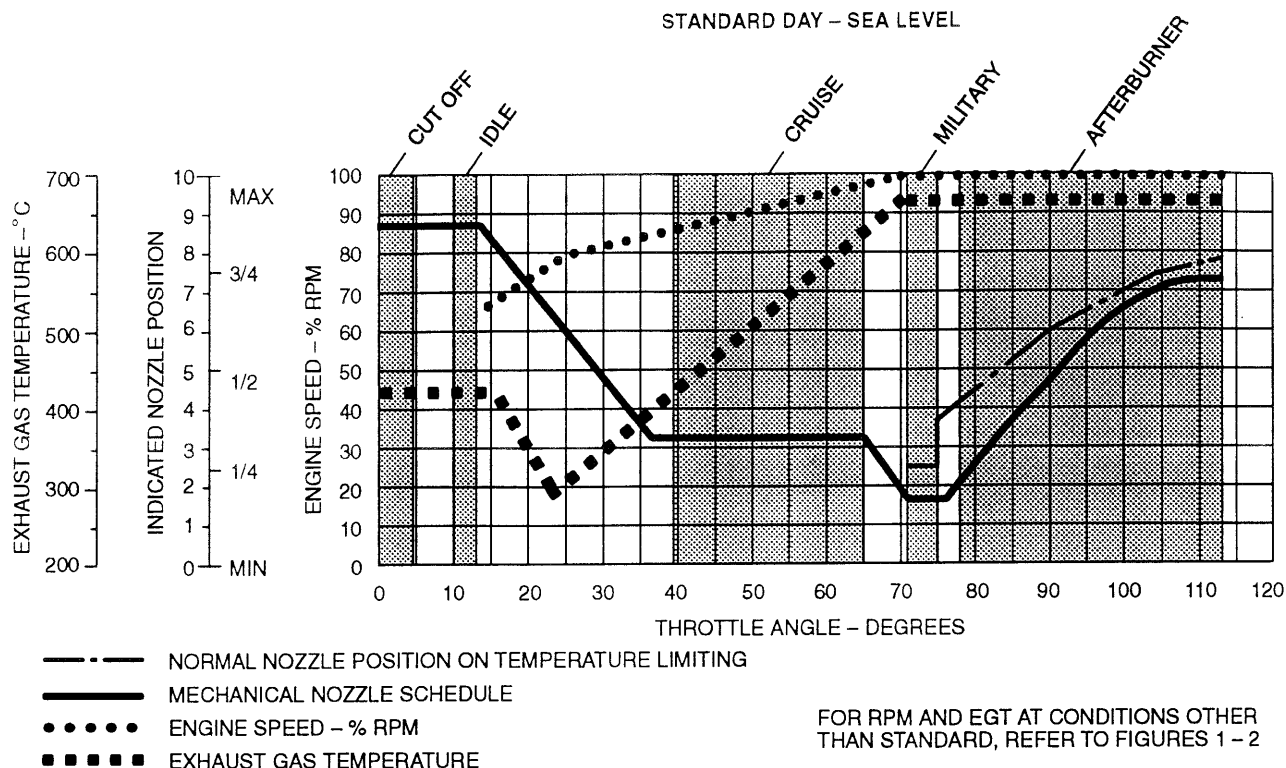

### NOTE

INDICATED NOZZLE POSITION NORMALLY FOLLOWS THE MECHANICAL SCHEDULE UNTIL EXHAUST GAS REACHES THE HIGHEST TEMPERATURE DEPICTED; BEYOND THIS POINT, THE TEMPERATURE AMPLIFIER PRODUCES ELECTRONIC SIGNALS REQUIRED FOR NOZZLE AREA VARIATION. AS THROTTLE ANGLE IS INCREASED INTO THE MILITARY AND AFTERBURNER THRUST REGIONS, THE TEMPERATURE AMPLIFIER SIGNALS THE NOZZLE AREA CONTROL WHICH CAUSES THE NOZZLES TO MODULATE AS NECESSARY TO MAINTAIN EXHAUST GAS TEMPERATURE. AT MILITARY THRUST, INDICATED NOZZLE POSITION MAY VARY FROM 1.5 TO 4 TO MAINTAIN EGT. AT MAXIMUM AFTERBURNER, INDICATED NOZZLE POSITION MAY VARY FROM 7.5 TO 9.5 TO MAINTAIN EGT. EXHAUST GAS TEMPERATURE IS THE MOST ACCURATE INDICATION OF PROPER NOZZLE AREA. NOZZLE AREA WILL NOT DECREASE BELOW THOSE VALUES SHOWN FOR THE MECHANICAL SCHEDULE.

FA0231

Figure 1-9

continues to determine nozzle position throughout the military and afterburner ranges.

The nozzle mechanical schedule causes an increase in the minimum nozzle area, above that called for in the military setting, as throttle is advanced into the afterburner range to prevent severe overtemperature or stall if the nozzle fails in the closed direction. This mechanical schedule causes the nozzle to remain open whenever afterburner is selected even if afterburner fails to light, or blows out.

### Temperature Amplifier

The temperature amplifier provides an electrical signal to the nozzle area control. This signal overrides the "mechanical schedule" signal to prevent overtemperature operation of the engine and to improve engine acceleration ( $T5$  Vs  $N$ ). It also senses rate of change of engine speed to open or close the nozzle to reduce speed roll back during afterburner light-off.

The amplifier receives power from the control alternator (separate from the aircraft electrical system) and an electrical signal representing actual exhaust gas temperature from the thermocouples. The thermocouples' generated signal is compared with a signal representing desired exhaust gas temperature. The difference in voltage is amplified and delivered to the torque motor of the nozzle area control.

### Nozzle Pump

The nozzle hydraulic pump is a variable-pressure, variable-displacement pump driven by a single engine shaft. The amount and direction of flow are determined by a mechanical push-pull signal from the nozzle area control.

### Exhaust Nozzle Flap Actuators

There are four nozzle flap actuators equally spaced on the tailpipe. The actuators are supplied with high pressure engine oil from the nozzle hydraulic pump. The nozzle flap actuators mechanically open and close the nozzles automatically through a series of cams and linkages.

## EXHAUST NOZZLE EMERGENCY CLOSURE SYSTEM

An emergency exhaust nozzle lock system and a priority oil supply system (refer to Figure 1-8) is installed. The emergency exhaust lock system incorporates lock assemblies that are mounted on the No. 2 and 4 nozzle actuators. This system locks the nozzle to prevent it from exceeding the cruise position of an indicated nozzle position of 3 ÷ 4, thus preventing a full-open nozzle should the emergency nozzle closure system become inoperative as a result of an excessive oil loss.

The priority oil-supply system consists of a lube tank, modified to incorporate an emergency hydraulic port, and a standpipe which extends within the tank to the 4-pint level. This system separates the engine lubrication system from the emergency nozzle closure system supply ports and provides a reserve supply of 4 pints of oil for engine lubrication. During normal engine operation, the primary nozzle hydraulic system regulates the exhaust nozzle exit area as a function of throttle angle and exhaust gas temperature. The emergency nozzle closure system is inoperative and the locks are in the unlocked position. In the event of a primary nozzle control system malfunction, the emergency nozzle

lock system is activated by pulling the emergency nozzle closure handle.

### NOTE

- In order to prevent engine over-temperature, excessive RPM drop or engine stall, the emergency nozzle closure system shall not be used in afterburning condition.
- The oil supply for emergency nozzle closure is obtained through a standpipe. The standpipe will reserve four pints of oil for engine lubrication if an oil leak has developed in the nozzle closure system.
- A common engine-driven shaft drives the engine oil supply system pump and the emergency nozzle system pump.

### Engine Exhaust Nozzle Locks

Nozzle locks are incorporated to prevent the nozzle from opening after the emergency nozzle closure system has been actuated. The locks are mechanical devices attached to two of the nozzle actuators and connected directly to the emergency nozzle closure handle.

When the handle is pulled, the locks assume an over center position which allows a retaining collar on the nozzle actuator to slide into the locks but not out of them until the handle is returned.

When the handle has been pulled and oil is available to the emergency nozzle pump, the nozzle will close to and modulate at an area slightly smaller than the locked area. If oil to the emergency nozzle pump is depleted, the nozzle will open slightly to the locked area. Under this condition, the handle may not be pushed in until the aerodynamic loads in the nozzle are relieved.

### Emergency Nozzle Closure Handle

A T-handle (refer to Figure 1-3) labeled EMERGENCY NOZZLE CLOSURE, is installed on the lower right main instrument panel. This handle is connected by flexible cable to a transfer valve in the nozzle area control system. The transfer valve permits selecting either the normal of the emergency system for controlling the nozzle.

When the emergency nozzle closure handle is in the NORMAL (forward detent) position, the transfer valve is in its normal position, allowing free flow of oil between the normal nozzle pump and the nozzle actuators; nozzle area control is then maintained by the normal control system.

Pulling the handle to the EMERGENCY (aft detent) position, mechanically positions the transfer valve to direct oil from the emergency nozzle pump to the nozzle actuators, closing the nozzle to the 3.0 to 4.0 position and actuating the nozzle locks. Some modulation of the nozzle opening will still occur as a result of changes in thrust setting (exhaust gas pressure variations). If oil pressure in the emergency system is lost, the nozzles will attempt to open, but will be stopped by the emergency nozzle locks at a reading of approximately 4 on the exhaust nozzle position indicator. Under this condition, the handle may not be pushed in until the aerodynamic loads in the nozzle are relieved.

### NOTE

The nozzle may not close under certain conditions of altitude and speed. If the nozzle does not close, retard the throttle to decrease nozzle pressure.

#### Exhaust Nozzle Position Indicator

An indicator (refer to Figure 1-3) located on the right side of the main instrument panel shows the exit area of the exhaust nozzle. The instrument is powered by the XP5 AC bus. The instrument is labeled NOZZLE POSITION and is calibrated from 0 through 10.

#### Exhaust Gas Temperature Gage

An exhaust gas temperature gage (refer to Figure 1-3), located on the right side of the main instrument panel, is calibrated from 0° to 1200° C. The unit is operated electrically by self-generating thermocouples and provides visual indications of exhaust gas temperature (EGT). The instrument is electrically powered by the XP5 AC bus.

#### ENGINE OIL SUPPLY SYSTEM

The engine oil system (refer to Figure 1-10) operates automatically. The system is serviced with 28

± 32 pints U.S. Refer to the table in Figure FO-13 for oil grade and specification. Necessary pressure and scavenge pumps and supply lines to those areas requiring lubrication are provided. Engine oil is also used to actuate the exhaust nozzles. The flow of engine oil for the exhaust nozzle actuators is automatically controlled by the nozzle area control system. Access to the oil quantity dipstick (calibrated in pints) is provided on the top surface of the fuselage directly over the wing.

#### ENGINE OIL PRESSURE

Abnormal engine oil pressure is frequently an early indication of engine malfunction. It is important to notice a change in the oil pressure reading for a given RPM from the value that was considered normal prior to this time.

Each oil pressure gage is marked with the oil pressure limits established for that particular engine/airframe combination at 100% engine RPM. Therefore, oil pressure limits are valid only for a given engine/airframe combination. Any change to this combination requires determining new limits are re-marking of the oil pressure gage.

The oil pressure value at 100% engine RPM for any uninstalled engine shall be in the range of 40 psi ±10 psi. When the engine is installed in the aircraft, the engine is run at 100% RPM to determine the oil pressure value. This oil pressure value determined at 100% engine RPM is placarded on the face of the oil pressure gage. From flight to flight indicated oil pressure at 100% engine RPM shall agree within ±5 psi (the installation tolerance) of this placard value.

If unable to obtain 100% engine RPM, the oil pressure may be corrected to 100% value by adding one psi to the indicated oil pressure for each one percent of RPM below 100 percent RPM. When operating the engine in excess of 100% RPM, indicated oil pressure may be placarded psi ±5 psi, plus one psi for each one percent of RPM above 100% engine RPM.

### CAUTION

IF INDICATED OIL PRESSURE CORRECTED TO 100% RPM IS NOT PLACARDED PSI ±5 PSI, ABORT THE FLIGHT AND HAVE THE ENGINE INSPECTED.

**ENGINE OIL SUPPLY SYSTEM**

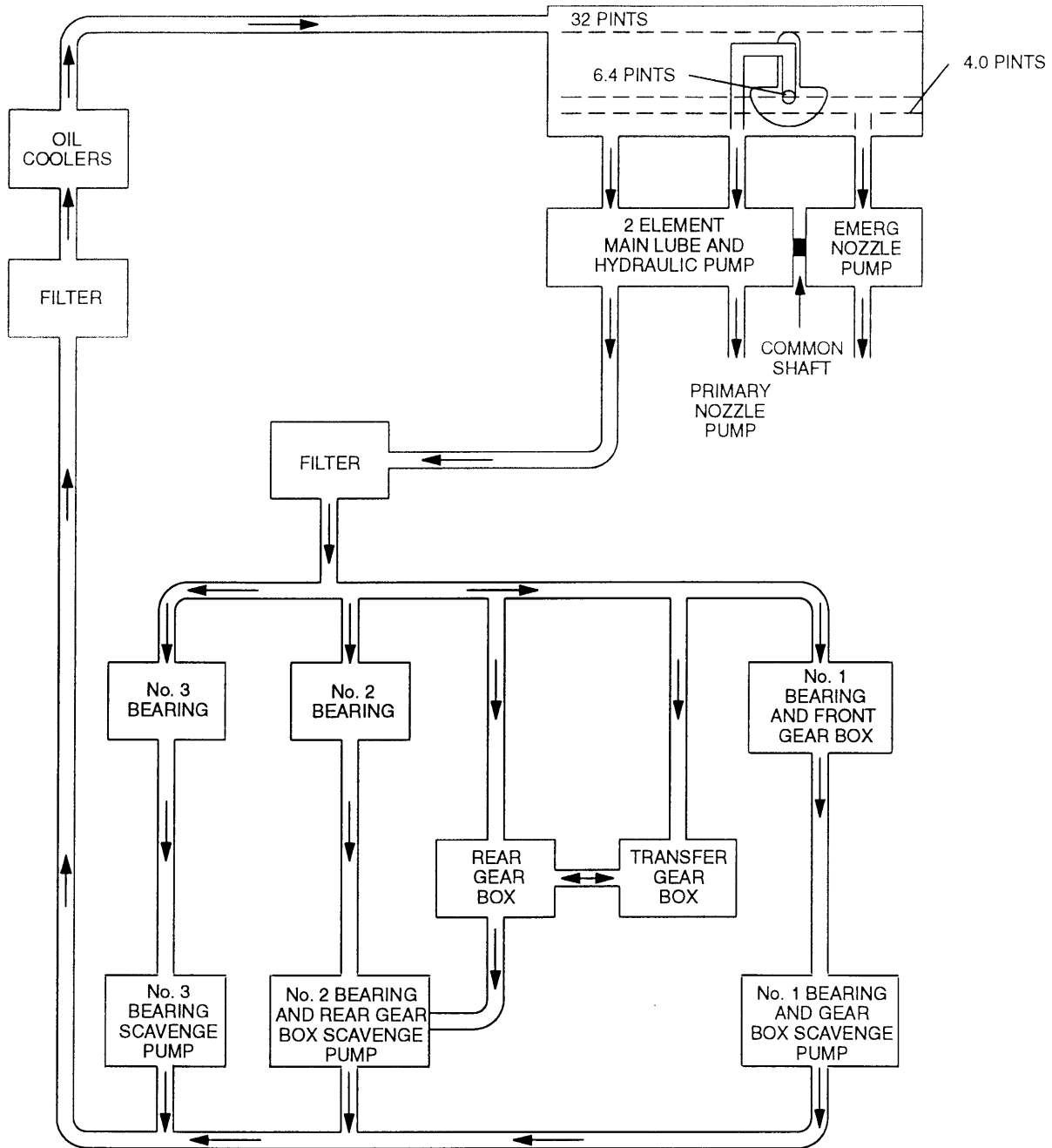

FA0079

Figure 1-10

## Oil Pressure Gage

An oil pressure gage (refer to Figure 1-3) is mounted on the right side of the upper main instrument panel. The gage registers oil pressure in pounds per square inch. The gage receives power from the XP6 AC bus. Each oil pressure gage is marked in accordance with the oil pressure limits established for that particular engine/airframe combination at 100% RPM.

## Engine Oil Level Low Warning Light

An ENGINE OIL LEVEL LOW warning light (refer to Figure 1-3) is installed on the warning lights panel. The warning light is actuated by a transducer in the engine oil supply line. If the oil level in the tank drops below the engine oil supply line intake (approximately 6.4 pints remaining) loss of engine oil pressure results, thereby illuminating the warning light. This light is not, however, a direct measure of oil quantity in the reservoir. The warning light is powered by the PP2 DC bus.

## FUEL SUPPLY SYSTEM

The aircraft internal fuel system (refer to Figure FO-5) consists of a forward main fuel tank, an aft main fuel tank (composed of three interconnected cells), and auxiliary tanks. The forward and aft main fuel tanks and the auxiliary tank are bladder-type non-self-sealing cells. The fuel system also includes four submerged boost pumps, mounted in the forward main fuel cell, check valves, drain valves, a main shutoff valve, a strainer, and the necessary plumbing and electrical circuits. Plumbing and electrical circuits are provided for the installation of tip and pylon tanks. All internal and external fuel tanks are serviced by single-point pressure refueling. The refueling switch panel is located adjacent to the refueling adapter in the left side of the fuselage, aft of the cockpit. If pressure refueling ground equipment is not available, the internal fuel tanks may be gravity refueled through two filler wells located in the aft main tank and the auxiliary tank.

The pylon tanks may be refueled through individual filler wells. Each tip tank may be refueled through two filler wells. An adapter-fitted defueling disconnect is provided downstream from the strainer (refer to the data in Figure 1-11 and Figure 1-12 for fuel tank capacities for JP8 and JP4 respectively). Refer also to Figure 1-14 for fuel grade properties and limits.

## FORWARD MAIN FUEL CELL

All of the fuel which goes to the engine is fed from the forward main fuel cell. Fuel from the aft center fuel cell enters the forward main fuel cell through two flapper-type check valves. Fuel from the external tanks enters the aft main, the auxiliary, and extended range fuel cells through the refueling shutoff valves and then flows into the forward main fuel cell through the flapper valves (refer to Figure FO-5). Fuel from the auxiliary fuel cell enters the forward main fuel cell through either a flapper-type check valve or a transfer float valve. A low-level warning switch, quantity transmitters, four boost pumps, a dual fuel level pilot valve, two vent valves, and a fuel manifold are located inside the cell.

Fuel used to cool the hydraulic fluid which drives the hydraulically driven generators and to cool the MRAAM transmitter refrigerating fluid, is returned to the forward main fuel tank after passing through the heat exchangers. Fuel used to cool the hydraulic fluid, which drives the 5-KVA hydraulically driven generator and cool the MRAAM transmitter refrigerating fluid, is returned to the forward main fuel tank after passing through the heat exchanger drain valves are located in the pump wells of the cell and are accessible from outside the aircraft.

## AFT MAIN FUEL CELL

Three interconnected units make up the aft main fuel cell. These units are the aft center fuel cell and the aft right and left fuel cells.

### Aft Center Fuel Cell

The aft center fuel cell is located between the engine inlet ducts. Two vent valves, a dual refueling shutoff valve, a quantity transmitter, and two drain valves are in the cell. The drain valves, at the forward bottom end of the cell, are accessible from the forward end of the wheel well.

### Aft Right and Left Fuel Cells

The aft right and left fuel cells fit around the engine air inlet ducts outboard of the aft center fuel cell. Each cell is connected by tubes, at the bottom and top, to the aft center fuel cell. Fuel flows to the aft center fuel cell through the bottom tube; the top tube serves as a vent connection.

**FUEL QUANTITY DATA JP8**

Data Basis: Ground Test, Standard Day Conditions, Conversion Factor, 6.68 lbs per US Gal	Usable Fuel in Level Flight Attitude		Fully Serviced in Static Attitude	
	Lb	US Gal	Lb	US Gal
Internal Fuel:				
Main Fuel Cells	5037	755	5094	763
Auxiliary Fuel Cells	1463	219	1470	220
External Fuel:				
Tip Tanks (Each)	1135.5	170	1168	175
Pylon Tanks (Each)	1302.5	195	1328	199
<b>TOTAL USABLE FUEL IN LEVEL FLIGHT ATTITUDE</b>				
Internal Fuel Cells:				
Main and Auxiliary .....	(6500 Lb)		974 Gal	
Wing Tip Tank .....	(8771 Lb)		1314 Gal	
Wing Pylon Tanks .....	(9105 Lb)		1364 Gal	
Wing Tip and Pylon Tanks .....	(11376 Lb)		1704 Gal	
NOTES:				
1. Level Flight Attitude-Top of Fuselage 3° nose up				
2. Static Attitude-Top of Fuselage 0°				

**Figure 1-11**

**FUEL QUANTITY DATA JP4**

Data Basis: Ground Test, Standard Day Conditions, Conversion Factor, 6.5 lbs per US Gal	Usable Fuel in Level Flight Attitude		Fully Serviced in Static Attitude	
	Lb	US Gal	Lb	US Gal
Internal Fuel:				
Main Fuel Cells	4901	755	4959	763
Auxiliary Fuel Cells	1423	219	1430	220
External Fuel:				
Tip Tanks (Each)	1105	170	1137	175
Pylon Tanks (Each)	1267	195	1293	199
<b>TOTAL USABLE FUEL IN LEVEL FLIGHT ATTITUDE</b>				
Internal Fuel Cells:				
Main and Auxiliary .....	(6324 Lb)		974 Gal	
Wing Tip Tank .....	(8534 Lb)		1314 Gal	
Wing Pylon Tanks .....	(8858 Lb)		1364 Gal	
Wing Tip and Pylon Tanks .....	(11068 Lb)		1704 Gal	
NOTES:				
1. Level Flight Attitude-Top of Fuselage 3° nose up				
2. Static Attitude-Top of Fuselage 0°				

**Figure 1-12**

**AUXILIARY TANKS**

One auxiliary fuel cell is located forward of the main fuel cell. Fuel is automatically transferred by means of a submerged centrifugal transfer pump (through a level-control valve), or by a gravity flow connection to the main fuel cell. The auxiliary fuel cell also contains a dual fuel level control valve, a vent float valve, two drain valves, and a low-level pump shutoff float switch. The drain valves are accessible from beneath the aircraft. Without external fuel tanks installed the transfer pump will be energized when the aircraft electrical system is energized and there is fuel in the auxiliary cell. The transfer pump shuts off automatically when the cell empties. With external fuel tanks installed the transfer pump will not be energized until the external tanks are empty. The transfer pump is powered by the XP3 AC bus.

Two auxiliary tanks (extended range fuel tanks) are installed in the ammunition compartment, and case stowage compartment. The total fuel capacity is increased by approximately 77 US gallons. During pressure refueling, fuel enters the extended range tanks through the ammunition compartment tank. A refueling shutoff valve and a dual fuel level pilot

valve in this tank control the filling of the tanks. When using gravity refueling, the fuel tanks fill through an interconnection between the auxiliary fuel cell and the ammunition fuel tank. During operation, fuel flows from the ammunition compartment tank into the case stowage tank and then to the auxiliary fuel cell. The auxiliary cell is equipped with a flapper-type check valve to prevent backflow into the extended range tanks.

**FUEL BOOST PUMPS**

Four fuel boost pumps, operated by 3-phase AC motors, are installed, one in each corner of the forward main fuel cell. Power for operation of the No. 1 and No. 4 boost pumps is supplied from the XP3 AC bus. The No. 2 boost pump is normally powered by the XP2 AC bus. The XP2 will power the No. 2 fuel boost pump also when a single Wild Frequency (WF) generator failure occurs. During an engine flameout, the No. 2 fuel boost pump will be transferred to the No. 1 generator, in order to assure sufficient fuel boost pump pressure for a high altitude air start (up to 40% engine RPM). No. 3 boost pump is powered by the XP4 AC bus.

The pumps are manifolded together through check valves into the main fuel supply line to the engine. The main fuel supply line is routed aft from the forward cell to the shutoff valve at the firewall. A line connects the shutoff valve to the fuel strainer aft of the firewall. A drain valve and an overboard drain line is plumbed from the strainer sump. The fuel from the strainer is routed through a flexible hose to the engine and afterburner fuel pumps. The boost pump circuits are energized whenever the aircraft electrical system is energized and the switch-type circuit breakers are closed.

The pumps supply fuel at a boost pump discharge pressure of 20 to 26 psi at rated flow. A pressure switch, located downstream from the aircraft boost pumps causes the FUEL BOOST PUMPS FAIL warning light (located on the warning lights panel) to illuminate whenever the fuel pressure at the pressure manifold falls below approximately 12 psi. Failure of all four boost pumps is required to illuminate the warning light.

### WARNING

OPERATIONAL EXPERIENCE HAS SHOWN THAT ENGINE WILL FLAME OUT WITH 1000 LBS OR LESS OF REMAINING FUEL AND BOTH GENERATORS FAILED OR OFF (ALL FUEL BOOST PUMPS INOPERATIVE). TRY TO RESTORE NO. 3 FUEL BOOST PUMP OPERATION BY RAT EXTENSION, BEFORE ATTEMPT LANDING.

#### **FUEL TANK PRESSURIZATION AND VENT SYSTEM**

The vent system vents the internal fuel cells, provides self-pressurization of the cells in a climb to prevent loss of fuel, minimizes fuel boiling and evaporation, and provides controlled pressurization of the cells in a dive.

##### **Vent Float Valves**

Five vent float valves are installed in the system. Two are in the forward main fuel cell, two in the aft center fuel cell, and one in the auxiliary fuel cell. An additional vent float valve, connected to the

main vent system, is installed in the ammunition compartment (extended range) fuel tank. The valves are float-actuated and close the respective fuel cell vent in all attitudes of flight when the fuel reaches a predetermined level at the valve. This prevents fuel from flowing out of the vent.

##### **Altitude Vent Valve**

An altitude-closing vent valve is provided. Its purpose is to provide self-pressurization of the cells in a climb, reduce loss of fuel at high altitudes, provide unpressurized cells on the ground, and permit some measure of cell pressurization during a dive.

##### **Auxiliary Relief Valve**

An auxiliary relief valve, with an exit overboard at the wing tips, works in conjunction with the altitude vent valve to provide a pressure and vacuum relief if the altitude valve fails.

##### **Pressure Regulator**

A dual air-pressure regulator is installed to maintain an air pressure differential between the fuel cell cavity and the inside of the fuel cell through use of engine compressor bleed air. Either side of the dual regulator is capable of fulfilling the entire requirement. The regulator senses pressure both within the cells and in the cell cavity and closes when the pressure within the cells exceeds the cell cavity pressure by a preset value.

#### **EXTERNAL FUEL TANKS**

Provisions are included for carrying tip tanks and pylon tanks on each wing. A tip tank automatic drop system as well as means for electrically jettisoning the tip tanks, pylon racks, and pylon tanks is provided. Refer to the data shown in Figure 1-11 and Figure 1-12 for capacities.

##### **Automatic Fuel Transfer Shutoff**

In the external tanks, the fuel outlets to the transfer line are in the tip tank forward compartment and the pylon tank center compartment. Within the pylon tanks, fuel moves from the aft compartment and the forward compartment through flapper valves to the tank center compartment. Each tank contains a low-level transfer float switch which



shuts off the transfer valve and pressurizing air when the tanks become empty.

Pressurizing air is supplied by the engine compressor and is controlled automatically by the solenoid-operated shutoff valves. The shutoff valves prevent engine compressor air from entering the fuel transfer lines and internal cells when the external tanks are empty.

### External Fuel Transfer System

The fuel transfer system provides a means of transferring fuel from the external tanks to the internal tanks. Fuel transfer is accomplished by selecting pylon or tip tank fuel manually. Fuel is transferred by using bleed air pressure supplied by the engine compressor. Air is cooled by the primary heat exchanger and is controlled by a pressure regulator set to maintain a constant pressure in the tanks. The air passes through solenoid-operated air shutoff valves. The shutoff valves are controlled by low-level float switches and are open when the tanks are installed and contain fuel.

Plumbing is arranged so that it is symmetrical about the aircraft centerline to provide equal flow from right and left tip or right and left pylon tanks. "Sniffle" valves are located in the tip and pylon tanks and act as relief valves in case of a malfunctioning regulator. A failure in the regulator will cause it to fail to the open position. The unit is vented to the atmosphere by a line on the left side of the fuselage.

### NOTE

- Because some fuel may enter the vent line before the vent float valve closes, a nominal amount of fuel may be vented overboard at the wing tips, outboard of the tip tanks, through the fuselage-tanks-overboard vent at the time the tip tank becomes empty.
- A thumping noise may be heard during fuel transfer when the fuel lines turn dry. The nature of this phenomenon is harmless and no action is necessary.

- When pylon tanks and tip tanks are installed, either tip or pylon tanks may be selected; normally pylon tanks should be selected first. The selected tank empty light on the FUEL control panel will illuminate when the pylon tanks are empty. The external tank fuel selector switch should then be positioned to TIP. With the switch in the OFF position internal fuel will be used. Observe the limits contained in Section V "Operating Limitations".

Fuel transferred from the external tanks empties into the aft main and auxiliary fuel cells through the refueling shutoff valves (refer to Figure FO-5). Fuel from auxiliary (extended range) tank will also empty into the ammunition compartment fuel tank. One transfer valve controls fuel from the tip tanks and the other from the pylon tanks.

### Air Pressure Shutoff Valves

Two air pressure shutoff valves are installed in the engine compartment on the left side. One valve shuts off the supply of engine compressor air to the tip tanks and the other shuts off the air to the pylon tanks. The valves are solenoid-operated and controlled by a low-level float switch located in each external tank. The solenoids receive power from the PP2 DC bus. In case of electrical failure, the valves will fail to the open position.

### FUEL CONTROL PANEL

The FUEL control panel (refer to Figure 1-13) has the following controls and indicators:

#### Fuel Shut-Off Switch

The fuel shut-off switch is labeled SHUT-OFF and has two position ON and OFF. It is guarded to the ON position. The switch is used to actuate electrically the motordriven fuel shutoff valve, located just aft of the main fuel cell. The motor is connected through the fuel shutoff switch to the PP4 battery bus. The valve is used to shut off fuel to the engine in case of fire, crash landing, or ground maintenance.

## FUEL SUPPLY SYSTEM CONTROLS AND INDICATORS

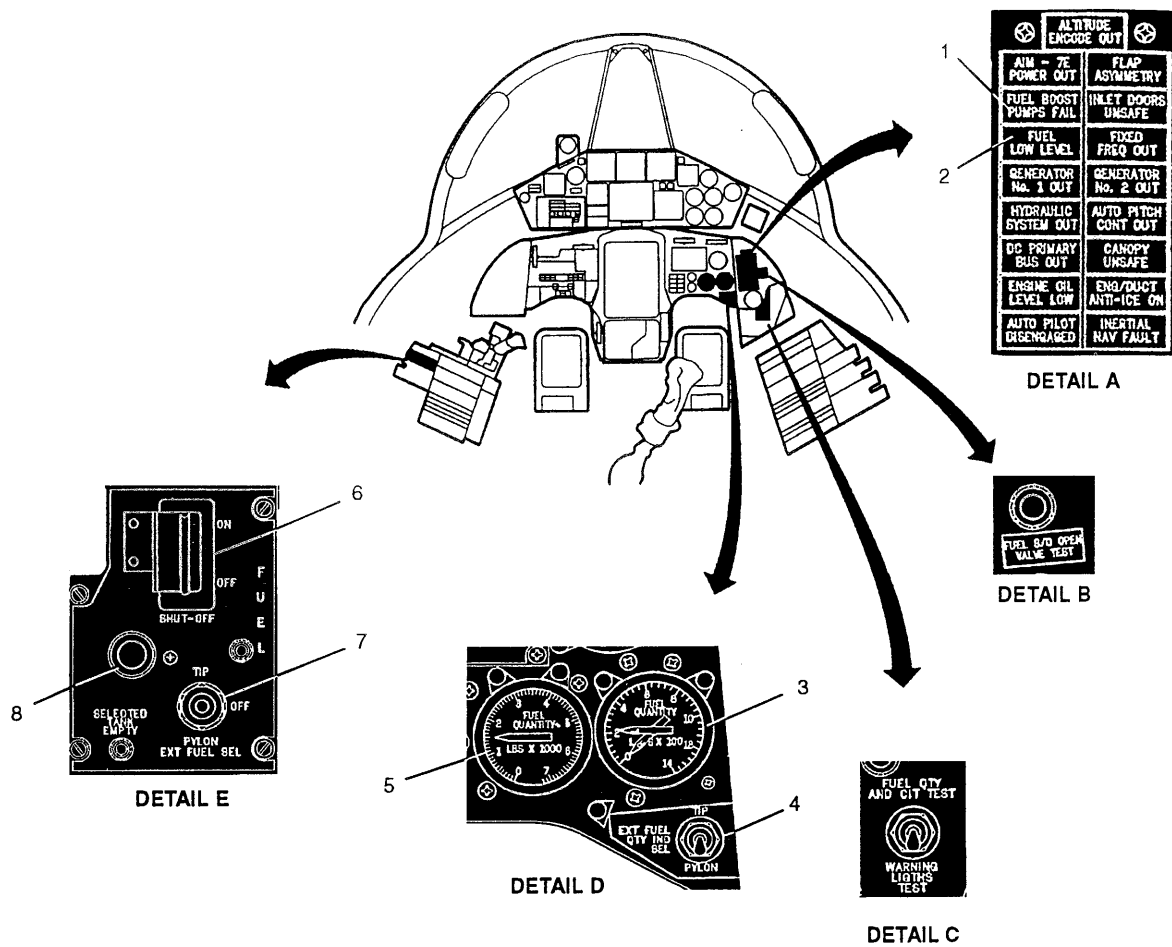

- A - WARNING LIGHTS PANEL**
  - 1 FUEL BOOST PUMPS FAIL WARNING LIGHT
  - 2 FUEL LOW LEVEL WARNING LIGHT
- B - FUEL SHUT OFF VALVE OPEN TEST LIGHT**
- C - FUEL QUANTITY AND CIT TEST SWITCH**
- D - FUEL INDICATIONS**
  - 3 EXTERNAL FUEL QUANTITY INDICATOR
  - 4 EXTERNAL FUEL QUANTITY INDICATOR SELECTOR SWITCH
  - 5 INTERNAL FUEL QUANTITY INDICATOR
- E - FUEL CONTROL PANEL**
  - 6 FUEL SHUT OFF SWITCH
  - 7 EXTERNAL TANK FUEL SELECTOR SWITCH
  - 8 SELECTED TANK EMPTY

FA0039

Figure 1-13

### External Tank Fuel Selector Switch

Solenoid-operated external fuel selector valves permit fuel to be transferred from both tip tanks or from both pylon tanks. The selector valves are connected to the PP2 DC bus through the air shutoff valve relays, the fuel selector switch on the FUEL control panel (labeled EXT FUEL SEL), and a circuit breaker marked EXT TANK FUEL TRAN on the cockpit left console circuit breaker panel (refer to Figure FO-8).

The three-position external tank fuel selector switch is labeled PYLON, TIP and OFF. The TIP and PYLON positions control valve operation as long as external tanks are installed.

Refueling shutoff valves in the aft and main auxiliary fuel cells governed by the dual level control pilot valve allow fuel transfer from the selected external tanks when fuel in the forward main fuel cell is decreased.

#### **WARNING**

IF TIP TANK FUEL IS SELECTED PRIOR TO SELECTING PYLON FUEL DO NOT EXCEED 500 KIAS UNTIL PYLON TANKS ARE EMPTY.

#### **CAUTION**

WITH FLETCHER AVIATION PYLON TANKS INSTALLED THE EXTERNAL FUEL TANK SELECTOR SWITCH SHALL BE RETURNED TO THE OFF OR TIP POSITION WHEN THE PYLON TANKS ARE EMPTY.

### Selected Tank Empty Light

A red push-to-test light located on the FUEL control panel illuminates when the tip or pylon tanks (as selected) are empty. The light is powered from the PP2 DC bus.

## FUEL QUANTITY INDICATING SYSTEM

### Internal Fuel Quantity Indicator

The internal fuel quantity indicating system indicates in pounds (0 to 7200) the fuel quantity remaining in the internal fuel cells, including auxiliary (extended range tanks). The system consists of an indicator (refer to Figure 1-13) on the right side of the lower main instrument panel, and three fuel cell transmitters, one in the auxiliary cell, one in the forward cell, and one in the aft cell. The transmitter in the forward cell is combined with a fuel density compensating unit. Two additional transmitters are provided in the extended-range tanks. The total fuel indicated on the gage includes the fuel remaining in the auxiliary (extended range) tanks.

The system is powered by the XP5 AC bus and the PP2 DC bus.

### External Fuel Quantity Indicator

The external fuel quantity indicating system indicates in pounds the fuel remaining in the wing tip or pylon tanks, as selected. The system consists of a dual indicator (refer to Figure 1-13) on the right side of the lower main instrument panel and ten fuel cell transmitters, two in each tip tank and three in each pylon tank. The indicator needles show the fuel quantity remaining in the left (L) and right (R) tip or pylon tanks, as selected. The system is powered by the XP7 AC bus and the PP2 DC bus.

### External Fuel Quantity Indicator Selector Switch

The external fuel quantity indicator selector switch (refer to Figure 1-13), labeled EXT FUEL QTY IND SEL, is located on the lower right side of the main instrument panel. It has two positions: TIP and PYLON. The switch is used to connect the external fuel quantity indicator to either the wing tip tanks or pylon tanks. The external fuel quantity indicator indicates the amount of fuel (in pounds) remaining in the respective tanks, depending on the position of the switch. This switch utilizes power from the PP2 DC bus.

### Fuel Quantity System Test Switch

A test switch (refer to Figure 1-13) is located on the right forward panel. When the aircraft electrical system is energized, operating the switch to the FUEL QTY AND CIT TEST position will ground

the system power supply from the XP7 AC bus. This will cause the fuel quantity gage indicating needle (both internal and external fuel quantity gage needles) to go toward zero and return to the original position when the switch is released if the system is functioning properly. This will not activate the low-level warning indication, as the systems are independent.

Holding the switch in the up position causes the needle of the engine air inlet temperature gage to fall below  $-70^{\circ}\text{C}$  and return to its original position when the switch is released. The switch is also used to check the warning light circuits, when placed in the WARNING LIGHTS TEST position.

### FUEL SHUT OFF VALVE OPEN TEST LIGHT

A green push-to-test light located on the right forward panel (refer to Figure 1-13) provides the pilots with the means of checking the fuel shut off valve in full opening position. The light is controlled by the fuel shut off valve open limit switch located in the valve and normally is off.

When the light lens is pressed, the light comes on if the valve is in full open position, or remains off if the valve is not in the above position.

### NOTE

If on preflight the light does not come on when the light lens is pressed, abort the mission and have the fuel shut off valve system checked.

### FUEL LOW-LEVEL WARNING LIGHT

A fuel low-level warning system is installed to indicate to the pilot that the fuel level in the forward main fuel cell has decreased to a predetermined level. The system includes a float-actuated switch, installed in the forward main fuel cell, and a light on the warning panel. When the fuel level falls to approximately  $1275 \pm 250$  pounds in level flight, the switch closes the circuit and energizes the FUEL LOW LEVEL warning light located in the warning lights panel.

### NOTE

- Changes in aircraft attitude or acceleration may cause the FUEL LOW LEVEL warning light to illuminate when the fuel level is close to the warning actuation level. Illumination of the warning light should be considered as a caution indication only. As soon as possible check the fuel quantity gage indication during steady-state straight-and-level flight.
- The fuel low-level warning light placard may be energized erroneously during sustained climbs or descents because of trapped fuel.

### FUEL BOOST PUMP FAILURE WARNING LIGHT

A pressure switch, installed downstream from the aircraft boost pumps, monitors the fuel pressure in the lines to the engine. The switch is normally closed but opens when the fuel boost pumps are in operation. If fuel pressure at the switch falls below approximately 12 psi, the switch will close and the FUEL BOOST PUMPS FAIL warning light will illuminate on the warning lights panel. Failure of all four boost pumps is required to illuminate the warning light.

### PRESSURE REFUELLING SYSTEM

The pressure refueling system makes it possible to service all internal fuel cells and external fuel tanks on the ground by single-point refueling.

#### Single-Point Refueling

The internal fuel cells and external fuel tanks are normally filled by using the single-point refueling system. The internal fuel cells may be filled in about 3 minutes, the internal fuel cells and external fuel tanks in about 5 minutes. The single-point refueling receptacle is located on the left side of the fuselage, forward of the intake ducts. Cell-mounted, dual fuel level control valves and refueling shutoff valves automatically shut off fuel to the internal fuel cells and they become full. Precheck test switches are provided on the external refueling switch panel to ensure proper operation of these valves. A refueling valve is provided for each set of external fuel tanks.

Float switches, located in each tank, close the respective refueling valve as soon as either tip tank or pylon tank becomes full.

### Refueling Switch Panel

A refueling switch panel (refer to Figure FO-13) located forward of and below the single-point refueling receptacle, contains six switches to check the internal cells dual fuel level control valves for proper operation, to select the external tanks to be refueled and to select either battery or normal power for the fuel control system.

**Refuel Switch.** The refuel switch, located on the external refueling panel is labeled ON and OFF. During normal operation power for refueling comes from the PP2 DC bus when the refuel switch is in the OFF position. However, the system is designed to alter the power source to the PP5 battery bus when the switch is operated to the ON position. This provides battery power for the refueling system, while the aircraft is on the ground, if an external power source is not available or desired during refueling. This refuel switch shall be set to the OFF position when refueling is completed to prevent discharging the battery. A mechanical interlock feature on the small access door will ensure the switch is in the OFF position when the door is closed.

**External Tanks Refuel Selector Switch.** The external tanks refuel selector switch, located on the external refueling panel is labeled TIP, PYLON, and BOTH. It provides a method of selective refueling of the external tanks. The switch utilizes power from the XP3 AC bus.

**Precheck Test Switches.** The master precheck switch is labeled PRI and SEC and is used to test the primary and secondary operation of the refueling shutoff valves. This switch is spring-loaded to the center OFF position.

During the first few seconds of refueling the master precheck switch should be placed first to the PRI, and then to the SEC position to check that the dual fuel level control valves close. Satisfactory valve operation is indicated by the shutoff of fuel flow causing gradual stiffening of the refueling hose after the switch is moved to each position. A more positive indication of fuel shutoff, however, is obtained by checking the counter on the ground refueling equipment.

There is approximately a 10-second delay between the time the switch is operated and the shutoff of fuel. If fuel flow continues, pressure refueling shall

be stopped immediately to prevent possible fuel cell rupture or airframe damage; enter note of this fact in aircraft forms. Individual valve precheck switches are also provided for isolating faulty or leaky valves in the auxiliary and main cells. If necessary, the aircraft may be refueled by the gravity refueling method.

### GRAVITY REFUELING

When single-point refueling is not used, the aircraft may be refueled in the conventional manner. Two filler wells (refer to Figure FO-13) are provided for refueling the internal fuel cells. To insure full internal servicing, refuel aft filler well first and then the forward well. Individual filler wells are provided for refueling the pylon tanks. Two filler wells are provided for each tip tank. Both shall be used to fully refuel both compartments of each tip tank.

## EXTERNAL TIP STORES AUTOMATIC DROP SYSTEM

A tip store automatic drop system is provided. If a fuel tip tank or launcher should become disengaged accidentally, the system will automatically jettison the corresponding fuel tank or launcher (with the installed missile) on the opposite wing tip. The system is electrically powered by the PP2 DC bus. To prevent the automatic drop system from operating on the ground when one store is intentionally removed, safety pins are provided for the tip stores to disarm the system. The pins are inserted under each wing near the tip stores.

### NOTE

- The automatic drop system for the missiles is in operation when missiles are on the wing tips. Automatic drop, or jettison of the wing tip missile launcher is possible only if a missile is on the launcher. A weapons-away switch on the launcher rail senses the presence of a missile. The circuit to the jettison cartridge is closed only if a missile is on the launcher rail.
- The automatic drop capability is not provided for the BL 75 pylon tanks.

## FUEL GRADE PROPERTIES AND LIMITS

USE	FUEL TYPE	GRADE	NATO SYMBOL	U.S. MILITARY SPECIFICATION/ COMMERCIAL	SPECIFIC GRAVITY	FREEZE POINT		LIMITS
						°F	°C	
Primary Fuel	Kerosene	JP-8	F-34	MIL-T-83133	.840-.775	-58	-50	1, 2, 3, 4, 5, 6
		Jet A-1	F-35	ASTMD 1655	.840-.775	-53	-47	1, 2, 3, 4, 5, 6
Alternate Fuel	Kerosene Wide Cut Gasoline	Jet-A	None	ASTMD 1655	.840-.755	-40	-40	1, 2, 3, 4, 5, 6
		JP-4	F-40	MIL-T-5624	.802-.751	-72	-58	6
Emergency Fuel	Aviation Gasoline (Avgas)	80/87	F-12	MIL-G-5572	.706	-76	-60	1, 2, 3, 4, 5, 6
		100/130	F-18	MIL-G-5572	.706	-76	-60	1, 2, 3, 4, 5, 6
		115/145	F-22	MIL-G-5572	.706	-76	-60	1, 2, 3, 4, 5, 6

### LIMITS

1. Whenever the use of alternate fuel is necessary, the specific gravity setting on the main fuel control and afterburner fuel control shall be adjusted to correspond with a mid-range or average value of the specific gravity of the fuel selected. The specific gravity or average value of authorized fuels can be obtained from the above table. The procedures for changing the specific gravity setting on the fuel controls are published in the aircraft power plant manuals. Whenever the specific gravity adjustments are changed from their standard preset point, an entry will be made in DD Form 781A. This entry can only be cleared when the aircraft is reserviced with the primary fuel and the specific gravity adjustments have been reset to the standard setting.
2. There is no operating time limit with alternate fuels. Use of emergency fuel is restricted to a maximum of 6 hours operation.
3. Airstarts initiated as soon as possible will assure best possible condition for restart.
4. Engine ground and aerial start times will increase when using JP-8, Jet A-1 and Jet-A fuels. Refer to Section III "Emergency Procedures - J79 Engine Air Start Envelope" Figure for engine estimated air start envelope.
5. Engine throttle transients, A/B light-off capability and thrust are not degraded by use of JP-8, Jet A-1 or Jet-A. A slight improvement in stall margin will result with the use of JP-8, Jet A-1 or Jet-A.
6. If there is any indication of improper fuel handling procedures, a fuel sample should be taken in a glass container and observed to fogginess, presence of water, or rust. The primary fuels JP-8 and fuels identified by NATO symbols F-34, F-35 and F-40 contain an icing inhibitor.
7.
  - a. Whenever the use of aviation gasoline is required, the aircraft will be restricted to a one-time flight not to exceed 6 hours duration. Specific gravity adjustments to the main and afterburner fuel controls are not required. Neither is the addition of lubricating oil additives required. When using AVGAS there is no restriction on afterburner operation, but the aircraft ceiling is limited to 35000 ft and aircraft velocity shall not exceed subsonic speed at any altitude. In addition to these limitations, certain engine parameters may be degraded under some atmospheric conditions:
    - (1) Longer time to start and accelerate with possible missed starts or start stalls.
    - (2) Maximum engine RPM and EGT may not be attained.
    - (3) Slow acceleration throughout the operating range.
    - (4) Reduced engine thrust.
    - (5) Reduced aircraft range.
  - b. If aircraft exceeds 6 hours of operation of AVGAS, drain aircraft fuel system completely and refuel with primary fuel. Inspect turbine exhaust nozzle area and perform ground run check. If no defects or engine malfunctions are found, release aircraft for flight.

### CAUTION

- AVOID FLYING AT ALTITUDES WHERE INDICATED OAT IS BELOW THE FREEZE POINT OF THE FUEL. PRIOR TO USING EMERGENCY COMMERCIAL FUEL, OBTAIN FREEZE POINT FROM VENDOR OR AIRLINE SUPPLYING THE FUEL; THEN FOLLOW THE LIMIT.
- ABOVE 22000 FEET THE TIME FOR ENGINE RESTART MAY BE 15 SECONDS LONGER WHEN USING JP-8/F-34 INSTEAD OF JP-4/F-40.

**Figure 1-14**

## EXTERNAL STORES JETTISON SYSTEM

This system allows the emergency and selective jettison of the external stores and provides the capability to jettison the BL 75 pylons. The system is electrically powered by the PP4 and PP5 battery busses. The external stores emergency jettison is available by means of the emergency external stores jettison button.

The external stores selective jettison is available by means of the external stores selector buttons and indicator lights, by external stores release selector switch and by droppable stores release button.

The BL 75 pylons jettison is available by means of the BL 75 pylon jettison switch.

### WARNING

EMERGENCY OR SELECTIVE JETTISON SHALL BE ATTEMPTED OVER CLEARED AREAS ONLY. REFER TO SECTION V "OPERATING LIMITATIONS" FOR EXTERNAL STORES JETTISON LIMITS.

### CAUTION

- EMERGENCY JETTISON ENVELOPE SHALL BE DETERMINED BY THE MOST RESTRICTIVE STORE SELECTIVE JETTISON ENVELOPE.
- WHEN JETTISONING AT LOW LEVEL, IN CASE OF TAKEOFF EMERGENCY, THE PILOT SHOULD ALSO CONSIDER THE POTENTIAL HAZARD TO THE AIRCRAFT CAUSED BY A STORE RICOCHETING FROM THE RUNWAY.

### NOTE

Any reference to the AIM-9L missile applies also to the AIM-9L/I and AIM-9L/I-1 missiles.

## EMERGENCY JETTISON

Emergency jettison is a one-step operation that clears all droppable stores. Pressing the EXT STORES JETTISON button, all stores and launchers, except the pylons, will be jettisoned. Once initiated, the emergency jettison will run until all stores are released. Power is supplied by the PP5 battery bus.

### NOTE

- The jettison of the AIM-9L launcher on the wing tip or on the BL 104 pylon is inhibited if the missile has already been fired.
- The jettison of the stores on BL 104 pylons is delayed with respect to the other stores, when the emergency jettison button is used. The jettison of the store on the left BL 104 pylon is delayed 0.75 seconds, the right 1.5 seconds.
- The jettison of the stores on the BL 104 pylons is enabled only when the aircraft is in flight.

## SELECTIVE JETTISON

Selective jettison is used to release selected stores and is controlled by the droppable stores release button on the control stick grip.

The stores are selected operating the stores release selector switch as desired on the stores release panel and pressing the appropriate external stores selector button on the armament control panel.

Both BL 75 pylon tanks or AIM-9L missiles on BL 104 pylons will be jettisoned if both selector buttons are pressed. In any case, if the selective jettison of a single tank on the BL 75 pylon or of a single AIM-9L on BL 104 pylon is necessary, this is possible by pressing only one selector button. An attempt to jettison a single wing tip tank/missile by pressing only one selector button, will cause the jettison of both tip stores due to the external stores automatic drop system.

BL 75 pylon may be jettisoned by means of the BL 75 pylon jettison switch only. Power is supplied by the PP4 battery bus.

## EXTERNAL STORE JETTISON SYSTEM CONTROLS AND INDICATORS

### Emergency External Stores Jettison Button

The emergency external stores jettison button labeled EXT STORES JETTISON is located on the left forward panel (refer to Figure 1-15).

#### NOTE

The EXT STORES JETTISON button is protected by a fragile guard. By pressing the cover, which will be broken, the button is actuated and the emergency jettison is carried out.

### Selective External Stores Release Selector Switch

The stores release selector switch, labeled STORES RELEASE (refer to Figure 1-15) is provided for the selection of the droppable stores and is located on the stores release panel.

The position clockwise and functions are as follows:

SAFE Disables the external stores selective jettison circuit

PYLONS (75/104) Select the BL 75 or BL 104 pylon stores for selective jettison. It is connected in series with the external stores selector buttons and the droppable store release button

TIP STORES Select wing-tip stores for selective jettison. It is connected in series with the external stores selector buttons and the droppable store release button

#### NOTE

The PYLONS (75 or 104) or TIP STORES selection causes the PYLON STATIONS TIP/104/75 "WPN ON" caption(s) (located on the armament control panel) to illuminate. The "WPN ON" captions are not illuminated when the SAFE position is selected.

## External Stores Selector Buttons and Indicator Lights

The external stores selector buttons and indicator lights are located on the armament control panel (refer to Figure 1-15).

These buttons (labeled PYLON STATIONS 75, 104 and TIP) provide individual selection for jettison of the particular store at its location, except for MRAAM and related launchers, which shall be only jettisoned through the emergency jettison button.

The WPN ON caption illuminates indicating the store presence.

The SELECT caption illuminates indicating the selection for selective jettison.

#### NOTE

- Since MRAAM/launcher jettison is available by means of the emergency external store jettison button only, pilot shall be aware that this operation causes all stores to be jettisoned.
- When MRAAM are installed and jettison is required, do not select the store release selector switch to "104" and do not press the relevant external stores selector buttons.

When the relevant button is pressed the corresponding green SELECT caption illuminates. The SELECT and WPN ON captions will extinguish when the store is jettisoned.

#### NOTE

In order to deselect the whole selective jettison function, the store release selector switch shall be set to SAFE. As a consequence the "WPN ON" caption extinguish.

### Droppable Stores Release Button

The droppable stores release button is located on the control-stick grip (refer to Figure 1-15) and controls the stores selective jettison sequence as selected through the external stores selector buttons and the stores release selector switch.



## EXTERNAL STORES JETTISON SYSTEM CONTROLS AND INDICATORS

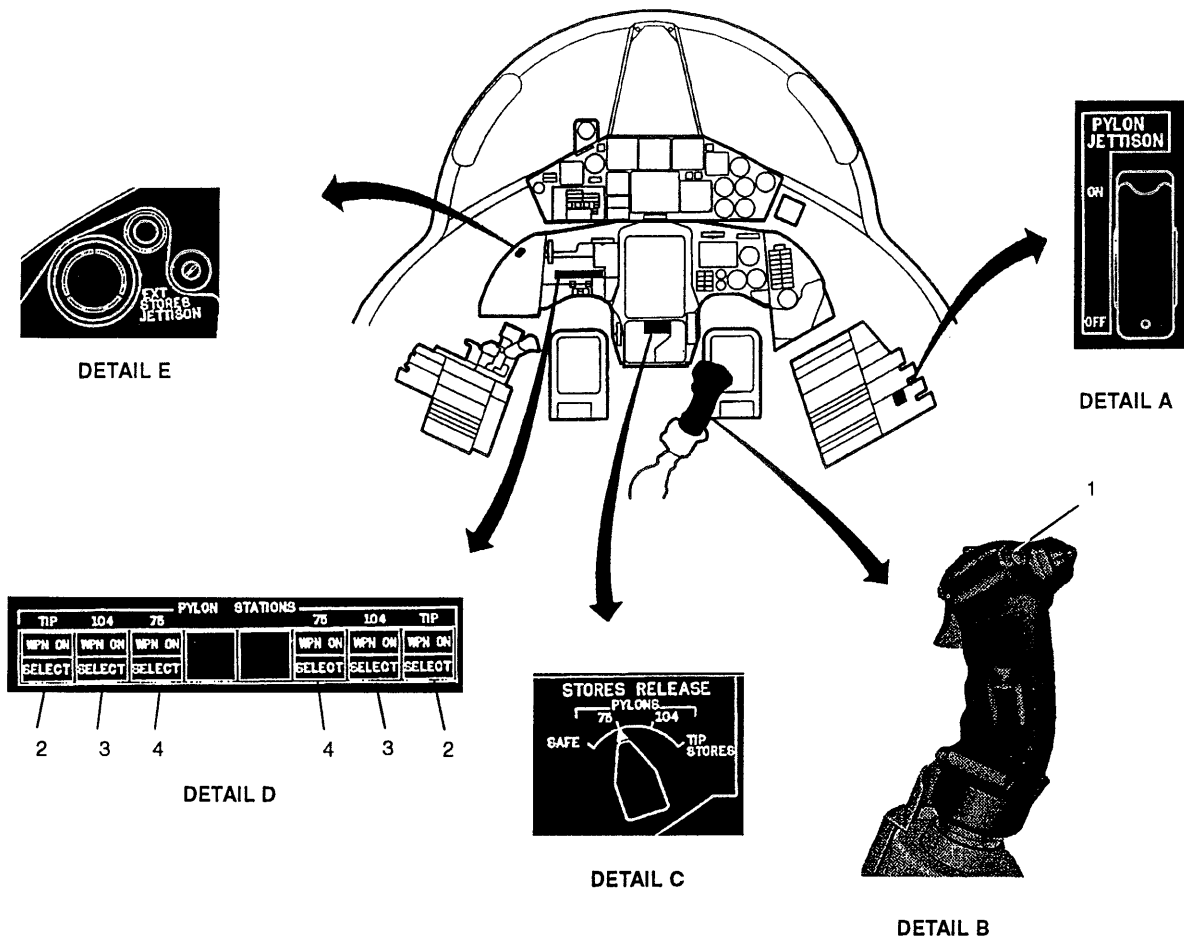

- A – BL75 PYLON JETTISON SWITCH
- B – CONTROL STICK GRIP
  - 1 DROPPABLE STORES RELEASE BUTTON
- C – SELECTIVE EXTERNAL STORES RELEASE SELECTOR SWITCH
- D – ARMAMENT CONTROL PANEL
  - 2 TIP EXTERNAL STORES SELECTOR BUTTONS AND INDICATOR LIGHT
  - 3 (BL)104 EXTERNAL STORES SELECTOR BUTTONS AND INDICATOR LIGHT
  - 4 (BL)75 EXTERNAL STORES SELECTOR BUTTONS AND INDICATOR LIGHT
- E – EMERGENCY EXTERNAL STORES JETTISON BUTTON

FA0106

Figure 1-15

### BL 75 Pylon Jettison Switch

A guarded ON-OFF pylon jettison switch labeled PYLON JETTISON is installed on the right console (refer to Figure 1-15). Use of the switch provides the only means of jettisoning the BL 75 pylons, when desired. Power is supplied by the PP5 battery bus.

#### NOTE

The pylons shall not be jettisoned unless the BL 75 pylon stores have been jettisoned.

## ELECTRICAL POWER SUPPLY SYSTEM

The aircraft electrical components operate on alternating current (AC), direct current (DC), or both. AC Wild Frequency (WF) power for normal operation is provided by two engine-driven generators. For emergency operation a Fixed Frequency (FF) ram air turbine-driven generator supplies power to emergency loads. Fixed Frequency AC is supplied by one hydraulically driven generator.

Autotransformer is provided for those components requiring 26 V AC fixed-frequency power (XP6 instrument bus). The DC power requirements are supplied by one transformer-rectifiers 120 A for normal operation and one transformer-rectifier 20 A for emergency operation. Refer to electrical power distribution (Figure FO-6 and FO-7).

### AC ELECTRIC POWER SUPPLY

The AC electrical power is derived from two engine-driven wild frequency generators GEN.1 and GEN.2, one hydraulically driven fixed-frequency generator GEN.3, and an emergency ram air turbine-driven generator.

### Wild Frequency Engine-Driven Generators

Two 20 KVA engine-driven generators, supplying 115/200 V, 3-phase, 320 to 522 Hz AC power, constitute the main electrical power source. Each generator is controlled by its own Generator Control Unit (GCU1 and GCU2).

Normally, the No. 1 generator energizes the XP1 No. 1 primary AC bus and XP3 secondary AC bus and the No. 2 generator energizes the XP2 No. 2 primary AC bus and XP4 emergency AC bus.

During high altitude engine air starts, the No. 1 wild frequency generator will power the No. 2 fuel boost pump.

If an overvoltage, undervoltage, underfrequency or overcurrent short circuit condition exists for either generator, that generator is automatically disconnected from its respective bus and the warning light panel illuminates to indicate which generator is inoperative.

#### CAUTION

IF BOTH GENERATORS FAIL, THERE WILL BE NO WARNING LIGHTS INDICATION UNTIL THE RAM-AIR TURBINE IS EXTENDED.

The bus transfer system provides six possible modes of operation (refer to Figure FO-6). The XP2 No. 2 AC bus also directs power to the 120 A transformer-rectifier unit TRU 1 which transforms the AC to 28 V DC to energize the PP1 primary DC, PP2 and PP3 emergency DC busses. The XP4 emergency AC bus directs power to the 20 A transformer-rectifier that provides 28 V DC to energize the PP4 and PP5 (No. 1 and No. 2 battery busses) for charge the batteries.

### Wild Frequency Generator Control Unit (1 and 2)

The GCU provides control of the generator field (including voltage regulation and current limiting), generator line contactor and generator transfer contactor. The field control function acts to maintain the system voltage within prescribed limits, and to limit the maximum phase current. It also controls the shaft power and generator heating for symmetrical and asymmetrical faults.

The generator contactor (GC1/2-G) control function, connects and disconnects the generator output from the load bus by means of the logic circuit. The generator contactor (GC1/2-T) control function, allows the load bus to be transferred to other power generating sources, whenever its own source is in fault condition or not available.

The GCU provides protection from out of limit of voltage, frequency and current to prevent damage to the bus bars loads. It ensures protection for

undervoltage (UV), overvoltage (OV), underfrequency (UF) and overcurrent (OC) phenomena. The GCU provides also the short circuit and anti-cycling protection to prevent generator cycling in case of failure. Each GCU provides warning indication if a generator failure occurs.

### NOTE

The electrical power supply system is equipped with GCUs which drop the two 20 KVA generators off the busses when engine RPM drops below approximately 67%. Under this condition, all electrically operated equipment, except the No. 2 boost pump and the battery busses, will be inoperative. The hydraulically driven generator will remain operative if engine speed is at 20% RPM or above. The No. 2 boost pump will continue to operate at lower engine RPM (down to approximately 40%). This feature ensures sufficient boost pump pressure for high altitude air starts.

**Generator Switches.** A generator switch is provided for each of the 20 KVA generator systems. These switches (refer to Figure 1-16) are identical and are located on the right forward panel. Each switch has two positions, ON and OFF/RESET.

When set to ON the respective generator is on line and connected to its distribution circuit.

When set to OFF/RESET the respective generator is disconnected from its distribution circuit; this position is also used to reset the generators.

**Generator-Out Warning Lights.** Two generator-out warning lights (refer to Figure 1-16), one for each of the 20 KVA generators, are located on the warning light panel. The lights are placarded GENERATOR NO. 1 OUT and GENERATOR NO. 2 OUT. Each light is powered by the PP2 No. 1 emergency DC bus and will illuminate whenever the respective generator is not generating or a protection occurs.

### Current Transformers

Each generator's single phase is provided with a current transformer capable of transmitting signals

directly proportional to the entity of current delivered. These signals are processed by the GCUs.

### Hydraulically-Driven Fixed-Frequency Generator (GEN.3)

A 5 KVA hydraulically driven generator provides 115/200 V, 3-phase fixed-frequency (400 Hz) AC power to the XP5 and XP7 primary and secondary fixed-frequency busses whenever the No. 2 hydraulic system is functioning. These busses energize those equipments requiring fixed-frequency AC power (refer to Figure FO-6).

If both main generators fail, the secondary fixed-frequency relay opens, deenergizing the XP7 secondary fixed-frequency bus. If the hydraulically driven generator fails, as indicated on the warning lights panel, the hydraulic generator power relay closes in transfer position, connecting variable frequency power from the XP4 emergency AC bus to XP5 and XP7 fixed frequency busses.

### NOTE

- The hydraulically-driven generator will start to operate at engine speed of 64% RPM if the No. 2 hydraulic supply pressure is 2400 to 3000 psi.
- A solenoid shutoff valve is installed in the hydraulic pressure line to the hydraulic-motor driven generator. The hydraulic motor starts by pressing for almost 5 sec. the fixed-frequency reset button if No. 2 system hydraulic pressure is present.

**Fixed Frequency Generator Control Unit.** The generator control unit (GCU3) provides hydraulically-driven fixed frequency generator AC output voltage regulation, line contactor and electrical system protection.

Whenever the generator output voltage reaches the correct value of voltage and frequency, the generator control unit provides 28 V DC power, which is used to close the GEN 3 status relay, to power the shutoff valve solenoid.

When a condition of underfrequency and/or undervoltage occurs which removes the 28 V DC signal shall be restored only by re-excitation of the hydraulically driven generator using the fixed-frequency reset button.

# ELECTRICAL POWER SUPPLY SYSTEM CONTROLS AND INDICATORS

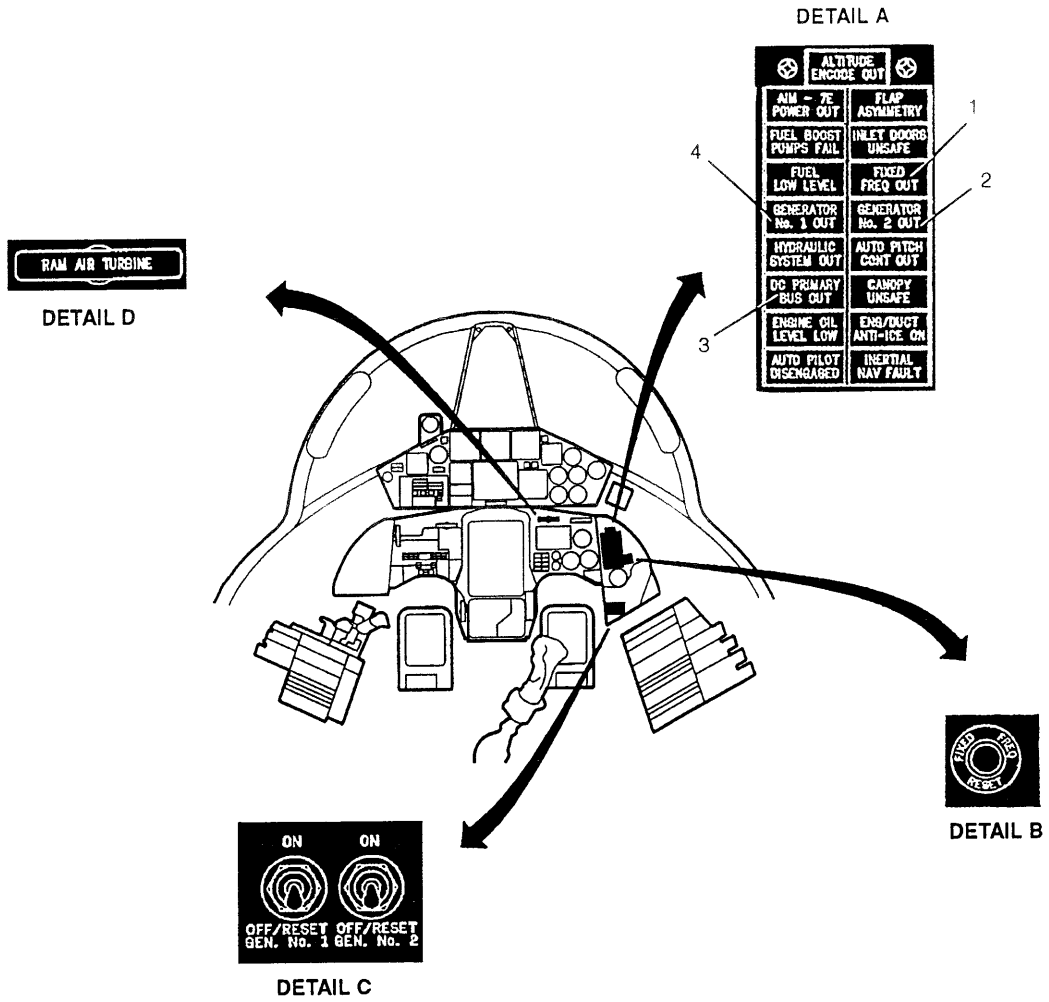

- A - WARNING LIGHTS PANEL
  - 1 FIXED FREQ. OUT WARNING LIGHT
  - 2 GENERATOR No. 2 OUT WARNING LIGHT
  - 3 DC PRIMARY BUS OUT WARNING LIGHT
  - 4 GENERATOR No. 1 OUT WARNING LIGHT
- B FIXED FREQUENCY RESET BUTTON
- C - GENERATOR SWITCHES
- D - RAM AIR TURBINE EXTENSION HANDLE

Figure 1-16

**Fixed-Frequency Reset Button.** This button (labeled FIXED FREQ RESET) is installed on the right forward panel (refer to Figure 1-16) and has two functions:

On Ground:

- after engine start, pressing for at least 5 seconds, it permits the starting of hydraulically driven generator GEN 3. The FIXED FREQ OUT warning light extinguishes.

In Flight or On Ground:

- if a GEN 3 fails (FIXED FREQ OUT warning light lit) is possible to reset the electrical fixed-frequency power system, pressing it for at least 5 seconds

The button is powered through the PP2 No. 1 emergency DC bus.

**Fixed-Frequency-Out Warning Light.** This light, labeled FIXED FREQ OUT, located on the warning lights panel (refer to Figure 1-16), is energized by the PP2 No. 1 emergency DC bus. The warning light will illuminate whenever the hydraulically driven generator GEN 3 is out. In this case the XP4 emergency AC bus is energizing the XP5, XP6 and XP7 fixed-frequency AC busses.

### Emergency AC Power Supply

The aircraft is equipped with an extendable ram air turbine (RAT) which drives an emergency hydraulic pump and a 4.5 KVA generator that supplies 115/200 V, 3-phase (400 Hz), AC power for emergency operation. Once extended, the ram air turbine is not capable of being retracted in flight. If both No. 1 and No. 2 engine driven generators fail, the ram air turbine-driven generator (when extended) will energize the XP4 emergency AC bus. In turn, if the hydraulically-driven generator is not operating, the RAT energizes the XP5 primary fixed-frequency AC bus, in addition to both PP2, PP3 emergency DC buses and both PP4, PP5 battery buses, through the 20 A transformer-rectifier.

### NOTE

The XP4 emergency AC bus will not operate the XP5 primary fixed-frequency AC bus if the hydraulically driven generator is operating.

**Ram Air Turbine Extension Handle.** Emergency AC power is made available by extending the ram air turbine into the aircraft slipstream.

This is done by pulling the yellow ram air turbine extension handle (refer to Figure 1-16) located on the right side of the instrument panel. The handle requires a firm pull of about 4 inches to the stop to extend the ram air turbine.

### NOTE

There is no means of retracting the ram air turbine in flight.

### DC ELECTRIC POWER SUPPLY

The direct current power requirements of the aircraft are normally supplied from the XP2 No. 2 primary AC bus through a 120 A transformer-rectifier unit TRU1.

This transforms 115/200 V AC to 28 V DC, which powers the PP1 primary DC bus. Power is drawn directly from this bus to energized the loads as per Figure FO-7.

The PP2 and PP3 No. 1 and No. 2 emergency DC busses, are also connected to PP1 primary DC bus during normal operation. The PP2 and PP3 No. 1 and No. 2 emergency DC busses, supply power to units which are considered essential for safe operation of the aircraft.

Due to this requirement, an alternate source of power to these buses is provided in the event that power from the PP1 primary DC bus is not available. Under this condition, the PP2 and PP3 No. 1 and No. 2 emergency DC buses, will be connected automatically to the 20 A transformer-rectifier unit which is connected to the XP4 emergency AC bus.

### CAUTION

NO WARNING LIGHT INDICATION IS PROVIDED IF PP2 NO. 1 EMERGENCY DC BUS IS NOT ENERGIZED.

**NOTE**

When the ram-air turbine-driven AC generator is operative following electrical emergency condition, it is important that the load on the emergency AC bus be minimized when using the aircraft leading and trailing edge flaps since they are powered directly from the XP4 emergency AC bus. To reduce loads and ensure maximum flaps effectiveness, the PP2 No. 1 emergency DC bus is automatically disconnected from the 20 A transformer-rectifier as long as the flaps are in operation, and those units which are powered from this bus, including the UHF command radio, will be inoperative during the period of flaps operation.

PP3 by blocking rectifiers. There is no battery control switch in the cockpit.

**CIRCUIT BREAKERS**

The circuit breaker panels (refer to Figure FO-8) on the left and right consoles contain push-to-reset, pullout-type breakers for certain AC and DC circuits. All the distribution circuits in the electrical system are protected by various types of circuit breakers.

Circuit breaker panels which are not accessible during flight but which should be inspected before, are located in the electronic compartment behind the cockpit and in the electrical load center on the right side of the fuselage.

**CAUTION**

CIRCUIT BREAKERS SHOULD NOT BE PULLED OR RESET WITHOUT A THOROUGH UNDERSTANDING OF ALL THE CONSEQUENCES. PULLING CIRCUIT BREAKERS MAY ELIMINATE FROM THE SYSTEM SOME RELATED WARNING SYSTEM, INTERLOCKING CIRCUIT, OR CANCELING SIGNAL, WHICH COULD RESULT IN AN UNDESIRABLE REACTION.

**Primary DC Bus-Out Warning Light**

The PRIMARY DC BUS OUT warning light (refer to Figure 1-16) is located on the warning light panel and is energized by the PP2 No. 1 emergency DC bus. The light will illuminate whenever power to the PP1 primary DC bus is not available.

Refer to Figure FO-7 for units which will be inoperative when the primary DC bus-out warning light is lit.

**BATTERIES**

Two 3.6 Ah Nickel Cadmium Batteries provide power to the No. 1 and 2 battery busses (PP4 and PP5) for the following main functions:

- Engine relight
- Emergency UHF radio
- External emergency store release
- Arrestor hook

The batteries and battery busses are fed by the 20 A transformer-rectifier unit TRU 2. The batteries output is prevented from discharging to the PP2 and

**EXTERNAL POWER SUPPLY**

The aircraft is equipped with a receptacle for connecting an external AC power source to the electrical system. This receptacle (refer to Figure FO-13) is located on the lower right side of the fuselage and is accessible through a door above the hydraulic panel.

Each main aircraft's generator has priority on the external power. The external power is controlled and monitored by means of the GCU No. 1.

The EXT PWR RESET button shall be pressed to power the aircraft: the EXT PWR OUT indication light shall extinguish.

## HYDRAULIC POWER SUPPLY SYSTEMS

Two completely independent hydraulic systems (No. 1 and No. 2) and an emergency system provide power to the various hydraulically operated units in the aircraft (refer to Figure FO-10). The No. 1 and No. 2 hydraulic systems function simultaneously during all normal operations and supply fluid at 3000 psi pressure to their respective hydraulically operated units. The No. 1 and No. 2 systems are provided with separate reservoirs, differing only in size and location; the No. 2 reservoir has the larger capacity. Each system includes an engine-driven pump, a cylindrical accumulator, a pressure transmitter, a pressure switch, and filters. In case of failure of either No. 1 or No. 2 system, the remaining system will maintain fluid pressure for flight control but at a reduced rate. If both No. 1 and No. 2 systems fail, and sufficient fluid is available in the No. 1 system, the emergency ram-air turbine-driven pump will furnish enough fluid pressure through the No. 1 system for operating flight controls at a reduced rate.

### NOTE

When hydraulic systems are pressurized, hydraulic system interflow will occur across the return bends of the valve spools in the servo control valves due to normally higher return pressures in the No. 2 system, resulting in flow of fluid from No. 2 system into No. 1 system. However, if No. 2 system is lost flow of fluid will be from No. 1 system into No. 2 system and will result in loss of fluid of the No. 1 hydraulic reservoir.

### Accumulators

The cylindrical accumulators are charged with nitrogen at approximately 1000 psi and are provided with an air valve and an air pressure gage. The accumulators store a supply of high-pressure fluid and also act as surge chambers. The accumulators and pressure gages for both No. 1 and No. 2 systems are accessible upon opening a large engine access door (refer to Figure FO-13) on the underside of the fuselage below the engine. Graduations on the gage dial are in increments of 100, from 0 to 5000 psi. The pressure gage shows the initial nitrogen charge

(1000 psi) in the accumulators only when hydraulic pressure is zero.

### Hydraulic Panel

Most of the hydraulic units are mounted directly on a hydraulic panel on the inside face of the engine access door (refer to Figure FO-13). Upon opening the door the various units are exposed for servicing, for testing, and for checking quantity indicators.

**Ground Test Selector Valve.** The manually controlled ground test selector valve on the hydraulic panel is the only link between the No. 1 and No. 2 systems. A three-position lever extends from the top of the valve and a mechanical linkage from this lever to a fixed bracket inside the fuselage causes the lever to be operated to the No. 2 position and locked in place when the engine access door is closed.

### NO. 1 HYDRAULIC POWER SUPPLY SYSTEM

The No. 1 hydraulic system (refer to Figure FO-9) supplies fluid (under regulated pressure) to the flight controls. Power is supplied to the stabilizer aft cylinder, the five inboard cylinders for each aileron, the bottom cylinder of each rudder actuator, the yaw damping control valve, the automatic-pilot actuators for the ailerons and stabilizer, and the automatic pitch actuator. The system includes a reservoir, an engine-driven pump, a cylindrical accumulator, a pressure transmitter, a pressure switch, a pressure-regulating flow-control valve, and a filter. Fluid is supplied to the pump from a piston-type reservoir. Fluid from the pump is supplied under 3000 psi pressure directly to the flight control components. The pressure regulating flow-control valve is connected to the pressure line. This valve contains a relief valve which relieves excessive system pressures to the return line. A pressure switch in the No. 1 system allows the automatic-pilot system to be energized when the No. 1 system pressure is above 1250 psi, and prevents operation of the automatic pilot if No. 1 system pressure drops to approximately 1250 psi. The pressure switch also energizes a warning light, on the warning lights panel, when the pressure drops below 1250 psi.

### NO. 2 HYDRAULIC POWER SUPPLY SYSTEM

The No. 2 hydraulic system (refer to Figure FO-9) supplies fluid under regulated pressure to the flight controls, pitch and roll damper control valves, landing gear, anti-skid brake system, nosewheel

steering, engine air bypass flaps, speed brakes, and hydraulically driven generator. The system includes a reservoir, an engine-driven pump, a cylindrical accumulator, a pressure transmitter, a pressure switch, a relief valve, a priority valve, and four filters. Fluid is supplied to the pump from a piston-type reservoir. Fluid from the pump is supplied under 3000-psi pressure, through a filter directly to the accumulator for each aileron, the stabilizer forward cylinder, and the top cylinder of each rudder actuator. A line connected to the pressure line immediately downstream from the filter feeds through a restrictor valve to the pressure switch and pressure transmitter. Another pressure line connected to the outlet port of the filter is routed to the pressure relief valve and the priority valve. The pressure relief valve will relieve system pressure to the return line if excessive pressure occurs in the system. The priority valve opens to full flow at 2600 psi.

A pressure line from the priority valve outlet port carries fluid to the utility hydraulic system (refer to Figure FO-10) which includes the engine air bypass flaps, landing gear system, anti-skid brake system, nosewheel steering system, speed brake selector valve and engine auxiliary air inlet doors. The priority valve resets to zero flow when system pressure drops to 2175 psi, thus retaining for flight controls and the hydraulically driven generator all system pressure below this range (refer to Electrical Power Supply System for further information). A pressure switch in the No. 2 system energizes the warning lights panel when the pressure drops below 1250 psi.

#### HYDRAULIC SYSTEMS PRESSURE GAGES

The hydraulic systems pressure gages (refer to Figure 1-17), located on the right side of the lower instrument panel, provide a visual indication of the pressure available in the hydraulic systems. The gages are powered from the XP6 AC bus. The gage dials are calibrated from 0 to 4000 psi in increments of 500.

#### EMERGENCY HYDRAULIC POWER SUPPLY SYSTEM

The emergency hydraulic system (refer to Figure FO-9) comprises a pump supplied with fluid from the No. 1 system reservoir. It delivers hydraulic pressure to the No. 1 system through the pressure regulating flow-control valve. The pump is a constant-volume gear type, powered by the ram air turbine. The pressure regulating flow-control valve diverts emergency pump fluid to return until the ram air turbine (and pump) has reached operating

speed. Thus, a hydraulic load can not be imposed on the turbine before it has reached a speed high enough to handle the demand. With the turbine and pump operating at the proper speed, fluid is then fed upon demand to the No. 1 system.

#### NOTE

- In addition to furnishing emergency hydraulic power, the ram air turbine will furnish emergency electrical power if necessary.
- There is no means of retracting the ram air turbine in flight.

#### RAM AIR TURBINE EXTENSION HANDLE

A yellow handle (refer to Figure 1-17), located on the right side of the lower instrument panel, is used to extend the ram air turbine, which powers the emergency hydraulic pump. The handle is labeled RAM AIR TURBINE and requires a firm pull of about 4 inches to the stop to extend the turbine. With the ram air turbine extended into the airstream, the emergency hydraulic pump will supply pressure, through the No. 1 system, for operation (at about one-sixth the normal rate) of the various hydraulic units normally operated by the No. 1 system.

#### HYDRAULIC SYSTEM OUT WARNING LIGHT

The HYDRAULIC SYSTEM OUT warning light, located on the warning lights panel (refer to Figure 1-17), illuminates when pressure in either the No. 1 or No. 2 hydraulic system decreases to approximately 1250 psi. The hydraulic pressure indicating system has to be used to determine which system is out.

#### WARNING

THE "HYDRAULIC SYSTEM OUT" WARNING LIGHT WILL NOT INDICATE A SECOND FAILURE. THE REMAINING GAGE SHALL BE MONITORED TO DETERMINE IF A SUBSEQUENT FAILURE OCCURS.



# HYDRAULIC POWER SUPPLY SYSTEM CONTROLS AND INDICATORS

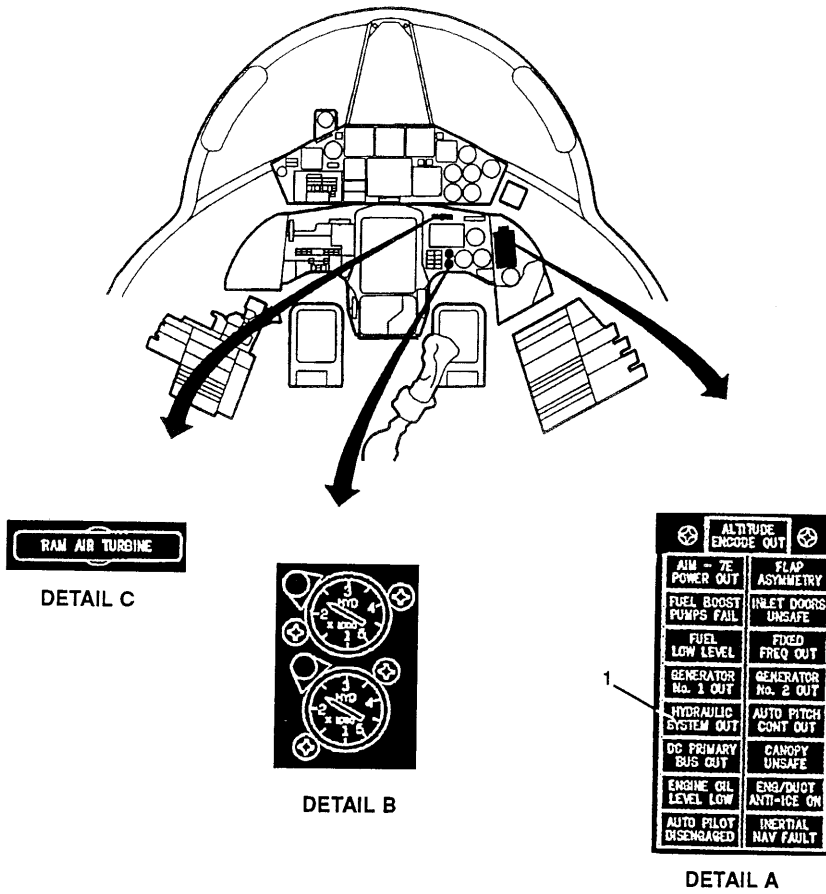

- A - WARNING LIGHTS PANEL
- 1 HYDRAULIC SYSTEM OUT WARNING LIGHT
- B - HYDRAULIC SYSTEMS PRESSURE GAGES
- C - RAM AIR TURBINE EXTENSION HANDLE

FA0041

Figure 1-17

## FLIGHT CONTROL SYSTEM

Flight controls consist of conventional cable and pushrod systems, mechanical and electrohydraulic servosystems, electrical trim systems, electrical control systems, and hydraulic control systems. The primary flight control surfaces include the ailerons, a pivoted one-piece controllable horizontal stabilizer, and a rudder.

### FULL POWER IRREVERSIBLE CONTROL SYSTEM

The ailerons, horizontal stabilizer, and rudder depend completely upon a hydraulic power control system for operation. Movement of the controls in any direction, even to the slightest degree, immediately activates a servomechanism which immediately responds and directs hydraulic pressure to the control surface control cylinders to move the control surfaces in the required direction. As soon as the control surfaces begin to move, a follow-up linkage begins to cancel the original control signal to stop the control surfaces at the required deflection. When the required deflection of the control surfaces is reached they are hydraulically locked in that position by the actuating cylinders and will not be moved by the action of external aerodynamic forces.

### Artificial Feel System

The use of a full power, irreversible control system for actuating the flight controls prevents air loads and resulting feel from reaching the cockpit controls. Therefore, an artificial feel system is installed to provide a sense of control feel under all flight conditions. Normal control forces are simulated by a system of cams and centering springs. This system applies loads to the controls in proportion to the degree of control deflection and proportionally to the number of "Gs" in the case of the stabilizer control system.

### CONTROL STICK

The control stick is mechanically connected (by means of control cables and pushrods) to hydraulic control valves at the ailerons and to horizontal stabilizer control valves. Movement of the stick positions these control valves so that power from the flight control hydraulic system is directed to the control surface actuators to move the control surfaces.

A follow-up system automatically closes off the flow of hydraulic fluid to the actuators when the desired control surface deflection is reached. The control-stick grip (refer to Figure 1-18) incorporates the primary aileron and horizontal stabilizer trim switch, trigger switch, nosewheel steering-microphone button, droppable stores release button, radar action reject button, and automatic pilot-APC disengage switch.

### RUDDER PEDALS

Primary control for the rudder consists of conventional rudder pedals, mechanically connected to a hydraulic control valve at the rudder hydraulic actuator. Movement of the rudder pedals positions the valve so that power from the flight control hydraulic system is directed to the control surface actuators to move the rudder. A follow-up system automatically closes off the flow of hydraulic fluid to the actuators when the desired rudder deflection is obtained. The rudder pedals may be adjusted by the rudder pedal adjustment handle labeled PEDAL ADJ and located to the left of the center control

### CONTROL STICK GRIP

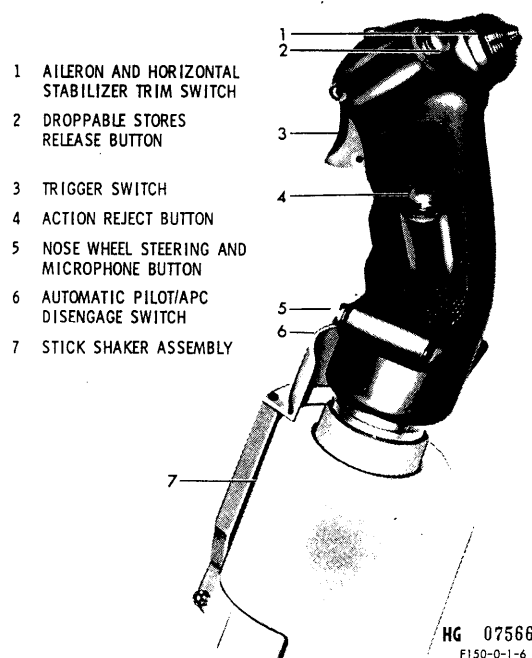

Figure 1-18

panel. The wheel brakes are applied conventionally by toe action on the rudder pedals (refer to Wheel Brake System paragraph). Rudder pedal movement also controls nosewheel steering (refer to Nosewheel Steering System paragraph).

### **AILERON AND RUDDER TRAVEL LIMITING SYSTEM**

Aileron and rudder travel is limited automatically when the gear is UP, and unlimited when the gear is DOWN. With gear DOWN, aileron travel is approximately  $\pm 20^\circ$  and with gear UP, aileron travel is approximately  $\pm 10^\circ$ . An additional  $5^\circ$  of aileron travel may be obtained with gear UP by using aileron trim.

With gear DOWN, rudder travel is  $20^\circ (\pm 2^\circ)$  to either side of neutral and with the gear UP, rudder travel is limited to  $6^\circ$  either side of neutral. An additional  $4^\circ$  of rudder travel is available with gear UP if rudder trim is used. Aileron and rudder limiting circuit is powered by the PP2 DC bus. If electrical failure occurs, rudder and aileron travel will not be limited.

Pulling the RUD/AIL LIMIT CONT circuit breaker, on the left console, will remove the rudder and aileron travel limiters (refer to Section VI "Flight Characteristics" for additional information on this system).

Aileron and rudder travel is automatically unlimited when gear is DOWN or when gear is UP and a flaps asymmetry condition exists as detected by the flaps asymmetry detection system. When the aileron and rudder travel is unlimited, a warning light on the main instrument panel illuminates.

### **WARNING**

THE USE OF FULL UNLIMITED AILERON OR RUDDER TRAVEL IN MANEUVERS AT SPEEDS ABOVE 300 KIAS MAY RESULT IN STRUCTURAL DAMAGE AND POSSIBLE LOSS OF THE AIRCRAFT.

#### **Aileron and Rudder Unlimited Warning Light**

The amber AIL AND RUD UNLIMITED warning light on the left side of the main instrument

panel (refer to Figure 1-19) will illuminate when the aileron and rudder travel is unlimited. This condition exists when gear is DOWN or when the gear is UP and the flaps asymmetry has been detected by the flaps asymmetry detection system.

### **STABILITY AUGMENTATION SYSTEM**

Aircraft dynamic response and handling characteristics are greatly improved through the use of a three-axis stability augmentation system. Electrical power is supplied from the XP7 AC bus. The system measures the rate-of-change of aircraft attitude and generates an electrically amplified signal. This signal moves a system of valves which in turn direct hydraulic pressure to the actuating cylinders to move the rudder, stabilizer, or ailerons to a position relative to the amount of correction necessary. This operation does not move the normal surface control linkage or have any effect upon cockpit controls. The stability augmentation system also includes a "washout" circuit which allows the pilot to execute maneuvers without interference by the stability augmentation devices.

The stability augmentation system causes the control surfaces to be deflected to correct for rapid small disturbances. The washout circuit cancels these signals in favor of pilot-initiated signals. In order to decrease the possibility of excessive pitch changes with resultant high negative-"G" forces, there is no washout circuit incorporated in the pitch axis.

Each damper channel also incorporates failsafe circuitry which causes the damper servo to drive to a hardover position in the event of certain types of circuit failures within the channel. A hardover damper servo is considered failsafe because of its limited authority.

#### **Roll, Pitch and Yaw Damper Switches**

Three guarded switches (refer to Figure 1-19) labeled STABILITY CONT, ROLL, PITCH and YAW are located on the left console. These switches are guarded in the ON position but are used to disconnect the stability augmentation control system in any one or all three axes, whenever required, by operating the switches to the OFF position. Any one or any two of the systems may be disconnected without adversely affecting stability augmentation control of the remaining system. If any one channel is turned off the automatic pilot will be disengaged (refer to Section VI "Flight Characteristics" for flight characteristics with and without stability augmentation control).

## FLIGHT CONTROL SYSTEM CONTROLS AND INDICATORS

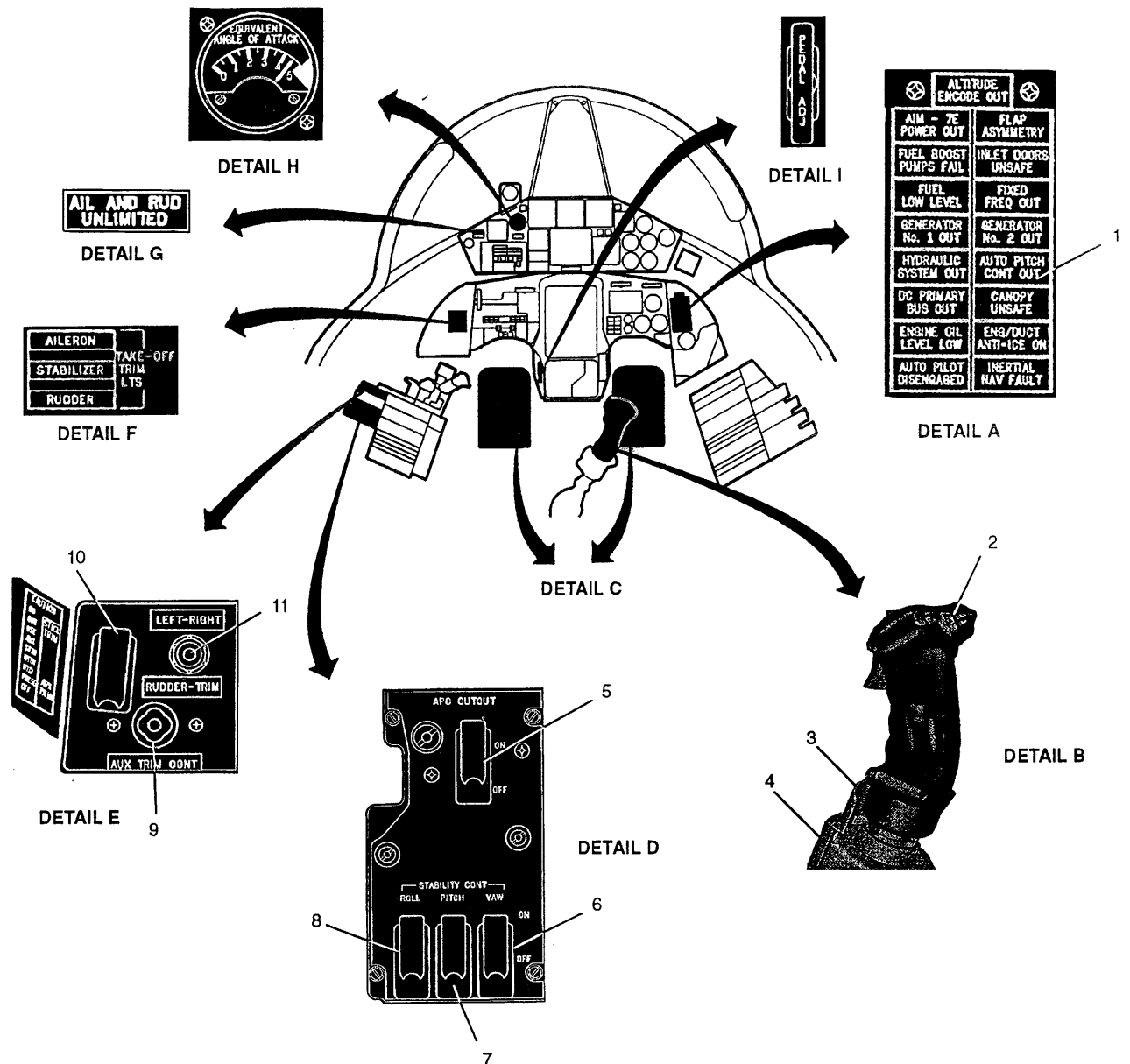

**A - WARNING LIGHTS PANEL**  
 1 AUTO PITCH CONT OUT WARNING LIGHT

**B - CONTROL STICK GRIP**  
 2 AILERON AND HORIZONTAL STABILIZER TRIM SWITCH  
 3 AUTOMATIC PILOT/APC DISENGAGE SWITCH  
 4 STICK SHAKER ASSEMBLY

**C - RUDDER PEDALS**

**D - STABILITY CONTROL PANEL**  
 5 APC CUT OUT SWITCH  
 6 YAW DAMPER SWITCH  
 7 PITCH DAMPER SWITCH  
 8 ROLL DAMPER SWITCH

**E - TRIM CONTROL PANEL**  
 9 AUXILIARY TRIM CONTROL SWITCH  
 10 AUXILIARY TRIM SELECTOR SWITCH  
 11 RUDDER TRIM SWITCH

**F - TAKEOFF TRIM INDICATOR LIGHTS**  
**G - AIL AND RUD UNLIMITED WARNING LIGHT**

**H - APC SYSTEM INDICATOR**

**I - RUDDER PEDALS ADJUSTMENT HANDLE**

Figure 1-19

FA0043

**AUTOMATIC PITCH CONTROL SYSTEM**

In the automatic pitch control system (APC) an automatic pitch actuator provides artificial stall warnings and prevents inadvertent stalls by moving the control stick approximately ½ inch forward of neutral when either the pitch rate or the angle of attack, or a combination of both, reaches a critical value.

Signals for APC operation come from APC rate gyro, and a vane-actuated, angle of attack detecting system. These signals are summed and amplified in such a manner as to produce outputs to obtain artificial buffeting and nose-down signals.

In order to avoid anomalous kicker operation due to APC rate gyro failure, the APC rate gyro output is constantly compared to the pitch damper gyro output. If the pitch rate difference is more than  $8.8 \pm 1.5$  deg/sec, the stick shaker operation and the AUTO-PITCH CONT OUT warning light will be activated while the kicker operation will be deactivated.

When a critical value is reached, signals trigger a solenoid valve to operate a small hydraulic cylinder, which causes the stabilizer to assume an aircraft nose-down deflection and the control stick to move forward.

This and the movements of the automatic pilot are the only control surface deflections that are transmitted back through the control system to the control stick. Thus the pilot is immediately made aware of an approaching stall attitude of the aircraft. A force of 40 to 50 pounds, in addition to normal control forces, applied on the stick may override the APC system.

**NOTE**

When the stick is more than ½ inch forward of neutral, the kicker will still operate; however, the kicker action will not be felt and will have no effect on the stabilizer.

Electrical power for the APC system is supplied by the XP5 AC bus. Hydraulic power is supplied from the No. 1 hydraulic system (refer to Section VI "Flight Characteristics" for additional information on this system).

**NOTE**

- A failure of, or the deactivation of the pitch damper will be felt as a sudden trim change. An intermittent failure or the reactivation of the pitch damper will result in a small rapid stick movement.
- With the APC system de-activated, the pilot is not able to predict the onset of pitch-up during rapid maneuvering flight. Pitch-up may be hazardous at any altitude and at low altitudes it may be impossible to recover from pitch-up in time to prevent an accident. Also, the dynamic motion of the aircraft during pitch-up may make it difficult to reach the seat ejection ring. Therefore, unless the system is malfunctioning, flying with the APC system deactivated is not recommended. However, if local operating procedures dictate flying with the APC system de-activated, avoid rapid maneuvers during pull-outs or turns which induce high pitch rates. Stay out of the stick shaker boundary as there is no way of knowing how far the boundary has been penetrated until pitch-up occurs. If the stick shaker boundary is penetrated inadvertently, immediately relieve the "G"-load and increase power if necessary.
- APC operation will cause the automatic pilot to disengage.

**Effect of Flaps Lever and Gear Position on APC Operation**

The stick shaker is operative in all gear and flaps positions. The kicker is inoperative either with gear down or flaps lever in LAND position.

**NOTE**

When flaps are lowered to TAKEOFF position, the angle at which the angle-of-attack sensing vane energizes the stick shaker or the kicker is automatically increased, thereby permitting aircraft maneuvering to a higher angle of attack than with flaps UP.

**WARNING**

THE ANGLE AT WHICH THE ANGLE-OF-ATTACK SENSING VANES ENERGIZE THE SHAKER OR KICKER IS DEPENDENT UPON THE WING FLAPS LEVER SETTING AND NOT THE ACTUAL POSITION OF THE FLAPS. IN NORMAL OPERATING CONDITION AFTER WING FLAPS LEVER HAS BEEN SELECTED FROM UP TO TAKEOFF (APC BOUNDARY VARIATION) AND BEFORE SAFE TAKEOFF INDICATION IS ACHIEVED A TIME INTERVAL OF 7/8 SECONDS EXISTS. THEREFORE INCREASING THE LOAD FACTOR (AOA) DURING THIS TRANSIENT CAN CAUSE A PITCH-UP WITH NO PREVIOUS SHAKER OR KICKER OPERATION.

**NOTE**

A single APC system malfunction will not result in a kick if the landing gear is down or flaps lever is in LAND position.

**Stick Shaker Stall Warning**

A control stick shaker stall warning has been incorporated in the APC system. The shaker will operate when pitching velocity or angle of attack, or a combination of both, reach a value which is slightly less than that which the APC system requires for kicker actuation. When energized, electrical power from the PP2 DC bus activates an eccentric motor on the control stick which agitates it in a rotary

motion. This shaking is a warning that a stall condition is imminent. Stick shaking will commence before the automatic pitch kicker is actuated (refer to Section VI "Flight Characteristics" for additional information on this system).

**NOTE**

- When the flaps are lowered to TAKEOFF or LAND position, the angle at which the angle-of-attack sensing vane energizes the stick-shaker motor is automatically increased, thereby permitting operation at a higher angle of attack than with flaps UP.
- No switch is provided to deactivate the stick shaker; however, a circuit breaker (refer to Figure FO-8) on the left console may be used to deactivate the shaker, if necessary.

**WARNING**

DEACTIVATING THE STICK SHAKER, BY PULLING THE STICK SHAKER CIRCUIT BREAKER, THE "AUTO-PITCH CONT OUT" WARNING LIGHT ILLUMINATES; HOWEVER, THE APC KICKER REMAINS OPERATIVE. IF IT IS NECESSARY TO PULL THE STICK SHAKER CIRCUIT BREAKER IN FLIGHT, OBSERVE THE EMERGENCY PROCEDURES UNDER STICK SHAKER FAILURE IN SECTION III SINCE THERE WILL BE NO FURTHER VISUAL INDICATION OF AN APC KICKER FAILURE.

**CAUTION**

IF THE STICK SHAKER MOTOR IS OPERATED CONTINUOUSLY FOR LONGER THAN 6 MINUTES, DAMAGE MAY RESULT FROM OVERHEATING.

### APC Cutout Switch

An APC system cutout switch (refer to Figure 1-19) is located on the left console and is guarded in the ON position. The OFF position is used to de-energize the APC kicker if necessary. Power for the switch is received from the XP5 AC bus. When the switch is in the OFF position the AUTO PITCH CONT OUT warning light illuminates.

#### NOTE

The APC system cutout switch does not deactivate the stick shaker, however, it will disengage the autopilot.

An APC emergency disconnect switch is installed on the control stick, approximately below the grip. For emergency disconnect of the APC kicker, activate the emergency APC disconnect switch and hold. If permanent deactivation of the APC kicker is desired, the emergency switch should be held in the activated position until the APC cutout switch is turned to the OFF position.

### Automatic Pitch Control System Indicator

An automatic pitch control (APC) system indicator (refer to Figure 1-19) is located on the upper left side of the main instrument panel.

The indicator (which is actuated by the combination of the APC rate gyro and the right vane) is used throughout the flight to inform the pilot of the aircraft's relation to the stall condition, as well as to ascertain that the APC system is operating. The indicator dial is graduated from 0 to 5 with a red area over 5, the point at which the APC kicker becomes effective.

#### NOTE

The indication is still available even if the APC cutout switch or the APC emergency disconnect switch have been operated.

### Automatic Pitch Control Out Warning Light

The AUTO-PITCH CONT OUT warning light on the warning lights panel will illuminate if the APC

system malfunctions or the No. 1 hydraulic system fails. This warning light is provided to warn the pilot that more attention will be required to prevent a stall by avoiding higher accelerations and low airspeed.

#### WARNING

WHEN THE "AUTO-PITCH CONT OUT" WARNING LIGHT IS ILLUMINATED, THE PILOT SHALL EXERCISE CARE TO PREVENT STALLS BY AVOIDING HIGH ANGLES-OF-ATTACK AND LOW AIRSPEEDS.

#### NOTE

The AUTO-PITCH CONT OUT warning light and CAUTION light may flicker during ground checks or change of wing flaps lever position. This condition is normal, provided the CAUTION light does not stay illuminated.

## TRIM CONTROL SYSTEM

### Aileron, Stabilizer, and Rudder

The aileron trim actuators are mechanically connected to the trim motor by flexible driveshafts and provide electrical trim of the control surfaces by movement of the servovalve assembly input linkage arms. The stabilizer and rudder trim actuators are directly connected to the servovalve assembly input linkage arms.

Movement of the input linkage arms causes deflection of the control surfaces to a trimmed position but does not move cockpit controls. The trim motors are powered by the PP2 DC bus. The aileron actuator contains cam-actuated, up-and-down limit switches.

The stabilizer and rudder trim actuators do not have limit switches, but utilize nonjamming mechanical stops to limit the travel.

<b>CAUTION</b>
----------------

- DO NOT USE PRIMARY OR AUXILIARY TRIM CONTROL WITHOUT HYDRAULIC PRESSURE AS THIS MAY DAMAGE THE TRIM MOTOR.
- CONTINUED OPERATION, IN SAME DIRECTION AFTER REACHING EXTREME LIMIT OF TRIM TRAVEL, SHOULD BE AVOIDED TO PREVENT POSSIBLE OVERLOADING OR BURN-OUT OF TRIM MOTOR.

#### Control Stick Aileron and Stabilizer Trim Switches

Normally, roll and pitch trim control is provided by a spring-loaded, thumb-actuated switch located on top of the control-stick grip (refer to Figure 1-18 and Figure 1-19). Movement of the switch to the left causes a left aileron up, right aileron down operation of the trim motor and trim actuators. Switch movement to the right causes a reverse operation. Forward movement of the switch causes a stabilizer leading edge up (aircraft nose down) operation of the trim motor and actuator. Aft movement causes reverse operation. The switch is powered by the PP2 DC bus.

**Auxiliary Trim Selector Switch.** A two-position, guarded trim selector switch (refer to Figure 1-19) is located on the left console and is labeled STICK TRIM and AUX TRIM. If failure of the control stick trim switch occurs, the selector switch allows use of the auxiliary trim switch for control of the stabilizer and aileron trim circuits. The switch is powered by the PP2 DC bus.

**Auxiliary Trim Control Switch.** A spring-loaded toggle switch (refer to Figure 1-19) is located on the left console. This switch produces the same effects as the control stick trim switch, provided the auxiliary trim selector switch is in the AUX TRIM position. The switch is labeled AUX TRIM CONT and functions as an auxiliary, or standby switch, to be used if the control-stick trim switch fails. The switch receives power from the PP2 DC bus.

**Rudder Trim Switch.** Directional trim control is provided by a three-position toggle switch (refer to Figure 1-19) located on the left console. The switch is spring-loaded to the center position from the LEFT and RIGHT positions and is used to control PP2 DC bus-powered trim motor to position the rudder in a trimmed position.

#### Stabilizer, Aileron, and Rudder Takeoff Trim Indicator Lights

Three trim indicator lights, located on the left forward panel (refer to Figure 1-19), are provided to indicate takeoff trim position of the flight control surfaces. When illuminated, the lights read AILERON, STABILIZER and RUDDER. With the aircraft on the ground, the trim lights will illuminate whenever the trim motors are run through the take-off trim position by operating the trim switch, and will extinguish when the switch is released.

<b>CAUTION</b>
----------------

DO NOT USE PRIMARY OR AUXILIARY TRIM CONTROL WITHOUT HYDRAULIC PRESSURE AS THIS MAY DAMAGE THE TRIM MOTORS.

The AILERON trim indicator light will operate both on the ground and airborne. The STABILIZER trim indicator light will remain illuminated (on the ground only) when the stabilizer takeoff trim is set, and the trim switch is released. When airborne, operation of the stabilizer and rudder trim lights is prevented by the actuation of the airground safety switch. The three lights may be tested by operating the warning lights system test switch. Power for the lights is provided by the PP2 DC bus.

#### Stabilizer Trim Marker

A black "T" (refer to Figure 1-20) painted on the right side of the vertical stabilizer is used as a takeoff trim index. When trim is set for takeoff, the leading edge of the horizontal stabilizer should be aligned with the index. The pilot should obtain ground confirmation that the stabilizer is within the correct tolerance.



## STABILIZER TRIM MARKER

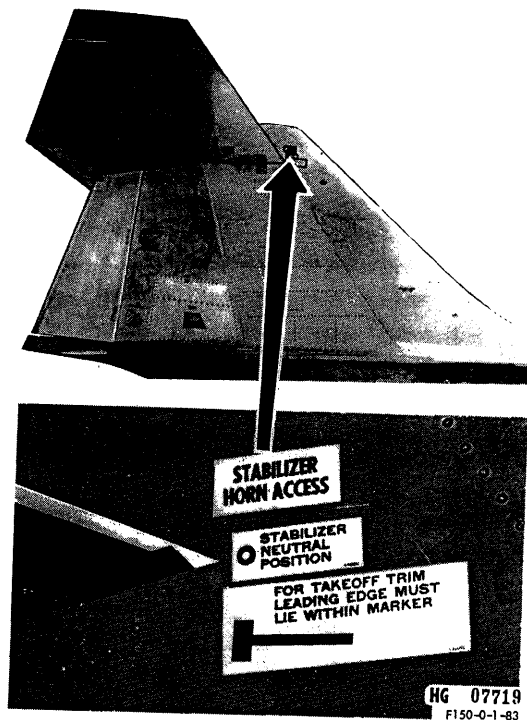

Figure 1-20

## WING FLAP SYSTEM

The wing flap system comprises a set of trailing edge flaps and a set of leading edge flaps. The trailing edge flaps are attached to the aft beam of each wing panel, between the wing fillets and the inboard end of the ailerons and are hinged at the forward lower edge. The leading edge flaps form the leading edge of each wing, between the fuselage and the wing-tip fairings; they are hinged at the aft lower edge. Both sets of flaps are actuated when the wing flaps lever is operated. Each set is electrically connected by a control circuit, and mechanically connected by flexible driveshafts; the trailing edge and leading edge flaps are only electrically interconnected by the control circuit. Each set of flaps is operated by two AC motor powered actuators. One motor is capable of operating a set of flaps, at a reduced rate, if the other is inoperative.

However, when only one actuator is functional, it is possible to overload the actuator motor causing

the actuator to disengage from the flaps gear train. The flaps will stop in an intermediate extended position, and a continuous barber pole indication will appear on the wing flaps position indicator. The actuator motor will continue to run under this condition unless the wing flaps lever is returned to the prior position, (thus reversing the motor). Refer to Section III "Emergency Procedures" "Flap Failure" procedures.

A leading edge flap lock is incorporated in the flap system to lock the flaps up. Each leading edge flap is provided with a locking assembly and lock actuator, the left flap lock and actuator being driven by the PP3 DC bus-powered motor, and the right flap lock actuator by the left lock actuator through an interconnecting flexible driveshaft. A boundary layer control system is automatically operated when the wing flaps are in the landing configuration.

Whenever the ram air turbine is extended for electrical power, and the wing flaps lever is moved to the TAKEOFF position, a wing flap sequencing system operates automatically to prevent electrical power from going to the leading edge flaps until the trailing edge flaps have moved to TAKEOFF position. This sequence reduces the electrical demands on the ram air turbine-driven generator under emergency conditions. The control circuit for the flaps receives power from the PP3 DC bus and the actuating power is from the XP4 AC bus. During sequenced flaps travel the PP2 bus is deenergized.

### Trailing Edge Flap Asymmetry Detection System

The trailing edge wing flap asymmetry detection system consists of a cam-actuated switch assembly mounted on a plate which is driven by the right-hand flap. The left-hand flap drives a disc cam. During symmetrical flaps travel, the switch roller rides in the cam detent. In the event of asymmetrical flaps travel in excess of  $3.5^\circ (\pm 1^\circ)$ , the switch roller rides out of the detent causing the switch to open the trailing edge flaps control circuit, stopping further flap travel. Thus, trailing edge flaps will not exceed approximately  $3.5^\circ (\pm 1^\circ)$  of asymmetry; therefore, a safe landing may be accomplished. However, if trailing edge flaps travel has been stopped by the asymmetry switch, thus preventing further operation of the trailing edge flaps, the landing shall be accomplished in whatever trailing edge flaps configuration existed at the time asymmetry occurred.

The detection of an asymmetrical condition of the trailing edge flap, will also cause the illumination of the FLAP ASYMMETRY warning light on the warning lights panel (refer to Figure 1-21), the disengagement of the aileron and rudder limiter and the

**WING FLAP SYSTEM CONTROLS AND INDICATORS**

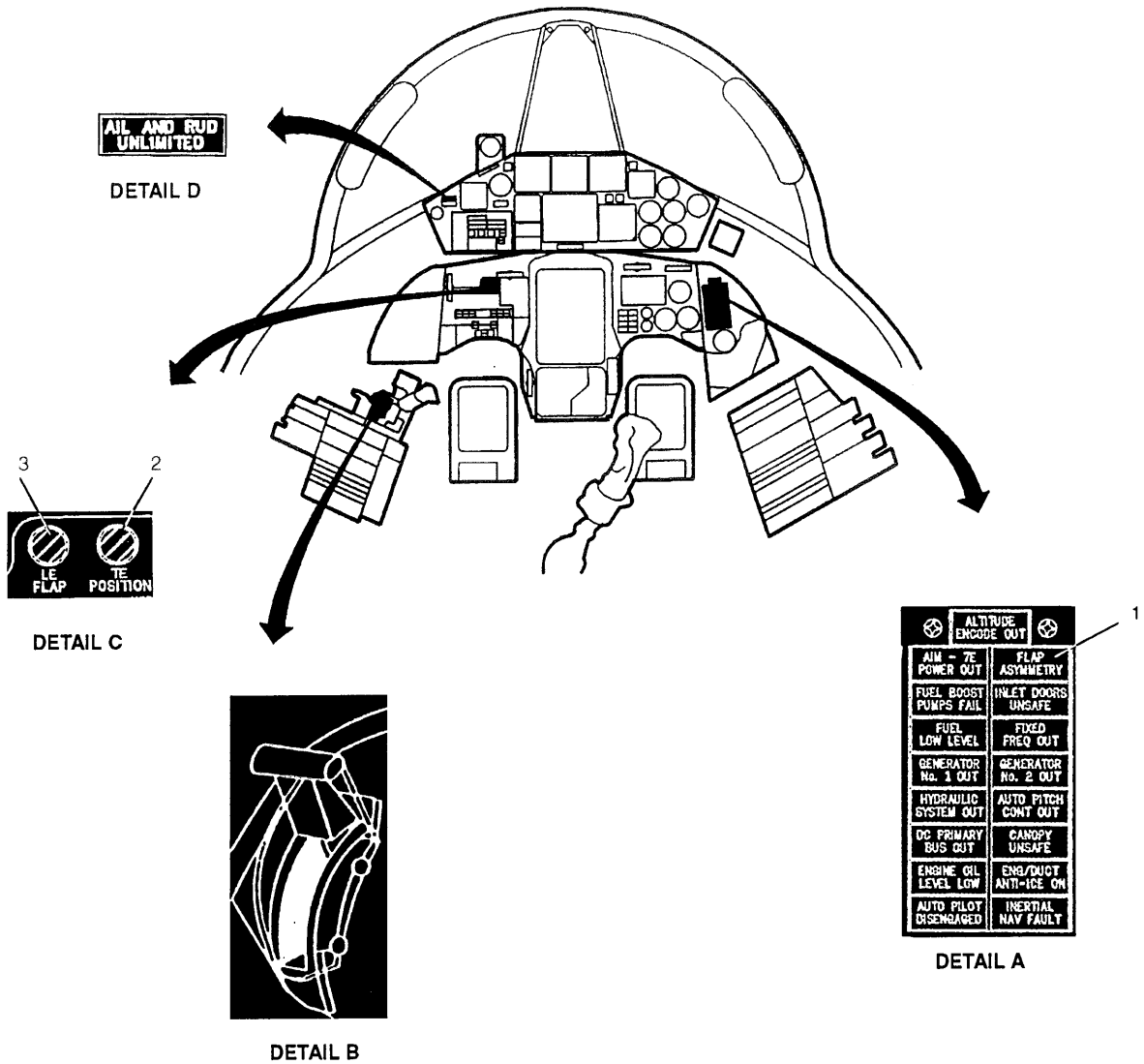

- A – WARNING LIGHTS PANEL**
- 1 FLAP ASYMMETRY WARNING LIGHT
- B – WING FLAPS LEVER**
- C – WING FLAPS POSITION INDICATORS**
- 2 TRAILING EDGE FLAPS
- 3 LEADING EDGE FLAPS
- D – AIL AND RUD UNLIMITED WARNING LIGHT**

Figure 1-21

illumination of AIL AND RUD UNLIMITED warning light. If flaps return to a symmetrical conditions, the flaps will move to the selected position, the limiters will engage, the FLAP ASYMMETRY and the AIL AND RUD UNLIMITED warning lights will extinguish.

### NOTE

The trailing edge flap asymmetry detection system will not detect asymmetry nor affect operation of the leading edge flaps.

### Wing Flaps Lever

The wing flaps lever is located immediately to the left of the throttle. The lever positions are UP, TAKEOFF, and LAND. A spring-loaded guard prevents inadvertent pulling of the lever from the UP position. Both leading and trailing edge flaps are controlled by the wing flaps lever. Selection of the TAKEOFF position will extend the leading edge flaps and trailing edge flaps 15° from faired.

In the LAND position, the leading edge flaps extend 30° from faired and the trailing edge flaps extend 45° from faired. In the UP position both sets of flaps will retract to the UP (faired) position however, the position indicator will not indicate UP until the leading edge flaps are fully retracted and locked.

When moving the wing flaps lever from the LAND to the UP position, the lever will latch at the TAKEOFF position. In order to release the latch, the lever shall be pulled back (toward LAND) approximately ¼ inch. The lever may then be moved forward to the UP position.

The wing flaps are electrically powered by the PP3 DC bus.

### Wing Flaps Position Indicators

Position indicators (refer to Figure 1-21) for the trailing and leading edge flaps are located on the left side of the lower instrument panel. The right indicator is for the trailing edge flaps and the left indicator is for the leading edge flaps.

Two windows are provided and are labeled FLAP POSITION, LE, and TE. Flap position indications for leading and trailing edge flaps are given in their respective windows. UP, T.O., or LAND rotates into view in each window to correspond with flaps deflection.

Crosshatched indications appear in the window when the flaps are between placarded positions, in any position other than that selected, or when the electrical system is not energized. The indicators are powered by the PP1 DC bus.

### NOTE

The leading edge wing flaps position indicator will not indicate flaps UP until both leading edge flaps are fully retracted and locked. The indicator will not indicate UP until both leading edge flaps are up and both leading edge flap latches actuate the series-wired switches installed in the latches.

### Trailing Edge FLAP ASYMMETRY Warning Light

The trailing edge FLAP ASYMMETRY warning light on the warning lights panel, illuminates immediately upon actuation of the asymmetry detection system thus warning the pilot of the asymmetrical flaps condition. The light is controlled through a relay powered by the PP3 DC bus.

## BOUNDARY LAYER CONTROL (BLC) SYSTEM

Air is bled from the last compressor stage of the engine and ducted to the boundary layer control (BLC) manifold, which is located above the trailing edge flap hinge line (refer to Figure 1-22).

The boundary layer control manifold has a series of nozzles which direct this high-pressure, high-temperature air over the upper surface of the flaps when the LAND position is used. The high velocity created by this jet of air causes it to adhere to the curved fairing and bend around and pass over the upper surface of the flaps.

This curving jet causes the adjacent layer of air to adhere and bend through the flaps-deflection angle, thus preventing airflow separation. This results in a reduced landing speed. The system operation is completely automatic.

### Boundary Layer Control Valve

Since boundary layer control is used only with a 45° flaps setting there is no airflow for flaps angles of

## BOUNDARY LAYER CONTROL DUCT SECTION

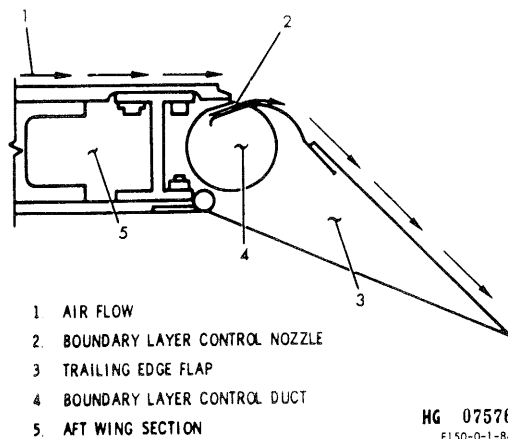

Figure 1-22

15° or less. This is accomplished by a valve which is mechanically driven by the flaps actuator; thus, the position of the valve always corresponds to that of the flaps.

The valve butterfly remains closed from 0° to 15° flaps angle; for angles greater than 15°, the valve moves until it is full open at 45°.

## SPEED BRAKE SYSTEM

The speed brakes consist of two flaps, one on the left and one on the right side of the fuselage, just aft of the trailing edge of each wing. Total projected area of the speed brakes is approximately 8.25 square feet. The flaps move both outward and aft as they are extended by hydraulic cylinders. Maximum outward deflection is approximately 52° from retracted (faired) position.

The speed brakes are electrically controlled by power from the PP2 DC bus and hydraulically actuated by the No. 2 hydraulic power supply system through the priority valve. The priority valve will close and prevent speed brakes operation if the No. 2 hydraulic system pressure drops to below 2175 psi. The speed brakes close automatically in the event of electrical power loss, because of a solenoid-operated valve in the system that fails to the closed position, allowing normal hydraulic pressure or windmilling engine hydraulic pressure to close the

speed brakes. No position indication is provided for the speed brakes.

**Speed Brakes Switch.** The speed brakes switch is a thumb-actuated, slide-type switch located on top of the throttle lever (refer to Figure 1-23); it is powered by the PP2 DC bus. The three positions are IN, NEUTRAL, and OUT. Incremental positioning of the speed brakes may be made by moving the switch back to the NEUTRAL position, which hydraulically locks the speed brakes in any intermediate position between OUT and IN.

## LANDING GEAR SYSTEM

The aircraft is equipped with two main landing gears and a nose landing gear. Normally, the landing gear system is hydraulically operated (No. 2 hydraulic power supply system) and electrically controlled by the PP2 DC bus. Normal extension time of the landing gear is  $\leq 6$  seconds while retraction time is  $\leq 7$  seconds. The gear may be recycled, if necessary, before reaching either the full up or full down position. A manual release system is provided for emergency extension of the gear: extension time is  $\leq 6$  seconds. There is no means of retracting the landing gear in flight after an emergency extension.

### Main Landing Gear

The main landing gear retracts forward and inward. A linkage causes the wheels to rotate 90° during retraction so that they fit into the wheel wells. Each main gear when retracted is enclosed by a forward and aft door. The forward door is hydraulically operated, while the aft door is mechanically linked to the gear and travels up and down with it. The doors are locked in the closed position by four latches on the fuselage structure. The latches also serve as main-gear uplocks because, in the event of hydraulic pressure loss, the doors support the gear in the closed position. The forward door is held open by hydraulic pressure and air loads while the gear is being extended.

During normal operation, after the gear is extended, the forward door is returned to within 4 inches of the fully closed position and held there by a mechanical detent. The main gear is locked in the down position by the drag strut cylinder assembly. Barrier engagement fingers are located on the forward doors to retain the barrier cable during low-speed engagements. When the gear is extended by the manual release the forward doors remain in the open position. Ground safety lockpins are provided

### SPEED BRAKES CONTROL

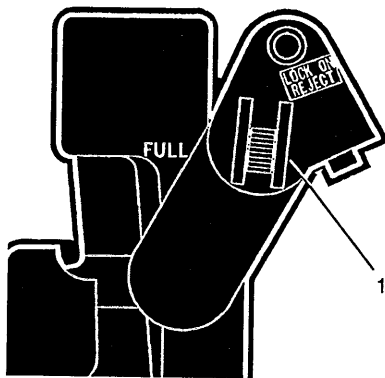
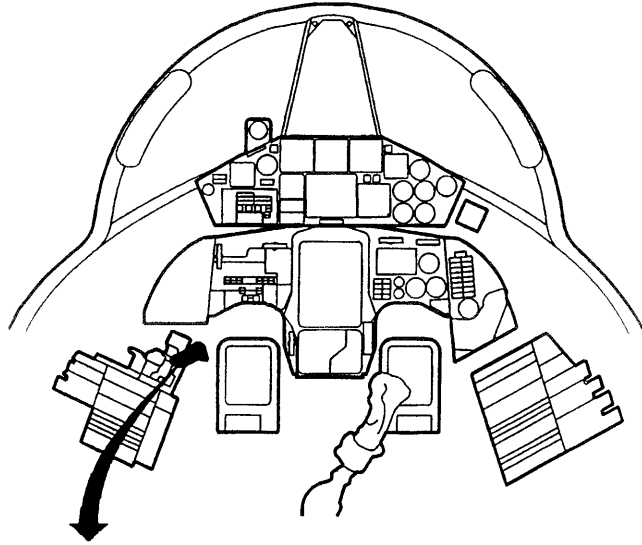

- A - ENGINE THROTTLE
- 1 - SPEED BRAKES SWITCH

DETAIL A

FA0044

Figure 1-23

for manual installation in the downlock linkage at the forward end of the drag strut cylinder (refer to Figure 1-24) of each gear.

### Nose Landing Gear

The forward retracting nose gear incorporates a conventional air-oil shock strut. When the nose gear is retracted, it is enclosed by two doors that are mechanically operated through contact with the nose gear strut. When the gear is extended, a downlock mechanism serves to lock the knee joint in the extended position.

An uplock cylinder is mounted on the drag strut support beam and is linked to an uplock hook mounted on the upper drag strut pin. The uplock hook engages a lug on the nosewheel fork to lock the gear up. A ground safety pin is provided for manual installation on the downlock stop cartridge (refer to Figure 1-24). The nose gear is steerable by the rudder pedals (Refer to Nosewheel Steering System paragraph).

### Landing Gear Lever

The landing gear lever (refer to Figure 1-25) is located on the left forward panel. The lever has two positions, UP and DOWN. The lever electrically controls the landing gear and landing gear door hydraulic selector valves. When the lever is moved to the UP position, selector valves which are electrically sequenced to direct hydraulic pressure to open the main gear forward doors, retract the nose and main gear (and aft doors), and then reclose the main gear forward doors.

The nose gear doors are mechanically connected to the nose gear strut and open and close with nose gear extension and retraction. When the landing gear lever is moved to the DOWN position the selector valves direct hydraulic pressure to lower the nose gear, open the main gear forward doors, and lower the main landing gear (which opens the aft main gear doors). When the gear reaches the down-and-locked position, hydraulic pressure is automatically selected to close the main forward doors to the mechanical detent position.

**Landing Gear Lever Uplock Button.** A landing gear lever uplock mechanism is provided to prevent the gear lever from being lowered inadvertently. A button, which extends upward from the top of the

landing gear lever is used to release the lever uplock mechanism.

**Landing Gear Lever Override Button.** A landing gear lever override button labeled DOWN-LOCK MECH OVERRIDE (refer to Figure 1-25) is provided just above the landing gear lever. The button is used in an emergency to override the lever downlock if it becomes necessary to raise the gear when the weight of the aircraft is on the landing gear. When the aircraft is on the ground with the gear down and locked, a solenoid-operated locking mechanism locks the landing gear lever in the DOWN position.

This locking mechanism is provided with a mechanical downlock bypass, operated by the push-button. When the weight of the aircraft is off the nose landing gear, PP2 DC bus power is directed to the control lock solenoid which permits the lever to be moved to the UP position.

### Manual Landing Gear Release Handle

A yellow handle (refer to Figure 1-25), located below the main instrument panel on the left side, is labeled MAN LDG GEAR; its purpose is to release the main and nose landing gear door uplocks and to open the dump valve, which allows the gear to lower by gravity and air-load forces.

The gear is then locked down by spring-loaded downlocks. Approximately a 10-inch pull (up to 50 lb force) to the top is required to release the gear. The landing gear is not capable of being retracted in flight after being lowered by means of the manual landing gear release handle.

If the manual landing gear release handle is used to lower the landing gear, the gear shall not be retracted until the system valve is repositioned manually prior to the next flight.

### CAUTION

GEAR EXTENSION BY MEANS OF THE MANUAL LANDING GEAR RELEASE HANDLE WILL RENDER THE ANTISKID BRAKES INOPERATIVE AND BRAKING WILL REVERT TO THE STANDBY MASTER BRAKE SYSTEM.

## LANDING GEAR GROUND SAFETY PINS

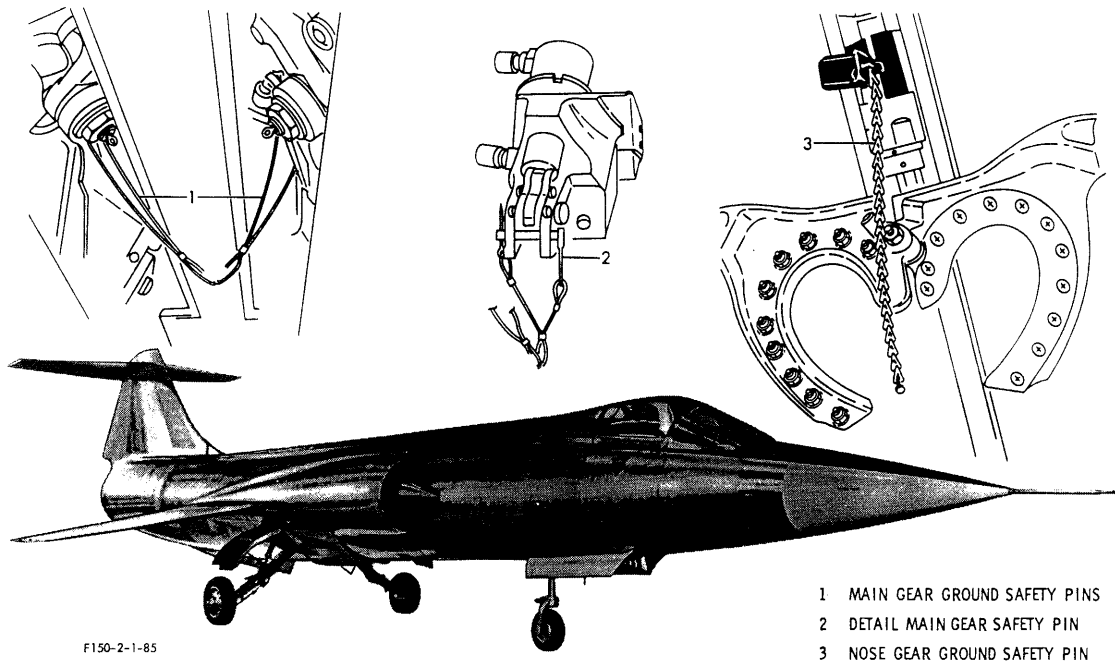

Figure 1-24

### Landing Gear Position Indicator Lights

Three green lights (refer to Figure 1-25), labeled LG INDICATORS, are installed on the left side of the lower main instrument panel. When the lights are illuminated they indicate that the respective landing gear is down and locked. As each gear reaches the down-and-locked position, power from the PP2 DC bus is directed through the warning light circuit to illuminate the indicator light. The lights go out any time the gear is not down and locked, except when they are energized by the warning light test switch.

### Landing Gear Lever Unsafe Warning Light

A red warning light is installed in the transparent knob of the landing gear lever. This light provides

the pilot with a visual signal whenever the landing gear is not in the position selected. The light receives power from the PP2 DC bus.

### NOTE

- Once a landing gear is retracted and the warning light is extinguished, the landing gear circuit is made insensitive to sequencing switch malfunctions and will remain in the UP position until the landing gear handle is placed in the DOWN position.

## LANDING GEAR SYSTEM CONTROLS AND INDICATORS

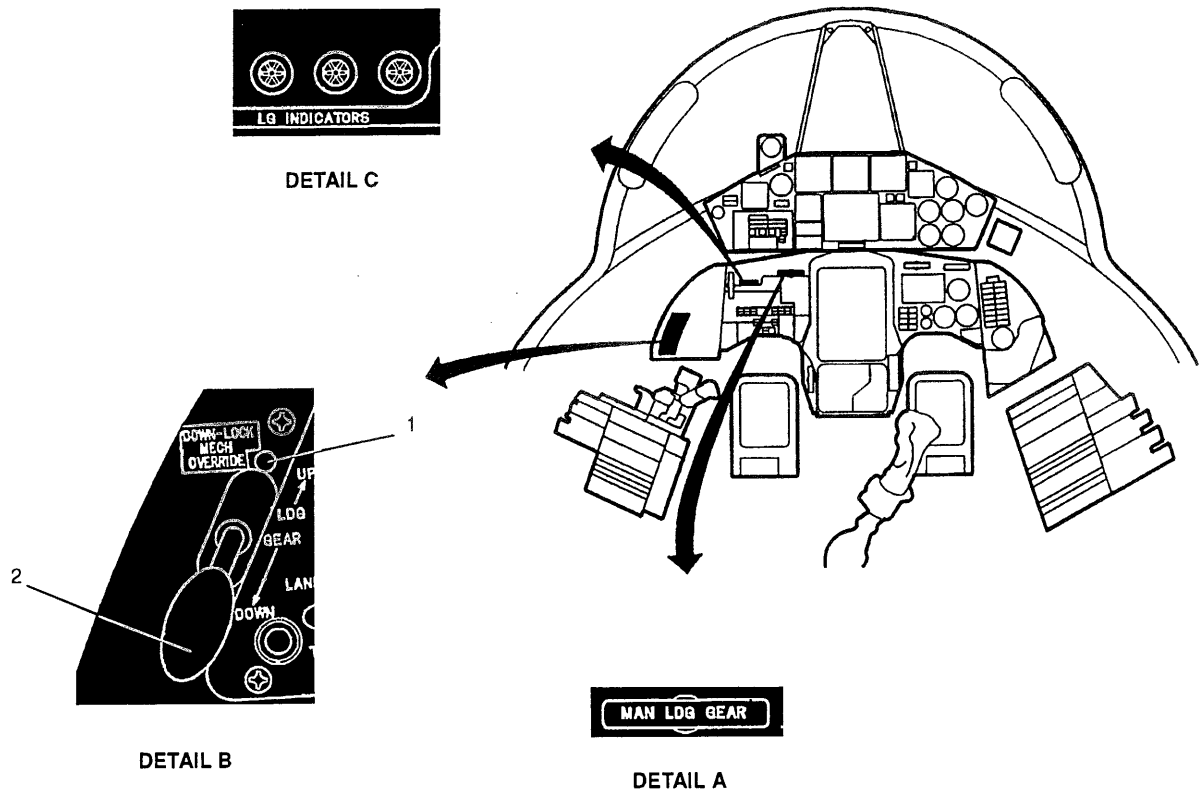

- A - MANUAL LANDING GEAR RELEASE HANDLE
- B - LEFT FORWARD PANEL
  - 1 LANDING GEAR LEVER OVERRIDE BUTTON
  - 2 LANDING GEAR LEVER
- C - LANDING GEAR POSITION INDICATOR LIGHTS

FA0045

Figure 1-25



- If the warning light flickers once the gear is up and locked, this indicates improper tolerances in the door microswitches; however, the gear and doors will remain up and locked. If this happens, the mission may be continued but the incident should be written up in the aircraft forms.
- If the warning light comes on steadily, this indicates a possible malfunction of the uplock relay. In this condition, the gear could be back under control of the sequencing switches. High positive or negative "G" maneuvers should be avoided, and the mission aborted.

### Landing Gear Warning Signal

A landing gear warning signal, relative to engine speed and air data computer sensing (altitude and airspeed) is transmitted to the pilot's earphones through the interphone system when the landing gear is not down and locked.

If the gear is up and the throttle is retarded below 95% to 97% RPM, the aircraft is below 10000  $\pm$  1000 feet, and the airspeed is less than 220  $\pm$  10 KIAS, the warning signal will be generated. Also, anytime the gear is unsafe, i.e., unlocked, and the throttle is retarded below 95%  $\div$  97% RPM, the warning signal will be transmitted regardless of airspeed or altitude. In addition, the landing gear lever unsafe warning light will illuminate anytime the landing gear warning signal is generated. The signal system receives power from the PP2 DC bus.

## NOSEWHEEL STEERING SYSTEM

The steering system provides power steering for the nosewheel when the aircraft is on the ground. The nosewheel is steerable 25° either side of center. The aircraft is steered by a hydraulically powered steerdamper unit controlled through a cable system by the rudder pedals. No. 2 hydraulic power supply system pressure is routed to the steering system through a solenoid shutoff valve, a filter, and a pressure-reducing valve that reduces system pressure from 3000 to 2500 psi. The solenoid shutoff valve is controlled by a button on the control-stick grip.

The system is irreversible in that forces on the nosewheel are not transmitted back to the rudder pedals. Upon retraction, the nosewheel automatically centers.

### NOTE

The ground-air safety switch and relay are connected to the shutoff valve circuit in a way which ensures that the steering system is inoperative unless the weight of the aircraft is on the main landing gear.

### Steer-Damper Unit

The steer-damper unit transforms hydraulic pressure into steering force when the unit is pressurized and when nosewheel steering is engaged. When unpressurized, the unit absorbs shock loads and dampens nosewheel shimmy. When pressure is applied, an internal clutch engages the unit with the rudder cables through a control pulley.

### Nosewheel Steering and Microphone Button

A button (refer to Figure 1-26) mounted on the control-stick grip engages the nosewheel steering system. When the button is pressed and held pressed, PP1 DC bus power is directed to a shutoff valve which directs No. 2 hydraulic power supply system pressure to the nosewheel steering unit. A clutch is then engaged hydraulically to link the rudder controls with the steering unit when rudder pedals and nosewheel are aligned.

### NOTE

- The nosewheel steering and microphone button should not be actuated unless the nosewheel and rudder pedals are aligned. If the pedals are deflected when the nosewheel steering and microphone button is actuated, clutch friction within the steering system may cause an undesired turn as the pedals are moved to align with the nosewheel.

## NOSEWHEEL STEERING SYSTEM CONTROLS AND INDICATORS

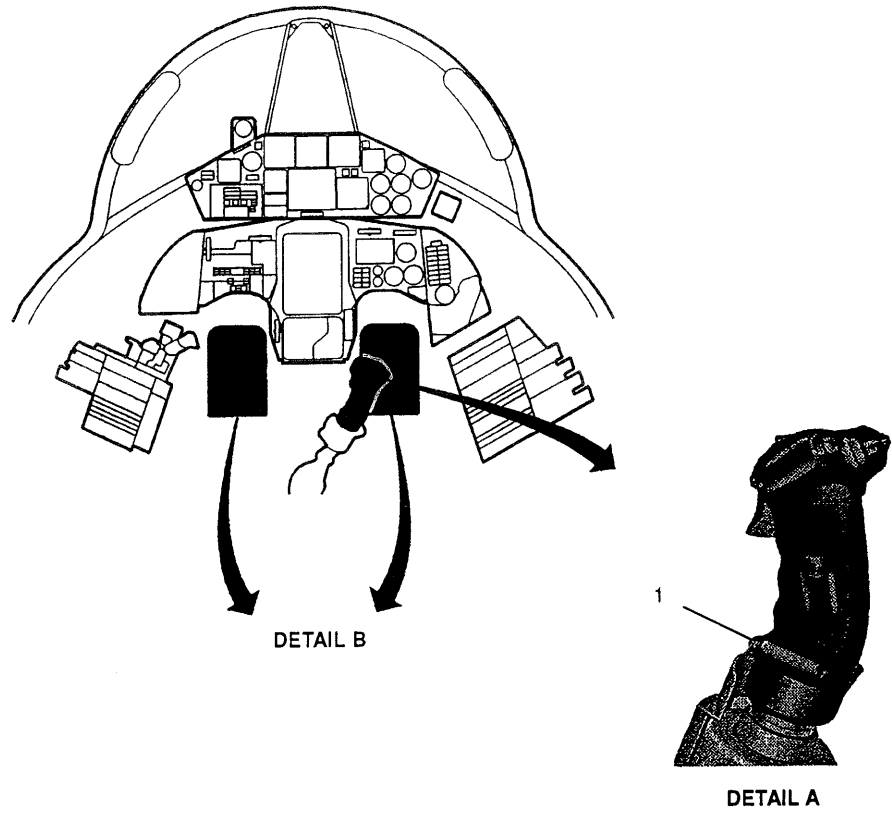

- A - CONTROL STICK GRIP
- 1 NOSE WHEEL STEERING/MICROPHONE BUTTON
- B - RUDDER PEDALS

FA0047

Figure 1-26

- The nosewheel steering and microphone button will energize nosewheel steering only if PPI DC bus power is available and the weight of the aircraft is on the main gear and/or nosewheel.
- With the weight of the aircraft off the main gear, the nosewheel steering and microphone button functions as a microphone button for the AN/ARC-150 radio and emergency UIIF radio, and will activate the identification-of-position pulse of the IFF/SIF if the IDENT-OUT-MIC switch is in MIC position.

to the three-way, solenoid-operated shutoff valve which in turn controls brake pressure. This valve is electrically energized from the PPI DC bus and dumps brake pressure (independently for each brake) when an incipient skid causes a sudden drop in generator output. Upon recovery of wheel speed, the valve is de-energized, allowing pressure to be reapplied to the brake.

A pressure switch is located in the landing gear hydraulic down line which closes when the gear is extended on the normal system. This, in series with the antiskid switch, energizes the antiskid system. The electrical system includes a "touchdown circuit" which prevents application of brake pressure until after touchdown.

A fail-safe circuit is also included which automatically shuts off the power brake system (and antiskid control) in the event of a malfunction which would prevent the application of brake pressure for longer than 3 seconds. The braking operation will then automatically return to the standby system.

## WHEEL BRAKE SYSTEM

Each main gear incorporates a hydraulic brake assembly. The brakes are of the self-adjusting, segmented rotor type. They are actuated by pressure supplied by the No. 2 hydraulic power supply system or the standby master brake system. Normally, the hydraulic power system with antiskid control is used. The standby master brake system is automatically available as an emergency backup to the power system.

### Power Brake/Anti-Skid System

Normally, the brakes are operated by a hydraulic power system which incorporates an anti-skid control. No. 2 hydraulic power supply system pressure at 3000 psi is delivered to the system through the landing gear down line.

Hydraulic pressure is directed to the brake assemblies through a solenoid shutoff valve and power brake valves. The power brake valves are controlled conventionally by toe pressure on the rudder pedals. The valves meter and control hydraulic pressure up to 1000 psi maximum to the right or left wheel brake through three-way, solenoid-operated shutoff valves.

Anti-skid action is accomplished by means of a DC generator, located in each main gear axle. The output voltage of each generator is proportional to wheel speed. This voltage controls electrical current

### NOTE

- The power brake system is not available separately from the anti-skid system except at speeds below 10 knots.
- At speeds below 10 knots, the output of the DC generators is too low for anti-skid operation. The brakes at these low speeds operate as straight power brakes; hence, with maximum braking the wheels will lock and skid when the speed drops below 10 knots.
- During the time the speed brakes move from open to closed, or closed to open, nosewheel steering and/or power brakes may be momentarily inoperative; also, antiskid brakes, if on, may automatically revert to manual. Upon completion of the movement of the speed brakes, nosewheel steering becomes available; however, it may be necessary to move the rudder pedals to re-engage the steering. The brakes will revert automatically to power/antiskid.

### Standby Master Brake System

The standby master brake system operates conventionally by toe pressure applied on the rudder pedals connected to a master brake cylinder which is integral with the power brake valve. The system is supplied by fluid from the hydraulic return lines. A small reservoir is incorporated in the return system for fluid supply when the return system (aircraft reservoir) is not pressurized.

The system will be available under any of the following conditions:

- antiskid switch OFF
- operation of fail-safe circuit in the antiskid system
- loss of electrical power supply
- loss of hydraulic power supply system pressure
- after manual gear extension.

### Antiskid Switch

The antiskid switch (refer to Figure 1-27) is located on the left forward panel. With the landing gear extended on the normal system and the switch in the ON position, electrical power from the PP1 DC bus is available for operation of the antiskid system.

### Anti-Skid Light

An amber light (refer to Figure 1-27) labeled ANTISKID is located on the left forward panel. The light illuminates with the anti-skid switch ON, the aircraft airborne, and the landing gear extended on the normal system.

The anti-skid light indicates to the pilot the following:

- a. When illuminated in the air – the system is ready for use and brake pressure shall not be applied until after touchdown.
- b. Light off after touchdown – brake pressure may be applied through the anti-skid system.

- c. Light on after touchdown – the anti-skid system is not functioning properly and the fail-safe circuit has shut off the power brake system. Brake pressure will be applied through the standby master brake system.

### WARNING

IF THE GROUND AIR SAFETY SWITCH DOES NOT CLOSE AFTER TOUCHDOWN, THE "ANTI-SKID" LIGHT WILL REMAIN ON AND THE SWITCH WILL HAVE TO BE SET TO OFF TO SELECT STANDBY BRAKES. UNDER THIS CONDITION, NOSEWHEEL STEERING WILL BE INOPERATIVE.

## DRAG CHUTE SYSTEM

A drag chute is provided to reduce landing distances. The chute, packed in a deployment bag, is stowed in a compartment located in the lower part of the aft fuselage. Deployment is mechanically controlled from the cockpit.

### CAUTION

- DUE TO THE POINT OF ATTACHMENT OF THE DRAG CHUTE, IT CAUSES AN AIRCRAFT NOSE-DOWN PITCHING MOMENT WHEN DEPLOYED; THEREFORE, IT SHOULD NOT BE DEPLOYED UNTIL THE NOSEWHEEL IS ON THE GROUND AND SPEED IS BELOW THE DESIGN LIMIT OF THE CHUTE DETAILED IN SECTION V "OPERATING LIMITATIONS".

# WHEEL BRAKE SYSTEM CONTROLS AND INDICATORS

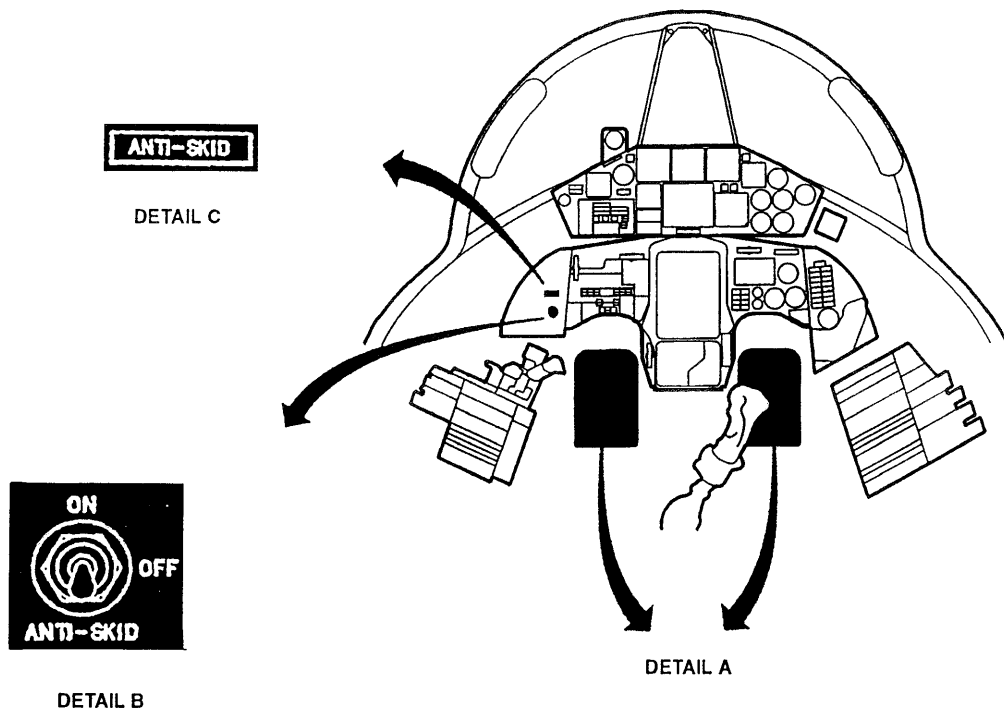

- A - RUDDER PEDALS
- B - ANTISKID SWITCH
- C - ANTISKID LIGHT

FA0046

Figure 1-27

- IF THE DRAG CHUTE IS DEPLOYED INADVERTENTLY AT AIRSPEEDS IN EXCESS OF DESIGN LIMITS, EITHER A LINK WILL FAIL RELEASING THE DRAG CHUTE OR THE DRAG CHUTE CANOPY WILL DISINTEGRATE. THIS SITUATION MAY BE DETECTED BY A SUDDEN DECELERATION FOLLOWED BY AN IMMEDIATE ACCELERATION. IN EITHER CASE, FOLLOWING SUCH AN OCCURRENCE THE DRAG CHUTE SHOULD BE JETTISONED, THUS DUMPING THE TRAILING CHUTE REMNANTS IN THE EVENT THE LINK DID NOT FAIL.

### NOTE

Landing distance performance is provided in the "Appendix - Performance Data" for the 18-foot ring-slot drag chute. This is also applicable to the 18-foot ribbon type drag chute.

### Drag Chute Handle

The drag chute handle (refer to Figure 1-28) is located at the left of the lower main instrument panel. When pulled straight aft (about 2 inches) to the stop (without turning the handle), the spring-loaded drag chute door opens and a pilot chute is deployed; the pilot chute in turn deploys the drag chute. The drag chute is jettisoned at any time by turning the handle 90° clockwise and pulling to the next stop (about 4 inches). The handle is under spring tension during the final pull. When the handle is released it will retract to the first stop.

## DRAG CHUTE SYSTEM CONTROLS

DRAG CHUTE  
HANDLE

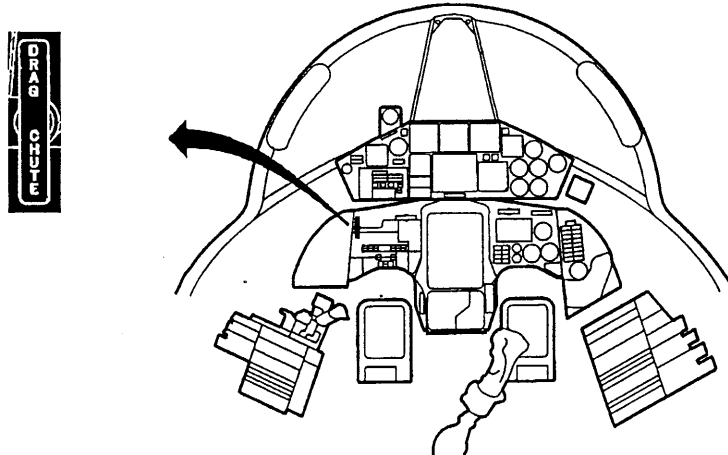

FA0048

Figure 1-28

# ARRESTING HOOK

The arresting hook installation is an emergency system designed to engage a barrier cable, reduce the landing roll, and bring the aircraft to an emergency stop. The hook installation (refer to Figure 1-29) consists of the hook assembly, piston, two springs and linkage, the self-contained hydropneumatic snubber assembly, the solenoid-operated latch assembly, arresting hook indicator light, and the hook release button. In the stowed position the hook lies beneath the drag chute compartment; this location requires the hook to drop to an intermediate position when the drag chute is deployed. The hook will extend from either the intermediate or stowed position. The hook is mounted slightly to the right of fuselage centerline and is partially submerged in fuselage to reduce aerodynamic drag and possible interference with the TACAN antenna patterns.

**WARNING**

STAY CLEAR OF ARRESTING HOOK WHEN IT IS IN A STOWED OR INTERMEDIATE POSITION AS INADVERTENT RELEASE COULD CAUSE SERIOUS INJURY.

**NOTE**

- The arresting hook is not retractable from the cockpit either in flight or on the ground. The hook shall be retracted and latched manually by the ground crew.

## ARRESTING HOOK

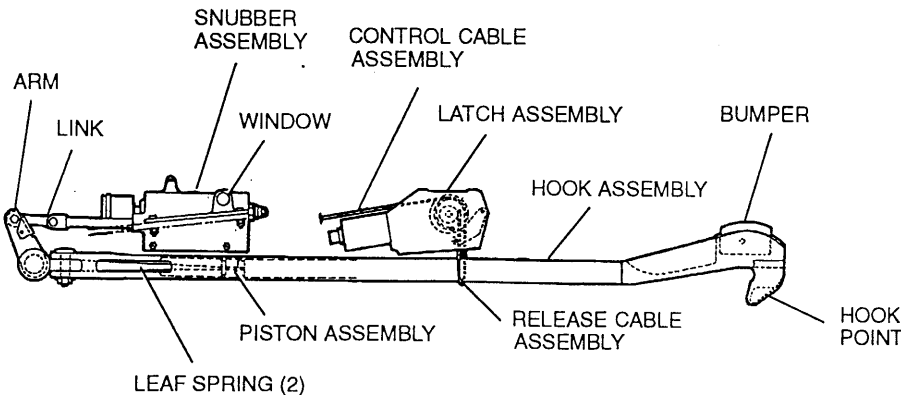
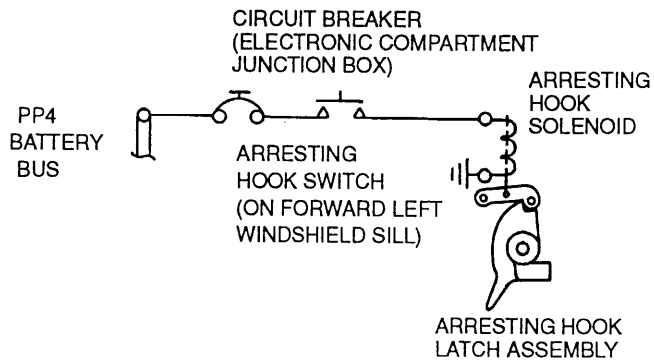
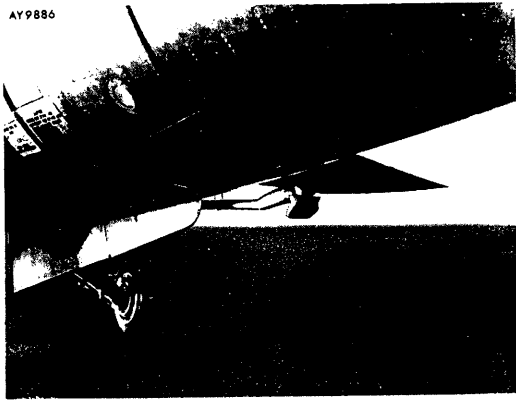

FA0315

Figure 1-29

- A safety lock assembly is provided to assure positive uplock of the arresting hook. This lock should be installed when the aircraft is on the ground.

### Arresting Hook Release Button

The arresting hook is extended by use of the HOOK RELEASE button located on the left windshield sill (refer to Figure 1-30).

When the button is pressed, the solenoid-operated latch assembly releases the hook and the hook is forced down to the runway.

The hook release button receives power from the PP4 battery bus.

### Arresting Hook Indicator Light

A HOOK DOWN indicator light, located below the arresting hook release button, illuminates anytime the hook extends below the drag chute deployment (intermediate) position. The light is powered from the PP4 battery bus.

## INSTRUMENTS

For information regarding instruments that are an integral part of a particular system, refer to applicable paragraphs in this Section.

### PITOT PRESSURE AND STATIC SYSTEMS

The pitot pressure and static systems operate the airspeed indicator altimeter, and vertical velocity indicator. The system is also connected to the air data computer and CPU-46A altitude computer.

The pitot-static head is mounted on a boom extending forward from the nose radome. A heating element in the head is controlled by the pitot-pitch temp probe switch on the right console (refer to Figure 1-41) (refer to Anti-icing Systems in this Section for additional information).

### AIRSPEED AND MACH NUMBER INDICATOR

The airspeed and Mach number indicator (refer to Figure 1-31) consists of a pitot-static-operated in-

## ARRESTING HOOK CONTROLS AND INDICATORS

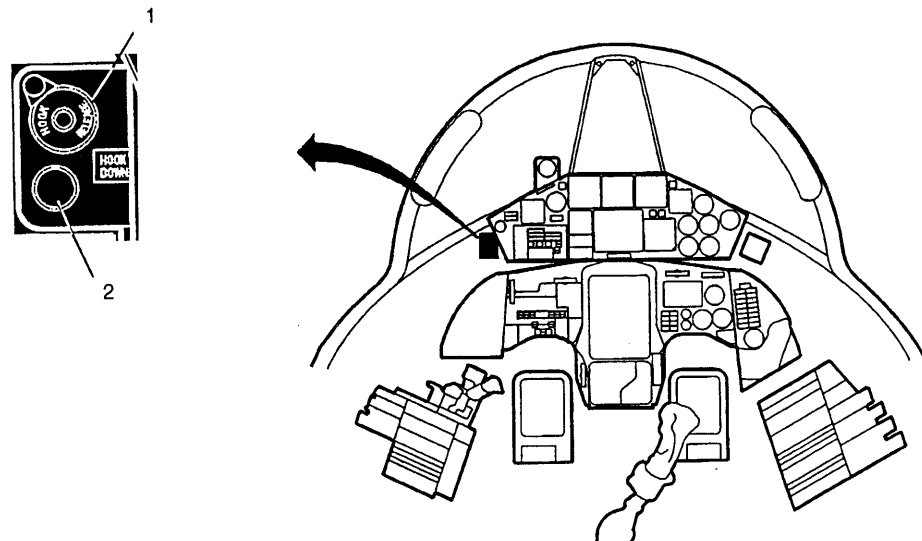

- 1 ARRESTING HOOK RELEASE BUTTON
- 2 ARRESTING HOOK INDICATOR LIGHT

FA0105

Figure 1-30



icated airspeed mechanism which drives a pointer to indicate airspeed on a fixed dial. The indicator also contains a static-pressure-operated altitude mechanism which drives a moving scale to indicate Mach number.

The gearing between the moving scale and the altitude mechanism is such that Mach number is indicated by the pointer on the moving scale at any combination of indicated airspeed and altitude within range of the instrument.

The indicator is designed to operate over a range of 80 to 850 knots indicated airspeed at altitudes from -1000 up to +80000 feet. The Mach number range is from 0.5 to 2.5. In addition, there is a maximum allowable pointer for a limiting equivalent airspeed of 600 to 800 knots.

**Maximum Speed Pointer.** The maximum allowable speed pointer is set to reflect an equivalent airspeed of 750 KEAS. The equivalent airspeed of 750 KEAS is indicated in terms of IAS which will vary with altitude.

For example, equivalent airspeed of 750 KEAS would be indicated as 750 KEAS at sea level and 799 KIAS at 20000 feet.

### **WARNING**

OBSERVE THE AIRSPEED LIMITS CONTAINED IN SECTION V "OPERATING LIMITATIONS".

**Airspeed Marker.** An airspeed marker is provided to assist the pilot in setting a speed reference. The setting of the marker is controlled by a knob at the lower right of the instrument.

### **ALTIMETER**

The AAU-37A servo-pneumatic altimeter, located on the main instrument panel (refer to Figure 1-31), has two modes of operation: servo mode (ELECT) and pneumatic mode (PNEU).

In the servo mode of operation the altimeter is controlled by signal inputs from the Altitude Computer (CPU 46/A). Direct readout of the altitude is accomplished by the numbers on the three drum counter indicating from -1000 to +80000 feet and

by a single pointer which simultaneously indicates 1000 feet per revolution both in servo and in pneumatic modes.

In the pneumatic mode the altimeter is mechanically driven by a pressure transducer integral to the altimeter. An internal vibrator reduces mechanical friction of gear trains and linkages of assembly. The instrument is automatically converted from servo to pneumatic mode in case of electrical and/or servo system failure.

An ELECT/PNEU function selector allows manual selection from servo to pneumatic mode or viceversa. No indication is provided on the window when the servo-pneumatic altimeter is operating in servo mode; the appearance of the PNEU flag, yellow backgrounded, will indicate the pneumatic mode of operation (manually or automatically selected) or a power interruption or a failure in the altimeter or in the altitude computer with possible resulting of loss of automatic altitude reporting (IFF mode C).

### **WARNING**

FOLLOWING A SERVO/PNEUMATIC ALTIMETER SWITCHING FROM "ELECT" TO "PNEU", USE OF RADAR ALTIMETER IS REQUIRED FOR PRECISION APPROACHES.

### **NOTE**

Following the CPU-46A altitude computer failure, the servo/pneumatic altimeter switches to baro mode (PNEU).

A barometric scale control, located on the lower left corner of the instrument, allows barometric settings from 950 to 1048 millibars which are displayed on the barometric window; clockwise rotation increases barometric settings. The left counter of the drum is covered by a black and white striped flag at altitudes below 10000 feet and by a red and white striped flag at altitudes below 0 feet.

The instrument is supplied by the XP5 AC bus and the vibrator is supplied by the PP2 DC bus.

# INSTRUMENTS

AIRSPPEED AND MACH NUMBER INDICATOR

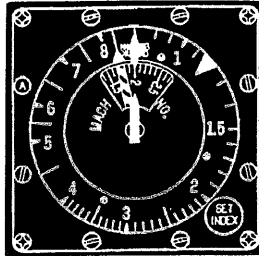

ATTITUDE INDICATOR

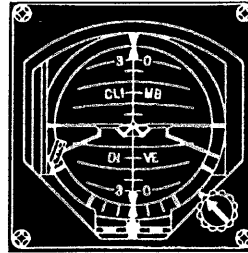

ALTIMETER

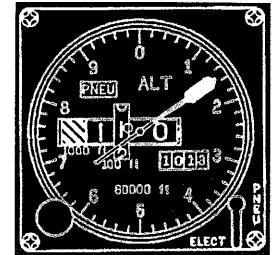

STANDBY COMPASS

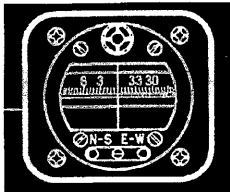

ACCELEROMETER

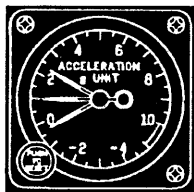

VERTICAL VELOCITY INDICATOR

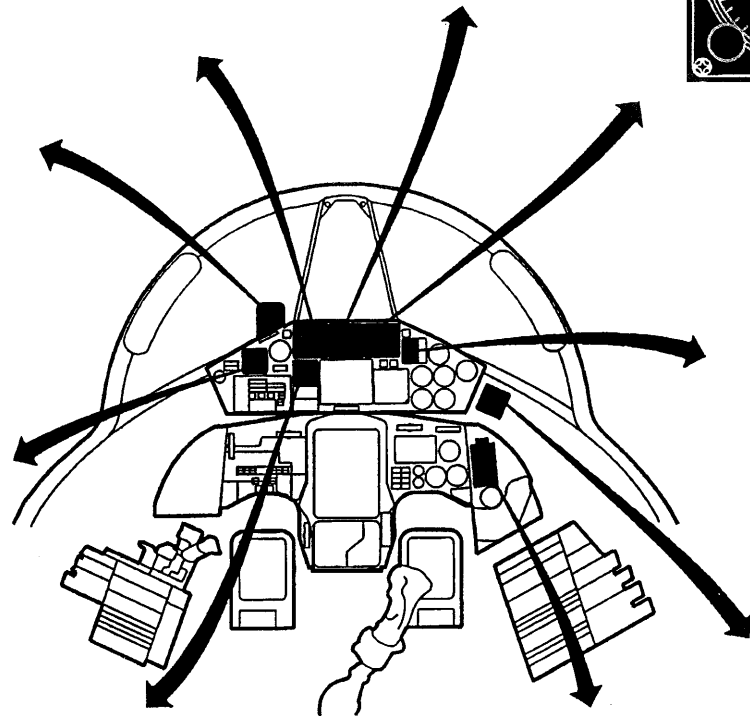
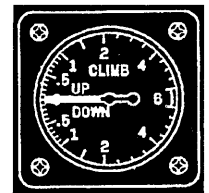

CLOCK

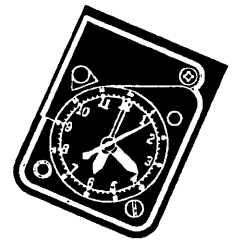

STANDBY ATTITUDE INDICATOR

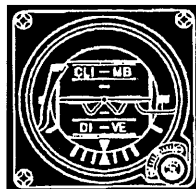

ALTRUDE ENCODE OUT	
AIR - TC POWER OUT	FLAP ASYMMETRY
FUEL BOOST PUMPS FAIL	INLET DOORS UNSAFE
FUEL LOW LEVEL	FIXED FREQ OUT
GENERATOR No. 1 OUT	GENERATOR No. 2 OUT
HYDRAULIC SYSTEM OUT	AUTO PITCH CONT OUT
DC PRIMARY BUS OUT	CANOPY UNSAFE
ENGINE OIL LEVEL LOW	ENG/DUCT ANTI-ICE ON
AUTO PILOT DISENGAGED	INERTIAL NAV FAULT

DETAIL A

- A - WARNING LIGHT PANEL
- 1 ALTITUDE ENCODE OUT WARNING LIGHT

Figure 1-31

### Servo Mode of Operation

In the servo mode of operation corrected pressure altitude (position error correction) synchro signals are sent from the altitude computer to the receiver-transmitter of the IFF system and to a servomechanism in the altimeter.

These signals are computed only for a barometric pressure of 1013 mb. To correct the altimeter indicated altitude for other than 1013 mb, set the correct altimeter setting in the altimeter barometric scale. When the IFF system is interrogated for altitude reporting (Mode C), the receiver-transmitter will automatically report the aircraft altitude to the nearest 100 feet for a barometric pressure of 1013 mb, regardless of the setting in the altimeter barometric scale.

### Pneumatic Mode of Operation

In the pneumatic mode of operation, the altimeter receives static air pressure directly from the pitot-static system and operates in exactly the same manner as a standard pressure altimeter. Altimeter installation error corrections shall be used to correct the aircraft altitude.

IFF Mode C reporting is available regardless of the selected mode of operation. Mode C altitude reporting will not be available if the system has automatically reverted to PNEU due to an altitude computer failure.

**Altitude Computer (CPU-46A).** The altitude computer, located in the left electrical compartment, senses pitot pressure and static pressure from the pitot-static system and known error parameters of the pressure system. It performs mechanical analog computation to provide analog outputs and one digital output.

The altitude computer consists of two pressure sensors, a computing mechanism and an electronic package. The analog output drives the servoed altimeter. The digital output comprises Mode C pressure-altitude information which is directed to the transponder for transmission in reply to a valid Mode C interrogation. The altitude computer is powered by the XP5 AC bus.

**Altitude Encode Out Warning Light.** The ALTI-TUDE ENCODE OUT warning light, located on the warning lights panel (refer to Figure 1-31), is installed to warn the pilot that the Altitude Computer fails to operate or the system is not energized. The light is energized by the PP5 battery bus.

### ACCELEROMETER

A three-pointer accelerometer (refer to Figure 1-31) indicates positive and negative "G" loads. In addition to the indicating pointer there are two recording pointers (one for positive-"G" loads and one for negative-"G" loads) which follow the indicating pointer to its maximum attained travel. The recording pointers remain at the maximum travel positions reached by the indicating pointer, thus providing a record of maximum-"G" loads encountered. To return the recording pointers to the normal 1"G" position, press the knob on the lower left corner of the instrument.

### STANDBY COMPASS

A standby magnetic compass (refer to Figure 1-31) is provided for navigation if the electrical system fails and may be also used for heading crosscheck with the HSI. The compass is located on the left side above the instrument panel glare shield and is hinged to fold forward. The light within the compass case is controlled by the INTERIOR INSTRUMENTS lights rheostat.

### ATTITUDE INDICATOR

The attitude indicator (refer to Figure 1-31) provides the pilot with a pictorial presentation of aircraft attitude. The installation consists of an attitude sphere background which is supported and rotates about two servo-driven gimbal axes, a bank index and scale, a miniature aircraft, a self-contained slip/skid indicator, a rate of turn indicator and an OFF warning flag indication. The instrument is electrically powered by the XP7 AC bus.

The sphere shall be of two colours, one depicting earth, the other sky, and markings with pitch angles. The pitch angle shall be read by means of pitch marking against the miniature aircraft that is located in front of the attitude sphere at zero pitch pattern. A pitch trim setting shall be allowed by means of a knob. Roll angle shall be read by means of the bank index, which rotates with the roll gimbal, against a fixed bank scale around the periphery of the display dial.

The spheroid rotation freedom is unlimited about the roll axis and  $\pm 90^\circ$  of indication about the pitch axis. The accuracy of pitch and roll indications with respect to input synchro-transmitter are within  $1^\circ$  for positions up to  $30^\circ$  in roll and pitch and  $2^\circ$  for any other position. The follow up rate is not less

than 300° per second in roll and 180° per second in pitch. Aircraft slip is indicated by a floating ball inside a tubular case located in the lower portion of the instrument with a range of  $\pm 5^\circ$ .

Rate of turn is provided by a gyro transmitter and is indicated by the rate of turn pointer and travels with a linear movement over the rate of turn scale. The rate of turn indication is a "four minutes" turn type.

### **WARNING**

THE "FOUR MINUTES TURN" INDICATION IS RELIABLE DURING CONSTANT ALTITUDE TURN AT ANY AIRCRAFT SPEED WITHIN  $\pm 40^\circ$  BANK ATTITUDE.

#### **OFF Flag**

The attitude malfunction detection circuit shall be designed to accept an attitude data validity signal from external source. An OFF warning flag indicates that the attitude data is invalid.

### **WARNING**

THE ATTITUDE INDICATOR OFF FLAG MAY NOT APPEAR WITH A SLIGHT REDUCTION IN AC POWER, OR FAILURE OF OTHER COMPONENTS WITHIN THE SYSTEM. FAILURE OF CERTAIN COMPONENTS MAY RESULT IN ERRONEOUS OR COMPLETE LOSS OF PITCH AND BANK PRESENTATIONS WITHOUT A VISIBLE OFF FLAG.

#### **Pitch Trim Knob**

A pitch trim knob is provided for adjusting the position of the spheroid. The knob is mounted on the lower right-hand side of the indicator display.

It has approximately 1/2 turn of freedom in the clockwise (CW) direction and 1/4 turn of freedom

in the counterclockwise (CCW) direction from the zero pitch trim position. When the knob is rotated to the stop in the CW direction, the spheroid shall rotate to deflect the horizon line upward to indicate a dive of about 15°.

When the knob is rotated to the stop in the CCW direction, the spheroid shall rotate to deflect the horizon line downward to indicate a climb of about 8°.

#### **STANDBY ATTITUDE INDICATOR**

A 2 inch standby attitude indicator (refer to Figure 1-31) located on the main instrument panel is installed to provide back-up aircraft attitude indications in case of failure of the attitude indicator. The indicator, electrically powered by the XP5 AC bus, incorporates a vertical gyroscope mounted on a pitch gimbal which in turn is mounted on a roll gimbal. The vertical gyroscope is erected to gravity with erection reducing during accelerations resulting from turns and fore and aft velocity changes. A moving drum, mechanically driven by the pitch gimbal and mounted on the roll gimbal, registers aircraft displacement in the pitch and roll axes with respect to a miniature aircraft. The miniature aircraft is mounted on an adjustable bracket and located at the centre of the indicator cover glass. A moveable roll index is fixed to the roll gimbal and moves over a scale fixed to the case.

The attitude presentation is 360° in roll, 87.5° in climb and 82.5° in dive. Rotation of a pitch trim knob, located on the bezel, adjust the position of the miniature aircraft to 5° in dive and 5° in climb. Pulling the knob cages the gyro with reference to the case and the indicator displays 0° in pitch and roll. This knob, when pulled, should be immediately released. Rotating the knob clockwise while is fully extended, locks the gyro in the caged position. An OFF warning flag comes into view when the gyro is caged or if the power supply is interrupted.

#### **VERTICAL VELOCITY INDICATOR**

The vertical velocity indicator (refer to Figure 1-31) is mounted on the main instrument panel. The instrument registers the rate of climb or descent in feet per minute ( $\pm 6000$ ) and is operated by the static air system.

#### **CLOCK**

A conventional stop watch is located on the right side of the main upper instrument panel.

## WARNING LIGHTS SYSTEM

### WARNING LIGHTS PANEL SYSTEM

The warning lights panel system gives the pilot visual indication of failure of certain critical equipment and gives an indication of failure or unsafe conditions in critical areas of the aircraft.

The system consists of a warning lights panel, a CAUTION light and reset bar (refer to Figure 1-32), and the associated equipment to automatically operate amber placard-type lights on the warning lights panel and CAUTION bar. The warning lights panel contains placard-type warning lights, each having its own operating circuit to indicate a particular condition in the aircraft.

If a failure occurs in one of the systems, the warning light for that particular system remains on until the failure is corrected.

The warning lights panel system (except for the FIRE warning lights) is powered by the PP2 DC bus (refer to the particular system associated with each warning light in this Section).

### NOTE

With both generators off, all warning lights are inoperative except the FIRE warning lights and tail hook indicator light.

### CAUTION Light

The CAUTION light (refer to Figure 1-32) illuminates when any of the warning lights panel are energized.

A reset bar, on which the CAUTION light is mounted, permits the pilot to push and de-energize the CAUTION light, even through a malfunction continues and the individual warning light stays on.

This permits the CAUTION light to indicate a second malfunction if one should occur while the first malfunction is uncorrected.

### Warning Lights Panel

The warning light panel contains the following placards (refer also to Figure 1-32):

ALTITUDE ENCODE OUT	
AIM-7E POWER OUT	FLAP ASYMMETRY
FUEL BOOST PUMPS FAIL	INLET DOORS UNSAFE
FUEL LOW LEVEL	FIXED FREQ OUT
GENERATOR NO. 1 OUT	GENERATOR NO. 2 OUT
HYDRAULIC SYSTEM OUT	AUTO PITCH CONT OUT
DC PRIMARY BUS OUT	CANOPY UNSAFE
ENGINE OIL LEVEL LOW	ENG/DUCT ANTI-ICE ON
AUTO PILOT DISENGAGED	INERTIAL NAV FAULT

### Warning Lights Dimming System

The warning lights dimming circuit provides a means for reducing the brilliance of all warning lights with a single rheostat. The warning light dimming relay coil is connected to the PP2 DC bus through the WARN LTS. circuit breaker and the instrument lights (INTERIOR INSTRUMENT) rheostat. When the rheostat is in the OFF position as it is for daylight flying, full bus voltage is directed to the warning lights and they burn at maximum brilliance when energized. When the rheostat is moved from OFF, the warning light dimming relay is energized and bus voltage is directed to the warning lights through a dimming resistor and the lights operate at reduced brilliance. Once the aircraft electrical system has been de-energized the warning light dimming relay automatically returns the warning lights to full brilliance, regardless of the position of the rheostat. To re-dim the warning lights the rheostat shall be returned to the OFF position and again moved out of the OFF position.

The FIRE warning lights, CANOPY UNSAFE light, engine air inlet temperature warning SLOW light, landing gear unsafe and landing gear indicator lights, lights on the warning light panel, trim lights,

## WARNING LIGHTS SYSTEM CONTROLS AND INDICATORS

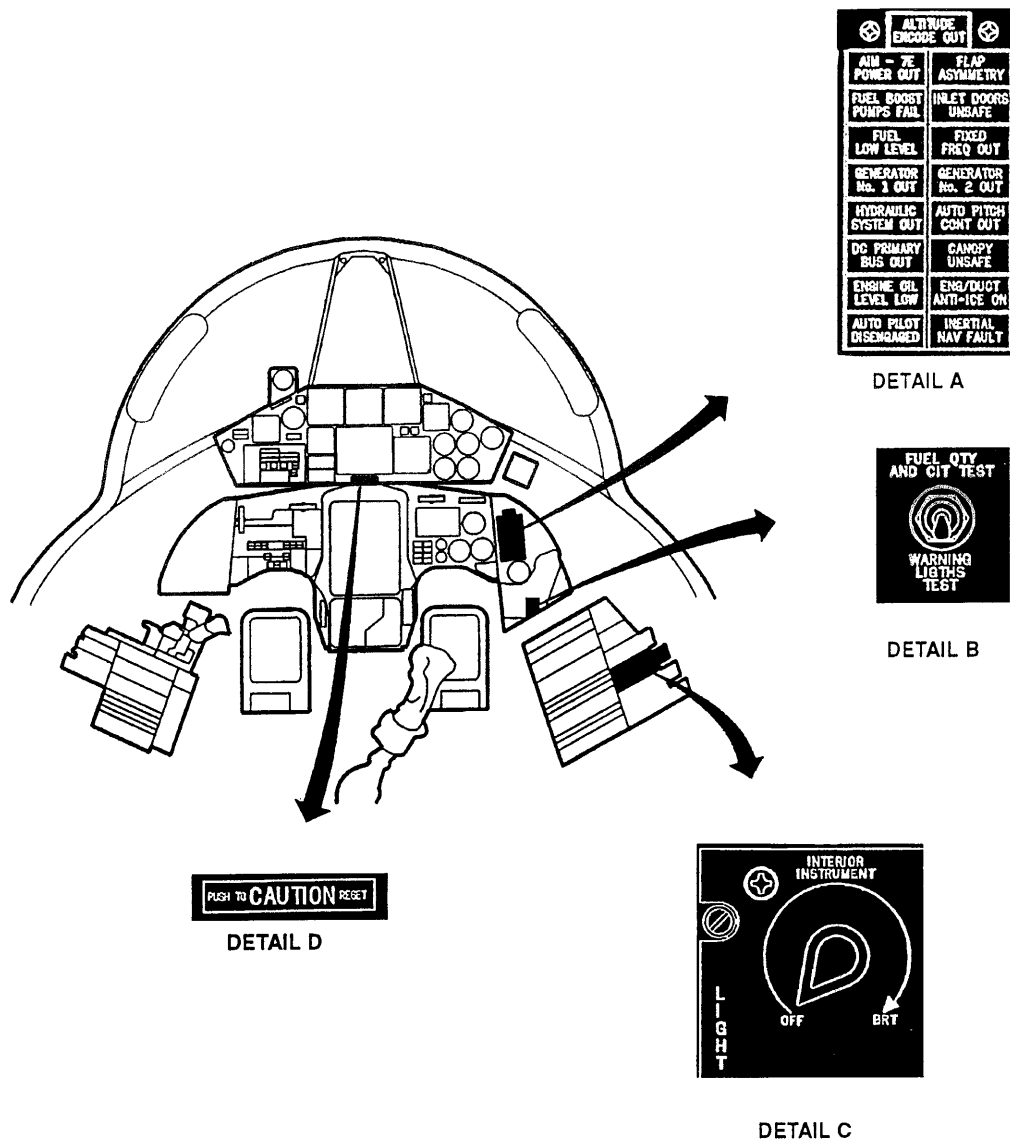

- A - WARNING LIGHTS PANEL
- B - WARNING LIGHTS SYSTEM TEST SWITCH
- C - WARNING LIGHTS DIMMING RHEOSTAT
- D - CAUTION LIGHT AND RESET BAR

FA0051

Figure 1-32

radar lights, antiskid light, external stores lights, terrain clearance light, and the CAUTION light are dimmed by use of this rheostat.

**NOTE**

If the instrument lights rheostat is inadvertently moved out of the OFF position the warning lights and landing gear position lights may not be visible during daylight operation.

**NOTE**

The switch is also used to check the fuel quantity indicating system and the engine air inlet temperature gage.

When the test switch is moved to WARNING LIGHTS TEST position the FIRE warning, CANOPY UNSAFE, engine air inlet temperature warning SLOW light, landing gear unsafe, landing gear indicator, takeoff trim indicator, antiskid, external stores, terrain clearance, radar, caution, and the warning lights panel are energized.

**Warning Light Test System**

The warning light test circuit provides a means for checking warning light filaments simultaneously by a single switch. The warning light test relay coils are tied to the PP2 DC bus through a circuit breaker and test switch. The FIRE warning lights are tested with power from the PP5 battery bus.

**Warning Light System Test Switch.** A warning light system test switch (refer to Figure 1-32) is located on the right forward panel.

**ENGINE FIRE DETECTOR WARNING SYSTEM**

The aircraft is equipped with a system to give visual warning in the cockpit of an overtemperature condition in the engine compartment or tail section. The system consists of 11 temperature-sensing detectors in the engine compartment, five detectors in the tail section, and two FIRE warning lights.

**ENGINE FIRE DETECTOR WARNING SYSTEM INDICATOR**

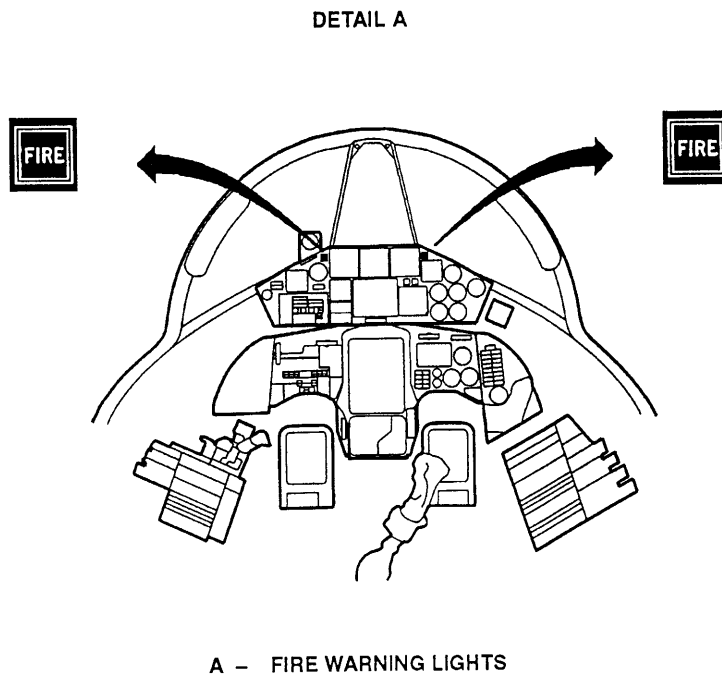

FA0050

Figure 1-33

## FIRE Warning Lights

Two FIRE warning lights (refer to Figure 1-33) are located on the main instrument panel. The warning lights are powered by the PP5 battery bus. The word FIRE will be illuminated by these lights if any of the overtemperature detectors close their contacts. The detectors in the engine compartment close at 235° C and those in the tail section at 343° C. Because of the secondary air flow used with this engine installation it is impossible to install a secondary firewall between the hot and cold ends of the engine. Due to the high compression ratio of the engine, the aft end of the compressor section is as hot as the combustion chamber on many other engines.

A secondary firewall would not effectively separate that portion of the engine containing fuel and oil system components from a high temperature region; therefore, no overheat warning lights have been provided.

## SURVIVAL PACK

The survival pack (refer to Figure 1-34) serves the dual purpose of seat cushion and container for dinghy and survival equipment. The seat cushion is designed and shaped to give maximum support and comfort to the pilot.

Survival equipment is stowed in a carrier and housed in the forward part (horns) of the glass fibre case giving rigid support to the thighs on ejection. The dinghy included in the pack is a SS. Mk. 5 single seat dinghy and embodies a separately inflatable canopy and floor which together provide protection against the elements.

It is left to the decision of the pilot to release the dinghy pack from the harness following ejection and thereby inflating the dinghy automatically. Pulling the survival pack release knob (refer to Figure 1-34) on either side of the pack releases the survival gear from the pilot and inflates the life raft. If the survival-pack was not released before landing, wind will separate the pilot automatically from parachute harness and canopy when he opens the quick release box. Although in this case the dinghy will be inflated automatically and the survival equipment will be retained.

The survival gear and life raft remains attached to the life vest by an approximately 15-foot long lowering line.

## NOTE

Should the survival pack not be released by pulling the survival pack release knob on either side of the pack before landing, the dinghy may be inflated after landing by pulling sharply the additional independently operating release handle (refer to Figure 1-34) on the bottom of the survival pack after the survival pack has been released from the parachute harness.

## CANOPY

The jettisonable canopy consists of a single piece of transparent plastic secured within a frame which is hinged to the left cockpit sill. Normal operation of the canopy is completely manual. Cartridge-type charges are provided for jettisoning the canopy during an emergency.

When jettisoned, the canopy is released from both sides and is raised about 2 inches above the canopy sills by the canopy unlatching thruster. The canopy unlatching thruster in turn fires the canopy ejector thrusters on the forward canopy sills to ensure upward rotation of the canopy. From this point the canopy is automatically hinged at the upper rear, allowing it to rotate upward and backward.

The canopy is automatically jettisoned during the pilot escape ejection sequence by actuating either firing handle.

## WARNING

CANOPY LOSS EXPERIENCE HAS SHOWN THAT EVEN IF THE CANOPY IS IN THE OPEN POSITION AND THE CANOPY THRUSTERS ARE NOT IN A POSITION TO MAKE THE THRUSTER PAD CONTACT, IMMEDIATELY JETTISONING THE CANOPY WILL RELEASE THE CANOPY HINGE ON THE LEFT CANOPY RAIL AND GREATLY LESSEN ENGINE FOREIGN OBJECT DAMAGE AND PILOT DISTRACTION.



# SURVIVAL PACK

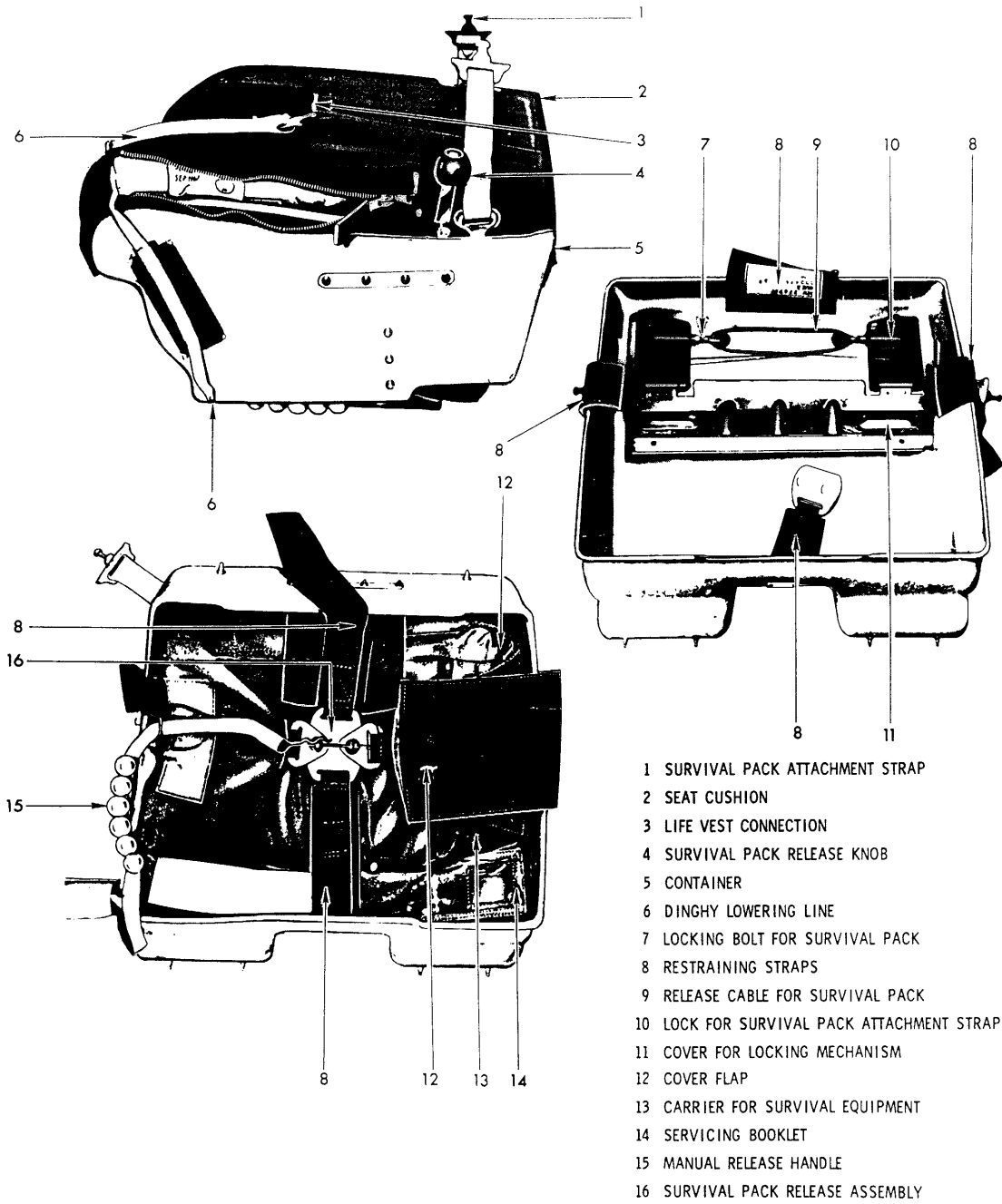

HG 07568  
F150-0-1-43

Figure 1-34

## CANOPY SEAL

An inflatable rubber seal is installed in the edge of the canopy frame and seats against the mating surfaces of the canopy sill and windshield to provide sealing for cockpit pressurization.

The seal pressurization switch is actuated by the center canopy latch when the canopy is down and locked.

The switch operates a valve which allows engine compressor air to inflate the seal.

Seal pressure will be dumped when the canopy is in the unlocked position, or when seat ejection is initiated. Electrical power is supplied to the switches from the PP2 DC bus.

### WARNING

DO NOT MANUALLY UNLOCK THE CANOPY IN FLIGHT. DUE TO THE CANOPY HINGE ATTACHMENT ON THE LEFT CANOPY RAIL, CANOPY SEPARATION IS UNPREDICTABLE AND MAY RESULT IN PILOT INJURY AND/OR ENGINE FOREIGN OBJECT DAMAGE.

### CAUTION

## CANOPY FULL OPEN LOCK RELEASE

The canopy is released from the full-open position by depressing a small canopy lock release (refer to Figure 1-35) attached to a handle mounted on the right canopy frame.

This allows the canopy to be lowered until it comes to rest on two lifter cams which protrude through the right canopy sill and hold the canopy approximately 2 inches from the sill. This places the canopy in position to be locked closed by use of the internal locking lever.

## CANOPY INTERNAL LOCKING LEVER

A lever (refer to Figure 1-35) located below the canopy sill on the right forward side of the cockpit, is used to lock or unlock the canopy.

After the canopy has been lowered so that it rests on the lifter cams it may be fully locked by moving the locking lever to the fully locked position. A very positive overcenter feel will be noticed as the lever is moved aft.

As the lever is moved aft, the lifter cams retract and the canopy lowers by gravity to the sill where three hooks engage three canopy brackets. These hooks may be observed by the pilot.

- THE CANOPY OPENING AND CLOSING OPERATION SHOULD WORK SMOOTHLY AND EFFORTLESSLY. IF THE CANOPY IS SLAMMED SHUT OR OPEN, THE SYSTEM MAY BE DAMAGED. IF ANY FORCING IS NECESSARY TO FACILITATE HOOK ENGAGEMENT, THE CANOPY IS EITHER OUT OF RIG OR IMPROPERLY FITTED, AND CORRECTIVE ACTION SHALL BE TAKEN BEFORE FLIGHT.
- TO PREVENT DAMAGE TO THE CANOPY, A TAXI SPEED OF 50 KNOTS SHALL NOT BE EXCEEDED WITH THE CANOPY IN ANY POSITION OTHER THAN FULLY CLOSED AND LOCKED.

## CANOPY EXTERNAL LOCKING LEVER

An external flush-mounted yellow lever (refer to Figure 1-35) provides external control of the canopy identical to the internal locking lever in the cockpit. The external locking lever is labeled CANOPY RELEASE and is located on the right side of the fuselage below the windshield. The handle may be extended for use by pushing on the release at the lower end of the handle.

## CANOPY CONTROLS AND INDICATORS

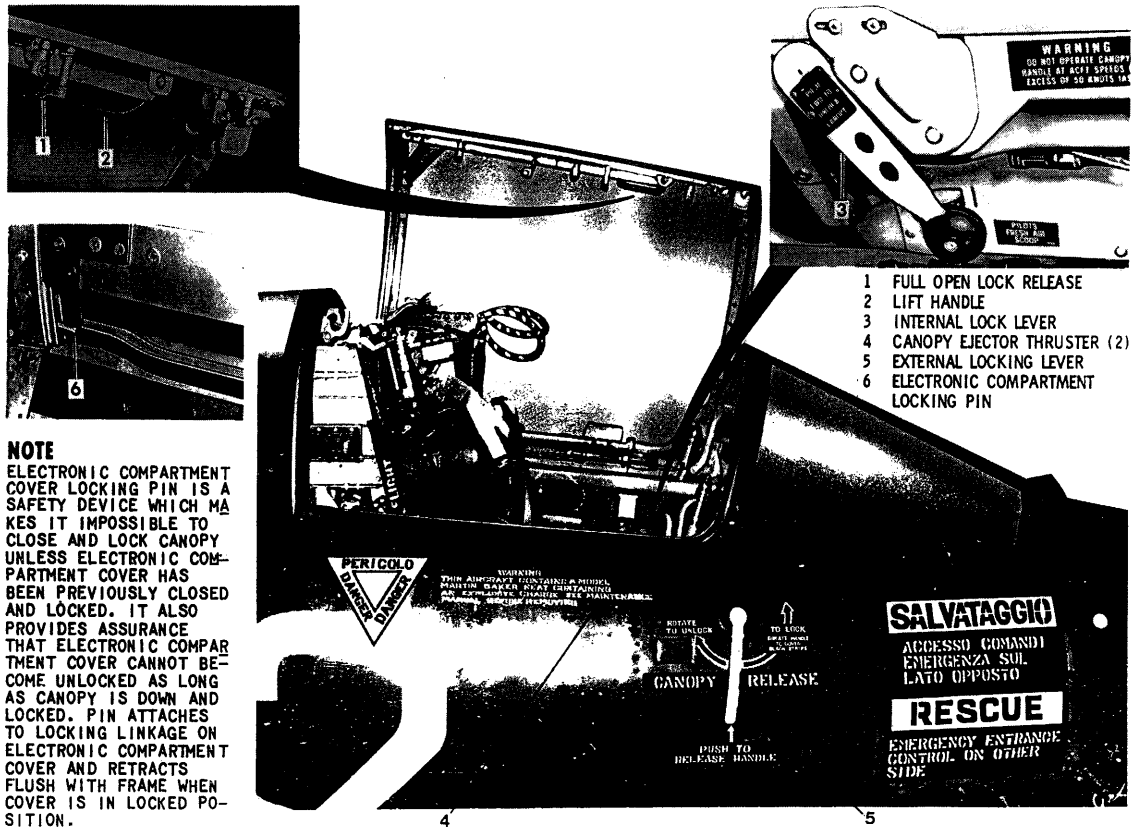

- 1 FULL OPEN LOCK RELEASE
- 2 LIFT HANDLE
- 3 INTERNAL LOCK LEVER
- 4 CANOPY EJECTOR THRUSTER (2)
- 5 EXTERNAL LOCKING LEVER
- 6 ELECTRONIC COMPARTMENT LOCKING PIN

**NOTE**  
 ELECTRONIC COMPARTMENT COVER LOCKING PIN IS A SAFETY DEVICE WHICH MAKES IT IMPOSSIBLE TO CLOSE AND LOCK CANOPY UNLESS ELECTRONIC COMPARTMENT COVER HAS BEEN PREVIOUSLY CLOSED AND LOCKED. IT ALSO PROVIDES ASSURANCE THAT ELECTRONIC COMPARTMENT COVER CANNOT BECOME UNLOCKED AS LONG AS CANOPY IS DOWN AND LOCKED. PIN ATTACHES TO LOCKING LINKAGE ON ELECTRONIC COMPARTMENT COVER AND RETRACTS FLUSH WITH FRAME WHEN COVER IS IN LOCKED POSITION.

Figure 1-35 (Sheet 1 of 2)

## CANOPY CONTROLS AND INDICATORS

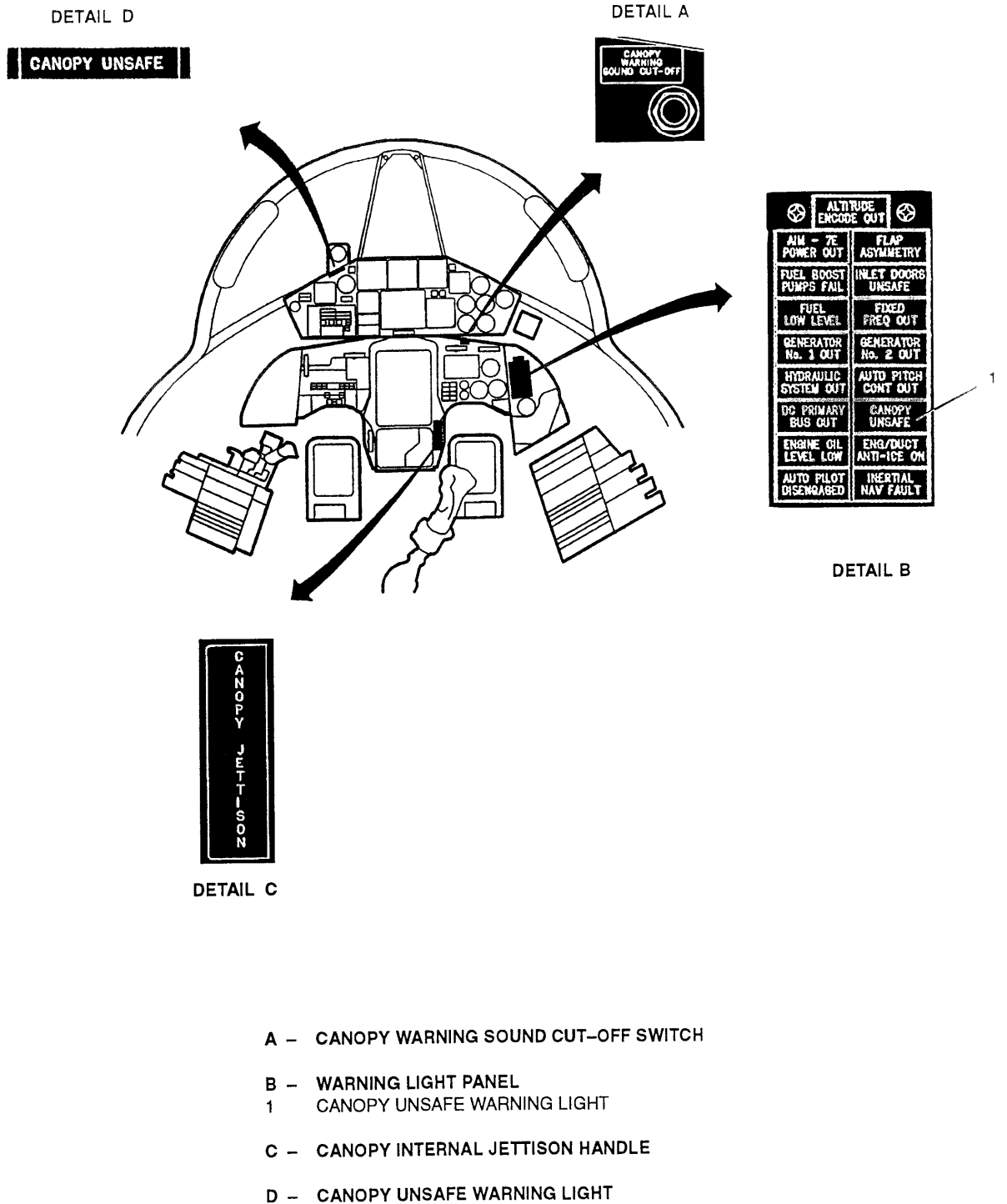

Figure 1-35 (Sheet 2 of 2)

### CANOPY INTERNAL JETTISON HANDLE

A red canopy jettison handle (refer to Figure 1-35), located on the lower right instrument panel may be used by the pilot to jettison the canopy independently of the automatic canopy-seat ejection system. The canopy may be jettisoned by the canopy emergency jettison handle with the ejection seat safety pin installed. A flagged canopy safety pin is provided so that the canopy initiator is safetied during ground operation.

### CANOPY EXTERNAL JETTISON HANDLE

The canopy external jettison handle (refer to Figure 3-1), located on the left side of the fuselage, permits ground rescue personnel to jettison the canopy from the aircraft for emergency entrance.

The handle cover is labeled EMERGENCY CANOPY JETTISON ACCESS DOOR. Operating this handle jettisons the canopy, using the same linkage used by the canopy jettison handle to fire the canopy.

### CANOPY UNSAFE WARNING LIGHTS

If the canopy is not properly locked, microswitches in the canopy locking mechanism and right canopy rail illuminate the CANOPY UNSAFE warning lights. One warning light is located on the warning lights panel (refer to Figure 1-35) and an additional CANOPY UNSAFE warning light is installed on the instrument panel glare shield above the accelerometer (refer to Figure 1-35). A microswitch in the throttle quadrant completes the circuit to energize the flashing red CANOPY UNSAFE light. The light will flash when the throttle is advanced to approximately 95% RPM and the canopy is not properly locked. Power for the warning lights is derived from the PP2 DC bus, through the existing warning circuit.

In addition to the warning lights, an audio signal is generated through the interphone indicating that the canopy is unlocked. A switch (refer to Figure 1-35) labeled CANOPY WARNING SOUND CUT-OFF is provided on the lower edge of the center main instrument panel to de-energize the audio signal.

### CANOPY BREAKING TOOL

The canopy breaking tool, located on the left sill, may be used to break the canopy if other methods

of opening fail. No set pattern of blows is necessary, normally three to four blows with the canopy breaking tool will open an adequate escape hole. Grasp the canopy breaking tool with both hands curved edge toward the head (with the curved edge away from face, the tool will glance off the curved canopy and may inflict a head injury) and put your whole body into an armswinging thrust. Aim the tool so as to strike perpendicular to the canopy surface. Always use the point of the tool as blade alignment will determine the direction of the cracks. Reversing the tool, to hammer with the butt produces ragged and unpredictable cracking.

## EJECTION SEAT

The Martin Braker-rocket assisted ejection seat (refer to Figure FO-11) is designed to provide safe escape under zero speed/zero altitude conditions. It is fully automatic in operation throughout the ejection sequence (refer to Figure FO-12).

### EJECTION GUN AND GUIDE RAILS

The telescopic ejection gun provides the initial power for ejection of the seat and pilot from the aircraft, the guide rails mounted on opposite sides of the outer tube serving as guides to the seat. The ejection gun comprises three tubes, namely outer tube, intermediate tube and inner tube. The intermediate and inner tube are telescoped inside the outer tube. Power is obtained from one primary and two auxiliary cartridges.

The ejection gun thrust is imparted against a top cross beam. The top latch piston assembly is located on the left side of this cross beam. The piston secures the seat to the ejection gun and prevents the seat from riding up the rails during negative "G" flight. The plunger on the internal portion of the top latch piston is forced aside as the ejection gun is fired allowing the inner tube to thrust against the top cross member and lift the seat.

### ROCKET PACK

The thrust of the ejection gun augmented by the rocket pack, consists of a series of tubes arranged in two banks and connected to a common combustion chamber fitted with discharge nozzles.

The rocket pack ignition is accomplished by a remote rocket firing unit mounted outboard of the drogue gun.

## DROGUE GUN AND DROGUE SYSTEM

The drogue gun, incorporating a time delay mechanism, fires a metal piston which in turn extracts the small controller drogue and the main stabilizer drogue from the drogue container.

The drogues, when deployed, tilt the seat into a horizontal attitude thus insuring deceleration approximately in line with the seat axis. Between the controller and the main drogue is a nylon line which allows the controller drogue to be fired well clear of the seat wake.

## TIME RELEASE MECHANISM

The ejection seat is fitted with a time release mechanism the function of which is to release the harness locks, thereby unfastening the pilot from the seat and to unlock the scissor shackle by which the drogues are connected to the seat, thereby enabling the drogues to stream the main parachute. For high altitude ejections the barostatic control prevents operation of the time release mechanism until the seat and pilot have descended to an altitude of approximately 16400 ft, stabilized by the drogue chute system. This prevents prolonged exposure to low temperature and rarified air, and enables the pilot to descend quickly to a more tolerable altitude, while strapped into the seat, stabilized and controlled by the drogues and supplied automatically with emergency oxygen before the main parachute is deployed.

## MAIN PARACHUTE AND COMBINED HARNESS

The main parachute (refer to Figure 1-36) is stowed in a rigid pack behind the pilot's shoulders. The parachute harness and seat harness are combined and connected to a single quick release box. The harness has a three point attachment to the seat: two locks in the seat pan securing the lap harness and the negative "G"-strap, and a third lock on the central cross member which secures the shoulder harness with roller brackets through the looped straps.

## AUTOMATIC LEG RESTRAINT

The leg restraining system is fitted to the ejection seat to draw back and restrain the pilot's legs close to the seat pan during ejection. The system consists of leg restraining straps, snubbing units, leg cord locks and leg restraint garters. The lower end of the leg restraining cords contain a fitting by which they

are attached to the aircraft structure, each fitting containing a shear rivet designed to fail under a load of approximately 400 pounds. From the structure each strap passes over a roller, through a snubbing unit and out through the front of the seat pan where it terminates in a metal end fitting, which after passing through "D" rings on the garters is plugged into a lock on the front of the seat pan. Provision is made on each snubbing unit to allow the pilot to adjust the leg restraining straps individually to give comfortable leg movement. The leg line release lever (refer to Figure FO-11) is located on the left hand side of the seat pan.

## POWER RETRACTION UNIT

The function of the cartridge operated power retraction unit is to ensure that, regardless of the pilot's position when ejection is initiated, he will be positioned and retained in the correct ejection posture before the seat commences to move and "G" forces are applied. During flight the pilot may, by operating the go-forward lever (refer to Figure FO-11) on the left side of the seat pan, lean forward and backward at will but any sudden forward movement by the pilot will be prevented by an inertia operated clutch mechanism.

Operation of the go-forward lever to the fully rear position from which it will automatically move to the center position raises an inertia pawl clear of the ratchet teeth on the port webbing drum permitting free forward and backward movement of the pilot. Should the seat then be subjected to any severe deceleration or acceleration forces (e.g., crash landing or ejection) then the "G" forces will rotate the pawl downwards and thus lock the webbing reels.

Upon initiation of the ejection seat, the cartridge operated power retraction mechanism retracts the shoulder harness so that the pilot is forced into a suitable position for ejection prior to seat movement.

## MANUAL OVERRIDE HANDLE AND GUILLOTINE SYSTEM

The manual override handle (refer to Figure FO-11) is mounted on the right side of the seat pan and is locked by a push button catch mechanism.

The operation of the handle opens in a single action the three harness locks, the PEC-pilot portion, the leg line locks and initiates the guillotine firing unit by which the parachute withdrawal line is cut thus enabling the pilot to leave the seat manually with the personal parachute.

**MAIN PARACHUTE AND COMBINED HARNESS**

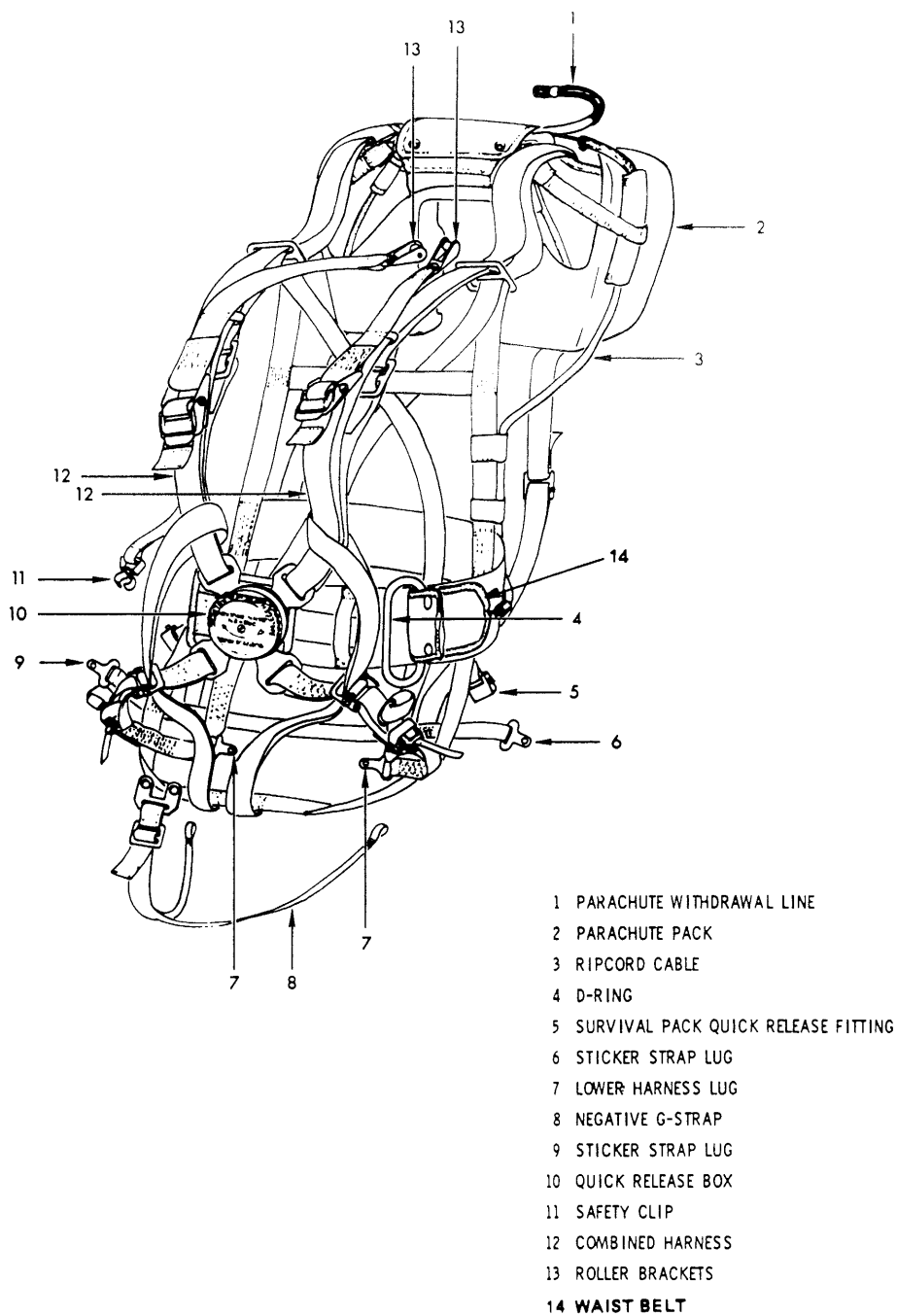

HG 07549  
F150-0-1-47

Figure 1-36

During automatic separation the withdrawal line is pulled out of the guillotine body by the drogue parachutes.

#### PERSONAL EQUIPMENT CONNECTOR (PEC)

The personal equipment connector (refer to Figure 1-37) couples the personal leads of the pilot to the appropriate aircraft supplies in a single action thus ensuring simultaneous connection.

During ejection all personal leads except emergency oxygen are disconnected from the aircraft supply and sealed, emergency oxygen being provided via a separate PEC-inlet to the pilot's oxygen hose.

Five supplies are incorporated in the PEC:

1. Tele/mic (and exhalation valve heating when partial pressure helmet is used)
2. Anti-G suit supply
3. Suit air ventilation
4. Main oxygen supply
5. Emergency oxygen supply

The personal equipment connector is mounted on the left hand side of the seat pan. A green apple is located on the front part of the PEC. When pulled by the pilot, emergency oxygen will be supplied during flight.

The emergency oxygen system mounted on the seat automatically provides oxygen supply from ejection until seat/man separation.

#### SEAT ADJUSTMENT MECHANISM

The height of the seat pan may be adjusted by an electrical actuator. The seat adjustment actuator switch is located on the right hand side of the seat pan (refer to Figure FO-11). Power for seat adjustment is from XP2 AC bus.

**CAUTION**

DO NOT OPERATE THE SEAT  
ADJUSTMENT MECHANISM  
FOR MORE THAN 30 SEC  
WITHIN 10 MINUTES OF TIME.

#### FIRING CONTROLS

The ejection seat is provided with two firing controls (refer to Figure FO-11), the primary firing handle located at the front of the drogue container, and the secondary firing handle located at the front edge of the seat pan.

The secondary firing handle may be used if due to injuries, acceleration forces or other circumstances the primary firing handle is not reached.

#### SAFETY PINS

There are eleven safety devices (ten pins and one swivel guard) provided on the ejection seat to prevent inadvertent firing.

Whilst the aircraft is parked in serviceable conditions, eight safety devices shall be in position all the time. These are:

1. Swivel guard of the SECONDARY FIRING HANDLE in SAFE (up) position (refer to Figure FO-11)
2. Safety pin in the CANOPY JETTISON INITIATOR (refer to Figure FO-11)
3. Safety pin in the EMERGENCY CANOPY JETTISON INITIATOR
4. Safety pin in the MAIN GUN (refer to Figure FO-11)
5. Safety pin in the PRIMARY FIRING HANDLE (refer to Figure FO-11)
6. Safety pin in the DROGUE GUN (refer to Figure FO-11)
7. Safety pin in the GUILLOTINE (refer to Figure FO-11)
8. Safety pin in the ROCKET PACK REMOTE CONTROL INITIATOR (refer to Figure FO-11)

The canopy jettison initiator safety pins are attached to a red streamer and to another red streamer connecting the safety pins for the main gun, primary firing handle, drogue gun, guillotine and rocket pack initiator.

When maintenance is performed in the vicinity of the seat and associated escape equipment, three safety pins, attached to a red streamer are inserted. These are:

1. Safety pin for Oxygen Release Lever (refer to Figure FO-11)



**PERSONAL EQUIPMENT CONNECTOR (PEC) AND STANDARD  
EMERGENCY OXYGEN SUPPLY SYSTEM**

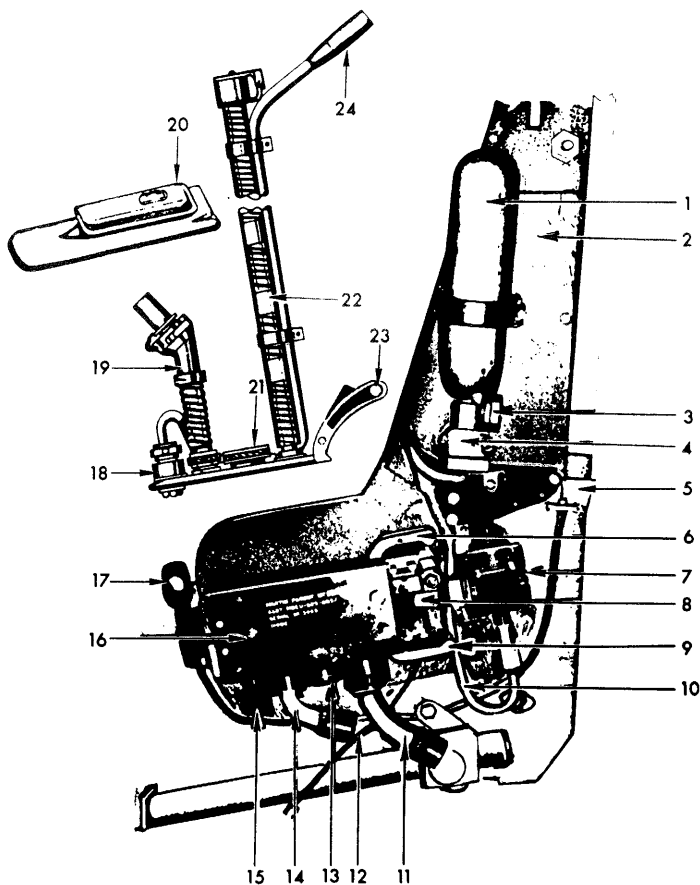

- |    |                                     |    |   |
|----|-------------------------------------|----|---|
| 1  | EMERGENCY OXYGEN BOTTLE             | 13 | VENT AIR PORT (NOT USED)                    |
| 2  | MOUNTING PLATE                      | 14 | ANTI-G PORT                                 |
| 3  | PRESSURE GAGE                       | 15 | COMMUNICATIONS AND EXHALATION VALVE HEATING |
| 4  | PRESSURE REDUCER VALVE              | 16 | PEC-SEAT PORTION                            |
| 5  | STRIKER LEVER                       | 17 | MANUAL RELEASE KNOB (GREEN APPLE)           |
| 6  | PEC-DUST COVER                      | 18 | TELE/MIC - CONNECTOR                        |
| 7  | OXYGEN REGULATOR                    | 19 | ANTI-G CONNECTOR                            |
| 8  | CONNECTION HOSE TO PEC-SEAT PORTION | 20 | COVER (FOR PEC PILOT PORTION WHEN REMOVED)  |
| 9  | PEC-AIRCRAFT PORTION                | 21 | VENT AIR PORT (NOT USED)                    |
| 10 | EMERGENCY OXYGEN SUPPLY TUBE        | 22 | OXYGEN SUPPLY HOSE                          |
| 11 | AIRCRAFT OXYGEN SUPPLY TUBE         | 23 | PEC-PILOT PORTION                           |
| 12 | LANYARD TO AIRCRAFT                 | 24 | TELE/MIC PLUG                               |

32026

Figure 1-37

2. Safety pin for the secondary firing handle (refer to Figure FO-11)
3. Safety pin for the power retraction unit (refer to Figure FO-11)

Before flight, maintenance personnel have to remove the eight parking and the three maintenance safety pins. The pins with attached red streamers will be stowed in the map case of the cockpit during flight. Before flight, the pilot has to rotate the swivel guard of secondary firing handle to "down" position.

### **STANDARD EMERGENCY OXYGEN SUPPLY SYSTEM (MB-STAND OX)**

The MB-Stand Ox consists of an emergency oxygen bottle, pressure gage, pressure reducer valve, oxygen regulator and a valving mechanism (refer to Figure 1-37). Refer to "Oxygen Supply System" in this Section for additional information.

## **AIR-CONDITIONING AND PRESSURIZATION SYSTEM**

### **COCKPIT AIR CONDITIONING**

Heated, compressed air for cockpit air conditioning and pressurization is obtained by bleeding air from the 17th (last) stage of the engine compressor (refer to Figure FO-14).

After passing through a primary heat exchanger, a small part of the air is directed to the fuel tank pressurization system. The main flow of air passes through a shutoff valve, after which a portion goes to the rain-remover duct, canopy and electronics compartment, anti-"G" suit, radar pressurization. The remainder then passes through or around a refrigeration unit, depending on the position of the bypass valves.

The compressor air which goes through the bypass valves is directed to an air mixing chamber where it mixes with the air which has gone through the refrigeration unit. This mixture is directed through a water separator and enters the cockpit through body outlets and foot warmers.

The temperature of the air entering the cockpit depends upon the position of the bypass valves. For maximum heating, the bypass valves will be fully open and most of the air entering the cockpit will bypass the refrigeration unit.

For maximum cooling, the bypass valves will be completely closed and all the air entering the cockpit will pass through the refrigeration unit, which includes a secondary heat exchanger, a water boiler, and a cooling turbine. The water boiler operates in such a manner that if the inlet temperature is above water-boiling temperature, the water will boil and the air will be cooled through an evaporation process.

The temperature of the air entering the cockpit may be varied by the pilot's cockpit heat rheostat, which controls the position of the bypass valves. In normal operation, air temperature is maintained between  $\sim 4.5^{\circ}\text{C}$  and  $\sim 38^{\circ}\text{C}$  automatically by means of an electronic temperature control system which senses cockpit temperature, compares this temperature with the cockpit temperature selector demand, and sends electrical signals to the bypass valves to change their positions as necessary.

The pilot may also control the temperature manually by means of the cockpit temperature mode selector switch. When this switch is in any position except automatic (AUTO), the thermostat control is cut out of the system, except that the maximum duct air temperature is limited. Manual control signals then bypass the electronic controller and position the temperature control valves electromechanically, depending on the position to which the pilot operates the control switch. The system is powered by the XP2 AC bus and PP2 DC bus.

### **COCKPIT PRESSURIZATION**

Cockpit pressurization is maintained at the proper level by an automatic cockpit pressure regulator located in the left forward area.

Below 5000 feet there is only slight pressure in the cockpit caused by forcing cabin exhaust air through the radar package.

Between 5000 and 18350 feet, the cockpit altitude will be constant, while the differential pressure will vary from 0 to 5.0 psi.

Above 18350 feet, cabin pressure is maintained at 5.0 psi differential, regardless of aircraft altitude (refer to Figure 1-38).

Exhaust air from the cockpit pressure regulator is ducted through the radar equipment forward of the cockpit for cooling purposes. The cockpit pressure regulator unit incorporates a cooling fan which forces cockpit air into the radar compartment when the aircraft is on the ground and the aircraft electrical system is energized. This fan is also actuated whenever the fresh-air scoop is opened. If the pressure regulator malfunctions, excessive cabin pressure

## COCKPIT PRESSURIZATION SCHEDULE

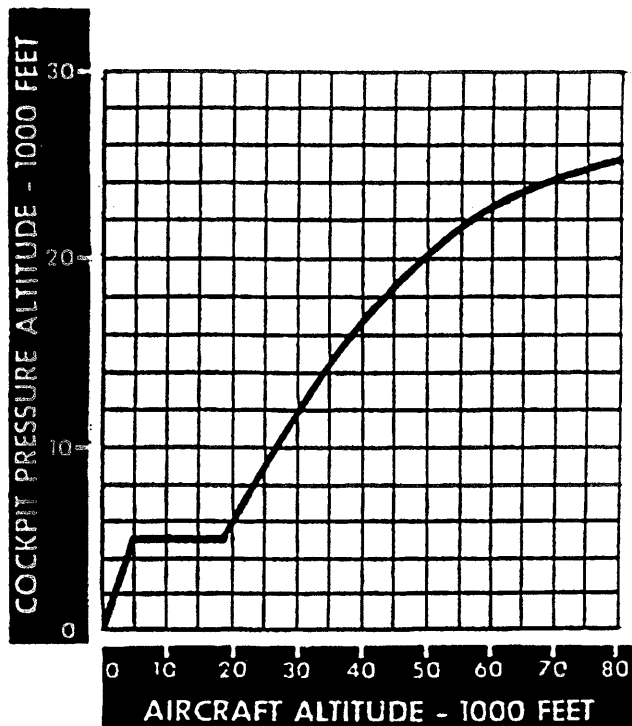

FA0279

Figure 1-38

will be relieved through the cockpit pressure relief and dump valve.

If the cockpit air becomes contaminated, the pilot may open the fresh air scoop to alleviate this condition. Opening the fresh air scoop allows outside ram air to enter the cockpit, shuts off the flow of compressor air into the cockpit, and releases cabin air overboard through the cockpit pressure dump valve.

With engine operating, pressurization may be checked on the ground, with the canopy locked, by pulling the LANDING GEAR CONT circuit breaker, located on the left console, and noting a slight pressure rise on the cabin altitude indicator.

### Cockpit Temp Mode Selector Switch and Cockpit Heat Rheostat

The cockpit heat rheostat (refer to Figure 1-39) is used in conjunction with the cockpit temperature

mode selector switch (both located on the heating control panel) to control cockpit temperature. These switches are powered from the XP2 AC bus. Under normal conditions, the selector switch is used in the AUTO (automatic) mode with the heat rheostat set at any point between COLD and HOT. Cockpit temperature will then be maintained automatically through the temperature control unit.

With the mode selector switch in the manual mode of operation (spring-loaded off), the temperature control unit does not function and the bypass valves are positioned directly in response to movement of the mode selector switch to the COLD or HOT positions.

Releasing the mode selector switch to the spring-loaded OFF position fixes the valves at any given location. It requires approximately 10 seconds for an excursion of the valves from full HOT position to full COLD position in the manual mode.

Operation of the system in the manual mode causes the low temperature limiter to drop out of the system. Operation in manual full cold, or nearly full cold, at altitudes where humidity is significant may cause freezing in the water separator. If this happens, airflow to the cabin will be reduced, and total cooling may be less than it would be if duct temperatures were held above freezing.

### CAUTION

DO NOT USE THE FULL COLD POSITION AT IDLE POWER SETTING OR DURING GROUND OPERATIONS. THE COMBINATION OF LOW FLOW, HIGH AMBIENT TEMPERATURES, AND HIGH HUMIDITY MAY CAUSE FREEZING TO OCCUR IN THE WATER SEPARATOR.

### NOTE

It should be recognized that, while duct temperature response to revised selector setting is immediate, cockpit air temperature may not stabilize in less than approximately 2 minutes due to the change in the temperature level of the metal and nonmetal masses in the cockpit area.

# AIR CONDITIONING AND PRESSURIZATION SYSTEM CONTROLS AND INDICATORS

DETAIL A

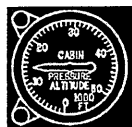

DETAIL B

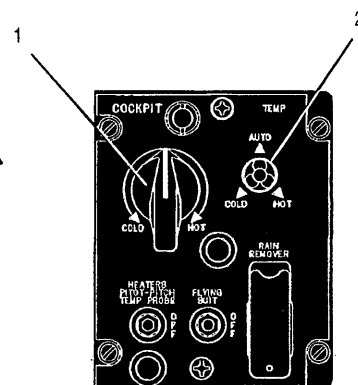
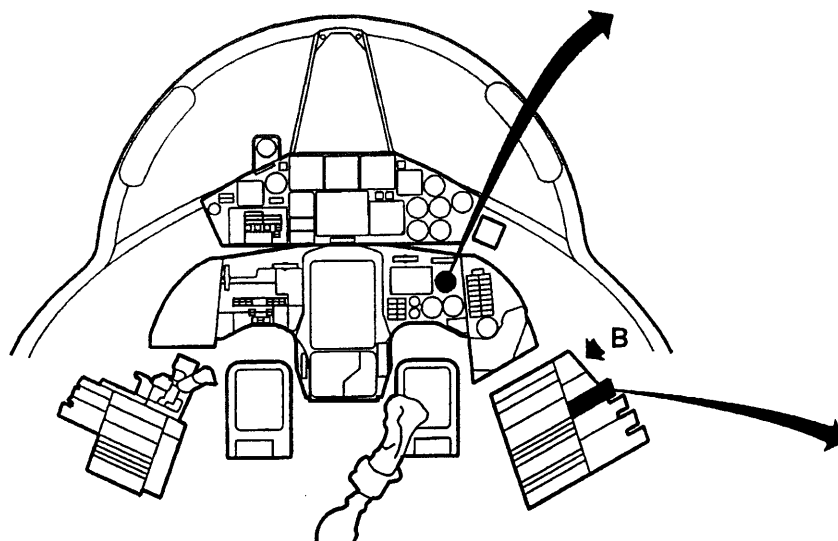
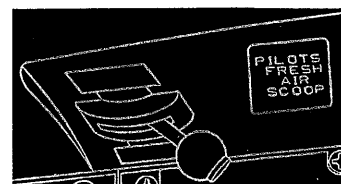

DETAIL C

- A - CABIN ALTIMETER
- B - FRESH AIR SCOOP LEVER
- C - HEATING CONTROL PANEL
  - 1 COCKPIT HEAT RHEOSTAT
  - 2 COCKPIT TEMPERATURE MODE SELECTOR SWITCH

FA0053

Figure 1-39

### Fresh Air Scoop Lever

The fresh air scoop lever is located outboard of the right console. Depressing a button on the handle of the lever allows forward movement which opens the scoop. Aft movement of the lever closes the fresh-air scoop but does not require depressing the button; however, the button shall be depressed before the lever be placed in the CLOSED position (last aft detent).

Initial movement of the lever out of the last aft detent actuates a switch which causes the PP2 DC bus power to close the bleed air shutoff valve, to open the cockpit relief and dump valve, and to energize the nose cooling fan.

### NOTE

Closing the bleed air shutoff valve shuts off bleed air to the air-conditioning package, anti-G suit system, rain-remover system, and the gun purge system as well as shutting off pressurization to the radar.

Forward movement of the lever out of the last aft detent into the next detent does not open the scoop; however, further forward movement of the lever will open the scoop.

### CAUTION

- DO NOT ATTEMPT TO OPERATE THE RADAR WITH THE FRESH-AIR SCOOP CLOSED AND THE HANDLE OUT OF THE LAST DETENT. IN THIS CONDITION THERE IS A NEGATIVE PRESSURE IN THE COCKPIT AND THE NOSE COOLING FAN WILL NOT DEVELOP SUFFICIENT PRESSURE TO FORCE COOLING AIR THROUGH THE RADAR NOSE PACKAGE.

- DURING GROUND OPERATION WITH THE ENGINE OPERATING AND THE FRESH-AIR SCOOP OPENED, THE SUPPLY OF COOLING AIR TO THE ELECTRONIC COMPARTMENT IS SHUT OFF. THIS MAY CAUSE THE ELECTRONIC EQUIPMENT TO OVERHEAT SINCE SUFFICIENT RAM AIR IS NOT AVAILABLE. THEREFORE, VERIFY THAT THE FRESH AIR SCOOP HANDLE IS DEFINITELY IN THE LAST AFT DETENT TO ENSURE THAT AIR IS AVAILABLE FOR COOLING THE ELECTRONIC COMPARTMENT AND FOR COCKPIT PRESSURIZATION.

### Cabin Altimeter

The cabin altimeter (refer to Figure 1-39), located on the right side of the lower instrument panel, is vented to the inside of the cockpit only. This instrument gives an accurate indication of the cockpit pressure altitude.

### ELECTRONICS COMPARTMENT COOLING

The electronics compartment is cooled by cold air from the cooling turbine. Minimum temperature of air entering the electronics rack is kept at approximately 27° C. Under most ambient conditions moisture will then be prevented from condensing onto the surfaces of electronics equipment. At low engine RPM an electronics compartment cooling control valve, located downstream of the water separator, moves toward the closed position which decreases the airflow through body and foot warmer outlets and vents a greater proportion of cooling air to the electronics compartment. In the event bleed air pressure is lost (flame-out, engine seizure, etc.) or shut off by the pilot by opening the fresh air scoop, a cooling air emergency shutoff valve automatically opens, diverting outside cooling air to the electronics compartment.

### NORMAL OPERATION OF COCKPIT AIR-CONDITIONING AND PRESSURIZATION SYSTEM

1. Fresh air scoop lever – CLOSED
2. Cockpit temp mode selector switch – AUTO
3. Cockpit heat rheostat – Positioned as desired (12 o'clock position recommended initially)

#### NOTE

- If the aircraft is operated in excessively humid conditions, moisture may condense in the air distribution ducts after engine shutdown. This may be evaporated if the air conditioning system is operated in manual HOT for a brief period after engine start. In order to minimize fog entering the cockpit, the cockpit heat rheostat should be set at as a high temperature in AUTO mode as practical. The defogger system should be turned up as high as needed to keep the transparent surfaces clear. Under no circumstances should the mode selector switch be set to manual full COLD as this will result in freezing the water separator bag and forcing the bypass valve open allowing all moisture to pass through the water separator.
- During aircraft operation in humid conditions, the air flow in the air conditioning and pressurization system may set up vibrations, which may be initially interpreted as engine problems. The problem may be solved by either positioning cockpit heat rheostat to HOT or opening RAM AIR SCOOP (if altitude permits).

### EMERGENCY OPERATION OF COCKPIT AIR-CONDITIONING AND PRESSURIZATION SYSTEM

Slight temperature cycling or pressure surging may occur when selecting full hot air. This is caused by the maximum temperature (thermal) switch, which produces a rapid reduction in airflow by closing the hot air bypass valve on the air-conditioning package

when duct temperature reaches  $\sim 94^{\circ}\text{C}$  ( $\pm 5.5^{\circ}\text{C}$ ). When duct temperature drops sufficiently, the thermal switch again opens, allowing hot air to flow. This cycle may repeat five or six times. Cycling is most likely to occur at high airspeeds when duct temperature may exceed  $\sim 205^{\circ}\text{C}$ .

#### WARNING

MANUAL CONTROL IS PROVIDED AS A BACKUP FEATURE ONLY AND SHOULD NOT BE USED EXCEPT IN CASE OF AUTOMATIC CONTROL FAILURE. THERE IS A POSSIBILITY OF FOGGING THE COCKPIT ON TAKEOFF IF MANUAL CONTROL IS USED.

If cockpit temperature is not maintained at the desired level automatically, do the following:

1. Cockpit temp mode selector switch – Release from AUTO detent
2. Cockpit temp mode selector switch – Move to HOT or COLD and hold until temperature approaches desired level and release (anticipate the required temperature)

#### NOTE

- If airflow surge occurs, move cockpit temp mode selector switch to COLD position and hold.
- A decrease in cockpit airflow while in manual cold mode may indicate freezing of the water separator. Move selector to HOT until airflow again increases. If cabin temperature is too high, move selector back to COLD and select a warmer setting than previously selected, and observe for evidence of water separator re-freezing.
- If cockpit temperature is excessive and may not be decreased automatically or manually, open the fresh-air scoop.

**CAUTION**

OPENING THE FRESH-AIR SCOOP WILL DUMP COCKPIT PRESSURE AND SHUT OFF BLEED AIR SUPPLY TO THE AIR-CONDITIONING UNIT.

## DEFOGGER AND RAIN-REMOVER SYSTEMS

### DEFOGGER SYSTEM

The defogger system consists of a number of small air jets directed parallel to the canopy and windshield surfaces. These jets entrap cockpit air and cause it to flow over the inside surface, thereby raising the surface temperature. As long as the surface temperature is above the cockpit dewpoint, no fog or frost will be formed.

Air for the defogger system is normally routed from downstream of the water boiler on the air-conditioning unit, through a check valve and defog flow control and shutoff valve (refer to Figure FO-14), to the defogger outlets located along the inside base of the windshield and electronics hatch transparent surface and in the forward frame of the canopy. This airflow, in itself, is not sufficient to meet all the requirements of the system.

To supplement the flow, a bleed line is provided which directs air from a point just downstream of the hot air shutoff valve to a differential relief and check valve. When pressure in the normal flow line drops because of large demands on the system (defog flow-control valve open), the differential relief valve will open and furnish the additional air necessary for effective defogging under all conditions.

### Canopy Defogger Knob

The amount of air directed to the windshield and canopy defog outlets is determined by the position of the canopy defogger knob located on the cockpit right forward panel (refer to Figure 1-40). Clockwise movement of the knob increases the amount of defogging air to the outlets by actuating the pneumatically operated shutoff valve. With the knob in the FULL (clockwise) position, the valve is open.

### NOTE

- The amount of control knob dead band motion required to initiate flow will vary considerably with altitude changes, decreasing as the altitude increases.
- The windshield and canopy defogging system should be operated throughout the flight at the highest flow possible consistent with pilot comfort so that sufficiently high temperature is maintained to preheat the canopy and windshield areas. It is necessary to preheat, because there is not sufficient time during rapid descents to heat these areas to temperatures which prevent the formation of frost or fog.

### RAIN-REMOVER SYSTEM

The rain-remover system receives compressor air from the same line that furnishes pressure for the canopy seal, radar, and the anti-G suit (refer to Figure FO-14). The air then passes through a pilot-controlled shutoff valve and is routed to a nozzle in a popup head at the outside base of the left windshield panel. This high-velocity hot air flows over the panel to remove rain and to prevent windshield icing.

**WARNING**

RAIN-REMOVER AIR IS DUCTED THROUGH THE LEFT SIDE OF THE COCKPIT. IF A LEAK SHOULD DEVELOP IN THIS DUCT LINE, AIR AT VERY HIGH TEMPERATURE WILL ENTER THE COCKPIT, IN WHICH CASE THE FRESH-AIR SCOOP SHOULD BE OPENED TO SHUT OFF ALL COMPRESSOR AIR TO THE DUCT LINE AND DIRECT COLD RAM AIR INTO THE COCKPIT.

# DEFOGGER AND RAIN REMOVER SYSTEMS CONTROLS

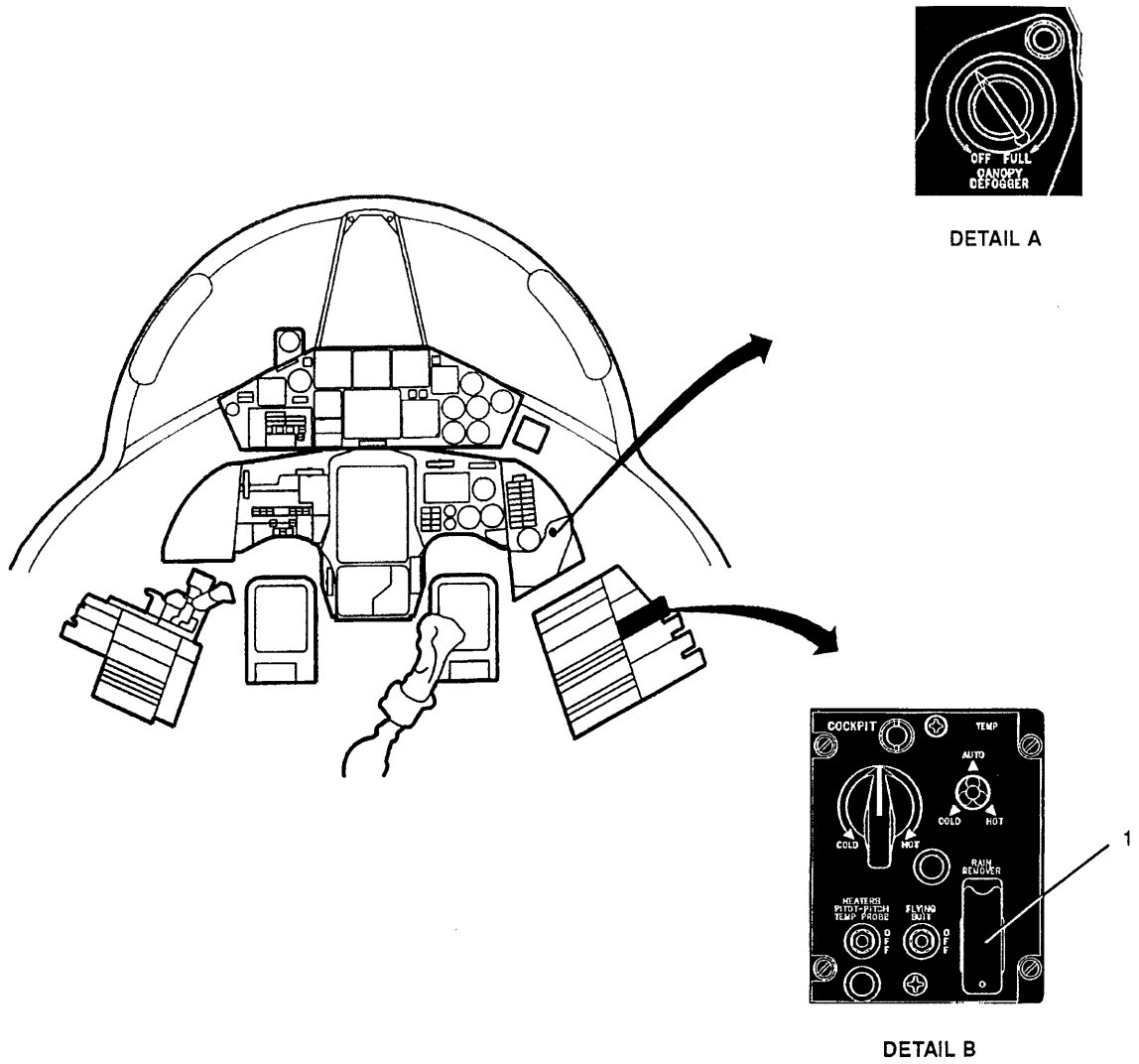

- A - CANOPY DEFOGGER KNOB
- B - HEATING CONTROL PANEL
- 1 RAIN REMOVER SWITCH

FA0054

Figure 1-40



## Rain-Remover Switch

The guarded rain-remover switch (refer to Figure 1-40) located on the right console controls the flow of compressor air to the rain-remover outlets.

Moving the switch forward from OFF to the RAIN REMOVER position closes the PP1 DC bus circuit to the rain-remover shutoff valve, opening the valve and allowing hot pressurized air to pass through the valve to the outlets.

### CAUTION

- DO NOT SET THE RAIN-REMOVER SWITCH TO RAIN REMOVER ABOVE ITS LIMIT AIRSPEED BECAUSE THE RAIN REMOVER NOZZLE MAY BE DAMAGED OR THE WINDSHIELD MAY CRACK. MAXIMUM AIRSPEED LIMIT IS 295 KIAS.
- THE RAIN REMOVER SHOULD NOT BE USED FOR TAKEOFF. THE COMBINATION OF HIGH TEMPERATURE AIRFLOW FROM THE RAIN REMOVER AND LOW AIRFLOW OVER THE CANOPY MAY DAMAGE THE WINDSHIELD. THESE TEMPERATURES ARE MORE CRITICAL AT HIGH RPM. HOWEVER, TO PRECLUDE THE POSSIBILITY OF DAMAGE, THE RAIN REMOVER SHOULD NOT BE OPERATED FOR LONGER THAN 30 SECONDS WITHOUT WINDSTREAM EFFECT.

### NOTE

Refer to Section VII "All-Weather Operation" for normal/emergency operation of defogger and rain remover system.

## ANTI-ICING SYSTEMS

### ENGINE/DUCT ANTI-ICING SYSTEMS

The engine duct anti-icing system is designed to prevent formation of ice in the engine air inlets and on the cones and scoops of the inlet ducts.

Ice accumulating in the engine air inlet reduces airflow through the engine and causes a loss of power accompanied by a possible increase in nozzle area and a decrease in fuel flow. For anti-icing of the engine air inlet, hot 17th-stage compressor air flows through a port in the compressor rear frame to the inlet of the solenoid-operated anti-ice valve.

The anti-ice valve, powered by the XP2 AC bus, regulates pressure and airflow to the four struts at 2, 3, 9, and 10-o'clock positions of the engine front frame. Air is passed through the struts into a manifold in the hub of the frame, from which it passes into the 20 hollow inlet guide vanes and the remaining 4 front frame struts.

The anti-icing air is then discharged into the primary airstream through holes in the outer ends of these four struts and the trailing edges of the inlet guide vanes.

Anti-icing of the cones and scoops of the inlet ducts is electrically powered by the XP3 AC bus. Electricity flowing through a power relay to the scoop and cone heaters warms these areas to a temperature high enough to eliminate or prevent ice formation. Overheat protection is provided automatically by thermostats located in each cone skin panel.

Scoop and cone heaters are inoperative on the ground as they are de-energized by the air ground safety switch.

The operation of both electrical and compressor air systems is controlled by the engine/duct anti-ice switch. Circuit breakers for the system are provided on the left console in the cockpit (refer to Figure FO-8).

### Engine/Duct Anti-Ice Switch

The engine duct anti-ice switch (refer to Figure 1-41) is located on the left lower panel. This switch controls the flow of compressor air to the engine inlet guide vanes by actuating the solenoid-operated engine anti-ice valve and the cone and scoop heater. The switch is powered by the PP1 DC bus.

## ANTI-ICING SYSTEM CONTROLS AND INDICATORS

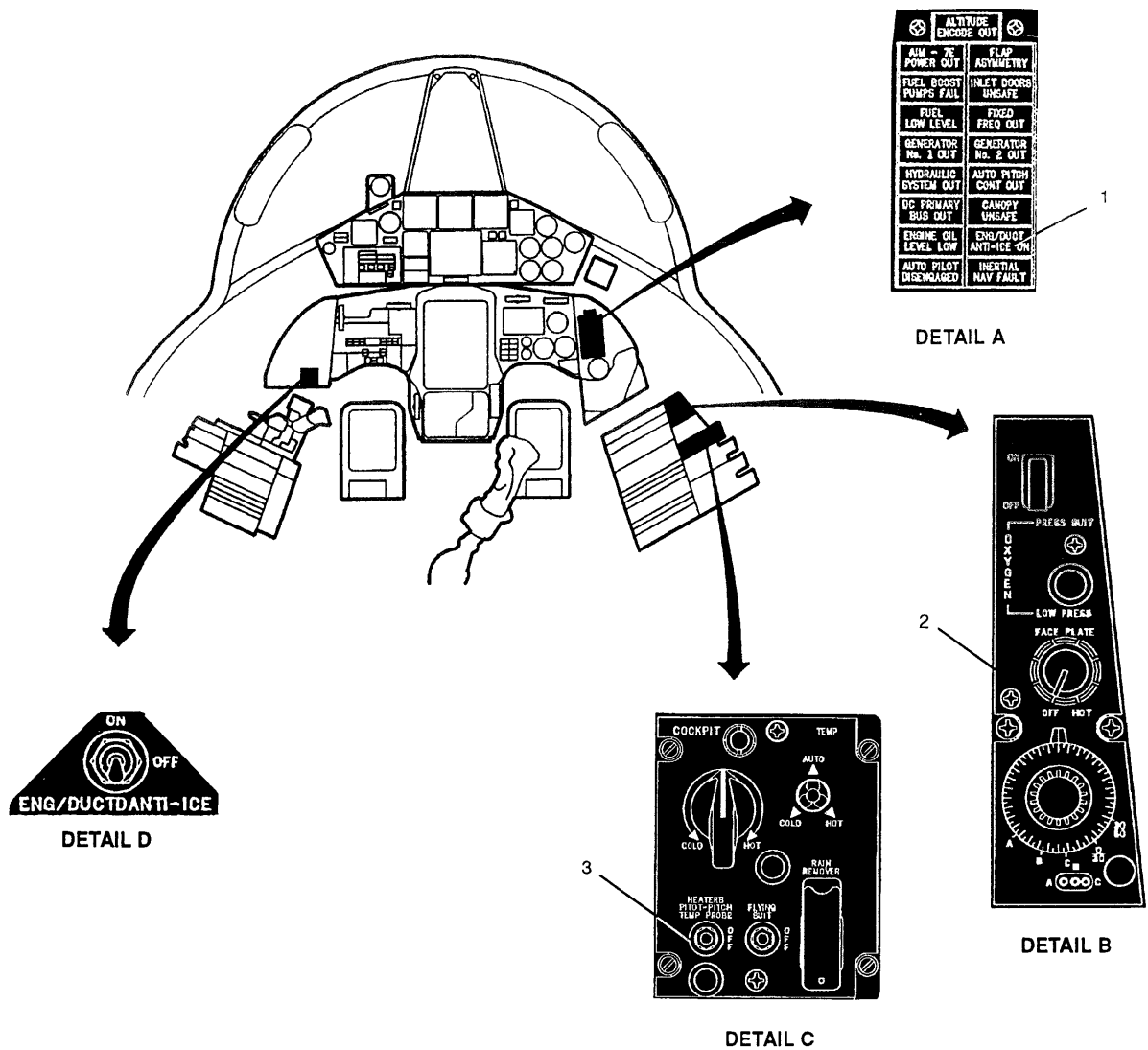

- A - WARNING LIGHTS PANEL
  - 1 ENG/DUCT ANTI-ICE ON WARNING LIGHT
- B - RIGHT CONSOLE
  - 2 FACE PLATE HEAT RHEOSTAT (INOPERATIVE)
- C - HEATING CONTROL PANEL
  - 3 PITOT-PITCH AND TEMPERATURE PROBE HEATERS SWITCH
- D - ENGINE/DUCT ANTI-ICE SWITCH

FA0055

Figure 1-41

### Engine/Duct Anti-Ice On Warning Light

A warning light, located on the warning lights panel (refer to Figure 1-41) provides a visual indication that the engine duct anti-icing system is operating. A differential pressure-operated switch which responds instantly to changes in pressure within the anti-icing system causes the ENG/DUCT ANTI-ICE ON warning light to illuminate when the anti-ice switch is operated.

#### NOTE

- Due to the extreme sensitivity of the warning light pressure sensing switch, the warning light may illuminate momentarily during rapid throttle bursts.
- The warning light normally extinguishes within 5 seconds after the engine/duct anti-ice switch is placed in the OFF position.

### ENGINE/DUCT ANTI-ICING SYSTEM OPERATION

Icing will occur on the inlet ducts and engine compressor front frame at subsonic speeds only. Ram air temperature rise at supersonic speeds is sufficient to prevent icing.

If the engine is operated above 82% RPM, the anti-icing air temperature is sufficient to prevent rapid ice buildup on the engine front frame and inlet guide vanes. The engine may safely ingest inlet duct ice at engine speeds less than 88% RPM.

At higher engine speeds, the inlet guide vanes may be damaged. Engine operation is still possible with limited inlet guide vane damage. The requirement for engine anti-icing is a direct function of indicated compressor inlet temperature (CIT). Operation of the anti-icing system at a CIT above 10° C degrades the service life expectancy of the aluminum front frame. If weather conditions indicate a need for anti-icing, the system should be actuated only at a CIT indication of 10° C or below.

#### NOTE

Refer to Section VII "All-Weather Operation" for ground/flight procedure under icing conditions.

### ELECTRICALLY HEATED WINDSHIELD

The left windshield panel is electrically heated. Glass temperature is controlled by a thermal switch which is powered by the PP2 DC bus (no manual switch is installed). This switch will provide electrical power to the heating element whenever the glass temperature falls below 35° C ( $\pm 3^\circ$  C).

When the glass is heated to 41° C ( $\pm 3^\circ$  C), the electrical power will be disconnected automatically. The windshield heating unit obtains power from the XP4 AC bus. A circuit breaker located on the right console, labeled WINDSHIELD DEFOG., may be pulled to deactivate the system in case of malfunction.

#### CAUTION

DO NOT PLACE OBJECTS SUCH AS CHECKLISTS OR CLIPBOARDS ON LEFT QUARTER PANEL GLARE SHIELD OR THERMAL SENSOR MAY BE DISLOCATED RESULTING IN DAMAGE TO THE ELECTRICALLY HEATED WINDSHIELD.

### PITOT-PITCH AND TEMPERATURE PROBE HEATERS

The automatic pitch control angle of attach vanes, the pitot-static head and the free air temperature probe are heated electrically by power from the XP2 AC bus. Heating elements within the sensors receive power whenever the HEATERS PITOT-PITCH TEMP PROBE switch (refer to Figure 1-41) on the heating control panel is moved from OFF to HEATERS PITOT-PITCH TEMP PROBE position.

This also actuates the free air temp probe heater through a double-throw switch. Heat should be applied any time instrument flying conditions are encountered in order to prevent the formation of ice on these units.

**CAUTION**

DO NOT OPERATE THE HEATERS FOR MORE THAN FOUR MINUTES CONTINUOUSLY WHILE THE AIRCRAFT IS ON THE GROUND.

**FACE PLATE HEAT SYSTEM****NOTE**

The face plate heat system is not operative.

Heating elements are incorporated in the pilot's face plate to prevent or remove any accumulation of moisture on the face plate which would obstruct the pilot's vision. This system becomes especially important at high altitudes in the event of any malfunction which may cause rapid decrease in cockpit temperature and pressure.

To ensure that face-plate heating will be available under all operating conditions (except during complete electrical failure) electrical power for the heating elements is taken from the PP4 battery bus.

**Face Plate Heat Rheostat**

DC electrical power from the battery bus to the face plate heating elements is controlled by the FACE PLATE rheostat (refer to Figure 1-41) located on the right console. Heat may be applied to the face plate in varying degrees by moving the rheostat clockwise from OFF to any desired position. Heating intensity will be maximum with the rheostat in the HOT (extreme clockwise) position.

**NOTE**

- Prior to takeoff, check face plate heat for proper operation.
- Use the minimum required heat to prevent or remove any accumulation of moisture on the face plate.

- The face plate heat rheostat should be at maximum heat just long enough to remove moisture, then returned to the minimum heat required to prevent moisture accumulation.

**COMMUNICATIONS AND NAVIGATION EQUIPMENT**

Refer to Figure 1-42 for a summary table.

**ANTENNA SYSTEM**

Antennas are installed on the aircraft to provide the sensing and radiating elements for communications, navigation, and identification systems. Antennas installed on the aircraft are of the flush-mounted type.

**UHF RADIO AN/ARC-150**

The equipment permits the selection of a frequency channel every 0.025 MHz in the range of 225.000 to 399.975 MHz, providing 7.000 possible frequency channels. Any 19 of these 7.000 possible channels may be preset to facilitate immediate use. The receiver and transmitter are automatically tuned after a channel or frequency change. In addition to the main receiver a separate fixed tuned crystal controlled UHF receiver with a frequency range of 238.000 to 248.000 MHz is installed to provide a constant alert emergency channel. This emergency guard channel frequency is normally set at 243.000 MHz and is pretuned prior to installation.

The transmitter is tonemodulated at an audio frequency of 1020 Hz for emergency or direction-finding purposes. The AN/ARC-150 (HQ) radio set may operate with the HAVE QUICK jam-resistant technique. Slow-frequency hopping is used and both transmitter and receiver use a time-varying frequency pattern which ranges throughout the UHF band.

The UHF antennas receive and radiate UHF signals through a frequency range of 225.000 to 399.975 MHz. Two flush-mounted antennas are provided: one, the bottom antenna, is located on the lower cockpit access hatch, while the top antenna is mounted on the ammunition compartment cover. These antennas are connected to an antenna selector circuit which transfers automatically to the antenna which is in the better position. An override switch

**COMMUNICATION, IDENTIFICATION AND NAVIGATION  
EQUIPMENT TABLE**

TYPE	DESIGNATION	FUNCTION	RANGE	CONTROL LOCATION
UHF COMMAND	AN/ARC-150	TWO-WAY COMMUNICATION	LINE OF SIGHT	LEFT CONSOLE/MAIN INSTRUMENT PANEL/ CONTROL STICK GRIP/ ENGINE THROTTLE
EMERGENCY UHF	SIT-301			
INTERPHONE	AN/AIC-18	PILOT/GROUND CREW INTERCOMMUNICATION	N/A	RIGHT CONSOLE
IFF-SIF	SIT-421T	AIRCRAFT IDENTIFICATION AND NOMINATIVE	LINE OF SIGHT	RIGHT CONSOLE/ CONTROL STICK GRIP/ ENGINE THROTTLE
DIRECTION INDICATOR	C-2G COMPASS	PROVIDE MAGNETIC HEADING	0° ÷ 360°	RIGHT CONSOLE
NAVIGATION	TACAN	DISTANCE MEASURING AND STATION BEARING	LINE OF SIGHT 390 NM (max)	RIGHT CONSOLE/ MAIN INSTRUMENT PANEL
NAVIGATION	HSI	INDICATES BEARING DISTANCE TO DESTINATION AND HEADING	RANGE 0 ÷ 399 NM BEARING 0° ÷ 360° HEADING 0° ÷ 360°	MAIN INSTRUMENT PANEL
NAVIGATION	INERTIAL NAVIGATOR	PROVIDES ATTITUDE, PRESENT POSITION, STEERING PARAMETERS TO HSI, AI, CDU AND OTHER EQUIPMENT	ALL ATTITUDE WORLD WIDE NAVIGATION	RIGHT CONSOLE/ MAIN INSTRUMENT PANEL
NAVIGATION	IN/CDU	PROVIDES LOADING OF MISSION DATA BASE, DISPLAYS NAVIGATION DATA AND PARAMETERS	N/A	MAIN INSTRUMENT PANEL
NAVIGATION	AI	INDICATES PITCH AND ROLL RATE OF TURN, SIDESLIP	PITCH ± 90° ROLL ± 180°	MAIN INSTRUMENT PANEL
NAVIGATION	ADAPTER	INTERFACES IN WITH OTHER EQUIPMENT	N/A	N/A
NAVIGATION	GPS	PROVIDES PRESENT POSITION, STEERING PARAMETERS AND "STAND-ALONE" MODE OF OPERATION	WORLD WIDE NAVIGATION	RIGHT CONSOLE/ MAIN INSTRUMENT PANEL

**Figure 1-42**

is provided to allow the pilot to manually select either antenna. The UHF command radio is, under normal condition, powered by the PP2 DC bus and following PP2 failure, by the PP5 battery bus.

### NOTE

Following the loss of PP2 DC bus the AN/ARC-150 UHF radio is available for 5 minutes only.

### UHF AN/ARC-150 (HQ) Control Panel

The AN/ARC-150 (HQ) panel (refer to Figure 1-43) is located on the left console. This control panel is used in conjunction with the AN/ARC 150 (HQ) channel/frequency indicator located on the main instrument panel.

**Manual Frequency Selector Knobs.** Five manual frequency selector knobs are provided across the panel to set up any desired operating frequency not preset on the channel selector. From left to right the first knob selects the proper number for hundreds of MHz, the second knob selects tens of MHz, the third knob selects units of MHz, the fourth knob selects tenths of MHz and the fifth knob varies the frequency by 0.025 MHz steps. These numbers appear in a window above their respective knob so that any frequency in the covered portion of the UHF band may be selected manually. In addition the first knob allows selection of the A and T function of the HAVE QUICK mode.

For the HQ facilities the following selections are available:

Manual Frequency Selector Knobs	Selections
Hundreds of MHz	T-TOD updating A-HQ operation
Tens of MHz	First NET digit selection
Units of MHz	Second NET digit selection
Tenths of MHz	Third NET digit selection
Units of MHz	HQ mode of operation

### NOTE

- "A" selection enables the HQ active mode of operation.
- The "T" selection is a momentary selection. After "T" selection the hundreds of MHz shows "2", "3" or "A".
- "A" + BOTH selections enables the guard channel reception.
- "A" + MAIN selections disables the guard channel.

**Channel Selector.** The channel selector at the top of the panel selects any of 19 preset channels for transmission and reception when the mode switch is in the PRE position. The selected channel number appears in a window to the right of the selector. The 20th channel is reserved for the HAVE QUICK mode. In HQ the CHAN 20 shall not be used for frequency storing.

**Memory Button.** When depressed the button sets a selected channel to the frequency value which had been set up using the frequency selector knobs, providing the function switch is set to the PRE position. In HQ, the button is used to memorize the WOD (CH 20) as well as the training frequencies (CH 15 to 19).

**Tone Button.** When depressed the button excites a tone oscillator which feeds the tone (1020 Hz) into the modulation, thereby providing continuous tone transmission on the selected channel frequency for emergency or direction finding operation. In HQ, when pressed momentarily, is used for the TOD transmission. When pressed for a longer time a tone is generated after the TOD.

**Mode Switch.** The mode switch determines the method of frequency selection. When the switch is in the MAN position, operation is permitted on the frequency selected by the manual frequency selector knobs. When the switch is in the PRE position use of the channel selector is permitted for operation of any one of the 19 preset frequencies. In addition the mode switch allows selection of the 243.000 MHz emergency guard frequency (GD). In the HQ the GD selection overrides the "A" selection.

**Volume Control Knob.** This knob, labeled VOL, permits the audio signal adjustment.

## UHF ANI/ARC-150 (HQ) RADIO CONTROLS AND INDICATORS

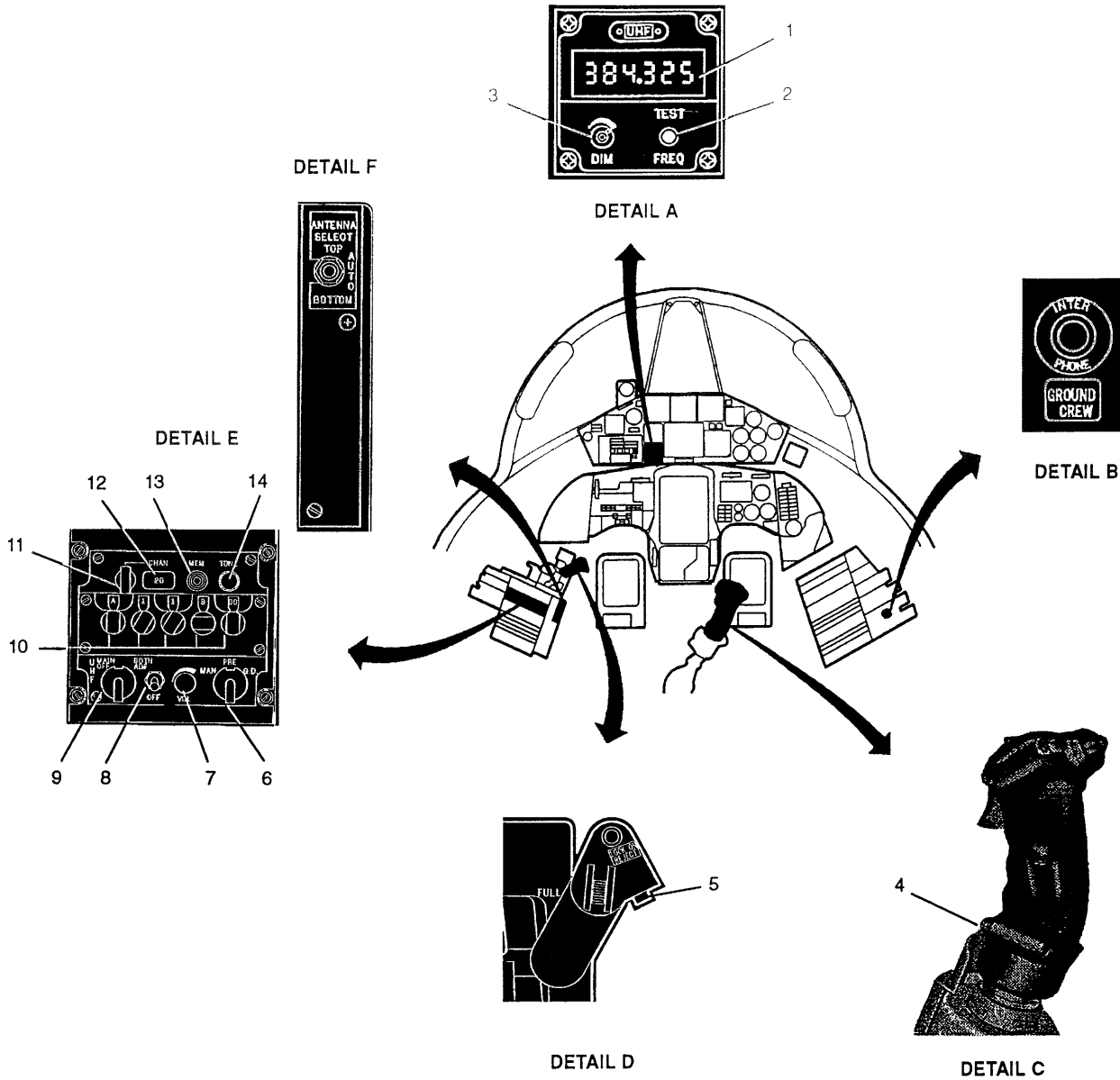

- |   |  |
|---|--|
| <p><b>A - CHANNEL FREQUENCY INDICATOR</b></p> <p>1 CHANNEL/FREQUENCY DISPLAY</p> <p>2 FREQUENCY SWITCH</p> <p>3 DIMMING KNOB</p><br><p><b>B - GROUND CREW INTERPHONE BUTTON</b></p><br><p><b>C - CONTROL STICK GRIP</b></p> <p>4 NOSEWHEEL STEERING/MICROPHONE BUTTON</p><br><p><b>D - ENGINE THROTTLE</b></p> <p>5 MICROPHONE BUTTON</p> | <p><b>E - UHF CONTROL PANEL</b></p> <p>6 MODE SWITCH</p> <p>7 VOLUME CONTROL KNOB</p> <p>8 SQUELCH SWITCH</p> <p>9 FUNCTION SWITCH</p> <p>10 MANUAL FREQUENCY SELECTOR KNOB AND DISPLAY</p> <p>11 CHANNEL SELECTOR AND DISPLAY</p> <p>12 WINDOW</p> <p>13 MEMORY BUTTON</p> <p>14 TONE BUTTON</p><br><p><b>F - ANTENNA SELECTOR SWITCH</b></p> |
|---|--|

Figure 1-43

FA0056

**Squelch Switch.** This switch permits the activation of the squelch circuit. When the noise threshold exceeds the calibration value, squelch provides for the elimination of noise signal. When set to OFF the squelch circuit is deactivated.

**Function Switch.** Operating the function switch to one of the four position set up the functions of the equipment as follows:

OFF	Deenergizes the equipment.
MAIN	Turns the radio on. The transmitter and main receiver operate on the same frequency. The equipment is switched from the receiver to the transmitter by depressing the microphone button. When the button is released the equipment returns to a receiving condition.
BOTH	The main receiver, transmitter and guard receiver are operative. The main receiver and transmitter operate on the frequency determined by the frequency control component. The guard receiver operates on a frequency preset on the ground. The BOTH position permits simultaneous monitoring of the main and guard receivers.

### NOTE

The BOTH position provides a monitor (receive) function only and does not permit transmission on the guard frequency. Transmission on the guard frequency is selected by positioning the mode selection to GUARD or by setting up the guard frequency on the manual frequency selector knobs.

ADF This position is inoperative.

### Channel/Frequency Indicator

The channel/frequency indicator (refer to Figure 1-43) is located on the left side of the upper main instrument panel. This indicator has the following controls and indicators:

**Channel/Frequency Display.** A LED display which shows the channel/frequency which has been se-

lected through the channel selector or through the manual frequency selector knobs, both located on the UHF radio control panel. When the Active HQ mode is selected, the first digit shows "A".

**TEST/FREQ Switch.** A three position TEST, neutral and FREQ switch.

When set to TEST (momentary position) a display check is carried out (888.888 displayed).

When set to FREQ (momentary position) the indicator shows the frequency (MAN) or the channel (PRE) selected on the UHF control panel.

**Dimming Knob.** This knob labeled DIM permits the channel/frequency display brightness control and adjustment.

### Antenna Selector Switch

An antenna selector switch (refer to Figure 1-43) is located in the left console circuit breaker panel and provides a means for manually controlling the antenna selector. Three position TOP, BOTTOM and AUTO, enable the pilot to select a particular antenna when desired or necessary for proper reception.

### Microphone Buttons

Two microphone buttons (refer to Figure 1-43) are available for transmitting. One is located on the throttle and is always usable while the other is located on the control stick grip.

### NOTE

The nosewheel steering/microphone button (located on the control stick grip) may be used for communications in flight only. During on-ground procedures the button is used for the nosewheel steering control.

### UHF AN/ARC-150 (HQ) Operation

1. Channel frequencies: check
2. Function switch: as required (MAIN or BOTH)
3. Mode switch: PRE or MAN



4. For pre-operation select a preset channel by rotating the channel selector knob so that the desired channel number appears in the window
5. Before transmitting message, check for operation and warmup of the transmitter, using either of the microphone buttons while listening for a tone
6. Adjust volume control, rotating (as desired) the VOL control knob
7. If it is desired to transmit and receive on a frequency not previously preset on the channel selector, place the mode switch in the MAN position and setup the new frequency selector knobs
8. Turn the function switch to OFF to deenergize the set

#### HAVE QUICK (HQ) FACILITY

The Have Quick (HQ) facility provides the aircraft on effective air-to-air and air-to-ground jam resistance in the UHF voice communications which allows the pilot to carry out its mission in a jammed environment.

The HQ programme consists of a simultaneous frequency change (frequency hopping) in the transmitter and receiver, following a pseudo-casual frequency sequence in a way that users are syntonized, instant for instant, on the same frequency. This is done provided that they have a "common reference", both during transmission and during reception. This synchronization of all radio equipment may be available provided they have a common time frame of reference defined as Time Of Day (TOD). The sequence of the frequency hopping is determined by a key defined as Word Of Day (WOD) that changes daily in order to avoid the possibility of a cross reference of the disturber with the communications.

The system is able to store up to six WOD defined as Multiple WOD (MWOD), each consisting of six elements. The frequency hopping modality is established by the number of network (NET). The NET number is defined as the starting point of the common frequency hopping.

The HQ may be operated in the Active mode ("A") as well as in the Training ("T") mode.

#### UHF HAVE QUICK SYSTEM OPERATION

##### NOTE

CHAN 20 is used for active ("A") HQ operation only.

In order to operate in HQ is necessary to have WOD and TOD loaded. If WOD and TOD are not loaded, a continuous high tone (3125 Hz) is heard in headset. To initialize the system proceed as follows:

#### ON-GROUND OPERATION

##### System Initialization

1. Function switch – Set to MAIN
2. Mode switch – Set to PRE
3. Channel selector – Set 20
4. Manual frequency selector knobs – Set 220.000
5. Memory button – Press, check audio tone

##### WOD Loading

1. Mode switch – Set to PRE
2. Channel selector – Set 20
3. Manual frequency selector knobs – Set 220.025
4. Memory button – Press
5. Channel/frequency indicator – Set momentarily to FREQ, check 220.025 displayed, then release
6. Mode switch – Set to MAN
7. Manual frequency selector knobs – Set first WOD segment
8. Tone button – Press
9. The remaining 5 segments are loaded following the above steps from 6. to 8. down to CHAN 15

**TOD Loading**

10. Channel selector — Set 14
11. Manual frequency selector knobs — Set 3AB.000 where:
  - A — Tens of day
  - B — Units of day
12. Tone button — Press

**MWOD Loading**

In order to load the remaining five WOD, repeat steps from 7. to 12.

**NOTE**

- Pilot shall be aware of the following:
- at each WOD, a different operative date shall be associated
  - storing of the first segment shall be carried out in CHAN 20.

**Final Loading**

13. Mode switch — Set to PRE
14. Channel selector — Set 20
15. Manual frequency selector knobs — Set 220.000
16. Memory button — Press

**WOD/MWOD Erasing**

1. Channel selector — Set 20
2. Mode switch — Set to PRE
3. Manual frequency selector knobs — Set to 220.050
4. Memory button — Press
5. Mode selector switch — Set to MAN
6. Tone button — Press

**HQ Training Loading**

1. Channel selector — Set 20
2. Mode switch — Set to PRE

3. Manual frequency selector knobs — Set to 220.075
4. Memory button — Press
5. Mode switch — Set to MAN
6. Manual frequency selector knobs — Set desired frequency
7. Tone button — Press
8. The remaining 15 training frequencies loading may be carried out following the above steps 6. and 7. down to CHAN 5

**PRE-FLIGHT OPERATION****CAUTION**

IF THE RADIO IS SWITCHED OFF FOR MORE THAN 5 SECONDS, "TOD" AND "WOD" INFORMATION IS LOST.

**WOD Recall**

1. Mode switch — Set to PRE
2. Channel selector — Set to 20
3. Manual frequency selector knobs — Set 220.025
4. Memory button — Press
5. Channel selector — Set 1
6. Mode switch — Set to MAN
7. Manual frequency selector knobs — Set 3AB.000 where:
  - A — Tens of day
  - B — Units of day
8. Tone button — Press
9. Mode switch — Set to PRE
10. Channel selector — Set 20
11. Manual frequency selector knobs — Set 220.000
12. Memory button — Press

**WOD Check**

1. Channel selector — Set 20
2. Mode switch — Set to MAN
3. Manual frequency selector knobs — Set 3AB.000 where:  
A — Tens of day  
B — Units of day
4. Channel selector — Set 19 then 20. Check audio tone in headset

**NOTE**

The WOD is not available if no audio tone is heard in headset.

**TOD Acquisition****NOTE**

"T" selection, on the UHF control panel, causes the "A" indication to be displayed on the channel/frequency indicator.

1. Manual frequency selector knobs — Set as required
2. Manual frequency selector knob — Set "T" for at least 2 seconds
3. Call an HQ operative station and check audio tone (1667 Hz) within 1 minute

**Auto Synchronization**

1. Manual frequency selector knob — Set and hold "T" and simultaneously press tone button. Check audio tone

**NOTE**

To avoid TOD transmission, release tone button before the manual frequency selector knob.

**TOD TRANSMISSION**

1. Mode switch — As desired
2. Manual frequency selector knobs — Set as required
3. Tone button — Press for at least 2 seconds then release. Check audio tone (1667 Hz)

**Active HQ Activation****NOTE**

Active mode is available provided that WOD and TOD have been previously loaded.

1. Mode switch — Set to MAN
2. Antenna selector switch — TOP or BOTTOM
3. Manual frequency selector knobs — Set in sequence NET (3 digit), HQ mode (2 digit) then "A"
4. Channel/frequency indicator. Check A + NET + HQ displayed

**NOTE**

Following a wrong NET setting, an intermittent 3125 Hz audio tone is listened.

**AN/AIC-18 INTERPHONE**

The AN/AIC-18 interphone is an integral part of the AN/ARC-150 UHF radio. The interphone provides amplification of all transmitted audio signals and communications between pilot and ground crew during on ground procedures. The interphone is connected to the aircraft through a jack located in the external power receptacle.

Pilot/ground crew communications are enabled when the relevant microphone/headset assembly is connected to the PEC. In order to transmit to the ground crew, the GROUND CREW INTERPHONE button (refer to Figure 1-43), located on the right console, has to be pressed and held pressed. The pilot may receive communications from the ground crew whenever the AN/ARC-150 UHF radio is operating and the headset is connected.

The landing gear warning signal, the canopy unlocked warning signal, the TACAN station identification audio signal, the AN/ARC-150 UHF radio as well as the AIM-9L audio tone and the breakaway audio signal are connected to the interphone system. The interphone is powered by the PP2 DC bus.

### EMERGENCY UHF RADIO

The emergency UHF equipment SIT-301 (refer to Figure 1-44) provides two-way, short range voice transmission in the event of AN/ARC-150 UHF failure. The integrative emergency solid-state UHF equipment (receiver, transmitter, power supply, and control panel) is contained in a one-package unit which is installed in the left console.

The emergency UHF receiver-transmitter operates in the 241.000 to 245.000 MHz range, providing 5 preset channels on a 4 MHz segment. This equipment normally remains in the receiver condition (OFF-RCV-RCV/XMT rotary switch in the RCV

position) and it is used only if the main UHF or its power source becomes inoperative.

Both emergency UHF and main UHF communications receiver outputs are connected to the headset. The microphone is connected to the emergency UHF equipment only when the emergency UHF control panel OFF-RCV-RCV/XMT rotary switch is in the RCV/XMT position. Transmission is not possible on the normal UHF transmitter when the OFF-RCV-RCV/XMT rotary switch is in the RCV/XMT position. Under this condition the status of normal UHF is receive only. The emergency UHF radio is powered by the PP4 battery bus.

### Emergency UHF Radio Control Panel

The emergency UHF control panel (refer to Figure 1-44) located on the left console, consists of a receive or transmit selector switch, a channel selector switch, and a volume control knob.

## UHF SIT-301 EMERGENCY RADIO CONTROLS

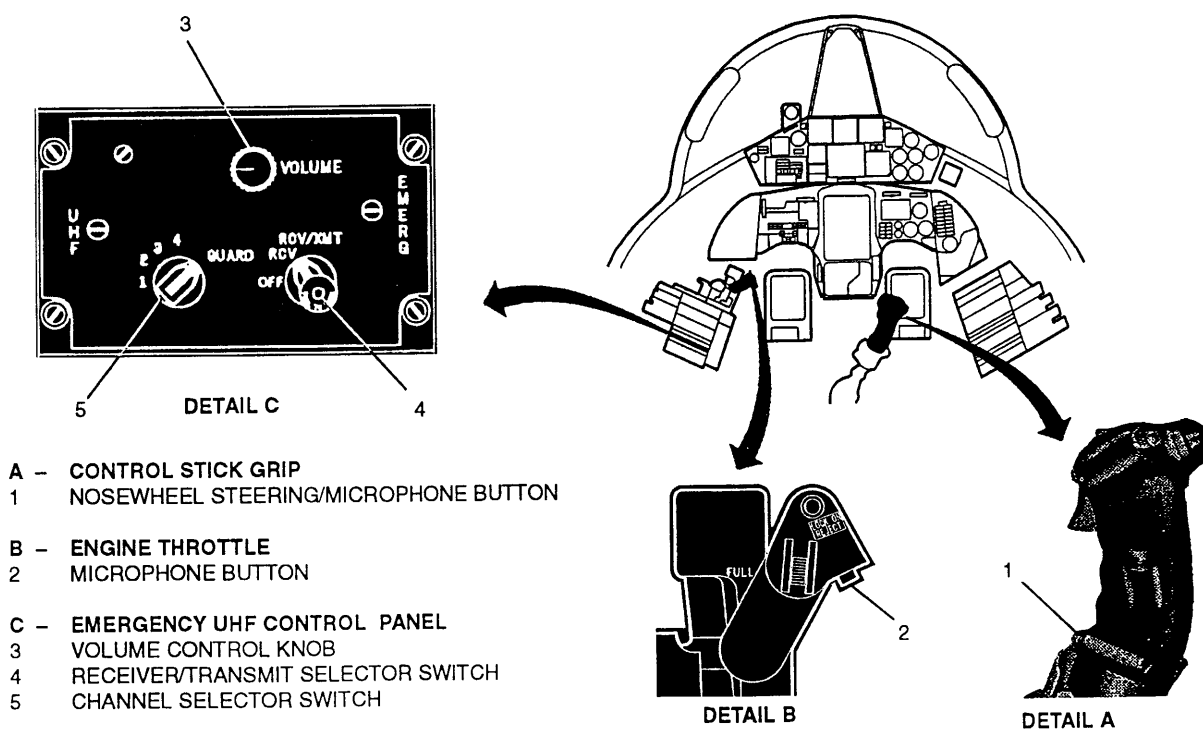

Figure 1-44

FA0057

**Channel Selector Switch.** This five-position switch selects the UHF emergency preset channel of operation. Frequencies from 241.000 to 245.000 MHz may be preset in channels from 1 to 4 as desired. The GUARD position selects a crystal-controlled guard frequency of 243.000 MHz.

**Receive/Transmit Selector Switch.** The PULL TO TURN OFF-RCV-RCV/XMT switch transfers the microphone switching circuitry between the main UHF (receive position) and emergency UHF (receive and transmit position).

**Volume Control Knob.** The volume control knob provides a mean of adjusting emergency UHF audio level.

### Microphone Buttons

Two microphone buttons (refer to Figure 1-43) are available for transmitting. One is located on the throttle and is always usable while the other is located on the control stick grip.

### NOTE

The nosewheel steering/microphone button (located on the control stick grip) may be used for communications in flight only. During on-ground procedures the button is used for the nosewheel steering control.

### IFF SYSTEM

The SIT 421T IFF system consists, primarily, of a control panel, a transponder unit and two antennas. The IFF control panel is located on the right console while the IFF transponder is located in the battery bay.

The upper antenna is installed on the panel of the electronic compartment and the lower antenna on the ventral fin. The IFF system provides automatic identification of the aircraft when challenged by other airborne or ground radar installation.

The modes of operation have the following significance: Mode 1 – security identity, Mode 2 – personal identity, Mode 3/A – air traffic identity, Mode C – altitude reporting and Mode 4 – security identity (provision only). The IFF system transmits coded replies to correctly coded interro-

gations. The system is powered by the PP2 DC bus.

The IFF transponder is a diversity transponder operating according to the MARK XA-SIF system in Modes 1, 2, 3/A and C. When the crypto-computer is installed, the equipment is enabled to operate in Mode 4.

The transponder receives interrogations on a carrier frequency of 1030 MHz via two antennas; the signals are decoded and revealed, and if interrogation is correct, reply transmission is enabled via the antenna which has received the strongest signal. Reply signals are transmitted on a carrier frequency of 1090 MHz. Normal operation of the transponder is constantly monitored by the BIT circuits; incorrect performance causes a NO GO indication lamp to be displayed.

### Crypto-Computer (Provision only)

The crypto-computer will be installed in the battery bay and be used for Mode 4 operation only.

### IFF Control Panel

The IFF control panel (refer to Figure 1-45) is located on the right console and has the following controls and indicators:

**Test Lamp.** The TEST GO lamp, when illuminated, indicates correct operation of the IFF system in self-test of Mode 1, or 2, or 3/A or C when the respective switches are positioned to TEST position.

**Failure Test Lamp.** The TEST/MON-NO GO lamp, when illuminated, indicates incorrect operation of the IFF system during self-test of Mode 1, or 2, or 3/A or C when the respective switches are positioned to TEST position. It also indicates that the IFF system does not respond properly to the received interrogations.

**Antenna Selector Switch.** This three position toggle switch, labeled ANT, permits the following antenna selection:

TOP	Only the upper antenna is used.
DIV	The system automatically selects the antenna to be used for transmission; reception is through both antennas.
BOT	Only the lower antenna is used.

### IFF SYSTEM CONTROLS AND INDICATORS

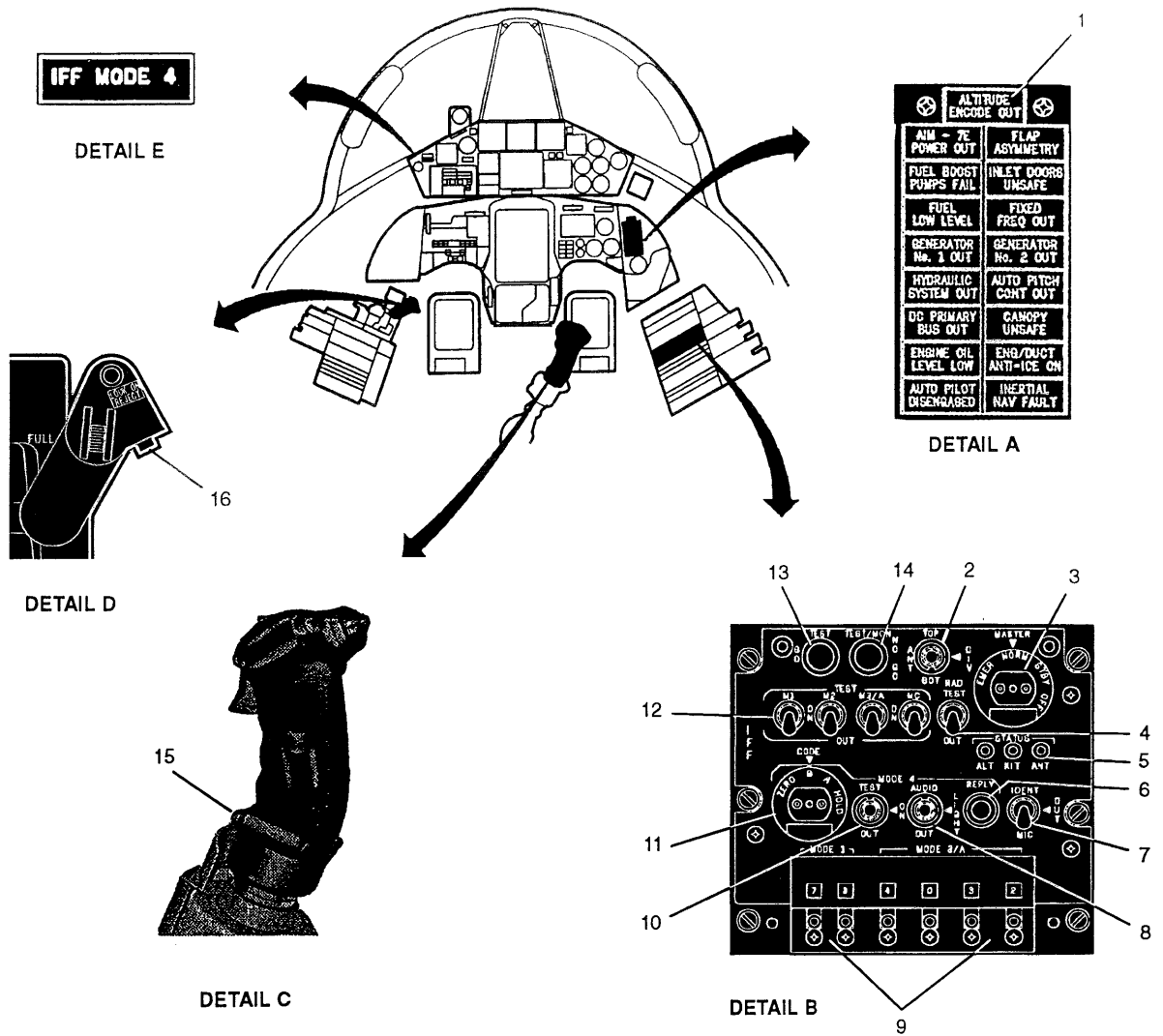

**A - WARNING LIGHTS PANEL**  
 1 ALTIUDE ENCODE OUT WARNING LIGHT

**C - CONTROL STICK GRIP**  
 15 NOSEWHEEL STEERING/MICROPHONE BUTTON

**B - IFF CONTROL PANEL**  
 2 ANTENNA SELECTOR SWITCH  
 3 MASTER SELECTOR KNOB  
 4 RADIATION TEST MODE SWITCH  
 5 STATUS LAMP  
 6 MODE 4 REPLY LAMP  
 7 IDENTIFICATION SWITCH  
 8 MODE 4 MONITOR SWITCH  
 9 MODE 3/A, 1 AND 2 CODE SELECTORS  
 10 MODE 4 TEST SWITCH  
 11 MODE 4 FUNCTIONAL KNOB  
 12 MODE SWITCHES  
 13 TEST LAMP  
 14 FAILURE/TEST LAMP

**D - ENGINE THROTTLE**  
 16 MICROPHONE BUTTON

**E - IFF MODE 4 WARNING LIGHT**

FA0063

Figure 1-45

**MASTER Selector Knob.** This four position rotary selector knob has the following positions:

- OFF            The system is de-energized.
  
- STBY          Places receiver-transmitter in warm-up (standby condition). Selector should remain in STBY a minimum of 1 minute for standard temperature conditions and 5 minutes under extreme ranges of temperature.
  
- NORM          The system is in operation.
  
- EMER          Transmits emergency reply signals to Mode 1, 2 or 3/A interrogations regardless of mode control setting.

**NOTE**

- The EMER position enables the functions of all operating modes regardless of the position of the M-1, M-2, M-3A or M-C switches.
  
- The EMER function enables Mode 4 and C regardless of the position of the MASTER selector. The transmission of an emergency reply requires that an interrogation signal be received prior to enabling transmission.
  
- The emergency functions are automatically enabled, through a pull connector on the ejection seat, when the pilot ejects.

**Radiation Test Mode Switch.** The RAD TEST-OUT switch is a two position toggle switch with the following selections:

- RAD TEST    Enables an appropriately equipped transponder to reply to TEST mode interrogations from test equipment. In RAD TEST position, the switch is spring-loaded to return to the OUT position.
  
- OUT            Deenergizes RAD TEST position. The OUT position should be selected when activating a switch to TEST position.

**Status Lamps.** These lamps, labeled ALT, KIT and ANT, are illuminated when M1, M2, M3/A, M4

or M-C mode switches are in TEST position. The ALT lamp illuminates when altitude computer data are not received by the IFF system. The KIT lamp illuminates when the data processed by the KIT-1A/TSEC computer are not received by the IFF system (operative with crypto-computer installed only).

The ANT lamp illuminates indicating a malfunction of one of the two antennas or that the standing wave ratio is higher than 3:1.

**Mode 4 Reply Lamp.** The REPLY lamp is operated by the Mode 4 monitor switch. It illuminates when valid Mode 4 replies are present. Operative only with crypto-computer installed.

**Identification Switch.** The IDENT-OUT-MIC three position switch permits the following selections:

- IDENT        When momentarily actuated (spring-loaded to return), enables a special reply for approximately 20 seconds.
  
- OUT           Prevents transmission of identification position replies.
  
- MIC           Enables identification of position replies to be transmitted for approximately 20 seconds every time the PTT pushbutton, located on the engine throttle or on the control stick grip, is pressed.

**Mode 4 Monitor Switch.** The AUDIO-LIGHT-OUT switch is operative only with the crypto-computer installed and permits the following selections:

- AUDIO        Enables aural tone and REPLY lamp monitoring of valid Mode 4 interrogations and replies only.
  
- LIGHT        Enables REPLY lamp monitoring of valid Mode 4 interrogations and replies only.
  
- OUT           Disables aural and REPLY lamp monitoring if Mode 4.

**MODE 3/A Code Selectors.** It includes four aligned pushbuttons permitting selection of the reply code for Mode 3/A (digits from 0 to 7).

**MODE 1 Code Selectors.** It includes two pushbuttons selecting the reply code for Mode 1. The left one selects a digit from 0 to 7, the next one a digit from 0 to 3.

**MODE 4 TEST Switch.** This switch, operative with the crypto-computer installed only, has the following positions:

TEST	Momentary position. Permits self-test of the IFF transponder in Mode 4 operation.
ON	Enables the receiver-transmitter to reply to Mode 4 interrogations.
OUT	Disables the reply capability to Mode 4 interrogations.

**Mode 4 Functional Knob.** This rotary knob labeled CODE, operative only with the crypto-computer installed, has the following positions:

HOLD	Retains code in the computer when aircraft has landed.
A	Selects A computer code.
B	Selects B computer code.
ZERO	Erases Mode 4 code from computer.

**Mode Switches.** Four three-position toggle switches, labeled M-1, M-2, M-3/A and M-C, permit the following operation:

OUT	The corresponding mode is disabled.
ON	Predisposition replies when the IFF transponder is interrogated in the corresponding mode.

### NOTE

Mode C is enabled with M-3/A switch to ON only.

TEST	Momentary position. A self-test is carried out (TEST GO light on), provided the MASTER selector is in NORM or EMER position.
------	--

### Warning Lights

Two warning lights are associated to the IFF. The ALTITUDE ENCODE OUT warning light, located on the warning lights panel, illuminates following the CPU-46A altitude computer failure or when is not energized. As a consequence the IFF Mode "C" is lost.

The IFF MODE 4 warning light, located in the upper left part of the main instrument panel, illuminates following a failure to reply to Mode 4 interrogations or a zeroed crypto-computer code. This warning light is operative only when the crypto computer is installed.

### Microphone Buttons

Two microphone buttons are available for the IFF transmission. One is located on the engine throttle and is always available, the other is on the control stick grip and is associated to the nosewheel steering operation control.

### NOTE

- With the weight of the aircraft on the main gear, operations of the microphone button located on the control stick grip are inhibited.
- Operation of both microphone buttons are abled only when the IFF identification switch is set to MIC.

### IFF SYSTEM OPERATION

Operation of the system is obtained by moving the master selector knob from OFF to any position. The STBY position is used to warm up (the system is ready in 5 to 10 seconds) and maintain the system ready for operation.

The system is ready to respond to the interrogations only when the master selector knob is either in the NORM or EMER position. In case of ejection, the system permits transmission of the emergency signals regardless of the master selector knob position. The transponder normally operates with the master selector knob at NORM.

### IFF MODES SYSTEM OPERATION

The IFF system may operate in the following modes:

- MODE 1
- MODE 2
- MODE 3/A
- MODE C
- MODE 4 with crypto-computer installed



The M-1 mode switch, when set to ON, enables Mode 1 (security identity) operation of the transponder, by activating the Selective Identification Feature (SIF) decoder to recognize Mode 1 interrogations and enable Mode 1 replies. The settings of the Mode 1 code selector, on the IFF control panel, select the coders of the A and B pulse combinations for reply to valid Mode 1 interrogations. The Mode 1 code selector of the tens digit designates the group A pulses and the units digit designates the group B pulses. The coding capability is 32 code combinations. The mode and validity of the interrogation signals are determined by the SIF decoder. If the interrogation signal is valid, the SIF decoder enables the commutator circuit and the A and B coders to reply. The commutator circuit determines the timing and sequence of all pulses (initial frame pulse, code pulses selected via coders A and B, and final frame pulse) routed to the modulator drive for transmission.

The M-2 mode switch, when set to ON, enables Mode 2 (personal identity) operation of the transponder; in this condition the SIF decoder identifies Mode 2 interrogations and enables Mode 2 replies. Mode 2 code shall not be changed during flight: selection is carried out on the ground only. The Mode 2 code selectors, select combination of A, B, C and D group pulses in reply to valid Mode 2 interrogations. The mode and validity of the interrogation signals are determined by the SIF decoder. If the interrogation signal is valid, the SIF decoder enables the commutator circuit and the A, B, C and D coders to reply. The commutator circuit determines the timing and sequence of all pulses (initial frame pulse, code pulses selected via coders A, B, C and D, and final frame pulse) routed to the modulator driver for transmission.

The M-3/A mode switch, when set to ON, enables Mode 3/A (traffic identity) operation of the transponder; in this condition the SIF decoder identifies Mode 3/A interrogations and enables Mode 3/A replies. The settings of the Mode 3/A code selectors select combination of A, B, C and D pulse combinations for reply to valid Mode 3/A interrogations. The Mode 3/A code selector of the thousands digit designates group A pulses, the hundreds digit designates group B pulses, the tens digit designates group C pulses, and the units digit designates group D pulses. The mode and validity of the interrogation signals are determined by the SIF decoder. If the interrogation signal is valid, the SIF decoder enables the commutator circuit and the A, B, C and D coders to reply. The commutator circuit determines the timing and sequence of all pulses (initial frame pulse, code pulses selected via coders A, B, C and

D, and final frame pulse) routed to the modulator driver for transmission.

The M-C mode switch, when set to ON, enables Mode C operation of the transponder.

#### NOTE

To permit Mode C operation, the Mode 3/A shall be set to ON.

In this condition the SIF decoder identifies Mode C (altitude reporting) interrogations and enables Mode 3/A replies. The digital signals reporting pressure altitude are routed from the CPU-46A altitude computer to coders A, B, C and D. When the IFF system is interrogated for altitude reporting (Mode C), the IFF transmitter-receiver will automatically report the aircraft altitude to the nearest 100 feet for a barometric pressure of 1013 mb., regardless of the altimeter barometric setting.

#### NOTE

- The IFF Mode "C" is available regardless of the ELECT or PNEU servo/pneumatic altimeter setting, provided the CPU-46A altitude computer is operative.
- Following CPU-46A altitude computer failure, the IFF Mode "C" is lost and the servo-pneumatic altimeter switches to baro mode (PNEU). As a consequence the ALTITUDE ENCODE OUT warning light illuminates.

The digital signals select the pulse combinations for reply to valid Mode C interrogations. The mode and validity of the interrogation signals are determined by the SIF decoder. If the interrogation signal is valid, the SIF decoder enables the commutator circuit and the A, B, C and D coders to reply. The commutator circuit determines the timing and sequence of all pulses (initial frame pulse, code pulses selected via coders A, B, C and D, and final frame pulse) routed to the modulator driver for transmission.

Mode 4 (encrypted identity) interrogations include a series of pulses followed by side suppression pulses. The interrogation signal is routed, via the Side Lobe Suppression (SLS) decoder, to the Mode 4 decoder. The mode and validity of the Mode 4

interrogation signals (first four pulses) are determined by the Mode 4 decoder. The SLS decoder uses the SLS pulse to key the SLS circuit which inhibits the SIF decoder, via the SIF suppression circuit during the Mode 4 interrogation period. Upon determination of valid Mode 4 interrogation, the Mode 4 decoder outputs three Mode 4 signals (video gate, delay code, and trigger). The Mode 4 video gate is routed to the Mode 4 video circuit, which in turn, transfers the Mode 4 video signals to the Mode 4 computer (KIT-1A/TSEC). The Mode 4 delay coding is routed to the Mode 4 control circuit, which enables a Mode 4 reply gate for codes A or B, each selected by the Mode 4 functional knob located on the IFF control panel. The Mode 4 trigger is directly routed to the Mode 4 computer. A Mode 4 reply video (selected code A or B reply pulses) is generated in response to the Mode 4 trigger when the Mode 4 enable switch is set to ON and the Mode 4 computer does not detect any disparity in the interrogation Mode 4 video signal. The Mode 4 reply video is routed to the modulator driver for transmission. When the Mode 4 monitor switch is set either to AUDIO or LIGHT, the REPLY lamp illuminates whenever a Mode 4 reply is transmitted. When the Mode 4 monitor switch is set to AUDIO, and the transponder interrogated in Mode 4 is not enabled to reply by the crypto-computer, an audio signal is routed to the pilot's headset, via the audio control system. When the Mode 4 monitor switch is set to OUT, the REPLY lamp, the audio monitoring of Mode 4 replies and the IFF MODE 4 warning lamp are disabled.

### System Starting

To start the system proceed as follows:

1. MASTER selector knob – STBY for 1 minute under standard temperature conditions (5 minutes under extreme temperature conditions), then to NORM
2. Mode code selectors – As required
3. Mode switches – On
4. IDENT/OUT/MIC switch – OUT
5. ANT switch – DIV

### Identification-of-Position Operation

When the IDENT-OUT-MIC switch is energized, the system transmits position identifying signals to

all interrogating stations on Modes 1, 2 and 3/A. Transmission of the identification-of-position signal occurs in these modes even if the mode switches are in the OUT position.

The two types of identification-of-position are as follows:

1. Momentarily hold the IDENT-OUT-MIC switch in the IDENT position, then release. This action causes the identification-of-position signal to be transmitted for a period of 20 seconds to all interrogation stations on Mode 1, 2 and 3/A. Repeat as required
2. Set the IDENT-OUT-MIC switch to the MIC position. Identification-of-position signals are transmitted by pressing one of two PTT push-buttons located on the control stick grip or on the engine throttle. When the need for further identification signals has ended, return the IDENT-OUT-MIC switch to the OUT position

### Emergency Operation

During an emergency or distress condition, with the master selector knob set to EMERG, the IFF system transmits automatically in the mode corresponding to the interrogation signal received. This occurs independently of the selected mode and the response code selected manually on the panel. The code signals are transmitted as follows:

- For 1, 2 and 3/A Modes, the military emergency reply consists of 4 pulse trains: the first train contains the selected mode code if the reply is Mode 1 or 2; code 7700 if the reply is Mode 3/A. The remaining 3 pulse trains merely consist of a pair of "frame" pulses spaced from the first reply framing pulse.
- The emergency selection enables Mode 4 and Mode C regardless of control settings, but does not affect the reply code format of these modes (the transmitted codes are the same used during normal operation).

These emergency codes are transmitted as long as the master selector knob is set to EMER position. The transmission of an emergency reply requires that an interrogation signal be received.

For emergency operation, proceed as follows:

- A. Pull and rotate the master selector knob to the EMER position.
- B. Leave the master selector knob at EMER for the duration of the emergency.
- C. When the emergency has ended, return the master selector knob to the NORM position.

**NOTE**

The emergency functions are automatically enabled, through a pull connector on the ejection seat, when the pilot ejects, regardless of the master selector knob position.

**IFF System Self-Test**

Self-test is possible for Modes 1, 2, 3/A and C. With the MASTER selector placed in NORM position, self-test is commenced by turning one of the Mode switches to TEST.

A signal generated for the selected mode of operation arrives at the set and is processed as a normal interrogation signal. Normal operation of the mode being tested is indicated by the illumination of the TEST GO lamp.

**AIR DATA COMPUTER**

The air data computer is located in the electronics compartment. The system utilizes power from the XP7 AC bus and PP1 DC bus. The transducers accept input information in the form of angle of attack, pitot pressure, static pressure, and total temperature.

These inputs are then converted to electrical signal outputs of air density ratio, angle of attack, impact pressure, Mach number, pressure altitude, total pressure, and true airspeed.

They are then automatically supplied to the using equipment (when operating) as follows:

OUTPUT	USING EQUIPMENT
Impact pressure Mach number Pressure altitude Altitude rate Mach No. rate	Automatic Pilot
Air density ratio Angle of attack Mach number True airspeed Pressure altitude Total pressure	Armament Computer
Pressure altitude Angle of attack	RADAR
Pressure altitude	Inertial Navigator
Impact pressure Pressure altitude	Landing Gear Warning
Mach number	Engine RPM Lockup system and Engine Bypass Flap system
Pressure altitude	CIT Gage (SLOW lamp)

**NOTE**

The air data computer is entirely automatic, containing no indicators or pilot-operated controls. Consequently, failure is detected by malfunction of any or all of the above using equipment.

**RADAR ALTIMETER**

The APN-198(V) radar altimeter is designed to instantaneously sense absolute altitude above ground level (AGL) during low-level flight. The system provides precise height information, unaffected by atmospheric or barometric conditions, from 0 to 5000 feet height. The system is electrically powered by the XP5 AC bus and by the PP2 DC bus. The system consists of a receiver/transmitter, two an-

tennas and a height indicator. The system is provided with LOW level warning lights and with an audio warning signal on headset. The radar altimeter indicator is located on the main instrument panel (refer to Figure 1-46) and incorporates the following features:

**Fixed Scale Dial.** The fixed scale dial incorporates three linear-scale segments, 0 to 700 ft, 700 to 1000 ft, and 1000 to 5000 ft. The scale of segment from 0 to 700 is graduated in 10 ft increments, the 700 to 1000 ft segment has an expanded scale graduated in 25 ft increments and, from 1000 to 5000 ft, the scale is graduated in 200 ft increments.

**Control Knob.** The control knob functions as the system on/off switch. It also provides control for setting the low-level index, and incorporates a push-to-test feature. When the knob is in OFF position, no power is applied to the system, the low-level index will be off the scale and the flag indicator will be displayed. Clockwise rotation of the knob from the OFF position applies power to the system. Additional clockwise rotation positions the low-level index to the desired warning height. When the knob is pushed the system self-test is initiated for preflight or in-flight confidence check. The self-test simulates an altitude range signal which positions the height pointer to read  $100 \pm 15$  ft.

**Height Pointer.** The height pointer indicates the actual height whenever the system is operating and tracking properly. If the system is not operating properly the pointer will swing to a point beyond the height scale and behind the pointer mask. This precludes any possibility of reading an erroneous height.

**Pointer Mask.** The height indicator pointer will move behind the pointer mask if the actual height indication is above 5000 ft or when the radar altimeter system is in warm-up/search phase. This will occur also in case of a radar altimeter failure.

**Low-Level Index and Low Level Warning Light.** The low-level index provides the selection of the desired height by use of the control knob. Whenever the aircraft descends below this selected height, the yellow LOW warning light will illuminate. The LOW warning light may be dimmed through use of the INTERIOR INSTRUMENT switch control located on the LIGHT CONTROL panel (right console).

**Flag Indicator.** A black and yellow striped (barber pole) flag is displayed through a window on the dial whenever power to the radar altimeter is removed or the altimeter is not tracking properly.

**Radar Altimeter Low Height Warning Light Repeater.** The red radar altimeter warning light repeater, located on the right upper part of the windshield, illuminates simultaneously with the LOW warning light.

## RADAR ALTIMETER PREFLIGHT CHECK

With the system powered:

1. Control knob – Rotate clockwise from the OFF position

Note that height pointer moves behind the pointer mask. After approx. 45 sec., the flag disappears and the pointer returns to zero.

### WARNING

DO NOT PASS UNDER THE AIRCRAFT WHEN THE RADAR ALTIMETER IS OPERATING.

2. Control knob – Rotate clockwise until the low level index reads 50 ft. The yellow LOW light and the red radar altimeter warning light repeater will illuminate indicating that the aircraft is below the low level index setting. Also the audio warning signal is routed to the headset
3. Control knob – Press and hold. The height pointer will indicate an height of  $100 \pm 15$  ft indicating proper system self-test and the LOW light, the radar altimeter warning light repeater and the audio warning signal will extinguish
4. Control knob – Release. The pointer will return to zero feet and the LOW light and radar altimeter warning light repeater will illuminate. Also the audio warning signal is listened in the headset
5. Control knob – Rotate clockwise to select the desired low height limit

## RADAR ALTIMETER CONTROLS AND INDICATORS

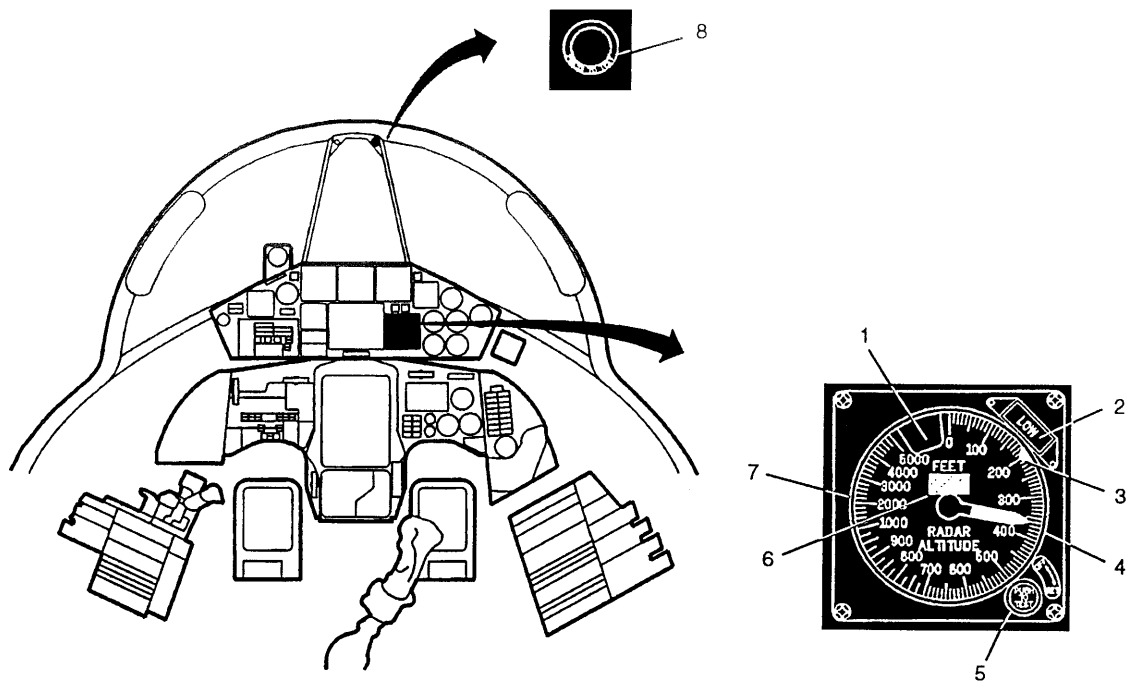

- |  |   |
|--|---|
| <ul style="list-style-type: none"> <li>1 POINTER MASK</li> <li>2 LOW LEVEL WARNING LIGHT</li> <li>3 LOW LEVEL INDEX</li> <li>4 HEIGHT POINTER</li> <li>5 CONTROL KNOB</li> </ul> | <ul style="list-style-type: none"> <li>6 FLAG INDICATOR</li> <li>7 FIXED SCALE DIAL</li> <li>8 RADAR ALTIMETER LOW HEIGHT WARNING LIGHT REPEATER</li> </ul> |
|--|---|

FA0064

Figure 1-46

## INERTIAL NAVIGATION SYSTEM (INS)

The LN39A2 Inertial Navigation System consists of an inertial navigation unit (INU) and a control panel labeled IN. The INU is a self contained, fully automatic, gyro stabilized platform with built-in test equipment facilities. The IN shall provide generation of present position, attitude angles, velocity components and magnetic heading parameters. In addition to these typical functions, it shall provide processing functions and interfacing capabilities for other equipment. The system shall support analog interface with Horizontal Situation Indicator (HSI), Attitude Indicator (AI), Air Data Computer (ADC), Automatic Flight Control Computer (AFCC), Adapter, Armament Computer (AC), and warning lights panel; moreover it shall communicate with the IN/CDU and Global Positioning System (GPS) by means of an EIA RS-422 interface.

The INU receives power from the XP5 AC bus, in case of failure of the fixed frequency generator (GEN.3) the IN is powered by the XP4 AC bus; concerning the DC power the IN receive supply from PP1 DC bus and, as back up, supply from the PP4 battery bus. The system function electrical interface is shown in Figure 1-48. Avionic system architecture is shown in Figure 1-49.

### INS CONTROLS AND INDICATORS

The INS controls and indicators are illustrated in Figure 1-47.

#### INS Control Panel

The INS control panel, labelled IN and located on the right console, has the following controls and indicators:

**Function Selector Knob.** This knob labeled FUNCTION has five positions:

OFF            The system is turned off

TEST            Permits the IN self-test

ALN             Provides the IN alignment in the GC or STO mode

NAV             The IN is operative for navigation

CAL             Permits the IN calibration by ground personnel only

**Mode Selector Knob.** This knob labeled MODE has two positions:

GC              Selects the gyrocompassing alignment mode

STO             Selects the alignment mode which employs the stored heading

**Ready Navigation Lamp.** This lamp, labeled RDY NAV, illuminates steadily to indicate that the IN has got an alignment status sufficient to sustain the NAV mode.

#### NOTE

The flashing RDY NAV indication means the achievement of maximum alignment status for each alignment selected mode.

**Fail Lamp.** This amber lamp, labeled FAIL, illuminates if an INS failure occurs.

**Alignment Status Indicator.** This indicator, labeled ALIGN/STATUS, is a one digit display that indicates approximately the radial position error in nautical miles, for each hour of flight. If an INS failure occurs the alignment status indicator extinguishes.

#### NOTE

During the alignment procedure, for all modes, the INU will compute the present alignment status and make it available on the alignment status indicator, while fixing it when the NAV mode is selected.

#### NOTE

The INS switching off causes the deletion of all station points (including the mark point, if any).

# INERTIAL NAVIGATION SYSTEM CONTROLS AND INDICATORS

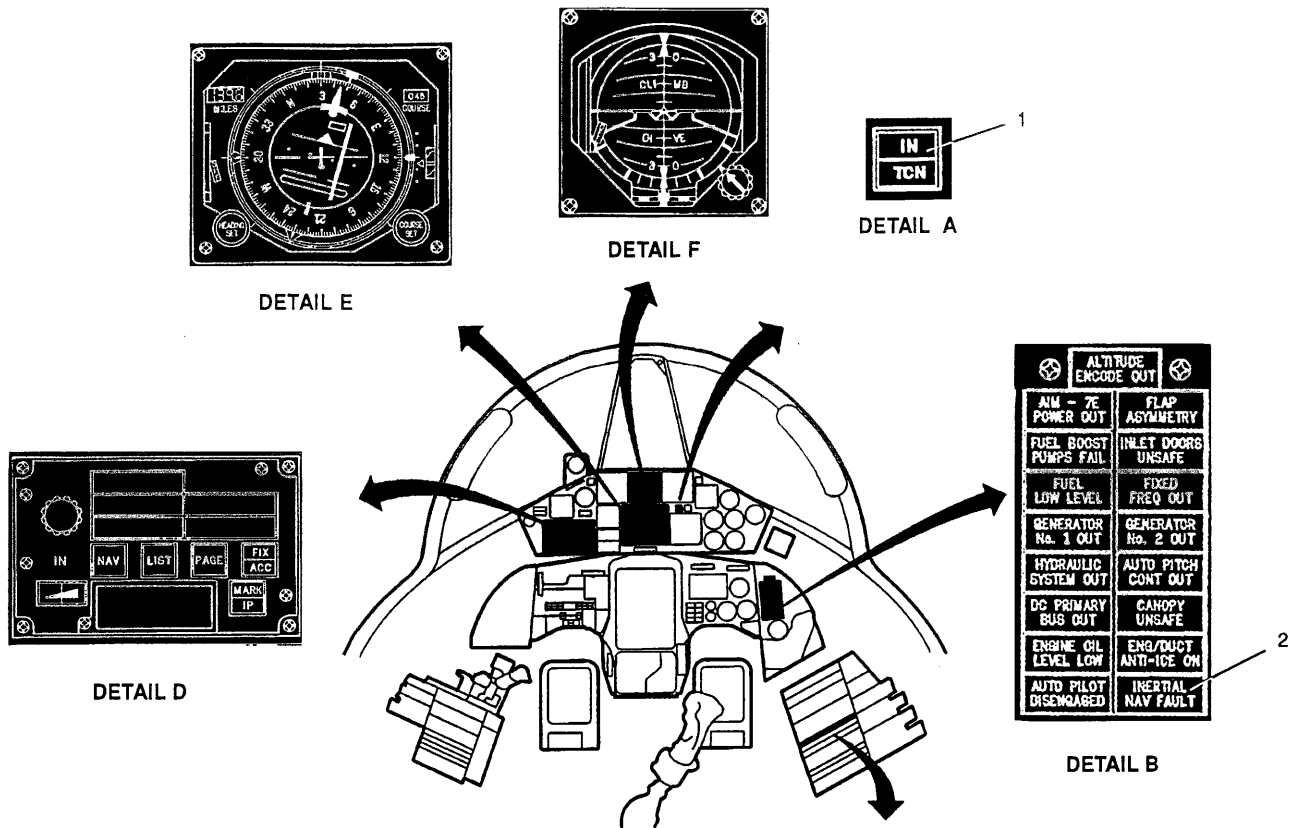

**A - NAVIGATION STEERING MODE SELECTOR PUSHBUTTON**

1 IN INDICATOR

**B - WARNING LIGHT PANEL**

2 INERTIAL NAV FAULT WARNING LIGHT

**C - INERTIAL NAVIGATOR CONTROL PANEL**

- 3 MODE SELECTOR KNOB
- 4 ALIGNMENT STATUS INDICATOR
- 5 FAIL LAMP
- 6 FUNCTION SELECTOR KNOB
- 7 READY NAVIGATION LAMP

**D - IN/CDU**

**E - HORIZONTAL SITUATION INDICATOR (HSI)**

**F - ATTITUDE INDICATOR**

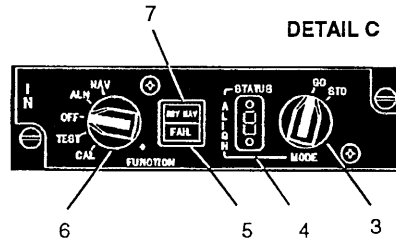
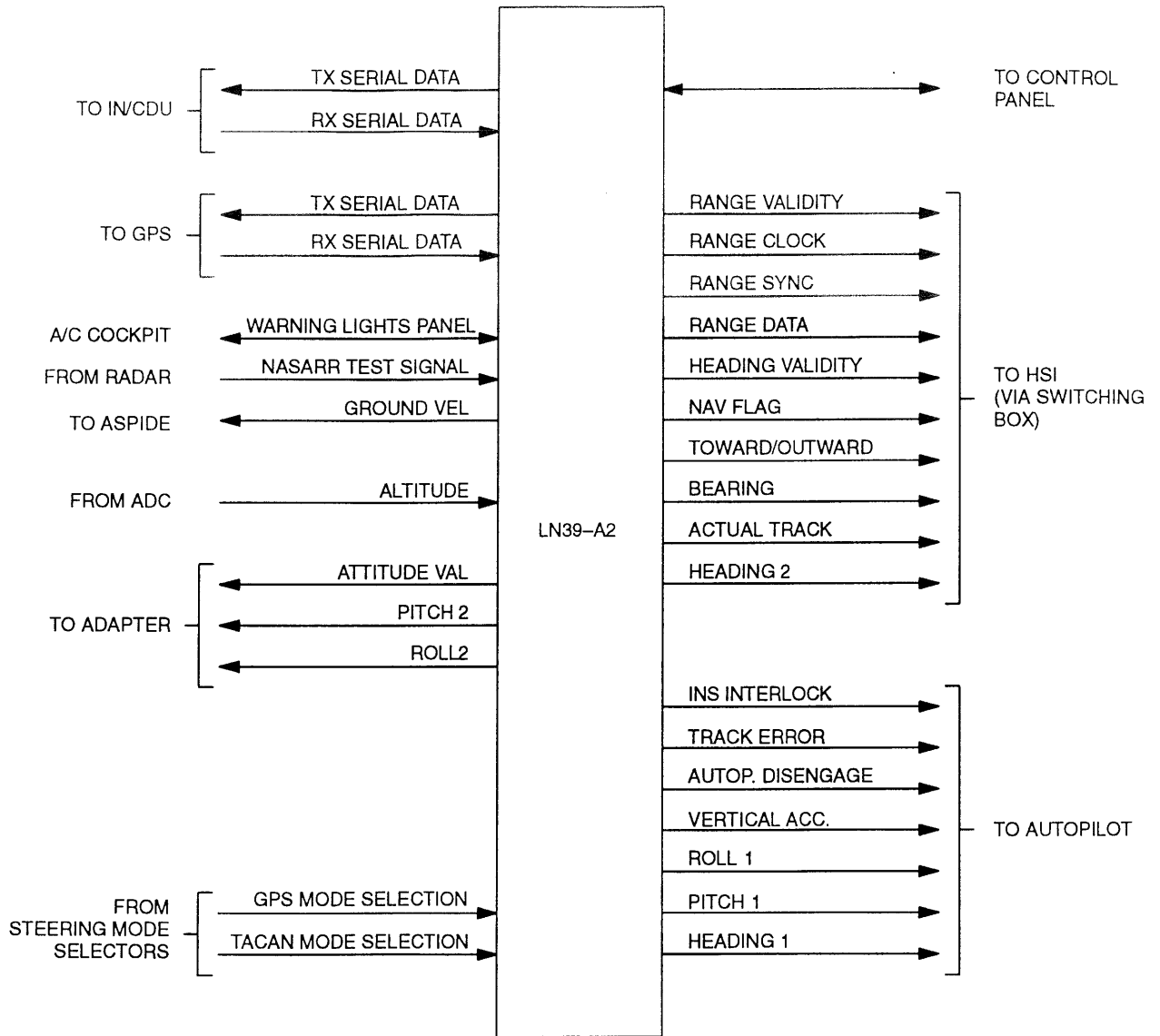

Figure 1-47

**INS – FUNCTIONAL ELECTRICAL INTERFACE**



FA0058

Figure 1-48



AVIONIC SYSTEM ARCHITECTURE

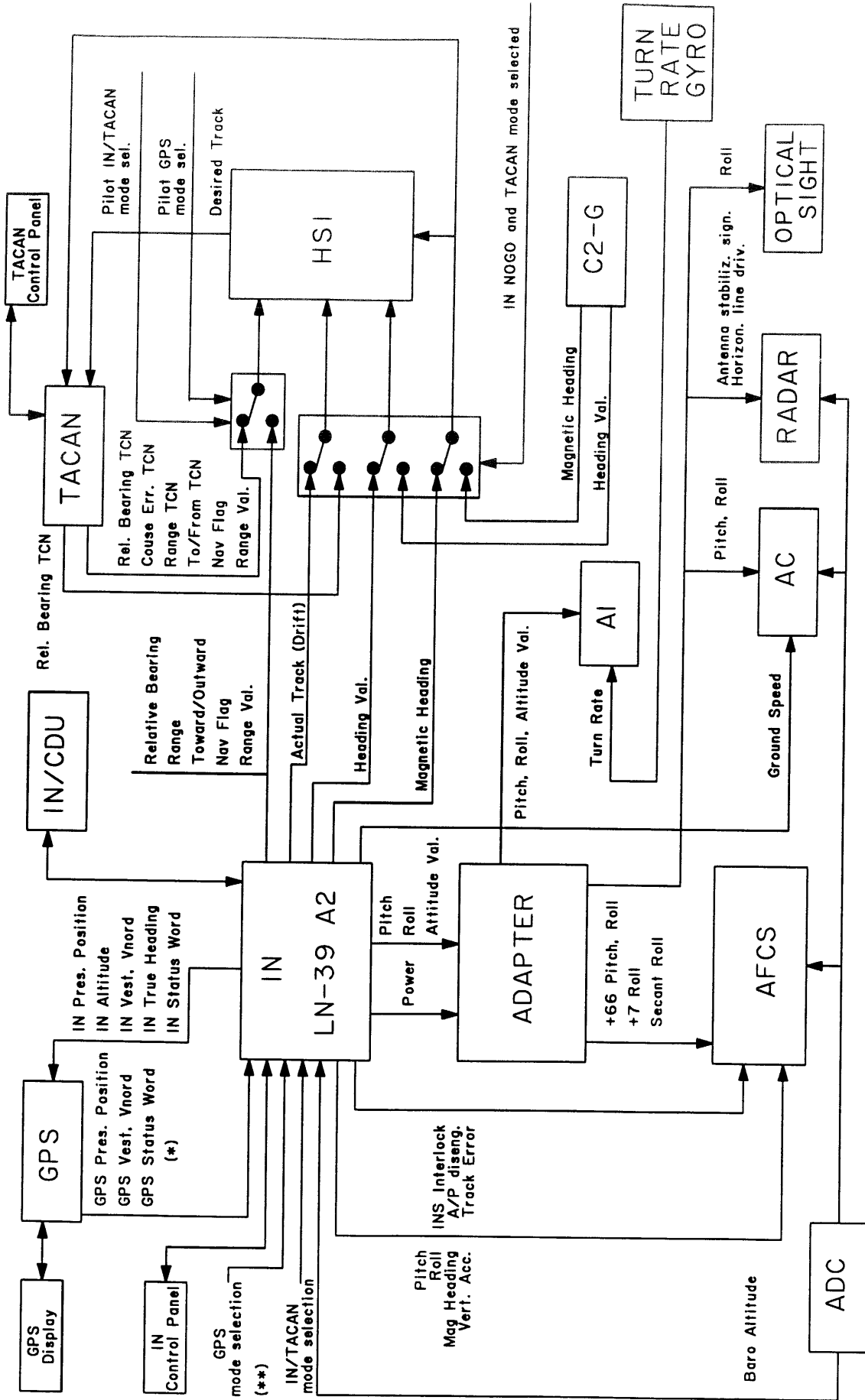

Figure 1-49

(\*) In IN-GPS communication only relevant parameters are specified.  
 (\*\*) GPS and IN/TACAN mode selection discretes supplied by switching box.  
 Switching box receives pilot IN/TCN and GPS mode selections.

### Warning Light

The INERTIAL NAV FAULT warning lamp, located in the warning lights panel, lights up whenever a failure is detected in the INS.

### Navigation Steering Mode Selector Pushbutton

The navigation steering mode selector pushbutton, located on the main instrument panel, is a dual captions press-to-select pushbutton. The IN caption illuminates indicating the selection of the INS as steering mode source.

#### NOTE

Refer to Navigation Sub-System paragraph for further information.

### Horizontal Situation Indicator (HSI)

The HSI will show steering parameters referenced to the Magnetic North and navigation information.

#### NOTE

The IN system does not compute the course error. The lateral deviation bar, on HSI, is inoperative when flying in IN steering mode (centered). The TO/FROM indication are derived from the IN system as a TOWARD (range decreasing) or OUTWARD (range increasing) according to the range numerical display (MILES) on HSI. The desired course indication is slaved to the course knob and rotates in conjunction with the compass card.

### Attitude Indicator

The attitude indicator shows pitch and roll information.

### IN/CDU

The IN/CDU shows all loaded mission data, navigation data, as well as fixing error and mark points.

## INS MODE OF OPERATIONS

### ALIGN MODE – "ALN"

In the ALIGN mode, system operation shall be initiated by selecting the ALIGN method with the ALIGN mode switch and then switching the function switch from "OFF" to "ALN" position. At the switch-on the system shall download the mission from the DTM previously inserted by the pilot in the socket on the IN/CDU, that includes information of latitude, longitude, ICAO code, station height above the sea level and TACAN channel, to the navigation subsystem, validating, by means of the single waypoint checksums and by means of the checksum of the whole database, the integrity of the data. The following alignment modes shall be available:

### Gyrocompassing – "GC"

During gyrocompassing alignment, the equipment shall perform a self-alignment and levelling procedure requiring only input of initial position (IP).

Aircraft initial position is acquired and entered when the function selector knob is set to ALN. During the first 2 minutes period, the initial position may be updated and used by IN without restart of the IN alignment procedure. A full gyrocompassing alignment or a rapid gyrocompassing alignment shall be achieved depending upon time at which navigate function is selected.

When rapid gyrocompassing alignment is completed, the INU shall provide a steady "RDY NAV" indication and the ALIGN STATUS indicator shall display "3": at this time the "NAV" position may be selected if a fast alignment is desired. Otherwise the "NAV" position should be selected after the "RDY NAV" lamp flashing is initiated, indicating that a full gyrocompass alignment is completed (STATUS "1"). During alignment, the INU shall compute and make available for display an alignment status indication as defined in Figure 1-50.

### Stored Heading – "STO"

Stored heading alignment mode shall be a fast alignment mode having as pre-requisites the following:

- the aircraft is stopped and a full gyrocompassing alignment is performed before IN shut down

## ALIGN STATUS PREDICTED NAVIGATION ACCURACY DEFINITION

ALIGN STATUS	DEFINITION	MODE	RDY NAV
8	IN is performing levelling procedure If NAV is selected the IN fails	GC or STO	--
7 ÷ 3	IN is performing gyrocompassing alignment or stored alignment If NAV is selected the navigation is performed with degraded performance The navigation accuracy is predicted to be equivalent to the Align Status number displayed, expressed in nm/hr (C.E.P.)	GC RAPID or STO	STEADY "3"  FLASH "3"
3 ÷ 1	The navigation accuracy is predicted to be equivalent to the Align Status number displayed, expressed in nm/hr (C.E.P.)	GC FULL	FLASH "1"

**Note 1:** Align status codes shall be used for operator information only and do not imply system performance requirement

**Note 2:** Align status 7 shall be achieved in 7.5 minutes max. after turn-on at T = -40 °C

**Figure 1-50**

— the aircraft is not moved prior to next alignment.

During stored heading alignment, the equipment shall perform a levelling procedure and shall align to the last stored heading utilizing the last stored present position for initialization. Input of initial position shall be ignored. When stored heading alignment is completed, the INU shall provide a flashing "RDY NAV" indication. At this time the NAV mode shall be selected. During stored heading alignment mode, the INU shall compute and make available for display an alignment status indication as defined in Figure 1-50.

### NAVIGATE Mode – "NAV"

NAV mode is the flight mode of operation and shall be selected after a satisfactory alignment is reached and the "RDY NAV" lamp is lit or flashing. When NAV is selected the IN shall enter the navigation mode and the "RDY NAV" extinguishes.

### NOTE

In the event of an internal computer failure or the selection of NAV mode prior to the system capability of sustaining NAV mode, the IN shall revert to a first order levelling mechanization in order to avoid platform damage during flight.

### CALIBRATE Mode – "CAL"

The CAL mode shall provide automatic calibration of three axis gyro bias drift. The CAL mode shall require no more than 90 minutes to complete, and shall include provision for updating the affected calibration constants stored in the INU. The CAL mode does not require external inputs other than aircraft present position for operation. It shall operate in the ground alignment environment, without the need for any support equipment. At the end of calibration the "RDY NAV" flashing indication is displayed.

**TEST Mode – "TEST"**

To perform correctly the INS self-test the aircraft shall not be moved until the test is completed. The INS self-test is initiated by setting the function selector knob to TEST position. During the self-test procedure the alignment status indicator will provide a numeric indication varying from 8 to 1. When the number 1 is displayed it means that the self-test is valid and completed. If a INS failure is detected during the self-test procedure, the FAIL lamp comes on while, the alignment status indicator, maintains a fixed number on the display.

**INS OPERATION**

To operate the system proceed as follows:

- A. Set the mode selector knob to the desired alignment mode (GC or STO)
- B. Set the function selector knob from OFF to ALN. When the ALN function is selected the INS platform alignment is initiated

**NOTE**

The INS may be switched off during alignment procedure (or in other term before setting the function selector knob to NAV) by setting the function selector knob to OFF without causing damage to the system. After the alignment status indicator digit extinguishes, the function selector knob may be set again to ALN position.

- C. Set the function selector knob from ALN to NAV position after a satisfactory alignment is completed. The INS navigate function is initiated and the "RDY NAV" caption extinguishes

For IN alignment and emergency procedures refer to Sections II and III respectively.

**TACTICAL AIR NAVIGATION (TACAN) SYSTEM**

The TACTical Air Navigation system consists of a receiver-transmitter unit installed in the electronics compartment, a control panel installed in the cockpit, and an antenna. The equipment receives

power from the PP1 DC bus and from XP6 AC bus. The system operates from 962 MHz to 1213 MHz. 126 two-way operating channels, spaced 1 megacycle apart, are available on X and Y mode. The equipment operates to provide continuous distance and bearing information from any received surface beacon within a line-of-sight distance from the aircraft of up to 390 NM nautical miles or less depending on aircraft altitude and station location. The pilot, knowing his approximate location, may select a nearby beacon and navigate by it. Visual indication of bearing to the station is provided by the pointer of the HSI system. Range to the station is also displayed on the HSI.

Following a correct TACAN station acquisition, the station identification audio signal is sent to the pilot's headset.

The equipment is provided with a self-test capability automatically activated at the switch-on or manually selected by pressing the TEST button: the test lamp flashes once.

During the first two seconds of the test all HSI displays are not valid, then bearing displays 180° for six seconds. At the end of the test, normal HSI/TACAN conditions are resumed.

**TACAN Control Panel**

The TACAN control panel (Figure 1-51) is located on the right console, and has the following controls:

**Channel Window.** A four digit display shows the selected operating channel and mode of operation.

**Function Selector Switch.** The function selector is a five-position rotary type knob, placarded clockwise as follows:

OFF	The system is turned off.
REC	The system provides indication of the bearing to the selected station on HSI.
T/R	The system provides bearing and slant range distance to the selected station on HSI.
A/A REC	The system provides bearing to the cooperating aircraft on HSI.
A/A T/R	The system provides bearing and distance to the cooperating aircraft on HSI.

**Volume Control Knob.** Ground beacon identification audio level may be adjusted by rotating the knob placarded VOL to the right or left as desired.

## TACAN CONTROLS AND INDICATORS

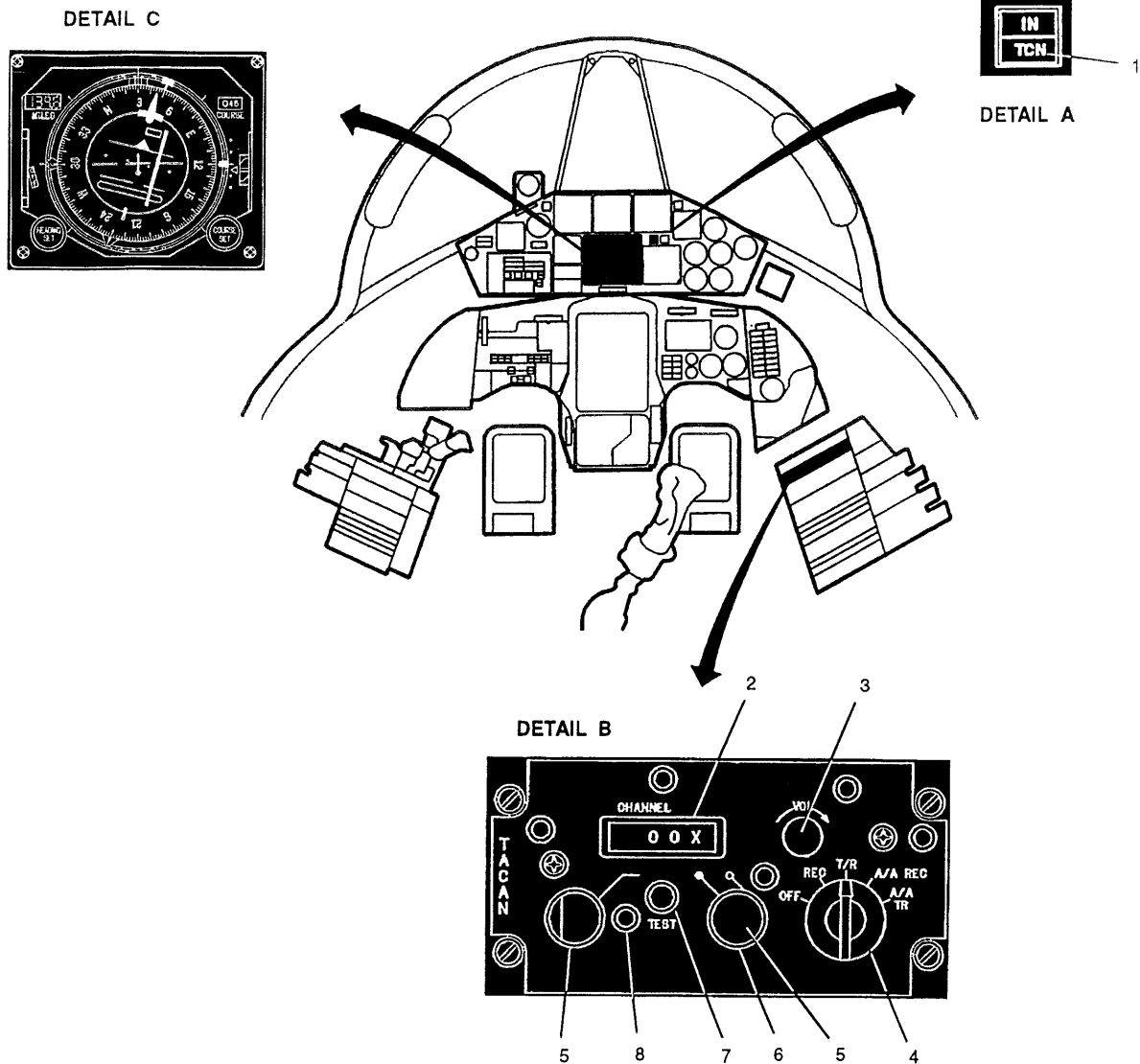

**A - NAVIGATION STEERING MODE SELECTOR PUSHBUTTON**  
 1 TCN INDICATOR

**B - TACAN CONTROL PANEL**  
 2 CHANNEL WINDOW  
 3 VOLUME CONTROL KNOB  
 4 FUNCTION SELECTOR SWITCH  
 5 CHANNEL SELECTOR KNOBS  
 6 MODE SELECTOR KNOB  
 7 TEST LAMP  
 8 TEST BUTTON

**C - HORIZONTAL SITUATION INDICATOR (HSI)**

FA0066

Figure 1-51

**Channel/Mode Selector Knobs.** The selector on the left selects hundred and tens (digit 0-120). The selector on the right contains two concentric knobs. The inner knob selects units (digit 0-9), the outer knob selects X/Y modes.

**TEST Button.** When pressed it test the TACAN.

**TEST Lamp.** It flashes once automatically after switch-on or when the TEST button is pressed, indicating that the TACAN system self test has been initiated. It also illuminates if a TACAN malfunction is detected during self test or normal operation.

#### Navigation Steering Mode Selector Pushbutton

The navigation steering mode selector pushbutton, located on the main instrument panel, is a dual captions press-to-select pushbutton. The TCN caption illuminates indicating the selection of the TACAN as steering mode source.

#### NOTE

Refer to Navigation Sub-System paragraph for further information.

#### Horizontal Situation Indicator (HSI)

The HSI will show bearing and range information to the selected TACAN station.

#### TACAN Operation

To operate the TACAN equipment, proceed as follows:

1. Channel and mode selector knobs – Select desired channel and mode of operation
2. Function selector switch – As desired
3. Volume control knob – As desired
4. Verify station identification
5. Navigation steering mode selector pushbutton – Press, check TCN caption lit
6. Set desired course on HSI
7. Monitor bearing TO/FROM and course deviation on HSI

8. Observe distance to the station as indicated by the HSI

#### NOTE

In case of IN failure, perform a C2-G synchronize operation.

#### TACAN Station Approach from a Desired Radial

In conjunction with the HSI, the TACAN equipment allows the approach of the selected TACAN station from a desired radial. The course pointer and the digital course readout on the HSI indicate the desired course manually set using the COURSE SET knob. The TACAN calculates the track angular error, as a function of the desired course setting and the selected TACAN station bearing, to drive the HSI course deviation bar (5° per dot). Rightward deflection of the HSI course deviation bar requires a rightward correction maneuver of the aircraft while, leftward deflection requires an analogous leftward maneuver. The "TO/FROM" arrows of the HSI are also driven from the TACAN, and are referred to an axis perpendicular to the set desired course which passes through the selected TACAN station and delimits two zones: "TO" is the zone containing the aircraft, the other is "FROM".

## GLOBAL POSITIONING SYSTEM (GPS)

The Global Positioning System (GPS) NAVSTAR (NAVigation System using Time And Ranging) is a worldwide coverage, high precision radio navigation system which provides position, speed information along three coordinates (longitude, latitude and altitude) and time information.

The GPS is divided into 3 main segments:

- a space segment, consisting of 24 satellites (21 operating satellites plus 3 emergency satellites) orbiting around the earth
- a monitoring segment, consisting of ground stations which monitor and correct data transmitted from the satellites
- a user segment, consisting of one system receiving the information transmitted from the satellites; this is used for precise calculation of posi-

tion along the three space coordinates (longitude, latitude and altitude)

In order to define the aircraft's position, the GPS NAVSTAR uses space and time information received from 4 different satellites. Reception of signals from the satellites requires that each satellite is optically aligned with the user.

The aircraft's position is calculated as summarised below:

- while transmitting signals to the aircraft, each satellite creates an hypothetical sphere whose centre is the satellite and whose radius is the distance between the satellite and the aircraft
- signals transmitted from 2 satellites create a circle obtained by intersecting both spheres; the aircraft is located on the circumference of such a circle
- signals transmitted from the 3rd satellite are used to define two points obtained by intersecting the 3rd sphere with the previously created circle: one point corresponds to the aircraft position, the second point is negligible
- in order to obtain the two intersection points of the 3 spheres, the distance between the aircraft and satellite (sphere radius) and precise position of the satellite in the outer space (sphere centre) shall be calculated.

The satellite position is calculated upon knowledge of the orbit (ephemeris) and the signal transmission time.

Distance between aircraft and satellites is calculated through the formula:

$$d = c \times \Delta t$$

where:

- d = distance between satellites and aircraft
- c = light speed ( $3 \times 10^8$  m/sec)
- $\Delta t$  = time interval from signal transmission to signal reception

In the above formula, the signal transmission speed is a known value, while the time interval between signal transmission and reception (TOA - time of arrival) is obtained by subtracting the transmission time, as given in the satellite message, from the time at which the signal is received.

In order to have at least 4 satellites constantly in the viewing range, the constellation consists of 24 satellites (21 operating satellites plus 3 emergency satellites) orbiting around the earth.

Information received from each satellite is:

- position of the satellite in the constellation (satellite constellation almanac)
- precise trajectory or ephemeris of the satellite
- signal transmission time.

Additional information, called "satellite health data", is also transmitted to ensure quality of the transmitted signal. This guarantees that the information received was actually transmitted from a satellite belonging to the constellation. If this information is missing, the message received will be considered not reliable. The 24 satellites comprised in the space segment are controlled by one common monitoring segment.

The monitoring segment is designed to monitor transmission from all satellites. It consists of:

- 5 monitoring stations
- 1 master control station
- 3 data transmission stations (ground antennas)

Every monitor station receives a signal from the satellite covering the following information:

- data on satellite ephemeris
- range of the satellite transmission signal
- time data on the satellite clock
- data on constellation almanac

This information is subsequently transmitted to the Master Control Station, where the ephemeris and data on almanac is corrected and set to the data transmission station that views the satellite. Time information from the satellite is compared with the time of the Master Control Station clock.

In this way, each satellite calculates its own orbital position with the highest precision with time reference to the GPS.

The user (aircraft) segment consists of various GPS users that decode and calculate the signal received from the GPS satellite; this is received on the R-202 receiver, that calculates its own position referred to the earth surface. The receiver calculates the GPS time and the space coordinates (latitude, longitude and altitude) upon reception of signals from 4 satellites selected among the ones optically aligned with it. Calculation of the receiver position requires the time interval between signal transmission and arrival (TOA Time of Arrival) to be measured and the precise position of the satellite during transmission to be known.

When transmission occurs by means of three satellites only, the receiver shall be set up so as to include one of the three variable (altitude) as a reading value.

Speed is calculated taking advantage of the doppler effect produced by the received signal: difference in the frequency variation of the signal consequent to the receiver motion (doppler effect) permits speed along the 3 axes to be calculated with high precision.

The GPS is interfaced with each user on two frequencies (band L) with two different degrees of precision:

- L1 = 1575.42 MHz
- L2 = 1227.60 MHz

Data transmitted from the satellite includes different information necessary for navigation:

- C/A code (Coarse Acquisition) for position calculation with a low degree of precision
- P code (Precision Code) for position calculation with a high degree of precision
- Navigation message (Nav-msg) for information on satellite (ephemerides, transmission time, constellation almanac, etc.)

Frequency L1 contains codes C/A and P, while frequency L2 contains code P only. Using or not P code it is possible to have two different degrees of precision:

- PPS (Precise Positioning Service)
- SPS (Standard Positioning Service)

PPS provides a higher standard of precision than SPS, and uses crypted information.

SPS provides a lower degree of precision than PPS and is not crypted.

The GPS consists of the following:

- Antenna FRPA-4
- Receiver GPS R-202
- Control Display Unit (CDU) CP-1520

Refer to Figure 1-52 for GPS block diagram.

The FRPA-4 antenna receives signals transmitted from the GPS NAVSTAR system.

In the antenna there are 7 sensors, where central sensor constitutes the reference channel, while the remaining 6 elements are auxiliary channels through which the control unit may cut-off up to 6 interfering signals at the same time.

The GPS R-202 receiver consists of electronic modules.

The CP-1520 Control Display Unit is the interface unit between the pilot and the system.

### GPS BLOCK DIAGRAM

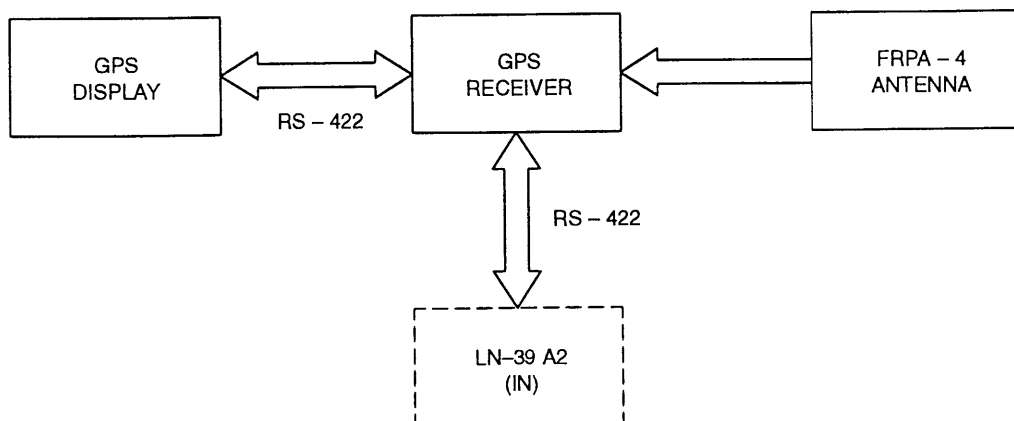

FA0223

Figure 1-52



The GPS generates aircraft's present position (PP), altitude and velocity components and provides these parameters to the INU via the RS-422 interface. This means that when flying GPS steering mode, the steering parameters are computed by the IN system on the base of the present position and velocity parameters provided by the GPS system itself and not on those generated by the IN system. Refer to Navigation System paragraph for further information. The GPS is electrically powered by XP5 and PP2 bus bars.

#### NOTE

The GPS shall be used only as a source of present position. For this reason only the control and indicators, related to GPS steering mode operation, are herein described.

### GPS SYSTEM CONTROLS AND INDICATORS

The GPS system control panel (refer to Figure 1-53), located on the right console, has the following controls:

#### Hard Keys

NAV	When pressed, navigation data according to the aircraft's position and speed are displayed.
STA	When pressed, it enables the receiver status data (detected satellites, precision estimation and signal acquisition) to be displayed.
Brightness Control	Two hard keys permit, when pressed, to control/adjust the brightness of the GPS display.
ON/OFF	When pressed, it switches on/off the GPS system.

#### Navigation Steering Mode Selector Pushbutton

The GPS navigation steering selector pushbutton, located on the main instrument panel provides, when pressed, the activation of the GPS navigation steering mode in conjunction with the IN.

#### NOTE

- The GPS selector pushbutton lighting control is carried out by means of the INTERIOR INSTRUMENT switch located on the right console. When the INTERIOR INSTRUMENT switch is set to OFF, the GPS selector pushbutton is lit at the maximum level.
- Pilot shall be aware that the green GPS caption illuminates regardless the GPS switch on/off condition.

#### HSI and IN/CDU

The HSI and IN/CDU show steering parameters referenced to Magnetic North and are related on the destination waypoint selected on the IN/CDU.

#### NOTE

The IN system does not compute the course error. The lateral deviation bar, on HSI, is inoperative when flying in GPS steering mode (centered). The TO/FROM indication are derived from the IN system as a TOWARD (range decreasing) or OUTWARD (range increasing) according to the range numerical display (MILES) on HSI. The desired course indication is slaved to the course knob and rotates in conjunction with the compass card.

### GPS SYSTEM OPERATION

The GPS system operates in four modes namely OFF, TEST, INIT and NAV. Refer to Figure 1-54 for the operational mode block diagram.

#### OFF Mode

In the "off" mode, the GPS system is not operative, but the following functions remain available:

- the internal clock operates

## GLOBAL POSITIONING SYSTEM (GPS) CONTROLS AND INDICATORS

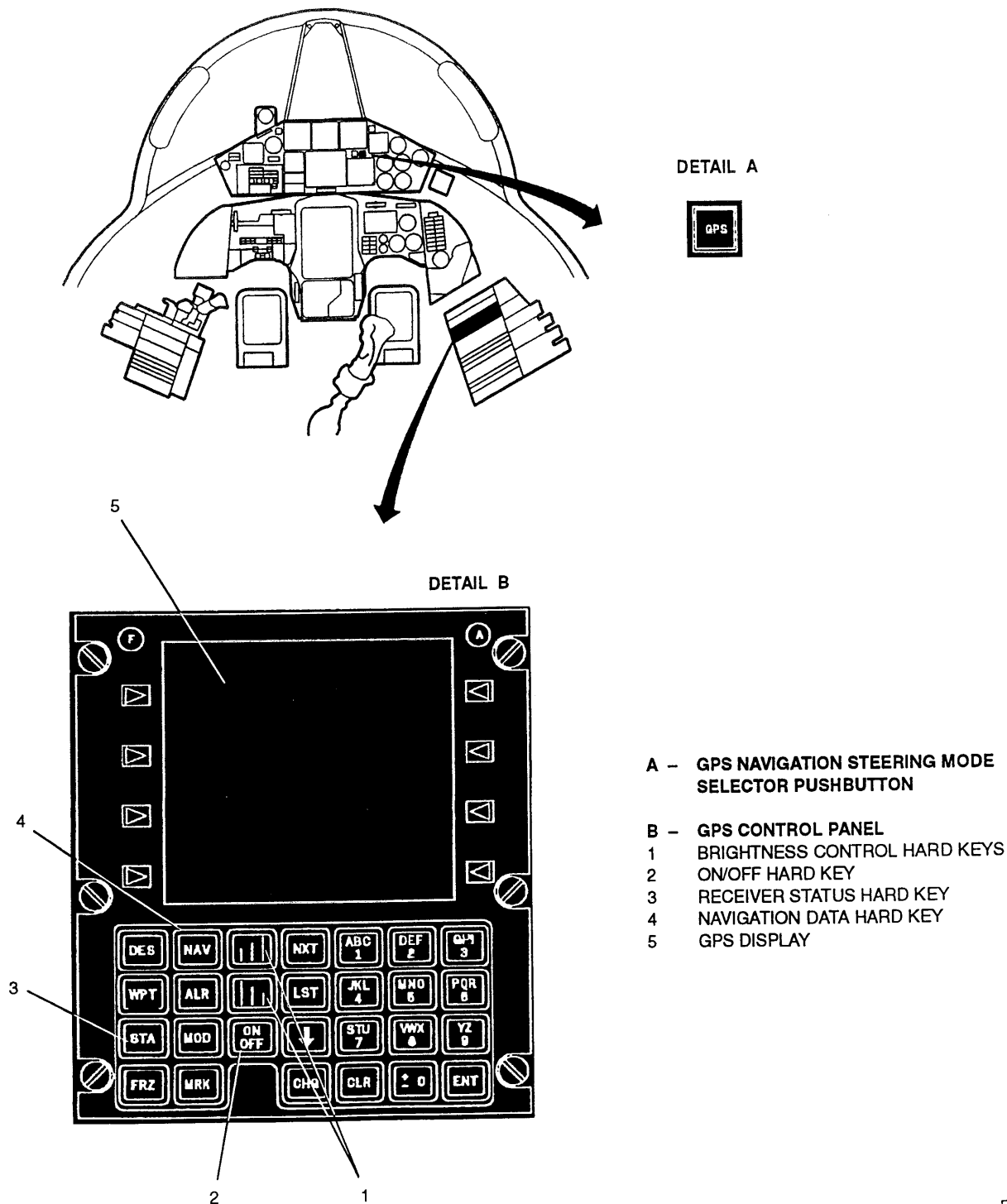

FA0229

Figure 1-53 (Sheet 1 of 2)

# GLOBAL POSITIONING SYSTEM (GPS) CONTROLS AND INDICATORS

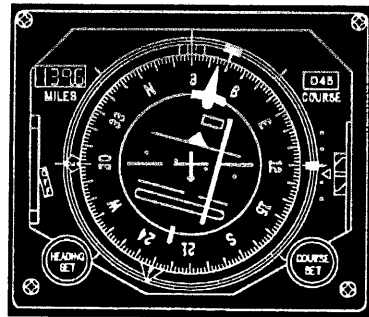
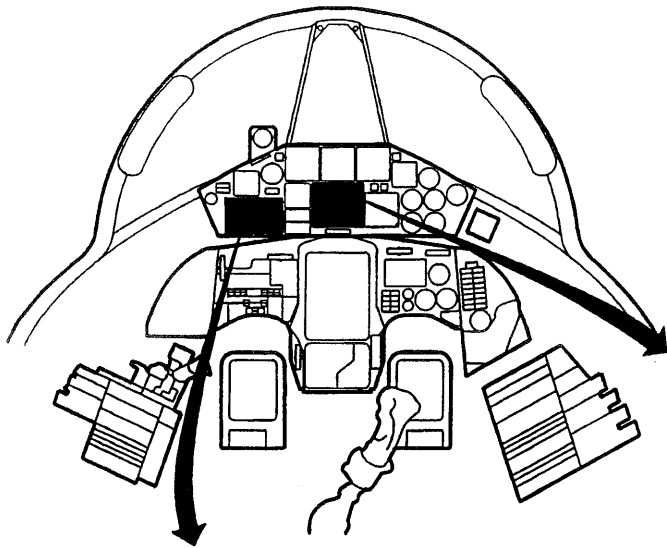

DETAIL C

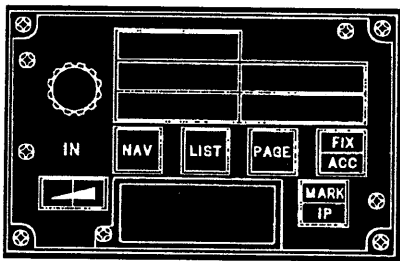

DETAIL D

- C - HORIZONTAL SITUATION INDICATOR (HSI)
- D - INS CONTROL DISPLAY UNIT (IN/CDU)

FA0230

Figure 1-53 (Sheet 2 of 2)

- some initialization data (such as last computed position etc.) remain stored.

These data remain stored by means of an internal battery.

### GPS SYSTEM SWITCH-ON AND BIT/AFI FUNCTION

By pressing the ON/OFF hard key the GPS system is switched on. After system start-up, the BIT/AFI (Built In Test/Automatic Fault Isolation) function starts in order to find any hardware or software failure. If the BIT/AFI is successful (no defects found), the receiver tests if configuration data are present inside the memory (the memory containing these data is constantly supplied from a buffer battery). At the same time, the antenna starts detecting signals on both GPS frequencies and transmits these signal to the receiver.

The BIT/AFI function, tests the system units for correct operation and detects their failures. The BIT/AFI and the fault isolation subfunctions lasts approximately of 10 seconds; during this time, the receiver shall not be operated in the NAV mode.

A successful BIT/AFI is displayed by the all "OK" TEST RESULTS format as shown in Figure 1-55.

### SATELLITES DETECTION STATUS

After BIT/AFI function, in order to check the satellites detection, the following procedure has to be performed:

- 1) Press STA hard key: the format shown in Figure 1-56 is displayed

#### NOTE

- Data shown are not modifiable.
- If "STATUS 4 SAT" is not reached, the GPS shall be switched off.

### NAVIGATION MODE

By pressing once the NAV hard key the "NAV 1" format is displayed. Refer to Figure 1-57 which also shows a description of the displayed data.

## C-2G DIRECTIONAL GYRO SYSTEM

The C-2G directional gyro system provides stabilized magnetic heading to the HSI when the TCN navigation mode is selected following the INS failure. The system consists basically of a gyro-amplifier, a compass control panel, a power converter, and a flux valve. The system receives power from the XP7 AC bus and from the XP6 AC bus.

### C-2G Compass Control Panel

The C-2G compass control panel (refer to Figure 1-58) is located on the right console and has the following controls:

**DG-MAG Selector Switch.** The DG/MAG selector switch selects the mode of operation of the directional gyro system. When this switch is set to MAG position, the system operates as a normal slaved gyro magnetic compass, and the directional indicator responds accordingly. Setting the DG/MAG selector switch to the DG position, causes the compass to operate as a directional gyro. This mode of operation is designed for use in the polar regions where the earth's magnetic field is such that the slaved gyro magnetic compass is very unreliable.

**Annunciator.** The annunciator indicates, in the MAG mode of operation, whether or not the heading output and the sensed direction of the flux valve are the same. When they are the same, the white bar on the annunciator dial will be centered, indicating system synchronization.

If they are not the same, the discrepancy is evidenced by the white bar moving toward the dot (•) or cross (+) markings on the panel, depending on the direction of this misalignment. This fluctuation is normal and indicates that the compass system is operating properly. The annunciator is inoperative in the DG mode of operation.

**Synchronizing Knob.** The synchronizing knob is used to manually synchronize the system. In the MAG mode of operation the knob is rotated in the direction of the arrow on the panel, depending on the direction of misalignment indicated by the annunciator. If the white bar is toward the dot, the knob shall be rotated counterclockwise.

In the DG mode of operation the synchronizing knob may be used to arbitrarily rotate the heading output. The design of the C-2G synchronizing circuit and control makes it extremely difficult to remove errors incurred when leveling off after a turn,

### GPS OPERATIONAL MODE BLOCK DIAGRAM

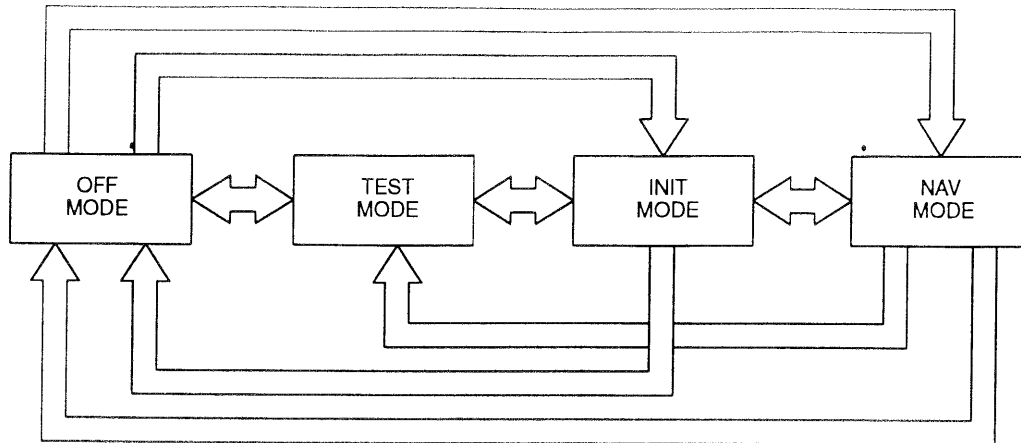

FA0225

Figure 1-54

### GPS BIT/AFI TEST FORMAT

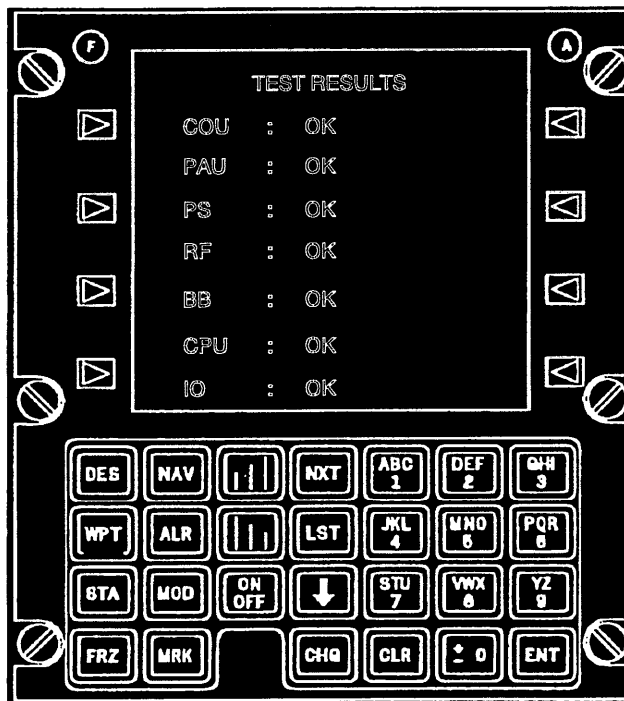

FA0228

Figure 1-55

## GPS SATELLITES DETECTION STATUS FORMAT

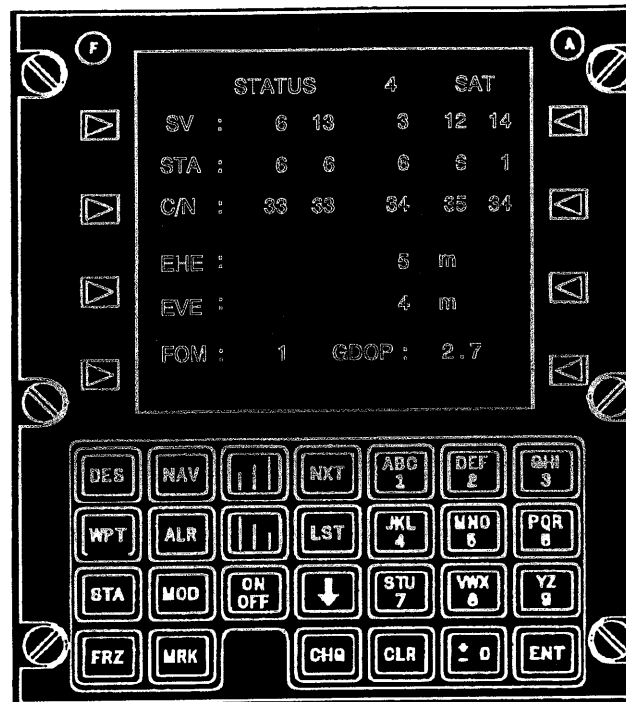

FA0227

DATA	DESCRIPTION
Title	STATUS Number of receiving satellites: 4 SAT the indication in this case.
SV	PRN of detected satellite: this indicates the PRNs of satellites detected in the five receiver channels. If SV is zero, the related STA and C/N values are not valid.
STA	Status: this indicates the code number of the receiving status on each receiving channel (transmission is received from the satellite identified with a visible SV on the upper line of the screen).
C/N	Signal-to noise ratio: this indicates the signal-to-noise ratio of each receiver channel. When this value is lower than 30 dB, the receiver requires use of an aiding mode.
EHE	Estimated Horizontal Error: indicates the estimated error in horizontal position calculations.
EVE	Estimated Vertical Error: indicates the estimated error in vertical position calculations.
FOM	Figure-Of-Merit (FOM): indicates the accuracy grade of position data. GDOP: this indicates the decrease rate of geometric precision. When GDOP exceeds "6", GPS accuracy begins to decrease.

Figure 1-56

**GPS "NAV 1" FORMAT (TYPICAL)**

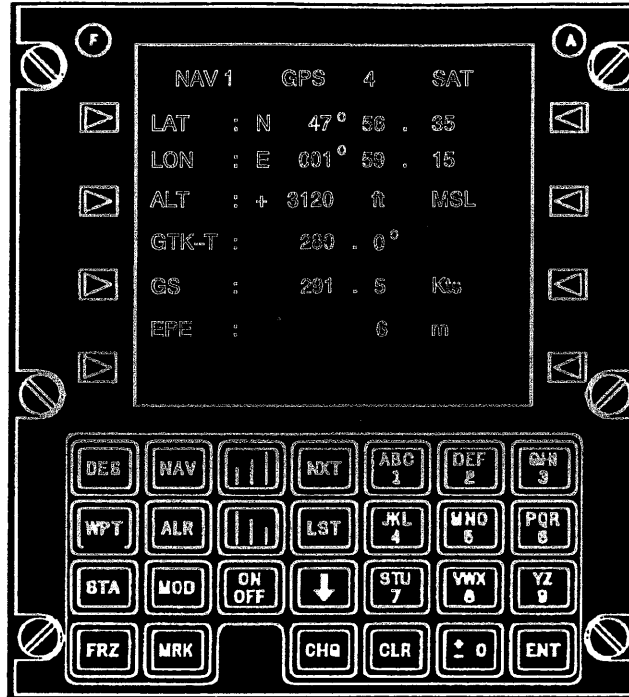

FA0226

DATA	DESCRIPTION
Title	NAV 1 Mode: possible mode of navigation (GPS, ALT, INS), number of satellites received (4, 3 or less than 3).
LAT	Latitude: present latitude. Resolution 1/1000 minute.
LON	Longitude: present longitude. Resolution 1/1000 minute.
ALT	Altitude: present altitude. If this data is not available (alarm code ALT) is possible digit it on this line changing the navigation mode in INS or ALT.
GTK-T	Ground Track Angle: present angle. It is possible to modify the north reference (true or magnetic). The GTK value is not displayed if the ground speed is less than 1 m/sec.
GS	Ground Speed: present speed (km/h or kts).
EPE	Estimated Position Error: resolution 1 meter.

Figure 1-57

## C-2G DIRECTIONAL GYRO SYSTEM CONTROLS

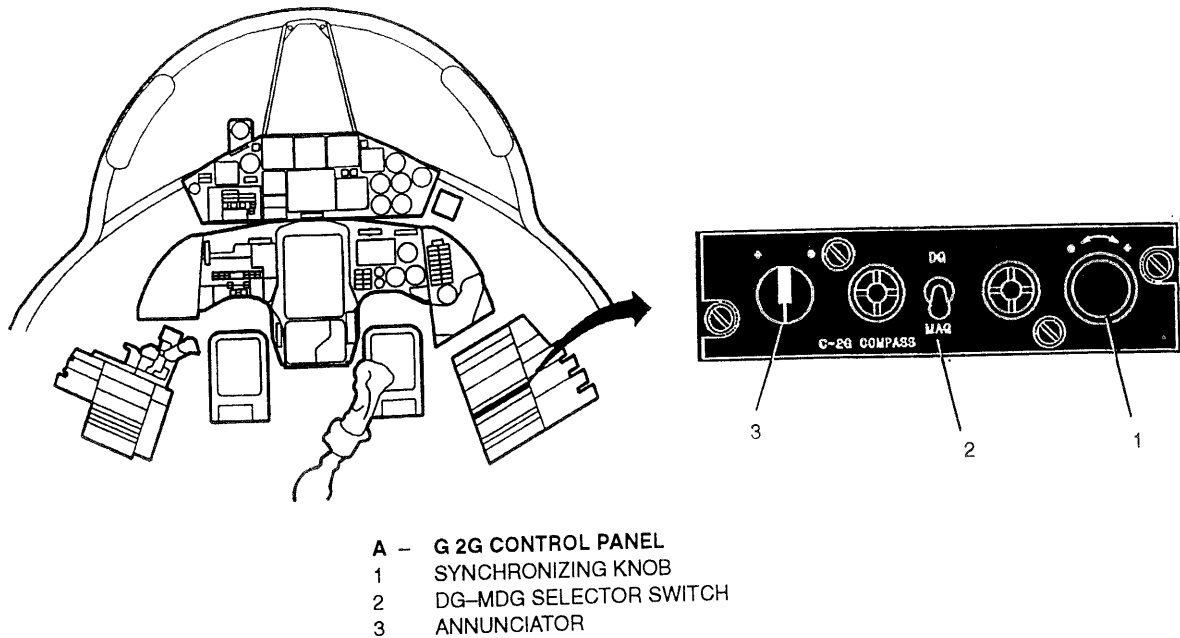

FA0069

Figure 1-58

by fast synchronization. If extreme care is not used, it is possible to get an instantaneous null which could be false.

This false null, if it does occur, will be for only a short duration; therefore, after synchronization a recheck should be accomplished after the aircraft is straight and level.

- IF THE SYNCHRONIZING KNOB IS ROTATED OPPOSITE TO THE DIRECTION INDICATED, THE SYSTEM MAY SYNCHRONIZE ON A FALSE NULL 180° FROM TRUE HEADING. THIS NULL IS UNSTABLE.

CAUTION

- IT IS RECOMMENDED THAT IN CASE OF "INS" FAILURE THE PILOT AT ALL TIMES USES THE C-2G COMPASS AS A REFERENCE AND CROSS-CHECK READINGS WITH STANDBY COMPASS.

## NOTE

During acceleration, the flux gate pendulum will swing in the direction of the force applied; therefore, the C-2G compass should be synchronized and checked only after straight and level unaccelerated flight has been attained.



## INERTIAL NAVIGATION CONTROL DISPLAY UNIT (IN/CDU)

The IN/CDU operates as an input/output terminal and is connected to the INU by means of the RS422 interface.

### NOTE

Following an INS failure, the IN/CDU is lost.

As input terminal it provides a means for the mission data base loading using a Data Transfer Module (DTM), which contains an electrical erasable programmable memory (EPROM) in which all mission data are stored. The mission data base consist of a maximum of 58 generic and/or radio station waypoints identified from 01 to 58. Points having latitude, longitude and height data are defined as generic waypoints. Points having latitude, longitude, height and TACAN channel/mode data are defined as radio waypoints.

### CAUTION

AS LONG AS THE IN/CDU EQUIPMENT IS POWERED, THE DTM SHALL NOT BE REMOVED FROM ITS HOUSING.

### NOTE

- The DTM shall be inserted before INS switch-on (ALN selection). If the INS is already switched-on, the insertion of the DTM is ignored.
- If before power-on the DTM is not inserted, the "NO DTM" indication is displayed at the system switch-on.
- The "DTM FAIL" indication is displayed if the validation of the DTM fails.

- All stored waypoints may be identified with an ICAO or an appropriate code.
- The mission data shall be loaded on the DTM on ground only.

The DTM has to be inserted in a proper socket located in the front side of the IN/CDU.

The IN/CDU allows selection and acceptance of the IP value for INS alignment procedure.

The IN/CDU provides a means for:

- listing of all mission data
- manual recall and presentation of all navigation data
- selection of a destination waypoint (fly-to function)
- visual on-top fixing (OTF) navigation updating
- visual mark point data acquisition with OTF technique

The IN/CDU is electrically powered by the INS.

### IN/CDU CONTROLS AND INDICATORS

The IN/CDU control panel, labeled IN, (refer to Figure 1-59) located on the left lower part of the main instrument panel has the following controls and indicators.

**Hard Keys.** Five hard keys provide, when pressed, the following selections:

- |         |  |
|---------|--|
| NAV     | The navigation format (also shown as default) is displayed   |
| LIST    | Stored waypoints data are displayed  |
| PAGE    | Navigation and station point data are displayed in subsequent pages  |
| FIX/ACC | When pressed the first time enables the system for on-top fixing activation. When pressed a second time enables the fix error to be accepted in the system               |
| MARK/IP | When pressed during the GC/INS alignment procedure enables the system to accept the IP data. When pressed during flight enables the mark point data acquisition function |

**Brightness Control Switch.** It permits to control the brightness of the IN/CDU alphanumeric display.

## INICDU CONTROLS AND INDICATORS

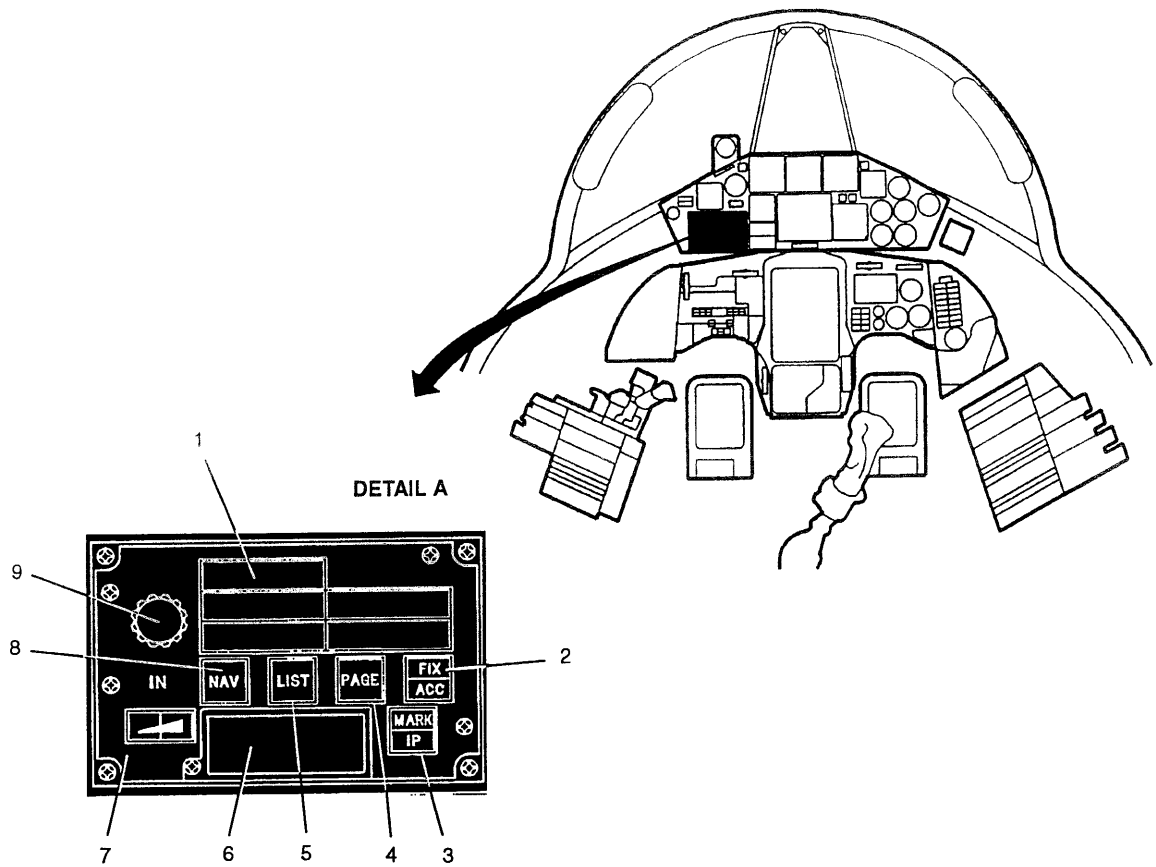

- A - IN /CDU
- 1 ALPHANUMERICAL DISPLAY
  - 2 FIX/ACC HARD KEY
  - 3 MARK/IP HARD KEY
  - 4 PAGE HARD KEY
  - 5 LIST HARD KEY
  - 6 SOCKET
  - 7 BRIGHTNESS CONTROL SWITCH
  - 8 NAV HARD KEY
  - 9 ROTARY SWITCH

FA0068

Figure 1-59

**NOTE**

The IN/CDU lighting control is carried out by means of the INTERIOR INSTRUMENT switch, located on the LIGHT CONTROL panel.

**Rotary Switch.** A rotary switch permits, when operated, the selection of any stored waypoint to be displayed on the alphanumerical display

**Socket.** A socket, located in the lower part of the IN/CDU, permits the DTM insertion/extraction

**Alphanumerical Display.** It consists of three rows in which all stored waypoint data are shown. On the first row up to eight data may be shown while on the other two up to sixteen data may be shown.

**IN/CDU SYSTEM OPERATION**

After power on, a five seconds automatic test is carried out. A successfully test is indicated by the "CDU OK" indication while an unsuccessful test is indicated by the "CDU FAIL" indication.

After the successful test completion, the mission data base stored in the DTM is transmitted, via RS422, to the INS.

Then these data are validated by the INS itself and, should a failure be detected, the "DTM FAIL" caption appears.

**IN/CDU MODE OF OPERATION**

The IN/CDU may be used on ground for initial position (IP) selection and acceptance (for INS/GC alignment mode only) and during flight (or on the ground with the INS set to NAV) for the following:

- IN and GPS steering mode data presentation
- station point display
- fly-to function
- on-top fixing updating
- mark points data acquisition

**IN/CDU Mode of Operation during Alignment Procedures**

With the INS set to ALN/GC, it is possible to select the IP data (for INS/GC alignment purpose) different from the last stored INS/PP (present position) provided that the DTM (in which the station points are loaded) has been inserted.

Being the last stored INS/PP shown as default, the following format is displayed:

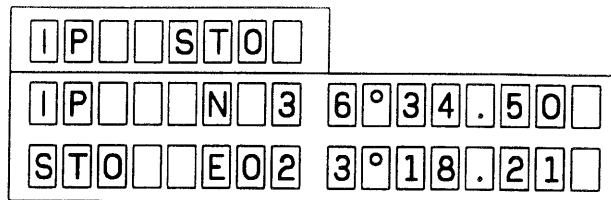

If the DTM has been inserted, only the MARK/IP hard key and rotary switch (for IP selection and station point presentation) are operative.

If the DTM is not inserted, none of the IN/CDU controls are available and on the alphanumerical display the following format is shown:

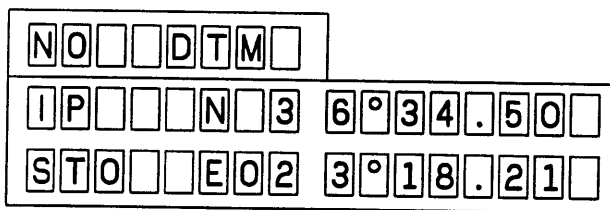

By rotating the rotary switch the pilot may select the station point on which the INS will be aligned that, in other terms, shall be the initial position.

**NOTE**

The INS continues to align using the stored INS/PP until the MARK/IP hard key actuation.

The IN/CDU alphanumerical display shows the following:

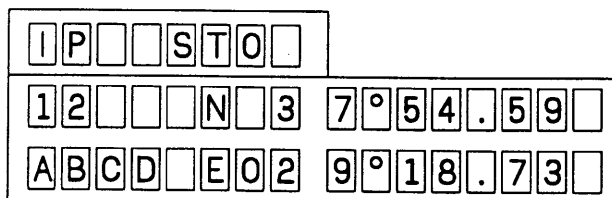

**NOTE**

After the IP data are shown, the MARK/IP hard key shall be pressed: the INS will start the alignment procedure using the selected data and the IN/CDU shows the following:

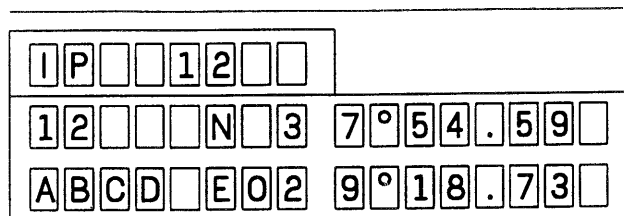

FA0059

The NAV, PAGE, LIST and FIX/ACC hard keys are disabled while, by means of the rotary switch, it is possible to show the loaded station points.

Pilot has to check, on the IN control panel located on the right console, the alignment status indicator which is in accordance with the desired GC alignment mode (fast or full).

If INS/STO alignment is carried out, the IN/CDU shows the default format: in this condition only the rotary switch is operative, which permits the station points presentation.

The NAV, LIST, PAGE, FIX/ACC and MARK/IP hard keys are disabled.

**IN/CDU Navigation Moding****Navigation Format**

After INS alignment, with the INS function selector knob set to NAV, the IN/CDU may show the navigation information relevant to the stored station points.

IN/CDU data presentation and moding is not function of the selected steering mode. Navigation information is an INS outputs and referred to the selected fly-to waypoint.

Navigation data calculations are based on PP and GS (ground speed), derived from INS for both IN and TACAN steering mode and from GPS in the GPS steering mode.

IN/CDU displayed data are consistent with the HSI indications only when the IN or GPS steering mode is selected; in TACAN steering mode, the HSI shows navigation information derived from the TACAN system itself while the information shown on the IN/CDU is INS outputs.

Refer to Figure FO-15 for the IN/CDU navigation moding block diagram.

The navigation format is shown as default (after the INS function selector knob is set to NAV) and is referred to the page one.

**NOTE**

The DWP (destination waypoint) is the station point "00" or in other terms the point on which the INS alignment was carried out.

The page one of the navigation format may be also shown if, while in station point listing or in fixing error format, the NAV hard key is pressed.

If the FIX/ACC hard key has been pressed while in navigation format, pressing a second time the FIX/ACC hard key or if the 30 seconds period has elapsed without pressing the FIX/ACC hard key, the previously selected navigation page is displayed on the IN/CDU.

If the FIX/ACC hard key has been pressed while in navigation format, pressing the FIX/ACC hard key or if the 30 seconds period has elapsed without pressing the FIX/ACC hard key and following the rotary switch actuation for a fly-to function, the first navigation page (page one) is displayed on the IN/CDU. The page one of the navigation format may also be displayed when the mark point format is displayed if the NAV hard key is pressed or if the rotary switch is actuated.

**NOTE**

If the MARK/IP hard key has been pressed while in navigation or in LIST format, when the 10 seconds period has elapsed without any action on the IN/CDU, the previously selected navigation or LIST page is displayed on the IN/CDU.

The "NAV" format is formed by three pages, each of one cyclically selected by pressing the PAGE hard key.

Fly-to function may be carried out by acting on the rotary switch and following steering information shown on the HSI and on the IN/CDU. The fly-to activation causes the first page of the intended fly-to waypoint to be automatically displayed.

If the LIST hard key is pressed, the first page of the station point listing is shown. In the navigation format both the OTF and mark point data acquisition facilities are available.

NAV hard key actuation shall have no effect when in "NAV" format. Refer to Figure 1-60 for a typical navigation format display.

### Station Point Listing Format

The station point listing format is shown when, in "NAV" format, the LIST hard key is pressed. As default the first of the two pages is shown.

The station point list format may be also shown when, in fixing error format, the LIST hard key is pressed: the first page is shown.

If the FIX/ACC hard key has been pressed while in station point listing format, pressing again the FIX/ACC hard key or if the 30 seconds period has elapsed without pressing the FIX/ACC hard key, the previously selected station point listing page is displayed on the IN/CDU.

The station point list format may be also shown when, in mark point data acquisition format, the LIST hard key is pressed: the first page is shown.

### NOTE

If the MARK/IP hard key has been pressed while in station point listing format, when the 10 seconds period has elapsed without any action on the IN/CDU, the previously selected station point listing page is displayed on the IN CDU.

The "LIST" format is formed by two pages, each of one cyclically selected by pressing the PAGE hard key. Rotating the rotary switch the information relevant to the other stored waypoints is shown. The waypoint station identification number with its identification (ICAO) code will be flashing. If the NAV hard key is pressed the first page of the navigation format is shown. In the station point listing format both the OTF and mark point data acquisition facilities are available.

LIST hard key actuation shall have no effect when in "LIST" format. Refer to Figure 1-61 for a typical station point listing format display.

### On-Top Fixing (OTF) Format

The on-top fixing format is shown when the FIX/ACC hard key is pressed while in navigation or station point listing or mark point data acquisition format.

The OTF format is available in the IN or TACAN steering mode and has to be carried out only for the "selected to" waypoint only. The OTF format is formed by a single page. Pilot shall be aware of the following:

- if fixing error has to be accepted, the FIX/ACC hard key shall be pressed a second time within 30 seconds. After this action, the IN/CDU shows the previously selected format
- if no action are carried out within 30 seconds, the IN/CDU shows the previously selected format and no system updating shall be carried out
- if NAV or LIST hard key is pressed, the first page (page one) relevant to the selected waypoint of the relevant format shall be displayed and no fixing updating is carried out
- the MARK/IP and PAGE hard keys are disabled
- it is possible to act on the rotary switch to perform the fly-to function: the selected waypoint is shown in the first row of the IN/CDU. This action does not imply the fixing error which is shown on the second and third rows of the IN/CDU. After the FIX/ACC actuation or after the 30 seconds have elapsed, the first page (page one) of the navigation format is resumed.

During OTF procedure the "FIX ERROR" readout is displayed on the second row of the alphanumeric display while on the third the fixing error (in the form of bearing and range) is displayed. Range error up to 99.99 NM may be shown; if the error exceeds this value the "> 100 NM" readout is displayed.

Refer to Figure 1-62 for a typical fixing error readout.

### Mark Point Data Acquisition Format

The mark point data acquisition format is shown when the MARK/IP hard key is pressed while in navigation or station point listing format. The mark

**INICDU NAVIGATION FORMAT DISPLAY (TYPICAL)**

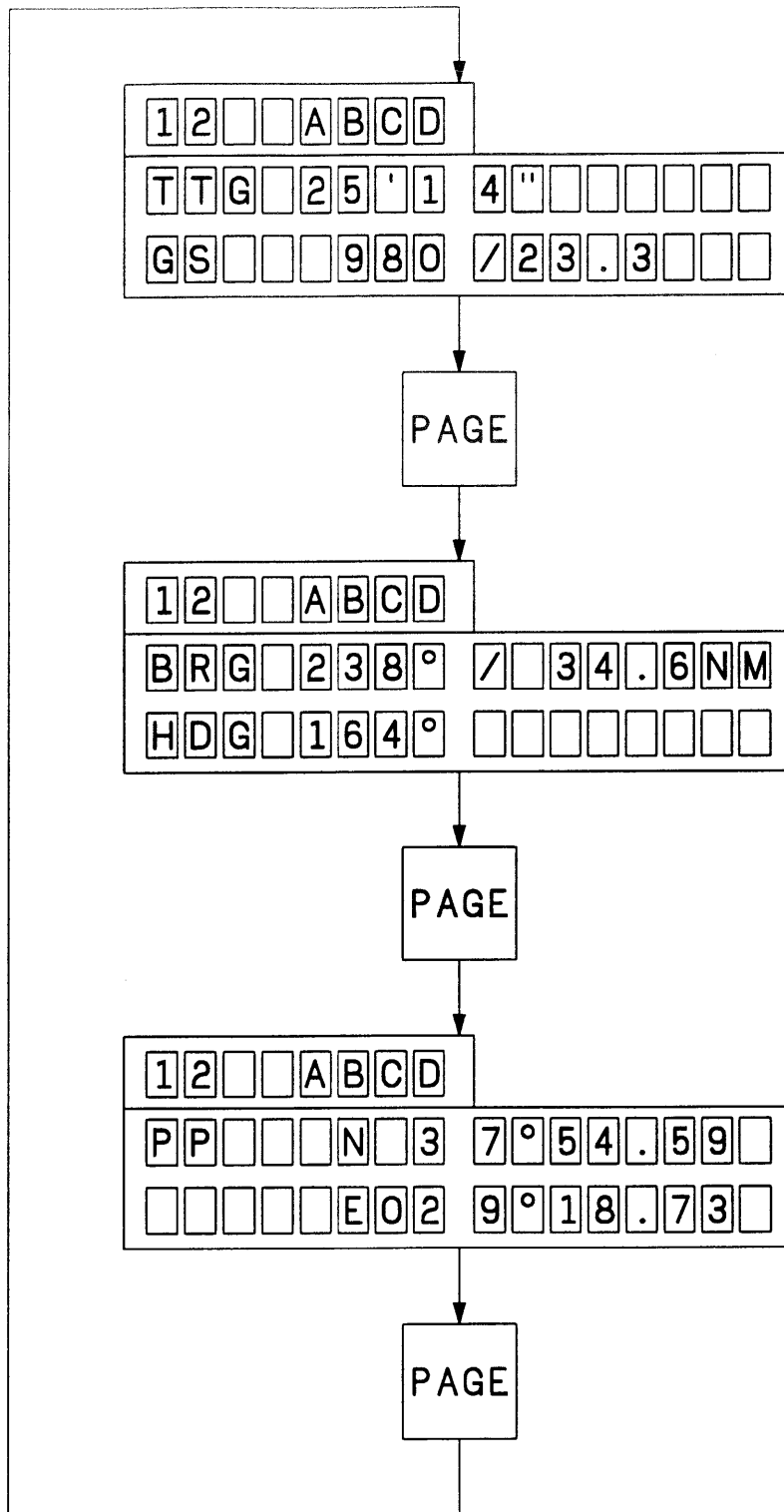

FA0062

Figure 1-60



point data acquisition format is available for all steering modes.

The mark point data acquisition format is formed by a single page. Up to two mark points may be acquired: further acquisition delete the previously stored mark point. After 10 seconds from MARK/IP hard key actuation the previously format shown is resumed. Pilot shall be aware of the following:

- if NAV hard key is pressed within 10 seconds the first page (page one) of the navigation format is shown
- if the rotary switch is operated within 10 seconds the fly-to function is activated: after 10 seconds from MARK/IP actuation, the first page (page one) of the navigation format is shown

- if LIST hard key is pressed within 10 seconds, the first page (page one) of the station point listing is shown
- if FIX/ACC hard key is pressed, the fixing error format is shown
- if the MARK/IP hard key is pressed, a new mark point acquisition selection is carried out
- the PAGE hard key is disabled

The "MARK" readout is shown on the second row while the station identification number (59 or 60) is shown on the third row of the alphanumeric display.

Refer to Figure 1-63 for a typical mark point data acquisition readout.

**INICDU ON-TOP FIXING FORMAT DISPLAY (TYPICAL)**

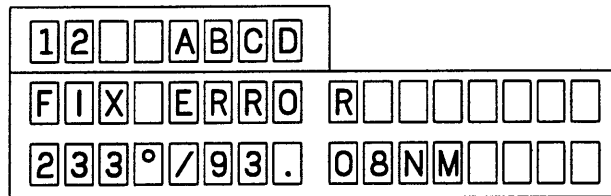

Figure 1-62

FA0060

**INICDU MARK POINT DATA ACQUISITION FORMAT DISPLAY (TYPICAL)**

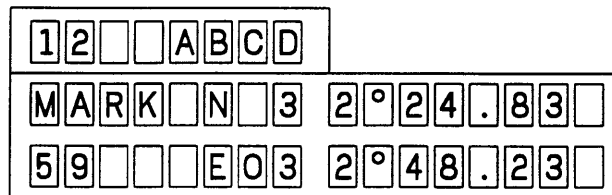

Figure 1-63

FA0061



## HORIZONTAL SITUATION INDICATOR (HSI)

The Horizontal Situation Indicator (HSI), located on the main instrument panel, provides a horizontal view of the aircraft with respect to the navigation situation. The HSI operates according to the following steering mode of operation:

- IN/GPS
- TACAN

These modes shall be selected by pressing the relevant navigation steering mode selector pushbuttons. The aircraft symbol in the center of the HSI represents the aircraft superimposed on a compass card which rotates so that the aircraft heading is indicated on the upper fixed lubber line. The system is powered by XP7 AC bus. Loss of power to the HSI will cause the OFF failure flag to appear on the left side of instrument.

When IN or GPS steering mode is selected, the HSI shall show steering indications toward the destination waypoint currently selected by the pilot on the IN/CDU. The INS will not compute course error. In these steering modes, the TO/FROM indication shall be derived by INS (and supplied to the HSI) as a TOWARD/OUTWARD indication (TOWARD: range decreasing condition; OUTWARD: range increasing condition).

**CAUTION**

COURSE ERROR IS NOT COMPUTED AND DISPLAYED WHEN FLYING IN "IN" OR "GPS" STEERING MODE.

The desired course indication (and therefore the axis of the TO/FROM arrows) will be slaved to the course knob and will rotate together with the compass card.

When TACAN steering mode is selected, the HSI shows steering indications toward the radio station currently selected on the TACAN control panel. Magnetic heading and actual track shall be supplied by INS.

When TACAN mode is selected and INS is in "NO GO" status, the actual track indication shall not be available, and will be hidden below the bearing indication supplied by TACAN, while magnetic heading shall be provided by C2-G.

The TACAN, receiving the desired course information from HSI, shall use it to compute and supply to the HSI the TO/FROM and course error parameters in TACAN steering mode. The desired course indication will be slaved to the course knob.

### HORIZONTAL SITUATION INDICATOR CONTROLS AND INDICATORS

The horizontal situation indicator displays and controls are illustrated in Figure 1-64.

Refer also to Figure 1-65 which shows the HSI display indications according to each navigation steering mode.

## NAVIGATION SUB-SYSTEM

The navigation sub-system is designed to provide navigation parameters computation and displaying, by means of the following equipment:

- Inertial Navigation System (INS)
- TACAN
- GPS
- C-2G Directional Gyro System
- Inertial Navigation Control Display Unit (IN/CDU)
- Horizontal Situation Indicator (HSI)
- Automatic Flight Control System (AFCS)
- Attitude Indicator (AI)
- Adapter
- Rate Gyro

The INS is the primary self-contained source of position, velocity, attitude and magnetic heading data. It also provides central processing functions and interface capabilities for HSI (via switching box), AI, ADC, AFCS and armament computer. A dedicated warning light (INERTIAL NAV FAULT), located on the warning lights panel, illuminates when an INS failure is detected.

Via two RS-422 lines, the INS is interfaced with the Control Display Unit (IN/CDU) located on the main instrument panel, and with the GPS receiver, whose control panel is located on the right console.

## HORIZONTAL SITUATION INDICATOR (HSI)

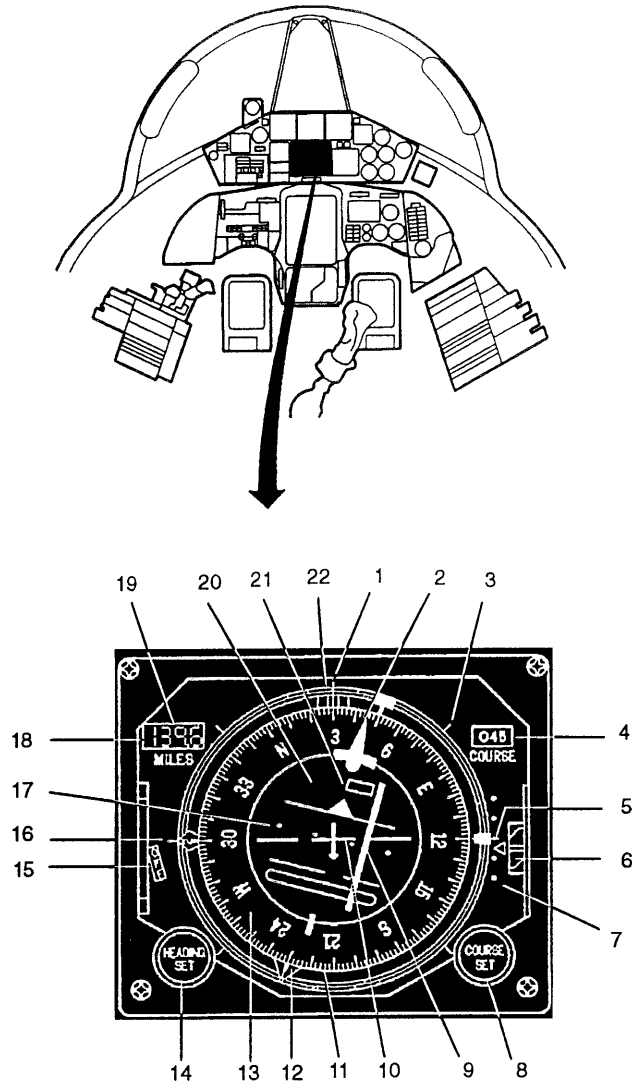

- |    |                            |    |                                  |
|----|----------------------------|----|----------------------------------|
| 1  | UPPER FIXED LUBBER LINE    | 12 | POINTER No. 1                    |
| 2  | COURSE POINTER             | 13 | COMPASS CARD                     |
| 3  | REFERENCE MARK             | 14 | HEADING SET KNOB                 |
| 4  | DIGITAL COURSE READOUT     | 15 | DISPLAY FAILURES FLAG            |
| 5  | GLIDESLOPE DEVIATION SCALE | 16 | POINTER No. 2                    |
| 6  | GLIDESLOPE FLAG            | 17 | LATERAL DEVIATION SCALE          |
| 7  | GLIDESLOPE DEVIATION SCALE | 18 | NUMERICAL RANGE DISPLAY          |
| 8  | COURSE SET KNOB            | 19 | RANGE FAILURE FLAG (OUT OF VIEW) |
| 9  | LATERAL DEVIATION BAR      | 20 | TO/FROM ARROW                    |
| 10 | AIRCRAFT SYMBOL            | 21 | NAV FLAG                         |
| 11 | LOWER FIXED LUBBER LINE    | 22 | HEADING INDEX                    |

FA0067

Figure 1-64

**HSI DISPLAY INDICATION**

INDICATION	IN STEERING MODE	TACAN STEERING MODE	GPS STEERING MODE
Course Pointer	Present but inoperative	Selected TACAN radial	Present but inoperative
Course Display	Present but inoperative	Selected TACAN radial	Present but inoperative
Compass Card and Lubber Line	Magnetic Heading	Magnetic Heading	Magnetic Heading
Pentagonal Pointer (Pointer No. 2)	DWP Bearing	TACAN Station Bearing (1)	DWP Bearing (2)
Triangular Pointer (Pointer No. 1)	Actual Track	Actual Track (3)	Actual Track
Distance Indicator	Horizontal Range to selected DWP	Slant range to selected TACAN station	Horizontal range to selected DWP
Heading Index	Present but inoperative	Present but inoperative	Present but inoperative
TO/FROM Arrow	Toward/Outward	TO/FROM	Toward/Outward
Glideslope Deviation Bar	Inoperative and centered	Inoperative and centered	Inoperative and centered
Glideslope Flag	Inoperative	Inoperative	Inoperative
Course Deviation	Inoperative and centered	Track angular error (5° per dot)	Inoperative and centered
Power OFF Flag	– HSI failure – INS Heading failure	– HSI failure – Heading failure (4)	– HSI failure – INS Heading failure
NAV Flag	– HSI failure – INS steering failure	– HSI failure – TACAN steering failure	– HSI failure – GPS steering failure

- (1) During the TACAN searching phase, the pointer rotates clockwise until the TACAN station has been tracked
- (2) When GPS data are not valid, the pointer rotates clockwise
- (3) Following an INS failure, the actual track indication is hidden by the relative bearing indication provided by the TACAN.
- (4) Following an INS failure, the magnetic heading is derived from the C-2G. In this condition the OFF flag is not shown. Following a C-2G failure the OFF flag will be shown.

*Figure 1-65*

The TACAN is a receiver/transmitter radio equipment whose function is to provide aircraft slant range and bearing information with respect to a ground station or to another airborne TACAN equipment. The GPS furnishes present position and velocity components to the INS.

The C-2G is a gyrostabilized magnetic compass to be used as reversionary magnetic heading sensor to the HSI, following an INS failure with TACAN steering mode selected.

The AI provides head down attitude information as well as turn rate indication generated by a rate gyro. The gyro transmitter provides electrical signals directly proportional to the aircraft yaw rate. The parameter, in terms of magnitude and polarity, is displayed on the attitude indicator.

The HSI displays head down navigation/steering information when flying either in IN, TACAN or GPS steering mode.

#### NOTE

- Magnetic heading datum is always provided by the INS regardless the selected steering mode.
- Following an INS failure, the C-2G shall supply the magnetic heading datum when TACAN steering mode is selected.

#### NAVIGATION SYSTEM FUNCTIONS

Three navigation steering modes are available:

- IN mode
- TACAN mode
- GPS mode

These steering mode are manually selectable by means of two dedicated navigation steering mode selector pushbuttons, located on the main instrument panel.

#### NOTE

The navigation steering mode selector pushbuttons lighting control is carried out by means of the INTERIOR INSTRUMENT switch located on the LIGHT CONTROL panel. When the INTERIOR INSTRUMENT switch is set to OFF, the navigation steering mode selector pushbuttons are lit at the maximum level.

The pilot, after having inserted the DTM in the IN/CDU, shall select the INS/ALN function on the IN control panel, thus allowing the data loading of the station points from the DTM to the INS memory. One navigation steering mode selector pushbutton alternatively selects the IN or TACAN steering mode while the other one selects the GPS steering mode only.

#### NOTE

When the GPS steering mode is selected, further action on the IN/TCN steering mode selector pushbutton causes the following:

- if IN was selected before GPS selection, the TCN steering mode is selected
- if TCN was selected before GPS selection, the IN steering mode is selected.

#### Alignment Phase

The navigation sub-system shall be aligned before takeoff. Two alignment modes are available: "CG" or "STO".

The initialization phase starts at the INS switch-on (ALN selection) and lasts until the INS is manually set to NAV.

At the INS switch-on, the system downloads the mission data from the DTM, previously inserted on its receptacle located on the IN/CDU. In case of mission data loading error detection, the "DTM FAIL" caption appears on the IN/CDU readouts. Should the DTM not be inserted, the "NO DTM" caption is displayed.

**CAUTION**

BOTH FAILURE OF DTM DOWNLOADING AND DTM NOT INSERTED CAUSE ABSENCE OF MISSION DATA BASE IN THE SYSTEM WHICH ENTERS IN AN IMPROPER MODE OF OPERATION. THE NAVIGATION SYSTEM SHALL NOT BE ABLE TO PROVIDE STEERING INFORMATION TOWARD THE WAYPOINTS EXCEPT FOR THE WAYPOINT USED FOR INS ALIGNMENT (LAST STORED PRESENT POSITION). NEVERTHELESS THE "INS" MAY BE SET TO "NAV" AND THE "IN" STEERING MODE IS AVAILABLE FOR SELECTION.

The INS begins its alignment procedure using the last stored present position. During initialization, the pilot shall select, using the rotary switch on the IN/CDU, the initial position (IP). After the IP data are shown on the readouts, the MARK/IP pushbutton shall be pressed and the INS will align on the selected IP.

During initialization phase (which depends on the selected alignment mode) no navigation functions are available as well as no IN/CDU pushbutton actuations, except the MARK/IP pushbutton (IP function only) and the rotary switch (for IP selection).

During the initialization/navigation INS transition, the data used for initialization (IP) are stored in the first location, identified as "00". During navigation, this waypoint may be used as any other destination waypoint. As soon as the initialization phase is terminated, the INS shall be set to NAV.

**NOTE**

On ground, after alignment is completed, it will be possible to select the first desired destination WPT being on HSI shown the steering information relevant to the IP.

**IN Steering Mode**

The "IN" steering mode is the primary autonomous navigation mode and is based on the INS as the sole navigation source. If an OTF operation has been carried out, the PP will be updated accordingly.

The "IN" steering mode uses the stored coordinates of the selected destination waypoint in order to calculate steering parameters toward the waypoint. Destination waypoint is selected by using the rotary switch located on the IN/CDU and shown on the alphanumeric display.

Rotating the switch, all the programmed and stored waypoint are selectable one by one, and the "current to" waypoint is recognized by the navigation system as the one toward which compute all the steering parameters: no further actions are required for selection and acceptance.

**NOTE**

- The selected waypoint becomes the new destination waypoint only after 1 second from the stop of the rotary switch.
- Waypoint identifier and label appear immediately on the first readout row while, the other waypoint information (TTG, GS and range), appear on the second and third rows after some instance later.

Steering information are displayed on both the HSI and IN/CDU, related to the same destination waypoint and referred to the magnetic north (refer to Figure 1-66).

**TACAN Steering Mode**

The "TACAN" steering mode uses the TACAN equipment as the basic navigation sensor. The TACAN is used in the receive and transmit/receive functions. In the receive function the TACAN provides the avionic system with the bearing to a selected radio station.

In the transmit/receiver function the TACAN provides the avionic system with slant range and bearing information relative to the selected radio station. Range and bearing information is used to generate steering data as relative bearing, course error, to/from and slant range to destination.

By operating the TACAN, the pilot shall select the desired TACAN/DME channel; successively the selection of the TACAN channel/mode shall cause

**IN STEERING MODE — DATA GENERATION**

HSI		IN/CDU	
Parameter	Source	Parameter	Source
Magnetic Heading	INS	Magnetic Heading	INS
Horizontal Range to DWP	INS	Horizontal Range to DWP	INS
Bearing to DWP	INS	Bearing to DWP	INS
Actual Track	INS		
Toward/Outward Indication	INS		
		Time to DWP	INS
		Ground Speed	INS
		A/C Present Position	INS

**Figure 1-66**

the displaying of the corresponding navigation data on the HSI only.

In case of selection of a TACAN channel, the pilot shall be able to select the desired course value towards the station by acting on the HSI course knob. In case of DME channel selection the slant range only shall be displayed.

**NOTE**

Pilot shall be aware that if DME channel is selected, being the bearing not available, the HSI NAV flag will be in view; the course knob is not operative.

Magnetic heading parameter is computed by the INS. The steering indications are displayed on the HSI while on the IN/CDU the steering indications are INS outputs and relevant to the destination waypoint selected on the IN/CDU itself (refer to Figure 1-67).

**NOTE**

Pilot shall be aware that HSI and IN/CDU steering information is different.

**GPS Steering Mode**

In GPS navigation steering mode, the steering parameters are computed by the INS on the base of present position and velocity parameters furnished by the GPS. The steering parameters displayed on the HSI and on the IN/CDU are referred to the magnetic north and relevant to the destination waypoint selected on the IN/CDU by means of the rotary switch.

Steering information are displayed on both HSI and IN/CDU (refer to Figure 1-68).

**FLIGHT AND STEERING PARAMETERS DISPLAYING**

The following equipment display the flight and steering parameters:

- HSI
- IN/CDU
- AI

The HSI shows flight and steering information according to the selected steering mode.

When flying in the "IN" or "GPS" steering mode, the HSI shows steering information toward the destination waypoint selected on the IN/CDU.

**TACAN STEERING MODE — DATA GENERATION**

HSI		IN/CDU	
Parameter	Source	Parameter	Source
Magnetic Heading	INS (*)	Magnetic Heading	INS
Slant Range to Selected TACAN Station	TACAN	Horizontal Range to DWP (**)	INS
TACAN Station Bearing	TACAN	DWP Bearing (**)	INS
Track Angular Error	TACAN		
Actual Track (***)	INS		
TO/FROM Indication	TACAN		
		Time to DWP (**)	INS
		Ground Speed	INS
		A/C Present Position	INS

- (\*) Following an INS failure the magnetic heading is derived from the C-2G  
(\*\*) Data base mission DWP selected on IN/CDU  
(\*\*\*) Following an INS failure the actual track pointer is hidden by the bearing pointer

**Figure 1-67****GPS STEERING MODE — DATA GENERATION**

HSI		IN/CDU	
Parameter	Source	Parameter	Source
Magnetic Heading	INS	Magnetic Heading	INS
Horizontal Range to DWP (*)	INS (**)	Horizontal Range to DWP (*)	INS (**)
Relative DWP Bearing (*)	INS (**)	Relative DWP Bearing (*)	INS (**)
Actual Track	INS (**)		
Toward/Outward Indication	INS (**)		
		Time to DWP (*)	INS (**)
		Ground Speed	GPS
		A/C Present Position	GPS

- (\*) Data base mission DWP selected on IN/CDU  
(\*\*) Data calculation performed by the IN based on GPS PP and GS data

**Figure 1-68**

When flying in the TACAN steering mode, the HSI shows steering information toward the radio station selected on the TACAN control panel. Magnetic heading and actual track are INS outputs.

The attitude indicator shows pitch and bank angles as long as the INS is available. Turn rate will be provided by the dedicated gyro equipment.

The IN/CDU displays various navigation data sets. The data shown are always INS outputs. Steering indications are always referred to the destination waypoint selected on the IN/CDU regardless the selected navigation steering mode.

### NAVIGATION SUB-SYSTEM FUNCTIONALITY UNDER FAILURE CONDITIONS

Following an INS failure (INERTIAL NAV FAULT warning light lit on the warning lights panel), the steering information is not available on IN/CDU and HSI in both IN and GPS steering modes. Moreover the attitude indications are not displayed on the attitude indicator. TACAN selection permits navigation toward the selected radio station with steering indication shown on the HSI only. The magnetic heading is provided by the C-2G.

#### NOTE

On HSI, the actual track indication is hidden by the relative bearing indication provided by the TACAN.

Following a TACAN failure, both "IN" and "GPS" steering mode of operation may be selected, with steering information shown on the HSI, IN/CDU and GPS display. Following a GPS failure, both "IN" and "TACAN" steering modes may be selected.

### INFLIGHT OPERATION

The navigation sub-system permits, during flight, the following:

- Fly-To function
- On Top Fixing (OTF) procedure
- Mark point data acquisition

### Fly-To Function

This function permits the pilot to reach, from the aircraft's PP, any point whose position is stored in the system. The navigation sub-system is capable to supply steering parameters to fly the aircraft to that point by means of the HSI. Selection of the fly-to waypoint is carried out on the IN/CDU by using the rotary switch.

### On Top Fixing Procedure

The aircraft's PP updating may be performed by the on top fixing (OTF) procedure. This updating shall be carried out by flying over the selected destination waypoint, and is based on the assumption that this point has been visually identified. The point on which the OTF procedure has to be carried out has to be one of those inserted in the mission data base. The OTF facility is available provided that the aircraft is not flying in the "GPS" steering mode. The OTF facility may be automatically or manually rejected.

The function shall be activated pressing the FIX/ACC hard key on the IN/CDU, whichever mode is currently active on the IN/CDU. The OTF function is activated whenever is desirable to update the current PP (affected by the platform error) with the known DWP coordinates selected on the IN/CDU. At the first press of the FIX/ACC hard key, the IN/CDU shall receive the computed fixing error via RS422 interface and shall display it in polar coordinates with:

Angular error:

- Range: 0° – 359°
- Resolution: 1°

Range error:

- Range: 0 – 99.99 NM
- Resolution: 0.01 NM

#### NOTE

In case the computed range error is greater than 99.99 NM, the IN/CDU shall display the range error as "> 100 NM".

If, starting from the moment of the fixing error displaying, 30 seconds elapse without any other pilot action on any pushbutton of the IN/CDU, the fixing error format shall disappear and the IN/CDU



shall revert to the format and the page displayed before the OTF activation.

At the end of flight, with the aircraft in steady state condition, the IN final error check may be performed using the OTF technique.

The pilot selects (if not already done), on the IN/CDU, the relevant waypoint which shall be coincident with the OTF point. After having pressed the FIX/ACC hard key, the fixing error is displayed (refer also to Figure 1-62 for a typical fixing error readout).

Pilot shall be aware of the following: the destination waypoint identified as "00" should not be used for this purpose because on ground, with a ground speed < 10 knots, the relevant fixing data are not reliable. This does not affect the utilization of waypoint "00" (as any other waypoint) on ground and/or in flight provided that the ground speed is > 10 knots.

### MARK POINT DATA ACQUISITION

The mark point data acquisition provides a means to acquire the position (in terms of latitude and longitude) of an unknown point. This procedure shall be carried out by flying over the interested point and is based on the assumption that this point has been visually identified. Up to two mark points may be acquired within the system and they shall be identified by the identification numbers 59 and 60. The position of the point is stored in the navigation system. After its/their acquisition, they may be selectable on the IN/CDU as any other waypoint by using the rotary switch. After INS switch off the mark points data are lost.

Pressing the first time the MARK/IP hard key, the IN/CDU shall command to the INS, via RS422, to store the actual present position of the aircraft in the first memory location. Pressing the second time the MARK/IP hard key the same operation is done for the second point on the second location.

Subsequent presses of the MARK/IP hard key shall cyclically memorize the PP of the aircraft in the first/second location, thus deleting the previously acquired coordinates.

### AUTOPILOT INTERFACE

When flying in "IN" navigation steering mode, the AFCS maneuvers the aircraft according to INS input. The AFCS NAV mode is referred to the destination waypoint selected on the IN/CDU.

The AFCS NAV mode is not available in GPS and TACAN navigation steering modes.

The INS controls the AFCS by means of the INS interlock and AFCS disengage signals.

The INS interlock signal disengages the AFCS NAV mode when one of the following conditions occur:

- selection of TCN steering mode
- selection of GPS steering mode
- range to destination < 10 NM
- change of destination waypoint (in this case, if desired, the AFCS NAV mode shall be selected again)

The AFCS disengage signal disengages all the AFCS modes following an "INS" failure.

## AUTOMATIC FLIGHT CONTROL SYSTEM (AFCS)

The MH-97 automatic pilot (automatic flight control system, AFCS) provides the pilot with modes for holding pitch and roll attitudes, altitude, Mach number, and heading. It also includes a mode for automatically commanding and holding a rate of turn proportional to true airspeed. The automatic pilot computer is electronic and commands are transferred through parallel hydraulic servo actuators in the pitch and roll axes. Inputs are obtained from the air data computer, rate gyros, accelerometers, and INS. The AFCS is powered by the XP7 AC bus and PP1 DC bus. The system provides maneuvering control of the aircraft through the aileron and stabilizer parallel servo actuators.

The servo actuators are powered by the No. 1 hydraulic system and incorporate force-limiting characteristics. Automatic stabilizer trim is provided while the automatic pilot is engaged. Rudder trim is not provided by the autopilot; however, the rudder may be trimmed manually. Synchronization is provided so that upon engagement of the automatic pilot or any of its functional modes, there are no undesirable transients of the aircraft or control stick. The system is arranged with sufficient interlocking to prevent engagement or operation of conflicting modes, to provide function priority where required, to ensure positive sequencing of events, and to ensure positive operation of functional modes when selected.

The operation modes are interconnected in such a manner that the modes are arranged in a priority order. Separate modes are provided for pitch channel operation and roll channel operation. When the

autopilot is engaged, the pitch channel operates according to the pitch mode set and the roll channel operates according to the roll mode set.

Roll modes in ascending order of priority are: roll attitude hold and heading hold, low level roll (CSS), standard turn, navigation (IN), and high level roll (CSS) modes. Pitch modes in ascending order of priority are: pitch attitude hold, low level pitch (CSS), mach hold, altitude hold, and high level pitch (CSS) modes.

### NOTE

When flying below 2000 ft, autopilot operation should be crosschecked with standby attitude indicator, altimeter and airspeed/Mach indicator.

The automatic pilot will disengage under any of the following conditions:

- a. Loss of electrical power

### NOTE

Momentary loss of PP1 (primary) DC power may cause autopilot disengagement and illumination of the AUTO PILOT DISENGAGED warning light. This may occur when No. 2 AC WF generator, for any reason, goes off line. Reengagement of the autopilot will extinguish the warning light; the warning light may also be extinguished by actuating the disengage switch.

- b. Loss of No. 1 or No. 2 hydraulic system pressure (loss of No. 2 system renders fixed-frequency generator inoperative)

### NOTE

The autopilot may disengage due to loss of the fixed-frequency generator (Generator 3); however, the loss of power will be momentary as the function will automatically transfer to the XP4 AC bus. If the autopilot does disengage, it may be re-engaged permitting normal autopilot operation.

- c. Moving the yaw, roll, or pitch stability augmenter switches to OFF

- d. APC kicker operation
- e. INS failure
- f. Operation of auxiliary trim control
- g. Operation of disengage switch
- h. Moving autopilot engage switch to OFF
- i. Disengage limiter action
- j. APC switch off
- k. Operation of any one of the damper failsafe circuits

### Disengage Limiter

The autopilot disengage limiter circuit senses "G"s, pitch rate, and autopilot stabilizer servo rate. Should an AFCS malfunction cause an erratic or hard-over autopilot stabilizer servo action, the disengage limiter circuit sums inputs from the autopilot normal accelerometer, pitch rate, and autopilot stabilizer servo and will automatically disengage the autopilot before unsafe airframe loads may be imposed. If the maneuver caused by a malfunction results in a very high servo and pitch rate, the disengage limiter will disengage the autopilot instantly on a summed signal from the three sensors. If the maneuver results in a very slow displacement of the servo, with little or no pitch or servo rate inputs to the limiter, the autopilot will disengage at approximately +3.9 "G" or -1.4 "G". Since a malfunction will generally result in some pitch rate inputs to the limiter, disengagement will usually occur at values less than +3.9 "G" or -1.4 "G".

**Low and High-Level Force Optoswitches.** Low and high-level force optoswitches are installed in the control-stick grip. A force of approximately 1.5 pounds exerted on the stick grip in either pitch or roll will close the low-level force optoswitch and allow control stick steering. A force of 5 to 7.5 pounds exerted on the stick grip, in either pitch or roll, will close the high-level force optoswitch. Closing the pitch high-level force optoswitch will disengage altitude hold or Mach hold. Closing the roll high-level force optoswitch will disengage navigation mode or standard turn mode.

### Control Stick Steering

The control stick steering (CSS) mode is initiated by applying a small force (approximately 1.5

pounds) to the control stick. This action closes the low-level force optoswitch in the control system and commands signals proportional to the pitch or roll forces exerted on the control stick. These signals are transmitted to the aircraft control surfaces by the parallel servos.

In this mode the pilot may attain any attitude desired. CSS will disengage any time the control stick force is released at less than the attitude hold limits of  $\pm 66^\circ$  of pitch or roll. The attitude hold or heading hold mode will then regain control at the attitude heading reference existing at the time the stick was released.

### Roll And Pitch Attitude Stabilization

The automatic pilot will maintain the aircraft at its existing roll or pitch attitude if the attitude is within the range of approximately  $\pm 66^\circ$  of pitch and within  $7^\circ$  to  $66^\circ$  of bank angle. Following a CSS maneuver, the automatic pilot will control the aircraft to maintain the attitude at the time control stick forces were removed if this attitude is within the above limits.

When the aircraft is maneuvered to an attitude beyond the attitude hold of  $\pm 66^\circ$ , the attitude hold function becomes inoperative. If the control stick is released at roll or pitch attitudes  $> 66^\circ$ , CSS will remain engaged; however, the aircraft will continue to fly in a rate-stabilized configuration. If control stick forces are released at a bank angle  $< 7^\circ$  and a pitch angle  $< \pm 66^\circ$ , the heading hold mode will re-engage at the wings level heading which existed at the time CSS roll forces were removed and a pitch attitude which existed at the time pitch control stick forces were removed.

Application of stick forces will develop aircraft roll rate or pitch acceleration proportional to stick forces.

(The relationship between roll rate or pitch acceleration and stick force is approximately that provided by pure manual control).

### Autopilot Control Panel

The autopilot control panel, labeled AUTOPILOT (refer to Figure 1-69) has the following controls:

**Engage Switch.** The engage switch is spring-loaded to OFF. The switch is held in the ENGAGE position by a solenoid if the autopilot is functional. The switch will return to the OFF position if, for any reason, the autopilot cannot assume smooth control of the aircraft. If the autopilot is engaged while the aircraft is in a bank at an angle  $< 7^\circ$ , the autopilot

will smoothly roll the aircraft to a wings-level attitude and heading hold will engage.

**Altitude Hold Switch.** Altitude hold may be engaged during autopilot operation by use of the two-position toggle switch. The aircraft will maintain the altitude existing at the time the switch was placed in ALTITUDE HOLD. The altitude-hold function will control the aircraft in a satisfactory manner when engaged during aircraft rates of climb or descent of 5000 feet per minute or less. The air data computer provides the primary reference control signals. The INS provides vertical acceleration signals. Application of pitch CSS forces sufficient to activate the high-level force optoswitches (5.5 to 7.5 pounds) will automatically disengage the altitude-hold mode. Maneuvering the aircraft beyond the roll attitude hold limits will also automatically disengage the altitude-hold mode.

**Mach Hold Switch.** Mach hold may be engaged, during automatic pilot operation, by the two-position toggle switch. The aircraft will maintain the Mach number existing at the time the switch was placed in MACH HOLD by controlling the pitch attitude of the aircraft. The air data computer provides the primary reference control signals.

### NOTE

Engagement of the altitude hold mode will override and cause the Mach hold mode to automatically disengage. The Mach hold mode shall not be engaged if altitude hold mode is engaged.

Pitch CSS forces sufficient to activate the high-level force optoswitches (5.5 to 7.5 pounds) will cause the solenoid-held Mach hold switch to return to OFF.

**Heading Switch.** A two-position switch is labeled HEAD. The two positions are HOLD and NAV. The switch is spring-loaded to the HOLD position and is solenoid-held in the NAV position. In the HOLD position, the autopilot will maintain the aircraft at its existing heading except when (1) stick forces in excess of the low-level force switches setting (approximately 1.1 lb) are applied, (2) stick forces are removed at bank angles  $> 7^\circ$ , (3) the pitch angle is  $> 66^\circ$ , or (4) a standard turn mode maneuver is executed. In the NAV position, the autopilot uses outputs from the HSI indicator which is driven by the INS. Pitch CSS may be used concurrently with the navigation modes. Roll CSS is interlocked so that forces sufficient to activate the high-level force optoswitches will cause the navigation mode

# AUTOMATIC FLIGHT CONTROL SYSTEM CONTROLS AND INDICATORS

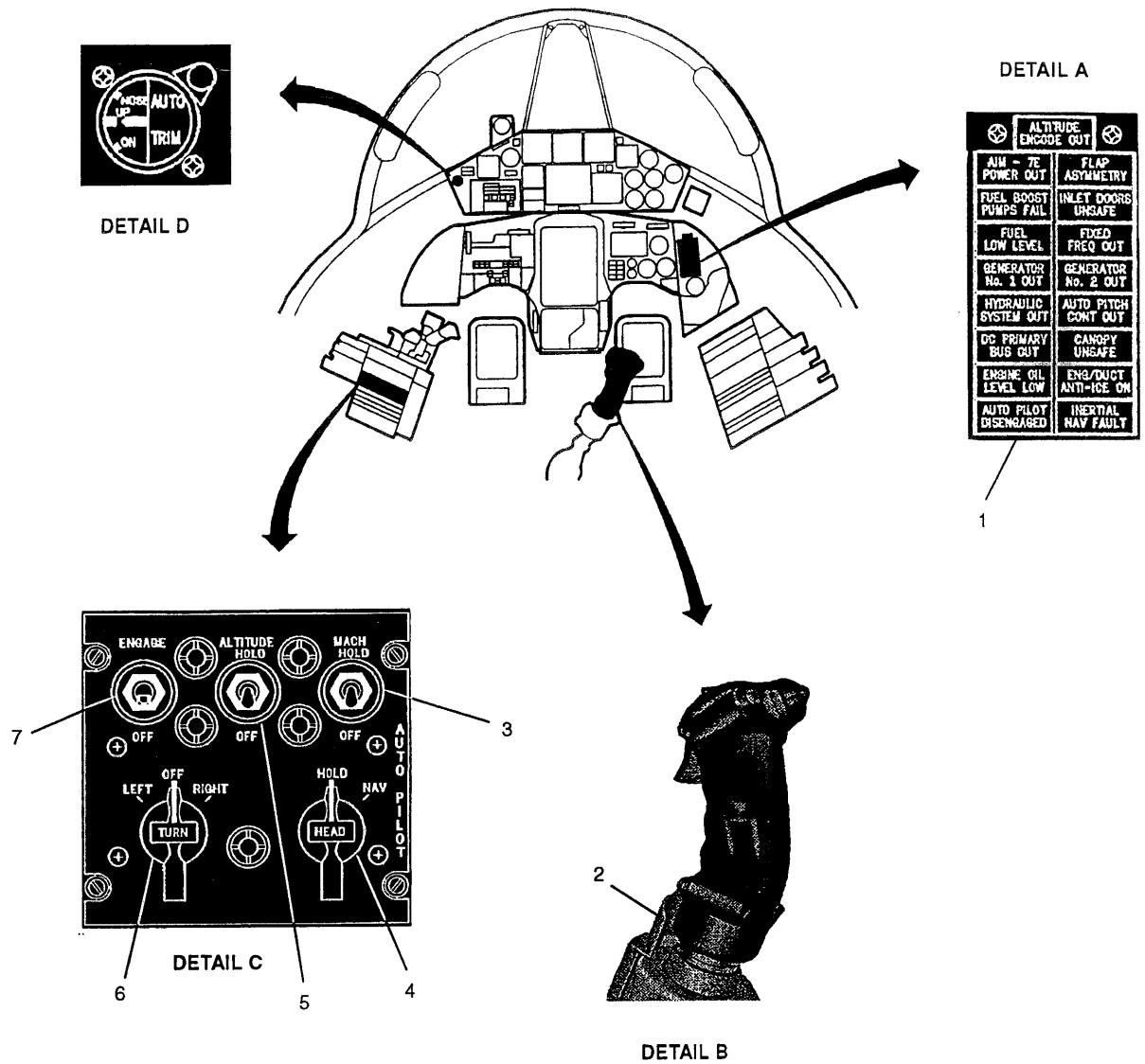

- A - WARNING LIGHTS PANEL**
  - 1 AUTO PILOT DISENGAGE WARNING LIGHT
- B - CONTROL STICK GRIP**
  - 2 AUTOMATIC PILOT/APC DISENGAGE SWITCH
- C - AUTOPILOT CONTROL PANEL**
  - 3 MACH HOLD SWITCH
  - 4 HEADING SWITCH
  - 5 ALTITUDE HOLD SWITCH
  - 6 TURN SWITCH
  - 7 ENGAGE SWITCH
- D - AUTO TRIM INDICATOR**

FA0072

Figure 1-69

to disengage and the heading switch will return to the normal HOLD position. When the range to destination is < 10 NM the navigation mode will automatically disengage, and the automatic pilot will revert to the pilot-assist modes.

**Turn Switch.** A switch labeled TURN is used to engage the standard turn mode. The switch has three positions, LEFT, OFF, and RIGHT. Operation of the switch produces left or right turning maneuvers at a bank angle which will not exceed 48° or less than 15°. The switch is solenoid-held in the LEFT or RIGHT positions. Centering the switch to the OFF position will cause the aircraft to roll to a wings-level attitude and the heading hold mode will engage. Upon selection of a noncompatible, higher priority mode, the turn switch automatically returns to the OFF position and control reverts to the newly selected mode. Roll CSS will be deactivated by selection of the constant turn maneuver. Upon application of roll CSS forces sufficient to activate the high-level force optoswitches, the standard turn mode automatically disengages and control of the roll axis will revert to the CSS mode. At attitudes beyond the pitch and roll attitude hold limits, it is not possible to engage the standard turn mode.

### **NOTE**

Engagement of the NAV hold mode will override and cause the turn switch to return to the OFF position. The mode shall not be engaged with the heading switch in the NAV position.

### **Automatic Pilot Disengage Switch**

A disengage switch (refer to Figure 1-69) is provided on the control stick. The control stick assembly also contains the force transducer which produces signals proportional to forces applied to the grip for control stick steering. The low-level and high-level force CSS optoswitches are also included in the assembly.

### **Auto Trim Indicator**

The auto trim indicator, located on the left upper part of the main instrument panel (refer to

Figure 1-69), provides an indication of control stick position with respect to stick rigged neutral. The trim indicator is used to visually show the pilot the trim condition of the aircraft when it is being controlled by the autopilot.

### **Autopilot Disengage Warning Light**

The AUTO-PILOT DISENGAGED warning light on the warning lights panel (refer to Figure 1-69) illuminates whenever the automatic pilot becomes disengaged by any means other than by use of the stick disengage switch.

## **AUTOPILOT OPERATION**

### **Inertial Nav Homing**

Upon selection of the IN steering mode and NAV mode, the aircraft is automatically maneuvered to a heading corresponding to the direction toward the selected waypoint. Bank angles will be limited to 30° during NAV mode.

When the aircraft is within 10 nautical miles of the selected station, the NAV mode is disengaged and the aircraft will remain stabilized on the heading hold mode.

The NAV mode is also disengaged when either GPS or TACAN steering mode is selected or when a change of destination waypoint is carried out. In the last case, if desired, the NAV mode shall be selected again.

### **Automatic Pitch Trim**

Automatic trim signals are provided in the pitch axis to automatically minimize any out-of-trim condition produced by steady-state changes in longitudinal trim introduced by changes in flight conditions. The automatic trim system operates on a long term reduced-rate basis to maintain autopilot effort in the pitch axis at a minimum.

The system operates on stick position inputs and drives a series-link trim servomotor (part of the stabilizer servo) to alter surface position such that the control stick is maintained at rigged neutral. Automatic pitch trim is inoperative during application of CSS in pitch. The system will trim to an accuracy of ½ bar width as indicated on the auto trim indicator.

## LIGHTING SYSTEM

### EXTERIOR LIGHTING

#### Landing and Taxi Lights

A landing light is installed on each main gear aft door. The light will be in position for use any time the landing gear is extended. The landing lights receive power from the XP2 AC bus and both lights are controlled by a switch (refer to Figure 1-70) on the left forward panel. The switch has three positions, LANDING LIGHT, OFF, and TAXI LIGHT. The lights automatically shut off when the nose gear is retracted.

#### NOTE

A prolonged use on the ground may cause damage to the landing lights.

#### Navigation Lights and Switches

The navigation lights include two yellow upper tail lights, two white lower tail lights, a green and a red fuselage light, and white top and bottom fuselage lights.

The formation lights are installed on the tip tanks or missile launchers. The lights are controlled by a selector switch and a dimming switch located on the LIGHT CONTROL panel on the right console (refer to Figure 1-70).

The lights are energized from XP2 AC bus when the selector switch is moved from OFF to STEADY or FLASH.

With the selector switch in the STEADY position, all of the navigation lights are energized continuously. In the FLASH position, the top and bottom fuselage lights still burn steadily while the remaining navigation lights are energized intermittently through a flasher unit at a rate of 40 flashes per minute. Intensity of the navigation lights depends upon the position (BRIGHT or DIM) of the dimming switch.

### INTERIOR LIGHTING

The interior lighting system comprises instrument lights, console panel lights, console floodlights, thunderstorm lights, spotlights, and associated wiring, circuit breakers, and controls.

### Instruments and Console Panel Lights

The individual instruments are illuminated with post or shielded light fixtures located as required adjacent to each indicator. The major left and right console control panels are indirectly illuminated by edge-lighted plastic plates.

The instrument lights are controlled by a rheostat-type switch labeled INTERIOR INSTRUMENT. The console panel lights are controlled by a rheostat-type switch labeled INTERIOR CONSOLE. Both switches are located on the LIGHT CONTROL panel (refer to Figure 1-70).

They turn the lights on and provide brightness control. These lights receive power from the XP2 AC bus through the CKPT.LTS. circuit breaker located on the right console.

#### NOTE

The interior instrument rheostat-type switch also controls the warning light brilliancy (refer to Warning Lights Dimming System).

#### Floodlights

Four floodlights are installed to provide overall lighting for each of the consoles and the instrument panel. Two lights are located on each side of the cockpit, above the aft and forward portion of the consoles.

They are controlled by a rheostat-type switch labeled INTERIOR FLOOD, located on the LIGHT CONTROL panel (refer to Figure 1-70).

Power is provided by the XP2 AC bus through the CKPT. FLOOD LTS. circuit breaker located on the right console.

#### Thunderstorm Lights

High intensity (thunderstorm) lights are installed in the cockpit to illuminate the upper and lower main instrument panel. These lights are normally used during thunderstorm conditions or when normal illumination is inadequate.

Thunderstorm lights are controlled by the two position (ON/OFF) STORM LIGHTS switch, located on the right forward panel. They are electrically powered by the PP2 DC bus through the

### LIGHTING SYSTEM CONTROLS



DETAIL F



DETAIL A



DETAIL E

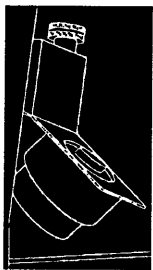
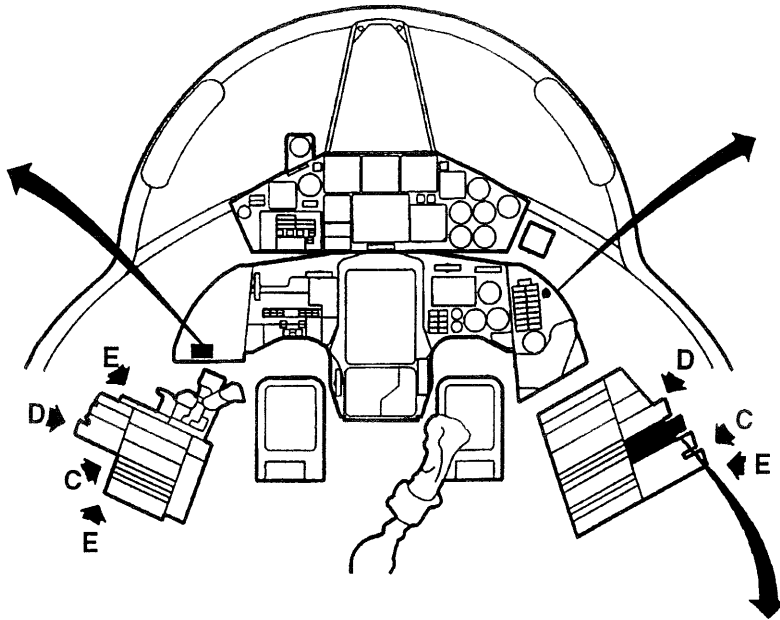

DETAIL D

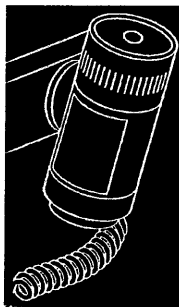

DETAIL C

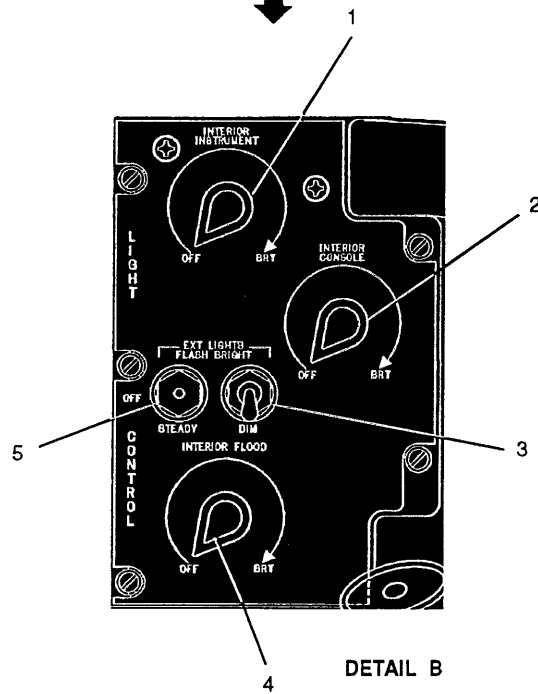

DETAIL B

- A - STORM LIGHTS SWITCH
- B - LIGHTING SYSTEM CONTROL PANEL
  - 1 INTERIOR INSTRUMENT SWITCH
  - 2 INTERIOR CONSOLE SWITCH
  - 3 NAVIGATION LIGHTS DIMMING SWITCH
  - 4 FLOODLIGHTS SWITCH
  - 5 NAVIGATION LIGHTS SELECTOR SWITCH
- C - SPOT LIGHTS
- D - STORM LIGHTS
- E - FLOOD LIGHTS
- F - LANDING AND TAXI LIGHTS SWITCH

FA0071

Figure 1-70

CKPT SPOT LTS circuit breaker located on the right console.

### Spotlights

Two spotlights are used for emergency illumination. Both are located on the end of the left and right consoles. The right spotlight may be also placed in a proper fitting located in the right side of the cockpit.

The light intensity may be controlled by a rheostat located in the rear part of each spotlight. They are electrically powered by the PP2 DC bus through the CKP SPOT LTS circuit breaker located on the right console.

## OXYGEN SUPPLY SYSTEM

The oxygen system consists of an aircraft oxygen system and an emergency oxygen system.

### AIRCRAFT OXYGEN SYSTEM

A liquid oxygen system (refer to Figure 1-71) is used to provide the normal oxygen supply requirements. The liquid oxygen is converted to a gaseous state in a convert-container tank which has a capacity of 5 liters.

The oxygen is made suitable for breathing after passing through a heat exchanger which keeps the oxygen within a few degrees of cockpit ambient temperature. Oxygen is delivered at a pressure of approximately 70 psi. The oxygen regulator provides for the selection of normal diluter oxygen, 100% oxygen, and emergency oxygen.

Oxygen duration varies depending upon altitude, control setting and pilot's usage. Refer to Figure 1-73 for duration of oxygen supply. A liquid oxygen quantity gage allows to monitor oxygen quantity. A oxygen low pressure lamp illuminates when oxygen pressure is below a pre-set value.

### STANDARD EMERGENCY OXYGEN SUPPLY SYSTEM (MB-STAND OX)

The MB-Stand Ox (refer to Figure 1-71) consists of an emergency oxygen bottle, pressure gage, pressure reducer valve, oxygen regulator, and a valving mechanism (refer to also Figure 1-37).

The valving mechanism is controlled by a striker lever, which turns on the oxygen during seat

ejection by striking a pin inserted in the emergency oxygen trip bracket. A manual release knob (green apple) is located on the front of the PEC and is cable-connected to the striking lever. It may be utilized by the pilot in the event at the aircraft oxygen system fails. The emergency oxygen bottle contains 50 liters of gaseous oxygen, charged at 1800 psi. Ten minutes of oxygen supply is available.

A lanyard attached to the aircraft structure disengages the aircraft oxygen supply system by removing the PEC-aircraft portion upon seat ejection. The PEC-seat portion is designed to stay with the seat, and when the PEC-aircraft portion is disconnected, spring-loaded valves close off the aircraft oxygen system and anti "G" line ports, allowing the emergency oxygen system to function without leakage. The PEC-pilot portion stays connected to the PEC-seat portion during pilot descent until seat and pilot separation takes place.

At that time, the PEC-pilot portion stays with the pilot, until the pilot elects to disconnect it from the oxygen mask.

### OXYGEN SUPPLY SYSTEM CONTROLS AND INDICATORS

The oxygen supply system controls and indicators are shown in Figure 1-72.

#### Oxygen Control Panel

The oxygen control panel, labeled OXYGEN REGULATOR, is located on the top of the right console and has the following controls and indicators:

**Oxygen Supply Lever.** The (green) oxygen SUPPLY lever has two position:

ON	Permits oxygen supply from the aircraft system to the regulator
OFF	Interrupts oxygen supply from the aircraft system to the regulator

**Oxygen Diluter Lever.** The (white) oxygen diluter lever permits the following oxygen selections:

- NORMAL OXYGEN Selects an air/oxygen mixture as function of cabin altitude. This mixture is supplied upon pilot's demand
- 100% OXYGEN Selects pure oxygen supply. The oxygen is supplied upon pilot's demand



### OXYGEN SUPPLY SYSTEM

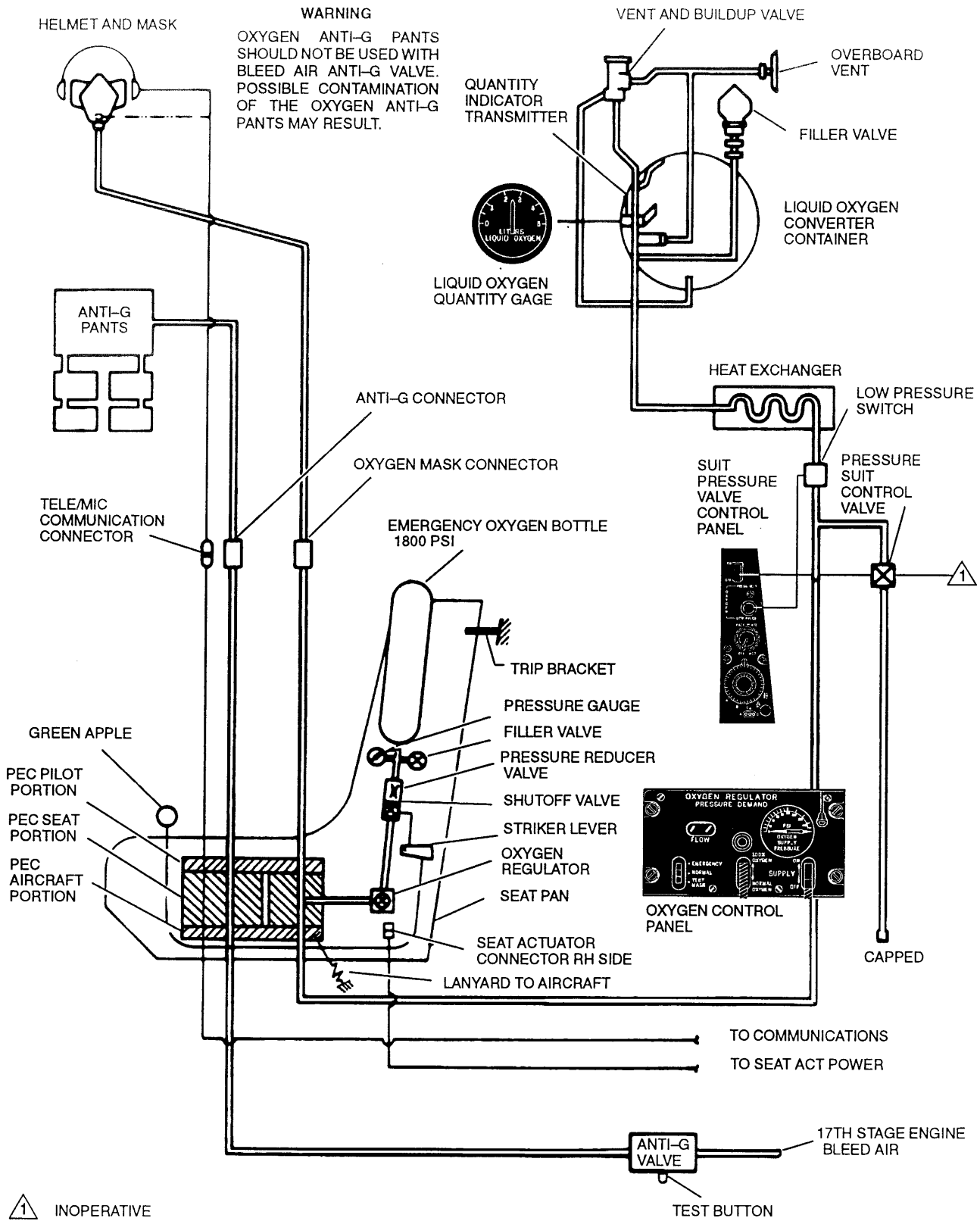

FA0303

Figure 1-71

## OXYGEN SUPPLY SYSTEM CONTROLS AND INDICATORS

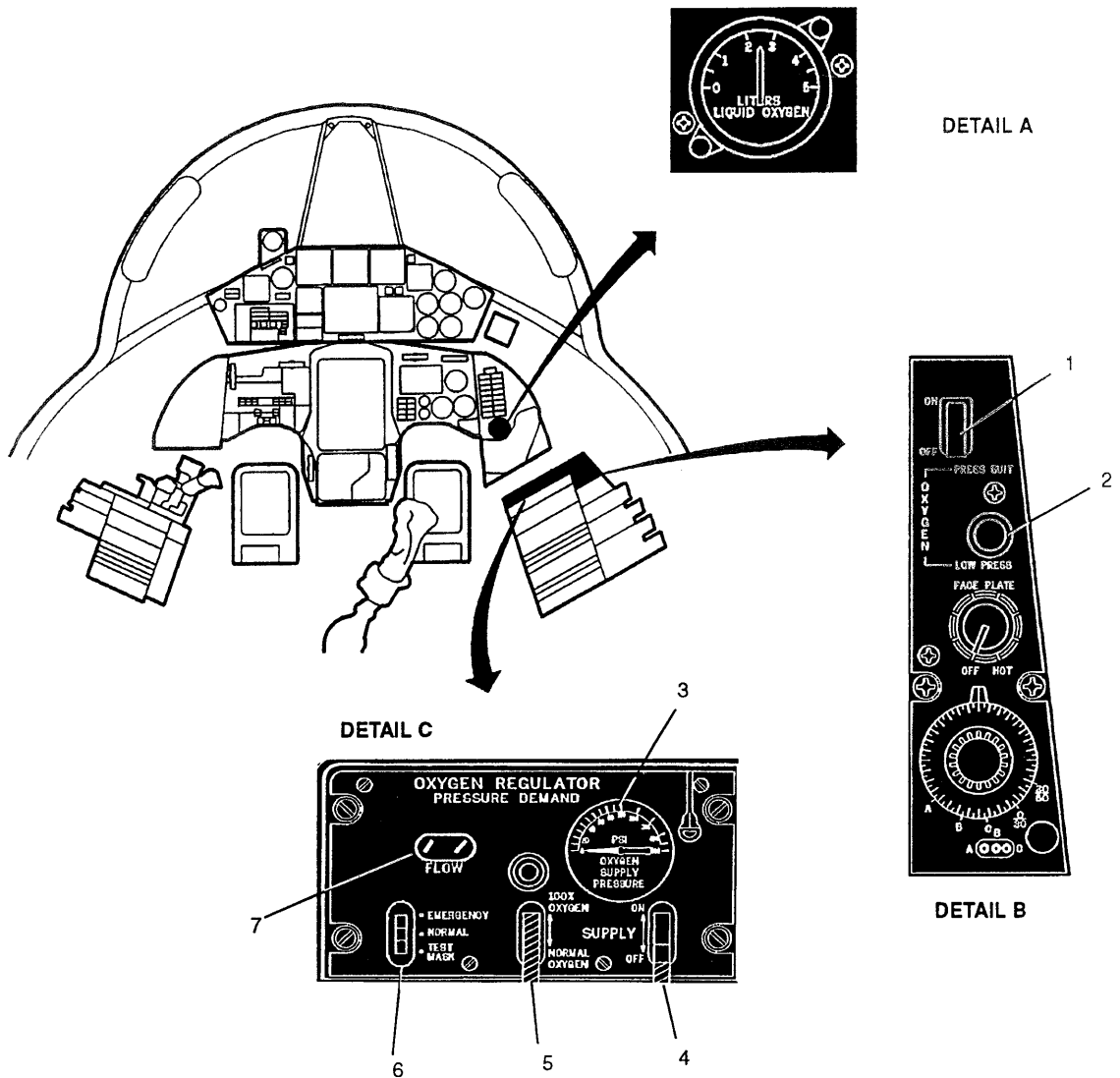

- A - LIQUID OXYGEN QUANTITY GAGE**
- B - RIGHT CONSOLE**
  - 1 OXYGEN PRESSURE SUIT SWITCH (INOPERATIVE)
  - 2 OXYGEN LOW PRESSURE LAMP
- C - OXYGEN CONTROL PANEL**
  - 3 OXYGEN PRESSURE GAGE
  - 4 OXYGEN SUPPLY LEVER
  - 5 OXYGEN DILUTER LEVER
  - 6 OXYGEN NORMAL/EMERGENCY LEVER
  - 7 OXYGEN FLOW INDICATOR

FA0081

Figure 1-72

**NOTE**

Oxygen supply is function of the oxygen normal/emergency lever.

**Oxygen Normal/Emergency Lever.** The (red) oxygen normal/emergency lever permits the following selections:

**EMERGENCY** Selects a flow of pure oxygen (with a constant overpressure) to the mask regardless of the position of the oxygen diluter lever

**NORMAL** Selects a flow of air/oxygen mixture supplied upon pilot's demand

**TEST MASK** A momentary position used to test the mask for leakage

**Oxygen Flow Indicator.** The FLOW indicator (blinker) shows black (no flow) and white (flow) alternately during the breathing cycle. Continuous black indicates that no air/oxygen is being furnished while, a continuous white indicates a leak in the system.

**Oxygen Supply Pressure Gage.** The OXYGEN SUPPLY PRESSURE (PSI) gage shows oxygen system pressure from 0 to 600 psi.

**Liquid Oxygen Quantity Gage**

The LITERS LIQUID OXYGEN gage shows liquid oxygen converter content from 0 to 5 liters. The gage is electrically powered by the XP2 AC bus.

**Oxygen Low Pressure Lamp**

A press-to-test red OXYGEN LOW PRESS lamp, located on the suit pressure control panel, illuminates when oxygen pressure decreases below 50 ( $\pm 5$ ) psi.

**Oxygen Pressure Suit Switch**

A two position PRESS SUIT switch which opens, when set to ON, the supply valve to the high altitude emergency oxygen supply and allows oxygen to flow into it. The lever has no control over the anti-"G" pants, since these are operated in conjunction with engine bleed air anti-"G" valve.

**NOTE**

The oxygen pressure suit switch is deactivated with the MB-Stand Ox. installed. Normal operating oxygen pressure suit switch position is OFF.

**OXYGEN SYSTEM PREFLIGHT CHECK****Diluter Demand (MB-Stand Ox)**

1. Oxygen supply lever – ON
2. Oxygen normal/emergency lever – NORMAL
3. Oxygen pressure gage – Approximately 65-120 psi
4. Liquid oxygen quantity gage – Check for required minimum
5. Emergency oxygen pressure 1800 psi – Checked
6. Connect anti-G hose to anti-G pants

**WARNING**

PROPER HOOKUP OF PERSONAL LEADS IS ESSENTIAL TO PREVENT ENTANGLEMENT DURING EJECTION. CHECK THAT PILOTS ANTI-"G" SUIT HOSE AND OXYGEN SUPPLY HOSE WITH ATTACHED TELE/MIC CABLE IS ROUTED UNDER THE HARNESS WAIST BELT.

7. Check oxygen regulator with oxygen diluter lever at NORMAL OXYGEN, and at 100% OXYGEN as follows:
  - a. Blow gently into end of oxygen regulator hose in same way as during normal exhalation
  - b. Resistance should be encountered to blowing. Little or no resistance to blowing indicates a leak or faulty operation

**OXYGEN DURATION TABLES****NOTE**

Conditions of oxygen usage will vary considerably depending upon pilot, system leakage, and operational procedures. Therefore, monitor the oxygen supply to determine that sufficient oxygen is available for mission completion. The following tables reflect oxygen duration under various configurations.

<b>OXYGEN MASK</b>		
<b>CABIN ALTITUDE (FEET)</b>	<b>OXYGEN DURATION (HOURS)</b>	
	<b>100% OXYGEN</b>	<b>NORMAL OXYGEN</b>
Sea level	4:00	24:00
5000	4:45	24:00
10000	6:00	24:00
20000	9:30	17:15
25000	12:30	15:30
30000	16:00	16:15
35000 and above	22:00	22:00

<b>PRESSURE SUIT AND HELMET</b>	
<b>NOTE</b>	
The table below refers to aircraft fitted with high altitude oxygen equipment.	
<b>CABIN ALTITUDE</b>	<b>OXYGEN DURATION (HOURS)</b>
Sea Level	2:15
5000	2:45
10000	3:30
15000	4:15
20000	5:30
25000	7:00
30000	9:00
35000	12:15
40000	9:30
50000	6:30
60000	6:00
70000	6:30

Figure 1-73

8. With oxygen supply lever in ON position, oxygen mask connected and oxygen diluter lever at 100% OXYGEN, breathe normally into mask and conduct following checks:
  - a. Observe flow indicator for proper operation
  - b. Set normal/emergency lever in EMERGENCY position. A positive pressure should be supplied to the mask. Hold breath to determine if leakage exists around mask. Return the lever to NORMAL position. Positive pressure should cease
9. Check along sides of seat for obstructions

### NORMAL OXYGEN SYSTEM OPERATION

#### Diluter Demand (MB-Stand Ox)

1. Oxygen pressure gage – 65-120 psi
2. Liquid oxygen quantity gage – Check for required minimum
3. Oxygen supply lever – ON
4. Oxygen diluter lever – NORMAL OXYGEN
5. Oxygen normal/emergency lever – NORMAL

### EMERGENCY OXYGEN SYSTEM OPERATIONS

#### Diluter Demand

1. Oxygen diluter lever – 100% OXYGEN
2. Oxygen normal/emergency lever – EMERGENCY

#### NOTE

Placing the oxygen diluter lever in 100% OXYGEN position and/or use of emergency oxygen will rapidly deplete the oxygen supply. Return oxygen diluter lever to NORMAL OXYGEN and the oxygen normal/emergency lever to NORMAL position when emergency is over.

3. If oxygen regulator becomes inoperative – Pull green apple to actuate emergency oxygen supply. (Oxygen supply for approximately 10 minutes available)
4. Descend to an altitude below 10000 feet

If symptoms of hypoxia or anoxia are noted:

1. Green apple – Pull

#### NOTE

When pulling green apple, disconnect the normal oxygen connection as normal oxygen may be contaminated. The action is irreversible.

2. Descend immediately below 10000 feet
3. Fresh air scoop – Open, below 10000 feet
4. Oxygen mask – Remove after bottle is empty
5. Land as soon as possible

### ENGINE BLEED AIR ANTI-G SUIT SYSTEM

An engine bleed air anti-"G" suit system is installed for use with anti-"G" suit to provide pressurization on critical parts of the pilot's body during flight maneuvers when positive "G" forces in excess of 1.5 "G" are encountered.

Engine bleed air from the gun purge duct is routed to an anti-"G" valve which opens under positive forces in excess of 1.5 "G". The amount of pressure applied is regulated and is directly proportional to the applied "G" force. The anti-"G" valve is located outboard of the cockpit left console and adjacent to the pilot's seat.

When a "G" force is applied, a weight moves down, closing the exhaust valve and opening a second stage valve to admit air pressure to the anti-"G" suit. A relief valve prevents the suit from pressurizing in excess of 9-11 psi. Decreasing "G" force allows the weight to move up, closing the second stage valve and exhausting the air from the suit through the exhaust valve.

**WARNING**

- IF THE ANTI-"G" SUIT FAILS TO DEFLATE AFTER COMPLETION OF A POSITIVE ACCELERATION, DISCONNECT THE ANTI-"G" SUIT FROM THE PRESSURE SOURCE AT THE CONNECTION TO RELIEVE PRESSURE. IF THE CHECK VALVE IN THE ANTI-"G" SUIT IS INSTALLED, PLACE THUMB OVER HALF OF CHECK VALVE AND PRESS IN ON THE VALVE. NOTE THAT AIRFLOW MAY BE BLOCKED IF THUMB COVERS MORE THAN HALF OF CHECK VALVE.
- PROPER HOOKUP OF PERSONAL LEADS IS ESSENTIAL TO PREVENT ENTANGLEMENT DURING EJECTION. CHECK THAT PILOTS ANTI-"G" SUIT HOSE AND OXYGEN SUPPLY HOSE WITH ATTACHED TELE/MIC CABLE IS ROUTED UNDER THE HARNESS WAIST BELT.

**Anti-G Valve Test Pushbutton**

An anti-"G" valve test pushbutton is provided to test the anti-"G" system whenever the aircraft bleed air system is pressurized.

The test button is located on the top of the anti-"G" valve installation on the outboard side of the cockpit left console. To test the operation of the

valve, press the pushbutton. The valve should open and supply pressure to the anti-"G" suit connection.

**MISCELLANEOUS**

One handle is installed on the left side of the forward extremity canopy frame.

**SERVICING DATA**

For general servicing data and location of servicing points refer to Figure FO-13.

**TIRE PRESSURE****WARNING**

WHEN SERVICING AIRCRAFT TIRES USE REGULATED AIR PRESSURE NOT TO EXCEED 250 PSI. PERSONNEL SHOULD STAND FORWARD OR AFT OF WHEEL WHEN SERVICING TIRES. OVERPRESSURE MAY CAUSE FAILURE OF TIRE OR WHEEL AND RESULT IN SERIOUS OR FATAL INJURY TO PERSONNEL.

Tire pressure for various aircraft configurations are shown in Figure 1-74.

These pressure are based on using 26 × 8.00, 14-16 ply tires on the main landing gear and 18 × 5.5, 14 ply tire on the nose landing gear.

### TIRE PRESSURE CHART

AIRCRAFT CONFIGURATION	NOSE LANDING GEAR TIRE PRESSURE (PSI)	MAIN LANDING GEAR TIRES PRESSURE (PSI)
CLEAN (1)	190	160
2 x WING TIP FUEL TANKS (FULL)	205	185
2 x WING TIP FUEL TANKS (FULL) + 2 x BL75 FUEL-TANKS (FULL)	225	210
2 x WING TIPS AIM-9L	190	165
2 x WING TIPS AIM-9L + 2 x BL75 FUEL TANKS (FULL)	205	190
2 x BL104 MRAAM (2)	205	170
2 x WING TIP FUEL TANKS (FULL) + 2 x BL104 MRAAM (2)	215	195
2 x WING TIP FUEL TANKS (FULL) + 2 x BL75 FUEL TANKS (FULL) + 2 x BL104 MRAAM (2)	225	220
2 x WING TIPS AIM-9L + 2 x BL104 MRAAM (2)	205	175
2 x WING TIPS AIM-9L + 2 x BL75 FUEL TANKS (FULL) + 2 x BL104 MRAAM (2)	215	200
2 x BL104 AIM-9L	205	170
2 x WING TIP FUEL TANKS (FULL) + 2 x BL104 AIM-9L	215	195
2 x WING TIP FUEL TANKS (FULL) + 2 x BL75 FUEL TANKS (FULL) + 2 x BL104 AIM-9L	225	220
2 x WING TIPS AIM-9L + 2 x BL104 AIM-9L	205	175

**NOTE:**

- (1) Clean aircraft configuration is referred to the aircraft with full internal fuel tanks with no external stores
- (2) The term MRAAM refers to the AIM-7E or ASPIDE missile

Figure 1-74

## SECTION II

### NORMAL PROCEDURES

#### TABLE OF CONTENTS

Title	Page
Preparation for Flight .....	2-1
Preflight Check .....	2-2
Before Starting Engine .....	2-8
Starting Engine .....	2-9
Ground Operation .....	2-14
Before Taxiing .....	2-17
Taxiing .....	2-18
Before Takeoff .....	2-20
Takeoff .....	2-22
After Takeoff .....	2-25
Climb .....	2-26
Cruise .....	2-26
Descent .....	2-27
Before Landing .....	2-28
Landing .....	2-29
Touch-and-Go Landings .....	2-34
Go-Around .....	2-35
After Landing .....	2-35
Engine Shutdown .....	2-37
After Shutdown .....	2-38
Strange Field Procedures .....	2-38
Alert Cocking Procedures .....	2-38
Alert Scramble Procedures .....	2-40
INS Alignment Procedure .....	2-40
IN/CDU Operation .....	2-41
GPS Operation .....	2-43

#### PREPARATION FOR FLIGHT

##### NOTE

For all weapon related checks, refer to the Nonnuclear Weapons Delivery Manual AER.1F-104S/ASAM-34-1.

#### FLIGHT RESTRICTIONS

Refer to Section V "Operating Limitations" for detailed aircraft and engine limitations.

#### FLIGHT PLANNING

Refer to the Appendix - Performance Data to determine the fuel quantity, engine settings and airspeeds required to complete the mission.

#### EMERGENCY PROCEDURES

Refer to Section III for Emergency Procedures.

#### TAKEOFF AND LANDING DATA CARD

Refer to Appendix - Performance Data for information necessary to fill-out the takeoff and landing data cards.



**MASS AND BALANCE**

For maximum gross mass takeoff and landing limitations, refer to Section V "Operating Limitations". For mass and balance information refer also to "Manuale dei Dati di Peso e di Centramento" AER.1F-104S/ASAM-5.

**PROCEDURES**

The procedures described in this Section are intended to give an extensive information concerning normal procedures that shall be carried out for the F-104S/ASAM aircraft operation. An abbreviated form is given in the Flight Crew Checklist.

**PREFLIGHT CHECK****BEFORE EXTERIOR INSPECTION**

1. Aircraft engineering status and servicing – Check
2. Lower firing handle swivel guard – Up
3. Armament and RADAR switches – SAFE/OFF, or as required
4. LDG GEAR – DOWN
5. Radar glareshield – Secure
6. IN/CDU – Check DTM inserted
7. Check the following ejection seat safety pins installed:
  - Main gun safety pin
  - Safety pin upper firing handle
  - Safety pin of canopy jettison initiator
  - Safety pin of emergency canopy jettison initiator

**EXTERIOR INSPECTION**

Perform exterior inspection as outlined in Figure 2-1.

**WARNING**

EACH TIP TANK HAS TWO FILLERS, ONE FOR EACH COMPARTMENT. IF A FLIGHT IS NECESSARY WITH PARTIALLY FILLED TIP TANKS, THE FORWARD COMPARTMENT SHALL BE FILLED FIRST. FILLING THE AFT COMPARTMENT FIRST WOULD RESULT IN A TIP TANK AFT CENTER OF GRAVITY AND THE POSSIBILITY OF TIP TANK FLUTTER. IF PARTIAL REFUELING HAS BEEN ACCOMPLISHED FOR THE MISSION, OR IF INCOMPLETE REFUELING IS SUSPECTED DUE TO TIP TANK FUEL GAGE INDICATIONS ON COCKPIT PREFLIGHT, VISUALLY CHECK THAT THE TIP TANKS HAVE BEEN REFUELED IN ACCORDANCE WITH DECALED INSTRUCTIONS ON THE TANK. IF PARTIAL REFUELING IS REQUIRED, CHECK TO MAKE SURE THAT THE FORWARD COMPARTMENT HAS BEEN REFUELED TO WITHIN 3 INCHES FROM THE TOP IF THERE IS ANY FUEL IN THE AFT COMPARTMENT; OTHERWISE, DO NOT FLY THE AIRCRAFT. IF COCKPIT TIP TANK GAGES HAVE BEEN CHECKED, VISUAL CHECK OF FULLY SERVICED TIP TANKS IS NOT REQUIRED.

**BEFORE ENTERING COCKPIT**

1. Canopy – Check. Check for cracks, cleanliness and distortion
2. Safety pin upper firing handle – Check inserted
3. Lower firing handle swivel guard – Check up
4. PEC connecting strap – Check for proper attachment
5. Scissor shackle – Closed and locked
6. Drogue gun safety pin, – Removed

## EXTERIOR INSPECTION

THE FLIGHT CREW EXTERIOR INSPECTION PROCEDURES ARE BASED ON MAINTENANCE PERSONNEL HAVING COMPLETED ALL POSTFLIGHT AND PREFLIGHT REQUIREMENTS; THEREFORE, DUPLICATE INSPECTIONS BY THE FLIGHT CREW HAVE BEEN ELIMINATED, EXCEPT FOR CERTAIN ITEMS REQUIRED FOR FLIGHT SAFETY. THE FLIGHT CREW IS TO CHECK THE AIRCRAFT FOR GENERAL CONDITION AND SHOULD FOLLOW THE PATH SHOWN BELOW. IF AIRCRAFT PREFLIGHT IS ACCOMPLISHED AT A STRANGE FIELD, REFER TO THE DETAILED AIRCRAFT PREFLIGHT UNDER STRANGE FIELD PROCEDURES, CONTAINED IN THIS SECTION.

- CRACKS, DISTORTIONS, LOOSE FASTENERS OR DAMAGE ON ALL SURFACES
- LEAKS OF FUEL, OIL, HYDRAULIC OR OTHER FLUIDS
- SECURITY OF ACCESS DOORS, PANELS, COVERS AND FILLER CAPS
- REMOVAL OF GROUND SAFETY GUARDS AND COVERS

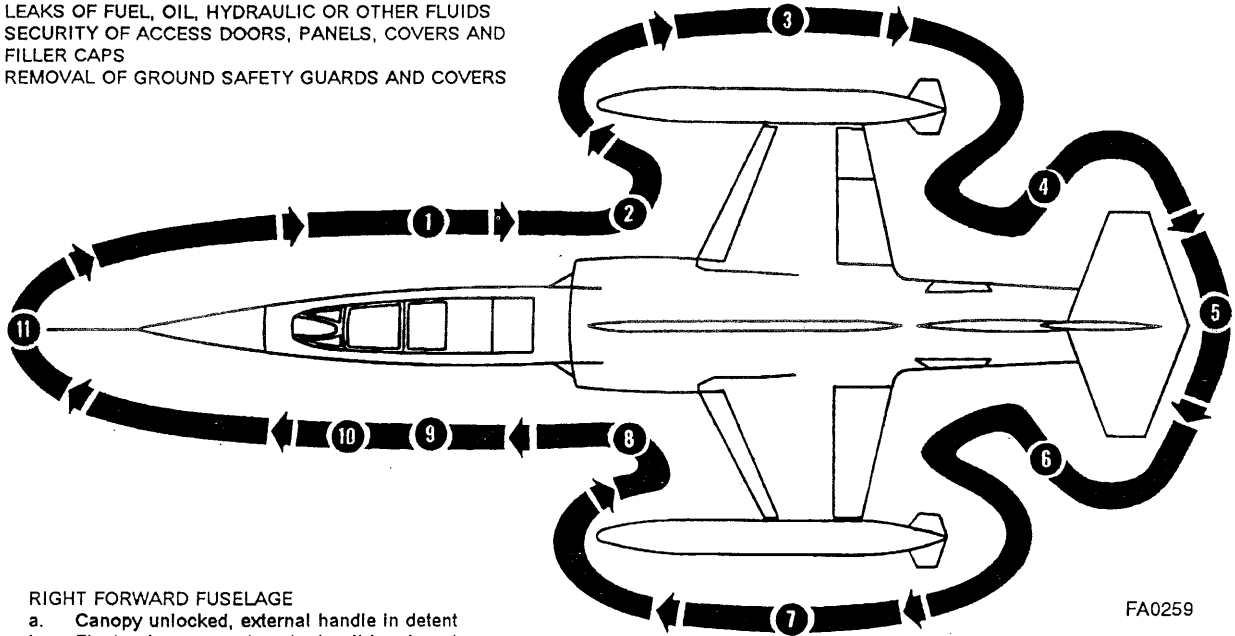

- FA0259
1. RIGHT FORWARD FUSELAGE
    - a. Canopy unlocked, external handle in detent
    - b. Electronics compartment, circuit breakers in and cover secure; electronics compartment access door closed
    - c. Ammunition compartment door secure
    - d. Open electrical load center, check circuit breakers
    - e. Ram air turbine door secure
    - f. Air conditioning ram air scoop, no debris
    - g. Engine Intake duct unobstructed
    - h. Engine auxiliary airdoors condition, no leakage
    - i. Navigation lights undamaged
  2. RIGHT MAIN LANDING GEAR
    - a. Landing gear door uplocks, cocked
    - b. Ground safety pins removed
    - c. Landing gear dump valve - Safetied
    - d. Dowlocks in place (knob on drag strut down)
    - e. Liquid spring extended (1 1/2 x 1 3/4")
    - f. Landing lights secure and undamaged
    - g. Check for clearance between wheel and tie rod
    - h. Wheel brake lines secure, no leakage, self adjuster exposed not less than 1/4"
    - i. Tires - Inflation, condition
    - j. Wheel chocks in place
  3. RIGHT WING
    - a. Leading edge flap and tip condition
    - b. Attachment of external stores secure, general condition
    - c. Visually check tip and pylon tank caps, secure; if installed
    - d. Aileron and trailing edge flap distortions and conditions
    - e. Wing surface condition
  4. RIGHT AFT FUSELAGE
    - a. Speed brake condition, no leakage
    - b. Navigation lights undamaged
    - c. Ventral fin and strakes condition
  5. EMPENNAGE
    - a. Vertical and horizontal stabilizer condition
    - b. Exhaust nozzle flap linkages and segments secure, no cracks, distortions or oil leaks
    - c. Afterburner spray bars, flameholder and liners condition, no cracks or distortions
  6. LEFT AFT FUSELAGE
    - a. Navigation lights undamaged
    - b. Stabilizer servo drain, no leaks
    - c. Speed brake condition, no leakage
  7. LEFT WING
    - a. Same as right wing
  8. LEFT MAIN LANDING GEAR
    - a. Same as right main landing gear
    - b. Manual fuel shutoff switch check
    - c. Ground-air safety switch clean and undamaged
  9. LEFT FORWARD FUSELAGE
    - a. Fuel filler caps secure
    - b. Engine oil dipstick - Cover secure and flag down
    - c. Navigation light undamaged
    - d. Engine auxiliary airdoors condition, no leakage
    - e. Engine intake duct unobstructed
    - f. Single point filler cap secure and aligned
    - g. Refueling switch panel, cover secure
  10. NOSE GEAR
    - a. Ground safety pin removed
    - b. Scissors properly connected
    - c. Downlock fully engaged in slot
    - d. Taxi light secure and unbroken
    - e. Shock strut extended 2" (check tape)
    - f. Tire - Inflation, condition
  11. NOSE SECTION
    - a. Gun port and blast tubes - Cover installed
    - b. Pitch sensor vanes free to move (guards removed)
    - c. Check windshield thermal sensor and proper installation
    - d. Radome latches secure
    - e. Pitot tube - Secure, cover removed, openings clean
    - f. Temperature probe, guards removed, opening clean

Figure 2-1

7. Emergency oxygen safety pin – Removed
8. Emergency oxygen pressure – Check
9. Manual override handle linkages (two) – Connected  
Safety pin – Removed

**WARNING**

- DO NOT STOW ANY ITEMS ON OR UNDER THE EJECTION SEAT.
- IF ANY SAFETY WIRE OR LEAD SEAL IS BROKEN, DO NOT FLY AIRCRAFT UNTIL CLEARED BY MAINTENANCE PERSONNEL.

**INTERIOR CHECKS**

1. Seat – Adjust

**CAUTION**

DO NOT OPERATE SEAT ADJUSTMENT MECHANISM FOR MORE THAN 30 SEC WITHIN 10 MINUTES OF TIME.

2. Attach leg lines as follows (refer to Figure 2-2):
  - a. Route left leg line from inside to outside through lower D-ring, then upward and from outside to inside through upper D-ring of left leg and press into right lock
  - b. Route right leg line from inside to outside through lower D-ring, then upward and from outside to inside through upper D-ring of right leg and press into left lock, so that leg lines are crossed before connected to the locks
  - c. Rudder pedals – Adjust

- d. Pull release rings on snubbers, place feet on rudder pedals and adjust leg lines
3. PEC-pilot portion – Connected
4. Survival pack attachment lanyards – Secured to parachute harness and survival pack
5. Strap-in combined harness as follows:
  - a. Quick release box in attack position – Check
  - b. Metal lug of negative-g-strap – Insert into quick release box

**WARNING**

DO NOT ROUTE NEGATIVE-G-STRAP THROUGH THE SECONDARY FIRING HANDLE.

- c. Lugs of blue lap straps – Connect to quick release box on top of metal lug for negative-g-strap and tighten all straps
- d. Route leg loops through rings on lap straps accomplishing a quarter of a turn, and feed lug of corresponding shoulder strap through end of leg loop into quick release box
- e. Rotate quick release box to safetied position, insert safety clip and tighten harness

**WARNING**

TO AVOID INJURIES UPON EJECTION IT IS IMPERATIVE TO TIGHTEN COMPLETE HARNESS AS TIGHT AS TOLERABLE AND YET COMFORTABLE.

6. Primary firing handle can be reached properly – Check
7. Check shoulder harness lock by operating go-forward lever
8. Dinghy lowering line – Connect to life vest

### DINGHY LOWERING ROUTING

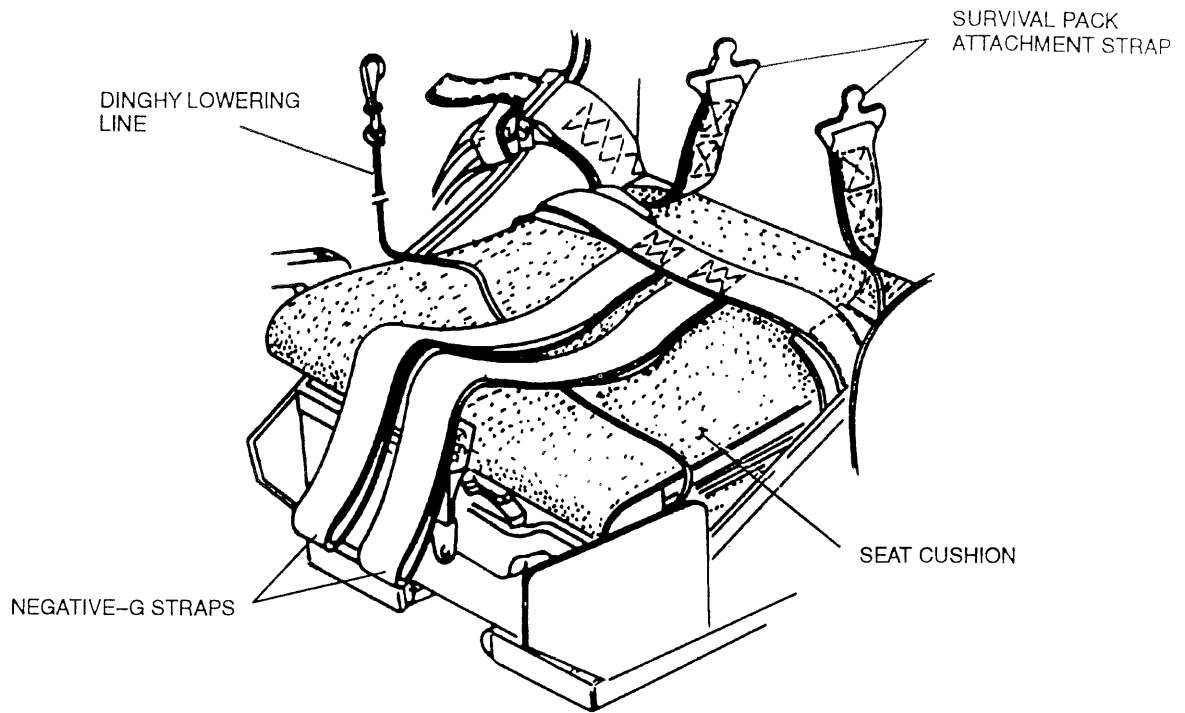

### LEG-LINE ATTACHMENT

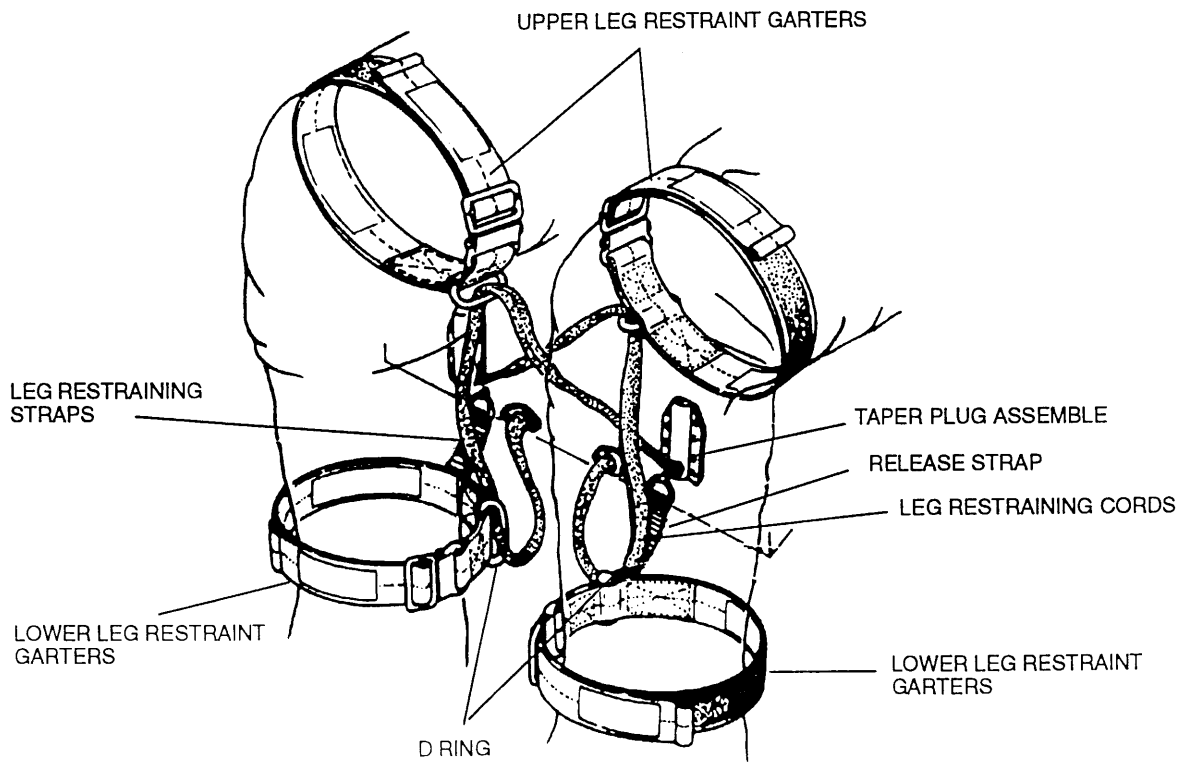

Figure 2-2

FA0339

**CAUTION**

AFTER CONNECTION TO LIFE VEST, THE DINGHY LOWERING LINE SHOULD NOT HAVE ANY SLACK BOTH ON THE RIGHT AND LEFT SIDE TO PREVENT LINE ENTANGLEMENT AND BURNING DURING EJECTION.

9. Personal leads – Connect

Route personal leads as follows:

- a. Route the pilots anti-G suit hose under the harness waist belt and connect with PEC-pilot portion
- b. Route oxygen supply hose with attached tele/mic cable of PEC-pilot portion under the harness waist belt

**WARNING**

ALL PERSONAL LEADS HAVE TO BE ROUTED AS DESCRIBED IN "A." AND "B." TO PREVENT ENTANGLEMENT DURING EJECTION AND/OR INJURY UPON EJECTION.

10. Emergency UHF radio switch – OFF (test emergency UHF if required, adjust volume as desired)
11. Left console circuit breakers – In
12. ENGINE AIR INLET DOORS switch – AUTO-CLOSE, guarded
13. AUTO PILOT switches – OFF
14. STABILITY CONT switches (ROLL, PITCH, YAW) – ON, guarded
15. APC CUT-OUT switch – ON, guarded
16. UHF radio – As required
17. EXT FUEL SEL switch – As required

**NOTE**

If pylon and tip tanks are installed, set external tank fuel selector switch to PYLON position.

18. FUEL SHUT-OFF switch – Guard down, clip in place and safetied
19. UHF ANTENNA SELECT switch – AUTO
20. RADAR – OFF
21. STICK TRIM-AUX TRIM selector switch – STICK TRIM, guarded

**CAUTION**

DO NOT USE PRIMARY OR AUXILIARY TRIM CONTROL WITHOUT HYDRAULIC PRESSURE AS THIS MAY DAMAGE THE TRIM MOTORS.

22. ENG RPM LOCK UP – AUTO and safetied
23. ENG RPM PWR ON indicator light – Off, press to test (light on when pressed then off at release)

**WARNING**

TO PREVENT AN IDLE OVER-SPEED CONDITION THE GROUND AIR SAFETY SWITCH SHALL NOT BE ACTUATED BY GROUND CREW IF "ENG RPM LOCKUP PWR ON" INDICATOR LIGHT IS LIT.

24. Wing flaps – UP
25. Throttle – Check OFF
26. Speed brakes – IN
27. External power unit – Connected and on

**NOTE**

- Connecting the external power unit will cause the CAUTION light and the following warning lights to be illuminated:

AIM-7E PWR OUT  
 FUEL BOOST PUMP FAIL (if circuit breakers are out)  
 FIXED FREQ OUT  
 GENERATOR NO. 1 OUT  
 GENERATOR NO. 2 OUT  
 HYDRAULIC SYSTEM OUT  
 AUTO PITCH CONT OUT  
 CANOPY UNSAFE  
 ENGINE OIL LEVEL LOW  
 AUTO PILOT DISENGAGED  
 INERTIAL NAV FAULT.

- The AIM-7E PWR OUT warning light will illuminate only if the MRAAM POWER switch, on the MRAAM panel, is in AUTO or RUN position
28. TACAN – Set to REC, channel and mode
  29. IN/TCN mode selector – Press, check TCN caption lit
  30. HSI – Check flags out of view
  31. C-2G function selector switch – MAG and synchronize
  32. IFF master switch – OFF
  33. GPS – As required (refer to "GPS Operation" procedures contained in this Section)
  34. HSI – Check conformity between aircraft and HSI headings
  35. IN/TCN mode selector – Press, check TCN caption extinguished

**NOTE**

If INS alignment is required before starting engine perform steps 36., 37. and 38. If not, perform step 3., 4. and 5. in the "Ground Operation - After Start Check" para, contained in this Section.

36. IN – ALN function, GC or STO mode (refer to "INS Alignment" procedures contained in this Section). Check INERTIAL NAV FAULT warning light extinguished

37. IN/CDU self test – Check "CDU OK" displayed

**NOTE**

Abort mission if "CDU FAIL" indication is displayed.

38. IN/CDU – Select and insert initial position, if GC selected
39. Landing gear lever unsafe warning light – Out
40. LG INDICATORS – Lit
41. LANDING LIGHTS AND TAXI LIGHT switch – OFF
42. ENG/DUCT ANTI-ICE switch – OFF
43. ANTI-SKID switch – ON
44. EXT STORES JETTISON button – Check integrity
45. DRAG CHUTE handle – Stowed
46. HOOK DOWN light – Press to test, check light lit
47. AIL AND RUD UNLIMITED warning light – Lit
48. Accelerometer – Reset
49. CANOPY UNSAFE warning light and sound check – Move throttle to military, check warning light flashing and audio warning. Press CANOPY WARNING SOUND CUT-OFF, check audio warning out. Retard throttle to OFF, check CANOPY UNSAFE warning light extinguished
50. Airspeed marker – Set as desired
51. Attitude indicator – Check, OFF warning flag in view
52. Standby attitude indicator – Check, cage and quickly release
53. HSI – Check OFF and NAV flags in view
54. Radar altimeter – On
55. Altimeter – ELECT and set

**NOTE**

The appearance of the PNEU flag, when altimeter is selected in ELECT mode, will indicate a power interruption or a failure in the altimeter.

56. Vertical velocity indicator – Check
57. Clock – Check
58. EMERGENCY NOZZLE CLOSURE handle – Stowed
59. RAM AIR TURBINE handle – Stowed
60. CANOPY JETTISON handle – Stowed
61. RADAR day/night visors (if installed) – Check for correct locked position
62. Weapons selector panel:
  - a. STORE RELEASE selector switch – SAFE
  - b. MRAAM POWER switch – OFF
63. Armament control panel:
  - a. ARMT switch – OFF
  - b. Armament mode selector switch – SAFE
  - c. Sight switch – OFF
64. MAN LDG GEAR release handle – Stowed
65. UHF channel frequency indicator – Check
66. EXT FUEL QTY IND SEL switch – Check fuel quantity
67. STORM LIGHTS switch – OFF
68. FUEL S/O OPEN VALVE TEST – Press to test, check light lit
69. CANOPY DEFOGGER – As required
70. FUEL QTY AND CIT TEST/WARNING LIGHTS TEST switch:
  - a. Up. Check internal fuel quantity, fuel decreasing, and compressor inlet temperature gage
  - b. Down. Check warning lights and audio warning
71. Generator switches – ON
72. Liquid oxygen quantity gage – 2 liters minimum
73. Oxygen pressure gage – Approximately 65-120 psi
74. Oxygen system – Checked (Refer to Oxygen System Preflight Check in Section I)
75. Pressure suit valve lever – As required
76. Fresh air scoop lever – Closed, lever in last aft detent

<b>CAUTION</b>
----------------

KEEP THE FRESH AIR SCOOP LEVER IN CLOSED POSITION DURING THE PREFLIGHT CHECK AND ALL GROUND OPERATION. THIS WILL PROVIDE SUFFICIENT COOLING AIR FOR THE ELECTRONIC EQUIPMENT. IF THE FRESH AIR SCOOP IS OPENED ON THE GROUND, THE SUPPLY OF COOLING AIR TO THE ELECTRONICS COMPARTMENT IS SHUT OFF AND THE ELECTRONIC EQUIPMENT MAY OVERHEAT.

77. TACAN – As required
  78. IFF – As required
  79. COCKPIT TEMP mode selector switch – AUTO
  80. Cockpit heat rheostat – As required
  81. HEATERS PITOT-PITCH TEMP PROBE switch – OFF
  82. FLYING SUIT switch – As required
  83. RAIN REMOVER switch – OFF, guarded
  84. Right console circuit breakers – In
  85. LIGHT CONTROL panel – As required
  86. PYLON JETTISON switch – OFF, guarded
- If INS initialization performed, proceed as follows:
87. IN function selector knob – NAV if requested alignment status reached (refer to "INS Alignment" procedures contained in this Section). If not, wait for requested ALN status. Check RDY NAV extinguished. Check HSI OFF/NAV flags out of view
  88. IN/TCN mode selector – As required
  89. Attitude indicator – Check
    - a. OFF warning flag out of view
    - b. Attitude sphere for proper attitude and freedom from oscillation
    - c. Attitude sphere for proper response to trim knob
  90. IN/CDU – Check format

## BEFORE STARTING ENGINE

Before starting the engine, make sure danger areas (refer to Figure 2-3) fore and aft of aircraft are clear of personnel, aircraft, and vehicles. The boundary layer control outlet for the intake ducts on each side of the lower fuselage will have a strong suction when the engine is started which may be strong enough to draw articles of clothing or loose equipment into the engine. When practicable, start engine with aircraft headed into the wind. An external electrical power source should be connected and used when starting the engine unless an emergency condition exists.

### CAUTION

- STARTER LIMITATIONS ARE AS FOLLOWS:
  - 1 MINUTE CONTINUOUS OPERATION
  - 3 MINUTES COOLING PERIOD
  - 1 MINUTE CONTINUOUS OPERATION
  - 10 MINUTES COOLING PERIOD.
  
- THE AUTOMATIC STARTING FEATURE SHALL BE USED WHENEVER POSSIBLE. IF THE AUTOMATIC START SYSTEM MALFUNCTIONS, THE MISSION NEED NOT BE ABORTED; HOWEVER, THE MALFUNCTION SHALL BE CORRECTED PRIOR TO THE NEXT FLIGHT. IF THE AUTOSTART CABLE IS NOT CONNECTED, THE PILOT HAS NO CONTROL OVER STARTING AIR IN THE EVENT OF STARTER OVERSPEED. REPEATED EXPOSURE TO OVERSPEED CONDITIONS (ABOVE 47% RPM) WILL CAUSE STARTER FATIGUE AND SUBSEQUENT DISINTEGRATION OF THE STARTER. THIS CAN RESULT IN SERIOUS DAMAGE TO THE AIRCRAFT.

## STARTING ENGINE

### CAUTION

DO NOT START ENGINE IF "ENG RPM LOCK UP PWR ON" INDICATOR LIGHT IS LIT. IF THIS LIGHT IS LIT, ABORT.

Basically, three types of starts may be made. These are automatic, manual and battery. The following chart shows the difference between the starts, and how existing equipment may be utilized to effect a start:

Type of Start	Automatic Start Control Cable Connected	Air Compressor Connected	External Electrical Power Connected
Automatic	Yes	Yes	Yes
Manual	No	Yes	Yes
Battery	Yes or No	Yes	No

### CAUTION

DURING ANY START, IT IS IMPERATIVE THAT PILOT AND GROUND CREW COORDINATE THEIR ACTIONS TO PREVENT OVERSPEED OF THE STARTER. PILOT SHALL SIGNAL THE GROUND CREW AT 40% ENGINE RPM TO DISCONNECT EXTERNAL AIR IMMEDIATELY. THIS WILL PREVENT EXCEEDING THE 47% OVERSPEED RPM.

### MANUAL START

1. Ground turbine compressor – Connected and on
2. Start switch – START and release



## DANGER AREAS

### WARNING

- THE AREA NEAR THE INTAKE DUCTS AND THE EXHAUST IS VERY DANGEROUS - KEEP CLEAR.
- DURING START AND RUNUP AVOID PLANE OF STARTER TURBINE AND ENGINE TURBINE WHEELS.
- DURING RUNUP, ENGINE NOISE CAN CAUSE PERMANENT DAMAGE TO EARS. WITHIN 100 FEET USE EAR PLUGS. WITHIN 50 FEET USE EAR PLUGS AND PROTECTIVE COVERS.
- IF BLAST DEFLECTOR IS NOT AVAILABLE, CLEAR AREA FOR 250 FEET.

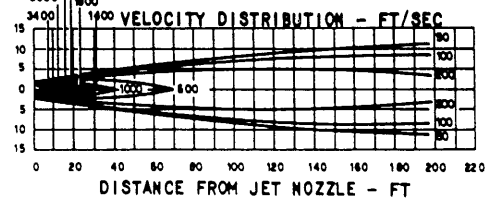
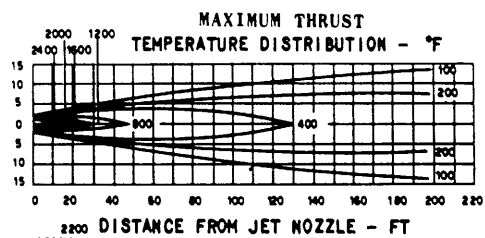
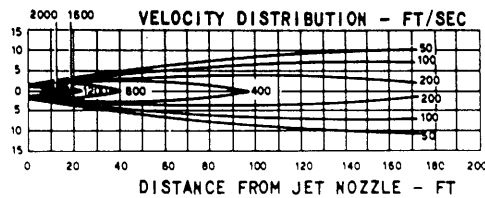
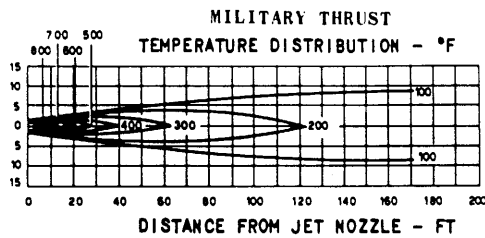
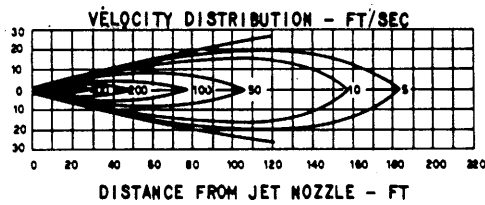
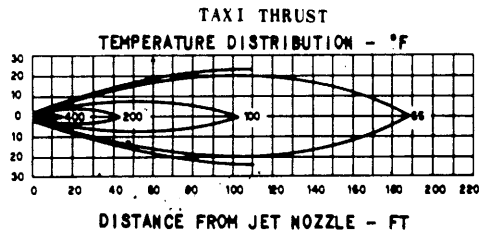
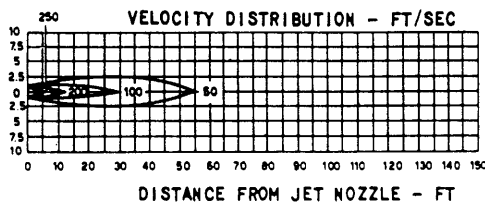
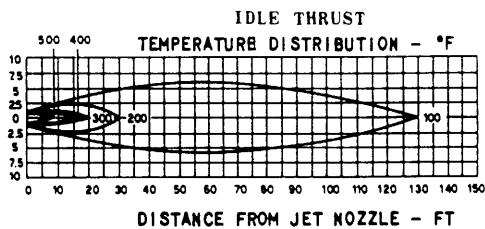
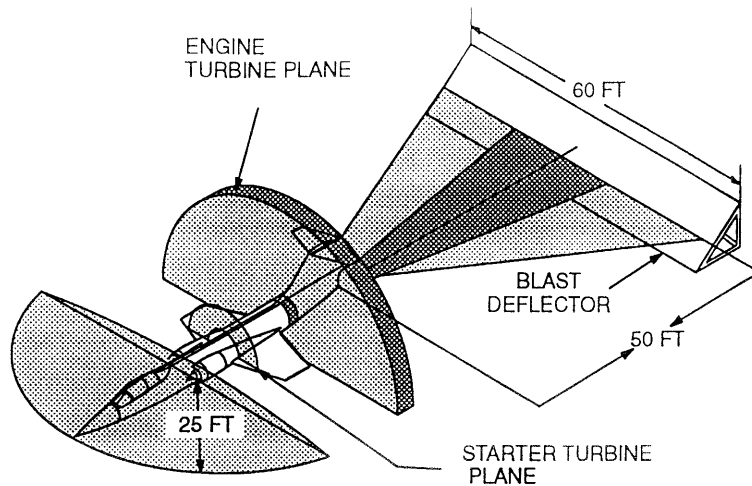

FA0260

Figure 2-3

**NOTE**

- Use No. 1 ignition system for engine starts on odd-numbered days and use No. 2 ignition system for engine starts on even-numbered days. The alternate usage of ignition systems provides a check on operation of both ignition systems. In case of malfunction of either No. 1 or No. 2 start system, flight should be aborted.
  - During cold weather operation, false starts may be encountered; especially on first start of the day. If this condition is experienced, activate both ignitions systems and let RPM build up to 12-14% before advancing throttle to idle range.
  - Maximum starting time should not exceed the values shown in Figure 2-4 from time start switch is actuated until engine reaches idle RPM.
3. Throttle – IDLE  
(At 10% RPM advance throttle to military and check sound and CANOPY UNSAFE warning light, then retard to IDLE, clock act)
  4. Fuel flow 425-800 pounds per hour – Check at 10-12% RPM

**CAUTION**

- IF FUEL FLOW EXCEEDS 800 POUNDS PER HOUR, A "HOT START" MAY RESULT. IF FUEL FLOW IS LESS THAN 425 POUNDS PER HOUR FOR GROUND STARTS, A "HUNG START" MAY RESULT. IF EITHER OF THESE CONDITIONS OCCUR, THE AIRCRAFT SHALL BE CLEARED BY MAINTENANCE PERSONNEL BEFORE FLIGHT.

- COMBUSTION NORMALLY OCCURS BETWEEN 16% AND 18% RPM AND WITHIN 5 TO 10 SECONDS AFTER FIRST FUEL FLOW INDICATION. IF COMBUSTION DOES NOT OCCUR BY 20% RPM OR 15 SECONDS AFTER FUEL FLOW INDICATION, OR THE ENGINE FAILS TO ACCELERATE TO NORMAL IDLE RPM, OR THE ENGINE SPONTANEOUSLY ACCELERATES WITH THROTTLE IN IDLE POSITION BEYOND THE NORMAL IDLE RPM (IDLE OVERSPEED CONDITION), OR EXHAUST GAS TEMPERATURE EXCEEDS STARTING LIMITS, PROCEED AS INDICATED IN "FALSE, HANGING, IDLE OVERSPEED OR HOT START" PROCEDURES IN THIS SECTION.

5. Check indication of EGT at 20% RPM or 15 seconds maximum whichever occurs first
6. Start switches – STOP-START at 40% RPM. At 40% RPM, simultaneously move the No. 1 and No. 2 start switches to the STOP-START position and signal ground crew to stop air flow

**CAUTION**

IF THE THROTTLE IS UNINTENTIONALLY RETARDED TO OFF, A FLAMEOUT WILL OCCUR IMMEDIATELY. DO NOT REOPEN THROTTLE, AS RELIGHT IS IMPOSSIBLE AND THE RESULTING FLOW OF UNBURNED FUEL INTO THE ENGINE CREATES A FIRE HAZARD.

7. External electrical power and ground turbine compressor – At idle RPM signal ground crew to disconnect
8. Engine instruments for proper indications – Check:
  - a. Nozzle position – 8 to 9

### ENGINE START

ENGINE ESTIMATED GROUND START TIME TO IDLE  
FROM START SWITCH ACTUATION

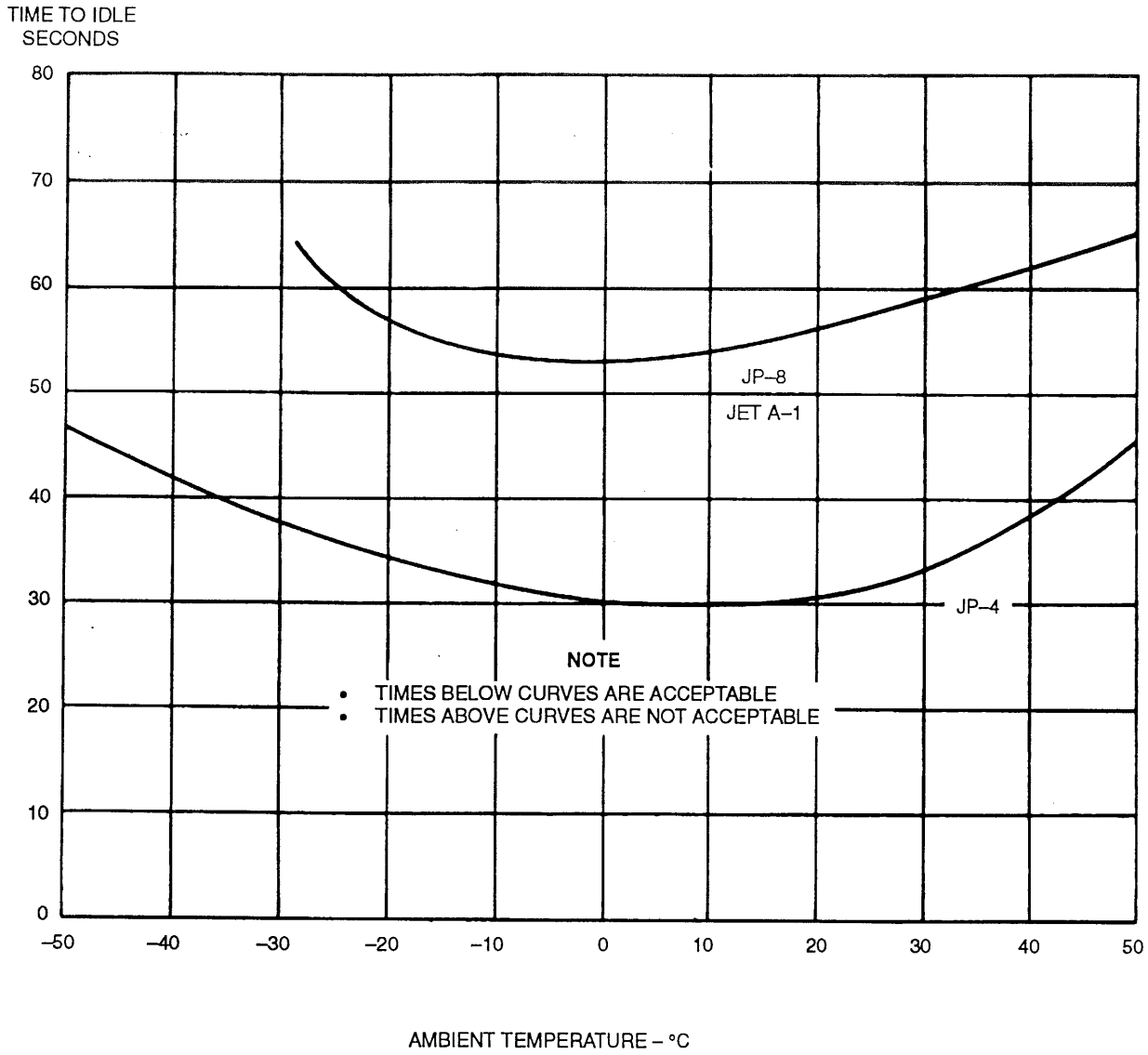

AMBIENT STARTING PERFORMANCE 100%  
RAM RECOVERY FACTOR SEA LEVEL STATIC

FA0338

Figure 2-4

- b. Tachometer — 67% ( $\pm 1$ ) RPM

**CAUTION**

IF THE ENGINE SPONTANEOUSLY ACCELERATES (WITH THROTTLE IN IDLE POSITION) BEYOND 67% ( $\pm 1$ ) RPM (IDLE OVERSPEED CONDITION) PROCEED IMMEDIATELY AS INDICATED IN "FALSE, HANGING, IDLE OVERSPEED OR HOT START" PROCEDURES IN THIS SECTION.

- c. Exhaust gas temperature — Normal (320° C to 420° C, not a limit for reference only)

**NOTE**

In extremely hot weather with ramp temperatures in excess of +38° C, EGT may increase as high as 500° C. In extremely cold weather with ramp temperatures as low as -40° C, EGT may be as low as 120° C.

- d. Oil pressure — 12 psi minimum

**NOTE**

The ENG OIL LEVEL LOW warning light may flicker at engine speeds below idle. This is acceptable as long as the warning light is not lit for longer than 3 seconds.

- e. Fuel flow — 700-1600 lb/hr

**AUTOMATIC START**

An automatic start is the same as a manual start, except that, for manual start, starting air should be applied prior to actuating the start switch, and because, for automatic start, the auto-start control ca-

ble is connected, automatic cockpit control is available to control starting air.

**BATTERY START**

A battery start is accomplished with only the air compressor unit connected and with or without the autostart control cable connected.

With the auto-start control cable connected, the starting procedure is the same as in an automatic start.

Without the auto-start control cable connected, the starting procedure is the same as in a manual start. Stop starting ignition switches after positive indication of combustion will not affect starting performance but will improve battery life by disengaging ignition circuit.

**CAUTION**

DURING A BATTERY START, THE ONLY ENGINE INSTRUMENTS AVAILABLE UNTIL THE GENERATORS REACH OPERATING SPEED WILL BE THE EXHAUST GAS TEMPERATURE GAGE AND THE TACHOMETER; THEREFORE, EXHAUST GAS TEMPERATURE SHALL BE MONITORED CLOSELY TO PREVENT A POSSIBLE OVERTEMPERATURE CONDITION. EXCESSIVE FUEL FLOW WILL ALWAYS BE INDICATED BY INSTANTANEOUS EGT RISE, WHILE INSUFFICIENT FUEL WILL RESULT IN NO ENGINE START.

**FALSE, HANGING, IDLE OVERSPEED OR HOT START PROCEDURES**

1. Throttle — OFF
2. Start switches — STOP-START. Simultaneously move start switches to STOP-START and signal ground crew to stop air flow
3. Check for absence of fuel in tailpipe

**WARNING**

WAIT UNTIL THE ENGINE STOPS ROTATING BEFORE CHECKING FOR FUEL IN THE TAILPIPE. IF FUEL IS PRESENT, MOTOR ENGINE.

**CAUTION**

STARTER LIMITATIONS ARE AS FOLLOWS:

1 MINUTE CONTINUOUS OPERATION

3 MINUTES COOLING PERIOD

1 MINUTE CONTINUOUS OPERATION

10 MINUTES COOLING PERIOD.

**NOTE**

Before attempting restart a check of engine RPM Lock-up system with ground crew shall be made.

4. Attempt restart after troubleshooting

**GROUND OPERATION****AFTER START CHECK**

1. Check the following warning lights extinguished: GENERATOR NO. 1 OUT, GENERATOR NO. 2 OUT, HYDRAULIC SYSTEM OUT, AUTO PITCH CONT OUT and ENGINE OIL LEVEL LOW

**NOTE**

The INERTIAL NAV FAULT warning light may be still lit.

2. FIXED FREQ RESET button – Press for at least 5 seconds, check FIXED FREQ OUT warning light extinguished

**NOTE**

Check IN function selector knob on NAV. If not perform steps 3., 4. and 5.

3. IN – ALN function, GC or STO mode (refer to "INS Alignment" procedures contained in this Section). Check INERTIAL NAV FAULT warning light extinguished
4. IN/CDU self test – Check "CDU OK" displayed

**NOTE**

Abort mission if "CDU FAIL" indication is displayed.

5. IN/CDU – Select and insert initial position, if GC selected
6. Sight switch – NORM
7. ENG/DUCT ANTI-ICE switch – Check, as required

**CAUTION**

ABORT FLIGHT IF "ENG/DUCT ANTI-ICE ON" WARNING LIGHT DOES NOT ILLUMINATE OR DOES NOT EXTINGUISH WITHIN 5 SECONDS AFTER ENGINE/DUCT ANTI-ICE SWITCH IS SET IN OFF POSITION. MAKE NOTATION OF MALFUNCTION IN AIRCRAFT LOG.

8. ENG RPM LOCKUP PWR ON indicator light – Check extinguished

**PILOT/CREW CHIEF CHECK**

With assistance of ground crew, proceed as follows:

1. (At least once per day) Fuel booster pumps –

Check FUEL BOOST PUMP FAIL warning light extinguished

2. Speed brakes – OUT, No. 2 pressure gage 2175-3300

**WARNING**

SHOW HANDS UNTIL CREW CHIEF GIVES CLOSURE SIGNAL.

3. Speed brakes – IN
4. Controls – Check for free movement. Pressure gages 2600 (ailerons), 2700 (stabilizer) - 3300
5. Autopilot – Check
6. Trim – Check and set to takeoff. Have a ground crew confirmation

**WARNING**

AN IMPROPERLY INSTALLED OR DEFECTIVE TRIM SWITCH IS SUBJECT TO STICKING IN ANY OR ALL ACTUATED POSITIONS, RESULTING IN APPLICATION OF EXTREME TRIM. IF SWITCH DOES NOT RETURN AUTOMATICALLY TO OFF POSITION, ABORT FLIGHT.

**CAUTION**

TRIM MECHANISM CAN BE DAMAGED BY OPERATING TRIM CONTROLS WITH CONTROL STICK IN A FULL THROW POSITION. MAKE ALL TRIM SYSTEM CHECKS WITH CONTROL STICK IN NEUTRAL POSITION.

**NOTE**

- The STABILIZER takeoff trim light will remain illuminated when the trim switch is released and the stabilizer is in the takeoff trim position. Have ground crew verify proper trim surface position.
  - Leading edge of horizontal stabilizer should be aligned with black T-index on vertical stabilizer.
7. STABILITY CONT switches – Lift cover, OFF then ON then guarded. Check pressure gages flickering and have a ground crew confirmation
  8. RAIN REMOVER switch – Check

**WARNING**

TO PREVENT AN IDLE OVER-SPEED CONDITION THE GROUND AIR SAFETY SWITCH SHALL NOT BE ACTUATED BY GROUND CREW IF "ENG RPM LOCKUP PWR ON" INDICATOR LIGHT IS LIT.

9. APC check – Wing flaps UP, stick released
  - a. Right vane 4.25 to 4.75 – Shaker
  - b. Right vane 5 – No kicker
  - c. Right vane 5 – Kicker
  - d. Overpower APC – Obtain an aft stick movement of 2 to 3 inch (if force is maintained stick will slowly move to full aft position at approximately ½ inch per second)
  - e. APC emergency disengage switch (paddle switch) – Press, check AUTO PITCH CONT OUT warning light lit
  - f. Aileron/ rudder limiters – Check limited travel
  - g. Left vane up – Shaker

- h. HEATERS PITOT-PITCH TEMP  
PROBE switch -- On for 5 seconds

**CAUTION**

DO NOT OPERATE FLAPS THROUGH MORE THAN ONE CYCLE AT IDLE RPM. IF REPEATED CYCLES ARE REQUIRED, RPM SHALL BE INCREASED TO 85% OR ABOVE TO PREVENT CONTROL FREEZE.

**NOTE**

It is recommended, when practical, to allow the flaps to remain in the selected position for a minimum of 30 seconds before reversing flaps travel.

10. Wing flaps -- LAND have ground crew check BLC airflow (check that flaps extension time does not exceed 20 seconds maximum)
11. Wing flaps -- TAKEOFF have ground crew verify flaps position (check that flaps retraction time does not exceed 12 seconds maximum), check absence of BLC airflow

**CAUTION**

IN ORDER TO PREVENT RADAR ANTENNA DAMAGE THE RADAR MODE SELECTOR SWITCH SHALL BE SET TO SBY.

12. RADAR -- SBY
13. Emergency nozzle closure system -- Check:
- a. Throttle -- IDLE
  - b. EMERGENCY NOZZLE CLOSURE handle -- Out

- c. Nozzle position indicator -- 3.0 to 4.0
- d. EMERGENCY NOZZLE CLOSURE handle -- In

**NOTE**

Movement of handle should be rapid (within one second).

- e. Nozzle position indicator -- Check for return to idle area

**NOTE**

If operational conditions permit, RPM may be increase to 85% prior to pushing EMERGENCY NOZZLE CLOSURE handle in.

If unable to push in EMERGENCY NOZZLE CLOSURE handle:

- a. EMERGENCY NOZZLE CLOSURE handle -- Out
  - b. Abort
14. TACAN -- As required
15. IFF -- As required
16. IN function selector knob -- NAV if requested alignment status reached (refer to "INS Alignment" procedures contained in this Section). If not, wait for requested ALN status. Check RDY NAV lamp extinguished. Check HSI OFF/NAV flags out of view
17. IN/TCN mode selector -- As required
18. Attitude indicator -- Check
- a. OFF warning flag out of view
  - b. Attitude sphere for proper attitude and freedom from oscillation
  - c. Attitude sphere for proper response to trim knob
19. IN/CDU -- Check format

20. Parking safety pins in the emergency canopy jettison initiator, canopy jettison initiator, main gun primary firing handle, removed with the aid of the crew chief

**CAUTION**

THE SAFETY PINS ARE ATTACHED TO TWO RED STREAMERS. AFTER REMOVAL CHECK THAT THE SEVEN PINS ARE ATTACHED TO THE RED STREAMERS AND HAVE NOT BEEN LEFT, BY ERROR, IN THEIR LOCATION.

21. Swivel guard of secondary firing handle – Down
22. Engine auxiliary air inlet doors operation – Check

**NOTE**

After the weight of the aircraft is off the landing gear and the auxiliary air doors have closed automatically, they cannot be opened in flight.

- a. ENGINE AIR INLET DOORS switch – Lift cover, OPEN, INLET DOORS OPEN light lit
- b. ENGINE AIR INLET DOORS switch – CLOSE, INLET DOORS OPEN light extinguished and verified by ground crew
- c. ENGINE AIR INLET DOORS switch – OPEN, then AUTO-CLOSE, guarded. Ground crew verifies that doors are open
23. External stores safety pins – Removed and shown by ground crew

**WARNING**

EXTERNAL STORES SAFETY PINS HAVE TO BE REMOVED IN A CLEAR AREA, WHERE ACCIDENTALLY DROPPED STORES CANNOT ENDANGER GROUND CREW-MEMBERS AND/OR MATERIAL. IT MAY BE ADVISABLE TO TAXI CLEAR OF CONGESTED AREAS PRIOR TO REMOVING PINS.

24. UHF HAVE QUICK pre-flight operation – Perform (refer to "UHF HAVE QUICK System Operation" contained in Section I)

**BEFORE TAXIING**

1. Canopy – Locked or full open

During all pre-takeoff operations the canopy should be full open, or closed and locked.

When locking the canopy, visually check that the three locking hooks are over the three canopy brackets.

**CAUTION**

- TO PREVENT DAMAGE TO CANOPY, A TAXI SPEED OF 50 KNOTS SHALL NOT BE EXCEEDED WITH THE CANOPY IN ANY POSITION OTHER THAN FULLY CLOSED AND LOCKED.
- THE CANOPY MAY BE DAMAGED DURING LOWERING OPERATIONS IF A FIRM GRIP IS NOT MAINTAINED ON THE CANOPY LIFT HANDLE. AS THE CANOPY PASSES OVER TOP DEAD CENTER, THE WEIGHT OF THE CANOPY AND HIGH OR GUSTY WINDS MAY CAUSE THE CANOPY TO SLAM SHUT.



- ANTI-SKID SYSTEM IS INOPERATIVE AT SPEEDS BELOW 10 KNOTS. MAXIMUM BRAKING AT LOW SPEEDS MAY CAUSE WHEEL LOCKING AND SKIDDING.

2. IN – Check NAV
3. Attitude indicator – Set – 5°

**WARNING**

DO NOT PASS UNDER AIRCRAFT WHEN RADAR ALTIMETER IS OPERATING.

4. Radar altimeter – On, set bug 50 ft check LOW warning lights lit. Check  $100 \pm 15$  ft and LOW warning lights extinguished. Set as required
5. Wheel chocks – Removed

**TAXIING**

(Refer to Figure 2-5 for minimum turning radius and ground clearances).

1. Nosewheel steering – Engage

The nosewheel and rudder pedals shall be correctly aligned before engaging nosewheel steering.

**CAUTION**

- DURING TAXIING, THE SPEED BRAKES SHOULD NOT BE OPERATED WHILE NOSEWHEEL STEERING OR POWER/ANTISKID BRAKES ARE REQUIRED.

- UPON COMPLETION OF THE MOVEMENT OF THE SPEED BRAKES, NOSEWHEEL STEERING BECOMES AVAILABLE; HOWEVER, IT MAY BE NECESSARY TO MOVE THE RUDDER PEDALS TO REENGAGE THE STEERING. THE BRAKES WILL AUTOMATICALLY REVERT TO POWER-ANTISKID.
- TO PREVENT STRUCTURAL DAMAGE, ADDITIONAL DIFFERENTIAL BRAKING SHOULD NOT BE APPLIED IN TURNS WITH NOSEWHEEL STEERING ENGAGE.

2. Brakes – Check

Check brake action with ANTI-SKID switch set to OFF.

**NOTE**

With the ANTI-SKID switch set to OFF, power brakes will not be available and the standby brakes may be checked.

3. ANTI-SKID switch – ON

**NOTE**

Leave ANTI-SKID switch to ON throughout flight.

4. Flight instrument and navigation equipment – Check
  - a. Check HSI for proper indication and operation while taxiing
  - b. Attitude indicators – Check – 5°
  - c. Turn-and-slip indicator – Operating (check for turn needle deflection in the direction of turn while taxiing and ball free in the race)
  - d. Vertical velocity indicator – Check for zero setting

### MINIMUM TURNING RADIUS AND GROUND CLEARANCE

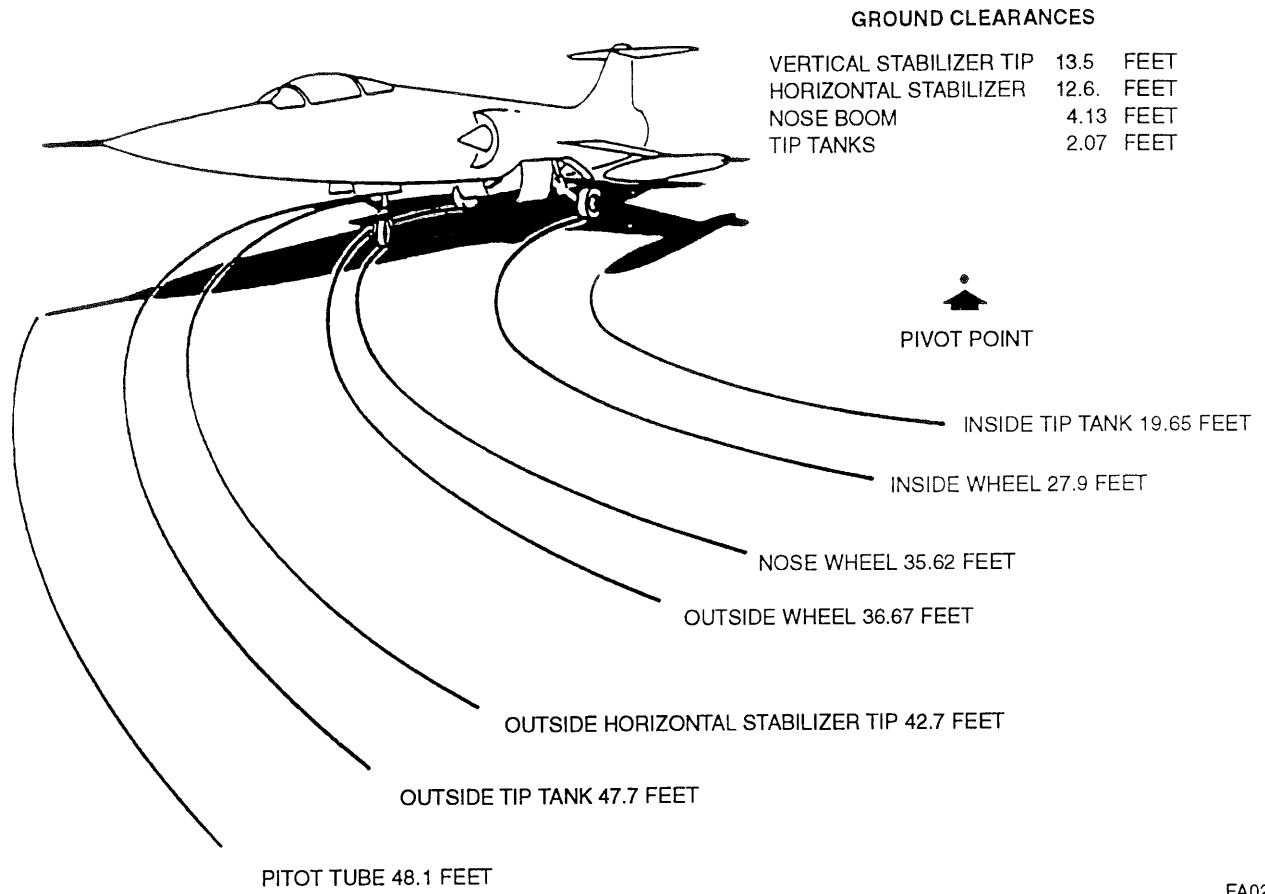

FA0270

Figure 2-5

- e. Standby magnetic compass – Extract check heading indication and that the card swings freely and the bowl is full of fluid. Retract
- f. IN/CDU – Check for proper indications on navigation format (refer to "IN/CDU Operation" contained in this Section)
- 9. Ejection seat safety pin of primary firing handle – Out
- 10. Swivel guard of secondary firing – Check down
- 11. CANOPY DEFOGGER – Check for operation, operate if required
- 12. STABILIZER takeoff trim light – Check

**NOTE**

To preclude oil vapors from entering the cockpit during prolonged operation at idle RPM, every 10 minutes advance throttle to 80% RPM for 1 minute.

**NOTE**

To assure full stabilizer travel availability, takeoff trim is required. If autopilot has been engaged after the "Ground Operation-Trim Check", the auto trim may have driven the stabilizer away from the takeoff trim setting; therefore, it should be rechecked.

**BEFORE TAKEOFF**

Perform the following checks:

- 1. Tanks (external) – Feeding
- 2. Wing flaps – TAKEOFF, detent
- 3. Inertial reel – Locked
- 4. Seat combined harness and leg straps for tightness – Check
- 5. Speed brakes – Check IN
- 6. Canopy – Locked, CANOPY UNSAFE warning lights extinguished. Check locks visually

**WARNING**

**EVEN THROUGH THE CANOPY UNSAFE WARNING LIGHTS ARE OUT, OBSERVE THAT HOOKS ARE PROPERLY ENGAGED FOR POSITIVE INDICATION THAT CANOPY IS LOCKED.**

- 7. Oxygen – As required, check quantity, pressure, blinker working, and connections
- 8. TACAN, IFF and RADAR – As required

- 13. Pitot heat and engine anti-ice – As required

**ENGINE CHECK**

Check CIT prior to takeoff and consult Figure 1-2 for engine RPM and exhaust gas temperature variations versus CIT. (Runway temperature may be used in lieu of CIT during static operation). Refer to Figure 5-1 for engine limitations. Align aircraft with runway centerline and check that nosewheel is centered and nosewheel steering is engaged to prevent the aircraft from pivoting to either side in case of a brake failure or tire slippage.

**NOTE**

With the engine operating in the 100% RPM region, tire traction may not be sufficient to hold the aircraft.

- 1. Throttle – Advance rapidly to military and retard to 90% RPM when engine speed reaches 93% RPM – Check for compressor stall
- 2. Throttle – 90% RPM
- 3. Fuel flow – Check (refer to Figure 2-6)
- 4. Throttle – Rapidly to IDLE position – Check for compressor stall, throttle linkage and minimum fuel flow of approximately 450 lb/h (440 ± 15 lb/h)

## 90% RPM FUEL FLOW

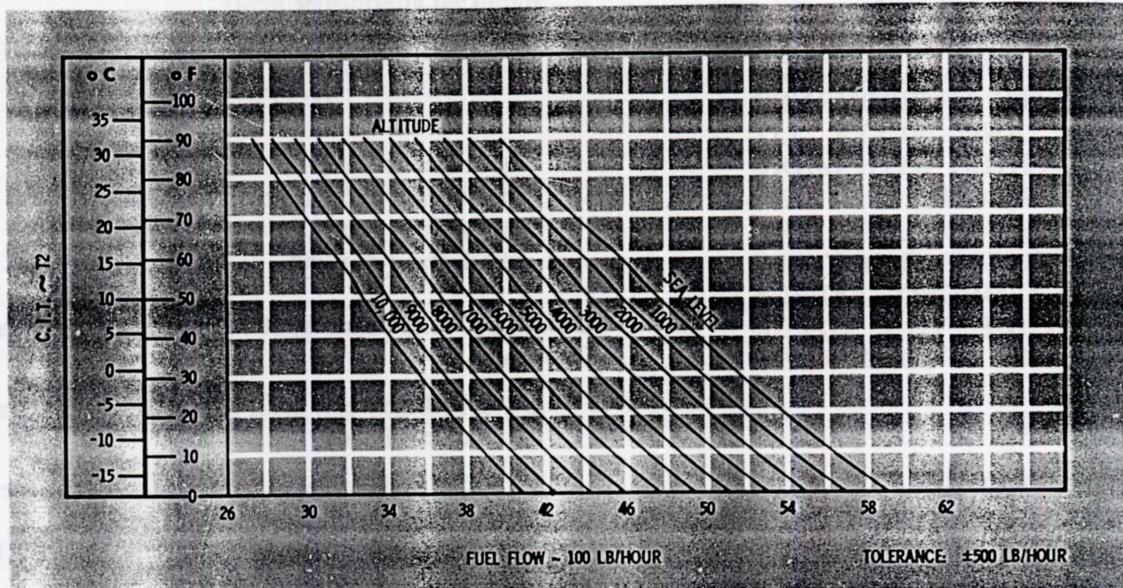
GROUND OPERATION  
ENGINE CHECK AT 90% RPM

## NOTE

A FLUCTUATION OF  $\pm 500$  LB PER HOUR ABOUT THE MEAN VALUES IS PERMISSIBLE PROVIDED NO ASSOCIATED INCREASE OR DECREASE IN EGT, NOZZLE POSITION, RPM OR ENGINE SURGE IS EVIDENT.

Figure 2-6

5. ENGINE AIR INLET DOORS switch – AUTO CLOSE, guarded. INLET DOORS OPEN light lit
  - e. Oil pressure – Check
6. Advance throttle rapidly to military – Check engine acceleration and instruments:
  - a. Engine acceleration – 10 seconds maximum
  - b. RPM – Normal
  - c. EGT – Normal
  - d. Nozzle position 1.5 to 4

**CAUTION**

AFTER OIL PRESSURE HAS STABILIZED, CHECK OIL PRESSURE CORRECTED TO 100% RPM. IF CORRECTED PRESSURE IS NOT PLACARD PSI  $\pm 5$  PSI, ABORT THE MISSION.

## TAKEOFF

### WARNING

TAKEOFF SHALL BE PERFORMED WITH AFTERBURNER PROPERLY AND FULLY LIT AND COMPLETED WITH MAXIMUM THRUST ONLY. IF NECESSARY WHEN IN AFTERBURNER RANGE THE THROTTLE MAY BE REDUCED SAFELY ONLY WITHIN THE UPPER HALF OF THE AFTERBURNER RANGE.

### NOTE

- Engine bench tests demonstrated that, in case of nozzle failure to fully open, the afterburner does not light-off if the throttle is set in the upper half of the afterburner range (between 95° of throttle angle and maximum afterburner position).
- Being 95° throttle position not directly displayed to the pilot, the following readings are an indication that the throttle is in the upper half of the afterburner range and that the engine behaviour is normal:
  - EGT between 670° C - 688° C (660° C - 678° C for engine PRE AER.2J-J79GE19-148)
- and
  - Nozzle position between 7.5 and 9.5
- The procedure set forth below will produce the results shown in the Appendix - Performance Data "Takeoff" charts.

### NORMAL TAKEOFF

(Refer to Figure 2-7 for typical takeoff)

1. Nosewheel steering – Engage

2. Throttle – Military
3. Engine instruments – Check
4. Brakes – Release
5. Throttle – Minimum afterburner (ensure a stabilized afterburner light)

### NOTE

It is recommended that a stabilized afterburner light be obtained prior to advancing throttle to maximum afterburner position.

A stabilized afterburner light will be indicated by the following:

- a. RPM may roll back then return to normal and stabilize
  - b. EGT will increase to above 700° C then decrease and stabilize between 670° C - 688° C (660° C - 678° C for engines PRE AER.2J-J79GE19-148)
6. Throttle – Maximum thrust
  7. Engine instruments – Check

### CAUTION

WITH THROTTLE AT MAXIMUM THRUST, NOZZLE POSITION WILL STABILIZE BETWEEN 7.5 AND 9.5. WITH THROTTLE REMAINING AT MAXIMUM THRUST, AFTERBURNER BLOWOUT WILL BE INDICATED BY A DEFINITE LOSS OF THRUST AND A NOZZLE POSITION READING OF LESS THAN 7.5, ACCOMPANIED BY AN EGT BELOW 600° C. IF BLOWOUT OCCURS, THRUST WILL BE CONSIDERABLY BELOW MILITARY AND TAKEOFF SHOULD BE EITHER ABORTED OR CONTINUED AT MILITARY THRUST, DEPENDING ON SPEED AND REMAINING RUNWAY. MILITARY THRUST TAKEOFF WITH EXTERNAL STORES WILL RESULT IN ABNORMALLY LONG TAKEOFF RUN.

## TYPICAL TAKEOFF

**NOTE**

- REFER TO APPENDIX FOR TAKEOFF DISTANCE AND SPEED FOR OTHER GROSS WEIGHTS.

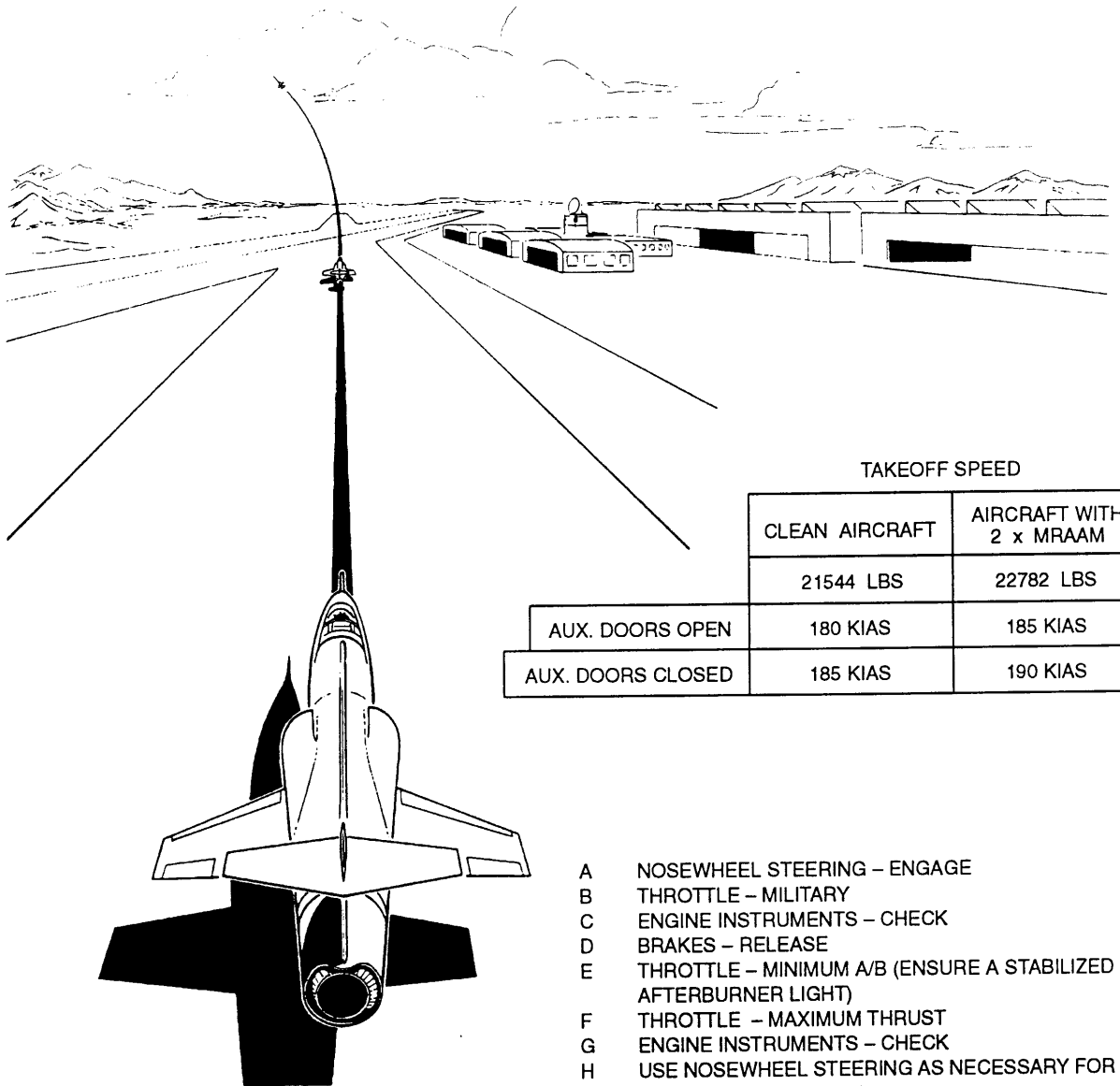

TAKEOFF SPEED

	CLEAN AIRCRAFT	AIRCRAFT WITH 2 x MRAAM
	21544 LBS	22782 LBS
AUX. DOORS OPEN	180 KIAS	185 KIAS
AUX. DOORS CLOSED	185 KIAS	190 KIAS

- A NOSEWHEEL STEERING – ENGAGE
- B THROTTLE – MILITARY
- C ENGINE INSTRUMENTS – CHECK
- D BRAKES – RELEASE
- E THROTTLE – MINIMUM A/B (ENSURE A STABILIZED AFTERBURNER LIGHT)
- F THROTTLE – MAXIMUM THRUST
- G ENGINE INSTRUMENTS – CHECK
- H USE NOSEWHEEL STEERING AS NECESSARY FOR DIRECTIONAL CONTROL
- I ASSUME TAKEOFF ATTITUDE

Figure 2-7

FA0271

8. Use nosewheel steering as necessary for directional control

### NOTE

The rudder becomes effective at approximately 70 KIAS.

### CAUTION

- NOSEWHEEL STEERING SHOULD BE DISENGAGED PRIOR TO NOSEWHEEL LIFT-OFF TO ENSURE PROPER STEERING CLUTCH RELEASE.
  - WITH STEERING SYSTEM ENGAGED, SHIMMY DAMPING IS LESSENED. IF NOSEWHEEL SHIMMY IS ENCOUNTERED, RELEASE NOSEWHEEL STEERING.
9. Assume takeoff attitude (approximately 5° nose up)

### WARNING

IF AFT STICK INPUT IS MADE AT AN AIRSPEED WHICH IS TOO LOW OR IF FULL AFT STICK IS USED PRIOR TO NOSEWHEEL LIFT OFF, THEN THE NOSE MAY FAIL TO ROTATE. IF THIS OCCURS, ABORT.

### NOTE

- The takeoff "optimum stick technique" is to anticipate aircraft acceleration to rotate the nose so that takeoff attitude and speed are reached smoothly and simultaneously. During takeoff roll, hold the stick in takeoff trimmed neutral position to minimize the aerodynamic drag. At 20 knots below computed takeoff speed, smoothly bring the stick back a little over 3 inches (less than 1/2 stick travel aft) to obtain the optimum stabilizer deflection. Once rotation and nosewheel lift-off occur, further aft stick is unnecessary. Rotation and nosewheel lift-off will normally occur 10 to 20 knots below the computed takeoff speed. (Refer to Appendix - Performance Data for computed takeoff speed).
- As the stick is pulled smoothly back toward the optimum deselection, the moving stabilizer will actually provide more pitching moment than a static deflection held at a given setting. This stick movement figure is a target value to use as a guide. The actual technique is to feel when the tail lift moment is at maximum effect. (Refer to Section VI, Takeoff Characteristics).
- A lowered or binding nose gear strut will affect and increase the speed at which the nose will begin to rotate, however, it will not affect the speed at which the nosewheel leaves the runway.

### MINIMUM RUN TAKEOFF

The procedure is the same as for normal takeoff with afterburner. Maximum performance takeoff speed is 5 knots less than for normal performance takeoff.

**OBSTACLE CLEARANCE TAKEOFF**

The procedure to takeoff and clear an obstacle is the same as for normal takeoff with afterburner; refer to the Appendix - Performance Data for distances to clear a 50-foot obstacle.

**CROSSWIND TAKEOFF**

Under gusty crosswind conditions, increase nosewheel lift-off and takeoff speed 5 knots for each 10 knots above steady wind velocity.

Delay gear retraction to 225 KIAS in order to provide unrestricted aileron travel and better lateral control.

Nosewheel steering may be required in excess of 100 knots if strong crosswind is present.

**TAKEOFF WITH ASYMMETRIC LOADS**

When performing a takeoff with asymmetric loading, increase takeoff speeds 10-15 knots over those shown in Appendix - Performance Data in Figure A2-2 in order to provide better lateral control at lift off.

**WARNING**

REFER TO SECTION V "OPERATING LIMITATIONS" FOR FORMATION TAKEOFF LIMITATION.

**AFTER TAKEOFF**

## 1. LDG GEAR – UP

When aircraft is definitely airborne, retract gear.

**WARNING**

THE LANDING GEAR MAY BE RETRACTED WHEN THE WEIGHT OF THE AIRCRAFT IS OFF THE NOSE GEAR BUT STILL ON THE MAIN GEAR. THEREFORE, BE SURE THE AIRCRAFT IS DEFINITELY AIRBORNE BEFORE MOVING GEAR HANDLE.

**CAUTION**

WHEN MAKING AFTERBURNER TAKEOFFS, THE LANDING GEAR SHOULD BE RETRACTED AS SOON AS PRACTICABLE TO PREVENT EXCEEDING THE LANDING GEAR TRANSIENT LIMIT AIRSPEED. THE LANDING GEAR AND DOORS SHOULD BE COMPLETELY UP AND LOCKED BEFORE REACHING 260 KIAS; OTHERWISE EXCESSIVE AIRLOADS MAY DAMAGE THE MECHANISM OR PREVENT GEAR RETRACTION.

2. Landing gear warning lights out – Check
3. Wing flaps – UP at 300 KIAS minimum. Check indicator

**NOTE**

Expect an easily controllable nose-up tendency as the flaps retract.

4. Engine auxiliary air inlet doors closed – Check INLET DOORS OPEN light extinguished at 300 KIAS

At safe speed and altitude:

5. Throttle – As desired (monitor nozzle position indicator)



**WARNING**

THE AFTERBURNER SHUT DOWN SHALL BE CARRIED OUT ONLY AFTER CHECKING (WITHIN THE UPPER HALF OF THE AFTERBURNER RANGE) THAT THE NOZZLE HAS NOT REACHED THE FULLY OPEN POSITION. SHOULD THE NOZZLE REMAIN OPEN, APPLY THE NOZZLE CONTROL SYSTEM FAILURE EMERGENCY PROCEDURE.

6. Engine instruments – Check
7. Automatic pilot – As desired
8. Airspeed – Best climb

**NOTE**

Refer to the Appendix - Performance Data for best climb speed.

Take care following takeoff to anticipate the high forward acceleration. As climb speed is approached assume the proper climb attitude to ensure maximum performance.

9. Fuel quantity – Check
10. Oxygen diluter lever – NORMAL
11. Altimeter – Set

**NOTE**

Monitor external fuel depletion to assure symmetric tip tank fuel depletion. If an asymmetric fuel condition in excess of 750 pounds is indicated, reduce speed to Mach 0.9 avoiding load factors in excess of 2.0 G's and maintain altitude less than 35000 feet until the asymmetric condition no longer exists. If the asymmetric condition persists, refer to Section VI "Flight Characteristics" for flight characteristics under low airspeed conditions.

**CLIMB**

The climb attitude with maximum thrust is extremely steep and until experience is gained, some difficulty in holding the climb schedule will be experienced.

Refer to the Appendix - Performance Data climb charts for recommended speeds to be used during climb, and for rates of climb and fuel consumption.

**CAUTION**

THE ROLL STABILITY AUGMENTER SHOULD BE TURNED OFF BEFORE REACHING 575 KNOTS IAS WITH UNPINNED ROLLERON WING-TIP MISSILES INSTALLED. WITH THIS CONFIGURATION AND THE ROLL STABILITY AUGMENTER OPERATING, WING TORSIONAL OSCILLATIONS SUFFICIENT TO CAUSE STRUCTURAL DAMAGE MAY BE EXPERIENCED AT HIGH INDICATED AIRSPEEDS. MISSILE LAUNCHERS ARE NOT CONSIDERED AS TIP STORES; THEREFORE, ROLL STABILITY AUGMENTER SHOULD BE LEFT ON WHEN CARRYING BARE LAUNCHERS.

**CRUISE****NOTE**

Refer to the Appendix - Performance Data for cruise operating data.

The windshield and canopy defogging system should be operated throughout the flight at the highest flow possible (consistent with pilot comfort) so that a sufficiently high temperature is maintained to preheat the canopy and windshield areas.

It is necessary to preheat because there is insufficient time during rapid descents to heat these areas to temperatures which prevent the formation of frost or fog.

**CAUTION**

IF AN AFTERBURNER LIGHT IS NOT OBTAINED WITHIN APPROXIMATELY THREE SECONDS AT SEA LEVEL OR APPROXIMATELY FIVE SECONDS AT ALTITUDE AFTER THE THROTTLE IS MOVED INTO AFTERBURNER RANGE, MOVE THE THROTTLE INBOARD TO THE MILITARY THRUST POSITION. AFTER 3-5 SECONDS, RETURN TO THE AFTERBURNER RANGE TO RECYCLE THE SYSTEM. AFTER LIGHTOFF IS OBTAINED, MOVE THE THROTTLE FORWARD WITH A POSITIVE MOTION IF MAXIMUM THRUST IS DESIRED.

**NOTE**

The APC and stick shaker may be checked in flight as follows: while applying a slow stick deflection, note APC indicator reading increase in relation to angle of attack and increasing G force indicating satisfactory system operation from sensing of vane angle. Apply a small rapid stick deflection and note APC indicator reading increase rapidly in relation to the increasing pitch rate, indicating a satisfactory signal from the pitch rate gyro. The stick deflection should be great enough to induce a pitch rate sufficient to actuate the stick shaker.

**FLIGHT CHARACTERISTICS****NOTE**

Refer to Section VI for information regarding flight characteristics.

**NOTE**

- The fuel flow indicator does not indicate afterburner fuel flow.
- As soon as afterburner thrust is no longer needed, shut down the afterburner by moving throttle aft and inboard to the military thrust position. Monitor the nozzle position indicator to ensure that the nozzle is not fully open and closes normally. During afterburner operation with nozzle failed to open position, reducing the throttle below full afterburner will cause afterburner blowout. Throttle should remain in maximum afterburner until landing is assured.

**AFTERBURNER OPERATION**

Before moving the throttle into the afterburner range, check the nozzle position indicator for normal indication in the military thrust range. Move the throttle smoothly outboard and forward into the afterburner range.

Check exhaust gas temperature, RPM and nozzle position.

**DESCENT**

Refer to the Appendix - Performance Data for recommended descent technique and accomplish the following steps:

1. Engine/duct anti-ice, defogger, and pitot heat  
– As required
2. Altimeter – Set

3. Fuel quantity – Check (determine final approach speed)
4. Oxygen diluter lever – As required

**CAUTION**

IN ORDER TO PREVENT RADAR ANTENNA DAMAGE THE RADAR MODE SELECTOR SWITCH SHALL BE SET TO SBY.

**BEFORE LANDING**

Following the procedures set forth below will produce the results shown in the Appendix - Performance Data landing charts.

**WARNING**

THE AIRSPEEDS LISTED HEREIN ARE BASED ON A GROSS WEIGHT OF 16000 POUNDS. INCREASE APPROACH AND LANDING SPEEDS 5 KNOTS FOR EACH 1000 POUNDS GROSS WEIGHT OR PORTIONS THEREOF ABOVE 16000 POUNDS. REFER TO LANDING SPEED SCHEDULE IN THE APPENDIX FOR OTHER CONFIGURATIONS AND GROSS WEIGHT.

**CAUTION**

THE AVAILABLE STICK RATE IS REDUCED WITH THE AUTOMATIC PILOT ENGAGED AND DIFFICULTY COULD BE EXPERIENCED DURING THE LANDING FLARE AND TOUCHDOWN IN GUSTY WIND CONDITIONS WHERE LARGE, RAPID STICK DISPLACEMENTS MAY BE REQUIRED.

1. AUTOPILOT ENGAGE switch – OFF

2. RADAR – SBY
3. Armament switches – OFF/SAFE

**Initial**

1. Wing flaps – TAKEOFF, check indicator
2. Airspeed – 325 KIAS
3. Altitude – 2000 feet (AGL) minimum

**Downwind**

1. LDG GEAR – DOWN when speed has decreased to less than 260 KIAS, check indicators
2. Landing lights – On

**NOTE**

If the INTERIOR INSTRUMENT lights rheostat is inadvertently moved out of the OFF position, the warning lights and landing gear position lights may not be visible during daylight operation.

**WARNING**

THE CONFIGURATION CHANGE SHOULD BE PERFORMED NOT LOWER THAN 2000 FT AGL IN ORDER TO ALLOW ENOUGH ALTITUDE FOR AIRCRAFT RECOVERY SHOULD A BLC MALFUNCTION OR ASYMMETRIC FLAPS OCCUR.

3. Wing flaps — LAND when speed is below 240 KIAS and above 210 KIAS

Check indicators. Maintain level flight and keep hand on lever until flaps and BLC are known to be functioning normally.

### NOTE

A mild roll transient may be experienced on some aircraft as flaps move from TAKEOFF to LAND positions. The cause is attributed to asymmetric differences in boundary layer control systems and will vary in intensity and direction with individual aircraft. Maximum lateral stick displacement should not exceed one inch.

### Base Leg Turn

1. Landing gear down and locked — Check
2. Wing flaps selected position — Check
3. ANTI-SKID and AIL AND RUD UNLIMITED lights — Check
4. Airspeed — 200 KIAS minimum or APC meter 2.5 maximum whichever comes first

### Final

When on final approach, accomplish following:

1. Minimum recommended distance from end of runway — 6000 feet
2. Recommended airspeed — 175 KIAS plus correction
3. Landing gear — Recheck: three green lights
4. Engine speed — Not less than 83% RPM

### WARNING

- UNDER CONDITIONS OF HEAVY GROSS WEIGHT OR HIGH AMBIENT TEMPERATURE (AND WITH FLAPS IN THE LAND POSITION), SUFFICIENT POWER MAY NOT BE AVAILABLE AT MILITARY TO MAINTAIN PROPER RATE OF DESCENT AND AIRSPEED DURING TURN FROM DOWNWIND TO FINAL. A HIGHER THAN NORMAL AIRSPEED IS NECESSARY TO MAINTAIN DESIRED RATE OF DESCENT. REFER TO HEAVY WEIGHT LANDING PROCEDURE.
- THE RECOMMENDED FINAL APPROACH SPEED DOES NOT INCLUDE SUFFICIENT MARGIN TO ALLOW FOR AIR TURBULENCE. UNDER GUSTY WIND CONDITIONS, INCREASE APPROACH SPEED 5 KIAS FOR EACH 10 KNOTS ABOVE STEADY WIND VELOCITY.

## LANDING

### BOUNDARY LAYER CONTROL

The installation of boundary layer control (BLC) to effect lower landing approach and touchdown speeds has resulted in some new flight characteristics and changes in required piloting technique. The pilot should remember at all times when using LAND flaps that the additional lift afforded by BLC is dependent on engine airflow. This lift, therefore, varies with airspeed, altitude, and engine RPM. The greatest effect is realized at low airspeed, low altitude, and engine speeds above 80% RPM although some effectiveness is still retained at lower power settings.

The significance of this is that, under the landing condition especially as touchdown is approached, proper use of the throttle is mandatory to accomplish a smooth reduction in engine RPM so that a smooth reduction in the effects of BLC on lift will result.

## LANDING TECHNIQUE

The recommended landing pattern results in a flat powered approach similar to that used for ILS and PAR approaches, carrying a minimum of 83% RPM until touchdown is approached.

A straight-in approach of 6000 feet, minimum, is recommended to simplify the technique and judgment involved in the landing flare. The thrust should be controlled to hold airspeed and sink rate to the recommended values on the final approach (use of the recommended speeds provides ample speed margin from the back side of the power-required curve).

Airspeed response to throttle adjustments is extremely positive and rapid, aiding considerably in establishing a good approach. The high drag of the aircraft in the landing configuration makes it unnecessary to use speed brakes in the landing pattern (especially on the approach). Speed brakes may be used during roundout to aid in controlling touchdown point.

The approach should be maintained to establish a flareout just short of the runway. As the touchdown point is approached, flareout rotation should be started, followed by a smooth reduction of thrust to 81%-82% RPM. An abrupt thrust reduction results in abrupt rolloff tendency and a rapid increase in rate of sink.

These characteristics make it necessary to approach touchdown carrying power, and to reduce power to idle as main gear contacts the runway. The smooth thrust reduction reduces the rolloff tendency, thereby making it easy to maintain wings level throughout the flare as well as to provide positive control of rate of sink. It may seem unnatural to touch down with more than idle thrust; however, with the drag of the landing flaps it is possible to slow down rapidly enough so that idle thrust need not be used. Adhere to recommended approach and touchdown speeds. If the aircraft is held off to lower speeds lateral stability and control will deteriorate and wing drop tendencies will be experienced. In addition, the high pitch angle required for flight at these low airspeeds will be excessive and may result in tail dragging.

## NORMAL LANDING

(Refer to Figure 2-8 for a typical landing pattern)

1. Touch down at not less than 150 KIAS (normal landing speed range 155 to 160 KIAS)
2. Throttle – Retard to IDLE after touchdown
3. Nosewheel – Lower
4. Nosewheel steering – Engage

### NOTE

If nosewheel shimmy is encountered, release nosewheel steering and hold weight off nosewheel if possible. Do not deploy drag chute until nosewheel is back on the ground.

5. Drag chute – Deploy

To obtain maximum aerodynamic braking, deploy drag chute as soon as nosewheel is on the ground.

### CAUTION

- BECAUSE THE LOCATION OF THE DRAG CHUTE WILL CAUSE A NOSE-DOWN PITCHING MOMENT WHEN DEPLOYED, DO NOT DEPLOY THE CHUTE UNTIL ALL THREE GEARS ARE ON THE GROUND.
- DURING THE LANDING GROUND ROLL, DO NOT OPERATE THE SPEED BRAKES WHILE NOSEWHEEL STEERING OR POWER/ANTISKID BRAKES ARE REQUIRED.

## CROSSWIND LANDING

Wind drift may be compensated for by crabbing or the wing down method or a combination of both for approach and landing. In strong crosswinds the crab method or a combination of the two methods is more suitable.

A maximum crosswind component of 25 knots is permissible on a dry runway. Landing in excess to this component is not recommended as alignment on the runway is difficult and because such components are greater than those recommended for drag chute deployment. LAND flaps are used with the maximum crosswind component.

The nose should be lowered immediately after touch down and nosewheel steering should be engaged before deploying the drag chute.

For dry runway conditions the drag chute may be deployed in 90° crosswinds of 25 knots or 45° crosswinds of 35 knots provided nosewheel steering is engaged. The aircraft tends to weather-vane but directional control can be maintained by nosewheel steering.

After landing, some difficulty may be encountered in releasing the drag chute; however, turning the aircraft directly into the wind should solve this difficulty. When landing on wet or icy runways the maximum permissible crosswind component should be adjusted accordingly.

A weather-vaning effect of the drag chute may be sufficient to cause a skid, therefore, the pilot should be prepared to jettison the drag chute. The fact that slick runway conditions reduce braking capability make it desirable to obtain the initial braking effect of the drag chute even though it may be necessary to jettison it later to retain directional control.

Under extreme weather conditions when low visibility prevents the pilot from seeing that directional control is being maintained, the drag chute should be jettisoned.

#### NOTE

- Increase approach and touchdown speed 5 knots for each 10 knots of effective crosswind velocity, if landing with LAND flaps.
- Do not actuate the nosewheel steering button unless the nosewheel and rudder pedals are aligned. If the pedals are deflected when the nosewheel steering button is actuated, clutch friction within the steering system may cause an undesired turn as the pedals are moved to align with the nosewheel.

#### HEAVYWEIGHT LANDING

When a heavyweight landing shall be made, adjust the approach and touchdown airspeeds for gross weight. Refer to the landing charts in the Appendix - Performance Data for the airspeed at any landing gross weight. Fly a wider than normal pattern or make a straight-in approach. This is especially important on approaches under high temperature or high altitude landing conditions.

Rate of descent should be monitored closely and not allowed to become excessive. Be prepared to use afterburning thrust if necessary (refer to Section VI and to Appendix - Performance Data for charts showing the expected variation of flight performance).

Under marginal conditions, a straight-in approach is recommended. In addition, minimize drag by using a TAKEOFF-flap or gear-up configuration for the approach, changing to the final landing configuration when the landing is assured.

If landing roll distance is a major consideration, use LAND flaps to reduce the touchdown speed and delay extension until the flare is assured.

#### WARNING

UNDER HEAVYWEIGHT CONDITIONS, THE AFTERBURNER WILL HAVE TO BE USED IF A GO-AROUND IS ATTEMPTED WITH THE LANDING GEAR EXTENDED AND FLAPS IN THE LAND POSITION.

#### MINIMUM RUN LANDING

For a landing with minimum ground roll, fly the approach so that close control can be exercised over touchdown point and airspeed. Land as near as possible to the end of the runway, touching down at 145 knots for normal landing gross weight. Use the speed brakes to aid in controlling touchdown point and speed as well as for maximum drag during the rollout. Plan the chute deployment so that it blossoms as the nosewheel touches down. Smoothly apply anti-skid brakes with constantly increasing pedal pressure. If cycling occurs, indicating maximum braking, reduce pedal force.

## TYPICAL LANDING PATTERN

BASED ON A GROSS WEIGHT OF 16000 LB. 1000 LB FUEL REMAINING  
(NO EXTERNAL STORES)

### NOTE

- INCREASE APPROACH AND LANDING SPEED 5 KNOTS FOR EACH 1000 LB OF FUEL REMAINING ABOVE 1000 LB.
- REFER TO LANDING DISTANCE CHARTS IN THE APPENDIX FOR FINAL APPROACH AND TOUCHDOWN SPEEDS FOR OTHER CONFIGURATIONS AND GROSS WEIGHTS.

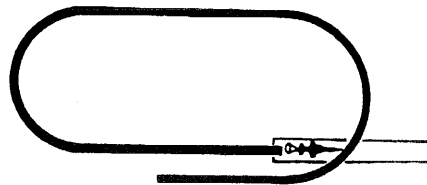

- LOWER LAND FLAPS AT 240 KIAS.
- APPROXIMATELY 86% RPM

### NOTE

LOSS OF ALTITUDE ON BASE LEG TO INITIATING FINAL TURN SHOULD NOT EXCEEDS 500 FEET, WITH 300-400 FOOT LOSS DESIRED. AIRSPEED NOT LESS THAN 200 KIAS

ROLL OUT ON FINAL APPROACH, MINIMUM RECOMMENDED DISTANCE FROM END OF RUNWAY 6.000 FEET, APPROXIMATELY 300 FEET ABOVE TERRAIN, RECOMMENDED AIRSPEED 175 KIAS PLUS CORRECTION

FA0272

Figure 2-8 (Sheet 1 of 2)

## TYPICAL LANDING PATTERN

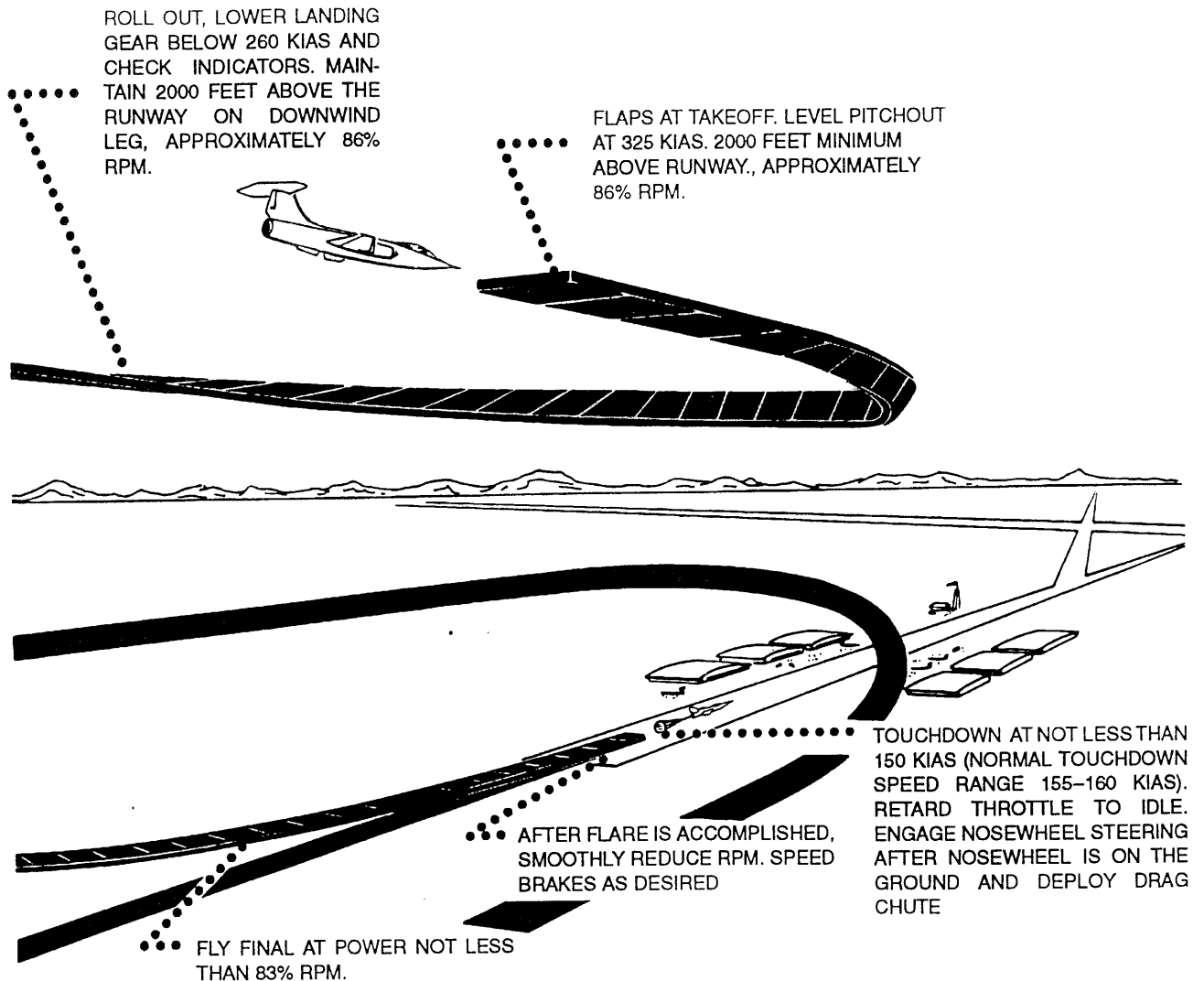

### WARNING

DO NOT "CHOP" THROTTLE WHILE AIRBORNE AS ABRUPT LOSS OF LIFT WILL ACCOMPANY THE DECREASE IN BOUNDARY LAYER CONTROL AIRFLOW.

### CAUTION

- STEEP FINAL APPROACHES CAN BE HAZARDOUS IF THE AIRSPEED DROPS BELOW NORMAL, TURNS ARE MADE, OR GUSTY WINDS PREVAIL. THESE FACTORS MAY CAUSE AN EXCESSIVE RATE OF SINK WHICH WILL NOT BE RECOGNIZED AND CORRECTED BEFORE CONTACT WITH THE GROUND.
- ALL FINAL APPROACHES SHOULD BE MADE WITH POWER, AND ON A GLIDE SLOPE SIMILAR TO THAT FOR ILS/PAR (700-800 FEET PER MINUTE). THIS SLOPE MAY BE INTERCEPTED AT ANY POINT, BUT SHOULD BE INTERCEPTED AT NOT LESS THAN 1 MILE FROM TOUCHDOWN.

FA0273

Figure 2-8 (Sheet 2 of 2)



**NOTE**

Cycling of the antiskid system can be detected by the change in longitudinal deceleration as braking action is automatically released and reapplied by the antiskid system.

**CAUTION**

TO PREVENT DAMAGING BRAKES, TIRES, OR WHEELS DUE TO HEAT, SUFFICIENT TIME MUST BE ALLOWED BETWEEN MAXIMUM EFFORT STOPS FOR COOLING THE BRAKES TO HANDLING TEMPERATURES.

minimum. The approach should be slightly flatter than normal. Touchdown speed should be 165 KIAS minimum. Throttle and speed brakes may be used as necessary to control airspeed and touchdown point

2. If flying an overhead approach, fly a slightly wider than normal pattern. On base leg, maintain 230 KIAS minimum or APC meter 2.5 maximum whichever occurs first and stay out of shaker. Adjust the final airspeed to 195 KIAS minimum

**NOTE**

Power may be adjusted from military to idle, if necessary, as BLC is not operative with TAKEOFF flaps.

**TOUCH-AND-GO LANDINGS****LANDING ON SLIPPERY RUNWAYS**

To land on wet or icy runways use the same procedure as for a minimum run landing. Leave the flaps at LAND during the landing roll for maximum aerodynamic drag.

Refer to the landing charts in the Appendix - Performance Data for information on how stopping distance varies with surface condition.

Painted areas on runways, taxiways, and ramps are significantly more slippery than non-painted areas. In addition, painted areas sometimes serve as condensation surfaces and it is possible to have wet, frosty or even icy conditions on these areas when the overall weather condition is dry. When conditions of snow or ice exist, the approach ends of the runway are usually more slippery than other areas because of the melting and refreezing of the ice and snow at this point.

**TAKEOFF FLAPS LANDING**

TAKEOFF flaps landing may be made from a straight-in approach or an overhead approach.

1. If flying a straight-in approach extend the gear prior to intercept the glide path. Slow to final approach airspeed of not less than 195 KIAS

**NOTE**

LAND flaps touch-and-go and low approaches will be flown only when necessary.

After touchdown proceed as follows:

1. Throttle - IDLE
2. Wing flaps - TAKEOFF

**NOTE**

Check flaps indicators for safe indication of TAKEOFF flaps before becoming airborne again.

3. Throttle - Military
4. Speed brakes - IN
5. Trim - As required

Before going airborne:

6. FLAP POSITION - Takeoff
7. Use normal takeoff technique

## GO-AROUND

(Refer to Figure 2-9 for a typical go-around pattern)

Make decision to go around as soon as possible and accomplish the following:

1. Throttle – Military (maximum thrust if necessary)

### WARNING

THE AVAILABLE EXCESS THRUST TO PERFORM A GO-AROUND VARIES WITH AIRSPEED, GROSS WEIGHT, AIRCRAFT CONFIGURATION, FIELD ELEVATION AND AMBIENT TEMPERATURE. AS EXTREMES OF THESE VARIABLES ARE APPROACHED THE ABILITY TO PERFORM A SUCCESSFUL GO-AROUND WITH MILITARY THRUST DECREASES, THUS REQUIRING AFTERBURNING. REFER TO SECTION VI AND THE APPENDIX FOR ILLUSTRATIONS AND CHARTS SHOWING THE VARIATIONS IN PERFORMANCE TO EXPECT WITH CHANGES IN THESE OPERATING CONDITIONS.

2. Speed brakes – IN
3. LDG GEAR – UP

When definitely airborne and rate of climb is established:

4. Wing flaps – TAKEOFF, at not less than 180 KIAS

### NOTE

- Select TAKEOFF flaps only after a definite climb is established.
- Expect a definite nose-up trim change when raising flaps to TAKEOFF position.

5. Wing flaps – UP if desired (at not less than 300 KIAS)

### WARNING

WHEN MAKING A GO-AROUND, LEAVE THE WING FLAPS LEVER IN THE TAKEOFF POSITION FOR 30 TO 60 SECONDS. THIS ACTION WILL COOL THE BLC RAMP AND KEEP THE RETRACTING FLAPS FROM PINCHING THE RAMP. PINCHED BLC RAMPS CAN CAUSE UNDESIRABLE ROLLING MOMENTS WHEN THE BLC SYSTEM IS OPERATING.

## AFTER LANDING

### NOTE

Drag chute should be jettisoned in the appropriate area as local procedures dictate.

1. Wing flaps – TAKEOFF

### NOTE

Leave flaps in TAKEOFF position for a minimum of one minute to ensure sufficient cooling of the flaps after BLC operation.

2. Heaters and defogger, pitot heat, and engine anti-ice, if applicable – OFF
3. Swivel guard of secondary firing handle – Up
4. RAIN REMOVER switch – Check then OFF and guarded or OFF if used, then guarded
5. Landing lights – Off

## TYPICAL GO-AROUND

BASED ON A GROSS WEIGHT OF 16000 LB., 1000 LB FUEL REMAINING (NO EXTERNAL STORES). INCREASE FLAPS RETRACTION SPEEDS 5 KNOTS FOR EACH ADDITIONAL 1000 LB ABOVE 1000 LB FUEL REMAINING

### NOTE

- THE AIRCRAFT IS SLOW TO ACCELERATE WHILE LANDING FLAPS ARE DOWN. IF POSSIBLE, MAKE DECISION TO GO AROUND AT NOT LESS THAN 170 KIAS.
- A LATERAL TRIM CHANGE MAY BE EXPERIENCED WHEN FLAPS ARE RETRACTED TO TAKEOFF.
- A MINIMUM OF 200-300 LB OF FUEL IS REQUIRED FOR A MILITARY OF AFTER-BURNER GO-AROUND IN A CLOSED PATTERN.
- WHEN ENTERING CLOSED PATTERN FOR LANDING LEAVE FLAPS IN TAKEOFF POSITION.

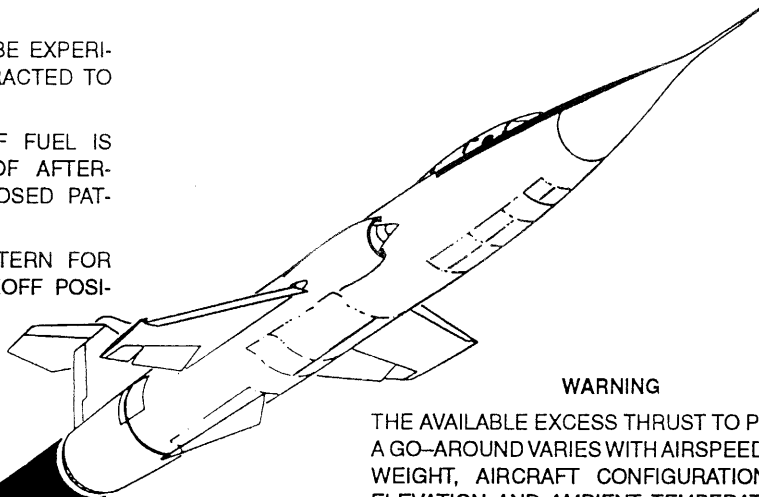

### WARNING

THE AVAILABLE EXCESS THRUST TO PERFORM A GO-AROUND VARIES WITH AIRSPEED, GROSS WEIGHT, AIRCRAFT CONFIGURATION, FIELD ELEVATION AND AMBIENT TEMPERATURE. AS EXTREMES OF THESE VARIABLES ARE APPROACHED, THE ABILITY TO PERFORM A SUCCESSFUL GO-AROUND WITH MILITARY THRUST DECREASES, THUS REQUIRING AFTERBURNING THRUST.

- 1 THROTTLE - MILITARY, MAXIMUM THRUST IF NECESSARY
- 2 SPEED BRAKE - IN
- 3 LANDING GEAR LEVER - UP
- 4 WING FLAPS LEVER - TAKEOFF, AT NOT LESS THAN 180 KIAS

### WARNING

WHEN MAKING A GO-AROUND, LEAVE THE WING FLAPS LEVER IN THE TAKEOFF POSITION FOR 30 TO 60 SECONDS. THIS ACTION WILL COOL THE BOUNDARY LAYER CONTROL RAMP AND KEEP THE RETRACTING FLAPS FROM PINCHING THE RAMP. PINCHED BOUNDARY LAYER CONTROL RAMPS CAN CAUSE UNDESIRABLE ROLLING MOMENTS WHEN THE BOUNDARY LAYER CONTROL SYSTEM IS OPERATING.

### NOTE

- EXPECT DEFINITE NOSE-UP TRIM CHANGE WHEN RAISING FLAPS TO TAKEOFF
- IF IT IS DESIRED TO RAISE FLAPS FROM TAKEOFF TO UP, DO SO AT 300 KIAS MINIMUM.

FA0274

Figure 2-9

**NOTE**

If rain remover has not been used during flight, turn switch ON for not more than 30 seconds, then OFF to remove condensation and protect rain remover shutoff valve from corrosion. If visible moisture is dissipated before 30 seconds turn switch OFF.

6. RADAR – Recheck SBY
7. Speed brakes – IN
8. Trim – TAKEOFF
9. IFF, TACAN – OFF, as desired
10. Canopy – Locked or full open

**CAUTION**

WHEN UNLOCKING THE CANOPY, THE PILOT SHALL FIRMLY GRIP THE CANOPY LIFT HANDLE TO AVOID LOSS OF OR DAMAGE TO THE CANOPY DURING HIGH OR GUSTY WINDS. WHEN OPENING THE CANOPY TO THE FULL-OPEN POSITION, A FIRM GRIP ON THE CANOPY LIFT HANDLE IS NECESSARY UNTIL THE CANOPY IS IN THE FULL-OPEN LOCKED POSITION.

**ENGINE SHUTDOWN**

1. Ejection seat safety pin of primary firing handle – Installed
2. Wing flaps – UP
3. IN terminal error – Record

**NOTE**

- The IN terminal error may be performed using the OTF technique.

- Terminal error referred to "00" is not reliable.

4. IN – OFF
5. GPS – Switch off
6. RADAR – OFF
7. All electrical and electronic equipment – Off
8. Temperature rheostat full hot – If required

**NOTE**

Leave temperature in full hot position for 30 seconds in order to remove condensation from the air conditioning system.

9. Run engine for 3 minutes at IDLE for proper cooling

**NOTE**

Operation during taxi may be considered as part of this time.

10. Fast erect standby attitude indicator before engine shutdown, if not in normal position
11. Open canopy

**NOTE**

Canopy seal keeps inflated if engine shuts down with canopy in closed position.

12. Throttle – OFF

**NOTE**

Check that engine decelerates freely. Listen for any excessive noise during shutdown. Typical run down time 40 ÷ 60 (±5) seconds.

## AFTER SHUTDOWN

1. Ejection seat safety pin of primary firing handle – Check installed
2. Swivel guard of secondary firing handle – Up (check)
3. Remove safety clip and open quick release box of combined harness
4. Dinghy lowering line – Disconnect from life vest
5. Leg lines – Release
6. PEC-pilot portion – Detach
7. Personal leads – Disconnect
8. External stores safety pins – Installed
9. Aircraft forms – Complete

**CAUTION**

IN ADDITION TO ESTABLISHED REQUIREMENTS FOR REPORTING ANY SYSTEM DEFECTS OR UNUSUAL AND EXCESSIVE OPERATIONS, THE PILOT WILL ALSO MAKE ENTRIES IN AIRCRAFT FORMS TO INDICATE WHEN ANY LIMITS PUBLISHED IN THE FLIGHT MANUAL HAVE BEEN EXCEEDED.

## STRANGE FIELD PROCEDURES

If it is necessary to land at an airfield where normal ground support is not available, the pilot shall be responsible for performing or at least closely supervising the required aircraft service. The following instructions apply:

1. Complete aircraft preflight inspection and postflight inspection in accordance with the aircraft turnaround procedures in the checklist
2. Use fuel, oil, and hydraulic fluid to service this aircraft as required by the following specifications:
  - Fuel – JP-8, MIL-T-83133 (Refer to Figure 2-10)

- Oil – MIL-L-7808
  - Hydraulic fluid -- MIL-H-5606  
Reservoir Capacity:  
No. 1 – 0.49 US gallon  
No. 2 – 1.83 US gallons
  - Oxygen – Liquid MIL-O-27210
  - Nitrogen – MIL-N-6011 Grade A Type 1 (Water-pumped or dry air)
3. External air source for starting (Refer to Figure FO-13)
  4. External electrical power (Refer to Figure FO-13)
  5. Single-point refuelling pressure = 50 psi

If airfield is not a DWP stored in DTM, if possible do not move the aircraft after IN shutdown. For next flight, perform GC alignment without pressing IP pushbutton on IN/CDU.

## NOTE

The navigation performances are degraded.

## ALERT COCKING PROCEDURES

1. External electrical power – On
2. Aircraft preflight – Accomplish normal preflight inspection
3. Engine start – Accomplish normal engine start
4. Accomplish all pre-taxi and pilot/crew chief checks except:
  - a. Do not remove safety pin of primary firing handle, swivel guard up
  - b. Do not remove external load safety pins

## NOTE

A full GC alignment shall be performed.

5. Engine – Accomplish a normal engine shut-down except:
  - a. Wing flaps – TAKEOFF

## FUEL GRADE PROPERTIES AND LIMITS

USE	FUEL TYPE	GRADE	NATO SYMBOL	U.S. MILITARY SPECIFICATION/ COMMERCIAL	SPECIFIC GRAVITY	FREEZE POINT		LIMITS
						°F	°C	
Primary Fuel	Kerosene	JP-8 Jet A-1	F-34 F-35	MIL-T-83133 ASTMD 1655	.840-.775	-58	-50	1, 2, 3, 4, 5, 6
					.840-.775	-53	-47	1, 2, 3, 4, 5, 6
Alternate Fuel	Kerosene Wide Cut Gasoline	Jet-A JP-4	None F-40	ASTMD 1655 MIL-T-5624	.840-.755	-40	-40	1, 2, 3, 4, 5, 6
					.802-.751	-72	-58	6
Emergency Fuel	Aviation Gasoline (Avgas)	80/87	F-12	MIL-G-5572	.706	-76	-60	1, 2, 3, 4, 5, 6
		100/130	F-18	MIL-G-5572	.706	-76	-60	1, 2, 3, 4, 5, 6
		115/145	F-22	MIL-G-5572	.706	-76	-60	1, 2, 3, 4, 5, 6

### LIMITS

1. Whenever the use of alternate fuel is necessary, the specific gravity setting on the main fuel control and afterburner fuel control shall be adjusted to correspond with a mid-range or average value of the specific gravity of the fuel selected. The specific gravity or average value of authorized fuels can be obtained from the above table. The procedures for changing the specific gravity setting on the fuel controls are published in the aircraft power plant manuals. Whenever the specific gravity adjustments are changed from their standard preset point, an entry will be made in DD Form 781A. This entry can only be cleared when the aircraft is reserviced with the primary fuel and the specific gravity adjustments have been reset to the standard setting.
2. There is no operating time limit with alternate fuels. Use of emergency fuel is restricted to a maximum of 6 hours operation.
3. Airstarts Initiated as soon as possible will assure best possible condition for restart.
4. Engine ground and aerial start times will increase when using JP-8, Jet A-1 and Jet-A fuels. Refer to Section III "Emergency Procedures - J79 Engine Air Start Envelope" Figure for engine estimated air start envelope.
5. Engine throttle transients, A/B light-off capability and thrust are not degraded by use of JP-8, Jet A-1 or Jet-A. A slight improvement in stall margin will result with the use of JP-8, Jet A-1 or Jet-A.
6. If there is any indication of improper fuel handling procedures, a fuel sample should be taken in a glass container and observed to foginess, presence of water, or rust. The primary fuels JP-8 and fuels identified by NATO symbols F-34, F-35 and F-40 contain an icing inhibitor.
7.
  - a. Whenever the use of aviation gasoline is required, the aircraft will be restricted to a one-time flight not to exceed 6 hours duration. Specific gravity adjustments to the main and afterburner fuel controls are not required. Neither is the addition of lubricating oil additives required. When using AVGAS there is no restriction on afterburner operation, but the aircraft ceiling is limited to 35000 ft and aircraft velocity shall not exceed subsonic speed at any altitude. In addition to these limitations, certain engine parameters may be degraded under some atmospheric conditions:
    - (1) Longer time to start and accelerate with possible missed starts or start stalls.
    - (2) Maximum engine RPM and EGT may not be attained.
    - (3) Slow acceleration throughout the operating range.
    - (4) Reduced engine thrust.
    - (5) Reduced aircraft range.
  - b. If aircraft exceeds 6 hours of operation of AVGAS, drain aircraft fuel system completely and refuel with primary fuel. Inspect turbine exhaust nozzle area and perform ground run check. If no defects or engine malfunctions are found, release aircraft for flight.

### CAUTION

- AVOID FLYING AT ALTITUDES WHERE INDICATED OAT IS BELOW THE FREEZE POINT OF THE FUEL. PRIOR TO USING EMERGENCY COMMERCIAL FUEL, OBTAIN FREEZE POINT FROM VENDOR OR AIRLINE SUPPLYING THE FUEL; THEN FOLLOW THE LIMIT.
- ABOVE 22000 FEET THE TIME FOR ENGINE RESTART MAY BE 15 SECONDS LONGER WHEN USING JP-8/F-34 INSTEAD OF JP-4/F-40.

Figure 2-10

- b. UHF radio – On
- c. Pitot heat – As required
- d. Navigation and Taxi Lights – On (as required)
- e. TACAN – REC
- f. IFF – NORM
- g. RADAR – SBY (if applicable)
- h. IN function selector knob – OFF
- i. IN mode selector knob – STO

**NOTE**

Aircraft shall not be moved after alert alignment procedure has been performed.

**ALERT SCRAMBLE PROCEDURES**

1. External electrical power – On (if required)
2. Personal equipment – All required equipment on and secure
3. Enter cockpit – Strap in
4. Engine start – Accomplish normal engine start by using both start switches
5. IN function/mode selector knobs – ALN/STO
6. IN function selector knob – NAV (at RDY NAV flashing)
7. Safety pin of primary firing handle – Removed
8. Swivel guard – Down
9. STABILIZER takeoff trim light – Check
10. External load safety pins – Removed
11. Wheel chocks – Removed
12. Taxi – To takeoff runway
13. Canopy – Locked, CANOPY UNSAFE warning lights extinguished. Check locks visually

14. Takeoff – Accomplished normal takeoff for configuration

**INS ALIGNMENT PROCEDURE****NOTE**

- The procedure contained in this Section are based on the assumption that the DTM has been inserted before INS switch-on (ALN selection). If DTM is not inserted, the pilot shall be aware of the following:
  - during INS alignment, the IN alignes using the last stored INS PP
  - IN NAV function is available only for IP (00).
- The DTM shall not be inserted/removed during INS alignment and navigation phases.

**GYROCOMPASS ALIGNMENT**

1. IN function/mode selector knobs – ALN/GC
2. IN – Check FAIL lamp out
3. IN/CDU – (AUTOMATIC POWER ON TEST). After 5 seconds max., check "CDU OK" indication displayed. If "CDU FAIL" indication displayed: ABORT

**NOTE**

If "DTM FAIL" appears on IN/CDU, switch-off the INS and check for correct DTM insertion. Repeat steps from 1. to 3. If "DTM FAIL" still displayed the INS alignes on the last stored PP. Only the TACAN steering mode is available.

4. IN/CDU rotary switch – Rotate to select requested initial point
5. IN/CDU – Press IP within 2 minutes from IN/ALN selection

**NOTE**

In case no DTM Initial Position is available or not selected by the pilot, the system carries out the alignment on the last stored present position. In this case, the navigation subsystem performance is degraded.

If fast GC alignment is requested:

6. IN – Check status 3. Set to NAV when RDY NAV is steady. Check RDY NAV lamp extinguished

If full GC alignment is requested:

6. IN – Check status 1. Set to NAV when RDY NAV flashes. Check RDY NAV lamp extinguished

**NOTE**

In ALN/GC mode, rotating the rotary switch on IN/CDU, allows presentation of stored waypoints.

**STORED HEADING ALIGNMENT****NOTE**

- Stored heading alignment shall be carried out provided that an INS full "GC" alignment has been performed before the INS switch-off.
- The aircraft shall not be moved after the last INS switch-off.
- No IN/CDU IP selection is available.

1. IN function/mode selector knobs – ALN/STO
2. IN – Check FAIL lamp out
3. IN/CDU – (AUTOMATIC POWER ON TEST). After 5 seconds max., check "CDU OK" indication displayed. If "CDU FAIL" indication displayed: ABORT

**NOTE**

If "DTM FAIL" appears on IN/CDU, switch-off the INS and check for correct DTM insertion. Repeat steps from 1. to 3. If "DTM FAIL" still displayed the INS aligns on the last stored PP. Only the TACAN steering mode is available.

When RDY NAV flashes:

4. IN – Check STATUS 3. Set to NAV and check RDY NAV lamp extinguished

**NOTE**

In ALN/STO mode, rotating the rotary switch on IN/CDU will allow presentation of stored waypoints data. Selection of different initial positions is not enabled.

**IN/CDU OPERATION**

1. DTM – Insert before INS switch-on
2. IN – Switch on
3. IN/CDU – Check no "DTM FAIL" displayed

**NOTE**

If DTM is not inserted the "NO DTM" is displayed.

After IN/CDU self test:

4. IN/CDU – Check "CDU OK" displayed

**NOTE**

If failure occurs the "CDU FAIL" is displayed: ABORT.

**SELECTION OF DESTINATION WAYPOINT (FLY TO FUNCTION)**

1. IN/CDU rotary switch – Rotate to select the desired destination waypoint



2. IN/CDU rotary switch – Hold for 1 sec. to select the destination waypoint

### IN/CDU NAVIGATION DATA PRESENTATION

When a destination waypoint is selected on IN/CDU:

1. IN/CDU – Press NAV pushbutton. Check navigation parameters displayed.
2. IN/CDU – Press PAGE pushbutton to display the desired navigation parameters. After pressing the PAGE pushbutton the third time, the IN/CDU display return to the first page.

#### NOTE

Entering NAV mode from IN/ALN, the first page is displayed.

### IN/CDU STATION POINT LISTING

1. IN/CDU – Press LIST pushbutton. Check destination waypoint coordinates displayed. Rotate the rotary switch to display consequently any other stored point

#### NOTE

The station identifier number and ICAO label flash during station point listing.

2. IN/CDU – Press PAGE pushbutton

#### NOTE

- The PAGE pushbutton may be pressed up to 2 times.
- By pressing the PAGE pushbutton the information relative to the station height above the sea (except for mark point) and TACAN channel (only for radio station) are displayed.

At any time to resume previous format:

3. IN/CDU – Press NAV pushbutton

#### NOTE

At any time, after pressing NAV pushbutton, the first page of navigation parameter is displayed.

### MARK POINT ACQUISITION

#### NOTE

- Only two mark points may be stored (identifier No. 59 and 60).
- Subsequent mark points acquisition shall delete the previously stored mark points.
- Mark points are not stored into the DTM: after INS switch-off, mark points data are lost.
- After mark point acquisition, the mark point may be used as any other destination waypoint.
- Mark point acquisition shall be carried out with the OTF technique.
- A MARK label on the second row is displayed as mark point acquisition feedback. After 10 seconds the MARK label disappears and the previous format is resumed.

1. IN/CDU – Press MARK pushbutton. Check MARK format

### ON TOP FIX

#### NOTE

- The OTF facility is not available when flying in GPS steering mode.

- OTF procedure is available only for the current destination waypoint.
- During OTF procedure the actuation of NAV or LIST pushbutton, on the IN/CDU, causes the OTF rejection.
- The MARK/IP and PAGE pushbuttons are disabled.

1. IN/CDU – Press FIX/ACC pushbutton. Check fixing error displayed

To accept fixing error:

2. FIX/ACC pushbutton – Press within 30 seconds

To reject fixing error:

3. Wait 30 seconds  
or  
NAV or LIST pushbutton – Press

## GPS OPERATION

### NOTE

- The following procedures are based on the assumption that the GPS memory contains all data required for the satellites acquisition.
- The GPS switch-on and subsequent satellites acquisition may be carried out in any on-ground or in-flight phase.

1. ON/OFF hard key – Press

After BIT/AFI function:

2. GPS display – Check on “TEST RESULTS” format all “OK” displayed (refer to Figure 2-11)
3. STA hard key – Press, check “STATUS ACQ SAT” readout and format displayed

After 12 minutes maximum:

4. GPS display – Check “STATUS 4 SAT” readout and format displayed (refer to Figure 2-12)

### NOTE

If “STATUS 4 SAT” is not reached, the GPS shall be switched off.

5. NAV hard key – Press, check LAT and LONG data displayed (refer to Figure 2-13)

## GPS STEERING MODE SELECTION

### NOTE

The GPS shall be used only as source of present position. The GPS shall not be used for navigation purposes in the stand-alone mode of operation.

With INS in NAV:

1. GPS selector pushbutton – Press, check GPS caption lit

### GPS BIT/AFI FORMAT

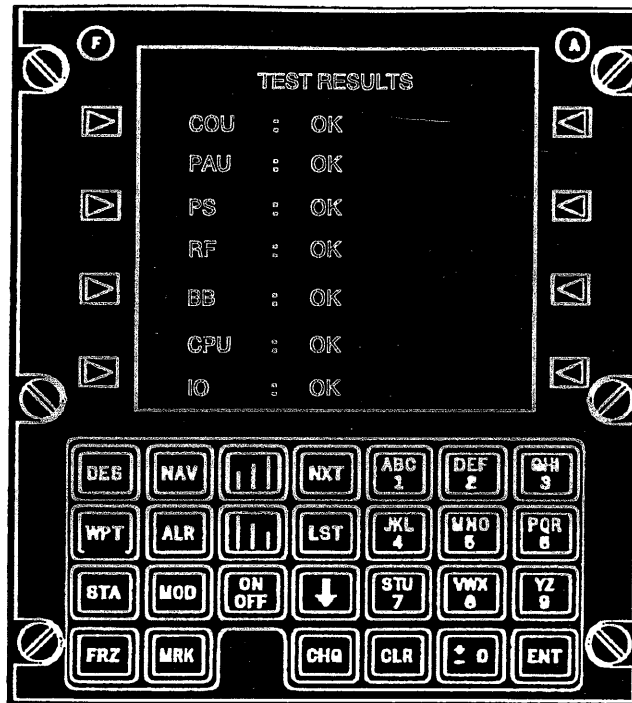

Figure 2-11

FA0228

### GPS SATELLITES DETECTION STATUS FORMAT

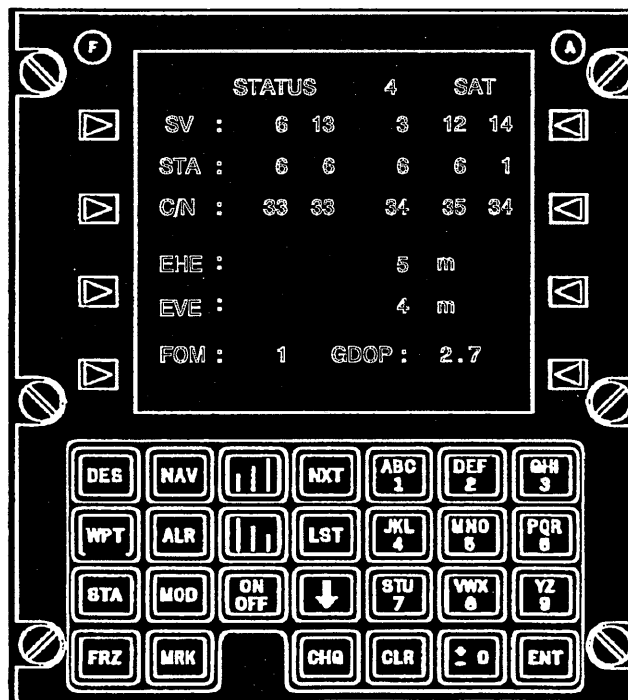
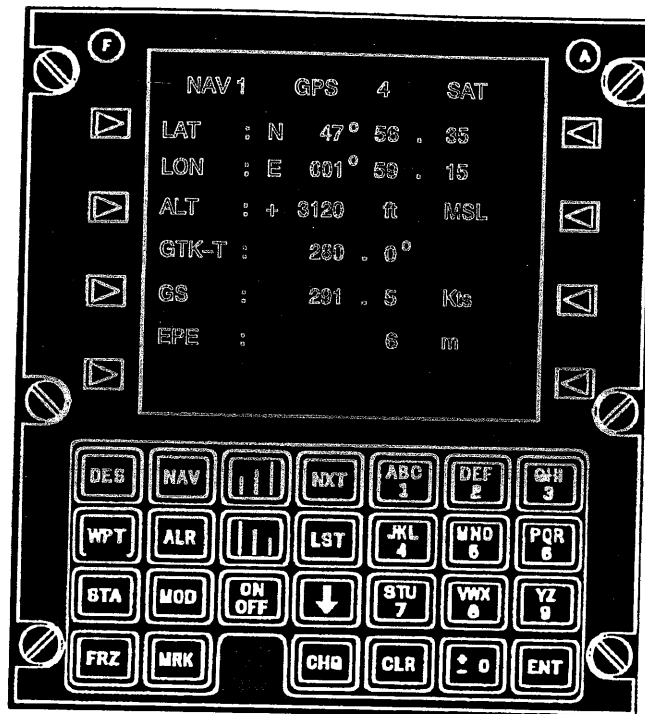

Figure 2-12

FA0227

## GPS NAV FORMAT (TYPICAL)



FA0226

Figure 2-13

## SECTION III

### EMERGENCY PROCEDURES

#### TABLE OF CONTENTS

Title	Page
INTRODUCTION	3-2
GROUND EMERGENCIES	3-2
Emergency Entrance	3-2
Fire during Start	3-2
RPM Lock-up Failure during Start	3-2
Ground Abandonment	3-4
TAKEOFF EMERGENCIES	3-4
Abort/Barrier Engagement	3-4
Afterburner Blowout	3-7
Afterburner Surge	3-7
Auxiliary Inlet Door Malfunction	3-7
Canopy Open/Loss/Broken during Takeoff	3-8
Engine Failure during Takeoff	3-8
External Stores Emergency/Selective Jettison	3-9
Engine Oil Level Low	3-9
Exhaust Nozzle Fails Open without Indication of Engine Oil System Malfunction (Afterburning)	3-10
Fire during Takeoff	3-10
Landing Gear Lever Downlock Malfunction	3-11
Landing Gear Retraction Failure	3-11
Nosewheel Shimmy	3-11
Tire Failure	3-12
IN-FLIGHT EMERGENCIES	3-12
Air Start/Stall Clearing	3-12
Auto-Pitch Control System Failure	3-15
Bleed Air Duct Separation/False RPM Reset	3-16
Canopy Open/Loss/Broken during Flight	3-17
Cockpit Pressurization Malfunction	3-17
Ejection - General Consideration	3-18
Before Ejection	3-20
Ejection	3-20
After Ejection	3-22
Smoke or Fumes in Cockpit	3-22
Electrical Fire	3-23
Electrical Power Supply System Failure	3-24
Fire	3-29
External Stores Emergency/Selective Jettison	3-29
Fuel System Failure	3-30
Hydraulic System Failure	3-31
Engine Failure during Flight	3-32
IGV Closure	3-33
Exhaust Nozzle Fails Open without Indication of Engine Oil System Malfunction (Afterburning)	3-33
Exhaust Nozzle Fails Open without Indication of Engine Oil System Malfunction (Non-Afterburning)	3-33
Exhaust Nozzle Fails to Mechanical Schedule or Severe Nozzle Fluctuations Occur (Afterburning)	3-34
Exhaust Nozzle Fails to Mechanical Schedule or Severe Nozzle Fluctuations Occur (Non-Afterburning)	3-34
Engine Oil System Malfunction	3-35
Oxygen System Failure	3-36
RAT Extended Flight	3-36
Pitch-Up Recovery and Spin Prevention/Spin Recovery	3-38
Stability Augmentation System Failure	3-39
Trim Failure or Runaway Trim	3-39
Throttle Control System Malfunction	3-40
Control Stick Steering (CSS) Failure	3-41
INS Failure	3-41
APPROACH AND LANDING EMERGENCIES	3-42
Airspeed System Failure	3-42
Approach-End Arrestment	3-42
Asymmetric Tip Tank Fuel Load	3-43
Barrier Engagement	3-43
Belly Landing	3-43
Boundary Layer Control Malfunction	3-44
Flame-Out Landing	3-44
Flaps Failure	3-48
Landing Gear Emergency Extension	3-50
Main Gear Flat Tire Landing	3-51

Maximum Glide . . . . . 3-51  
 Nose Gear Flat Tire . . . . . 3-51  
 Nose Gear Up Landing . . . . . 3-53  
 One Main Gear Up or Unlocked . . . . . 3-53  
 Power Brake/Anti-Skid System Malfunction . . . . . 3-54  
 Precautionary Partial Power Pattern . . . . . 3-54  
 Precautionary Straight-In Pattern . . . . . 3-56  
 Precautionary High RPM/Thrust Pattern . . . . . 3-56  
 RPM Lockup . . . . . 3-57  
 RPM Reset Landing . . . . . 3-57  
 Stuck-Throttle Landing (Alternate Procedure) . . . . . 3-58

## INTRODUCTION

This Section contains procedures to be followed in various emergencies to ensure maximum safety for the pilot and/or aircraft. Through knowledge of these procedures will enable the aircraft to better cope with an emergency.

The steps should be performed in the listed sequence. However, the procedures do not restrict the pilot from taking any additional action necessary to deal with the emergency.

The procedures contain items classified as critical or noncritical. The critical items are actions that shall be performed immediately to avoid aggravating the emergency and causing personal injury, loss of life or loss or damage to the aircraft.

Critical items are presented in **boldface letters** and shall be committed to memory. Verbal knowledge of bold face procedures is not necessary, however, it is mandatory that pilots commit to memory the full intent of the actions indicated and the proper sequence of steps. Non critical items are considered to be less urgent and shall be accomplished by direct reference to the checklist.

When practical, other concerned agencies (i.e., flight lead, ATC, etc.) should be advised of the problem and intended course of action. When an emergency occurs, three basic rules should be followed.

They apply to most in-flight emergencies and shall be borne in mind by the pilot:

1. Maintain aircraft control
2. Analyse the situation and take proper action
3. Land as the situation dictates.

The emergency conditions and type of emergency, combined with the pilot's analysis of the situation

and his proficiency are of prime importance in determining the urgency to land. The terms "land as soon as possible" and "land as soon as practicable" are used in this Section as defined below:

**LAND ASAP (AS SOON AS POSSIBLE)** – An emergency will be declared. A landing should be accomplished at the nearest suitable airfield considering the severity of the emergency, weather conditions, field facilities, ambient lighting, aircraft gross mass and command guidance.

**LAND AS SOON AS PRACTICABLE** – Emergency conditions are less urgent and, although the mission is to be terminated, the degree of the emergency is such that an immediate landing at the nearest adequate airfield may not be necessary.

## GROUND EMERGENCIES

### EMERGENCY ENTRANCE

The procedure to be used by rescue personnel in assisting the pilot from the aircraft following a crash landing is shown in Figure 3-1.

### FIRE DURING START

Illumination of the FIRE warning lights and/or other evidence of fire during engine starting, is/are an indication of a broken or disconnected fuel line. If this condition occurs proceed as follows:

1. Throttle – OFF
2. **FUEL SHUT-OFF SWITCH – OFF**
3. 1 START 2 switches – STOP-START
4. Perform "Ground Abandonment" procedure contained in this Section

### RPM LOCK-UP FAILURE DURING START

A RPM lock-up failure during start is indicated by the illumination of the ENG RPM LOCK-UP PWR ON light and by an idle overspeed condition.

1. **THROTTLE – OFF**
2. 1 START 2 switches – STOP-START (if applicable)

EMERGENCY ENTRANCE

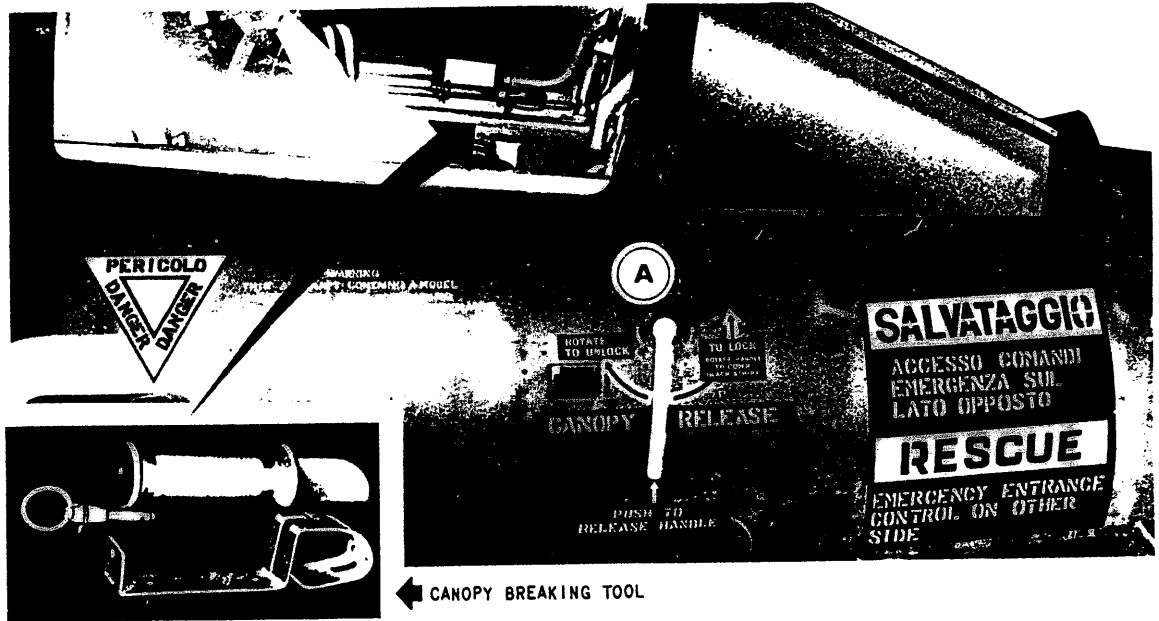

- 1 IF CANOPY IS LOCKED, UNLOCK BY ROTATING THE EXTERNAL LOCKING LEVER (A) AFT AND OPEN CANOPY
- 2 IF AIRCRAFT IS ON FIRE, JETTISON CANOPY BY PULLING CANOPY JETTISON T-HANDLE (B)
- 3 SECURE FIRING CONTROLS, DROGUE GUN AND ROCKET CHARGE
- 4 SHUT OFF OXYGEN SUPPLY AT OXYGEN CONTROL PANEL
- 5 REMOVE OXYGEN MASK OR OPEN FACEPLATE OF PRESSURE HELMET
- 6 UNLOCK AND OPEN THE QUICK RELEASE BOX
- 7 DISCONNECT THE DINGHY LANYARD FROM THE LIFE VEST
- 8 PULL MANUAL OVERRIDE HANDLE
- 9 REMOVE PILOT GENTLY TO AVOID AGGRAVATING POSSIBLE INTERNAL INJURIES

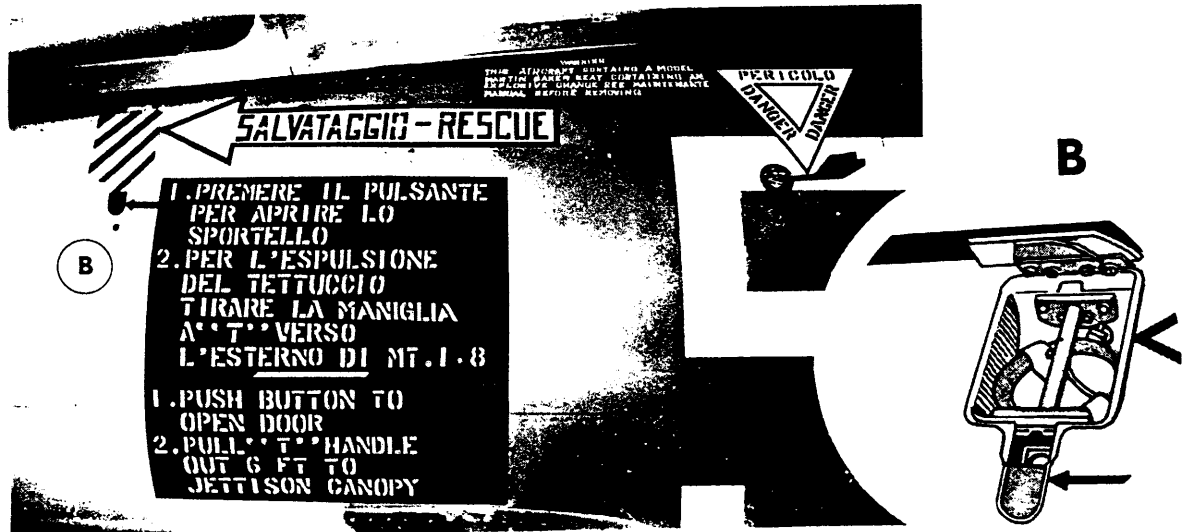

32088

Figure 3-1.

**NOTE**

Before attempting restart a check of ENG RPM LOCK-UP system shall be made with ground crew.

**GROUND ABANDONMENT**

In any situation where rapid abandonment is required, two methods of removing the canopy shall be considered: manual opening and jettison.

If necessary and circumstances permit:

**1. EJECT**

If time permits:

1. SWIVEL GUARD – UP
2. LEG LINES – RELEASE
3. RELEASE BOX – OPEN
4. SURVIVAL PACK LINE – DISCONNECT
5. PEC PILOT PORTION – DISCONNECT

If time is critical:

**6. CANOPY – JETTISON**

If time is not of prime importance or if no fire exists:

**6. CANOPY – OPEN MANUALLY****NOTE**

If survival pack is not disconnected, pilot will still be able to evacuate the cockpit, as the connected line allows approximately 15 feet of movement. Pulling the manual override handle will also release leg lines and PEC-pilot portion, but it should be noted that pilot will be pushed forward by released parachute pack (weight 30 pounds) and personal leads may cause entanglement during evacuation.

**TAKEOFF EMERGENCIES****ABORT/BARRIER ENGAGEMENT**

During takeoff an emergency may present a situation where groundspeed, aircraft gross weight, existing barrier, runway conditions, and other such factors will not permit a safe barrier engagement. In this situation, the only possible course of action may be a ground-level ejection.

Refer to Figure 3-2 for maximum barrier engagement speed.

If abort required:

**1. THROTTLE – IDLE****WARNING**

NOSEWHEEL STEERING AND ANTISKID BRAKES BECOME INOPERATIVE WITH THROTTLE OFF. REQUIRED BRAKE PEDAL PRESSURE WILL BE GREATER THAN NORMAL TO EFFECT BRAKING.

**CAUTION**

ENGINE SPEEDS ABOVE IDLE MAY CAUSE DRAG CHUTE FAILURE.

If necessary:

**2. EXTERNAL STORES – JETTISON**

Retain stores if the aircraft may be safely stopped within the remaining runway. Refer to "External Stores Emergency/Selective Jettison" procedure contained in this Section.



**MAXIMUM BARRIER ENGAGEMENT SPEED**

AIRCRAFT WEIGHT POUNDS	BAK-9 (5)	BAK-12 (5)	AAE 44B2-C (1-2-3-4)	AAE 44B2-D (1-2-3-4)
	MAXIMUM ENGAGEMENT SPEEDS-KNOTS			
14000	188	181	185	135
15000	187	180	185	135
16000	186	179	185	135
17000	185	178	185	135
18000	184	177	184	135
19000	183	176	184	135
20000	182	175	184	130
21000	181	174	184	130
22000	180	173	183	130
23000	179	172	183	130
24000	178	171	183	125
25000	177	170	182	125
26000	176	169	182	125
27000	175	168	181	125
28000	174	167	180	125

## NOTE

TRY TO CONTACT THE BARRIER AT THE RUNWAY CENTERLINE

1. THE ARRESTMENT GEAR MAY BE ENGAGED UP TO 7.5 METERS (25 FEET) OFF CENTER
2. WHEN THE ARRESTMENT GEAR IS ENGAGED OFF CENTER, THE AIRCRAFT MAY BE DISPLACED TO ONE SIDE AS FAR AS THE EDGE OF THE RUNWAY PAVEMENT
3. WHEN ENGAGEMENT SPEED FOR AAE 44-B-2C EXCEEDS 100 KNOTS, THE AIRCRAFT WILL BE PULLED REARWARD AFTER ARRESTMENT
4. LIMITING FACTOR IS NOSE GEAR STRENGTH
5. LIMITING FACTOR IS DESIGN HOOK STRENGTH

Figure 3-2

**WARNING**

IF POSSIBLE JETTISONING OF EXTERNAL STORES SHOULD TAKE PLACE 3000 FT PRIOR TO BARRIER ENGAGEMENT.

**NOTE**

- Jettisoned pylon tanks may strike the adjacent main landing gear but will not alter the course of the aircraft.
- Stores should be jettisoned prior to landing in those cases of a known emergency.
- Retain empty tip tanks if they are the only external store.
- Stores should be retained when engaging AAE-44B2-C barrier.
- External stores may create a fire hazard when the aircraft stops in the barrier.

**3. HOOK DOWN – PRESS**

**NOTE**

Arresting hook should be lowered at least 2000 feet from barrier.

**4. DRAG CHUTE – DEPLOY**

**WARNING**

IF PYLON STORES ARE JETTISONED AFTER DRAG CHUTE DEPLOYMENT, THEY MAY DAMAGE OR COLLAPSE THE DRAG CHUTE.

**CAUTION**

ENGINE SPEEDS ABOVE IDLE MAY CAUSE DRAG CHUTE FAILURE.

5. Brakes – Apply

If barrier engagement is required:

6. Brakes – Release prior to engagement

**CAUTION**

A LOCKED WHEEL, REGARDLESS OF TIRE STATE, WILL SNAG OR CUT THE ARRESTING HOOK CABLE.

7. Barrier – Contact at 90° angle and as close as possible to the centerline

**NOTE**

Corrections for yaw after hook engagement should be avoided to prevent nose gear damage from side loads.

If aircraft becomes uncontrollable:

8. Throttle – OFF

9. FUEL SHUT-OFF switch – OFF

10. Perform "Ground Abandonment" procedure (contained in this Section) when aircraft has stopped

**WARNING**

DO NOT UNFASTEN THE COMBINED HARNESS UNTIL THE AIRCRAFT HAS COME TO REST.

**AFTERBURNER BLOWOUT**

Afterburner blowout is indicated by:

- A. EGT below 600° C IT
- b. Nozzle position reading less than 7.5
- c. A definite loss of thrust

If decision is made to stop:

1. **ABORT**

If takeoff is continued:

1. **THROTTLE – MILITARY**
2. **EXTERNAL STORES – JETTISON (IF NECESSARY)**

Refer to "External Stores Emergency/Selective Jettison" procedure contained in this Section.

3. Engine instruments – Monitor

At safe position:

4. Throttle – Minimum practical

**WARNING**

LOSS OF AFTERBURNER COULD BE AN EARLY INDICATION OF ENGINE FAILURE OR FIRE. DO NOT RECYCLE AFTERBURNER.

5. Confirm fire

If on fire:

6. Eject

If fire cannot be confirmed:

6. Land – ASAP

**AFTERBURNER SURGE**

Afterburner surge is indicated by:

- unstable feel

- EGT oscillation
- nozzle position indicator oscillation

If decision is made to stop:

1. **ABORT**

If takeoff is continued:

1. **THROTTLE – MILITARY**

**WARNING**

COMPRESSOR STALL AND FLAMEOUT MAY OCCUR IF THROTTLE IS NOT MOVED OUT OF AFTERBURNER DURING SURGE, PREFERABLY BEFORE MORE THAN TWO CYCLES OF SURGE. DO NOT RECYCLE AFTERBURNER.

2. **EXTERNAL STORES – JETTISON (IF NECESSARY)**

Refer to "External Stores Emergency/Selective Jettison" procedures contained in this Section.

3. Land – As soon as practicable

**CAUTION**

DO NOT USE AFTERBURNER UNLESS NECESSARY TO MAINTAIN SAFE FLIGHT.

**AUXILIARY INLET DOOR MALFUNCTION**

If one or both auxiliary doors fail to close:

1. Maintain speed below 340 KIAS
2. ENGINE AIR INLET DOORS switch – CLOSE
3. INLET DOORS OPEN warning light – Extinguished

**NOTE**

With one auxiliary door open and the other closed, the aircraft will roll slowly in the direction of the open door. This roll is easily controlled and requires only a slight amount of aileron to re-trim for wings level flight.

If door(s) may not be closed with manual override:

1. Maintain speed below 340 KIAS
2. Burn off fuel
3. Land

**CAUTION**

- LANDING WITH ONE OR BOTH AUXILIARY DOORS OPEN SHOULD BE PERFORMED WITH AT LEAST 2000 LB OF FUEL REMAINING. THIS IS TO PROVIDE ADEQUATE LONGITUDINAL STABILITY.
- EXTERNAL FUEL TANKS SHOULD BE EMPTY.

**CANOPY OPEN/LOSS/BROKEN DURING TAKEOFF**

If decision is made to stop:

1. ABORT

If takeoff is continued:

1. If canopy is not locked – Jettison
2. Throttle – Maintain takeoff thrust until a safe position

**CAUTION**

DO NOT CHANGE POWER SETTING. THROTTLE MOVEMENT MAY PRECIPITATE AN ENGINE STALL IF ENGINE HAS SUSTAINED FOREIGN OBJECT DAMAGE. ENGINE STALL MAY OCCUR DUE TO PRESSURE CHANGES ACCOMPANYING AFTERBURNER THROTTLING OR SHUTDOWN AS WELL AS IN CHANGING RPM.

3. Keep airspeed below 300 KIAS to minimize windblast and noise, use speed brakes as necessary

If necessary:

4. External stores – Jettison

Refer to "External Stores Emergency/Selective Jettison" procedures contained in this Section.

5. Land – As soon as practicable using "Precautionary Partial Power Pattern" procedure contained in this Section.

**ENGINE FAILURE DURING TAKEOFF**

Engine failure is defined as a complete power failure which, in the pilot's judgment, makes a restart impossible or inadvisable. Examples are engine seizure, explosion, etc.

If decision is made to stop:

1. ABORT

If takeoff is continued:

1. EXTERNAL STORES – JETTISON

Refer to "External Stores Emergency/Selective Jettison" procedure contained in this Section.

**NOTE**

Maximum altitude gain may be achieved by jettisoning stores prior to zoom. The later in the zoom the stores are jettisoned, the less additional altitude will be gained.

## 2. ZOOM, IF POSSIBLE, AND EJECT

If the hung up condition persists a landing with an hung store has to be made.

**WARNING**

EJECT WHILE THE AIRCRAFT HAS A POSITIVE RATE OF CLIMB IN A WINGS-LEVEL ATTITUDE. DO NOT PULL UP TOO RAPIDLY AS THE AIRCRAFT WILL STALL BEFORE ALTITUDE HAS BEEN GAINED, EVEN THOUGH THE INITIAL AIRSPEED SEEMED TO BE ADEQUATE. AT 240 KIAS IT IS POSSIBLE TO ZOOM NEARLY 400 FEET WITH A DEAD ENGINE.

**WARNING**

FOLLOWING AN ATTEMPTED JETTISON OPERATION ANY STORE WHICH DOES NOT SEPARATE FROM THE AIRCRAFT SHOULD BE CONSIDERED UNLOCKED AND SUSCEPTIBLE OF INADVERTENT RELEASE. THE PILOT SHALL BE PREPARED TO EXECUTE AN IMMEDIATE GO AROUND, SHOULD RELEASE OF STORE OCCUR DURING LANDING.

**EXTERNAL STORES EMERGENCY/SELECTIVE JETTISON**

To jettison all external stores during an emergency, use the following procedures:

1. EXT STORES JETTISON button – Press

If a selective jettison has to be carried out or if a store fails to jettison following an emergency jettison:

1. STORE RELEASE selector switch – As required (Relevant WPN ON buttons lit)
2. External stores selector buttons – Press (Relevant SELECT indicator lights lit)
3. Droppable stores release button – Press

**NOTE**

- Refer to Section V "Operating Limitations" for external stores jettisoning speed limit.
- The MRAAM missiles and the related launchers may be only jettisoned through the emergency jettison button.

An unsuccessful jettison of a store is indicated by the relevant "WPN ON" indication light still lit after the emergency and selective jettison attempt and/or by visual check.

**NOTE**

Refer to AER.1F-104S/ASAM-34 for further information.

**ENGINE OIL LEVEL LOW**

The ENGINE OIL LEVEL LOW warning light on indicates oil depletion to 6.4 pints or less.

If decision is made to stop:

1. ABORT

If takeoff is continued:

1. THROTTLE – MAINTAIN TAKEOFF THRUST AND CLIMB

If necessary:

2. EXTERNAL STORES – JETTISON

Refer to "External Stores Emergency/Selective Jettison" procedure contained in this Section.

At safe position:

3. THROTTLE – MILITARY
4. NOZZLE HANDLE – OUT
5. Land – ASAP, using a "Precautionary Partial Power Pattern" procedure contained in this Section.

**EXHAUST NOZZLE FAILS OPEN WITHOUT INDICATION OF ENGINE OIL SYSTEM MALFUNCTION (AFTERBURNING)**

The most probable cause is failure of the nozzle area control amplifier or control alternator.

Indicated by:

- A slight reduction in thrust
- EGT approximately 550° C
- An increase in nozzle area to approximately 10

**NOTE**

Failure will probably not be detected. Afterburner will continue to operate provided throttle is not retarded to sector/core range. As long as afterburning is maintained, immediate corrective action is not required.

If decision is made to stop:

1. **ABORT**

If takeoff is continued:

1. **THROTTLE - MAINTAIN TAKEOFF THRUST**

Sufficient thrust will be available with full afterburning to climb to a safe altitude and to establish a position from which a safe landing with an open nozzle may be accomplished.

At safe position:

2. Throttle - Military
3. Nozzle handle - Out

If nozzle closes:

4. Land - As soon as practicable (monitor EGT with throttle adjustment)

After touchdown:

5. Nozzle handle - In

If nozzle fails to close:

4. External Stores - Jettison if necessary

Refer to "External Stores Emergency/Selective Jettison" procedure contained in this Section.

5. Land - ASAP using "Precautionary Partial Power Pattern" procedure contained in this Section.

**FIRE DURING TAKEOFF**

Illumination of the FIRE warning lights during takeoff requires immediate action. The exact procedure to follow varies with each set of circumstances and depends upon altitude, airspeed, length of runway and overrun clearing remaining, location of populated areas, etc.

Perform the following procedures if possible:

If decision is made to stop:

1. **ABORT**

When aircraft is under positive control:

2. Throttle - OFF

If takeoff is continued:

1. **THROTTLE - MAINTAIN TAKEOFF THRUST TO SAFE POSITION**

If necessary:

2. External stores - Jettison

Refer to "External Stores Emergency/Selective Jettison" procedure contained in this Section.

At safe altitude:

3. **THROTTLE - MINIMUM PRACTICABLE SETTING**

**NOTE**

At safe altitude retarding throttle to minimum practical setting may be beneficial in eliminating fire.

**4. CONFIRM FIRE**

Confirm fire by any possible means such as report from ground, other aircraft, engine instruments, FIRE warning lights, fire warning lights test, smoke in cockpit or visible smoke trail behind aircraft.

**NOTE**

- If FIRE warning lights go out upon power reduction and illuminate during testing, a fire is not likely in the areas where fire detectors are installed.
- If the FIRE warning lights do not illuminate during testing, an explosion may have resulted in serious damage in the areas where fire detectors are installed with a great possibility of fire.

**5. IF ON FIRE – EJECT**

If fire cannot be confirmed but FIRE warning lights remain on or if fire warning lights test fails proceed as follows:

5. Fresh air scoop lever – Open
6. Land – ASAP, using "Precautionary Partial Power Pattern" procedure (contained in this Section) continuously checking for fire

**LANDING GEAR LEVER DOWNLOCK MALFUNCTION**

If the landing gear lever will not move to the UP position when airborne, proceed as follows:

1. Wing flaps – Keep TAKEOFF
2. Airspeed – Keep below 260 KIAS
3. DOWN LOCK MECH OVERRIDE – Press
4. LDG GEAR – UP

**LANDING GEAR RETRACTION FAILURE**

If landing gear lever warning light remains on after lever is UP:

1. Wing flaps – Keep TAKEOFF
2. Airspeed – Keep below 260 KIAS
3. Landing gear – Recycle once at the lowest practical airspeed (T/O + 30 KIAS)

**CAUTION**

IF GEAR IS DAMAGED, RECYCLING MAY CAUSE MORE DAMAGE AND PREVENT GEAR FROM LOCKING IN DOWN POSITION.

If warning light still remains on:

4. LDG GEAR – DOWN
5. Land – As soon as practicable

**NOSEWHEEL SHIMMY**

1. Nosewheel steering – Release

If decision is made to stop:

2. Hold weight off nose gear
3. Throttle – IDLE. If shimmy is severe and conditions permit: Throttle – OFF

**NOTE**

If throttle is moved to the OFF position, nosewheel steering, antiskid brakes, and UHF radio will be lost.

If necessary:

4. External Stores – Jettison

Refer to "External Stores Emergency/Selective Jettison" procedure contained in this Section.

5. HOOK DOWN – Press
6. Drag Chute – Deploy

If takeoff is continued:

2. LDG GEAR – UP immediately after airborne
3. Throttle – Maintain takeoff thrust and climb

At safe position:

4. Check for FOD

If damage is indicated or a nose gear flat tire is suspected:

5. Land – As soon as practicable using "Nose Gear Flat Tire" procedure contained in this Section

**TIRE FAILURE**

The following procedure is recommended when a tire fails during takeoff run. The recommended technique applies to all gross weights and aircraft configurations.

Directional control of the aircraft becomes more difficult as aircraft gross weight increases. With main gear tire failure and less than 150 KIAS, an abort is recommended.

If decision is made to stop:

1. **ABORT**

If takeoff is continued:

1. **THROTTLE – MAINTAIN TAKEOFF THRUST TO SAFE POSITION**

If necessary:

2. **EXTERNAL STORES – JETTISON**

Refer to "External Stores Emergency/Selective Jettison" procedure contained in this Section.

If nose gear tire failed:

3. **LDG GEAR – UP**

**WARNING**

**WITH NOSE GEAR TIRE FAILURE, RETRACT GEAR IMMEDIATELY AFTER AIRBORNE AS ENGINE MAY BE SUBJECTED TO FOREIGN OBJECT DAMAGE.**

4. Land – As soon as practicable, using "Nose Gear Flat Tire" procedure contained in this Section

If main gear tire failed:

3. **LANDING GEAR – DO NOT RETRACT**
4. Tire – Check for fire (another aircraft/tower)
5. Land – As soon as practicable, using "Main Gear Flat Tire" procedure contained in this Section

If no fire is evident and mission dictates that gear retraction is necessary:

5. **ANTI-SKID – OFF**
6. Brakes – Apply
7. **LDG GEAR – UP**
8. **ANTI-SKID – ON**

**IN-FLIGHT EMERGENCIES**

**AIR START/STALL CLEARING**

Indication of compressor stall will be:

- Loss of thrust normally begins with a chug or pop, followed by mild vibration
- EGT – Usually 700° C to 800° C. EGT may be as low as 600° C. If stall persists, may rise above 800° C
- Nozzle wide open
- RPM will decrease and hangup in the 70% to 85% range
- If inlet duct stall is recognized, check for sideslip, correct sideslip with rudder and reduce speed
- For detailed engine compressor stall data, refer to Section I

When engine flameout or compressor stall is recognized, and time and altitude permits, take immediate corrective action:

1. **THROTTLE – OFF**
2. **1 START 2 SWITCHES – START AND HOLD**



3. THROTTLE – IDLE
4. EGT and RPM – Monitor for relight indication (be alert for RPM hangup)

#### NOTE

- The start switches have a holding relay that will give continuous ignition for 45 seconds after each actuation, if electrical power is available.
  - The procedure of throttle-off, start switches-start, throttle-idle reduces the chances of ignitor plug wetting and provide the best known conditions for engine relight and power recovery.
  - On engine relight, RPM hangup may occur (Refer to Section I).
  - In cases of known or suspected foreign-object-damage or if engine RPM hangup or stall occurs, and if time and conditions permit, advance throttle smoothly and slowly until maximum stall free engine operation is obtained. Attempt no further throttle movement until landing is assured.
  - At high altitude (above 25000 feet), to avoid the discomfort of loss of cabin pressurization an immediate air start may be attempted by retarding the throttle to IDLE instead of OFF. This procedure is recommended because of the time lapse to recover engine fuel flow at high altitude, after the throttle off position has been initiated. If engine fails to start or RPM hangs-up, use the normal air start procedure.
  - Air starts above 30000 feet may be slow, therefore, allow 30 seconds before initiating another airstart.
- The conditions inducing the stall are hard to predict. It may however, be assumed that the engine stall margin has been reduced. Therefore, conditions requiring engine stall margin, such as attitude changes, RAT operation and sudden throttle movements should be avoided whenever possible.
  - If maximum obtainable RPM is 93%, a cold shift has occurred. Land as soon as practicable, adjusting pattern for maximum RPM of 93%. Thrust will be equal to, or greater than that obtained at 93% under normal conditions. If the CIT is +38° C or less, there is not restriction on throttle movement in the idle to military range. Afterburner operation should be initiated only in emergencies. With a cold shift, landing should be made with TAKEOFF flaps.
  - In some instances of compressor stall, actuation of the trigger switch to close the variable stator vanes 5° degrees will help effect stall recovery, eliminate RPM hang-up, and prevent subsequent stalls (provided WEAPON FIRING circuit breaker is in closed position). If sufficient time exists during normal stall clearing procedures and indication of stall persists, actuation of the trigger switch to the second detent should be accomplished.

#### WARNING

WHEN CARRYING ARMAMENT, ENSURE THAT THE MASTER ARMT SWITCH IS SET TO "OFF" POSITION PRIOR TO TRIGGER SWITCH ACTUATION.

If relight is not obtained:

5. RAT – Pull, reaccomplish steps 1. through 4. Refer to "Rat Extended Flight" procedure contained in this Section

### J79 ENGINE AIR START ENVELOPE

ALTITUDE  
FT X 10<sup>3</sup>

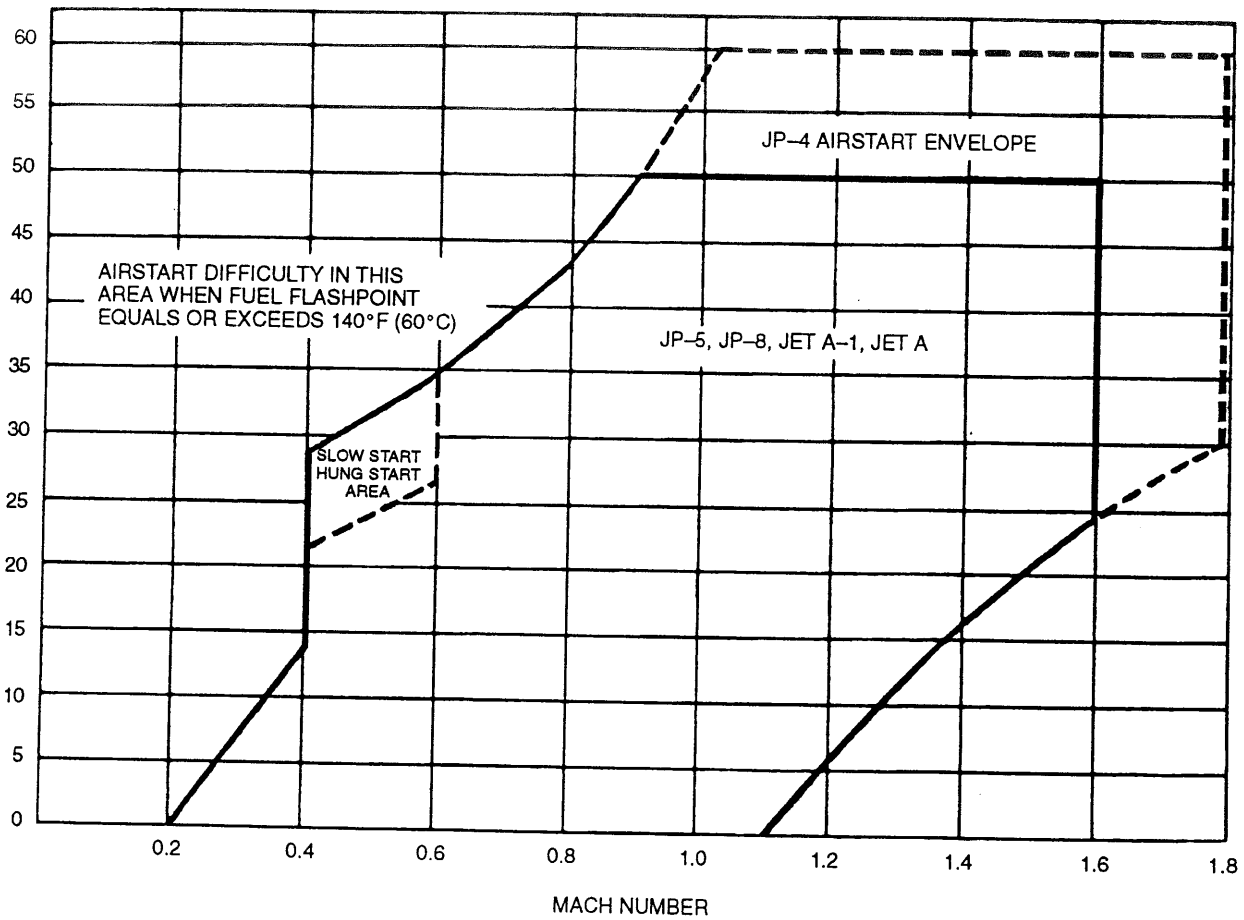

FA0304

Figure 3-3

**NOTE**

- Extending the RAT energizes the XP4 AC bus supplying power to the No. 3 fuel boost pump and energizes PP2 and PP3 DC busses and battery busses. In addition, if the hydraulic generator is not operating, the RAT energizes the XP5 AC bus.
- Do not extend the ram air turbine above 35000 feet as chances of obtaining normal engine operation are remote and the increased drag will reduce glide distance.
- With RAT extended, approximately the same glide distance may be realized at 245 KIAS and TAKEOFF flaps as with 275 KIAS and no flaps. However, the slower speed will result in a lower rate of descent.

If relight and stable flight idle conditions are obtained:

5. Throttle – Slowly advance until required engine thrust is obtained. Attempt no further throttle movement until landing is assured

If adequate thrust is obtained:

6. Land – ASAP during "Precautionary Partial Power Pattern" procedure contained in this Section

If adequate thrust is not obtained:

6. Eject

**AUTO-PITCH CONTROL SYSTEM FAILURE**

If the APC system fails, as indicated by illumination of the AUTO-PITCH CONT OUT warning light, or malfunctions in any way such as giving repeated or unreleased kicks under low angle of attack flight conditions; proceed as follows:

1. Overpower APC kicker, if necessary, to maintain flight attitude. Use emergency disconnect switch (paddle switch)

**NOTE**

Expect resistance and slow stick movement when overpowering the APC kicker. The APC actuator incorporates an orifice which restricts motion of the stick, after the APC kicker has been activated. Under extreme conditions it may be necessary to activate the emergency disconnect switch (paddle switch) with the left hand; this will preclude the necessity to release the existing back pressure on the control stick grip.

2. APC CUT-OUT switch – OFF

**NOTE**

The APC kicker will be deactivated automatically whenever the AUTO-PITCH CONT OUT warning light is illuminated. Turning the APC CUT-OUT switch off is an added safety measure.

3. Observe the stick shaker boundary as kicker will be inoperative

**NOTE**

- Any transient in electrical supply will usually cause momentary illumination of the AUTO-PITCH CONT OUT warning light (i.e.: transfer from XP5 to XP4 bus). This is a characteristic rather than a malfunction of the system. It is not necessary to switch the APC off in this case. High angle of attack maneuvering should be avoided as condition may occur again.

- If transfer of electrical power from the XP5 AC bus to the XP4 AC bus caused the APC operation, the FIXED FREQ OUT warning light will illuminate. Resetting back to the fixed frequency bus can cause momentary APC operation. However, if safe flight conditions may be assured the APC kicker may be reactivated at the pilot's discretion.

**Stick Shaker Failure**

1. STICK SHAKER circuit breaker – Pull

If the stick shaker circuit breaker is pulled to deactivate the stick shaker for any reason, the AUTO-PITCH CONT OUT warning light will illuminate. Since the AUTO-PITCH CONT OUT warning light is illuminated, further visual indication of APC kicker malfunction will be lost.

Under low altitude conditions, with gear and flaps UP wherein the stick shaker circuit breaker has been pulled, continue as follows:

2. APC CUT-OUT switch – OFF
3. Exercise extreme care to avoid abrupt maneuvers, low airspeeds, or maneuvers requiring operation at high angle of attack
4. Land using a "Precautionary Straight-In Pattern" procedure contained in this Section

**BLEED AIR DUCT SEPARATION/FALSE RPM RESET**

If FIRE warning lights illuminate during flight and there are no other indications of fire, a possible cause is leakage of hot compressor air from BLC or other bleed air ducts into the engine compartment where it may impinge against the fire warning detectors. One indication of this type of failure is the warning lights are likely to go out after a minute or two of operation at idle RPM, because retarding the throttle reduces the volume and temperature of compressor bleed air.

Further indications of this type of failure depend on the location of the leak and may include loss of cockpit pressurization, RPM reset actuation, and a severe rolloff tendency when the flaps are moved to the LAND position.

The rolloff tendency is an indication of BLC duct separation on one side resulting in asymmetric BLC airflow; therefore, it affords a means of checking for BLC duct separation at a safe altitude and airspeed (240 KIAS maximum).

RPM reset actuation may occur if duct failure permits hot compressor air to contact the CIT sensor. In this case, the RPM could increase to maximum allowable and remain in the RPM reset range regardless of throttle position. (During RPM reset operation, retarding the throttle below military will not reduce RPM, but will reduce thrust because the exhaust nozzle will open).

False RPM reset may be caused by:

- Leakage of hot compressor air from BLC or other bleed air ducts into the engine compartment
- Fuel leakage in main fuel control (servo line MFC-CIT)
- Fire

False RPM reset may be assumed with the following instrument readings:

- RPM: maximum allowable
- CIT: below 70° C

If bleed air duct separation or false RPM reset is indicated, proceed as follows:

1. Throttle – Minimum practical, confirm fire
2. Oxygen – 100%
3. Airspeed – Keep above 300 KIAS as long as possible
4. Landing gear – Keep up as long as practical

**NOTE**

It is advisable to keep the gear up as long as possible to keep the secondary airflow by-pass flaps open.

**WARNING**

IF A BLC DUCT SEPARATION IS INDICATED, DO NOT PLACE THE WING FLAPS LEVER TO THE LAND POSITION IN THE LANDING PATTERN BECAUSE THIS MAY RESULT IN A SEVERE ROLLOFF DUE TO ASYMMETRIC AIRFLOW OVER THE FLAPS.

5. Land – ASAP, using "Precautionary Straight-In Pattern" procedure contained in this Section

Immediately after touchdown:

6. Throttle – IDLE (OFF for fire)

7. Use optimum braking
8. Use nosewheel steering to position aircraft on runway centerline for possible barrier engagement (refer to Figure 3-2)

If false RPM reset persists:

9. Throttle – OFF

#### NOTE

Nosewheel steering and antiskid/power brakes will be inoperative when engine speed drops below 65% RPM. Directional control shall then be maintained by the standby brakes and rudder. Standby brakes may be used above 65% RPM by turning off the ANTI-SKID switch.

10. Drag chute – Deploy, observing drag chute limits

#### CAUTION

HIGH EXHAUST GAS VELOCITY COMBINED WITH EXCESSIVE AIRSPEED MAY FAIL THE DRAG CHUTE; THEREFORE, DEPLOY THE CHUTE AT MINIMUM PRACTICAL AIRSPEED.

#### CANOPY OPEN/LOSS/BROKEN DURING FLIGHT

If canopy is not locked:

1. Canopy – Jettison
2. Attain safe altitude
3. Slow the aircraft to 300 KIAS or less to minimize windblast and noise
4. Land – As soon as practicable

#### WARNING

- IN ANY CASE OF LOSS, OPENING OR BROKEN CANOPY, THE ENGINE MAY SUSTAIN FOREIGN OBJECT DAMAGE. THEREFORE, BE PREPARED TO FOLLOW ENGINE STALL CLEARING PROCEDURE.
- LOSS OF CANOPY IN SUPERSONIC FLIGHT MAY CAUSE SUFFICIENT PRESSURE CHANGE AT ENGINE INLET DUCTS TO CAUSE COMPRESSOR STALL OR ENGINE FLAMEOUT. FOREIGN OBJECT DAMAGE MAY NOT BE INVOLVED. THEREFORE, STALL CLEARING OR AIR START PROCEDURES SHOULD BE PERFORMED AS APPLICABLE.

#### COCKPIT PRESSURIZATION MALFUNCTION

Separation of the hot air duct at the refrigerator inlet may cause a loss of cockpit pressurization, damage to wiring, and subsequent failure of the electrical system. The electrical system failure may occur within a few minutes from hot compressor air melting the insulation on the wiring in the electrical compartment located behind the cockpit.

If the fresh air scoop is opened promptly after the cockpit pressure loss is recognized, the bleed air shutoff valve will shut off the hot air and prevent failure of the electrical system.

If cockpit pressurization reduces substantially and the cause is not apparent, proceed as follows:

1. Start immediate descent to 25000 feet (or lower if circumstances permit)

If complete pressure loss is experienced or if at a safe flight level for depressurization:

2. Fresh air scoop lever – Open
3. Oxygen regulator – Adjust as necessary

**EJECTION — GENERAL CONSIDERATION**

The basic ejection procedure is shown in Figure 3-4.

**Ejection Versus Flame-Out Landing**

In general flame-out landings are not recommended. Because of the many variables encountered, the final decision to attempt a flame-out landing or to eject shall remain with the pilot.

These variables make a quick and correct decision difficult. Furthermore, it is impossible to establish a predetermined set of rules and instructions which would provide a ready-made decision applicable to all emergencies of this nature because unique circumstances will be associated with each such emergency. Ejection is generally the best course of action unless the following basic conditions exist.

- a. Flame-out landings should be attempted only by pilots who have thorough and recent experience performing simulated flame-out landings.
- b. Flame-out landings should be attempted only on prepared or designated suitable surfaces that provide at least twice the landing distance normally required.
- c. Approaches to the landing field shall be unrestricted (clear area approximately 3000-5000 feet long).

**NOTE**

If a suitable area is available to abandon the aircraft, no attempt should be made to land a flamed-out aircraft at any field whose approaches are over heavily populated terrain.

- d. Weather and terrain conditions shall be favorable. Cloud cover, ceiling, visibility, turbulence, surface wind, etc., shall not impede in any manner the establishment of a proper flame-out landing pattern.

- e. If a flame-out landing is to be made it usually should be attempted when either a satisfactory High Key or Low Key position may be achieved.

**WARNING**

DO NOT ATTEMPT NIGHT FLAME-OUT LANDINGS, OR FLAME-OUT LANDINGS UNDER POOR LIGHTING CONDITIONS SUCH AS AT DUSK OR DAWN REGARDLESS OF WEATHER OR FIELD LIGHTING.

- f. If at any time during the flame-out approach conditions do not appear ideal for successful completion of the landing, ejection should be accomplished. Due to the high rate of descent ejection should be no later than Low Key altitude.
- g. If conditions a. through e. are favorable, the pilot should further evaluate the condition of the aircraft, the type of emergency and his own proficiency, before making a decision.

**Ejection Clearance**

Cockpit knee clearance during ejection is 3.5 inches for a pilot with buttock-to knee length of 25.9 inches. Ejection-through-the-canopy clearance is 1.7 inches.

These measurements are based on a pilot wearing the flying suit orange (or gray) and a HGU 2AP helmet.

**Ejection Attitudes**

During any low altitude ejection, the chances for successful ejection may be greatly increased by zooming the aircraft (if airspeed permits) to exchange airspeed for altitude.

## EJECTION PROCEDURE

IF TIME AND CONDITIONS PERMIT -

- 1 REDUCE SPEED

**WARNING:**

HIGH SPEED EJECTION MAY INVOLVE MASK AND HELMET LOSS. THIS CONDITION MAY BE DANGEROUS AT HIGH ALTITUDES BECAUSE EMERGENCY OXYGEN CAN NOT BE USED.

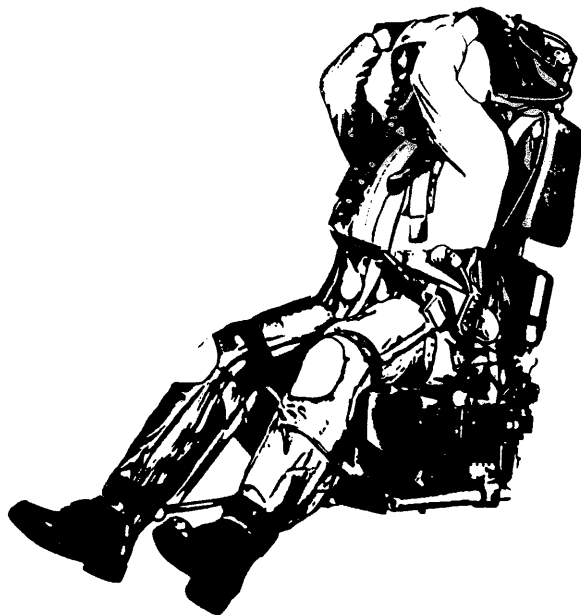

- 2 TRANSMIT LOCATION AND INTENTION TO NEAREST RADIO FACILITY AND TURN IFF TO EMERGENCY
- 3 HEAD AIRCRAFT TOWARDS UNPOPULATED AREA. IF TIME AND CONDITIONS PERMIT, THROTTLE IDLE PRIOR TO EJECTION
- 4 NOZZLE CLOSURE HANDLE - IN
- 5 LOWER VISOR
- 6 LEAVE FEET ON RUDDER PEDALS

GRASP THE PRIMARY FIRING HANDLE WITH BOTH HANDS, KNUCKLES FACING FORWARD AND ELBOWS AS CLOSE TOGETHER AS POSSIBLE. PULL THE PRIMARY FIRING HANDLE SMARTLY DOWNWARD TO ITS FULL EXTENT DRAWING THE FACE SCREEN OVER THE FACE

**NOTE**

THE SECONDARY FIRING HANDLE SHOULD BE USED IF DUE TO INJURIES, ACCELERATION FORCES OR OTHER CIRCUMSTANCES THE PRIMARY FIRING HANDLE CANNOT BE REACHED.

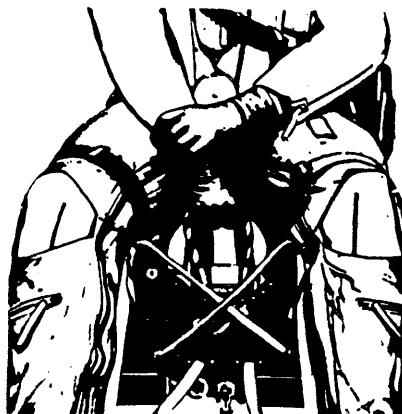

IF ACTUATING THE SEAT BY MEANS OF SECONDARY FIRING HANDLE, GRIP HANDLE WITH ONE HAND AND PLACE THE OTHER HAND AROUND THE WRIST, THE EJECTION SEQUENCE REMAINS THE SAME.

**NOTE**

IN THE EVENT THE CANOPY FAILS TO JETTISON, THE PILOT WILL EJECT THROUGH THE CANOPY.

**WARNING:**

DURING CRITICAL LOW ALTITUDE EJECTION INVOLVING ROLLING MANEUVERS AN ATTEMPT SHOULD BE MADE TO HOLD WINGS LEVEL OR REDUCE THE ROLLING WHILE EJECTING. THIS CAN BE ACCOMPLISHED BY FLYING THE AIRCRAFT WITH ONE HAND AND PULLING THE SECONDARY FIRING HANDLE WITH THE OTHER HAND.

32084

Figure 3-4

Ejection should be accomplished while the aircraft is in a positive climb whenever possible. This will result in more altitude and time for seat separation and parachute deployment.

### Ejection Altitudes

A safe ejection may be carried out from zero altitude to zero speed when the aircraft is in a level attitude. To increase the escape chance it is strongly recommended to use optimum altitude and speed whenever possible, especially when considering the extremely high sink rate possible in this type of aircraft. For minimum safe ejection altitudes under various conditions of speed and dive angles, refer to Figure 3-5.

When ejections are carried out at altitudes above 16400 ft, parachute deployment will be delayed by the barostat until the seat and man have descended to approximately 16400 ft. During this time the seat will be stabilized by the drogue system but may rotate about its vertical axis. This rotation is not abnormal and the pilot should wait for the parachute to be automatically deployed at approximately 16400 ft.

### Ejection Speed

The Mk.IQ7(A) seat may be safely used throughout the speed range of the aircraft from zero speed at zero altitude to the highest speeds likely to be encountered.

Although very high indicated airspeed ejections are rare, a successful emergency ejection has been carried out in a Martin Baker-seat at a speed in excess of 700 KIAS employing the same speed control principles as the IQ7(A) seat.

If time and conditions permit, a speed of approximately 250 KIAS should be selected for a controlled ejection.

### BEFORE EJECTION

If time and conditions permit:

1. Reduce speed

### WARNING

HIGH SPEED EJECTION MAY INVOLVE MASK AND HELMET LOSS. THIS CONDITION MAY BE DANGEROUS AT HIGH ALTITUDES, BECAUSE EMERGENCY OXYGEN CANNOT BE USED.

2. Transmit location and intention to nearest radio facility and turn IFF to EMER
3. Head aircraft towards unpopulated area if time and conditions permit, throttle IDLE prior to ejection
4. Nozzle handle - In
5. Lower visor
6. Leave feet on rudder pedals

### EJECTION

Refer also to Figure 3-4.

1. ASSUME EJECTION POSITION
2. PULL FIRING HANDLE WITH BOTH HANDS

Grasp the primary firing handle with both hands, knuckles facing forward and elbows as close together as possible. Pull the primary firing handle smartly downward to its full extent drawing the face screen over the face.

### NOTE

The secondary firing handle should be used if due to injuries, acceleration forces or other circumstances the primary firing handle cannot be reached.

If actuating the seat by means of secondary firing handle, grip handle with one hand and place the other hand round the wrist, the ejection sequence remains the same.



### MINIMUM SAFE EJECTION ALTITUDES AT VARIOUS DEGREES OF DIVE ANGLES

NOTE

- 1 ALTITUDES ARE CALCULATED FROM EJECTION GUN INITIATION AND THEREFORE MAKE NO ALLOWANCE FOR AIRCRAFT CANOPY DELAY, PILOT'S REACTION TIME OR ANY PRE-EJECTION ACTION.
- 2 CALCULATIONS ARE MADE ASSUMING A WINGS LEVEL ATTITUDE, SO ADDITIONAL ALTITUDE IS REQUIRED IF THE AIRCRAFT IS BANKED.

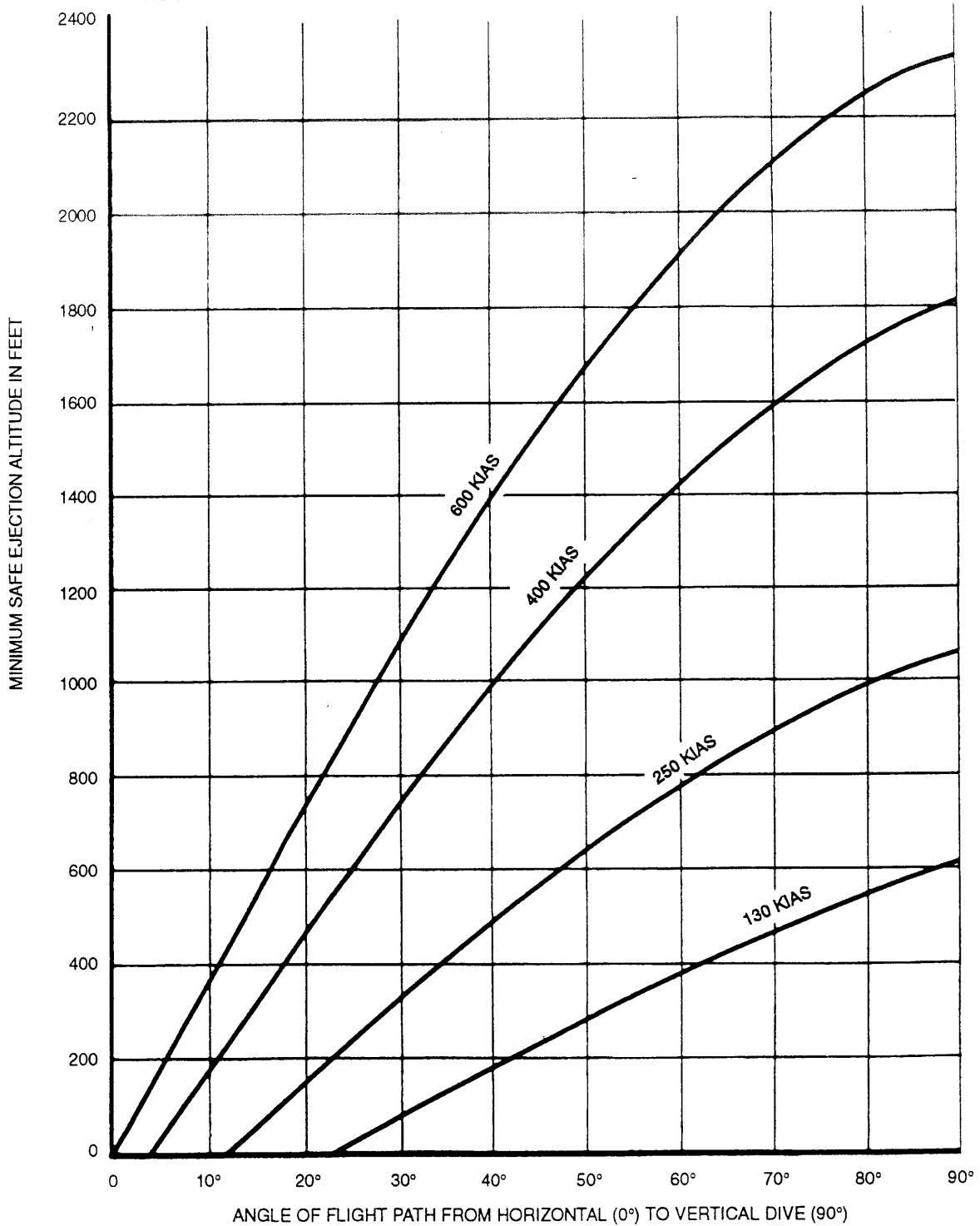

FA0340

Figure 3-5

**NOTE**

In the event the canopy fails to jettison, the pilot will eject through the canopy.

**WARNING**

DURING CRITICAL LOW ALTITUDE EJECTION INVOLVING ROLLING MANEUVERS AN ATTEMPT SHOULD BE MADE TO HOLD WINGS LEVEL OR REDUCE THE ROLLING WHILE EJECTING. THIS CAN BE ACCOMPLISHED BY FLYING THE AIRCRAFT WITH ONE HAND AND PULLING THE SECONDARY FIRING HANDLE WITH THE OTHER HAND.

**Ball-Out Without Ejection Seat**

If seat fails to eject proceed as follows:

1. Pull the manual override handle. This action will cause separation from the ejection seat

**NOTE**

If time permits, release and unlace leg straps and recheck the pilots PEC portion disconnect.

2. Jettison canopy
3. Abandon the aircraft
4. Pull parachute D-ring to deploy the parachute when clear of the aircraft and below parachute barometric setting

**Manual Separation From Seat After Ejection**

If the seat automatic sequence fails after ejection, proceed as follows:

1. Pull the manual override handle. This action will cause separation from the ejection seat

2. Push off the seat
3. Pull parachute D-ring to deploy the parachute when clear of the seat and below parachute barometric setting

**AFTER EJECTION****After Seat/Man Separation**

1. Throw off face blind and check parachute canopy
2. Oxygen mask – Release
3. Life jacket – Inflate
4. Quick release box safety clip – Out
5. Prepare for landing, close your legs
6. After landing rotate and press quick release box disc

**NOTE**

- Survival pack may be released at pilot's discretion.
- If landing on terrain is confirmed and survival pack was released, disconnect dinghy lowering line shortly before touchdown.

**SMOKE OR FUMES IN COCKPIT**

If smoke or fumes enter the cockpit proceed as follows:

1. OXYGEN DILUTER LEVER – 100%
2. Descend to 25000 feet or lower if circumstances permit

3. Fresh air scoop lever – Open

If smoke persists:

4. Land – ASAP. Jettison canopy if necessary

5. If it can be determined that the smoke is caused by an electrical fire, use Electrical Fire procedures

<b>CAUTION</b>
----------------

<b>WARNING</b>
----------------

- ALL FUEL BOOST PUMPS ARE NOT AVAILABLE WHEN BOTH WILD FREQUENCY GENERATORS ARE OFF OR FAILED AND, WHEN REMAINING FUEL (INTERNAL) IS BELOW 1000 LBS, A FLAMEOUT COULD OCCUR IF RAT FAILS TO POWER NO. 3 FUEL BOOST PUMP. MOREOVER FLIGHT WITH NO. 3 FUEL BOOST PUMP POWERED BY RAT AND 1000 LBS. OR LESS INTERNAL FUEL REMAINING, SHOULD BE PERFORMED IN NOSE UP FLIGHT ATTITUDE WITH EASY COORDINATED MANEUVERS AND NEGLIGIBLE DECELERATION FORCES. FLIGHT WITH NOSE DOWN AT THIS FUEL LOAD MAY ALLOW THE NO. 3 FUEL BOOST PUMP TO CAVITATE RESULTING IN SUBSEQUENT ENGINE FLAME OUT. ILLUMINATION OF THE FUEL BOOST PUMPS WARNING LIGHT UNDER THESE CONDITIONS MAY NOT PROVIDE ADEQUATE WARNING TO TAKE CORRECTIVE ACTIONS AND PREVENT AN ENGINE FLAME OUT.
- LANDING WITH RAT EXTENDED AND 1000 LBS. OR LESS REMAINING FUEL SHOULD BE PERFORMED FOLLOWING "PRECAUTIONARY STRAIGHT-IN PATTERN" PROCEDURE.

- WHEN BOTH WILD FREQUENCY GENERATORS ARE OFF OR FAILED, THE EXTERNAL FUEL QUANTITY INDICATION ARE NOT AVAILABLE AND FUEL DATA ARE FROZEN. WHEN RAT IS EXTENDED, THE INTERNAL FUEL QUANTITY INDICATION IS AVAILABLE EXCEPT WHEN FLAPS/SLATS ARE OPERATED: IN THIS CONDITION FUEL QUANTITY DATUM IS TEMPORARILY FROZEN.
- WHEN BOTH WILD FREQUENCY GENERATORS ARE OFF OR FAILED, NO WARNING LIGHTS (EXCEPT FIRE) ARE AVAILABLE UNTIL RAT IS EXTENDED.

#### ELECTRICAL FIRE

Circuit breakers and fuses protect most of the circuits and tend to prevent electrical fires; however, if electrical fire occurs, proceed as follows:

1. Oxygen diluter lever – 100%
2. Fresh air scoop lever – Open
3. Descent to 25000 ft or lower if circumstances permit
4. Generator switches – OFF/RESET
5. Clock – Hack (calculate fuel remaining using fuel flow indicator)
6. All electrical accessory switches – OFF
7. Generator switches – ON (one by one needed)

8. Operate only those units necessary for safe flight and landing
9. Return generator switches to OFF/RESET position when operation is complete
10. Land – ASAP

**WARNING**

- ALL FUEL BOOST PUMPS ARE NOT AVAILABLE WHEN BOTH WILD FREQUENCY GENERATORS ARE OFF OR FAILED AND, WHEN REMAINING FUEL (INTERNAL) IS BELOW 1000 LBS, A FLAMEOUT COULD OCCUR IF RAT FAILS TO POWER NO. 3 FUEL BOOST PUMP. MOREOVER FLIGHT WITH NO. 3 FUEL BOOST PUMP POWERED BY RAT AND 1000 LBS. OR LESS INTERNAL FUEL REMAINING, SHOULD BE PERFORMED IN NOSE UP FLIGHT ATTITUDE WITH EASY COORDINATED MANEUVERS AND NEGLIGIBLE DECELERATION FORCES. FLIGHT WITH NOSE DOWN AT THIS FUEL LOAD MAY ALLOW THE NO. 3 FUEL BOOST PUMP TO CAVITATE RESULTING IN SUBSEQUENT ENGINE FLAME OUT. ILLUMINATION OF THE FUEL BOOST PUMPS WARNING LIGHT UNDER THESE CONDITIONS MAY NOT PROVIDE ADEQUATE WARNING TO TAKE CORRECTIVE ACTIONS AND PREVENT AN ENGINE FLAME OUT.
- LANDING WITH RAT EXTENDED AND 1000 LBS. OR LESS REMAINING FUEL SHOULD BE PERFORMED FOLLOWING "PRECAUTIONARY STRAIGHT-IN PATTERN" PROCEDURE.

**CAUTION**

- WHEN BOTH WILD FREQUENCY GENERATORS ARE OFF OR FAILED, THE EXTERNAL FUEL QUANTITY INDICATION ARE NOT AVAILABLE AND FUEL DATA ARE FROZEN. WHEN RAT IS EXTENDED, THE INTERNAL FUEL QUANTITY INDICATION IS AVAILABLE EXCEPT WHEN FLAPS/SLATS ARE OPERATED: IN THIS CONDITION FUEL QUANTITY DATUM IS TEMPORARILY FROZEN.
- WHEN BOTH WILD FREQUENCY GENERATORS ARE OFF OR FAILED, NO WARNING LIGHTS (EXCEPT FIRE) ARE AVAILABLE UNTIL RAT IS EXTENDED.

**ELECTRICAL POWER SUPPLY SYSTEM FAILURE**

**NOTE**

Refer to Figure 3-6 for a summary table of electrical power supply system failure.

**Single AC (WF) Generator Failure**

Following a single generator failure the XP3 bus and utilities are lost.

If either generator-out warning light illuminates, perform the following procedure:

1. Corresponding generator switch OFF/RESET then ON (check generator warning light extinguished)

If failure confirmed:

2. Failed generator – OFF/RESET

## ELECTRICAL POWER SUPPLY SYSTEM FAILURES SUMMARY TABLE

NOTE: REFER TO THE APPLICABLE FOLDS-OUT FOR UTILITIES LOST

TYPE OF FAILURE	WARNING INDICATION(S) ON WARNING LIGHTS PANEL	BUSSES AVAILABLE AND POWER SOURCES											
		XP1	XP2	XP3	XP4	XP5	XP6	XP7	PP1	PP2	PP3	PP4	PP5
WF GENERATOR 1 FAILURE	GENERATOR NO. 1 OUT	X XP2	X GEN2		X XP2	X GEN3	X XP5	X XP5	X TRU1	X PP1	X PP1	X TRU2	X TRU2
WF GENERATOR 2 FAILURE	GENERATOR NO. 2 OUT	X GEN1	X XP1		X XP2	X GEN3	X XP5	X XP5	X TRU1	X PP1	X PP1	X TRU2	X TRU2
WF GENERATORS 1 AND 2 FAILURE	NONE					X GEN3	X XP5					X BATT1	X BATT2
WF GENERATORS 1 AND 2 FAILURE (RAT EXTENDED)	GENERATOR NO. 1 OUT GENERATOR NO. 2 OUT PRIMARY DC BUS OUT (1)				X RAT	X GEN3	X XP5			X TRU2 (2)	X TRU2	X TRU2	X TRU2
FF GENERATOR FAILURE	FIXED FREQ OUT	X GEN1	X GEN2	X XP1	X XP2	X XP4	X XP5	X XP5	X TRU1	X PP1	X PP1	X TRU2	X TRU2
FF GENERATOR FAILURE WITH MRAAM POWER SWITCH SET TO AUTO OR RUN	FIXED FREQ OUT AND AIM 7E PWR OUT	REFER TO FF GENERATOR FAILURE											
XP1 BUS SHORT CIRCUIT	GENERATOR NO. 1 OUT		X GEN2		X XP2	X GEN3	X XP5	X XP5	X TRU1	X PP1	X PP1	X TRU2	X TRU2
XP2 BUS SHORT CIRCUIT	NONE	X GEN1				X GEN3	X XP5	X XP5				X BATT1	X BATT2
XP2 BUS SHORT CIRCUIT (RAT EXTENDED)	GENERATOR NO. 2 OUT PRIMARY DC BUS OUT (1)	X GEN1			X RAT	X GEN3	X XP5	X XP5		X TRU2 (2)	X TRU2	X TRU2	X TRU2
XP3 BUS SHORT CIRCUIT	GENERATOR NO. 1 OUT		X GEN2		X XP2	X GEN3	X XP5	X XP5	X TRU1	X PP1	X PP1	X TRU2	X TRU2
XP4 BUS SHORT CIRCUIT	NONE	X GEN1	X GEN2	X XP1		X GEN3	X XP5	X XP5	X TRU1	X PP1	X PP1	X BATT1	X BATT2
XP5 BUS SHORT CIRCUIT	FIXED FREQ OUT	X GEN1	X GEN2	X XP1					X TRU1	X PP1	X PP1	X BATT1	X BATT2
26 V AC TRANSFORMER FAILURE	NONE	X GEN1	X GEN2	X XP1	X XP2	X GEN3		X XP5	X TRU1	X PP1	X PP1	X TRU2	X TRU2
XP6 BUS SHORT CIRCUIT	NONE	X GEN1	X GEN2	X XP1	X XP2	X GEN3		X XP5	X TRU1	X PP1	X PP1	X TRU2	X TRU2
XP7 BUS SHORT CIRCUIT	FIXED FREQ OUT	X GEN1	X GEN2	X XP1					X TRU1	X PP1	X PP1	X BATT1	X BATT2
TRU1 FAILURE	PRIMARY DC BUS OUT	X GEN1	X GEN2	X XP1	X XP2	X GEN3	X XP5	X XP5		X TRU2 (2)	X TRU2	X TRU2	X TRU2

Figure 3-6 (Sheet 1 of 2)

## ELECTRICAL POWER SUPPLY SYSTEM FAILURES SUMMARY TABLE

TYPE OF FAILURE	WARNING INDICATION(S) ON WARNING LIGHTS PANEL	BUSES AVAILABLE AND POWER SOURCES												
		XP1	XP2	XP3	XP4	XP5	XP6	XP7	PP1	PP2	PP3	PP4	PP5	
TRU2 FAILURE	NONE	X GEN1	X GEN2	X XP1	X XP2	X GEN3	X XP5	X XP5	X TRU1	X PP1	X PP1	X BATT1	X BATT2	
DOUBLE TRU FAILURE	NONE	X GEN1	X GEN2	X XP1	X XP2	X GEN3	X XP5	X XP5				X BATT1	X BATT2	
PP1 SHORT CIRCUIT	PRIMARY DC BUS OUT	X GEN1	X GEN2	X XP1	X XP2	X GEN3	X XP5	X XP5		X TRU2 (2)	X TRU2	X TRU2	X TRU2	
PP2 SHORT CIRCUIT	NONE	X GEN1	X GEN2	X XP1	X XP2	X GEN3	X XP5	X XP5	X TRU1		X PP1	X TRU2	X TRU2	
PP3 SHORT CIRCUIT	NONE	X GEN1	X GEN2	X XP1	X XP2	X GEN3	X XP5	X XP5	X TRU1	X PP1		X TRU2	X TRU2	
PP4 SHORT CIRCUIT	NONE	X GEN1	X GEN2	X XP1	X XP2	X GEN3	X XP5	X XP5	X TRU1	X PP1	X PP1		X TRU2	
PP5 SHORT CIRCUIT	NONE	X GEN1	X GEN2	X XP1	X XP2	X GEN3	X XP5	X XP5	X TRU1	X PP1	X PP1	X TRU2		

### WARNING

FAILURE OF BATT1 OR BATT2, OR FAILURE OF BOTH BATT1 AND BATT2 CAUSES THE PP4 OR/AND PP5 NOT TO BE SUPPLIED BY THE RESPECTIVE BATTERY.

### NOTES:

- (1) If No. 1 emergency DC BUS (PP2) is not energized there will be no warning light indication.
- (2) PP2 temporarily inoperative when operating flaps/slats.

Figure 3-6 (Sheet 2 of 2)

**NOTE**

Following a single AC (WF) generator failure, the remaining generator is able to power all the busses and their utilities which are, in normal condition, electrically powered by the failed generator provided that the relevant contactor switches to the transfer position. Following the No. 1 generator failure, if the No. 1 generator contactor fails to switch to the transfer position, the XP1, XP3 and their utilities are lost. Following the No. 2 generator failure, if the No. 2 generator contactor fails to switch to the transfer position, the XP2, XP3, XP4, PP1, PP2 and PP3 busses and their utilities are lost: as a consequence also the warning lights panel is lost. Only the FIRE warning lights as well as the arresting hook indicator light are available. Extension of the RAT will restore power to XP4, PP2 and PP3 busses and utilities. In this condition the XP2, XP3 and PP1 busses and utilities are not available. Successful RAT operation is confirmed by the illumination of the GENERATOR NO. 1 OUT or GENERATOR NO. 2 OUT warning light on the warning lights panel.

If warning lights panel is operative (i.e. GENERATOR NO. 1 OUT or GENERATOR NO. 2 OUT warning light lit):

3. Land – As soon as practicable

If warning lights panel is inoperative (i.e. GENERATOR NO. 1 OUT and GENERATOR NO. 2 OUT warning lights out):

3. RAT – Pull (refer to "RAT Extended Flight" procedure contained in this Section)
4. Land – As soon as practicable using "RAT Extended Flight" and "Precautionary Straight-In Pattern" procedures contained in this Section

#### **Double AC (WF) Generator Failure/Automatic Bus Transfer System Failure**

Following a double generator failure the XP1, XP2, XP3, XP4, XP7, PP1, PP2 and PP3 busses and their utilities are lost.

For a double AC (WF) generator failure/automatic bus transfer system failure the indication will be:

- flaps position indicators: barber pole
- UHF radio available for 5 minutes
- only the FIRE warning lights as well as the arresting hook indicator light are available.

The warning lights panel is inoperative.

**CAUTION**

THE GENERATOR NO. 1 OUT AND GENERATOR NO. 2 OUT WARNING LIGHTS SHALL BE LIT, ON THE WARNING LIGHTS PANEL, ONLY FOLLOWING RAT EXTENSION.

**NOTE**

The PRIMARY DC BUS OUT warning light shall be also lit only following RAT extension.

If transmitting:

1. Radar – SBY
2. Generator switches – OFF/RESET, then ON

The successful reset is indicated by the availability of some utilities.

If only one generator is restored (and electrical power supply system is operating properly - i.e. failed generator contactor switches to the transfer position as indicated by the illumination of either the GENERATOR NO. 1 OUT or GENERATOR NO. 2 OUT warning light on the warning light panel):

3. Failed generator – OFF/RESET
4. Land – As soon as practicable

If both generators are not restored (warning lights panel not operative):

3. Generator switches – OFF/RESET
4. RAT – Pull (refer to "RAT Extended Flight" procedure contained in this Section)

**NOTE**

Refer to Figure 3-6 for busses available/not available following RAT extension.

5. Land — As soon as practicable using "Rat Extended Flight" and "Precautionary Straight-In Pattern" procedures contained in this Section

**WARNING**

- ALL FUEL BOOST PUMPS ARE NOT AVAILABLE WHEN BOTH WILD FREQUENCY GENERATORS ARE OFF OR FAILED AND, WHEN REMAINING FUEL (INTERNAL) IS BELOW 1000 LBS, A FLAMEOUT COULD OCCUR IF RAT FAILS TO POWER NO. 3 FUEL BOOST PUMP. MOREOVER FLIGHT WITH NO. 3 FUEL BOOST PUMP POWERED BY RAT AND 1000 LBS. OR LESS INTERNAL FUEL REMAINING, SHOULD BE PERFORMED IN NOSE UP FLIGHT ATTITUDE WITH EASY COORDINATED MANEUVERS AND NEGLIGIBLE DECELERATION FORCES. FLIGHT WITH NOSE DOWN AT THIS FUEL LOAD MAY ALLOW THE NO. 3 FUEL BOOST PUMP TO CAVITATE RESULTING IN SUBSEQUENT ENGINE FLAME OUT. ILLUMINATION OF THE FUEL BOOST PUMPS WARNING LIGHT UNDER THESE CONDITIONS MAY NOT PROVIDE ADEQUATE WARNING TO TAKE CORRECTIVE ACTIONS AND PREVENT AN ENGINE FLAME OUT.



- LANDING WITH RAT EXTENDED AND 1000 LBS. OR LESS REMAINING FUEL SHOULD BE PERFORMED FOLLOWING "PRECAUTIONARY STRAIGHT-IN PATTERN" PROCEDURE.

**CAUTION**

- WHEN BOTH WILD FREQUENCY GENERATORS ARE OFF OR FAILED, THE EXTERNAL FUEL QUANTITY INDICATION ARE NOT AVAILABLE AND FUEL DATA ARE FROZEN. WHEN RAT IS EXTENDED, THE INTERNAL FUEL QUANTITY INDICATION IS AVAILABLE EXCEPT WHEN FLAPS/SLATS ARE OPERATED: IN THIS CONDITION FUEL QUANTITY DATUM IS TEMPORARILY FROZEN.
- WHEN BOTH WILD FREQUENCY GENERATORS ARE OFF OR FAILED, NO WARNING LIGHTS (EXCEPT FIRE) ARE AVAILABLE UNTIL RAT IS EXTENDED.

**Hydraulically Driven Fixed-Frequency Generator Out**

If the FIXED FREQ OUT warning light illuminates the hydraulically driven generator has been disconnected from the XP5, XP6 and XP7 busses. A relay connects variable-frequency power from the XP4 AC bus to the XP5, XP6 and XP7 AC busses.

Fixed frequency powered flight instruments operate adequately on wild-frequency; however, the NASARR system will be inoperative and the inertial navigation system operation will be degraded.

If a nonpersistent type of failure has caused the generator to be disconnected proceed as follows:

1. Autopilot and APC emergency disengage switch (paddle switch) – Actuate and hold before and during all reset operations, then release
2. FIXED FREQ RESET button – Press for at least 5 seconds. Check FIXED FREQ OUT warning light extinguished

If warning light is still illuminated (and conditions permit):

3. RADAR – OFF

**WARNING**

PROBLEM MAY BE HYDRAULIC RATHER THAN ELECTRIC. IF THE PROBLEM IS HYDRAULIC, CONTINUED ATTEMPTS TO RESET THE FIXED-FREQUENCY GENERATOR COULD RESULT IN LOSS OF HYDRAULIC FLUID.

4. FIXED FREQ RESET button – Press for at least 5 seconds. Check FIXED FREQ OUT warning light extinguished

**WARNING**

IF FIXED FREQUENCY IS NOT RESTORED, NAVIGATION INSTRUMENTS WILL PRESENT INDICATING ERRORS. BEST RPM FOR MINIMUM INDICATING ERRORS IS  $85 \pm 4\%$ . WITH "FIXED FREQUENCY OUT" WARNING LIGHT STILL DISPLAYED, A SIGNIFICANT PRESSURE DECREASING SHOWN ON HYD SYSTEM 2 COCKPIT PRESSURE INDICATOR WILL EVIDENCE THE HYDRAULIC ORIGIN OF THE FAILURE. IF NO PRESSURE REDUCTION IS SHOWN, THE FAILURE WILL BE ELECTRICAL.

### Hydraulically Driven Fixed-Frequency Generator Out (MRAAM Operation)

If FIXED FREQ OUT warning light illuminates, the MRAAM can not be powered with fixed-frequency AC power and are considered not available for launch. In this condition the AIM-7E PWR OUT warning light will illuminate provided that the MRAAM POWER switch is set to AUTO or RUN.

#### NOTE

Refer to AER.1F-104S/ASAM-34 for further information.

### Primary DC Bus Failure/TRU1 Failure

Following the PP1 DC bus failure or following the TRU1 failure, the PP1 bus and utilities are lost and the DC PRIMARY BUS OUT warning light is lit on the warning light panel.

If DC PRIMARY BUS OUT warning light illuminates:

1. Land – As soon as practicable

### WARNING

NOSEWHEEL STEERING AND ANTISKID BRAKES WILL BE INOPERATIVE. AIRCRAFT DIRECTIONAL CONTROL SHALL BE MAINTAINED BY USE OF RUDDER AND/OR STANDBY BRAKES.

### FIRE

1. THROTTLE – MINIMUM PRACTICABLE
2. CONFIRM FIRE

Confirm fire by any possible means such as report from other aircraft, engine instruments, FIRE warning lights, fire warning test circuit, smoke in cockpit or visible smoke trail behind aircraft.

### NOTE

- If FIRE warning light go out upon power reduction and illuminate during testing, a fire is not likely in the areas where fire detectors are installed.
- If the FIRE warning lights do not illuminate during testing, an explosion may have resulted in serious damage in the areas where fire detectors are installed with a great possibility of fire.

If on fire:

### 3. EJECT

If fire cannot be confirmed but FIRE warning lights remain on below 25000 ft:

3. Fresh air scoop lever – Open
4. Land – ASAP using "Precautionary Partial Power Pattern" procedure (contained in this Section), continuously checking for fire

### EXTERNAL STORES EMERGENCY/SELECTIVE JETTISON

To jettison all external stores during an emergency, use the following procedures:

1. EXT STORES JETTISON button – Press

If a selective jettison has to be carried out or if a store fails to jettison following an emergency jettison:

1. STORE RELEASE selector switch – As required (Relevant WPN ON buttons lit)
2. External stores selector buttons – Press (Relevant SELECT indicator lights lit)
3. Droppable stores release button – Press

### NOTE

- Refer to Section V "Operating Limitations" for external stores jettisoning speed limit.

- The MRAAM missiles and the related launchers may be only jettisoned through the emergency jettison button.

An unsuccessful jettison of a store is indicated by the relevant "WPN ON" indication light still lit after the emergency and selective jettison attempt and/or by visual check

If the hung up condition persists a landing with an hung store has to be made.

### WARNING

FOLLOWING AN ATTEMPTED JETTISON OPERATION ANY STORE WHICH DOES NOT SEPARATE FROM THE AIRCRAFT SHOULD BE CONSIDERED UNLOCKED AND SUSCEPTIBLE OF INADVERTENT RELEASE. THE PILOT SHALL BE PREPARED TO EXECUTE AN IMMEDIATE GO AROUND, SHOULD RELEASE OF STORE OCCUR DURING LANDING.

### NOTE

Refer to AER.1F-104S/ASAM-34 for further information.

## FUEL SYSTEM FAILURE

### External Fuel Transfer Failure

If fuel fails to transfer from the tip or pylon tanks, the external fuel tanks transfer circuit breaker on the left console can be opened to deenergize the circuit to the transfer valves allowing the valves to open and fuel to transfer.

When the tanks have emptied the circuit breaker should be closed to prevent internal tank fuel entrapment.

If external fuel fails to transfer proceed as follows:

1. EXT TANK FUEL TRANS circuit breaker  
– Pull

### NOTE

Monitor external fuel quantities for simultaneous decrease. If internal quantity increases, push circuit breaker in as tanks will probably continue to feed.

2. Reset circuit breaker after affected tanks are empty

If steps 1., 2., do not establish external fuel transfer, proceed as follows:

3. EXT TANK FUEL TRANS circuit breaker  
– Reset
4. Throttle – Military
5. Descend – 10000 feet or below
6. Fresh air scoop lever – Open

### NOTE

With empty tip tanks and more than residual fuel in pylon tanks, adhere to airspeed limitation of 500 KIAS.

### External Tip Tank Asymmetric Fuel Load

1. EXT FUEL SEL switch – OFF

If asymmetric external fuel load exceeds 450 lbs:

2. Do not exceed Mach 0.9, 30° bank and 2 "G"

If roll control becomes marginal:

3. "G" load factor – Reduce

When below 300 KIAS:

4. RUD/AIL LIM CONT circuit breaker – Pull
5. Minimum speed 260 KIAS enroute
6. Land – As soon as practicable (refer to "Asymmetric Tip Tank Fuel Load" procedure contained in this Section)

If necessary:

7. Tip tanks – Jettison (refer to "External Stores Emergency/Selective Jettison" procedure contained in this Section)

#### HYDRAULIC SYSTEM FAILURE

### WARNING

DURING ZERO OR NEGATIVE "G" FLIGHT, PRESSURE IN ONE OR BOTH HYDRAULIC SYSTEM MAY BE TEMPORALY LOST IF AIR IS PRESENT IN THE SYSTEM. IF LOSS OF HYDRAULIC PRESSURE IS EXPERIENCED AT ZERO OR NEGATIVE "G" IMMEDIATELY RETURN THE AIRCRAFT TO POSITIVE "G" CONDITIONS. IF THIS MANEUVER IS NOT SUFFICIENT TO RESTORE THE HYDRAULIC PRESSURE, ASSIMILATE THIS FAILURE AS NO. 1 AND/OR NO. 2 HYDRAULIC SYSTEMS OUT AND PROCEED CONSEQUENTLY.

#### No. 1 System Out

Indicated by:

- HYDRAULIC SYSTEM OUT warning light lit and No. 1 low system pressure
  - AUTO PITCH CONT OUT warning light lit
  - AUTOPILOT DISENGAGED warning light lit
  - Yaw damper inoperative
1. No. 2 pressure – Monitor for the remainder of flight

### WARNING

THE HYDRAULIC SYSTEM OUT WARNING LIGHT WILL NOT INDICATE A SECOND FAILURE. THE REMAINING GAGE SHALL BE MONITORED TO DETERMINE IF SUBSEQUENT FAILURE OCCURS.

2. Land – ASAP using "Precautionary Straight-In Pattern" procedure contained in this Section

#### No. 2 System Out

### WARNING

CLOSE SPEED BRAKES IF A HYDRAULIC FAILURE IS IMMINENT. THE SPEED BRAKES CANNOT BE CLOSED WITHOUT NO. 2 HYDRAULIC SYSTEM PRESSURE.

Indicated by:

- HYDRAULIC SYSTEM OUT warning light lit and No. 2 low system pressure
- FIXED FREQ OUT warning light lit
- AIM-7E POWER OUT warning light lit
- Pitch and roll dampers inoperative
- Items operated by utility hydraulic system inoperative

### NOTE

- The AIM-7E PWR OUT warning light will illuminate only if the MRAAM POWER switch, on the MRAAM panel, is in AUTO or RUN position.

- The autopilot may disengage and warning light illuminate due to loss of the fixed frequency generator; however, the loss of power will be momentary as the function will automatically transfer to the emergency ac bus. If the autopilot disengages, it may be reengaged permitting normal autopilot operation.

1. No. 1 pressure – Monitor for the remainder of flight
2. Land – ASAP using “Precautionary Straight-In Pattern” procedure contained in this Section
3. Landing gear – Extend with MAN LDG GEAR handle

**CAUTION**

- NOSEWHEEL STEERING AND ANTISKID BRAKES ARE INOPERATIVE WITH NO. 2 SYSTEM OUT.
- IF THE NO. 2 HYDRAULIC SYSTEM FAILS OR FLUCTUATES DO NOT USE NOSEWHEEL STEERING. USE OF NOSEWHEEL STEERING UNDER THESE CONDITIONS ALLOWS AIR TO ENTER THE SYSTEM, RESULTING IN VIOLENT SHIMMY ACTION WHICH MAY CAUSE SUBSTANTIAL DAMAGE.

#### No. 1 and No. 2 Hydraulic Systems Out

1. RAT – Pull (refer to “RAT Extend Flight” procedure contained in this Section)
2. Monitor No. 1 hydraulic system pressure gage

If pressure builds up:

3. Land – ASAP using “Precautionary Straight-In Pattern” procedure contained in this Section
4. Landing gear – Extend with MAN LDG GEAR handle

**CAUTION**

- NOSEWHEEL STEERING AND ANTISKID BRAKES ARE INOPERATIVE WITH NO. 2 SYSTEM OUT.
- IF THE NO. 2 HYDRAULIC SYSTEM FAILS OR FLUCTUATES DO NOT USE NOSEWHEEL STEERING. USE OF NOSEWHEEL STEERING UNDER THESE CONDITIONS ALLOWS AIR TO ENTER THE SYSTEM, RESULTING IN VIOLENT SHIMMY ACTION WHICH MAY CAUSE SUBSTANTIAL DAMAGE.

If pressure fails to provide adequate flight control response:

3. Eject

#### ENGINE FAILURE DURING FLIGHT

Engine failure is defined as a complete power failure which, in the pilot's judgment, makes a restart impossible or inadvisable. Example are engine seizure or explosion.

If glide is required, prior to ejection:

1. Throttle – OFF
2. RAT – Pull (refer to “RAT Extend Flight” procedure contained in this Section)
3. Wing flaps – TAKEOFF
4. Glide speed – 245 KIAS
5. Ejection preparation – (Refer to “Ejection Procedures” contained in this Section) or attempt a flame-out landing

**IGV CLOSURE**

IGV closure will be indicated by:

- a. Abnormally low fuel flow
- b. Severe thrust reduction

**NOTE**

EGT will be normally due to nozzle modulating open; however, if nozzle is full open, EGT will then increase. RPM will be normal for throttle setting.

If IGV closure is indicated:

1. Throttle – Max afterburner
2. Monitor EGT and retard throttle in afterburner range as necessary to avoid overtemperature

If necessary:

3. External Stores – Jettison (refer to "External Store Emergency/Selective Jettison" procedure contained in this Section)
4. Establish a precautionary pattern or land with afterburner

**EXHAUST NOZZLE FAILS OPEN WITHOUT INDICATION OF ENGINE OIL SYSTEM MALFUNCTION (AFTERBURNING)**

The most probable cause is failure of the nozzle area control amplifier or control alternator.

Indicated by:

- A slight reduction in thrust
- EGT approximately 550° C
- An increase in nozzle area to approx. 10

**NOTE**

Failure will probably not be detected. Afterburner will continue to operate provided throttle is not retarded to sector/core range. As long as afterburning is maintained, immediate corrective action is not required.

1. Throttle – Maintain max afterburner

At safe position:

2. Throttle – Military
3. Nozzle handle – Out

If nozzle closes:

4. Land – As soon as practicable, monitor EGT with throttle adjustments

If nozzle fails to close:

4. External Stores – Jettison (if necessary)

Refer to "External Stores Emergency/Selective Jettison" procedure contained in this Section.

5. Land – ASAP using "Precautionary Partial Power Pattern" procedures contained in this Section

After touchdown:

6. Nozzle handle – In

**EXHAUST NOZZLE FAILS OPEN WITHOUT INDICATION OF ENGINE OIL SYSTEM MALFUNCTION (NON-AFTERBURNING)**

The most probable cause is failure of the nozzle area control amplifier or control alternator.

Indicated by:

- Significant thrust decrease
- EGT approximately 350° C
- An increase in nozzle area to approx. 10

**WARNING**

SUFFICIENT THRUST IS NOT AVAILABLE TO MAINTAIN LEVEL FLIGHT WITH ANY CONFIGURATION.

1. NOZZLE HANDLE – OUT

**CAUTION**

DO NOT LIGHT AFTERBURNER. LIGHTING AFTERBURNER WILL RESULT IN AN OVER-TEMPERATURE CONDITION AND MAY CAUSE EXCESSIVE RPM DROP OR ENGINE STALL.

If nozzle closes:

2. Land – As soon as practicable, monitor EGT with throttle adjustment

After touchdown:

3. Nozzle handle – In

If nozzle fails to close:

2. **THROTTLE – RAPIDLY TO MAX AFTERBURNER**

A 3 to 5 second delay may occur before an afterburner light is obtained. Afterburner lights with the nozzle failed open are not assured, but the probability of a successful light increases as altitude decreases.

If afterburner lights:

3. **NOZZLE HANDLE – IN**

**WARNING**

DURING AFTERBURNER OPERATIONS WITH NOZZLE FAILED TO OPEN POSITION, REDUCING THE THROTTLE BELOW FULL AFTERBURNER WILL CAUSE AFTERBURNER BLOWOUT. THROTTLE SHOULD REMAIN IN MAXIMUM AFTERBURNER UNTIL LANDING IS ASSURED.

At safe position:

4. Throttle – Military

5. Land – ASAP using "Precautionary Partial Power Pattern" procedures contained in this Section

**EXHAUST NOZZLE FAILS TO MECHANICAL SCHEDULE OR SEVERE NOZZLE FLUCTUATIONS OCCUR (AFTERBURNING)**

Indicated by:

- EGT of approximately 700° C
- Nozzle indication of 7.5 maximum

At safe position:

1. **AFTERBURNER – OFF**
2. **NOZZLE HANDLE – OUT**
3. EGT – Monitor with throttle adjustments

**CAUTION**

DO NOT LIGHT AFTERBURNER. LIGHTING AFTERBURNER WILL RESULT IN AN OVER-TEMPERATURE CONDITION AND MAY CAUSE EXCESSIVE RPM DROP OR ENGINE STALL.

4. Land – As soon as practicable

After touchdown:

5. Nozzle handle – In

**EXHAUST NOZZLE FAILS TO MECHANICAL SCHEDULE OR SEVERE NOZZLE FLUCTUATIONS OCCUR (NON-AFTERBURNING)**

Indicated by:

- EGT of approximately 700° C
- Nozzle indication of about 1.5 minimum

1. EGT – MONITOR WITH THROTTLE ADJUSTMENTS
2. NOZZLE HANDLE – OUT

**CAUTION**

DO NOT LIGHT AFTERBURNER. LIGHTING AFTERBURNER WILL RESULT IN AN OVER-TEMPERATURE CONDITION AND MAY CAUSE EXCESSIVE RPM DROP OR ENGINE STALL.

3. Land – As soon as practicable  
After touchdown:
4. Nozzle handle – In

**ENGINE OIL SYSTEM MALFUNCTION**

Engine oil system malfunction is evidenced by:

- Abnormal oil pressure
- Illumination of ENGINE OIL LEVEL LOW warning light indicates oil depletion to 6.4 pints or less. With depletion to 4.0 pints the nozzle will fail open and complete loss of oil may be imminent with oil starvation of engine bearings. With a complete loss of oil, the engine may operate for 1 minutes at military thrust without detrimental effects to the bearings. Limited experience has indicated the engine should operate for a period of approximately 4 to 5 minutes at 80% to 90% RPM before a complete failure occurs.  
High thrust settings should be avoided when possible to keep temperature and bearings loads at a minimum. Increasing vibration is an indication of bearings failure. Throttle movement will accelerate this failure.

1. THROTTLE – 86% to 89% RPM
2. NOZZLE HANDLE – OUT

**NOTE**

- The nozzle may not close under certain conditions of airspeed and altitude. If nozzle does not close, zoom and reduce power to reduce airspeed/nozzle area pressure.
- If the nozzle opens to the 4.2 position, the mechanical locks have engaged. Under this condition the nozzle will not open when the nozzle handle is pushed in.

3. EXTERNAL STORES – JETTISON (IF NECESSARY)

Refer to "External Stores Emergency/Selective Jettison" procedure contained in this Section.

If nozzle closes:

4. Land – ASAP using "Precautionary Partial Power Pattern" procedures contained in this Section

**CAUTION**

AFTER NOZZLE CLOSURE HANDLE HAS BEEN PULLED AND NOZZLE IS CLOSED, DO NOT LIGHT AFTERBURNER. LIGHTING AFTERBURNER WILL RESULT IN AN OVER-TEMPERATURE CONDITION AND MAY CAUSE EXCESSIVE RPM DROP OR ENGINE STALL.

After touchdown:

5. Nozzle handle – In

**NOTE**

If the nozzle handle does not go in, landing roll will increase and the drag may fail at deployment.

If nozzle fails to close:

4. THROTTLE – RAPIDLY TO MAX AFTERBURNER



A 3 to 5 second delay may occur before an afterburner light is obtained. Afterburner lights with the nozzle failed open are not assured, but the probability of successful lights increases as altitude decreases.

If afterburner lights:

5. **NOZZLE HANDLE – IN**

At safe position:

6. Throttle – Military
7. Land – ASAP using "Precautionary Partial Power Pattern" procedure contained in this Section

If extreme vibration/EGT is encountered:

8. **RAT – PULL**
9. **THROTTLE – OFF**
10. **EJECT**

**WARNING**

EXTREME VIBRATION, USUALLY ACCOMPANIED BY A RISE IN EGT, INDICATES ENGINE SEIZURE IS IMMINENT AND COULD LEAD TO EXCESSIVE ENGINE/AIRCRAFT DAMAGE WHICH MAY JEOPARDIZE SUCCESSFUL BAILOUT CAPABILITY.

**OXYGEN SYSTEM FAILURE**

If symptoms of hypoxia or anoxia are noted:

1. Mask connection – Check
2. Green apple – Pull
3. Oxygen supply lever – OFF (normal oxygen may be contaminated)

4. Descend immediately below 10000 feet
5. Radio – Call MAYDAY and state intentions
6. IFF – EMER

If below 10000 feet:

7. Fresh air scoop lever – Open
8. Mask – Disconnect (after bottle is empty and supply stops)
9. Land – ASAP

**RAT EXTENDED FLIGHT**

The ram air turbine (RAT) is available for emergency electrical and hydraulic power when the engine-driven power sources are lost.

Extension of the RAT with the engine running may, under certain conditions, adversely affect engine operation.

**WARNING**

- FLIGHT WITH RAT EXTENDED AND WING FLAPS IN LAND POSITION WILL RESULT IN A STRONG RIGHTROLL TENDENCY AT SPEEDS BELOW 160 KIAS. THE ROLL IS CAUSED BY TURBULENT AIRFLOW FROM THE RAT OVER THE INBOARD RIGHT WING SECTION. FULL AILERON MAY BE REQUIRED TO STOP THE ROLLOFF AND MAINTAIN WINGS-LEVEL FLIGHT; THEREFORE, NEITHER EXTEND RAT WITH LAND FLAPS EXTENDED NOR EXTEND WING FLAPS TO LAND WITH RAT EXTENDED.

- ALL FUEL BOOST PUMPS ARE NOT AVAILABLE WHEN BOTH WILD FREQUENCY GENERATORS ARE OFF OR FAILED AND, WHEN REMAINING FUEL (INTERNAL) IS BELOW 1000 LBS, A FLAMEOUT COULD OCCUR IF RAT FAILS TO POWER NO. 3 FUEL BOOST PUMP. MOREOVER FLIGHT WITH NO. 3 FUEL BOOST PUMP POWERED BY RAT AND 1000 LBS. OR LESS INTERNAL FUEL REMAINING, SHOULD BE PERFORMED IN NOSE UP FLIGHT ATTITUDE WITH EASY COORDINATED MANEUVERS AND NEGLIGIBLE DECELERATION FORCES. FLIGHT WITH NOSE DOWN AT THIS FUEL LOAD MAY ALLOW THE NO. 3 FUEL BOOST PUMP TO CAVITATE RESULTING IN SUBSEQUENT ENGINE FLAME OUT. ILLUMINATION OF THE FUEL BOOST PUMPS WARNING LIGHT UNDER THESE CONDITIONS MAY NOT PROVIDE ADEQUATE WARNING TO TAKE CORRECTIVE ACTIONS AND PREVENT AN ENGINE FLAME OUT.
- LANDING WITH RAT EXTENDED AND 1000 LBS. OR LESS REMAINING FUEL SHOULD BE PERFORMED FOLLOWING "PRECAUTIONARY STRAIGHT-IN PATTERN" PROCEDURE.

Because several inadvertent RAT extensions have been experienced, an operating envelope with the engine running and the RAT extended is provided below.

- The RAT may be extended in level flight without affecting engine operation within the following airspeed limits:

Altitude	Airspeed Limits (Knots IAS)	
	Minimum	Maximum
Up to 30000 feet	None	550
Above 30000 feet	350	

- Normal air starts with the RAT extended can be made at all altitudes up to 35000 feet
- Maneuverability is satisfactory with the No. 1 and No. 2 hydraulic pumps inoperative and the RAT supplying hydraulic pressure up to 550 KIAS.
- Spiral climbs and descents may be made without affecting normal engine operation or aircraft maneuverability.
- Best range with the RAT extended and 3000 pounds of fuel remaining is realized by cruising at 0.82 Mach at 27000 feet. Range will be approximately 170 nautical miles per 1000 pounds of fuel used.
- Factors such as G's, yaw, abrupt maneuvers, or rapid throttle movements may induce engine instability, stalls, or flame-outs with the RAT extended, especially above 30000 feet. Below 30000 feet, 45° banks do not affect engine operation.
- With RAT extended, approximately the same glide distance may be obtained at 245 KIAS and TAKEOFF flaps as with 275 KIAS and no flaps. However, the slower speed will result in a lower rate of descent.

Deploy the RAT under the following circumstances:

- Double hydraulic failure
- Double generator failure
- Flame-out landing
- Seized engine
- Dead engine descent in weather

**NOTE**

If a flame-out or engine stall occurs when the RAT is extended, accomplish normal air start/stall-clearing procedures.

When flying with the RAT extended, avoid abrupt or uncoordinated maneuvers and move throttle slowly and only when necessary. Do not attempt afterburner lights unless absolutely necessary. Land as soon as practicable and use thrust as required. If possible, fly a precautionary straight-in pattern.

**NOTE**

- Extending the RAT powers hydraulic system No. 1, energizes the XP4 bus, both PP2 and PP3 busses and both PP4 and PP5 busses. In addition, if the hydraulic generator is not operating, the RAT energizes the XP5 and XP6 busses. Illumination of the warning lights indicates RAT operation.
- The leading and trailing edge flaps are sequenced to extend separately to the TAKEOFF position only when using ram air turbinedriven generator for electrical power. Therefore, the LAND or UP position should never be selected under this condition as it may stall the generator. Keep airspeed above 200 KIAS until flaps have reached TAKEOFF position. The wing flaps position indicator will be inoperative.

## PITCH-UP RECOVERY AND SPIN PREVENTION/SPIN RECOVERY

### Pitch-Up Recovery and Spin Prevention

Subsonic 1-G/accelerated pitch-up is preceded by buffet, stick shaker, lateral instability, and kicker. If the kicker warning is ignored and the angle-of-attack is increased beyond the kicker boundary the aircraft will pitch up and enter post-stall gyrations of uncontrolled motions about all axis.

During these motions the turn needle will oscillate around the mid-position. Entry into a spin mode

may be prevented if immediate corrective action is taken. Refer to Section VI "Flight Characteristics" for detailed pitch-up information.

**WARNING**

A FULLY-DEVELOPED PITCH-UP MAY REQUIRE 15000 FEET BEFORE RECOVERY IS COMPLETE.

**NOTE**

The pitch-up differs from a developed spin. During pitch-up, the turn needle will oscillate around the mid-position, where during a spin, the turn needle will indicate a steady direction.

At first indication of pitch-up, if time and altitude permits:

1. **STICK – FULL FORWARD WITH FULL NOSE-DOWN TRIM**
2. **RUDDER AND AILERONS – NEUTRAL**

If extended:

3. Gear, flaps, and speed brakes – Retract
- If oscillations stop and airspeed begins to increase:
4. Start a gradual pullout observing APC limitations and avoiding excessive aircraft buffet
  5. Wing flaps – TAKEOFF (observe airspeed limitations)

If turn needle indicates a steady full deflection:

4. Maintain full forward stick and perform "Spin Recovery" procedure contained in this Section

### Spin Recovery

The normal spin is characterized by pronounced oscillations in pitch, roll, and yaw. The flat spin is characterized by no oscillations about any axis. The turn needle will always be pegged in the direction of the spin.

Accomplish spin recovery procedures immediately to prevent early oscillatory spin from developing

into flat spin from which flight controls may not effect recovery. Refer to Section VI "Flight Characteristics" for detailed spin information.

If aircraft enters a spin, and time and altitude permits:

1. **THROTTLE – IDLE**
2. **RUDDER – FULL OPPOSITE TO SPIN ROTATION (opposite turn needle)**
3. **STICK – FULL FORWARD, WITH FULL NOSEDOWN TRIM AND FULL IN THE DIRECTION OF SPIN (with turn needle)**

If above 25000 ft:

4. Drag chute – Deploy

If extended:

5. Gear, wing flaps and speed brakes – Retract

If rotation stops:

6. Drag chute – Jettison as nose swings down

### WARNING

USE FORWARD STICK TO PREVENT ABRUPT NOSE-UP PITCH AS CHUTE IS JETTISONED OR FAILS.

### NOTE

Chute panels will burn out at RPM above 90% and shear link should fail above 225 kts.

7. Aileron and rudder controls – Neutralize
8. Start gradual pullout, observe APC limitations and avoid excessive aircraft buffet
9. Wing flaps – TAKEOFF (observe airspeed limitations)

If engine has stalled or flamed out:

10. Perform "Air Start/Stall Clearing" procedures contained in this Section

If spin rotation has not stopped by 15000 ft AGL:

6. **EJECT**

### Inverted Spin Recovery

1. **NEUTRALIZE ALL CONTROLS**

If spin rotation has not stopped by 15000 ft AGL:

2. **EJECT**

### NOTE

Refer to Section VI "Flight Characteristics" for further information on pitch-up and spin characteristics/prevention, and use of drag chute.

### STABILITY AUGMENTATION SYSTEM FAILURE

Failure in any one of the stability augmentation system channels (roll, pitch or yaw) may cause control system oscillation.

One or all three of the STABILITY CONT circuits may be disengaged as follows:

1. ROLL, PITCH, or YAW switches (as required) – OFF

### TRIM FAILURE OR RUNAWAY TRIM

In event of trim failure, proceed as follows:

1. STICK TRIM-AUX TRIM selector switch – Lift guard, AUX TRIM
2. AUX TRIM CONT switch – Use as necessary

### NOTE

Maximum nose down stabilizer travel is dependent upon trim setting. In the event of stick trim button failure, resulting in full nose up trim, the auxiliary trim switch will have to be used to decrease the nose up trim in order to gain full nose down capability of the stabilizer.

If trim still malfunctions:

3. TRIM CONTROL circuit breaker – Pull
4. Control pitch to obtain constant attitude
5. Autopilot – Engage

#### NOTE

- Autopilot engagement with aircraft out of trim shall be accomplished by grasping the control stick at shaker motor zone or below, so that the force switches located in the stick grip are not activated.
  - If autopilot does not engage a straight-in TAKEOFF flaps landing is mandatory.
6. Before landing – Disengage autopilot (check auto trim indicator before disengaging autopilot)

If trim failure has caused full nose-down trim:

7. Land – As soon as practicable, using "Precautionary Straight-In Pattern" procedure (TAKEOFF flaps mandatory)

#### WARNING

IN THE EVENT OF TRIM FAILURE RESULTING IN FULL NOSE DOWN TRIM, AVAILABLE NOSE UP STABILIZER TRAVEL WILL BE REDUCED BY 4°. IN THIS CASE A STRAIGHT-IN TAKEOFF FLAPS LANDING IS MANDATORY.

#### THROTTLE CONTROL SYSTEM MALFUNCTION

If an uncommanded decrease or increase in RPM is experienced, a failure in the cable of the throttle control system may have occurred. During a throttle system malfunction, the EGT and nozzle will correspond to stabilized engine RPM.

If a throttle control system malfunction occurs, the RPM may increase or decrease, depending on the location of the cable failure. The most probable failure location is in the advance-throttle cable and will result in a decrease in RPM.

If the engine is at or near military power when this failure and RPM decrease occurs, the engine will probably roll back to approximately 92% RPM. If the engine is at a lower power setting when the failure occurs, the RPM will decrease further and the engine may flame-out.

If this failure has occurred and the throttle is subsequently pulled back, RPM will be further reduced with no capability to increase it with throttle advancement. If a sudden decrease in RPM is noted with no change in throttle setting, note other engine instruments (EGT, nozzle) to determine if the problem is a compressor stall or throttle control system failure.

If a throttle control system failure is suspected:

1. Throttle – Advance slowly checking for any change in engine instrument readings

#### WARNING

DO NOT RETARD THROTTLE FROM ORIGINAL POSITION UNTIL TYPE OF MALFUNCTION MAY BE DETERMINED. IF THE ADVANCE THROTTLE CABLE HAS FAILED, ANY REDUCTION IN THROTTLE POSITION WILL ALSO REDUCE ENGINE RPM/THRUST, WITH NO CHANCE OF RECOVERY.

#### NOTE

If any engine instrument(s) change as a result of the throttle advance, some other type of engine component failure has occurred and advance-throttle cable failure can be discounted.

If there is no engine instrument(s) change due to the throttle advance:

2. Throttle – Maximum afterburner

**NOTE**

Placing the throttle in max. afterburner position with an advance throttle cable failure will not increase RPM or select afterburner. This procedure will cause a release of tension on the retard throttle cable to the main fuel control unit, decreasing the chance of any further reduction in RPM/thrust.

If sufficient thrust is available:

3. Land – ASAP

**WARNING**

DO NOT RETARD THROTTLE BELOW MAX AFTERBURNER POSITION UNTIL LANDING IS ASSURED, AS ENGINE SHUT-DOWN AT A MID-THROTTLE POSITION IS POSSIBLE.

If throttle retard fails to shut-off engine:

4. FUEL SHUT-OFF switch – OFF

If sufficient thrust is not available:

3. Eject

**CONTROL STICK STEERING (CSS) FAILURE**

When flying in autopilot CSS mode, if a significant hardening of the control stick is felt in pitch and/or roll axis, a CSS optoswitch failure has occurred.

**WARNING**

NO VISUAL INDICATION IS PROVIDED FOLLOWING A CSS FAILURE.

In this case:

- forced pitch inputs will disengage the autopilot
- forced roll inputs will not disengage the autopilot, the control surface may be moved,

but releasing the control stick it returns to the pre-failure position, which might cause an unintentional roll input.

Should a CSS failure occur, proceed as follows:

1. Autopilot – Disengage (paddle switch), if still engaged
2. Control stick – Neutral

**NOTE**

Autopilot may be furtherly re-engaged and all modes are available except CSS.

**INS FAILURE**

Failure of the INS is indicated by the illumination of the amber INERTIAL NAV FAULT warning light on the warning lights panel and by the amber FAIL lamp on the IN control panel. If the aircraft was flying in the INS steering mode, the relevant "IN" caption, on the navigation steering mode selector pushbutton extinguishes.

The following utilities are lost:

- IN/CDU
- all AFCS modes
- attitude indication (pitch and roll)
- HSI (the data on the HSI will be available again when TACAN steering mode is selected by pressing IN/TCN pushbutton)
- GPS steering mode

The TACAN steering mode is available provided that the TACAN is set to on. On HSI all data are TACAN outputs except for the magnetic heading which is derived from the C-2G. On HSI actual track indication is hidden by the relative bearing indication.

1. TACAN – On, check/set channel and mode
2. IN/TCN mode selector – Press, check TCN caption lit
3. C-2G – Check/set MAG
4. C-2G – Crosscheck magnetic heading with standby compass

## APPROACH AND LANDING EMERGENCIES

### AIRSPPEED SYSTEM FAILURE

The best procedure for a landing approach with questionable airspeed indication is to fly formation with another aircraft.

However, if another aircraft is not available, the APC meter may be used to indicate equivalent angle of attack which may be used to accomplish a safe approach for all conditions of weight and drag. Use the APC meter as follows:

1. At a safe altitude, fly a 1-G stall approach to stick shaker action with gear and land flaps extended
2. Note the APC meter reading at beginning of stick shaker action
3. Subtract 2½ from the APC meter stick shaker value and hold this meter number on final approach
4. If unable to perform the stall check, fly to hold an APC meter reading of one

### APPROACH-END ARRESTMENT

Approach-end arrestments reduce the exposure time to which the pilot and aircraft are subjected during a landing roll with adverse directional control; therefore, approach-end engagements may be made when landing with one main gear up or unlocked, or whenever a directional control problem after touchdown is anticipated.

#### NOTE

Landing with a blown main tire does not present a critical directional control problem; therefore, barrier arrestment is optional under this condition.

Approach-end arrestments are practical only when the barrier has at least 1000 feet of runway ahead of the barrier and a clear approach.

Make sure the MA-1A barrier has been removed prior to landing. If possible, burn excess fuel and jettison external stores to reduce landing gross weight and minimize fire hazard.

However, if landing with one main gear up or unlocked, retain the empty tip and pylon tanks to

cushion wing drop. In any event, retain empty tip tanks if they are the only external store and proceed as follows:

1. Inertial reel – Locked
2. HOOK DOWN – Press. If time permits, confirm hook extension by other aircraft or tower
3. Make straight-in flat approach at minimum practicable landing speed. Plan touchdown, on runway or hard surfaced overrun, 500 to 1000 feet short of barrier. Refer to Figure 3-2 for maximum barrier engagement speeds

Immediately after touchdown:

4. Throttle – IDLE
5. Lower nosewheel to runway

#### CAUTION

THE NOSEWHEEL SHALL BE ON THE RUNWAY PRIOR TO BARRIER ENGAGEMENT, OTHERWISE THE NOSE GEAR MAY FAIL AS IT CONTACTS THE RUNWAY.

6. Nosewheel steering – Engage. Contact barrier as close as possible to 90° angle

#### CAUTION

DO NOT USE THE BRAKES. A LOCKED WHEEL MAY SNAG OR CUT THE CABLE. THE WHEEL SHOULD BE ROLLING WHEN PASSING OVER THE CABLE.

#### NOTE

The cockpit canopy provides protection from flash fire; therefore, do not jettison the canopy.

If decision is made to shut-down engine:

7. Throttle – OFF

8. FUEL SHUT-OFF switch – OFF

When aircraft stops:

9. Perform "Ground Abandonment" procedure contained in this Section

- AT THE FORESEEN LANDING SPEED WITH THE AIRCRAFT LATERALLY TRIMMED, CHECK THE AMOUNT OF THE LATERAL CONTROL STILL AVAILABLE.

**ASYMMETRIC TIP TANK FUEL LOAD**

Adequate control is available for landing with one external tank full and one external tank empty under smooth air conditions. Lateral control may be improved by using TAKEOFF flaps.

Consideration should be given to the added aileron requirements under strong or gusty crosswind conditions before attempting a landing with an asymmetric fuel load.

A crosswind from the side with the light tank increases the aileron requirements in the same direction as used to balance the heavy tank. Low speed control should be tested prior entering the landing pattern. If lateral control appears marginal for the landing pattern, the tanks should be jettisoned.

1. Plan to land so that crosswind is from the heavy tank side

**NOTE**

If it is not possible to land with crosswind on the heavy tank side, landing is still possible with a crosswind component of up to 5 knots on the light tip tank side.

2. Maintain at least 260 KIAS until established for straight-in approach (5 NM – 1000 ft AGL – 400/500 ft/min)
3. Wing flaps – TAKEOFF

**CAUTION**

- FLAPS IN LAND POSITION PROVIDE MARGINAL STABILITY BEHAVIOURS BOTH FOR ENGINE AND LATERAL CONTROL.

4. The following speed limits shall be applied during approach and touchdown:

Configuration	Flaps Position	Approach Speed	Touch Down Speed
TIP	T/O	225 KTS	196 KTS
TIP	LAND	215 KTS	188 KTS
TIP + PYLON	T/O	235 KTS	204 KTS
TIP + 1 MRAAM + AIM-9L, -9L/I, -9L/I-1 (Worst asym. configuration: MRAAM on same side of the heavier tip tank)	T/O	240 KTS	212 KTS
TIP + 1 MRAAM + AIM-9L, -9L/I, -9L/I-1 (Best asym. configuration: MRAAM on opposite side of the heavier tip tank)	T/O	230 KTS	201 KTS

If the above procedure is not applicable:

5. Tip tanks – Jettison (refer to "External Stores Emergency/Selective Jettison" procedure contained in this Section)
6. Perform normal approach and landing

**BARRIER ENGAGEMENT**

Refer to "Abort/Barrier Engagement" procedure. Refer also to Figure 3-2 for Maximum Barrier Engagement Speed.

**BELLY LANDING**

The decision to eject or to accomplish a belly landing shall remain with the pilot. Belly landing should be considered:

1. Empty tip and/or pylon tanks – Retain External armament – Jettison (in appropriate area)



2. Fuel — Burn down to minimum safe level
3. Shoulder harness — Locked and tight
4. Helmet visor — Check down
5. RUD/AIL LIMIT CONT circuit breaker — Pull
6. Perform straight-in pattern. Gear UP; LAND wing flaps; establish flat final

At touchdown:

7. Throttle — OFF
8. Drag chute — Deploy
9. FUEL SHUT-OFF switch — OFF

When aircraft stops:

10. Perform "Ground Abandonment" procedure contained in this Section

## BOUNDARY LAYER CONTROL MALFUNCTION

### WARNING

THE AIR SPEEDS LISTED HEREIN ARE BASED ON A GROSS WEIGHT OF 16000 POUNDS. INCREASE APPROACH AND LANDING SPEEDS 5 KNOTS FOR EACH 1000 POUNDS GROSS WEIGHT OR PORTIONS THEREOFF ABOVE 16000 POUNDS. REFER TO LANDING SPEED SCHEDULE IN APPENDIX FOR OTHER CONFIGURATIONS AND GROSS WEIGHT.

If a boundary layer control system malfunction is experienced as manifested by a strong rolling tendency as the wing flaps travel to the LAND position, proceed as follows:

1. Wing flaps — TAKEOFF
2. Throttle — Adjust to minimum safe setting to reduce the effect of asymmetric BLC while flaps are returning to TAKEOFF

3. Fly final approach at not less than 195 KIAS with wing flaps in TAKEOFF position
4. Touch down at 160 KIAS minimum

## FLAME-OUT LANDING

In general, flame-out landings are not recommended. In all cases, flame-out landings should be performed only by pilots who have thorough and recent experience performing simulated flame-out landings. Refer also to "Ejection Versus Flame-Out Landing" paragraph contained in this Section.

The recommended procedure for making a flame-out landing is illustrated in Figure 3-7. The overhead pattern offers the most accurate control of the touchdown point and should be utilized whenever possible. Since it may not be possible to enter the pattern at the High Key point in all cases, conditions should be practiced with pattern entry at any point down to the Low Key position to develop technique and proficiency for these cases as well as the ideal situation.

The most important elements of a successful flame-out landing are thorough and recent simulated flame-out landing practice, close control of glide speed, and a carefully executed flare.

The pilot must take into consideration aircraft weight, field elevation, and wind conditions to determine if the recommended glide speed requires adjustment. The glide speed recommended for a flame-out approach is 245 to 260 knots, based on no external stores, or tip stores installed, 2000 pounds of fuel, the RAT extended, and flaps in the TAKEOFF position. However, the 245-knot recommended speed does not provide a margin for error during the flare, the most critical part of a flame-out approach. To allow maneuvering speed, a 260-knot glide speed (attained prior to final approach) should be used. Under no circumstances should glide speed be less than 245 knots prior to the flare.

Various glide speed allowance for weight, field elevation, and wind are as follows:

- a. Increase glide speed 5 knots per 1000 pounds of excess fuel weight over 2000 pounds. If the remaining fuel weight is 2000 pounds or less, no speed correction is necessary
- b. If the pattern is entered at minimum altitude, a 245-knot speed throughout the approach may be required to reach the field
- c. A 260-knot approach speed may result in a long, high-speed landing under conditions of calm wind, sea level elevation, and fuel weight

less than 2000 pounds. Under these circumstances, a 245-knot approach speed is recommended

- d. The pattern should be adjusted for wind conditions (wider pattern can be flown in a no-wind situation)

### WARNING

DO NOT EXTEND THE LANDING GEAR UNTIL THE FLARE IS ASSURED IN ORDER TO AVOID EXCESSIVE SINK RATES FROM WHICH A FLARE MAY NOT BE POSSIBLE.

### NOTE

Successful flame-out landings can be made carrying external stores. However, glide distance and flare capabilities are substantially improved without external stores. Stores should be jettisoned whenever possible. Empty tip tanks can be retained if desired.

#### Air Start Attempts During Flame-out Landing Pattern

The pilot must devote his full attention to flying the flame-out pattern once High Key is reached. He must not be distracted by air-start attempts; however, regaining power must be afforded a high priority, since flame-out landings should be attempted only under ideal conditions.

- a. In the event of a flame-out, attempt to complete all air start efforts before High Key is reached so that full attention may be devoted to accomplishing a flame-out landing
- b. If the circumstances of flame-out have prevented conclusive air start attempts prior to High Key, further air starts may be attempted

but primary attention should be devoted to proper execution of the flame-out landing

- c. Do not attempt air starts after Low Key is reached

### NOTE

This does not prohibit air start attempts when flame-out occurs below Low Key altitude.

- d. These instructions in no way alter previously established requirements for ejection versus flame-out landing

### NOTE

If a decision is made to eject, the pilot should first attempt to head the aircraft toward an area where injury to persons or damage to property on the ground or water is least likely to result.

#### Simulated Flame-Out Landing

(Refer to Figure 3-7 for typical flame-out landing pattern).

Simulation of flame-out landings may be accomplished by using the following configuration:

1. Throttle – 82% RPM
2. Speed brakes – Out
3. Landing gear lever – UP
4. Wing flaps – TAKEOFF
5. RAT – As required

This landing configuration results in drag approximating that which occurs during a dead-engine descent with TAKEOFF flaps, RAT extended, and gear retracted.

If it is desired to simulate a glide to the flame-out pattern with flaps up, gear up, and RAT retracted, glide at 275 knots and 83% RPM with the speed brakes fully extended.

## TYPICAL FLAME-OUT LANDING PATTERN

GLIDE CHARACTERISTICS ARE THE SAME FOR WINDMILLING OR FROZEN ENGINE

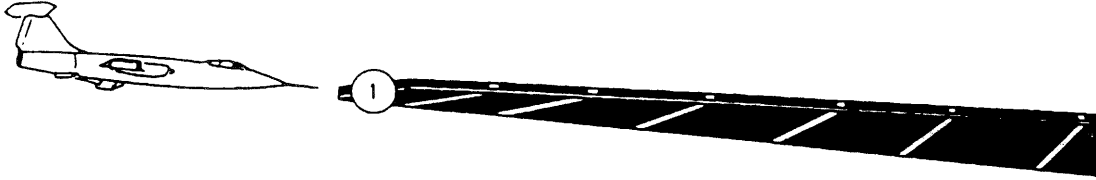

**INITIAL**

- a. GLIDE - 245 KIAS
- b. RAT - EXTENDED
- c. WING FLAPS - TAKEOFF

**LOW KEY (ABOVE FIELD ELEVATION)**

- a. 6000 FEET MINIMUM  
8000 FEET DESIRED
- b. AIRSPEED - 250 KIAS

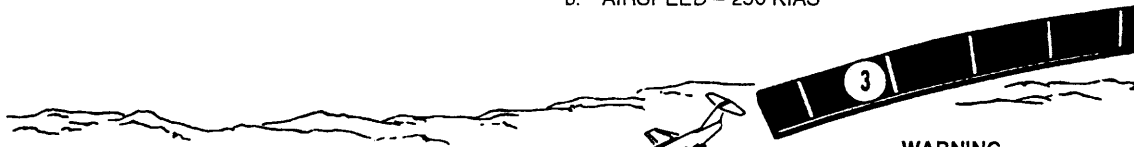

**WARNING**

AIRSPEED SHALL NOT BE ALLOWED TO DROP BELOW 245 KIAS. ATTEMPTS TO REGAIN SPEED WILL CAUSE RATE OF DESCENT TO INCREASE TO THE POINT WHERE FLARE CANNOT BE ACCOMPLISHED.

**FINAL TURN**

- a. FLY TURN TO ROLLOUT ON FINAL APPROACH NOT LESS THAN 1000 FEET ABOVE AND 3/4 MILE FROM THE END OF THE RUNWAY. INITIALLY AIM AIRCRAFT SHORT OF RUNWAY
- b. AIRSPEED - 250 KIAS MINIMUM

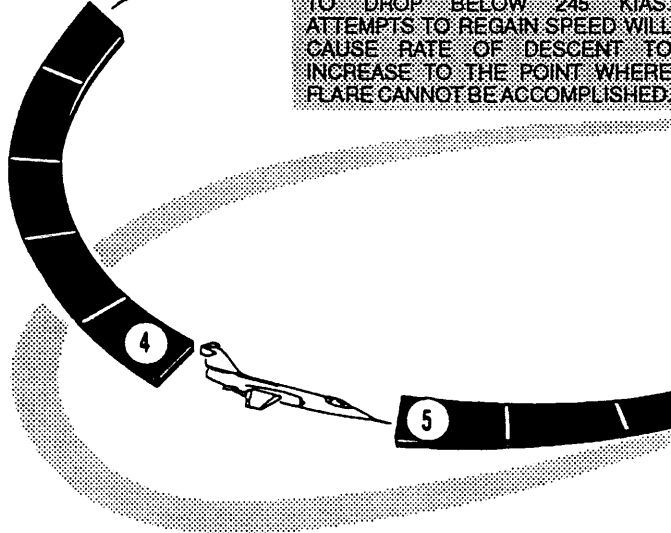

**WARNING**

- LANDING GEAR SHALL BE LEFT UP UNTIL AFTER FLARE IS ASSURED. RATE OF DESCENT WILL INCREASE FROM APPROXIMATELY 7000 TO 11000 FEET PER MINUTE IF GEAR IS EXTENDED PRIOR TO FLARE AND THE SUBSEQUENT LOSS OF ALTITUDE AND SPEED DURING FLARE WILL MAKE A DEAD-STICK LANDING EXTREMELY DIFFICULT TO PERFORM.
- FROM THE LOW KEY POINT MONITOR AIRSPEED CLOSELY TO MAINTAIN RECOMMENDED SPEEDS.

**FLARE**

- a. START FLARE 300-500 FEET ABOVE RUNWAY

FA0342

Figure 3-7 (Sheet 1 of 2)

**TYPICAL FLAME-OUT LANDING PATTERN**

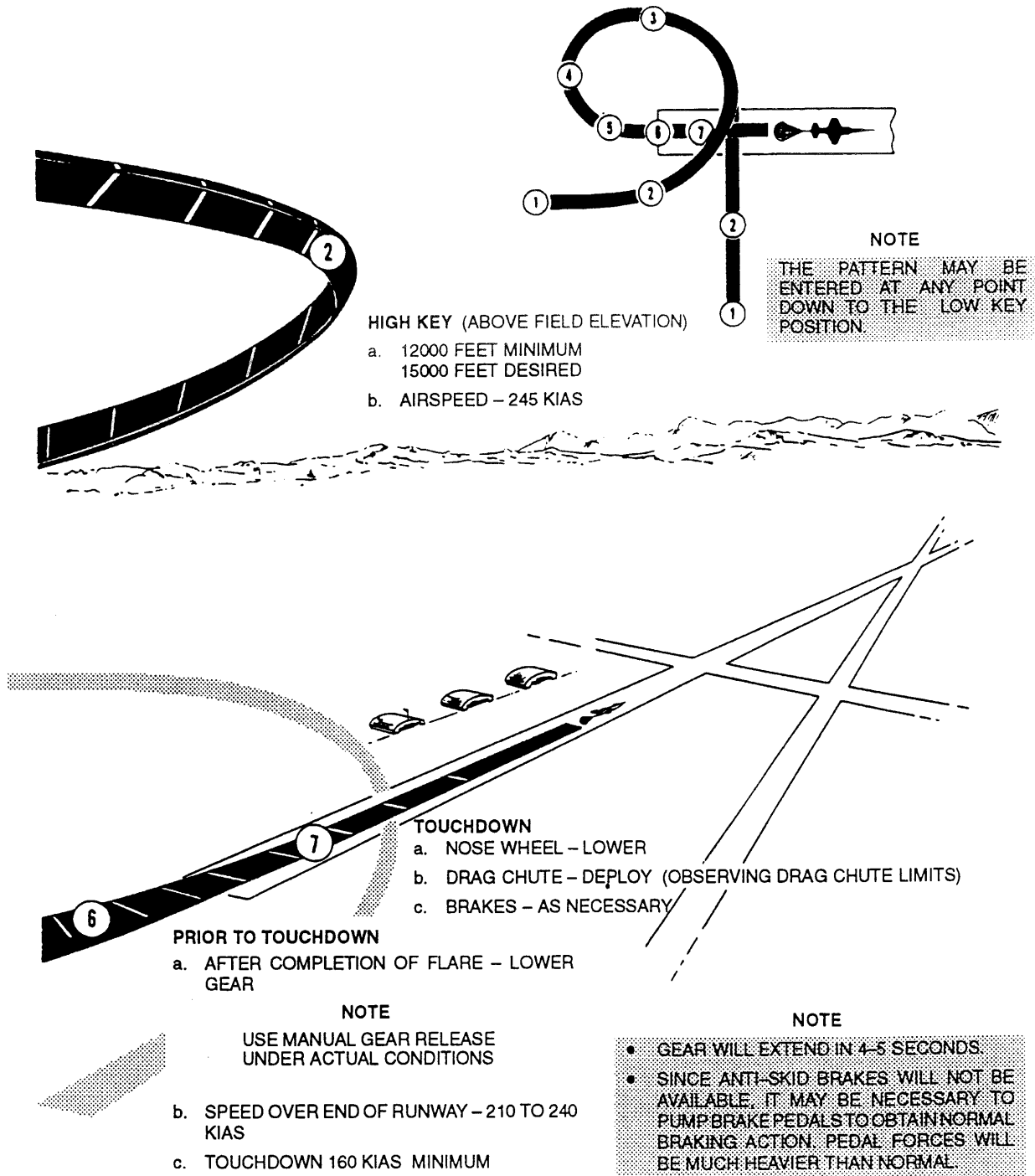

FA0343

Figure 3-7 (Sheet 2 of 2)

**NOTE**

When executing a simulated flame-out landing pattern, after the flare is completed the landing gear should be extended by the normal procedure and the speed brakes should remain extended. With the gear down and the landing point assured, retard the throttle to IDLE.

**WARNING**

DO NOT EXTEND THE LANDING GEAR UNTIL AFTER THE FLARE IS ASSURED IN ORDER TO AVOID EXCESSIVE SINK RATES FROM WHICH A FLARE MAY NOT BE POSSIBLE.

**FLAPS FAILURE****WARNING**

WHEN LANDING WITH FLAPS UP IS NECESSARY, ALL EXTERNAL STORES, EXCEPT TIP TANKS IF EMPTY, SHOULD BE JETTISONED TO HAVE THE BEST FLIGHT CHARACTERISTICS. WITH MRAAMs AT BL104 AND TIP TANKS THERE IS NO POSSIBILITY FOR SELECTIVE JETTISONING OF THE MISSILE, BECAUSE, MRAAMs CAN BE JETTISONED ONLY USING THE EMERGENCY JETTISON BUTTON. IN THIS CASE TIP TANKS ALSO ARE JETTISONED TOGETHER WITH THE OTHER STORES.

**NOTE**

- When either set of flaps are operating on one actuator it is possible to overload the actuator, causing flap drive disengagement and a barber pole indication. Should disengagement occur during extension in flight, the flaps lever should be returned to the previously selected position and left there until landing. When the trailing edge flaps are operating on one motor, landing should be accomplished using TAKEOFF flaps. Extension to TAKEOFF flaps may be accomplished at any speed below 370 KIAS. Retraction of the flaps with one motor can be accomplished in all cases except retraction of leading edge flaps from LAND to TAKEOFF at speeds in excess of 230 KIAS.

- Aircraft flight characteristics are generally improved with tip tanks configurations in subsonic flight with same conditions, in level flight or maneuvering flight. This improvement comes up, when landing, for every flaps position. On typical conditions tip tanks decrease the Minimum Operative Speed and Minimum Control Speed, respectively, of 10 knots with "FLAPS T/O" and 5 knots with "FLAPS LAND", compared to configurations without tip stores, with same load. With "FLAPS UP" the Minimum Operative Speed is almost 20 kts lower and the Minimum Control Speed is almost 10 knots. The definition of the run in and landing speed depends on the flaps configuration, load conditions and external stores configuration.

No flaps landings require high approach and touchdown speeds, during which the maneuverability of the aircraft around the pitch-axis is very critical. Therefore, a successful no-flaps landing can best be executed if a flat approach is made.

This eliminates the possibility of misjudging the rotation, which could result in an uncontrollable rate of descent. The following instructions should be observed.

### NOTE

Speeds in the following procedures are based on a landing gross weight of 16000 lb (no external stores and 1000 lb fuel remaining). Increase approach and touchdown speeds 5 KIAS for each additional 1000 lb of aircraft weight. Refer to appendix for final approach and touchdown speeds for other configurations and gross weights.

If trailing edge flaps fail:

If the trailing edge flaps fail to extend (regardless of the position of the leading edge flaps) perform the following procedure:

1. Reduce fuel load as low as practicable

### WARNING

THIS PROCEDURE IS HAZARDOUS WITH MORE THAN 3000 LBS FUEL LOAD.

If landing cannot be delayed and tanks contains fuel:

2. External tanks – Jettison

Refer to "External Stores Emergency/Selective Jettison" procedure contained in this Section.

3. Fly a long, flat final approach of at least 5 NM, beginning at 1000 feet AGL with gear extended
4. Final approach speed – 230 KIAS minimum
5. Initial altitude loss should be approximately 200 feet/NM, requiring a rate of descent of approximately 800 feet/minute
6. APC reading 2.5 maximum
7. At approximately 1 NM from beginning of runway, start decreasing rate of descent to arrive over beginning of runway with a near-landing attitude

### CAUTION

DO NOT AT ANY TIME ALLOW THE RATE OF DESCENT TO EXCEED 2000 FEET/MINUTE AS RECOVERY WILL REQUIRE A MINIMUM OF 400 FEET ALTITUDE.

8. Touchdown speed – 195 KIAS minimum
9. Lower nose and deploy drag chute, observing drag chute limits

### CAUTION

DO NOT DEPLOY DRAG CHUTE AT ENGINE SPEED ABOVE IDLE RPM.

If leading edge flaps fail:

1. If only the leading edge flaps fail and the trailing edge flaps can be lowered to the LAND position (thereby making boundary layer control available), normal pattern and touchdown speeds can be used
2. If trailing edge flaps can be extended only to the TAKEOFF position, fly final approach at not less than 195 KIAS and touchdown at not less than 165 KIAS

### Emergency Wing Flap Operation

Partial flap extension is obtainable for landing when alternating current is being furnished under emergency conditions by the ram air turbine. With the RAT extended, wing flaps extension is obtained by placing the wing flap lever in the TAKEOFF position. The flaps are then extended in sequence (trailing edge first) to the TAKEOFF position, thereby reducing the RAT momentary electrical load.

### Asymmetric Flaps

It is possible that an asymmetric wing flap condition occurs any time the flaps configuration is changed. When the asymmetry condition exceed 3.5° ( $\pm 1^\circ$ ) the asymmetry detector switch will open the trailing

edge flap control circuit thus stopping flap movement.

The same switch will exclude the aileron and rudder limiters so that full aileron and rudder travel will be available even if the landing gear is UP.

At the same time the FLAP ASYMMETRY and the AIL AND RUD UNLIMITED lights will illuminate.

Under most conditions lateral control will be sufficient to maintain level flight and to land. The most critical time for flap asymmetry to occur is during the landing pattern.

If asymmetric wing flap condition occurs:

1. Immediately return wing flaps lever to previous position

### WARNING

- DO NOT ATTEMPT TO RECYCLE FLAPS BECAUSE THE ASYMMETRIC CONDITION MAY INCREASE.
- IF FULL SURFACE TRAVEL HAS BEEN APPLIED WITH LIMITER ENGAGED IT WILL NOT BE POSSIBLE TO ATTAIN ADDITIONAL TRAVEL WHEN THE LIMITER IS DISENGAGED. THIS IS CAUSED BY THE CONTROL INPUT INTERFERING WITH THE LIMITER STOP WHICH WILL HOLD IT IN THE LIMITED POSITION. THEREFORE, IT WILL BE NECESSARY TO RELAX THE CONTROL INPUT TOWARD NEUTRAL SLIGHTLY SO THAT THE LIMITER WILL RETRACT.
- IF AT ANY TIME THE FLAPS SHOULD RETURN WITHIN ASYMMETRY LIMITS, THE FLAPS WILL TRAVEL TO THE POSITION SELECTED BY THE FLAP LEVER.

- THERE MIGHT BE SOME ASYMMETRIC CONDITIONS IN WHICH FULL AILERON TRAVEL MAY NOT BE SUFFICIENT TO RETAIN LATERAL CONTROL.

2. Climb to a safe altitude, evaluate lateral control and determine a safe landing speed

### NOTE

- Jettison external stores if aileron control is marginal.
- With the limiters engaged, aileron travel is restricted to  $\pm 10^\circ$  and rudder travel to  $\pm 6^\circ$ . With the limiters disengaged aileron and rudder travel is  $\pm 20^\circ$ .

3. Perform a straight-in approach with airspeed adjusted for wing flaps setting and gross weight

If at any time the aircraft becomes uncontrollable:

2. Eject

### LANDING GEAR EMERGENCY EXTENSION

If the landing gear indicators do not show gear down and locked after the lever is placed in the DOWN position and gear indicator lights test was positive:

1. Landing gear – Recycle once (260 KIAS max)

If gear still indicate unsafe:

2. LDG GEAR – DOWN
3. LANDING GEAR CONT circuit breaker – Pull
4. LANDING GEAR CONT circuit breaker – Reset

If gear still indicates unsafe:

5. Maneuver – Pull g's and yaw/roll aircraft

If gear still indicates unsafe and it cannot visually be determined that three gears are clear of wheel wells:

2. LDG GEAR – UP

**NOTE**

Pulling MAN LDG GEAR handle with LDG GEAR lever DOWN will require a force exceeding 90 pounds.

3. MAN LDG GEAR handle – Pull

**CAUTION**

GEAR CANNOT BE RETRACTED IN FLIGHT AFTER BEING LOWERED BY MEANS OF MANUAL LANDING GEAR RELEASE HANDLE.

4. LDG GEAR – DOWN
5. ANTI-SKID – OFF

**CAUTION**

GEAR EXTENSION BY MEANS OF THE MANUAL LANDING GEAR HANDLE WILL RENDER THE ANTI-SKID AND POWER BRAKES INOPERATIVE. NOSE-WHEEL STEERING WILL OPERATE IF HYDRAULIC PRESSURE IS NORMAL.

If gear still indicates unsafe and it visually (another aircraft or tower) can be determined that all three gears are clear of their wheel wells and hydraulic No. 2 pressure is normal:

6. Land – As soon as practicable using "Precautionary Straight-In Pattern" procedure contained in this Section
7. Do not shut down engine before groundcrew has secured gear

If nose gear remains in wheel well, or is partially extended:

6. Refer to "Nose Gear Up Landing" procedure contained in this Section

If one main gear remains up or in an intermediate position:

6. Refer to "One Main Gear Up or Unlocked" procedure contained in this Section

**MAIN GEAR FLAT TIRE LANDING**

1. Perform straight-in approach
2. Touch down on good tire. Touch down on side of runway opposite flat tire
3. Nosewheel – Lower
4. Nosewheel steering – Engage
5. Drag chute – Deploy

**MAXIMUM GLIDE**

Figure 3-8 shows the glide distance obtainable with a windmilling or seized engine. The recommended configuration is with TAKEOFF flaps and 245 KIAS. Approximately the same distance may be obtained by gliding with flaps UP at 275 knots; however, the rate of descent with TAKEOFF flaps is approximately 1000 feet per minute less due to the lower speed for the same glide ratio. In addition, no change in configuration or speed is required when the flame-out landing pattern is entered.

The data shown in the chart are for RAT extended since this configuration represents the highest drag and is necessary for flaps extension under any engine inoperative condition and for hydraulic power under a seized engine condition. Gliding without the RAT extended increases these distances approximately 2 nautical miles per 10000 feet of altitude.

**NOTE**

Unless the engine is damaged, the windmilling engine speed will produce sufficient hydraulic pressure to operate the flight control system.

**NOSE GEAR FLAT TIRE**

1. Perform straight-in approach with minimum practical fuel load

After touchdown:

2. Nose gear – Hold off



### MAXIMUM GLIDE DISTANCE

ZERO WIND - STRAIGHT-LINE GLIDE  
 ENGINE WINDMILLING OR FROZEN  
 EXTERNAL STORES - NONE OR TIP STORES INSTALLED  
 GEAR UP - RAT EXTENDED  
 FLAPS - TAKE OFF

245 KIAS IS SUPERSONIC  
 ABOVE 50000 FEET

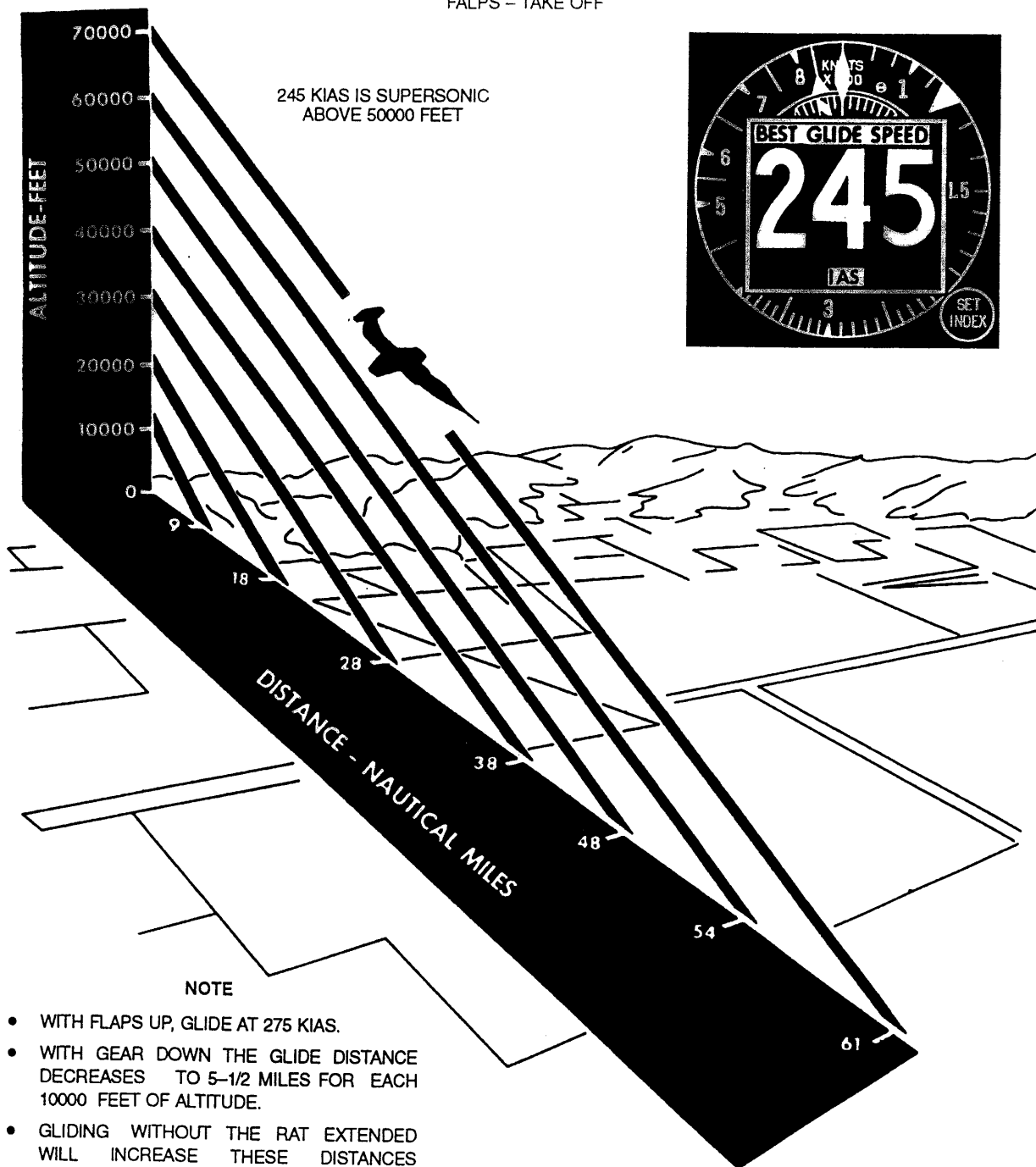
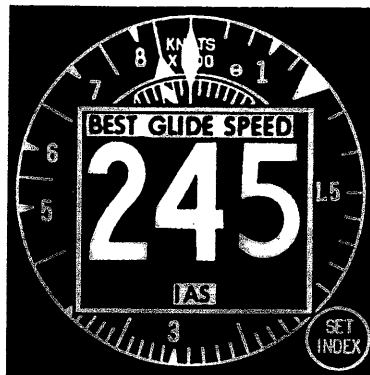

**NOTE**

- WITH FLAPS UP, GLIDE AT 275 KIAS.
- WITH GEAR DOWN THE GLIDE DISTANCE DECREASES TO 5-1/2 MILES FOR EACH 10000 FEET OF ALTITUDE.
- GLIDING WITHOUT THE RAT EXTENDED WILL INCREASE THESE DISTANCES APPROXIMATELY 2 NAUTICAL MILES PER 10000 FEET OF ALTITUDE.

FA0337

Figure 3-8

3. Nose – Lower slowly (at minimum of 130 KIAS)

After nosewheel contacts runway:

4. Drag chute – Deploy
5. Engine – Shutdown (FOD), using either throttle or FUEL SHUT-OFF switch

#### NOSE GEAR UP LANDING

1. Inertial reel – Locked
2. Perform normal approach procedure
3. Nose – Lower slowly at minimum of 130 KIAS

#### NOTE

If necessary, light braking application can be made with nose held off.

4. Throttle – OFF
5. FUEL SHUT-OFF switch – OFF
6. Drag chute – Deploy after nose contacts runway.
7. Apply brakes, using differential braking to maintain directional control.

#### ONE MAIN GEAR UP OR UNLOCKED

If one main gear remains up or in an intermediate position after all procedures to extend have failed:

1. Elect to eject or land. (Decision to land should include consideration of availability of long, wide runway with adjoining unobstructed runout area, condition of surface and area adjacent to runway and weather conditions. Also approach-end arrestment may be made with BAK-9/12 or the 44B-2C or the 44B-2D cable, refer to "Approach-End Arrestment" procedures, "Maximum Barrier Engagement Speeds").

If decision is made to land and time and conditions permit:

2. External stores – Jettison

Refer to "External Stores Emergency/Selective Jettison" procedure contained in this Section.

3. Fuel – Burn down to minimum practical load

Before landing:

4. Shoulder harness – Locked; seat belt and harness tight
5. Helmet visor – Down
6. RUD/AIL LIMIT CONT circuit breaker – Pull
7. APC CUT-OUT switch – OFF
8. Perform straight-in approach and landing, touch down on side of runway opposite to faulty gear
9. Throttle – IDLE

After nosewheel is on runway:

10. Nosewheel steering – Engage
11. Drag chute – Deploy
12. Keep load off faulty gear as long as possible
13. Brakes – As required, use nosewheel steering and brakes for directional control

#### CAUTION

- NOSEWHEEL STEERING AND POWER/ANTI-SKID BRAKES WILL NOT BE AVAILABLE IF THE LEFT MAIN GEAR IS UP.
- GEAR EXTENSION BY MEANS OF MANUAL LANDING GEAR RELEASE HANDLE WILL RENDER ANTI-SKID AND POWER BRAKES INOPERATIVE. REQUIRED BRAKE PEDAL PRESSURE WILL BE GREATER THAN NORMAL FOR EFFECTIVE BRAKING.

After nosewheel steering is no longer effective:

14. Engine – Shutdown (FOD) using either throttle or FUEL SHUT-OFF switch
15. Perform "Ground Abandonment" procedure contained in this Section

## POWER BRAKE/ANTI-SKID SYSTEM MALFUNCTION

The brake system will transfer automatically to the standby master brake system if the power brake/antiskid system malfunctions. Under this condition the ANTI-SKID warning light will be illuminated when aircraft is on the ground and it may be necessary to pump the foot pedals to obtain adequate braking action; pedal forces will be heavier than normal. There is another condition that can occur which will render the power brake/antiskid system inoperative and yet fail to transfer the system to the standby brakes. This resulting no-brake condition exists when the ground-air safety switch circuit malfunctions.

The anti-skid system relies on the ground-air safety switch signal indicating an on-the-ground condition before the brakes can be actuated. This touchdown safety feature prevents landing with the brakes applied. If the ground-air safety switch circuit indicates an in-the-air condition when the aircraft is actually on the ground, anti-skid brakes cannot be applied. Such a condition will be characterized by high brake pedal forces, a lack of deceleration, and possible loss of nosewheel steering.

In order to regain braking action a manual transfer to the standby brake system shall be made by moving the anti-skid switch to OFF.

If the anti-skid light illuminates on the ground, proceed as follows:

1. ANTI-SKID – OFF
2. Brakes – Pump to obtain adequate braking

### CAUTION

WITH INOPERATIVE POWER BRAKES, RELEASE PRESSURE ON BRAKE PEDALS PRIOR TO SWITCHING TO STANDBY BRAKES, OTHERWISE TIRES MAY BE BLOWN.

## PRECAUTIONARY PARTIAL POWER PATTERN

This procedure is illustrated in Figure 3-9 (Typical). The overhead pattern offers the most accurate control of the touchdown point and should be used when possible.

The pattern may be performed anytime when range and bearing data to touchdown is available (GCI, GCA, TACAN, DF, IN/CDU and HSI, or visually).

Exact distance to touchdown is vitally important and GCA should be used where available.

### NOTE

- The airspeed listed is based on 16000 lbs gross weight and zero wind. Aircraft weight, field elevation and wind conditions shall be considered to determine if airspeed and the pattern needs adjustment. Adjust approach and landing speeds 5 KIAS per 1000 lbs difference in gross weight or portions thereof. Refer to landing speed schedule in Appendix for other configuration and gross weights.
- This landing pattern may be used with an open nozzle and 100% RPM. Thrust with nozzle failed open is approximately that corresponds to 82% RPM.

1. Throttle – 82% RPM (with an open nozzle: 100% RPM)
2. LDG GEAR – UP
3. Wing flaps – TAKEOFF
4. Airspeed – 260 KIAS (adjust as necessary)
5. Speed brakes – As necessary to maintain 260 KIAS
6. Descent – Establish and maintain 1 to 2 ratio (1000 ft every 2 NM/1800 to 2000 fpm)
7. Entry altitude – 16000 ft AGL (overhead of touchdown point)

### NOTE

The final approach may be intercepted at any point and from any direction, but not less than 2 NM from touchdown.

8. Fly a 30° banked turn to downwind key at 11500 ft AGL

**PRECAUTIONARY PARTIAL POWER PATTERN**  
 (MAY BE USED FOR GCI, GCA AND TACAN PENETRATIONS)

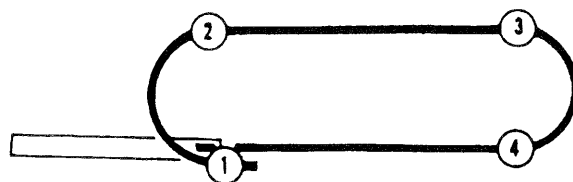

**NOTE**

USE SPEED BRAKES AS REQUIRED TO  
 MAINTAIN 260 KIAS

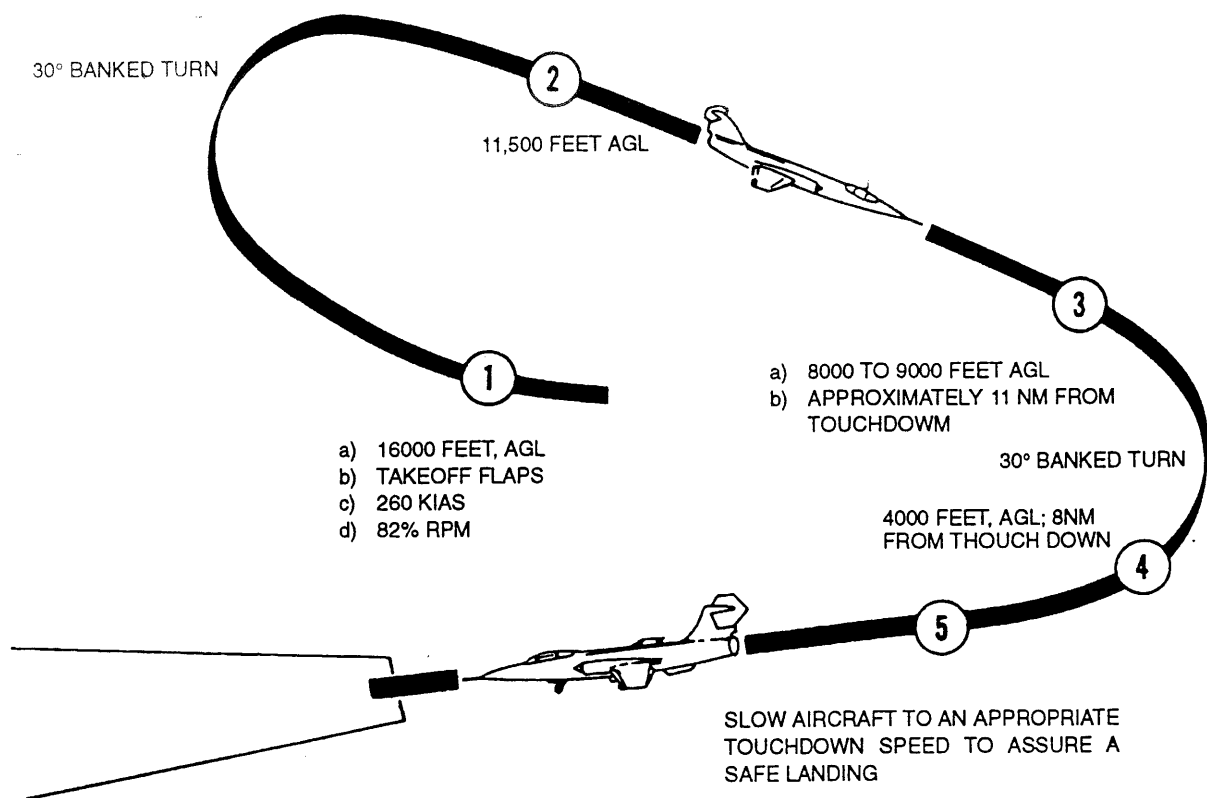

**NOTE**

- ON GLIDE PATH, MAINTAIN A 1 TO 2 RATIO BETWEEN ALTITUDE AND DISTANCE FROM TOUCHDOWN. DECREASE ALTITUDE 1000 FEET FOR EACH 2 NAUTICAL MILES TRAVELED
- DO NOT EXTEND GEAR UNTIL LANDING IS ASSURED OR RETARD THROTTLE UNTIL GEAR IS EXTENDED

**NOTE**

THIS LANDING PATTERN MAY BE USED WITH AN OPEN NOZZLE AND 100% RPM

FA0277

Figure 3-9

9. Base leg key – 8000 to 9000 ft AGL, approx. 11 NM from touchdown
10. Fly a 30° banked turn to final key – 4000 ft AGL, 8 NM from touchdown
11. Descent – Check 1 to 2 ratio

If descent ratio cannot be maintained:

12. Eject

If descent ratio is maintained and landing is assured:

12. Landing gear – Down at pilot's discretion

**PRECAUTIONARY STRAIGHT-IN PATTERN**

**NOTE**

The airspeed listed is based on 16000 lbs gross weight and zero wind. Aircraft weight, field elevation and wind conditions shall be considered to determine if airspeed and the pattern needs adjustment. Adjust approach and landing speeds 5 KIAS per 1000 lbs difference in gross weight or portions thereof. Refer to landing speed schedule in Appendix for other configurations and gross weights.

1. Wing flaps – TAKEOFF (in some cases LAND flaps could be used at pilot's discretion)
2. Airspeed – 20 KIAS above normal final approach speed for gross weight or as required for a specific condition
3. Speed brakes – As necessary
4. Landing gear – Down at pilot's discretion

**PRECAUTIONARY HIGH RPM/THRUST PATTERN**

This procedure is to be used for:

- False RPM reset
- Stuck throttle
- IGV closure
- Afterburner thrust requirement

If all efforts to adjust thrust fail or afterburner thrust is required:

1. Fuel – Burn down to highest acceptable landing weight

**WARNING**

FUEL CONSUMPTION WITH THROTTLE IN AFTERBURNER MAY EXCEED 500 POUNDS PER MINUTE.

2. Speed – Reduce (using speed brakes, G-forces and climb, as necessary) to permit extension of flaps and landing gear

**NOTE**

With speed brakes OUT, flaps at TAKEOFF and gear down, speed may be reduced to 240 KIAS for LAND flaps extension by pulling 2 to 3 G in a turn and/or climbing.

3. Establish a flat final approach. A flat final approach will result in a slower airspeed. With speed brakes, LAND flaps, and gear down at military power, 190 to 200 KIAS is typical (230 to 240 KIAS is typical with afterburner). Speed and glide slope may be controlled somewhat by modulation of speed brakes

At touchdown:

4. FUEL SHUT-OFF switch – OFF (IGV closure or afterburner landing: Throttle – IDLE)

**WARNING**

ENGINE FLAMEOUT TIME MAY VARY FROM 1 TO 5 SECONDS DEPENDING ON AIRSPEED AND POWER SETTING.

**NOTE**

If fuel is shut off prior to touchdown, a right rolloff will be experienced as engine torque is lost, however this rolloff is easily controlled. Sufficient hydraulic pressure will be available for the flight controls to control touchdown.

5. Drag chute — Deploy, observing drag chute limits

**NOTE**

With FUEL SHUTOFF switch OFF, nosewheel steering and power brakes are inoperative. Directional control shall be maintained with use of standby brakes.

If barrier engagement is to be made:

6. HOOK DOWN — Press, refer to "Abort/Barrier Engagement" procedure contained in this Section

**RPM LOCKUP**

If the RPM lockup system fails to disengage following high speed flight with ENG RPM LOCKUP PRW ON light on, proceed as follows:

1. RPM LOCKUP switch — OFF

Engine RPM should then follow throttle position.

**CAUTION**

IF IT IS NECESSARY TO USE THE RPM LOCKUP OVERRIDE SWITCH TO DISENGAGE RPM LOCKUP, DO NOT RETURN THE SWITCH TO THE AUTO POSITION IN FLIGHT OR UNTIL A GROUND CHECK OF THE SYSTEM CAN BE MADE AND THE CAUSE OF THE MALFUNCTION CORRECTED.

If moving the RPM lockup override switch from AUTO to OFF does not disengage the RPM lockup system, make a LAND flaps landing using the procedure for "Stuck-Throttle Landing" (alternate procedure contained in this Section).

**NOTE**

If the throttle is in IDLE position when RPM lockup is disengaged engine deceleration will be very rapid: therefore during malfunction it is recommended to set throttle in military position.

**RPM RESET LANDING**

If engine RPM remains in reset after retarding the throttle use aerodynamic braking as necessary to decrease airspeed and proceed as follows:

**WARNING**

IF A BLC DUCT SEPARATION IS INDICATED, DO NOT PLACE THE WING FLAP LEVER TO THE LAND POSITION IN THE LANDING PATTERN BECAUSE THIS MAY RESULT IN A SEVERE ROLLOFF TO ASYMMETRIC AIRFLOW OVER THE FLAPS.

Immediately after touchdown:

1. Throttle — IDLE
2. Use optimum braking
3. Use nosewheel steering to position aircraft on runway centerline for possible barrier engagement

If RPM reset persists:

4. Throttle — OFF

**NOTE**

Nosewheel steering and antiskid brakes will be inoperative. Directional control shall be maintained by use of the standby brakes.

5. Drag chute - Deploy, observing drag chute limits

**CAUTION**

HIGH EXHAUST GAS VELOCITY COMBINED WITH EXCESSIVE AIRSPEED MAY FAIL THE DRAG CHUTE; THEREFORE, DEPLOY THE CHUTE AT MINIMUM PRACTICAL AIRSPEED.

**STUCK-THROTTLE LANDING (ALTERNATE PROCEDURE)**

Letdown and approach under IMC with power not below 97% (after engine stall clearing).

1. Power - 97% RPM
2. Speed brakes - OUT
3. LDG GEAR - DOWN
4. Wing flaps - LAND

When reaching GCA pattern:

5. Wing flaps - TAKEOFF, or LAND

**NOTE**

- With LAND flaps, BLC flow may be interrupted if engine stall should occur.
- With TAKEOFF flaps, speed on final will be high (285 KIAS) and long runway may be required.

## SECTION IV

### CREW DUTIES

NOT APPLICABLE.



# SECTION V

## OPERATING LIMITATIONS

### TABLE OF CONTENTS

Title	Page
Introduction	5-1
Engine Limitations	5-1
Airspeed Limitations	5-5
Crosswind Limitation	5-8
Prohibited Maneuvers	5-8
Restricted Maneuvers	5-11
Aileron Roll Limitations	5-12
Acceleration Limitations	5-12
Center-of-Gravity Limitations	5-14
Weight Limitations	5-14
MRAAM Firing Envelopes	5-14

### INTRODUCTION

This Section includes the engine and aircraft limitations that shall be observed during normal operation. Cognizance shall be taken of the instrument markings (refer to Figure 5-1) since they represent limitations that are not necessarily repeated in the text.

### ENGINE LIMITATIONS

Refer to the Instrument Markings (Figure 5-1) and "Maximum Allowable Airspeed" paragraph, contained in this Section.

### DEFINITIONS AND TIME LIMITS

#### Military Thrust

Military thrust is obtained with a full non-afterburning throttle setting. There are no time limits for in-flight operation at this throttle setting.

#### Maximum Thrust

Maximum thrust is obtained with a full afterburning throttle setting and has no time limits for in-flight operation.

#### NOTE

Ground operation is limited to 45 seconds at military thrust or above but may be repeated after retarding the throttle to IDLE, then advancing to 80-82% RPM for a 2-minute cooling run.

### COMPRESSOR INLET TEMPERATURE

The compressor inlet temperature limit is a function of outside air temperature and flight Mach number. Therefore, the speed at which the limit temperature is reached varies with altitude, and from day to day at a given altitude. On a hot day, limit temperature is reached at lower Mach number and therefore may restrict the maximum permissible speed of the aircraft.

## INSTRUMENT MARKINGS

### AIRSPEED

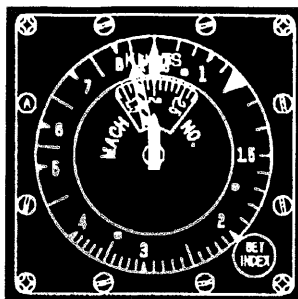

YELLOW 240 KIAS maximum with flaps set to LAND position

### COMPRESSOR INLET TEMPERATURE

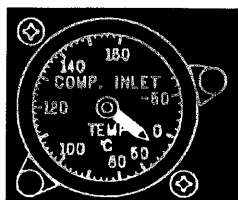

- GREEN -70° to 121° C Normal operating range below 35000 feet
- RED 121° C Limit CIT below 35000 feet
- YELLOW 121° C to 153° C Operating range at 35000 to 40000 feet
- RED 153° C Limit CIT at 40000 feet and above

### ACCELEROMETER

#### SYMMETRICAL MANEUVERS LIMITS

- RED +7.33 "G" maximum capability. Refer to Figure 5-9 for specific configurations.
- RED -3.0 "G" maximum capability. Refer to Figure 5-9 for specific configurations

#### WARNING

ACCELERATION LIMITS VARY WITH AIRSPEED  
AND EXTERNAL STORES CONFIGURATION.  
REFER TO FIGURE 5-9 FOR COMPLETE LIMITS.

### HYDRAULIC SYSTEMS PRESSURE

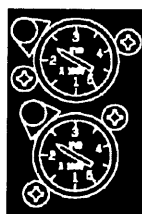

		No. 1 System	No. 2 System
YELLOW	400-2800 psi	Permissible with high flow demands on system	
			400-2175 psi flight controls have priority over utility system.
		Shows malfunction with no flow demands on system	
GREEN	2800-3200 psi	Normal	
YELLOW	3200-3850 psi	Permissible surge during rapid control surface movement	
		Shows malfunction with control surface static	
RED	3850 psi	Maximum	

FA0267

Figure 5-1 (Sheet 1 of 3)

## INSTRUMENT MARKINGS

### NOZZLE POSITION INDICATOR

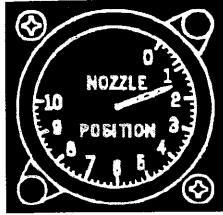

#### RPM

IDLE  
MILITARY  
MAXIMUM A/B  
MINIMUM A/B  
A/B BLOWOUT  
NOZZLE HANDLE PULLED

#### NOZZLE INDICATOR

8 to 9  
1.5 to 4  
7.5 to 9.5  
4 to 6  
Less than 7.5  
3 to 4

#### NOTE

During high mach number (1.85) flight on hotter than standard temperature days, it is acceptable for the nozzle position indicator to read 10 provided the EGT remains normal.

### TACHOMETER (105% MFC)

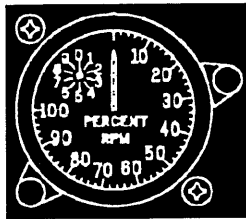

RED 66% Minimum  
GREEN 66% to 105.5% Normal operating range.  
RED 105.5% Maximum permissible.

#### CAUTION

- MAXIMUM ENGINE SPEED VARIES WITH CIT. REFER TO FIGURE 1-2.
- EXCLUDING NORMAL TRANSIENT OVERSPEED PEAKS, ANY OPERATION ABOVE THE MAXIMUM ALLOWABLE SPEED IS CONSIDERED AN OVERSPEED AND SHALL BE REPORTED FOR CORRECTIVE ACTION PRIOR TO THE NEXT FLIGHT.

### ALL CONDITIONS EXCEPT GROUND STATIC

Maximum allowable engine speeds are also shown in Figure 1-2. Transient engine overspeeds up to 107% are allowed without any remedial action. Although engine speeds of 105.5% to 107% are allowed for 3 minutes, if any steady state engine speed in excess of 105.5% occurs, retard throttle to obtain maximum speed of 105.5% RPM and have problem corrected before next flight. If the 3-minute period is exceeded or if engine speed exceeds 107% at any time, refer to engine handbook for corrective actions.

FA0268

Figure 5-1 (Sheet 2 of 3)

## INSTRUMENT MARKINGS

### FUEL FLOW

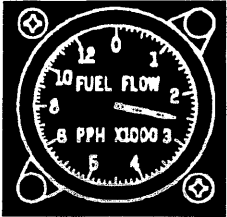

- RED 425 lb/hr Minimum
- GREEN 425 –12000 lb/hr Normal operating range

### OIL PRESSURE (105% MFC)

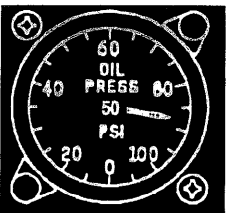

- RED 12 psi Minimum IDLE
- GREEN 12 psi to placard psi +10 psi Continuous operation
- RED Placard psi +10 psi with maximum engine RPM of 105.5%

#### NOTE

- Oil pressure value at 100% engine RPM is placarded on the gage.
- The gage markings shown are for the purpose of illustration only. These examples show markings for an engine/airframe combination with placard oil pressures of 50 psi. This means that the oil pressure will be within limits with an indication of 45 to 55 psi at 100% RPM or a maximum of 60 psi with maximum engine speed. Oil pressure gage markings vary with each engine/airframe installation. Refer to engine oil pressure, section I.

### EXHAUST GAS TEMPERATURE

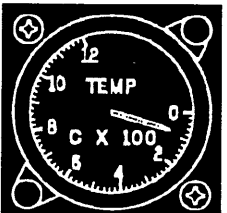

- RED 50° C Minimum
- GREEN 50° C to 688° C Normal operating range (678° C for engines pre AER. 2J-J79GE19-148)
- RED 688° C Maximum steady state (678° C for engines pre AER.2J-J79GE19-148)
- YELLOW 688° C (678° C for engines pre AER.2J-J79GE19-148) to 1000° C time limited.

#### CAUTION

REFER TO FIGURES 5-2 AND 5-3 FOR FURTHER LIMITS AND FOR CORRECTIVE ACTIONS IF LIMITS ARE EXCEEDED.

FA0269

Figure 5-1 (Sheet 3 of 3)

**NOTE**

The maximum permissible compressor inlet temperature (CIT) is 121° C up to 35000 feet and then increases linearly to 153° C up to 40000 feet. At 40000 feet and above, the limit is 153° C. Flight at CIT values in excess of 121° C constitute an allowable overtemperature condition which shall not exceed 5 minutes.

CIT operating limits are governed by the SLOW warning light below 35000 feet and above 40000 feet. Its mechanism is such that it will **not** reflect the permissible linear variation between 35000 feet and 40000 feet.

The warning light will illuminate at 121° C at altitudes below 40000 feet and as the aircraft ascends through 40000 feet, a step function changes the illumination temperature to 153° C CIT. The SLOW warning light will illuminate at 153° C CIT at altitudes above 40000 feet.

**EGT LIMITS**

Refer to Figure 5-2 and Figure 5-3 for the EGT limits.

**ENGINE OIL LEVEL LOW WARNING LIGHT**

The nozzle hydraulic pump and/or nozzle actuation system will suffer damage from insufficient oil. An entry in the aircraft form shall be made reporting all occurrences of warning light illumination of 1 second or longer and the approximate duration.

**ENGINE ANTI-ICING OPERATION LIMITS**

The engine anti-icing system may be operated when the indicated CIT is 10° C or less and at any speed up to 350 KIAS or Mach 1.0, whichever is lower. After flying in moderate to heavy icing for 2 minutes or more, reduce thrust (where practical) to 88% RPM to minimize inlet duct ice ingestion damage to the engine. Should it be necessary to fly in known icing conditions at low altitude and at low thrust settings (80 to 86% RPM), the engine power should be increased to 100% RPM every 5 minutes to ensure that adequate anti-icing air circulation is available at the engine compressor front frame. This thrust increase should be maintained for approximately 30 seconds.

**STARTER LIMITATIONS**

Starter limitations are as follows:

- 1 minute continuous operation
- 3 minutes cooling period
- 1 minute continuous operation
- 10 minutes cooling period

**AIRSPEED LIMITATIONS**

Landing gear transient operation (normal or emergency system)	260 KIAS
Landing gear down and locked	295 KIAS
Rain remover operation	295 KIAS
Auxiliary inlet doors	340 KIAS

Wing flaps:

**TAKE OFF**

- During extension 450 KIAS or 0.85 M  
(There is no Mach limit if 330 KIAS is not exceeded)
- Extended or during retraction 520 KIAS or 0.85 M  
(There is no Mach limit if 360 KIAS is not exceeded)

LAND 240 KIAS

Drag chute operation:

- Ring slot chute 180 KIAS
- Ribbon chute 200 KIAS

**NOTE**

Operational experience has shown that the maximum recommended airspeed for drag chute deployment is 180 KIAS.

**WARNING**

DO NOT EXCEED 500 KIAS WITH EMPTY TIP TANKS AND MORE THAN RESIDUAL FUEL IN THE PYLON TANKS.

### EGT LIMITS (STARTING)

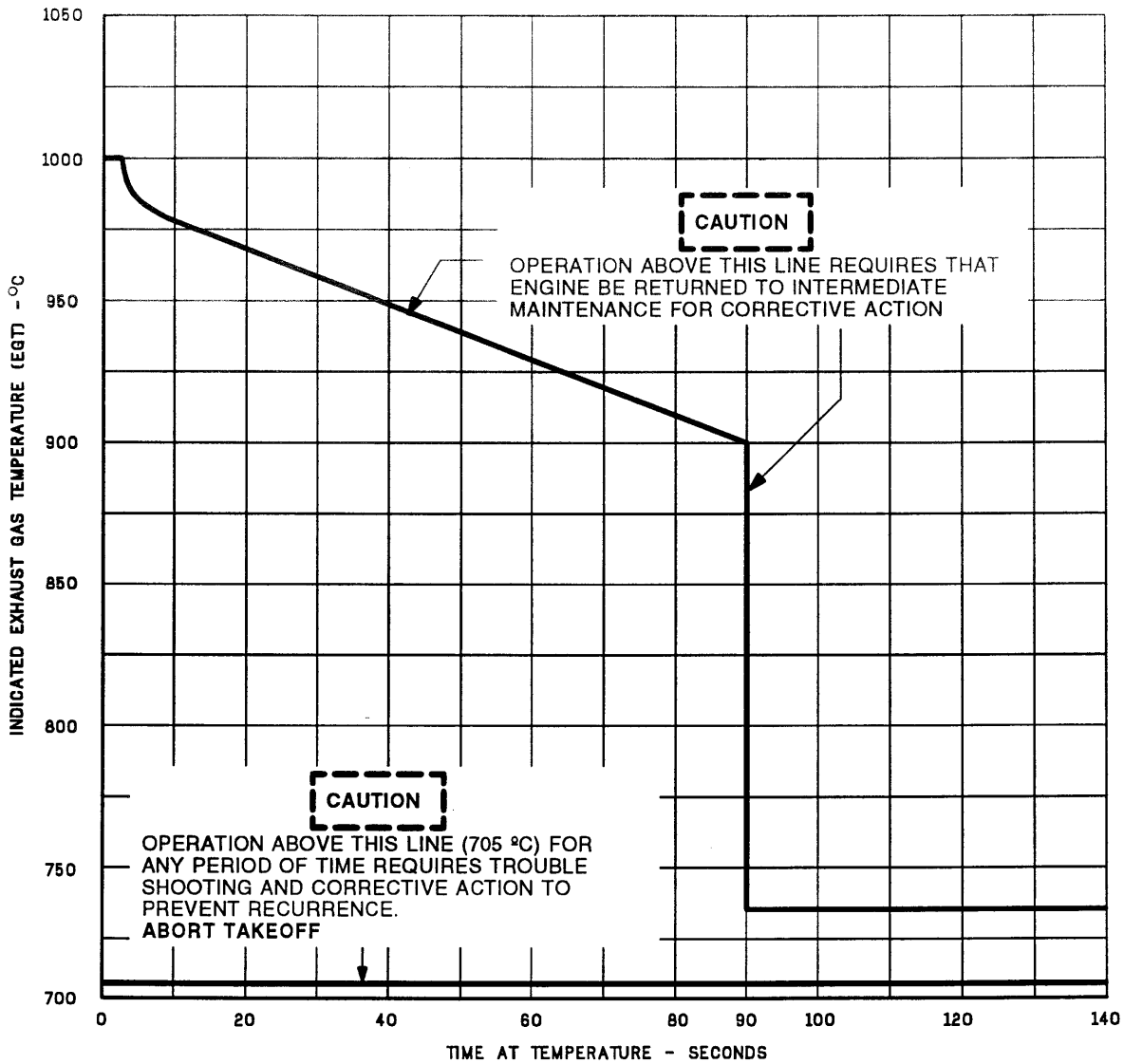

FA0012

Figure 5-2

**EGT LIMITS (ALL CONDITIONS EXCEPT STARTING)**

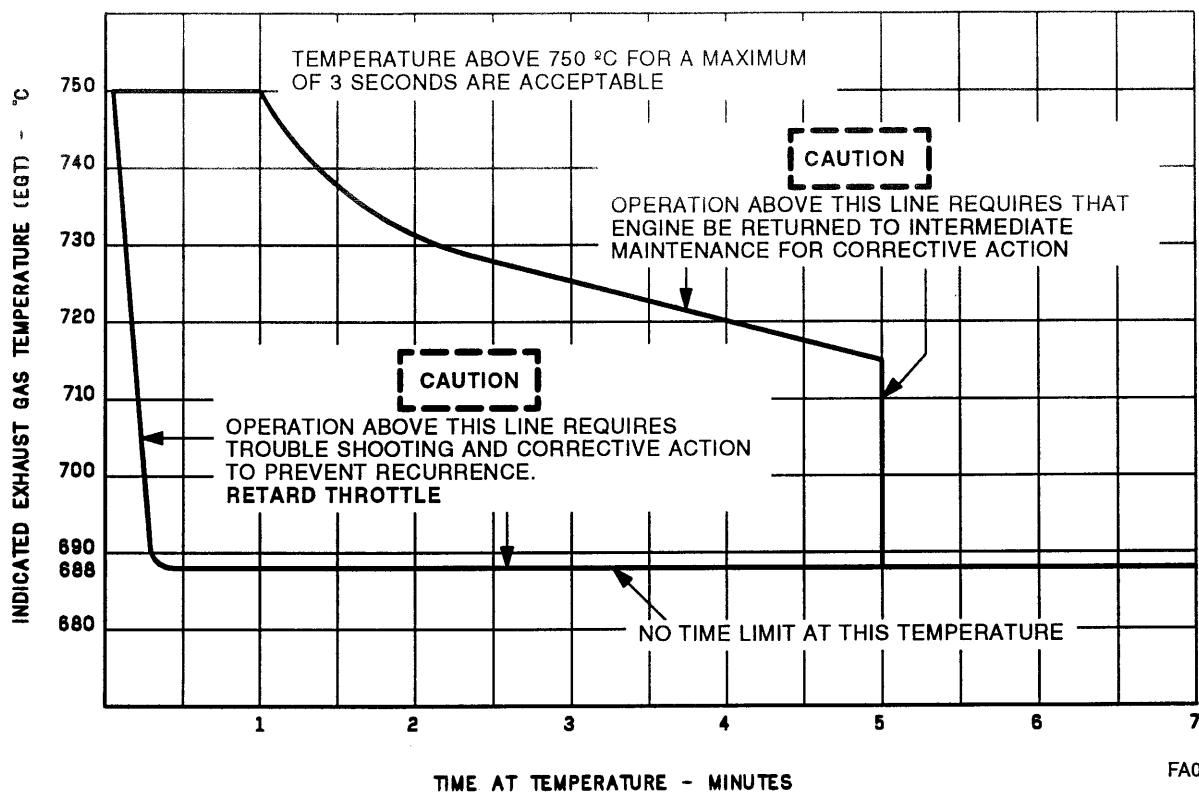

FA0013

**NOTE**

FOR ENGINES PRE AER.2J-J79GE19-148, THE LOWER LIMIT SHALL BE SHIFTED OF -10° C.

**Figure 5-3**

**NOTE**

Refer to Figure 5-4 for the clean aircraft maximum airspeed limitations.

**CAUTION**

- DO NOT UNLOCK THE CANOPY IN FLIGHT.
- ALTHOUGH AIRCRAFT MAY BE TAXIED WITH CANOPY IN FULL OPEN POSITION, CARE SHALL BE EXERCISED TO AVOID FAST TAXI OVER BUMPY STRIPS BECAUSE HIGH VERTICAL LOADS MAY RESULT, WHICH MAY DAMAGE THE CANOPY MECHANISM. IN STRONG CROSSWINDS IT IS POSSIBLE FOR THE CANOPY TO SLAM SHUT.
- TO PREVENT DAMAGE TO THE CANOPY, A TAXI SPEED OF 50 KNOTS SHALL NOT BE EXCEEDED WITH THE CANOPY IN ANY POSITION OTHER THAN FULLY CLOSED AND LOCKED.

**RAT EXTENSION LIMITS**

The RAT may be extended in level flight without affecting engine operation within the following airspeed limits:

Altitude	Airspeed Limits (KIAS)	
	Minimum	Maximum
Up to 30000 feet	None	550
Above 30000 feet	350	

**CROSSWIND LIMITATION**

Maximum crosswind component limit is 25 knots.

**NOTE**

Refer to "Appendix - Performance Data" for further information.

**MAXIMUM ALLOWABLE AIRSPEED**

The maximum allowable speed with no external stores is 750 KEAS or Mach 2.0 up to 35000 feet. From 35000 feet to 40000 feet, speed varies linearly from 2.0 to 2.2 Mach. At 40000 feet and above, Mach 2.2 is the maximum allowable airspeed. Maximum allowable airspeeds are shown on Figure 5-10.

A speed index relates the airspeed limit chart to the acceleration limit chart so that for each configuration given on Figure 5-9 it is easily possible to determine in Figure 5-10 by the speed index, the airspeed limits.

In all cases, airspeed limits are the same after one weapon has been expended as with two similar weapons symmetrically mounted.

**EXTERNAL STORES JETTISON LIMITS**

Refer to Figure 5-5 for the external stores jettison limits.

**PROHIBITED MANEUVERS**

**PITCHUP AND SPINS**

Intentional pitchup and spins are prohibited because of the high loads they impose on the aircraft. These loads may be of sufficient magnitude to cause structural damage.



# MAXIMUM AIRSPEED LIMITATIONS (NO EXTERNAL STORES)

**NOTE**

REFER TO FIGURE 5-10 FOR AIRSPEED LIMITS APPLICABLE TO EACH CLEARED EXTERNAL STORES CONFIGURATION SHOWN IN FIGURE 5-9.

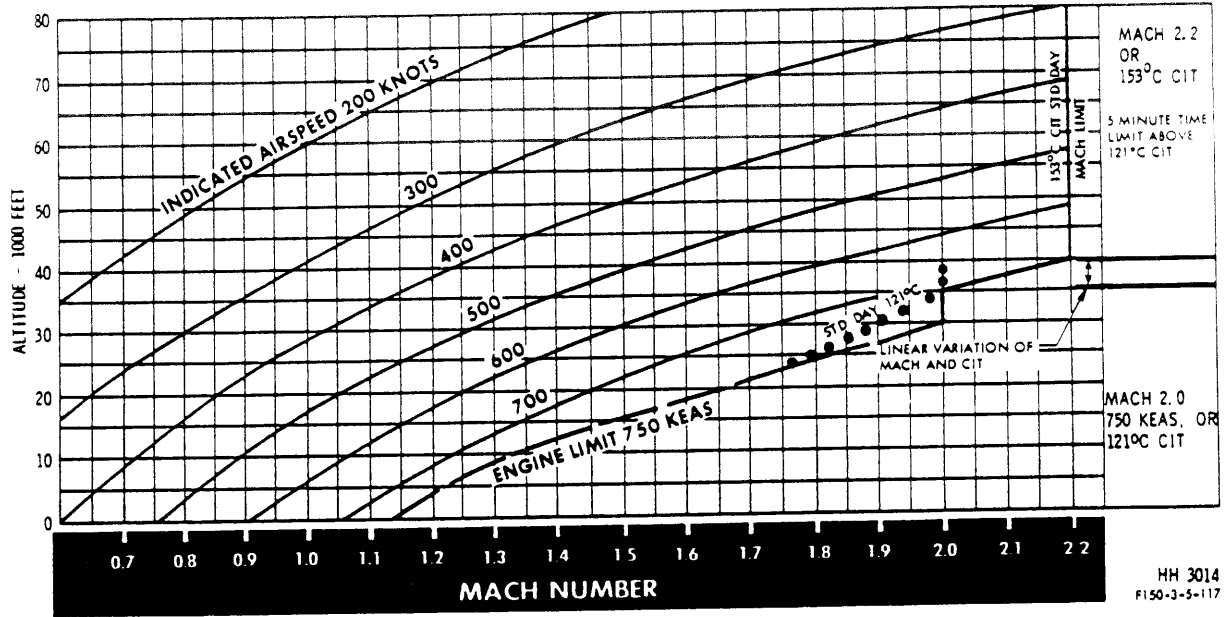

Figure 5-4

**EXTERNAL STORES JETTISON LIMITS**

STORE	STATION	LIMIT
FUEL TANKS	WING TIP	MACH 0.9 NOTE IN EMERGENCY, EMPTY TIP TANKS MAY BE JETTISONED AT SUPER- SONIC SPEEDS. IF POSSIBLE, HOW- EVER, JETTISON TANKS AT LESS THAN MACH 1.5
	BL 75 PYLON	MACH 1.5
FLETCHER AVIATION PYLON TANK (TA-23-225-4800A, C OR E)	BL 75 PYLON	GREATER THAN 250 KIAS BUT NOT TO EXCEED MACH 0.9 OR 500 KIAS
200 US GALLONS FUEL TANK P/N 500900-501	BL 75 PYLON	500 KIAS OR MACH 1.0
PYLONS	BL 75 PYLON	MACH 0.9
	BL 104 PYLON	NOT JETTISONABLE
AIM-9L, AIM-9L/I AND AIM-9L/I-1 MISSILE - ADAPTER AND LAUNCHER	BL 104 PYLON	MACH 0.8 / 500 KTS
	WING TIP	MACH 0.7 / 400 KTS $\infty \leq 5^\circ$
AIM-7E MISSILE AND LAUNCHER ASPID MISSILE AND LAUNCHER	BL 104 PYLON	MACH 0.90 BUT NOT EXCEEDING 500 KIAS / 2.0 G MAXIMUM
<b>NOTE</b> EXTERNAL STORES SHOULD BE JETTISONED IN 1.0 G FLIGHT.		

**Figure 5-5**

**CAUTION**

EXERCISE EXTREME CARE TO AVOID ABRUPT MANEUVERS OR LOW INDICATED AIRSPEEDS WHEN THE "AUTO PITCH CONT OUT" WARNING LIGHT IS LIT OR WHEN THERE ARE OTHER INDICATIONS THAT THE APC SYSTEM IS INOPERATIVE.

**FORMATION TAKEOFF**

Formation takeoffs involving any aircraft in any asymmetric wing tip or wing pylon loading are prohibited.

**NOTE**

Refer to Section VI "Flight Characteristics" "Flight With Asymmetrical Load" paragraph for further information.

**RESTRICTED MANEUVERS****NEGATIVE OR ZERO "G" FLIGHT****WARNING**

TO AVOID FUEL STARVATION, INVERTED FLIGHT SHOULD NOT BE ATTEMPTED WITH LESS THAN 5000 LBS INTERNAL FUEL REMAINING.

Any maneuvers resulting in prolonged negative load factor will result in engine flame-out as a result of fuel starvation.

Prolonged zero "G" flight will result in loss of engine oil pressure causing nozzle to go open and lack of lubrication.

Do not fly negative or zero "G" flight for longer than 10 seconds. This limit applies for fuel flow not greater than 6500 pph. At higher fuel flows, fuel starvation may occur earlier.

**NOTE**

During negative "G" flight it is normal for the fuel boost pumps to cavitate, causing the "FUEL BOOST PUMPS FAIL" warning light to illuminate. Also a loss of oil pressure may be experienced.

**WARNING**

DURING NEGATIVE "G" FLIGHT, EXCESSIVE OIL LOSS MAY OCCUR IF THE OIL IN THE TANK SEPARATES FROM THE OIL PENDULUM PICK-UP PORT DUE TO PENDULUM HANG-UP. IF THIS OCCURS COMPLETE LOSS OF OIL MAY BE EXPERIENCED IN 30 SECONDS OR LESS. OIL LOSS MAY RESULT IN NOZZLE OPEN FAILURE AND/OR ENGINE OIL STARVATION. IF NEGATIVE "G" FLIGHT IS EXPERIENCED, A 5° TO 10° PITCH-UP OR DECELERATION MANEUVER SHOULD BE ACCOMPLISHED TO ASSURE CORRECT PENDULUM POSITIONING AND THE "ENGINE OIL LEVEL LOW" WARNING LIGHT AND NOZZLE SYSTEM MONITORED FOR INDICATION OF OIL LOSS AND/OR NOZZLE OPEN FAILURE.

## AILERON ROLL LIMITATIONS

In order to avoid inertial coupling and high structural loads approaching limit values, aileron rolls are subject to the following restrictions:

### WING FLAPS RETRACTED

#### Entry Load Factor of 0.5 "G" and Greater

Full deflection rolls are limited to 360°. Below 1 "G" with pitch or yaw stability augmenters inoperative, full deflection 360° rolls are prohibited.

#### Entry Load Factor Less Than 0.5 "G"

Full deflection 360° rolls are prohibited. All rolls below 0.5 "G" load factor shall be executed with extreme caution.

### NOTE

Application of some back stick pressure during roll helps to terminate the roll more rapidly and make a smoother transition to normal flight.

### TAKEOFF (MANEUVERING) FLAPS EXTENDED

- a. Rolls are limited to 360°. High roll rates may develop from moderate aileron displacement
- b. Either the pitch or yaw stability augmenters shall be operative for all rolling maneuvers
- c. Aileron rolls are prohibited for entry load factors of less than 1 "G"

### NOTE

Application of some back stick pressure during rolls helps to terminate the roll more rapidly and make a smoother transition to normal flight.

## ACCELERATION LIMITATIONS

Maximum allowable acceleration limits are shown in Figure 5-9. A speed index is shown and corresponds to the values shown in Figure 5-10 to readily obtain allowable airspeed limits.

### CAUTION

- THE INSTRUMENT MARKINGS OF FIGURE 5-1 ARE THE MAXIMUM CAPABILITY OF THE AIRCRAFT.
- REFER TO FIGURE 5-9 FOR ALLOWABLE ACCELERATION LIMITS FOR EACH CLEARED EXTERNAL STORES CONFIGURATION.

"G"-limits for symmetrical maneuvering such as straight pullups or steady turns and "G"-limits for unsymmetrical maneuvering such as rolling pullouts or rolling pushovers are shown in Figure 5-9. In rolling pullouts or rolling pushovers, lower "G"-limits shall be observed because of the higher structural loads that are imposed on the aircraft.

### MANEUVERING BOUNDARIES

An operating flight limits diagram is shown in Figure 5-6. This diagram shows the maximum maneuvering load factors over the operating range of speeds and altitudes of the aircraft. It includes the load factor and airspeed combination at which the stall occurs (refer to Section VI "Flight Characteristics", "Stall" paragraph) as well as the maximum allowable structural "G" limits for the no-external-stores configuration.

Also it will be noted in the diagram that for altitudes of 30000 feet and above, bends in the vertical lines represent additional limits to prevent flight into areas where the vertical tail structure may be overloaded.

Use of the diagram is illustrated. Since the maximum allowable airspeed depends on different limitations at various altitudes, the diagram for any particular altitude is cut off at the airspeed at which the applicable limit is encountered.

For example, this is indicated at the higher altitudes shown on the figure by the vertical lines labeled Mach 2.2.

## OPERATING FLIGHT LIMITS FOR SYMMETRICAL FLIGHT IN SMOOTH AIR

LANDING GEAR AND FLAPS UP. NO EXTERNAL STORES. LESS THAN COMBAT WEIGHT (18506 LBS).

### NOTE

REFER TO FIGURE 5-9 FOR ACCELERATION LIMITS APPLICABLE TO EACH CLEARED EXTERNAL STORES CONFIGURATION. OBSERVE IAS AND CIT LIMITS.

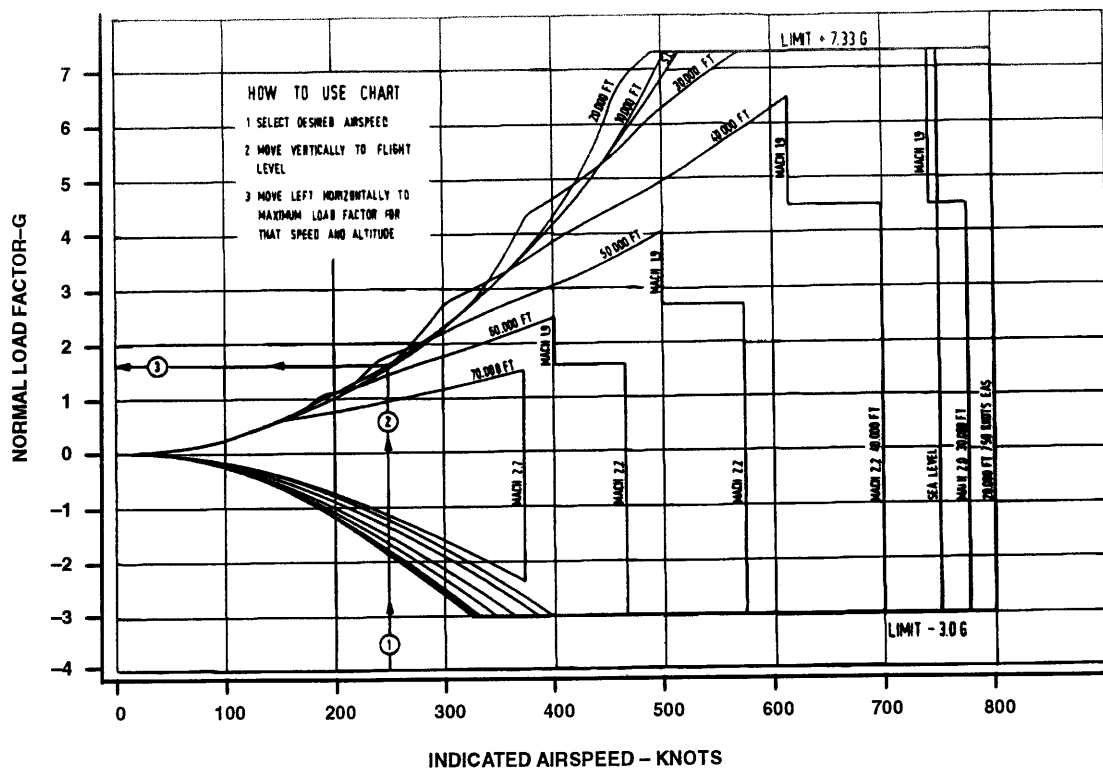

FA0336

Figure 5-6

The diagram does not include the compressor inlet temperature airspeed limitation; therefore, a reference to the airspeed limitations of Figure 5-4, in conjunction with this diagram, is necessary for establishing the complete limits.

Use of Figure 5-4 will also permit determination of the corresponding Mach number for any airspeed and altitude combination if the maximum load factor for a particular Mach number is desired.

## CENTER-OF-GRAVITY LIMITATIONS

For configuration with ASAS equipment plus two extended range fuel tanks installed and any combination of wing tip and pylon stores and/or fuel tanks, landing should be accomplished with at least 1000 lbs fuel to provide adequate longitudinal stability.

### CAUTION

CLEARED WING-TIP STORES MEET CERTAIN REQUIREMENTS AS TO BALANCE AND AERODYNAMIC STABILITY. PILOTS SHALL BE ASSURED THAT STANDARD WING-TIP STORES ARE USED OR THAT REPLACEMENT COMPONENTS CONFORM TO THE STANDARD AERODYNAMIC CONFIGURATION AND CENTER OF GRAVITY.

## CENTER-OF-GRAVITY EXCURSIONS

The following CG position excursions, in percent of MAC (Mean Aerodynamic Chord), are applicable to all operative configurations, including fuel failure conditions, both for landing gear UP and DOWN and to any wing flaps configurations:

Max Aft 22%

Max Fwd 2%

## WEIGHT LIMITATIONS

Maximum gross weight for takeoff of the aircraft is 31000 lbs. Maximum landing weight is 25440 lbs, at 5 feet per second rate of sink.

Landing may be made at higher gross weight but extreme caution shall be used to maintain a lower rate of sink.

## MRAAM FIRING ENVELOPES

Refer to Figure 5-7 and Figure 5-8 for ASPIDE missile and AIM-7E Sparrow missile firing envelopes.

### NOTE

Refer also to Section VI "Flight Characteristics" for further information.

## ASPIDE MISSILE FIRING ENVELOPE

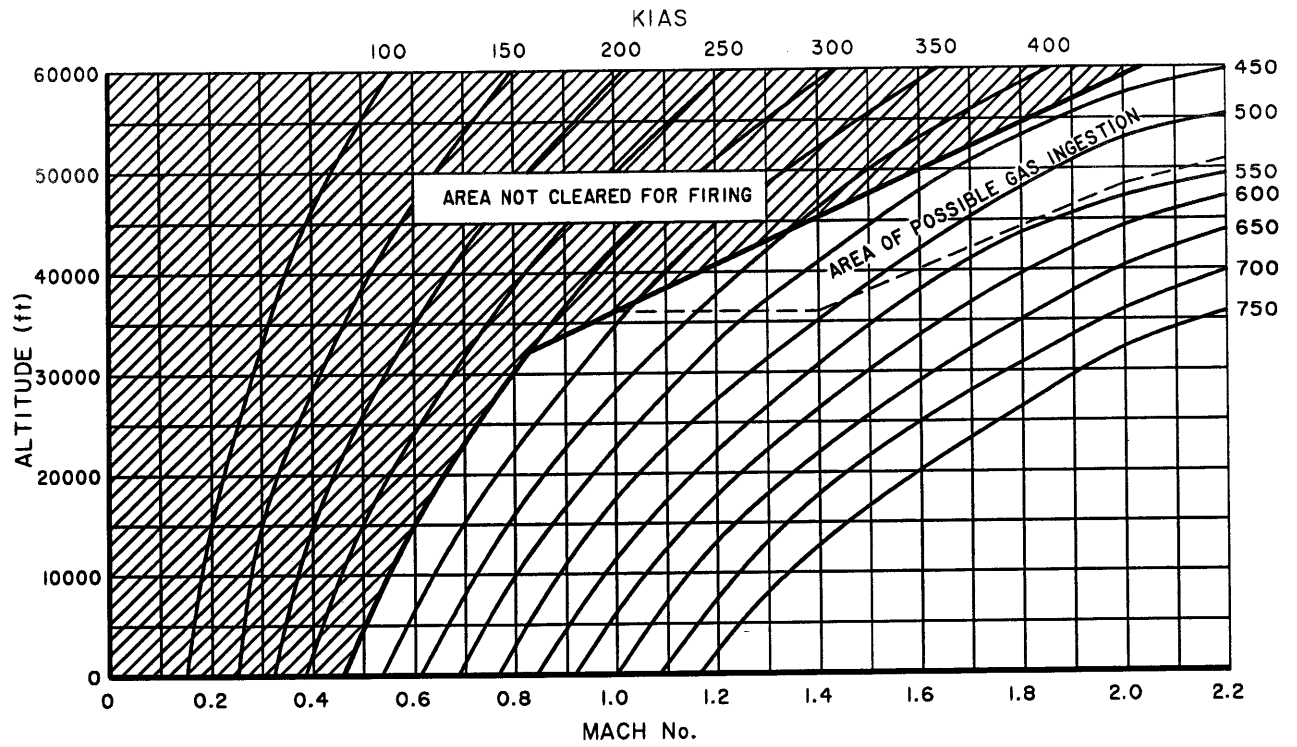

FA0004

Figure 5-7

### AIM-7E SPARROW FIRING ENVELOPE

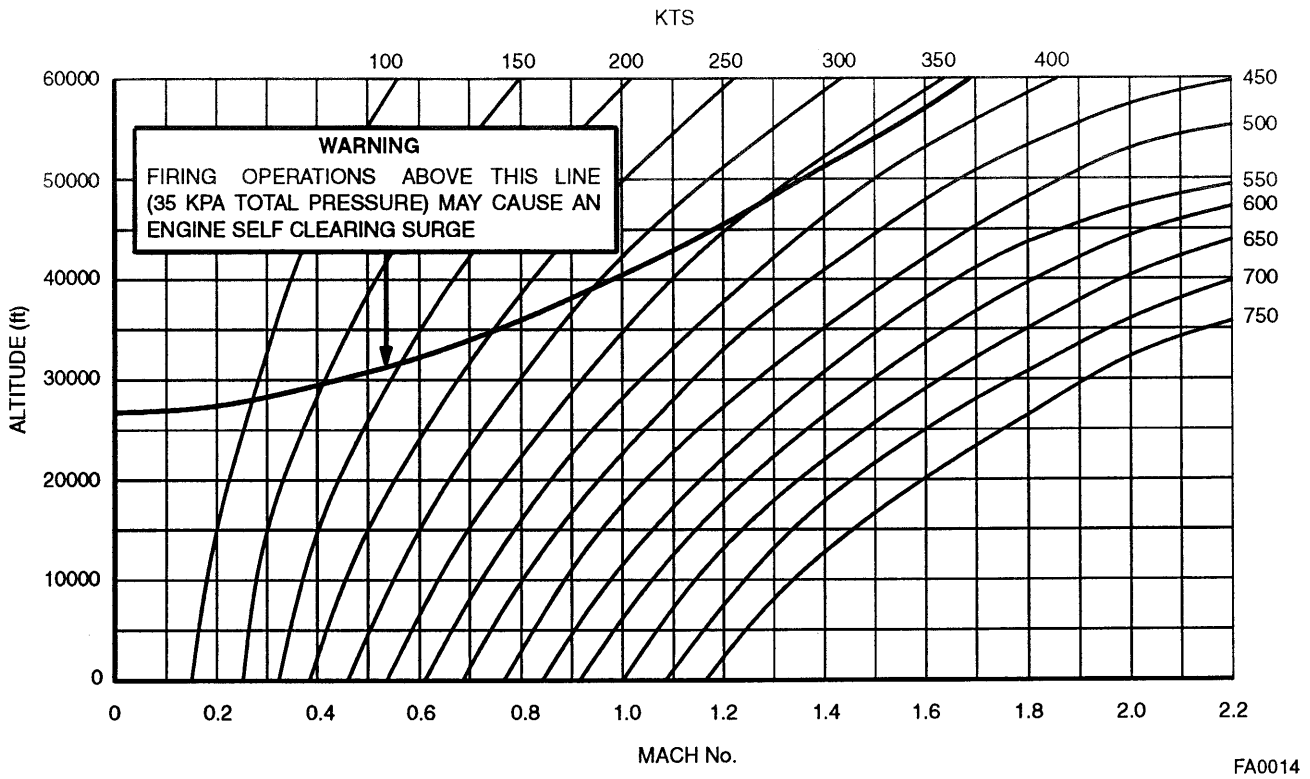

Figure 5-8



**MAXIMUM ALLOWABLE ACCELERATION**

TAKEOFF WEIGHT = MORE THAN 3500 LBS INTERNAL FUEL OR FUEL IN THE EXTERNAL TANKS  
 COMBAT WEIGHT = LESS THAN 3500 LBS INTERNAL FUEL AND NO FUEL IN THE EXTERNAL TANKS

Speed Index	Aircraft Configuration			Acceleration Limits - G's					
	External Store Location			Conditions		Symmetrical Maneuvers		Unsymmetrical Maneuvers	
	BL 75	BL 104	Wing Tip	Mach	Altitude	Takeoff Weight	Combat Weight	Takeoff Weight (*)	Combat Weight (*)
1	None	None	None	Below 1.9	All	+6.3 -2.6	+7.33 -3.0	+4.2	+4.9
				1.9 to limit	Up to 40000	+4.0 -2.0	+4.5 -2.2	+3.3	+3.7
					40000 to 50000	+2.4 -2.0	+2.7 -2.2	+2.4	+2.7
					Above 50000	+1.4 -2.0	+1.6 -2.2	+1.4	+1.6
2	None	None	1 or 2 AIM-9L or AIM-9L/I (5)	Below 1.9	All	+6.0 -2.5	+7.33 -3.0	+4.0	+4.9
				1.9 to limit	Up to 40000	+5.0 -2.0	+5.6 -2.2	+4.0	+4.9
					40000 to 50000	+3.0 -2.0	+3.4 -2.2	+3.0	+3.4
					Above 50000	+1.9 -2.0	+2.1 -2.2	+1.9	+2.1
3	2 Fuel Tanks (**)	None	2 AIM-9L or AIM-9L/I (5)	Below 1.0	All	+3.5 -1.4	+3.9 -1.6	+2.3	+2.6
				1.0 to 1.5	All	+4.6 -1.9	+5.0 -2.0	+3.0	+3.3
3	2 Fuel Tanks (**)	2 AIM-9L or AIM-9L/I (5)	None	Below 1.0	All	+3.7 -1.5	+4.0 -1.6	+2.4	+2.7
				1.0 to 1.5	All	+4.5 -1.8	+5.0 -2.0	+3.0	+3.3
3	2 Fuel Tanks (**)	2 AIM-9L or AIM-9L/I (5)	2 Fuel Tanks	Below 1.0	All	+3.7 -1.5	+4.0 -1.6	+2.4	+2.7
				1.0 to 1.5	All	+4.5 -1.8	+5.0 -2.0	+3.0	+3.3
2	None	2 AIM-9L or AIM-9L/I (5)	None	Below 1.9	All	+6.4 -2.6	+7.33 -3.0	+4.2	+4.9
				1.9 to limit	Up to 40000	+3.5 -2.0	+3.8 -2.2	+3.3	+3.7
					40000 to 50000	+2.1 -2.0	+2.3 -2.2	+2.1	+2.3
					Above 50000	+1.3 -2.0	+1.4 -2.2	+1.3	+1.4

Figure 5-9 (Sheet 1 of 5)

**MAXIMUM ALLOWABLE ACCELERATION**

TAKEOFF WEIGHT = MORE THAN 3500 LBS INTERNAL FUEL OR FUEL IN THE EXTERNAL TANKS  
 COMBAT WEIGHT = LESS THAN 3500 LBS INTERNAL FUEL AND NO FUEL IN THE EXTERNAL TANKS

Speed Index	Aircraft Configuration			Acceleration Limits - G's					
	External Store Location			Conditions		Symmetrical Maneuvers		Unsymmetrical Maneuvers	
	BL 75	BL 104	Wing Tip	Mach	Altitude	Takeoff Weight	Combat Weight	Takeoff Weight (*)	Combat Weight (*)
2	None	1 AIM-9L or AIM-9L/I (5)	None	Below 1.9	All	+6.4 -2.6	+7.33 -3.0	+3.6	+4.0
				1.9 to limit	Up to 40000	+3.5 -2.0	+3.8 -2.2	+3.3	+3.7
					40000 to 50000	+2.1 -2.0	+2.3 -2.2	+2.1	+2.3
					Above 50000	+1.3 -2.0	+1.4 -2.2	+1.3	+1.4
2	None	1 or 2 AIM-9L or AIM-9L/I (5)	2 Fuel Tanks	Below 1.0	All	+4.2 -1.7	+5.0 -2.0	+2.8	+3.3
				1.0 to 1.85	All	+5.0 -2.0	+5.0 -2.0	+3.3	+3.3
				1.85 to limit	Up to 40000	+3.6 -2.0	+4.1 -2.0	+3.3	+3.3
					40000 to 50000	+2.2 -2.0	+2.5 -2.0	+2.2	+2.5
					Above 50000	+1.4 -2.0	+1.6 -2.0	+1.4	+1.6
2	None	2 AIM-9L or AIM-9L/I (5)	1 or 2 AIM-9L or AIM-9L/I (5)	Below 1.0	All	+5.0 -2.0	+6.5 -2.6	+3.3	+4.0
				1.0 to 1.9	All	+6.2 -2.5	+6.5 -2.6	+3.4	+3.9
				1.9 to limit	Up to 40000	+4.1 -2.0	+4.5 -2.2	+3.4	+3.9
					40000 to 50000	+2.7 -2.0	+3.0 -2.2	+2.7	+3.0
					Above 50000	+1.6 -2.0	+1.8 -2.2	+1.6	+1.8
3	2 Fuel Tanks (**)	1 or 2 AIM-9L or AIM-9L/I (5)	2 AIM-9L or AIM-9L/I (5)	Below 1.0	All	+3.5 -1.4	+3.9 -1.6	+2.3	+2.6
				1.0 to 1.5	All	+4.4 -1.8	+4.8 -1.9	+2.9	+3.2

Figure 5-9 (Sheet 2 of 5)

**MAXIMUM ALLOWABLE ACCELERATION**

TAKEOFF WEIGHT = MORE THAN 3500 LBS INTERNAL FUEL OR FUEL IN THE EXTERNAL TANKS  
 COMBAT WEIGHT = LESS THAN 3500 LBS INTERNAL FUEL AND NO FUEL IN THE EXTERNAL TANKS

Speed Index	Aircraft Configuration			Acceleration Limits - G's					
	External Store Location			Conditions		Symmetrical Maneuvers		Unsymmetrical Maneuvers	
	BL 75	BL 104	Wing Tip	Mach	Altitude	Takeoff Weight	Combat Weight	Takeoff Weight (")	Combat Weight (")
2	None	1 or 2 MRAAM (****)	1 or 2 AIM-9L or AIM-9L/I (5)	Below 1.0	All	+5.0 -2.0	+6.5 -2.6	+3.3	+4.0
				1.0 to 1.9	All	+6.2 -2.5	+6.5 -2.6	+3.4	+3.9
				1.9 to limit	Up to 40000	+4.1 -2.0	+4.5 -2.2	+3.4	+3.9
					40000 to 50000	+2.7 -2.0	+3.0 -2.2	+2.7	+3.0
3	2 Fuel Tanks (**)	1 or 2 MRAAM (****)	2 AIM-9L or AIM-9L/I (5)	Below 1.0	All	+3.5 -1.4	+3.9 -1.6	+2.3	+2.6
				1.0 to 1.5	All	+4.4 -1.8	+4.8 -1.9	+2.9	+3.2
2	None	1 AIM-9L or AIM-9L/I (5) (RH Pylon) (***) + 1 MRAAM (LH Pylon) (****)	None	Below 1.9	All	+6.4 -2.6	+7.33 -3.0	+4.2	+4.9
				1.9 to limit	Up to 40000	+3.5 -2.0	+3.8 -2.2	+3.3	+3.7
					40000 to 50000	+2.1 -2.0	+2.3 -2.2	+2.1	+2.3
3	2 Fuel Tanks (**)	1 AIM-9L or AIM-9L/I (5) (RH Pylon) (***) + 1 MRAAM (LH Pylon) (****)	None	Below 1.0	All	+3.5 -1.4	+3.9 -1.6	+2.3	+2.6
				1.0 to 1.5	All	+4.6 -1.9	+5.0 -2.0	+3.0	+3.3
2	None	1 AIM-9L or AIM-9L/I (5) (RH Pylon) (***) + 1 MRAAM (LH Pylon) (****)	2 Fuel Tanks	Below 1.0	All	+4.2 -1.7	+5.0 -2.0	+2.8	+3.3
				1.0 to 1.85	All	+5.0 -2.0	+5.0 -2.0	+3.3	+3.3
				1.85 to limit	Up to 40000	+3.6 -2.0	+4.1 -2.0	+3.3	+3.3
					40000 to 50000	+2.2 -2.0	+2.5 -2.0	+2.2	+2.5
3	2 Fuel Tanks (**)	1 AIM-9L or AIM-9L/I (5) (RH Pylon) (***) + 1 MRAAM (LH Pylon) (****)	None	Below 1.0	All	+3.5 -1.4	+3.9 -1.6	+2.3	+2.6
				1.0 to 1.5	All	+4.6 -1.9	+5.0 -2.0	+3.0	+3.3
2	None	1 AIM-9L or AIM-9L/I (5) (RH Pylon) (***) + 1 MRAAM (LH Pylon) (****)	2 Fuel Tanks	Below 1.0	All	+4.2 -1.7	+5.0 -2.0	+2.8	+3.3
				1.0 to 1.85	All	+5.0 -2.0	+5.0 -2.0	+3.3	+3.3
				1.85 to limit	Up to 40000	+3.6 -2.0	+4.1 -2.0	+3.3	+3.3
					40000 to 50000	+2.2 -2.0	+2.5 -2.0	+2.2	+2.5
3	2 Fuel Tanks (**)	1 AIM-9L or AIM-9L/I (5) (RH Pylon) (***) + 1 MRAAM (LH Pylon) (****)	None	Below 1.0	All	+3.5 -1.4	+3.9 -1.6	+2.3	+2.6
				1.0 to 1.5	All	+4.6 -1.9	+5.0 -2.0	+3.0	+3.3
2	None	1 AIM-9L or AIM-9L/I (5) (RH Pylon) (***) + 1 MRAAM (LH Pylon) (****)	2 Fuel Tanks	Below 1.0	All	+4.2 -1.7	+5.0 -2.0	+2.8	+3.3
				1.0 to 1.85	All	+5.0 -2.0	+5.0 -2.0	+3.3	+3.3
				1.85 to limit	Up to 40000	+3.6 -2.0	+4.1 -2.0	+3.3	+3.3
					40000 to 50000	+2.2 -2.0	+2.5 -2.0	+2.2	+2.5
3	2 Fuel Tanks (**)	1 AIM-9L or AIM-9L/I (5) (RH Pylon) (***) + 1 MRAAM (LH Pylon) (****)	None	Below 1.0	All	+3.5 -1.4	+3.9 -1.6	+2.3	+2.6
				1.0 to 1.5	All	+4.6 -1.9	+5.0 -2.0	+3.0	+3.3
2	None	1 AIM-9L or AIM-9L/I (5) (RH Pylon) (***) + 1 MRAAM (LH Pylon) (****)	2 Fuel Tanks	Below 1.0	All	+4.2 -1.7	+5.0 -2.0	+2.8	+3.3
				1.0 to 1.85	All	+5.0 -2.0	+5.0 -2.0	+3.3	+3.3
				1.85 to limit	Up to 40000	+3.6 -2.0	+4.1 -2.0	+3.3	+3.3
					40000 to 50000	+2.2 -2.0	+2.5 -2.0	+2.2	+2.5
3	2 Fuel Tanks (**)	1 AIM-9L or AIM-9L/I (5) (RH Pylon) (***) + 1 MRAAM (LH Pylon) (****)	None	Below 1.0	All	+3.5 -1.4	+3.9 -1.6	+2.3	+2.6
				1.0 to 1.5	All	+4.6 -1.9	+5.0 -2.0	+3.0	+3.3

Figure 5-9 (Sheet 3 of 5)

### MAXIMUM ALLOWABLE ACCELERATION

TAKEOFF WEIGHT = MORE THAN 3500 LBS INTERNAL FUEL OR FUEL IN THE EXTERNAL TANKS  
 COMBAT WEIGHT = LESS THAN 3500 LBS INTERNAL FUEL AND NO FUEL IN THE EXTERNAL TANKS

Speed Index	Aircraft Configuration			Acceleration Limits - G's					
	External Store Location			Conditions		Symmetrical Maneuvers		Unsymmetrical Maneuvers	
	BL 75	BL 104	Wing Tip	Mach	Altitude	Takeoff Weight	Combat Weight	Takeoff Weight (*)	Combat Weight (*)
3	2 Fuel Tanks (**)	1 AIM-9L or AIM-9L/I (5) (RH Pylon) (***) + 1 MRAAM (LH Pylon) (****)	2 Fuel Tanks	Below 1.0	All	+3.5 -1.4	+3.9 -1.6	+2.3	+2.6
				1.0 to 1.5	All	+4.6 -1.9	+5.0 -2.0	+3.0	+3.3
1	None	2 MRAAM (****)	None	Below 1.9	All	+6.4 -2.6	+7.33 -3.0	+4.2	+4.9
				1.9 to limit	Up to 40000	+3.5 -2.0	+3.8 -2.2	+3.3	+3.7
					40000 to 50000	+2.1 -2.0	+2.3 -2.2	+2.1	+2.3
					Above 50000	+1.3 -2.0	+1.4 -2.2	+1.3	+1.4
1	None	1 MRAAM (LH Pylon) (****)	None	Below 1.9	All	+6.4 -2.6	+7.33 -3.0	+3.6	+4.0
				1.9 to limit	Up to 40000	+3.5 -2.0	+3.8 -2.2	+3.3	+3.7
					40000 to 50000	+2.1 -2.0	+2.3 -2.2	+2.1	+2.3
					Above 50000	+1.3 -2.0	+1.4 -2.2	+1.3	+1.4
2	None	1 or 2 MRAAM (****)	2 Fuel Tanks	Below 1.0	All	+4.2 -1.7	+5.0 -2.0	+2.8	+3.3
				1.0 to 1.85	All	+5.0 -2.0	+5.0 -2.0	+3.3	+3.3
				1.85 to limit	Up to 40000	+3.6 -2.0	+4.1 -2.0	+3.3	+3.3
					40000 to 50000	+2.2 -2.0	+2.5 -2.0	+2.2	+2.5
					Above 50000	+1.4 -2.0	+1.6 -2.0	+1.4	+1.6
3	2 Fuel Tanks (**)	1 or 2 MRAAM (****)	None	Below 1.0	All	+3.5 -1.4	+3.9 -1.6	+2.3	+2.6
				1.0 to 1.5	All	+4.4 -1.8	+4.8 -1.9	+2.9	+3.2
3	2 Fuel Tanks (**)	1 or 2 MRAAM (****)	2 Fuel Tanks	Below 1.0	All	+3.5 -1.4	+3.9 -1.6	+2.3	+2.6
				1.0 to 1.5	All	+4.4 -1.8	+4.8 -1.9	+2.9	+3.2

Figure 5-9 (Sheet 4 of 5)

## MAXIMUM ALLOWABLE ACCELERATION

TAKEOFF WEIGHT = MORE THAN 3500 LBS INTERNAL FUEL OR FUEL IN THE EXTERNAL TANKS  
 COMBAT WEIGHT = LESS THAN 3500 LBS INTERNAL FUEL AND NO FUEL IN THE EXTERNAL TANKS

Speed Index	Aircraft Configuration			Acceleration Limits -- G's					
	External Store Location			Conditions		Symmetrical Maneuvers		Unsymmetrical Maneuvers	
	BL 75	BL 104	Wing Tip	Mach	Altitude	Takeoff Weight	Combat Weight	Takeoff Weight (*)	Combat Weight (*)
2	None	None	2 Fuel Tanks	Below 1.9	All	+5.0 -2.0	+5.0 -2.0	+3.3	+3.3
				1.9 to limit	Up to 40000	+4.0 -2.0	+4.7 -2.0	+3.3	+3.3
					40000 to 50000	+2.5 -2.0	+2.9 -2.0	+2.5	+2.9
					Above 50000	+1.5 -2.0	+1.7 -2.0	+1.5	+1.7
3	2 Fuel Tanks (**)	None	None	Below 1.0	All	+3.5 -1.4	+3.9 -1.6	+2.3	+2.6
				1.0 to 1.5	All	+4.6 -1.9	+5.0 -2.0	+3.0	+3.3
3	2 Fuel Tanks (**)	None	2 Fuel Tanks	Below 1.0	All	+3.5 -1.4	+3.9 -1.6	+2.3	+2.6
				1.0 to 1.5	All	+4.6 -1.9	+5.0 -2.0	+3.0	+3.3
4	Any of the above configuration with takeoff flaps			Below takeoff flaps speed limits		All acceleration limits are the same as above except minimum symmetrical G limit is -1.0 G			

(\*) For rolling pushovers refer to aileron roll limitation in text

(\*\*) With Fletcher Aviation P/N 347701-103 230 gallon pylon tanks, observe the following limits:

- 500 KIAS or MACH 0.9 whichever occurs first
- 4.0 G acceleration limit

With P/N 500900-501 200 gallon pylon tanks observe the following limits:

- 500 KIAS or MACH 1.0 whichever occurs first
- 4.0 G - 1.6 G (symm.), 2.7 G (asymm.), acceleration limits

(\*\*\*) When one missile has been fired, refer to one AIM-9's or one AIM-7's limits

When launchers only are installed observe same limits as with both missiles installed

(\*\*\*\*) The term MRAAM refers to the AIM-7E or ASPIDE missile

### NOTES:

1. See Figure 5-10 to correlate speed index to airspeed limitation
2. With LAND flap the minimum symmetrical "G" limit is 0.0 "G" for all configurations
3. With auxiliary inlet doors open, the maximum symmetrical "G" limit is +4.0 "G" for all configurations
4. Bare pylons do not affect limits, observe limits for other applicable stores
5. Or AIM-9L/I-1

### NOTE

The AIM-9L is not mixable with either the AIM-9L/I or AIM-9L/I-1 missile.

**Figure 5-9 (Sheet 5 of 5)**

**AIRSPED LIMITATIONS**

AIRSPED LIMITS
OBSERVE MACH NUMBER, AIRSPED OR COMPRESSOR INLET TEMPERATURE LIMIT WHICHEVER OCCURS FIRST

SPEED INDEX	CONDITIONS		AIRSPED	COMPRESSOR INLET TEMPERATURE	
	ALTITUDE	MACH		UNLIMITED OPERATION	OVERTEMPERATURE OPERATION
1	UP TO 35000 FT	2.0	750 KEAS	121° C	NONE
	35000 FT TO 40000 FT	VARIES LINEARLY FROM 2.0 TO 2.2	750 KEAS	121° C	VARIES LINEARLY FROM 121° TO 153°
	ABOVE 40000 FT	2.2	750 KEAS	121° C	153°
2	ALL	2.0	750 KEAS	121° C	NONE
3	ALL	1.5	750 KEAS	121° C	NONE
4	ALL ALTITUDES DURING TAKE OFF FLAPS EXTENSION	0.85 NO MACH LIMIT IF 330 KIAS NOT EXCEEDED	450 KIAS	NOT APPLICABLE	NOT APPLICABLE
	ALL ALTITUDES TAKE OFF FLAPS EXTENDED OR RETRACTING	0.85 NO MACH LIMIT IF 360 KIAS NOT EXCEEDED	520 KIAS	NOT APPLICABLE	NOT APPLICABLE

**WARNING**

DO NOT EXCEED 500 KIAS WITH EMPTY TIP TANKS AND MORE THAN RESIDUAL FUEL IN THE PYLON TANKS.

**CAUTION**

OVERTEMPERATURE OPERATION LIMITED TO 5 MINUTES ABOVE 121° C.

**NOTE**

REFER TO FIGURE 5-9 TO CORRELATE SPEED INDEX WITH AIRCRAFT CONFIGURATION.

**Figure 5-10**

## SECTION VI

### FLIGHT CHARACTERISTICS

#### TABLE OF CONTENTS

Title	Page
Introduction	6-1
Aircraft Configuration	6-1
Flight Controls	6-3
Takeoff Characteristics	6-5
Stalls	6-6
Pitchup/Spins	6-11
Pitchup/Spin Recovery	6-11
Performance Capabilities	6-12
Level Flight Characteristics	6-17
Maneuvering Flight	6-20
Diving	6-21
Pilot Induced Oscillations	6-22
Flight with External Stores	6-22
Flight with Asymmetrical Load	6-26
Formation Flying	6-28
APC Meter	6-29

#### INTRODUCTION

This section presents a description of the flight characteristics and performance capabilities of the aircraft. The operational speed and altitude capabilities include level-flight and climb speed of Mach 2.2. The aircraft is capable of attaining altitudes in excess of 90000 feet. Flight characteristics and handling qualities are excellent throughout this large range of operating speeds and altitudes. Low-speed flight characteristics are conventional and transition from subsonic to supersonic speed is made with negligible trim changes.

#### MACH NUMBER

Except for possibly the low-speed stall, the flight characteristics are generally a function of Mach

number rather than indicated airspeed. Flight characteristics are therefore more easily associated with Mach number than IAS. Increasing altitude at a constant indicated airspeed result in increasing Mach number; therefore, for each altitude there is a different indicated airspeed for the same Mach number. The effect of airspeed at a given Mach number is simply to vary the magnitude of a particular flight characteristic. At high indicated airspeeds, a given flight characteristic generally is more pronounced. For these reasons, reference to flight speed generally will be made in terms of Mach number rather than airspeed.

#### AIRSPEED AND ALTITUDE ERRORS

The airspeed system was designed and developed to minimize the altimeter error at low altitude throughout the airspeed range. In-flight calibration of this system establishes that a small error exists, being affected by aircraft attitude at subsonic speeds. The error is small enough to be disregarded during takeoff and landing and normal flight at low altitudes. In 1 "G" level flight at cruise speed, the altimeter indicates an altitude higher than the true pressure altitude. On entering a level turn at low altitude, the altimeter will indicate a loss of altitude of 200 to 300 feet, depending on the aircraft load factor used. In level turns at high altitude during supersonic flight, the altimeter will also indicate a loss in altitude of about 300 feet. In order to provide altitude corrections ensuring terrain clearance during low-altitude operation, calibrations are presented in the "Appendix - Performance Data, Part 1 Introduction".

#### AIRCRAFT CONFIGURATION

The overall configuration of the aircraft was chosen with an emphasis on high Mach number flight while maintaining conventional landing and takeoff char-

acteristics. Since the appearance of this aircraft is somewhat unconventional, a brief discussion of some of the aerodynamic aspects of its configuration is given before describing the flight characteristics.

## NEGATIVE DIHEDRAL

With the exception of the short span of the thin, straight wing, the configuration feature arousing the most interest on the aircraft is the 10° negative wing dihedral. The empennage arrangement will be discussed first and then the negative wing dihedral.

## EMPENNAGE

The empennage of the aircraft, aside from its very high effectiveness, is conventional in most respects. The unconventional aspect of the empennage is the location of the horizontal stabilizer on top of the vertical fin. This location of the horizontal stabilizer was determined from extensive wind tunnel tests of the tail located in many positions from below the fuselage to its present high position.

These tests showed that the high position gave the best stability and control characteristics about the pitch axis over the wide operating range of the aircraft. This tail configuration gives a minimum of transonic trim changes and provides high stabilizer effectiveness throughout the speed range. In addition, the high location provides the minimum drag at supersonic speeds.

## DIHEDRAL EFFECT

The position of the horizontal stabilizer atop the fin makes it act as an end plate to the vertical fin. The effective aspect ratio of the vertical fin is thus greatly increased, raising the center of pressure of the side load on the fin higher than would be the case for a low horizontal stabilizer position. This high-side center-of-pressure location on the fin results in a relatively large rolling moment in a sideslip condition.

Comparison of the vertical fin height to the wing semi-span shows that the fin is almost as important in producing roll as the wing. Thus, the high center of pressure resulting from the horizontal stabilizer location provides the equivalent dihedral effect of 15° to 20° of positive wing dihedral angle. Negative dihedral of the wing is then introduced to reduce the net positive dihedral effect to that equivalent to 5° to 10° of dihedral. It is to be emphasized that despite the negative wing dihedral, the aircraft possesses a normal positive dihedral effect, as the pilot will immediately detect from the position of the stick in maintaining a steady sideslip at low speeds.

## WING

The wing is of basically straight planform in order to minimize drag at very high Mach numbers. The ailerons are conventional outboard ailerons. The flaps comprise leading-edge and trailing-edge flaps. The full-span leading edge flap is deflected for landing and takeoff in order to delay flow separation over the sharp leading edge at the higher angles of attack.

The inboard trailing edge flaps incorporate boundary layer control. The boundary layer control system directs high-energy air over the trailing edge flaps in the LAND position, thereby delaying airflow separation on the flaps. This permits the use of larger flaps deflections than normally would be possible, with a resulting increase in lift at high angles of attack.

The combination of leading and trailing edge flaps results in normal approach and landing touchdown speeds, while maintaining the capability of very high speed flight with the basic wing.

## MANEUVERING FLAPS

Maneuvering capabilities of the aircraft may be improved by the use of "maneuvering flaps". "Maneuvering flaps" are the wing flaps lowered to TAKE-OFF position with the gear retracted.

This permits an increase of approximately 1 "G" in the available load factor over that with the aircraft flaps UP, thereby improving the turn radius of the aircraft.



**WARNING**

THE ANGLE AT WHICH THE ANGLE-OF-ATTACK SENSING VANES ENERGIZE THE SHAKER OR KICKER IS DEPENDENT UPON THE WING FLAPS LEVER SETTING AND NOT THE ACTUAL POSITION OF THE FLAPS. IN NORMAL OPERATING CONDITION AFTER WING FLAPS LEVER HAS BEEN SELECTED FROM UP TO TAKEOFF (APC BOUNDARY VARIATION) AND BEFORE SAFE TAKEOFF INDICATION IS ACHIEVED A TIME INTERVAL OF 7/8 SECONDS EXISTS. THEREFORE INCREASING THE LOAD FACTOR (AOA) DURING THIS TRANSIENT CAN CAUSE A PITCH-UP WITH NO PREVIOUS SHAKER OR KICKER OPERATION.

**FLIGHT CONTROLS****STABILIZER**

The fully powered horizontal stabilizer is an extremely powerful longitudinal control and provides excellent maneuvering characteristics at all flight speeds. Due to the high response rates possible with this type of control, use caution in rapid maneuvering, especially at high indicated subsonic airspeeds, until you are familiar with its effectiveness. The artificial feel system provides satisfactory stick forces under all conditions with good centering and excellent incremental control qualities.

**AILERONS**

The ailerons are fully powered, are capable of producing extremely high roll rates, and have stick forces supplied by feel springs. The action of the feel springs results in essentially constant stick forces for any amount of deflection, regardless of airspeed. Aileron travel is limited to approximately  $\pm 10^\circ$  of travel with gear UP to reduce effectiveness and avoid inertial coupling tendencies in rolls over the wide operating limits of the aircraft.

When the gear is DOWN the available aileron travel is increased to approximately  $\pm 20^\circ$  to permit more effective control such as is necessary during approach and landing.

Aileron travel is also unlimited when the gear is UP and a trailing edge flaps asymmetry, as detected by the flaps asymmetry detector system, occurs.

When the ailerons are unlimited, the AIL AND RUD UNLIMITED warning light, located on the left part of the upper main instrument panel, will illuminate.

**RUDDER**

The rudder is a fully powered irreversible control surface. Feel forces are provided by springs up to the power limit of the system. In order to maintain tail loads below structural values, the rudder incorporates two limits.

With the gear extended, rudder travel is  $\pm 20^\circ$ . On retracting the gear, the rudder travel is automatically limited to  $\pm 6^\circ$  from trim position. Directional trim control is provided with the rudder surface with  $\pm 4^\circ$  deflection for trimming.

Rudder travel is also unlimited when the gear is UP and a trailing edge flaps asymmetry, as detected by the flaps asymmetry detector system, occurs. When the rudder is unlimited, the AIL AND RUD UNLIMITED warning light, located on the left part of the upper main instrument panel, will illuminate.

**STABILITY AUGMENTERS**

The handling characteristics and dynamic response of the aircraft about all three aircraft axes are greatly improved through the use of stability augmenters. The yaw and roll augmenters provide effective damping of "dutch-roll" motion and the pitch augments provides longitudinal damping, resulting in a steady and effective weapon platform.

To obtain optimum handling characteristics, the yaw and pitch augmenters should be in use at all times and the roll augments should be on at all times. Figure 6-1 and Figure 6-2 graphically illustrate the effect of these augmenters, showing typical characteristics with and without the augmenters in operation.

Should failure occur in the yaw augments system the surface will remain stationary or drift slowly to any position within its control range and yaw damping will be noticeably reduced. Failure of the roll augments system does not reduce the effectiveness of the aircraft but results in more sensitivity to roll disturbances in turbulent air. Flight may be continued, and in smooth air little or no effect will

## EFFECT OF STABILITY AUGMENTERS ON ROLL AND YAW DYNAMIC FLIGHT CHARACTERISTICS

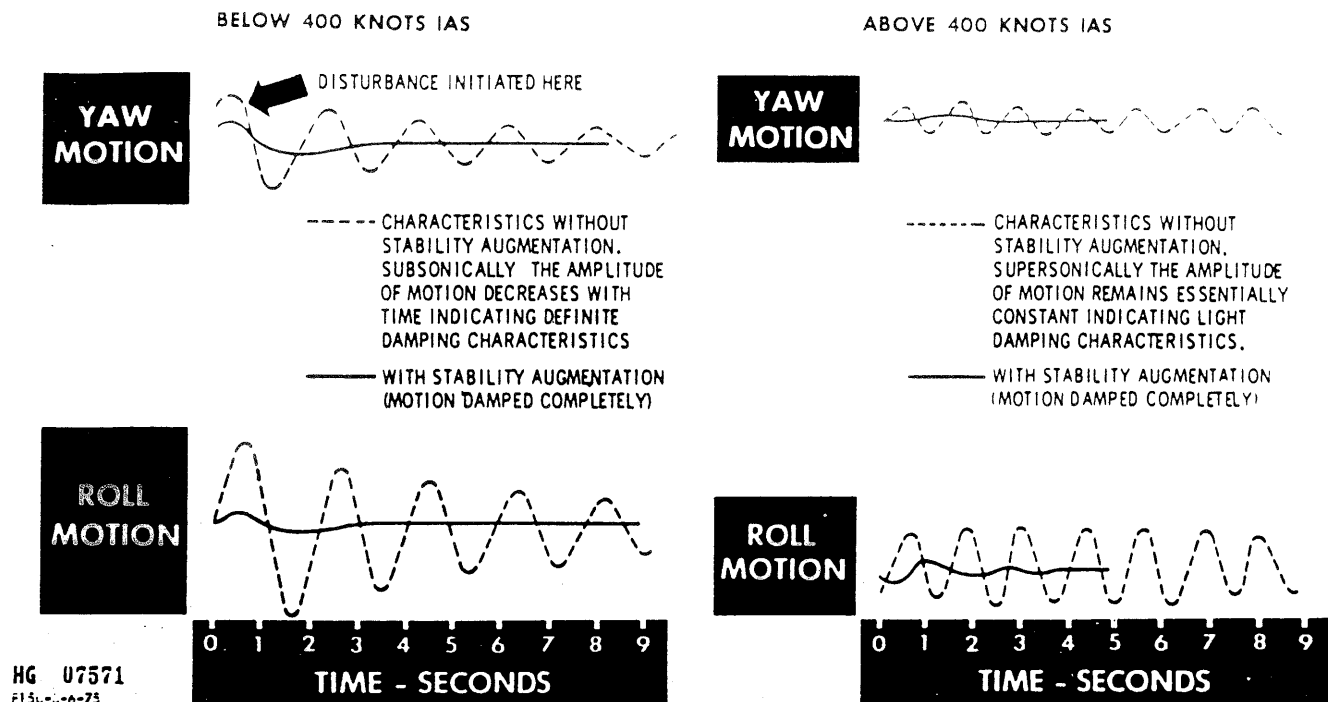

Figure 6-1

be noticed. This is because the yaw augments is sufficient to dampen effectively the "dutch-roll" even though the roll augments is inoperative. Loss of the pitch stability augments will be evident primarily in tracking maneuvers in that effective pitch control is impaired.

### SPEED BRAKES

Speed brakes effectiveness is proportional to airspeed. At high airspeeds they produce tremendous drag without objectionable buffeting and only a mild nose-up trim change below Mach 1.75. A mild nose-down trim change is experienced at higher speeds. Combined with engine power reduction the speed brakes provide exceptionally rapid deceleration, particularly at the lower altitudes.

### AIR INTAKE SCOOPS

The air intake scoops are of the high-supersonic type. The conical ramps leading up to the inlet cause oblique, or slanting shock waves at high supersonic speeds rather than vertical or normal shocks. These oblique shock waves decelerate the airflow before it enters the inlet, thereby reducing the intensity and resultant pressure losses through the normal shock at the inlet. These scoops, combined with the internal characteristics of the ducts accomplish efficient compression of the air and maintain a high level of pressure at the engine inlet over the wide operating range of the aircraft.

### AUXILIARY INLET DOORS

The auxiliary air inlet doors are used only during the takeoff ground run and remain open until a speed of about 280 KIAS is reached.

## EFFECT OF PITCH STABILITY AUGMENTER ON DYNAMIC LONGITUDINAL CHARACTERISTICS

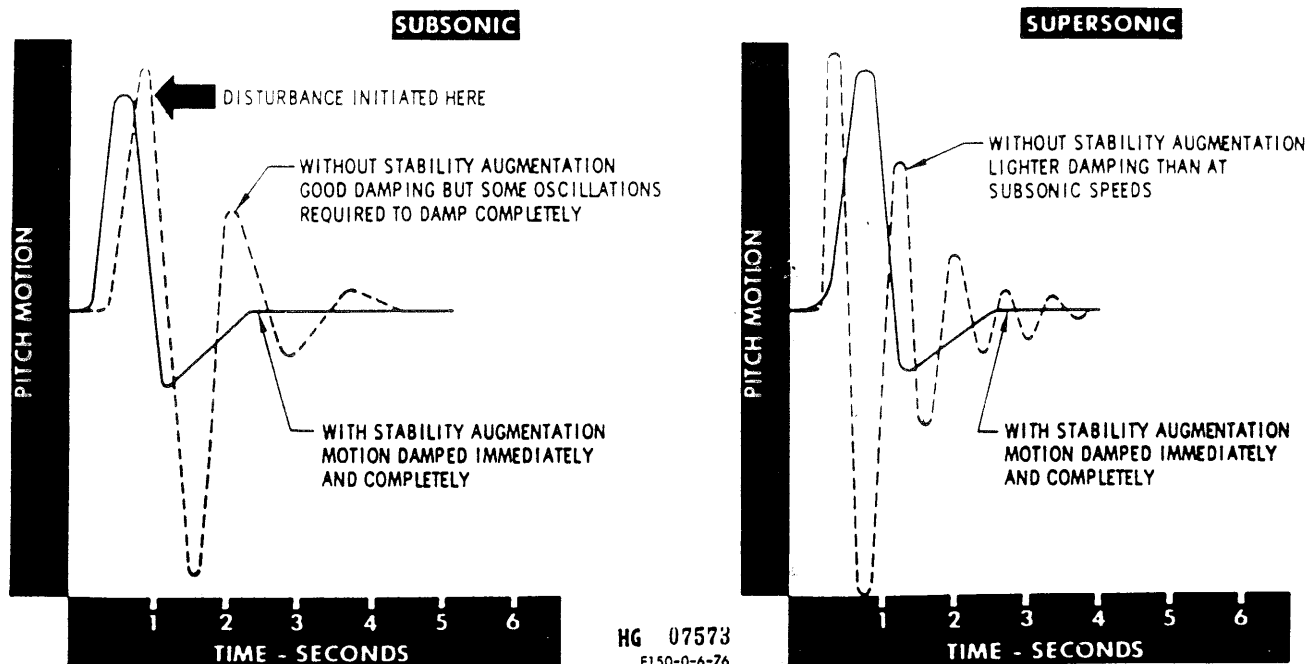

Figure 6-2

Door closure is automatic at that speed. Aircraft handling qualities are not noticeably affected with the doors open and trim changes are negligible during closure.

### NOTE

Use of the auxiliary inlet doors is not recommended for touch and go landings. This is because they will not be opened until the aircraft is on the ground and considering pilot duties and time involved they would not be of any significant advantage.

## TAKEOFF CHARACTERISTICS

Aircraft handling qualities and response during takeoff are excellent. Upon aft stick application the nose will initially raise until the nose strut is fully extended and then the aircraft will rotate to the takeoff attitude. The minimum speed at which the aircraft will begin to rotate and assume the takeoff attitude is dependent on the stabilizer deflection, the rate at which back stick is applied, aircraft gross weight and the aircraft center of gravity.

In general, the speed at which rotation and subsequent nosewheel lift-off occur will increase as the aircraft weight is increased and as the center of gravity is moved forward. The addition of external fuel tanks or wing pylon armament will result in an increase in takeoff weight but will result in a more aft center of gravity than without external stores. The amount of stabilizer deflection and the rate at which the stick is moved aft may have a large effect

on rotation and nosewheel lift-off. Flight tests have shown that a dynamic stabilizer input results in a more nose up moment on the aircraft than if the stabilizer were at full travel in a static condition. Therefore, in high rate back stick application instances, it is possible to achieve rotation and nosewheel lift-off with less stabilizer deflection than would be required at a slower rate of back stick application.

If a high rate stick input is made too early in the takeoff, i.e., too low an airspeed, this dynamic effect may cause the nose to raise slightly due to full or partial nose strut extension and then seem to fall back again once the inertial (dynamic) effect bleeds off. This will give the sensation of an ineffective stabilizer or "light stick". Because of this, it is important that back stick be initiated at the speed at which the stabilizer will develop sufficient lift to raise the nose and achieve takeoff attitude. The speed at which the nosewheel leaves the runway should always be less than the computed takeoff speed. The recommended technique is to anticipate the aircraft acceleration in order to rotate the nose so that takeoff attitude and speed are reached smoothly and simultaneously.

During the takeoff roll the stick shall be held in the takeoff trimmed neutral position to minimize aerodynamic drag. Rotation should be initiated approximately 20 knots below the computed takeoff speed bringing smoothly the stick back a little over 3 inches (less than 1/2 stick aft) to obtain the optimum stabilizer deflection. Rotation and nosewheel liftoff will occur 10 to 20 knots below the computed takeoff speed. Once rotation and nosewheel lift-off occurs, further aft stick is unnecessary to complete takeoff.

Additional factors that may affect takeoff characteristics are stabilizer trim setting and a lowered or binding nose gear strut. The maximum amount of aircraft nose up stabilizer travel of 17° leading edge down may be obtained only when the stabilizer is trimmed between 1° and 11° leading edge down. The optimum takeoff trim setting is 5° leading edge down. If the trim is set at less than 1° leading edge down, full back stick will not provide the full 17° of travel.

If the trim shifts or is positioned full nose down, 3 inches stick travel (less than 1/2 stick aft) will be far short of the optimum stabilizer deflection angle (12.5°) required to achieve nosewheel lift-off.

If the trim shifts or is positioned full nose up, then the 3-inch aft stick input will provide a stabilizer deflection of 17° versus the optimum 12.5°. A lowered or binding nose gear strut will affect and increase the speed at which the nose will begin to rotate, however, it will not affect the speed at which the nose wheel leaves the runway.

## STALLS

The airflow characteristics associated with the high-fineness-ratio fuselage and the sharp leading edge, and the low-aspect-ratio wing at high angle of attack combined with the high horizontal tail position, result in a pronounced pitchup characteristic in the fully stalled condition. Beyond a certain point, this pitchup is uncontrollable and results in severe gyration of the aircraft and a large loss in altitude before recovery to level flight.

At high indicated airspeeds, structural failure of the aircraft will result under the excessive airloads due to the large angles of pitch and yaw encountered in such a maneuver.

In addition to these characteristics at the stall, it is possible to develop stall angles of attack very readily and rapidly in abrupt maneuvers, such as quick pullups, even though relatively small amounts of stabilizer are used.

This results from the combination of high stabilizer effectiveness and the high inertia in pitch of the modern supersonic aircraft. Under these conditions the usual stall warnings are inadequate to prevent an excessive angle of attack.

Because of these characteristics, this aircraft incorporates an automatic pitch control system which provides adequate warning by initiating corrective action at the proper time to prevent reaching an angle of attack high enough to cause pitchup under any operating condition.

### AUTOMATIC PITCH CONTROL (APC)

The APC system provides stall warning in the form of a stick shaker followed by kicking the stick forward abruptly. This action provides pilot warning and automatically applies aircraft nose-down stabilizer to initiate pilot follow-through. It is, in effect, both a built-in buffet warning and an artificial stall that occurs ahead of the aerodynamic stall.

The APC operational boundaries are actuated by two stick shaker channels, and two kicker channels which also drive the APC meter in the cockpit. One stick shaker channel responds to angle-of-attack only, sensed by the vane located on the forward left side of the fuselage.

The second stick shaker channel provides similar response utilizing the vane on the forward right side of the fuselage. The two kicker channels provide kicker operation signals, also sensed by the vane on the right forward fuselage.

In addition, pitch rate gyro output is used in combination with the right forward fuselage vane shaker and the kicker channels to provide an anticipatory function during maneuvering flight.

APC gyro output is continuously compared with the pitch damper gyro output and in case of discrepancy the AUTO PITCH CONT OUT warning light, located on the warning lights panel, lights up. The left and right vanes provide shaker operation sufficiently before kicker operation to warn of the impending stall. The left vane actuates the stick shaker from low speed to approximately 1.3 Mach number. The right vane actuates the stick shaker at higher Mach numbers.

When TAKEOFF or LAND flaps are selected the angle at which the angle of attack sensing vanes energize the stick shaker or kicker is automatically increased permitting operation at a higher aircraft angle of attack than with flaps UP.

### WARNING

**THE ANGLE AT WHICH THE ANGLE-OF-ATTACK SENSING VANES ENERGIZE THE SHAKER OR KICKER IS DEPENDENT UPON THE WING FLAPS LEVER SETTING AND NOT THE ACTUAL POSITION OF THE FLAPS. IN NORMAL OPERATING CONDITION AFTER WING FLAPS LEVER HAS BEEN SELECTED FROM UP TO TAKEOFF (APC BOUNDARY VARIATION) AND BEFORE SAFE TAKEOFF INDICATION IS ACHIEVED A TIME INTERVAL OF 7/8 SECONDS EXISTS. THEREFORE INCREASING THE LOAD FACTOR (AOA) DURING THIS TRANSIENT CAN CAUSE A PITCH-UP WITH NO PREVIOUS SHAKER OR KICKER OPERATION.**

In maneuvering flight such as a turn or dive pullout, the aircraft experiences a pitch rate about its pitch axis. This is necessary in order to change the flight direction.

Under steady-state turn or pull-up conditions, the pitch rate will be constant and there will be no change in aircraft angle-of-attack. However, when such a maneuver is initiated, there is a change in angle-of-attack and an angular pitch acceleration. Under these conditions the aircraft moment of in-

ertia and the angular rate of pitch change will result in momentum to continue pitching. The desired "g" will be overshoot unless it is anticipated and back stick is relaxed prior to reaching the desired "g". The amount of overshoot will depend on the magnitude of the rate of change of angle-of-attack generated; consequently, the higher the rate-the more overshoot. This means that, when back stick is applied abruptly to initiate a pullup, the stick shall be moved forward much earlier to stop the nose up pitching than in a slow entry pullup.

When this characteristic is related to the APC system, it may be seen that the shaker and kicker also shall anticipate in order to prevent the aircraft overshooting into the pitch-up flight regime. The shaker and kicker are set to operate as a function of aircraft pitch rate as well as angle-of-attack to provide this anticipatory function. Under steady-state turning or pullup conditions, the aircraft will have a pitch rate but the rate of angle-of-attack change will be zero. Under these conditions, there will be no overshoot into pitch up; therefore, the anticipatory function of the pitch rate input would penalize the aircraft maneuverability.

In order to avoid this loss of maneuverability due to the pitch rate input to the APC, the pitch rate signal is "washed out" prior to summing with the angle-of-attack vane. Washout is accomplished such that any given constant aircraft pitch rate signal into the APC will be reduced to  $\frac{3}{4}$  of the aircraft pitching rate in  $\frac{1}{2}$  second. Therefore, the APC provides pitch-up protection by anticipating the overshoot in any type of maneuver entry such that the angle-of-attack never exceeds the maximum safe value.

As long as the aircraft is operated beyond the safe maneuvering range, the kicker will continue to operate and continue to force the stick forward. The kicker moves the stick forward to slightly ahead of neutral. The amount of aircraft nose-down stabilizer that is applied is therefore dependent on the stabilizer trim setting. Under normal operating conditions, this amount of stabilizer ensures adequate nose down corrective action. If the aircraft is trimmed close to a high angle-of-attack condition, additional pilot follow through corrective action is necessary.

The kicker is inoperative with wing flaps lever in LAND or with gear DOWN. Thus, the kicker feature is available for high speed maneuvering with flaps UP or TAKEOFF flaps but is inoperative when the gear is DOWN to prevent undesirable kicker operation during takeoff and landing.

Figure 6-3 shows the maneuvering boundary of the kicker and stick shaker in terms of Mach number, and Figure 6-4 presents the kicker boundary in terms of indicated airspeed.

MANEUVERING BOUNDARIES OF AUTOMATIC  
PITCH CONTROL SYSTEM

NO EXTERNAL STORES, 18000 LBS

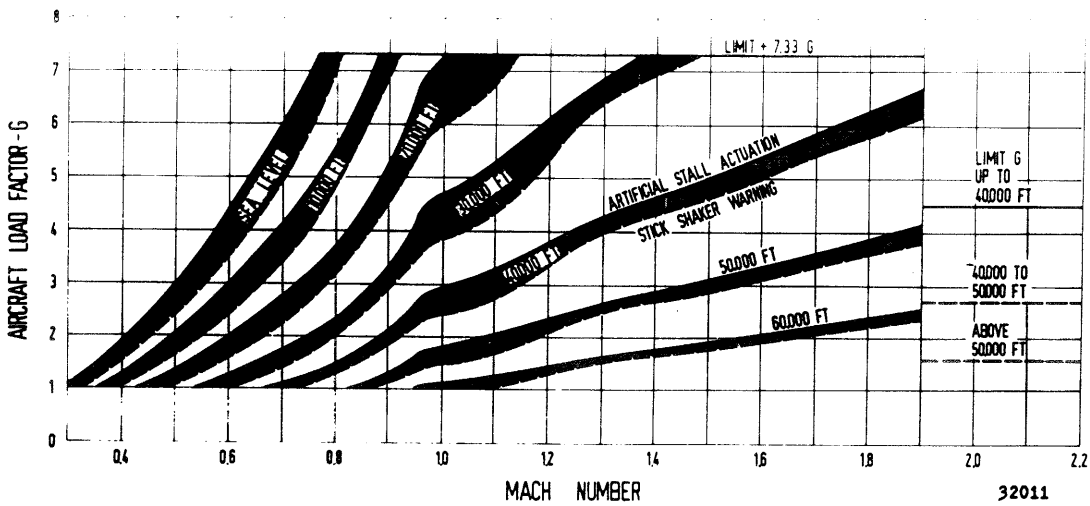

Figure 6-3

**WARNING**

WITH THE APC SYSTEM DE-ACTIVATED, AVOID RAPID MANEUVERS DURING PULL-OUTS OR TURNS WHICH INDUCE HIGH PITCH RATES. STAY OUT OF THE STICK SHAKER BOUNDARY AS THERE IS NO WAY OF KNOWING HOW FAR THE BOUNDARY HAS BEEN PENETRATED UNTIL PITCH-UP OCCURS. IF THE STICK SHAKER BOUNDARY IS PENETRATED INADVERTENTLY, REDUCE THE "G" LOAD AND INCREASE POWER IF NECESSARY.

**UNACCELERATED STALLS**

Since automatic pitch control actuation is, in effect, a built-in stall, the word stall is used in the following discussions to define the point of automatic pitch control operation.

The low-speed stall is preceded by a rather wide speed range of heavy airframe buffet. This buffeting builds up from light to heavy and then remains heavy with further reduction in airspeed. Speeds below the onset of heavy buffet do not represent a useful operating range of the aircraft.

With further reduction in speed, the aircraft becomes laterally unstable. This lateral instability may increase in intensity or reflect a definite wing drop tendency just prior to the stall. The stick-shaker action will be noticeable under the airframe buffeting condition, indicating that further reduction in speed will result in stall.

**MINIMUM OPERATING SPEEDS – KNOTS**  
**(MINIMUM CONTROL SPEEDS IN PARENTHESIS)**

ALTITUDE SEA LEVEL TO 10,000 FEET	GEAR AND FLAPS UP POWER ON OR OFF			TAKEOFF FLAPS GEAR UP OR DOWN POWER ON OR OFF			LAND FLAPS GEAR UP OR DOWN POWER ON			
	Bank Angle Load Factor	0° 1.0G	40° 1.3G	60° 2.0G	0° 1.0G	40° 1.3G	60° 2.0G	0° 1.0G	40° 1.3G	60° 2.0G
23,500 Pounds	23,500 Pounds	245 (220)	285 (250)	345 (310)	210 (200)	240 (225)	295 (280)	170 (165)	200 (190)	240 (230)
		235 (210)	270 (240)	330 (295)	200 (190)	230 (215)	285 (265)	165 (160)	190 (180)	230 (220)
		225 (200)	260 (230)	315 (280)	190 (180)	220 (205)	270 (255)	155 (150)	180 (170)	220 (210)
19,500 Pounds	19,500 Pounds	195 (175)	225 (200)	280 (245)	170 (160)	195 (180)	235 (220)	135 (130)	160 (150)	195 (185)
		235 (215)	275 (245)	335 (300)	200 (190)	235 (220)	285 (270)	170 (165)	195 (185)	240 (230)
		225 (205)	260 (235)	320 (290)	195 (185)	225 (210)	275 (260)	160 (155)	185 (180)	230 (220)
19,500 Pounds	19,500 Pounds	215 (195)	250 (225)	305 (275)	185 (175)	215 (200)	260 (245)	155 (150)	175 (170)	220 (210)
		190 (170)	220 (195)	270 (240)	160 (150)	185 (175)	230 (215)	135 (130)	155 (150)	190 (180)
		245 (225)	285 (260)	350 (320)	215 (205)	250 (235)	305 (290)	180 (175)	210 (200)	255 (245)
23,500 Pounds	23,500 Pounds	225 (205)	260 (240)	320 (290)	195 (185)	230 (215)	280 (265)	165 (160)	190 (185)	235 (225)
		215 (200)	250 (230)	305 (280)	190 (180)	220 (205)	265 (250)	160 (155)	185 (175)	225 (215)
		205 (190)	240 (220)	290 (265)	180 (170)	210 (195)	255 (240)	150 (145)	175 (170)	215 (205)
19,500 Pounds	19,500 Pounds	180 (165)	210 (190)	260 (235)	160 (150)	180 (170)	220 (210)	130 (125)	155 (145)	190 (180)

**NOTES**

1. Minimum operating speeds are the speeds at which automatic stick-shaker action occurs
2. Minimum control speeds are the speeds at which either of the following occur:
  - a. Kicker is experienced with flaps UP or with TAKEOFF flaps and gear UP
  - b. Noticeable stability reduction is experienced with TAKEOFF flaps and gear DOWN, or with LAND flaps
3. Full stall will be encountered if there is further reduction in speed
4. Speeds in excess of the LAND flap limit are shown for interpolation purposes only

Figure 6-4

**WARNING**

APPROACHES TO A STALL IN AIRCRAFT CONFIGURATIONS WHERE THE KICKER IS INOPERATIVE SHOULD BE TERMINATED AT STICK-SHAKER ACTION, LATERAL INSTABILITY, OR WING DROP. IN ADDITION, IF THE KICKER IS INOPERATIVE THE STALL WARNINGS IN ABRUPT HIGH-PITCH-RATE MANEUVERS ARE INADEQUATE. THEREFORE, THIS TYPE OF MANEUVER SHALL BE AVOIDED. THE KICKER IS INOPERATIVE WITH WING FLAP LEVER SET TO LAND OR WITH LANDING GEAR DOWN.

**ACCELERATED STALLS**

In the subsonic region, stall characteristics are similar to those described under unaccelerated stalls in that a range of natural airframe buffet and lateral instability warning precedes the stall. In the transonic region, the speed or "G" range of natural buffet and lateral instability warning gradually reduces and is indicated to be non-existent above approximately Mach 0.9. In this subsonic range and at all supersonic speeds the stick-shaker warning preceding the stall in normal maneuvering flight provides the only warning prior to the stall.

**PRACTICE STALLS**

Practice stalls maintained to stick-shaker warning or to the minimum control speeds of Figure 6-4 may be executed at any reasonable altitude; however, 25000 feet should be used for general familiarization with aircraft characteristics. The airspeeds, at which the various lowspeed flight characteristics occur, vary with external store configuration, gross weight, altitude, and load factor; however, typical unaccelerated stall approaches for an aircraft with no external stores and a gross weight of 16200 pounds are described in the following paragraphs. Increase speeds approximately 5 knots for each ad-

ditional 1000 pounds of internal fuel weight or pylon stores weight. The addition of tip stores will lower the typical speeds due to an incremental increase in aircraft lift. Refer to Figure 6-4 for magnitude.

**Gear and Flaps Up.** In the clean configuration, the aircraft starts buffeting at approximately 230 KIAS; this buffeting becomes heavy at 220 KIAS. The stick shaker operates below approximately 205 KIAS. Lateral instability will be experienced at approximately 195 KIAS, increasing in intensity to kicker operation at 180 KIAS.

**Takeoff Flaps; Gear Up or Down.** With TAKEOFF flaps extended, the stick-shaker action is the initial stall warning at 175 KIAS. Moderate airframe buffet is experienced at 175 KIAS with a noticeable lowering of overall stability at 165 KIAS, the minimum control speed. With gear up, the kicker will actuate at 165 KIAS.

**Land Flaps; Gear Up or Down.** With LAND flaps, gear up or down, and with sufficient engine RPM for boundary-layer control operation, there is no airframe buffet or significant lateral instability. At 25000 feet with military power, the stick-shaker action will be felt at 150 KIAS. As speed is lowered further a noticeable lowering of overall stability will occur at 145 KIAS, the minimum control speed.

**WARNING**

APPROACHES TO A STALL IN AIRCRAFT CONFIGURATIONS WHERE THE KICKER IS INOPERATIVE SHOULD BE TERMINATED AT STICK-SHAKER ACTION, LATERAL INSTABILITY, OR WING DROP. ADDITIONALLY, IF THE KICKER IS INOPERATIVE, THE STALL WARNINGS IN ABRUPT HIGH-PITCH-RATE MANEUVERS ARE INADEQUATE; THEREFORE, THIS TYPE OF MANEUVERING SHALL ALSO BE AVOIDED. THE KICKER IS INOPERATIVE WITH WING FLAPS LEVER SET TO LAND OR WITH LANDING GEAR DOWN.



## GROUND EFFECT

Due to the ground effect during takeoff and landing, buffet and lateral instability characteristics will not be experienced if the recommended operating speeds are used; however, if the aircraft is lifted off or held off to speeds below the recommended speeds, lateral stability and control will deteriorate and wing-drop tendencies will occur.

In addition, the high pitch angles required for flight at these low speeds, will be excessive and may result in tail dragging.

## PITCHUP/SPINS

### SUBSONIC 1 "G" FLIGHT

Pitchups and possible spins are preceded by stick shaker operation, heavy buffet, lateral instability and APC kicker operation.

If the aircraft is permitted to progress beyond APC kicker operation, it will pitch to extreme attitudes of about 50° to 60°. During this period, the oscillations in roll and yaw will diverge in magnitude.

At forward center of gravity locations (more than 2000 pounds of fuel remaining), the aircraft is considered spin resistant and will generally oscillate out of control about all three axes until a nose down attitude is attained.

At fuel loadings of less than 2000 pounds (aft c.g.), the aircraft will probably enter a spin following any pitchup. If the engine is running, the spin will probably be to the right due to a large gyroscopic inertia moment causing a right yaw during the pitchup. With engine flamed-out the spin may be to either the left or right.

The spin is characterized by pronounced oscillations in pitch, roll and yaw which may develop into a stable flat spin if recovery is not effected in the early stages.

A spin revolution will result in a loss of about 1800 to 2000 feet with each revolution taking 5 to 6 seconds and producing rate of descent of approximately 18000 feet per minute. Flight tests evaluating pitchups and spins with external stores have not been conducted.

## SUBSONIC ACCELERATED FLIGHT

The same stall warnings are present when entered from accelerated flight; however, the aircraft will progress through buffet and lateral instability more rapidly and pitchup will be more abrupt.

## SUPERSONIC FLIGHT

Supersonic pitchup and spins have not been investigated. Slow rate approaches have been carried into the neutral stability region but not allowed to develop into the uncontrollable region.

Natural stall warnings such as buffet or lateral instability are nonexistent, therefore the stick shaker and the APC kicker provide the only supersonic stall warning.

## PITCHUP/SPIN RECOVERY

The Flight Test spin program was very limited in scope and did not fully investigate all spin modes nor spins in the very high altitude regime, nor spins with the engine flamed-out.

Subsequent operational experience has proved that the aircraft does have a flat spin mode from which recovery may not be effected using the flight controls. In the event the aircraft enters pitchup and spin:

1. Throttle — Idle
2. Rudder — Full opposite to spin rotation (opposite turn needle)
3. Stabilizer — Full forward, with full nose down trim
4. Aileron — Full into direction of spin (with turn needle)

### NOTE

Retract gear, flaps and speed brakes if they are extended.

5. Neutralize aileron and rudder controls as soon as rotation stops. Begin gradual pullout, activate start switches, and apply power

**NOTE**

- It is important that recovery procedures be accomplished promptly to prevent the early oscillatory spin from developing into a stable spin. This is because recovery capability, from a stable spin, has not been established. After spin rotation has been stopped, altitude required for dive recovery may be as much as 12000 feet due to low initial airspeed. The dive recovery shall be gradual to avoid excessive angles of attack. It may not be possible to rely on the APC system if RPM has dropped below 20% and the RAT is not extended.
  - It is recommended that attention not be diverted from spin recovery to attempt an airstart.
6. If normal recovery technique fails or a stable spin has developed, deploy the drag chute. As soon as rotation stops, stabilize the aircraft in a vertical nosedown attitude. If there are persistent pitching oscillations, jettison the drag chute as the nose swings down. Application of forward stick as the chute is jettisoned may be required to prevent abrupt noseup pitching. Use slight aft stick pressure to recover without exceeding the shaker boundary. If the APC system is inoperative, control attitude by avoiding excessive aircraft buffet.

**NOTE**

- If the chute is used, it should be deployed above 25000 feet. This is to provide recovery by 5000 feet since an altitude loss of 6000 to 8000 feet may occur from the time of deployment to jettison and a loss of 12000 feet during dive recovery.
- There is no maximum altitude limit for chute deployment. Deployment of the drag chute at or above 40000 feet is recommended in spins entered at high altitude.

**WARNING**

THE AIRCRAFT SHOULD BE ABANDONED IF ROTATION HAS NOT STOPPED BY 15000 FEET ABOVE GROUND LEVEL.

**INVERTED SPINS**

Inverted spins have not been investigated; however, recovery procedure for inverted spins is to neutralize all controls.

**VERTICAL STALL RECOVERY**

In the event extremely steep or vertical climb paths are maintained to the point where normal recovery appears questionable, the recommended procedure is to neutralize the controls and allow the maneuver to "peak out". In most cases, the aircraft will arc over the top of its zoom and normal dive recovery may be effected when sufficient airspeed has been regained. In the extreme case of a vertical zoom, a mild "hammer-head" stall-type maneuver will probably be experienced at the apex of the flight path as the aircraft reverses direction and heads back toward the ground. Altitude required for complete recovery to level flight may be as much as 15000 to 20000 feet. In all probability, a pitchup will not be encountered in a vertical zoom; however, the possibility should not be ignored. In such cases, follow the proper recovery procedure.

**PERFORMANCE CAPABILITIES****THRUST AND DRAG**

The relatively low drag and the high thrust-to-weight ratio of this aircraft result in high performance capabilities. This relationship of thrust and drag results in supersonic level-flight speeds over a wide range of altitude. An understanding of the thrust and drag relationship will permit optimum utilization of these capabilities. Figure 6-5 shows typical thrust and drag variations over the flight range of speed and altitude.

**THRUST AND DRAG**  
NO EXTERNAL STORES

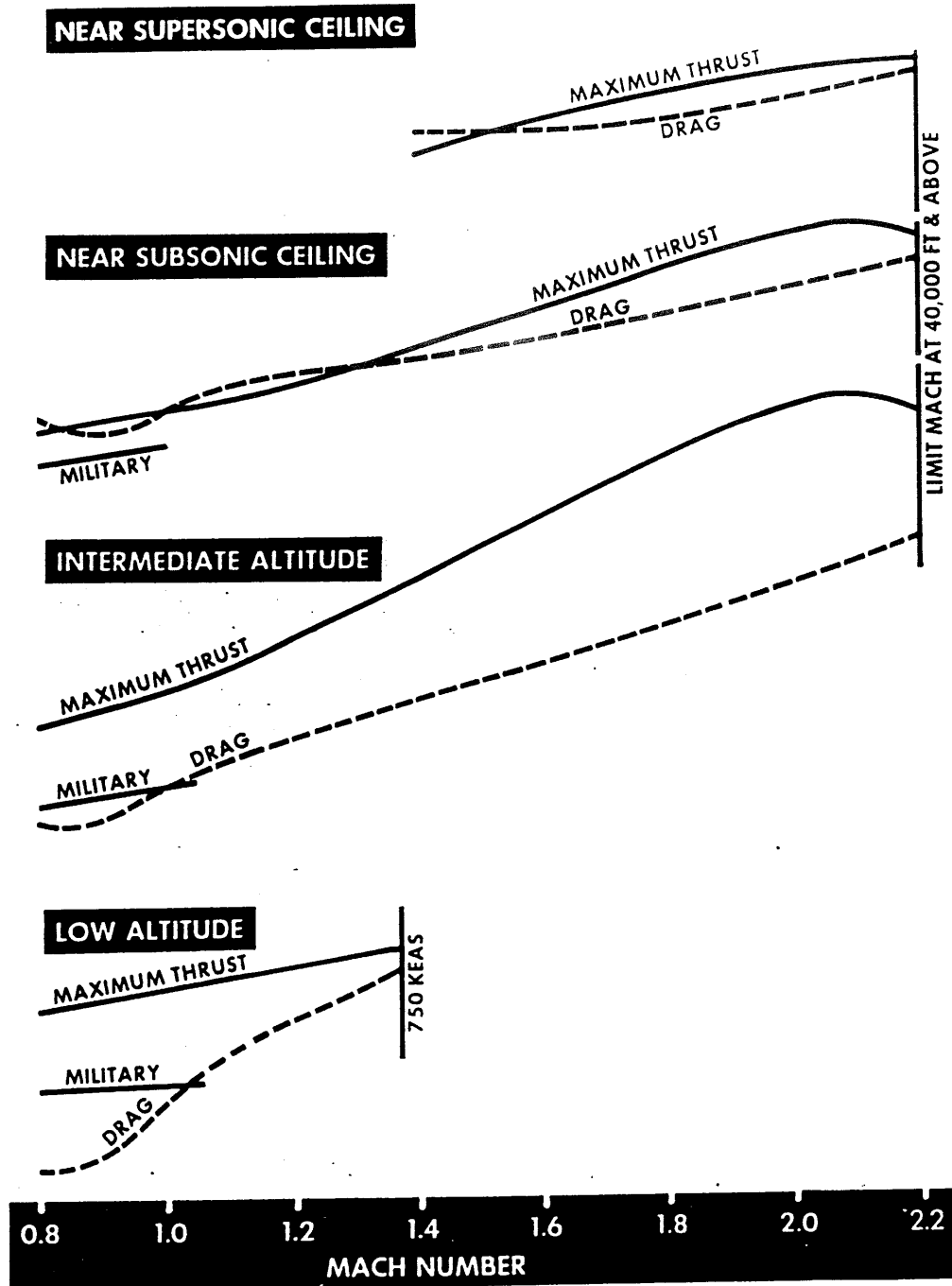

HG 07695  
1150-0-6-35

Figure 6-5

At a given speed, the difference between thrust and drag represents the excess thrust that is available to produce rate of climb, to accelerate the aircraft from one speed to another or to maneuver without losing speed. The intersections of the thrust and drag lines are the points where thrust and drag are equal and therefore represent the stabilized level-flight conditions. The thrust lines shown are for the maximum thrust operation. Obviously, at lower power settings the entire level of thrust is lowered, resulting in less excess thrust and lower stabilized level-flight speeds. Near sea level, level-flight speeds are only slightly supersonic even at maximum afterburning thrust. Maximum rate of climb under these conditions occurs at high subsonic speed.

At intermediate altitudes the thrust and drag curves do not intersect within the permissible speed range, and maximum level-flight speed is limited only by engine and airframe design limitations. In this altitude range, sufficient excess thrust is available at all flight speeds for climb, acceleration, and maneuvering flight without loss of speed. As altitude is increased, due to the relative shape of the two curves, drag exceeds thrust at subsonic speed at a lower altitude than at supersonic speed. This results in a considerable variation in the power-limited ceiling with flight speed. Near the subsonic ceiling the thrust exceeds the drag in two regions, a subsonic and a supersonic region. This means that in order to reach supersonic speed at this altitude the proper climb schedule shall be used.

For example, if you climbed to this altitude at a subsonic speed the aircraft would not accelerate past the transonic drag rise. The only way to become supersonic in this case would be to lose altitude, accelerate, and make a supersonic climb to the desired altitude. In the supersonic speed range, the excess power (excess thrust multiplied by velocity) increases with flight speed, resulting in the most excess power at Mach 2.2.

## PERFORMANCE ENVELOPE

The performance envelope (the speed and altitude capability of the aircraft) contains three separate and distinct regions. These are illustrated in Figure 6-6. The military thrust region is limited in speed and altitude by the available thrust and by the low-speed stall. The right-hand boundary is the maximum level-flight speed without afterburning. This boundary may be extended in dives to about Mach 1.3. The maximum thrust region represents the level-flight speed versus altitude capability with full afterburning thrust. Level-flight speeds are limited under standard atmospheric temperature conditions only by engine compressor restrictions from ap-

proximately 10000 feet to altitudes well over 50000 feet. Note the increase in ceiling of approximately 10000 feet obtainable at high supersonic speeds. The ceiling is also dependent upon aircraft gross weight and ambient temperature and will therefore vary slightly from day to day. The upper, or zoom path region is where the aircraft is trading airspeed for altitude. The aircraft possesses a high level of energy at high speed and may greatly increase its altitude capability by zooming to altitudes as great as 30000 feet above the power-limited ceiling. In this region, the drag exceeds the thrust available from the engine and steady speeds will not be maintained without loss of altitude. Therefore, careful flight planning is necessary for optimum utilization of zoom capabilities.

## CLIMB

At maximum thrust, the high rate of climb at best climb Mach number results in a steep flight path angle. Care should be exercised following takeoff to anticipate the high forward acceleration of the aircraft as climb speed is approached and to assume the proper climb attitude to ensure maximum performance. Figure 6-7 shows relative angles for the various climb configurations.

## ZOOM CLIMBS

### WARNING

THE MAXIMUM PERFORMANCE ZOOM CLIMB IS A HAZARDOUS MANEUVER WHICH MAY RESULT IN A SPIN AND SHOULD BE PERFORMED ONLY IF THE OPERATIONAL REQUIREMENT WARRANTS.

A zoom climb forms an important aspect of the performance capability of the aircraft. It is the quickest way to reach a higher altitude once an adequate level of total energy has been achieved. The high speed capability of the aircraft permits a wide flexibility in changing altitude in zooming flight in relatively short distances and permits zooming to altitude far in excess of the thrust-limited ceiling. Zoom climbs may be initiated from any point within the thrust envelope of the aircraft. The altitude reached and the final speed are dependent upon the speed and altitude at the start of the zoom.

**FLIGHT ENVELOPE**  
 J79 - GE-19 ENGINE  
 STANDARD DAY  
 NO EXTERNAL STORES, 16000 LBS

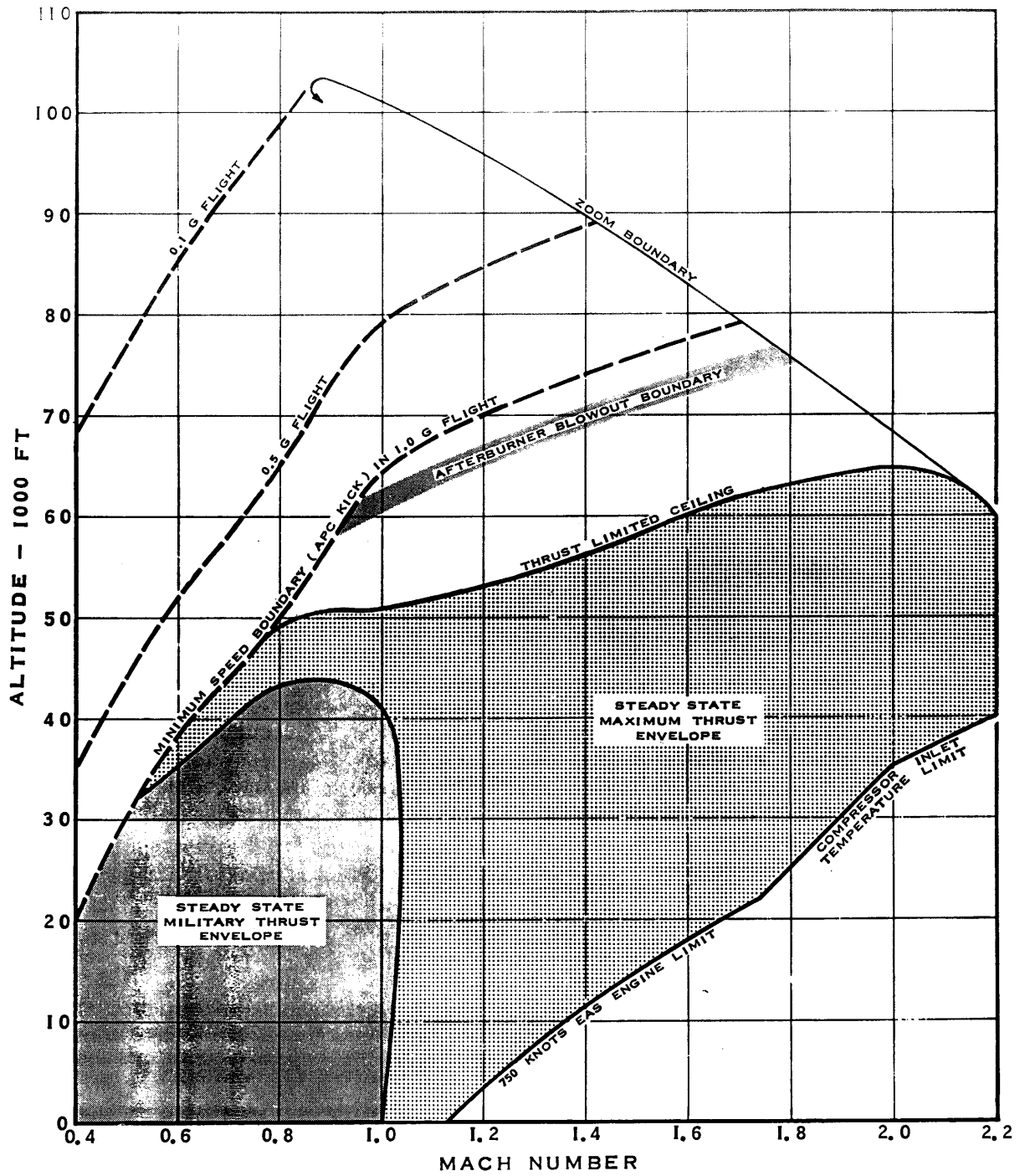

Figure 6-6

## FLIGHT PATH ANGLE AT BEST CLIMB MACH

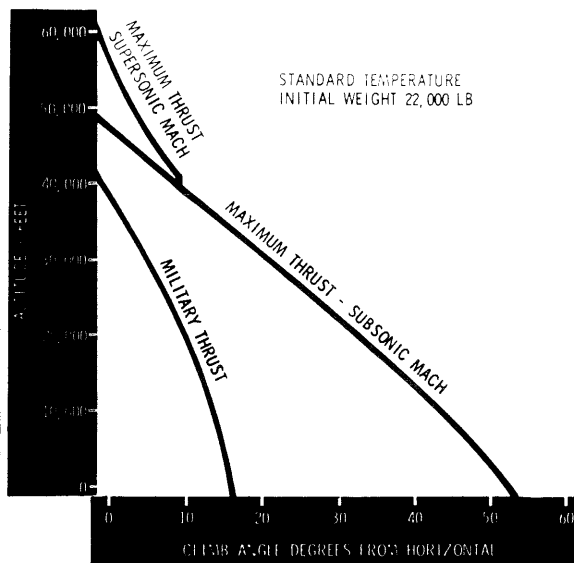

Figure 6-7

Generally speaking, the higher the initial speed and altitude, the higher will be the airspeed upon reaching a given altitude.

In zooms started from 40000 to 45000 feet, and a Mach number of 2.2, approximately 4000 feet may be gained with proper pilot technique, for each 0.1 Mach number loss. Zooms made from a lower speed or higher altitude give a smaller ratio of height gained to speed lost. This ratio may decrease to as little as 2000 feet gained for each 0.1 Mach number lost from the thrust-limited ceiling.

Maximum altitude is obtained in a zoom initiated from maximum permissible speed in the 40000 ft altitude range. In this altitude range sufficient excess thrust is available to permit rotation of the flight path to a steep climb angle with a minimum bleed-off in speed.

In zooms initiated at or near the thrust-limited ceiling of the aircraft, the speed loss in rotating to steep angles is greater due to the absence of excess thrust to hold speed. Practice is required to perfect pilot technique.

Zooms to intercept a target should be preplanned as much as possible since the intercept altitude, desired intercept speed, etc, will dictate the technique required. It is essential to position the aircraft correctly before the zoom is started because further maneuvering after the zoom is initiated will decrease the energy available for the zoom. Therefore, the approximate time and distance required shall be known to conserve energy and assure closure on the target. In tactical situations, zoom climbs will probably not be initiated until target detection has been obtained on the radar indicator. A pullup to boresight will be accomplished with a boresighted flight path followed from that point on to firing range. In this case, the technique to be used is automatic since the flight path is dictated by the boresight requirements. In practice zooms from the Mach 2.2 thrust ceiling to a preselected altitude, it is best to make a pullup of approximately 1.5 "G", attaining a maximum climb angle of approximately 20°. The pushover to the preselected altitude should be started after approximately one half the desired altitude gain. In zooms to above 65000 feet, afterburner blowout will occur as the minimum operating pressure level of the afterburner is crossed. The speed and altitude combination for this boundary is approximated in Figure 6-7.

Actually, the boundary is a fairly wide band because the blowout point is affected by individual afterburner performance and is also sensitive to pullup or pushover technique. Also, if the flight path is leveled prior to afterburner blowout, the afterburner will blowout as speed bleeds to the blowout boundary.

As the zoom continues above the afterburner blowout boundary, the minimum fuel flow that may be supplied by the fuel control will become greater than required to maintain full RPM. When this happens the nozzle will open and EGT and RPM will increase. To avoid exceeding limit EGT, the throttle may have to be retarded to OFF.

### CAUTION

THROTTLE REDUCTION TO IDLE OR POSSIBLE ENGINE SHUTDOWN MAY BE NECESSARY IN ORDER TO CONTROL EGT. IF A SHUTDOWN IS NECESSARY A RESTART WILL BE ACCOMPLISHED DURING THE DESCENT FOLLOWING THE ZOOM.

**NOTE**

At very high altitudes following high Mach or sustained afterburner operation, cooling airflow is reduced due to low airspeeds, it is possible for the aft section temperature to increase enough to cause illumination of the fire warning lights.

If the throttle is retarded to OFF, the engine will be windmilling. Should the windmill RPM drop below approximately 65% RPM, the GCUs will cut No. 1 and No. 2 generators off the buses.

However, the hydraulically-driven generator will continue to operate down to 20% RPM. Zooms accomplished to attain maximum altitude are initiated, as stated previously, from 40000 feet of wherever in this altitude range maximum Mach number is permissible. An initial pullup of 2.0 "G" to 2.5 "G" should be used to increase climb angle.

As the climb progresses, increasing back stick will be required to hold the nose up; however, at no time should the stick shaker stall warning be exceeded.

**NOTE**

Do not trim out aft stick forces after pullup is initiated. This will ensure adequate nose down control for pushover as top of zoom is approached.

A maximum climb attitude of 45° will be reached at about 50000 feet. Greater climb attitudes should not be used because indicated airspeed may drop to too low a value at the apogee. Beginning no later than 60000 feet a small nose down pitch rate shall be established to maintain aircraft attitude in a safe relation to ballistic flight path. Airspeed should not be permitted to decrease below 100 KIAS or Mach 1.0 to assure adequate control over the top of the zoom. This is done by maintaining angle of attack well below the shaker boundary. Although indicated airspeed over the top may fall below normal 1 "G" stall speed, the aircraft load factor will be less than 1, and consequently aircraft angle of attack will be well below stall attitude. Zoom climbs initiated from 40000 feet might reach 80000 feet if unchecked.

Because of the pressure lag in the airspeed system, the indicated readings will lag the actual flight path. This becomes obvious when the peak of the zoom has been passed as indicated by the airspeed increasing while the altimeter still shows a climb. Altimeter range limitations are exceeded in maxi-

mum altitude zooms, resulting in a maximum reading of 85000 to 87000 feet.

Prior to making a high altitude zoom, a pressure check on the high altitude suit should be made as well as cinching down the helmet because cockpit pressurization may be expected to decrease, causing suit inflation if engine stall is encountered above the afterburner blowout point.

The natural descent angle from the peak altitude of a zoom may be expected to be as steep, or nearly, as the climb angle.

**GO-AROUND**

The excess thrust available for go-around varies with aircraft configuration, airspeed, gross weight, field elevation and ambient temperature. In the landing configuration, military thrust may be inadequate for go-around (or even approach) as extremes of these variables are approached; afterburning thrust will then be necessary. Figure 6-8 shows the effect of temperature, altitude, and weight on go-around capability in terms of maximum speed and rate of climb available with military thrust.

However, before a rate of climb may be attained, several seconds may be required to make the transition from the downward flight path. Altitude lost during this time may exceed 100 feet, depending upon the steepness of the glide slope. Therefore, flat approaches are essential and the pilot should be ready to apply immediate power under marginal conditions.

In addition, under marginal conditions, a straight-in approach with TAKEOFF flaps or gear-up configuration is recommended. Change to final landing configuration only after the landing is assured.

Determination of marginal conditions may be made readily before flight from the "Rate-of-Climb for Go-Around Chart" contained in the Appendix - Performance Data. This is especially important for high drag configurations as they may have a marked effect on go-around capability.

**LEVEL FLIGHT CHARACTERISTICS****LOW SPEEDS**

Low-speed handling characteristics are good. Longitudinal and lateral control are positive and effective down to the minimum usable speeds. Sideslip may be used as desired. The rudder should not be used to pick up a low wing.

Due to the high location of the rudder, the initial rolling moment is in a direction to lower the low wing further.

**CRUISE AND TRANSONIC SPEEDS**

At cruise speeds and in the transonic speed range, excellent stability and control characteristics are exhibited. There are no tendencies for wing drop or any significant trim changes when operating in or passing through this speed range.

Longitudinal stability is positive except for a mild nose-down trim change experienced around Mach 0.88 to 0.90. This is so slight that it will be barely perceptible. At altitudes above 25000 feet, an undamped lateral-directional oscillation of approxi-

mately 1/2 cycle per second frequency may occur in the speed range from Mach 0.94 to 0.98. The oscillation is due to formation of unstable shock patterns on the empennage at these speeds. Increasing or decreasing speed to values outside the Mach 0.94 to 0.98 range will eliminate the oscillation.

In the 450 to 550-knot speed region below 25000 feet, small amplitude residual oscillations of approximately 1 cycle per second frequency may be experienced on some aircraft. This oscillation is much smaller than that experienced at Mach 0.94 to 0.98 and in most aircraft it will be barely perceptible. This characteristic is considered normal although it is evidence of less than optimum operation of the yaw stability augments in the individual aircraft.

**CHANGE IN GO-AROUND CAPABILITY WITH AIRSPEED, ALTITUDE, TEMPERATURE AND GROSS WEIGHT**

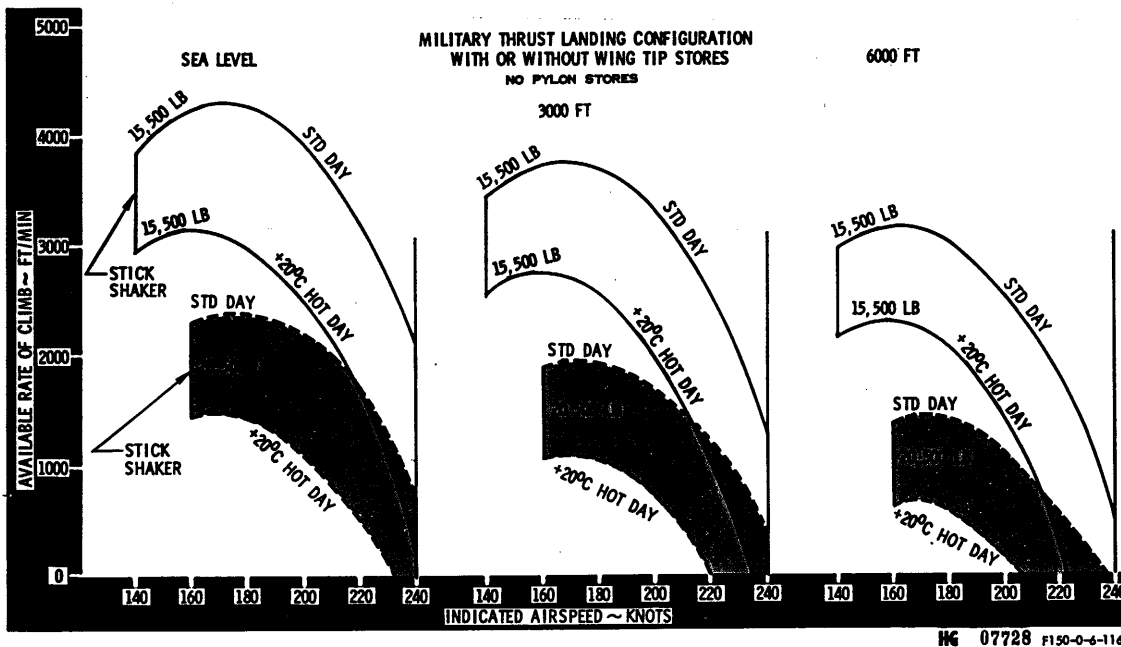

Figure 6-8



**NOTE**

During flight, a cockpit pressure drop occurs between 0.93 and 1.0 Mach. This may result in a cockpit altitude increase as high as 2000 feet and is caused by shockwaves passing over the static sensing ports during transonic flight.

**SUPERSONIC FLIGHT**

As speed is increased from Mach 1.05, a slight nosedown trim change will be noticed up to approximately Mach 1.5. The normal nose-up trim change is experienced with further increase in speed. Although there is this variation in trim over the supersonic speed range, the magnitude of the change is very small as indicated in Figure 6-9.

In addition, at any speed in this range positive maneuvering stability will be evident in that a back pressure on the stick control is always necessary to increase the normal acceleration, and vice versa (Figure 6-12).

A directional trim change which requires increasing trim with increasing Mach number may be experienced or detected on some aircraft. Generally, the sideslip is to the left giving left ball displacement. In most cases, the directional trim is adequate; however, some cases may be experienced in which

**PITCH TRIM CHANGES  
STRAIGHT AND LEVEL FLIGHT  
NO EXTERNAL STORES**

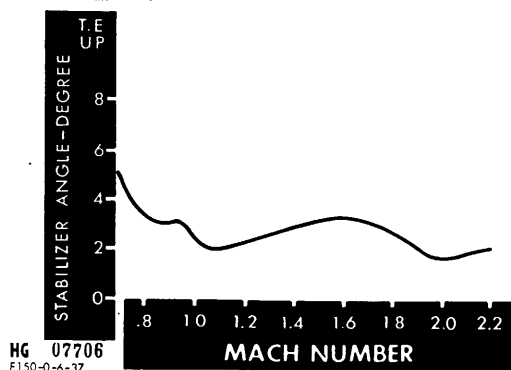

Figure 6-9

a small ball displacement will persist near design speed with full trim applied.

**LEVEL FLIGHT SPEED ACCELERATION**

Operation of this aircraft in the supersonic region requires an acceleration from subsonic speed to the desired supersonic speed. This acceleration is a component of any mission utilizing the high-speed and high-altitude capabilities of this aircraft. Figure 6-10 shows the difference in time, fuel, and distance requirements to accelerate at various altitudes.

The variation with altitude is emphasized in Figure 6-11 which shows the optimum altitude for the minimum fuel is 35000 feet. This will vary somewhat with the existing atmospheric temper-

**LEVEL FLIGHT ACCELERATION  
NO EXTERNAL STORES  
20000 LBS - GROSS WEIGHT**

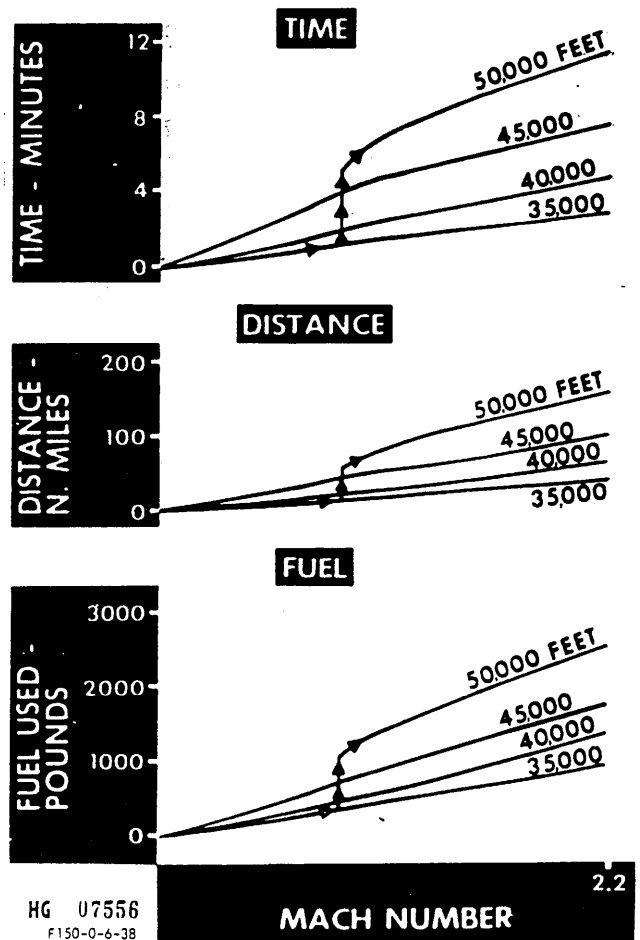

Figure 6-10

ature but usually occurs in the 35000 to 40000-foot altitude range.

This is not intended to imply that this range is the only possible acceleration altitude but to emphasize that the best time, fuel, and distance capabilities are available in this range.

**AILERON ROLLS**

Aileron roll characteristics within the prescribed limits are excellent. Because of inertial coupling tendencies peculiar to all supersonic configurations, certain restrictions on rolling maneuvers have been imposed to prevent loss of control and/or exceeding structural limits.

These inertial coupling tendencies result from the large pitch and yaw inertia of the supersonic configurations and the angular relationship of the longitudinal inertia axis of the aircraft with the axis of rotation. This angular relationship varies with flight conditions (speed, altitude and load factor). Depending on whether the inertia axis is nose-up or nose-down relative to the flight path or rolling axis, a sideslip is developed during a roll which produces inhibiting or augmenting roll rate. In extreme cases, if sufficient aileron control power is allowed, this divergent type roll rate due to sideslip may result in excessive rolling velocity, uncontrollable rolls or structural damage and failure.

**BEST ACCELERATING ALTITUDE  
NO EXTERNAL STORES**

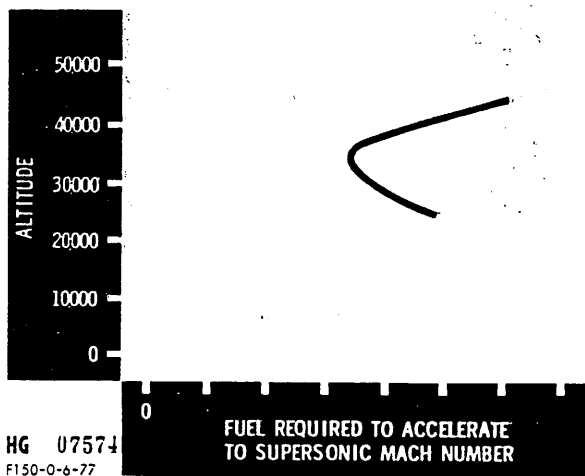

Figure 6-11

In order to remain within safe limits, the available aileron travel is reduced with gear up to prevent high roll rates. In addition, the amount of continuous rotation is placarded in all configurations to prevent large amounts of sideslip from developing.

**MANEUVERING FLIGHT**

Maneuvering stick forces are moderate and generally unaffected by Mach number at a given altitude Figure 6-12. Forces will, however, vary with altitude, increasing as altitude is increased.

This is because forces vary with the amount of stabilizer deflection and bobweight effect, and are not dependent on airloads at the control surface as in the case in unboosted or semiboosted control systems.

As a result, the aircraft will feel more stable and be more comfortable in maneuvers at high altitude where greater stabilizer deflection is required. In turning flight, adverse sideslip is not experienced, and it is not necessary to use the rudder above 300 KIAS.

**MANEUVERING STICK FORCES  
NO EXTERNAL STORES**

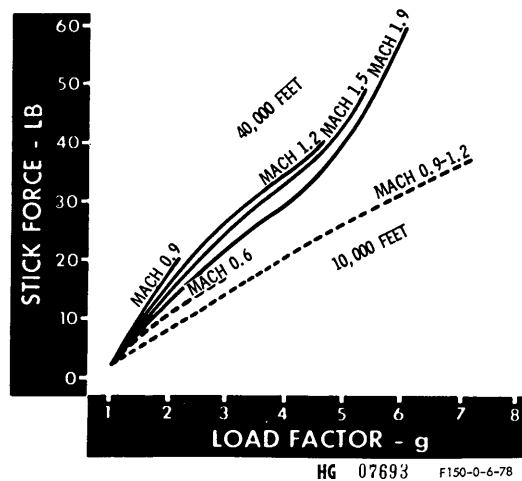

Figure 6-12

**TURNING PERFORMANCE**

This aircraft has an unusually large amount of excess thrust under normal operating conditions, which gives it excellent constant-speed maneuverability. This maneuverability is somewhat disguised by the relatively large turn radius incurred in high-speed flight. Figure 6-13 shows this normal increase in turn radius due to Mach number. Figure 6-14 and Figure 6-15 show the maneuvering capabilities of the aircraft without a speed loss, for various altitudes in terms of both load factor and turn radius.

Notice that at any altitude the available constant speed G's increase with Mach number and are a maximum of 2.0 "G" where excess thrust is greatest. Minimum turn radius, however, is the result of the combined effect of speed and available constant-speed load factor and varies, therefore, considerably with flight condition. Figure 6-14 also illustrates the constant Mach number and constant load factor capability in a climbing turn.

**MAXIMUM CONSTANT SPEED  
MANEUVER LOAD FACTOR**

NO EXTERNAL STORES  
18000 LBS

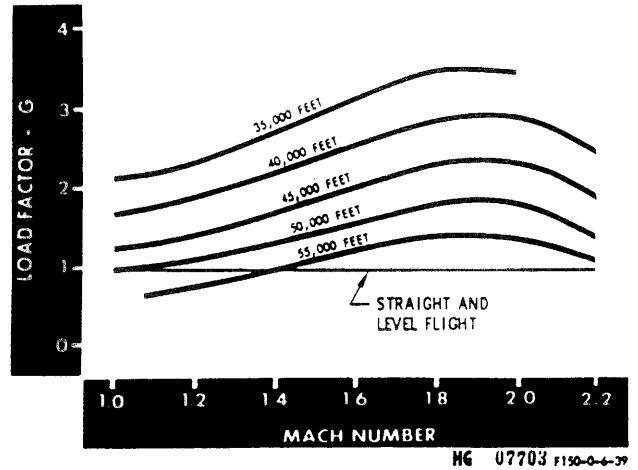

HG 07703 F150-0-6-79

**EFFECT OF MACH ON TURN RADIUS  
ABOVE 35000 FT**

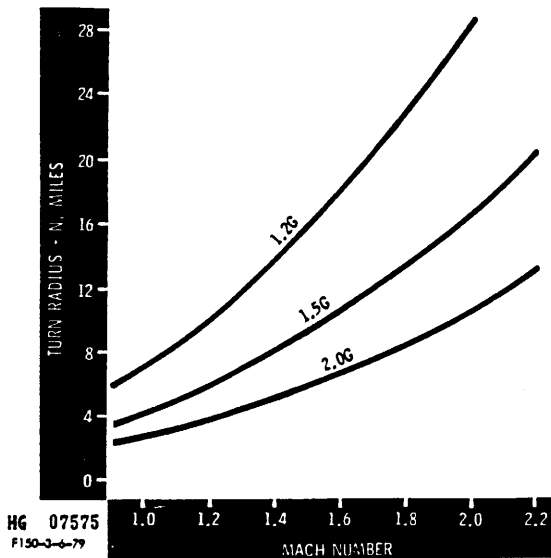

HG 07575  
F150-0-6-79

Figure 6-13

Figure 6-14

For example, it may be seen that ample constant speed is available to permit a 1.5 "G" turn with sufficient excess thrust remaining to climb quite readily to approximately 50000 feet at which altitude there is only enough excess thrust to maintain the 1.5 "G" turn. Higher load factors than shown on these figures may be utilized to accomplish the desired maneuvering in decelerating flight.

**DIVING**

As the maximum allowable Mach number in dive and level flight are the same, all of the foregoing comments on stability and control cover the speed range encountered in dives.

This means that flight characteristics during dives at all speeds are excellent and no new or different trim changes will be experienced. The stick forces remain at comfortable levels and the aircraft is easily controlled.

## MINIMUM TURNING RADIUS AT CONSTANT SPEED

NO EXTERNAL STORES  
18000 LBS

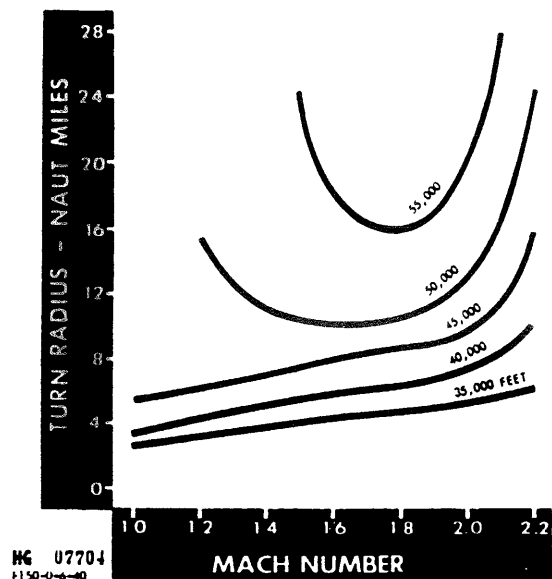

Figure 6-15

Due to the high rates of descent that are possible, steep dives should be executed with caution.

Altitude loss in dive recovery is shown in Figure 6-16 for any combination of speed, dive angle, and pullout load factor. The altitude loss in recovery is the same for this aircraft for the same condition of speed, "G", dive angle, and altitude as for other aircraft; however, cognizance shall be taken of the higher permissible speeds of this aircraft.

Because the maximum permissible speeds may be reached in level flight over a large portion of the altitude range, limit speeds may be reached quite readily; therefore, care should be exercised in diving flight to prevent exceeding limits.

## PILOT INDUCED OSCILLATIONS

The aircraft is not prone to pilot induced oscillations; however, rough applications of pitch control

may induce some oscillations in pitch. If oscillations are encountered, releasing the stick will allow the inherent aircraft stability to dampen the oscillation. Do not attempt to dampen the oscillations with further pitch inputs.

## FLIGHT WITH EXTERNAL STORES

### WARNING

DO NOT FLY WITH MODIFIED WING TIP OR BL-104 STORES UNLESS THEY MEET THE REQUIREMENTS OF STANDARD STORES AS TO CONFIGURATION AND CENTER OF GRAVITY. FOR EXAMPLE, IF THE POWER PACKAGE IS REMOVED FROM THE MISSILE LAUNCHER, IT SHALL BE REPLACED BY AN EQUIVALENT BALLAST PROPERLY SECURED IN THE SAME LOCATION.

### NOTE

Flight characteristics with the AIM-9L/I or AIM-9L/I-1 missile is comparable with those applicable to the AIM-9L missile.

Flight characteristics with external stores installed are essentially the same as without external stores. Naturally, performance is degraded in proportion to the increased weight and drag of the configuration being flown.

During climb out in the 450 to 550 knots speed region below 25000 ft and without external stores, a small amplitude lateral directional oscillation may occur. Stall warning characteristics with multiple store configurations are nearly the same as without external stores.

The onset of buffet will be noted to occur earlier in accelerated stalls with configurations of wing tip fuel tanks plus BL 104 stores. Buffet intensity is heavier but will not mask shaker or kicker.

# ALTITUDE LOSS IN DIVE RECOVERY - SEA LEVEL TO 20000 FT

**EXAMPLE:**

REFER TO FIGURE 5-7 AND 5-8 TO DETERMINE WHETHER THE NUMBER OF Gs REQUIRED FOR PULLOUT ARE AVAILABLE

1. ENTER CHART AT ALTITUDE AT START OF PULLOUT (10,000 FEET)
2. MOVE RIGHT AT CONSTANT ALTITUDE TO AIRSPEED AT WHICH PULLOUT IS STARTED (MACH 0.8, 450 KNOTS IAS)
3. MOVE VERTICALLY DOWN TO DIVE ANGLE (45°)
4. MOVE TO RIGHT TO PULLOUT LOAD FACTOR (4G)
5. READ ALTITUDE LOST DURING PULLOUT (3,500 FEET)

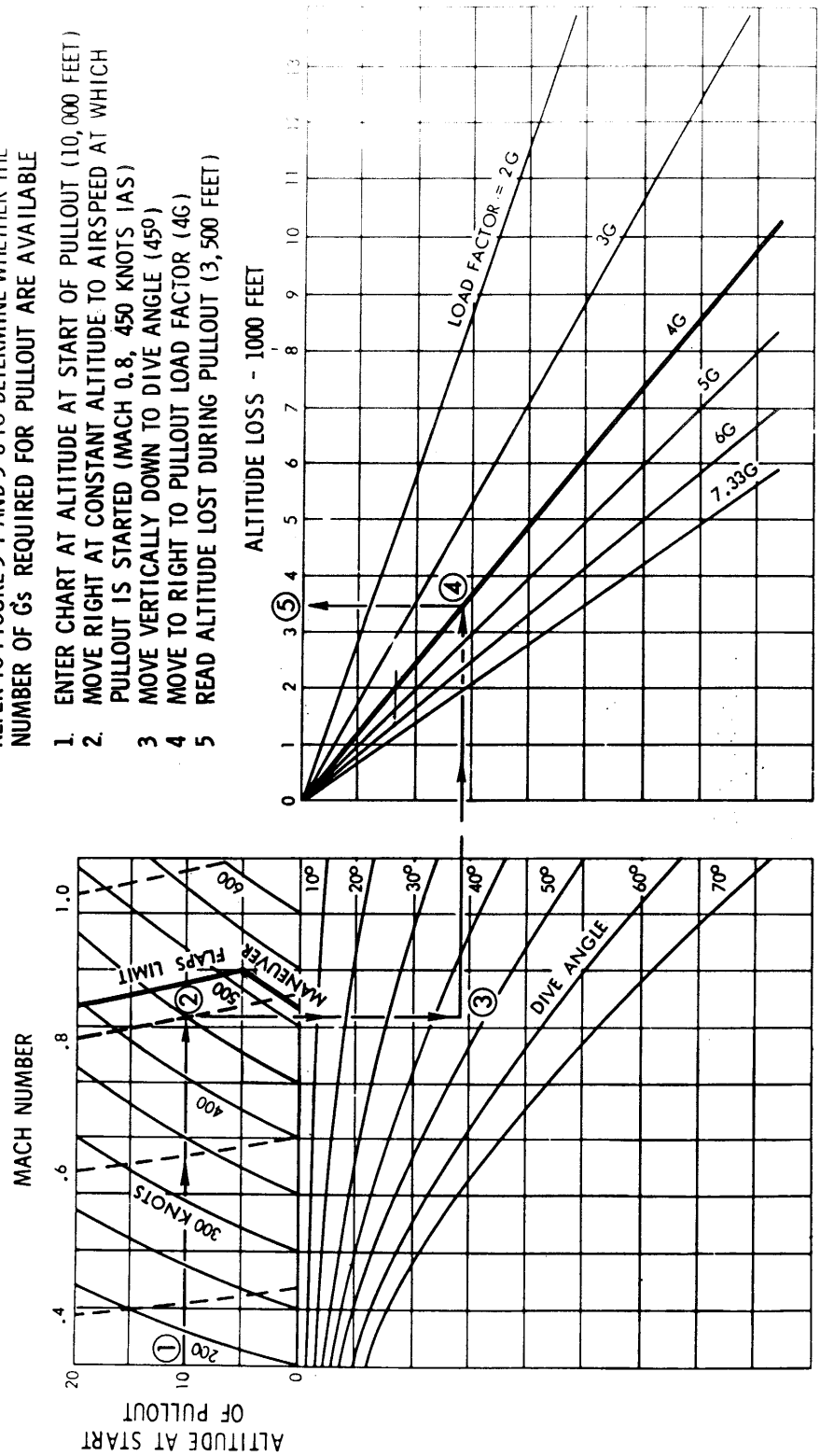
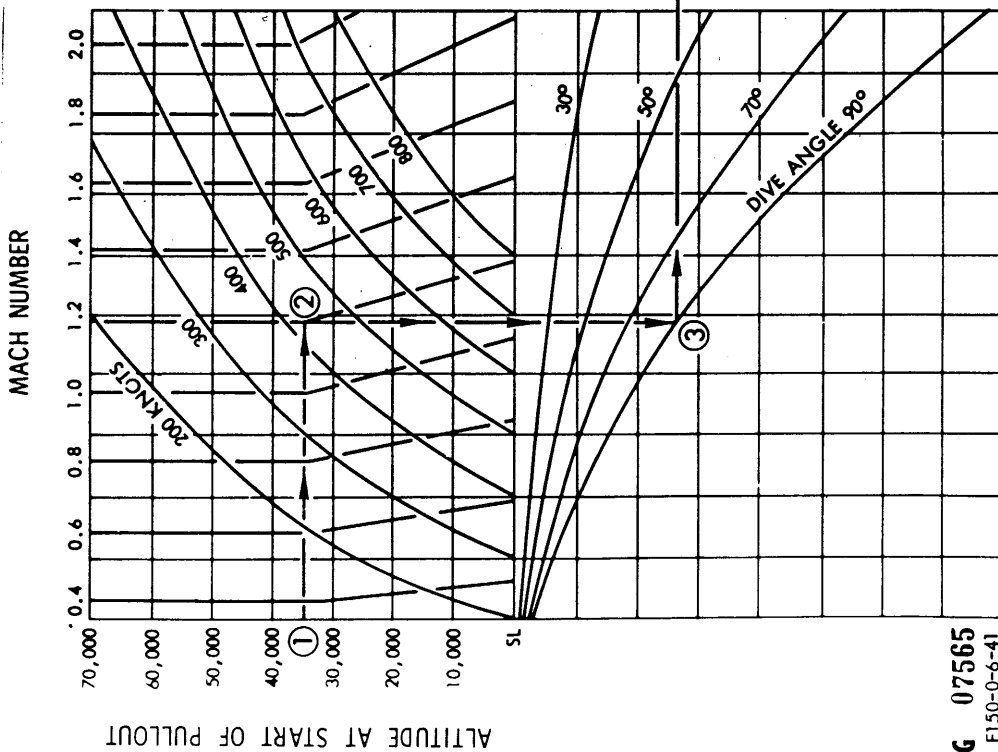
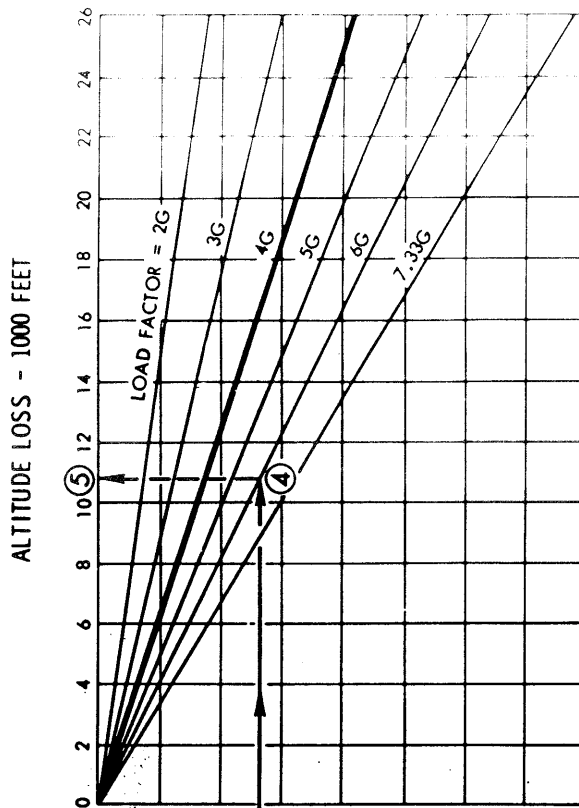

Figure 6-16 (Sheet 1 of 2)

**ALTITUDE LOSS IN DIVE RECOVERY — SEA LEVEL TO 70000 FT**



- EXAMPLE:**  
 REFER TO FIGURE 5-7 AND 5-8 TO DETERMINE WHETHER THE NUMBER OF Gs REQUIRED FOR PULLOUT ARE AVAILABLE
- 1 ENTER CHART AT ALTITUDE AT START OF PULLOUT (35,000 FEET)
  - 2 MOVE RIGHT AT CONSTANT ALTITUDE TO AIRSPEED AT WHICH PULLOUT IS STARTED (MACH 1.2, 430 KNOTS IAS)
  - 3 MOVE VERTICALLY DOWN TO POINT ON CURVE OF DIVE ANGLE (90°)
  - 4 MOVE TO RIGHT TO PULLOUT LOAD FACTOR (6G)
  - 5 READ ALTITUDE LOST DURING PULLOUT (10,800 FEET)



HG 07565  
 F150-0-6-41

Figure 6-16 (Sheet 2 of 2)

**MISSILE FIRING****WARNING**

FOLLOWING ANY ATTEMPTED FIRING OR JETTISON, ANY CONVENTIONAL MUNITION THAT DOES NOT SEPARATE FROM THE AIRCRAFT SHOULD BE CONSIDERED ARMED AND SUSCEPTIBLE TO INADVERTENT RELEASE DURING LANDING IMPACT. IF VISUAL EXAMINATION MAY NOT POSITIVELY CONFIRM A SAFE CONDITION, JETTISON PRIOR TO LANDING.

**AIM-9L Sidewinder Missile Firing From BL-104 and Wing Tip**

AIM-9L missile may be fired from BL-104 and wing tip throughout the operational flight envelope. Aircraft response is amply acceptable and any perturbations may be eliminated by the damper system. AIM-9L firing may be considered safe in the operational flight envelope.

As the missile leaves the launcher, some exhaust gas and smoke ingestion may be expected without significant effects on the flight characteristics and engine life.

**WARNING**

- AT ALTITUDE ABOVE 45000 FEET AND SPEED UP TO 350 KNOTS, AIM-9L FIRING MAY BE CONSIDERED SAFE FOR THE EFFECTS ON THE ENGINE OPERATION. HOWEVER, IF AIM-9L EXHAUST GAS INGESTION OCCURS, THIS WILL CAUSE ENGINE SELF-CLEARING SURGE WITHOUT AFTERBURNER FLAMEOUT.

- AT ALTITUDE UP TO 45000 FEET AND SPEED NOT BELOW 350 KNOTS, AIM-9L FIRING IS FULLY ACCEPTABLE. SHOULD AIM-9L EXHAUST GAS INGESTION OCCUR, EFFECTS ON THE ENGINE OPERATION MAY BE CONSIDERED SIMILAR TO THE AFORESAID SITUATION.

When firing the missile, trigger shall be held depressed for a time corresponding to the missile's leaving the launcher, plus 6 seconds to improve the compressor surge margin during the firing.

This keeps the IGV's closed 5° while the aircraft is in proximity to the missile exhaust. This is recommended for firings in any part of the flight envelope

**WARNING**

SHOULD THE MISSILE NOT LEAVE THE LAUNCHER AFTER A CERTAIN TIME (4 SECONDS AS A REFERENCE) AIM-9L SYSTEM MALFUNCTIONS IS EXPECTED, FURTHER MISSILE FIRING PROCEDURES ARE NOT RECOMMENDED.

**AIM-7E Sparrow Missile Firing**

Firing of the AIM-7E missile does not produce any significant change in pitch or yaw.

Approximately 10° to 15° of roll may be expected but it is easily corrected with aileron application.

The actual roll angle is dependent upon speed and load factor with the larger angles occurring at high speed in accelerated flight.

When firing the missile, trigger shall be held depressed for a time corresponding to the missile's leaving the launcher, plus 6 seconds to improve the compressor surge margin during the firing. Refer to Section V "Operating Limitations" for AIM-7E firing envelope.

**ASPIDE Missile Firing**

To avoid hangfire occurrence, the trigger shall be pressed for a time corresponding to the missile's leaving launcher time. After missile firing, to im-

prove the compressor surge margin during the firing, the trigger shall be kept pressed for another 6 seconds. Should the missile not leave the launcher after a certain time (4 seconds as a reference), ASPIDE system malfunctions are expected and any further missile firing procedure is not recommended. Refer to Section V "Operating Limitations" for ASPIDE firing envelope.

### CAUTION

ENGINE HANDLING DURING ASPIDE MISSILE FIRING IS NOT PERMITTED.

## FLIGHT WITH ASYMMETRICAL LOAD

### NOTE

Flight characteristics with the AIM-9L/I or AIM-9L/I-1 missile is comparable with those applicable to the AIM-9L missile.

During a takeoff with one asymmetric store, the aircraft will tend to turn in the direction of the heavy wing due to the weight outboard of the center of gravity. Nosewheel steering will be necessary to higher than normal speed to overcome this tendency. At liftoff, the heavy wing will drop but it may be picked up with aileron. Normal takeoff speeds should be increased 10-15 knots to provide better lateral control at lift off. During gusty conditions delay gear retraction to provide unrestricted aileron travel. During flight, lateral trim will be required maintain in wings-level flight. The yawing moment due to the asymmetric load is small at all speeds and directional trim is adequate.

Adequate control is available under smooth air conditions for landing with one asymmetric load. Consideration should be given to the added aileron requirements under strong or gusty crosswind conditions before attempting to land with an asymmetric external load.

A crosswind from the side with the load increases the aileron requirements in the same direction as used to balance the load. It is recommended that low-speed control be evaluated prior to entering pattern. A wider than normal pattern should be

used and final approach and touchdown speeds should be increased 10-15 knots. If the lateral control appears marginal for the existing landing condition, the asymmetric load should be jettisoned.

### WARNING

FORMATION TAKEOFFS INVOLVING ANY AIRCRAFT IN A ONE-MISSILE (AIM-9L OR MRAAM) CONFIGURATION ARE PROHIBITED. WHEN FLIGHT IN A ONE-MISSILE CONFIGURATION IS ANTICIPATED OR REQUIRED, EXERCISE CAUTION DURING TAKEOFF AND DURING LOW AIRSPEED NEGATIVE-"G" MANEUVERS.

### CAUTION

THE INCREASED TAKEOFF SPEEDS TO COMPENSATE FOR ASYMMETRICAL LOADING AND THE INCREASED TAKEOFF SPEEDS TO COMPENSATE FOR GUSTS ARE ADDITIVE.

### Asymmetric External Tank Fuel Load

In 1 "G" flight, with an asymmetric tip tank fuel condition, aileron requirements are highest near APC kicker operation and decrease as speed is increased up to Mach 1.0, increasing again as speed is increased above Mach 1.0 and as altitude is increased. Lateral control may be improved by using TAKEOFF flaps.

At approximately Mach 1.2 at altitudes above 35000 feet, the available lateral trim is insufficient to maintain wings level flight with 750 lb or more fuel in one tip tank. In addition, increasing aircraft load factor increases the aileron requirements and lateral control will be insufficient to control bank angle at load factors in excess of 2 "G". Reducing speed to Mach 0.9 and decreasing altitude to below 35000 feet will reduce the aileron requirements to within lateral trim capacity.



**NOTE**

It is possible that a speed of Mach 1.2 to 1.3 may be attained before tip tank fuel is selected. If this speed occurs before the tip tank fuel is selected and one tip tank fails to feed, an asymmetric tip tank fuel condition may occur wherein one tank is empty and one full approximately six minutes after tip tank fuel is selected. This may result in an asymmetric wing tip load of 1000 pounds.

**WARNING**

**DO NOT EXCEED MACH 0.9 IF AN ASYMMETRIC EXTERNAL TANK FUEL LOAD EXISTS.**

**Asymmetric BL 75/BL 104 Pylon Store**

In 1 "G" flight, aileron requirements are highest near APC kicker operation and decrease as speed is increased up to Mach 1.0, increasing again above Mach 1.0. Above Mach 1.0, the aileron requirements with one store will increase, reaching a maximum at Mach 1.3.

In accelerated flight, the aileron trim necessary to balance the asymmetric load increases with aircraft load factor. Sufficient aileron travel is available to maneuver at 4 "G" at all speeds. Aileron requirements are increased with the tip tanks installed and approximately full stick without trim is necessary to maintain a 4 "G" turn above Mach 1.6. Without tip tanks, a 5 "G" turn may be maintained.

**Asymmetric Wing Tip AIM-9L Missile**

Installation of wing-tip stores increases the efficiency of the wing and produces additional lift. Installation of a single missile results, therefore, in more lift on one wing than the other, creating a rolling moment. The roll tendency is easily controllable under all flight conditions. On takeoff, the wing which has the missile installed will roll up immediately after becoming airborne.

During negative load factor maneuvers the wing with the missile will roll down. This characteristic is also noticeable during longitudinal acceleration

and deceleration. Acceleration produces a wing-up rolling tendency.

When firing missiles, a slight wing drop will be noticeable on the side of the fired missile. This is due to the reduced lift on that side when the missile leaves the wing tip.

Installation of AIM-9L wing tip missiles does not result in a large loss of aircraft longitudinal stability. However, a little longitudinal instability will be present in the speed range between Mach 1.0 and Mach 1.5, but this is still within the operational flight limits.

The directional stability reduction, due to AIM-9L missile installation, is lower than for the aircraft equipped with AIM-7E or ASPIDE missile on BL-104 pylons. Aileron requirements are adequate and APC kicker operation starts at speed a little higher than for symmetrical configuration.

Lateral stability is positive and sufficient aileron travel is available to maintain "straight ground track". To perform wind-up-turns, aileron requirements are low, thus permitting the pilot a large control authority until APC kicker operation, while rudder is required only to balance the sideslip due to asymmetric load. During supersonic acceleration, aileron requirements will increase progressively up to Mach 1.6, remaining constant up to Mach 2.0.

Full directional trim authority will be necessary to balance the yaw moment up to Mach 1.7, while pedals operation is recommended for speed above Mach 1.85.

**NOTE**

The rudder travel is limited to  $\pm 6^\circ$  from trim position. Directional trim control is provided with rudder surface with  $\pm 4^\circ$  deflection for trimming

**TIP TANK OSCILLATIONS**

In rough air it is normal for the pitching motion of the tip tanks to be large enough to be both seen and felt. However, flight tests and operational experience have shown that, under certain conditions, a steady and continued oscillation of the tip tanks may be encountered. This characteristic is usually the result of a high yaw damper setting, but it may also occur if there is a malfunction in the yaw or roll damper. Therefore, if an oscillation occurs, both the yaw and roll dampers should be deactivated to assure elimination of the condition.

Deactivating the pitch damper has no significant effect. The oscillation is most likely to be encountered

below 5000 feet at approximately 0.80 Mach number with 400-800 pounds of fuel in each tip tank. It may be mild or severe; however, it is not of sufficient magnitude to cause structural failure. The nose of the tip tank moves up and down at about 4 cycles per second. The aircraft response is noted as a lateral-directional oscillation at the same frequency and is most predominate in yaw. For severe cases, cockpit lateral accelerations may approach  $\frac{1}{2}$  "G".

Once the oscillation has started, the intensity may be aggravated by aileron inputs. These inputs may be pilot induced or the result of a defective roll damper. Pilot inputs are inadvertent and result from cockpit side motion experience during the oscillation. They may be minimized by attempting to hold the stick in a fixed position to prevent lateral stick movement. Aileron inputs resulting from a defective roll damper may be considerably larger than those induced by the pilot. Accordingly, the intensity of the oscillation will be more severe.

Generally, oscillation initially encountered in 1 "G" flight will not be aggravated by increase of load factor. Also, if an oscillation is encountered in accelerated flight, the severity will probably be reduced by decreasing load factor. Speed reduction may also be helpful in eliminating a tip tank oscillation. This may be accomplished through the use of throttle and speed brakes.

## FORMATION FLYING

Because of the rapid aircraft acceleration characteristics, a pilot of low proficiency may find himself quite busy while flying formation; however after a learning period of two or three flights, a good close formation takeoff and flight may be made.

### AFTERBURNER FORMATION TAKEOFFS

Due to the rapid acceleration of the aircraft, it is necessary for the leader to use a throttle setting somewhat less than full throttle to allow the wingman to maintain his position. This should be an indicated nozzle position of approximately 8. Large variations in thrust with a relatively small throttle movement are obtained when operating with the afterburner. Because of the brief time involved in takeoff, the wingman may find some difficulty in stabilizing his position. The wingman should become airborne with the leader; TAKE-OFF flaps should be retracted on a signal from the leader. If afterburner light-off is accomplished si-

multaneously between the two aircraft and throttle adjustments made immediately, the wingman will be able to maintain a satisfactory position throughout takeoff with small throttle changes.

### AFTERBURNER FORMATION CLIMB

If the wingman is in formation at takeoff, he may easily maintain position throughout a climb with afterburner to subsonic ceiling. The leader shall select a setting of less than full throttle to allow the wingman to make throttle adjustments. Formation join-up from individual takeoffs may be made if the leader turns after takeoff and reduces thrust. A leader who maintains an excessively high throttle setting probably will reach cruise altitude before his wingman may reach formation climb position.

### SUPERSONIC FORMATIONS

In close and combat formation at speeds up to Mach 0.9 no critical or safety-of-flight regions of operation are involved. However, as the aircraft reaches supersonic flight, shock waves begin to form. These shock waves attach themselves to such places as the nose, wing, ducts, and the tail. The bow wave and the tail shock wave are parallel and effectively form one wide, disturbed area. This shock wave pattern bends back as the Mach number is increased. If a constant normal formation position is held, the shock wave will begin to envelop the wing aircraft as the speed is increased. When this occurs, the reaction is much the same as if the aircraft had flown through a jet wake. Yaw and rolling disturbances will develop as the aircraft passes in and out of the shock wave.

If the wing aircraft passes completely through the wave on a course parallel to and level with the lead aircraft, the passing aircraft will experience one yaw cycle. As the nose of the wing aircraft enters the wave, the aircraft will yaw toward the leader. As the aircraft becomes enveloped by the wave, it will yaw away; and as it leaves the wave, it will again yaw in, completing one oscillation. If the overtake rate is in the vicinity of Mach 0.01 or 0.02 per second or if the passage through the wave lasts approximately 2 seconds, there is a possibility of structural damage due to high sideslip angles. If the wing aircraft passes directly above or below the lead aircraft, pitching moments instead of yawing moments will be experienced.

The first movement will be toward the lead aircraft, then away, then back again as passage through the flow field is completed. If the wingman remains behind the shock cone, no difficulty will be experi-

enced. Staying behind the shock cone, may be accomplished by dropping back as Mach number is increased. When flying tactical formation at supersonic speeds, the wing aircraft may receive random actuations of the stick shaker and kicker while crossing through the wave. If kicker operation is experienced, the wing aircraft will fall behind, but that is all.

## APC METER

The APC meter is inadequate as a primary flight instrument, however, service experience indicates it is useful as a guide in setting up certain flight conditions at speeds below 0.85 Mach number. Typical

flight conditions for which it may be used are speeds for minimum drag and best cruise, and a qualitative indication of the maneuvering margin before APC actuation occurs. Nominal meter readings are shown on Figure 6-17 for various airspeeds and gross weights in steady state flight. Non-steady state conditions may cause higher meter readings depending on pitch rate.

APC meter reading is affected by flaps position and wing tip configurations. This effect varies with angle-of-attack, therefore, it is not constant over the full scale range of the APC meter. In the range where most flight operations are conducted, 0 to 1 on the meter, the extension of takeoff flaps will decrease the APC meter reading about 0.6 units. Meter readings with tip tanks will be about 0.5 units lower than for no tip stores for comparable flight conditions.

# APPROXIMATE APC METER READING IN STEADY STATE FLIGHT

WING TIP FUEL TANKS, FLAPS UP

CHART NOT VALID ABOVE 0.85 MACH

NOTES:

1. CHART VALID UP TO 35,000 FT
2. WITHOUT TIP TANKS, CHART VALUES SHOULD BE INCREASED A NOMINAL 0.5 UNITS.
3. TAKEOFF FLAPS DECREASE METER READING A NOMINAL 0.6 UNITS IN THE 0 TO 1 RANGE.
4. METER READINGS CAN VARY AT LEAST .25 UNITS AMONG AIRCRAFT.

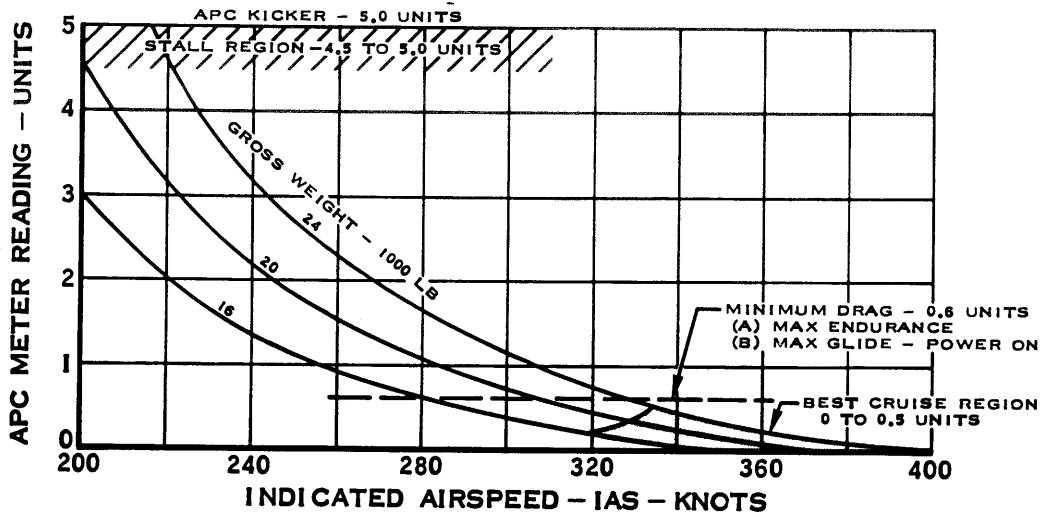

Figure 6-17

## SECTION VII

### ALL-WEATHER OPERATION

#### TABLE OF CONTENTS

Title	Page
Instrument Flight Procedures . . . . .	7-1
Ice and Rain . . . . .	7-3
Turbulence and Thunderstorms . . . . .	7-5
Night Flying . . . . .	7-6
Cold Weather Operations . . . . .	7-6
Hot Weather and Desert Operations . . . . .	7-8

**CAUTION**

- DO NOT SET THE PITOT-PITCH AND TEMPERATURE PROBE HEATERS SWITCH TO PITOT-PITCH TEMP PROBE POSITION FOR MORE THAN FOUR MINUTES CONTINUOUSLY WHILE THE AIRCRAFT IS ON THE GROUND: OVERHEATING MAY CAUSE THE ELECTRICAL HEATING ELEMENTS TO FAIL.
- DO NOT USE THE RAIN REMOVER FOR TAKEOFF. HIGH POWER SETTING AND LOW AIRSPEED MAY RESULT IN WINDSHIELD DAMAGE.

#### INSTRUMENT FLIGHT PROCEDURES

These procedures and techniques pertain primarily to instrument flight conditions and are in addition to normal operating procedures contained in Section II. The data are based on normal gross weight, clean configuration, and standard day conditions. Because navigation facilities and terrain features are different at each base, this information is intended to serve as a guide to commanders in establishing their own instrument flight procedures.

Except for some repetition necessary for emphasis or clarify, only those procedures required for all-weather operation are discussed in this Section.

#### INSTRUMENT TAKEOFF

An instrument takeoff is essentially the same as a normal VFR takeoff. The pitot-pitch and temperature probe heaters switch shall be set to PITOT-PITCH TEMP PROBE prior to takeoff when anticipating an IFR climb-out.

#### INSTRUMENT CLIMB

1. Hold 5° nose-up pitch attitude until climb airspeed is attained
2. Adjust pitch attitude to maintain desired climb speed. For afterburner climbs, pitch attitude will vary between 25° and 50° nose-up on attitude indicator

#### NOTE

If the landing gear lever is not moved to the UP position until a climb is indicated on the altimeter and vertical velocity indicator, transient gear speed limit will be exceeded.

**WARNING**

WHEN TURNS ARE MADE DURING AFTERBURNER CLIMB, THE NOSE OF THE AIRCRAFT TENDS TO DESCRIBE AN ARC, NOT PARALLEL TO THE HORIZON, BUT INCREASING IN PITCH ATTITUDE. THIS INCLINATION IS CONDUCTIVE TO VERTIGO. THEREFORE, TURNS DURING AN AFTERBURNER INSTRUMENT CLIMB SHOULD BE MADE ONLY AS NECESSARY.

**INSTRUMENT CRUISING FLIGHT**

Aircraft handling qualities make supersonic instrument cruise flight possible. Refer to Section VI "Flight Characteristics" for level flight characteristics at high speeds. For ease and precision of flight, angles of bank exceeding 30° should be avoided whenever possible.

**NOTE**

Upon initiating a turn, expect a momentary instrument indication opposite to the direction of bank. During transition from subsonic to supersonic flight, all pitot static instruments will be unreliable due to the aircraft shock wave. The standby attitude indicator will erroneously indicate a nose-up due to acceleration.

**HOLDING**

TAKEOFF flaps setting and 260 KIAS is recommended for holding; however, depending on configuration or formation, a speed of 300 KIAS may be necessary. Fuel consumption is as shown in the following table:

Altitude	Approx. Fuel Flow	RPM (Approx.)
30000 FT	2400 lb/hr	90%
20000 FT	2600 lb/hr	88%

**NOTE**

For ease and precision of flight, limit bank angles to 30°. During turns, increase power as necessary to maintain desired airspeed.

**JET PENETRATION**

Both engine and airframe shall be considered during descents. Inlet guide vanes icing is most probable at 82% RPM or below, because of inadequate airflow for anti-icing. If icing is anticipated, maintain a minimum of 85% RPM during descent.

**PENETRATION PROCEDURE**

Prior to entering the holding pattern or when approaching the initial approach fix, decrease speed to 260 KIAS or 300 KIAS if configuration or formation requires and lower flaps to TAKEOFF position. If holding pattern is not to be entered, approach fix at 300 KIAS with flaps to TAKEOFF position.

1. CANOPY DEFOGGER knob – As required
2. HEATERS PITOT-PITCH TEMP PROBE switch – HEATERS PITOT-PITCH TEMP PROBE
3. ENG/DUCT ANTI-ICE switch – As required

When starting descent:

1. Power – Reduce to 85% RPM
2. Pitch – Lower nose to establish 300 KIAS
3. Speed brakes – As required, when approaching 300 KIAS by adjusting pitch attitude

**NOTE**

The average rate of descent will be approximately 3500 ft/min with speed brakes IN and 8500 feet per minute with speed brakes OUT. With TAKEOFF flaps and 85% to 88% RPM, the aircraft will stabilize at approximately 260 KIAS in level flight inbound to station.

When levelling off:

1. Pitch attitude – 2000 feet above level-off altitude, reduce rate of descent to approximately 2000 ft/min
2. Speed brakes – IN, if used, when approaching 260 KIAS
3. Power – Adjust to maintain 260 KIAS

When two nautical miles before glide path:

For straight-in approach, set up glide-path configuration:

1. LDG GR – DOWN
2. Wing flaps – LAND

### WARNING

THE CONFIGURATION CHANGE SHOULD BE PERFORMED NOT LOWER THAN 2000 FT AGL IN ORDER TO ALLOW ENOUGH ALTITUDE FOR AIRCRAFT RECOVERY SHOULD A BLC MALFUNCTION OR ASYMMETRIC FLAPS OCCUR.

3. Altitude – Descend to and maintain minimum altitude
4. Airspeed – Maintain calculated final airspeed

#### GCI RECOVERY

When a radar approach is required, the descent from the inbound cruising altitude should be initiated at a sufficient distance out to allow 5 to 7 nautical miles for deceleration and change to approach configuration before reaching the turn-on point (gate) to final approach. Aircraft configuration will be the same as that used during a jet penetration.

#### NOTE

When a TACAN ground station is unavailable, the aircraft may be flown to within 5 nautical miles of the base equipped with GCI radar using the IN/HSI navigation system to perform a fly-to to the base provided that it is one of the waypoints present in the mission data base. The radar controller then vectors the aircraft to the turn-on point (gate).

#### RADAR APPROACH

1. Maintain 260 KIAS (approximately 85% to 88% RPM) with wing flaps in TAKEOFF position. Limit all bank angles to 30°
2. Lower landing gear on base leg or 10 nautical miles out on final if making a straight-in approach. Allow airspeed to bleed off to 230 KIAS and adjust power (approximately 87% to 90% RPM) to maintain this airspeed
3. Move wing flaps to LAND position 1 nautical mile prior to glide path. Allow airspeed to decrease to calculated final airspeed and adjust power (approximately 90% to 92% RPM) to maintain this airspeed
4. Lower nose approximately 5° on attitude indicator when intercepting glide path. Establish and maintain a rate of descent of approximately 750 ft/min. Maintain calculated final approach airspeed

#### MISSED APPROACH

In case of a missed approach, follow the procedure given in Section II "Normal Procedures" for a go-around and follow published missed-approach procedure.

#### ICE AND RAIN

Although this aircraft does not have anti-icing systems for the wing and empennage, flight under icing conditions may be made. Defogging, rain removal, engine/duct anti-icing, pitot, pitch vanes, and temperature probe heat should be turned on prior to

entering an area where icing conditions prevail or are anticipated.

Continued use of the rain-remover system will cause discoloration of the windshield adjacent to the rain-remover nozzle. Successive flights through rain at high speeds may cause erosion of the radome. Therefore, observe the following:

- a. Whenever possible, avoid flight in conditions conducive to rapid buildup of ice
- b. Inspect windshield for discoloration after any flight in which the rain remover was used, and have windshield replaced if discoloration is noted
- c. Do not use rain remover for takeoff

Refer also to Sections I, "Description and Operation", and V, "Operating Limitations", for system description and operating limitations of the anti-icing and rain remover systems.

#### **Normal Operation of Defogger and Rain-Remover System**

If any portion of the windshield or canopy becomes obscured by moisture, operate the following controls:

1. CANOPY DEFOGGER knob – FULL
2. COCKPIT TEMP mode selector switch – AUTO
3. Cockpit heat rheostat – HOT
4. RAIN-REMOVER switch – Guard up, RAIN REMOVER. (If precipitation obscures forward visibility)

#### **NOTE**

Canopy defogging air should be used at the highest possible temperature consistent with pilot comfort. This will minimize the possibility of windshield and canopy fogging caused by extreme temperature differentials accompanying an engine failure or a rapid descent from altitude.

#### **Emergency Operation of Defogger and Rain-Remover Systems**

If the windshield may not be cleared by normal procedures and it is necessary to land without delay, do the following:

1. CANOPY DEFOGGER knob – Check (FULL position)
2. COCKPIT TEMP mode selector switch – Hold in manual HOT (for minimum of 10 seconds)
3. RAIN-REMOVER switch – Guard up, RAIN REMOVER
4. Engine RPM – Maximum, if fuel and time permit

The above procedure will direct compressor air to the windshield outlets at its maximum available temperature and pressure.

#### **NOTE**

If excessive fog, vapor, or visible moisture of any kind enters the cockpit, restricting visibility on takeoff, open the fresh-air scoop.

#### **Ground Check Prior to Flight Under Icing Conditions**

1. Engine – 80% RPM
2. ENG/DUCT ANTI-ICE switch – ON

ENG/DUCT ANTI-ICE ON warning light should illuminate immediately

3. ENG/DUCT ANTI-ICE switch – OFF (after warning light illuminates)

The ENG/DUCT ANTI-ICE ON warning light shall extinguish within 5 seconds.



**CAUTION**

ABORT FLIGHT IF WARNING LIGHT DOES NOT ILLUMINATE OR DOES NOT EXTINGUISH WITHIN 5 SECONDS AFTER ENGINE/DUCT ANTI-ICE SWITCH IS PLACED IN OFF POSITION. MAKE NOTATION OF MALFUNCTION IN AIRCRAFT LOG.

**Inflight Procedure**

1. If flight through icing conditions is anticipated, activate the anti-icing system when at subsonic speed and when the indicated CIT is 10° C or below. Do not exceed a maximum speed of 350 KIAS or Mach 1.0, whichever is lower, with the anti-ice valve open
2. After flying in moderate to heavy icing for 2 minutes or more, reduce thrust (where practical) to 88% RPM, to minimize inlet duct ice ingestion damage to the engine
3. Should it be necessary to fly in known icing conditions at low altitude and low thrust settings (80% to 86% RPM), the engine power should be increased to 100% RPM every 5 minutes to ensure that adequate anti-icing air circulation is available at the engine compressor front frame. This thrust increase should be maintained for approximately 30 seconds

**TURBULENCE AND THUNDERSTORMS**

Flight through turbulence and thunderstorms may result in structural damage to the aircraft, or engine flame-out (hail may cause rapid deterioration of the radome). Engine flame-outs have been experienced in jet aircraft which incorporate through-flow inlet systems, due singly or in combination to such factors as the following:

- a. Penetration of cumulus buildups with associated high water content
- b. Icing of duct inlet or engine inlet guide vanes

- c. High concentration of ice crystals associated with tops of cumulus clouds
- d. Changes in engine inlet pressure associated with turbulent air penetration
- e. Operating above 40000 feet where the surge margin of the engine is reduced

The last two factors are significant primarily at low indicated airspeeds.

The rapid closure of the exhaust nozzle if the afterburner blows out may in turn cause engine flame-out when operating under the marginal conditions mentioned above.

**CAUTION**

FLYING IN TURBULENCE OR HAIL MAY CAUSE DUCT AIR INLET DISTORTION. AT HIGH ALTITUDES, THIS DISTORTION MAY RESULT IN ENGINE SURGE AND POSSIBLE FLAME-OUT HOWEVER, NORMAL AIR RESTARTS MAY BE ACCOMPLISHED AS OUTLINED IN SECTION III "EMERGENCY PROCEDURES".

Areas of turbulent air, hailstorms, or thunderstorms should be avoided whenever possible because of the increased danger of engine flame-out.

If these areas are unavoidable, the following should be performed:

1. Establish a penetration airspeed of 350 KIAS for a clean aircraft or 275 knots if TAKEOFF flaps are extended. At altitudes where 350 KIAS is higher than normal cruise speed and would penalize range, use the best operating speed for performance. If a climb over the top is attempted, use the recommended climb Mach number to obtain best performance. Above 40000 feet, modify the climb schedule to maintain a minimum of 275 KIAS and use full afterburning in order to ensure adequate engine surge margin
2. ENG/DUCT ANTI ICE switch – ON
3. HEATERS PITOT-PITCH TEMP PROBE switch – HEATERS PITOT-PITCH TEMP PROBE

**CAUTION**

- THE WARNING PANEL LIGHTS ARE DIMMED AUTOMATICALLY WHEN THE INTERIOR INSTRUMENT LIGHTS ARE TURNED ON. SPECIAL CARE SHOULD BE EXERCISED, THEREFORE, TO DETECT ANY WARNING LIGHT ILLUMINATION.
- MONITOR ALL ENGINE INSTRUMENTS CONTINUOUSLY TO ENSURE TIMELY CORRECTIVE ACTION.

Refer also to "Ice and Rain" paragraph contained in this Section and to Section V, "Operating Limitations", for operation limitations of the anti-icing and rain-remover systems.

**NIGHT FLYING**

During night flights this aircraft does not present any special problems or require any special techniques except during landing. During final approach at night, the runway lights are reflected in the windshield panels and disorientation may occur. Monitor attitude and flight path, ignoring the runway light reflection in the windshield.

**COLD WEATHER OPERATIONS**

The success of operations at low temperatures depends primarily upon the preparations made during the post-flight inspection in anticipation of the requirements for operation on the following day. The procedures outlined should be followed during outdoor operation to expedite the preflight inspection and to ensure satisfactory operation of the aircraft and its systems during the next flight.

**BEFORE ENTERING THE AIRCRAFT**

1. Check the entire aircraft for freedom from snow and ice

**NOTE**

At idle, in extremely cold weather with ramp temperatures as low as  $-40^{\circ}\text{C}$ , EGT may be as low as  $120^{\circ}\text{C}$ .

**WARNING**

DO NOT ATTEMPT TO TAKE-OFF IF THERE IS ANY ICE, FROST, OR SNOW ON THE AIRCRAFT, BECAUSE ANY AMOUNT GREATLY REDUCES LIFT.

2. The pressure of both hydraulic accumulators will drop with temperature. A pressure as low as 700 psi may be expected at  $-18^{\circ}\text{C}$

**BEFORE STARTING ENGINE**

Make normal checks as outlined in Section II "Normal Procedures".

**STARTING ENGINE**

Make normal start as outlined in Section II "Normal Procedures".

**NOTE**

- During cold weather operation, false starts may be encountered; especially on first start of the day. If this condition is experienced, activate both ignition systems and let RPM build up to 12%-14% before advancing throttle to idle range.
- In extremely cold weather with ramp temperatures as low as  $-40^{\circ}\text{C}$ , exhaust gas temperature may be as low as  $120^{\circ}\text{C}$ .

- Use No.1 ignition system for engine starts on odd-numbered days and use No.2 ignition system for engine starts on even-numbered days. The alternate usage of ignition systems provides a check on operation of both ignition systems.
- During low ambient temperature engine starts, it is normal for engine oil pressure to be excessive for a short period of time. This, however, will not cause engine damage. Initial fuel flow indications are often delayed under the same conditions until after the engine reaches idle RPM, but the start may be readily monitored using the EGT indicator.
- On icy surfaces the aircraft will slide forward at approximately 84%-88% RPM with the brakes locked. Make certain the aircraft is clear before advancing the throttle.

### WARMUP AND GROUND CHECK

Refer to Section II "Normal Procedures".

#### NOTE

It will require 2-4 minutes to obtain warm air from the defogger. If immediate defrosting or deicing is required, turn on the rain remover until the left windshield and canopy have cleared, then turn rain remover off.

1. Check hydraulic pressure, oil pressure, and engine instruments. Allow oil pressure to decrease to operating limits before taxiing
2. Check flight instruments

### WARNING

MAKE SURE ALL INSTRUMENTS HAVE WARMED UP SUFFICIENTLY TO ENSURE NORMAL OPERATION. CHECK FOR SLUGGISH INSTRUMENT INDICATIONS DURING TAXIING.

### TAXIING INSTRUCTIONS

The aircraft may be successfully taxied in snow up to 6 inches deep.

1. Taxi at slow speed over rough snow-packed surfaces
2. Allow more distance than on a cleared surface to bring the aircraft to a stop

#### NOTE

Only nosewheel steering should be used in deep snow. Braking will cause the snow to melt and moisture to form on the wheels which may later freeze.

### BEFORE TAKEOFF

Make normal before-takeoff checks as outlined in Section II "Normal Procedures".

#### NOTE

Canopy defogging air should be operated at highest temperature consistent with pilot comfort at all times. This will minimize the possibility of windshield and canopy fogging caused by extreme temperature differential accompanying an engine failure or rapid descent from altitude.

### TAKEOFF

Be prepared for an increase in takeoff distance if runway is covered with snow.

**CAUTION**

ACCELERATION IS VERY RAPID IN COLD WEATHER. THE PILOT SHALL BE ASSURED THAT THE AIRCRAFT IS ROLLING STRAIGHT DOWN THE RUNWAY BEFORE APPLYING AFTERBURNER.

**AFTER TAKEOFF**

Follow normal after takeoff procedure as outlined in Section II "Normal Procedures". Climb performance will be improved during cold-weather operation at lower altitudes. Follow recommended climb speeds as given in climb charts.

**ENGINE OPERATION IN FLIGHT**

Engine operation during flight in cold weather should be governed by normal procedures.

**LANDING**

Use normal procedures. Refer to "Landing on Slippery Runways" paragraph in Section II "Normal Procedures".

**STOPPING THE ENGINE**

The engine is shut down in the normal manner.

**BEFORE LEAVING THE AIRCRAFT**

Refer to Section II "Normal Procedures".

**HOT WEATHER AND DESERT OPERATIONS****NOTE**

- At idle, in extremely hot weather with ramp temperature in excess of 38° C, exhaust gas temperature may indicate as high as 500° C.
- Inlet temperatures above 52° C may cause engine to idle at higher than normal RPM.

**TAKEOFF**

Takeoff distances will be longer during high ambient temperatures. Check takeoff distances required for existing conditions by referring to takeoff charts in the Appendix – Performance Data.

**CAUTION**

IT IS IMPERATIVE THAT TAKEOFF BE MADE AT THE RECOMMENDED SPEED. MORE THAN THE USUAL TAKEOFF DISTANCE WILL BE REQUIRED TO OBTAIN TAKEOFF SPEED WHEN OUTSIDE AIR TEMPERATURE IS HIGH; THEREFORE, EXERCISE CAUTION AGAINST LIFTING OFF THE RUNWAY TOO SOON.

**NOTE**

During afterburner takeoff under high ambient temperature conditions, EGT limits may be exceeded. Adjust the throttle to maintain EGT within limits.

**APPROACH AND LANDING**

Monitor rate of descent closely during approach. Do not allow rate of descent to exceed to 700-800 ft/min recommended during the final portion of the approach.

Be prepared to use afterburner if necessary. Refer to Section VI "Flight Characteristics" and the charts in the Appendix -- Performance Data, pertaining to variations in performance for changes in temperature, weight, and altitude.

# TABLE OF CONTENTS

## APPENDIX - PERFORMANCE DATA

Part 1	INTRODUCTION	A1-1
Part 2	TAKEOFF	A2-1
Part 3	CLIMB	A3-1
Part 4	RANGE	A4-1
Part 5	ENDURANCE	A5-1
Part 6	MILES PER POUND DATA	A6-1
Part 7	DESCENT	A7-1
Part 8	LANDING	A8-1
Part 9	COMBAT PERFORMANCE	A9-1
Part 10	MISSION PLANNING	A10-1

# PART 1

## INTRODUCTION

### TABLE OF CONTENTS

Index items in bold face characters denote illustrations.

Title	Page
Scope and Arrangement . . . . .	A1-1
<b>Symbols and Definitions</b> . . . . .	<b>A1-5</b>
<b>Configuration Drag Index</b> . . . . .	<b>A1-6</b>
<b>Store Drag Index and Loaded Gross Weight</b>	<b>A1-7</b>
<b>Configuration Drag Index Corrections</b> . . . .	<b>A1-8</b>
<b>Mach Number and Altimeter Position Error Correction</b>	<b>A1-9</b>
<b>Airspeed and Altimeter Position Error Correction</b>	<b>A1-15</b>
<b>Compressibility Correction to Calibrated Airspeed</b>	<b>A1-18</b>
<b>Airspeed - Mach Number Curves</b> . . . . .	<b>A1-19</b>
<b>Standard Altitude Table</b> . . . . .	<b>A1-20</b>
<b>Standard Units Conversion</b> . . . . .	<b>A1-21</b>

### SCOPE AND ARRANGEMENT

This appendix contains performance data necessary for accurate preflight planning. It is directly applicable to F-104ASA-M aircraft with the J79-GE-19 engine installed, equipped with 105% RPM fuel control unit. A part-type arrangement groups the material as needed for planning general phases of each flight. Descriptive text in each part discusses and explains the use of the charts.

All subsonic performance is applicable to aircraft with 105% RPM fuel control unit installed. Supersonic operation with the 105% fuel control unit is included in Part 9.

A mission-planning section (Part 10) at the end of the appendix shows how the individual performance charts for each part of a flight may be combined for overall planning purpose.

### PERFORMANCE DATA BASIS

Flight planning information shown in this appendix is based on manufacturer's flight test data and estimates, as required, to complete the general phases of flight. Allowances have not been included in fuel flow values to compensate for variations in aircraft or operational techniques. The material is presented for standard atmospheric conditions as defined by the Standard Altitude Table; however, corrections for non-standard temperature conditions have been included on the charts where possible.

### FUEL AND FUEL DENSITY

All performance and operating weight ranges included in this appendix are based on operation with JP-8 fuel at a nominal fuel density of 6.68 pounds per US gallon. If fuel density is known to be different from the nominal value, enter the performance charts with an aircraft weight which has been corrected to reflect the actual weight of fuel on board.

### SYMBOLS AND DEFINITIONS

Symbols used throughout this appendix are listed and defined in Figure A1-1.

### CONFIGURATION DRAG INDEX

The performance charts presented for subsonic climb, range, endurance and nautical miles per pound of fuel, include a configuration drag index. The configuration drag index groups configurations that have similar performance.

Figure A1-2 defines the configuration drag index of the cleared operating configurations and provides a quick reference to the applicable charted value of index performance. Figure A1-3 and Figure A1-4 shows the incremental corrections to be applied to

a known basic index (no external stores = clean aircraft = drag index zero). Performance which is available by dropping external stores is not shown directly by special charts but may be determined by referring to the appropriate charts for the initial and subsequent configuration drag index and use the charts on an incremental basis.

**CONFIGURATION DRAG INDEX – SAMPLE PROBLEM**

Determine the configuration drag index and the loaded gross weight for an aircraft equipped with wing tip fuel tanks and BL 104 AIM-7E Sparrow missiles.

- a. Determine the total of store drag numbers for the configuration (Figure A1-2).

Wing tip fuel tanks (2 × 8.0) .....	16.0
BL 104 pylons (2 × 9.5) .....	19.0
AIM-7E missiles (2 × 6.5) .....	13.0
<b>TOTAL (configuration drag index) .....</b>	<b>48.0</b>

Reference to the configuration drag index corrections for adjacent stores indicates no corrections are necessary.

- b. Determine the loaded gross weight.

Wing tip fuel tanks (2 × 1366) .....	2732 lb
BL 104 pylons (2 × 174) .....	348 lb
AIM-7E missiles (2 × 445) .....	890 lb
External Stores load .....	3970 lb
No External Stores zero fuel weight (with ASAS equipment) .....	15044 lb
Internal fuel (with main and auxiliary tanks) .....	6500 lb
<b>Loaded gross weight .....</b>	<b>25514 lb</b>

- c. Determine the configuration drag index for the above configuration with BL 75 pylon fuel tanks installed.

Wing tip fuel tanks (2 × 8.0) .....	16.0
BL 104 pylons (2 × 9.5) .....	19.0
AIM-7E missiles (2 × 6.5) .....	13.0
BL 75 pylons (2 × 3.0) .....	6.0
Pylon fuel tanks (2 × 23.0) .....	46.0
<b>Total .....</b>	<b>100.0</b>
Configuration drag index correction (total per symmetrical installation) .....	- 10.0
<b>TOTAL (configuration drag index) .....</b>	<b>90.0</b>

**COMPENSATED PITOT-STATIC HEAD POSITION ERROR CORRECTIONS**

The compensated pitot-static airspeed system is designed to minimize the corrections which are normally required for airspeed. Mach number, and altimeter position errors. The small variation of the system error at subsonic speeds is due to changes in aircraft attitude, which is dependent upon speed, altitude, aircraft weight, and wing-tip stores. Calibration curves are provided for configurations without wing-tip stores, with wing tip AIM-9L missiles and with tip tanks. Each of the curves shows the effect of speed, altitude, and gross weight. Stores at other stations do not alter aircraft attitude, except for the additional weight, and therefore do not require separate calibrations.

**NOTE**

The compensated pitot-static airspeed system position error is small and usually may be neglected so that CAS = IAS and true Mach number = indicated Mach number.

**MACH NUMBER CORRECTION**

Indicated Mach number is corrected for position error as follows: Enter the appropriate wing-tip store configuration calibration curve at the indicated Mach number, pressure altitude, and gross weight. Read the Mach correction ( $\Delta M$ ). Add or subtract the correction, as required, to determine the true Mach number.

For example, cruise operation in a configuration with wing tip fuel tanks at 0.90 indicated Mach number at 10000 feet and a gross weight of 20000 pounds requires a correction of minus 0.005 Mach. The true Mach number is 0.895 (system reads high – subtract).

**AIRSPEED POSITION ERROR CORRECTION**

Position error correction is obtained and applied to indicated airspeed to determine calibrated airspeed as follows: enter Figure A1-11 to Figure A1-13 with indicated airspeed (corrected for individual instrument mechanical error) and read the airspeed position error correction. Add or subtract, as appropriate, the correction to obtain the calibrated airspeed from the corrected instrument reading.



COMPRESSIBILITY CORRECTION TO CALIBRATED AIRSPEED

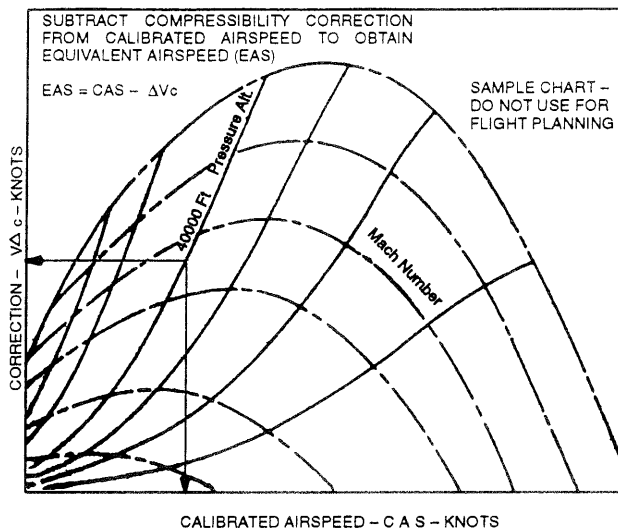

**ALTIMETER POSITION ERROR CORRECTION**

Correction for altimeter position error is obtained from Figure A1-5 to Figure A1-7 for subsonic and supersonic operation at various indicated Mach numbers, from Figure A1-8 to Figure A1-10 for subsonic, low-altitude operation at true Mach numbers and from Figure A1-11 to Figure A1-13 for subsonic operation at indicated airspeeds.

At low-level the altimeter may indicate an altitude higher than true pressure altitude. Therefore it is important that the appropriate calibration curve be used to establish the flight altitude required, to ensure terrain clearance.

For example, operation in a configuration with wing tip fuel tanks at an indicated Mach number of 0.95 at sea level and a gross weight of 18000 pounds requires a correction of minus 280 feet. The proper indicated altitude to fly for this condition then shall be at least 300 feet.

On entering level turns at low altitude, the altimeter will indicate a loss of 200 to 300 feet, depending upon the load factor in the turn. At high altitudes and supersonic speeds, the altimeter will also lose approximately 300 feet on entering level turns.

**AIRSPEED - MACH NUMBER CONVERSION**

True Mach number, true airspeed, or calibrated airspeed is obtained from the Airspeed-Mach Number curve, Figure A1-15. Use of the curve is illustrated by the sample problem.

AIRSPEED - MACH NUMBER CONVERSION

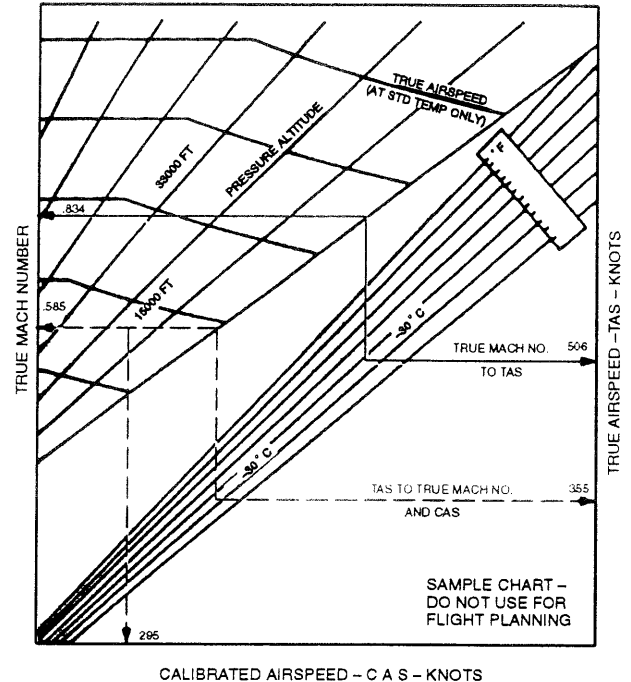

FA0282

**AIRSPEED - MACH NUMBER CONVERSION SAMPLE PROBLEMS**

Problem 1: To find true airspeed (TAS)

With true Mach number known, enter Figure A1-15 on the left and proceed horizontally to the altitude desired. If standard temperature exists at that altitude read the true airspeed from the speed line provided. If non-standard free air temperature exists, proceed horizontally to the baseline, then move down to the desired temperature, and read true airspeed from the right-hand scale.

True Mach Number .....	0.834
Pressure Altitude .....	33000 ft
Ambient Temperature .....	-30° C
True Airspeed (TAS) .....	506 knots

Problem 2: To find true Mach number, calibrated airspeed and indicated airspeed.

Using a procedure similar to steps described above, enter the curve on the right with true airspeed.

True Airspeed (TAS) .....	355 knots
Ambient Temperature .....	-30° C
Pressure Altitude .....	15000 ft
True Mach Number .....	0.585
Calibrated Airspeed (CAS) .....	295 knots
Indicated Airspeed (IAS) .....	294 knots

**AIRSPED COMPRESSIBILITY CORRECTION**

Compressibility correction is obtained and applied to the CAS for determining EAS as follows: enter Figure A1-14 with calibrated airspeed and subtract the compressibility correction value shown on the curve from the calibrated airspeed to obtain equivalent airspeed.

**AIRSPED CORRECTION SAMPLE PROBLEM**

Problem: To find equivalent airspeed (EAS).

Altimeter Reading .....	40000 ft
Calibrated Airspeed (CAS) .....	300 knots
Airspeed Compressibility Correction (Use Figure A1-14, find $\Delta V_c$ ) .....	25 knots
Equivalent Airspeed (EAS) (CAS - $\Delta V_c$ ) .....	275 knots

**STANDARD ALTITUDE TABLE**

The standard altitude table (Figure A1-16) provides reference temperature, pressure, air density, and sonic speed information which may be of assistance in overall flight planning.

**STANDARD UNITS CONVERSION CHART**

The standard units conversion chart (Figure A1-17) provides a means for direct conversions of temperature from degrees centigrade to degrees Fahrenheit, and of distance and speed from feet, nautical miles, feet per second, and feet per minute to metric equivalents of meters, kilometers, meters per second, and meters per minute, respectively.

## SYMBOLS AND DEFINITIONS

IAS *	Indicated airspeed (knots). Airspeed indication uncorrected for instrument error. Where this symbol is used on the performance charts, mechanical error is assumed to be zero
$\Delta V_i$	Airspeed position error correction
CAS *	Calibrated airspeed (knots). Indicated airspeed corrected for position error: $CAS = IAS + \Delta V_i$
$\Delta V_c$	Airspeed compressibility correction
EAS * ( $V_e$ )	Equivalent airspeed (knots). Calibrated airspeed corrected for compressibility: $EAS = CAS - \Delta V_c$
TAS * ( $V_T$ )	True airspeed (knots): $TAS = (EAS) \times (1/\sqrt{\sigma})$ . ( $1/\sqrt{\sigma}$ ) from Figure A1-16
GS ( $V_g$ )	Groundspeed
kt	Knot
fpm	Feet per minute
nmi/lb	Nautical miles per pound of fuel
lb-nmi/lb	Range factor expressed as pound-nautical miles per pound of fuel
G	Load factor
nmi	Nautical miles
W	Aircraft gross weight in pounds
$W_f$	Fuel flow in pounds per hour
% RPM	Engine speed expressed as (actual RPM/7460) x 100%
CIT	Compressor inlet temperature (engine air inlet temperature)
EGT	Exhaust gas temperature
$C_T$	Temperature recovery factor
OAT	Outside or ambient air temperature
$\alpha$	Speed of sound
$H_p$	Pressure altitude
P	Air pressure at altitude
$P_o$	Standard air pressure at sea level
$\rho$	Air density at altitude
$\rho_o$	Standard air density at sea level
$\Delta$	Pressure ratio ( $P/P_o$ )
$\sigma$	Density ratio ( $\rho/\rho_o$ )
avg	Average
ind	Indicate

\* The prefix "K" on these symbols indicates the airspeed in knots, such as KIAS, knots indicated airspeed

**Figure A1-1**

**CONFIGURATION DRAG INDEX**

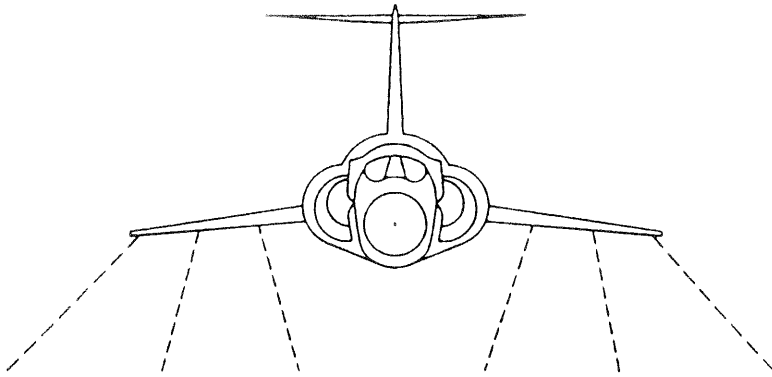

FA0009

EXTERNAL STORES MOUNTED						TAKEOFF WEIGHT (LBS)	CONFIGURATION DRAG INDEX
WING TIP	BL 104	BL 75	BL 75	BL 104	WING TIP		
AIM-9L (*)					AIM-9L (*)	22274	15
AIM-9L (*)		TANK	TANK		AIM-9L (*)	25504	67
	AIM-9L (*)			AIM-9L (*)		22406	36
	AIM-9L (*) (**)					21975	18
TANK	AIM-9L (*)			AIM-9L (*)	TANK	25137	52
AIM-9L (*)	AIM-9L (*)			AIM-9L (*)	AIM-9L (*)	23136	51
AIM-9L (*)	AIM-9L (*)	TANK	TANK	AIM-9L (*)	AIM-9L (*)	26366	103
AIM-9L (*)	MRAAM (***)			MRAAM (***)	AIM-9L (*)	23512	47
AIM-9L (*)	MRAAM (***)	TANK	TANK	MRAAM (***)	AIM-9L (*)	26742	99
	AIM-9L (*)			MRAAM (***)		22594	34
	AIM-9L (*)	TANK	TANK	MRAAM (***)		25824	86
TANK	AIM-9L (*)			MRAAM (***)	TANK	25325	50
TANK	AIM-9L (*)	TANK	TANK	MRAAM (***)	TANK	28555	102
	MRAAM (***)			MRAAM (***)		22782	32
				MRAAM (**)		22163	16
TANK	MRAAM (***)			MRAAM (***)	TANK	25513	48
	MRAAM (***)	TANK	TANK	MRAAM (***)		26012	84
TANK	MRAAM (***)	TANK	TANK	MRAAM (***)	TANK	28743	100
TANK					TANK	24275	16
	AIM-9L (*)	TANK	TANK	AIM-9L (*)		25638	88
TANK	AIM-9L (*)	TANK	TANK	AIM-9L (*)	TANK	28370	104

(\*) Or AIM-9L/I or AIM-9L/I-1

(\*\*) The "real external store" asymmetric configuration drag indices do not take into account any suspension devices on the unloaded wing

(\*\*\*) AIM-7E OR ASPIDE MISSILE

- Notes:**
- 1) Operating mass empty: 15044 lbs
  - 2) Take-off weights computed considering full internal and external fuel tanks (when applicable)
  - 3) Usable fuel:  
 Internal fuel 6500 lbs  
 External fuel 4876 lbs  
 Total usable fuel 11376 lbs
  - 4) 170 gall. external tank (P/N 851717) on wing tip
  - 5) 195 gall. external tank (P/N 791210) on BL 75
  - 6) Takeoff weights, for the configurations fitted with BL 104 MRAAM, are referred to the AIM-7E Sparrow Missile, which has a mass of 619 lbs, launcher included. If ASPIDE missile(s) is/are fitted, add 56 lbs, for each ASPIDE missile installed, to the above takeoff weight datum

**Figure A1-2**

## STORE DRAG INDEX AND LOADED GROSS WEIGHT

CLEAN AIRCRAFT CONFIGURATION DRAG INDEX = 0

EXTERNAL STORES MOUNTED			SINGLE WEIGHT - LBS -	STORE DRAG INDEX (Single Item)		
				BL75 PYLON	BL104 PYLON	WING TIP
PYLON	BL 104	INCLUDES AIM-7E LAUNCHER	174	—	9.5	—
		INCLUDES ASPIDE LAUNCHER	187	—	9.5	—
		INCLUDES AIM-9L, -9L/I, -9L/I-1 ADAPTER AND LAUNCHER	241	—	11.5	—
	BL 75	EQUIPPED FOR FUEL TANK	136	3.0	—	—
FUEL TIP TANK (INCLUDES 1135.5 LBS FUEL)			1366	—	—	8.0
FUEL PYLON TANK (INCLUDES 1302.5 LBS FUEL)			1480	23.0	—	—
AIM-9L, -9L/I, -9L/I-1 ADAPTER AND LAUNCHER (TIP)			175	—	—	4.5
AIM-9L, -9L/I, -9L/I-1 ADAPTER AND LAUNCHER (PYLON)			120	—	—	—
AIM-7E LAUNCHER			53	—	—	—
ASPIDE LAUNCHER			66	—	—	—
MISSILE	AIM-9L, -9L/I, -9L/I-1		190	—	6.5	3.0
	AIM-7E		445	—	6.5	—
	ASPIDE		488	—	6.5	—

**Figure A1-3**

## CONFIGURATION DRAG INDEX CORRECTIONS

(TOTAL CORRECTION PER SYMMETRICAL INSTALLATION)

STORE DRAG INDEX CORRECTION	EXTERNAL STORE MOUNTED		
	WING TIP	BL 104 PYLON	BL 75 PYLON
+ 6	-	AIM-9L, -9L/I, -9L/I-1/MRAAM (*)	Pylon
- 10	-	AIM-9L, -9L/I, -9L/I-1/MRAAM (*)	Tank

- Notes:**
- 1) Store drag index data basis is flight test unless otherwise indicated
  - 2) Operating mass empty (includes crew and lubricant) ..... 15044 lbs
    - Usable fuel (Total) ..... 11376 lbs
      - Internal ..... 6500 lbs
        - Main tanks ..... 5037 lbs
        - Auxiliary tanks ..... 1463 lbs
      - External ..... 4876 lbs
        - Tip tanks (two) ..... 2271 lbs
        - Pylons tanks (two) ..... 2605 lbs

(\*) AIM-7E or ASPIDE MISSILE

**Figure A1-4**

# MACH NUMBER AND ALTIMETER POSITION ERROR CORRECTION

FLAPS AND GEAR UP — NO WING TIP STORES

Compensated Pitot - Static Head

Model: F-104S  
 Date: 1 April 1970  
 DATA BASIS: FLIGHT TEST

Engine: J79-GE-19  
 Fuel Grade: JP-8  
 Fuel Density: 6.68 Lb/Gal

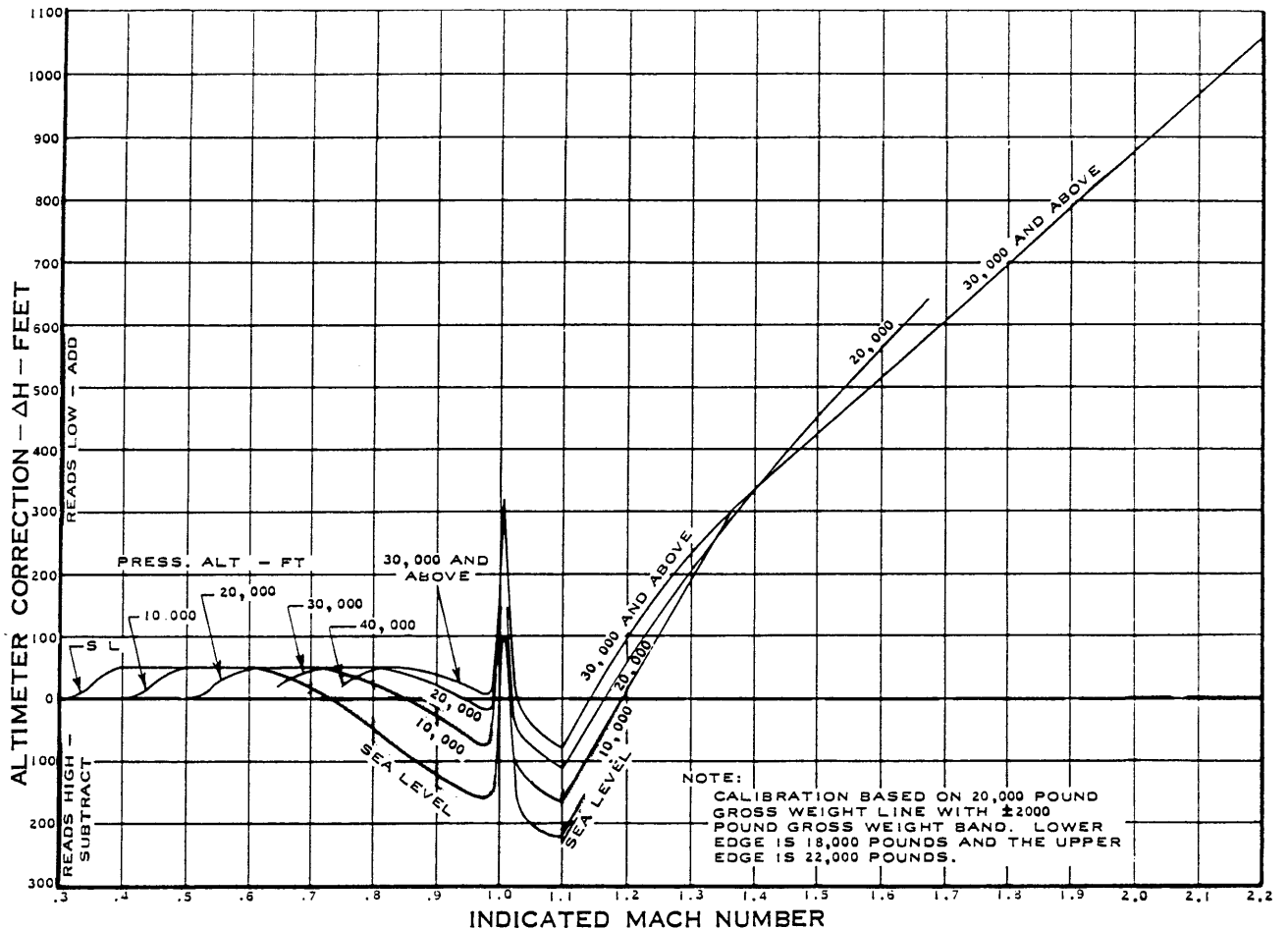
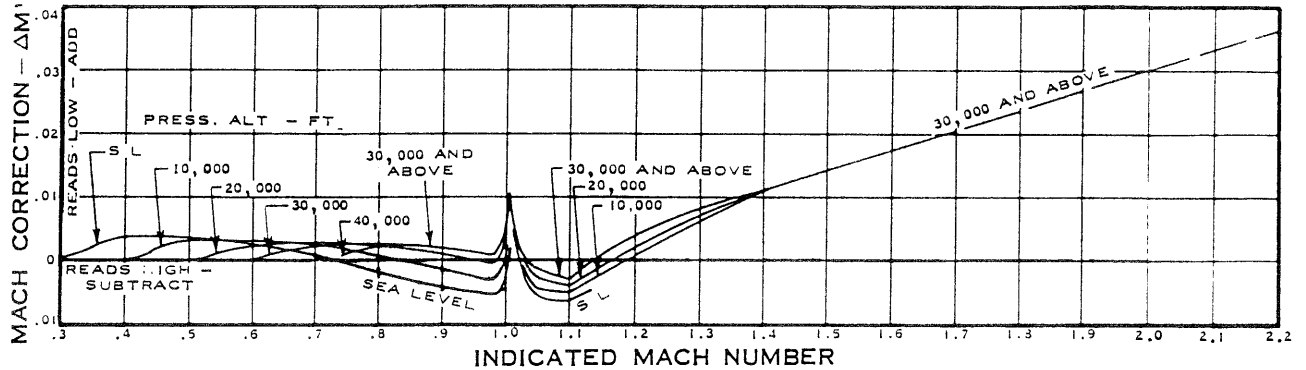

Figure A1-5

# MACH NUMBER AND ALTIMETER POSITION ERROR CORRECTION

FLAPS AND GEAR UP - TIP AIM-9L MISSILES

Compensated Pitot - Static Head

Model: F-104S  
 Date: 1 April 1970  
 DATA BASIS: FLIGHT TEST

Engine: J79-GE-19  
 Fuel Grade: JP-8  
 Fuel Density: 6.68 Lb/Gal

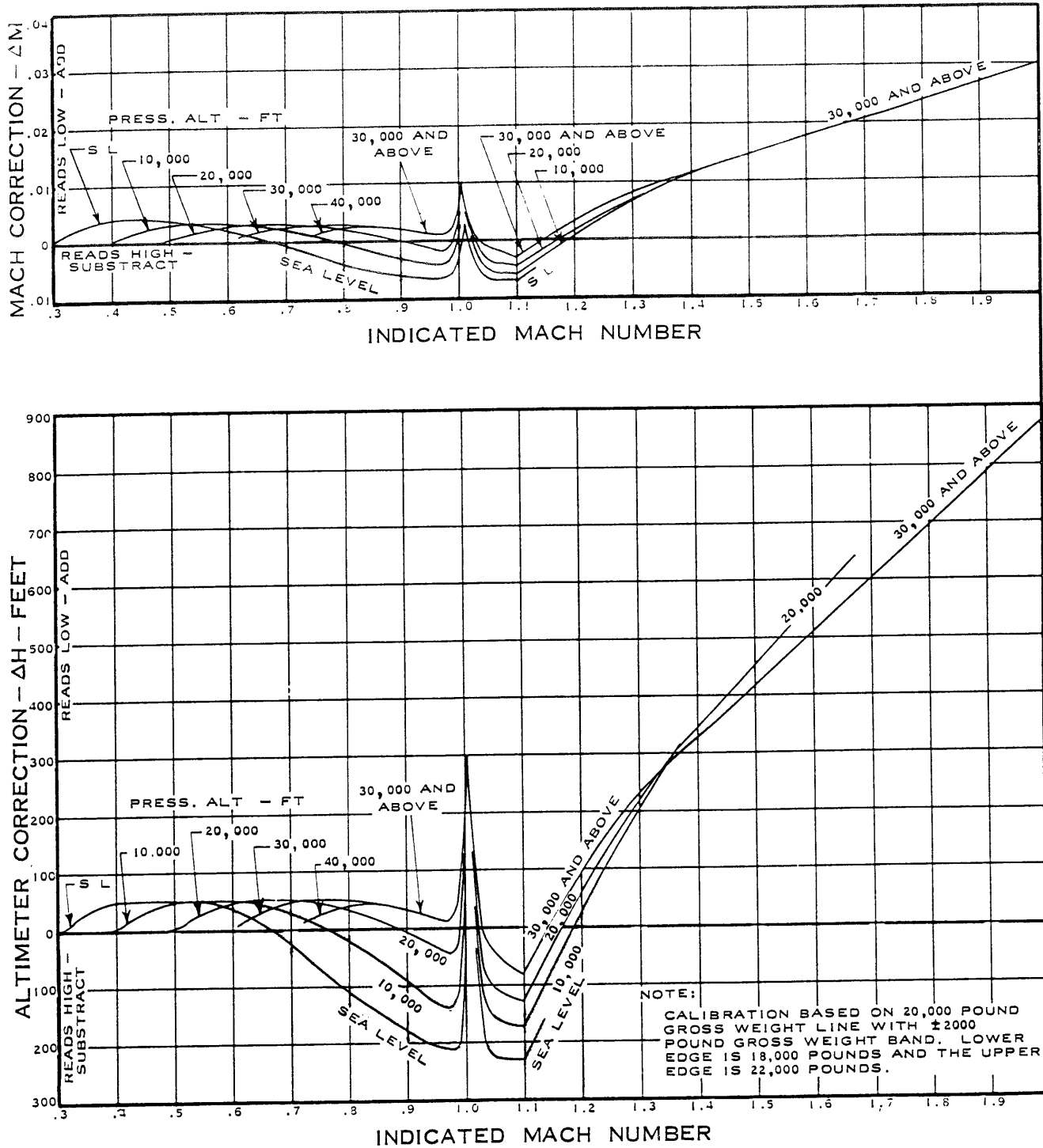

Figure A1-6



# MACH NUMBER AND ALTIMETER POSITION ERROR CORRECTION

FLAPS AND GEAR UP — TIP TANKS

Compensated Pitot - Static Head

Model: F-104S  
 Date: 1 October 1968  
 DATA BASIS: FLIGHT TEST

Engine: J79-GE-19  
 Fuel Grade: JP-8  
 Fuel Density: 6.68 Lb/Gal

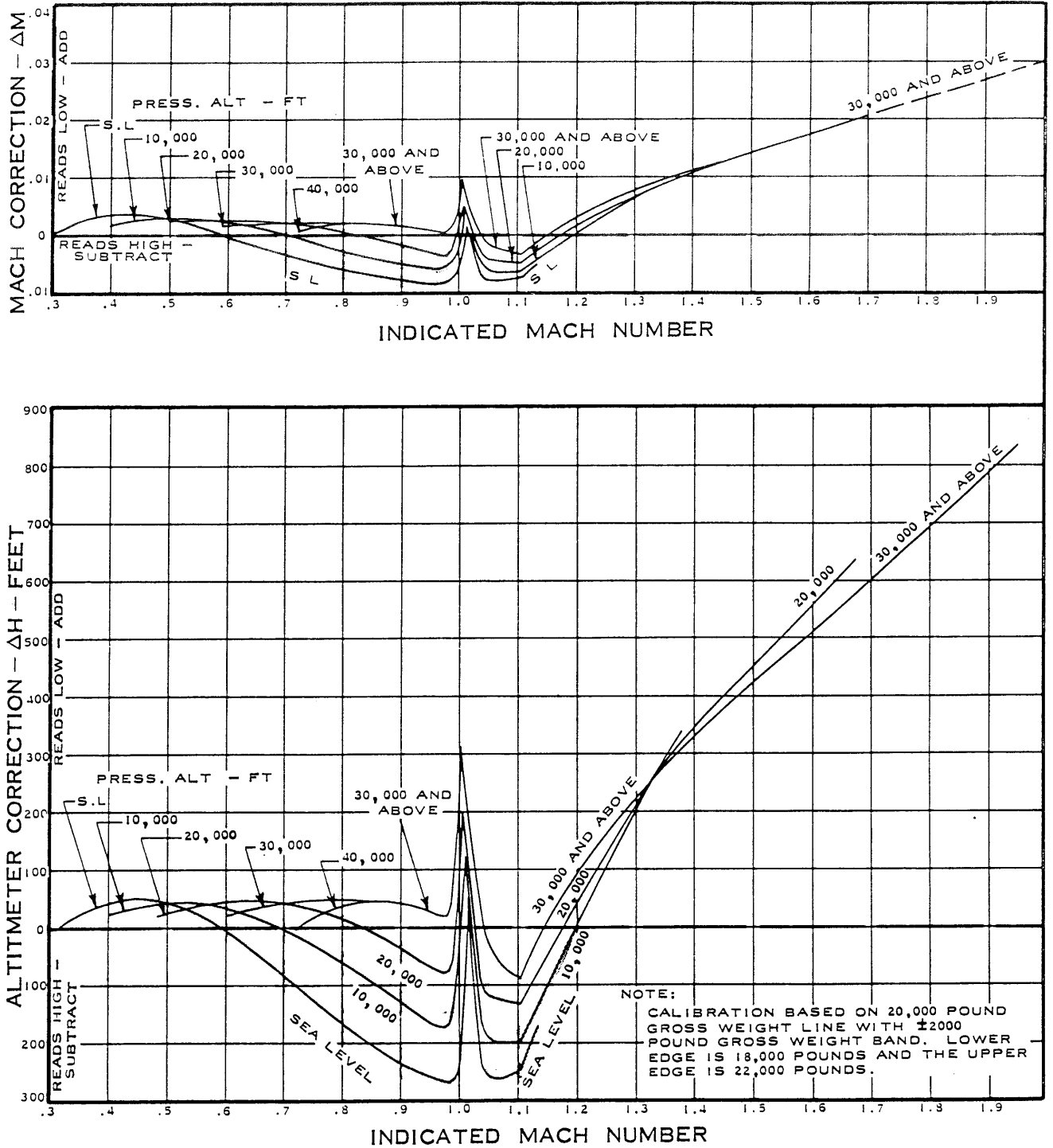

Figure A1-7

# SUBSONIC OPERATION MACH NUMBER AND ALTIMETER POSITION ERROR CORRECTION

LOW ALTITUDE - NO WING TIP STORES

Model: F-104S  
Date: 1 October 1968  
DATA BASIS: FLIGHT TEST

Engine: J79-GE-19  
Fuel Grade: JP-8  
Fuel Density: 6.68 Lb/Gal

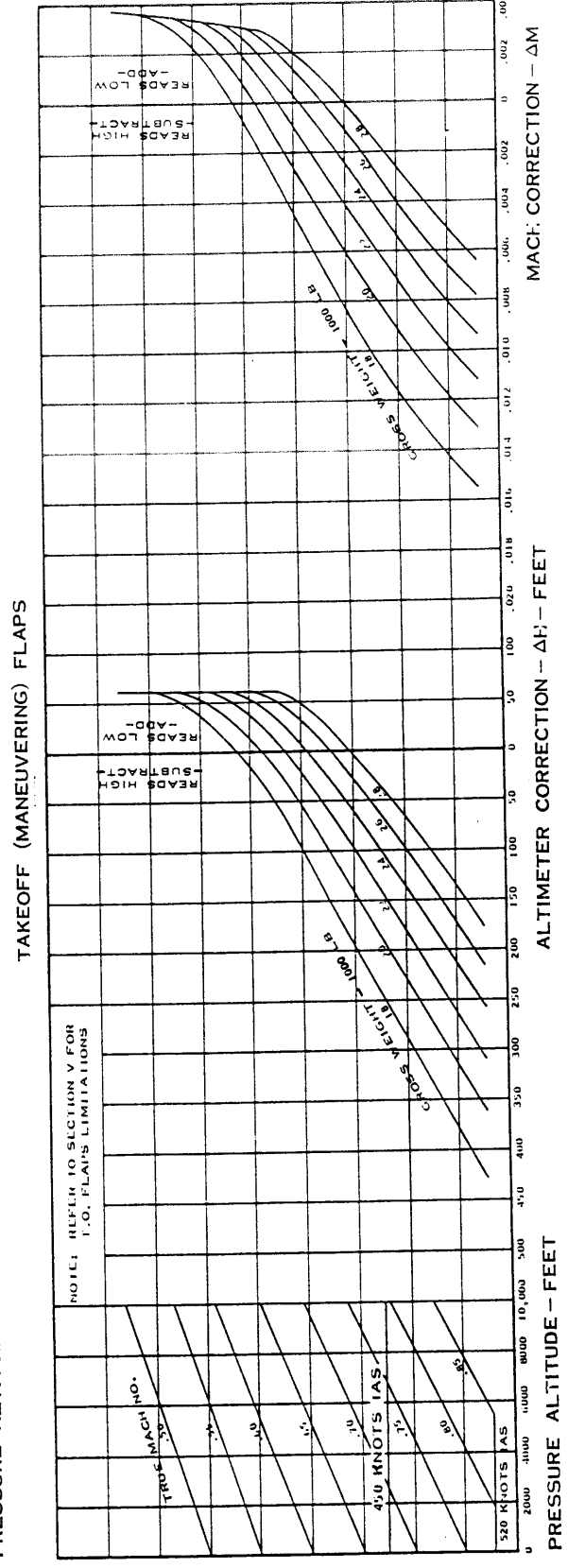
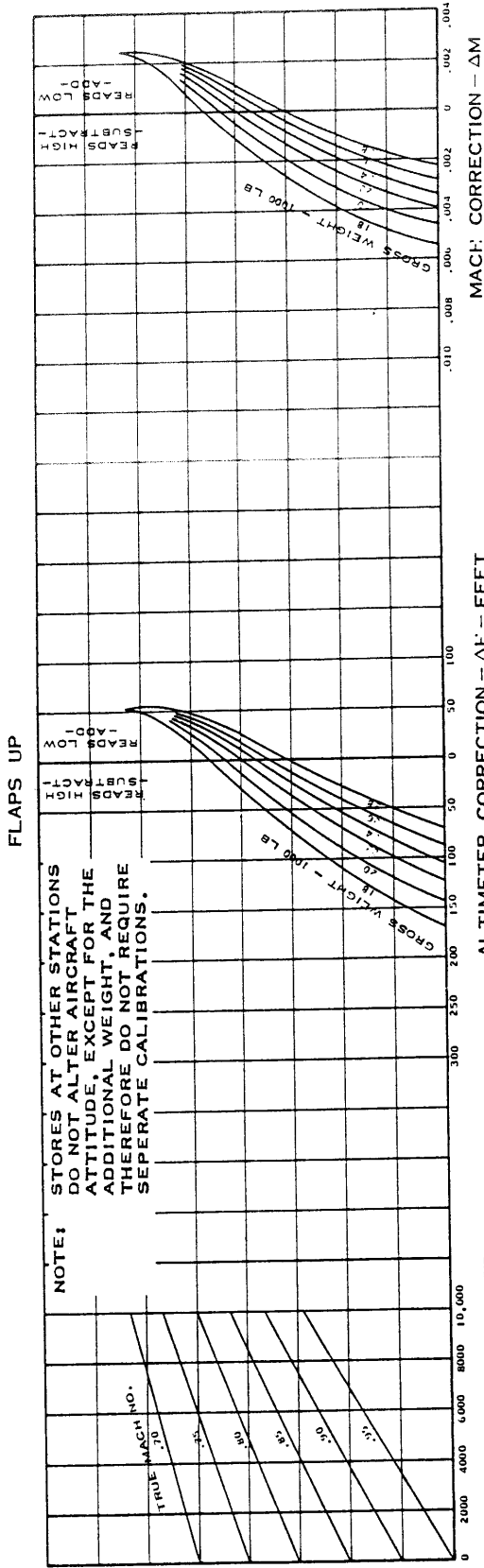

Figure A1-8

# SUBSONIC OPERATION MACH NUMBER AND ALTIMETER POSITION ERROR CORRECTION

LOW ALTITUDE - TIP AIM-9L MISSILES

Engine: J79-GE-19  
Fuel Grade: JP-8  
Fuel Density: 6.68 Lb/Gal

Model: F-104S  
Date: 1 April 1970  
DATA BASIS: FLIGHT TEST

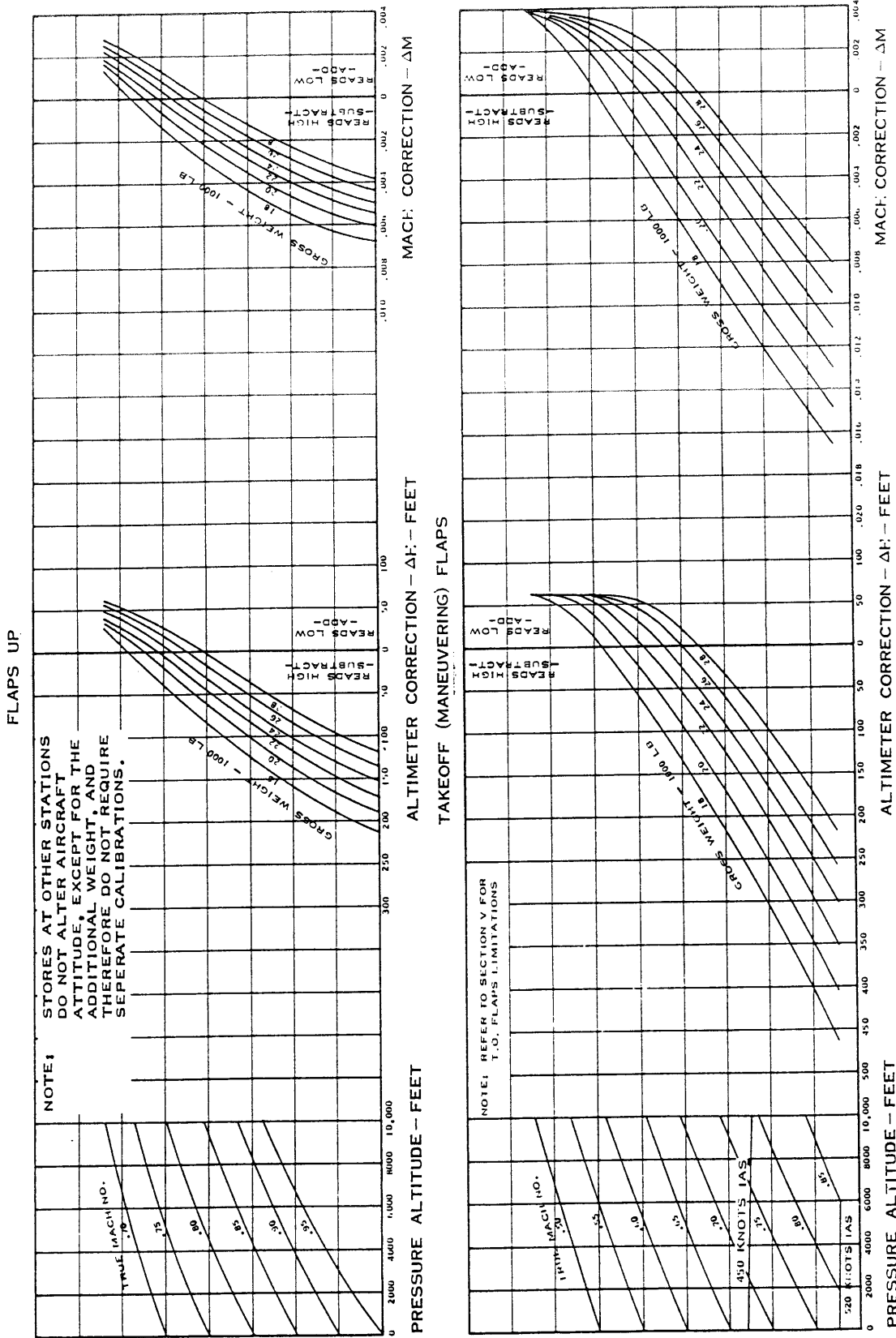

Figure A1-9

# SUBSONIC OPERATION MACH NUMBER AND ALTIMETER POSITION ERROR CORRECTION

LOW ALTITUDE - TIP TANKS

Model: F-104S  
Date: 1 October 1968  
DATA BASIS: FLIGHT TEST

Engine: J79-GE-19  
Fuel Grade: JP-8  
Fuel Density: 6.68 Lb/Gal

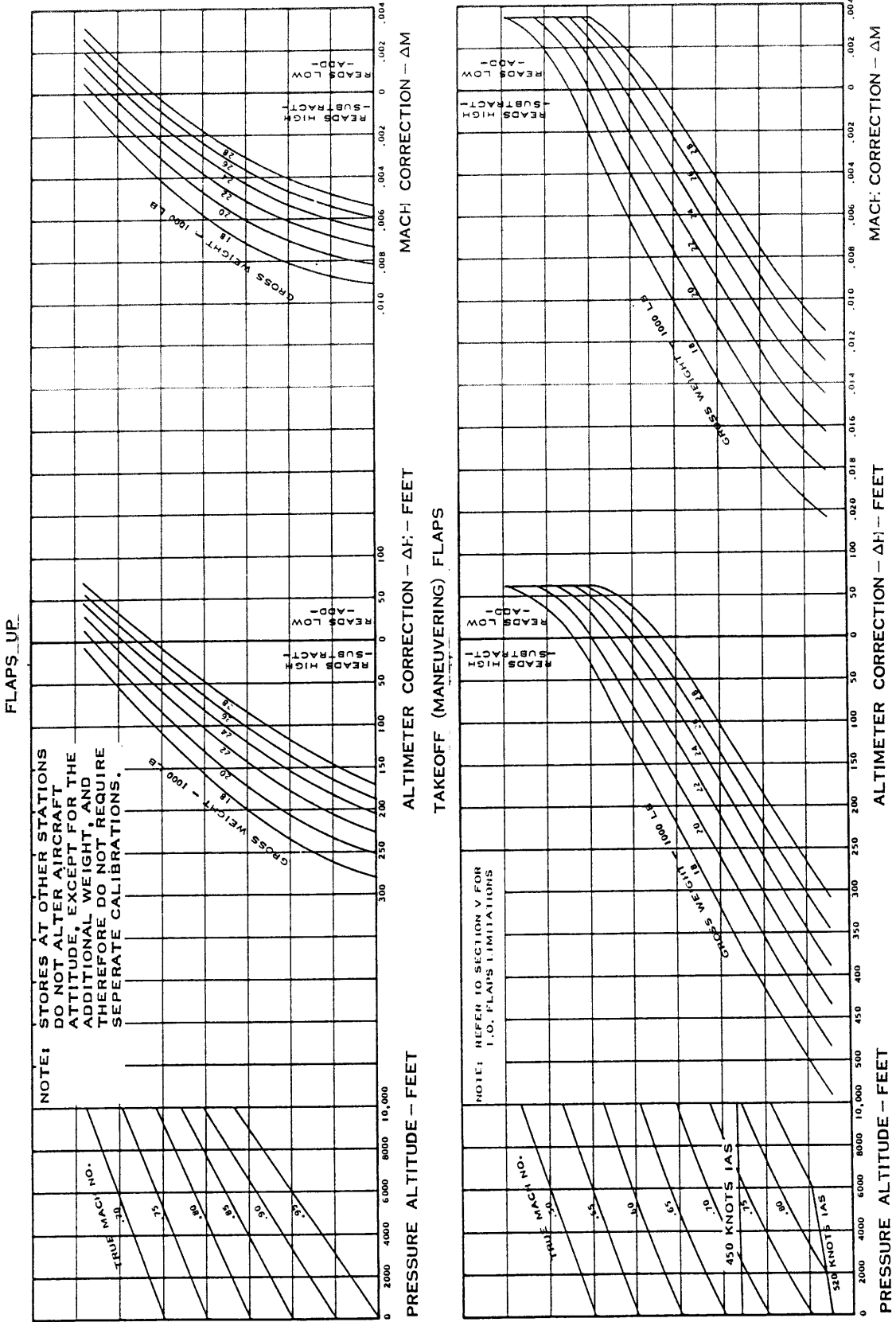

Figure A1-10

# SUBSONIC OPERATION AIRSPEED AND ALTIMETER POSITION ERROR CORRECTION

NO WING TIP STORES

Compensated Pitot - Static Head

Model: F-104S  
Date: 1 October 1968  
DATA BASIS: FLIGHT TEST

Engine: J79-GE-19  
Fuel Grade: JP-8  
Fuel Density: 6.68 Lb/Gal

NOTE: NO CORRECTION NECESSARY  
DURING GROUND RUN.

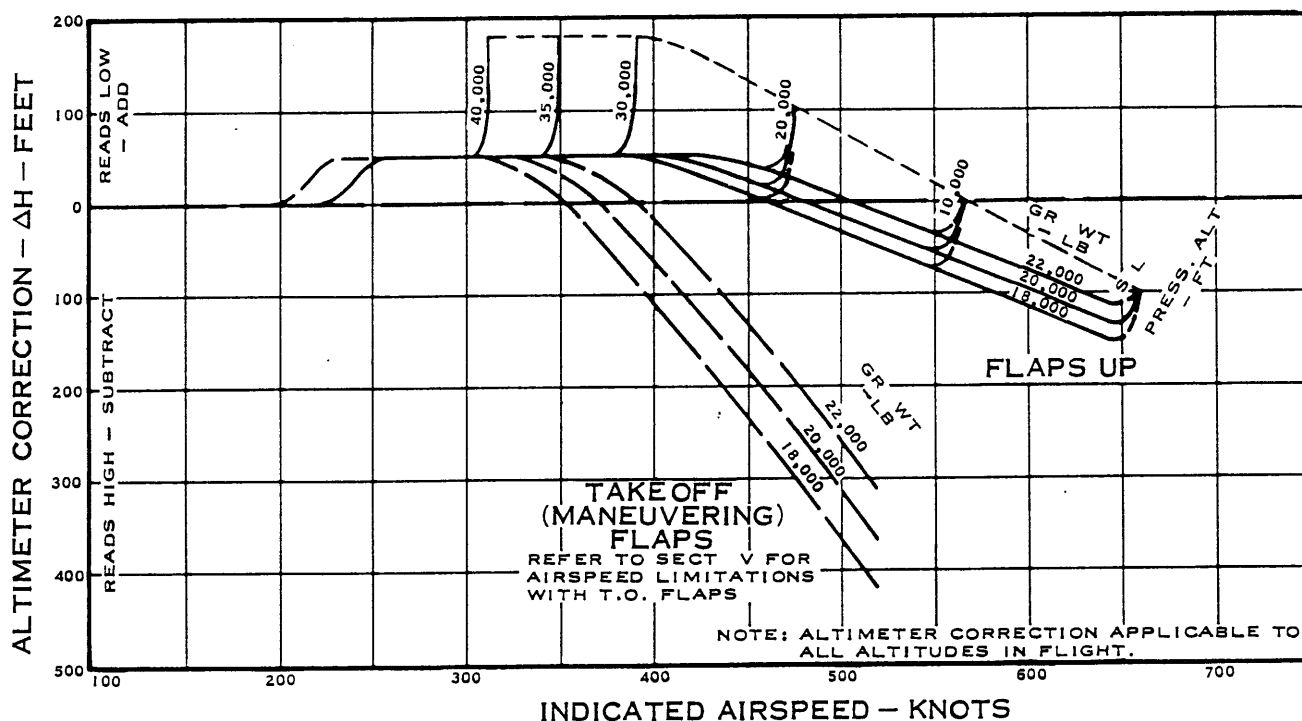
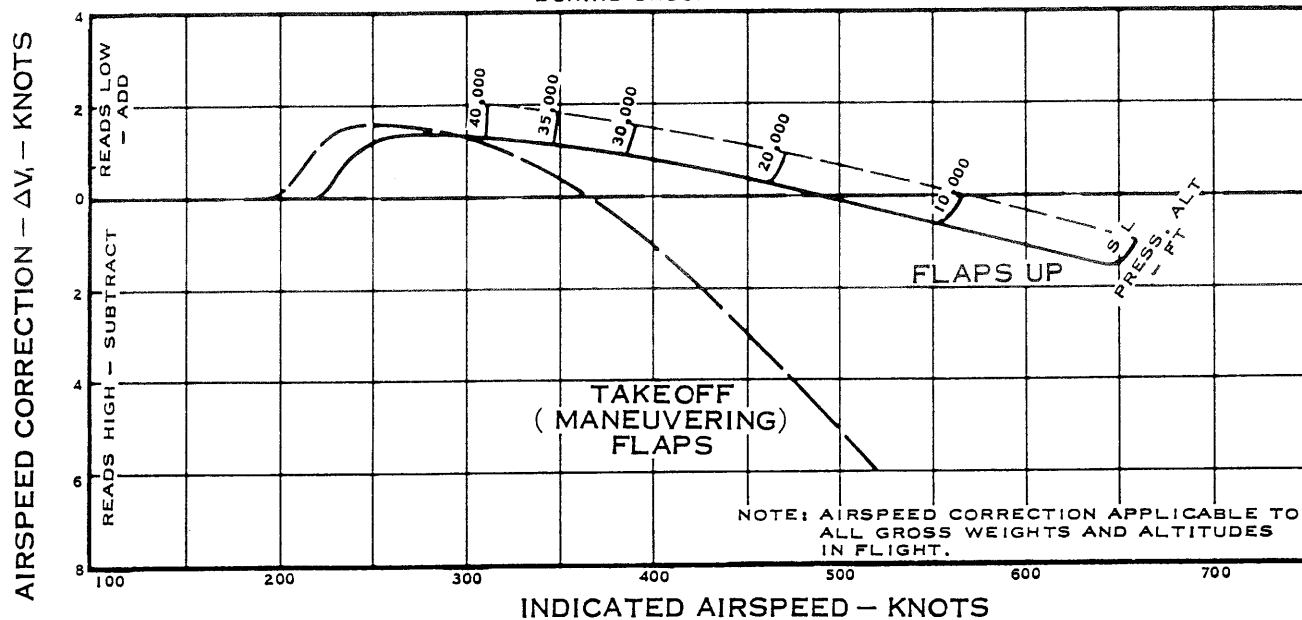

Figure A1-11

# SUBSONIC OPERATION AIRSPEED AND ALTIMETER POSITION ERROR CORRECTION

TIP AIM-9L MISSILES

Compensated Pitot - Static Head

Model: F-104S  
Date: 1 April 1970  
DATA BASIS: FLIGHT TEST

Engine: J79-GE-19  
Fuel Grade: JP-8  
Fuel Density: 6.68 Lb/Gal

NOTE: NO CORRECTION NECESSARY  
DURING GROUND RUN.

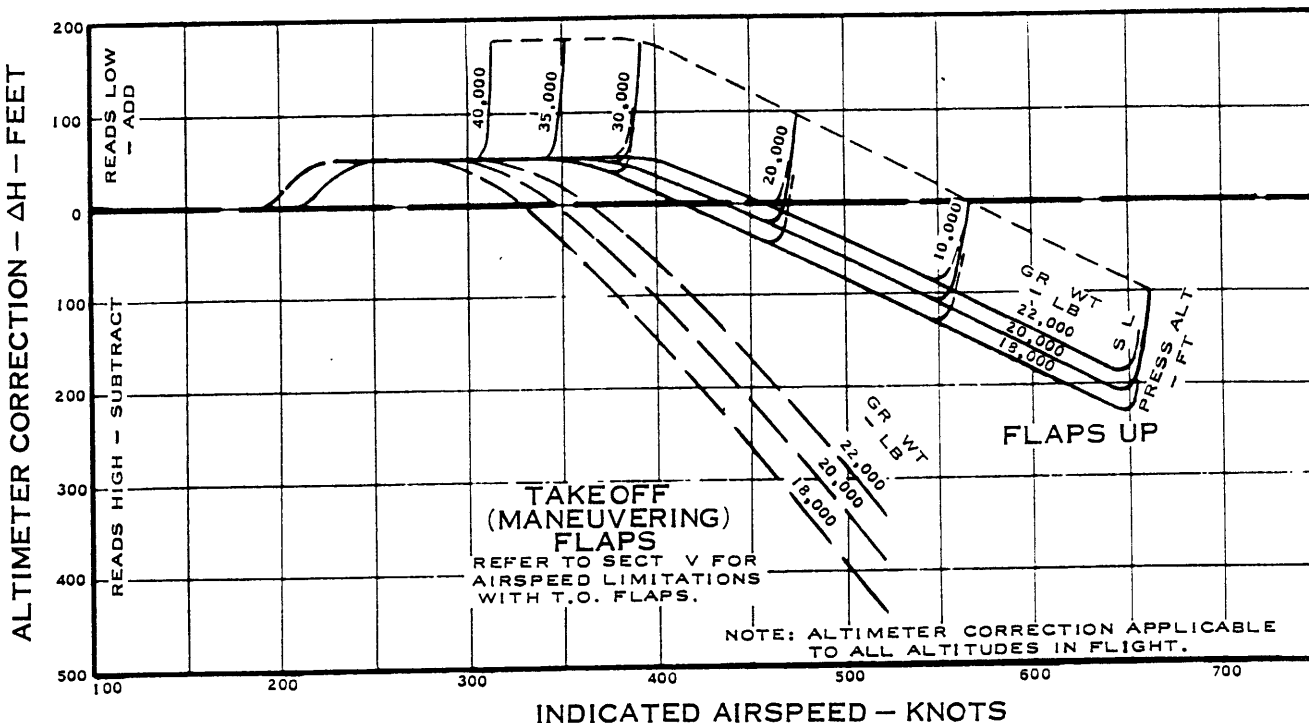
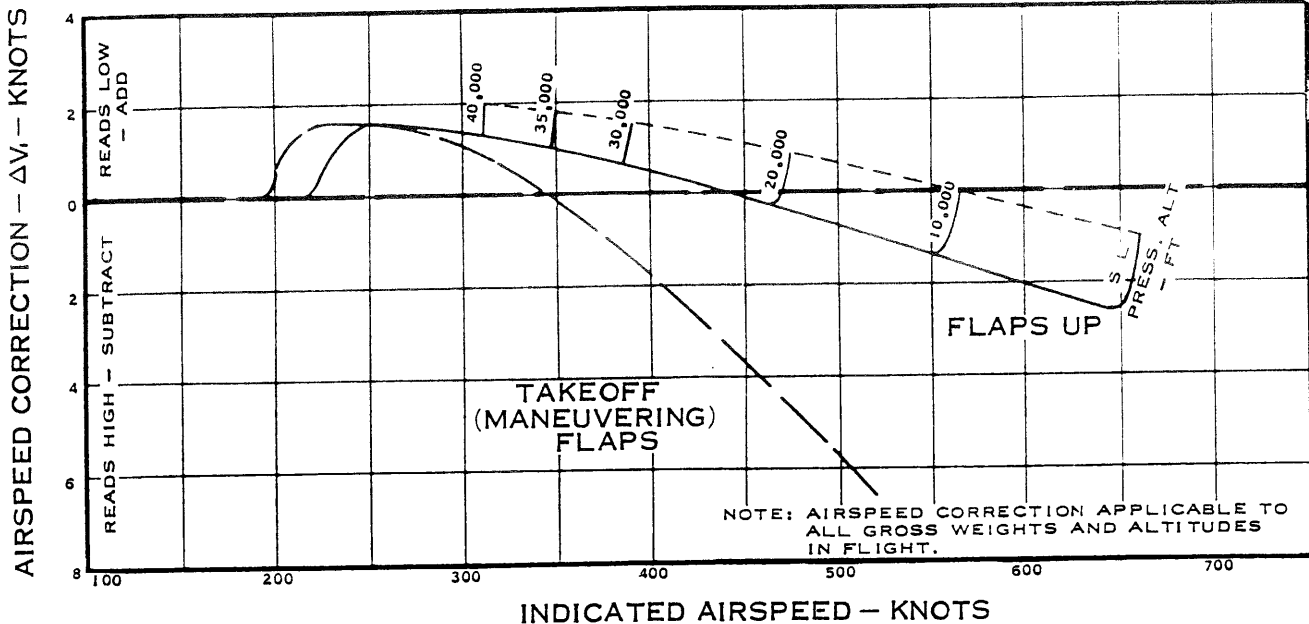

Figure A1-12

# SUBSONIC OPERATION AIRSPEED AND ALTIMETER POSITION ERROR CORRECTION

TIP TANKS

Compensated Pitot - Static Head

Model: F-104S  
Date: 1 October 1968  
DATA BASIS: FLIGHT TEST

Engine: J79-GE-19  
Fuel Grade: JP-8  
Fuel Density: 6.68 Lb/Gal

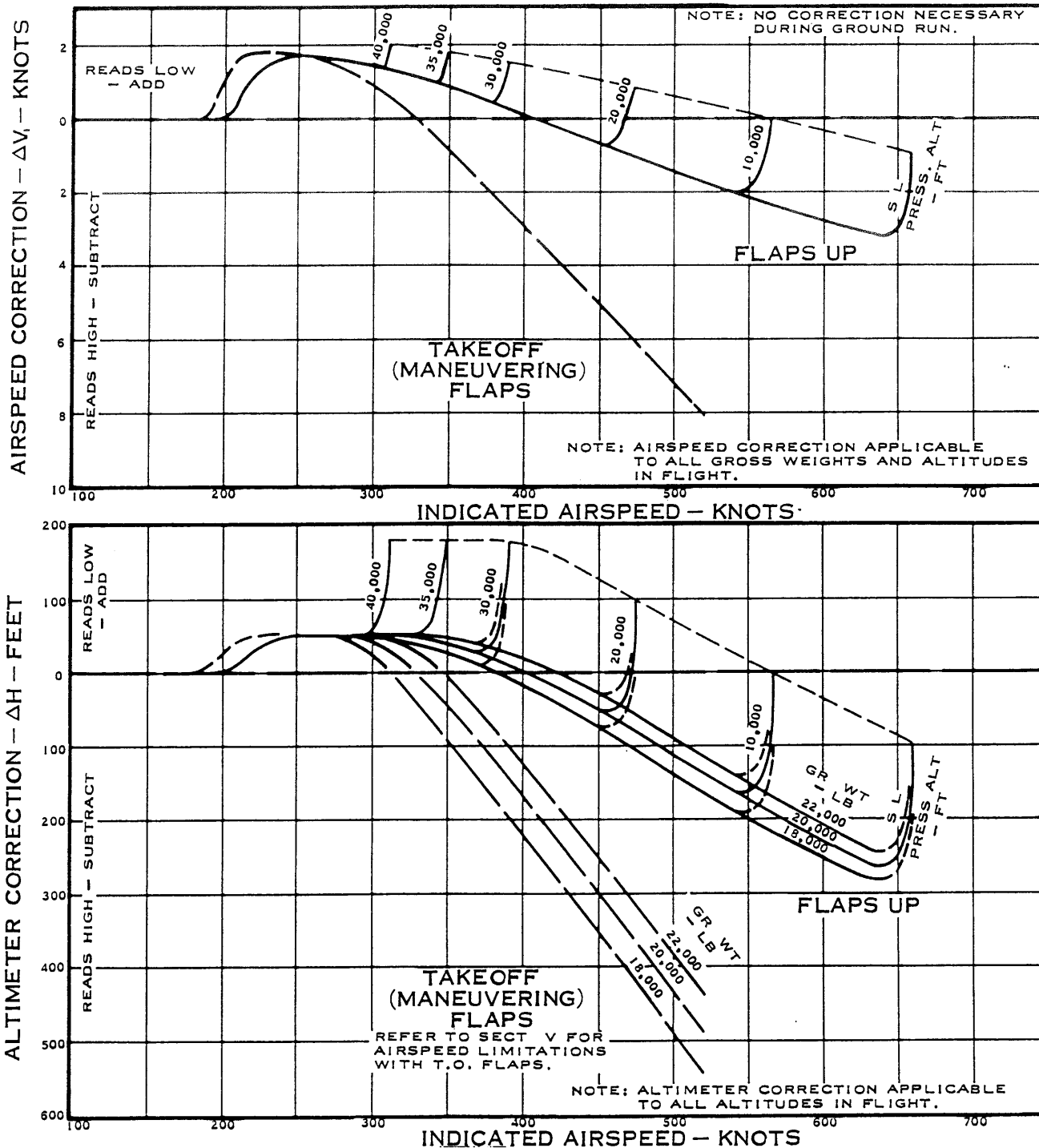

Figure A1-13

# COMPRESSIBILITY CORRECTION TO CALIBRATED AIRSPEED

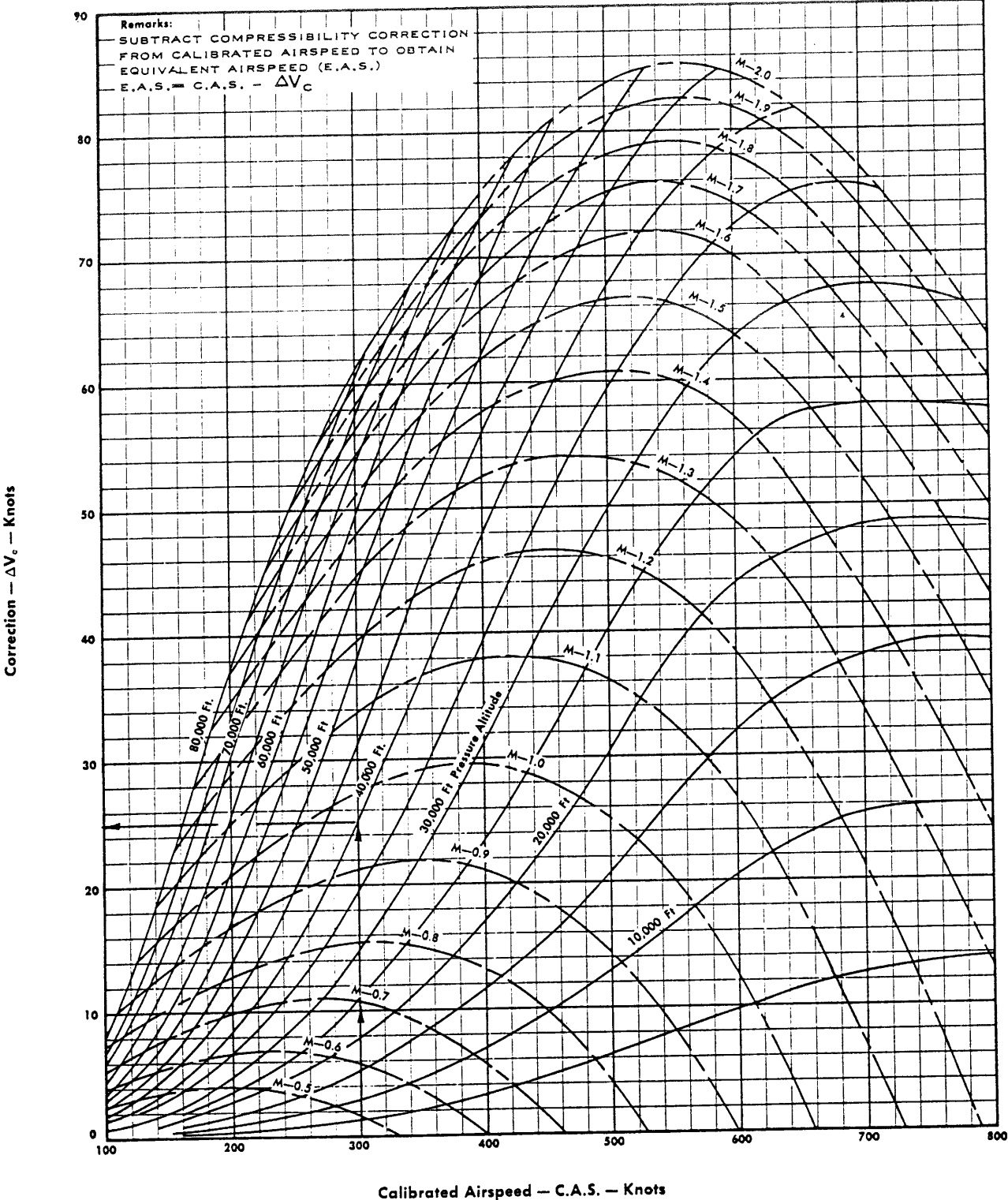

Figure A1-14



# AIRSPED — MACH NUMBER CURVES

0.4 TO 2.2 MACH NUMBER

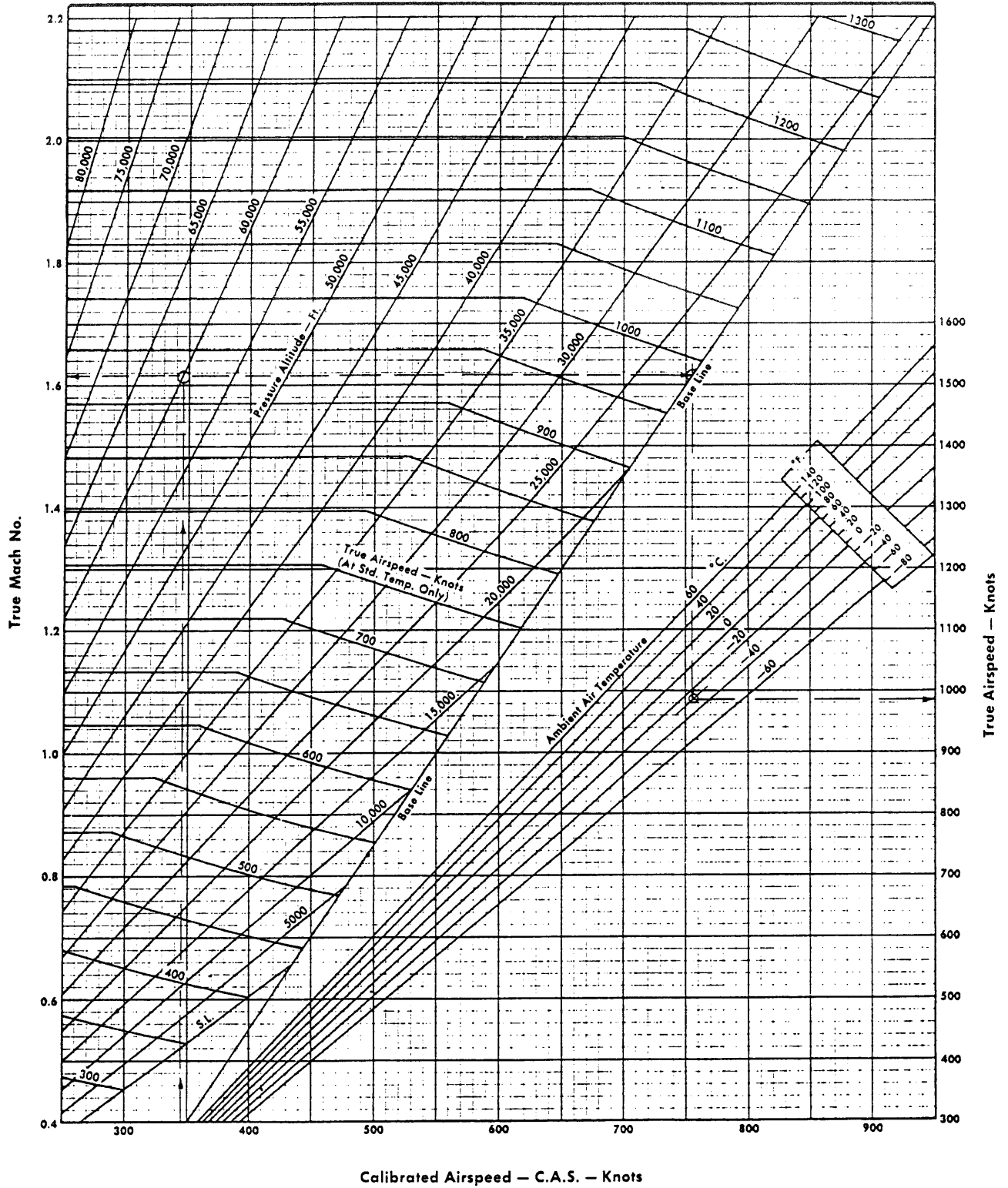

Figure A1-15

## STANDARD ALTITUDE TABLE

STANDARD SEA LEVEL AIR:  
 T = 59°F  
 P = 29.921 IN. OF HG.

W = .076475 LB./CU. FT.       $\rho_0 = .0023769$  SLUGS/CU. FT.  
 1" OF HG. = 70.732 LB./SQ. FT. = 0.4912 LB./SQ. IN.  
 $a_0 = 1116.89$  FT./SEC.

BASED ON INTERNATIONAL CIVIL AVIATION ORGANIZATION (ICAO) STANDARD ATMOSPHERE  
 (NACA TECHNICAL REPORT NO. 1235)

ALTITUDE FEET	DENSITY RATIO $\rho/\rho_0$	$1/\sqrt{\sigma}$	TEMPERATURE		SPEED OF SOUND RATIO $a/a_0$	PRESSURE	
			DEG. F	DEG. C		IN. OF HG.	RATIO P/P <sub>0</sub>
—2000	1.0598	0.9714	66.132	18.962	1.0064	32.15	1.0294
—1000	1.0296	0.9855	62.566	16.981	1.0030	31.02	1.0147
0	1.0000	1.0000	59.000	15.000	1.0000	29.92	1.0000
1000	.9711	1.0148	55.434	13.019	.9966	28.86	.9644
2000	.9428	1.0299	51.868	11.038	.9931	27.82	.9298
3000	.9151	1.0454	48.302	9.057	.9896	26.82	.8962
4000	.8881	1.0611	44.735	7.075	.9862	25.84	.8637
5000	.8617	1.0773	41.169	5.094	.9827	24.90	.8320
6000	.8359	1.0938	37.603	3.113	.9792	23.98	.8014
7000	.8106	1.1107	34.037	1.132	.9756	23.09	.7716
8000	.7860	1.1279	30.471	— 0.849	.9721	22.22	.7428
9000	.7620	1.1456	26.905	— 2.831	.9686	21.39	.7148
10000	.7385	1.1637	23.338	— 4.812	.9650	20.58	.6877
11000	.7156	1.1822	19.772	— 6.793	.9614	19.79	.6614
12000	.6932	1.2011	16.206	— 8.774	.9579	19.03	.6360
13000	.6713	1.2205	12.640	— 10.756	.9543	18.29	.6113
14000	.6500	1.2403	9.074	— 12.737	.9507	17.58	.5875
15000	.6292	1.2606	5.508	— 14.718	.9470	16.89	.5643
16000	.6090	1.2815	1.941	— 16.699	.9434	16.22	.5420
17000	.5892	1.3028	— 1.625	— 18.681	.9397	15.57	.5203
18000	.5699	1.3246	— 5.191	— 20.662	.9361	14.94	.4994
19000	.5511	1.3470	— 8.757	— 22.643	.9324	14.34	.4791
20000	.5328	1.3700	— 12.323	— 24.624	.9287	13.75	.4595
21000	.5150	1.3935	— 15.899	— 26.605	.9250	13.18	.4406
22000	.4976	1.4176	— 19.456	— 28.587	.9213	12.64	.4223
23000	.4807	1.4424	— 23.022	— 30.568	.9175	12.11	.4046
24000	.4642	1.4678	— 26.588	— 32.549	.9138	11.60	.3876
25000	.4481	1.4938	— 30.154	— 34.530	.9100	11.10	.3711
26000	.4325	1.5206	— 33.720	— 36.511	.9062	10.63	.3552
27000	.4173	1.5480	— 37.286	— 38.492	.9024	10.17	.3398
28000	.4025	1.5762	— 40.852	— 40.473	.8986	9.725	.3250
29000	.3881	1.6052	— 44.419	— 42.455	.8948	9.297	.3107
30000	.3741	1.6349	— 47.985	— 44.436	.8909	8.885	.2970
31000	.3605	1.6654	— 51.551	— 46.417	.8871	8.488	.2837
32000	.3473	1.6968	— 55.117	— 48.398	.8832	8.106	.2709
33000	.3345	1.7291	— 58.683	— 50.379	.8793	7.737	.2586
34000	.3220	1.7623	— 62.249	— 52.361	.8754	7.382	.2467
35000	.3099	1.7964	— 65.816	— 54.342	.8714	7.041	.2353
36000	.2981	1.8315	— 69.382	— 56.323	.8675	6.712	.2243
37000	.2864	1.8753	— 72.948	— 58.304	.8636	6.397	.2138
38000	.2750	1.9209	— 76.514	— 60.285	.8597	6.097	.2038
39000	.2638	1.9677	— 80.080	— 62.266	.8558	5.811	.1942
40000	.2528	2.0155	— 83.646	— 64.247	.8519	5.538	.1851
41000	.2420	2.0645	— 87.212	— 66.228	.8480	5.278	.1764
42000	.2314	2.1148	— 90.778	— 68.209	.8441	5.030	.1681
43000	.2211	2.1662	— 94.344	— 70.190	.8402	4.794	.1602
44000	.2111	2.2189	— 97.910	— 72.171	.8363	4.569	.1527
45000	.2013	2.2728	— 101.476	— 74.152	.8324	4.355	.1455
46000	.1916	2.3281	— 105.042	— 76.133	.8285	4.151	.1387
47000	.1821	2.3848	— 108.608	— 78.114	.8246	3.956	.1322
48000	.1728	2.4428	— 112.174	— 80.095	.8207	3.770	.1260
49000	.1636	2.5022	— 115.740	— 82.076	.8168	3.593	.1201
50000	.1545	2.5630	— 119.306	— 84.057	.8129	3.425	.1145
51000	.1455	2.6254	— 122.872	— 86.038	.8090	3.264	.1091
52000	.1366	2.6892	— 126.438	— 88.019	.8051	3.111	.1040
53000	.1278	2.7546	— 130.004	— 90.000	.8012	2.965	.09909
54000	.1191	2.8216	— 133.570	— 92.000	.7973	2.826	.09444
55000	.1105	2.8903	— 137.136	— 94.000	.7934	2.693	.09001
56000	.1020	2.9606	— 140.702	— 96.000	.7895	2.567	.08578
57000	.0936	3.0326	— 144.268	— 98.000	.7856	2.446	.08176
58000	.0853	3.1063	— 147.834	— 100.000	.7817	2.331	.07792
59000	.0771	3.1819	— 151.400	— 102.000	.7778	2.222	.07426
60000	.0690	3.2593	— 154.966	— 104.000	.7739	2.118	.07078
61000	.0610	3.3386	— 158.532	— 106.000	.7700	2.018	.06746
62000	.0531	3.4198	— 162.100	— 108.000	.7661	1.924	.06429
63000	.0453	3.5029	— 165.666	— 110.000	.7622	1.833	.06127
64000	.0376	3.5881	— 169.232	— 112.000	.7583	1.747	.05840
65000	.0300	3.6754	— 172.800	— 114.000	.7544	1.665	.05566

Figure A1-16

## STANDARD UNITS CONVERSION

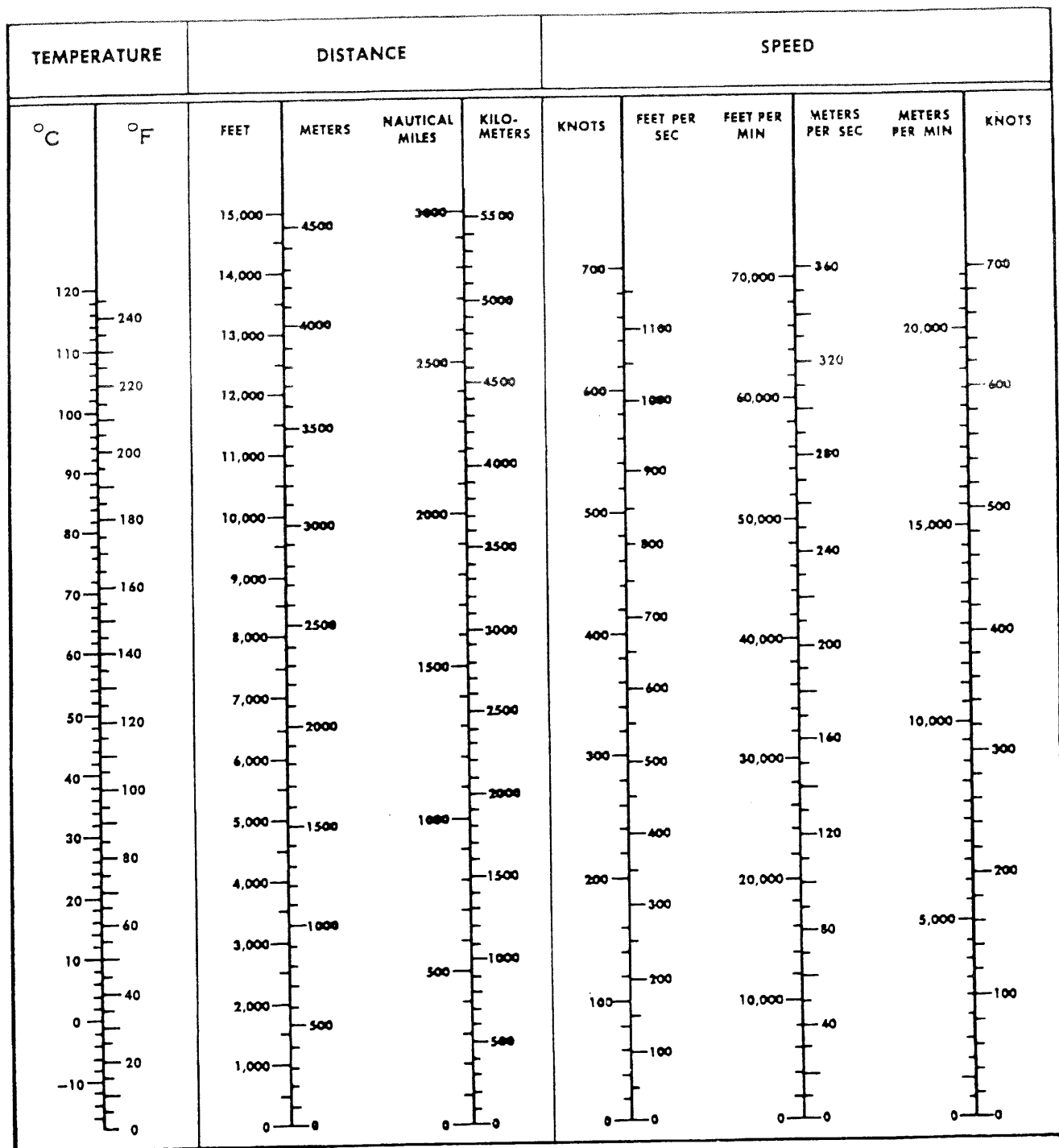

**NOTE:**

- TO OBTAIN U S GALLONS MULTIPLY LITERS BY 0.264
- TO OBTAIN IMPERIAL GALLONS MULTIPLY LITERS BY 0.220
- TO OBTAIN INCHES OF MERCURY MULTIPLY MILLIBARS BY .0295
- TO OBTAIN POUNDS MULTIPLY KILOGRAMS BY 2.20

*Figure A1-17*

## PART 2

### TAKEOFF

#### TABLE OF CONTENTS

Index items in bold face characters denote illustrations.

Title	Page
Takeoff Planning and Charts . . . . .	A2-1
Refusal Speed . . . . .	A2-2
Acceleration Check Distance . . . . .	A2-2
<b>Runway Marking System and Go, No-Go Concept . . . . .</b>	<b>A2-3</b>
Runway Wind Component . . . . .	A2-4
Total Distance to Clear a 50-Foot Obstacle . . . . .	A2-4
Runway Marking System . . . . .	A2-4
Takeoff Planning Problem at Light Weight . . . . .	A2-5
Takeoff Planning Problem at Heavy Weight . . . . .	A2-6
<b>Takeoff Speed Schedules . . . . .</b>	<b>A2-8</b>
<b>Takeoff Ground Run Distance - Maximum Thrust . . . . .</b>	<b>A2-9, A2-15</b>
<b>Refusal Speed - Maximum Thrust . . . . .</b>	<b>A2-10, A2-11</b>
<b>Velocity During Takeoff Ground Run - Maximum Thrust . . . . .</b>	<b>A2-12, A2-18</b>
Airspeed Acceleration Tolerance . . . . .	A2-13
<b>Takeoff Distance Over a 50-Foot Obstacle - Maximum Thrust . . . . .</b>	<b>A2-14, A2-19</b>
<b>Takeoff Ground Run Distance - Military Thrust . . . . .</b>	<b>A2-20</b>
<b>Refusal Speed - Military Thrust . . . . .</b>	<b>A2-21, A2-22</b>
<b>Velocity During Takeoff Ground Run - Military Thrust . . . . .</b>	<b>A2-23</b>
<b>Takeoff Distance Over a 50-Foot Obstacle - Military Thrust . . . . .</b>	<b>A2-24</b>

#### TAKEOFF PLANNING AND CHARTS

This part comprises the charts to be used in predicting takeoff performance with maximum thrust, auxiliary inlet doors open or closed, and military

thrust with the auxiliary inlet doors closed. Distances are based on normal acceleration and use of the normal takeoff technique described in Section II "Normal Procedures". They are applicable to all configurations and weights.

Typical configuration gross weights with full fuel load at the ramp before engine start are shown on Figure A1-2. Subtract the ground maneuver fuel allowance (nominally 150 pounds) from the aircraft loaded gross weight before computing takeoff performance.

Refusal speed and acceleration check data are provided so that a Go, No-Go procedure may be used if desired. Use of the Go, No-Go concept (Figure A2-1) lets the pilot check predicted airspeed at marked runway distances against actual performance while accelerating. The system assumes that failure to check within allowable tolerance indicates a malfunction that justifies aborting takeoff.

#### TAKEOFF SPEED SCHEDULES

Normal takeoff speeds and the speeds at which a 50-ft height should be attained are given in Figure A2-2 for the entire range of takeoff gross weights. The chart also provides the takeoff speed schedule as true airspeed with corrections to groundspeed to determine whether or not takeoff conditions exceed the groundspeed tire limit of 239 knots.

#### WIND COMPONENT

The takeoff distance and takeoff groundspeed charts incorporate correction grids which account for headwind and tailwind effects. The Wind Component Chart, Figure A8-1, allows reported winds to be converted directly into crosswind and headwind or tailwind components when the reported speed and angle between wind direction and runway heading are known. The takeoff charts do not make allowance for any difference in wind velocity between runway level and height of the anemometer.

**NOTE**

Use maximum reported gust velocity in computing crosswind components.

**GROUND RUN DISTANCE**

Takeoff ground run is the distance from the start of takeoff until the aircraft becomes airborne. Distances are shown for maximum thrust operation with the auxiliary inlet doors open or closed and military thrust with the auxiliary inlet doors closed. The chart may be used to predict takeoff distance for operation from dry, hard-surfaced runways for most normal variations of operating altitude, temperature, wind, and slope conditions.

**REFUSAL SPEED**

Refusal speed is the highest speed to which the aircraft may be accelerated, assuming normal acceleration, and still be stopped on the runway remaining. The refusal speed charts in this part assume maximum braking after the initial reaction time and prompt deployment of the drag chute if it is to be activated. They account for gross weight, pressure altitude, temperature, and actual runway length available. They do not consider the added variables of wind or slope. The data are directly applicable to operation on dry, hard-surface runways. A correction grid is supplied to cover operations on wet, icy, or snow-covered runways. The corrections are keyed to a braking coefficient index. The index may be used if the percentage of wheel braking force (available/maximum dry surface) may be determined for the existing condition. Otherwise, use the general ice, snow, and rain criteria provided.

**REFUSAL DISTANCE**

Refusal distance is the distance required to reach refusal speed with normal acceleration. It is determined from the "Velocity During Takeoff Ground Run" chart after refusal speed has been determined. Enter the "Velocity During Takeoff Ground Run" chart from the top with takeoff speed and find a point opposite the predicted takeoff distance value. The nearest guide lines now indicate the speed-distance relationship for the takeoff run. Follow the guide lines down and to the left until above the

predicted refusal speed. Read refusal distance on the ground run distance scale to the right of the grid. (Note: Normal takeoff speeds have been keyed to takeoff weight at the top of the chart for convenience.)

**ACCELERATION CHECK DISTANCE**

For lightweight operation, the acceleration check distance is the distance to the second marker from brake release. At heavy weights, this acceleration check should be made at the marker which is 2000 feet short of the go, no-go marker. For conditions where the normal speed (corrected for wind component) at this marker is less than the minimum range of the airspeed indicator, make the acceleration check at the marker that is 1000 feet short of the go, no-go marker.

**ACCELERATION CHECK SPEED**

The normal speed at the acceleration check marker is determined from the "Velocity During Takeoff Ground Run" chart. Use the same guide line found for obtaining Refusal Distance, extending it down and to the left until a point is located opposite the desired acceleration check distance. Read acceleration check speed on the bottom scale below this point. Increase the value by the amount of runway headwind component. During the takeoff run, compare actual indicated airspeed with the predicted value as the aircraft passes the acceleration check-point. If the airspeed is less than normal minus the allowable tolerance, the takeoff may have to be aborted. It is then mandatory that a careful speed check be made upon reaching the go, no-go marker.

**GO, NO-GO DISTANCE**

The last marker reached before passing the refusal point shall be used as an abort decision point, because the refusal point usually will not coincide with a marked runway distance. This marker, at which the final decision is made to continue the takeoff, or abort it, is called the "go, no-go marker". The distance that the aircraft has traveled in reaching the go, no-go marker is called the "go, no-go distance". The takeoff should be aborted if the aircraft is below the "go, no-go speed" at the go, no-go marker.



- e. The distance remaining at the go, no-go marker is the marker distance at that point plus  $\frac{1}{2}$  of the odd figure over exact thousands of feet in runway length.
- f. The go, no-go distance (distance from the lineup point to the go, no-go point) is the available runway length minus the distance from step (e). This distance is used to enter the "Velocity During Takeoff Ground Run" chart to find the normal speed at the go, no-go marker.

## ACCELERATION TOLERANCE

Acceleration tolerance is the amount that the speed at the go, no-go marker may fall below the normal speed at the marker without endangering the takeoff. The acceleration tolerance is based on the minimum allowable takeoff acceleration which will result in a zero-wind takeoff ground run go greater than 90% of the runway length available. Acceleration tolerance data are presented in Figure A2-7 for maximum thrust operation with the auxiliary inlet doors open or closed and military thrust with the auxiliary inlet doors closed. The tolerance values should not be exceeded, even when excess runway length is available and use of a larger acceleration tolerance might otherwise be permitted. There must be a serious deficiency in the performance of the aircraft and a takeoff should not be attempted if the acceleration is so low that the maximum allowable tolerance must be exceeded.

## RUNWAY WIND COMPONENT

Normal acceleration speeds at the go, no-go point and the acceleration checkpoint shall be corrected for wind. The correction is made by adding the runway headwind component directly to the no-wind speeds (use Figure A8-1). Acceleration check speed and go, no-go speed should always be corrected for runway wind component. Takeoff planning procedure may ignore the effect of headwind on takeoff ground run distance, thus considering the benefits of headwind as an added safety margin. If this is done a check should be made to be certain the crosswind conditions are not excessive.

## TOTAL DISTANCE TO CLEAR A 50-FOOT OBSTACLE

The total distance to clear a 50-foot obstacle is the sum of the ground run distance and the air distance traveled while attaining a height of 50 feet above the runway. A total distance chart is provided for maximum thrust operation with the auxiliary inlet doors open, Figure A2-8, auxiliary inlet doors closed, Figure A2-13, and military thrust operation with the auxiliary inlet doors closed, Figure A2-18. Distances are shown for a range of altitude, temperature, wind, and slope conditions. The obstacle clearance speeds are shown in Figure A2-2.

## RUNWAY MARKING SYSTEM

The takeoff planning procedure presented in this manual is based on the "distance remaining" marker concept. The standard numbering and placement of runway distance markers is illustrated in Figure A2-1. The markers are placed 1000 feet apart along the runway and are numbered to reflect the number of 1000-foot intervals remaining.

If the runway length is an odd figure (e.g., 7500 ft) then the last, or zero distance, marker will be one half of the odd figure over exact thousands of feet [ $\frac{1}{2} \times (7500 - 7000)$ ] from the end of the runway. Therefore, at any given marker, say No. 5, the aircraft will be 5000 feet plus one-half the odd figure over exact thousands of feet from the end of the runway (5250 ft in this case).

## LINEUP ALLOWANCE

The distance that the aircraft has traveled at any particular marker depends on the length of the runway and the location of the aircraft on the runway when the brakes were released. The distance from the starting end of the runway to the aircraft at brake release point is called the lineup allowance. If the lineup distance is 250 feet on a 7500-foot runway, brakes will be released at the No. 7 marker and the aircraft will have traveled 2000 feet at the No. 5 marker. The term "lineup allowance" should not be confused with "marshalling distance", the distance between aircraft during formation takeoffs.

## TAKEOFF PLANNING PROBLEM AT LIGHT WEIGHT

The procedures for accurate takeoff planning are illustrated by two sample problems. The first problem contains the minimum amount of planning necessary, and the procedures shown are adequate for normal operation at light weights. The second problem illustrates the procedures necessary for a complete solution when operating at heavy weights or under adverse conditions. The methods used for solution of the examples apply to the actual performance charts discussed. Sample charts are provided for illustration purposes. Determine takeoff performance for the following conditions:

- Maximum thrust (auxiliary inlet doors open)
  - Configuration - wing tip fuel tanks
  - Takeoff gross weight: 24000 - 150 lb = 23850 lb
  - Field ambient air temperature - 100° F
  - Field pressure altitude - 3000 ft
  - Wind - 20 knots from 060°
  - Runway - 10250 ft long, 035° heading, hard dry surface, 1% downhill slope
  - Lineup allowance - 250 feet from end of runway
- a. From Figure A8-1, at a reported wind velocity of 20 knots and an angle between wind and runway of 25° (60° - 35°), the runway component is 18 knots headwind.
  - b. From Figure A2-3 (Takeoff Ground Run Distance) the zero-wind, zero-slope ground run distance is 4700 ft. Predicted distance with wind and slope is 3850 ft.
  - c. The normal performance takeoff airspeed (from Figure A2-2) is 189 knots IAS and ground speed is 189 knots (less than tire limit speed).
  - d. The distance from the starting end of the runway to the No. 10 marker is 125 ft. (Refer to runway marking system text for explanation). Brakes will be released 125 ft beyond the first marker for a lineup allowance of 250 ft. The remaining runway length available is 10000 ft. Distance to clear 50 feet (Figure A2-8) is 7600 ft.

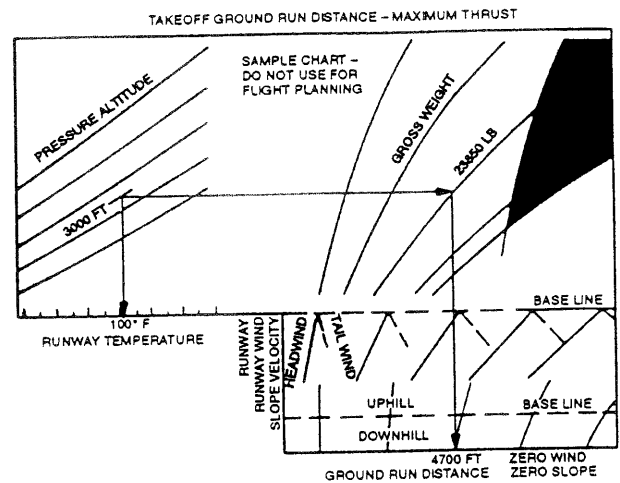

- e. The acceleration check marker is No. 8, the second marker beyond brake release. The rolling distance to this marker is 1875 ft (2000 ft - 125 ft).
- f. Enter Figure A2-6 (Velocity During Takeoff Ground Run) at the Takeoff gross weight (23850 lb) and zero-wind, zero-slope takeoff ground run distance (4700 ft) to establish the normal acceleration guide line.
- g. Still using Figure A2-6, enter the ground run distance scale at the acceleration check distance (1875 ft). At the intersection with the normal acceleration guide line read the normal speed at the acceleration check distance 122 knots.
- h. The runway wind component (18 knots headwind) added to the normal speed at the acceleration check distance (122 knots IAS) is the speed, 140 knots IAS, to be expected at the No. 8 marker.

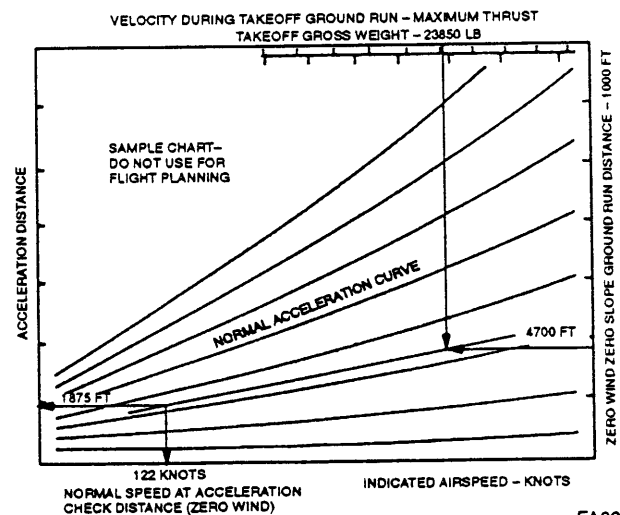

FA0283



# TAKEOFF PLANNING PROBLEM AT HEAVY WEIGHT

Determine takeoff performance for the following conditions:

- Configuration - Wing tip fuel tanks, pylon fuel tanks and AIM-7E missiles
- Takeoff gross weight: 28743 lb - 150 lb = 28593 lb
- Maximum thrust (auxiliary inlet doors open)
- Field pressure altitude - 2000 feet
- Field ambient air temperature - 100° F
- Wind - 20 knots from 060°
- Runway - 10250 feet long, 035° heading, dry, hard surfaced, 1% downhill slope
- Lineup allowance - 250 feet from end of runway

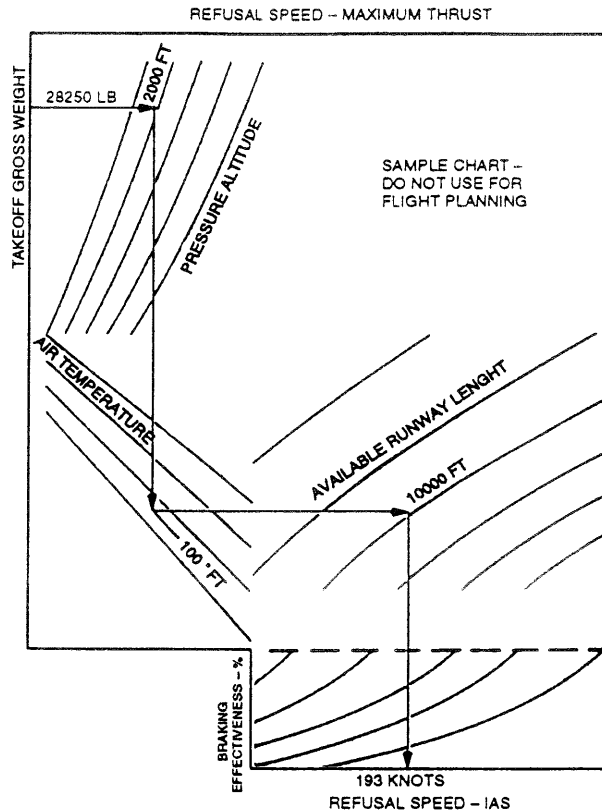

FA0284

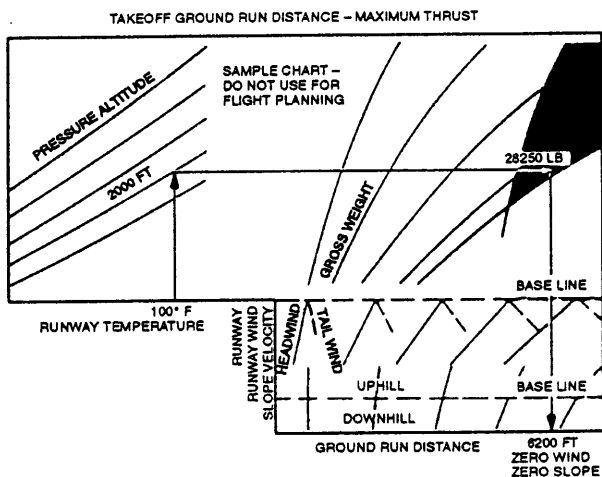

- a. From Figure A8-1, at a reported wind velocity of 20 knots and an angle between wind and runway of 25° (60° - 35°), the runway component of the wind is 18 knots headwind.
- b. From Figure A2-3 (Takeoff Ground Run Distance) the zero-wind, zero-slope ground run distance, for use in determining the go, no-go requirements, is 6200 ft. Predicted distance with wind and slope is 5100 ft.

- c. The groundspeed at lift-off should be obtained in order to determine whether or not the groundspeed tire limit is exceeded. From Figure A2-2, the takeoff groundspeed for the existing conditions will be 204 knots. Normal performance technique will be used. The airspeed at takeoff (also from Figure A2-2) is 206 knots IAS.
- d. The distance from the starting end of the runway to the No. 10 marker is 125 feet (see runway marking text for explanation). Brakes will be released 125 feet beyond the first marker for a lineup allowance of 250 feet. The remaining runway length available is 10000 ft.
- e. The refusal speed, from Figure A2-4 (Refusal Speed) is 193 knots.
- f. Enter Figure A2-6 (Velocity During Takeoff Ground Run) at the takeoff gross weight 28593 lb and zero-wind, zero-slope takeoff ground run distance (6200 ft) to establish the normal acceleration guide line.
- g. Still using Figure A2-6, enter (from the bottom) at the refusal speed (193 knots). At the intersection with the normal acceleration guide line read the refusal distance on the ground run distance scale 5350 ft.

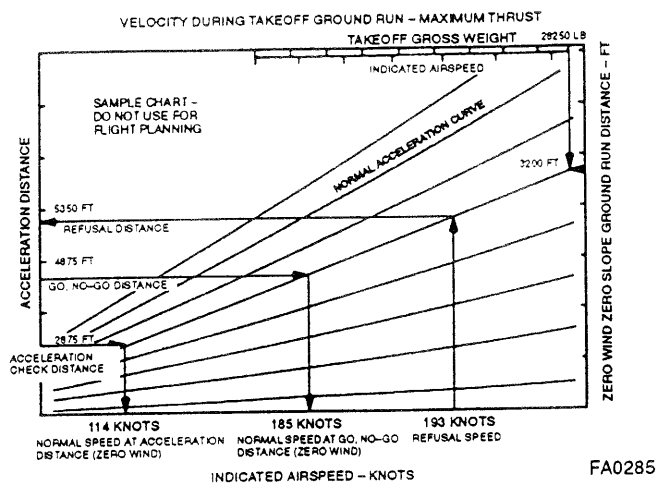

- h. The refusal point is reached (5350 + 125) 5475 feet beyond the No. 10 marker, 475 feet beyond the No. 5 marker. The No. 5 marker becomes the go, no-go marker. Ground run distance to the go, no-go marker is 475 feet less than to the refusal point 5350 ft - 475 ft, or 4875 ft.
- i. Using Figure A2-6 (Velocity During Takeoff Ground Run), enter the ground run distance scale at the go, no-go distance (4875 ft). At the intersection with the normal acceleration guide line, read the normal speed at the go, no-go distance 185 knots.
- j. From Figure A2-7, the allowable speed tolerance is 10 knots IAS. The zero wind go, no-go speed is 185 knots - 10 knots, or 175 knots IAS.
- k. Adding the headwind component to the go, no-go speed found above provides the final go, no-go speed of 18 knots + 175 knots, or 193 knots IAS. The takeoff should be aborted if airspeed is below 193 knots IAS at the No. 5 marker. Drag chute and maximum wheel braking should be used.
- l. The acceleration check marker is reached 2000 feet before the go, no-go marker. Ground run distance to this marker (No. 7) is the go, no-go distance of 4875 ft, - 2000 ft, or 2875 ft from the brake release point.
- m. Enter Figure A2-6 (Velocity During Takeoff Ground Run) with the acceleration check distance (2875 ft). At the intersection with the normal acceleration guide line read the normal speed at the acceleration check marker (zero wind) 144 knots.
- n. The runway wind component (18 knots headwind) added to the normal speed at the acceleration check distance provides the expected speed at the acceleration check distance 144 + 18 knots, or 162 knots. When the acceleration check speed is marginal, the speed at the go, no-go marker should be given close attention.
- o. Referring to Figure A2-8, the total distance to takeoff and clear a 50-foot obstacle, based on normal acceleration, zero-wind, and zero-slope is 12600 ft. Predicted distance with wind and slope is 10900 ft.

# TAKEOFF SPEED SCHEDULES

All Configurations

Model: F-104S  
 Date: 1 June 1969  
 DATA BASIS: FLIGHT TEST

Engine: J79-GE-19  
 Fuel Grade: JP-8  
 Fuel Density: 6.68 Lb/Gal

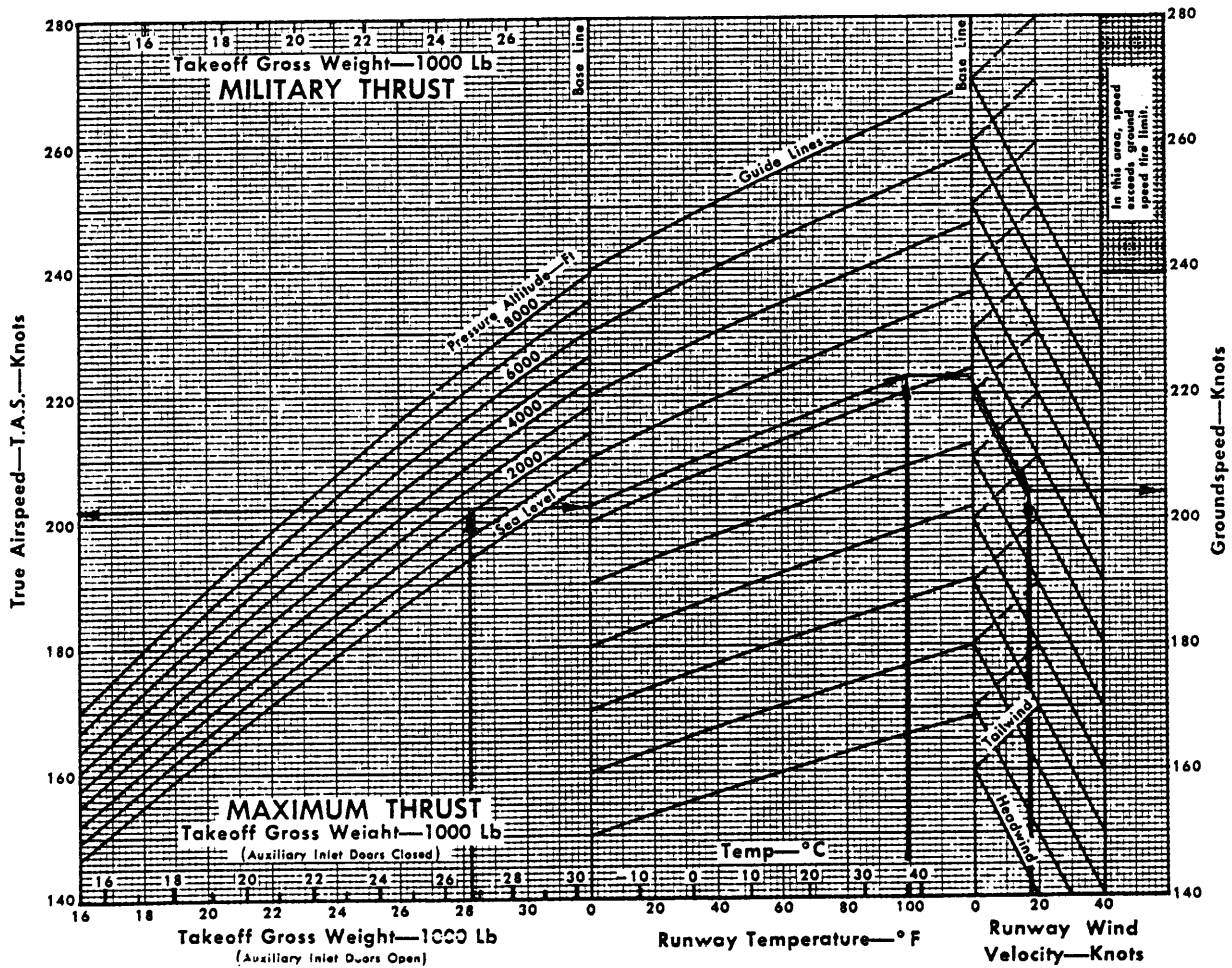
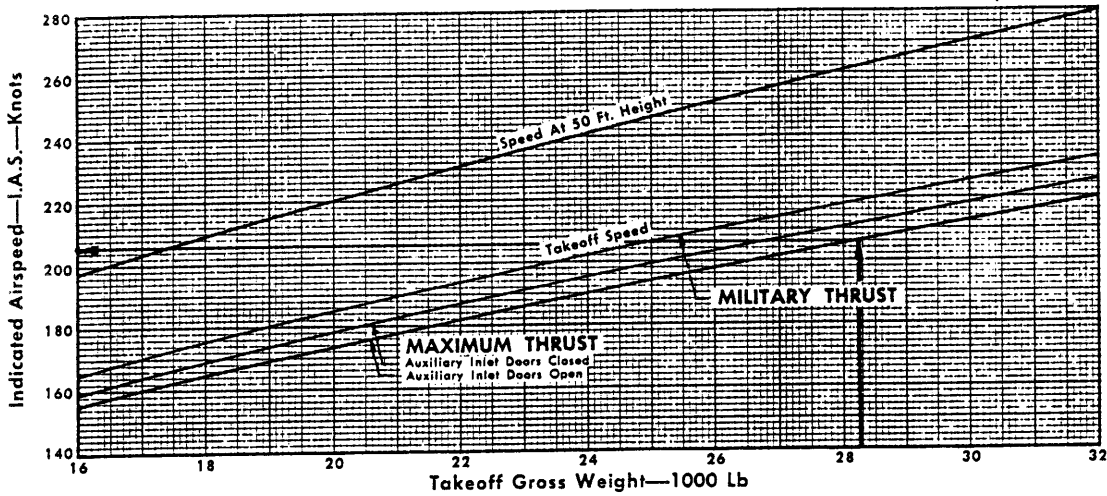

Figure A2-2

# TAKEOFF GROUND RUN DISTANCE — MAXIMUM THRUST

## AUXILIARY INLET DOORS OPEN

Takeoff Flaps      All Configurations      Dry Hard Surface Runway

Engine: J79-GE-19  
 Fuel Grade: JP-8  
 Fuel Density: 6.68 Lb/Gal

Model: F-104S  
 Date: 1 October 1968  
 DATA BASIS: FLIGHT TEST

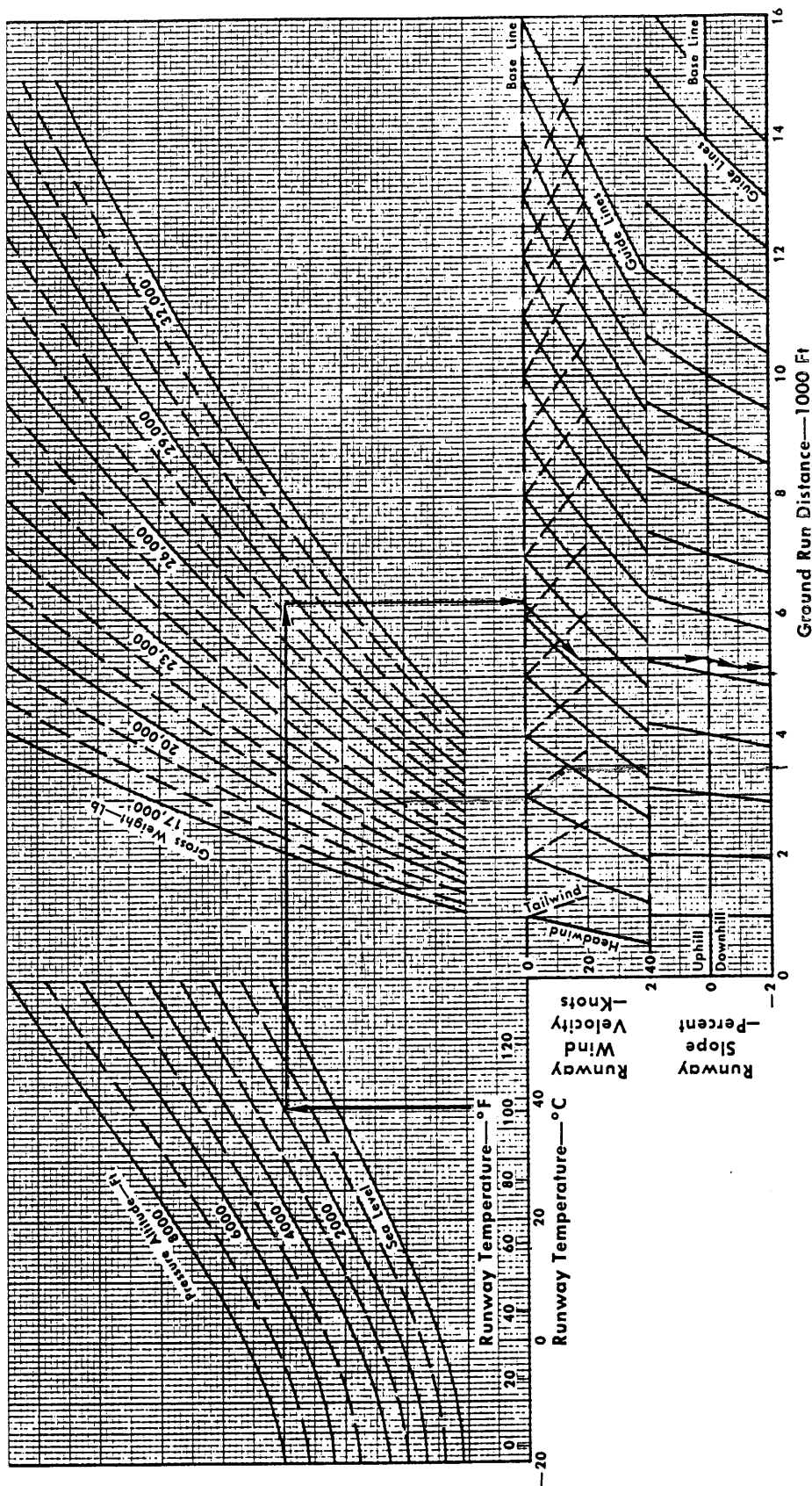

Figure A2-3

# REFUSAL SPEED — MAXIMUM THRUST — WITH DRAG CHUTE

AUXILIARY INLET DOORS OPEN

All Configurations    Takeoff Flaps    Zero Wind    Zero Slope

Engine: J79-GE-19  
 Fuel Grade: JP-8  
 Fuel Density: 6.88 Lb/Gal

Model: F-104S  
 Date: 1 October 1968  
 DATA BASIS: FLIGHT TEST

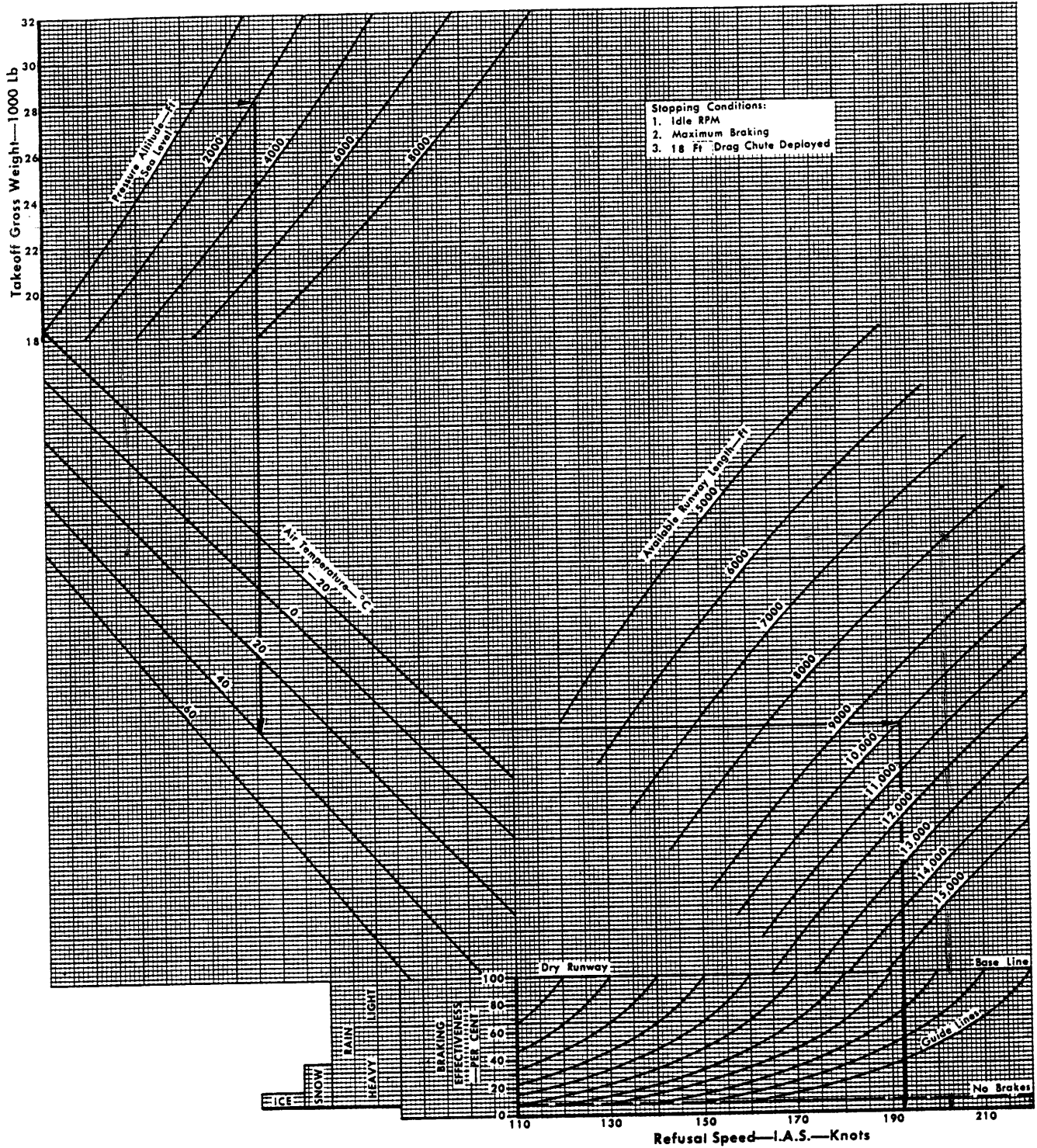

Figure A2-4

# REFUSAL SPEED — MAXIMUM THRUST — WITHOUT DRAG CHUTE

AUXILIARY INLET DOORS OPEN

All Configurations    Takeoff Flaps    Zero Wind    Zero Slope

Model: F-104S  
 Date: 1 October 1968  
 DATA BASIS: FLIGHT TEST

Engine: J79-GE-19  
 Fuel Grade: JP-8  
 Fuel Density: 6.68 Lb/Gal

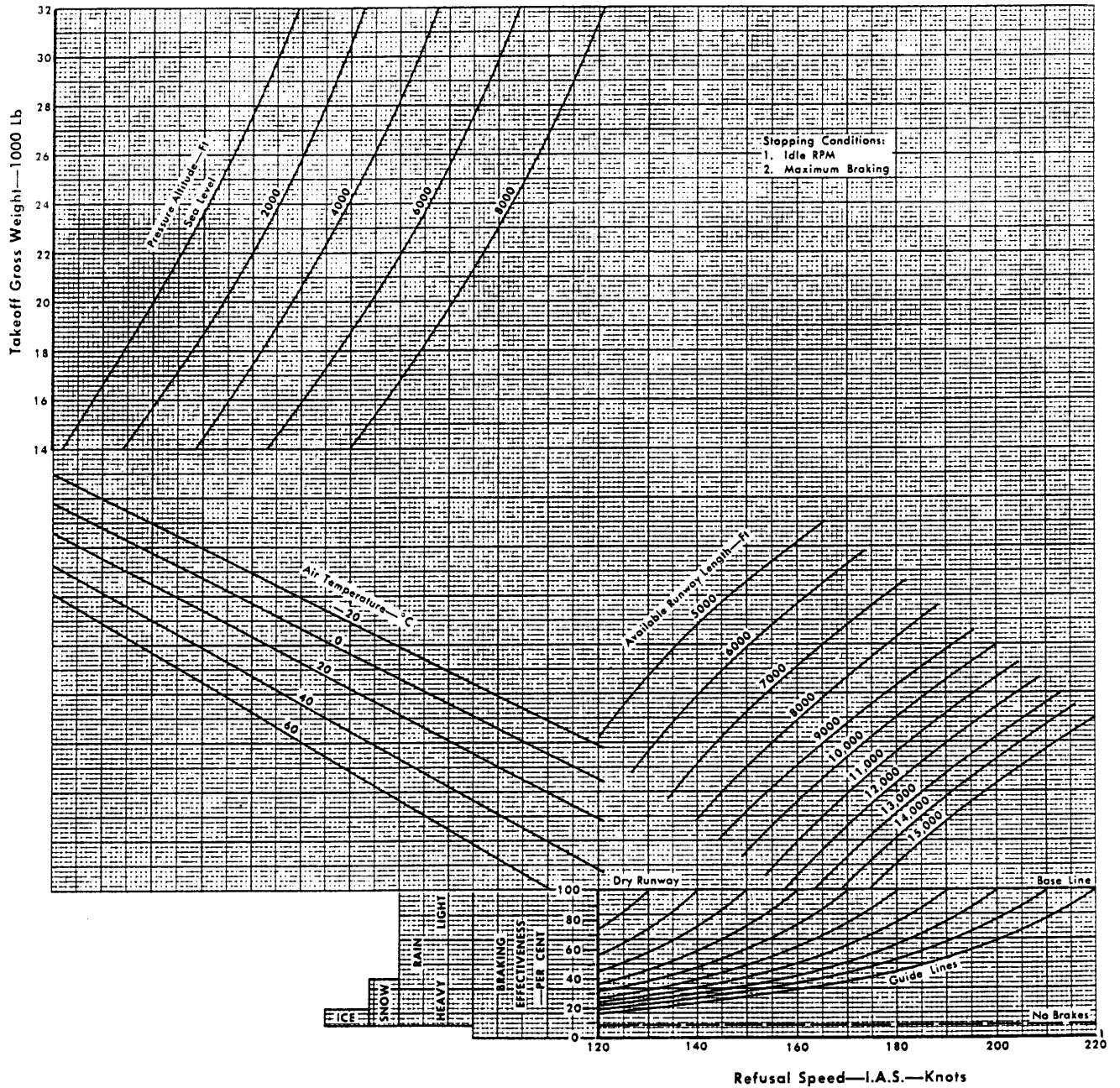

Figure A2-5

**VELOCITY DURING TAKEOFF GROUND RUN -- MAXIMUM THRUST**  
**AUXILIARY INLET DOORS OPEN**

All Configurations

Zero Wind

Takeoff Flaps

Zero Slope

Model: F-104S  
 Date: 1 October 1968  
 DATA BASIS: FLIGHT TEST

Engine: J79-GE-19  
 Fuel Grade: JP-8  
 Fuel Density: 6.68 Lb/Gal

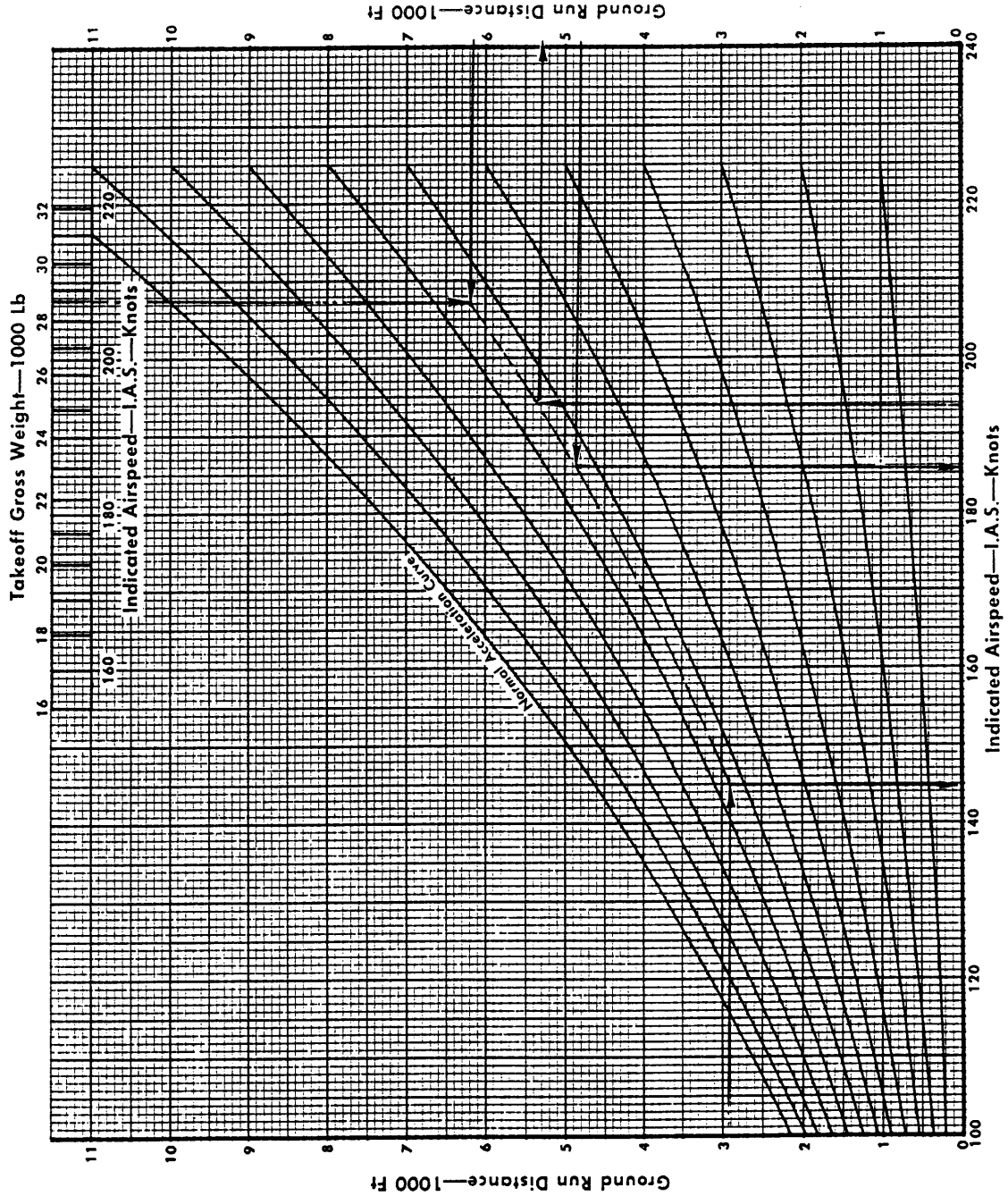

Figure A2-6

## AIRSPPEED ACCELERATION TOLERANCE

All Configurations      Takeoff Flaps  
 Zero Wind      Dry Hard Surface Runway      Zero Slope

Model: F-104S  
 Date: 1 June 1969  
 DATA BASIS: FLIGHT TEST

Engine: J79-GE-19  
 Fuel Grade: JP-8  
 Fuel Density: 6.68 Lb/Gal

### MAXIMUM THRUST AUXILIARY INLET DOORS OPEN OR CLOSED

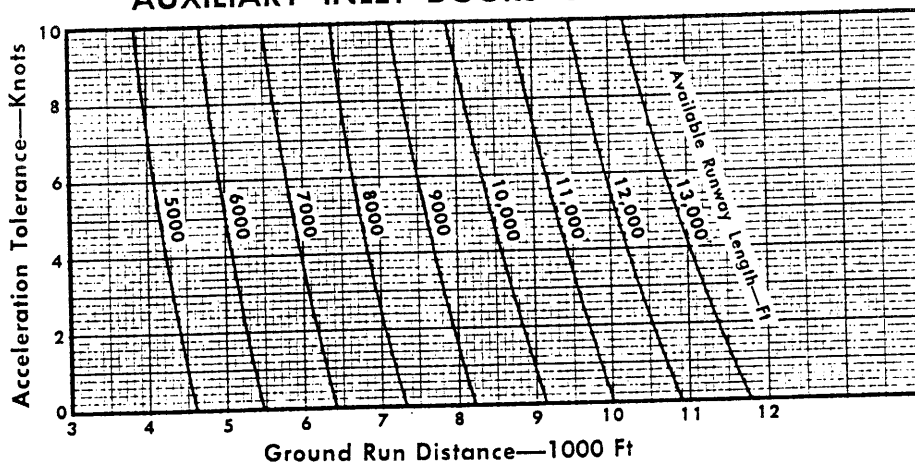

### MILITARY THRUST

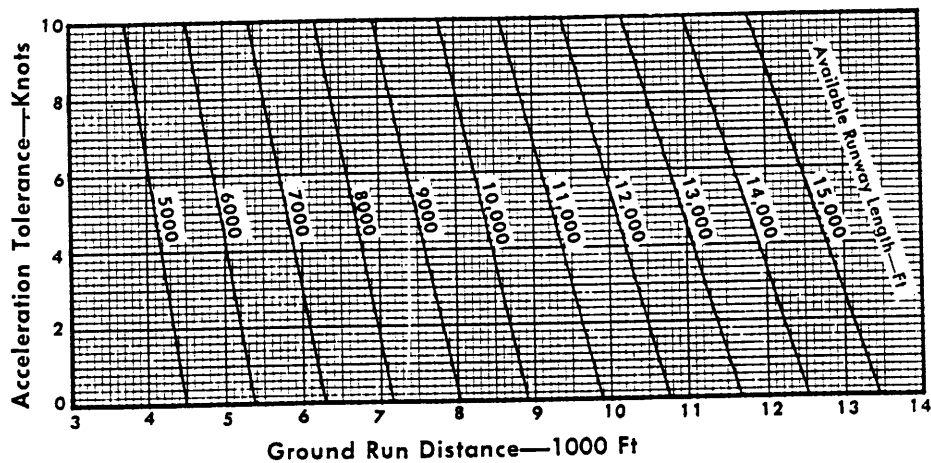

Figure A2-7



**TAKEOFF DISTANCE OVER A 50-FOOT OBSTACLE — MAXIMUM THRUST**  
**AUXILIARY INLET DOORS OPEN**

Takeoff Flaps      All Configurations      Dry Hard Surface Runway

Engine: J79-GE-19  
 Fuel Grade: JP-8  
 Fuel Density: 6.68 Lb/Gal

Model: F-104S  
 Date: 1 October 1968  
 DATA BASIS: FLIGHT TEST

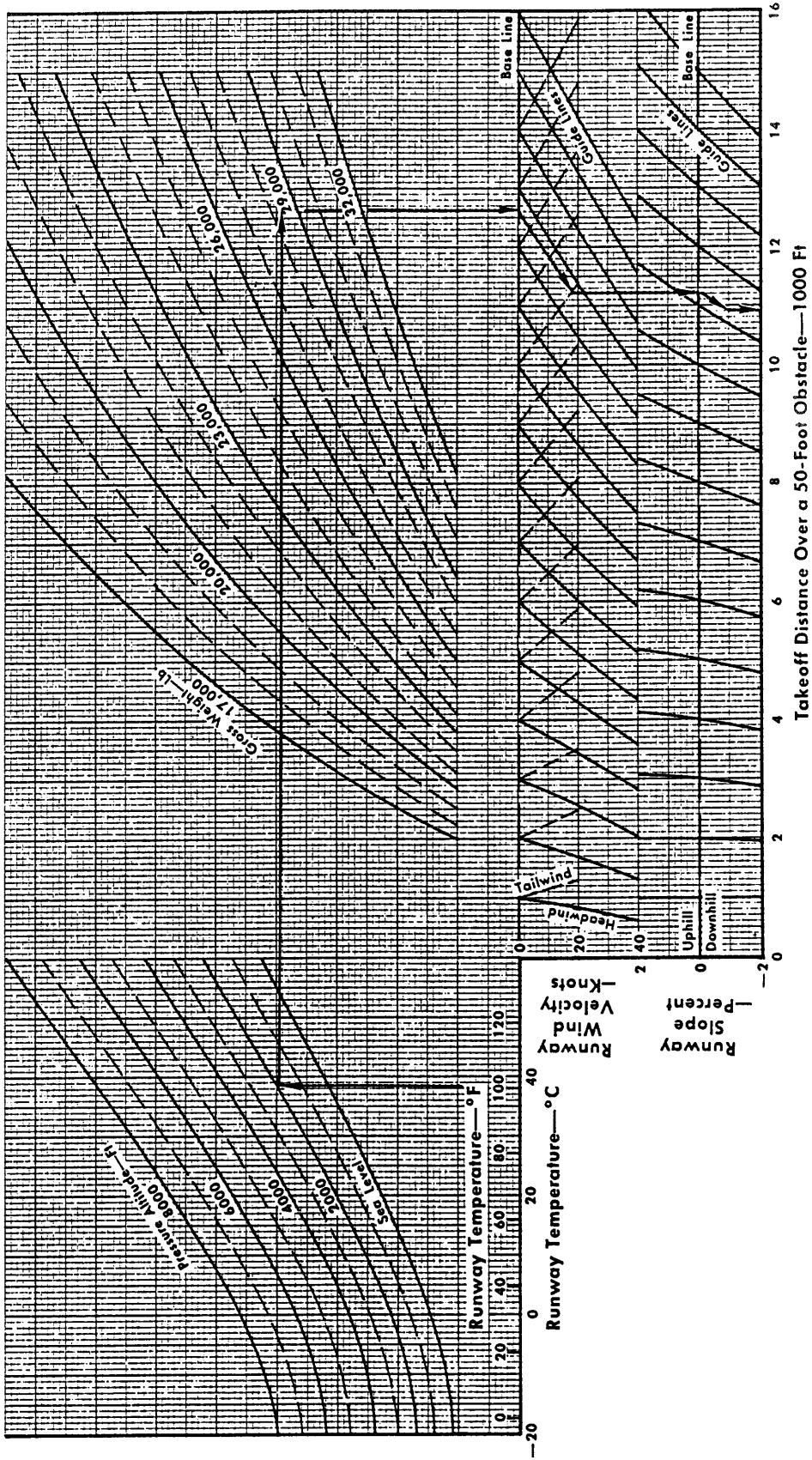

Figure A2-8

# TAKEOFF GROUND RUN DISTANCE — MAXIMUM THRUST

## AUXILIARY INLET DOORS CLOSED

Dry Hard Surface Runway

All Configurations

Takeoff Flaps

Engine: J79-GE-19  
 Fuel Grade: JP-8  
 Fuel Density: 6.68 Lb/Gal

Model: F-104S  
 Date: 1 March 1969  
 DATA BASIS: FLIGHT TEST

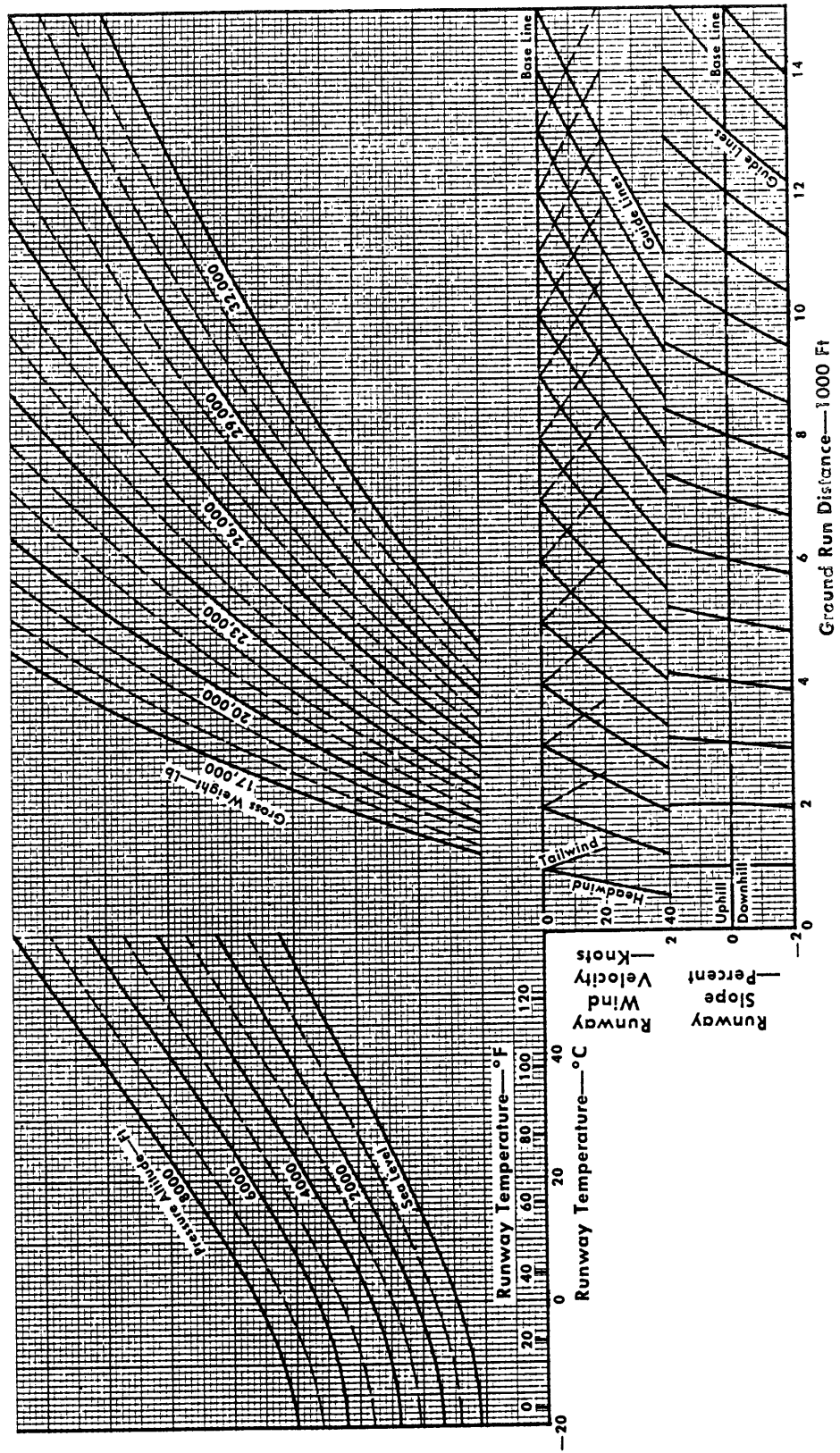

Figure A2-9

# REFUSAL SPEED — MAXIMUM THRUST — WITH DRAG CHUTE

AUXILIARY INLET DOORS CLOSED

All Configuration    Takeoff Flaps    Zero Wind    Zero Slope

Model: F-104S  
 Date: 1 March 1969  
 DATA BASIS: FLIGHT TEST

Engine: J79-GE-19  
 Fuel Grade: JP-8  
 Fuel Density: 6.68 Lb/Gal

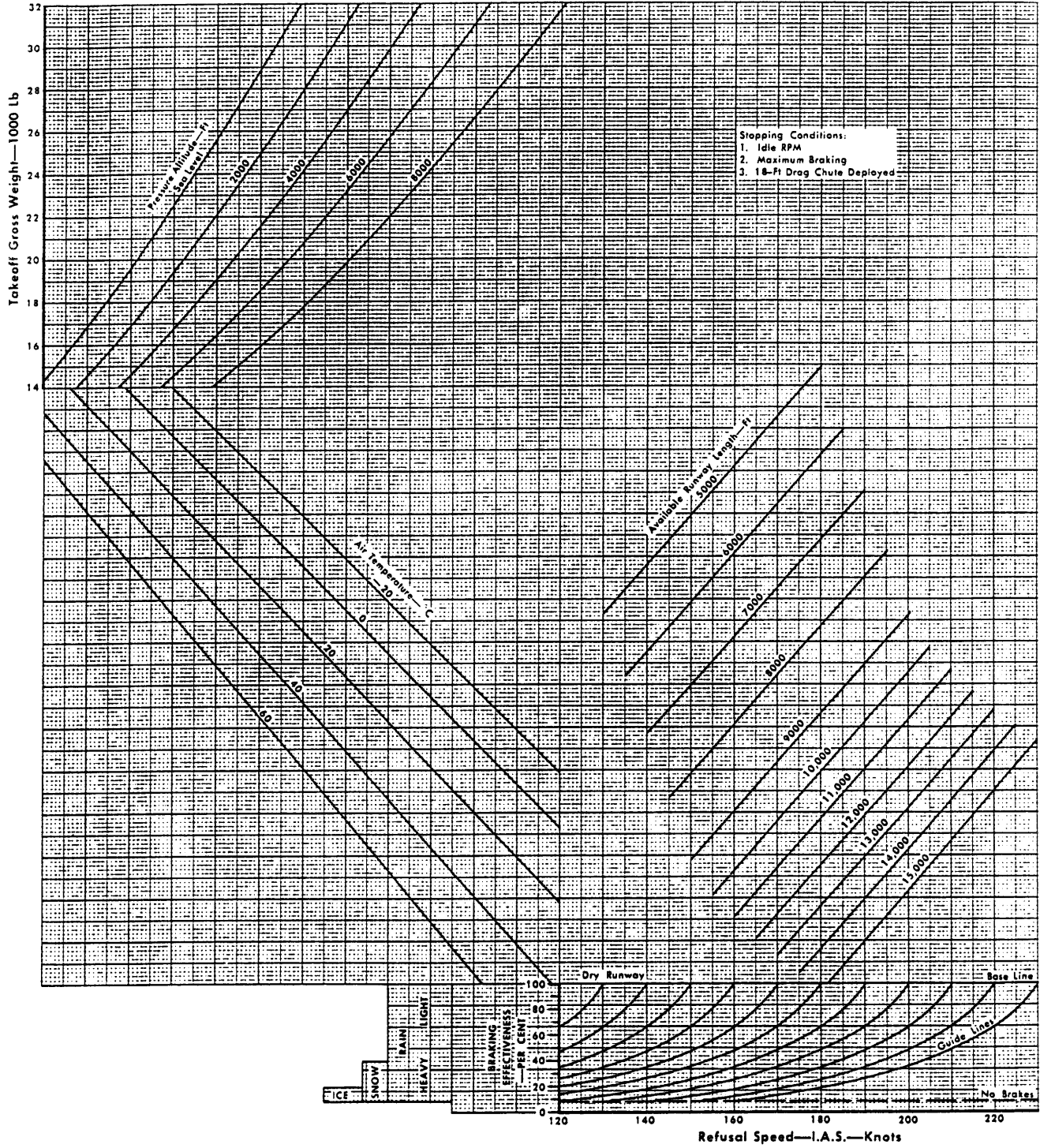

Figure A2-10

# REFUSAL SPEED — MAXIMUM THRUST — WITHOUT DRAG CHUTE

AUXILIARY INLET DOORS CLOSED

All Configuration    Takeoff Flaps    Zero Wind    Zero Slope

Model: F-104S  
 Date: 1 March 1969  
 DATA BASIS: FLIGHT TEST

Engine: J79-GE-19  
 Fuel Grade: JP-8  
 Fuel Density: 6.88 Lb/Gal

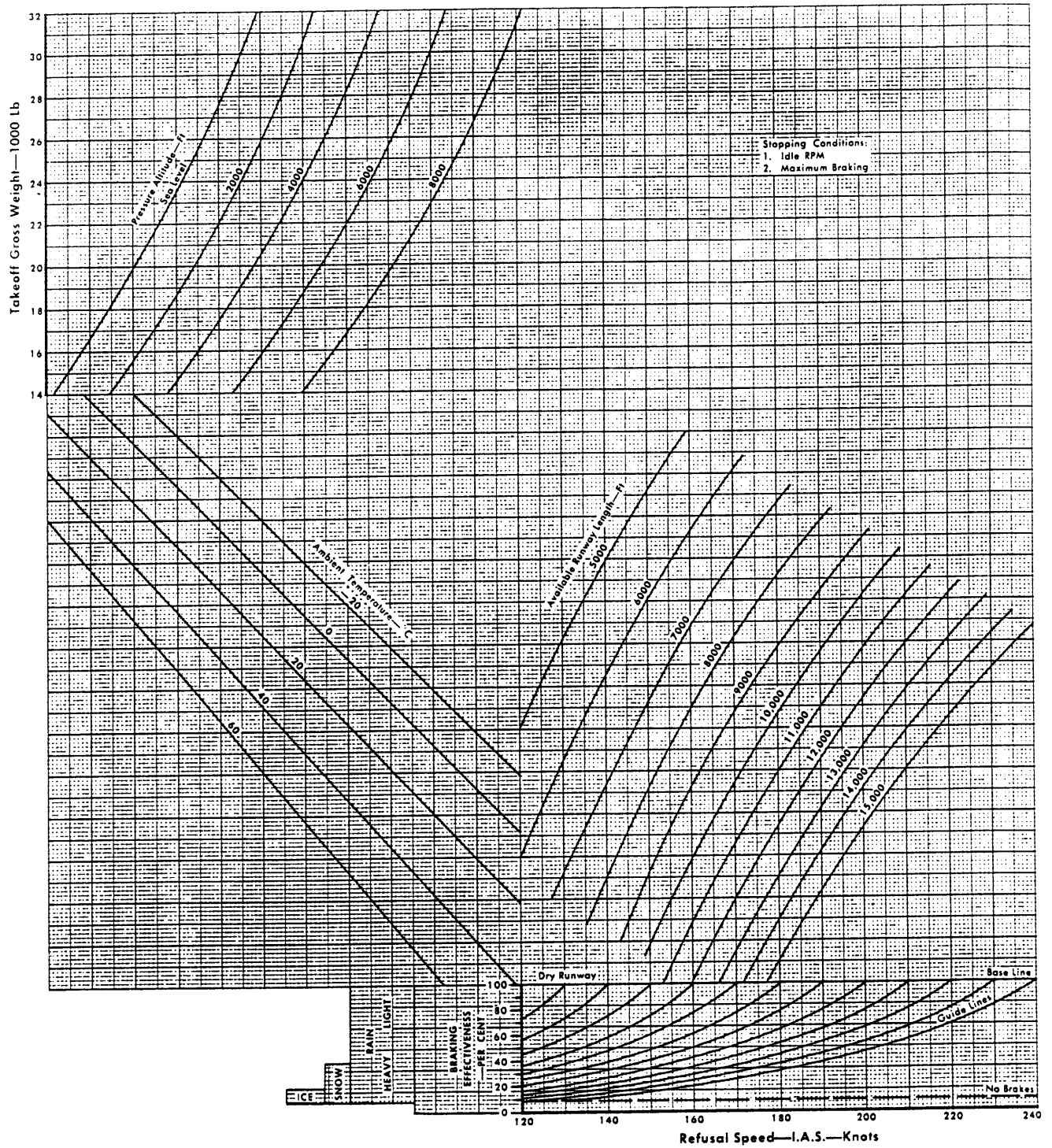

Figure A2-11

**VELOCITY DURING TAKEOFF GROUND RUN — MAXIMUM THRUST**  
**AUXILIARY INLET DOORS CLOSED**

All Configurations

Zero Wind

Takeoff Flaps

Zero Slope

Model: F-104S  
 Date: 1 March 1969  
 DATA BASIS: FLIGHT TEST

Engine: J79-GE-19  
 Fuel Grade: JP-8  
 Fuel Density: 6.68 Lb/Gal

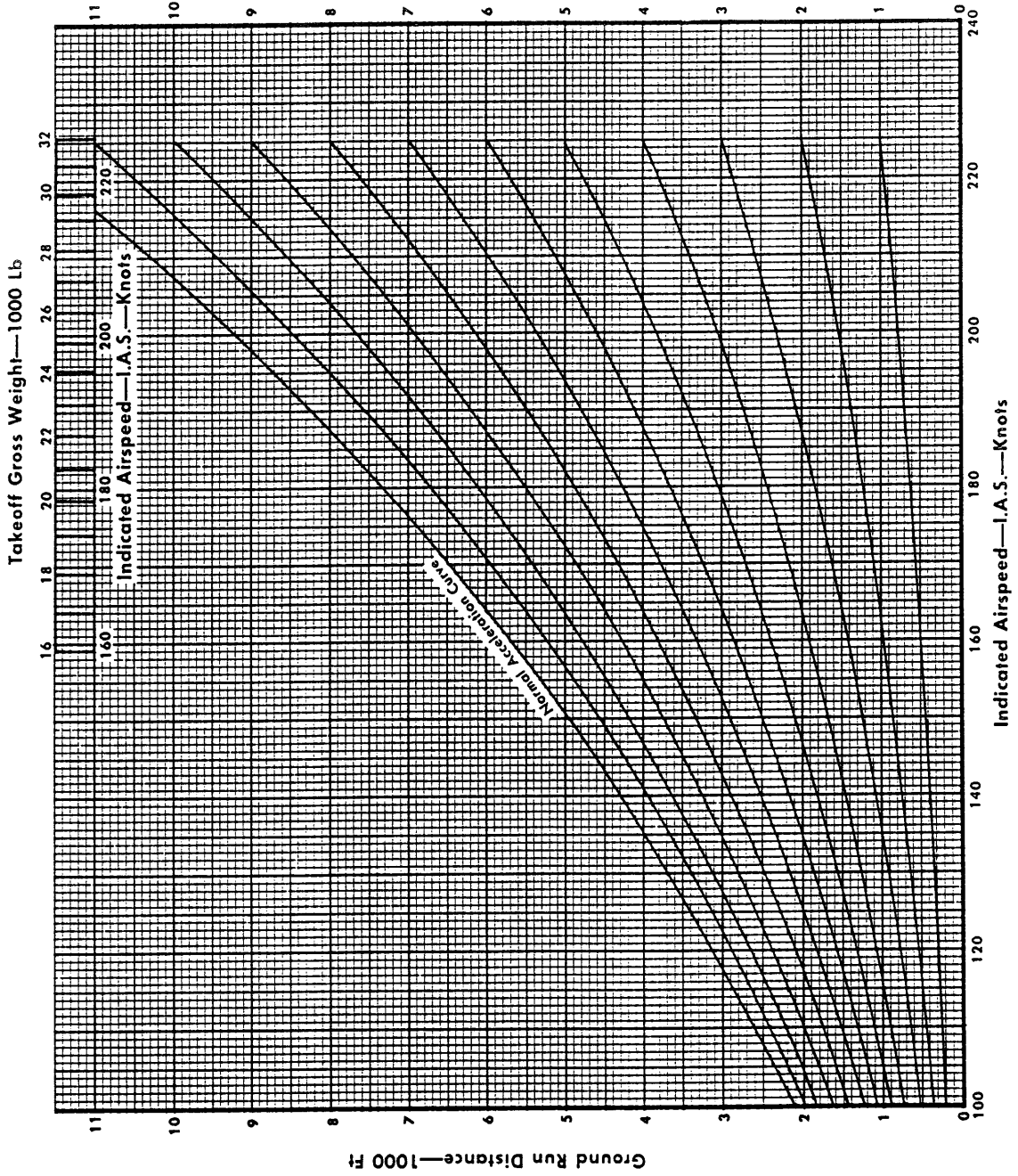

Figure A2-12

**TAKEOFF DISTANCE OVER A 50-FOOT OBSTACLE — MAXIMUM THRUST**  
**AUXILIARY INLET DOORS CLOSED**

Takeoff Flaps

All Configurations

Dry Hard Surface Runway

Engine: J79-GE-19  
 Fuel Grade: JP-8  
 Fuel Density: 6.68 Lb/Gal

Model: F-104S  
 Date: 1 March 1969  
 DATA BASIS: FLIGHT TEST

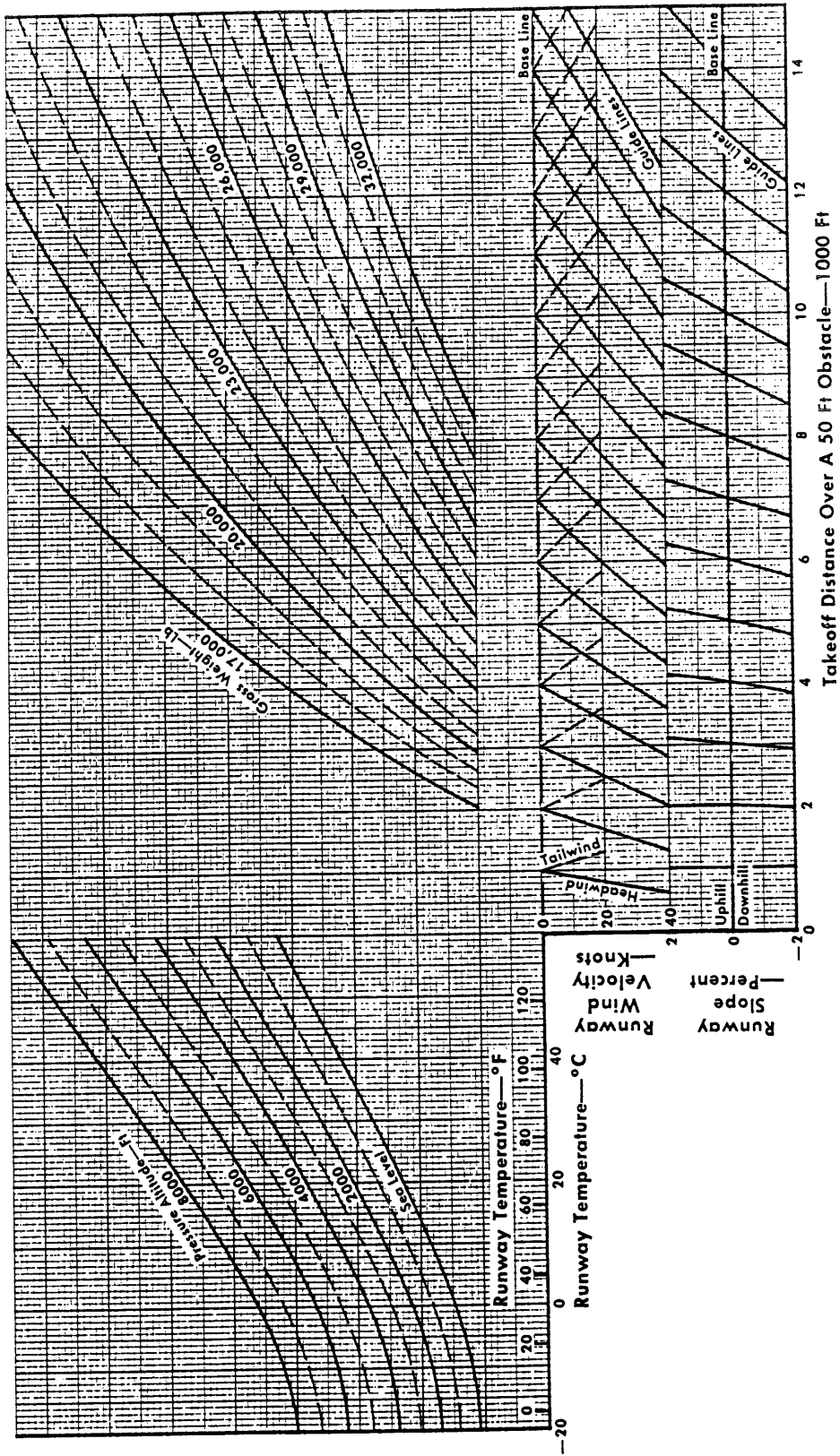

Figure A2-13

TAKEOFF GROUND RUN DISTANCE — MILITARY THRUST

Takeoff Flaps All Configurations Dry Hard Surface Runway

Model: F-104S  
 Date: 1 June 1969  
 DATA BASIS: ESTIMATED

Engine: J79-GE-19  
 Fuel Grade: JP-8  
 Fuel Density: 6.68 Lb/Gal

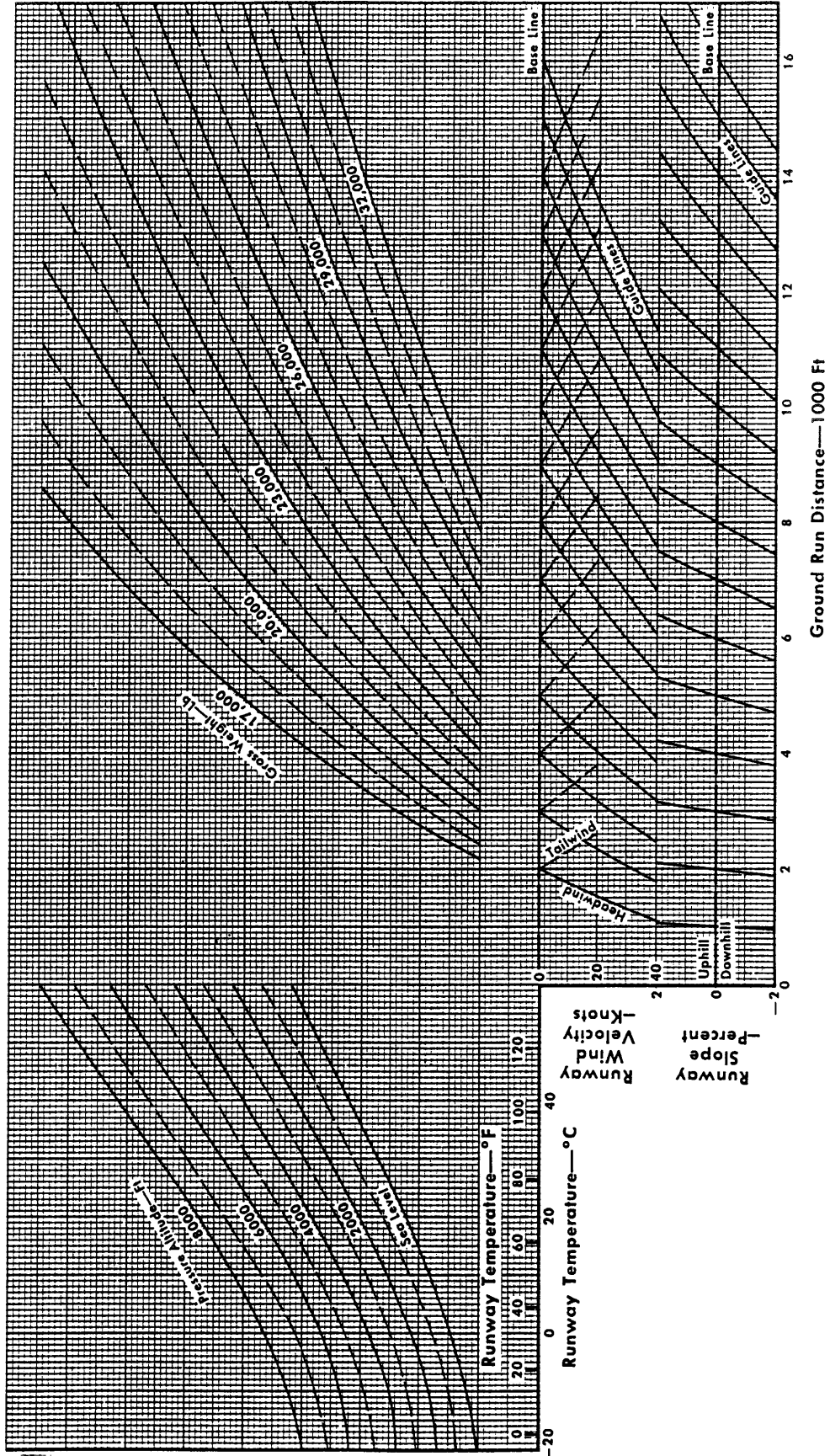

Figure A2-14

# REFUSAL SPEED — MILITARY THRUST — WITH DRAG CHUTE

All Configurations    Takeoff Flaps    Zero Wind    Zero Slope

Model: F-104S  
 Date: 1 June 1969  
 DATA BASIS: ESTIMATED

Engine: J79-GE-19  
 Fuel Grade: JP-8  
 Fuel Density: 8.68 Lb/Gal

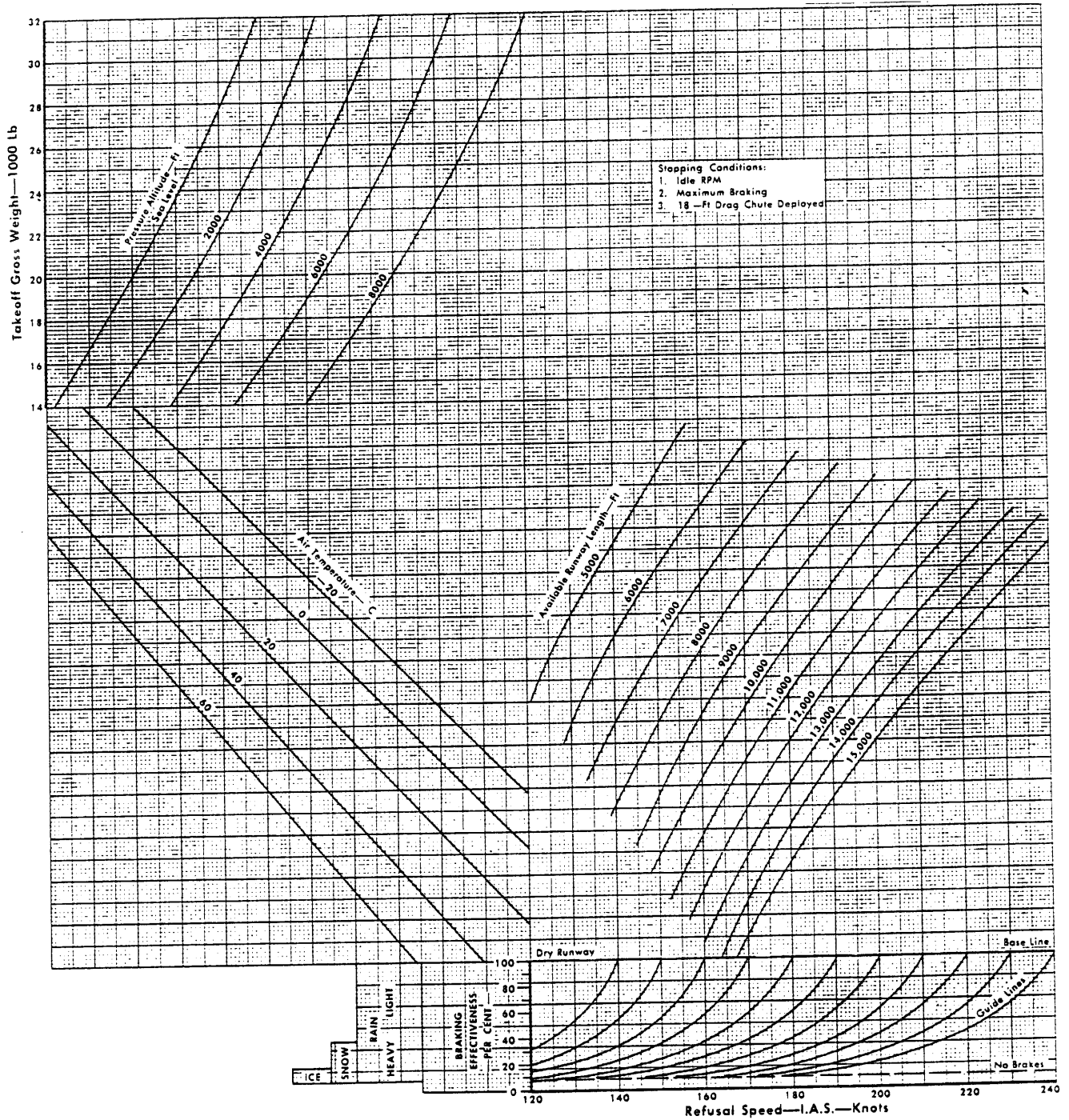

Figure A2-15



# REFUSAL SPEED — MILITARY THRUST — WITHOUT DRAG CHUTE

All Configurations    Takeoff Flaps    Zero Wind    Zero Slope

Model: F-104S  
 Date: 1 June 1969  
 DATA BASIS: ESTIMATED

Engine: J79-GE-19  
 Fuel Grade: JP-8  
 Fuel Density: 6.68 Lb/Gal

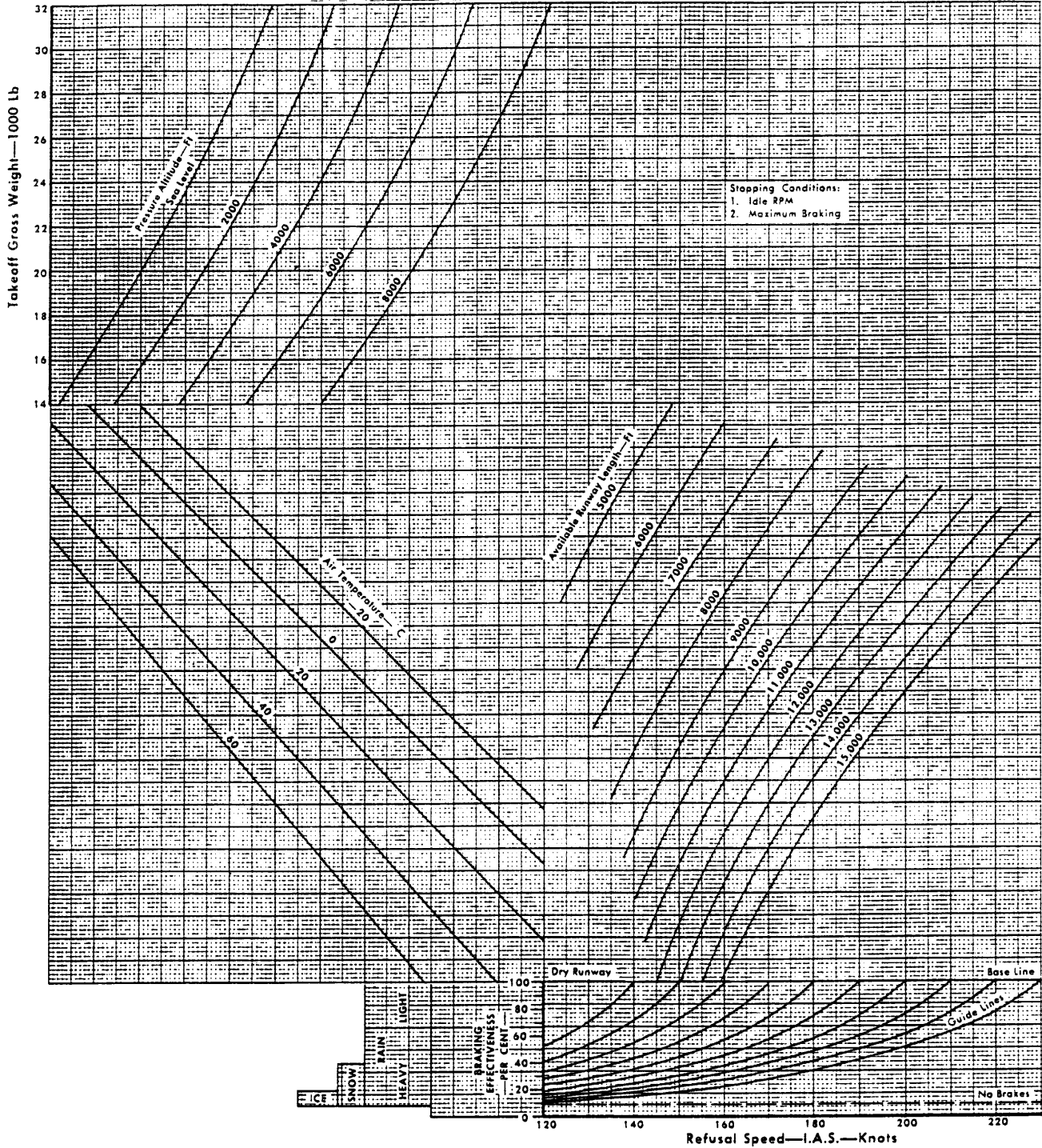

Figure A2-16

# VELOCITY DURING TAKEOFF GROUND RUN — MILITARY THRUST

All Configurations

Zero Wind

Takeoff Flaps

Zero Slope

Engine: J79-GE-19  
 Fuel Grade: JP-8  
 Fuel Density: 6.68 Lb/Gal

Model: F-104S  
 Date: 1 June 1969  
 DATA BASIS: ESTIMATED

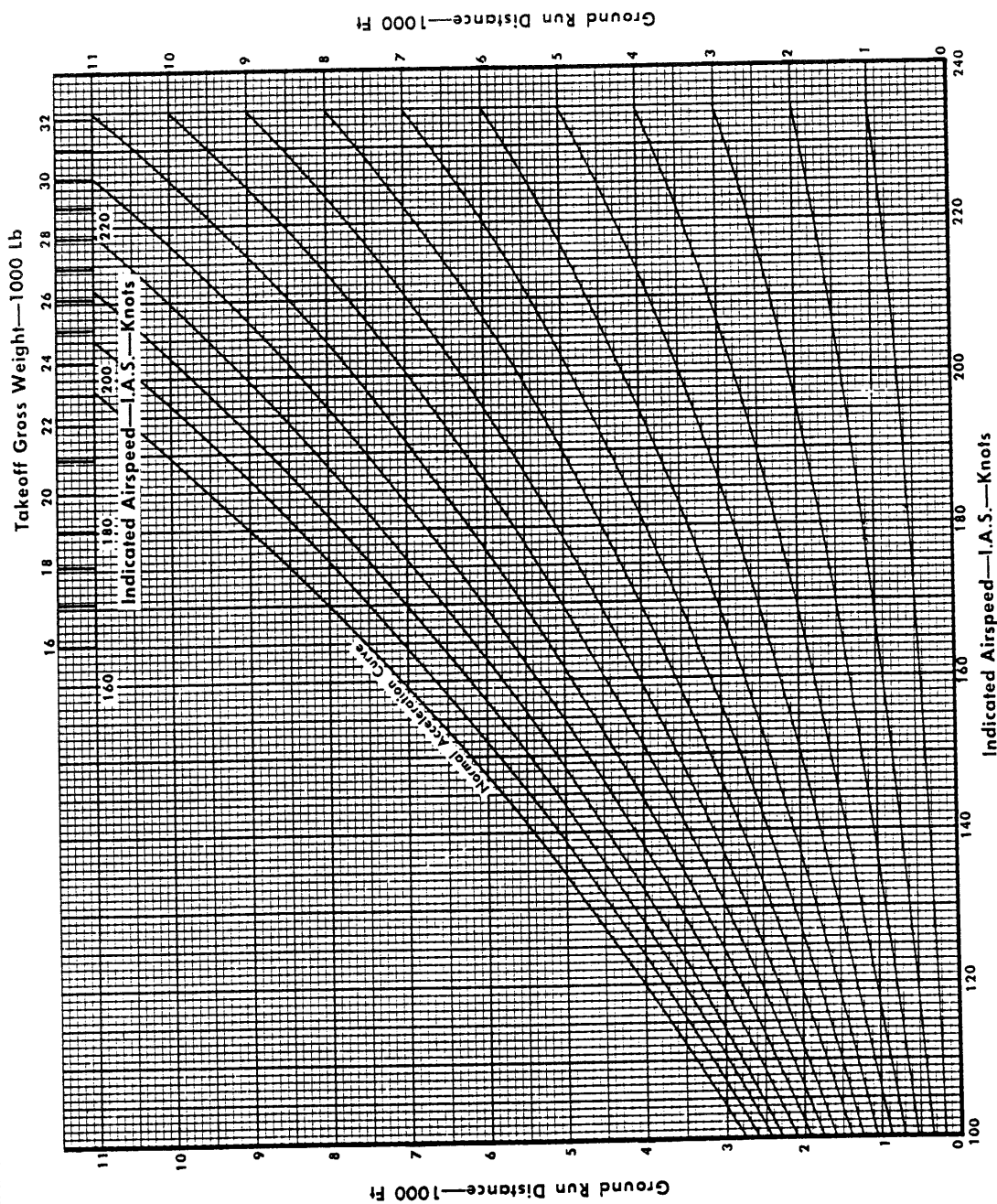

Figure A2-17

TAKEOFF DISTANCE OVER A 50-FOOT OBSTACLE — MILITARY THRUST

Model: F-104S  
 Date: 1 June 1969  
 DATA BASIS: ESTIMATED

Engine: J79-GE-19  
 Fuel Grade: JP-8  
 Fuel Density: 6.68 Lb/Gal

Takeoff Flaps: All Configurations  
 Dry Hard Surface Runway

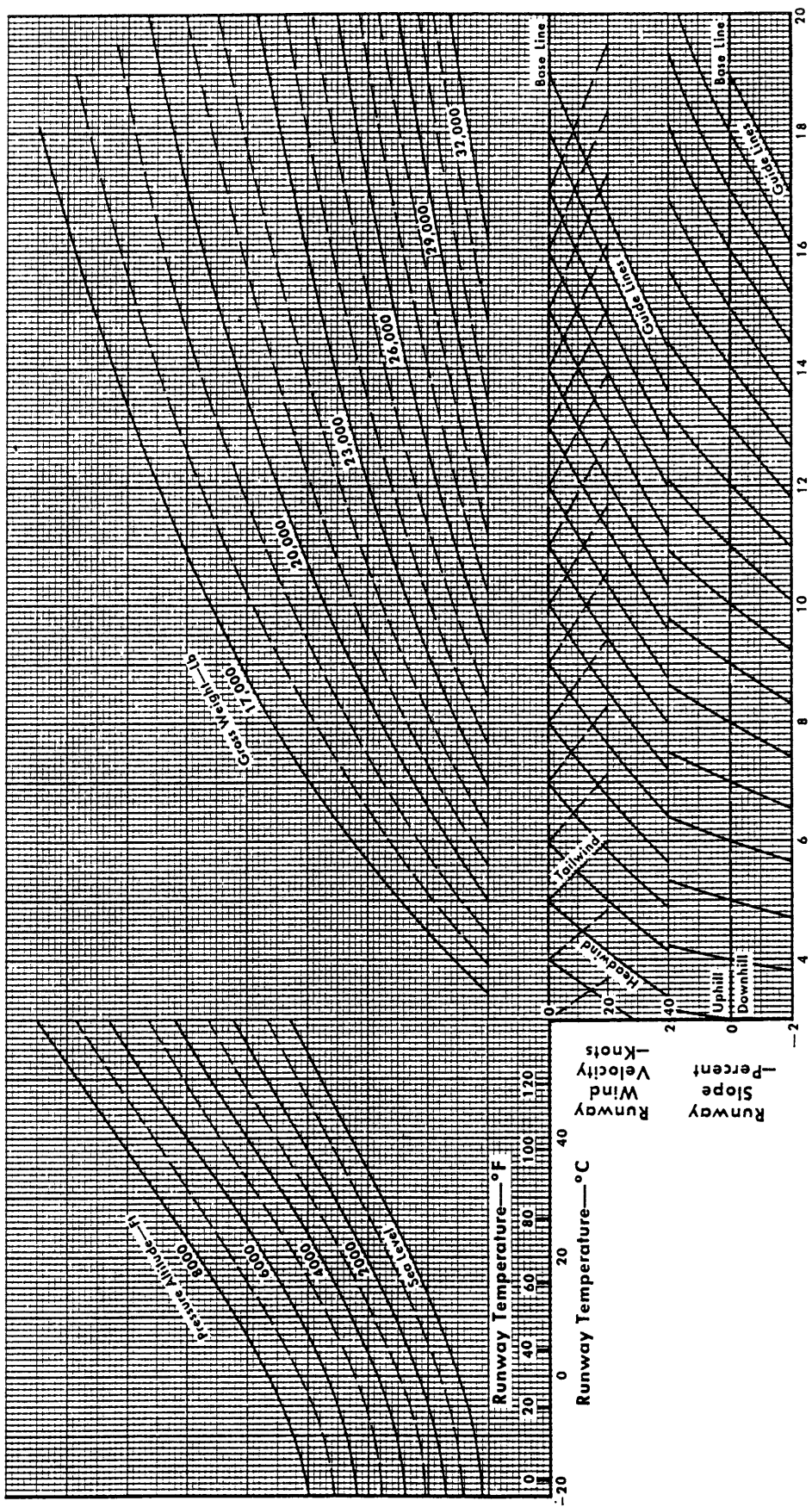

Figure A2-18

## PART 3

### CLIMB

#### TABLE OF CONTENTS

Index items in bold face characters denote illustrations.

Title	Page
Climb Control Charts . . . . .	A3-1
Combat Ceiling . . . . .	A3-2
Optimum Cruise Altitude . . . . .	A3-4
<b>Time, Distance and Fuel Required from Brake Release to Climb Speed . . . . .</b>	<b>A3-5</b>
Maximum Thrust Combat Ceiling . . . . .	A3-7
Military Thrust Combat Ceiling . . . . .	A3-8
Optimum Cruise Altitude . . . . .	A3-9
Maximum Thrust Climb Control . . . . .	A3-10
Military Thrust Climb Control . . . . .	A3-16

#### CLIMB CONTROL CHARTS

The climb control charts present data for planning the subsonic climb segments of flight. Performance curves show time, fuel used, and distance traveled. The curves are directly applicable to climbs initiated at or near sea level, and may be used on an incremental basis for climbs started at higher levels. Data are provided for operation at either military or maximum thrust settings.

#### CLIMB CONTROL INDEX

The climb control charts are indexed into groups of configurations having similar rates of climb. The small differences in operational performance among configurations in a given group may be disregarded. Typical configurations applicable to the performance index presented are illustrated on a chart in Part 1 - Introduction. If a climb performance is desired for a configuration not illustrated, refer to the index shown in Part 1 - Introduction, deter-

mine the configuration drag index and use the appropriate climb control chart.

#### CLIMB SPEED SCHEDULES

Subsonic maximum thrust climb control is presented at speed schedules of Mach 0.925, 0.90 and 0.85; military thrust at speed schedules of Mach 0.90, 0.85, 0.80 and 0.75. Use of the climb speed schedule noted on each chart will provide the climb performance shown. However, in some cases it may be desirable to initiate military thrust climb at lower airspeeds, to clear local traffic patterns, etc., rather than to accelerate directly to the climb speed schedule. In such cases, initiate climb at the speed desired (such as afterburner-off speed) and hold constant IAS until the normal Mach number speed schedule is obtained. Then climb at constant Mach number until cruise altitude is reached. This alternate schedule does not decrease range appreciably.

#### Recommended Constant Mach Climb Speed

Maximum Thrust	
Config. Drag Index	Mach No.
0 - 50	0.925
50 - 100	0.900
100 - 110	0.850

Military Thrust	
Config. Drag Index	Mach No.
0 - 30	0.90
30 - 60	0.85
60 - 110	0.80

#### TRANSITION TIME AND FUEL ALLOWANCES

Maximum and military thrust time distance and fuel used to accelerate to climb speed from the point of break release is shown in Figure A3-1 and Figure A3-2, respectively. A table of Mach num-

bers for 350 KIAS, 400 KIAS and 450 KIAS are also included in the chart to provide for a combination usage of maximum and military thrust where the thrust setting is changed at that speed. Also included on the charts are tables of fuel allowances during various periods of ground maneuver with engine throttle set to IDLE. The values are based on a nominal flow and should be adjusted if service experience indicates another value is more suitable.

**CLIMB PERFORMANCE**

The subsonic climb control charts are plots of pressure altitude versus distance, time, and fuel used for various gross weights. The charts are read directly for climbs started from sea level, and on an incremental basis for climbs initiated from higher altitudes and terminated at optimum cruise altitudes. The performance includes weight reduction due to fuel consumption and reflects the increase in rates of climb that result.

**EFFECT OF FREE AIR TEMPERATURE ON CLIMB PERFORMANCE**

The climb charts may be read directly to obtain performance data for standard-day conditions. When the free air temperature is higher than standard (a hot day) the aircraft will perform as though the weight is greater than actual. When the free air temperature is lower than standard (a cold day) the aircraft will perform as though the weight is less than actual.

A  $\Delta$  temperature grid is included on each climb control chart for the determination of nonstandard-day climb performance. The  $\Delta$  temperature for the climb is determined as follows:

1. Determine the average OAT (ambient air temperature) expected during the climb to desired altitude.
2. Enter the standard altitude table (in Part 1) at the average pressure altitude during the climb and obtain the standard-day temperature.
3. The difference between the standard-day temperature (step 2) and the average OAT (step 1) is the  $\Delta$  temperature.

**COMBAT CEILING**

Combat ceiling (500 fpm rate of climb) for either maximum or military thrust, at the appropriate Mach schedule, may be obtained from the summary curves provided. The combat ceiling is based on the actual gross weight at altitude. To determine the climb performance to combat ceiling, estimate the altitude based on the initial climb gross weight (gross weight corrected for fuel consumed during ground maneuver, takeoff and acceleration to climb speed). Refer to the appropriate climb control chart and read the fuel consumed to the estimated altitude. Subtract the fuel consumed from the initial climb gross weight and obtain a corrected combat ceiling for the fuel used in the climb. A sample problem illustrates use of the chart.

**SAMPLE PROBLEM**

Determine the standard day combat ceiling for a maximum thrust climb from sea level at Mach 0.925. The aircraft has a configuration drag index of 20 and a loaded gross weight of 24000 pounds.

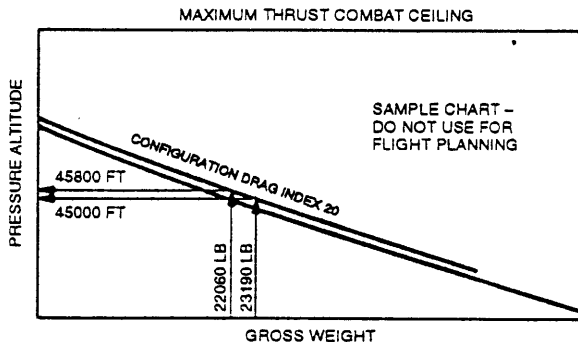

FA0286

- a. From Figure A3-1 determine the fuel required for ground maneuver, takeoff and accelerate to climb speed.
 

Ground maneuver for 8.5 minutes.....	190 lb
Takeoff and accelerate to climb speed ...	620 lb
TOTAL fuel used.....	810 lb
- b. Initial climb gross weight is 23190 lb (24000 – 810).
- c. Enter Figure A3-3 at 23190 pounds and read an estimated combat ceiling of 45000 feet.

- d. Enter Figure A3-6 (sheet 2 of 2) "Maximum Thrust Climb Control", Mach 0.925 at 23190 pounds. Proceed to a pressure altitude of 45000 feet. For a configuration drag index of 20 read climb fuel used as 1130 pounds.
- e. Gross weight at the estimated combat ceiling (45000 feet) is 22060 pounds (23190 - 1130).
- f. Reenter Figure A3-3 at 22060 pounds and read a corrected combat ceiling, 45800 feet.

**CLIMB PERFORMANCE**

**Sample Problem**

Determine the climb performance for a military thrust climb at Mach 0.85 from sea level to optimum cruise altitude. The aircraft has a configuration drag index of 60 and loaded gross weight of 26000 pounds.

Ambient temperature at sea level and the average temperature during the climb is 10° C below standard ( $\Delta T = -10^\circ C$ ).

- a. For 8.5 minutes of ground maneuvering, maximum thrust acceleration to 350 KIAS and military thrust acceleration to climb Mach 0.85, determine the fuel required and initial climb gross weight.

Ground maneuver fuel ..... 190 lb  
 Maximum thrust acceleration gross weight is 25810 (26000 - 190)  
 Fuel required to 350 KIAS ..... 350 lb  
 Gross weight at 350 KIAS ..... 25460 lb  
 Military thrust acceleration gross weight is 25460 (25810 - 350)  
 Fuel required to Mach 0.85..... 150 lb  
 Gross weight at start of climb ..... 25310 lb

- b. Enter Figure A3-5, "Optimum Cruise Altitude", at the initial climb gross weight, 25310 lb, and read an estimated altitude, 24700 feet.

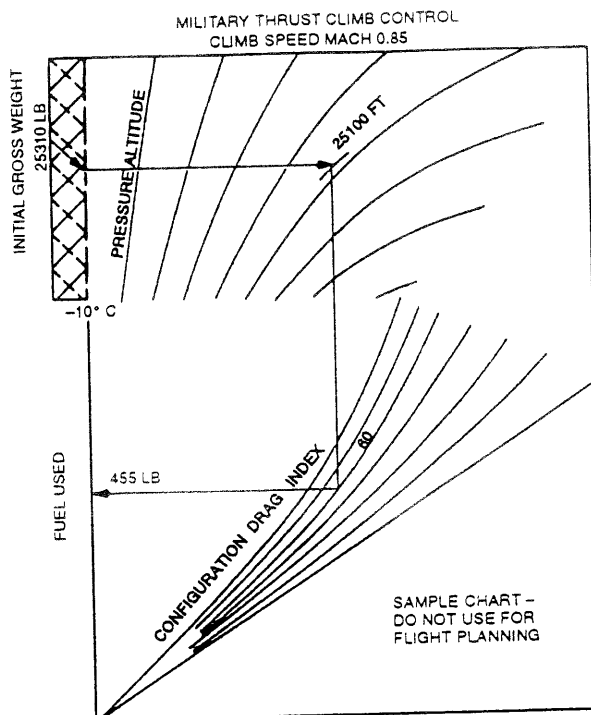

FA0287

- c. Enter Figure A3-10 (sheet 2) at the initial climb gross weight, correct for  $\Delta T = -10^\circ C$ , and proceed to the optimum cruise altitude, 24700 feet. For a configuration drag index of 60, fuel used is 450 pounds. Gross weight at the optimum cruise altitude is 24860 lb (25310 - 450).
  - d. Reenter Figure A3-5 at 24860 lb and read a corrected optimum cruise altitude, 25100 feet.
  - e. Reenter Figure A3-10 at the initial climb gross weight 25310 lb, correct for  $\Delta T = -10^\circ C$ , proceed to the optimum cruise altitude, 25100 feet. For a configuration drag index of 60, read time, distance and fuel used.
- Time ..... 3.3 min  
 Distance ..... 29 nmi  
 Fuel used ..... 445 lb

# OPTIMUM CRUISE ALTITUDE

The optimum altitude for maximum range cruise may be obtained from the summary plot provided. The altitude is based on actual gross weight. The altitude shall be corrected for fuel consumed in the climb. Determination of the corrected altitude and the climb performance are illustrated in the sample problem.

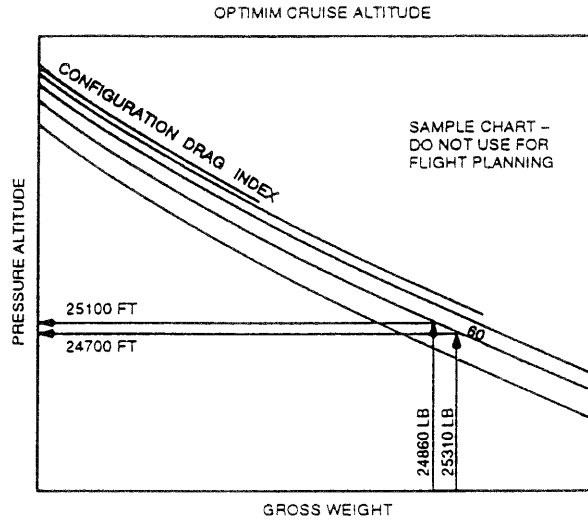

FA0288

# TIME, DISTANCE AND FUEL REQUIRED FROM BRAKE RELEASE TO CLIMB SPEED

## MAXIMUM THRUST

Model: F-104S  
 Date: 1 April 1970  
 DATA BASIS: ESTIMATED

Engine: J79-GE-19  
 Fuel Grade: JP-8  
 Fuel Density: 6.68 Lb/Gal

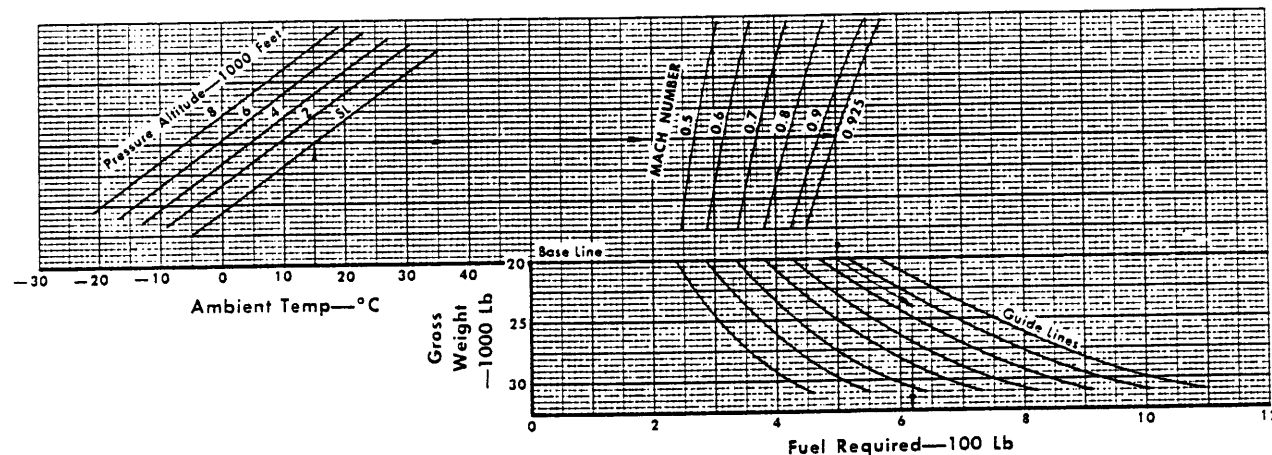
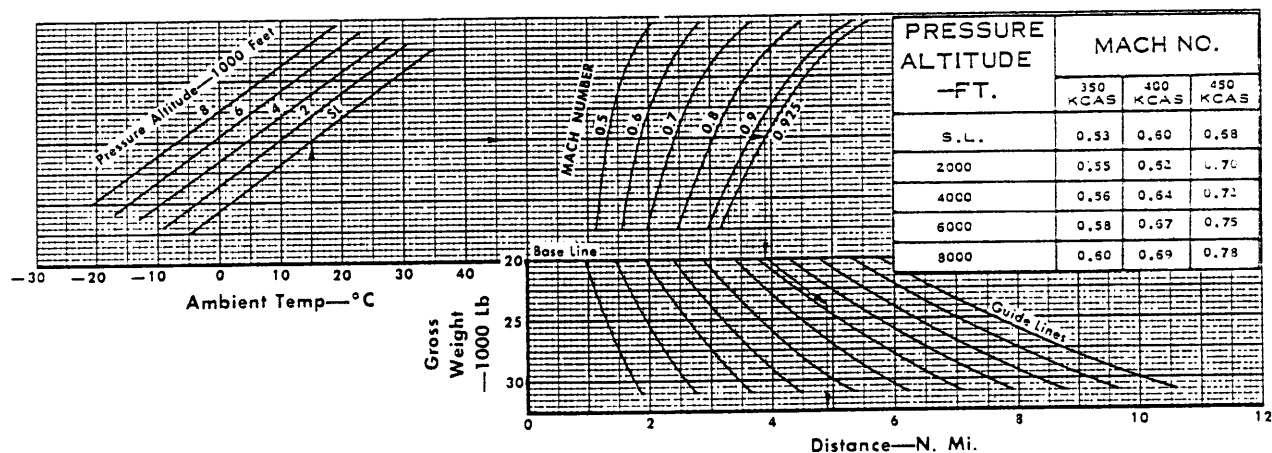
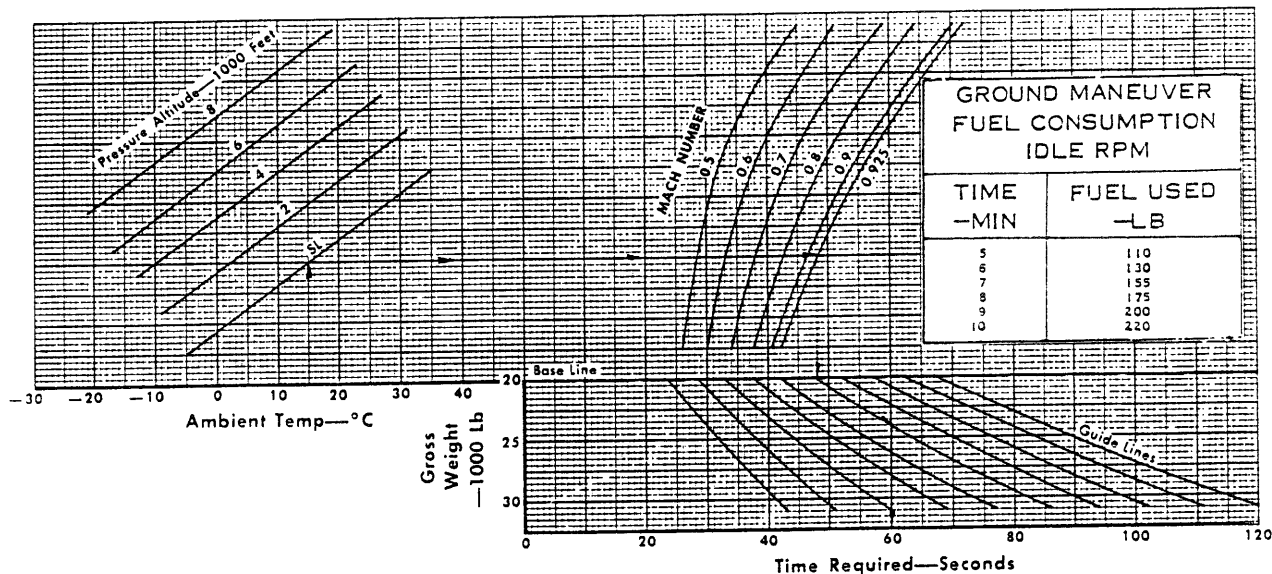

Figure A3-1



# TIME, DISTANCE AND FUEL REQUIRED FROM BRAKE RELEASE TO CLIMB SPEED

MILITARY THRUST

Model: F-104S  
 Date: 1 April 1970  
 DATA BASIS: ESTIMATED

Engine: J79-GE-19  
 Fuel Grade: JP-8  
 Fuel Density: 6.68 Lb/Gal

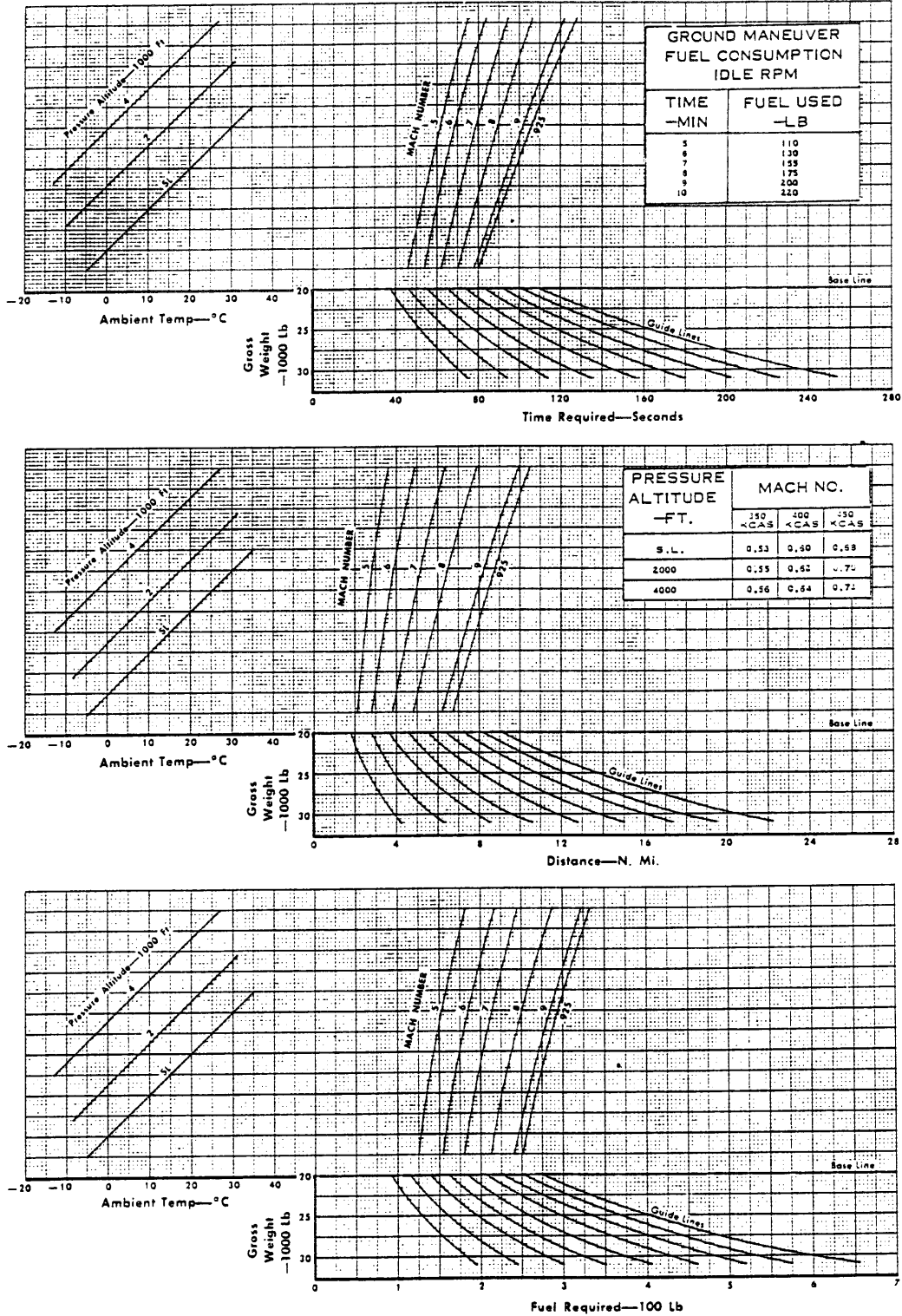

Figure A3-2

# MAXIMUM THRUST COMBAT CEILING

STANDARD DAY

Model: F-104S  
 Date: 1 April 1970  
 DATA BASIS: FLIGHT TEST

Engine: J79-GE-19  
 Fuel Grade: JP-8  
 Fuel Density: 6.68 Lb/Gal

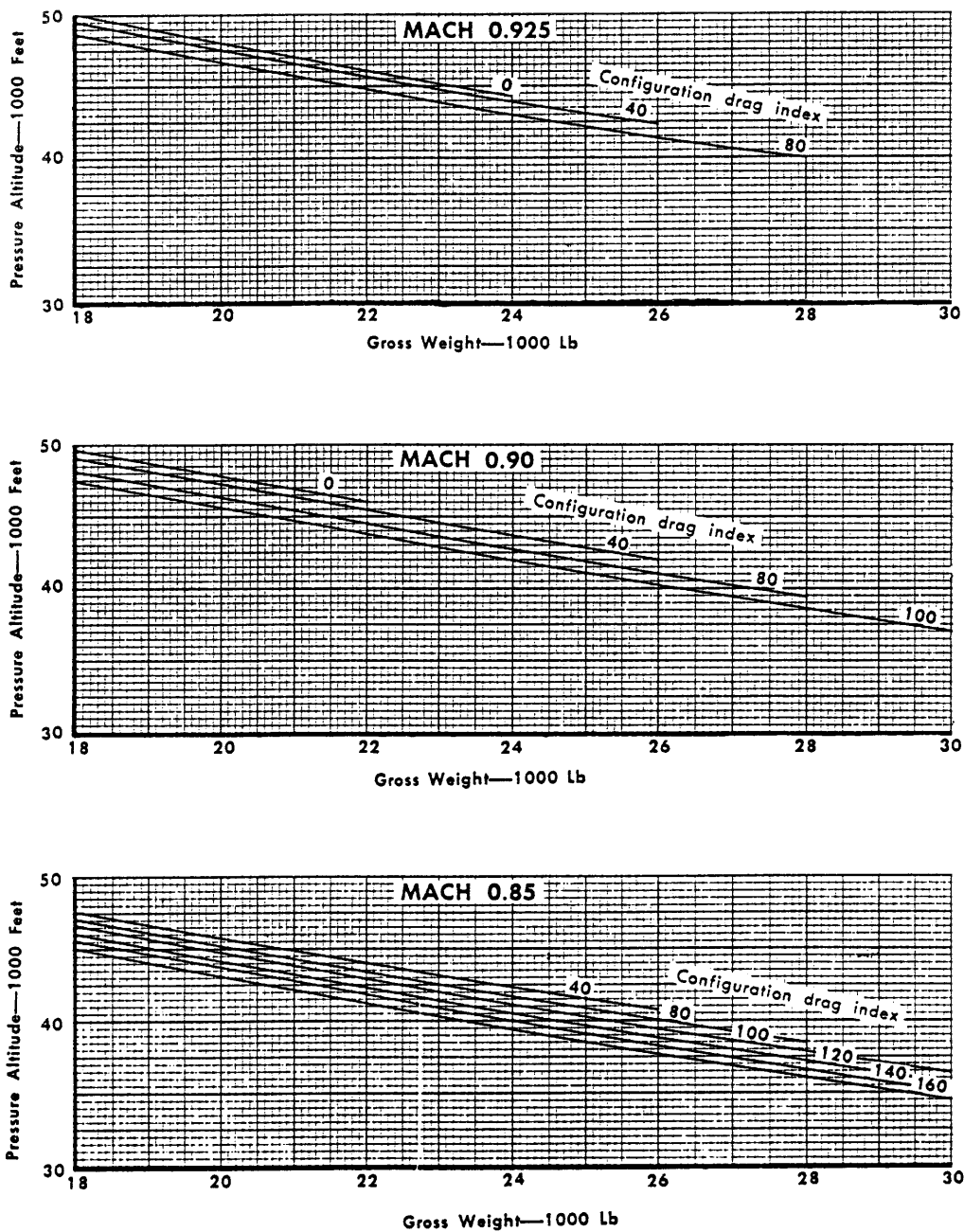

Figure A3-3

# MILITARY THRUST COMBAT CEILING

STANDARD DAY

Model: F-104S  
 Date: 1 April 1970  
 DATA BASIS: FLIGHT TEST

Engine: J79-GE-19  
 Fuel Grade: JP-8  
 Fuel Density: 6.68 Lb/Gal

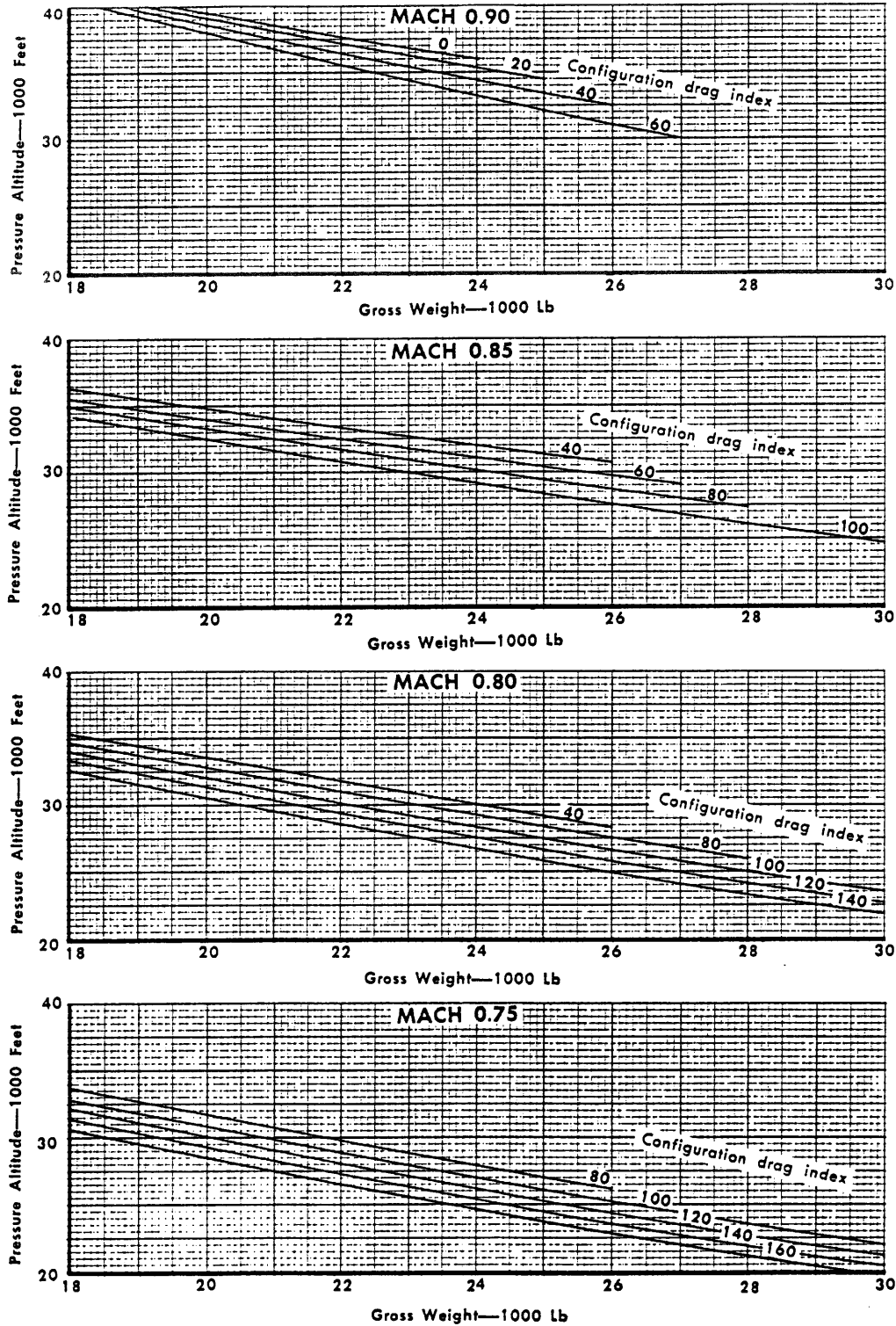

Figure A3-4

# OPTIMUM CRUISE ALTITUDE

Model: F-104S  
 Date: 1 April 1970  
 DATA BASIS: FLIGHT TEST

Engine: J79-GE-19  
 Fuel Grade: JP-8  
 Fuel Density: 6.68 Lb/Gal

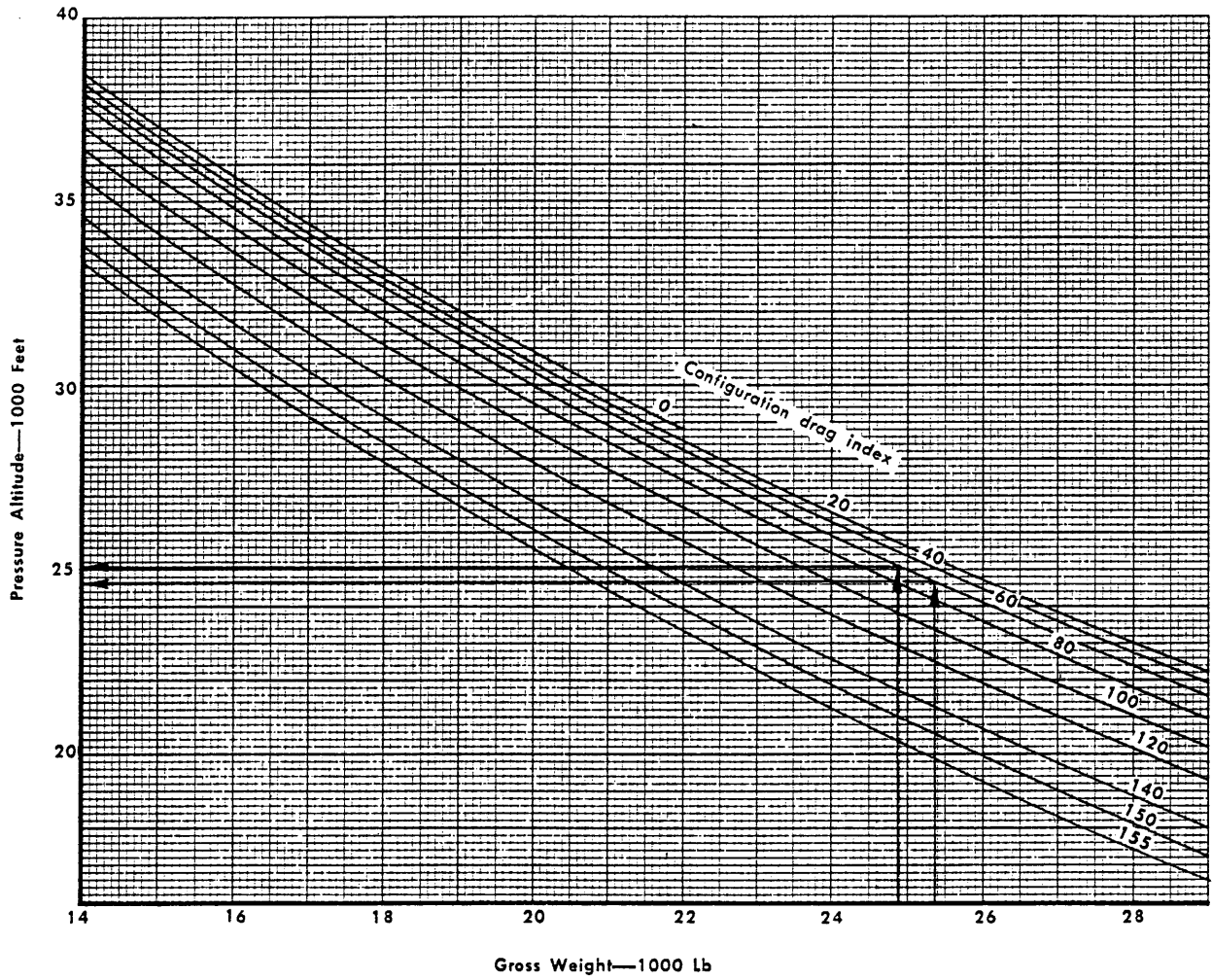

Figure A3-5

# MAXIMUM THRUST CLIMB CONTROL — CLIMB SPEED MACH 0.925

## TIME AND DISTANCE

Model: F-104S  
 Date: 1 April 1970  
 DATA BASIS: FLIGHT TEST

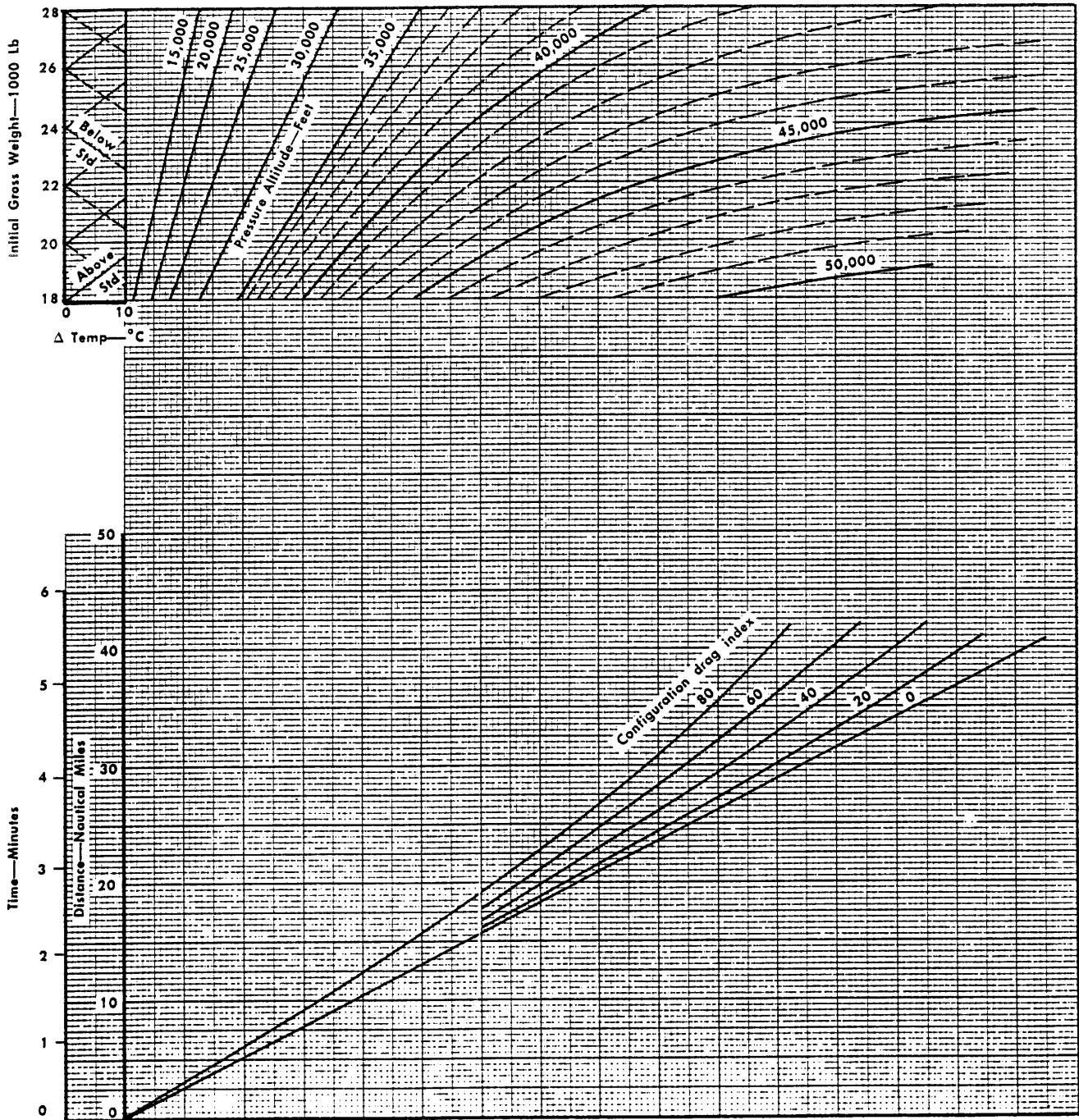

Figure A3-6 (Sheet 1 of 2)

# MAXIMUM THRUST CLIMB CONTROL — CLIMB SPEED MACH 0.925

## FUEL USED

Engine: J79-GE-19  
 Fuel Grade: JP-8  
 Fuel Density: 6.68 Lb/Gal

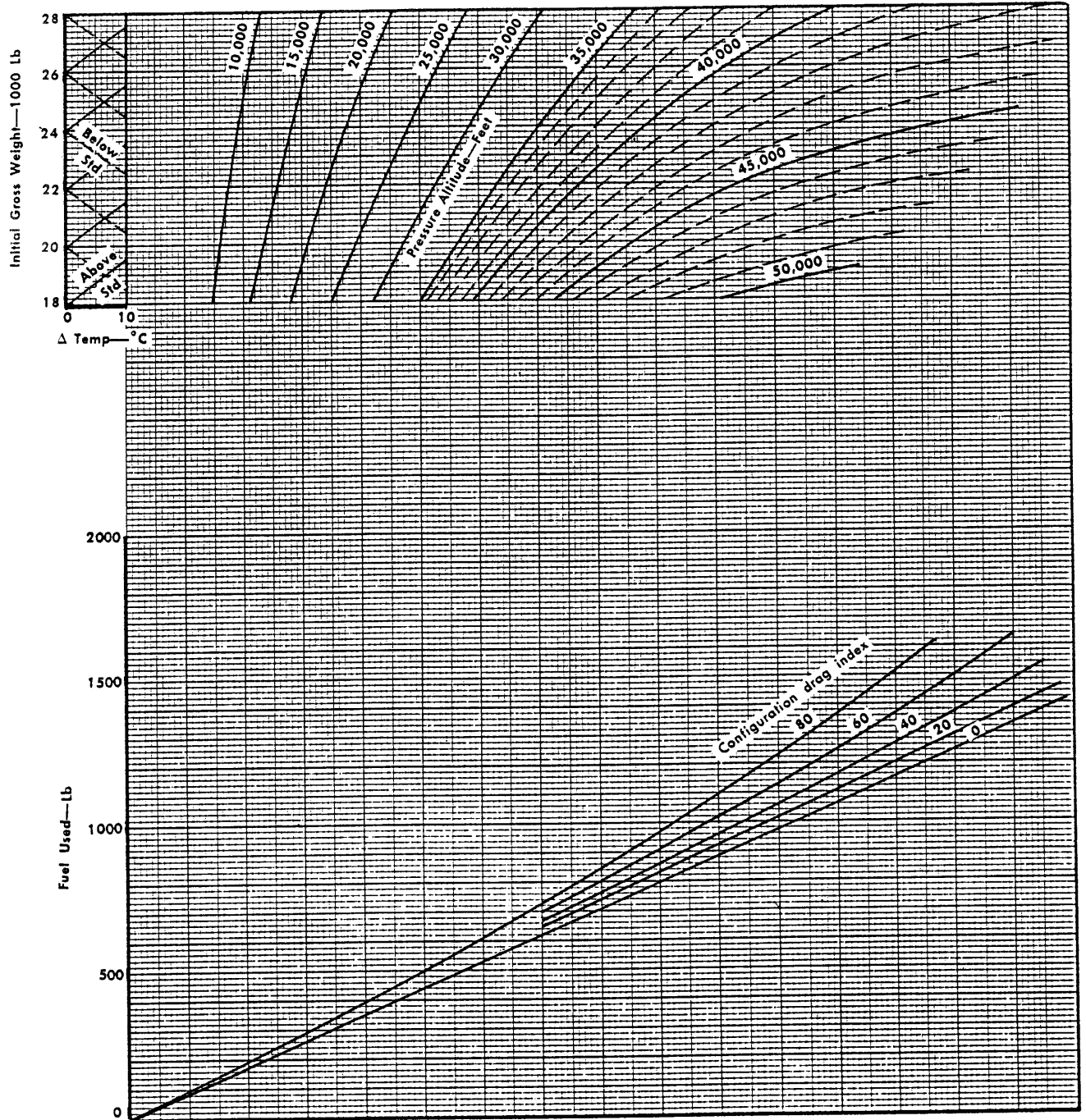

Figure A3-6 (Sheet 2 of 2)

# MAXIMUM THRUST CLIMB CONTROL — CLIMB SPEED MACH 0.90

## TIME AND DISTANCE

Model: F-104S  
Date: 1 April 1970  
DATA BASIS: FLIGHT TEST

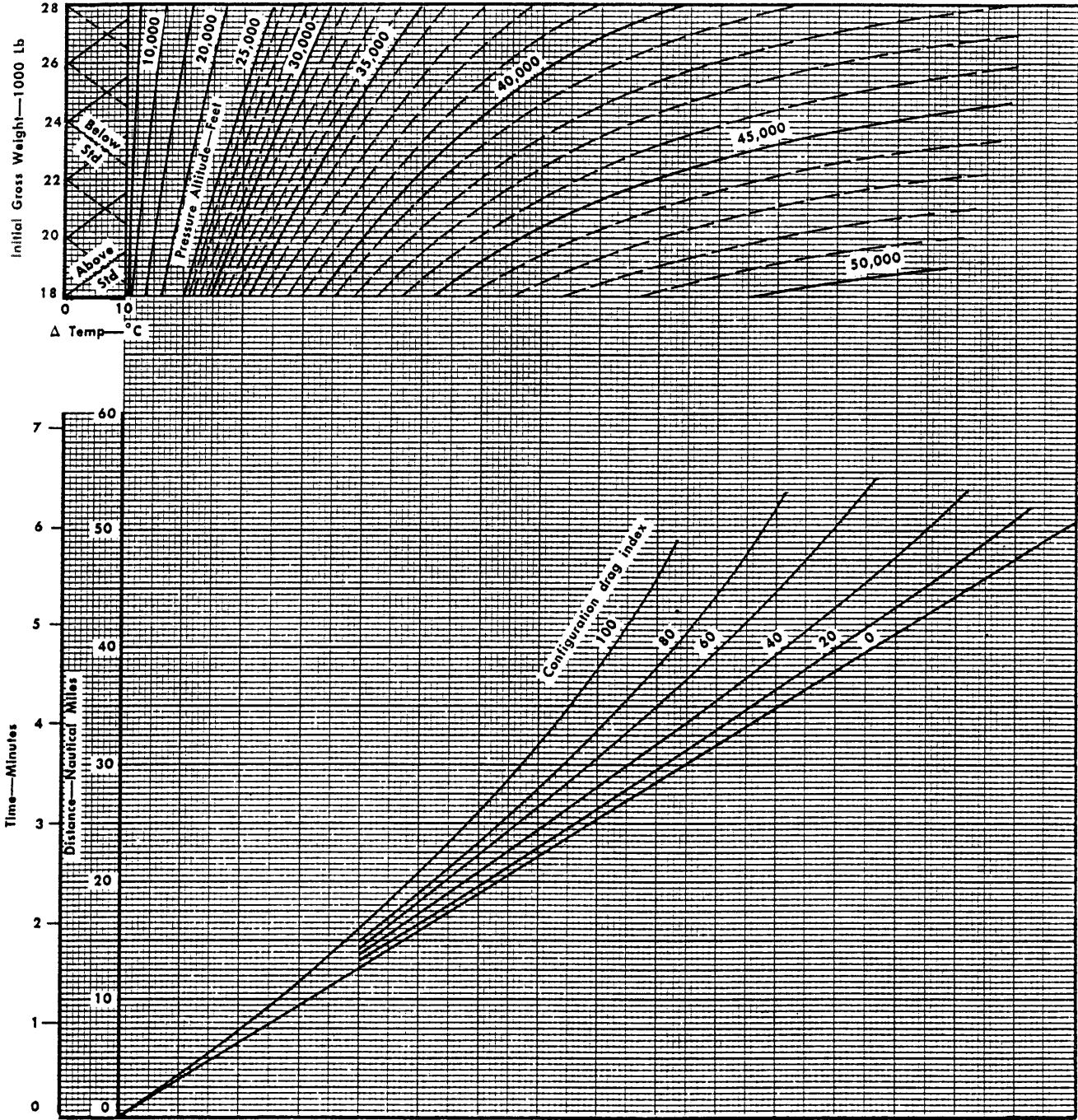

Figure A3-7 (Sheet 1 of 2)

# MAXIMUM THRUST CLIMB CONTROL — CLIMB SPEED MACH 0.90

## FUEL USED

Engine: J79-GE-19  
 Fuel Grade: JP-8  
 Fuel Density: 6.68 Lb/Gal

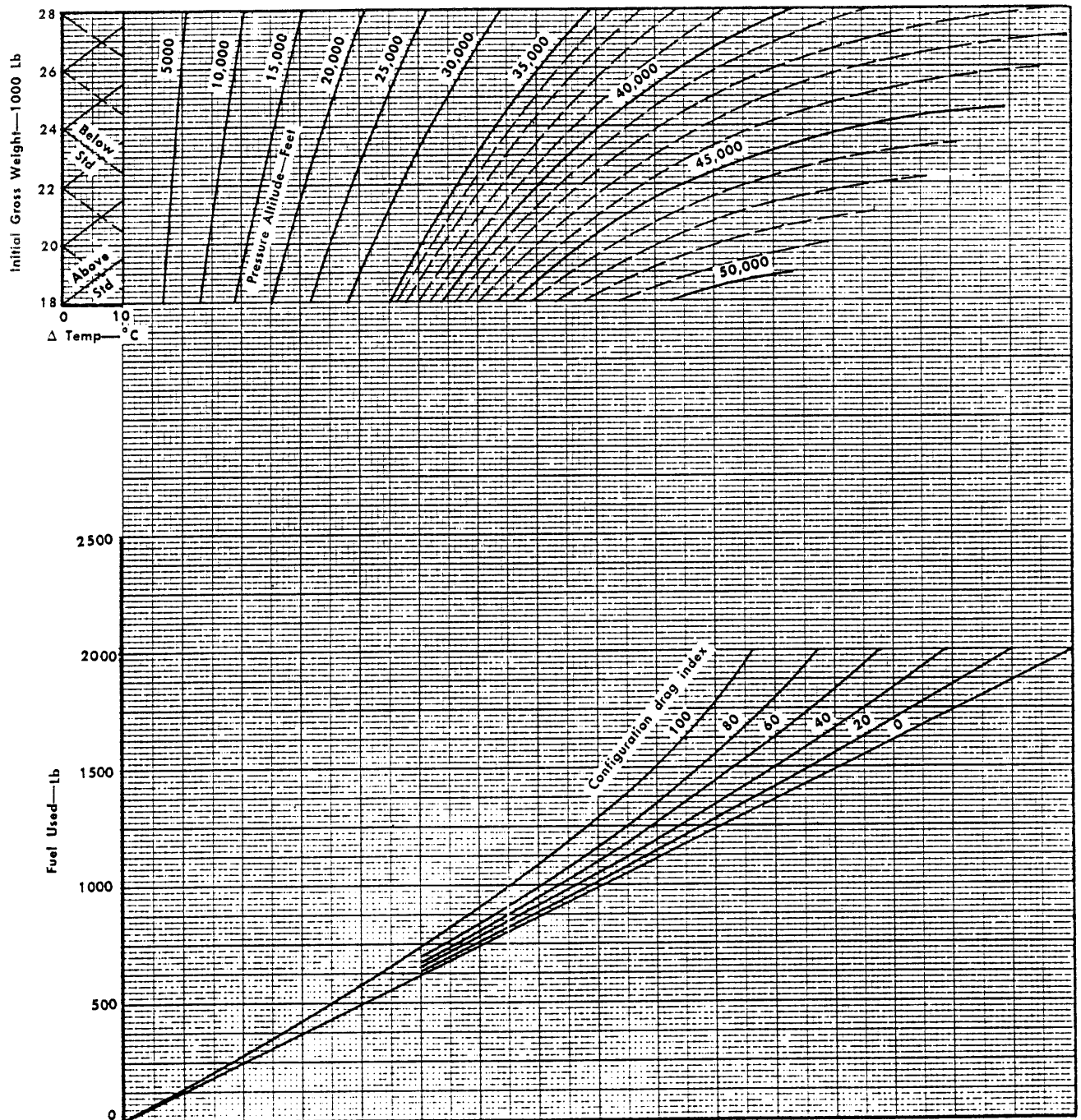

Figure A3-7 (Sheet 2 of 2)



# MAXIMUM THRUST CLIMB CONTROL — CLIMB SPEED MACH 0.85

## TIME AND DISTANCE

Model: F-104S  
 Date: 1 April 1970  
 DATA BASIS: FLIGHT TEST

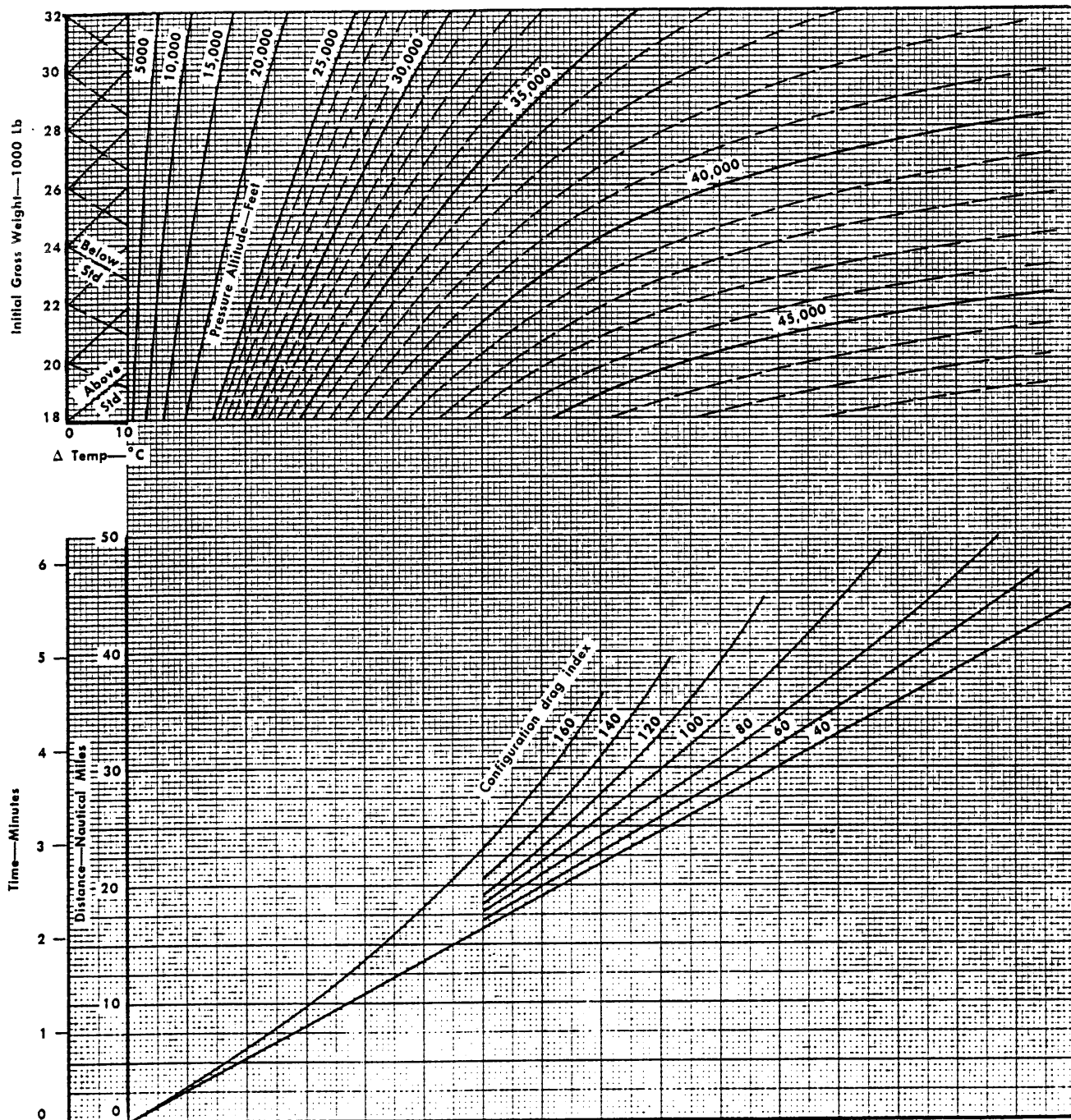

Figure A3-8 (Sheet 1 of 2)

# MAXIMUM THRUST CLIMB CONTROL — CLIMB SPEED MACH 0.85

## FUEL USED

Engine: J79-GE-19  
 Fuel Grade: JP-8  
 Fuel Density: 6.68 Lb/Gal

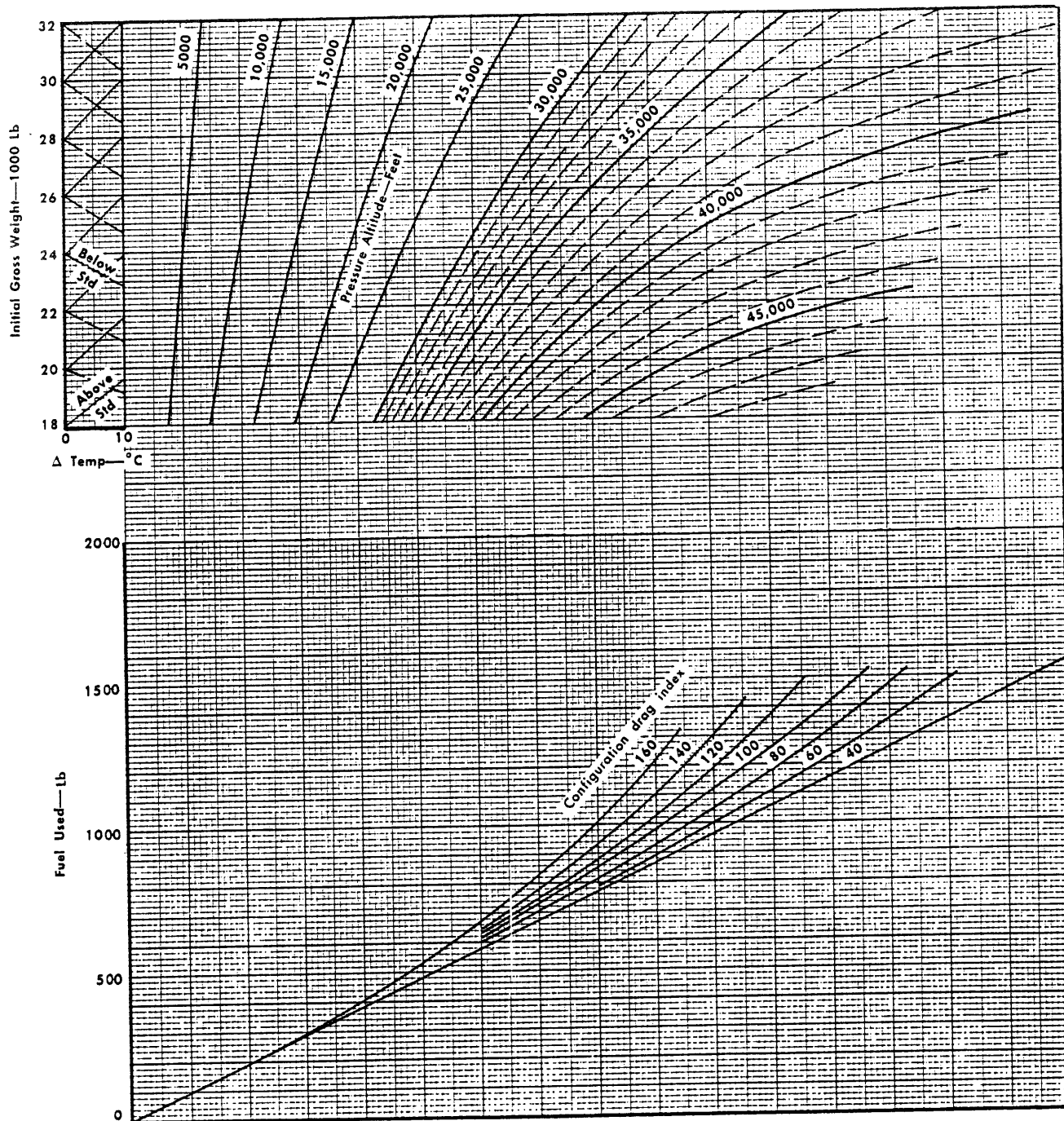

Figure A3-8 (Sheet 2 of 2)

# MILITARY THRUST CLIMB CONTROL — CLIMB SPEED MACH 0.90

## TIME AND DISTANCE

Model: F-104S  
Date: 1 June 1969  
DATA BASIS: FLIGHT TEST

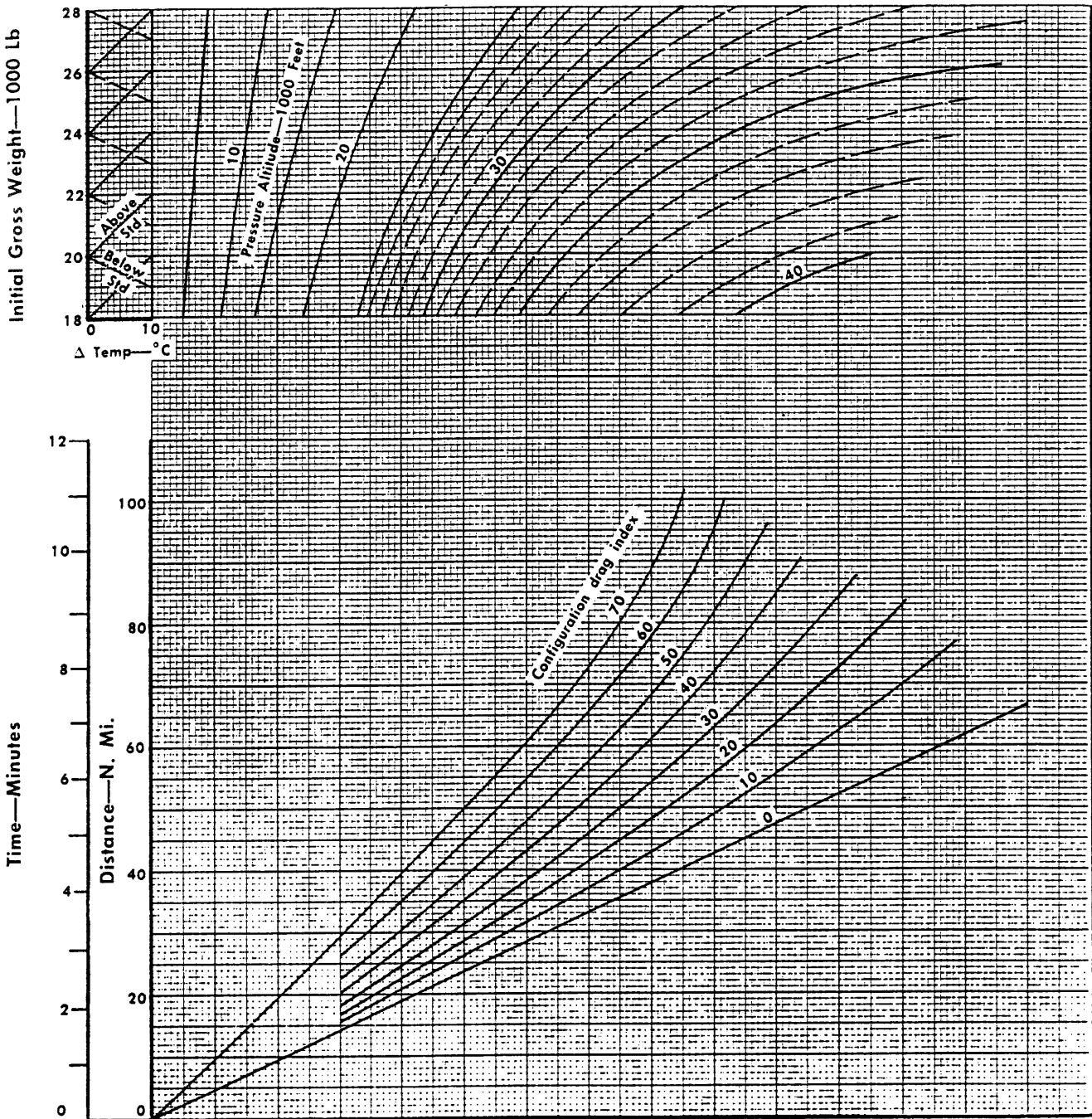

Figure A3-9 (Sheet 1 of 2)

# MILITARY THRUST CLIMB CONTROL — CLIMB SPEED MACH 0.90

## FUEL USED

Engine: J79-GE-19  
 Fuel Grade: JP-8  
 Fuel Density: 6.68 Lb/Gal

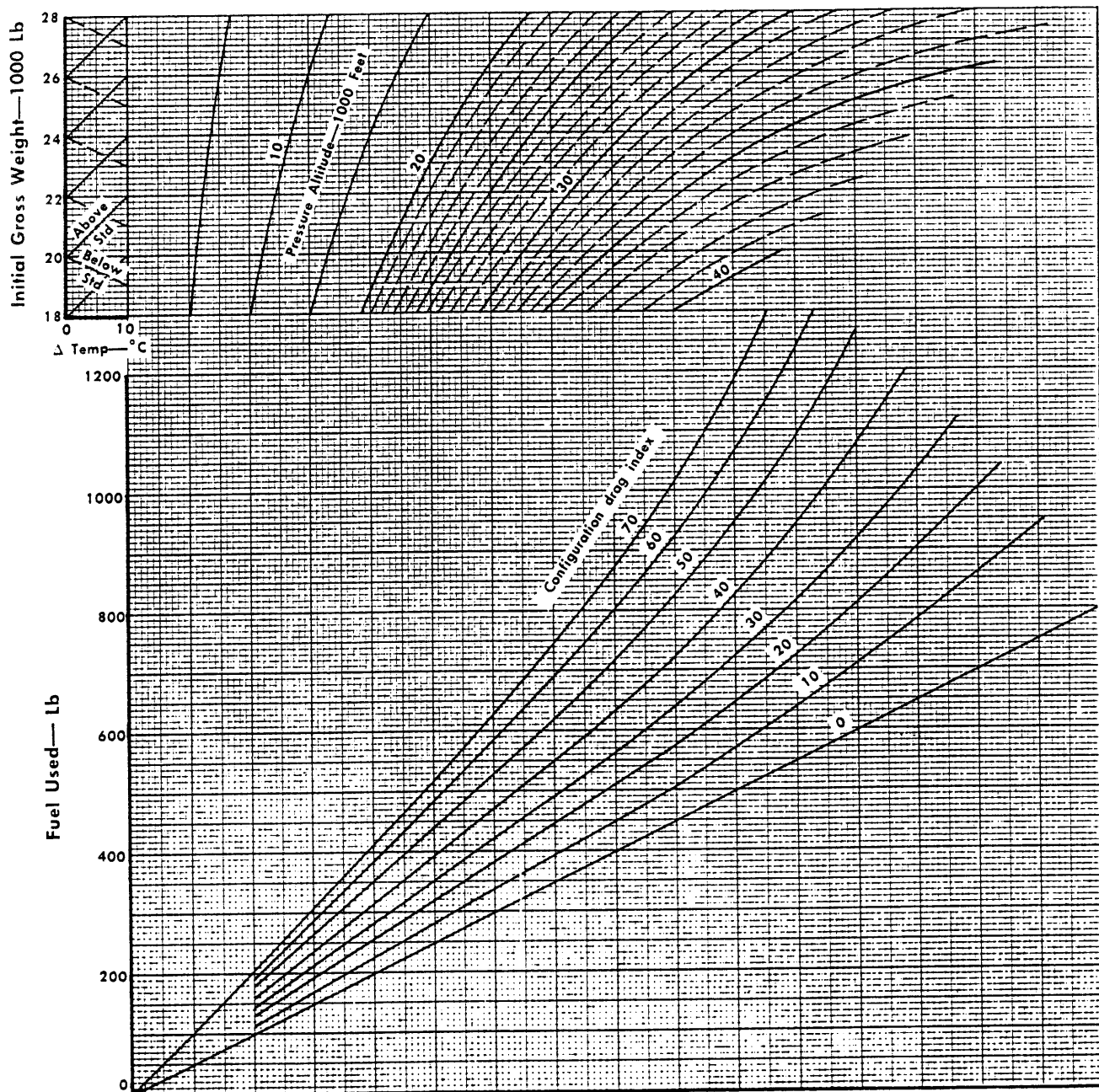

Figure A3-9 (Sheet 2 of 2)

# MILITARY THRUST CLIMB CONTROL — CLIMB SPEED MACH 0.85

## TIME AND DISTANCE

Model: F-104S  
 Date: 1 June 1969  
 DATA BASIS: FLIGHT TEST

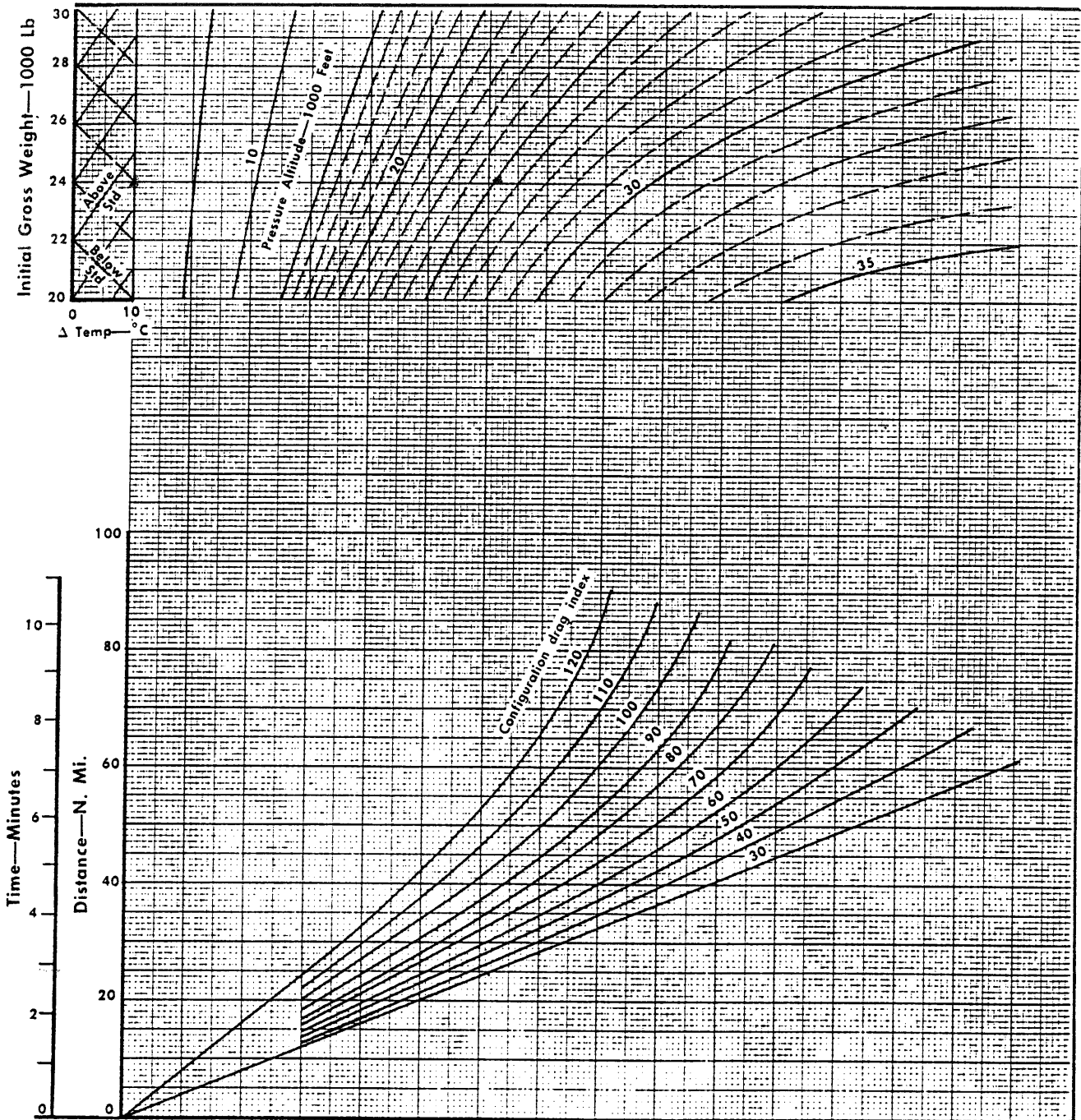

Figure A3-10 (Sheet 1 of 2)

MILITARY THRUST CLIMB CONTROL — CLIMB SPEED MACH 0.85

FUEL USED

Engine: J79-GE-19  
 Fuel Grade: JP-8  
 Fuel Density: 6.68 Lb/Gal

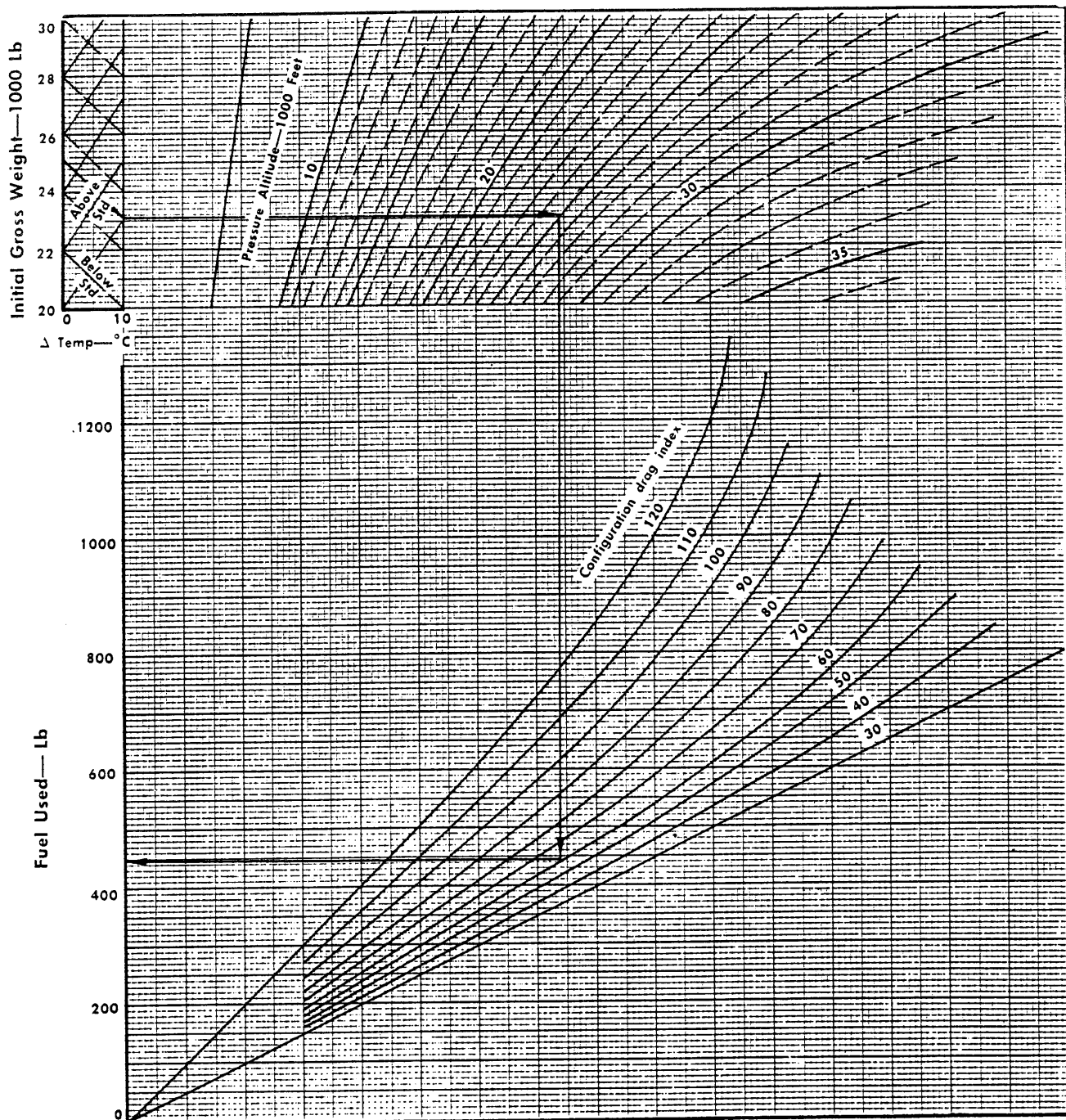

Figure A3-10 (Sheet 2 of 2)

# MILITARY THRUST CLIMB CONTROL — CLIMB SPEED MACH 0.80

## TIME AND DISTANCE

Model: F-104S  
 Date: 1 April 1970  
 DATA BASIS: FLIGHT TEST

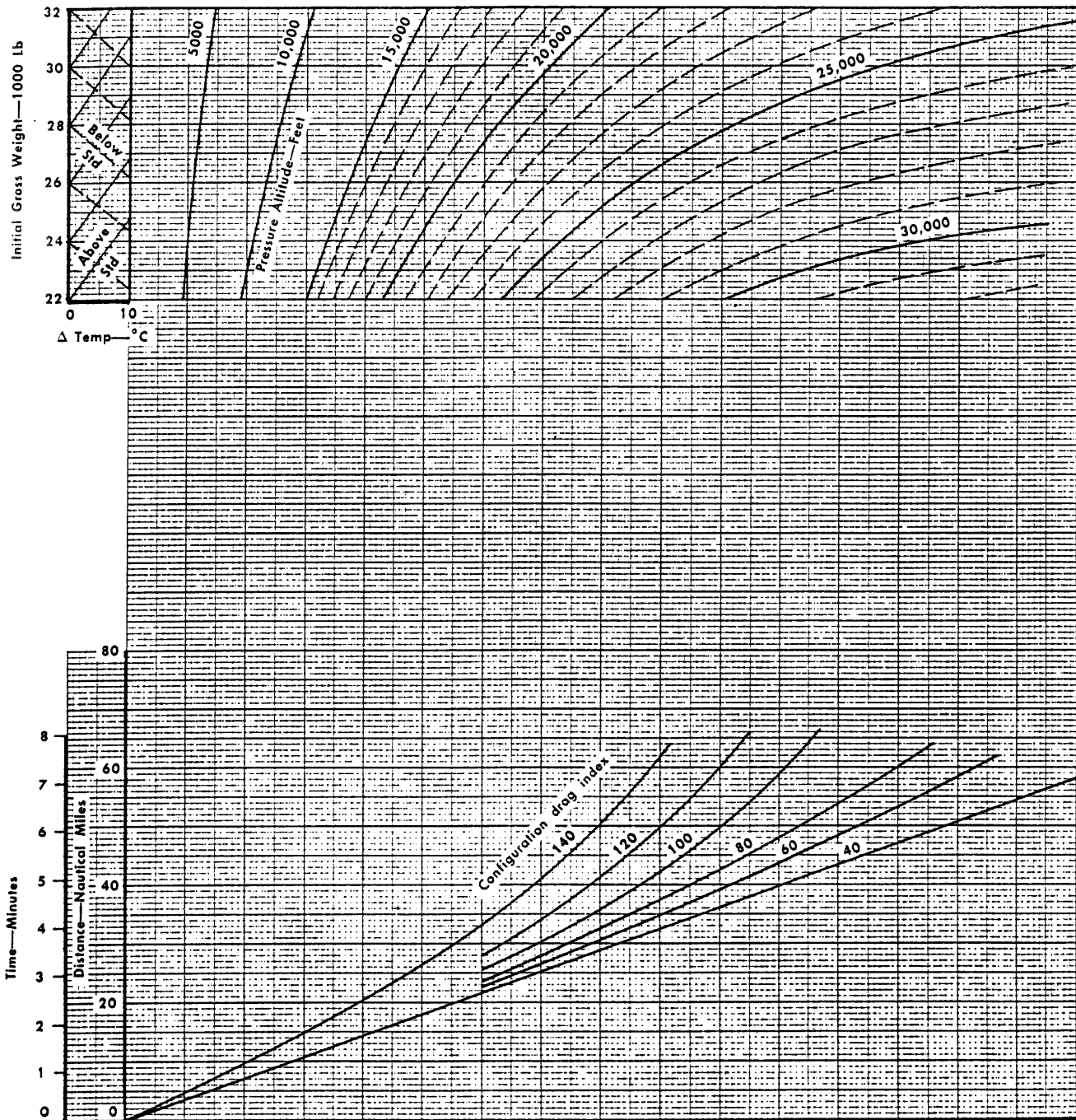

Figure A3-11 (Sheet 1 of 2)

# MILITARY THRUST CLIMB CONTROL — CLIMB SPEED MACH 0.80

## FUEL USED

Engine: J79-GE-19  
 Fuel Grade: JP-8  
 Fuel Density: 6.68 Lb/Gal

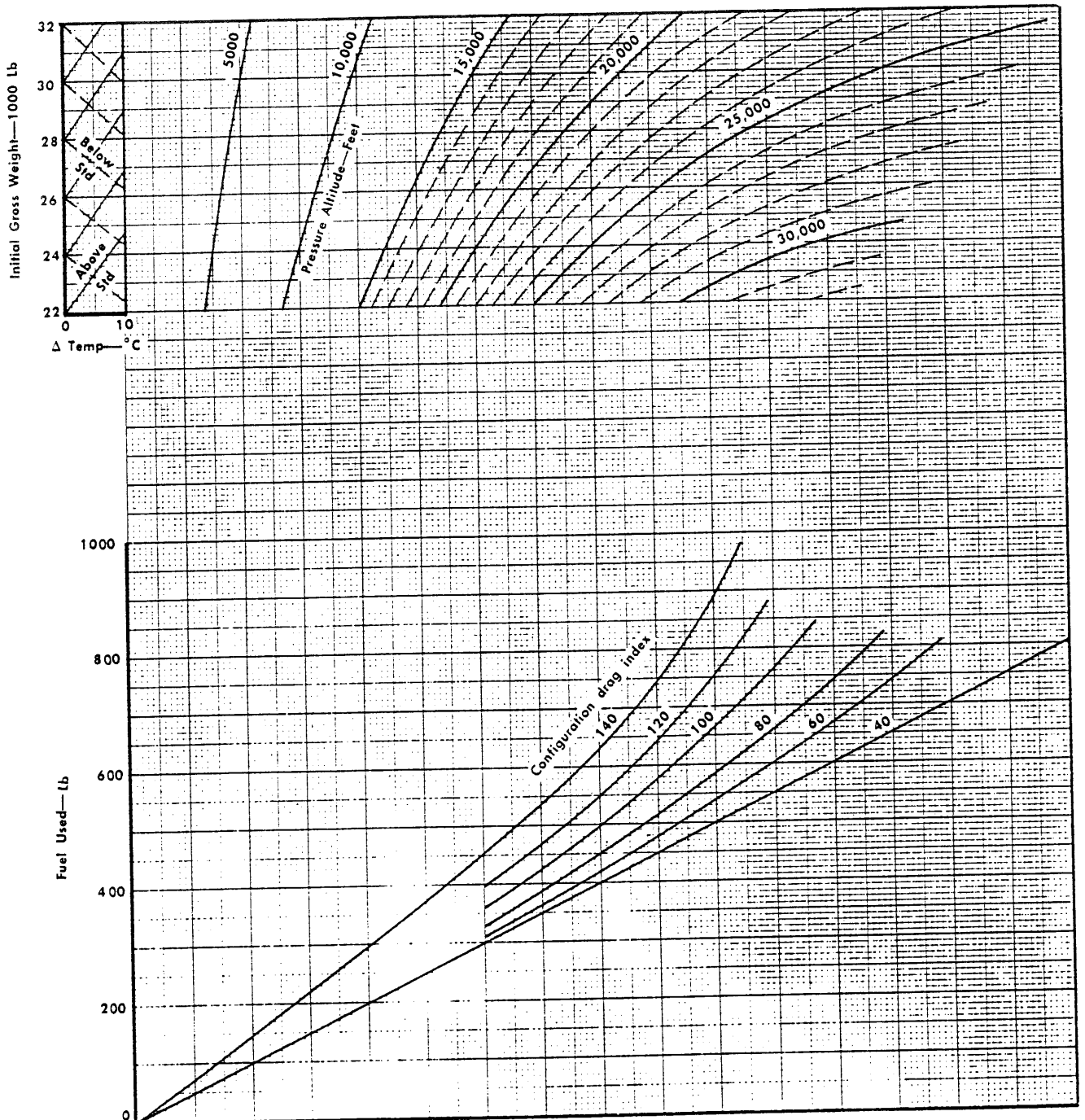

Figure A3-11 (Sheet 2 of 2)



# MILITARY THRUST CLIMB CONTROL — CLIMB SPEED MACH 0.75

## TIME AND DISTANCE

Model: F-104S  
Date: 1 April 1970  
DATA BASIS: FLIGHT TEST

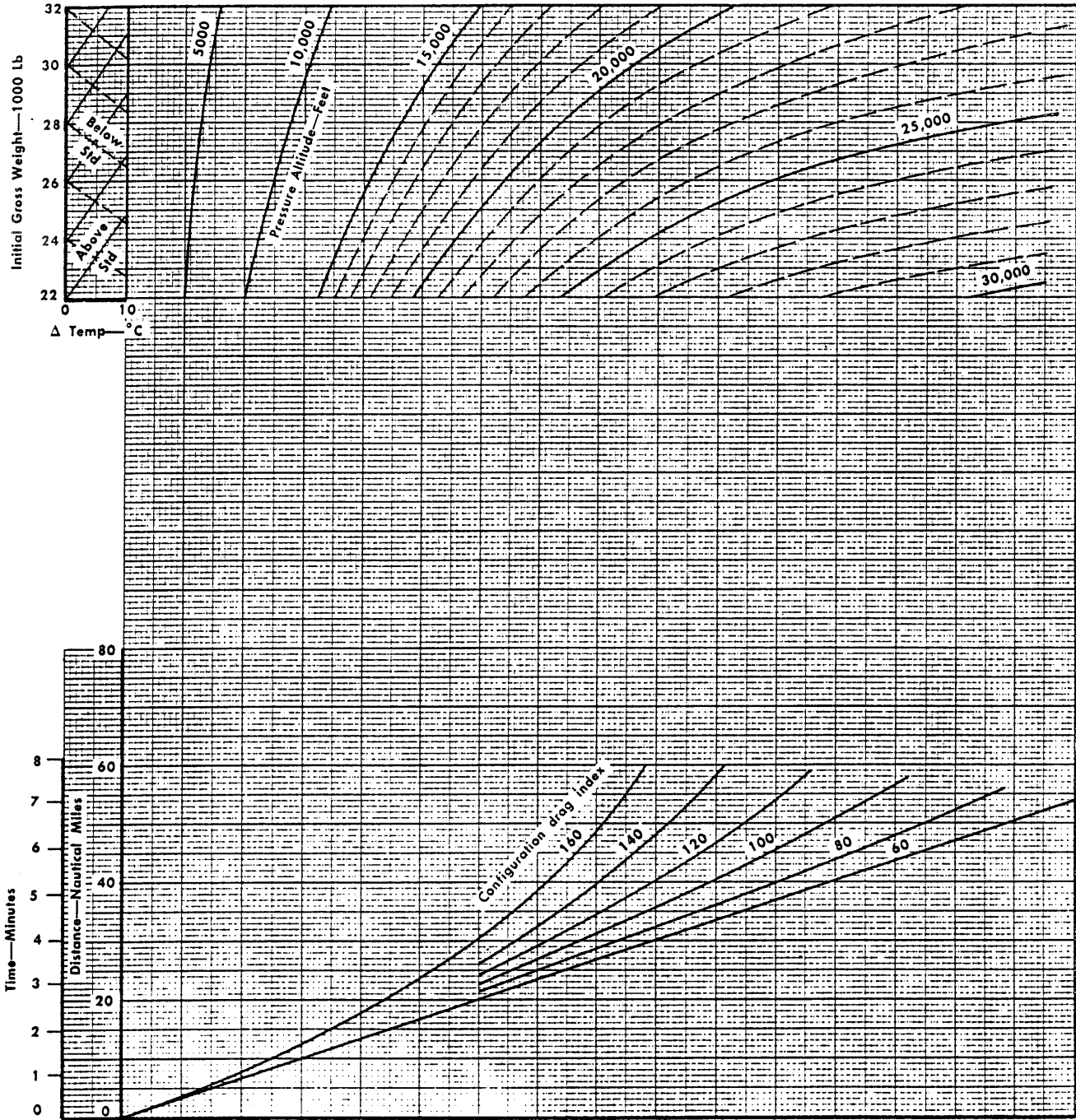

Figure A3-12 (Sheet 1 of 2)

# MILITARY THRUST CLIMB CONTROL — CLIMB SPEED MACH 0.75

## FUEL USED

Engine: J79-GE-19  
 Fuel Grade: JP-8  
 Fuel Density: 6.68 Lb/Gal

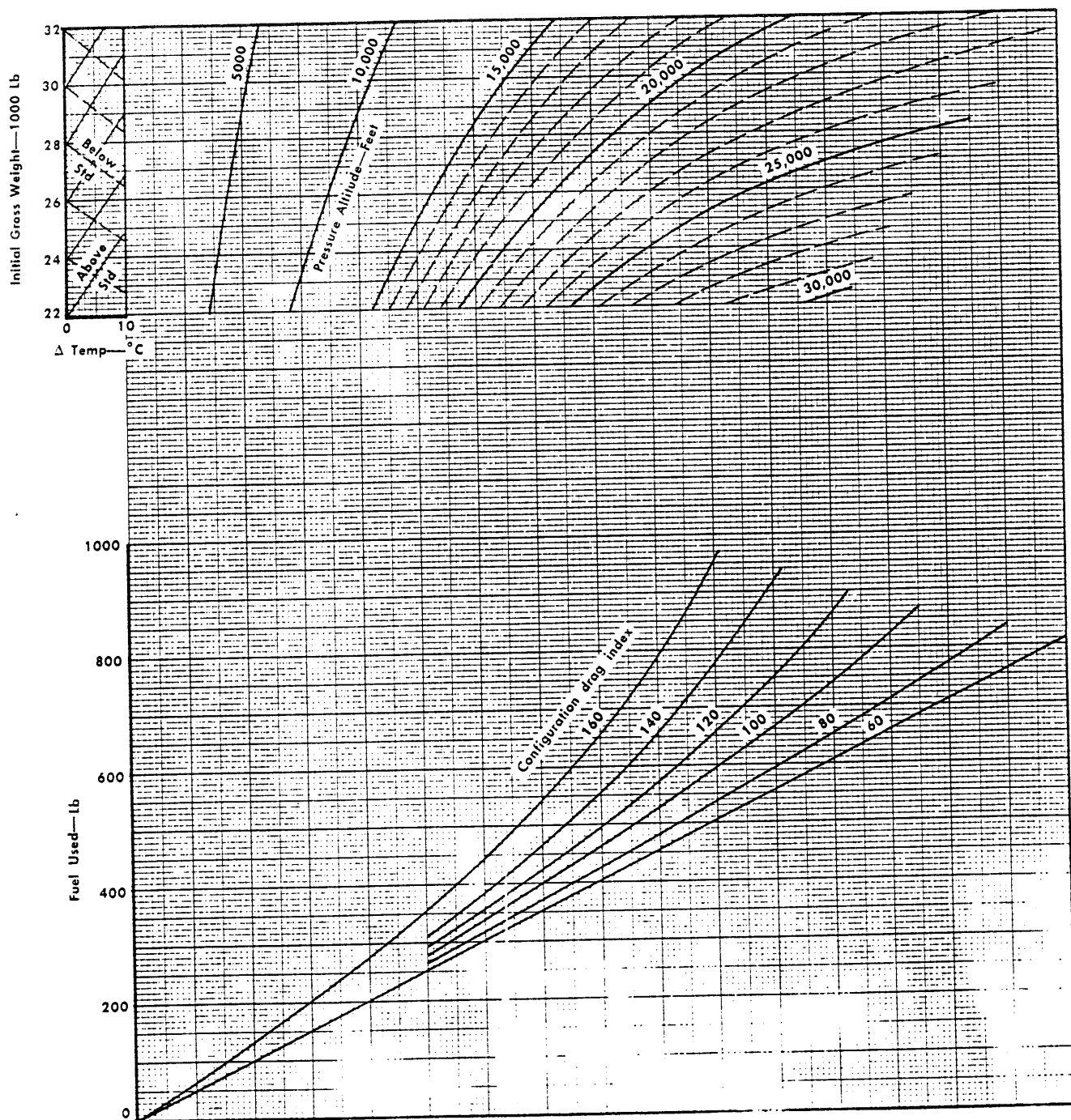

Figure A3-12 (Sheet 2 of 2)

# PART 4

## RANGE

### TABLE OF CONTENTS

Index items in bold face characters denote illustrations.

Title	Page
Range Data Presented . . . . .	A4-1
Maximum Range Performance . . . . .	A4-1
Maximum Range Constant Altitude Cruise . . . . .	A4-3

### RANGE DATA PRESENTED

Range data presented in this part show the range available at constant altitude based on operation at the recommended speed schedules. If detailed flight planning information is desired for speed schedules other than those defined in this part, refer to Part 6 "Miles Per Pounds Data" for applicable miles-per-pound charts.

### MAXIMUM RANGE PERFORMANCE

The range charts present the level flight cruise range capabilities of the aircraft for all gross weights and configurations. The maximum range cruise Mach number schedule is also included, and shall be used to achieve the charted performance. Altitudes shown assume that the altimeter is set at 29.92 inches Hg (1013.2 mb). To achieve the desired pressure altitude, indicated altitude shall be corrected for altimeter position error and instrument calibration, if known. Optimum altitude for maximum range cruise may be obtained from the chart provided in Part 3 "Climb". As indicated, the altitude is based on actual gross weight and shall be

corrected for the fuel consumed during ground maneuver, takeoff and acceleration to climb speed and climb. Use of the maximum range performance charts is illustrated by the following sample problems.

#### MAXIMUM RANGE - CONSTANT ALTITUDE SAMPLE PROBLEM

Determine the fuel required to cruise a ground distance of 500 nautical miles at an altitude of 20000 feet on a standard day with a 60 knot headwind component. The aircraft has a configuration drag index of 20. The initial cruise gross weight (gross weight after allowances have been made for ground maneuver, takeoff and acceleration to climb speed and climb to 20000 feet) is 22000 pounds.

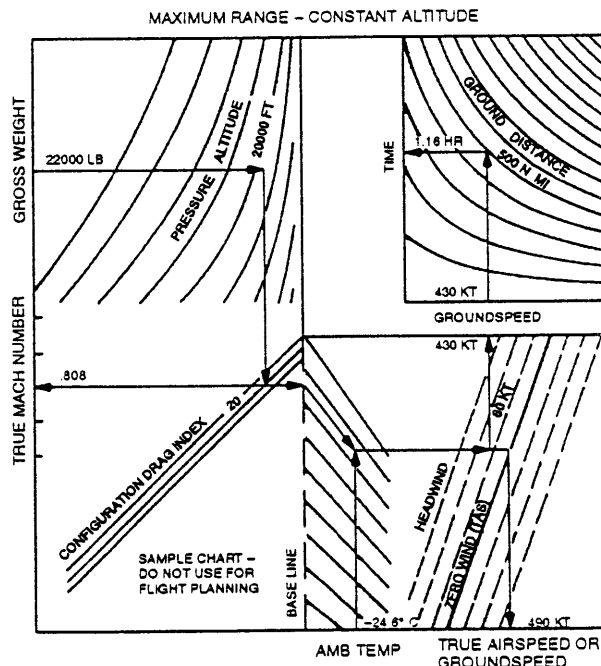

FA0289

- a. Enter Figure A4-1 (sheet 1) at 22000 lb and 20000 feet. At a configuration drag index of 20, read maximum range cruise true Mach 0.808.

Proceed horizontally to the right to the true airspeed base line, follow the guide lines to  $-24.6^{\circ}$  C, standard day temperature at 20000 feet. Continue to the right and read cruise true airspeed of 490 knots. Ground speed with a 60 knot headwind is 430 knots. Vertically upwards at a ground speed of 430 knots read a flight time of 1.16 hours for a cruise ground distance of 500 nautical miles.

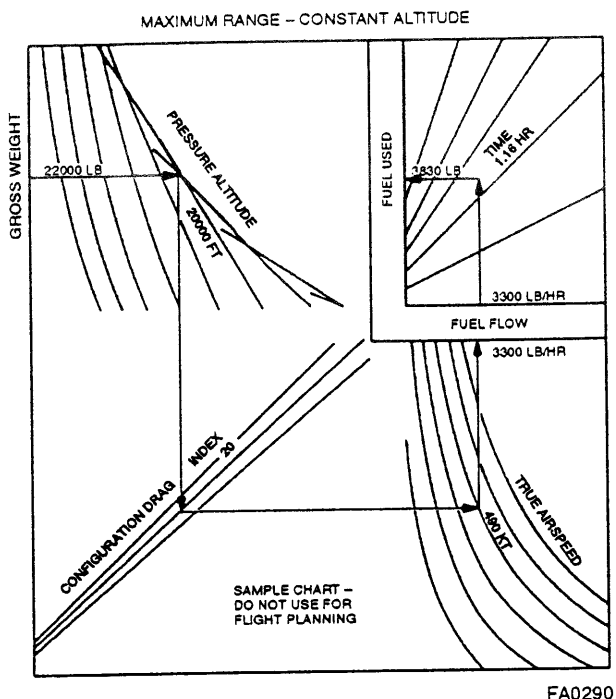

b. Enter Figure A4-1 (sheet 2) at 22000 lb and 20000 feet. Proceed vertically below this point to a configuration drag index of 20. Horizontally to the right intersect the true airspeed determined in step (a), 490 knots. Vertically above the true airspeed read an initial cruise fuel flow of 3300 lb per hour. Continue vertically to the cruise time from step (a) and read cruise fuel required, 3830 pounds ( $1.16 \times 3300$ ). The preceding steps assume cruise performance based on the initial conditions for cruise. Obviously, as fuel is consumed, the aircraft weight decreases and the maximum range capability increases. Therefore, when large quantities of

fuel are required, it is recommended that performance calculations be made in gross weight increments (fuel consumed) of 2000 pounds or less. The preceding problem should be used as an approximation, then recalculated as follows:

c. Determine the cruise ground run distance for 2000 pounds of fuel consumption. Average gross weight is 21000 lb  $(22000 + 20000)/2$ . Follow the same procedures as in step (a), Figure A4-1 (sheet 1) and read:

True Mach number ..... 0.800  
 True airspeed at  $-24.6^{\circ}$  C ..... 488 kt

d. Enter Figure A4-1 (sheet 2) at 21000 lb, follow the procedures of step (b) and read cruise fuel flow 3210 lb per hour at 488 knots.

e. Cruise time to consume 2000 pounds of fuel is 0.623 hr  $(2000/3210)$ .

f. Reenter Figure A4-1 (sheet 1) at a ground speed of 428 knots  $(488 - 60)$  and read cruise ground distance of 267 nautical miles or  $(428 \times 0.623)$ .

g. From step (b), the approximate additional fuel required to cruise the remaining distance of 233 nautical miles  $(500 - 267)$  is 1830 pounds  $(3830 - 2000)$ .

h. Average gross weight for the segment is 19085 lb  $(20000 - 1830/2)$ .

i. From Figure A4-1 (sheet 1) read:

True Mach number ..... 0.782  
 True airspeed at  $-24.6^{\circ}$  C ..... 480 kt  
 Ground speed (60 kt. headwind) ..... 420 kt  
 Time to cruise 233 nmi  $(233/420)$  ..... 0.555 hr

j. From Figure A4-1 (sheet 2) read cruise fuel flow, 3000 lb per hour at 480 knots true airspeed.

k. Fuel required to cruise remaining distance is 1660 lb  $(3000 \times 0.555)$ .

l. Total time and fuel required to cruise 500 nautical miles is:

Time  $(0.623 \text{ hr} + 0.555 \text{ hr})$  ..... 1 hr 10 min.  
 Fuel  $(2000 \text{ lb} + 1660 \text{ lb})$  ..... 3660 lb

# MAXIMUM RANGE CONSTANT ALTITUDE CRUISE

Model: F-104S  
 Date: 1 April 1970  
 DATA BASIS: FLIGHT TEST

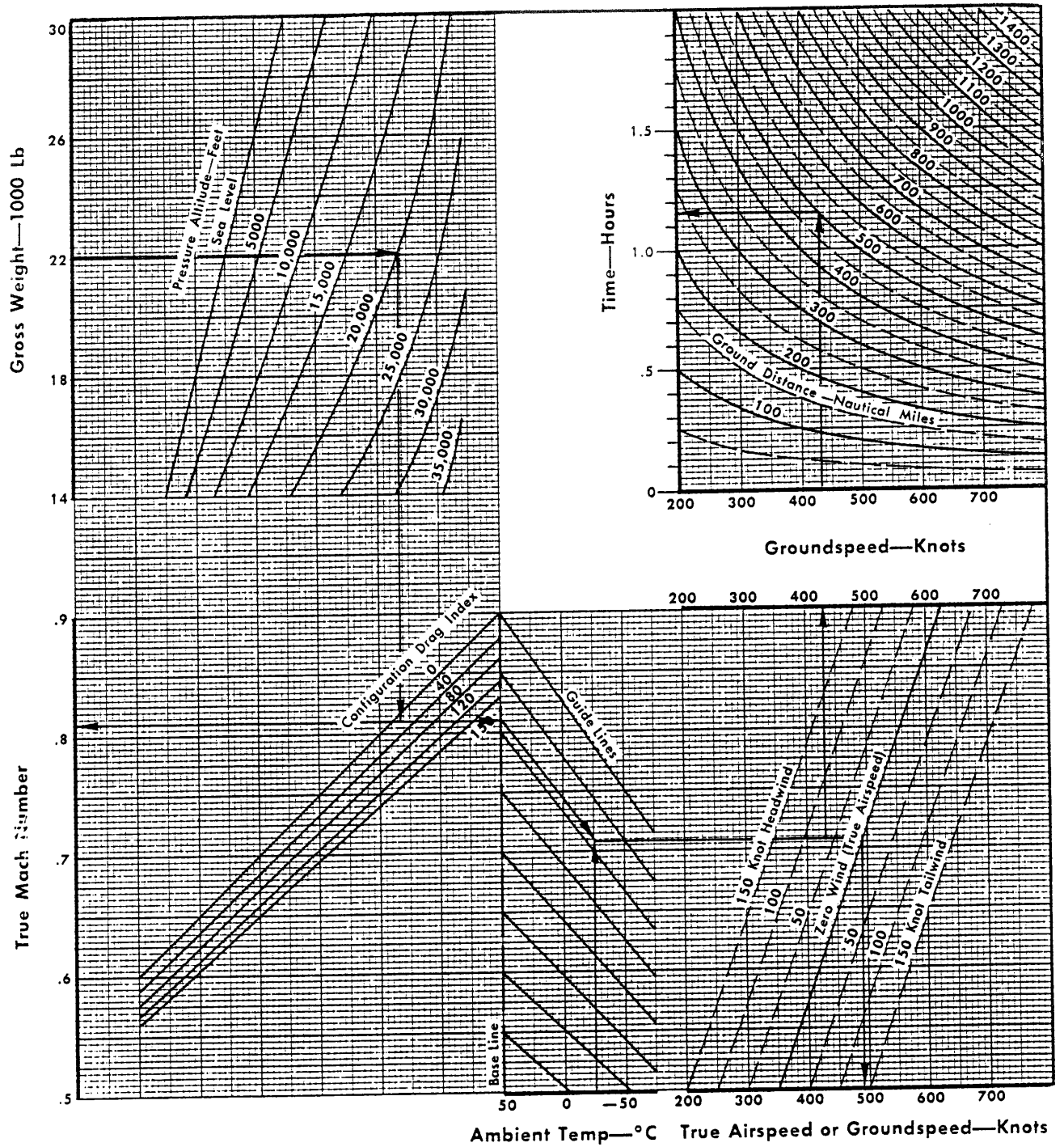

Figure A4-1 (Sheet 1 of 2)

### MAXIMUM RANGE CONSTANT ALTITUDE CRUISE

Engine: J79-GE-19  
 Fuel Grade: JP-8  
 Fuel Density: 6.68 Lb/Gal

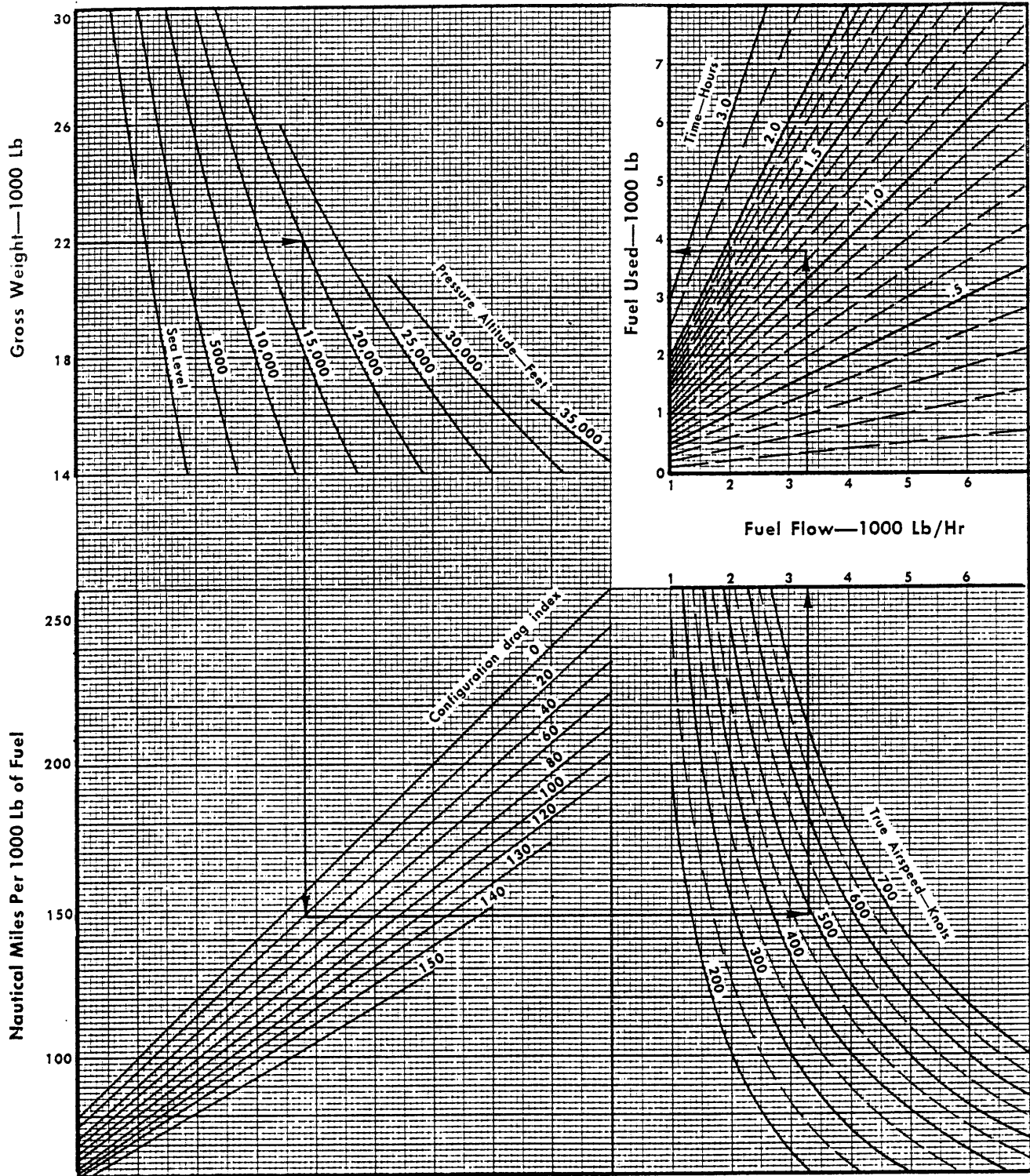

Figure A4-1 (Sheet 2 of 2)

# PART 5

## ENDURANCE

### TABLE OF CONTENTS

Index items in bold face characters denote illustrations.

Title	Page
Endurance Data Presented . . . . .	A5-1
Maximum Endurance Performance . . . . .	A5-1
Maximum Endurance . . . . .	A5-3

### ENDURANCE DATA PRESENTED

Endurance data presented in this part show the endurance available at constant altitude and are based on operation at the recommended speed schedules. Performance at other speed schedules may be obtained from the data shown on the miles-per-pound charts contained in Part 6.

### MAXIMUM ENDURANCE PERFORMANCE

The maximum endurance charts show the loiter time available at a constant altitude for any gross weight. The performance is presented in terms of loiter fuel flow and recommended loiter speed, and does not include climb or descent allowances. The recommended loiter speeds shall be used to obtain the predicted performance.

Endurance performance in turning flight may be estimated on the basis of an effective gross weight calculated from the load factor-bank angle chart provided. Effective gross weight equals gross weight multiplied by the load factor in the turn.

### MAXIMUM ENDURANCE PERFORMANCE SAMPLE PROBLEM

Determine the fuel required to loiter 40 minutes in a 20° bank at 30000 feet on a standard day for a configuration with a drag index of 20. The fuel on board at the start is 4000 lb. Assumed zero fuel weight is 14800 pounds.

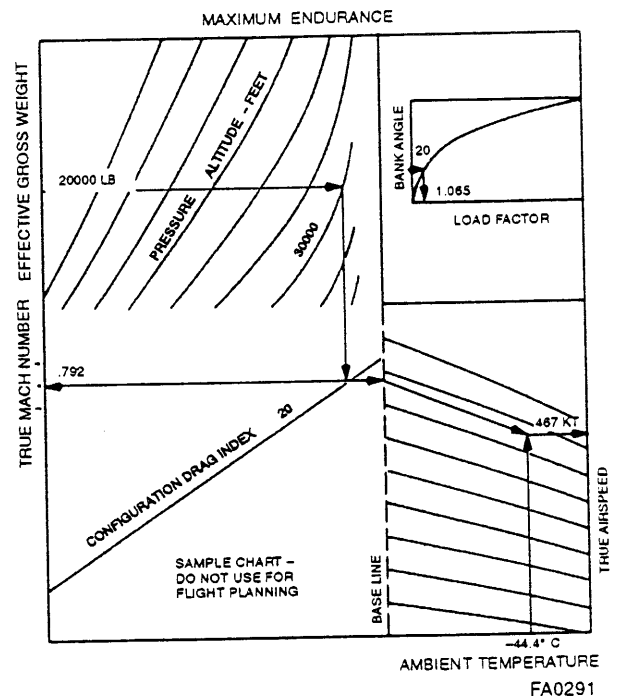

- The aircraft gross weight is 18800 lb (14800 + 4000).
- Enter the load factor-bank angle plot at a bank angle of 20° and read the load factor, 1.065 "G".
- The initial loiter effective gross weight is 20000 lbs. (18800 × 1.065).
- Enter Figure A5-1 (sheet 1) at 20000 lb and 30000 feet. Read loiter true Mach number of 0.792. Proceed horizontally to the right to the true airspeed base line, follow the guide lines to

-44.4° C, standard day temperature at 30000 feet. Continue to the right and read true airspeed of 467 knots.

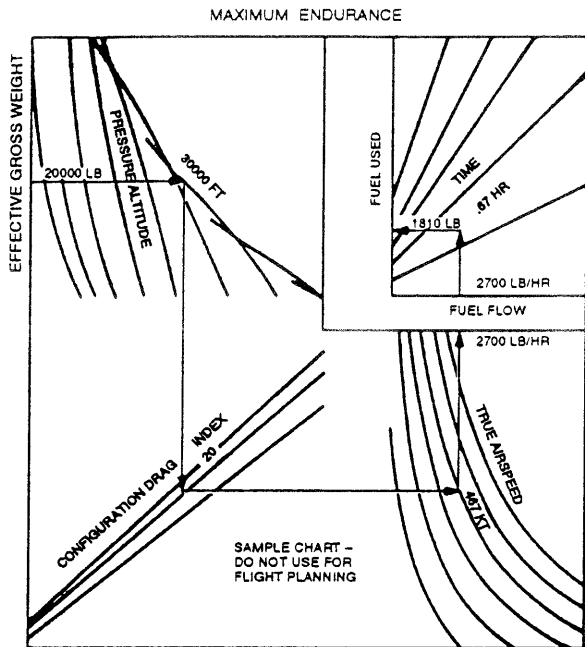

FA0292

- e. Enter Figure A5-1 (sheet 2) at 20000 lb and 30000 feet. Proceed vertically below this point to a configuration drag index of 20. Horizontally to the right intersect the true airspeed determined in step (d), 467 knots.
- f. Vertically above the point in step (e), read loiter fuel flow, 2700 pounds per hour. Continue to the desired loiter time of 0.67 hr (40 min.). Read fuel used for loiter, 1810 pounds ( $0.67 \times 2700$ ).

The preceding steps assume loiter performance based on the initial condition for loiter. Additional accuracy in the determination of the fuel require-

ments for loiter for the preceding conditions may be obtained by approximating the average loiter gross weight.

- g. Approximate final gross weight is 16990 lb ( $18800 - 1810$ ).
- h. Average gross weight is 17895 lb ( $(16990 + 18800)/2$ ).
- i. The average effective gross weight is 19100 lb ( $17895 \times 1.065$ ).
- j. Following the same procedures, enter Figure A5-1 at 19100 lb, and 30000 feet loiter true Mach .780, loiter true airspeed 460 knots, fuel flow 2560 pounds per hour. Fuel used for .67 hr (40 min.) is 1710 lb ( $.67 \times 2560$ ).

Determine the total endurance time for 4000 pounds of fuel remaining. When total loiter time is required for large quantities of fuel remaining, it is recommended that performance calculations be made in gross weight increments of 2000 pounds or less.

- a. Average gross weight for 2000 pound increment from 4000 lb to 2000 lb fuel remaining is, 17800 lb,  $(18800 + 16800)/2$ . Effective gross weight is 18950 lb.
- b. Loiter speed at 30000 feet is true Mach 0.775, true airspeed 456 knots, fuel flow 2530 lb per hour. Loiter time to consume 2000 lb of fuel is 47.5 minutes (.79 hr),  $(2000/2530)$ .
- c. Average gross weight for 2000 pound increment from 2000 lb to zero fuel remaining is 15800 lb,  $(16800 + 14800)/2$ . Effective gross weight is 16830 lb
- d. Loiter speed at 30000 feet is true Mach 0.748, true airspeed 440 knots, fuel flow 2260 lb per hour. Loiter time to consume 2000 lb of fuel is 53 minutes (.885 hr),  $(2000/2260)$
- e. Total loiter time is 1 hr. 40.5 min.  $(47.5 + 53.0)$ .



# MAXIMUM ENDURANCE

Model: F-104S  
 Date: 1 April 1970  
 DATA BASIS: FLIGHT TEST

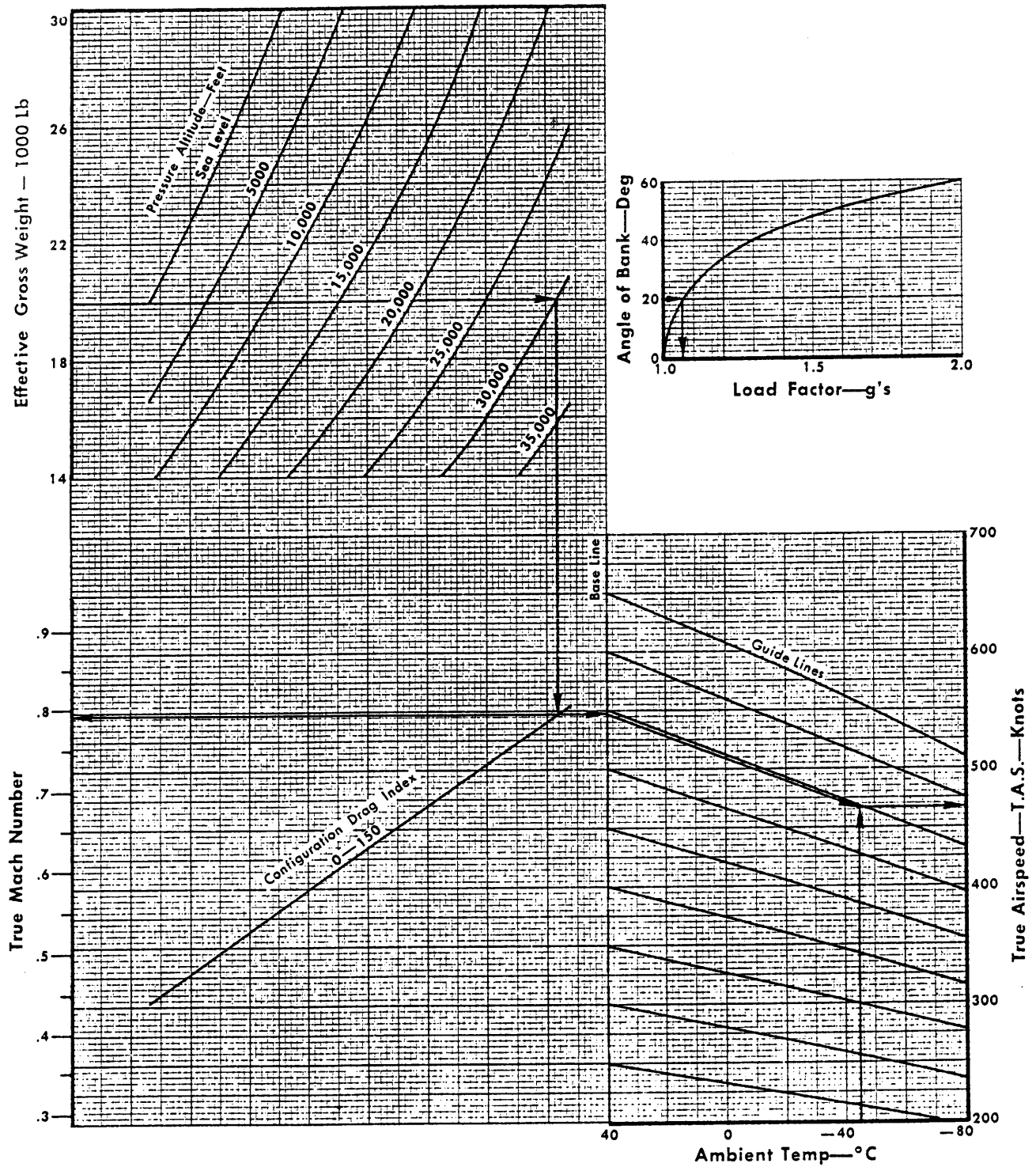

Figure A5-1 (Sheet 1 of 2)

# MAXIMUM ENDURANCE

Engine: J79-GE-19  
Fuel Grade: JP-8  
Fuel Density: 6.68 Lb/Gal

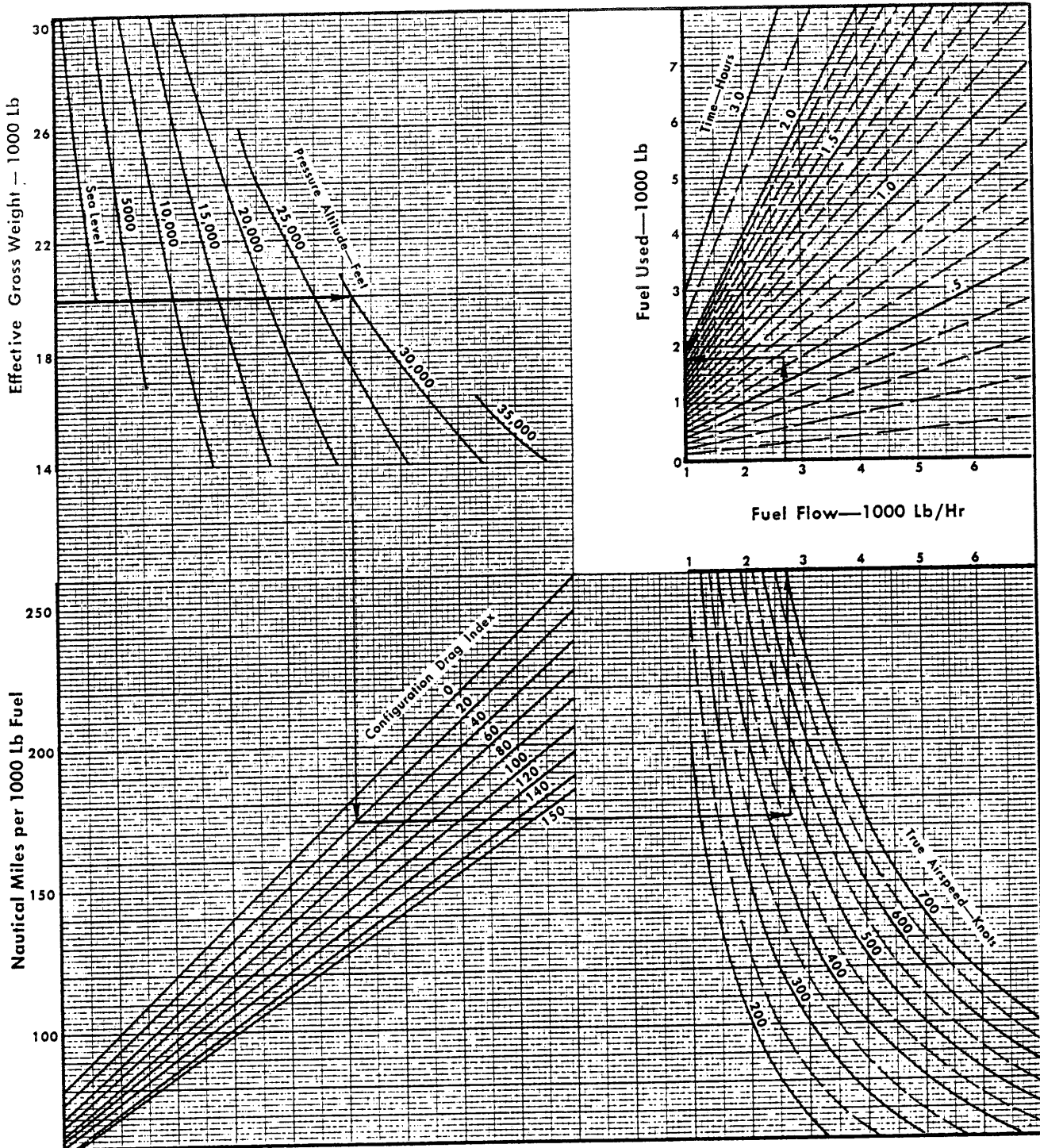

Figure A5-1 (Sheet 2 of 2)

## PART 6

### MILES PER POUND DATA

#### TABLE OF CONTENTS

Index items in bold face characters denote illustrations.

Title	Page
Miles per Pound Charts . . . . .	A6-1
<b>Nautical Miles per Pound of Fuel Charts . .</b>	<b>A6-6</b>

#### PURPOSE OF CHARTS

The purpose of the charts is to supply generalized flight planning data applicable to the cruise portion of any type of flight plan. The parametric miles-per-pound charts show subsonic level flight performance for operations between maximum endurance speeds and speeds resulting from use of military thrust.

#### MILES PER POUND CHARTS

The nautical miles per pound of fuel charts present cruise data for the speed range from maximum endurance to military thrust in a parametric form applicable to any altitude or gross weight. The chart parameters are basic plots of nautical miles per 1000 pounds of fuel  $\times \delta$  versus Mach number for various gross weights divided by  $\delta$ .

Conversion curves are supplied on the charts to find  $W/\delta$  for any flight weight and altitude condition, and actual miles per 1000 pounds of fuel from the fuel economy parameter.

Each chart includes the specific range available that will result from various speed settings and fuel flows. Engine speeds are not presented, because non-standard air conditions and the operating character-

istics of individual engines have a decided effect on the RPM setting required to maintain cruise airspeeds.

The recommended procedure is to cruise at Mach number recommended and monitor fuel flow to compare actual miles per pound with that predicted. Included are curves of recommended cruise Mach number and speeds for maximum endurance. Specific range is plotted versus true Mach numbers with conversion grids to obtain true airspeed for any ambient temperature.

#### NOTE

IAS = CAS and Indicated Mach = True Mach, because static position error calibration of the compensated pitot-static airspeed system is small and under normal operating conditions may usually be disregarded.

#### Miles per Pound Chart Index

The miles-per-pound charts are arranged in groups of configurations with similar drag characteristics. Typical configurations applicable to the fuel economy presented are illustrated on a chart in Part 1, "Introduction".

#### USE OF MILES PER POUND CHARTS

The miles-per-pound charts may be used to determine range when the speed schedules shown on the range charts are not satisfactory for mission requirements. The condition might arise on a buddy mission for example, when a long range speed schedule shall be selected which is a compromise between the maximum range schedules for two types of aircraft.

**MILES PER POUND CHART SAMPLE PROBLEM  
- RANGE**

Determine the range available, time required, and fuel flow to cruise in level flight at a constant true Mach 0.90 at 30000 ft. The initial cruise gross weight is 18000 lb and a 1000-lb reserve is desired. Assume a standard day with a 60-knot headwind component. The aircraft has a configuration drag index of 0, zero fuel weight assumed is 15500 lb.

standard temperature at 30000 feet. Horizontally from this point read cruise true airspeed of 530 knots.

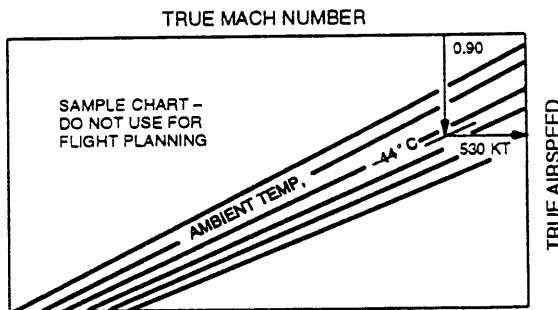
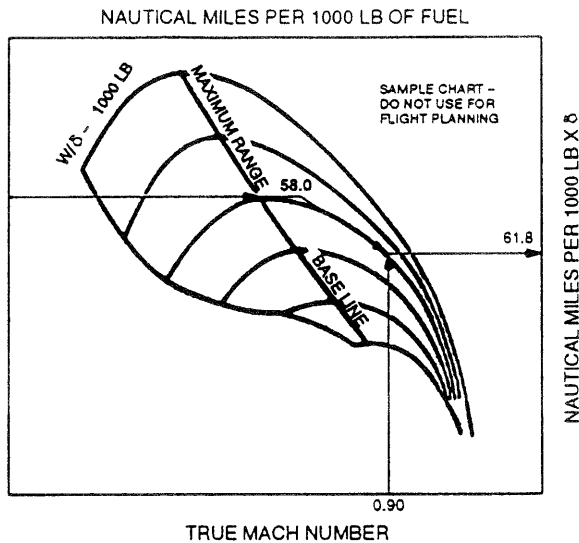
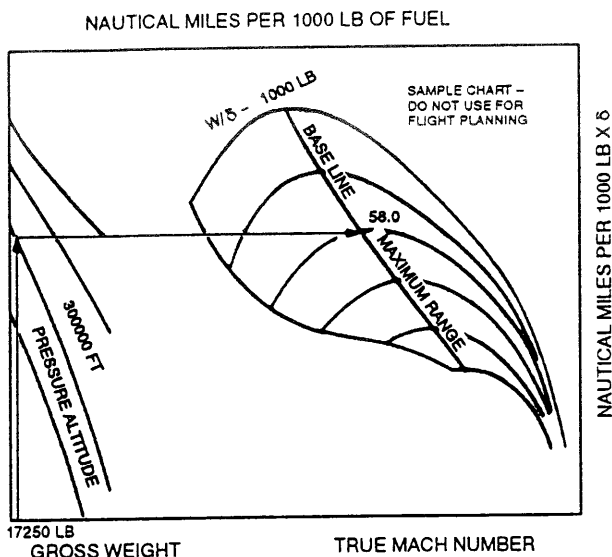

- Gross weight with a 1000-lb reserve is 16500 lb (15500 + 1000).
- Average cruise gross weight is 17250 lb (18000 + 16500)/2.
- Enter the  $W/\delta$  conversion chart at the average cruise gross weight and the cruise pressure altitude, proceed horizontally right to the base line, and read cruise  $W/\delta$  of 58000 lb.
- Enter the parametric fuel economy curve with the cruise true Mach of 0.90, proceed to the cruise  $W/\delta$ , and read nautical miles per 1000 lb of fuel  $x = 61.8 \text{ nmi}/1000 \text{ lb} \times \delta$ .
- From the same cruise true Mach number proceed vertically downward to  $-44^\circ \text{ C}$ , the

- Groundspeed,  $V_g$ , is 470 knots (530 - 60).
- To determine average air nautical miles per pound of fuel enter chart on right at 61.8 obtained in step d, proceed to the cruise pressure altitude, and read 208 air nautical miles per 1000 lb of fuel.

FA0293

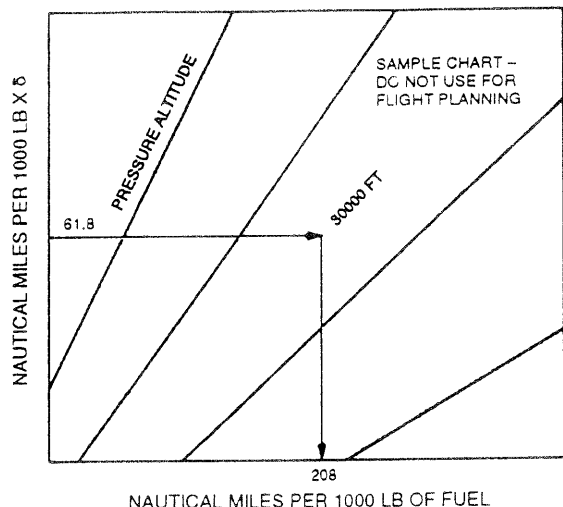

h. Determine the average ground nmi/1000 lb by using the formula:

$$\frac{\text{ground nmi}}{1000 \text{ lb fuel}} = \frac{\text{air nmi}}{1000 \text{ lb fuel}} \times \frac{\text{GS}}{\text{TAS}} =$$

$$208 \times \frac{470}{530} = 184.5 \times \frac{\text{nmi}}{1000 \text{ lb}}$$

- i. Fuel to be used in cruise is 1500 lb (18000 - 16500).
- j. Range available is 277 nmi = (184.5/1000 × 1500).
- k. Time required is 35.5 min (277/470).
- l. From the air nautical miles per 1000 lb of fuel obtained in step g, continue vertically downward and opposite the TAS read average fuel flow of 2540 lb/hr.

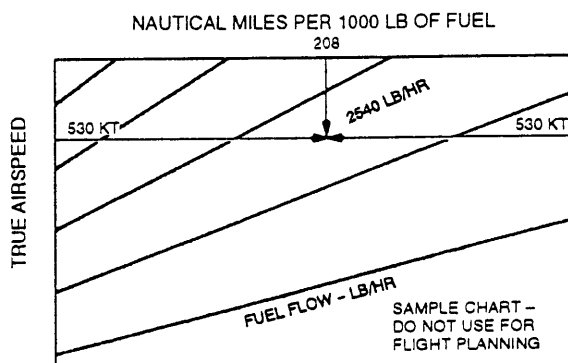

**NAUTICAL MILES PER POUND SAMPLE PROBLEM - ENDURANCE**

For an initial loiter gross weight of 18000 pounds, determine the loiter time at 20000 feet if 2000 pounds of fuel are available.

a. Determine the initial and average W/δ at the loiter altitude:

18000 lb at 20000 ft = 39200 lb  
 17000 lb at 20000 ft = 37000 lb

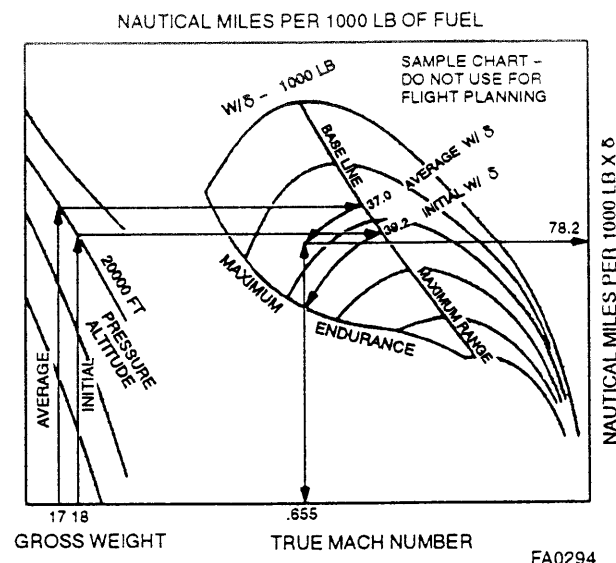

b. Find the intersection of the initial W/δ on the maximum endurance schedule on the left side of the fuel economy curve (the recommended loiter speed):

True Mach is 0.655  
 TAS at 20000 ft is 402 knots

c. Reenter at the average W/δ of 37000 lb. At the intersection of 37000 W/δ and the loiter Mach of 0.655 read 78.2 nautical miles per 1000 lb of fuel × δ.

d. Enter the right hand chart at 78.2 and the loiter altitude and read 170 nmi/1000 lb. Continue vertically downward opposite the loiter TAS and read average fuel flow of 2360 lb/hr.

e. Loiter time is 2000 lb fuel/2360 lb/hr = 0.848 hr, or 51 min.

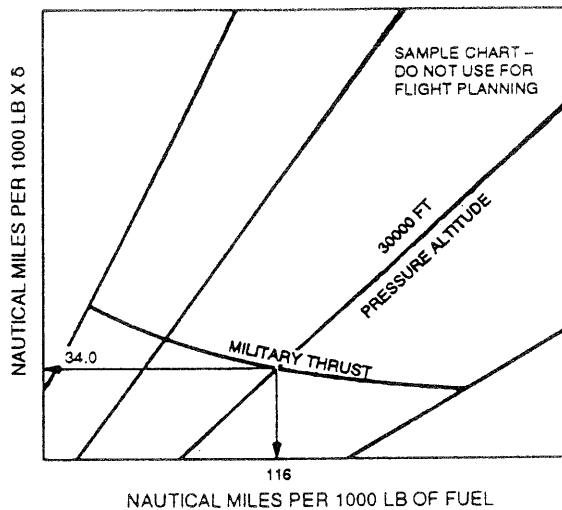
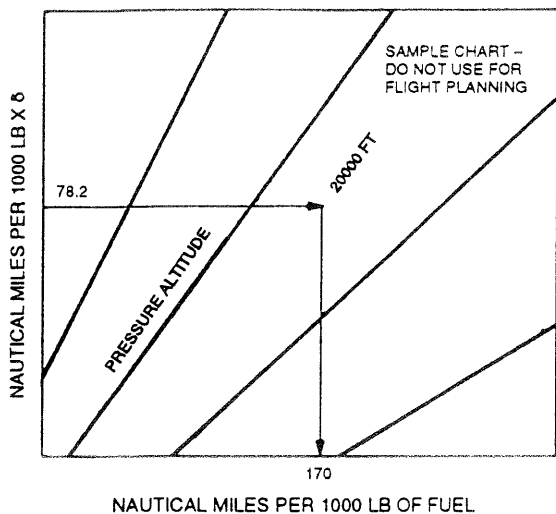

**MILES PER POUND CHART SAMPLE PROBLEM - MILITARY THRUST**

Reverse the order of sample problem sequence if the speed available at military thrust is desired. For the 30000-foot example conditions of the range problem, at the intersection of the military thrust line, the following result is obtained:

Nautical miles per 1000 lb of fuel  $\times \delta$  ..... 34.0  
 Actual fuel economy (nmi/1000 lb fuel) ..... 116

Enter the left-hand chart at 34 (F.E.  $\times \delta$ ) intersecting the 58,000 lb  $W/\delta$  and read:

True Mach number ..... 0.998  
 True airspeed ..... 588 knots

NAUTICAL MILES PER 1000 LB OF FUEL

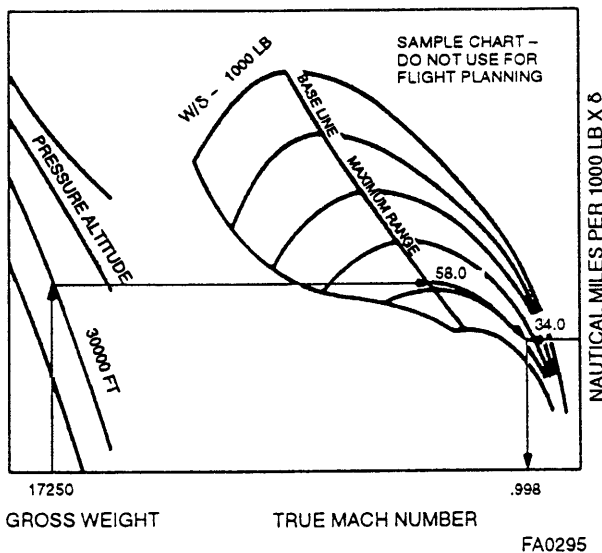

Reenter the right hand chart at 588 knots TAS and 116 nmi/1000 lb of fuel and read fuel flow of 5140 lb/hr.

## NAUTICAL MILES PER 1000 LB OF FUEL CONFIGURATION DRAG INDEX 0

Model: F-104S  
Date: 1 June 1969  
DATA BASIS: FLIGHT TEST

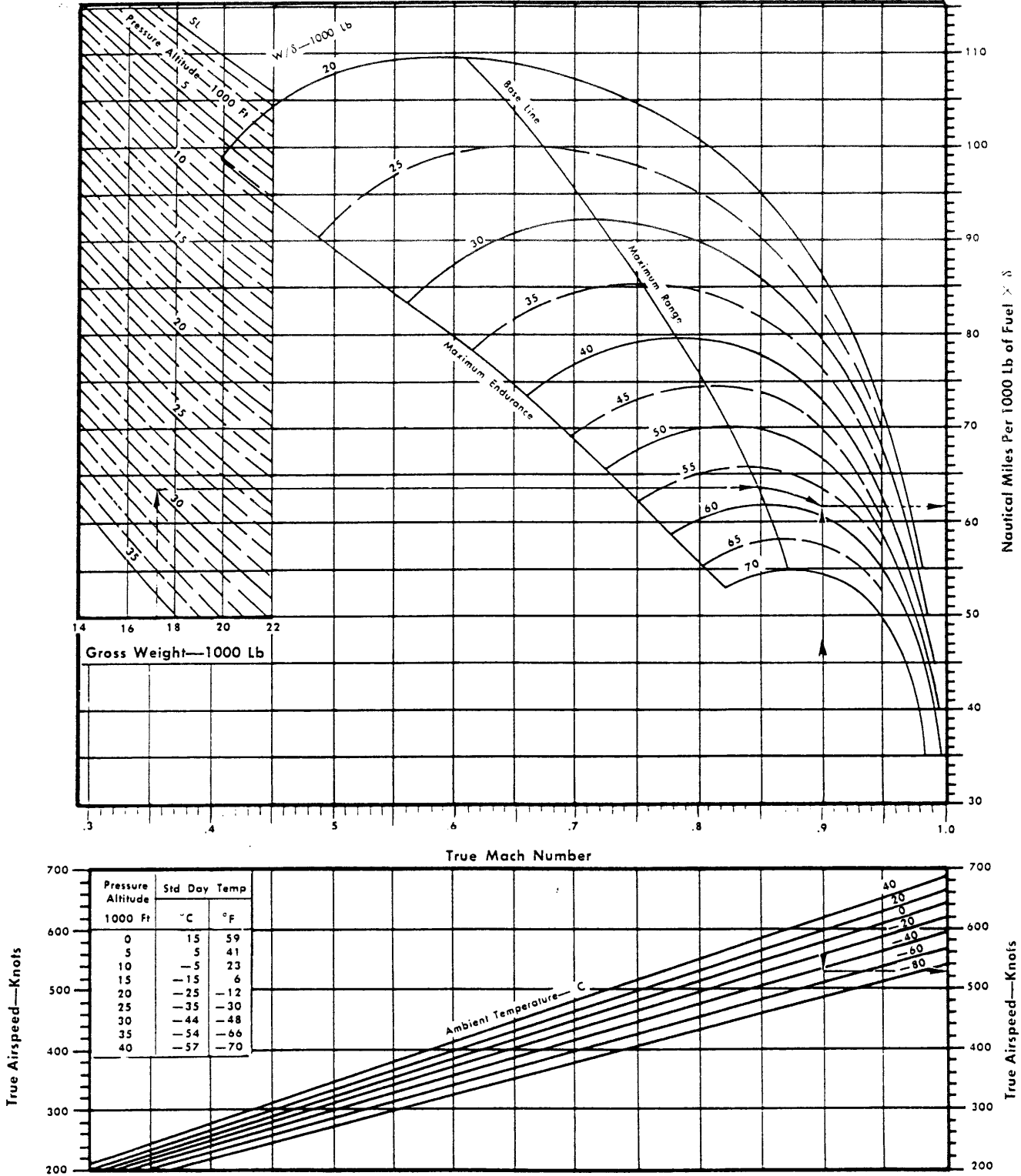

Figure A6-1 (Sheet 1 of 2)

# NAUTICAL MILES PER 1000 LB OF FUEL CONFIGURATION DRAG INDEX 0

Engine: J79-GE-19  
Fuel Grade: JP-8  
Fuel Density: 6.68 Lb/Gal

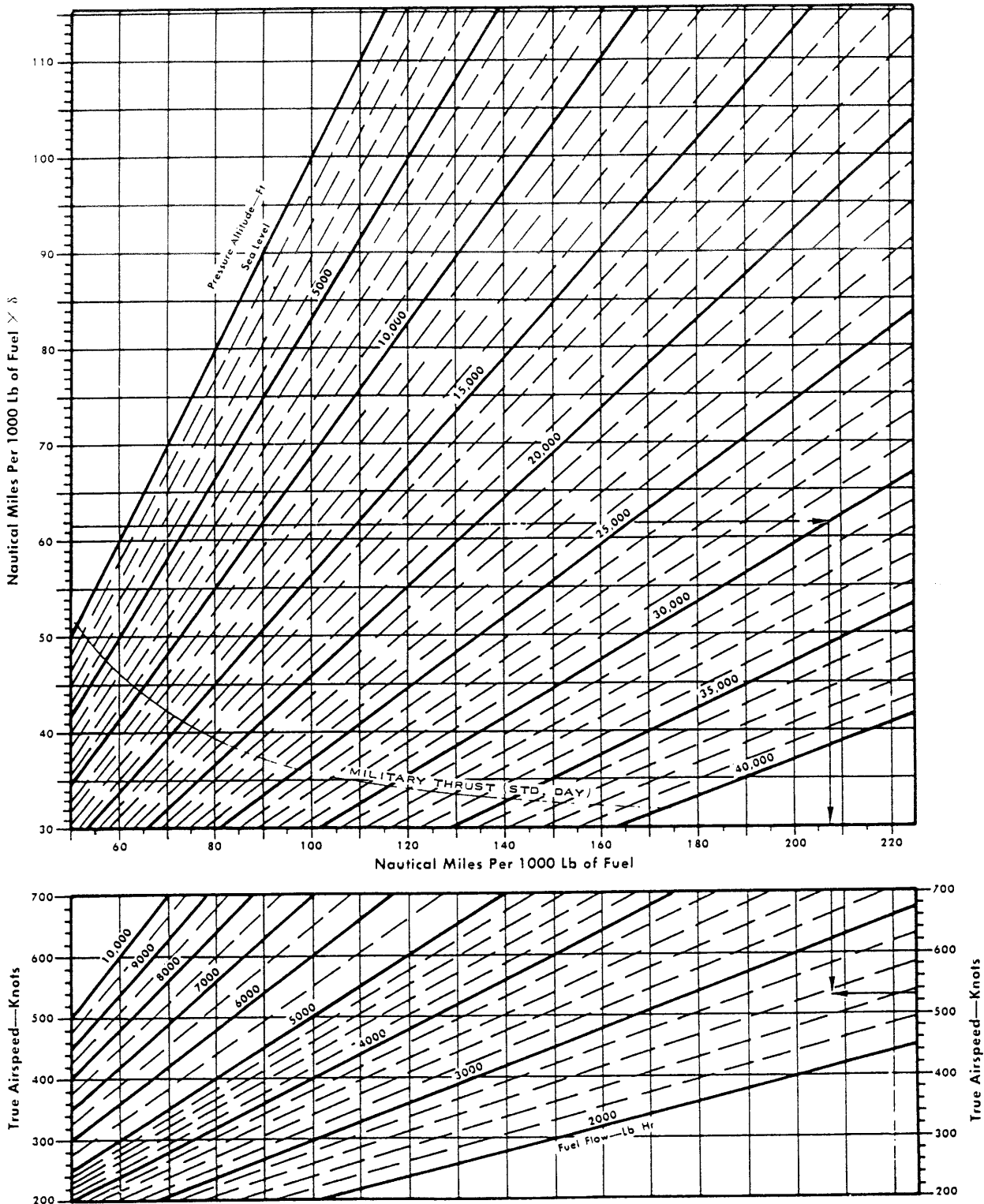

Figure A6-1 (Sheet 2 of 2)



# NAUTICAL MILES PER 1000 LB OF FUEL

## CONFIGURATION DRAG INDEX 10

Model: F-104S  
 Date: 1 June 1969  
 DATA BASIS: FLIGHT TEST

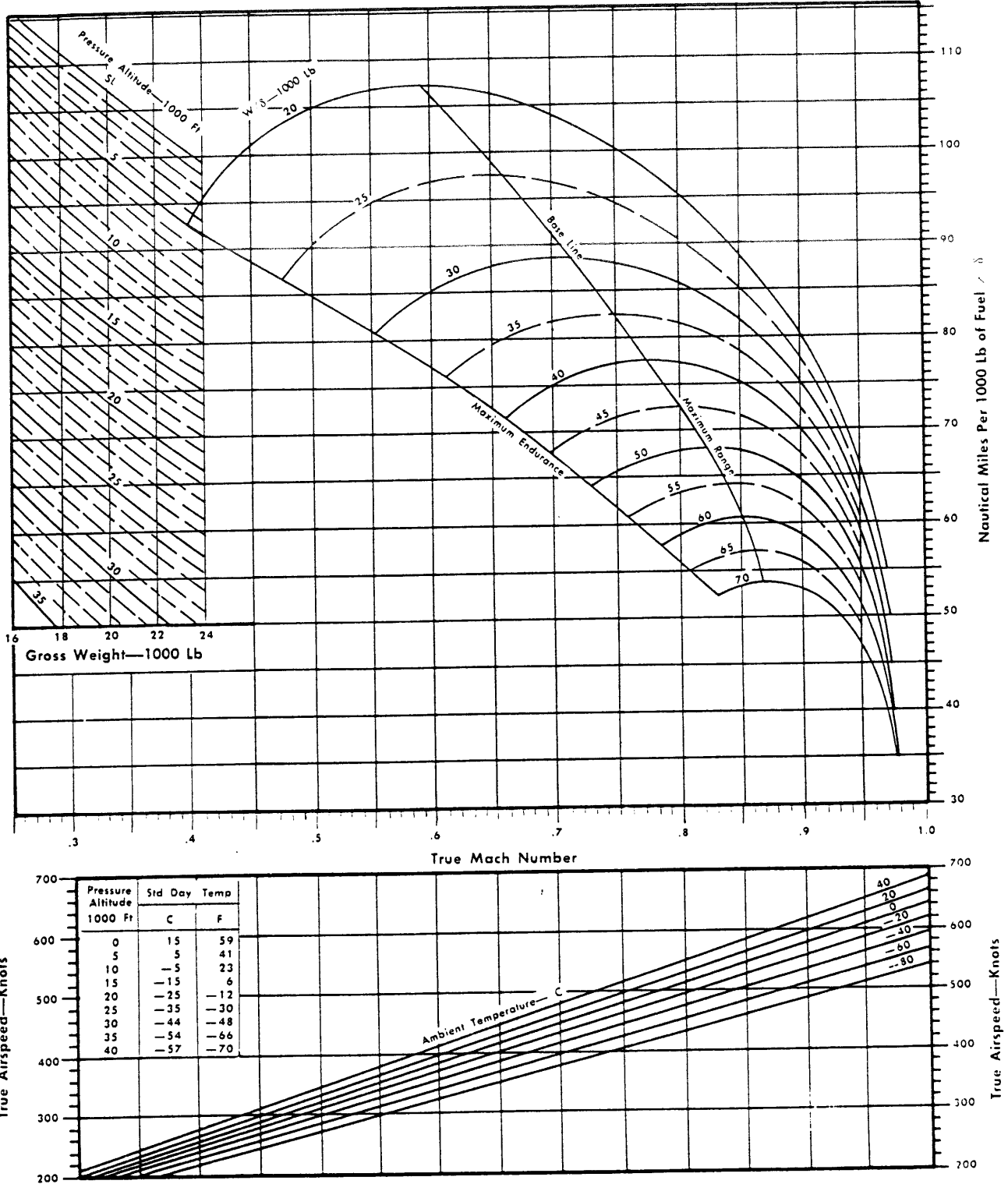

Figure A6-2 (Sheet 1 of 2)

# NAUTICAL MILES PER 1000 LB OF FUEL

## CONFIGURATION DRAG INDEX 10

Engine: J79-GE-19  
Fuel Grade: JP-8  
Fuel Density: 6.68 Lb/Gal

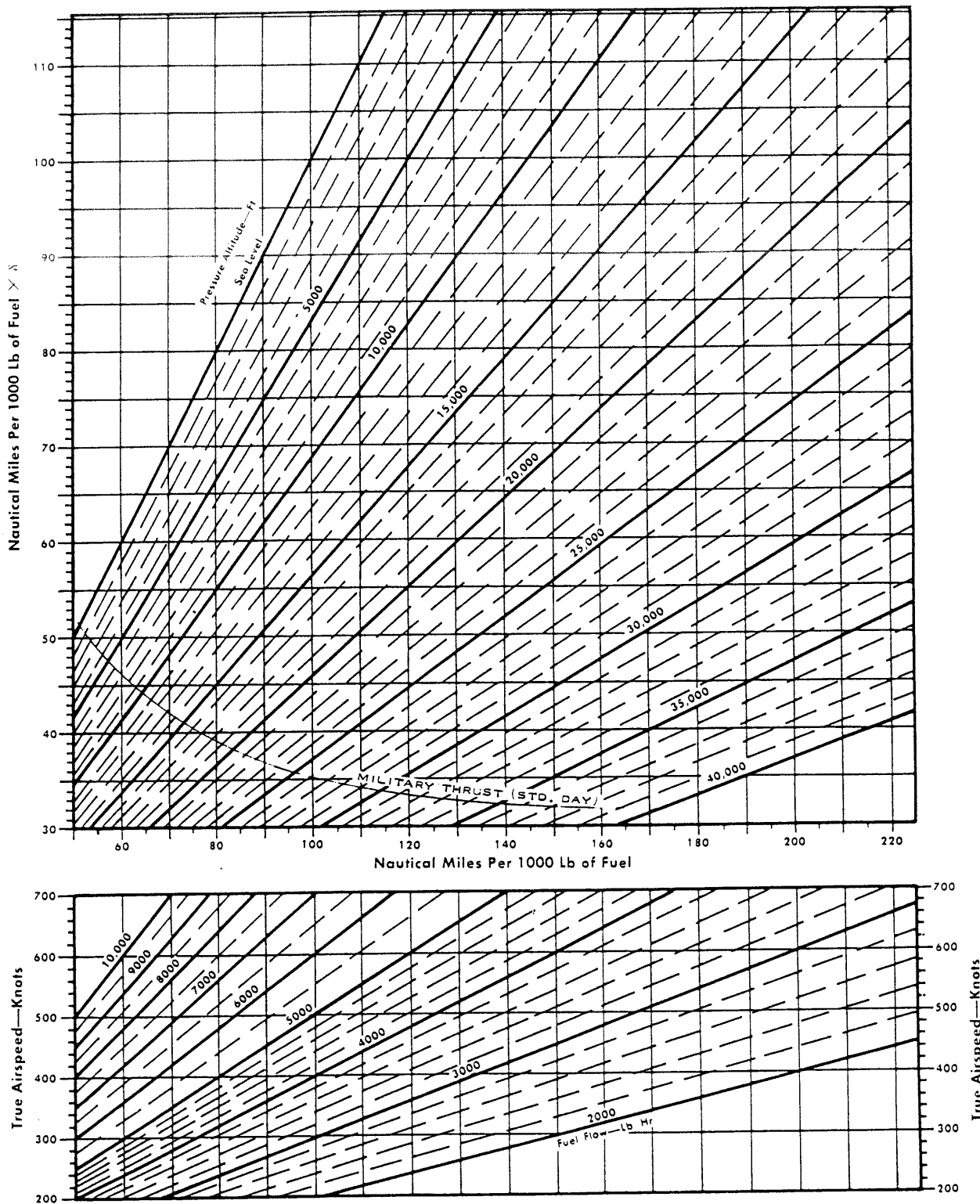

Figure A6-2 (Sheet 2 of 2)

## NAUTICAL MILES PER 1000 LB OF FUEL CONFIGURATION DRAG INDEX 20

Model: F-104S  
Date: 1 June 1969  
DATA BASIS: FLIGHT TEST

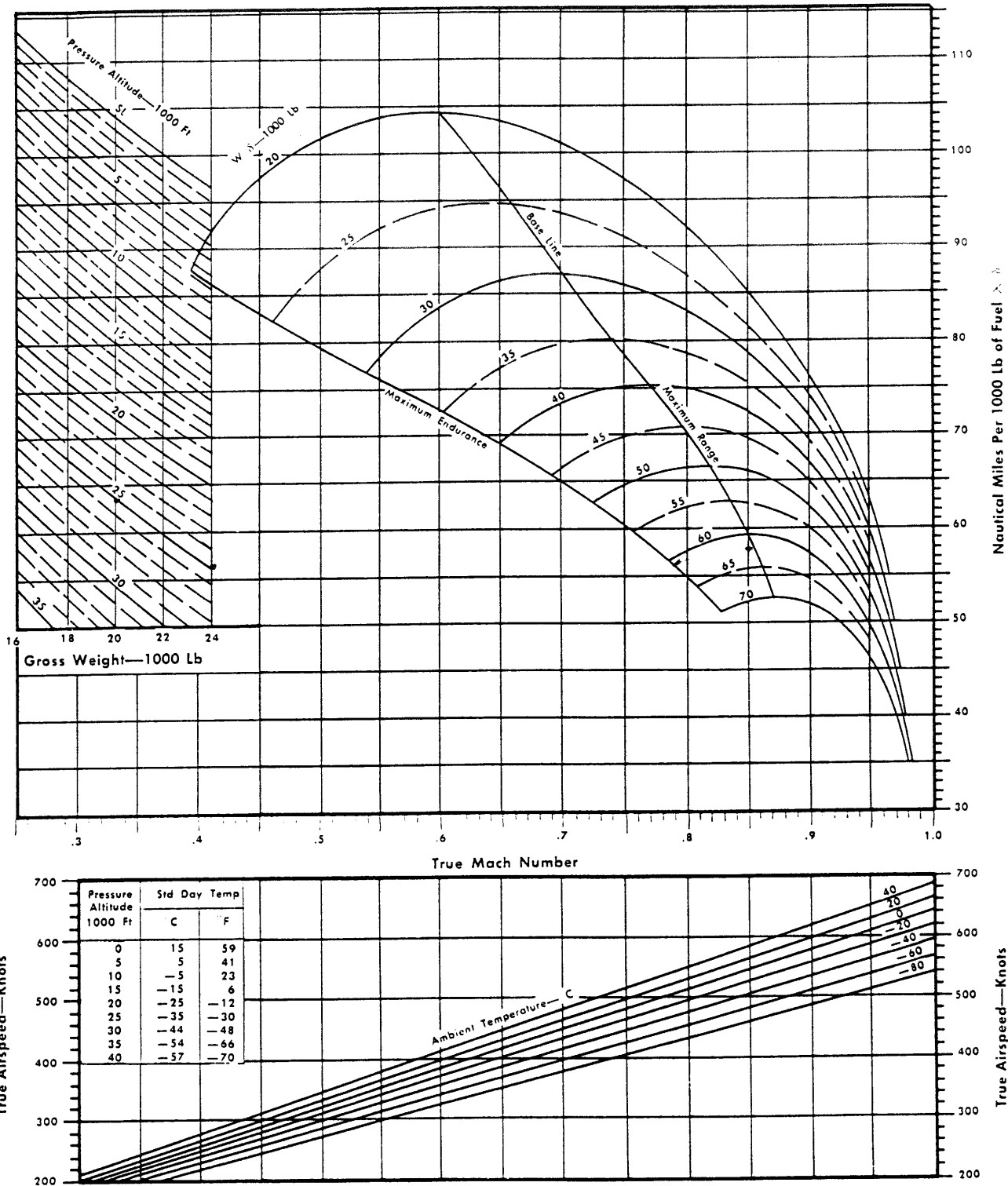

Figure A6-3 (Sheet 1 of 2)

## NAUTICAL MILES PER 1000 LB OF FUEL CONFIGURATION DRAG INDEX 20

Engine: J79-GE-19  
Fuel Grade: JP-8  
Fuel Density: 6.68 Lb/Gal

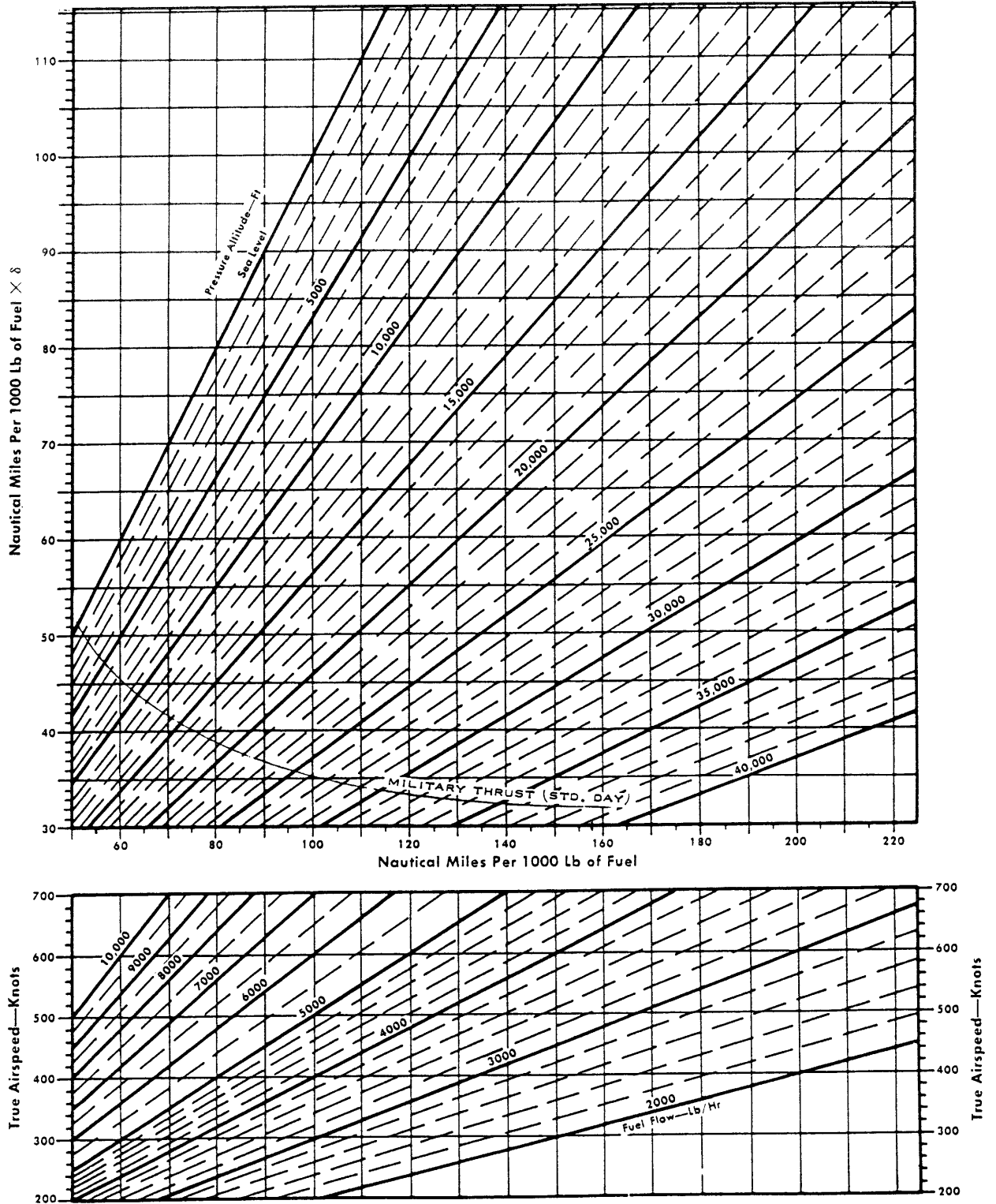

Figure A6-3 (Sheet 2 of 2)

## NAUTICAL MILES PER 1000 LB OF FUEL CONFIGURATION DRAG INDEX 30

Model: F-104S  
Date: 1 June 1969  
DATA BASIS: FLIGHT TEST

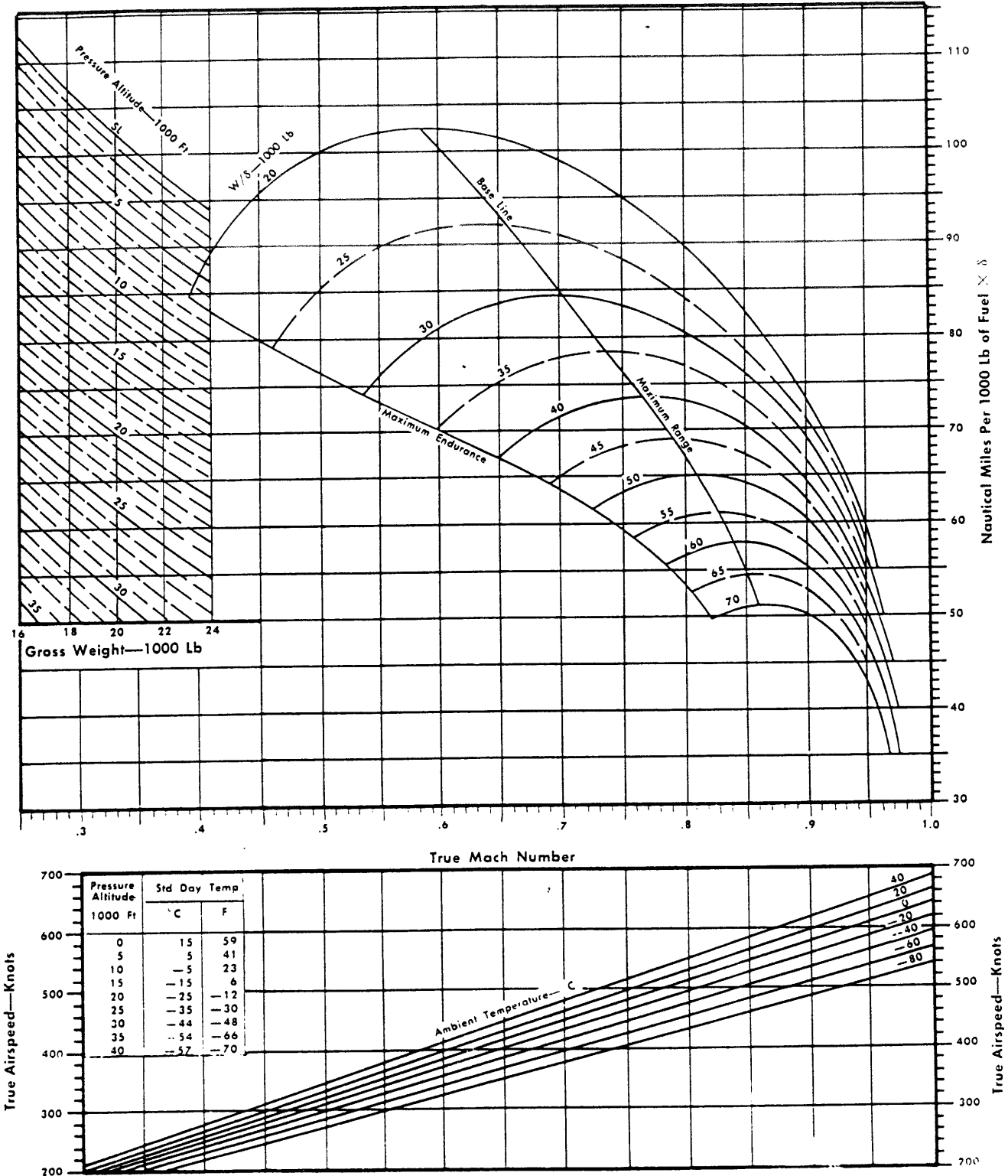

Figure A6-4 (Sheet 1 of 2)

# NAUTICAL MILES PER 1000 LB OF FUEL

## CONFIGURATION DRAG INDEX 30

Engine: J79-GE-19  
 Fuel Grade: JP-8  
 Fuel Density: 6.68 Lb/Gal

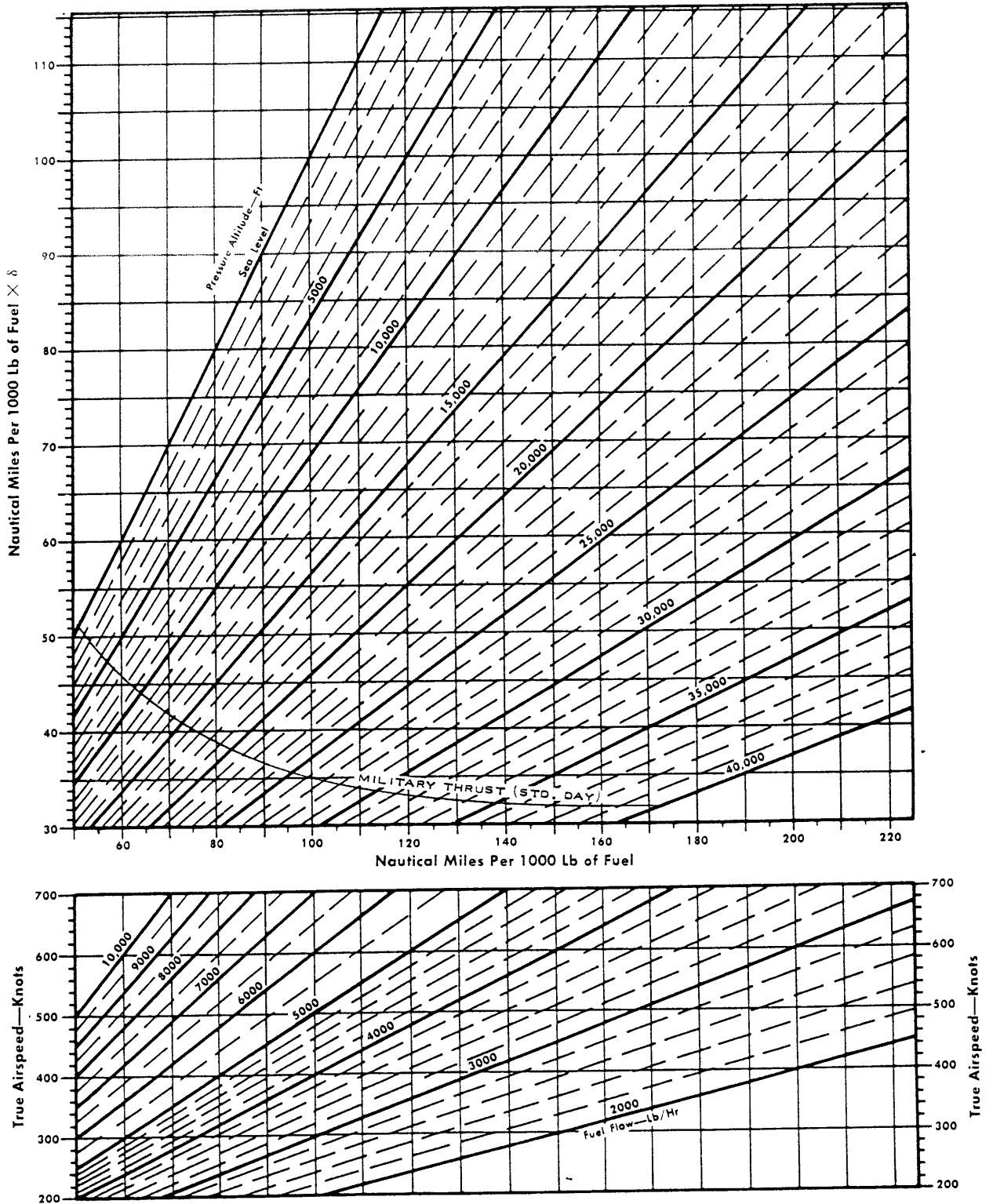

Figure A6-4 (Sheet 2 of 2)

# NAUTICAL MILES PER 1000 LB OF FUEL

## CONFIGURATION DRAG INDEX 40

Model: F-104S  
 Date: 1 June 1969  
 DATA BASIS: FLIGHT TEST

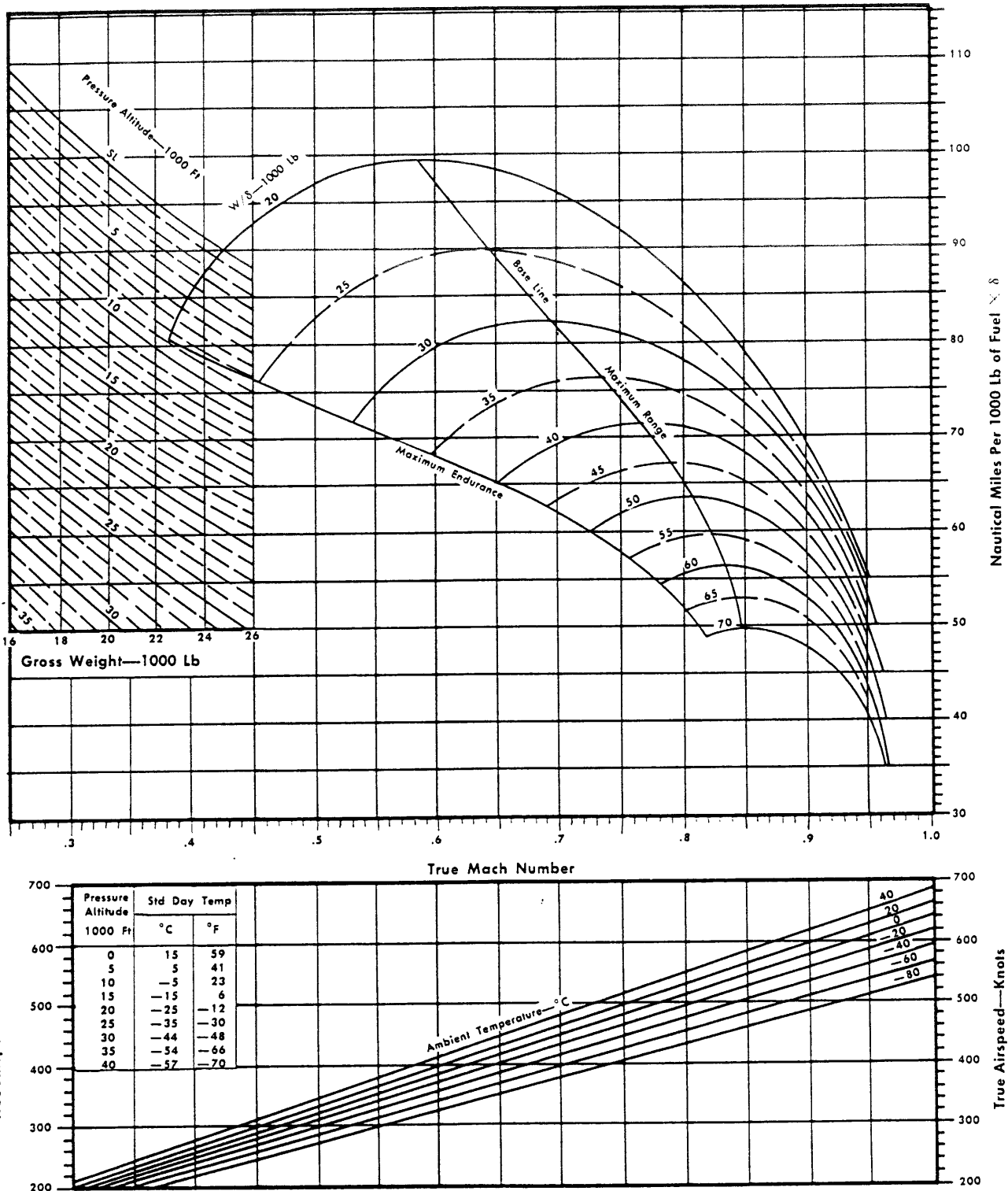

Figure A6-5 (Sheet 1 of 2)

## NAUTICAL MILES PER 1000 LB OF FUEL

### CONFIGURATION DRAG INDEX 40

Engine: J79-GE-19  
 Fuel Grade: JP-8  
 Fuel Density: 6.68 Lb/Gal

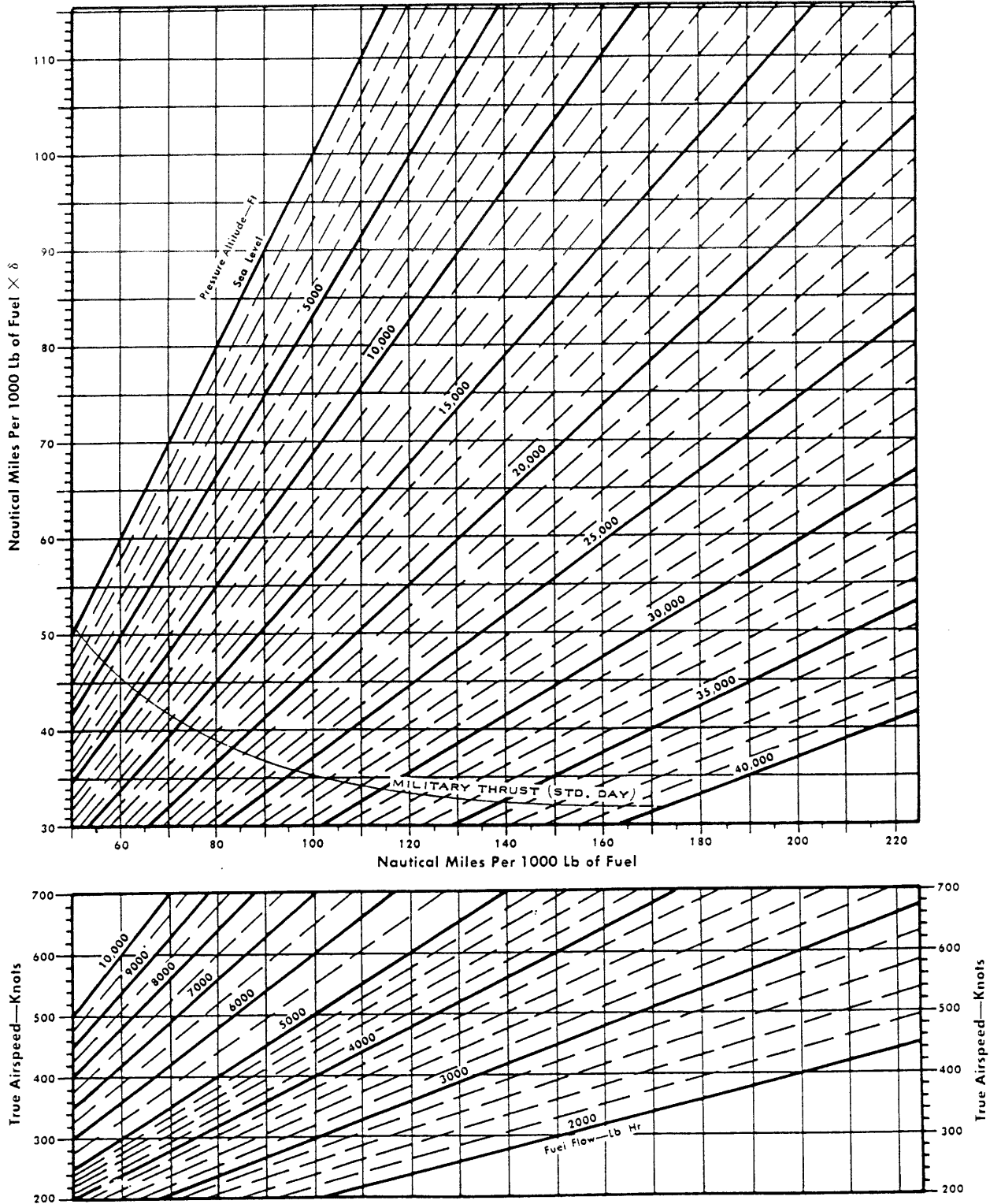

Figure A6-5 (Sheet 2 of 2)



## NAUTICAL MILES PER 1000 LB OF FUEL

### CONFIGURATION DRAG INDEX 50

Model: F-104S  
 Date: 1 June 1969  
 DATA BASIS: FLIGHT TEST

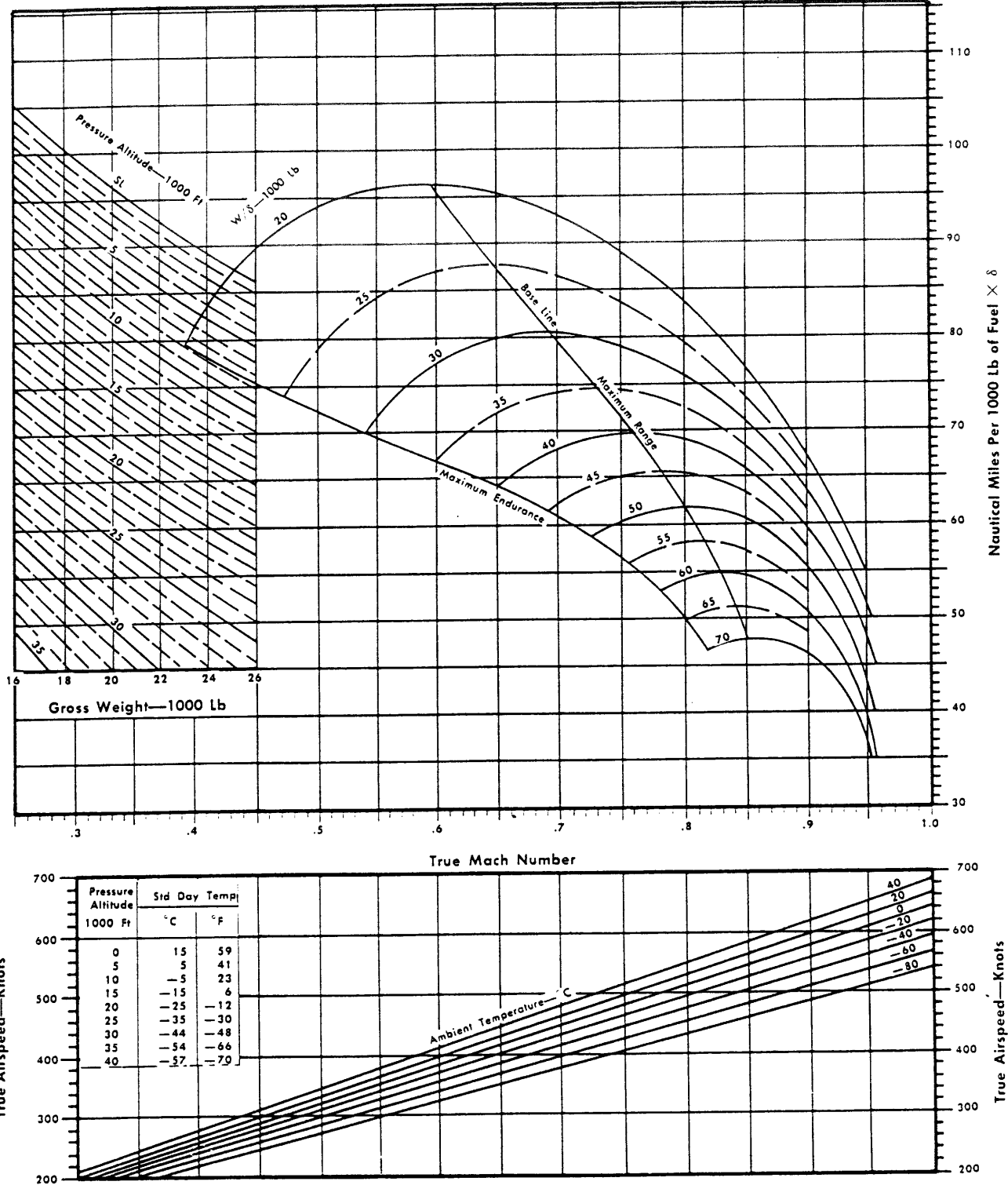

Figure A6-6 (Sheet 1 of 2)

# NAUTICAL MILES PER 1000 LB OF FUEL

## CONFIGURATION DRAG INDEX 50

Engine: J79-GE-19  
Fuel Grade: JP-8  
Fuel Density: 6.68 Lb/Gal

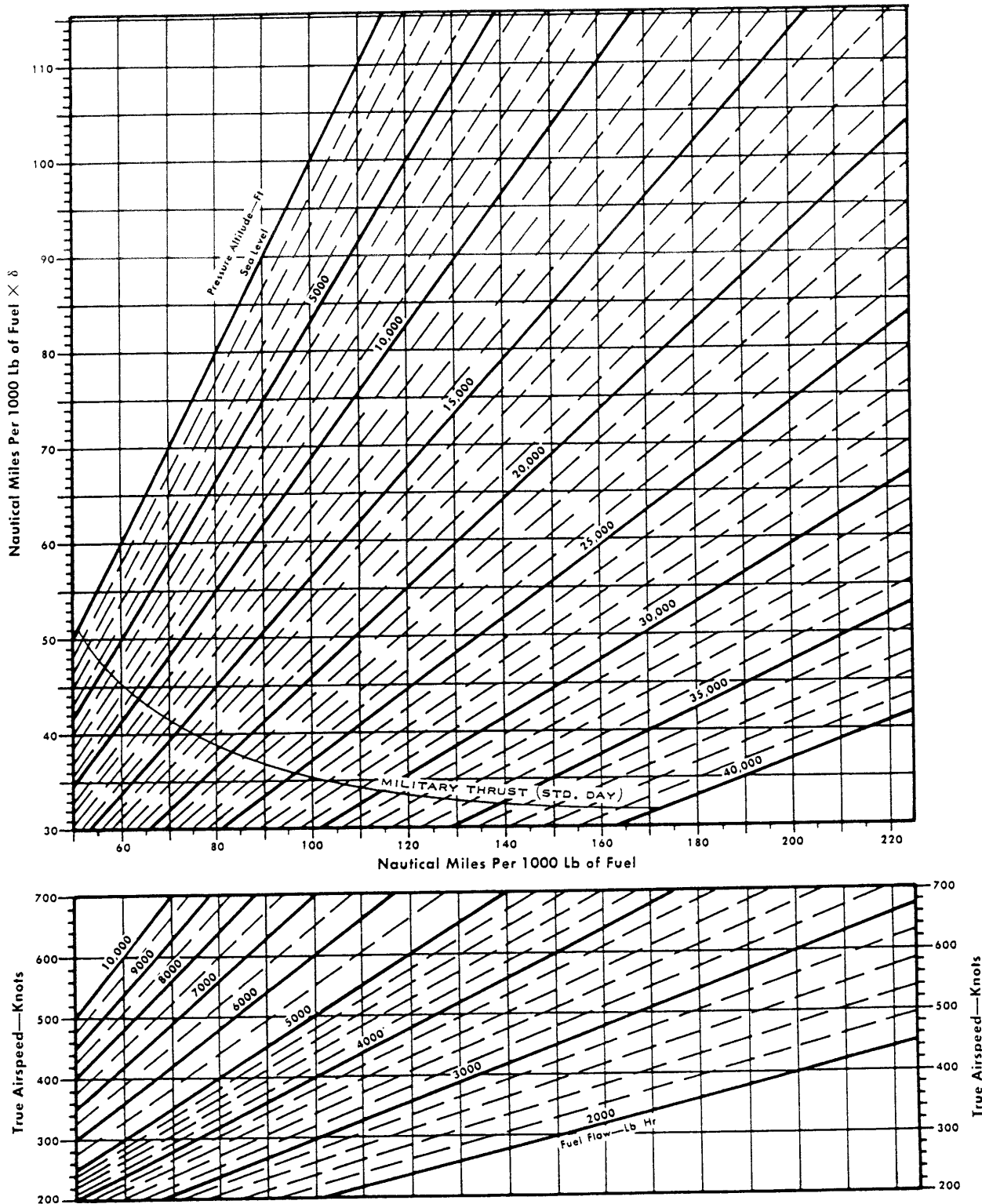

Figure A6-6 (Sheet 2 of 2)

## NAUTICAL MILES PER 1000 LB OF FUEL CONFIGURATION DRAG INDEX 60

Model: F-104S  
Date: 1 June 1969  
DATA BASIS: FLIGHT TEST

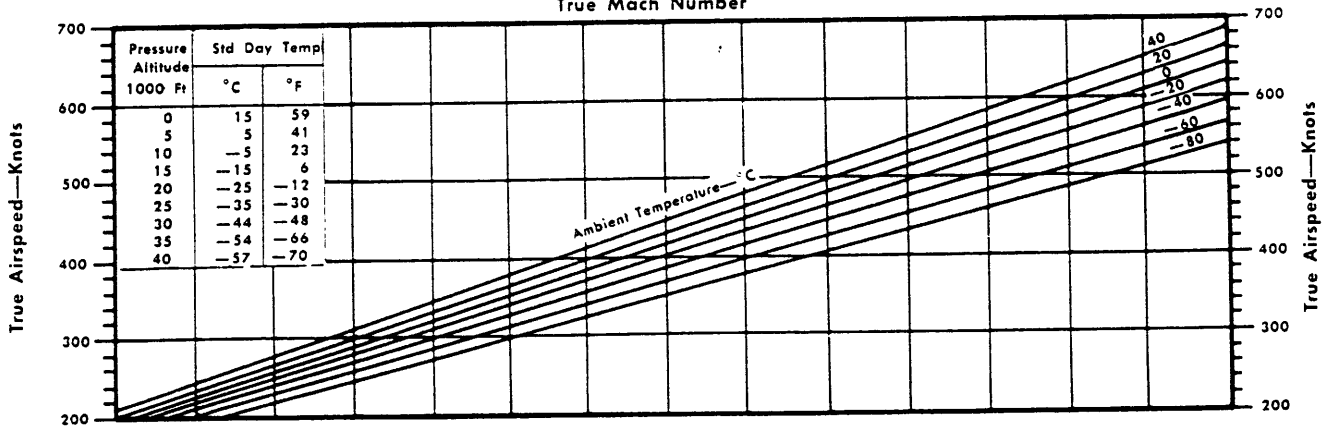
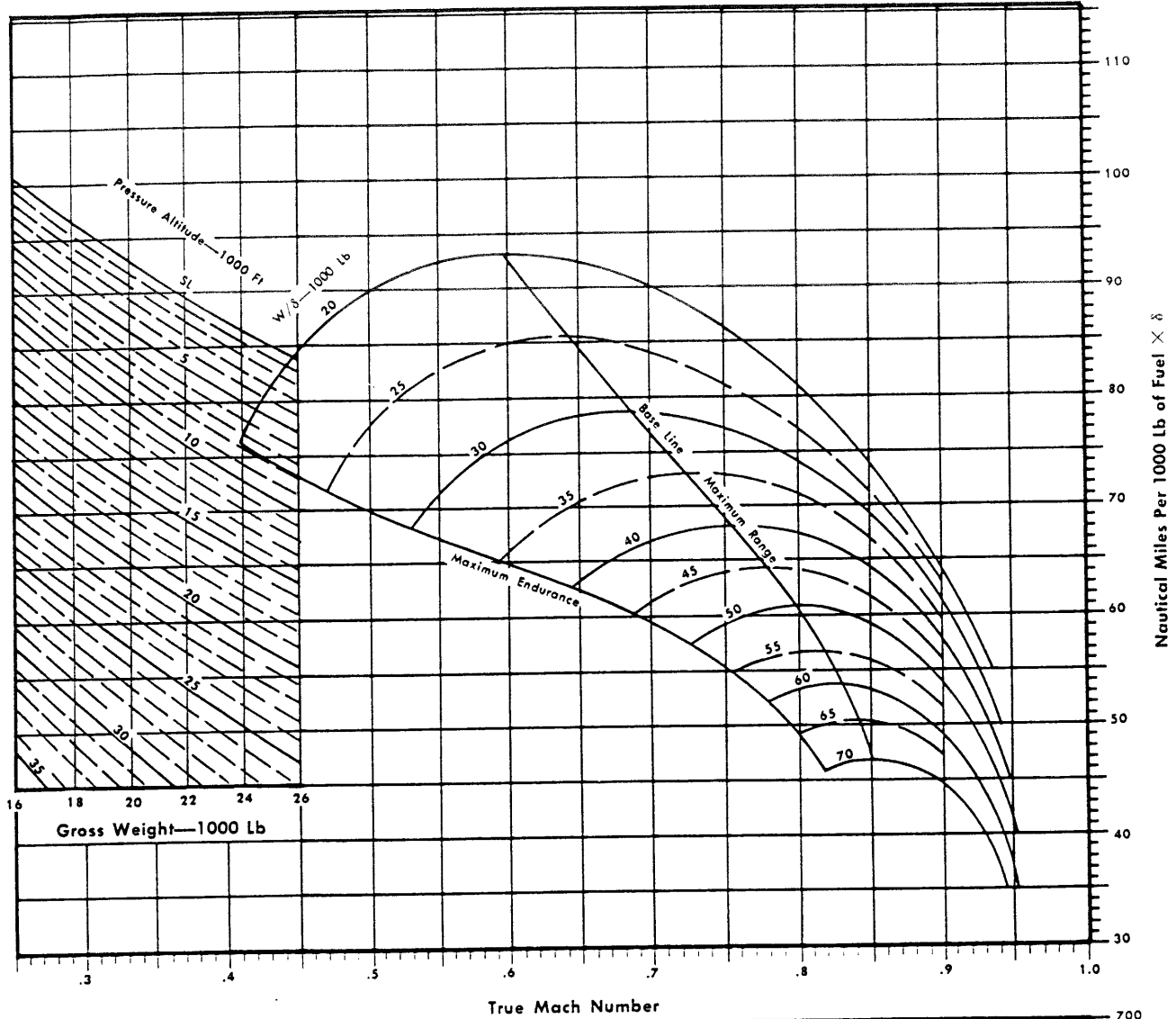

Figure A6-7 (Sheet 1 of 2)

# NAUTICAL MILES PER 1000 LB OF FUEL

## CONFIGURATION DRAG INDEX 60

Engine: J79-GE-19  
 Fuel Grade: JP-8  
 Fuel Density: 6.68 Lb/Gal

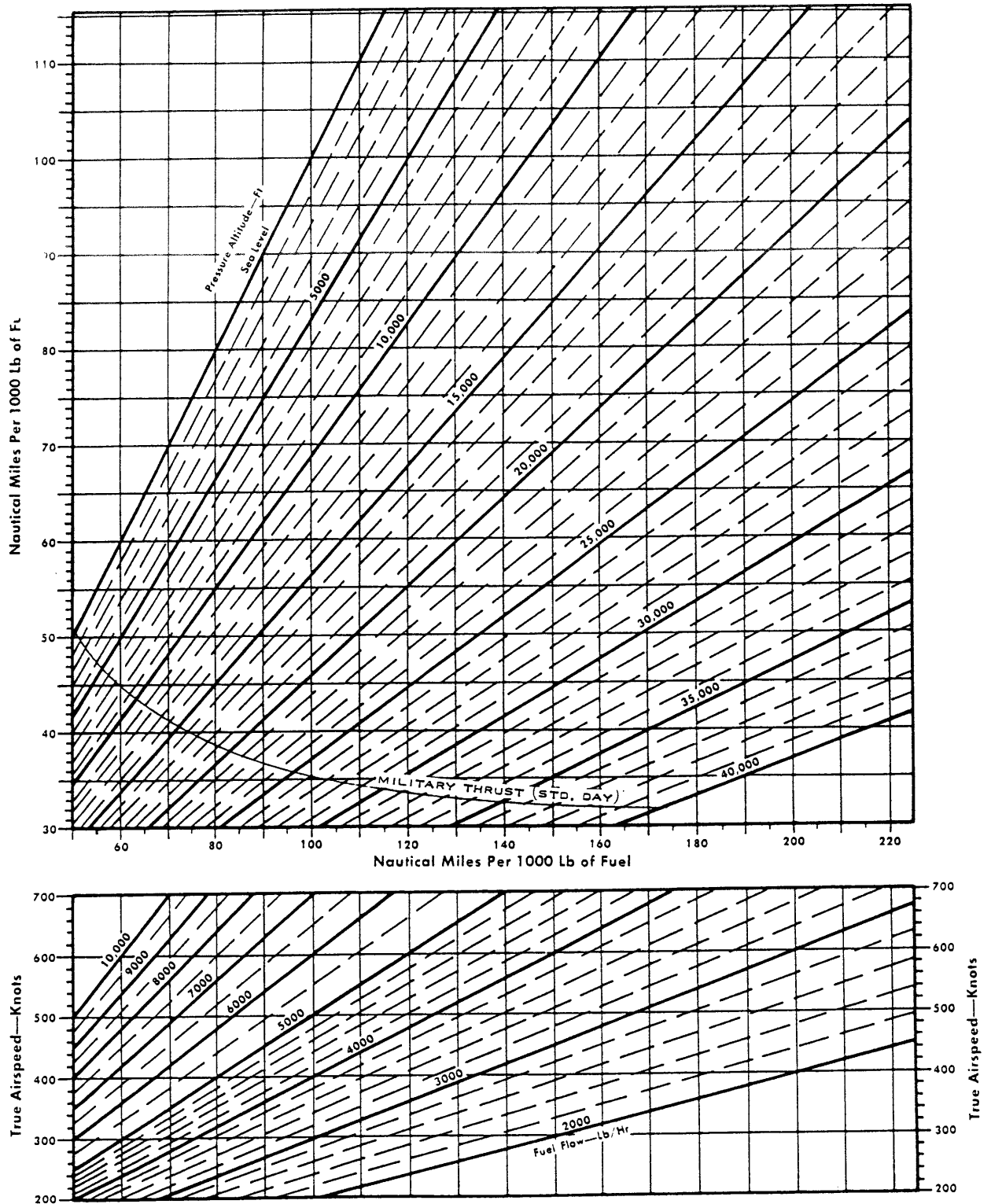

Figure A6-7 (Sheet 2 of 2)

# NAUTICAL MILES PER 1000 LB OF FUEL

## CONFIGURATION DRAG INDEX 70

Model: F-104S  
 Date: 1 June 1969  
 DATA BASIS: FLIGHT TEST

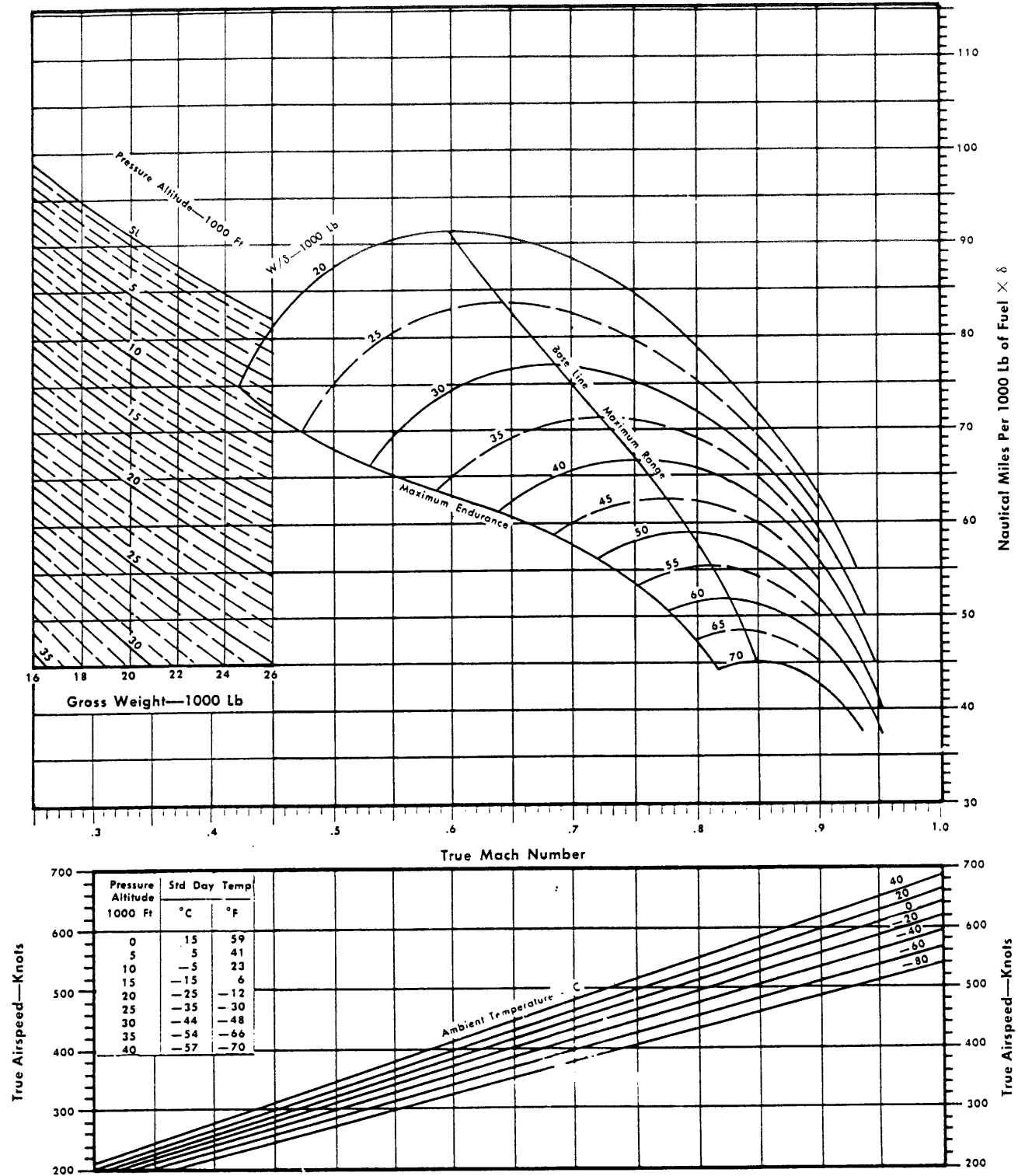

Figure A6-8 (Sheet 1 of 2)

# NAUTICAL MILES PER 1000 LB OF FUEL

## CONFIGURATION DRAG INDEX 70

Engine: J79-GE-19  
Fuel Grade: JP-8  
Fuel Density: 6.68 Lb/Gal

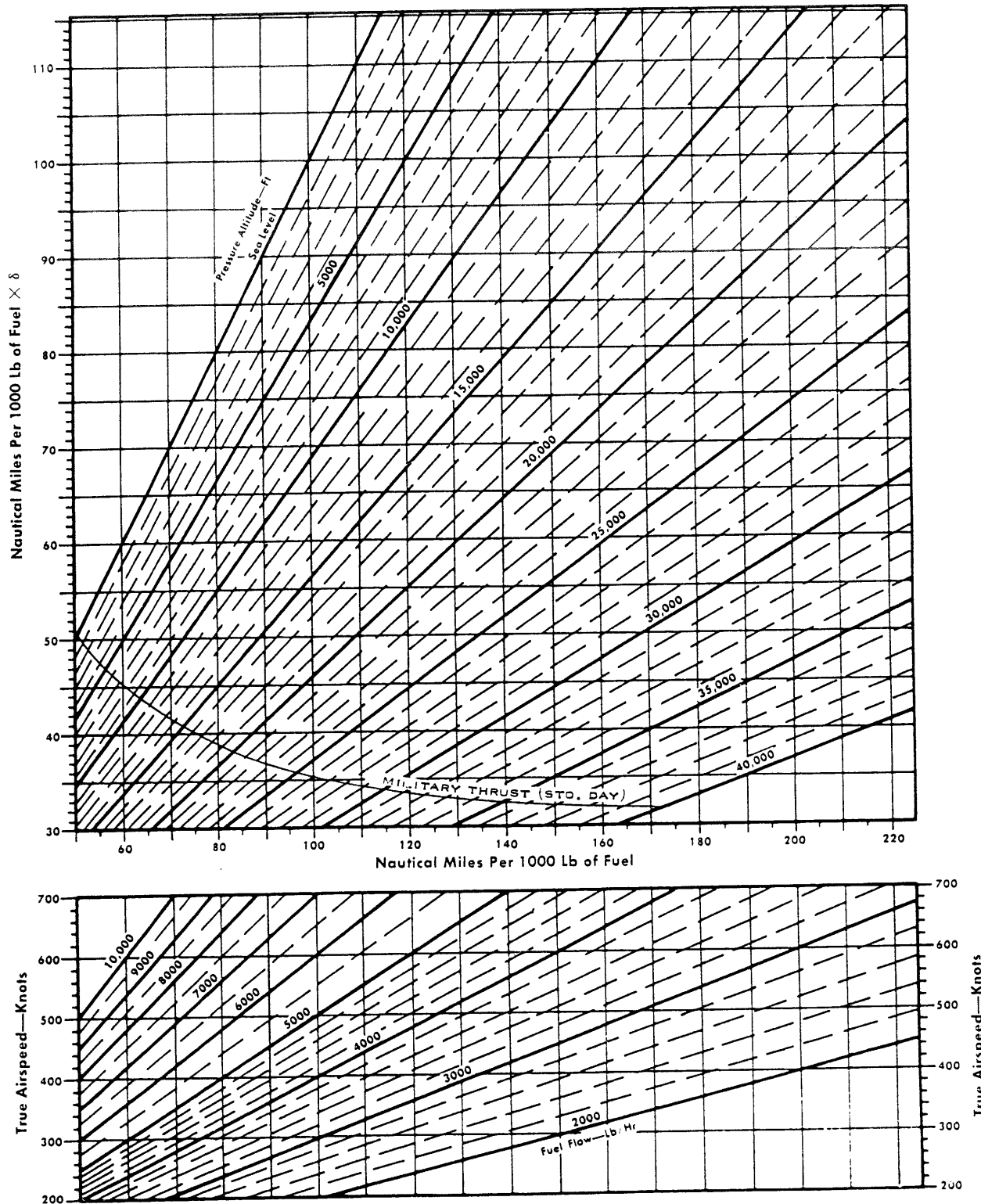

Figure A6-8 (Sheet 2 of 2)

## NAUTICAL MILES PER 1000 LB OF FUEL CONFIGURATION DRAG INDEX 80

Model: F-104S  
Date: 1 June 1969  
DATA BASIS: FLIGHT TEST

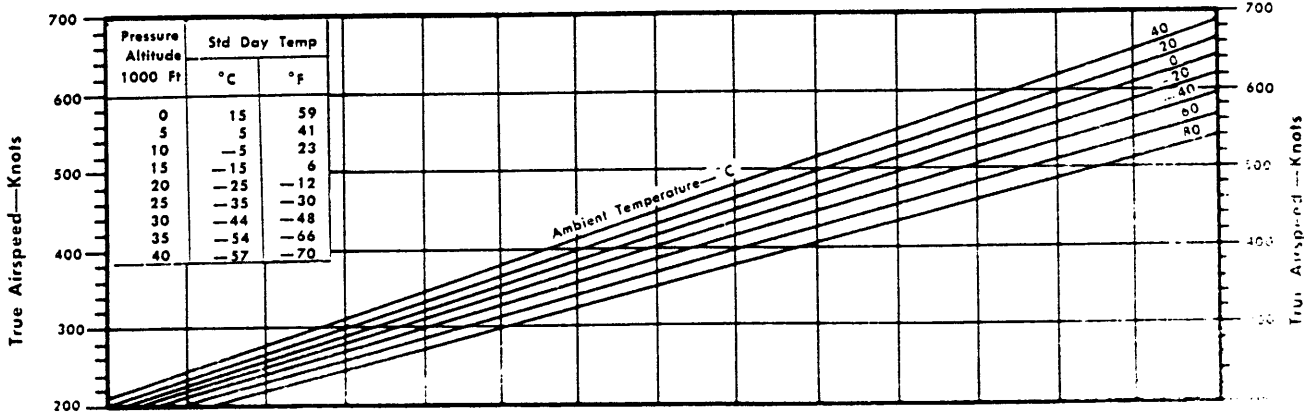
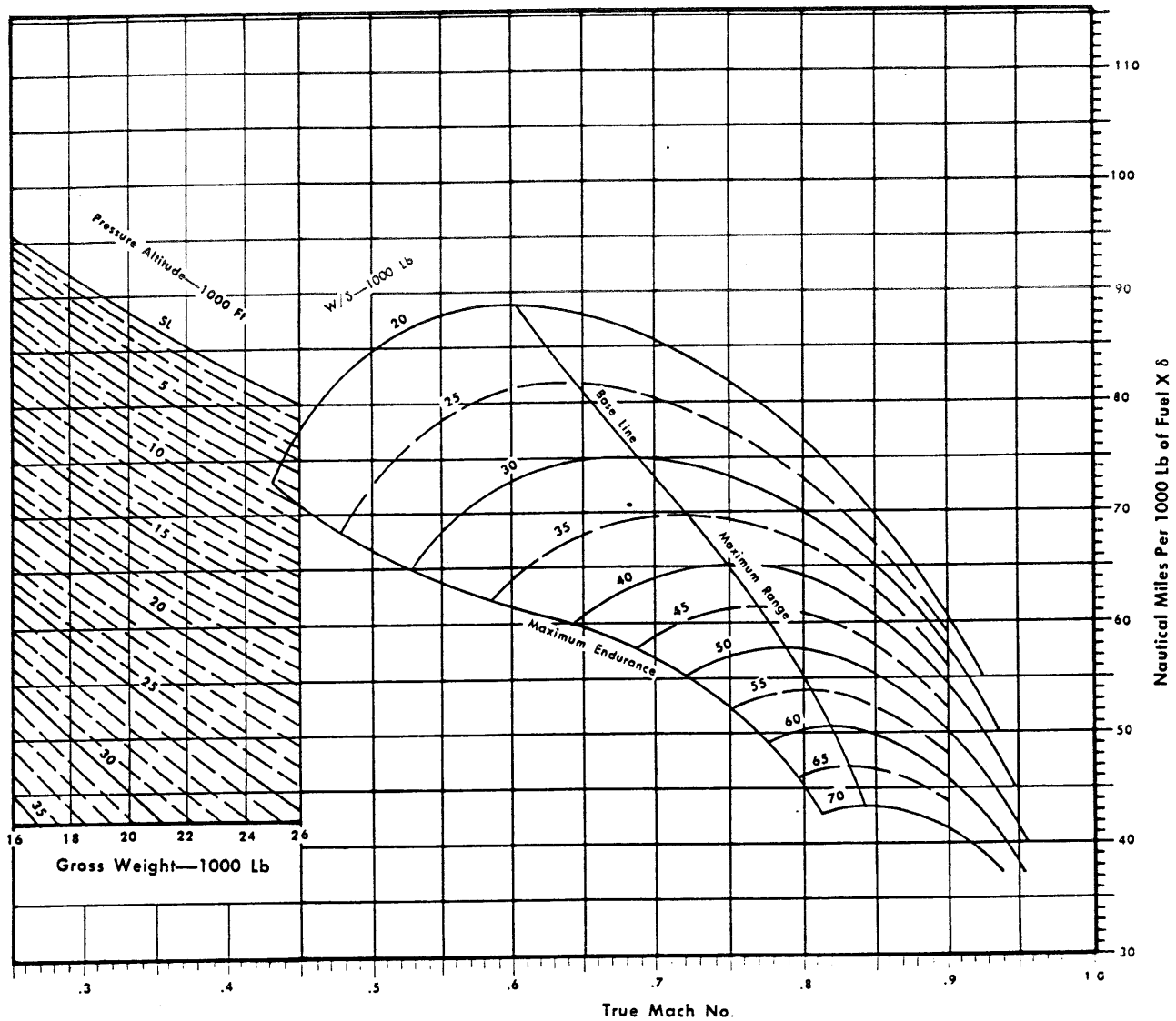

Figure A6-9 (Sheet 1 of 2)

## NAUTICAL MILES PER 1000 LB OF FUEL CONFIGURATION DRAG INDEX 80

Engine: J79-GE-19  
Fuel Grade: JP-8  
Fuel Density: 6.68 Lb/Gal

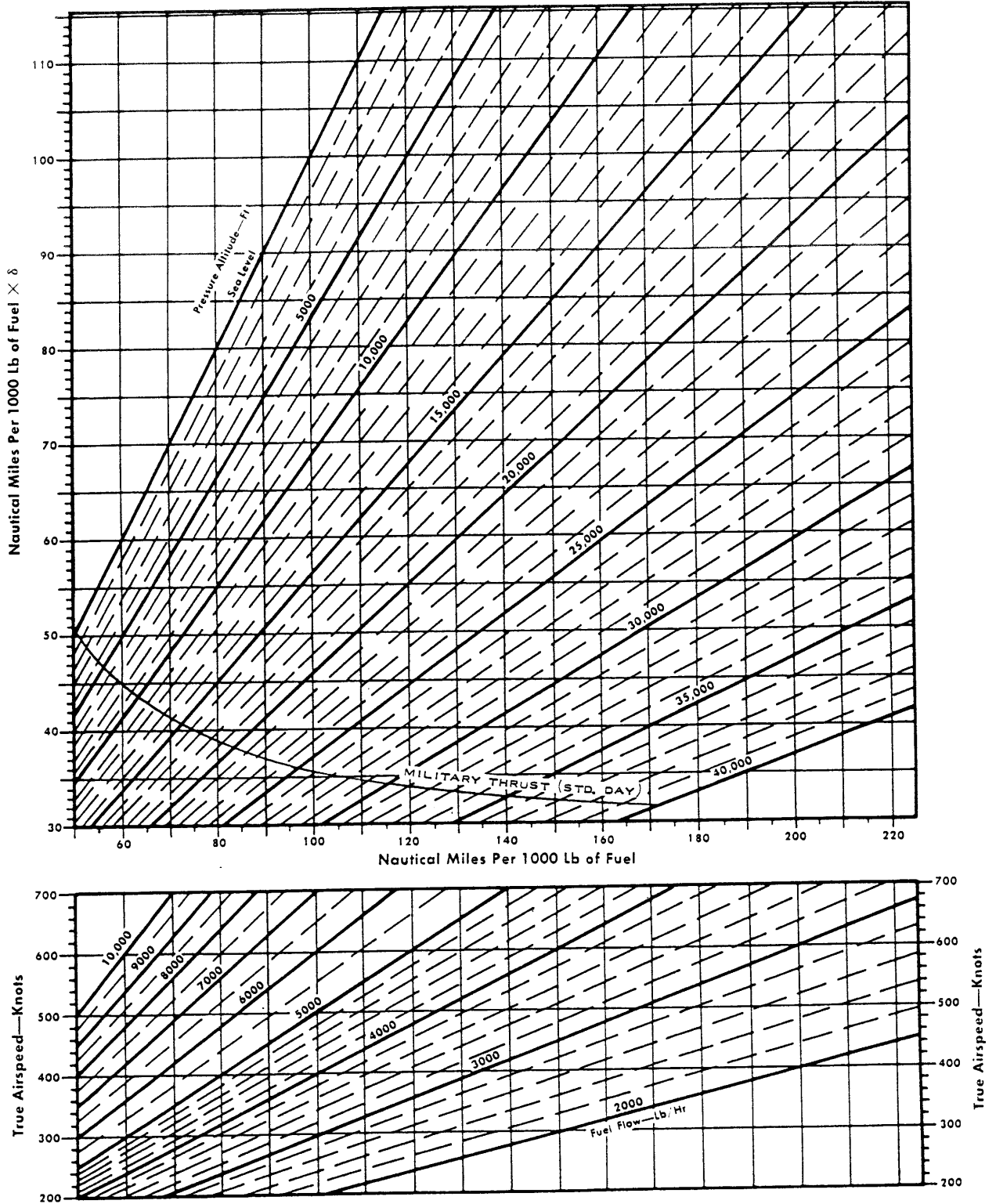

Figure A6-9 (Sheet 2 of 2)



# NAUTICAL MILES PER 1000 LB OF FUEL

## CONFIGURATION DRAG INDEX 90

Model: F-104S  
 Date: 1 June 1969  
 DATA BASIS: FLIGHT TEST

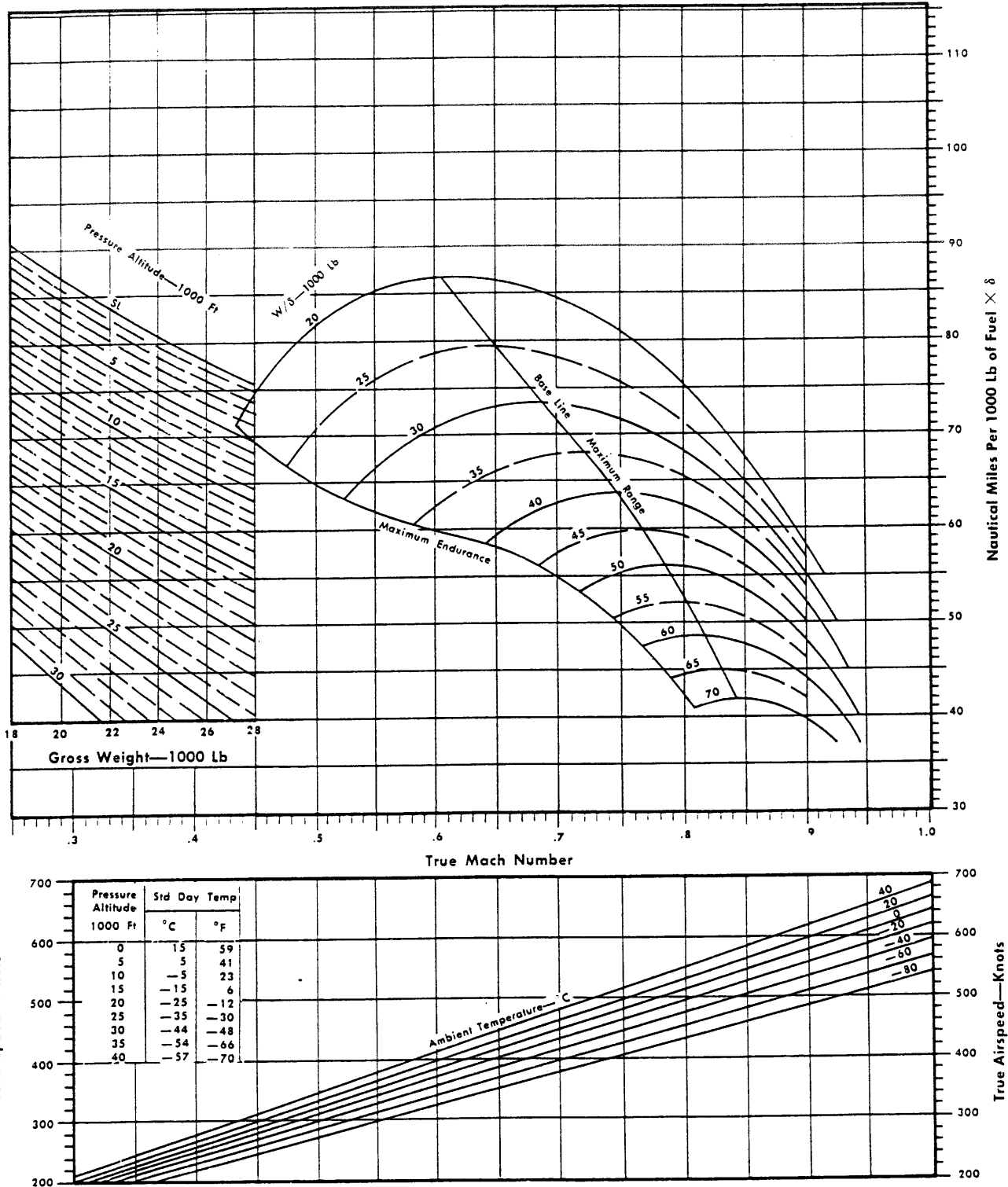

Figure A6-10 (Sheet 1 of 2)

# NAUTICAL MILES PER 1000 LB OF FUEL

## CONFIGURATION DRAG INDEX 90

Engine: J79-GE-19  
 Fuel Grade: JP-8  
 Fuel Density: 6.68 Lb/Gal

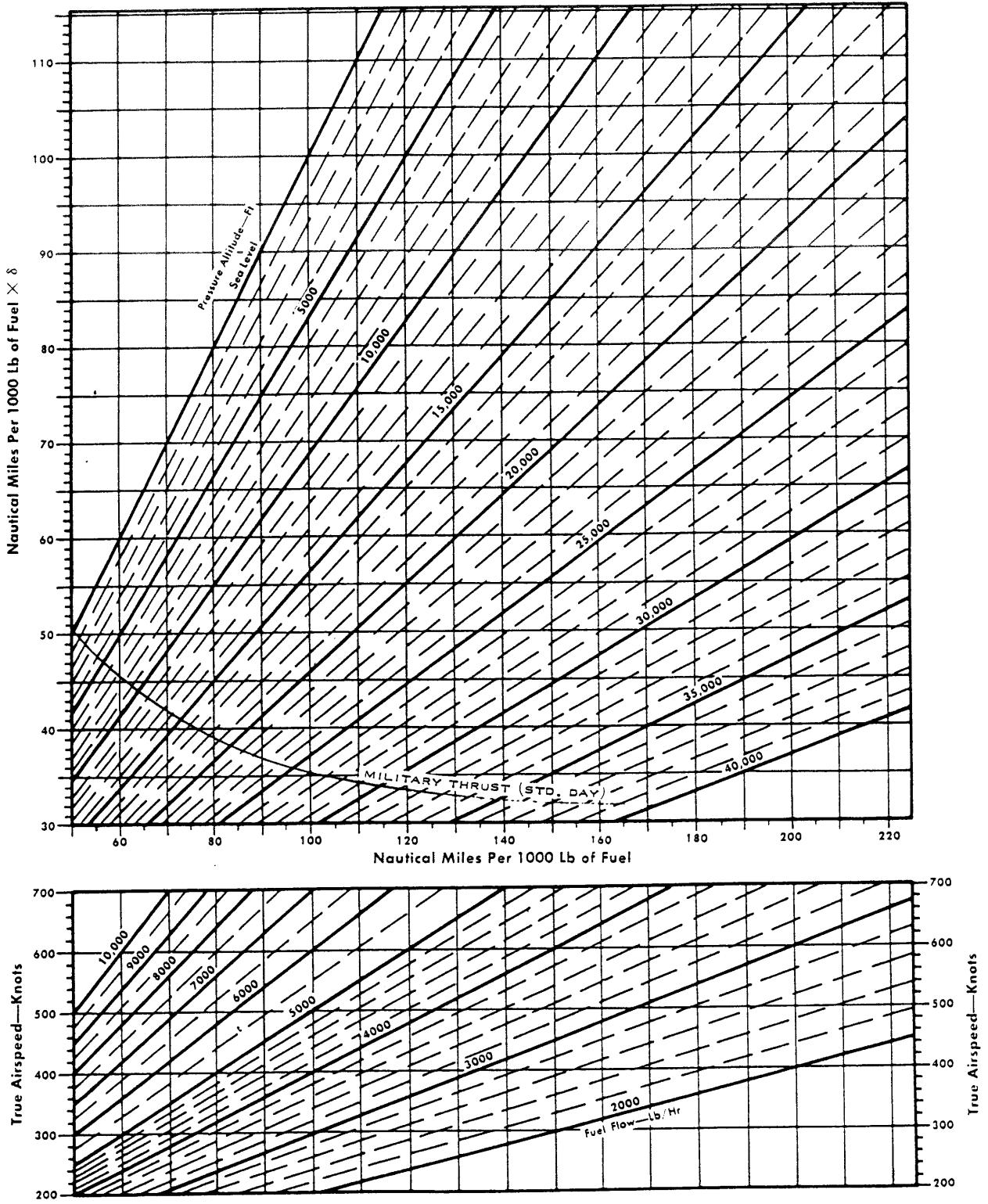

Figure A6-10 (Sheet 2 of 2)

## NAUTICAL MILES PER 1000 LB OF FUEL

### CONFIGURATION DRAG INDEX 100

Model: F-104S  
 Date: 1 June 1969  
 DATA BASIS: FLIGHT TEST

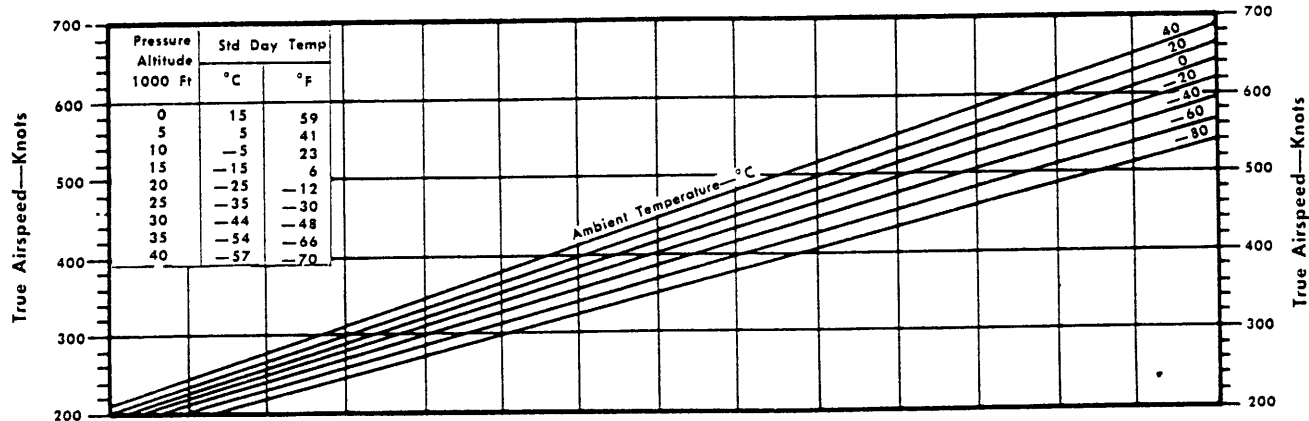
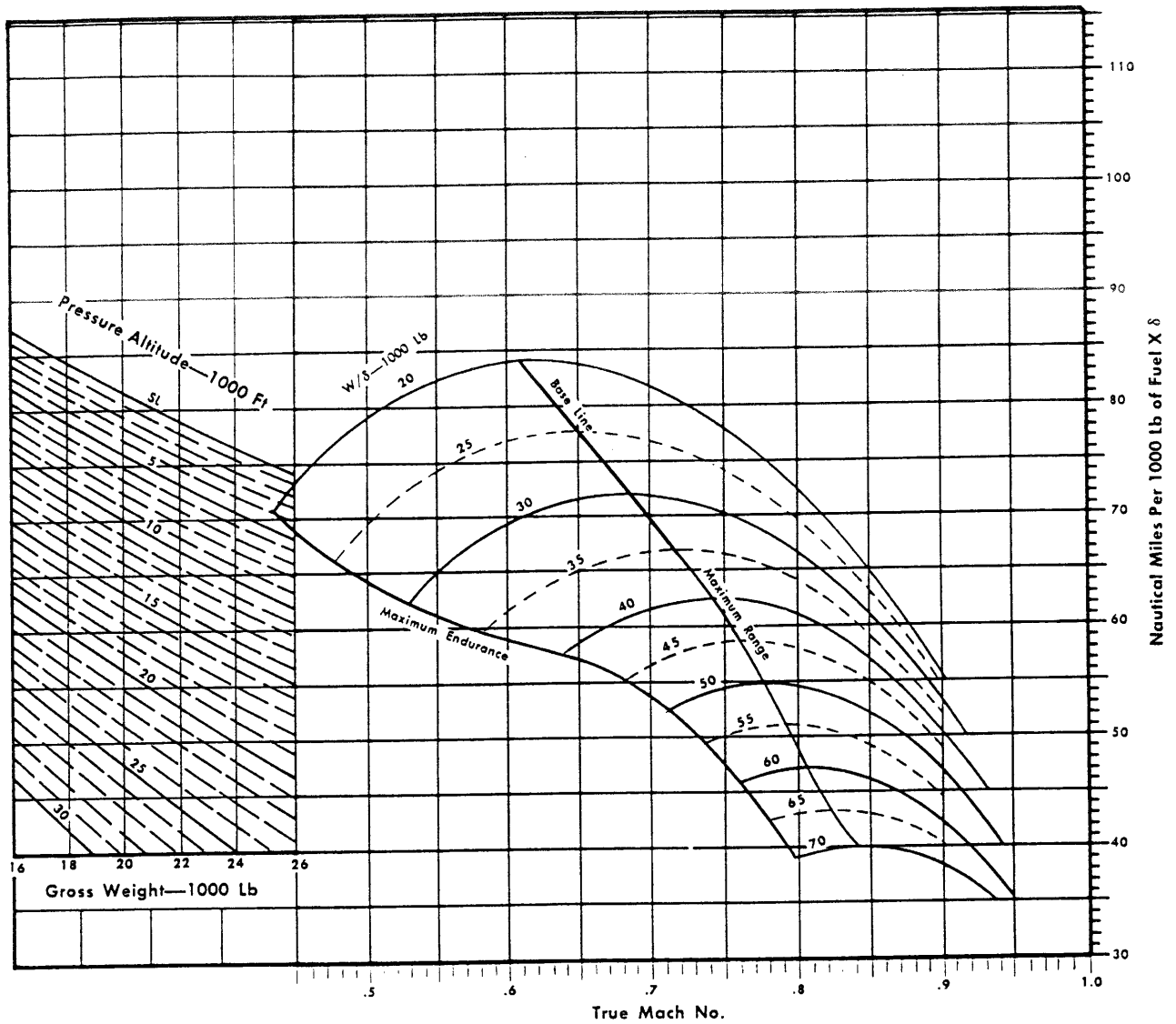

Figure A6-11 (Sheet 1 of 2)

# NAUTICAL MILES PER 1000 LB OF FUEL

## CONFIGURATION DRAG INDEX 100

Engine: J79-GE-19  
 Fuel Grade: JP-8  
 Fuel Density: 6.68 Lb/Gal

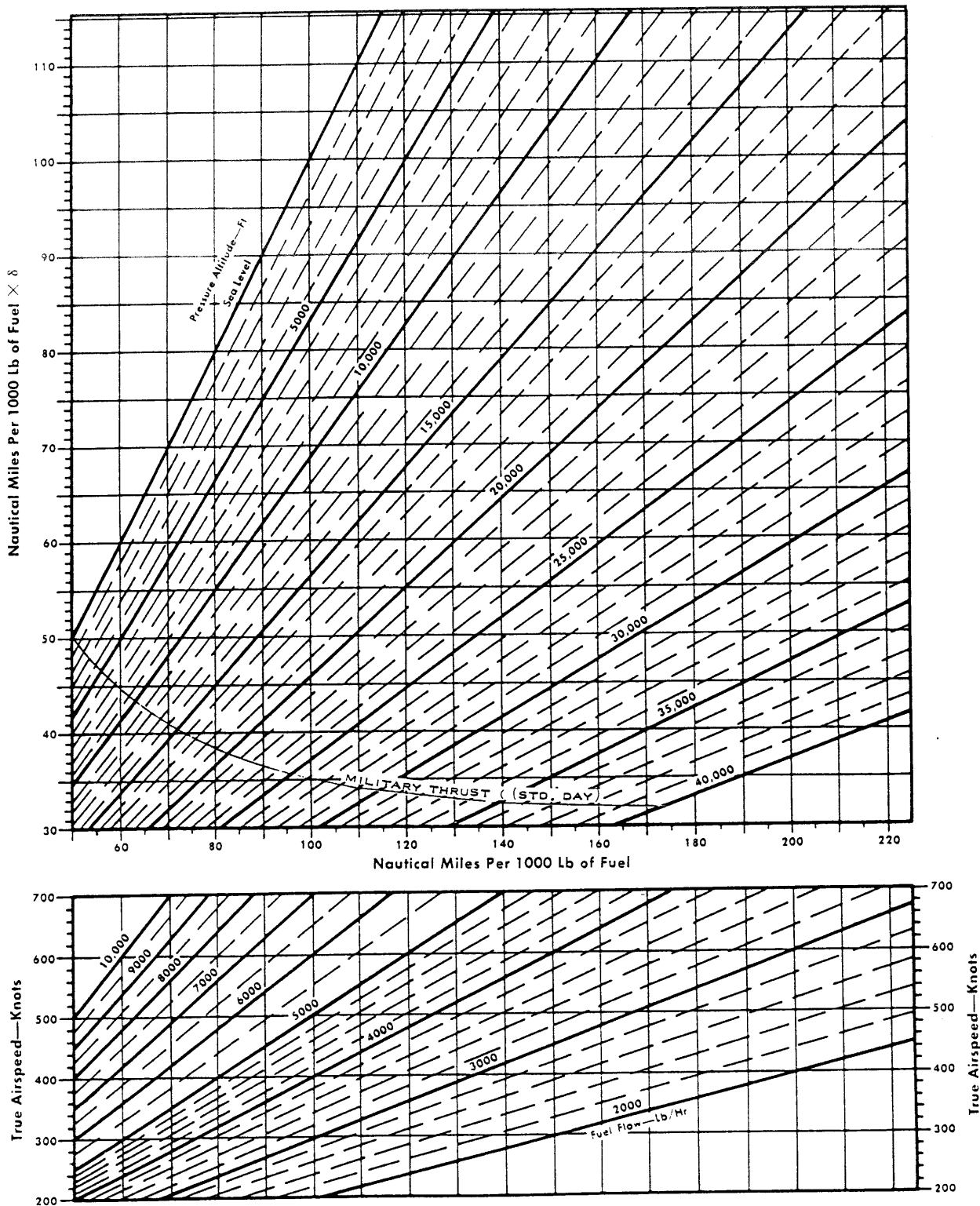

Figure A6-11 (Sheet 2 of 2)

## NAUTICAL MILES PER 1000 LB OF FUEL

### CONFIGURATION DRAG INDEX 110

Model: F-104S  
 Date: 1 June 1969  
 DATA BASIS: FLIGHT TEST

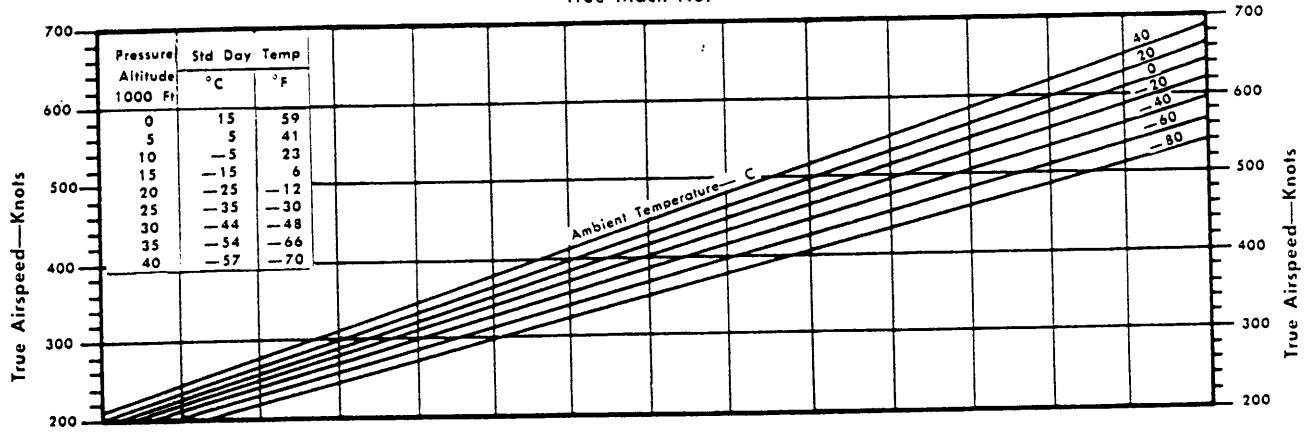
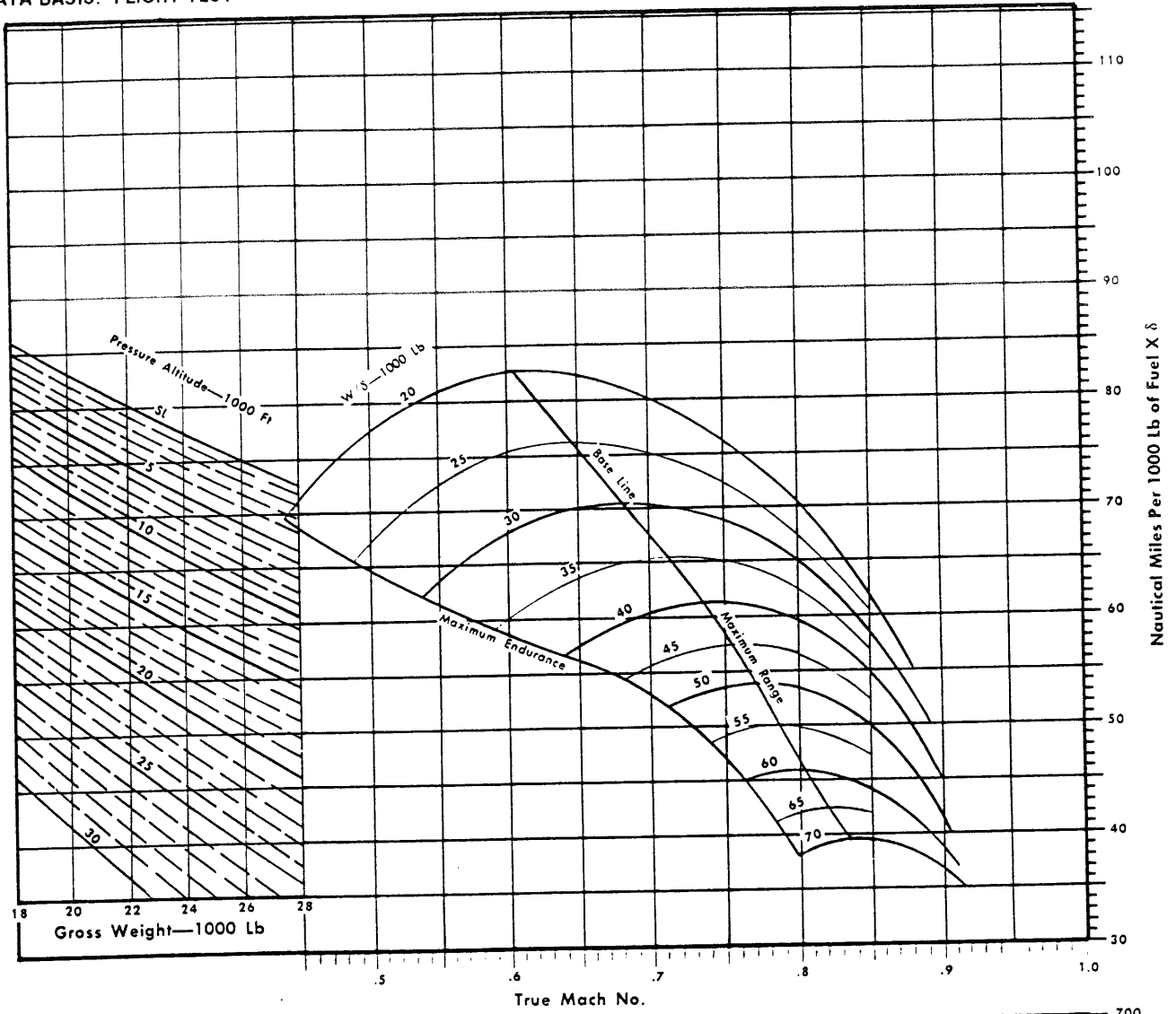

Figure A6-12 (Sheet 1 of 2)

# NAUTICAL MILES PER 1000 LB OF FUEL

## CONFIGURATION DRAG INDEX 110

Engine: J79-GE-19  
Fuel Grade: JP-8  
Fuel Density: 6.68 Lb/Gal

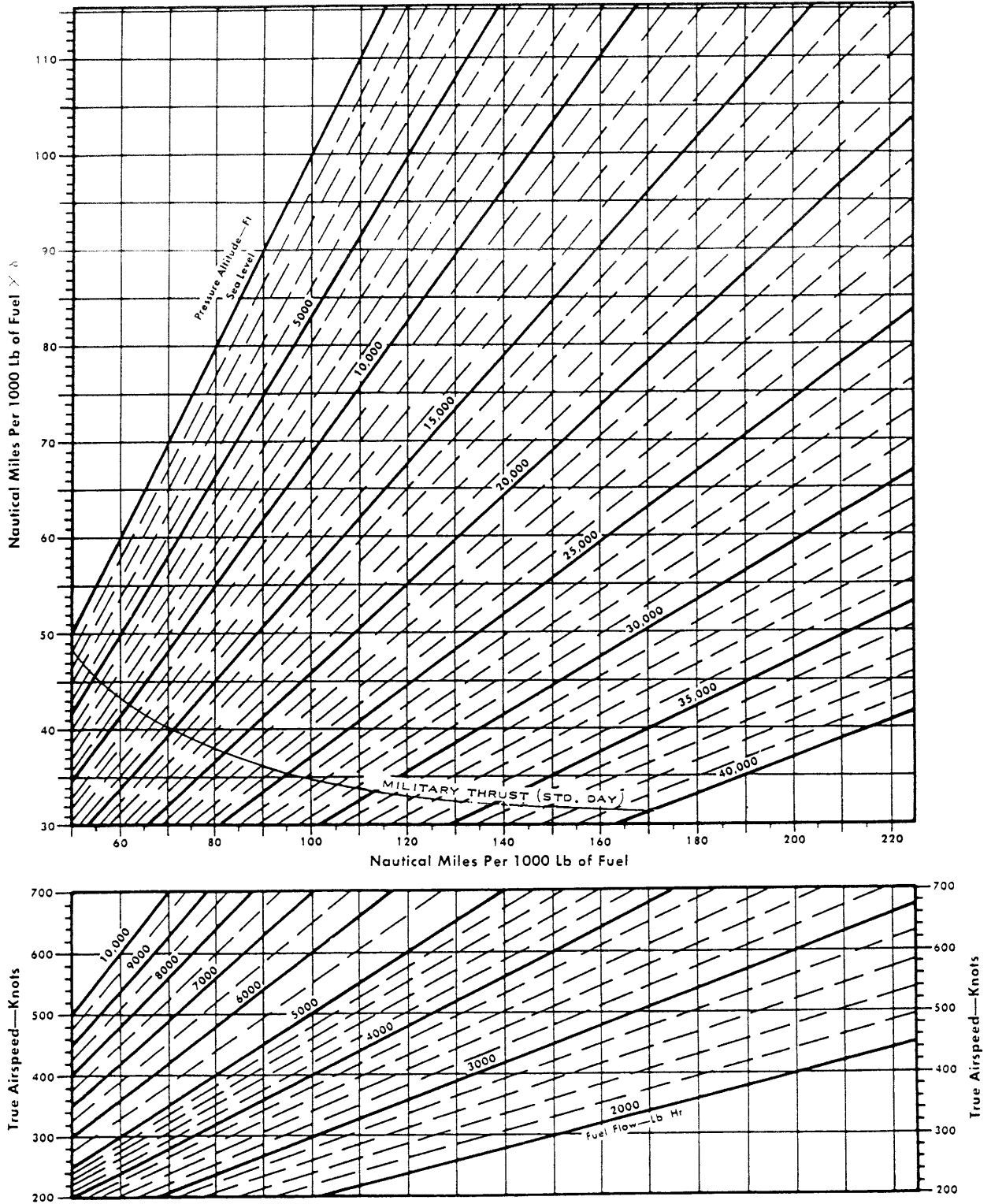

Figure A6-12 (Sheet 2 of 2)

# PART 7

## DESCENT

### TABLE OF CONTENTS

Index items in bold face characters denote illustrations

Title	Page
Descent Performance .....	A7-1
<b>Descent Performance</b> .....	<b>A7-2</b>

### DESCENT PERFORMANCE

Time, distance and fuel required to descent from altitude using idle throttle setting or 85% RPM are

presented in this part. Conditions include landing gear up, speed brakes extended and retracted, wing flaps UP and TAKEOFF.

Read the descent charts directly if sea level is the terminal altitude; otherwise, read the charts on an incremental basis between the initial and final altitudes.

#### SAMPLE PROBLEM

Find time, fuel used, and distance traveled during an idle decent from 29000 feet to sea level. Speed brakes are retracted. Enter Figure A7-1 at 29000 feet and read 32 nautical miles traveled, 5.2 minutes elapsed time, and 54 pounds of fuel used.

# IDLE DESCENT PERFORMANCE — 300 KIAS

FLAPS AND GEAR UP

Model: F-104S  
 Date: 1 October 1968  
 DATA BASIS: FLIGHT TEST

Engine: J79-GE-19  
 Fuel Grade: JP-8  
 Fuel Density: 6.68 Lb/Gal

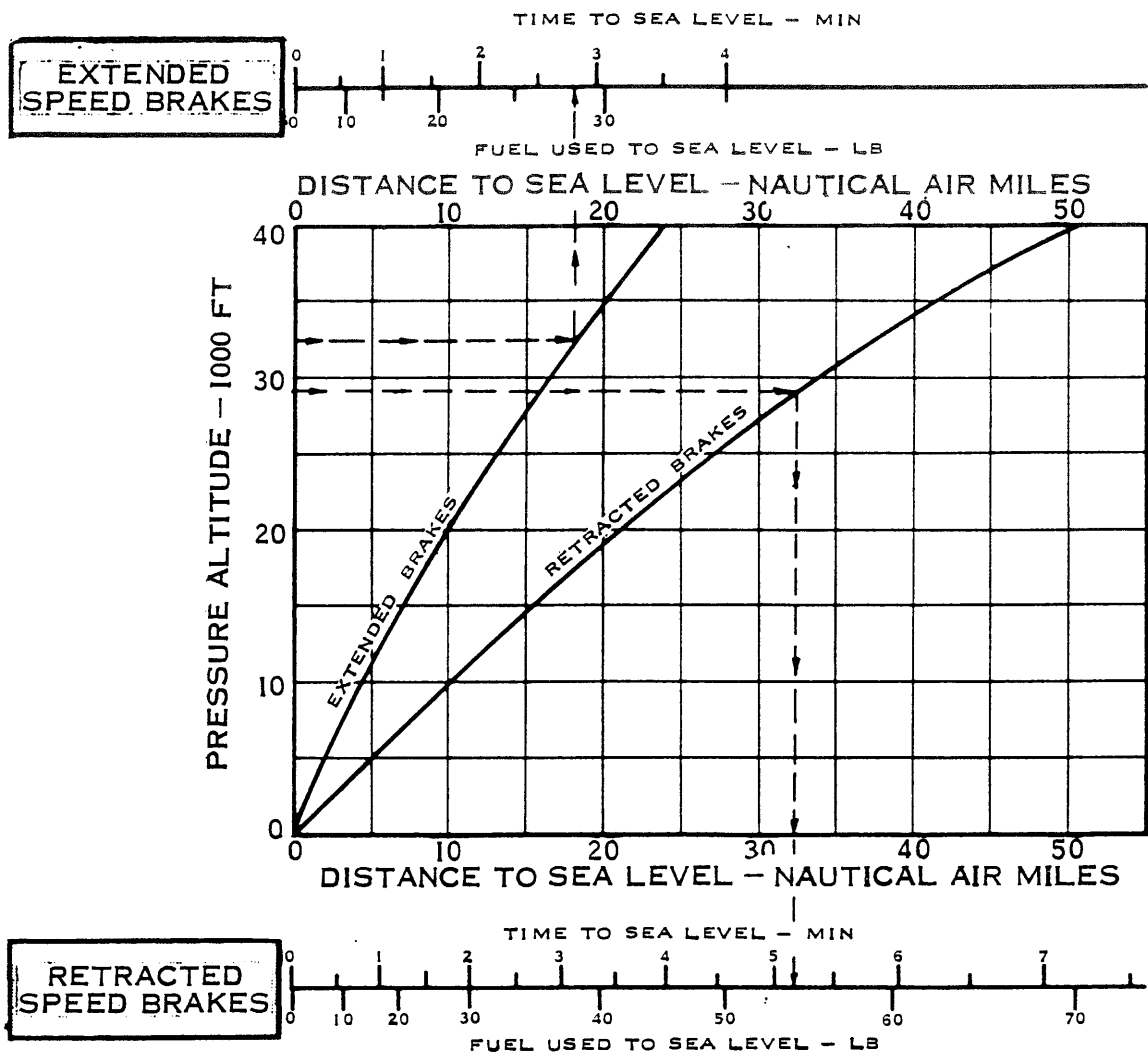

- REMARKS:
1. SET IDLE THRUST
  2. HOLD 300 KIAS DURING DESCENTS FROM ALTITUDES ABOVE 40000 FT
  3. AVERAGE RATES OF DESCENT:  
 SPEED BRAKES RETRACTED — 5600 FT/MIN  
 SPEED BRAKES EXTENDED — 11150 FT/MIN
  4. REFER TO SECTION VII "ALL WEATHER OPERATION" FOR 85% RPM JET PENETRATION DESCENT PERFORMANCE
  5. DATA BASED ON 14000 TO 16000 POUND GROSS WEIGHTS

Figure A7-1



## 85% RPM DESCENT PERFORMANCE — 300 KIAS

FLAPS AND GEAR UP

Model: F-104S  
 Date: 1 April 1970  
 DATA BASIS: FLIGHT TEST

Engine: J79-GE-19  
 Fuel Grade: JP-8  
 Fuel Density: 6.68 Lb/Gal

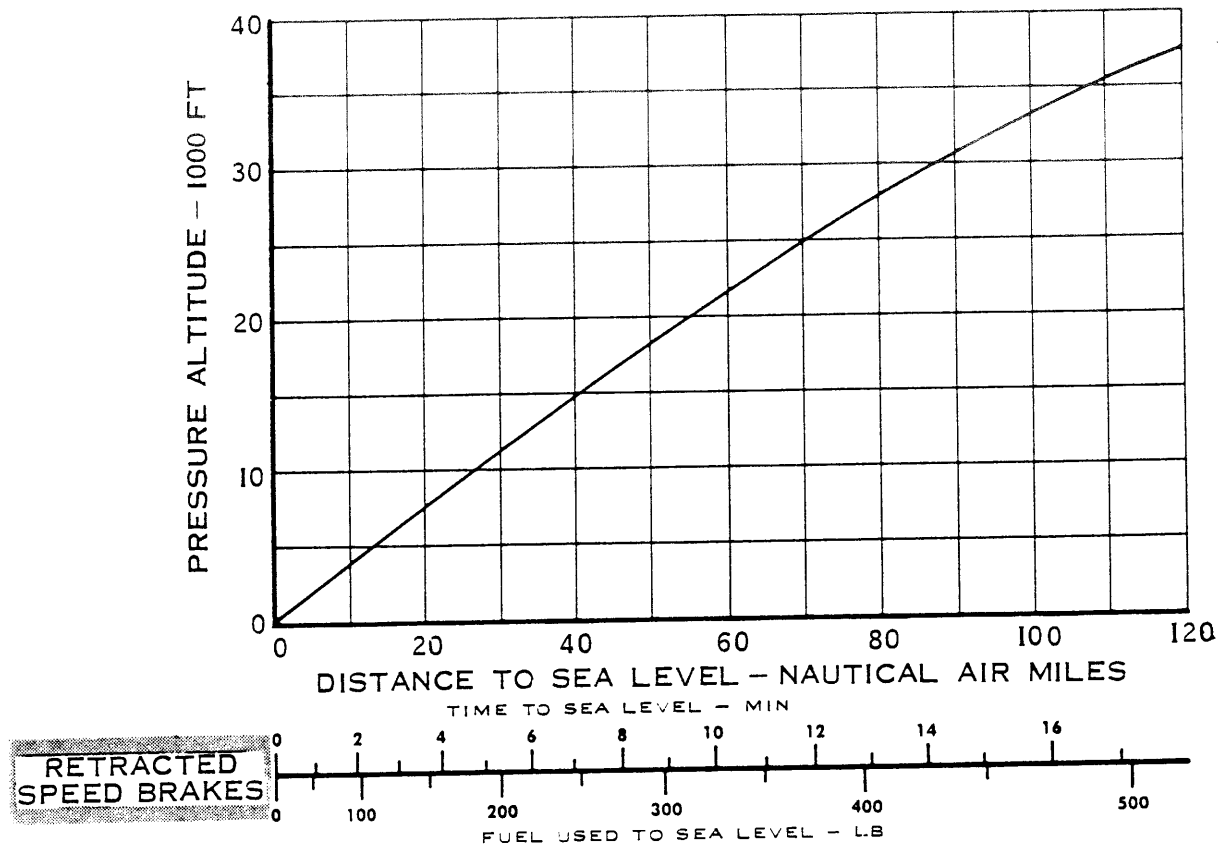

## REMARKS:

1. SET 85% ENGINE RPM
2. HOLD 300 KIAS DURING DESCENT
3. AVERAGE RATES OF DESCENT — 2000 FT/MIN
4. DATA BASED ON 15300 TO 16000 POUND GROSS WEIGHTS

Figure A7-2

# 85% RPM DESCENT PERFORMANCE — 300 KIAS

TAKEOFF FLAPS EXTENDED AND GEAR UP

Model: F-104S  
 Date: 1 April 1970  
 DATA BASIS: FLIGHT TEST

Engine: J79-GE-19  
 Fuel Grade: JP-8  
 Fuel Density: 6.68 Lb/Gal

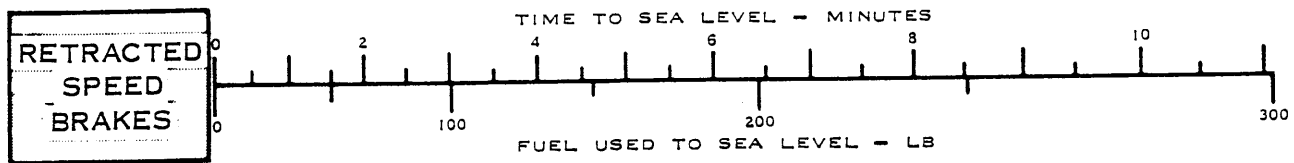
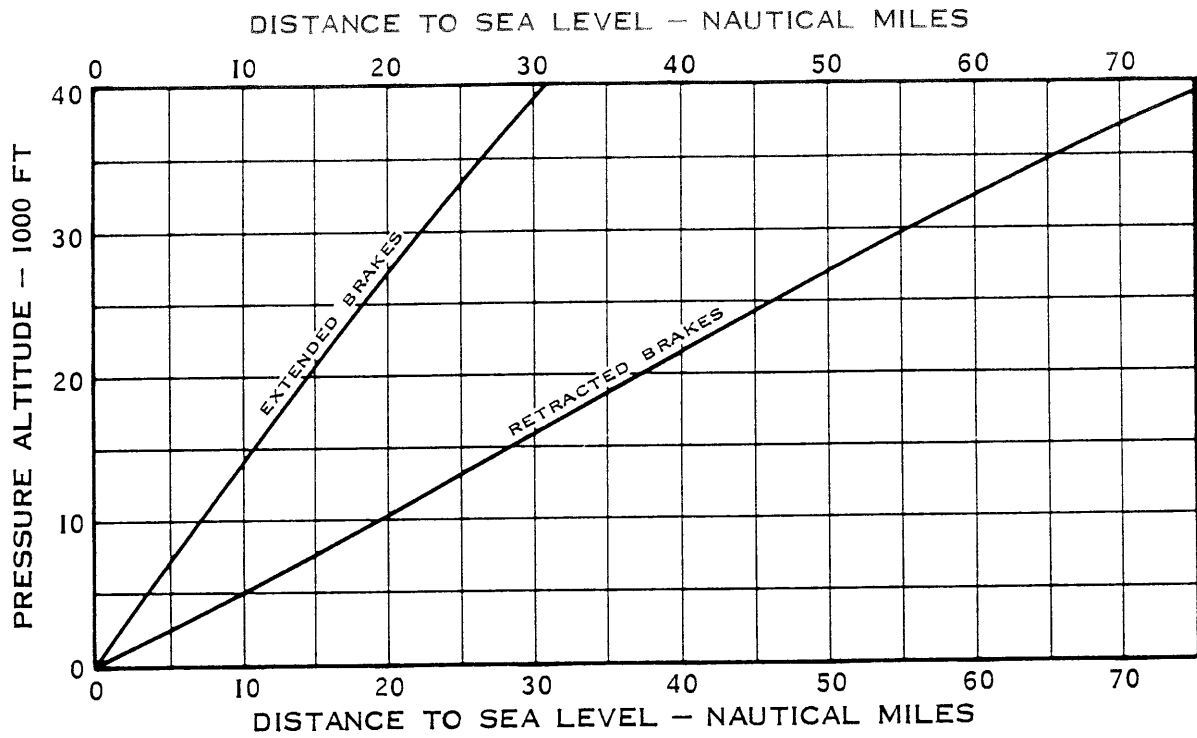
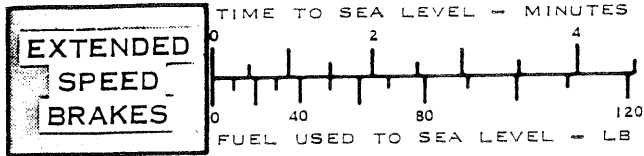

REMARKS:

1. SET 85% ENGINE RPM
2. HOLD 300 KIAS DURING DESCENT
3. AVERAGE RATES OF DESCENT:  
 SPEED BRAKES RETRACTED — 3500 FT/MIN  
 SPEED BRAKES EXTENDED — 8500 FT/MIN

Figure A7-3

# PART 8

## LANDING

### TABLE OF CONTENTS

Index items in bold face characters denote illustrations.

Title	Page
Normal Performance with Drag Chute . . . .	A8-1
Maximum Performance Landings . . . . .	A8-3
<b>Wind Component Chart</b> . . . . .	<b>A8-5</b>
<b>Landing Speed Schedule</b> . . . . .	<b>A8-6</b>
<b>Landing Distance Charts</b> . . . . .	<b>A8-7</b>
Available Rate of Climb for Go-Around . .	A8-11

nosewheel contact, prompt activation of the drag chute with hard anti-skid wheel braking during the transition period, and continuous hard wheel braking with full drag chute effectiveness during the remainder of the stop. Use of the drag chute allows a high rate of deceleration during the early portion of the ground roll: any unnecessary delay in its deployment will add considerably to the stopping distance. However, premature chute deployment before nosewheel contact may result in high structural loads on the aircraft. Use of moderate or light wheel braking will extend the landing roll beyond charted values, but will result in less wear on the brakes and tires. The normal braking force which is used operationally should be judged in terms of the difference between charted distance (for which hard braking was used) and landing roll distances actually available.

### NORMAL PERFORMANCE WITH DRAG CHUTE

Figure A8-3 presents landing ground roll distances and distances required to clear a 50-foot obstacle, land, and stop when the 18-foot drag chute is deployed during ground roll to assist wheel braking. Values shown are directly applicable to operation with LAND flaps, hard dry runway surface conditions, and runway wind component speeds from 20-knot tailwinds to 40-knot head-winds. A correction grid is provided for obtaining the ground roll distance under various runway surface conditions. Distances reflect results of flight tests with normal speed schedules for approach and touchdown, and hard wheel braking without skidding for the subsequent stop. Normal performance assumes that an approach flight path slope of approximately 2½° is maintained by use of thrust until the 50-foot obstacle point is cleared, and that thrust is reduced smoothly during the flare to just above idle throttle setting at the touchdown point. It also assumes a smooth rotation from touchdown attitude to

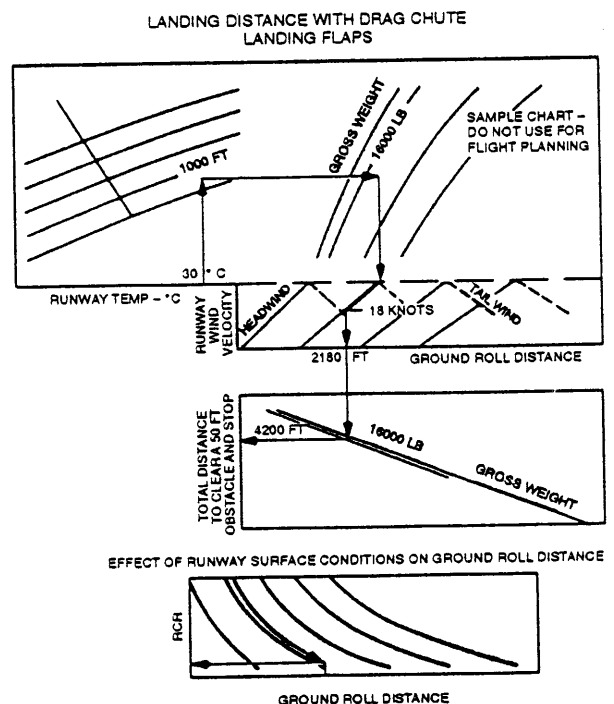

FA0296

**SAMPLE PROBLEM**

Determine the landing ground roll and total distance to clear a 50-foot obstacle and stop for the following conditions:

- Boundary Layer Control - On
  - Gross Weight - 16000 lb
  - Runway air Temperature - 30° C
  - Field Pressure Altitude - 1000 ft
  - Runway Wind Component
    - 18-knot headwind
  - Runway Slope - 1% downhill
  - Drag Chute - Deployed
  - Runway Surface - Dry and hard
- a. From Figure A8-3, the ground roll distance from touchdown to stop for a level runway with an 18-knot headwind is 2180 ft.
  - b. The ground roll distance with a 1% downhill slope is determined by increasing the zero slope value by 2%.  
 $2180 \text{ ft} + (.02 \times 2180 \text{ ft}) = 2224 \text{ ft}.$
  - c. For a level runway, total distance to clear a 50-foot obstacle and stop is 4200 ft.
  - d. Total distance with a 1% downhill slope is determined by increasing the zero-slope total distance by 4%.  
 $4200 \text{ ft} + (.04 \times 4200 \text{ ft}) = 4368 \text{ ft}.$
  - e. From Figure A8-2, normal touchdown speed is 155 to 160 KIAS.
  - f. From Figure A8-2, final approach speed is 175 KIAS.

**NORMAL PERFORMANCE WITHOUT DRAG CHUTE**

Figure A8-4 shows landing distances to be expected when the drag chute is not deployed and hard wheel braking is used for the stop. Performance is based on the same speed schedules as for normal operation with the drag chute. As discussed above, if hard braking is not used operationally, the pilot should ensure that landing field lengths in excess of those shown in Figure A8-4 are available.

**EFFECT OF RUNWAY SURFACE CONDITIONS**

A Runway Condition Reading (RCR) grid is included on each landing distance chart for determining the effect of runway surface conditions on landing ground roll distances. To use the grids, enter on the line labeled "Dry Hard Runway" with the dry hard runway ground roll distance.

Follow the guide lines to a point opposite the RCR given by the base weather station and read the ground roll distance for that condition directly below. If no RCR is available use a value of 12 for wet runways and 5 for icy runways. For an ICAO report of "Good", use an RCR value of 23; for "Medium" use 12; for "Poor" use 5.

General rain, snow, and ice criteria are also provided. Careful judgement shall be used in applying the information shown by the general surface conditions. A light rain on a clean, well-drained runway will probably result in very little reduction in braking effectiveness. On the other hand, a dirty or dusty runway, under the same rain conditions will probably present nearly the same surface condition as an icy runway. Similarly, an accumulation of water on the runway will produce a tendency for the tires to ride on a thin film of water. This also produces much the same result as an icy runway. When operating from snow-covered runways, the braking effectiveness shown may only be realized when the runway surface under the snow is dry. Slush or ice under the snow will further reduce the effective braking force. The grids also indicate the effect of brake failure on ground roll distance. If the drag chute is not deployed and brake failure occurs, the idle thrust setting of the engine is enough to keep the aircraft moving.

**EFFECT OF RUNWAY SLOPE**

Landing ground roll distances are increased 2% per 1% downhill runway slope and decreased 2% per 1% uphill slope, operating either with or without drag chute. Total landing distances are increased 4% per 1% downhill slope, decreased 3% per 1% uphill slope.

**EFFECT OF WIND - CROSSWIND CONVERSION**

Correction grids included on the landing distance charts show the effect of wind components along the runway. Actual surface wind velocities should be used for computing headwind component. Use maximum gust speeds for crosswind components. Wind speeds indicated by an anemometer located more than 50 feet above the surface may be cor-

rected for wind gradient by multiplying reported winds by a factor of 7/10. Figure A8-1 illustrates a means for converting wind velocity into runway and crosswind component speeds.

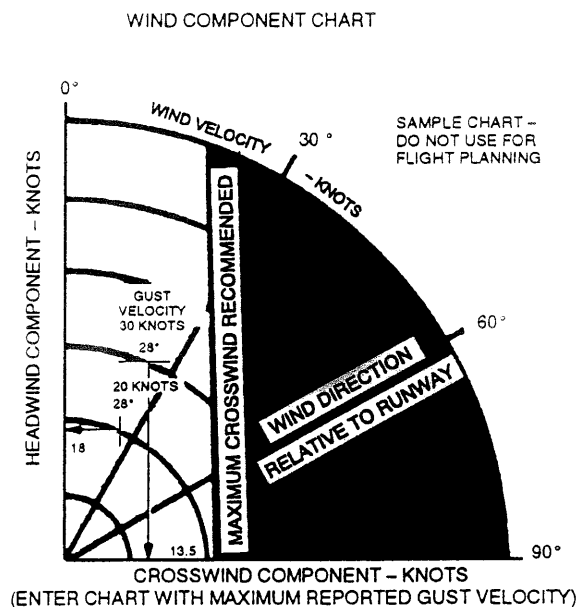

**SAMPLE PROBLEM**

The reported wind velocity is 20 knots with gusts to 30, blowing 27° relative to the service runway (wind velocity obtained from an anemometer located adjacent to the runway).

- a. From Figure A8-1 determine the crosswind component (using the maximum gust velocity) to be 13.5 knots. (This is less than the maximum recommended component.)
- b. If landings are to be made into the wind, the headwind component (using the reported wind of 20 knots) for the determination of landing distances is 18 knots.

**MAXIMUM PERFORMANCE LANDINGS**

The minimum recommended touchdown speed for maximum performance landings is 5 knots less than that used for normal operation. This will result in landing ground roll distances 5% less than shown for hard braking on Figure A8-3 and Figure A8-4.

**LANDING WITH TAKEOFF FLAPS**

Landing with TAKEOFF flaps may be desirable, because of external store – fuel load combinations, to maintain go-around capability under heavy weight and high temperature conditions, or for various other reasons. Landing ground roll distances to be expected with hard wheel braking and dry runway conditions may be obtained from Figure A8-5 or Figure A8-6 for operation with or without the drag chute. These values apply when touchdown speeds shown on Figure A8-2 are used. Distances for the descent from 50 feet to the touchdown point will remain substantially the same if final approach slope somewhat greater than 2½ % is used to compensate for the slight additional distance required to flare at the higher approach speeds. The need for such adjustment should be judged in terms of terrain clearance requirements.

**RATE OF CLIMB AVAILABLE FOR GO-AROUND**

Rates of climb available with zero bank angle at final approach gross weights, corresponding speeds and configuration drag index are given in Figure A8-7 for operation with military thrust. The chart also includes the maximum bank angle with zero rate of climb. Note that go-around performance given here for the military thrust setting applies to the landing configuration only. It may be desirable to use TAKEOFF flaps under marginal conditions, if sufficient field length is available. Rates of climb are not critical with TAKEOFF flaps, even at heavy weights and high ambient temperatures.

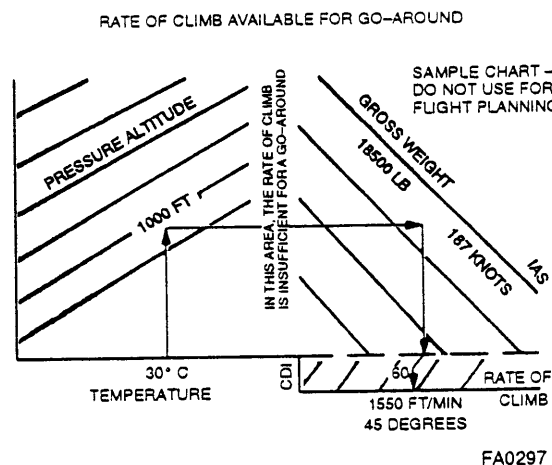

**SAMPLE PROBLEM**

Determine the rate of climb available for go-around with military thrust and landing configuration, for the following conditions:

- Configuration drag index - 60
- Gross Weight - 18500 lb

- Air Temperature - 30° C
- Pressure Altitude - 1000 ft
- IAS - 187 knots

From Figure A8-7 determine the available rate of climb to be 1550 fpm (zero bank angle). The maximum bank angle with zero rate of climb is 45°.

### WIND COMPONENT CHART — LANDING WITH OR WITHOUT CHUTE

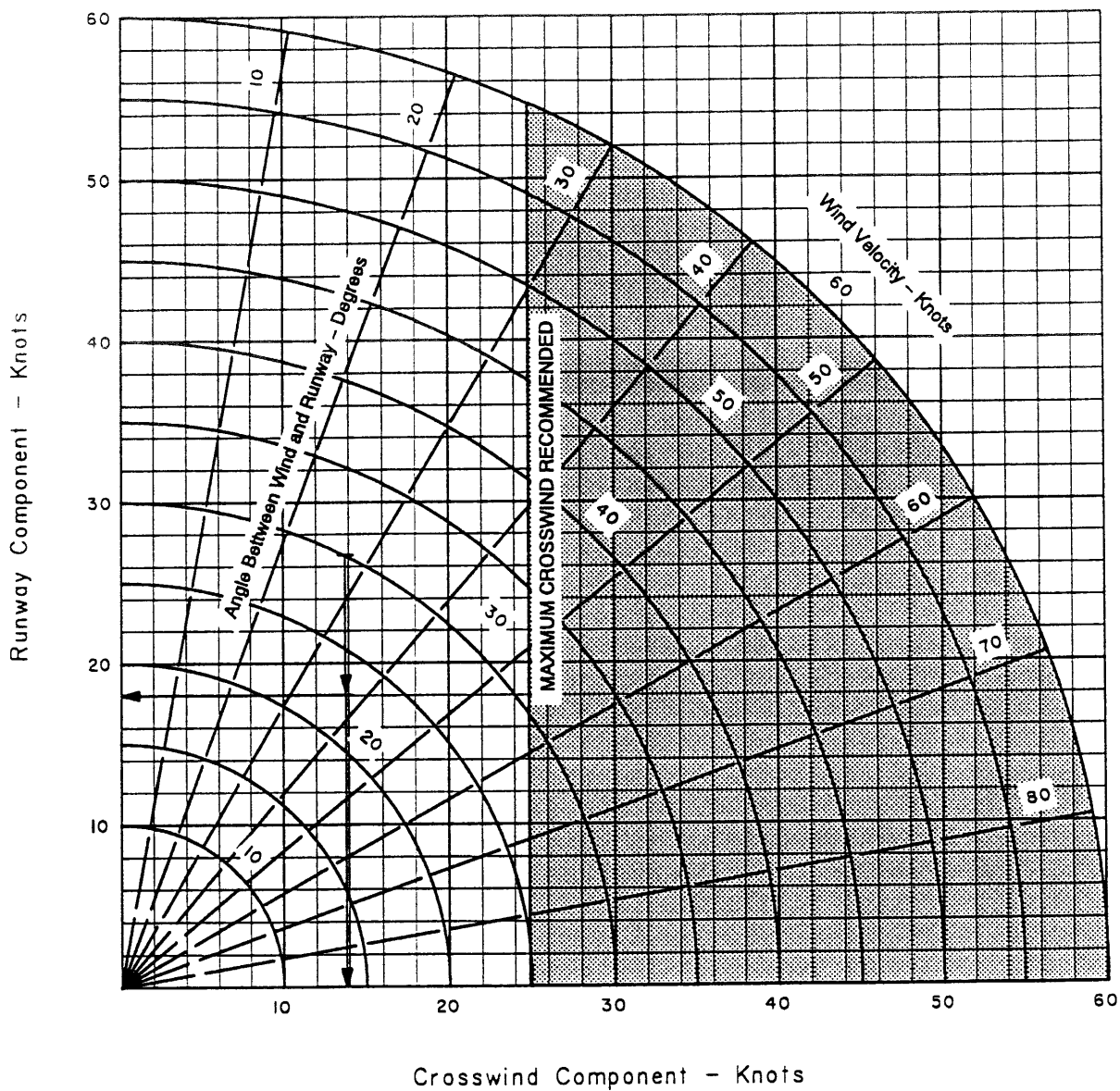

(NOTE: FOR CROSSWIND COMPONENT ENTER CHART WITH MAXIMUM  
REPORTED GUST VELOCITY)

FA0278

**Figure A8-1**

# LANDING SPEED SCHEDULE

All External Stores Configurations

Model: F-104S  
Date: 1 October 1968  
DATA BASIS: FLIGHT TEST

Engine: J79-GE-19  
Fuel Grade: JP-8  
Fuel Density: 6.88 Lb/Gal

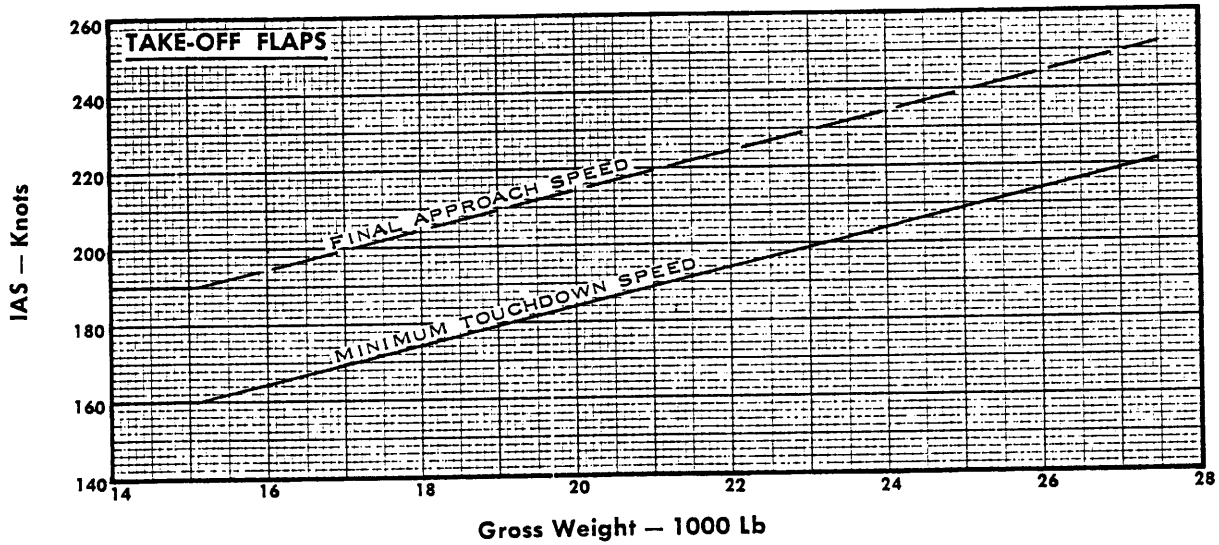
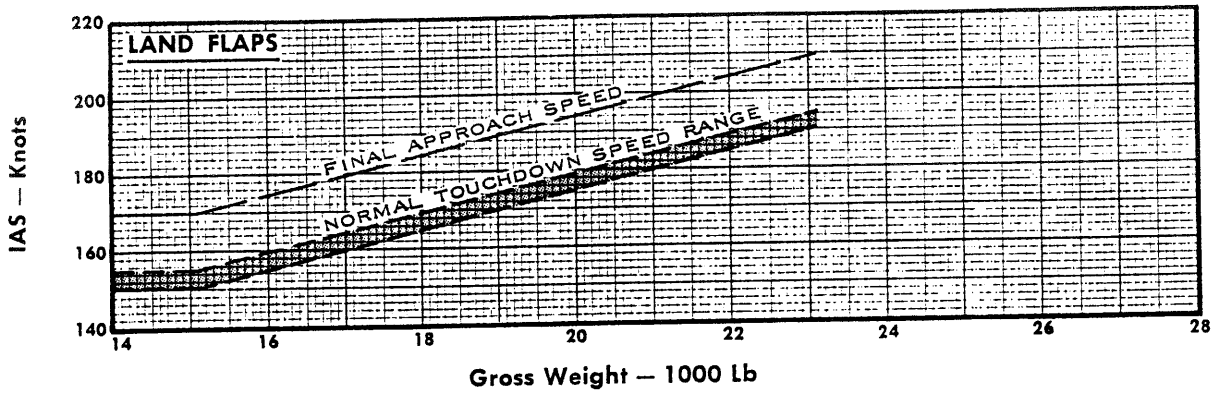

Figure A8-2



# LANDING DISTANCE WITH DRAG CHUTE LANDING FLAPS

ANTI-SKID BRAKES

Boundary Layer Control On  
All External Stores Configurations  
LEVEL RUNWAY

18-FOOT DRAG CHUTE

Model: F-104S  
Date: 1 October 1968  
DATA BASIS: FLIGHT TEST

Engine: J79-GE-19  
Fuel Grade: JP-8  
Fuel Density: 6.68 Lb/Gal

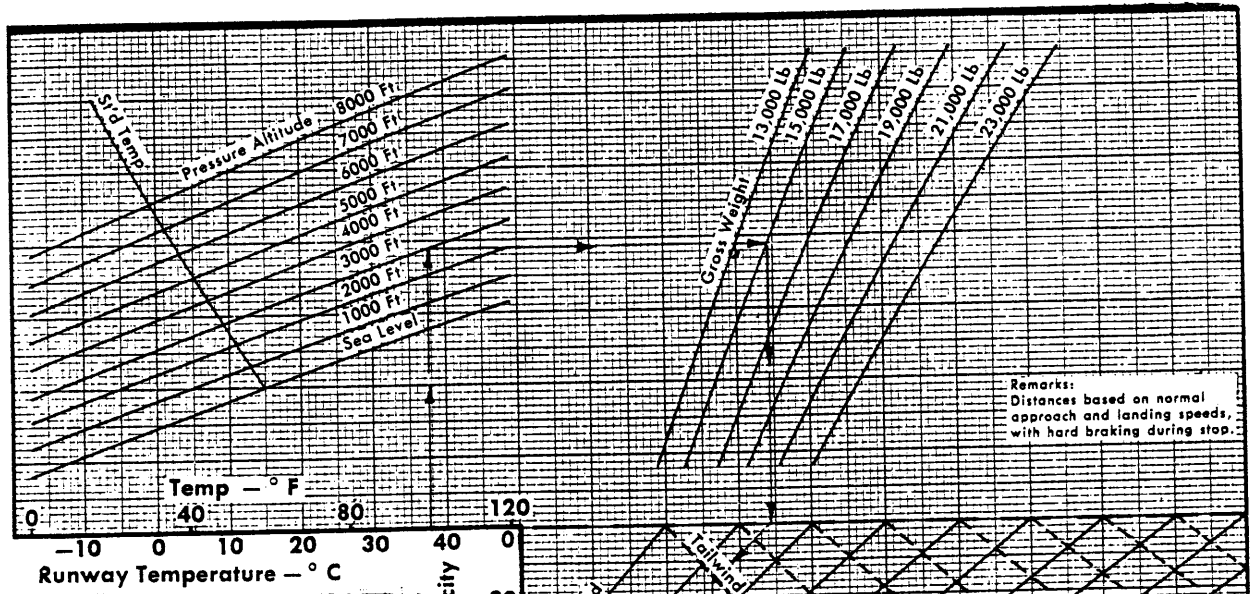

Remarks:  
Distances based on normal approach and landing speeds, with hard braking during stop.

### Effect Of Runway Surface Condition On Ground Roll Distance

NOTE:  
TO FIND GROUND ROLL DISTANCE FOR OTHER THAN DRY RUNWAY CONDITIONS, ENTER EFFECT OF RUNWAY SURFACE CONDITIONS CURVE WITH DRY HARD RUNWAY GROUND ROLL DISTANCE AND FOLLOW GUIDE LINES TO POINT OPPOSITE EXISTING RUNWAY CONDITION READING (RCR). READ GROUND ROLL DISTANCE FOR THAT CONDITION DIRECTLY BELOW THAT POINT. IF NO RCR IS AVAILABLE, USE 12 FOR WET RUNWAYS AND 5 FOR ICY RUNWAYS.

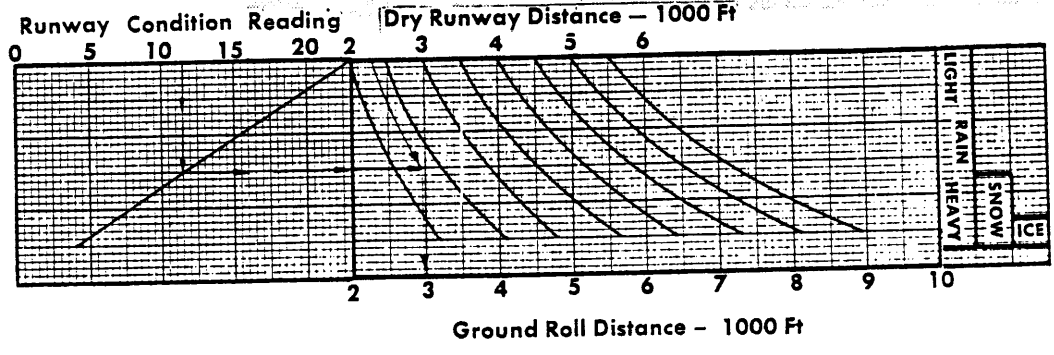
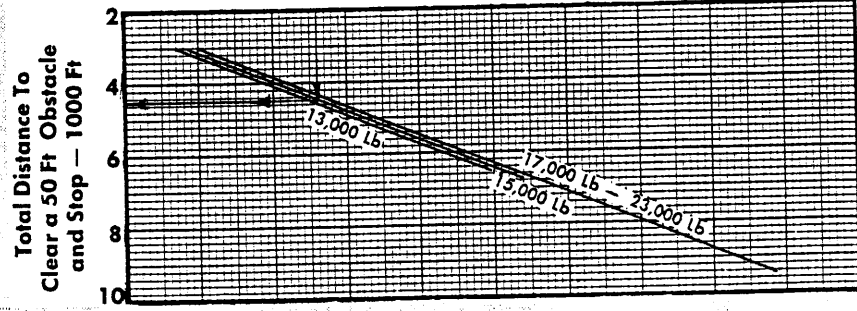
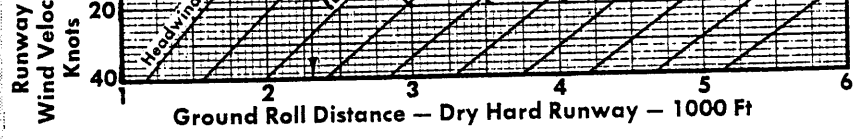

Figure A8-3

# LANDING DISTANCE WITHOUT DRAG CHUTE LANDING FLAPS

Boundary Layer Control On  
All External Stores Configurations  
LEVEL RUNWAY      ANTI-SKID BRAKES

Model: F-104S  
Date: 1 October 1968  
DATA BASIS: FLIGHT TEST

Engine: J79-GE-19  
Fuel Grade: JP-8  
Fuel Density: 6.68 Lb/Gal

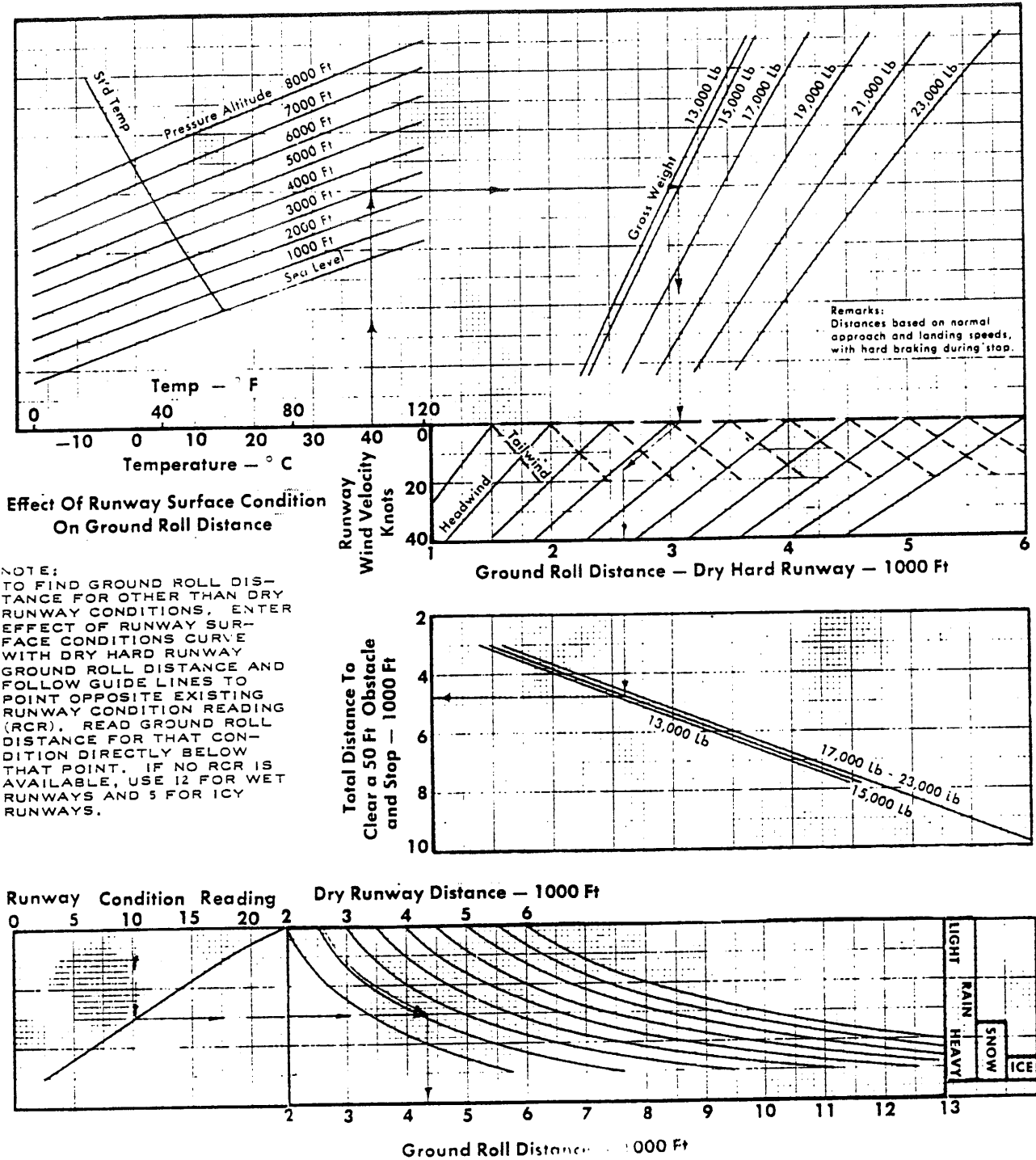

Figure A8-4

# LANDING DISTANCE WITH DRAG CHUTE — TAKEOFF FLAPS

All External Stores Configurations

ANTI-SKID BRAKES      LEVEL RUNWAY      18-FOOT DRAG CHUTE

Engine: J79-GE-19  
 Fuel Grade: JP-8  
 Fuel Density: 6.88 Lb/Gal

Model: F-104S  
 Date: 1 October 1968  
 DATA BASIS: FLIGHT TEST

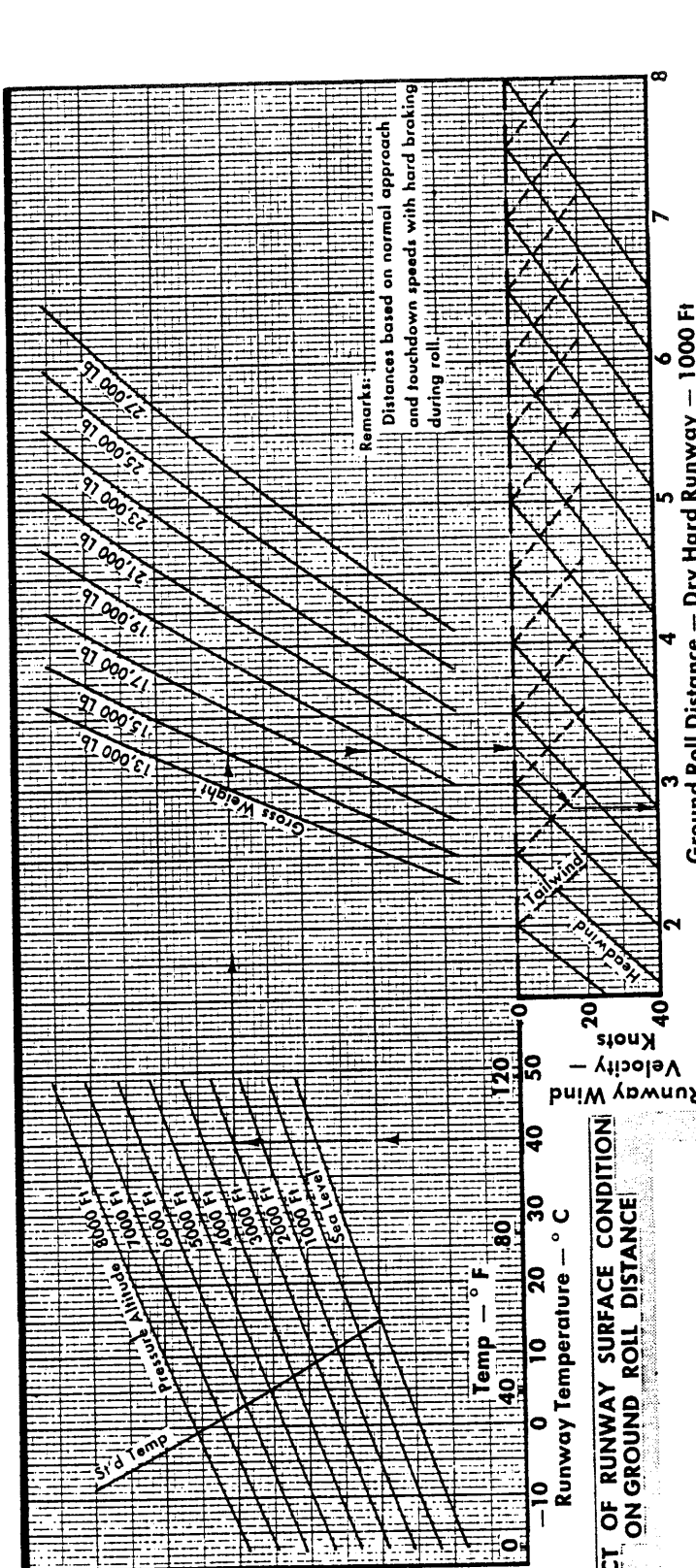

## EFFECT OF RUNWAY SURFACE CONDITION ON GROUND ROLL DISTANCE

NOTE: TO FIND GROUND ROLL DISTANCE TO OTHER THAN DRY RUNWAY CONDITIONS ENTER EFFECT OF RUNWAY SURFACE CONDITIONS CURVE WITH DRY HARD RUNWAY GROUND ROLL DISTANCE AND FOLLOW GUIDE LINES TO POINT OPPOSITE EXISTING RUNWAY CONDITION READING (RCR). READ GROUND ROLL DISTANCE FOR THAT CONDITION DIRECTLY BELOW THAT POINT. IF NO RCR IS AVAILABLE, USE 12 FOR WET RUNWAYS AND 5 FOR ICY RUNWAYS.

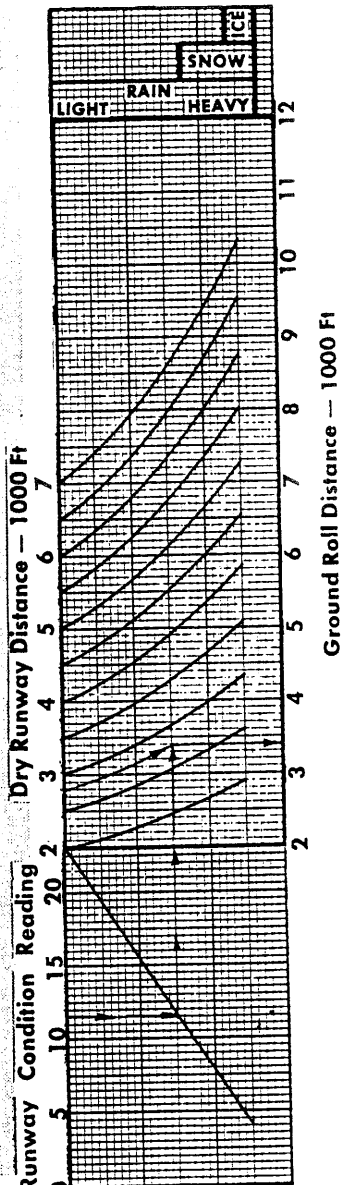

Figure A8-5

# LANDING DISTANCE WITHOUT DRAG CHUTE — TAKEOFF FLAPS

All External Stores Configurations  
 LEVEL RUNWAY      ANTI-SKID BRAKES

Engine: J79-GE-19  
 Fuel Grade: JP-8  
 Fuel Density: 6.68 Lb/Gal

Model: F-104S  
 Date: 1 October 1968  
 DATA BASIS: FLIGHT TEST

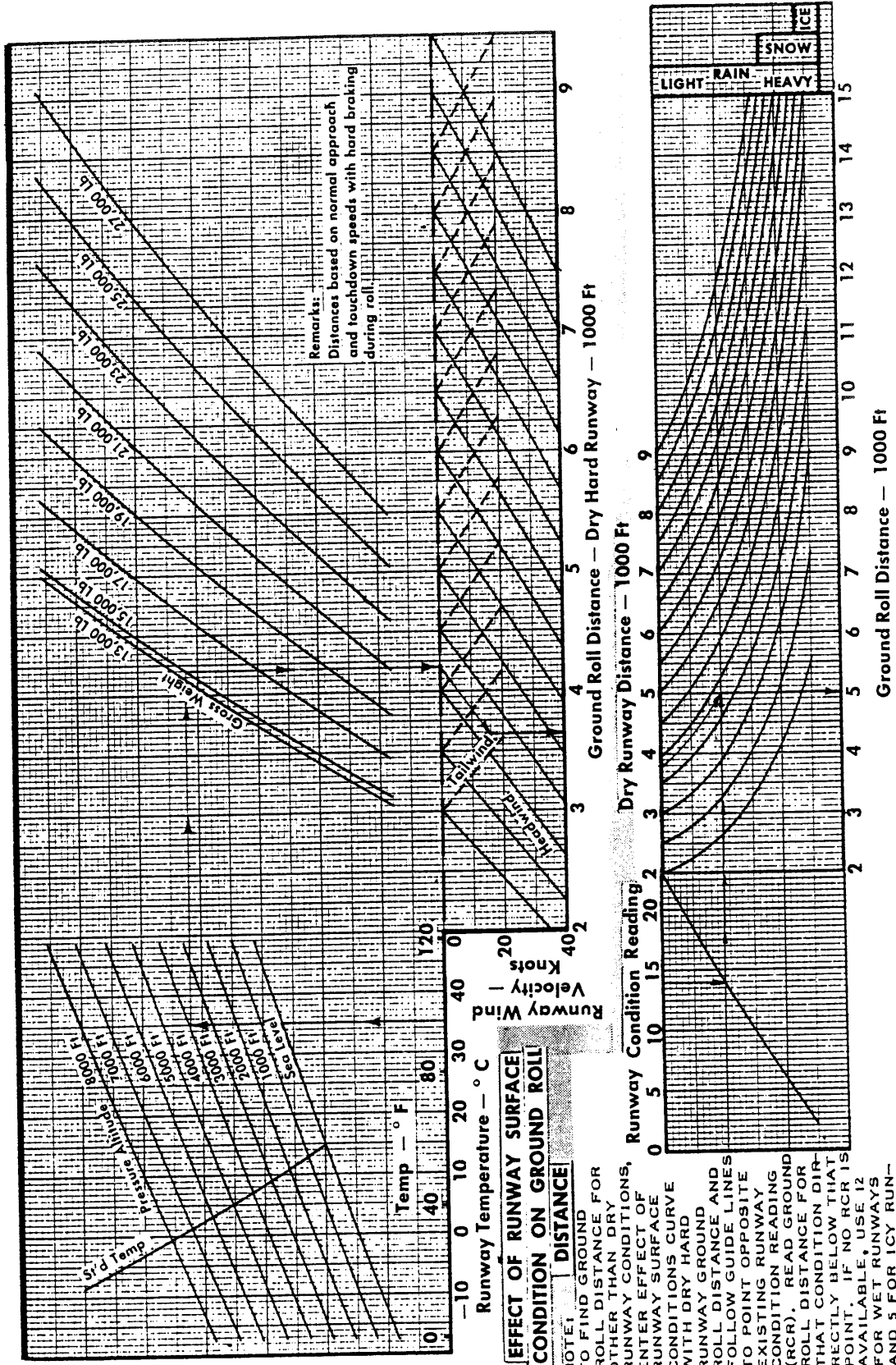

Figure A8-6

AVAILABLE RATE OF CLIMB FOR GO-AROUND — MILITARY THRUST

LANDING GEAR DOWN

All Configurations

LANDING FLAPS DOWN

Model: F-104S  
 Date: 1 April 1970  
 DATA BASIS: ESTIMATED

Engine: J79-GE-19  
 Fuel Grade: JP-8  
 Fuel Density: 6.68 Lb/Gal

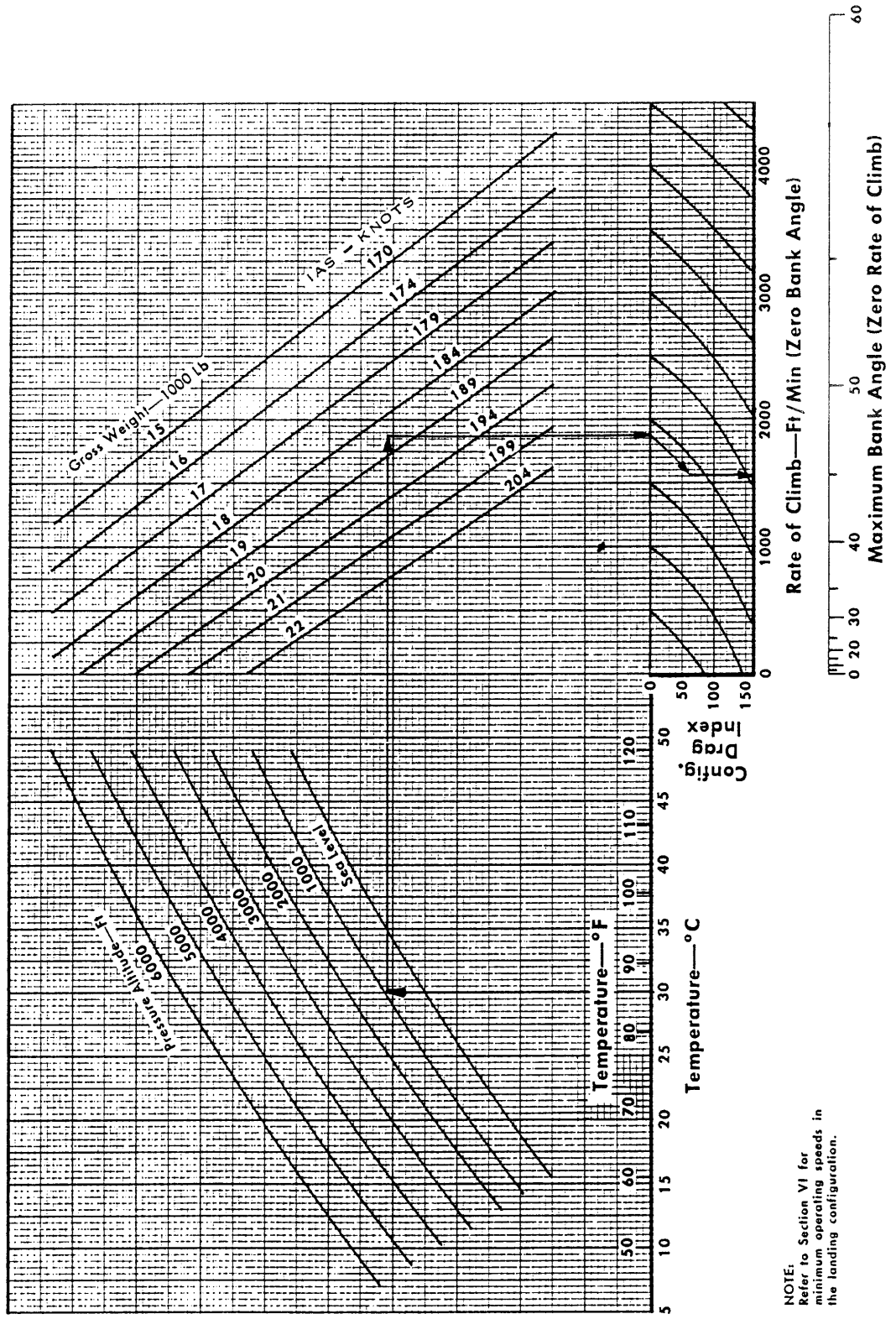

NOTE:  
 Refer to Section VI for  
 minimum operating speeds in  
 the landing configuration.

Figure A8-7

## PART 9

### COMBAT PERFORMANCE

#### TABLE OF CONTENTS

Index items in bold face characters denote illustrations.

Title	Page
Maximum Thrust Level Flight Acceleration	A9-1
Maximum Thrust Climb Control . . . . .	A9-2
Maximum Thrust Turning Performance . . .	A9-2
Afterburning Cruise Performance . . . . .	A9-4
Maximum Thrust Fuel Consumption . . . .	A9-4
<b>Maximum Thrust Level Flight Acceleration</b>	<b>A9-6</b>
<b>Maximum Thrust Climb Control . . . . .</b>	<b>A9-29</b>
<b>Maximum Thrust Turning Performance . .</b>	<b>A9-43</b>
<b>Turning Performance – General . . . . .</b>	<b>A9-48</b>
<b>Afterburner Cruise Performance . . . . .</b>	<b>A9-49</b>
<b>Military Thrust Fuel Consumption . . . . .</b>	<b>A9-54</b>
<b>Maximum Thrust Fuel Consumption . . . .</b>	<b>A9-55</b>

#### INTRODUCTION

This part presents information useful for preplanning combat and high-speed phases of operation. The data for BL 104 AIM-9L missiles, BL 104 pylons and AIM-9L launchers and adapter are estimated.

#### MAXIMUM THRUST LEVEL FLIGHT ACCELERATION

Maximum thrust level flight acceleration time, distance, and fuel required to accelerate from an initial cruise speed of Mach 0.90 are plotted as functions of the initial operating weight and the final desired Mach number. Data are provided for standard day temperatures and temperature deviations from standard of 10° C and 20° C, as applicable. Per-

formance is included for various configurations with no external stores, MRAAM, AIM-9L missiles and fuel tanks. Maximum acceleration performance on a standard day occurs at approximately 35000 feet pressure altitude for all configurations, and results in minimum fuel required to reach any desired final Mach number.

Ambient temperature above standard and the operating characteristics of individual engines may have a decided effect on acceleration performance. The maximum speed may be limited by compressor inlet temperature (refer to Section V "Operating Limitations"), thrust available or fuel required. Compressor inlet temperature is a function of ambient temperature and flight Mach number. This Mach limit is tabulated on each of the charts at the applicable temperature.

For example, in the no external stores configuration at 35000 feet pressure altitude and an ambient temperature of -44.3° C ( $\Delta$  temperature of +10° C), the maximum Mach number is 1.9. Obviously, as temperature increases above standard, maximum thrust will decrease and the level of excess thrust available for acceleration will also decrease. Therefore, operation at these temperatures requires careful flight planning because of the additional time required to accelerate and the corresponding increase in fuel used. The sample problem illustrates the use of the charts.

#### SAMPLE PROBLEM

Determine the time, distance and fuel required to accelerate from Mach 0.90 to Mach 2.0 at 40000 feet for operation without external stores. Assume the initial gross weight is 18000 pounds and the ambient temperature is -51.5° C ( $\Delta$  temperature +5° C). Enter Figure A9-2 at 18000 pounds in each of the performance columns for standard day and  $\Delta$  temperature of +10° C. At each final Mach number position of 2.0 read the time, distance and fuel required.

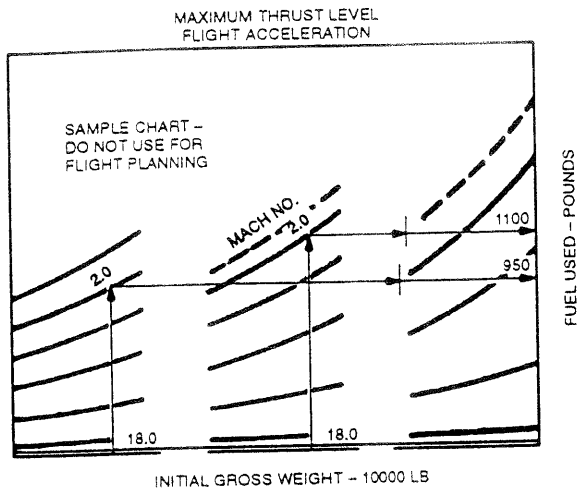

Std. Day  $\Delta T = +10^{\circ} C$

Time to accelerate	3.11 min	3.69 min
Distance to accelerate	40.2 nmi	49.0 nmi
Fuel to accelerate	950 lb	1100 lb

Interpolation of the above data provides the performance at an ambient temperature of  $-49.3^{\circ} C$  ( $\Delta T + 5^{\circ} C$ ).

Time to accelerate.....	3.40 min
Distance to accelerate.....	44.6 nmi
Fuel to accelerate.....	1025 lb

## MAXIMUM THRUST CLIMB CONTROL

Climb performance curves of time, distance, and fuel to climb at Mach 1.4, 1.6, 1.8 and 2.0 are presented from a base altitude of 35000 feet and Mach 2.2 from 40000 feet to the combat ceiling. Use of the curves is illustrated by the following sample problem.

### SAMPLE PROBLEM

Determine the standard-day climb performance for a maximum thrust climb at Mach 2.0 from 35000 feet to 55000 feet at an initial gross weight of 18000 pounds. The aircraft has no external stores.

- Enter Figure A9-27 at the final altitude, 55000 feet and proceed horizontally to the initial gross weight, 18000 lb read:

Time.....	.95 min
Fuel.....	350 lb
Distance.....	17.0 nmi

## MAXIMUM THRUST TURNING PERFORMANCE

A turn of up to  $180^{\circ}$  may be needed to complete the intercept, requiring appreciable amounts of time and fuel for the maneuver. Turn radius as well as time and fuel should be considered in overall mission planning.

Maximum thrust turning performance is shown for constant altitude, minimum radius turns where speed and load factor ( $G$ 's) are also held constant. Maximum thrust turning performance load factor are shown for operation without external stores and in configurations with tip tanks, AIM-9L missiles, and BL 104 MRAAM. Load factor when used in conjunction with the "Turning Performance" chart, Figure A9-43, provides turn radius and time for a  $180^{\circ}$  turn. The "Maximum Thrust Fuel Consumption" chart, Figure A9-50 and Figure A9-51, provides the fuel flow to calculate the fuel used.

### SAMPLE PROBLEM

Determine the  $180^{\circ}$  turn performance in the no external stores configuration at 40000 feet, ambient temperature of  $-40^{\circ} C$ , true Mach number of 1.6 and gross weight of 18000 pounds.

- Enter Figure A9-38 on the right with 1.6 true Mach number. Proceed up to a pressure altitude of 40000 feet and establish a horizontal reference line to the left through the guide lines.

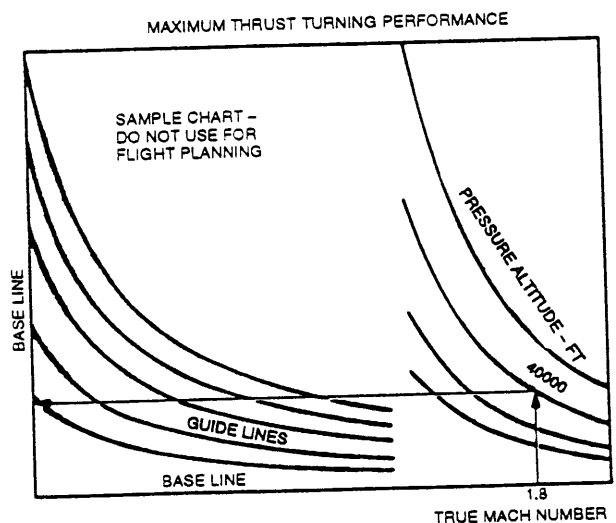

FA0298

- b. Reenter the chart on the left with 1.6 true Mach number. Proceed up to  $-40^{\circ}\text{C}$  ambient temperature, then horizontally to the base line. Follow the guide lines to an intersection with the horizontal reference line from step a. If an intersection shall not be made with the horizontal reference line, maneuvering capability is not available for the desired conditions.

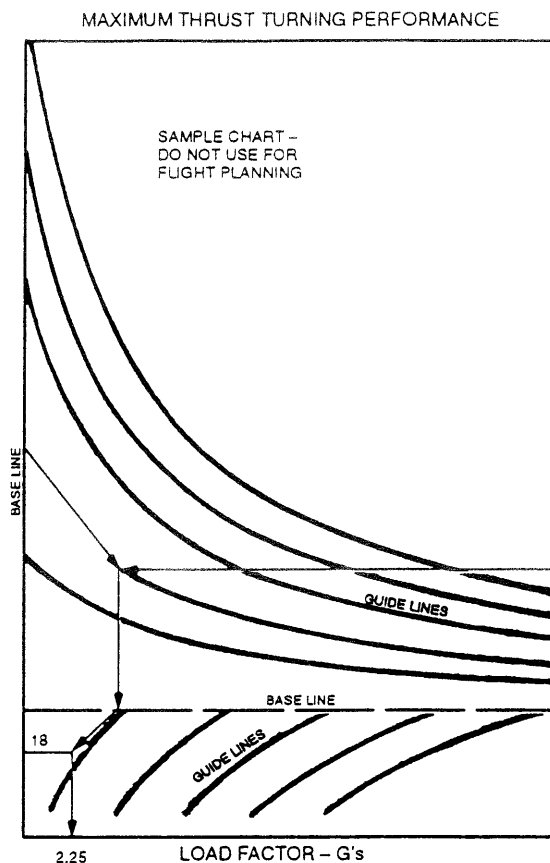
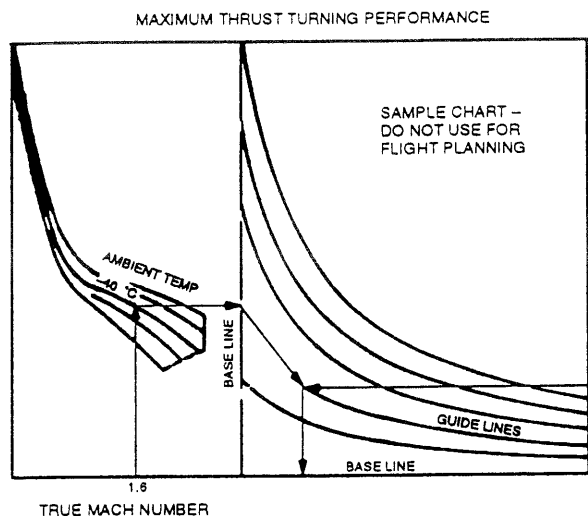

- c. Proceed down from this point to the base line. Follow the guide lines to the gross weight of 18000 pounds. Directly below this point read, load factor 2.25 "G".
- d. Refer to the turning performance chart to determine turn radius, time in  $180^{\circ}$  turn and bank angle. Enter the chart at the ambient temperature of  $-40^{\circ}\text{C}$  and proceed up to 1.6 Mach number. Horizontally to the right read, true airspeed 950 knots.
- e. Continue to the right to the load factor determined in step c (2.25 "G"), directly below this point read turn radius 6.6 nmi.
- f. Continue downward to the true airspeed from step d. (950 knots) and read 1.3 minutes for a  $180^{\circ}$  turn. From the table of bank angle and load factor interpolate the bank angle for 2.25 "G" as  $64^{\circ}$ .

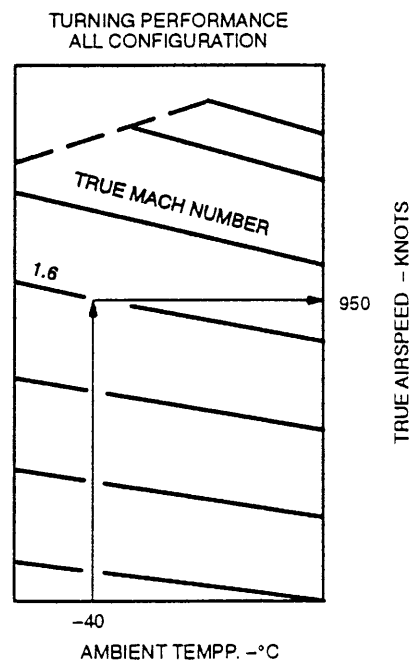

FA0299



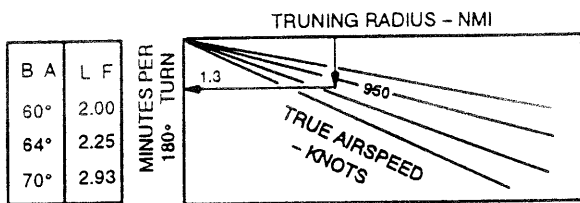
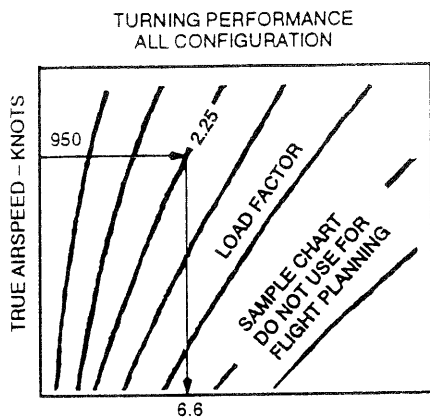

BA - Bank Angle  
LF - Load Factor

- g. Fuel used for the turn is determined from the maximum thrust fuel consumption curve (Figure A9-51). Enter with the ambient temperature of  $-40^{\circ}\text{C}$  and true Mach number 1.6. Proceed vertically upward to 40000 feet pressure altitude, at the left read fuel flow, 355 lb/min. Calculate the fuel used in 180° turn ( $355 \times 1.3$ ), or 462 lb.

## AFTERBURNING CRUISE PERFORMANCE

Afterburning cruise performance is provided for various configurations in Figure A9-44 to Figure A9-48. The nautical miles per 1000 pounds of fuel are applicable to supersonic cruising with the afterburner throttled to maintain level flight at constant Mach number. Flight conditions that require the use of minimum or maximum afterburner are also shown.

### SAMPLE PROBLEM

Determine the fuel required to make a 100 nautical mile dash at Mach 1.8 and 45000 feet, at a gross weight of 17000 pounds. The aircraft has MRAAM installed. Enter Figure A9-45 at cruise Mach 1.8 and 45000 feet pressure altitude. At a gross weight

of 17000 pounds read 76.5 nautical miles per 1000 lb of fuel. Fuel required for a 100 nautical mile dash is  $100/76.5$  or 1304 pounds.

## MAXIMUM THRUST FUEL CONSUMPTION

Fuel consumption for maximum thrust operation at constant speed and altitude applicable to full afterburning is provided for use in planning combat allowances at or near a target area. The charts should not be interpreted as providing fuel flows for unaccelerated level flight with less than full afterburner, such as a dash approach to a target. Figure A9-50 presents fuel consumption from sea level to 30000 feet and Figure A9-51 from 30000 to 60000 feet, as a function of ambient temperature and true Mach number.

### SAMPLE PROBLEM

Determine the time available for combat at Mach 1.6 and 40000 feet if 3000 pounds of fuel are to be used. The ambient temperature is  $-40^{\circ}\text{C}$ . Enter the maximum thrust fuel consumption chart (Figure A9-51) at  $-40^{\circ}\text{C}$  ambient temperature and Mach 1.6. Proceed vertically upward to 40000 feet pressure altitude and read fuel flow, 355 lb/min. Combat time available is  $3000/355$  or 8.45 min.

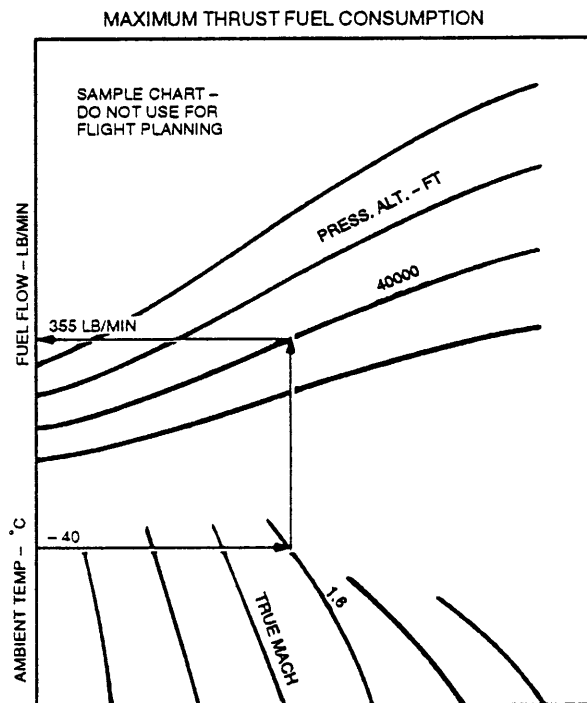

**Military Thrust Fuel Consumption**

Fuel consumption for military thrust operation at constant speed and altitude is provided in Figure A9-49. Use of the chart is illustrated by the following example.

pressure altitude of 3000 feet and an ambient temperature that is  $19^{\circ}\text{C}$  ( $\Delta T = +10^{\circ}\text{C}$ ). Enter Figure A9-49 at 3000 feet pressure altitude and proceed to Mach 0.90. Vertically below this point intersect the base line in the  $\Delta$  temperature grid. Follow the guide lines to a  $\Delta$  temperature above standard of  $10^{\circ}\text{C}$ . Directly below this point read fuel flow of 175 lb/min. Fuel required is 350 lb ( $2 \times 175$ ).

**SAMPLE PROBLEM**

Determine the fuel required for 2 minutes of combat maneuvering with military thrust at Mach 0.90 at a

MAXIMUM THRUST LEVEL FLIGHT ACCELERATION

NO EXTERNAL STORES

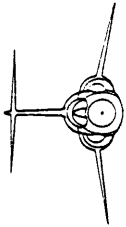

35000 FT PRESSURE ALTITUDE

Engine: J79-GE-19  
 Fuel Grade: JP-8  
 Fuel Density: 6.88 Lb/Gal

Model: F-104S  
 Date: 1 April 1970  
 DATA BASIS: FLIGHT TEST

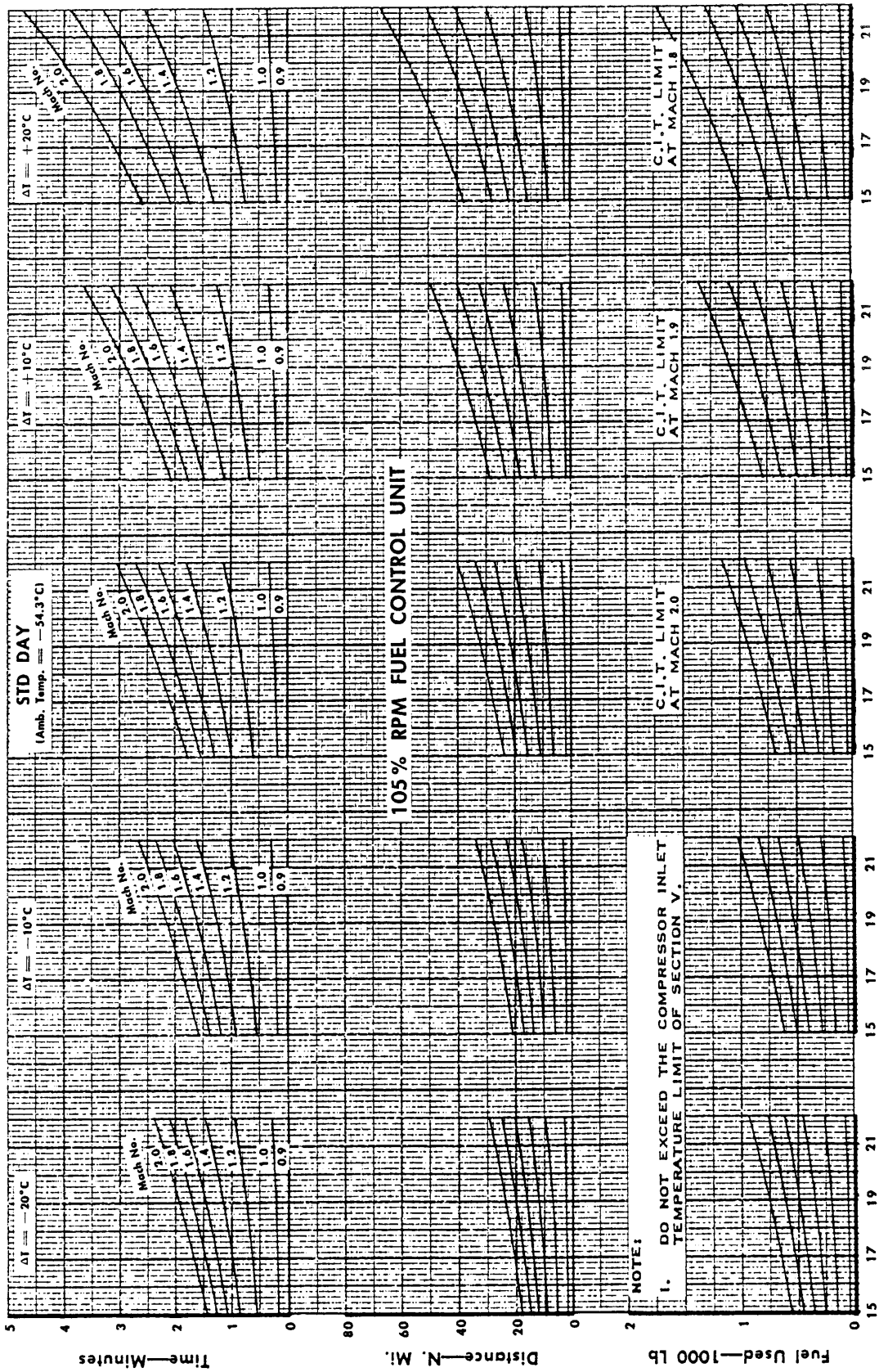

Initial Gross Weight—10000 Lb

Figure A9-1

# MAXIMUM THRUST LEVEL FLIGHT ACCELERATION

NO EXTERNAL STORES

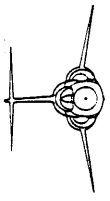

40000 FT PRESSURE ALTITUDE

Engine: J79-GE-19  
 Fuel Grade: JP-8  
 Fuel Density: 6.68 Lb/Gal

Model: F-104S  
 Date: 1 April 1970  
 DATA BASIS: FLIGHT TEST

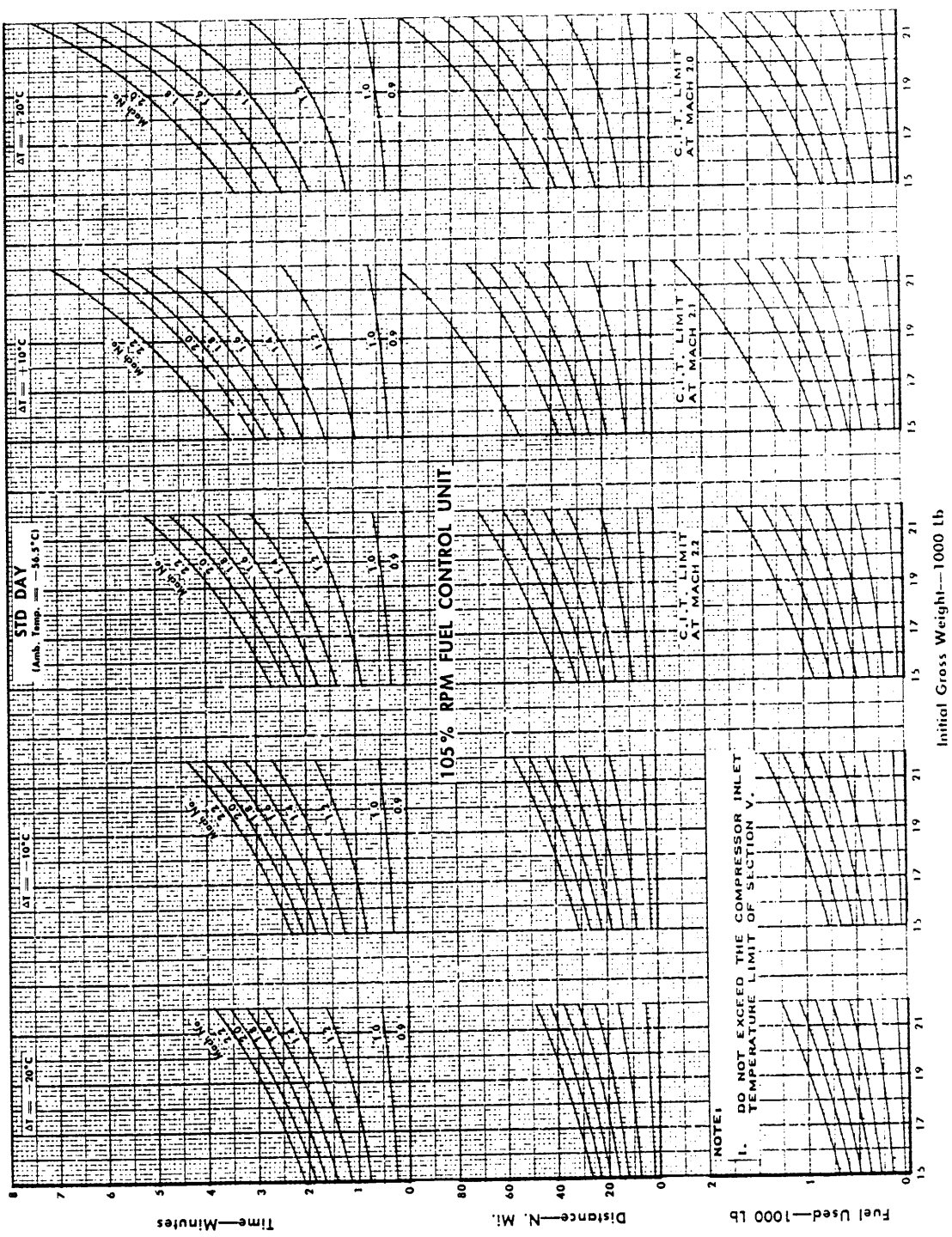

Initial Gross Weight—1000 lb

Figure A9-2

MAXIMUM THRUST LEVEL FLIGHT ACCELERATION

45000 FT PRESSURE ALTITUDE

NO EXTERNAL STORES

Model: F-104S  
 Date: 1 April 1970  
 DATA BASIS: FLIGHT TEST

Engine: J79-GE-19  
 Fuel Grade: JP-8  
 Fuel Density: 6.68 Lb/Gal

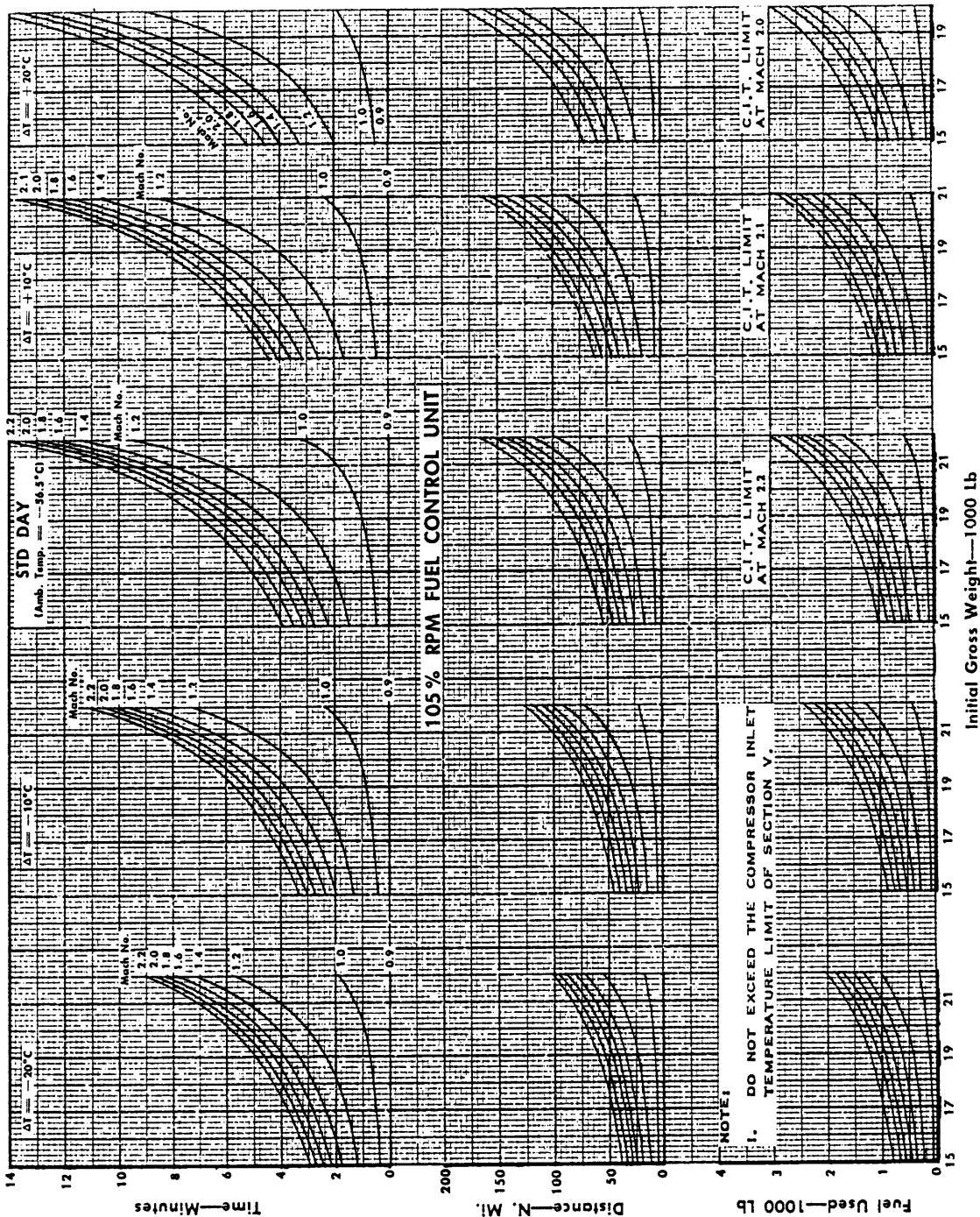
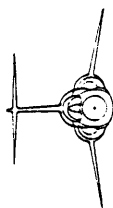
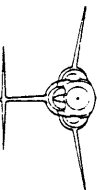

Figure A9-3

MAXIMUM THRUST LEVEL FLIGHT ACCELERATION

NO EXTERNAL STORES



Engine: J79-GE-19  
 Fuel Grade: JP-8  
 Fuel Density: 6.68 Lb/Gal

50000 FT PRESSURE ALTITUDE

Model: F-104S  
 Date: 1 April 1970  
 DATA BASIS: FLIGHT TEST

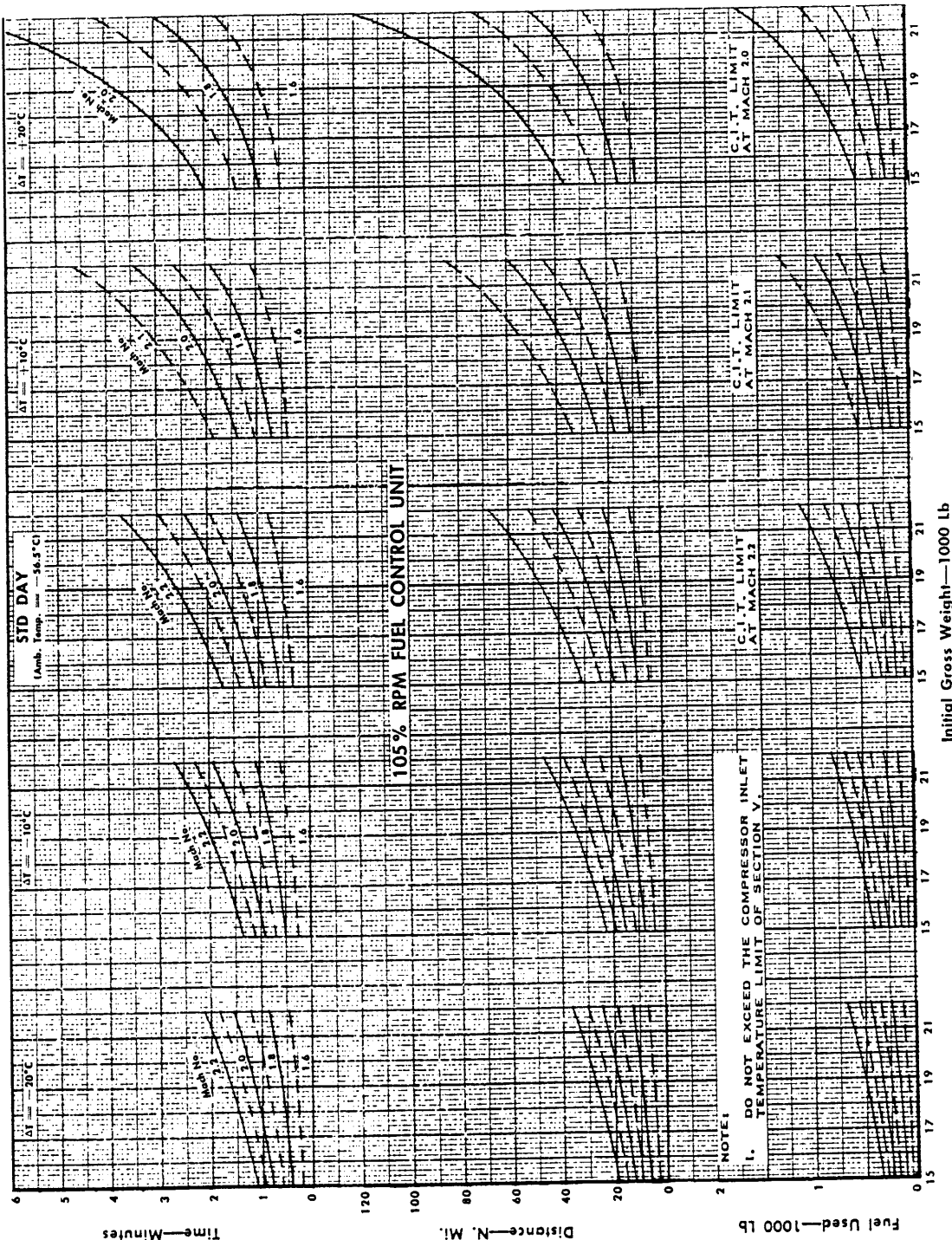

Initial Gross Weight—1000 Lb

Figure A9-4

MAXIMUM THRUST LEVEL FLIGHT ACCELERATION

55000 FT PRESSURE ALTITUDE

NO EXTERNAL STORES

Model: F-104S  
 Date: 1 April 1970  
 DATA BASIS: FLIGHT TEST

Engine: J79-GE-19  
 Fuel Grade: JP-8  
 Fuel Density: 6.68 Lb/Gal

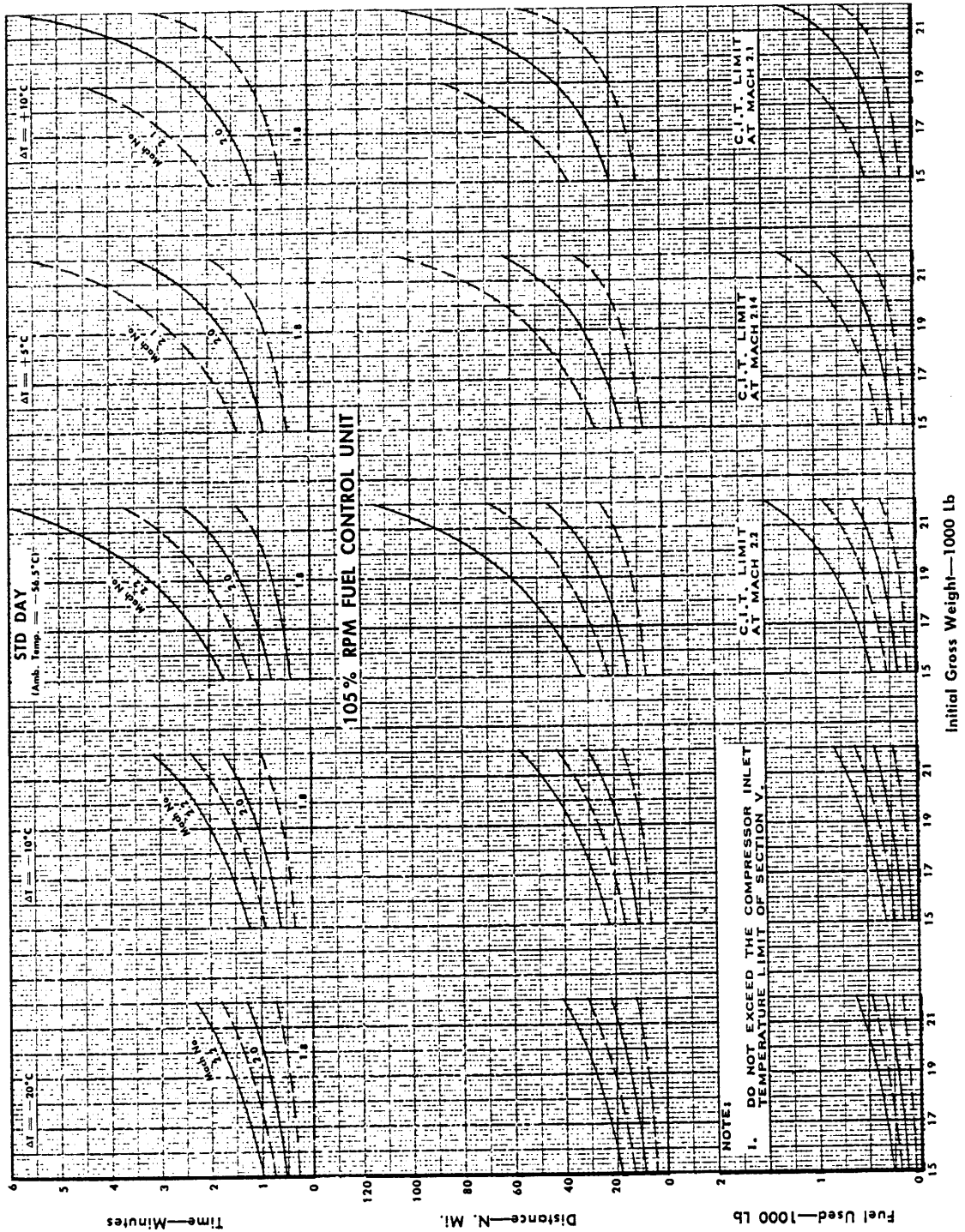
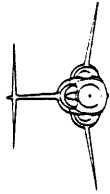

Figure A9-5

# MAXIMUM THRUST LEVEL FLIGHT ACCELERATION

- BL104 MRAAM
- BL104 AIM-9L Missiles
- BL104 AIM-9L Missile and BL104 MRAAM

Engine: J79-GE-19  
 Fuel Grade: JP-8  
 Fuel Density: 6.68 Lb/Gal

35000 FT PRESSURE ALTITUDE

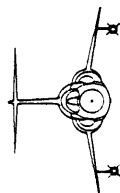

Model: F-104S  
 Date: 1 April 1970  
 DATA BASIS: FLIGHT TEST

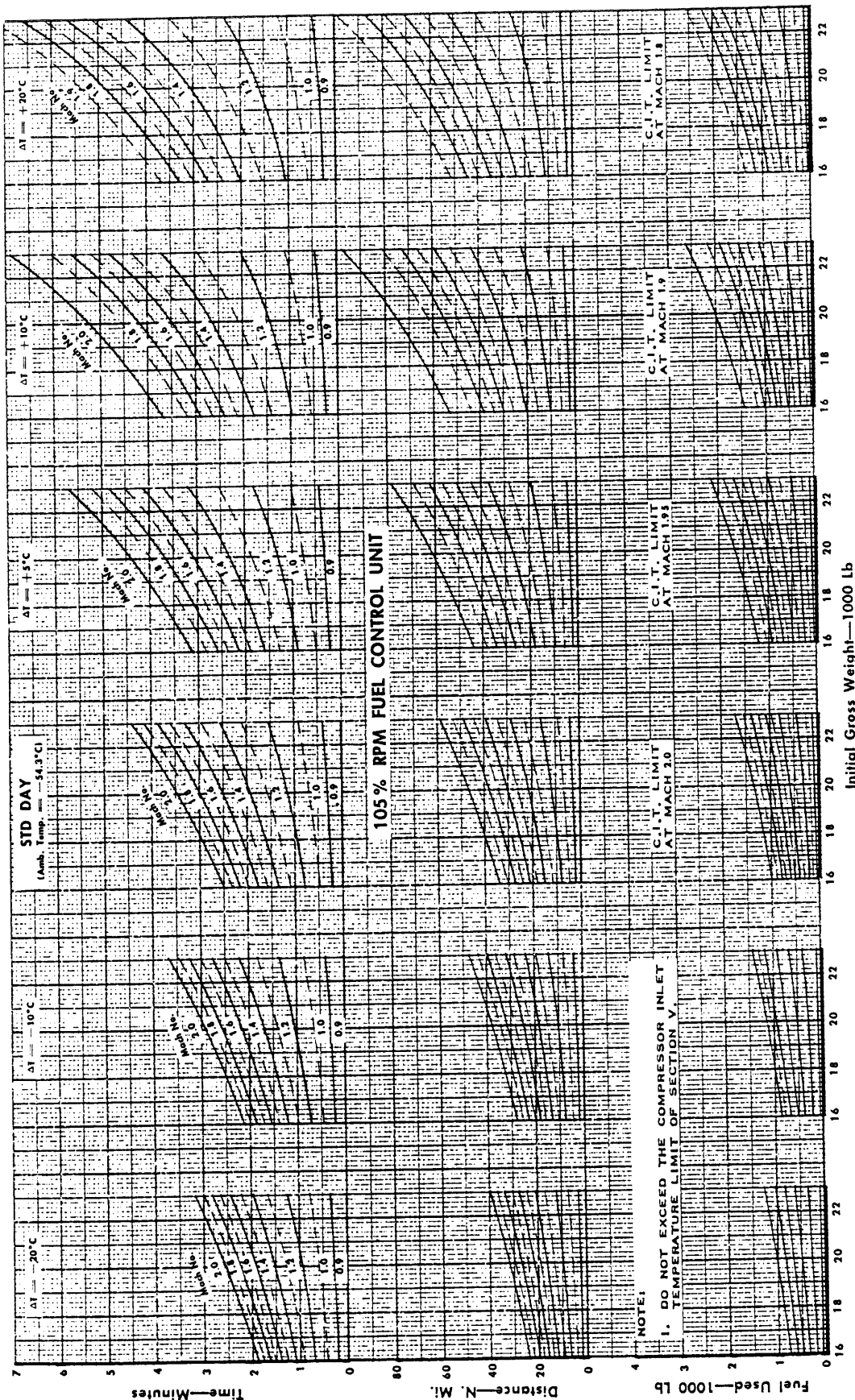

Figure A9-6



MAXIMUM THRUST LEVEL FLIGHT ACCELERATION

40000 FT PRESSURE ALTITUDE

Model: F-104S  
 Date: 1 April 1970  
 DATA BASIS: FLIGHT TEST

- BL104 MRAAM
- BL104 AIM-9L Missiles
- BL104 AIM-9L Missile and BL104 MRAAM

Engine: J79-GE-19  
 Fuel Grade: JP-8  
 Fuel Density: 6.68 Lb/Gal

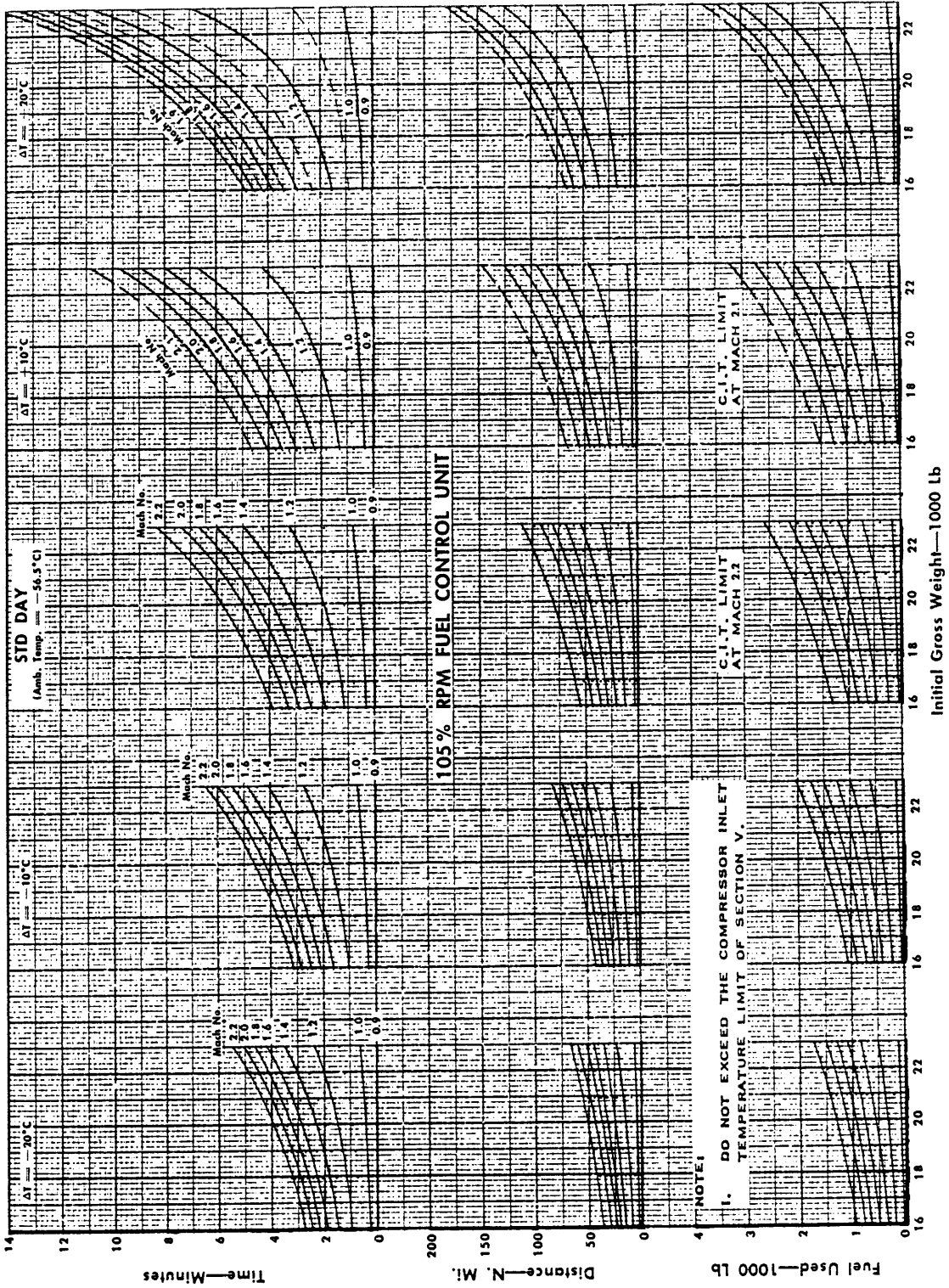
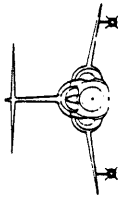
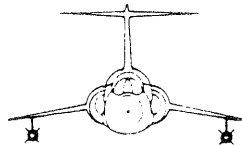

Figure A9-7

# MAXIMUM THRUST LEVEL FLIGHT ACCELERATION

45000 FT PRESSURE ALTITUDE



- BL104 MRAAM
- BL104 AIM-9L Missiles
- BL104 AIM-9L Missile and BL104 MRAAM

Model: F-104S  
 Date: 1 April 1970  
 DATA BASIS: FLIGHT TEST

Engine: J79-GE-19  
 Fuel Grade: JP-8  
 Fuel Density: 6.68 Lb/Gal

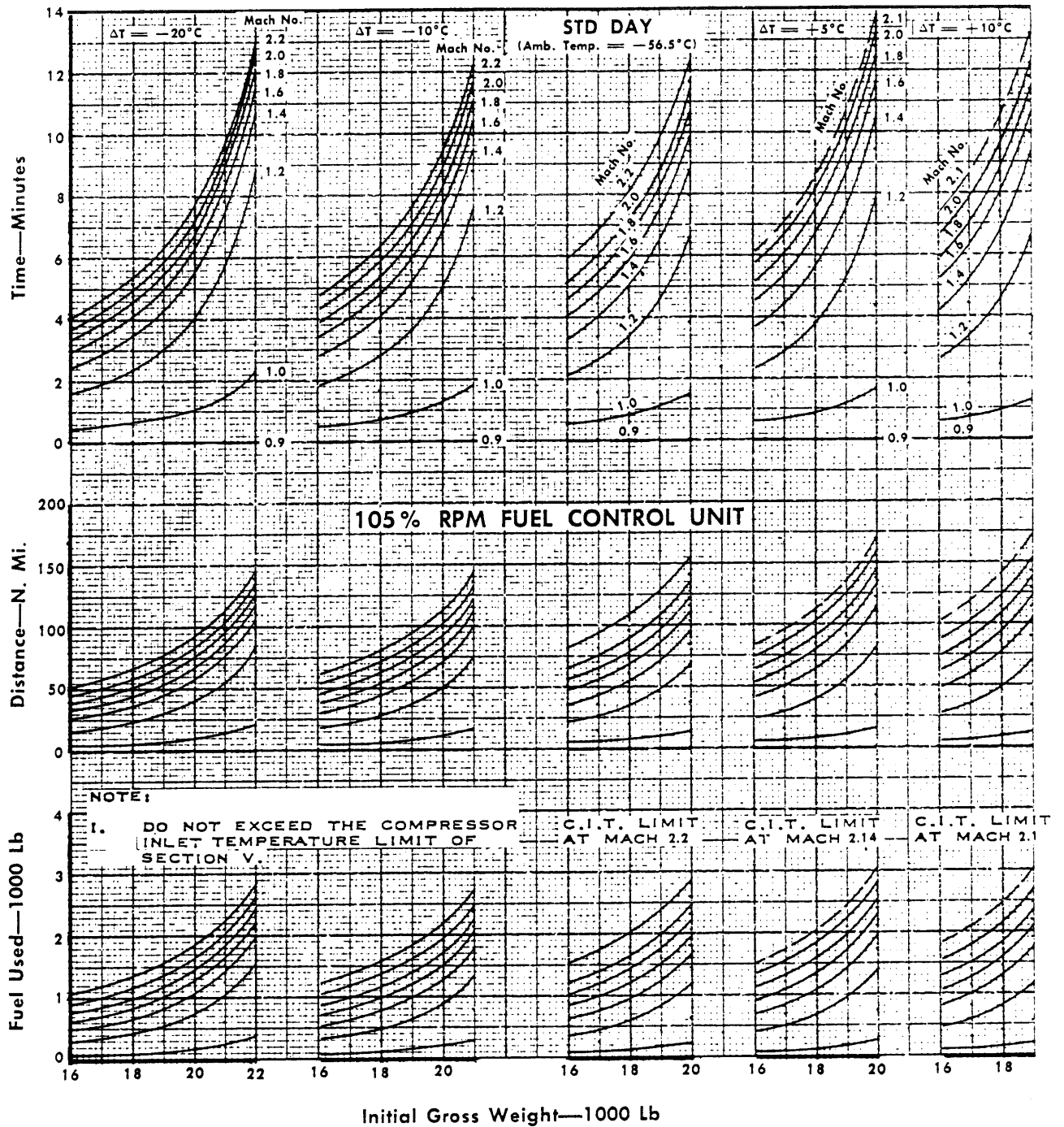

Figure A9-8

MAXIMUM THRUST LEVEL FLIGHT ACCELERATION

- BL104 MRAAM
- - - BL104 AIM-9L Missiles
- - - BL104 AIM-9L Missile and BL104 MRAAM

Engine: J79-GE-19  
 Fuel Grade: JP-8  
 Fuel Density: 6.68 Lb/Gal

50000 FT PRESSURE ALTITUDE

Model: F-104S  
 Date: 1 April 1970  
 DATA BASIS: FLIGHT TEST

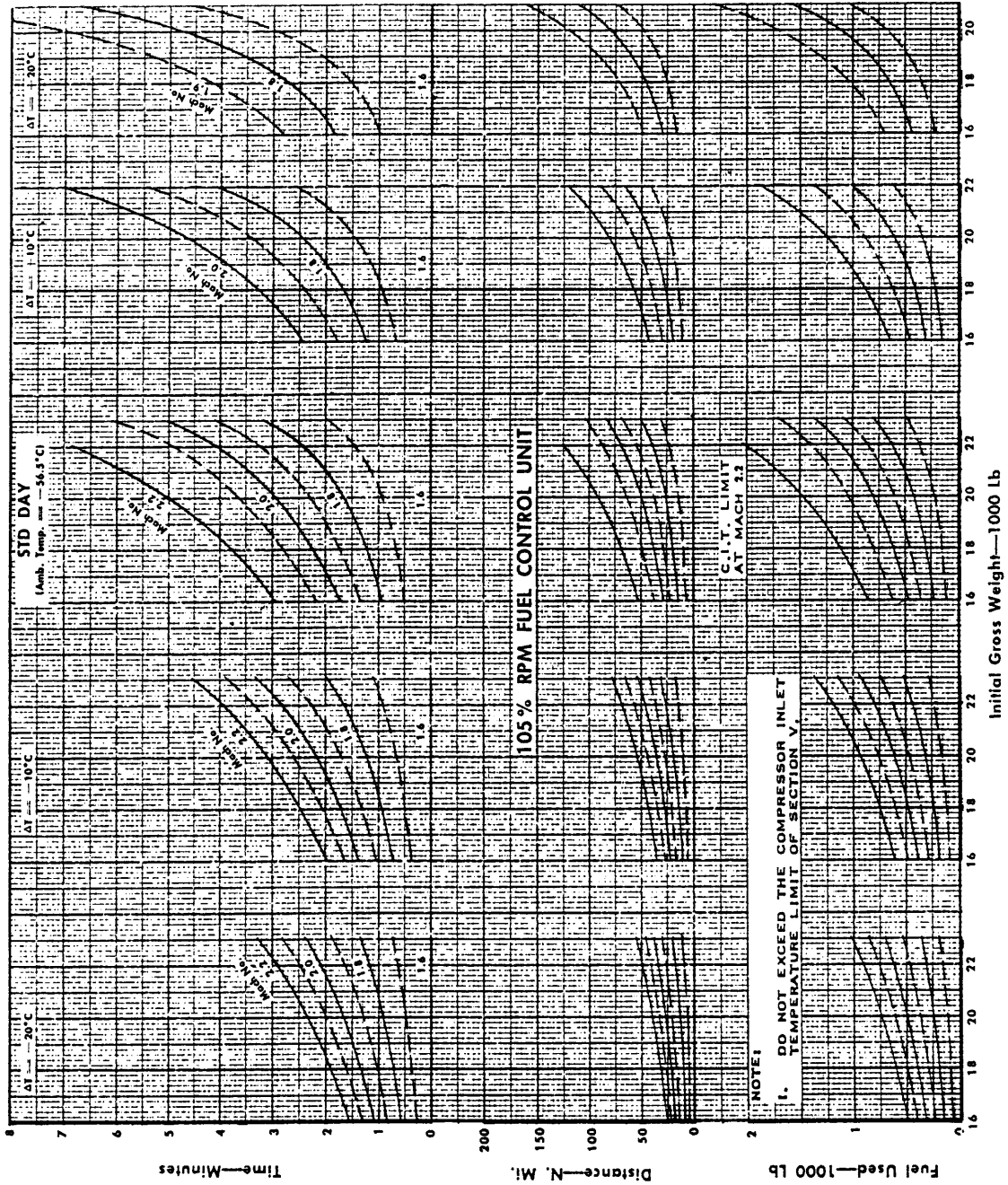
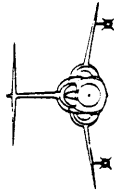

Figure A9-9

# MAXIMUM THRUST LEVEL FLIGHT ACCELERATION

35000 FT PRESSURE ALTITUDE

— Tip Tanks  
 - - - Tip AIM-9L Missiles

Engine: J79-GE-19  
 Fuel Grade: JP-8  
 Fuel Density: 6.68 Lb/Gal

Model: F-104S  
 Date: 1 April 1970  
 DATA BASIS: FLIGHT TEST

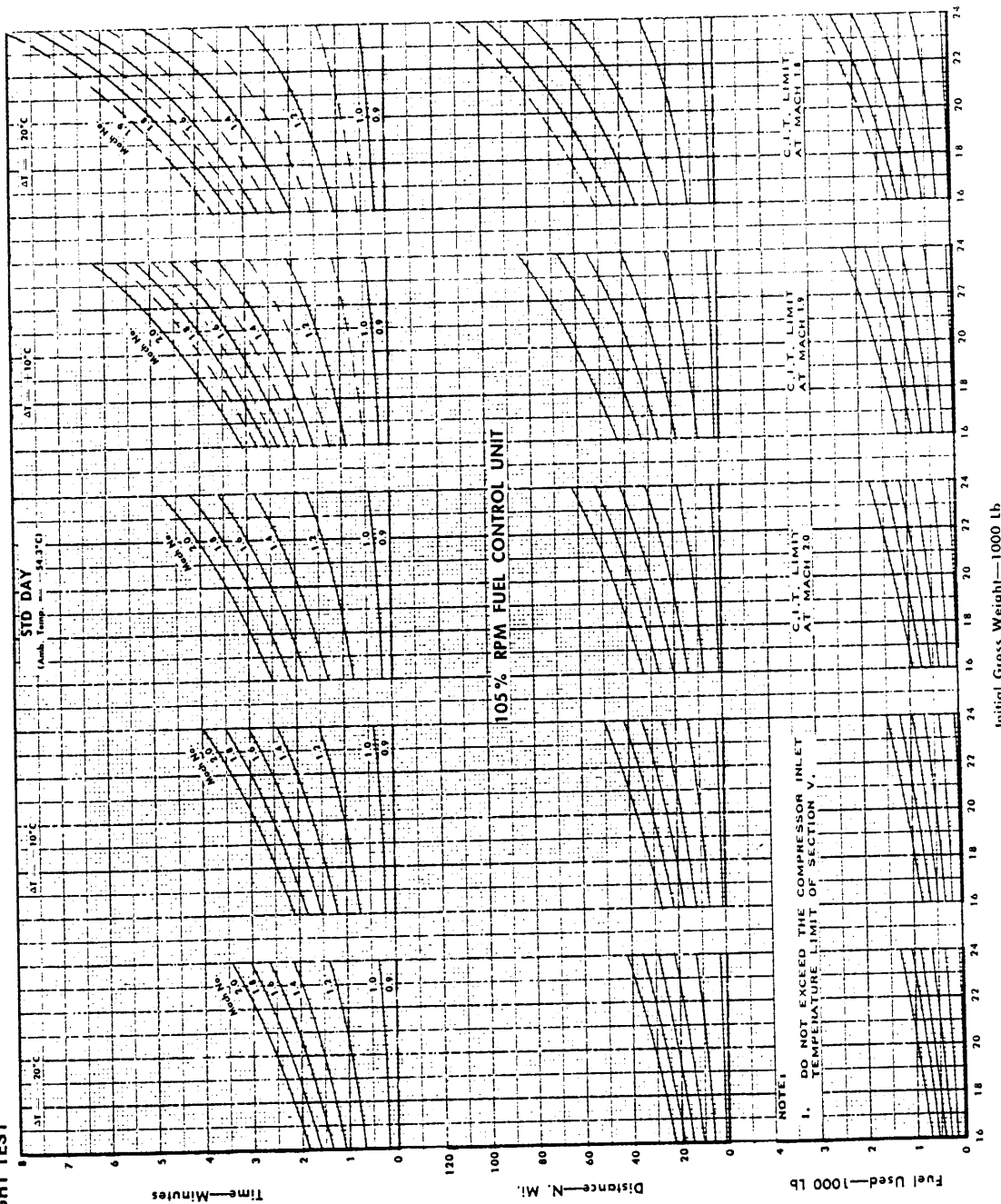
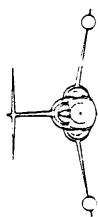

Initial Gross Weight—1000 Lb

Figure A9-10

MAXIMUM THRUST LEVEL FLIGHT ACCELERATION

— Tip Tanks  
 - - - Tip AIM-9L Missiles

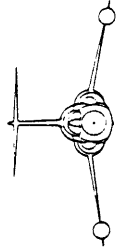

Model: F-104S  
 Date: 1 April 1970  
 DATA BASIS: FLIGHT TEST

Engine: J79-GE-19  
 Fuel Grade: JP-8  
 Fuel Density: 6.68 Lb/Gal

40000 FT PRESSURE ALTITUDE

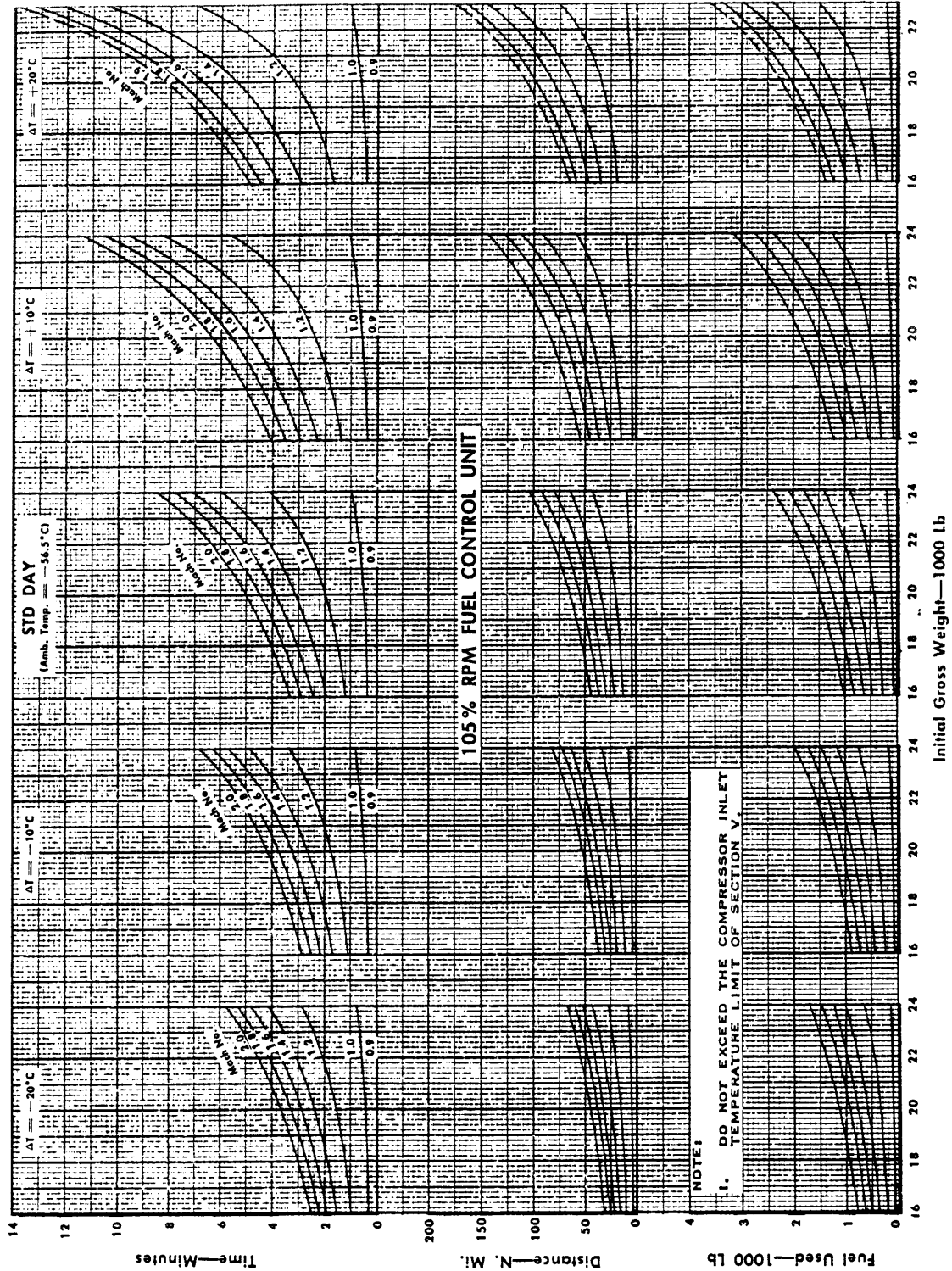

Figure A9-11

# MAXIMUM THRUST LEVEL FLIGHT ACCELERATION

- - Tip Tanks
- - Tip AIM-9L Missiles

45000 FT PRESSURE ALTITUDE

Engine: J79-GE-19  
 Fuel Grade: JP-8  
 Fuel Density: 6.68 Lb/Gal

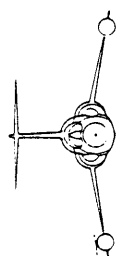

Model: F-104S  
 Date: 1 April 1970  
 DATA BASIS: FLIGHT TEST

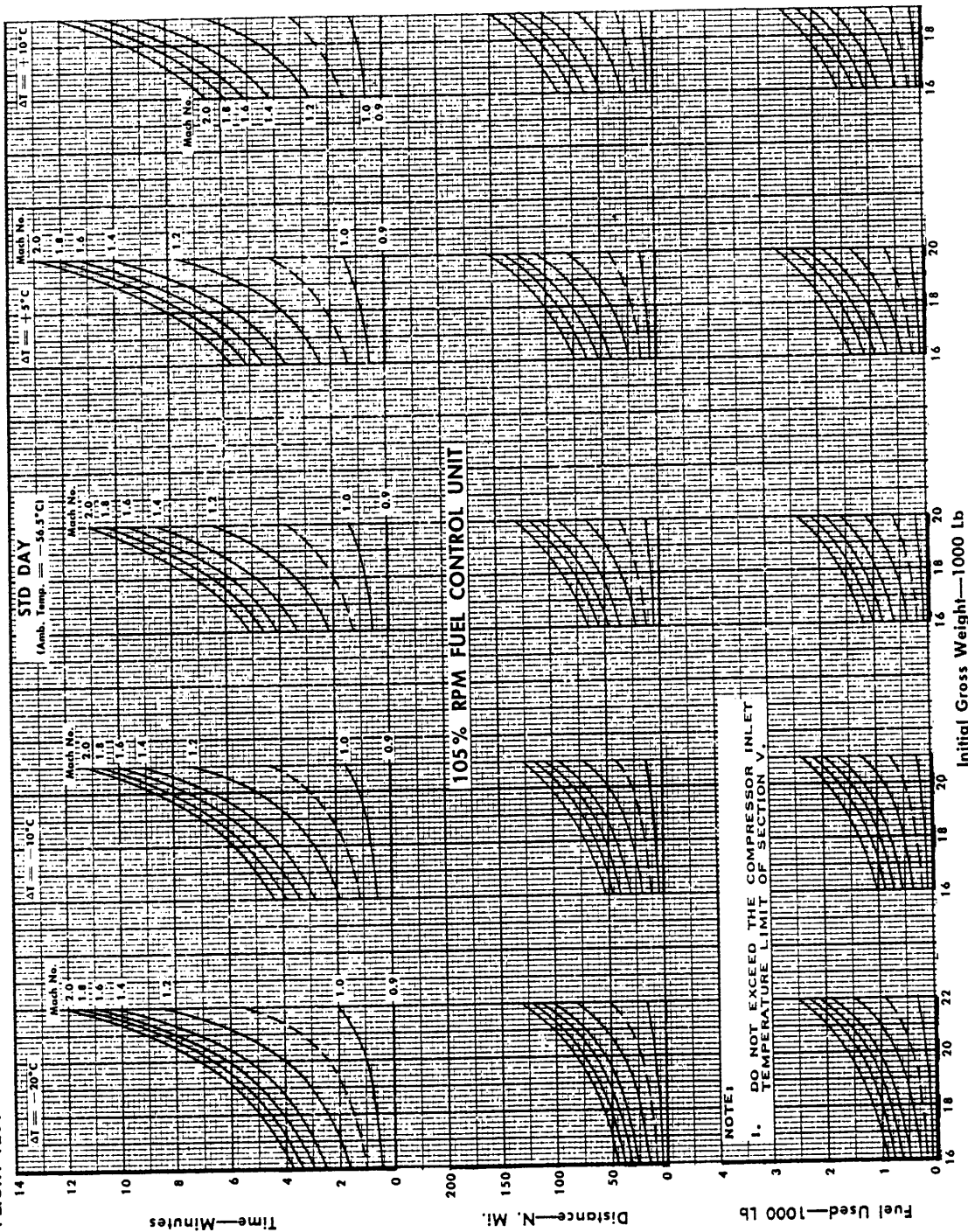

Figure A9-12

MAXIMUM THRUST LEVEL FLIGHT ACCELERATION

50000 FT PRESSURE ALTITUDE

Model: F-104S  
 Date: 1 April 1970  
 DATA BASIS: FLIGHT TEST

Engine: J79-GE-19  
 Fuel Grade: JP-8  
 Fuel Density: 6.88 Lb/Gal

--- Tip Tanks  
 --- Tip AIM-9L Missiles

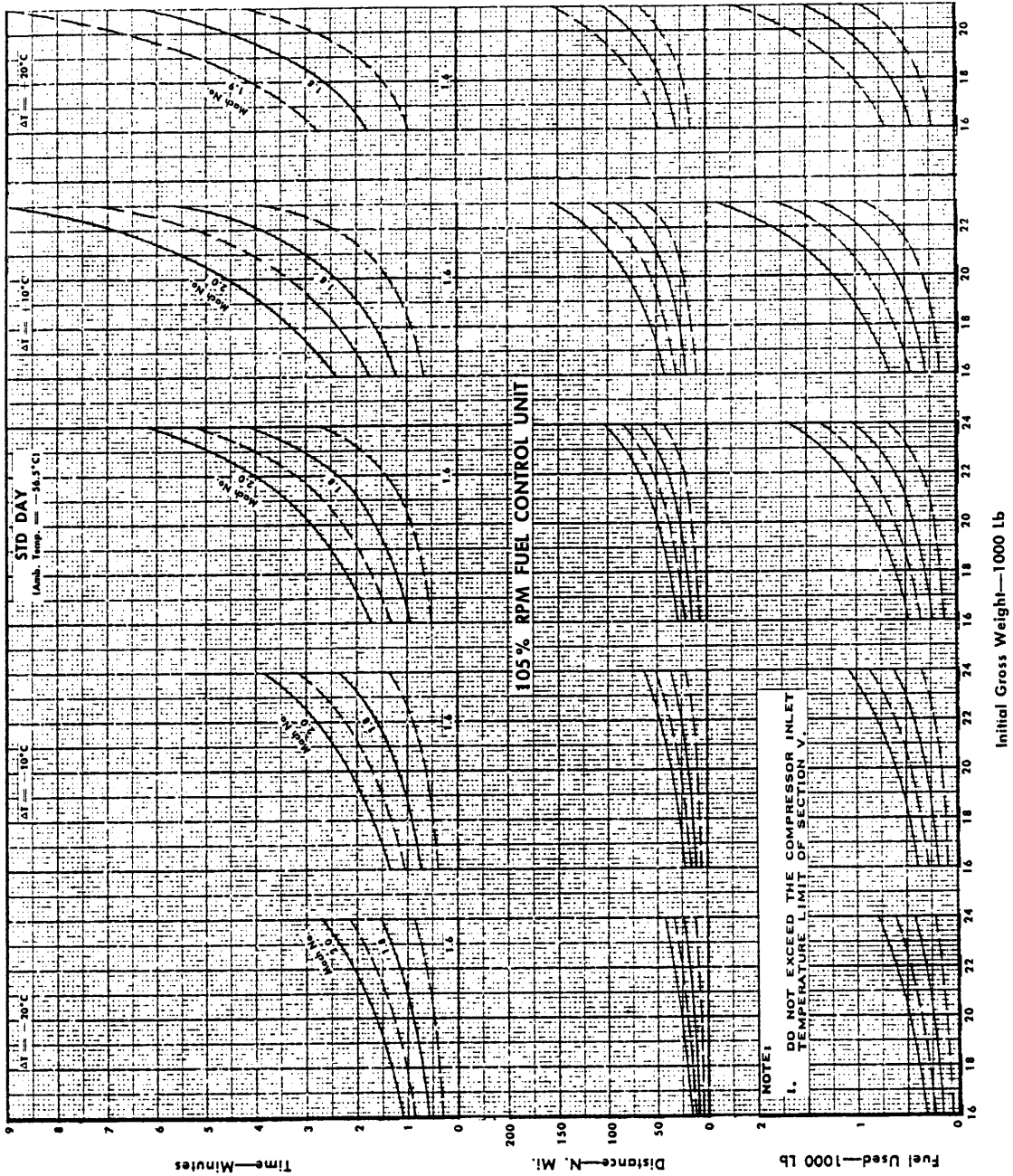
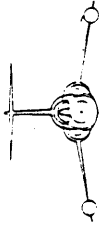

Figure A9-13

# MAXIMUM THRUST LEVEL FLIGHT ACCELERATION

35000 FT PRESSURE ALTITUDE

- Tip Tanks and BL104 MRAAM
- Tip Tanks and BL104 AIM-9L Missiles
- Tip Tanks and BL104 AIM-9L Missile and BL104 MRAAM
- BL75 Fuel Pylon Tanks
- Tip AIM-9L Missiles and BL104 MRAAM

Engine: J79-GE-19  
Fuel Grade: JP-8  
Fuel Density: 6.68 Lb/Gal

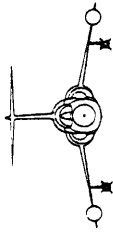

Model: F-104S

Date: 1 April 1970

DATA BASIS: FLIGHT TEST

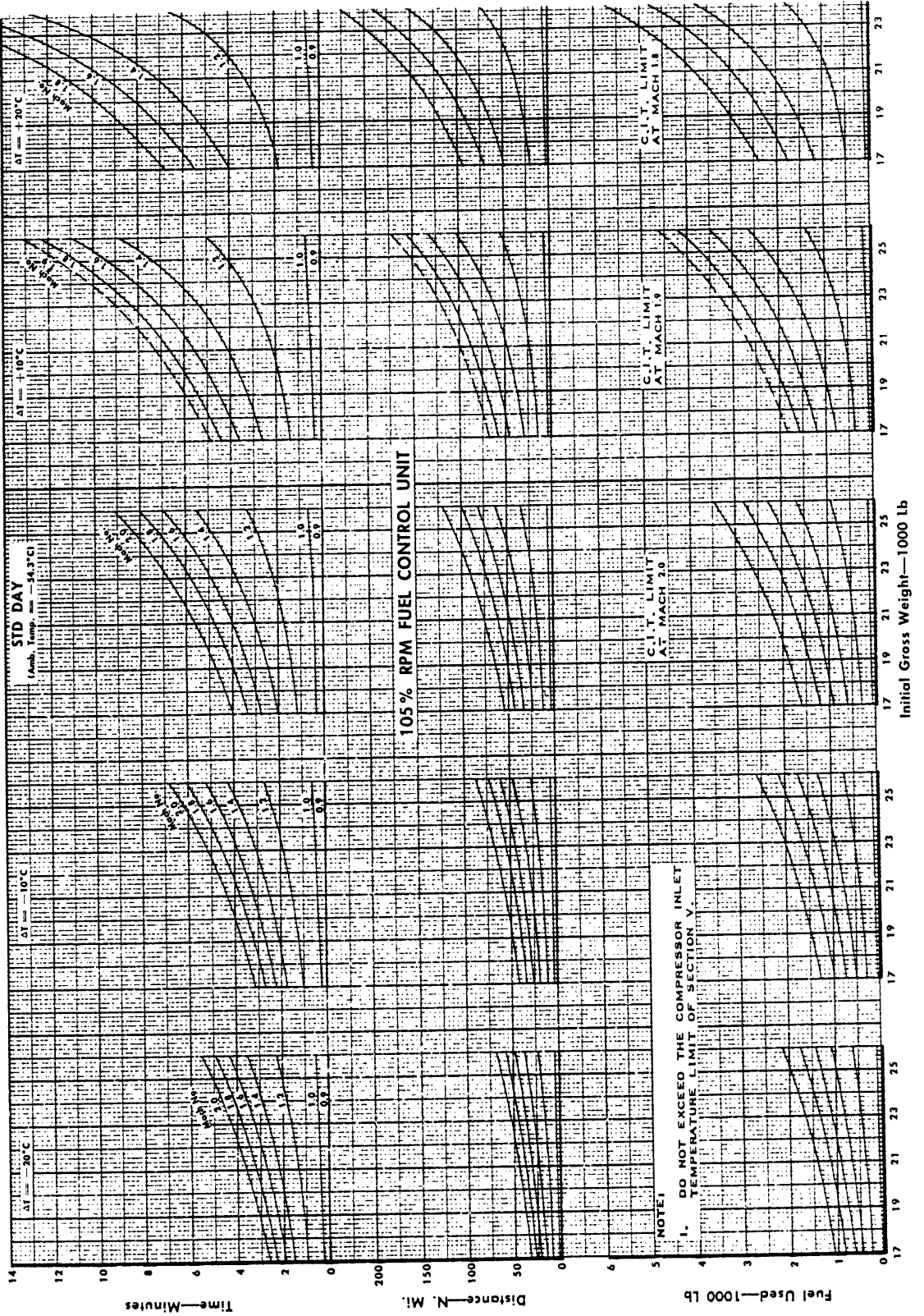

Figure A9-14



**MAXIMUM THRUST LEVEL FLIGHT ACCELERATION**

40000 FT PRESSURE ALTITUDE

Model: F-104S  
 Date: 1 April 1970  
 DATA BASIS: FLIGHT TEST

- Tip Tanks and BL104 MRAAM
- Tip Tanks and BL104 AIM-9L Missiles
- Tip Tanks and BL104 AIM-9L Missile and BL104 MRAAM
- BL75 Fuel Pylon Tanks
- Tip AIM-9L Missiles and BL104 MRAAM
- Tip AIM-9L Missiles and BL104 AIM-9L Missiles

Engine: J79-GE-19  
 Fuel Grade: JP-8  
 Fuel Density: 6.68 Lb/Gal

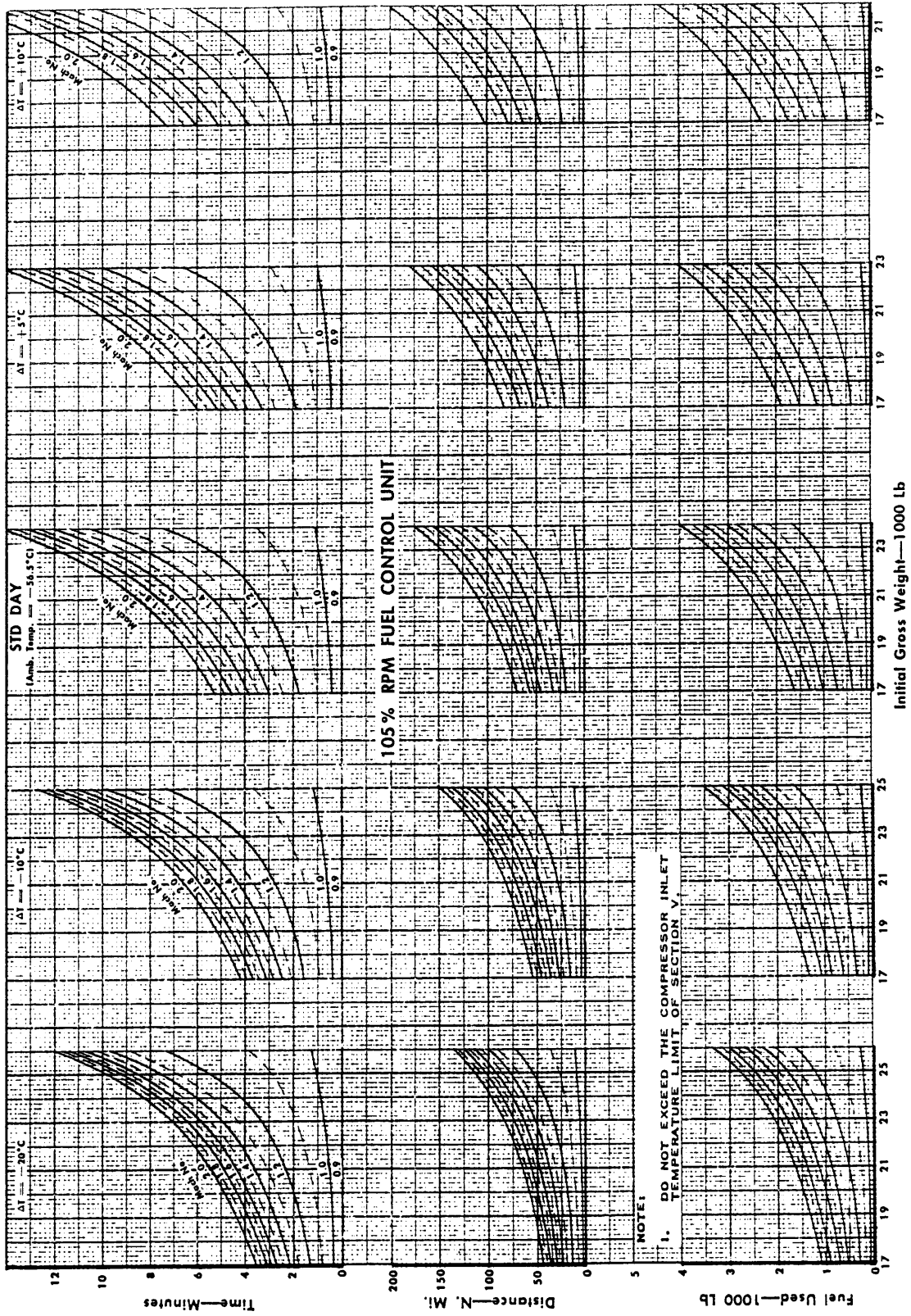
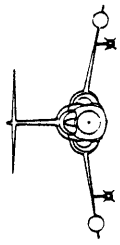
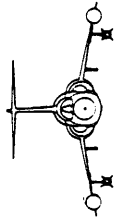

Figure A9-15



**MAXIMUM THRUST LEVEL FLIGHT ACCELERATION**

- Tip Tanks, BL104 MRAAM and BL75 Pylons
  - Tip Tanks, BL104 AIM-9L Missiles and BL75 Pylons
  - Tip AIM-9L Missiles, BL104 AIM-9L Missiles and BL75 Pylons
  - Tip AIM-9L Missiles, BL104 MRAAM and BL75 Pylons
- Engine: J79-GE-19  
 Fuel Grade: JP-8  
 Fuel Density: 6.68 Lb/Gal



40000 FT PRESSURE ALTITUDE

Model: F-104S  
 Date: 1 April 1970  
 DATA BASIS: FLIGHT TEST

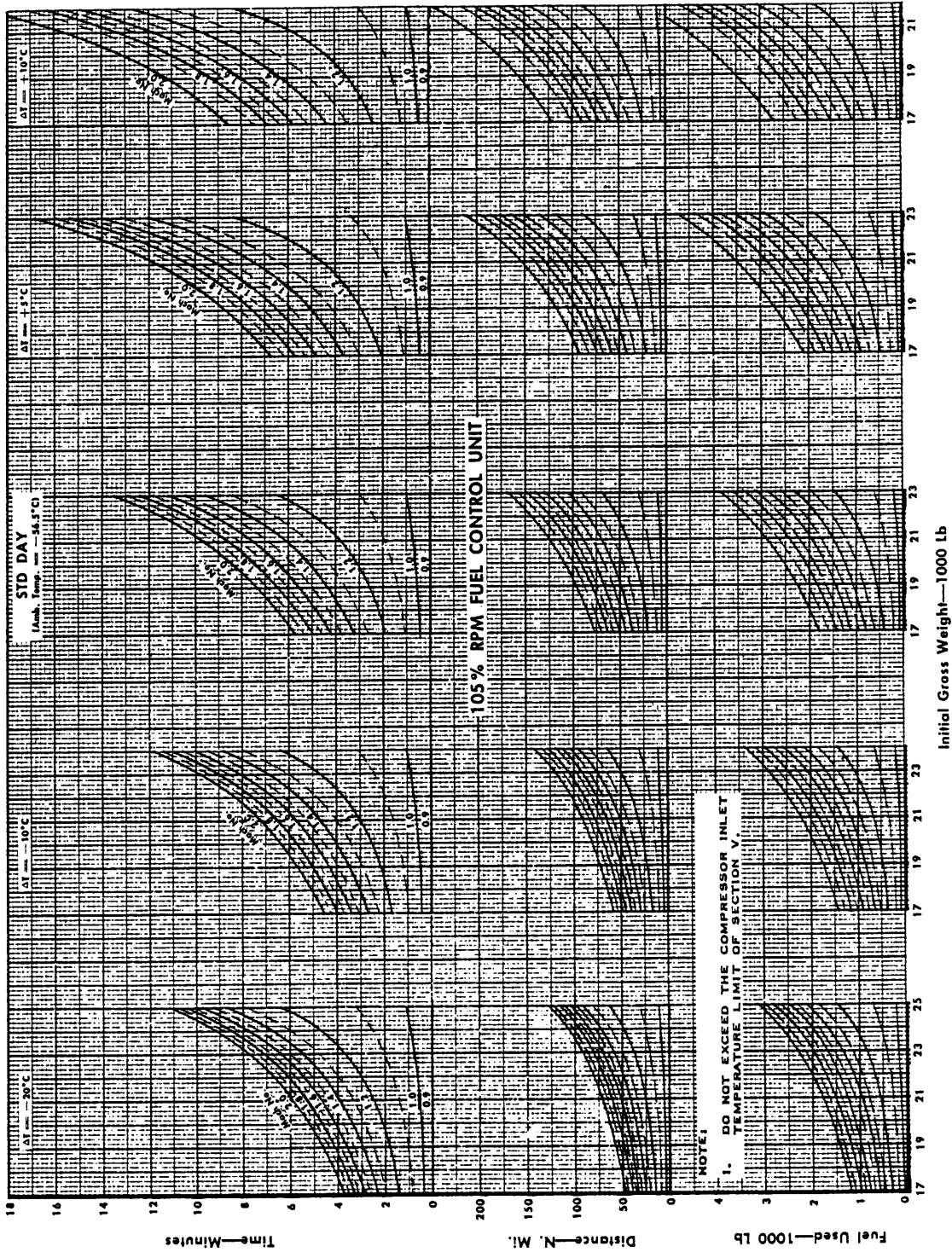
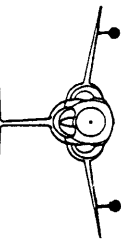

Figure A9-17

# MAXIMUM THRUST LEVEL FLIGHT ACCELERATION



- BL104 Pylons and MRAAM Launchers
- BL104 Pylons and AIM-9L Launchers and Adapter

Engine: J79-GE-19  
 Fuel Grade: JP-8  
 Fuel Density: 6.68 Lb/Gal

35000 FT PRESSURE ALTITUDE

Model: F-104S  
 Date: 1 April 1970  
 DATA BASIS: FLIGHT TEST

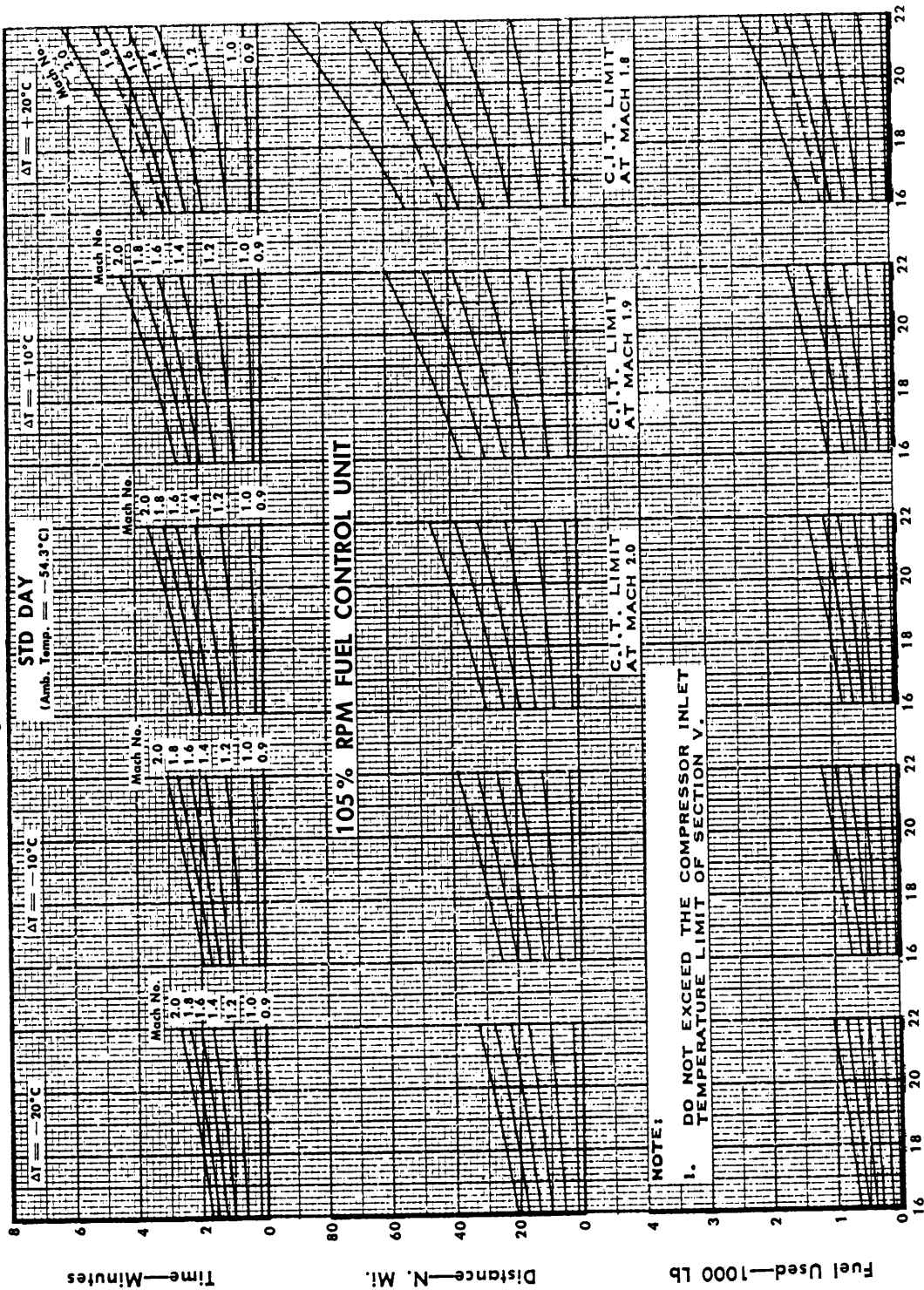
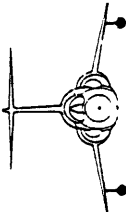

Figure A9-18

MAXIMUM THRUST LEVEL FLIGHT ACCELERATION



- BL104 Pylons and MRAAM Launchers
- BL104 Pylons and AIM-9L Launchers and Adapter

Engine: J79-GE-19  
 Fuel Grade: JP-8  
 Fuel Density: 6.68 Lb/Gal

40000 FT PRESSURE ALTITUDE

Model: F-104S  
 Date: 1 April 1970  
 DATA BASIS: FLIGHT TEST

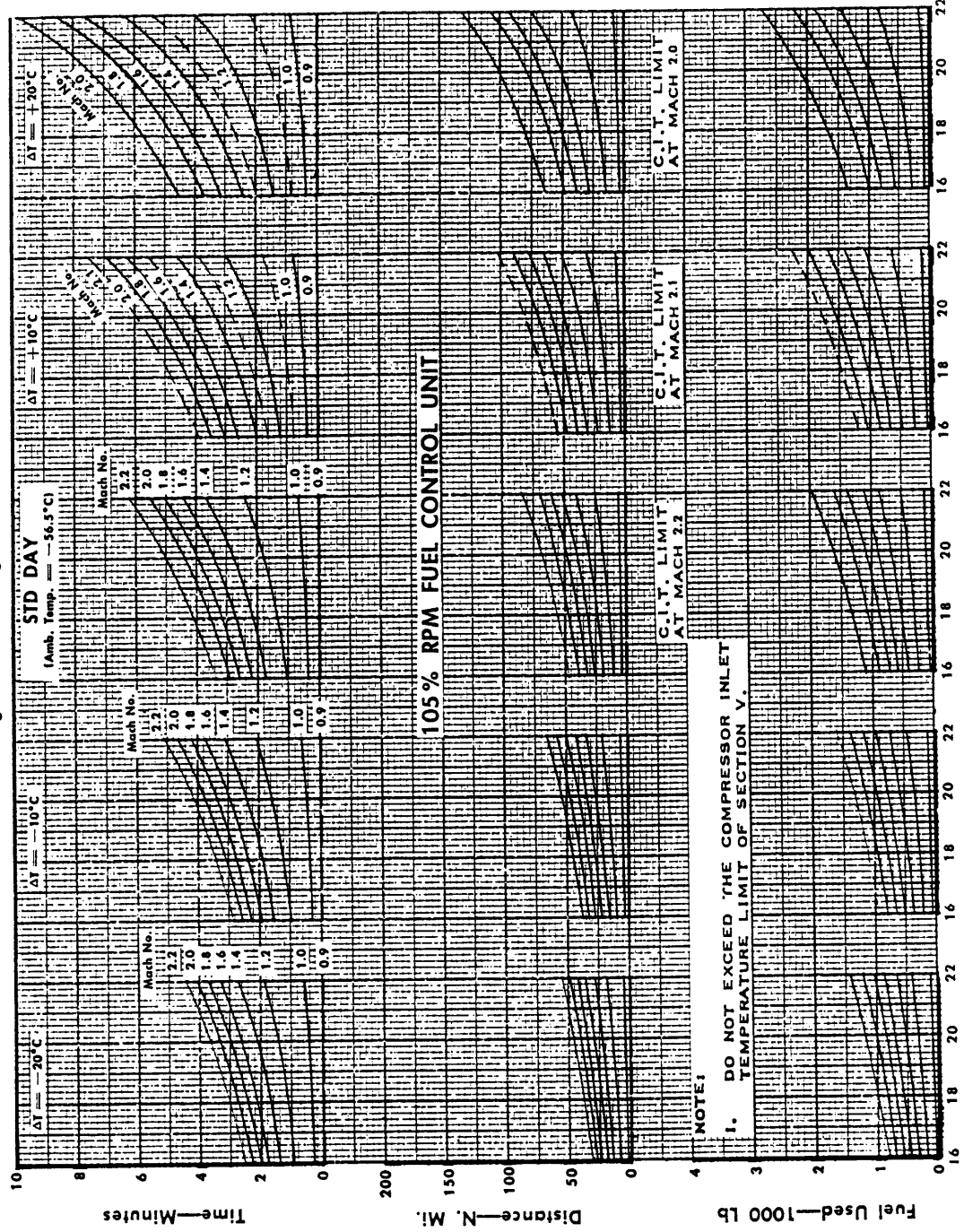

Initial Gross Weight—1000 Lb

Figure A9-19

# MAXIMUM THRUST LEVEL FLIGHT ACCELERATION

45000 FT PRESSURE ALTITUDE

Model: F-104S  
 Date: 1 April 1970  
 DATA BASIS: FLIGHT TEST

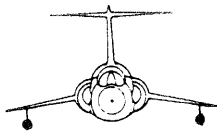

- BL104 Pylons and MRAAM Launchers
- BL104 Pylons and AIM-9L Launchers and Adapter

Engine: J79-GE-19  
 Fuel Grade: JP-8  
 Fuel Density: 6.68 Lb/Gal

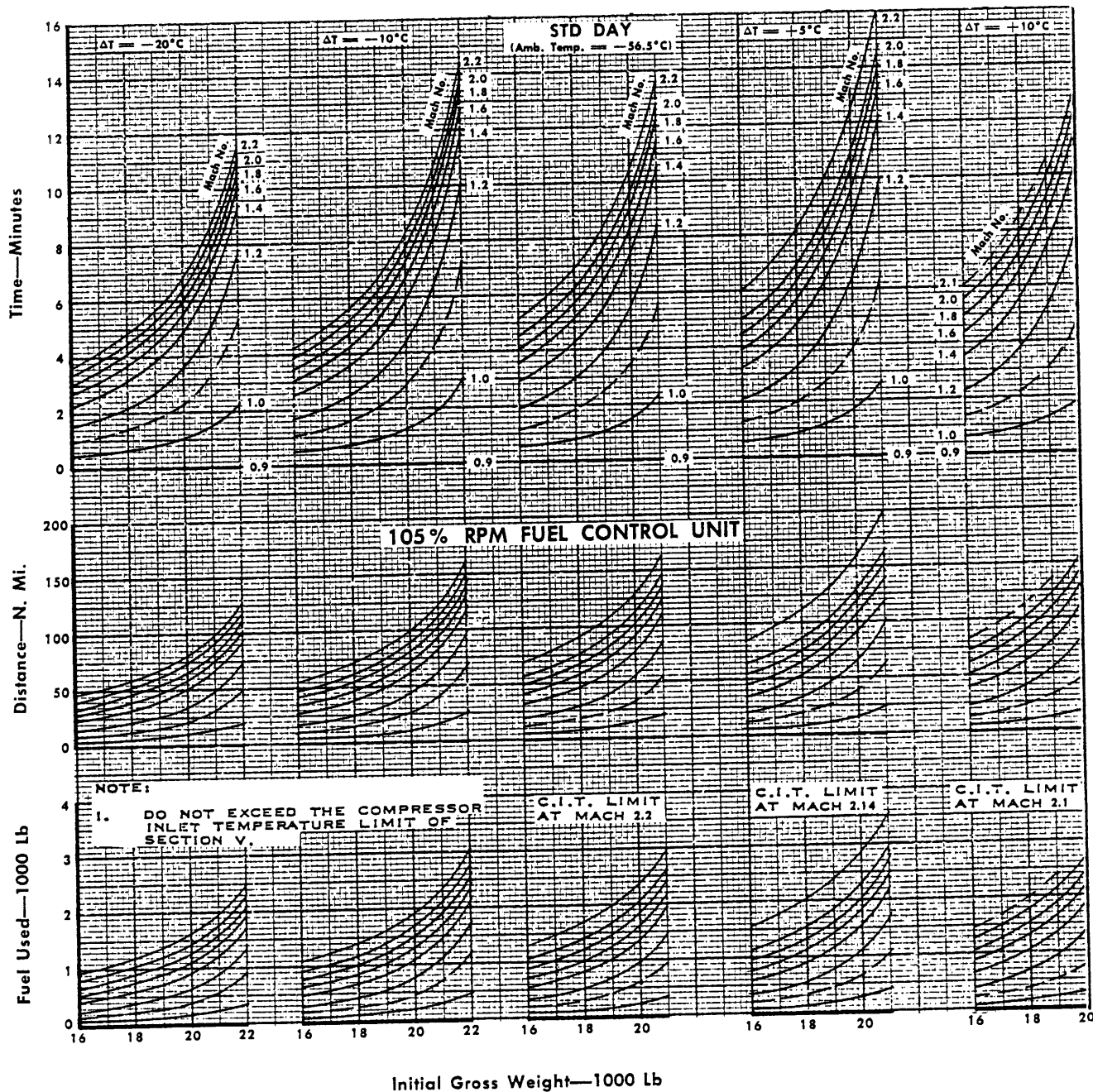
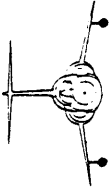

Figure A9-20

MAXIMUM THRUST LEVEL FLIGHT ACCELERATION

- BL104 Pylons and MRAAM Launchers
- BL104 Pylons and AIM-9L Launchers and Adapter

Engine: J79-GE-19  
 Fuel Grade: JP-8  
 Fuel Density: 6.68 Lb/Gal



50000 FT PRESSURE ALTITUDE

Model: F-104S  
 Date: 1 April 1970  
 DATA BASIS: FLIGHT TEST

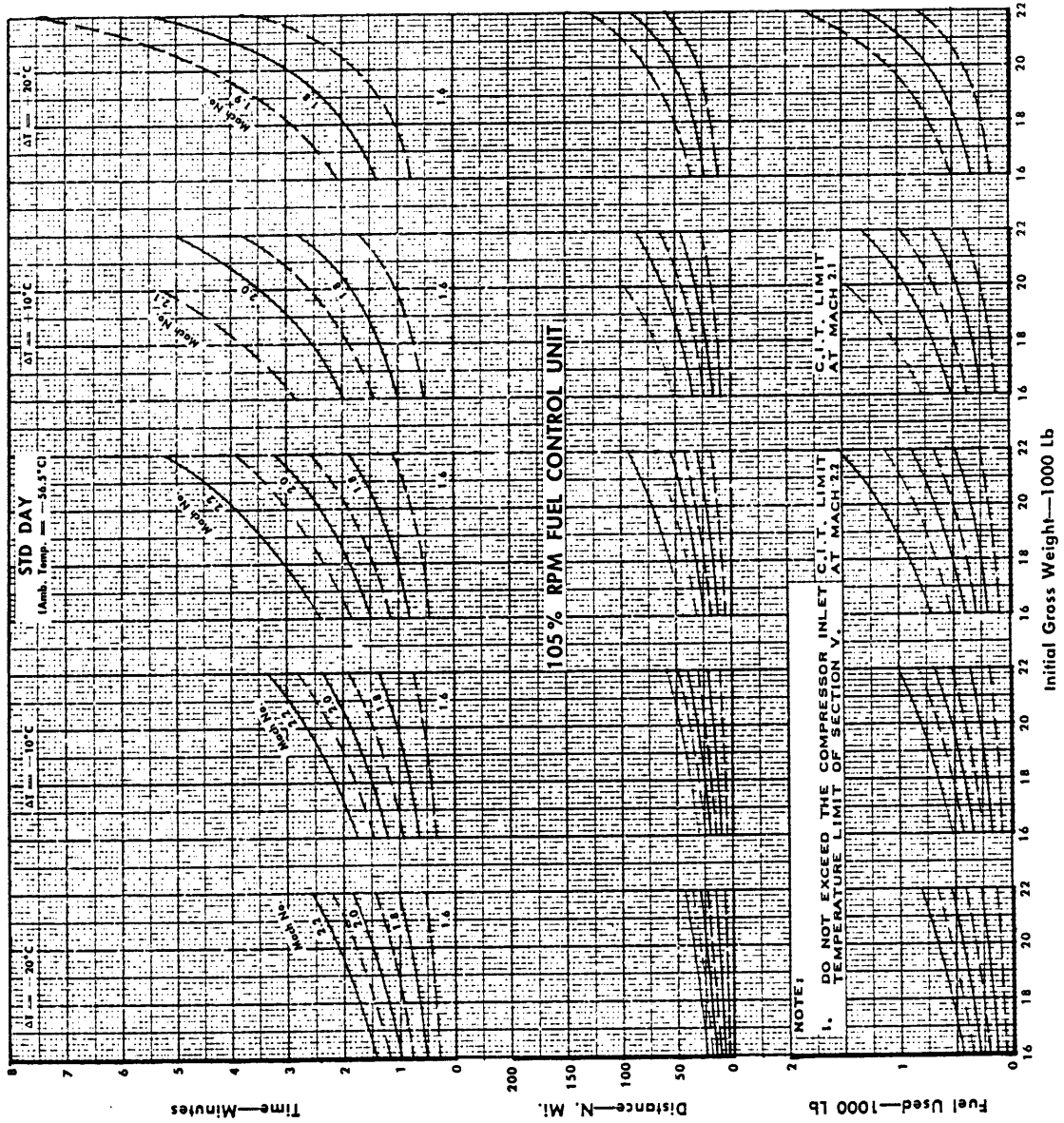

Figure A9-21

# MAXIMUM THRUST LEVEL FLIGHT ACCELERATION

- Tip AIM-9L and BL104 AIM-9L Missiles and BL75 Fuel Tanks
- Tip AIM-9L and BL104 MRAAM and BL75 Fuel Tanks
- Tip Tanks and BL104 AIM-9L Missile and BL104 MRAAM and BL75 Fuel Tanks
- Tip Tanks and BL104 AIM-9L Missiles and BL75 Fuel Tanks
- Tip Tanks and BL104 MRAAM and BL75 Fuel Tanks

Engine: J79-GE-19  
 Fuel Grade: JP-8  
 Fuel Density: 6.68 Lb/Gal

35000 FT PRESSURE ALTITUDE

Model: F-104S  
 Date: 1 April 1970  
 DATA BASIS: FLIGHT TEST

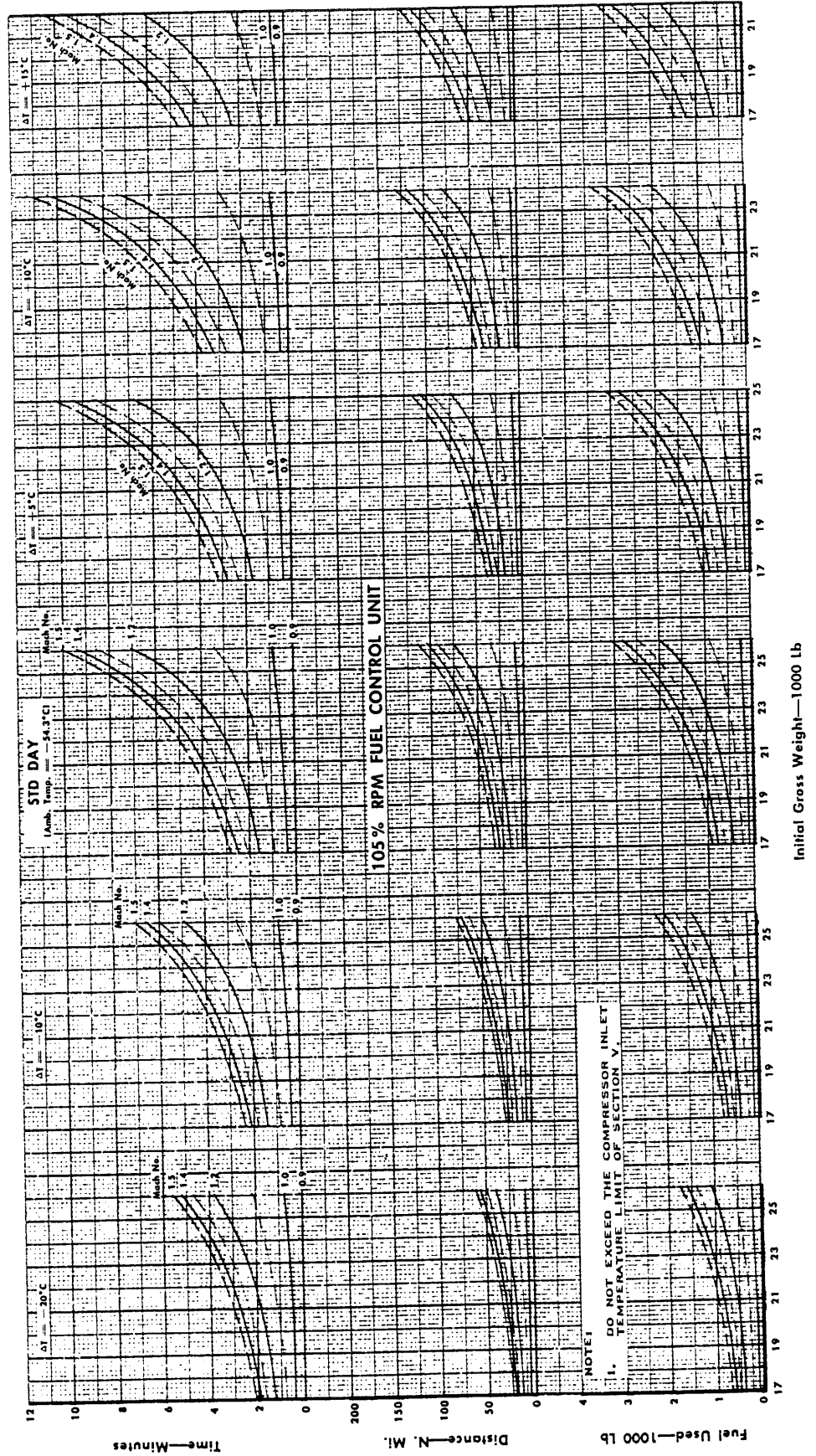
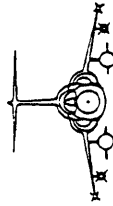

Figure A9-22

Initial Gross Weight—1000 Lb



## MAXIMUM THRUST LEVEL FLIGHT ACCELERATION

40000 FT PRESSURE ALTITUDE

- Tip Tanks and BL104 AIM-9L Missiles and BL75 Fuel Tanks
- Tip Tanks and BL104 MRAAM and BL75 Fuel Tanks

- Tip AIM-9L and BL104 AIM-9L Missiles and BL75 Fuel Tanks
- Tip AIM-9L and BL104 MRAAM and BL75 Fuel Tanks
- Tip Tanks and BL104 AIM-9L Missile and BL104 MRAAM and BL75 Fuel Tanks

Model: F-104S  
 Date: 1 April 1970  
 DATA BASIS: FLIGHT TEST

Engine: J79-GE-19  
 Fuel Grade: JP-8  
 Fuel Density: 6.68 Lb/Gal

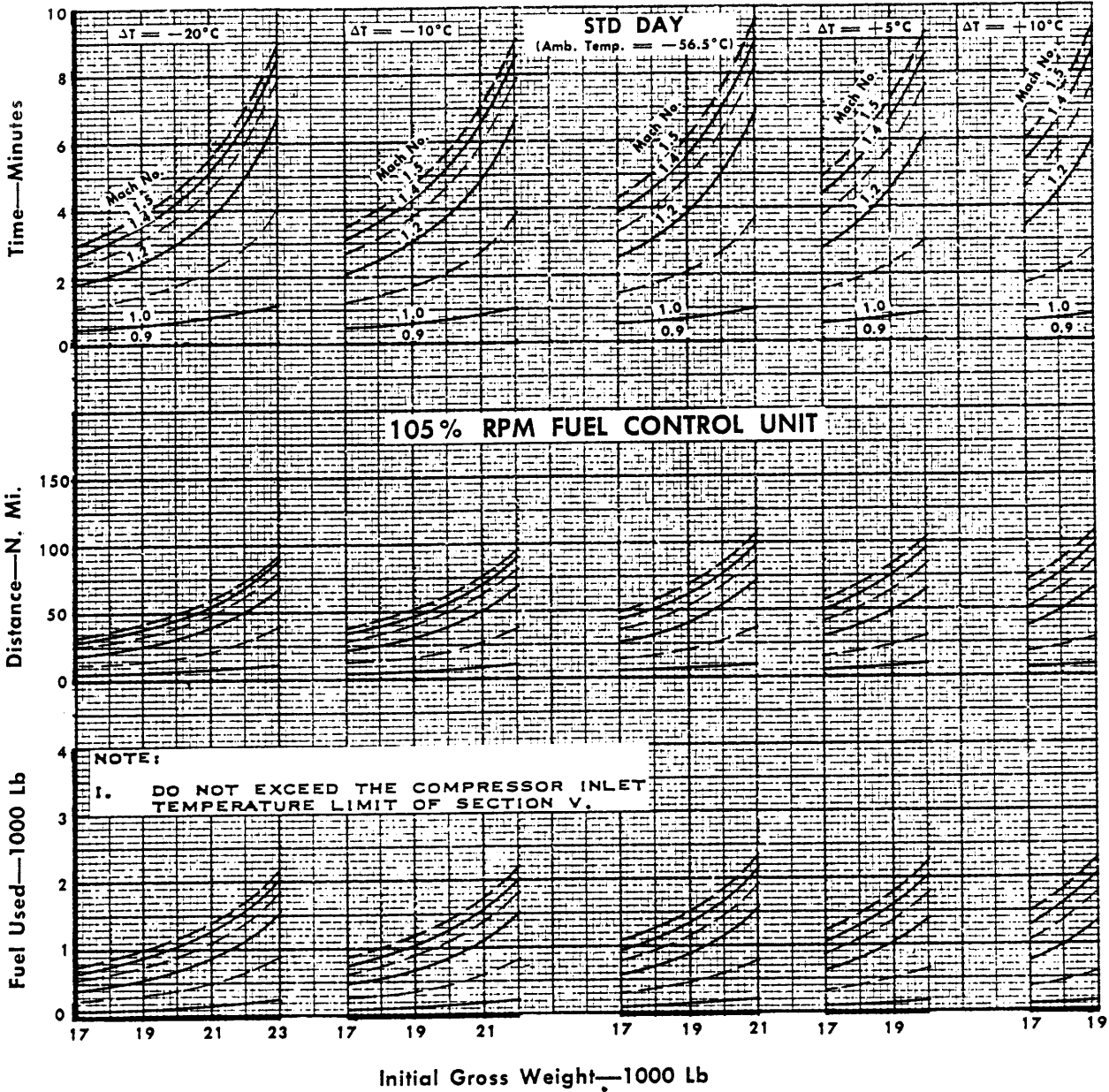

Figure A9-23

# MAXIMUM THRUST CLIMB CONTROL

## CLIMB SPEED MACH 1.4

NO EXTERNAL STORES

105% RPM  
FUEL CONTROL UNIT

Model: F-104S  
Date: 1 April 1970  
DATA BASIS: FLIGHT TEST

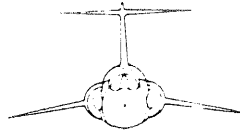

Engine: J79-GE-19  
Fuel Grade: JP-8  
Fuel Density: 6.68 Lb/Gal

### Standard Day

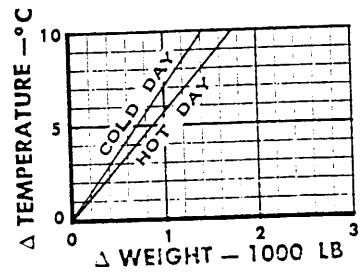
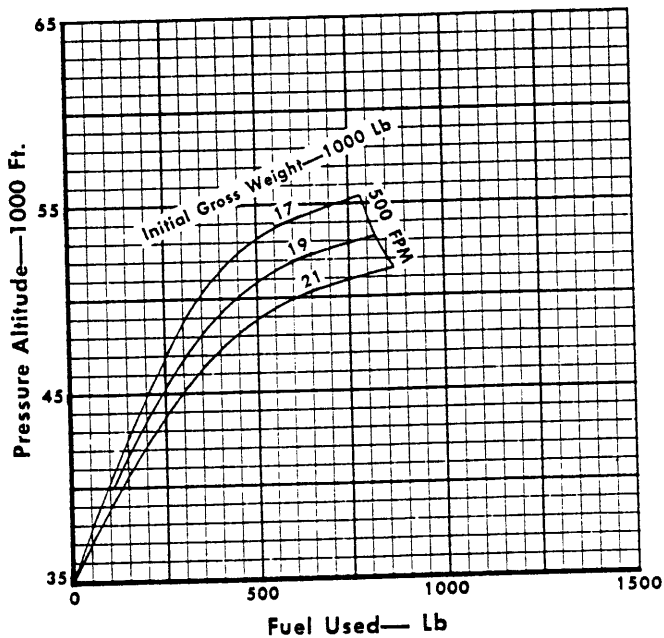
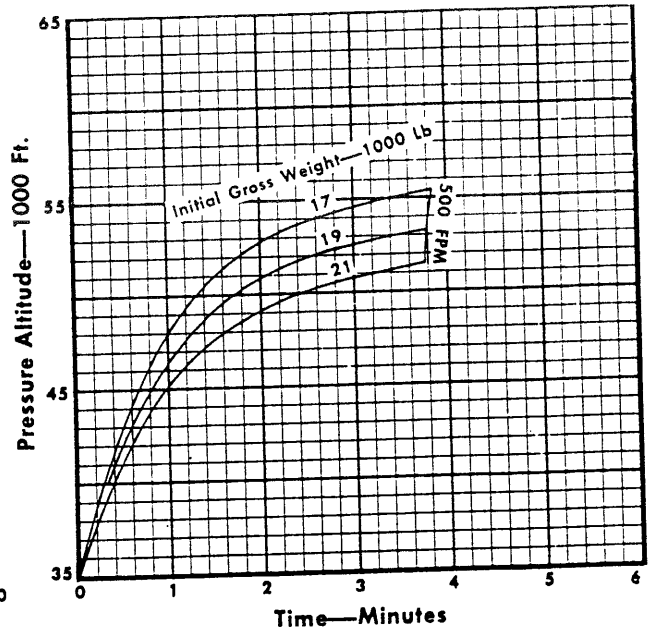
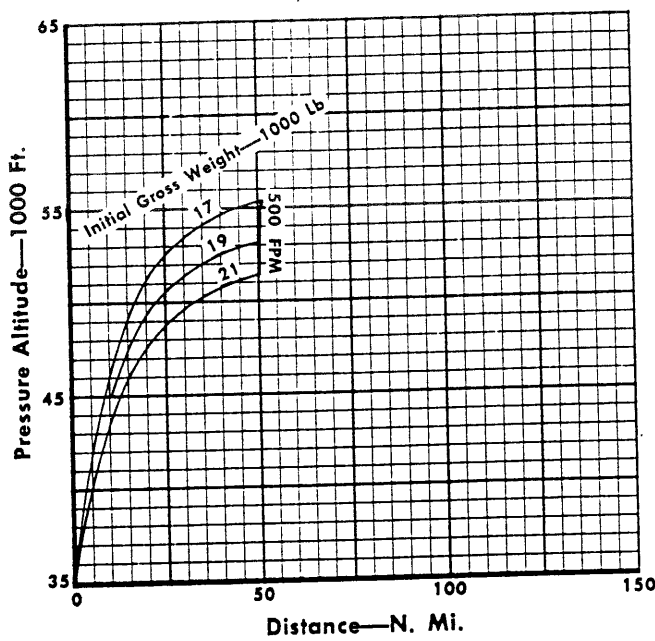

**REMARKS:**

To determine equivalent weight for non standard day conditions:

1. HOT DAY: Equivalent weight = Actual airplane gross weight +  $\Delta$  Weight (from  $\Delta$  Temp vs  $\Delta$  Weight curve)
2. COLD DAY: Equivalent weight = Actual airplane gross weight -  $\Delta$  Weight (from  $\Delta$  Temp vs  $\Delta$  Weight curve)

Figure A9-24

# MAXIMUM THRUST CLIMB CONTROL

CLIMB SPEED MACH 1.6

NO EXTERNAL STORES

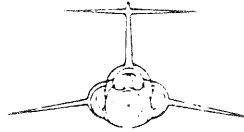

105% RPM  
FUEL CONTROL UNIT

Model: F-104S  
Date: 1 April 1970  
DATA BASIS: FLIGHT TEST

Engine: J79-GE-19  
Fuel Grade: JP-8  
Fuel Density: 6.68 Lb/Gal

## Standard Day

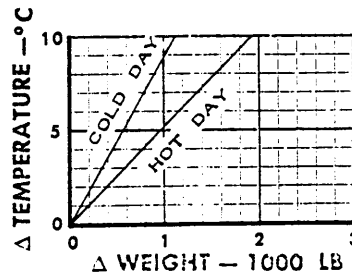
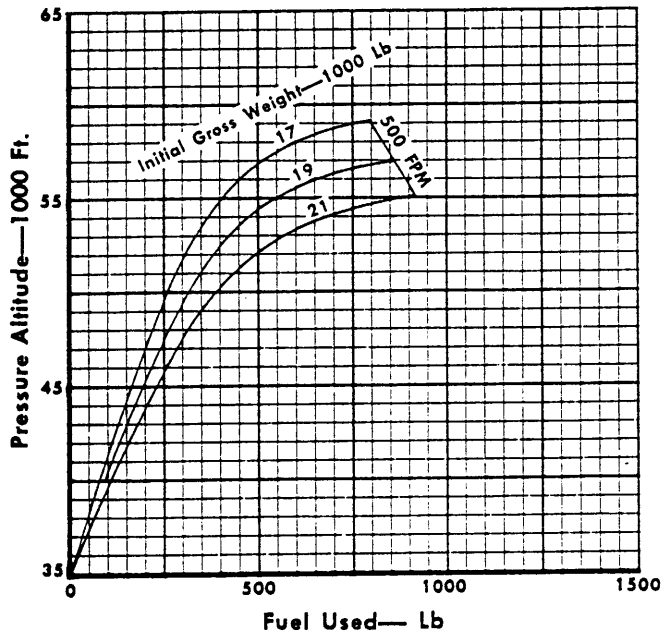
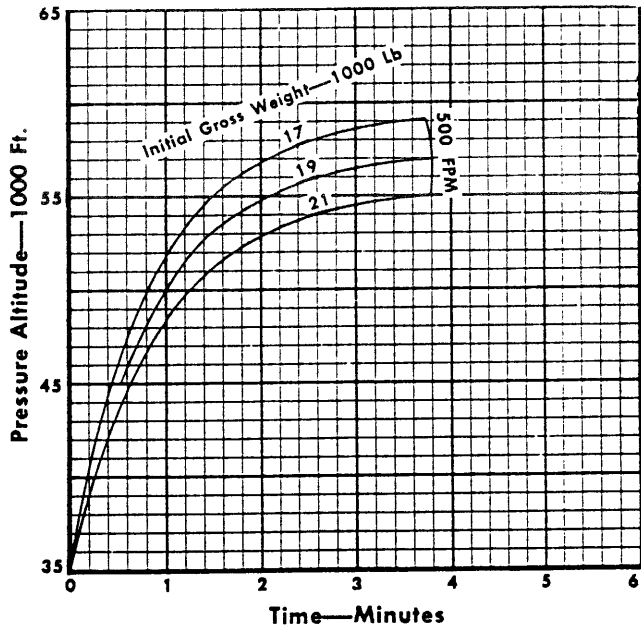
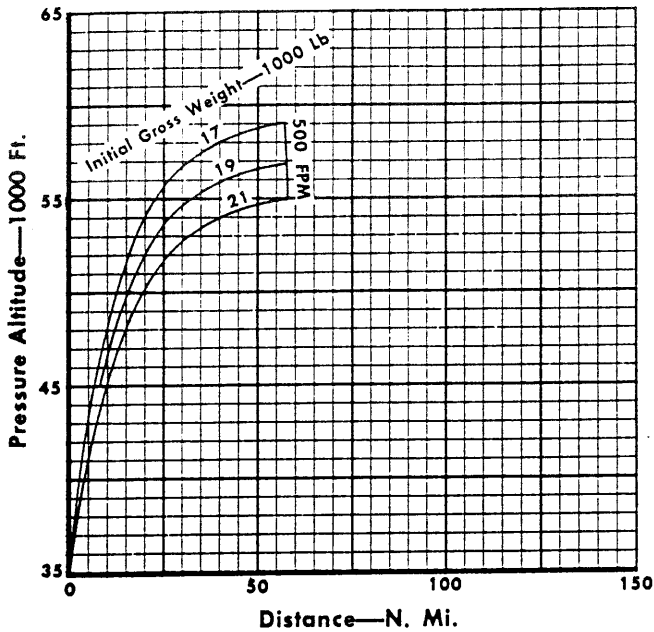

**REMARKS:**

To determine equivalent weight for non standard day conditions:

1. HOT DAY: Equivalent weight = Actual airplane gross weight +  $\Delta$  Weight (from  $\Delta$  Temp vs  $\Delta$  Weight curve)
2. COLD DAY: Equivalent weight = Actual airplane gross weight -  $\Delta$  Weight (from  $\Delta$  Temp vs  $\Delta$  Weight curve)

Figure A9-25

# MAXIMUM THRUST CLIMB CONTROL

CLIMB SPEED MACH 1.8

NO EXTERNAL STORES

Model: F-104S  
Date: 1 April 1970  
DATA BASIS: FLIGHT TEST

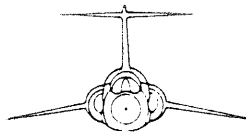

105% RPM  
FUEL CONTROL UNIT

Engine: J79-GE-19  
Fuel Grade: JP-8  
Fuel Density: 6.68 Lb/Gal

Standard Day

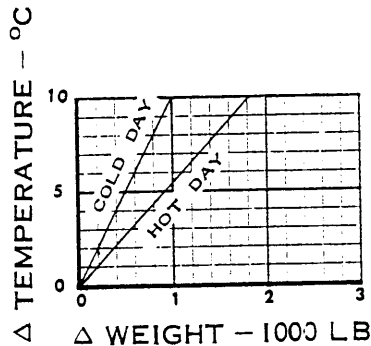
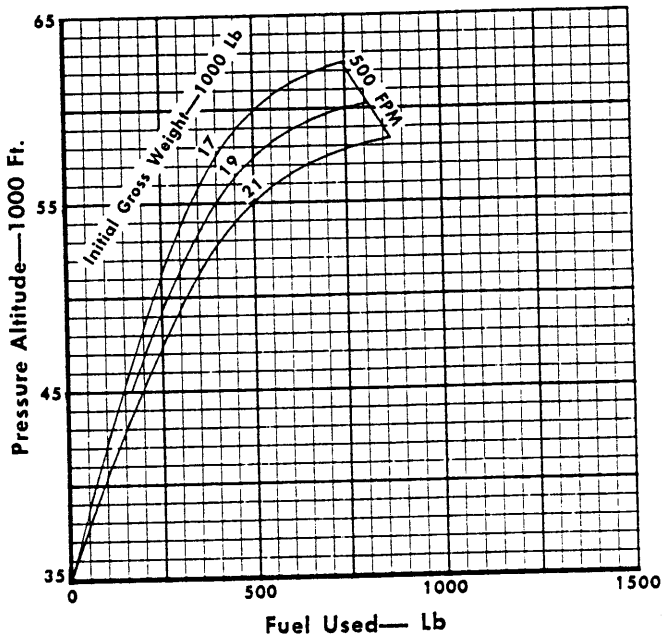
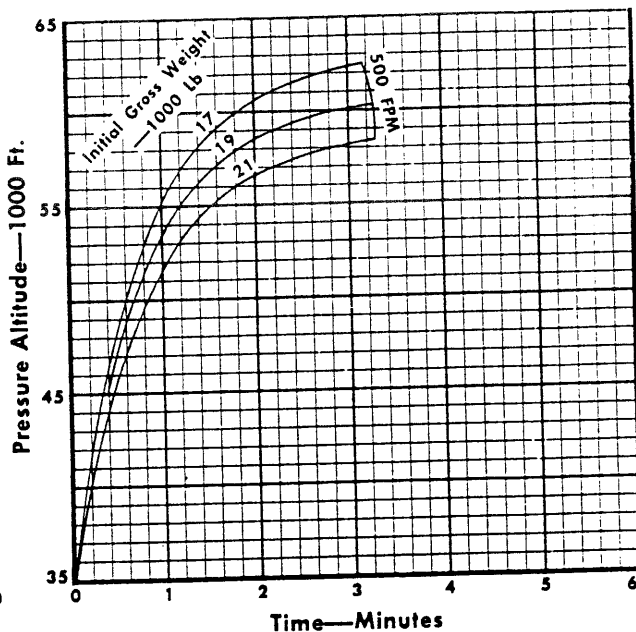
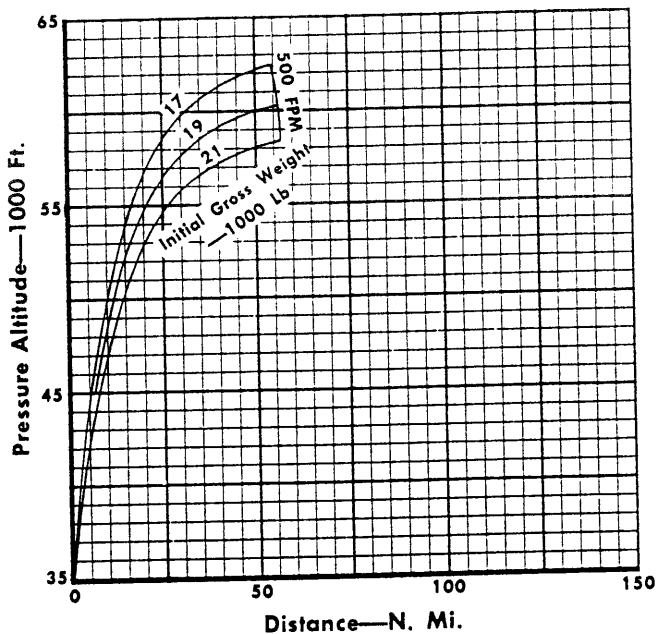

- REMARKS:
1. HOT DAY: Equivalent weight = Actual airplane gross weight +  $\Delta$  Weight (from  $\Delta$  Temp vs  $\Delta$  Weight curve)
  2. COLD DAY: Equivalent weight = Actual airplane gross weight -  $\Delta$  Weight (from  $\Delta$  Temp vs  $\Delta$  Weight curve)

Figure A9-26

# MAXIMUM THRUST CLIMB CONTROL

CLIMB SPEED MACH 2.0

NO EXTERNAL STORES

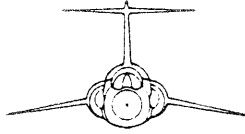

105% RPM  
FUEL CONTROL UNIT

Model: F-104S  
Date: 1 April 1970  
DATA BASIS: FLIGHT TEST

Engine: J79-GE-19  
Fuel Grade: JP-8  
Fuel Density: 6.68 Lb/Gal

## Standard Day

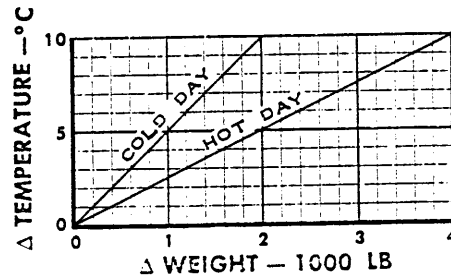
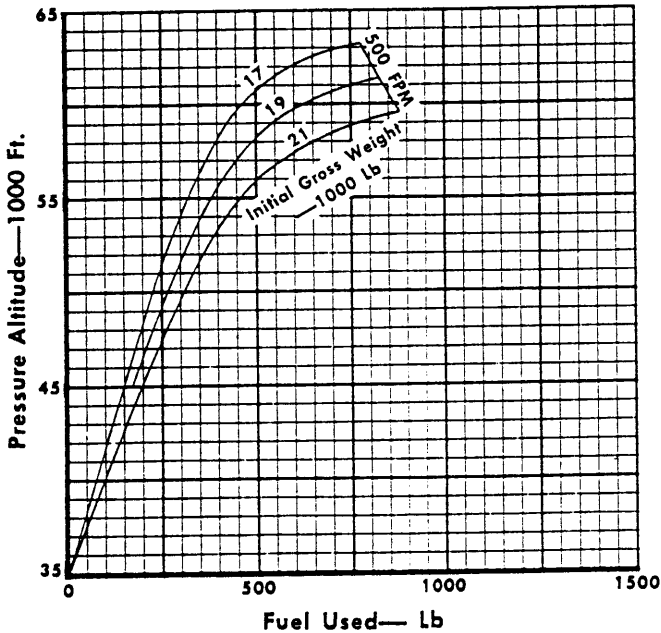
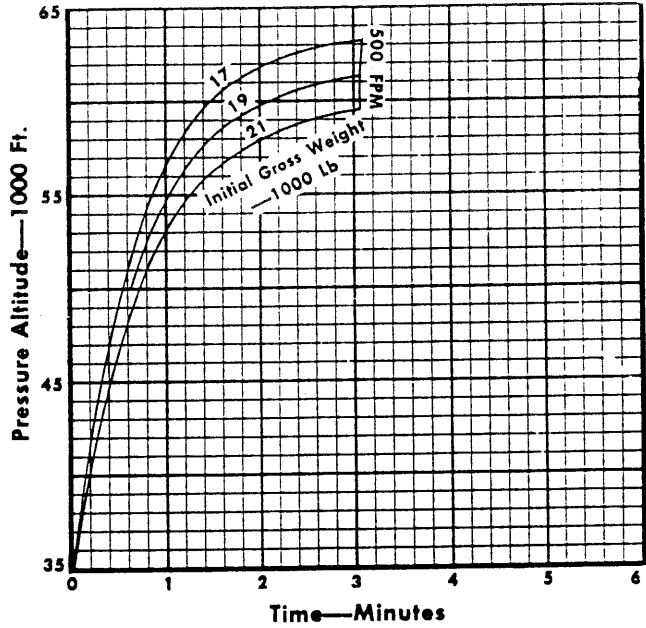
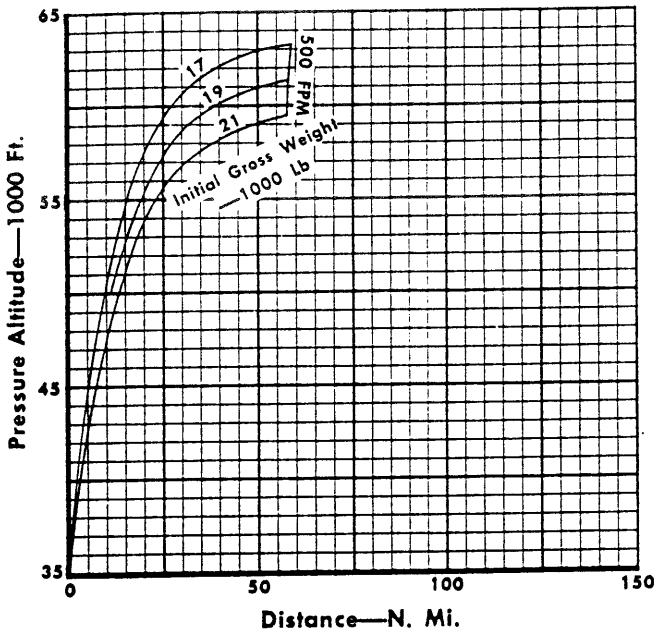

**REMARKS:**

To determine equivalent weight for non standard day conditions:

1. HOT DAY: Equivalent weight = Actual airplane gross weight +  $\Delta$  Weight (from  $\Delta$  Temp vs  $\Delta$  Weight curve)
2. COLD DAY: Equivalent weight = Actual airplane gross weight -  $\Delta$  Weight (from  $\Delta$  Temp vs  $\Delta$  Weight curve)

Figure A9-27

# MAXIMUM THRUST CLIMB CONTROL

## CLIMB SPEED MACH 2.2

NO EXTERNAL STORES

Model: F-104S  
 Date: 1 April 1970  
 DATA BASIS: FLIGHT TEST

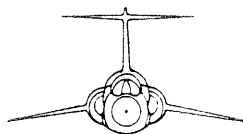

105% RPM  
 FUEL CONTROL UNIT

Engine: J79-GE-19  
 Fuel Grade: JP-8  
 Fuel Density: 6.68 Lb/Gal

Standard Day

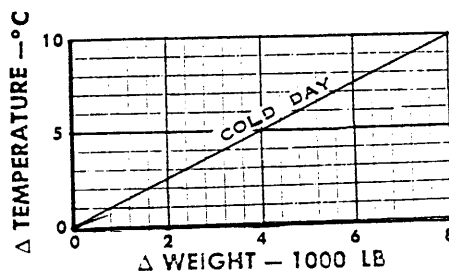
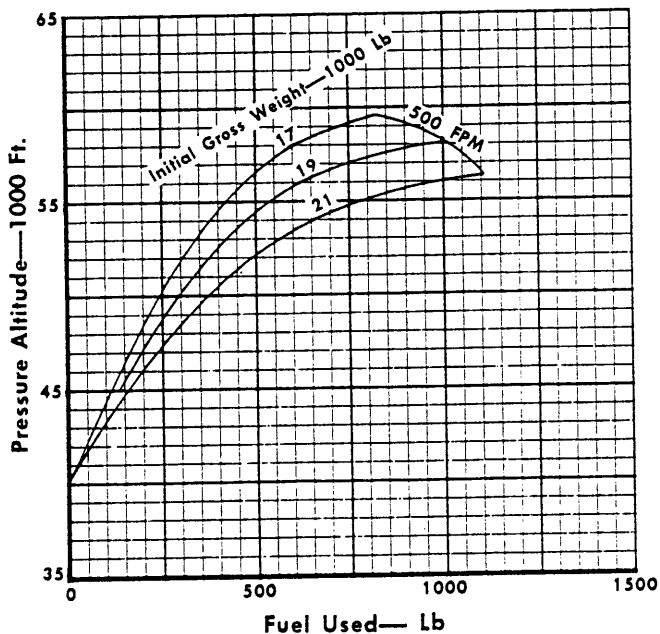
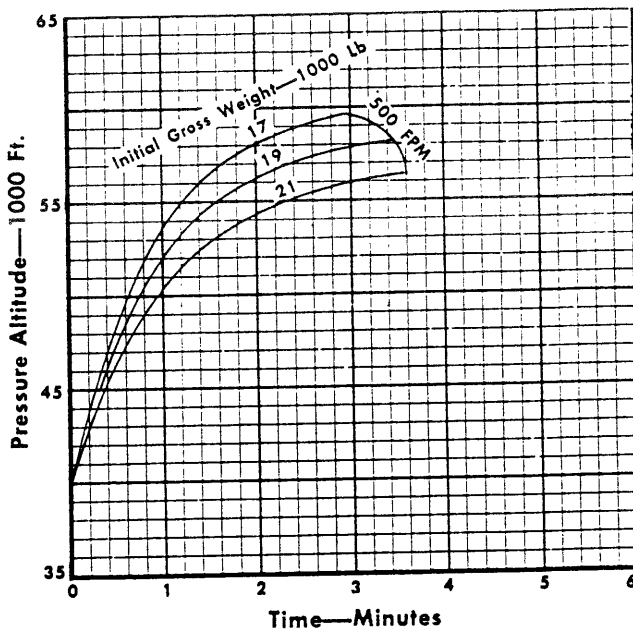
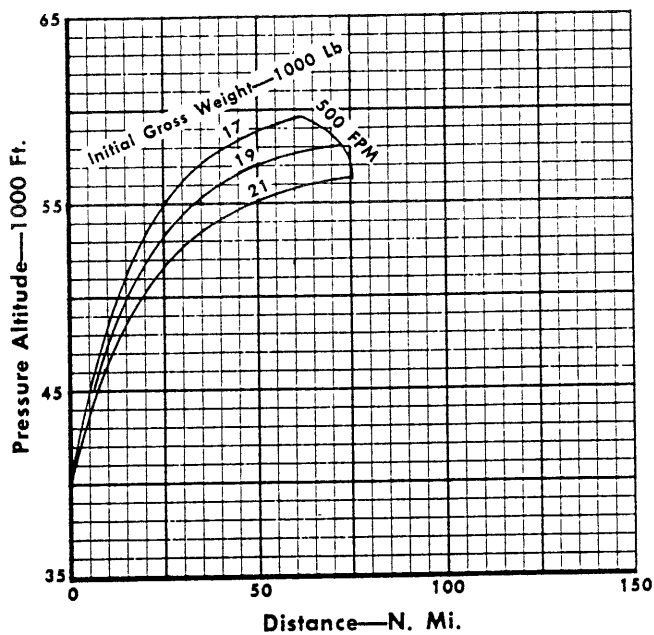

**REMARKS:**

To determine equivalent weight for non standard day conditions:

1. HOT DAY: Equivalent weight = Actual airplane gross weight +  $\Delta$  Weight (from  $\Delta$  Temp vs  $\Delta$  Weight curve)
2. COLD DAY: Equivalent weight = Actual airplane gross weight -  $\Delta$  Weight (from  $\Delta$  Temp vs  $\Delta$  Weight curve)

Figure A9-28

## MAXIMUM THRUST CLIMB CONTROL

### CLIMB SPEED MACH 1.4

- Tip Tanks
- BL104 MRAAM
- BL104 AIM-9L Missiles
- BL104 AIM-9L Missile and MRAAM
- Tip AIM-9L Missiles

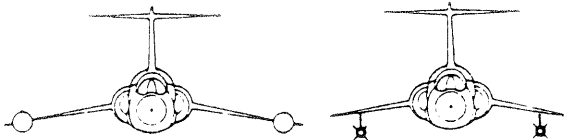

105% RPM  
FUEL CONTROL UNIT

Model: F-104S  
Date: 1 April 1970  
DATA BASIS: FLIGHT TEST

Engine: J79-GE-19  
Fuel Grade: JP-8  
Fuel Density: 6.68 Lb/Gal

### Standard Day

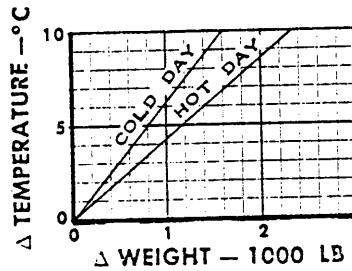
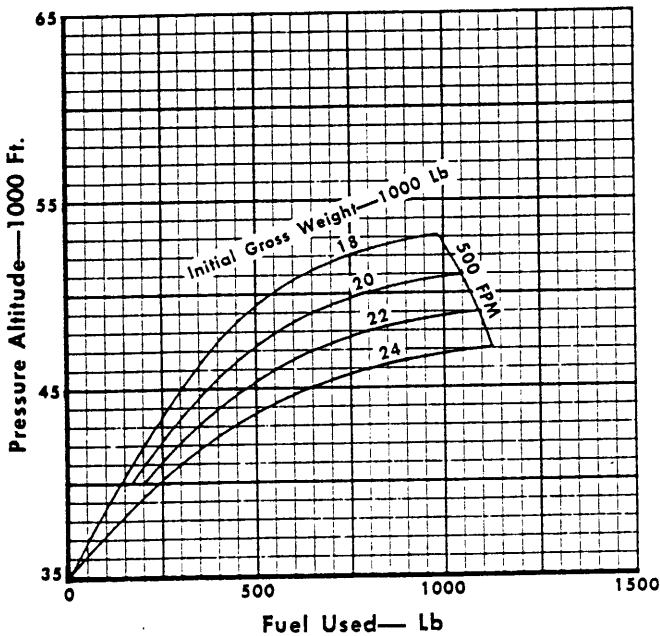
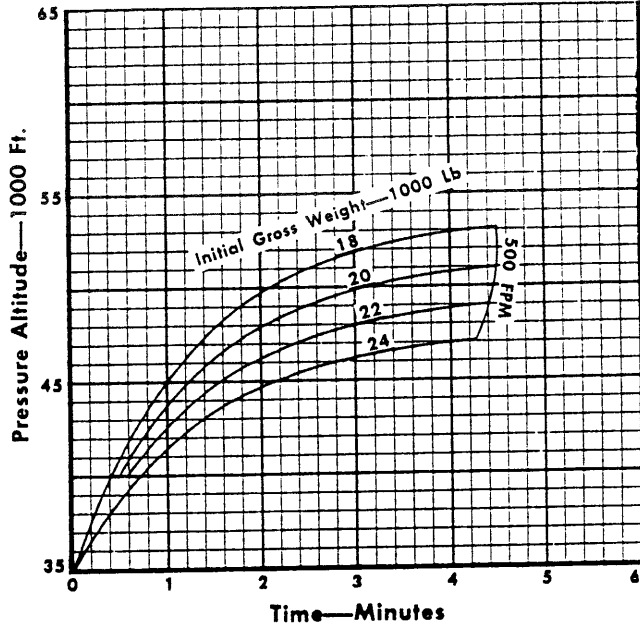
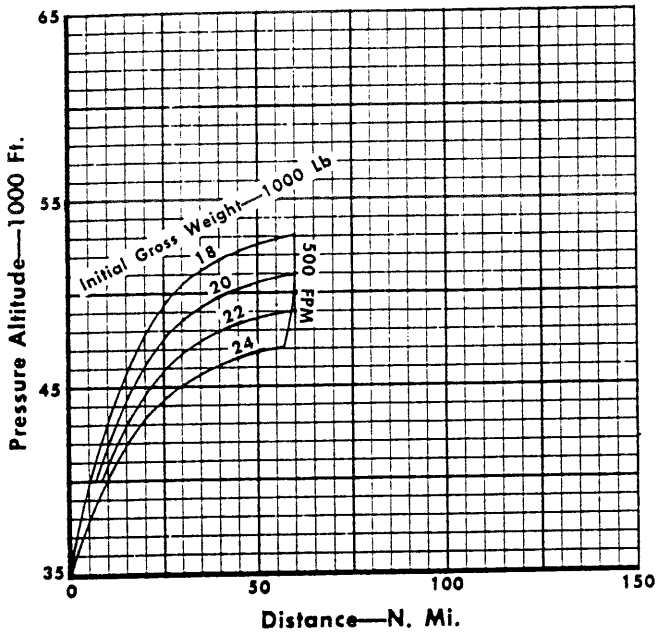

**REMARKS:**

To determine equivalent weight for non standard day conditions:

1. **HOT DAY:** Equivalent weight = Actual airplane gross weight +  $\Delta$  Weight (from  $\Delta$  Temp vs  $\Delta$  Weight curve)
2. **COLD DAY:** Equivalent weight = Actual airplane gross weight -  $\Delta$  Weight (from  $\Delta$  Temp vs  $\Delta$  Weight curve)

Figure A9-29

## MAXIMUM THRUST CLIMB CONTROL

CLIMB SPEED MACH 1.6

- Tip Tanks
- BL104 MRAAM
- BL104 AIM-9L Missiles
- BL104 AIM-9L Missile and MRAAM
- Tip AIM-9L Missiles

Model: F-104S  
 Date: 1 April 1970  
 DATA BASIS: FLIGHT TEST

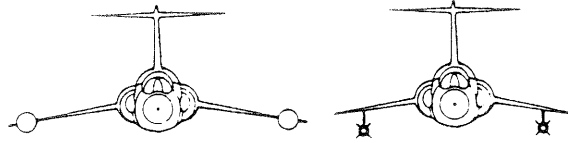

105% RPM  
 FUEL CONTROL UNIT

Engine: J79-GE-19  
 Fuel Grade: JP-8  
 Fuel Density: 6.68 Lb/Gal

### Standard Day

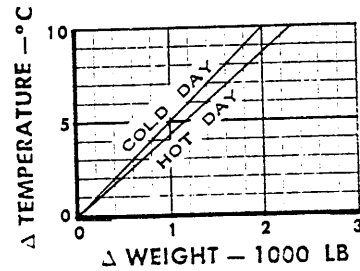
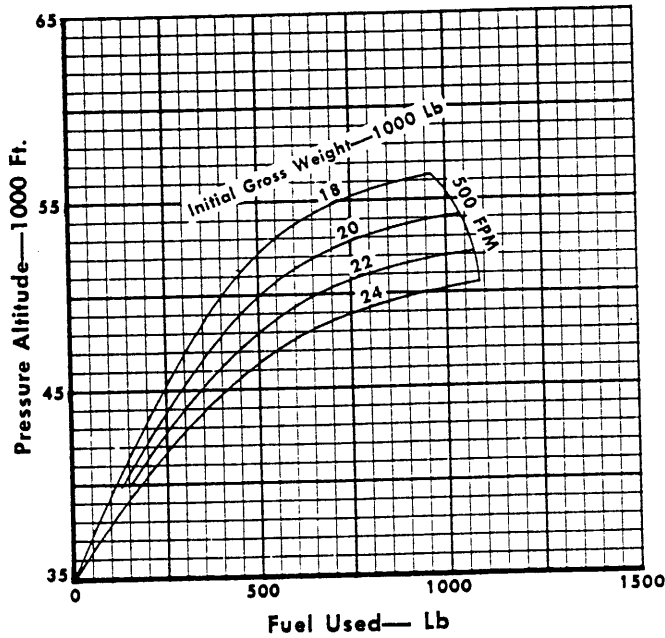
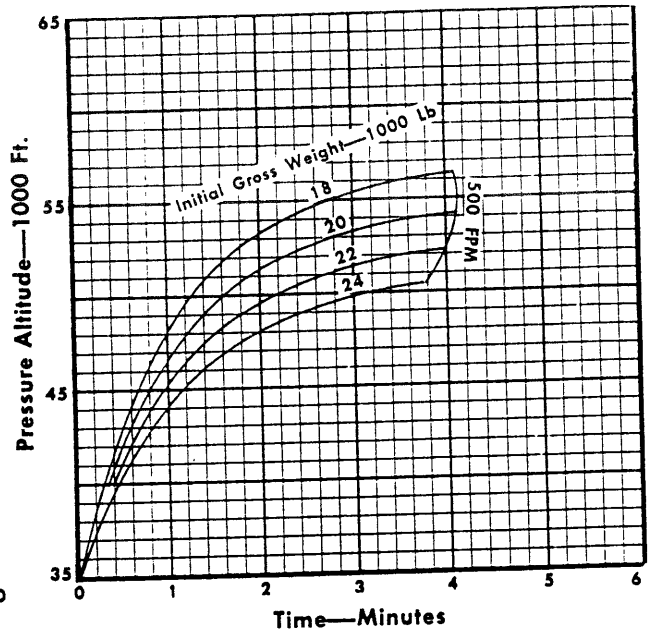
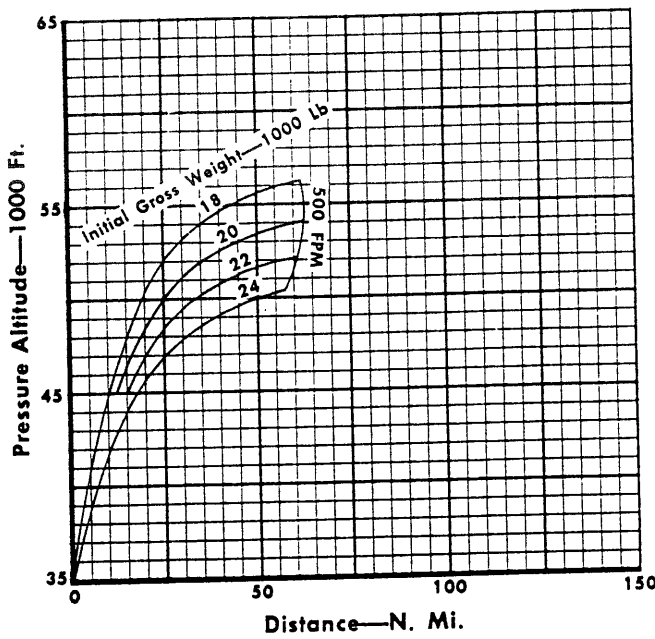

**REMARKS:**

To determine equivalent weight for non standard day conditions:

1. HOT DAY: Equivalent weight = Actual airplane gross weight +  $\Delta$  Weight (from  $\Delta$  Temp vs  $\Delta$  Weight curve)
2. COLD DAY: Equivalent weight = Actual airplane gross weight -  $\Delta$  Weight (from  $\Delta$  Temp vs  $\Delta$  Weight curve)

Figure A9-30



# MAXIMUM THRUST CLIMB CONTROL

CLIMB SPEED MACH 1.8

- Tip Tanks
- BL104 MRAAM
- BL104 AIM-9L Missiles
- BL104 AIM-9L Missile and MRAAM
- Tip AIM-9L Missiles

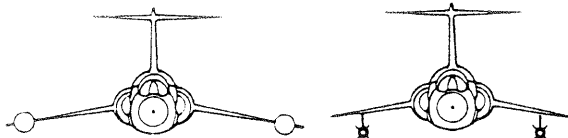

105% RPM  
FUEL CONTROL UNIT

Model: F-104S  
Date: 1 April 1970  
DATA BASIS: FLIGHT TEST

Engine: J79-GE-19  
Fuel Grade: JP-8  
Fuel Density: 6.68 Lb/Gal

## Standard Day

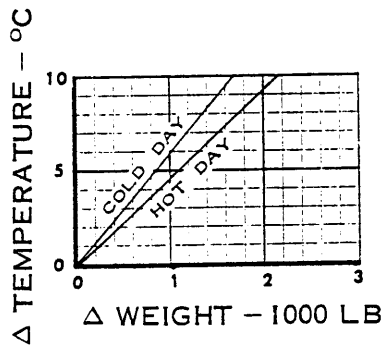
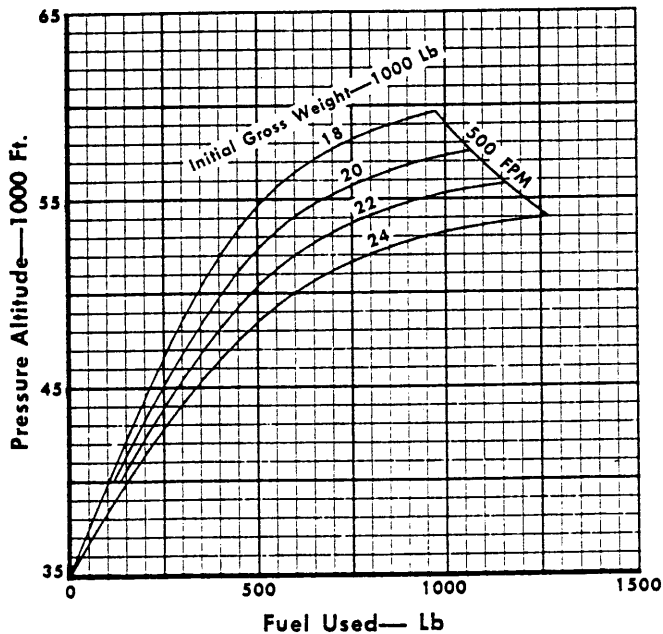
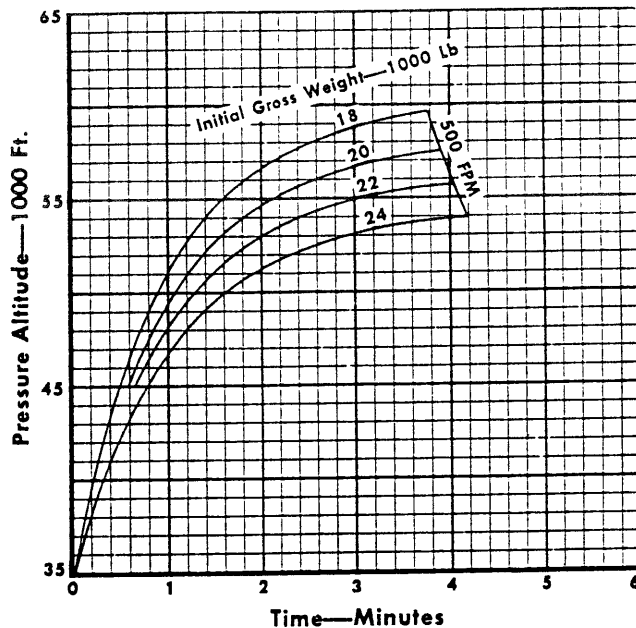
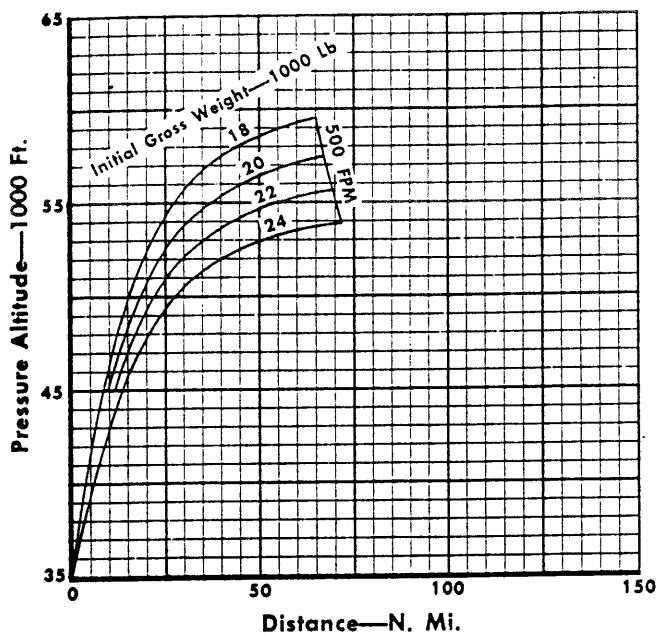

**REMARKS:**

To determine equivalent weight for non standard day conditions:

1. HOT DAY: Equivalent weight = Actual airplane gross weight +  $\Delta$  Weight (from  $\Delta$  Temp vs  $\Delta$  Weight curve)
2. COLD DAY: Equivalent weight = Actual airplane gross weight -  $\Delta$  Weight (from  $\Delta$  Temp vs  $\Delta$  Weight curve)

Figure A9-31

# MAXIMUM THRUST CLIMB CONTROL

CLIMB SPEED MACH 2.0

- Tip Tanks
- BL104 MRAAM
- BL104 AIM-9L Missiles
- BL104 AIM-9L Missile and MRAAM
- Tip AIM-9L Missiles

Model: F-104S  
 Date: 1 April 1970  
 DATA BASIS: FLIGHT TEST

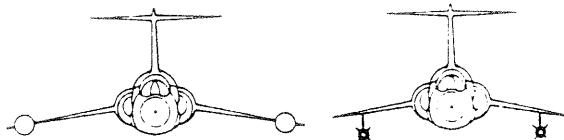

105% RPM  
 FUEL CONTROL UNIT

Engine: J79-GE-19  
 Fuel Grade: JP-8  
 Fuel Density: 6.68 Lb/Gal

## Standard Day

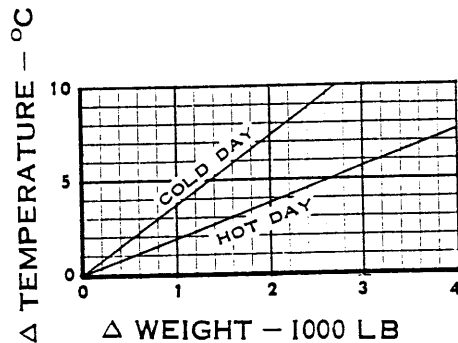
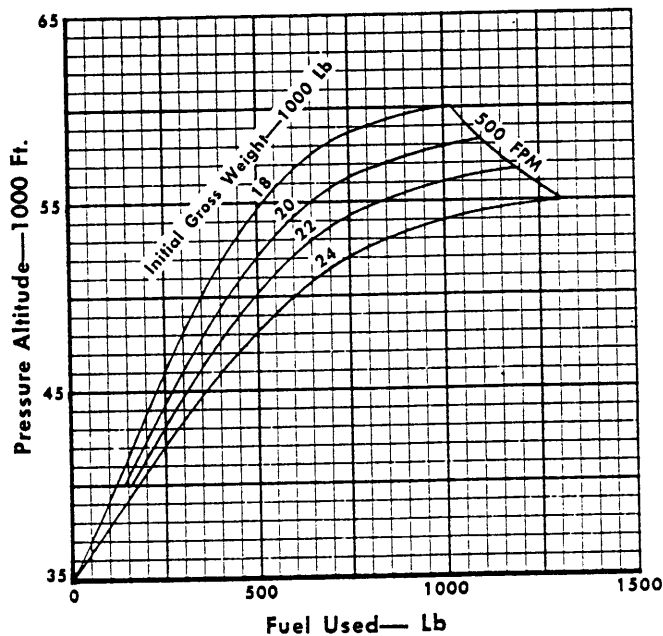
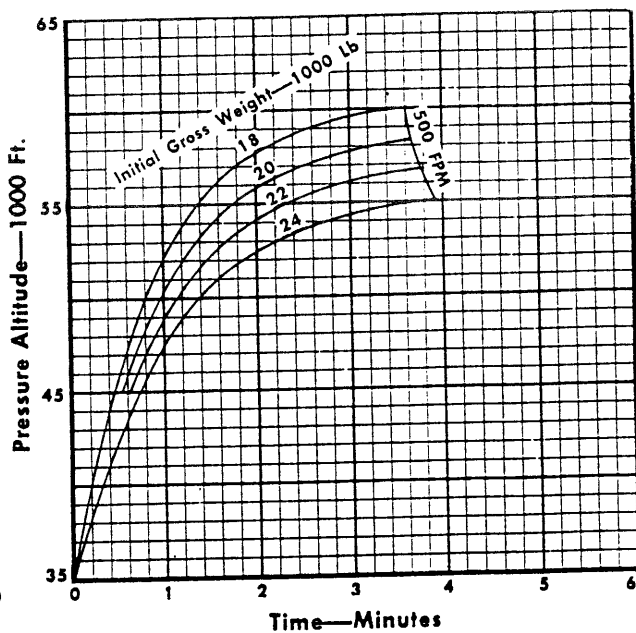
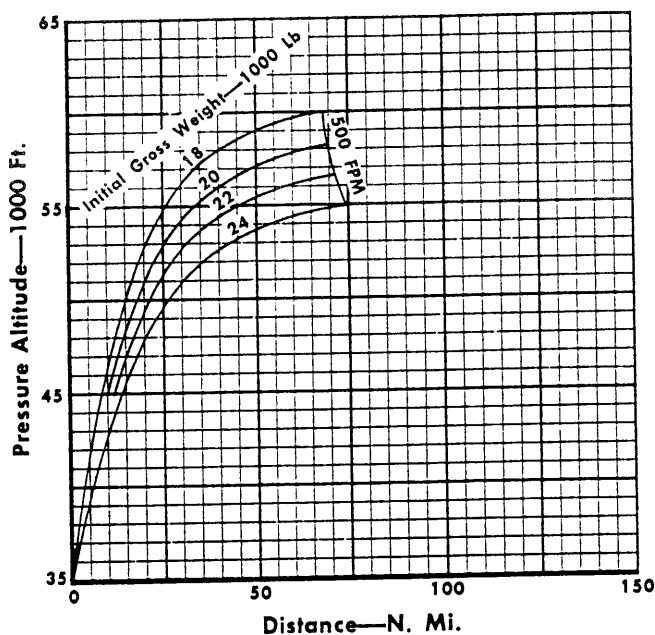

- REMARKS:
- To determine equivalent weight for non standard day conditions:
    1. HOT DAY: Equivalent weight = Actual airplane gross weight +  $\Delta$  Weight (from  $\Delta$  Temp vs  $\Delta$  Weight curve)
    2. COLD DAY: Equivalent weight = Actual airplane gross weight -  $\Delta$  Weight (from  $\Delta$  Temp vs  $\Delta$  Weight curve)

Figure A9-32

## MAXIMUM THRUST CLIMB CONTROL

### CLIMB SPEED MACH 2.2

- BL104 MRAAM
- BL104 AIM-9L Missiles
- BL104 AIM-9L Missile and MRAAM

Model: F-104S  
 Date: 1 April 1970  
 DATA BASIS: FLIGHT TEST

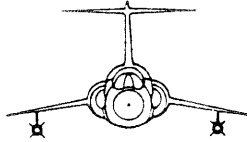

105% RPM  
 FUEL CONTROL UNIT

Engine: J79-GE-19  
 Fuel Grade: JP-8  
 Fuel Density: 6.68 Lb/Gal

### Standard Day

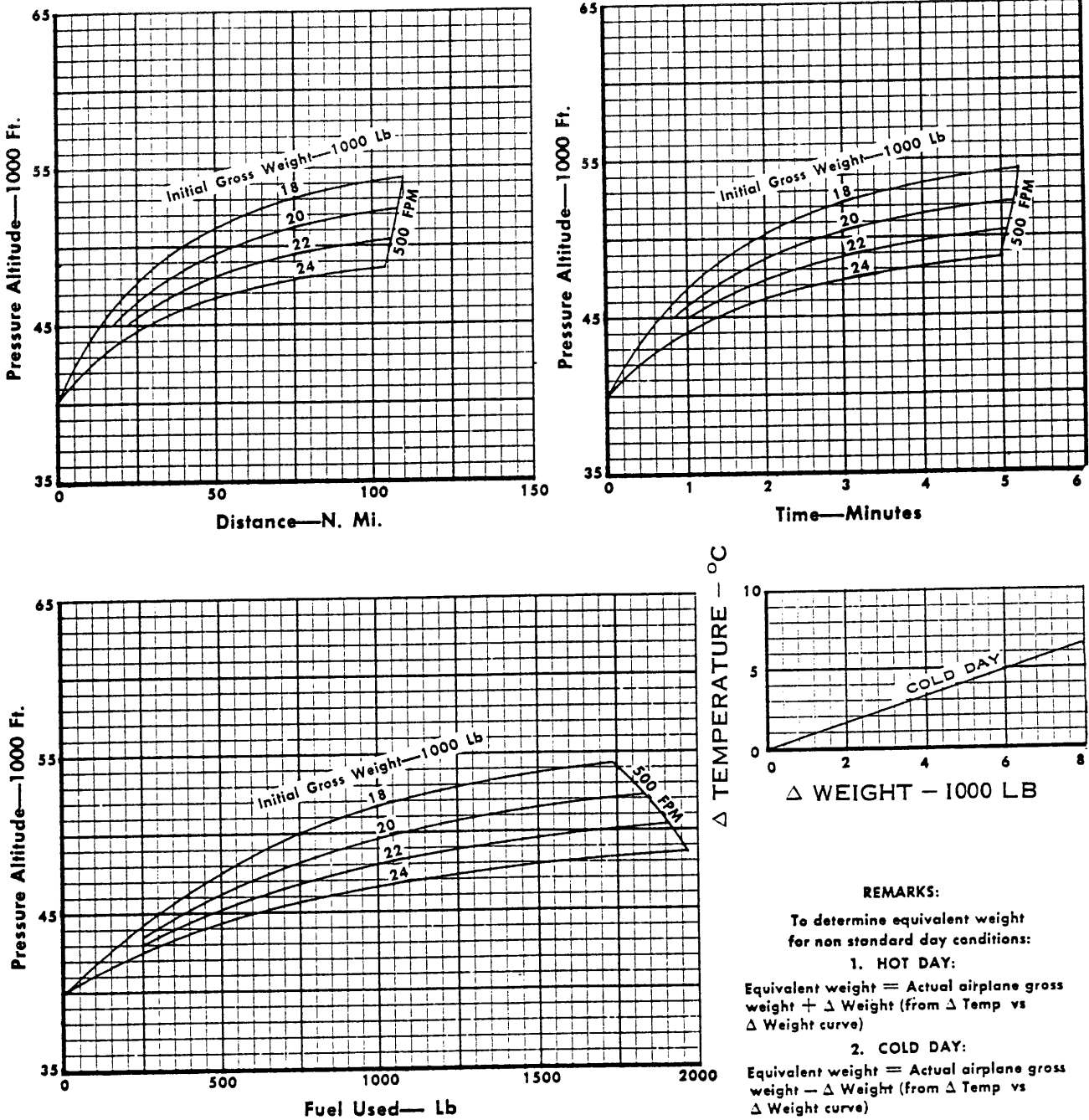

**REMARKS:**

To determine equivalent weight for non standard day conditions:

**1. HOT DAY:**

Equivalent weight = Actual airplane gross weight +  $\Delta$  Weight (from  $\Delta$  Temp vs  $\Delta$  Weight curve)

**2. COLD DAY:**

Equivalent weight = Actual airplane gross weight -  $\Delta$  Weight (from  $\Delta$  Temp vs  $\Delta$  Weight curve)

Figure A9-33

# MAXIMUM THRUST CLIMB CONTROL

CLIMB SPEED MACH 1.4

- Tip Tanks and BL104 MRAAM
- Tip Tanks and BL104 AIM-9L Missiles
- Tip Tanks and BL104 AIM-9L Missile and BL104 MRAAM
- BL75 Fuel Pylon Tanks
- Tip AIM-9L Missiles and BL104 MRAAM
- Tip AIM-9L Missiles and BL104 AIM-9L Missiles

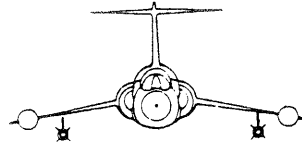

105% RPM  
FUEL CONTROL UNIT

Engine: J79-GE-19  
Fuel Grade: JP-8  
Fuel Density: 6.68 Lb/Gal

Model: F-104S  
Date: 1 April 1970  
DATA BASIS: FLIGHT TEST

Standard Day

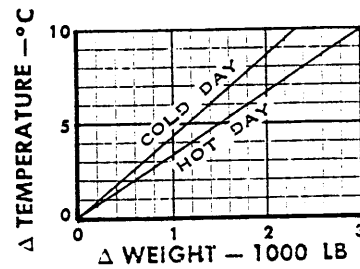
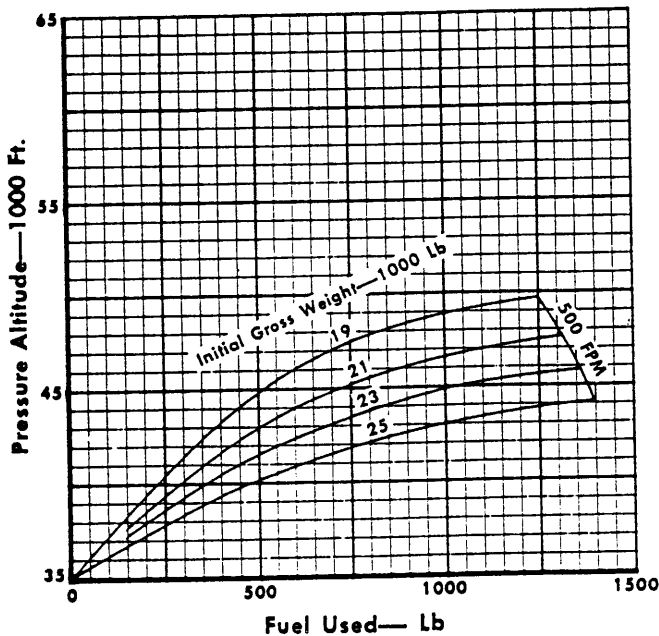
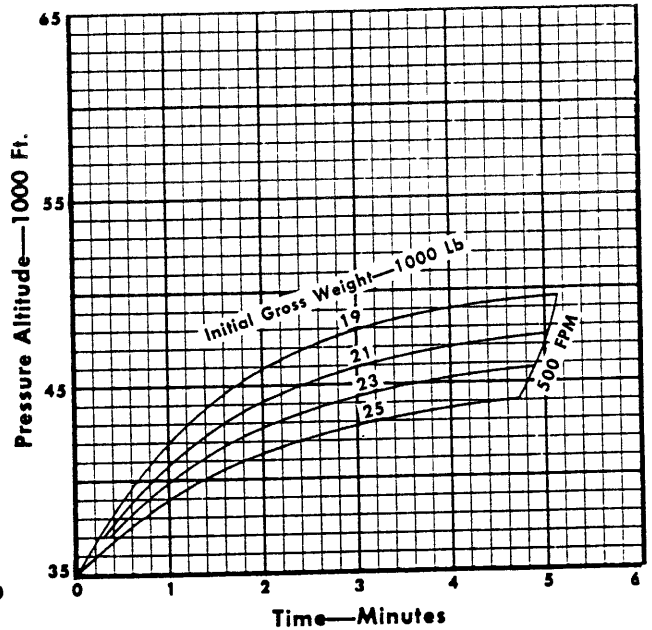
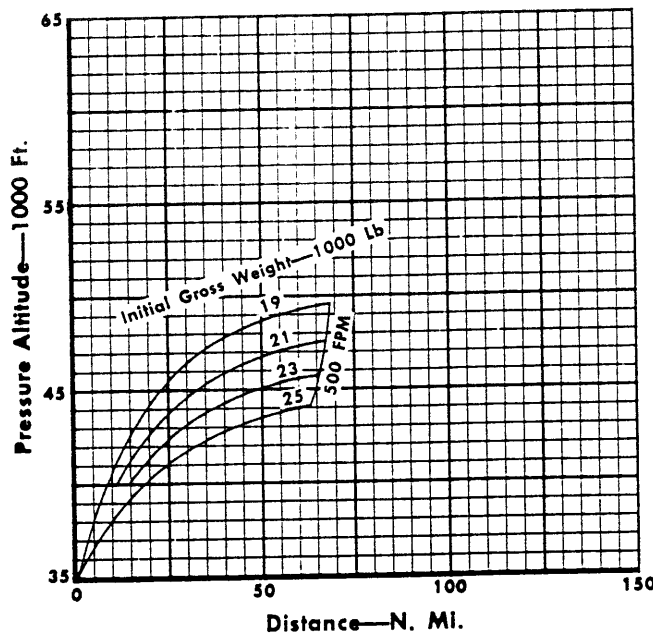

**REMARKS:**

To determine equivalent weight for non standard day conditions:

1. HOT DAY: Equivalent weight = Actual airplane gross weight +  $\Delta$  Weight (from  $\Delta$  Temp vs  $\Delta$  Weight curve)
2. COLD DAY: Equivalent weight = Actual airplane gross weight -  $\Delta$  Weight (from  $\Delta$  Temp vs  $\Delta$  Weight curve)

Figure A9-34

# MAXIMUM THRUST CLIMB CONTROL

CLIMB SPEED MACH 1.6

- Tip Tanks and BL104 MRAAM
- Tip Tanks and BL104 AIM-9L Missiles
- Tip Tanks and BL104 AIM-9L Missile and BL104 MRAAM
- BL75 Fuel Pylon Tanks
- Tip AIM-9L Missiles and BL104 MRAAM
- Tip AIM-9L Missiles and BL104 AIM-9L Missiles

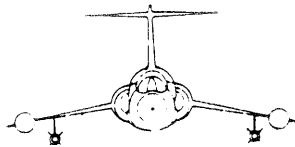

105% RPM  
FUEL CONTROL UNIT

Model: F-104S  
Date: 1 April 1970  
DATA BASIS: FLIGHT TEST

Engine: J79-GE-19  
Fuel Grade: JP-8  
Fuel Density: 6.88 Lb/Gal

Standard Day

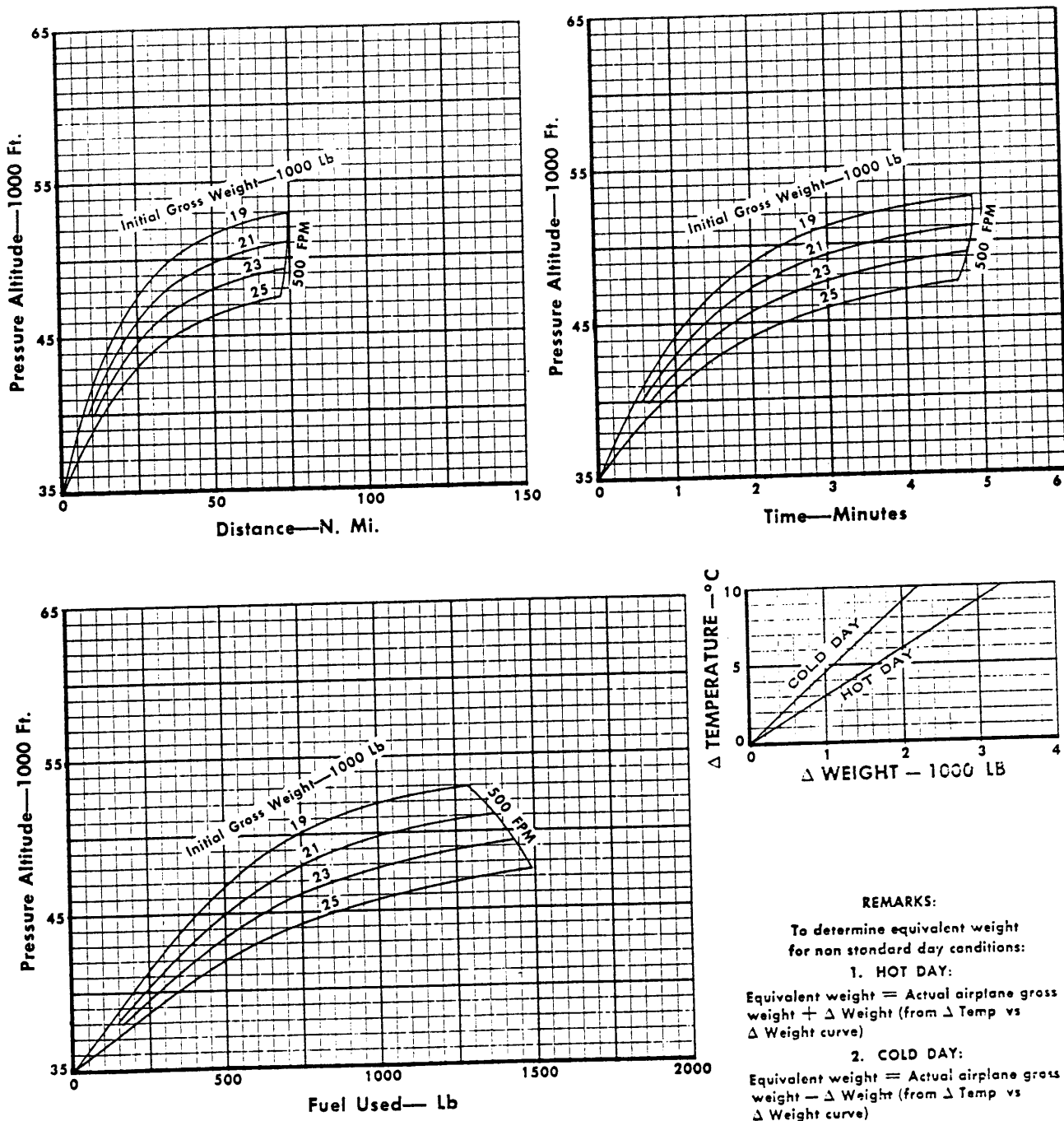

**REMARKS:**  
To determine equivalent weight for non standard day conditions:  
1. HOT DAY:  
Equivalent weight = Actual airplane gross weight + Δ Weight (from Δ Temp vs Δ Weight curve)  
2. COLD DAY:  
Equivalent weight = Actual airplane gross weight - Δ Weight (from Δ Temp vs Δ Weight curve)

Figure A9-35

# MAXIMUM THRUST CLIMB CONTROL

CLIMB SPEED MACH 1.8

- Tip Tanks and BL104 MRAAM
- Tip Tanks and BL104 AIM-9L Missiles
- Tip Tanks and BL104 AIM-9L Missile and BL104 MRAAM
- BL75 Fuel Pylon Tanks
- Tip AIM-9L Missiles and BL104 MRAAM
- Tip AIM-9L Missiles and BL104 AIM-9L Missiles

Model: F-104S  
 Date: 1 April 1970  
 DATA BASIS: FLIGHT TEST

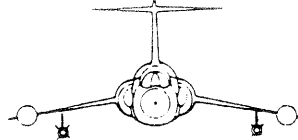

105% RPM  
 FUEL CONTROL UNIT

Engine: J79-GE-19  
 Fuel Grade: JP-8  
 Fuel Density: 6.88 Lb/Gal

Standard Day

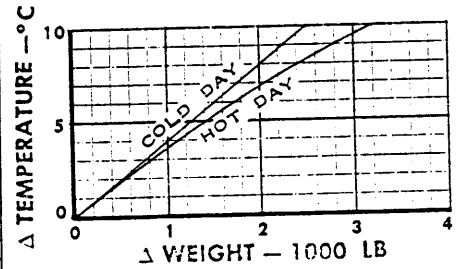
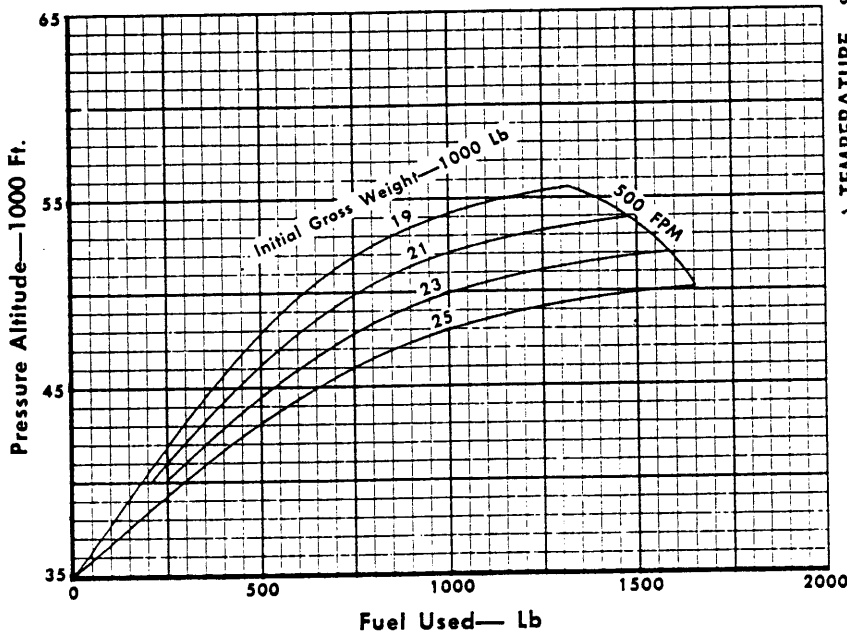
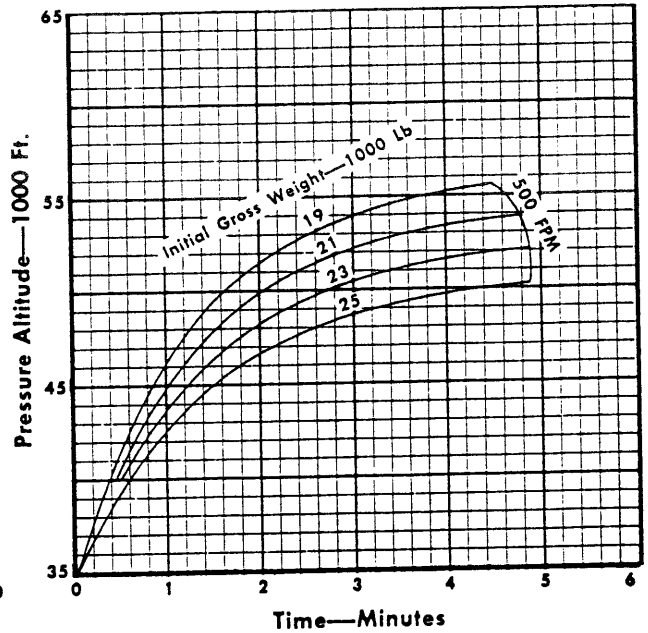
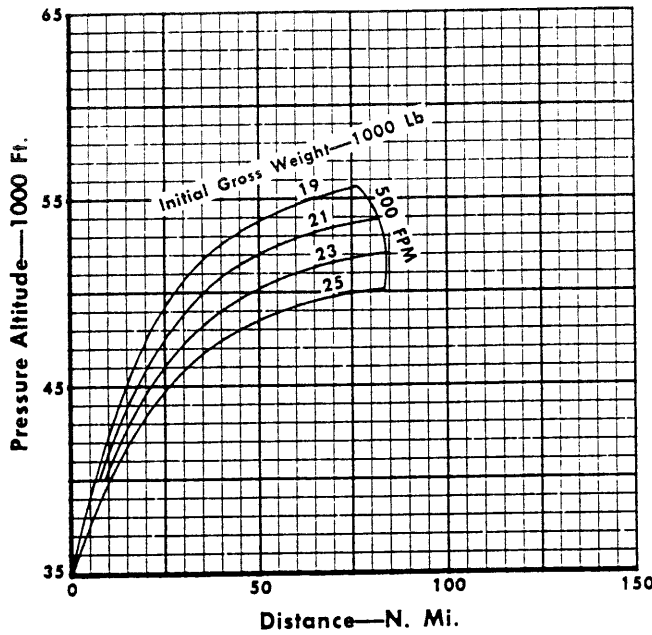

**REMARKS:**

To determine equivalent weight for non standard day conditions:

**1. HOT DAY:**

Equivalent weight = Actual airplane gross weight +  $\Delta$  Weight (from  $\Delta$  Temp vs  $\Delta$  Weight curve)

**2. COLD DAY:**

Equivalent weight = Actual airplane gross weight -  $\Delta$  Weight (from  $\Delta$  Temp vs  $\Delta$  Weight curve)

Figure A9-36

# MAXIMUM THRUST CLIMB CONTROL

CLIMB SPEED MACH 2.0

- Tip Tanks and BL104 MRAAM
- Tip Tanks and BL104 AIM-9L Missiles
- Tip Tanks and BL104 AIM-9L Missile and BL104 MRAAM
- BL75 Fuel Pylon Tanks
- Tip AIM-9L Missiles and BL104 MRAAM
- Tip AIM-9L Missiles and BL104 AIM-9L Missiles

Model: F-104S  
 Date: 1 April 1970  
 DATA BASIS: FLIGHT TEST

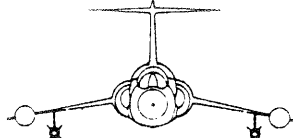

105% RPM  
 FUEL CONTROL UNIT

Engine: J79-GE-19  
 Fuel Grade: JP-8  
 Fuel Density: 6.68 Lb/Gal

Standard Day

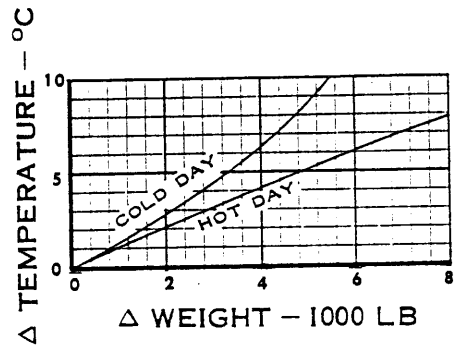
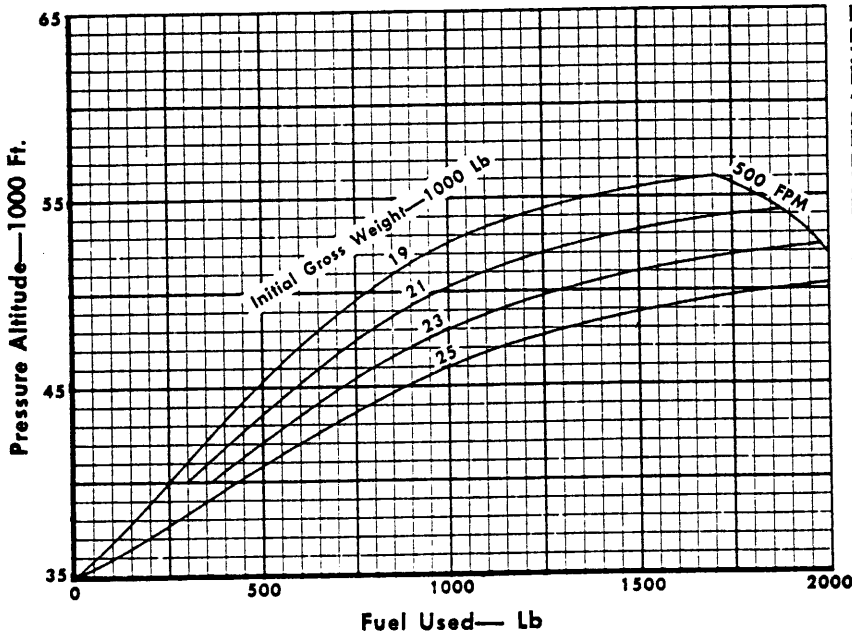
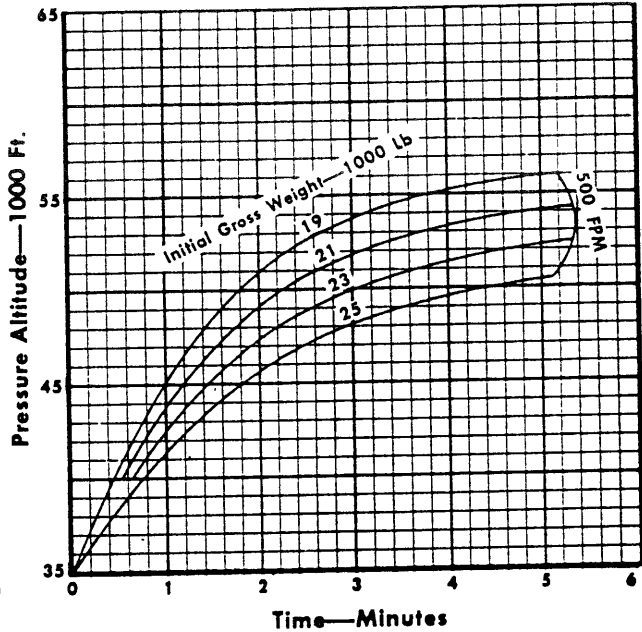
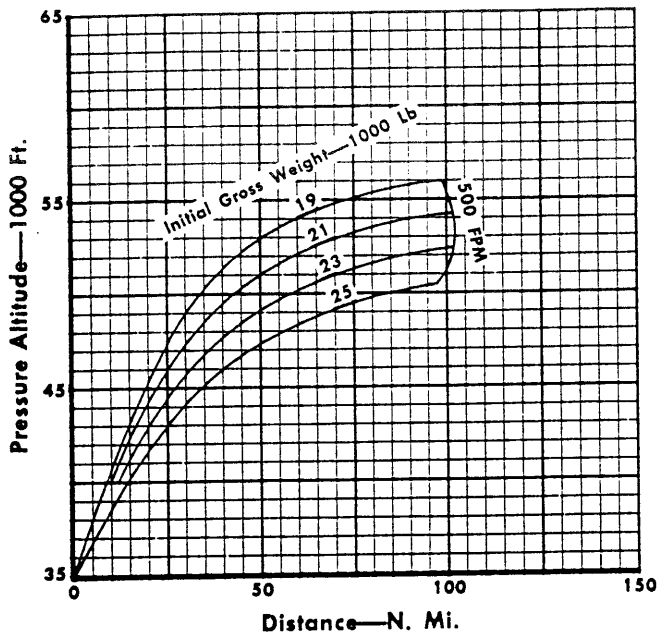

**REMARKS:**

To determine equivalent weight for non standard day conditions:

**1. HOT DAY:**

Equivalent weight = Actual airplane gross weight + Δ Weight (from Δ Temp vs Δ Weight curve)

**2. COLD DAY:**

Equivalent weight = Actual airplane gross weight - Δ Weight (from Δ Temp vs Δ Weight curve)

Figure A9-37

# MAXIMUM THRUST TURNING PERFORMANCE CONSTANT SPEED AND ALTITUDE

105% RPM

FUEL CONTROL UNIT

Engine: J79-GE-19  
Fuel Grade: JP-8  
Fuel Density: 6.68 Lb/Gal

NO EXTERNAL STORES

Model: F-104S  
Date: 1 April 1970  
DATA BASIS: FLIGHT TEST

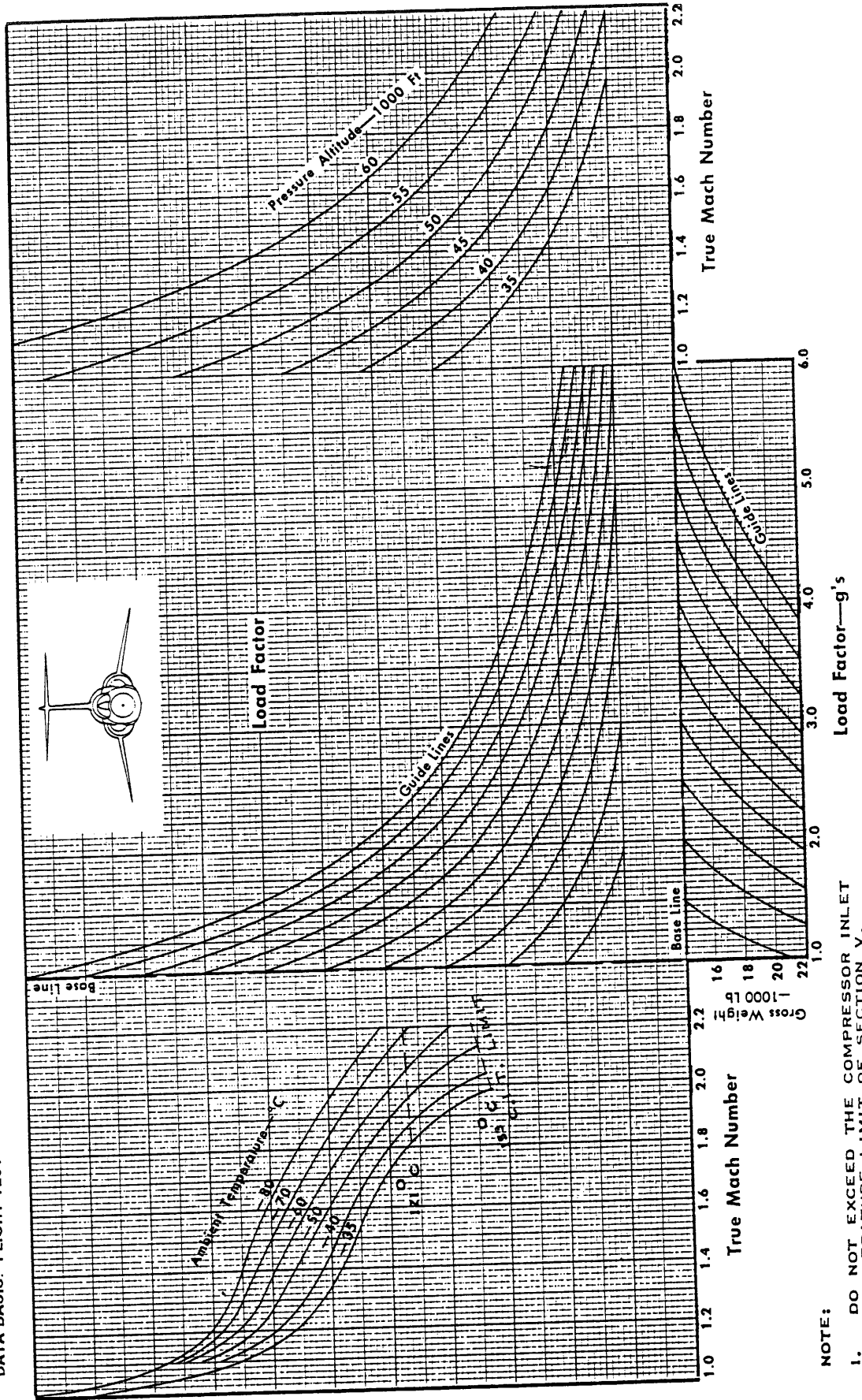

**NOTE:**  
1. DO NOT EXCEED THE COMPRESSOR INLET TEMPERATURE LIMIT OF SECTION V.

Figure A9-38



# MAXIMUM THRUST TURNING PERFORMANCE CONSTANT SPEED AND ALTITUDE

105% RPM

Engine: J79-GE-19  
Fuel Grade: JP-8  
Fuel Density: 6.68 Lb/Gal

FUEL CONTROL UNIT

— BL104 MRAAM  
— BL104 AIM-9L Missiles  
— BL104 AIM-9L Missile and BL104 MRAAM

Model: F-104S  
Date: 1 April 1970  
DATA BASIS: FLIGHT TEST

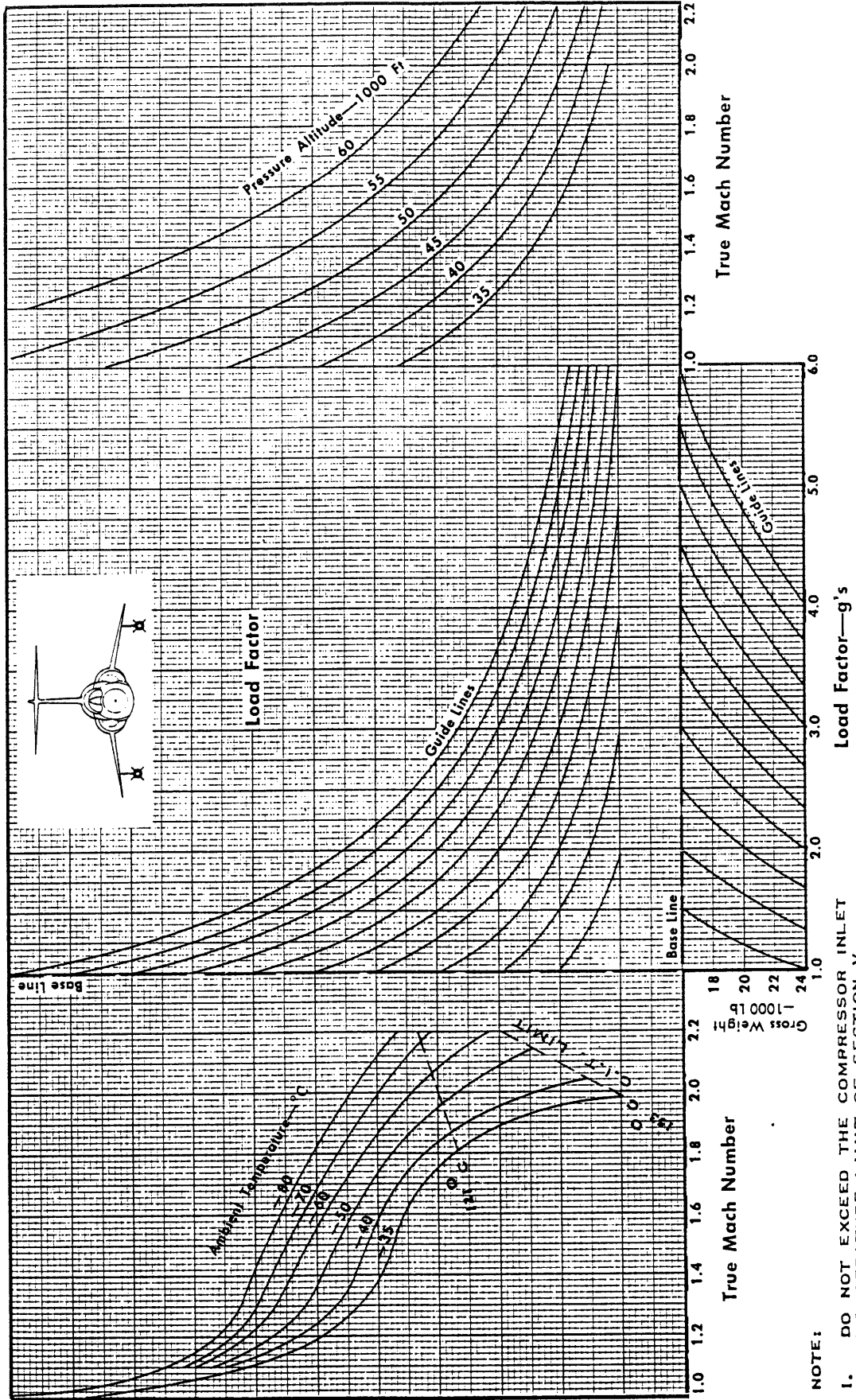

NOTE:

I. DO NOT EXCEED THE COMPRESSOR INLET TEMPERATURE LIMIT OF SECTION V.

Figure A9-39

# MAXIMUM THRUST TURNING PERFORMANCE CONSTANT SPEED AND ALTITUDE

105% RPM

105% RPM  
FUEL CONTROL UNIT

Engine: J79-GE-19  
Fuel Grade: JP-8  
Fuel Density: 6.68 Lb/Gal

Model: F-104S  
Date: 1 April 1970  
DATA BASIS: FLIGHT TEST

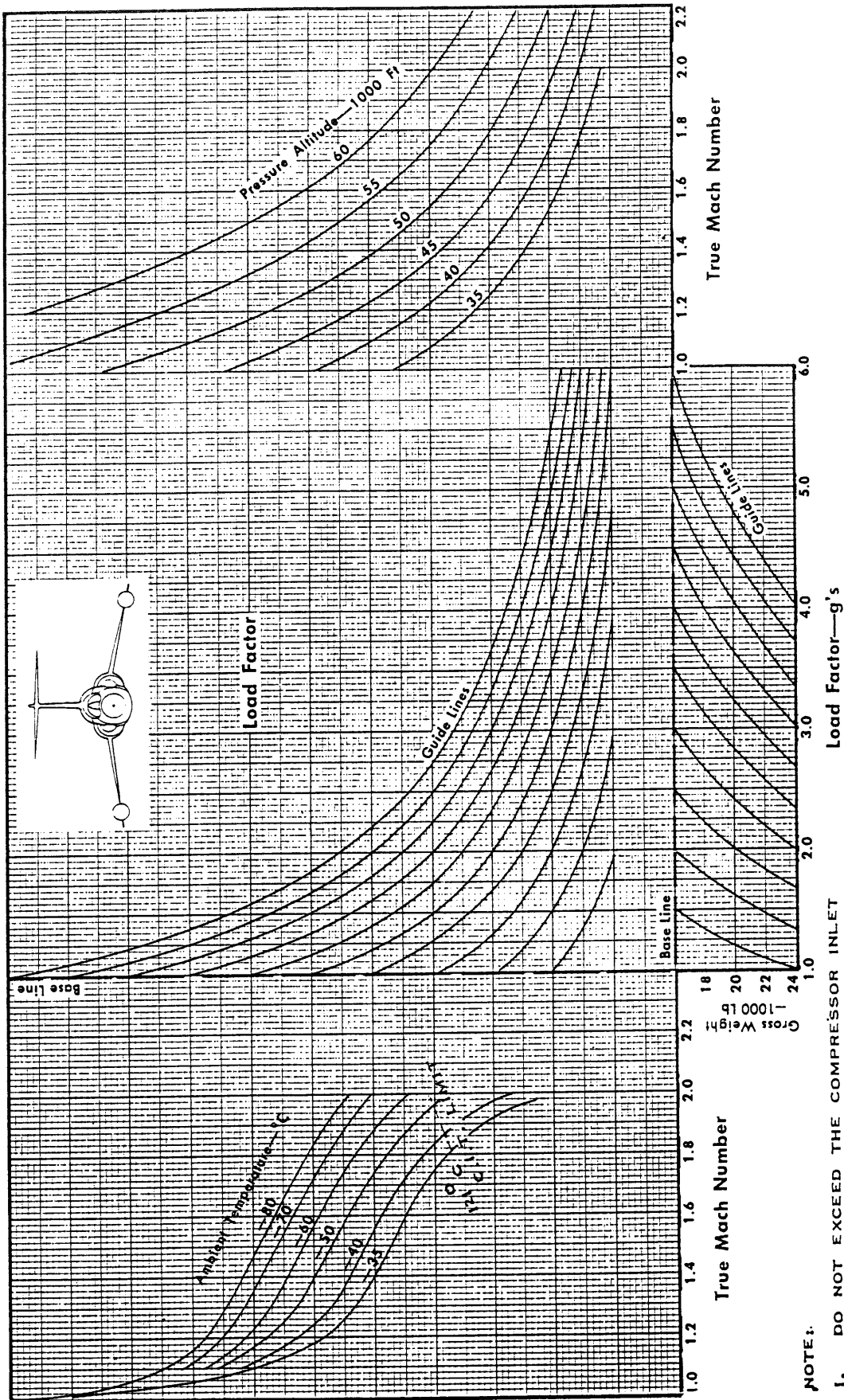

Figure A9-40

# MAXIMUM THRUST TURNING PERFORMANCE CONSTANT SPEED AND ALTITUDE

- Tip Tanks and BL104 MRAAM
- Tip Tanks and BL104 AIM-9L Missiles
- Tip Tanks and BL104 AIM-9L Missile and BL104 MRAAM
- BL75 Fuel Pylon Tanks
- Tip AIM-9L Missiles and BL104 MRAAM
- Tip AIM-9L Missiles and BL104 AIM-9L Missile

105% RPM

FUEL CONTROL UNIT

Engine: J79-GE-19  
Fuel Grade: JP-8  
Fuel Density: 6.88 Lb/Gal

Model: F-104S  
Date: 1 April 1970  
DATA BASIS: FLIGHT TEST

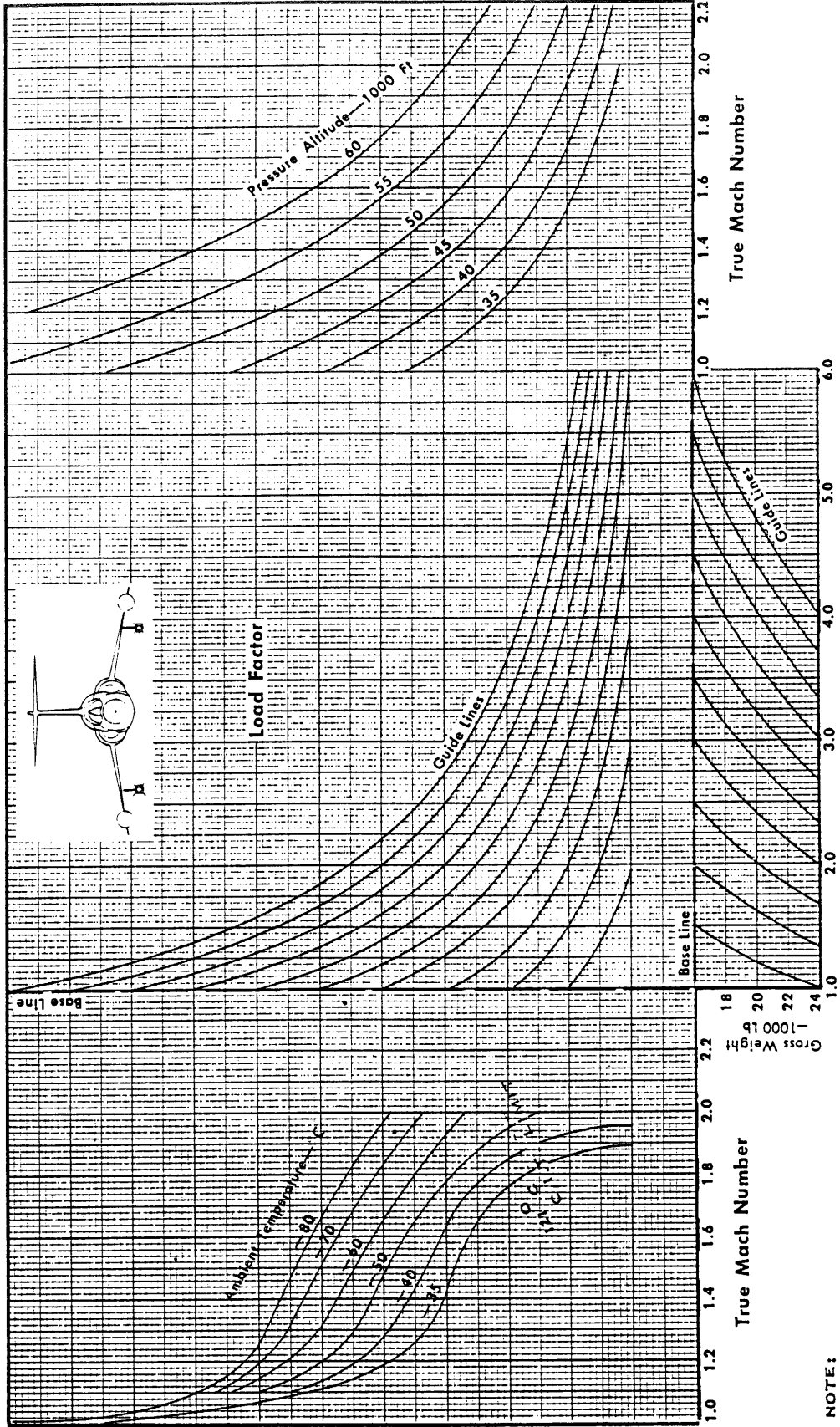

Figure A9-41

# MAXIMUM THRUST TURNING PERFORMANCE CONSTANT SPEED AND ALTITUDE

105% RPM

FUEL CONTROL UNIT

- BL104 Pylons and MRAAM Launchers
- BL104 Pylons and AIM-9L Launchers and Adapter

Engine: J79-GE-19  
Fuel Grade: JP-8  
Fuel Density: 6.68 Lb/Gal

Model: F-104S  
Date: 1 April 1970  
DATA BASIS: FLIGHT TEST

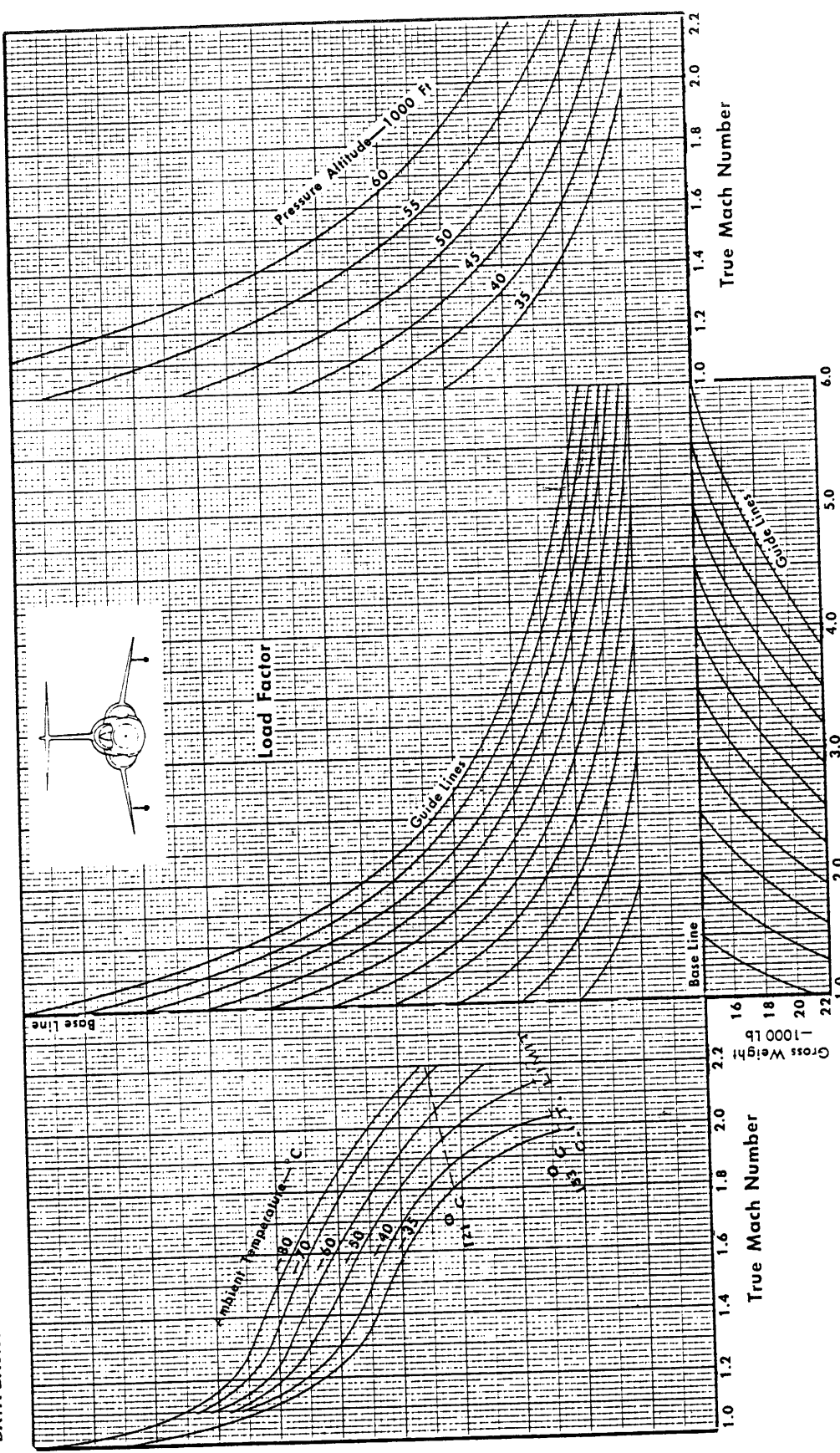

NOTE:  
1. DO NOT EXCEED THE COMPRESSOR INLET TEMPERATURE LIMIT OF SECTION V.

Figure A9-42

# TURNING PERFORMANCE — GENERAL CONSTANT SPEED AND ALTITUDE

Engine: J79-GE-19  
Fuel Grade: JP-8  
Fuel Density: 6.68 Lb/Gal

TURN RADIUS

MINUTES PER 180° TURN

All Configurations

BANK ANGLE

Model: F-104S  
Date: 1 April 1970  
DATA BASIS: FLIGHT TEST

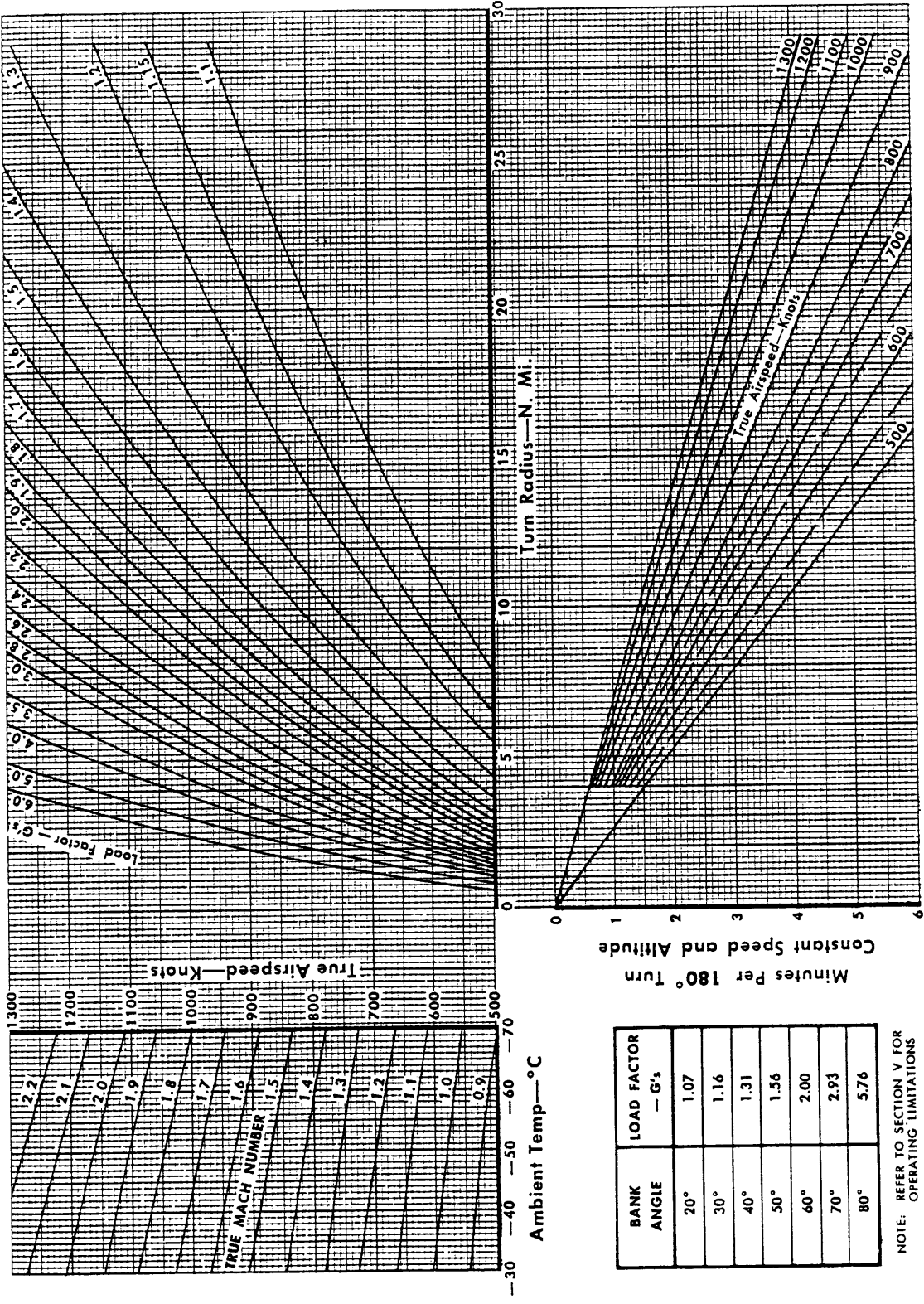

BANK ANGLE	LOAD FACTOR — G's
20°	1.07
30°	1.16
40°	1.31
50°	1.56
60°	2.00
70°	2.93
80°	5.76

NOTE: REFER TO SECTION V FOR OPERATING LIMITATIONS

Figure A9-43

# AFTERBURNER CRUISE PERFORMANCE

## STANDARD DAY

NO EXTERNAL STORES

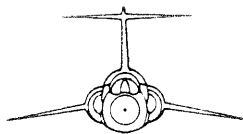

105% RPM  
FUEL CONTROL UNIT

Model: F-104S  
Date: 1 April 1970  
DATA BASIS: FLIGHT TEST

Engine: J79-GE-19  
Fuel Grade: JP-8  
Fuel Density: 6.68 Lb/Gal

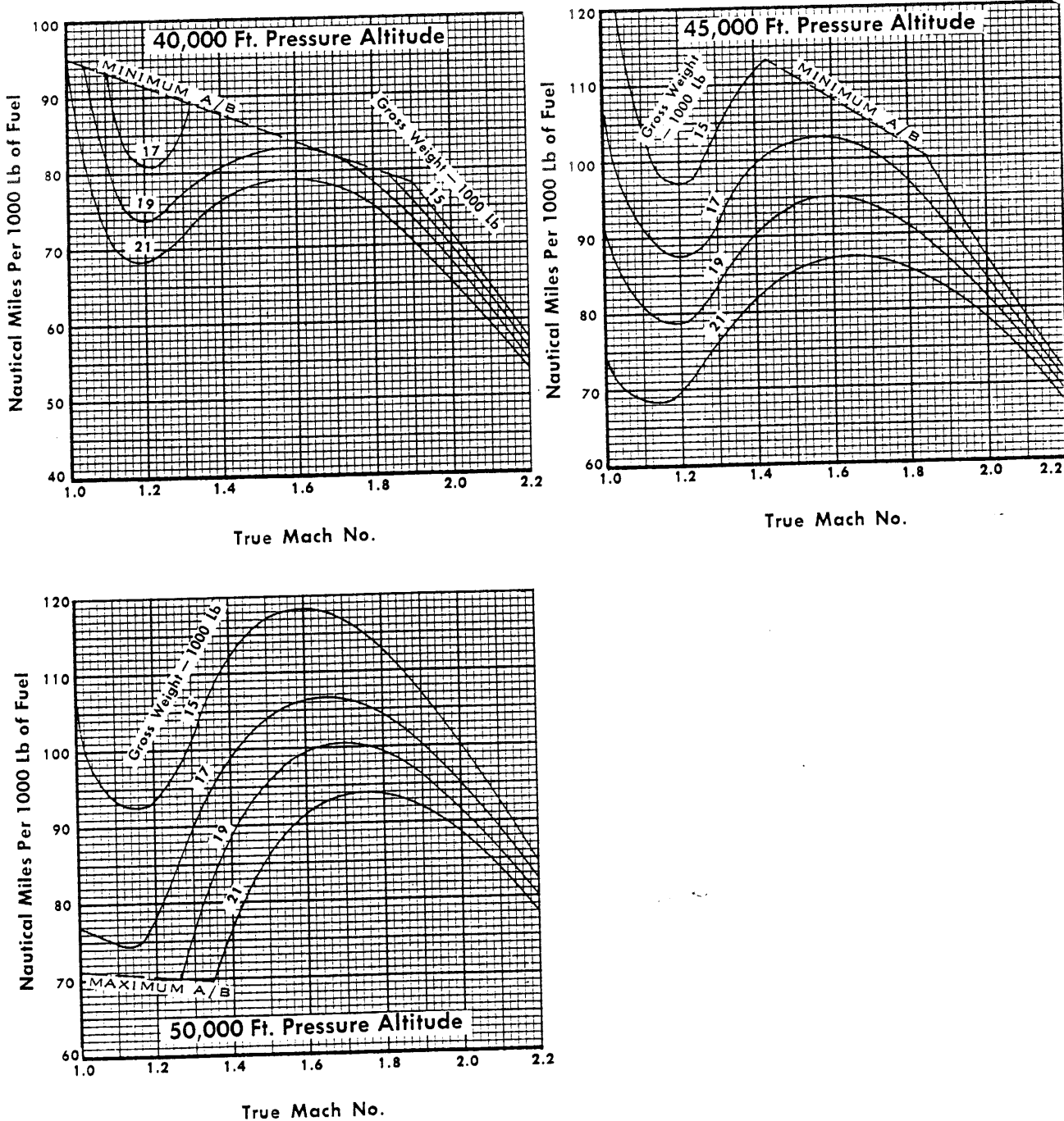
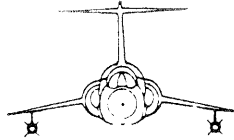

Figure A9-44

## AFTERBURNER CRUISE PERFORMANCE STANDARD DAY

- BL104 MRAAM
- BL104 AIM-9L Missiles
- BL104 AIM-9L Missile and BL104 MRAAM



105% RPM  
FUEL CONTROL UNIT

Model: F-104S  
Date: 1 April 1970  
DATA BASIS: FLIGHT TEST

Engine: J79-GE-19  
Fuel Grade: JP-8  
Fuel Density: 6.68 Lb/Gal

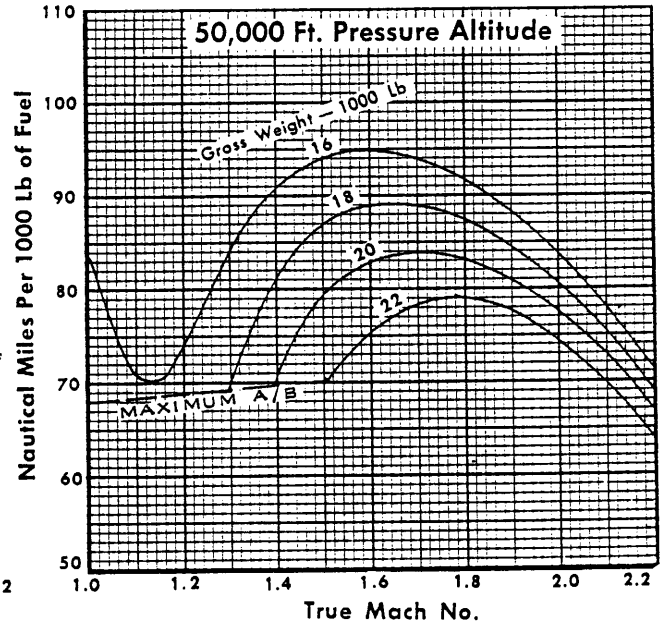
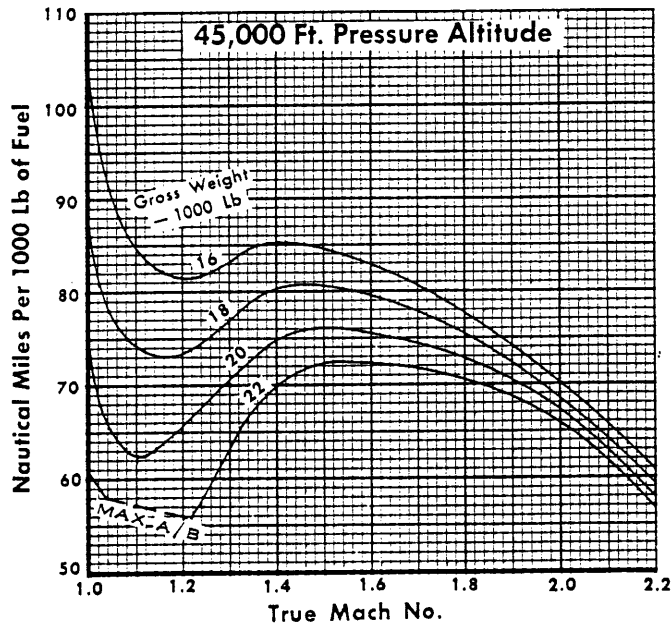
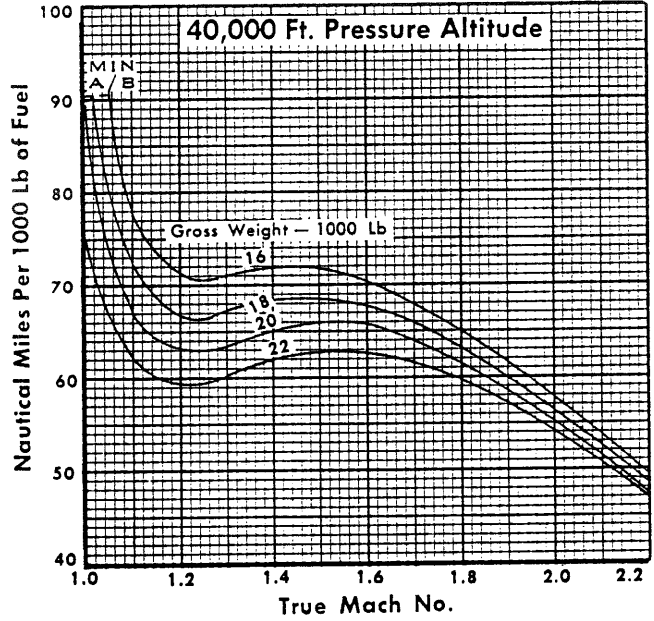
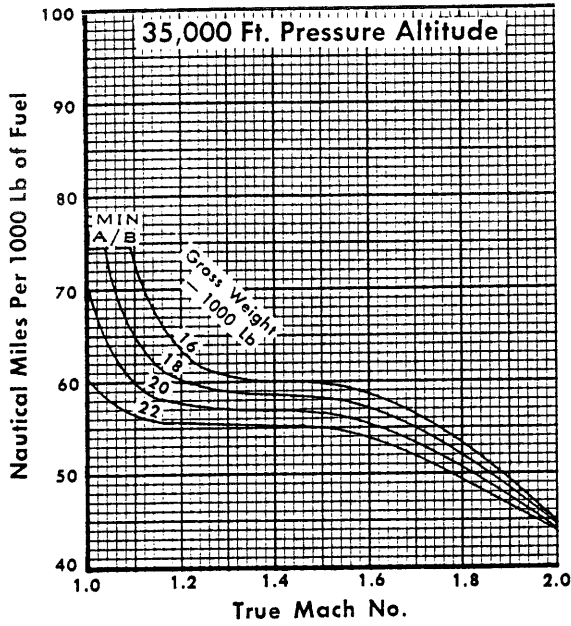
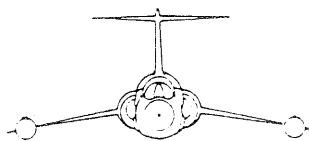

Figure A9-45

# AFTERBURNER CRUISE PERFORMANCE

STANDARD DAY

- Tip Tanks
- Tip AIM-9L Missiles



105% RPM  
FUEL CONTROL UNIT

Model: F-104S  
Date: 1 April 1970  
DATA BASIS: FLIGHT TEST

Engine: J79-GE-19  
Fuel Grade: JP-8  
Fuel Density: 6.68 Lb/Gal

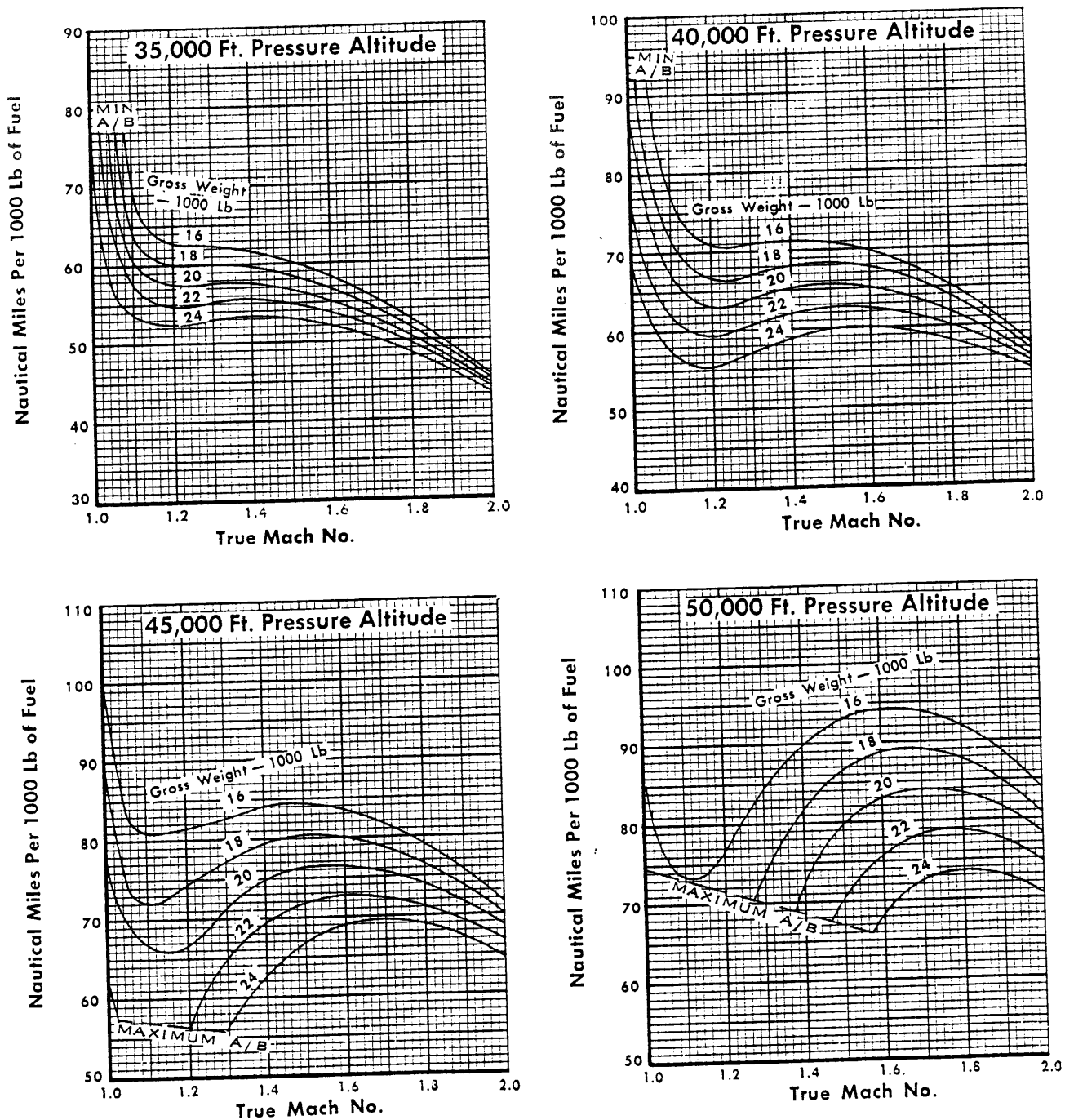
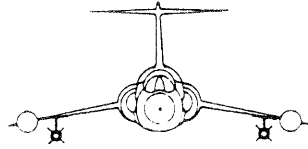

Figure A9-46



## AFTERBURNER CRUISE PERFORMANCE STANDARD DAY

- Tip Tanks and BL104 MRAAM
- Tip Tanks and BL104 AIM-9L Missiles
- Tip Tanks and BL104 AIM-9L Missile and BL104 MRAAM
- BL75 Fuel Pylon Tanks
- Tip AIM-9L Missiles and BL104 MRAAM
- Tip AIM-9L Missiles and BL104 AIM-9L Missiles



105% RPM  
FUEL CONTROL UNIT

Model: F-104S  
Date: 1 April 1970  
DATA BASIS: FLIGHT TEST

Engine: J79-GE-19  
Fuel Grade: JP-8  
Fuel Density: 6.68 Lb/Gal

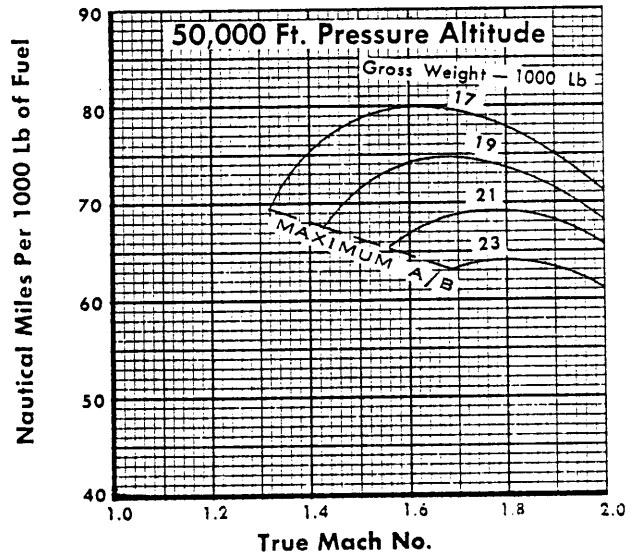
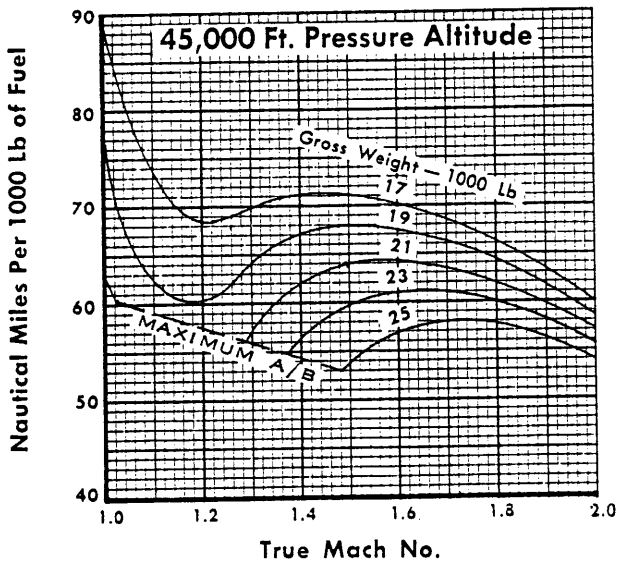
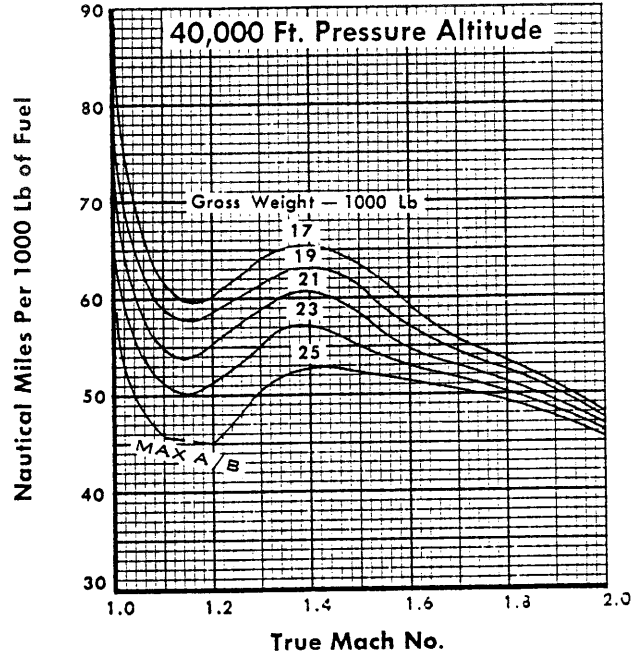
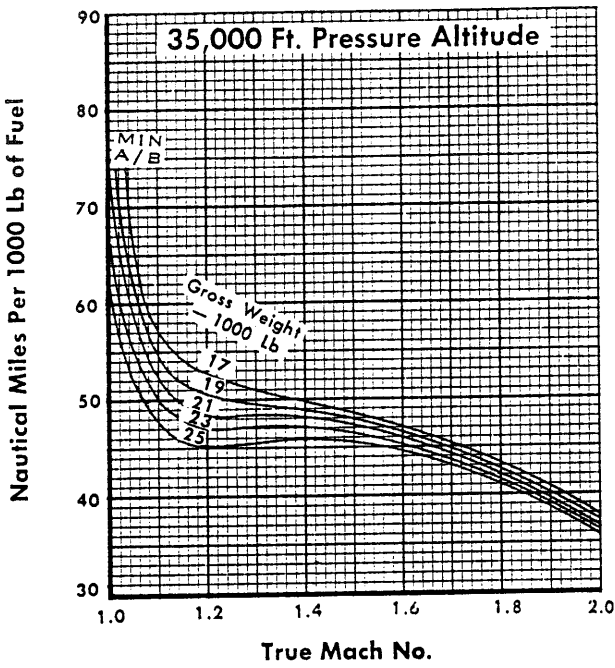

Figure A9-47

# AFTERBURNER CRUISE PERFORMANCE

## STANDARD DAY

- BL104 Pylons and MRAAM Launchers
- BL104 Pylons and AIM-9L Launchers and Adapter

105% RPM  
FUEL CONTROL UNIT

Model: F-104S  
Date: 1 April 1970  
DATA BASIS: FLIGHT TEST

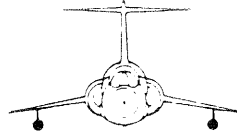

Engine: J79-GE-19  
Fuel Grade: JP-8  
Fuel Density: 6.68 Lb/Gal

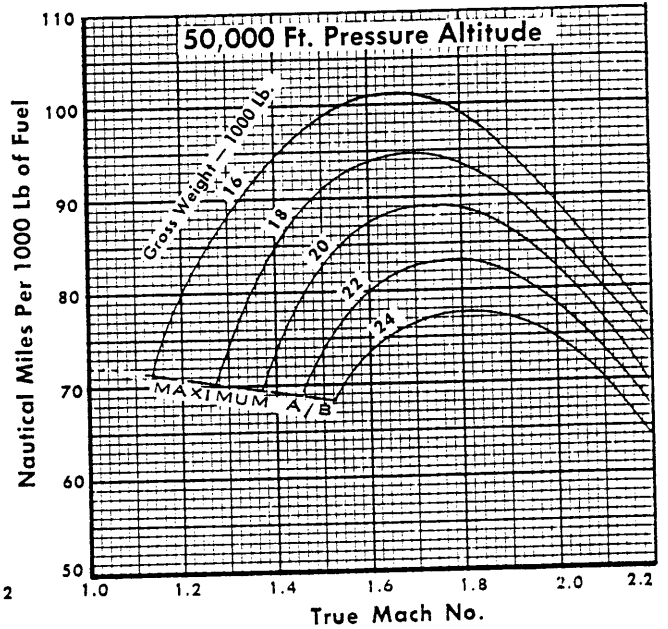
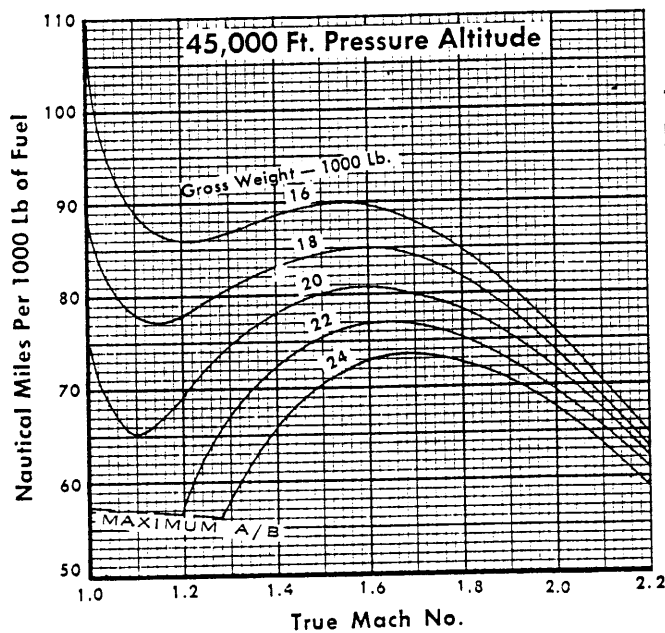
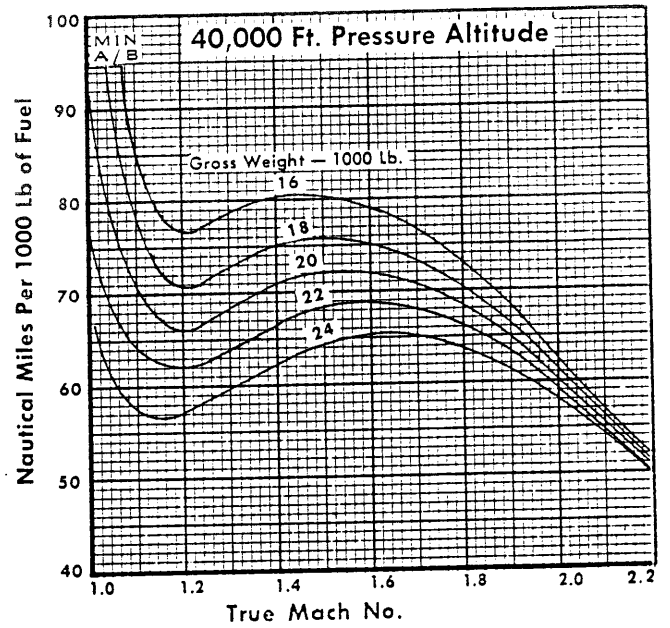
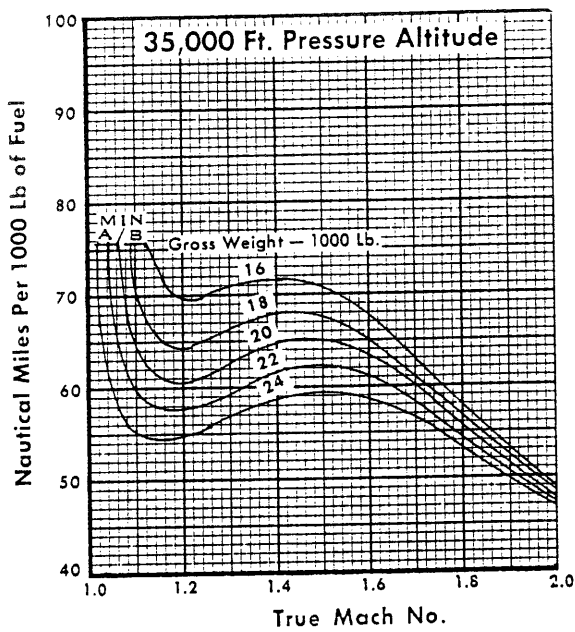

Figure A9-48

# MILITARY THRUST FUEL CONSUMPTION

Model: F-104S  
 Date: 1 April 1970  
 DATA BASIS: FLIGHT TEST

Engine: J79-GE-19  
 Fuel Grade: JP-8  
 Fuel Density: 6.68 Lb/Gal

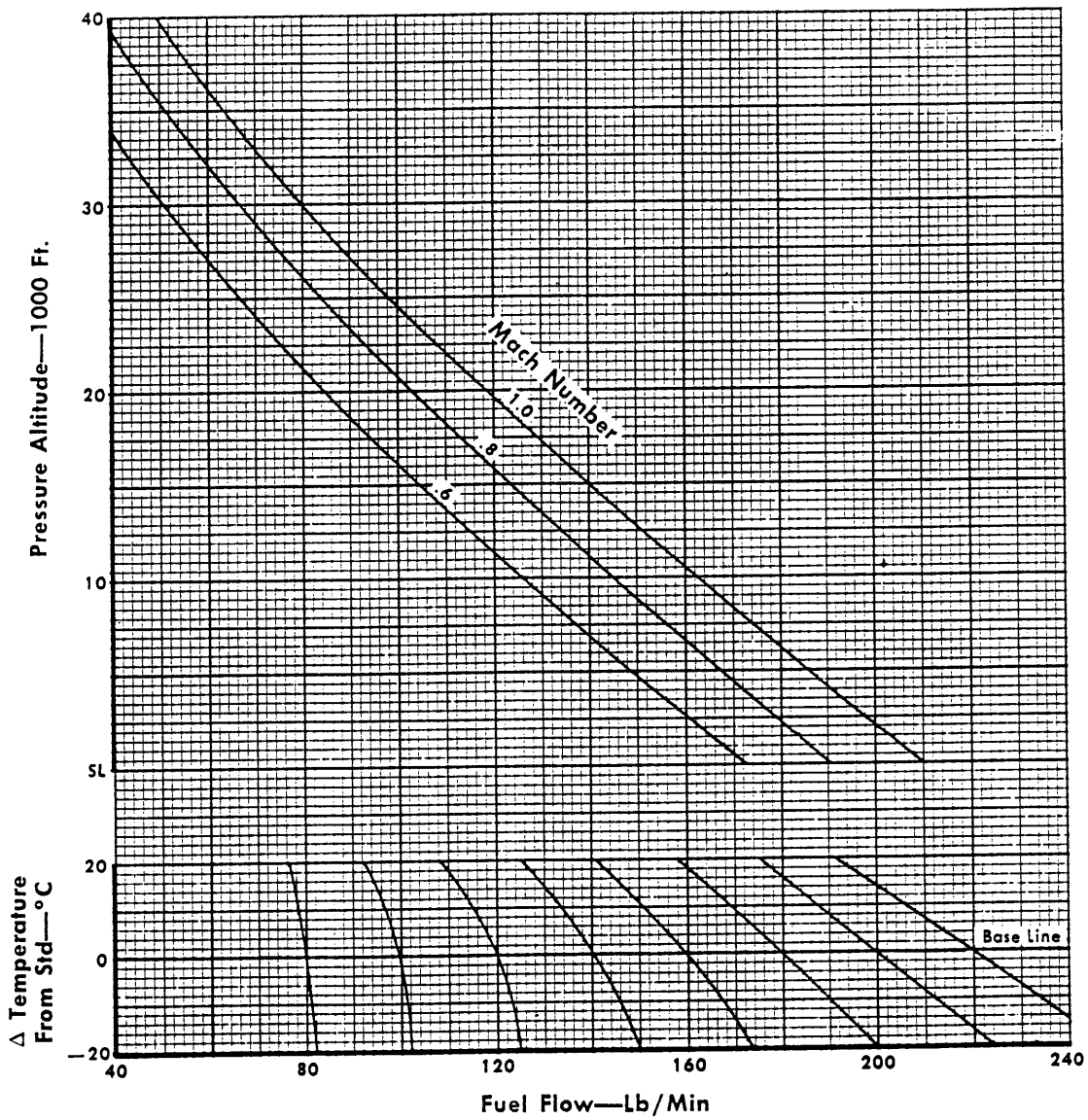

Figure A9-49

# MAXIMUM THRUST FUEL CONSUMPTION

SEA LEVEL TO 30000 FT

105% RPM  
FUEL CONTROL UNIT

Model: F-104S  
Date: 1 April 1970  
DATA BASIS: FLIGHT TEST

Engine: J79-GE-19  
Fuel Grade: JP-8  
Fuel Density: 6.68 Lb/Gal

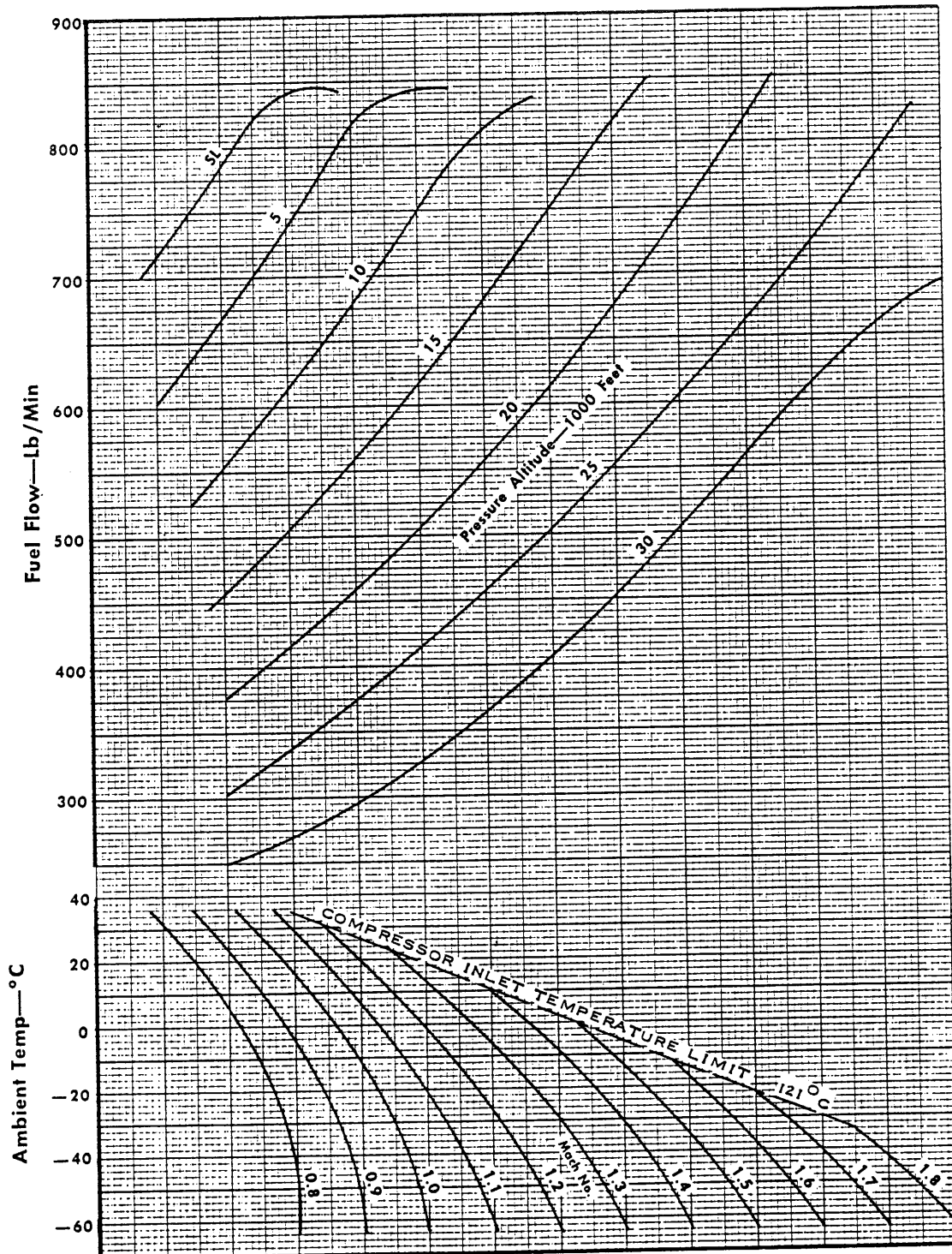

Figure A9-50

# MAXIMUM THRUST FUEL CONSUMPTION

30000 FT TO 60000 FT

105% RPM  
FUEL CONTROL UNIT

Model: F-104S  
Date: 1 April 1970  
DATA BASIS: FLIGHT TEST

Engine: J79-GE-19  
Fuel Grade: JP-8  
Fuel Density: 6.68 Lb/Gal

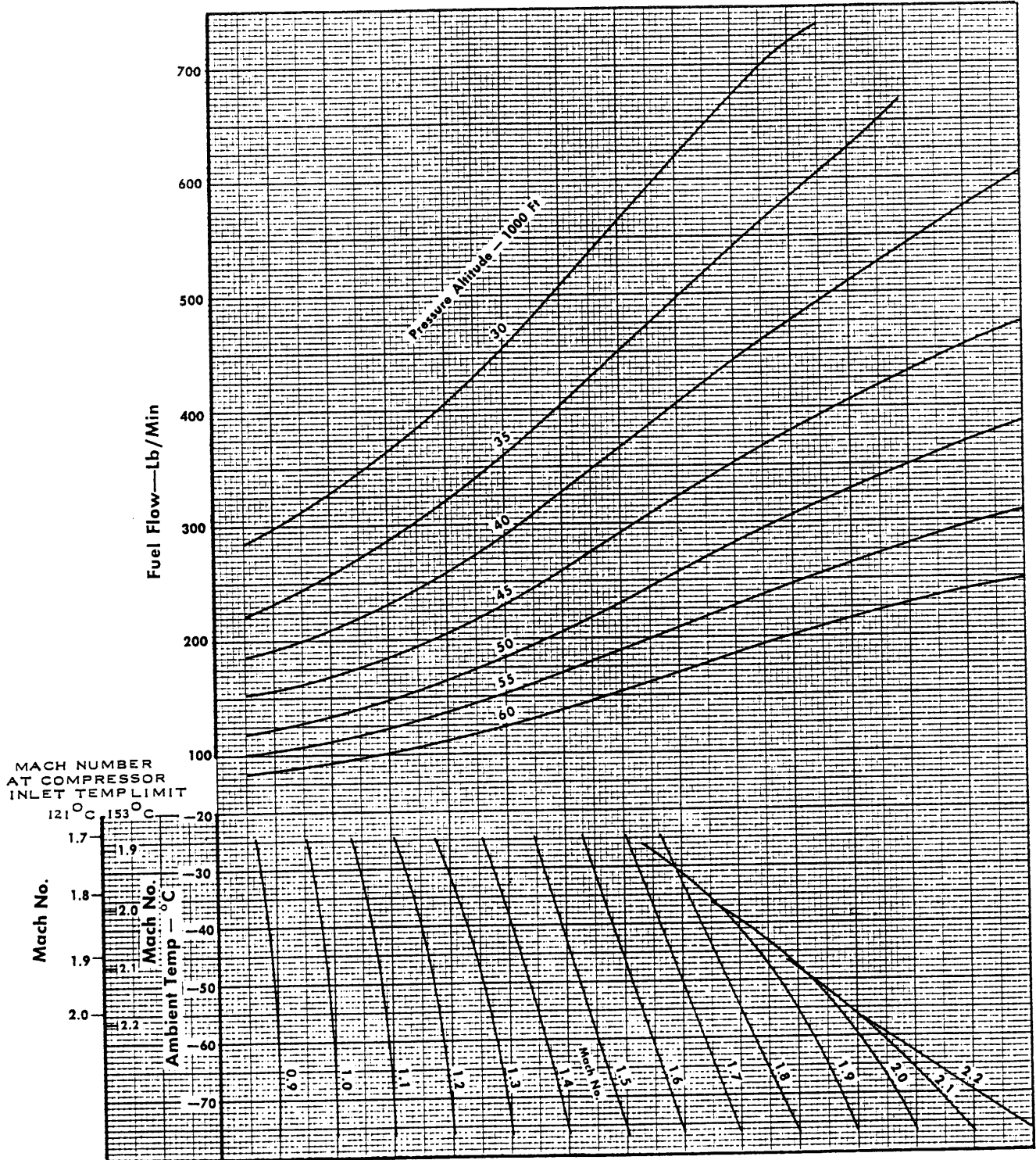

Figure A9-51

# PART 10

## MISSION PLANNING

### TABLE OF CONTENTS

Index items in bold face characters denote illustrations.

Title	Page
Mission Planning . . . . .	A10-1
Mission Planning Example . . . . .	A10-1
<b>Tentative Flight</b> . . . . .	<b>A10-2</b>
<b>Return and Reserve Fuel Allowance</b> . . . . .	<b>A10-4</b>
<b>Outbound Fuel</b> . . . . .	<b>A10-5</b>
<b>Acceleration to Combat Speed and Combat Turn</b> . . . . .	<b>A10-7</b>
<b>Combat Climb and Combat Fuel</b> . . . . .	<b>A10-9</b>
<b>Key Point, Combat, Return and Reserve</b> . . . . .	<b>A10-10</b>
<b>Final Flight</b> . . . . .	<b>A10-12</b>

### MISSION PLANNING

Optimum use of the aircraft to obtain maximum performance at a minimum rate of fuel consumption requires careful preplanning for the mission. One of the most important phase of mission planning is the determination of the maximum radius from base which will allow an adequate return and reserve fuel allowance. To find the maximum radius, a combat plan shall be formulated in advance, and a "key point" established from which the combat phase of the mission is begun. The key point is the point in flight where outbound cruise ends and the attack maneuver begins. Depending on the type of mission to be flown, a high-thrust run on the target may be necessary, or supersonic maneuvers might be required, including accelerations, dashes, climbs and turns. The rate of fuel consumption is high during these maneuvers and any delay in beginning the attack maneuver may reduce actual combat time

available. Likewise, any delay in breaking off the contact may seriously deplete the planned fuel reserve.

### MISSION PLANNING EXAMPLE

The following problem is an exercise in use of the performance charts. The problem is not intended to reflect actual or proposed tactical missions employing this aircraft. The charts presented in parts 1 through 10 provide the performance information necessary to plan many different types of missions. The following example illustrates how the performance charts may be integrated to form a complete tactical mission flight plan. A cut-and-try procedure may be used to find the key point, or a simple plot may be drawn to obtain a graphical solution. The steps used to develop such plots are shown with the problem.

#### Sample Problem Tentative Flight Profile

Configuration: BL104 AIM-7E Sparrow missiles with full internal fuel of 973 gallons (6500 lb). The assumed mission flight sequence includes, maximum thrust takeoff and acceleration to 350 KIAS; military thrust acceleration from 350 KIAS to climb speed Mach 0.85; military thrust climb to optimum cruise altitude, cruise away from base until assigned a firing mission or until fuel remaining is insufficient for completion of an intercept assignment plus return to original base. Assume the intercept assignment includes a military thrust climb to 35000 feet; maximum thrust acceleration to Mach 2.0, a 90° turn; maximum thrust climb to 50000 feet and 1 minute at maximum thrust and Mach 2.0. Make an idle thrust descent to optimum cruise altitude and maximum range return to base at the end of the combat period. The planned fuel reserve is 750 pounds over base at cruise altitude. Assume zero wind and standard day conditions. Refer to Figure A10-1.

### TENTATIVE FLIGHT

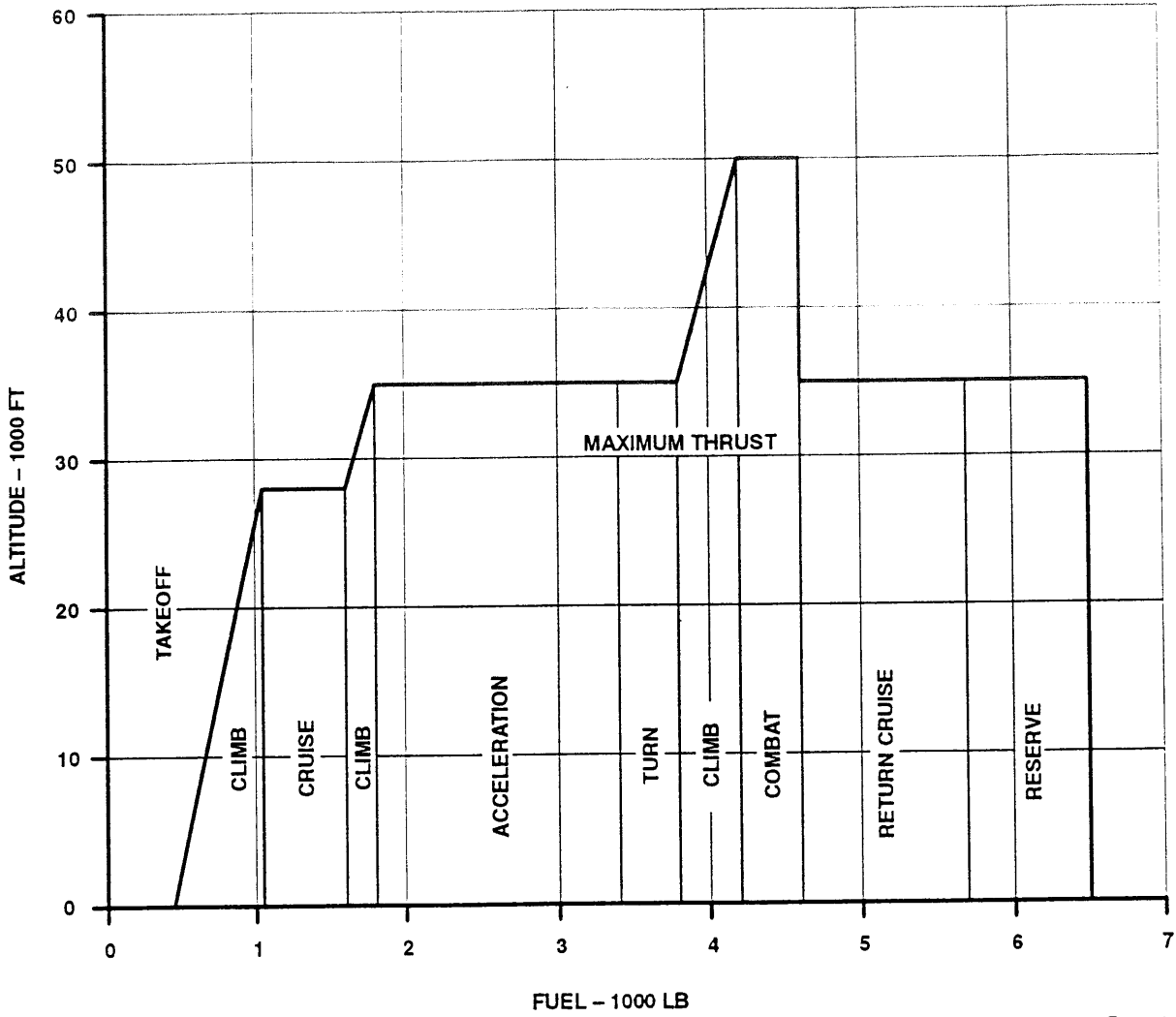

FA0029

Figure A10-1

**General Comments**

Combat, return and reserve fuel requirements define the fuel remaining condition at which the aircraft shall initiate return to base. This is the key point for the problem (the last point where the attack maneuver may begin). Find the return fuel requirements first, then the outbound cruise and combat segments. Combat may not always be expected to follow a predicted pattern. Deviation from assumed conditions and the affect on mission capability should be anticipated. Refer to Figure A10-2.

**Configuration Drag Index and Loaded Gross Weight**

- a. Configuration drag index  
 BL-104 AIM-7E missiles..... 32  
 BL-104 Pylons and AIM-7E missile launchers..... 19
- b. Loaded gross weight is as follows:  
 No external stores zero fuel weight (with ASAS)..... 15044 lb  
 Internal fuel..... 6500 lb  
 Pylons and AIM-7E missile launchers ..... 348 lb  
 AIM-7E missiles ..... 890 lb  
 Loaded gross weight ..... 22782 lb
- c. Zero fuel weight is as follows:  
 With pylons, AIM-7E missile launchers ..... 15392 lb  
 With pylons, AIM-7E missiles and launchers ..... 16282 lb

**Return and Reserve Fuel**

For this problem, assume that the BL104 AIM-7E missiles are fired at the end of the combat period. Return fuel requirements may be determined from the optimum cruise altitude chart in part 3 and the maximum range chart in part 4. Find the range available (Figure A4-1) using the 750 lb fuel reserve and arbitrary fuel remaining values of 1500 and 2500 lb. The aircraft zero fuel weight with BL104 pylons and AIM-7E missile launchers is 15392 lb.

Fuel Remaining lb (reserve)	Average Weight lb	Optimum Altitude ft	N.Mi. per 1000 lb fuel
750	15767	35700	238
1500	16142	35200	230
2500	16642	34500	222

Fuel Remaining lb (reserve)	Distance (nmi)
750	178 (238 × .75)
1500	345 (230 × 1.5)
2500	555 (222 × 2.5)

Return range available with 750 pounds reserve is:

Fuel Remaining (lb)	Distance (nmi)
1500	167 (345 - 178)
2500	377 (555 - 178)

**OUTBOUND FUEL**

Select two key points from which it is assumed the attack maneuver will begin. Takeoff, climb and cruise fuel planning to the key points are determined from Parts 3 and 4. Fuel used during ground maneuvering is 150 lb; maximum thrust takeoff and acceleration to 350 KIAS, 290 lb; military thrust acceleration from 350 KIAS to climb speed Mach 0.85, 130 lb. Total fuel used, 570 lb. Initial climb gross weight, 22212 lb (22782 - 570). Fuel remaining 5930 lb (6500 - 570).

Time for the maximum thrust takeoff and acceleration to 350 KIAS is 35 seconds; military thrust acceleration from 350 KIAS to climb speed Mach 0.85, 35 seconds. Total time from brakes release to climb speed, 1.17 minutes.

Military thrust climb to optimum cruise altitude may be determined from the optimum cruise altitude summary chart (Figure A3-5) and the military thrust climb control chart (Figure A3-10).

Approximate the optimum cruise altitude at the initial climb gross weight 22212 lb as 28000 feet. Climb fuel used to 28000 feet is 420 lb. The initial cruise gross weight is 21792 lb (22212 - 420).

Re-enter the optimum cruise altitude chart at the initial cruise gross weight, 21792 lb (accounts for the fuel used in the climb) and read the cruise altitude 28500 ft. Climb performance from sea level to 28500 feet is: time 3.2 minutes; distance 28 nautical miles and fuel 400 lb.

Initial cruise gross weight is 21812 lb (22212 - 400) and fuel remaining 5530 lb (5930 - 400). Assume that the key points are 100 and 200 nautical miles from base. Determine the cruise distance to reach each key point. Refer to Figure A10-3.

Key point	Total distance (nmi)	Cruise Distance (nmi)
A	100	72.0 (100 - 28)
B	200	172.0 (200 - 28)



## RETURN AND RESERVE FUEL ALLOWANCE

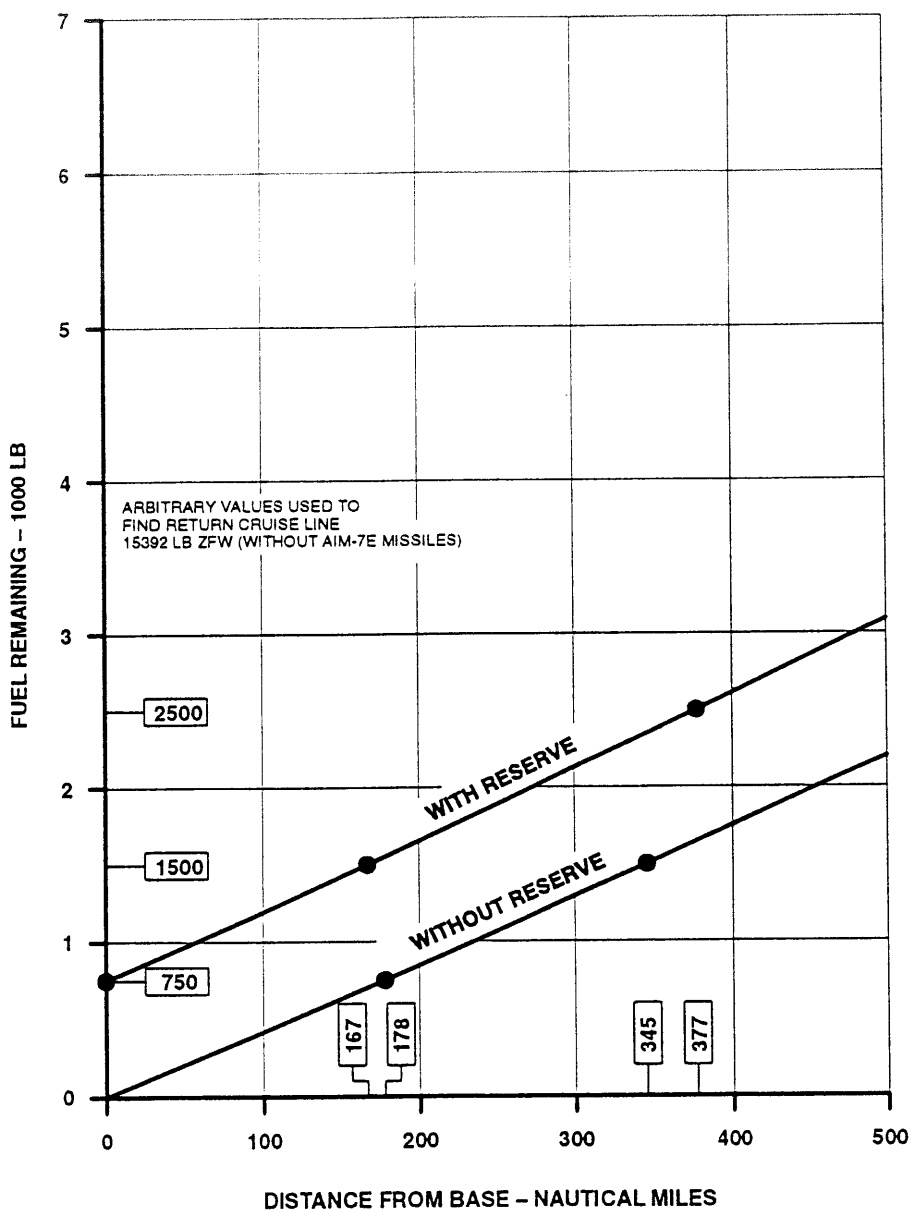

FA0030

Figure A10-2

# OUTBOUND FUEL

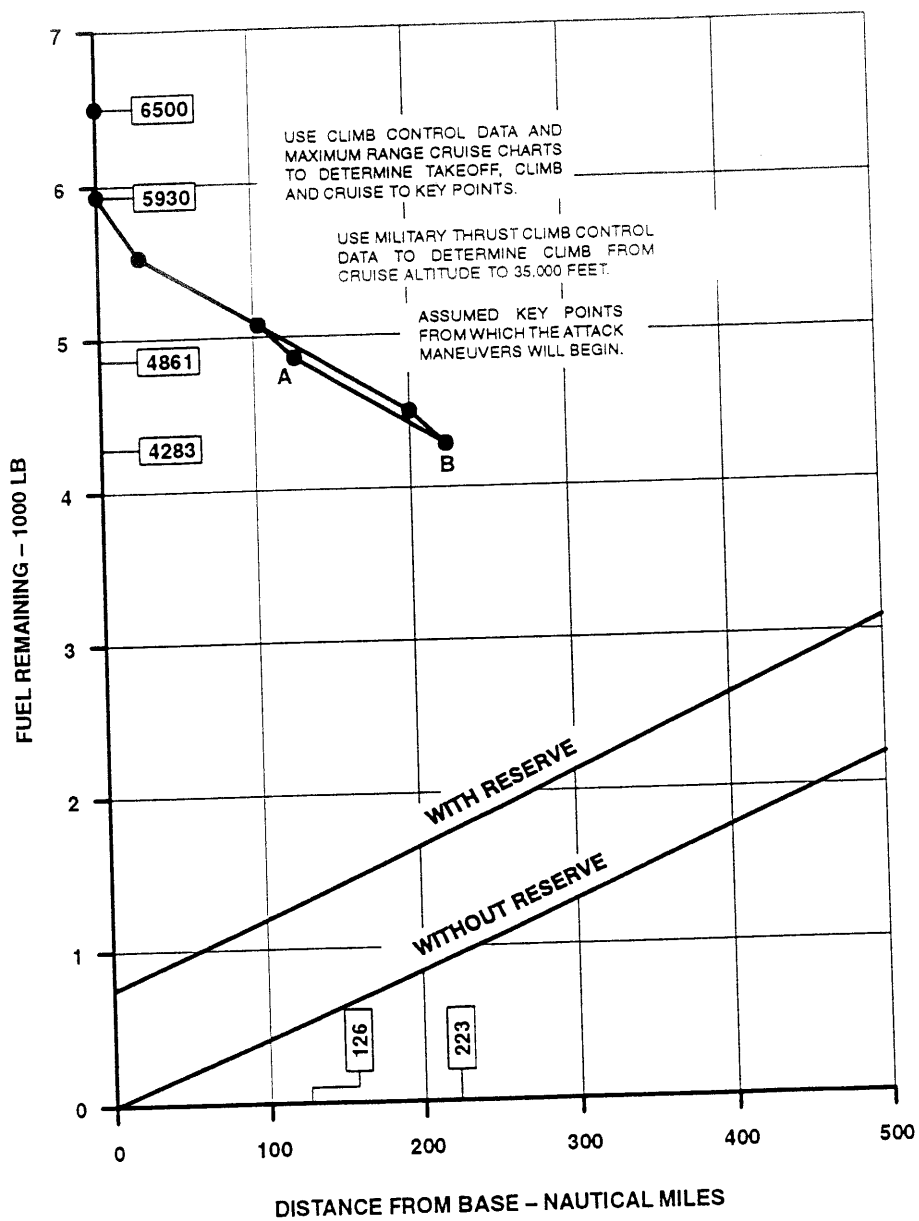

FA0031

Figure A10-3

Cruise fuel economy at the initial cruise gross weight, at 28500 ft, is 162 nautical miles for 1000 pounds of fuel (Figure A4-1). Determine the fuel remaining distance to the key points.

Key Point	Distance (nmi)	Fuel used (lb)
A	72.0	444 (72 : .162)
B	172.0	1062 (172 : .162)

Fuel remaining and gross weight at the key point is:

Key Point	Fuel remaining (lb)	Gross weight (lb)
A	5086 (5530 - 444)	21368 (21812 - 444)
B	4468 (5530 - 1062)	20750 (21812 - 1062)

Time to cruise climb to the key points may also be determined from Figure A4-1. Cruise true Mach number for a configuration drag index of 32 is 0.85. Standard temperature at 28500 ft is -41.4° C; true airspeed, 501 KIAS.

Key point	Cruise distance (nmi)	Cruise time (min.)
A	72	9.0
B	172	21.0

**MILITARY THRUST CLIMB**

Military thrust climb performance from cruise altitude to 35000 feet may be determined from Figure A3-10. The climb performance is:

Key Point	Time (min.)	Distance (nmi)	Fuel (lb)
A	3.0	26	225
B	2.8	23	185

Fuel remaining and gross weight are:

Key Point	Fuel remaining (lb)	Gross Weight (lb)
A	4861 (5086 - 225)	21143 (21368 - 225)
B	4283 (4468 - 185)	20565 (20750 - 185)

Total time and distance from brake release to 35000 feet are:

Key point	Time (min.)	Distance (nmi)
A	16.4	126
B	28.2	223

**Acceleration to Combat Speed**

Maximum thrust acceleration performance with BL104 AIM-7E missiles may be obtained from Figure A9-6. Enter the chart with the initial gross weights at the assumed key points and read time, distance and fuel consumed to accelerate to Mach 2.0. Refer to Figure A10-4.

Key Point	Time (min.)	Distance (nmi)	Fuel Used (lb)
A	3.8	51	1460
B	3.6	49	1390

Fuel remaining and gross weights are:

Key Point	Fuel remaining (lb)	Gross weight (lb)
A	3401 (4861 - 1460)	19683 (21143 - 1460)
B	2893 (4283 - 1390)	19175 (20565 - 1390)

Total time and distance at the end of the acceleration are:

Key Point	Time (min.)	Distance (nmi)
A	20.2 (16.4 + 3.8)	177 (126 + 51)
B	31.8 (28.2 + 3.6)	272 (223 + 49)

**Combat Turn**

Maximum thrust turning performance may be determined by using the maximum thrust turn performance chart, Figure A9-39. For the mission plan turn at 35000 feet and Mach 2.0, read the load factor capability for the gross weight at the end of the acceleration. Refer to Figure A10-4.

# ACCELERATION TO COMBAT SPEED AND COMBAT TURN

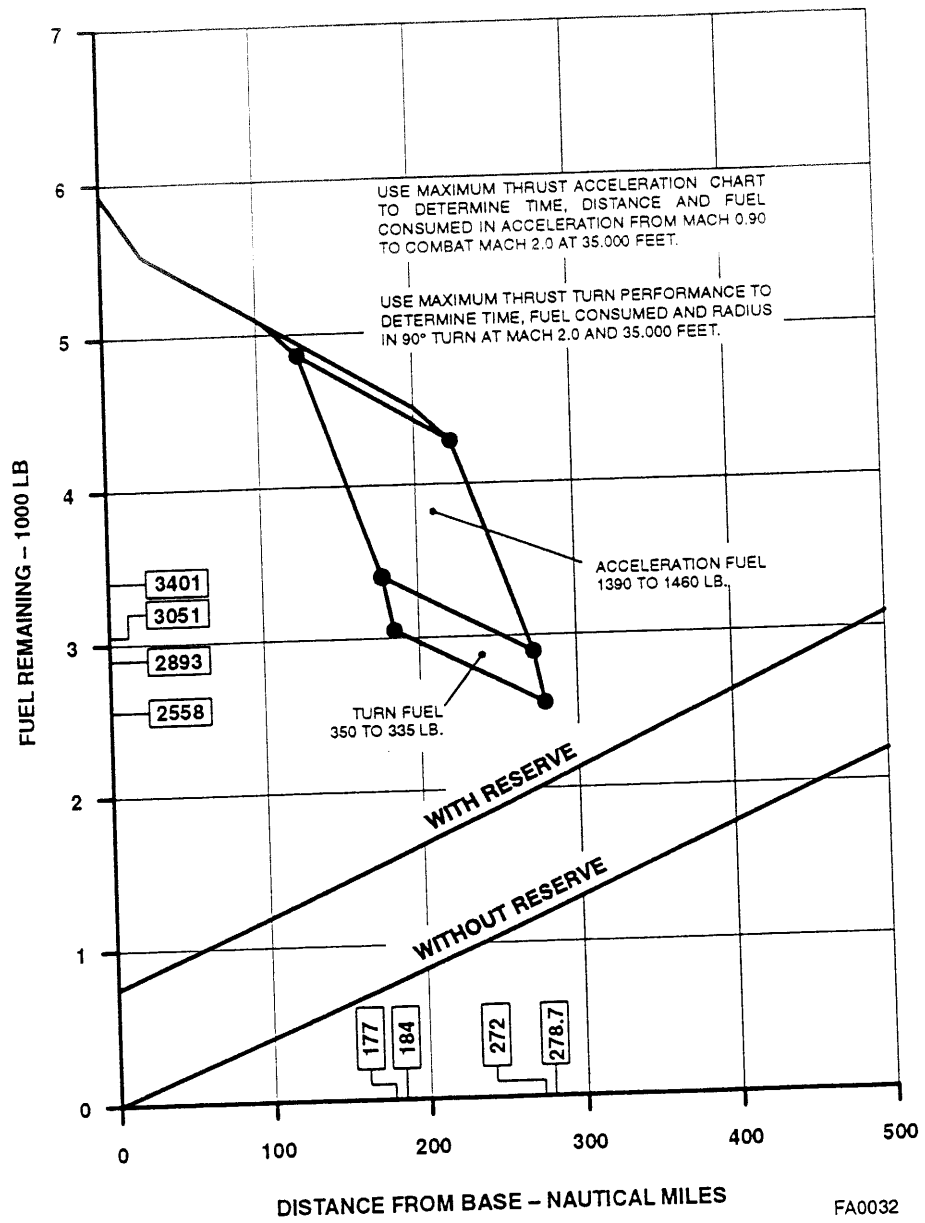

Figure A10-4

Key Point	Gross weight (lb)	Load factor (G)
A	19683	2.95
B	19175	3.03

Turning performance for the load factors is:

Key Point	Time (min.)	Radius (nmi)	Fuel (lb)
A	.57	7.0	350
B	.55	6.7	335

Total time and distance at the end of turn are:

Key Point	Time (min.)	Distance (nmi)
A	20.8 (20.2 + .6)	184 (177 + 7.0)
B	32.4 (31.8 + .6)	278.7 (272 + 6.7)

Fuel remaining and gross weights:

Key point	Fuel remaining (lb)	Gross weight (lb)
A	3051 (3401 - 350)	19333 (19683 - 350)
B	2558 (2893 - 335)	18840 (19175 - 335)

**Combat Climb**

Maximum thrust climb performance is obtained from climb control chart, Figure A9-32, with BL104 AIM-7E missiles. Read the time, distance and fuel used to climb at Mach 2.0 from 35000 ft to 50000 ft. Refer to Figure A10-5.

Key Point	Time (min.)	Distance (nmi)	Fuel Used (lb)
A	.90	17	400
B	.85	16	370

Total time and distance at the top of the climb is:

Key Point	Time (min.)	Distance (nmi)
A	21.7 (20.8 + .9)	201 (184 + 17)
B	33.25 (32.4 + .85)	294.7 (278.7 + 16)

Although 16 to 17 nautical miles are traveled in the climb assume no increase in distance relative to base after the 90° turn. Fuel remaining and gross weights are:

Key point	Fuel remaining (lb)	Gross weight (lb)
A	2651 (3051 - 400)	18933 (19333 - 400)
B	2188 (2558 - 370)	18470 (18840 - 370)

**Combat Fuel**

The maximum thrust fuel consumption chart, Figure A9-32, is used to determine combat fuel allowances.

Fuel flow at 50000 feet and Mach 2.0 is 320 lb/min. Fuel required for 1 minute is 320 lb. Refer to Figure A10-5.

Key point	Fuel remaining (lb)	Gross weight (lb)
A	2331 (2651 - 320)	18613 (18933 - 320)
B	1868 (2188 - 320)	18150 (18470 - 320)

From the airspeed Mach number conversion curve, Figure A9-15, note that at Mach 2.0 the true airspeed at 50000 feet on a standard day (-56.5° C) is 1147 KIAS, or 19.1 nautical miles per minute. The aircraft could travel 19.1 nautical miles in 1 minute following the climb to altitude.

Also note that no allowance is made for the time and distance to descend from combat altitude to cruise altitude, or for deceleration from combat to cruise speed.

Assume that the aircraft would turn toward base at the conclusion of the combat period and descend in the direction of the base.

**Key Point, Combat, Return and Reserve**

Establish an intersection between the end of the combat segment and the cruise return line. This is the maximum radius for the combat mission plan, 260 nautical miles.

Construct lines parallel to each of the calculated segments until an intersection is made with the outbound cruise data. Refer to Figure A10-6.

# COMBAT CLIMB AND COMBAT FUEL

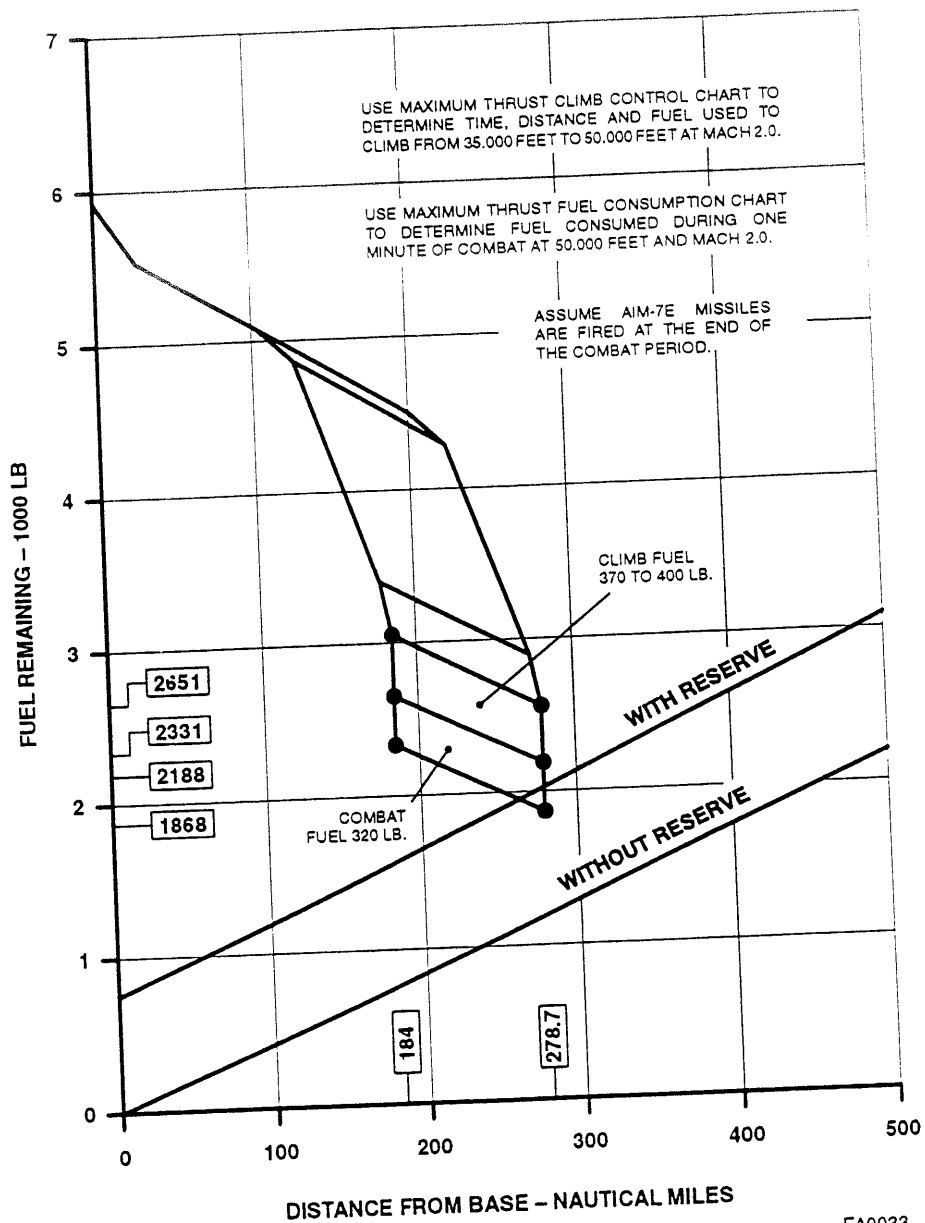

FA0033

Figure A10-5

### KEY POINT, COMBAT, RETURN AND RESERVE

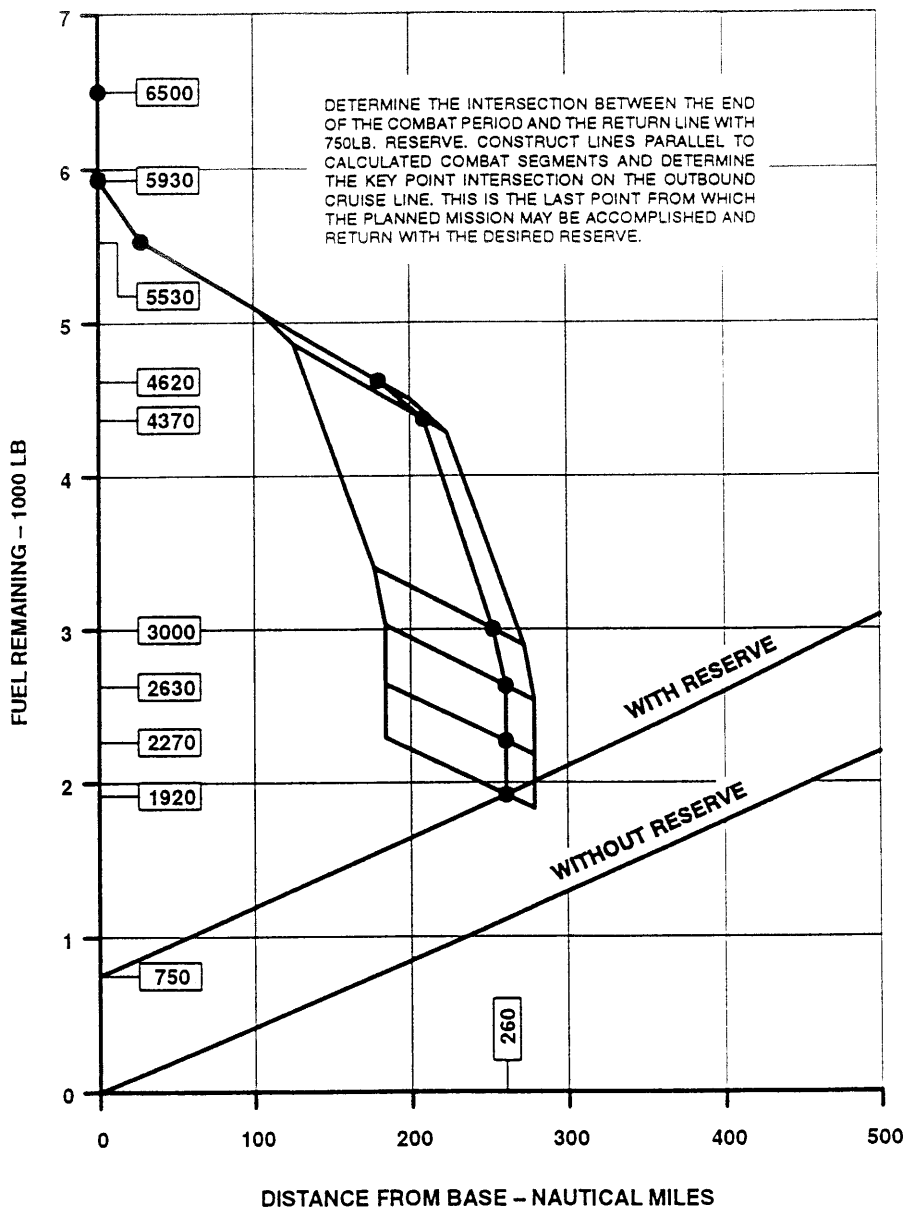

FA0034

Figure A10-6

This is the "key point", or the last point from which the planned mission may be accomplished and re-

turn with the desired reserve. The mission summary is:

Segment	Fuel (lb)	Fuel Remaining (lb)	Gross Weight (lb)	Distance (nmi)
Ground manoeuvre, takeoff and acceleration to climb speed	570	6500	22782	0
Climb to 28500 ft	400	5930	22212	28
Cruise at 28500 ft	910	5530	21812	175
Climb to 35000 ft	250	4620	20902	200
Acceleration	1370	4370	20652	250
Turn	370	3000	19282	260
Climb to 50000 ft	360	2630	18912	260
Combat (AIM-7E firing)	350	2270	18552	260
Return	1170	1920	17312	260
Reserve	750	750	16142	260

INITIAL FUEL: 6500 lb  
 INITIAL GROSS WEIGHT: 22782 lb  
 AIM-7E MISSILES: 890 lb



FINAL FLIGHT

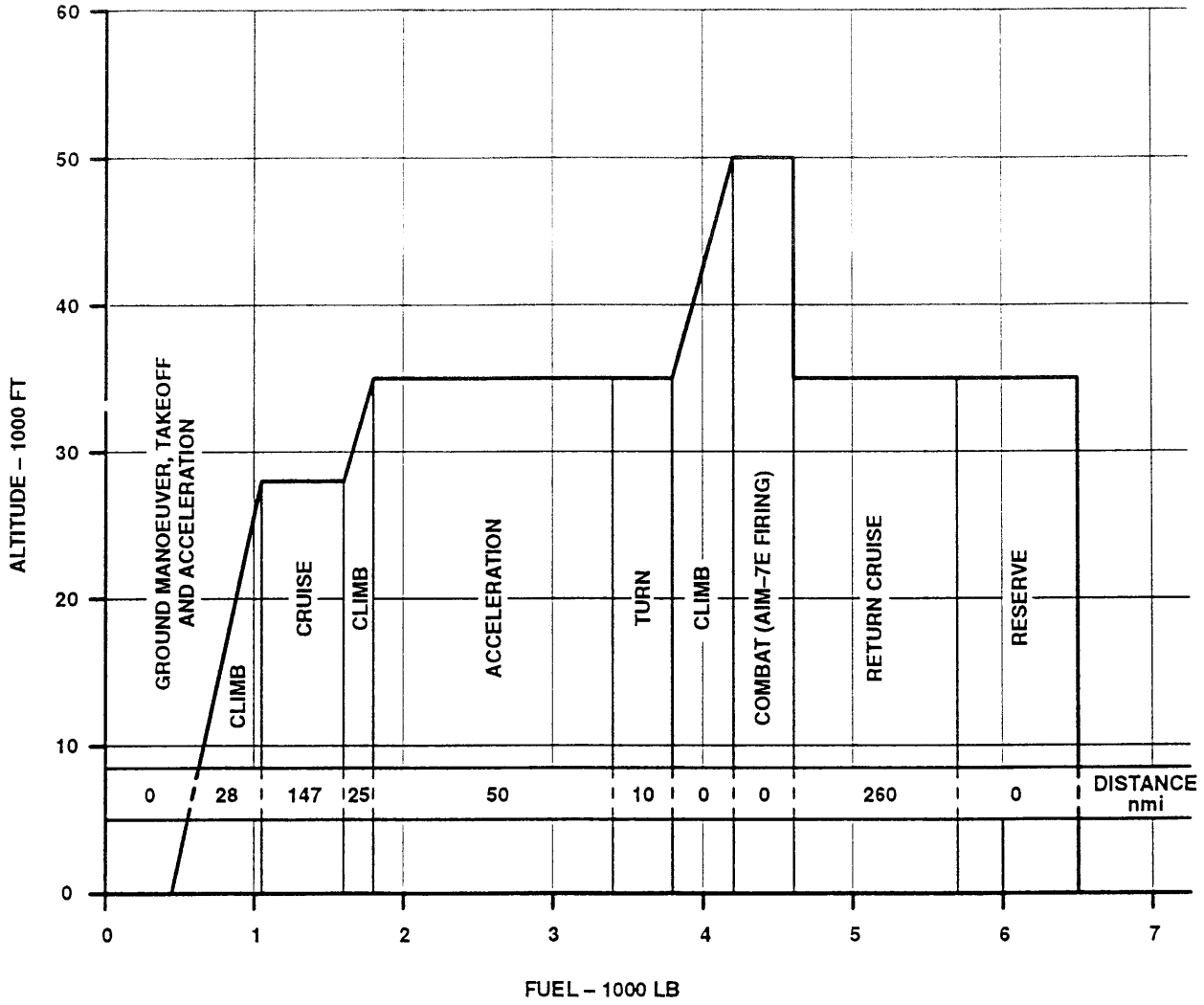

FA0035

Figure A10-7

## GENERAL ARRANGEMENT

- 1 PITOT STATIC BOOM
- 2 R21G M1 RADAR NOSE PACKAGE
- 3 OPTICAL SIGHT
- 4 GPS ANTENNA
- 5 ELECTRONICS COMPARTMENT HATCH
- 6 ELECTRONICS COMPARTMENT
- 7 UPPER IFF AND UHF ANTENNA
- 8 AMMUNITION COMPARTMENT TANK
- 9 NAVIGATION LIGHTS (4)
- 10 AUXILIARY FUEL CELL AND FILLER WELL
- 11 FORWARD MAIN FUEL CELL
- 12 AFT MAIN FUEL CELL
- 13 J79-GE-19 ENGINE WITH AFTERBURNER
- 14 HORIZONTAL STABILIZER POWER CONTROL ASSEMBLY
- 15 CONTROLLABLE HORIZONTAL STABILIZER
- 16 DRAG CHUTE DOOR AND STOWAGE COMPARTMENT
- 17 ARRESTING HOOK
- 18 SPEED BRAKE
- 19 STRAKES
- 20 TIP TANK

- 21 FILLER WELLS, TIP TANK
- 22 BL 104 PYLON
- 23 LEFT AILERON POWER CONTROL ASSEMBLY
- 24 LEADING EDGE AND TRAILING EDGE FLAPS
- 25 BL 75 PYLON
- 26 MAIN FUEL CELLS FILLER WELL
- 27 ENGINE AUXILIARY AIR INLET DOOR
- 29 SINGLE POINT REFUELING ADAPTER
- 30 ASAS
- 31 TAXI LIGHT (HIDDEN)
- 32 EJECTION SEAT
- 33 LOWER UHF ANTENNA
- 34 TACAN ANTENNA (HIDDEN)

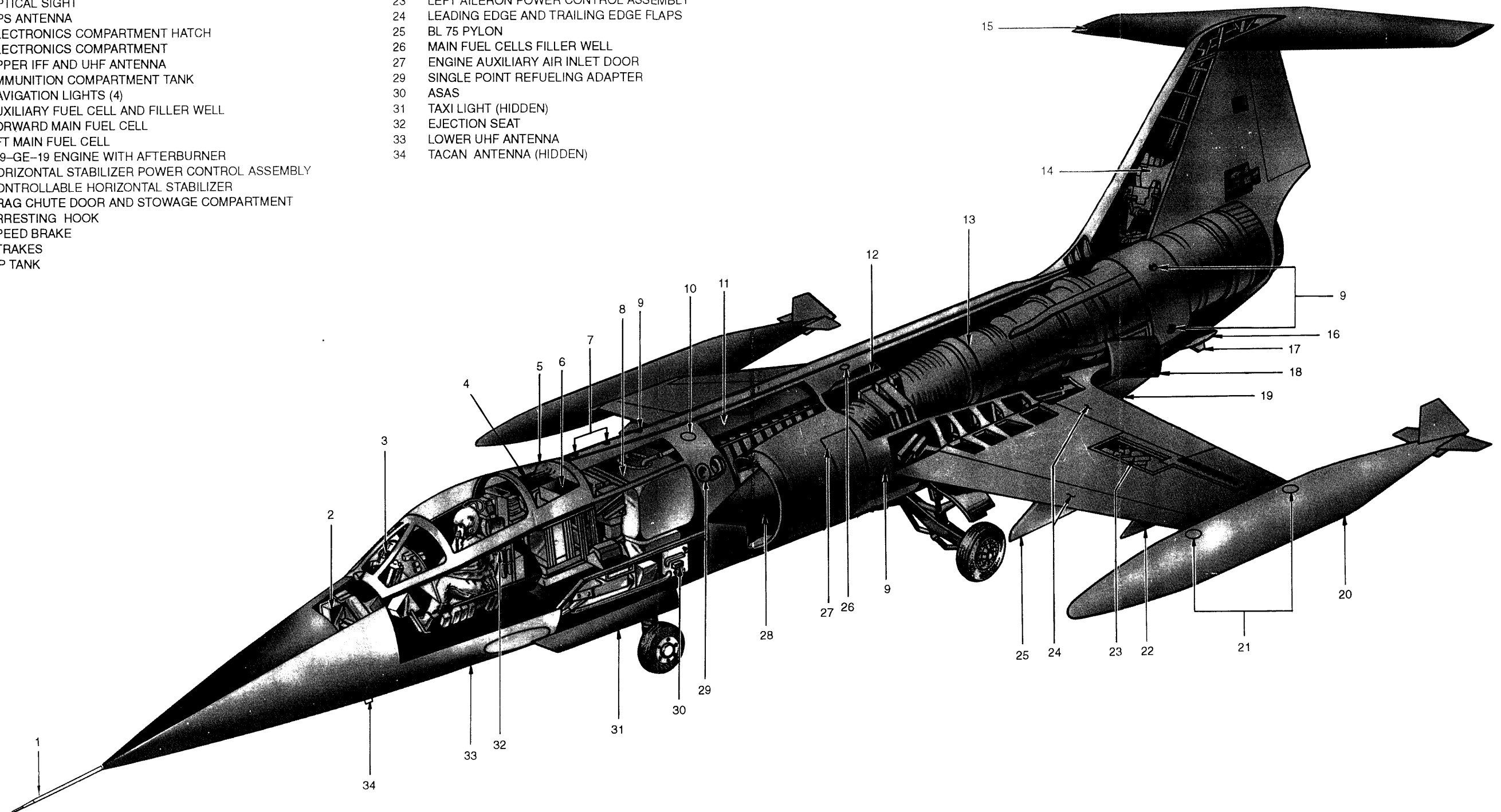

Figure FO-1

FA0308

ENGINE FUEL SYSTEM

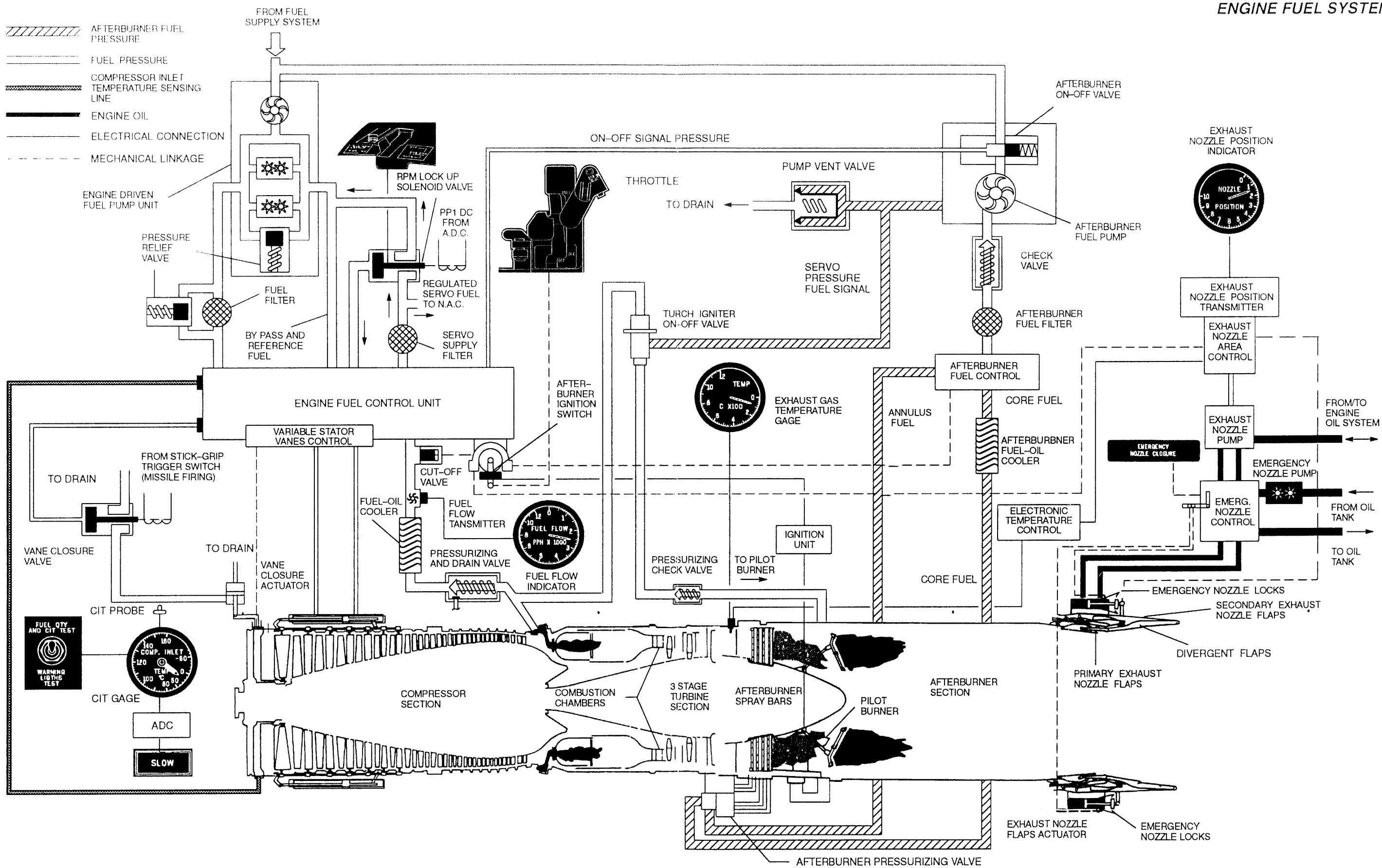
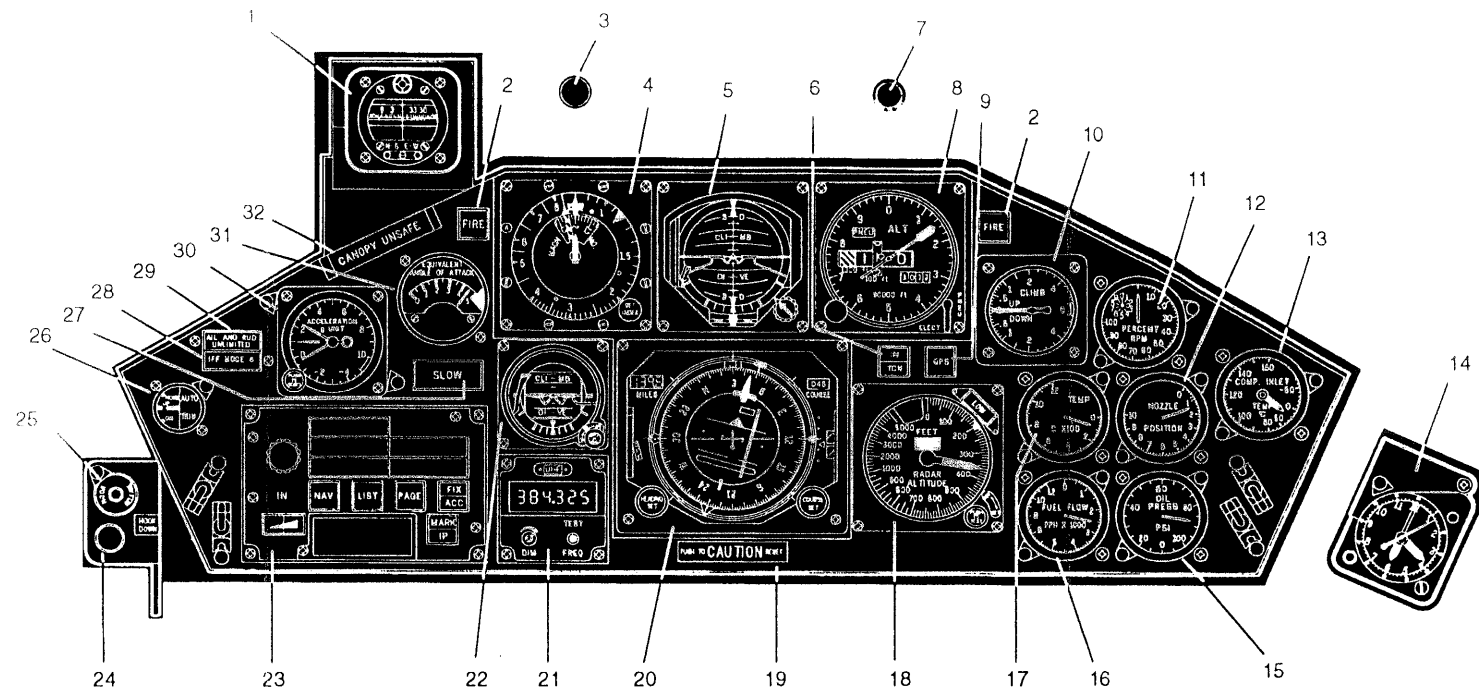

Figure FO-2

MAIN INSTRUMENT PANEL

UPPER INSTRUMENT PANEL

- 1 STANDBY COMPASS
- 2 FIRE WARNING LIGHTS
- 3 RADAR LOCK-ON LIGHT
- 4 AIRSPEED AND MACH NUMBER INDICATOR
- 5 ATTITUDE INDICATOR
- 6 IN/TACAN NAVIGATION STEERING MODE SELECTOR PUSHBUTTON
- 7 RADAR ALTIMETER LOW HEIGHT WARNING LIGHT REPEATER
- 8 ALTIMETER
- 9 GSP NAVIGATION STEERING MODE SELECTOR PUSHBUTTON
- 10 VERTICAL VELOCITY INDICATOR
- 11 TACHOMETER (RPM INDICATOR)
- 12 EXHAUST NOZZLE POSITION INDICATOR
- 13 COMPRESSOR INLET TEMPERATURE (CIT) GAGE
- 14 CLOCK
- 15 OIL PRESSURE INDICATOR
- 16 FUEL FLOW INDICATOR
- 17 EXHAUST GAS TEMPERATURE (EGT) GAGE
- 18 RADAR ALTIMETER
- 19 CAUTION LIGHT
- 20 HORIZONTAL SITUATION INDICATOR (HSI)
- 21 CHANNEL/FREQUENCY INDICATOR
- 22 STANDBY ATTITUDE INDICATOR
- 23 IN/CDU
- 24 ARRESTING HOOK INDICATOR LIGHT
- 25 ARRESTING HOOK RELEASE PUSHBUTTON
- 26 AUTO TRIM INDICATOR
- 27 SLOW WARNING LIGHT
- 28 IFF MODE 4 WARNING LIGHT
- 29 AIL AND RUD UNLIMITED WARNING LIGHT
- 30 ACCELEROMETER
- 31 AUTOMATIC PITCH CONTROL (APC) SYSTEM INDICATOR
- 32 CANOPY UNSAFE WARNING LIGHT



LOWER INSTRUMENT PANEL

- 33 EMERGENCY EXTERNAL STORES JETTISON BUTTON
- 34 DRAG CHUTE HANDLE
- 35 LANDING GEAR POSITION INDICATOR LIGHTS
- 36 WING FLAPS POSITION INDICATORS
- 37 MANUAL LANDING GEAR RELEASE HANDLE
- 38 OPTICAL SIGHT TEST BORESIGHT SWITCH
- 39 OPTICAL SIGHT CONTROL PANEL
- 40 RADAR CONTROL PANEL (CONTROLS AND DISPLAY)
- 41 RADAR CLEARANCE PLANE AND ANTENNA TILT INDICATOR
- 42 RAM AIR TURBINE (RAT) EXTENSION HANDLE
- 43 CANOPY WARNING SOUND CUT-OFF SWITCH
- 44 EMERGENCY NOZZLE CLOSURE HANDLE
- 45 CABIN ALTIMETER
- 46 EXTERNAL FUEL QUANTITY INDICATOR
- 47 WARNING LIGHTS PANEL
- 48 STORM LIGHTS SWITCH
- 49 FUEL SHUT-OFF VALVE OPEN TEST LIGHT
- 50 FIXED FREQUENCY RESET BUTTON
- 51 LIQUID OXYGEN GAGE
- 52 CANOPY DEFOGGER KNOB
- 53 FUEL QUANTITY AND CIT TEST/WARNING LIGHTS TEST SWITCH
- 54 GENERATOR No. 2 SWITCH
- 55 GENERATOR No. 1 SWITCH
- 56 EXTERNAL FUEL QUANTITY INDICATOR SELECTOR SWITCH
- 57 INTERNAL FUEL QUANTITY INDICATOR
- 58 HYDRAULIC SYSTEMS PRESSURE GAGES
- 59 RADAR MODE INDICATOR LIGHTS
- 60 CANOPY INTERNAL JETTISON HANDLE
- 61 MEDIUM RANGE AIR-TO-AIR MISSILES (MRAAM) CONTROL PANEL
- 62 SELECTIVE EXTERNAL STORES RELEASE SELECTOR SWITCH
- 63 RUDDER PEDAL ADJUSTMENT HANDLE
- 64 MASTER ARMAMENT SWITCH
- 65 ARMAMENT CONTROL PANEL
- 66 ANTI-SKID SWITCH
- 67 ENGINE/DUCT ANTI-ICE SWITCH
- 68 LANDING AND TAXI LIGHTS SWITCH
- 69 LANDING GEAR LEVER
- 70 LANDING GEAR LEVER OVERRIDE BUTTON
- 71 ANTI-SKID WARNING LIGHT
- 72 TAKEOFF TRIM INDICATOR LIGHTS
- 73 START 1 SWITCH
- 74 START 2 SWITCH

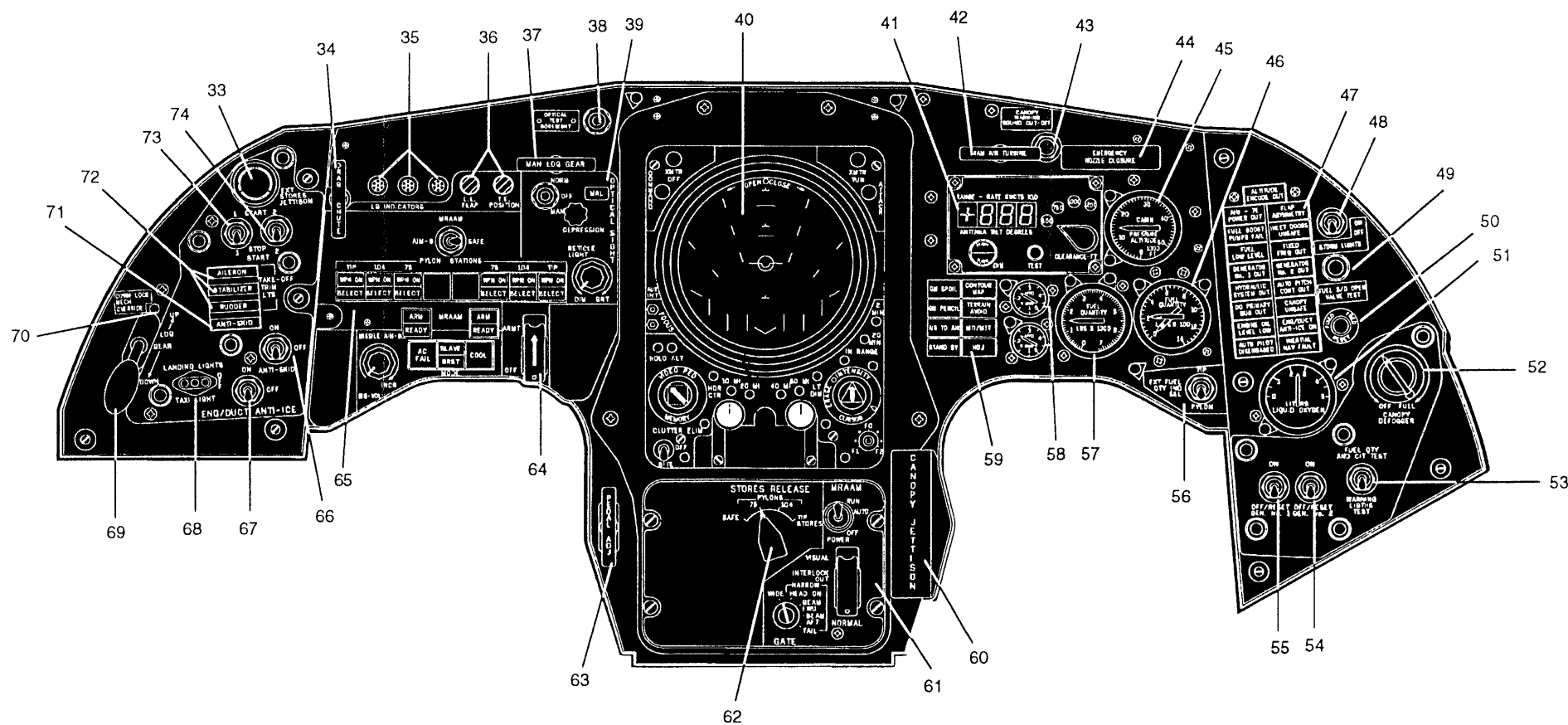
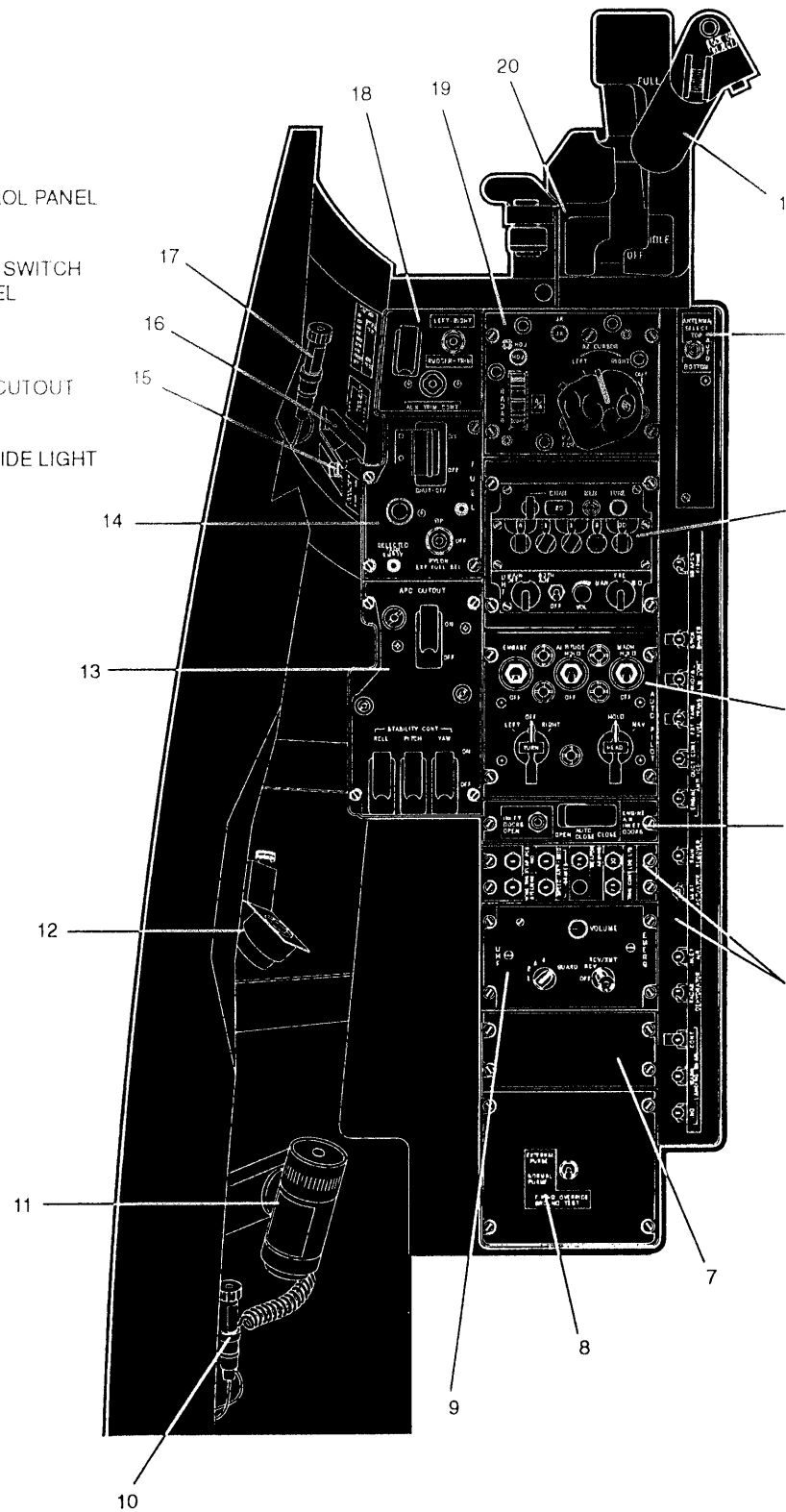

Figure FO-3

LEFT AND RIGHT CONSOLES

LEFT CONSOLE

- 1 ENGINE THROTTLE
- 2 ANTENNA SLECTOR SWITCH
- 3 UHF CONTROL PANEL
- 4 AUTOPILOT CONTROL PANEL
- 5 ENGINE AIR INLET DOORS CONTROL PANEL
- 6 CIRCUIT BREAKERS
- 7 BLANK
- 8 FIRING OVERRIDE GROUND TEST SWITCH
- 9 EMERGENCY UHF CONTROL PANEL
- 10 FLOOD LIGHT
- 11 SPOT LIGHT
- 12 STORM LIGHT
- 13 STABILITY CONTROL PANEL/APC CUTOUT SWITCH
- 14 FUEL CONTROL PANEL
- 15 RPM LOCK UP POWER ON OVERRIDE LIGHT
- 16 RPM LOCK UP OVERRIDE SWITCH
- 17 FLOOD LIGHT
- 18 TRIM CONTROL PANEL
- 19 RADAR CONTROL PANEL
- 20 WING FLAPS LEVER



RIGHT CONSOLE

- 1 OXYGEN PRESSURE SUIT SWITCH (INOPERATIVE)
- 2 OXYGEN LOW PRESSURE LAMP
- 3 FACE PLATE HEAT RHEOSTAT (INOPERATIVE)
- 4 RADAR RANGE CURSOR
- 5 CANOPY INTERNAL LOCKING LEVER
- 6 FRESH AIR SCOOP LEVER
- 7 BLANK
- 8 HEATING CONTROL PANEL/RAIN REMOVER SWITCH/ PITOT-PITCH AND TEMPERATURE PROBE HEATERS SWITCH
- 9 STORM LIGHT
- 10 LIGHT CONTROL PANEL
- 11 OPTICAL SIGHT SERVO AMPLIFIER BUTTON
- 12 SPOT LIGHT
- 13 FLOOD LIGHT
- 14 BL75 PYLON JETTISON SWITCH
- 15 GROUND CREW INTERPHONE BUTTON
- 16 SPARE LAMPS
- 17 ENGINE MOTORING SWITCH
- 18 BLANK
- 19 BLANK
- 20 BLANK
- 21 BLANK
- 22 CIRCUIT BREAKERS
- 23 C-2G CONTROL PANEL
- 24 INERTIAL NAVIGATOR (IN) CONTROL PANEL
- 25 IFF CONTROL PANEL
- 26 GLOBAL POSITIONING SYSTEM (GPS) CONTROL PANEL
- 27 TACAN CONTROL PANEL
- 28 OXYGEN CONTROL PANEL

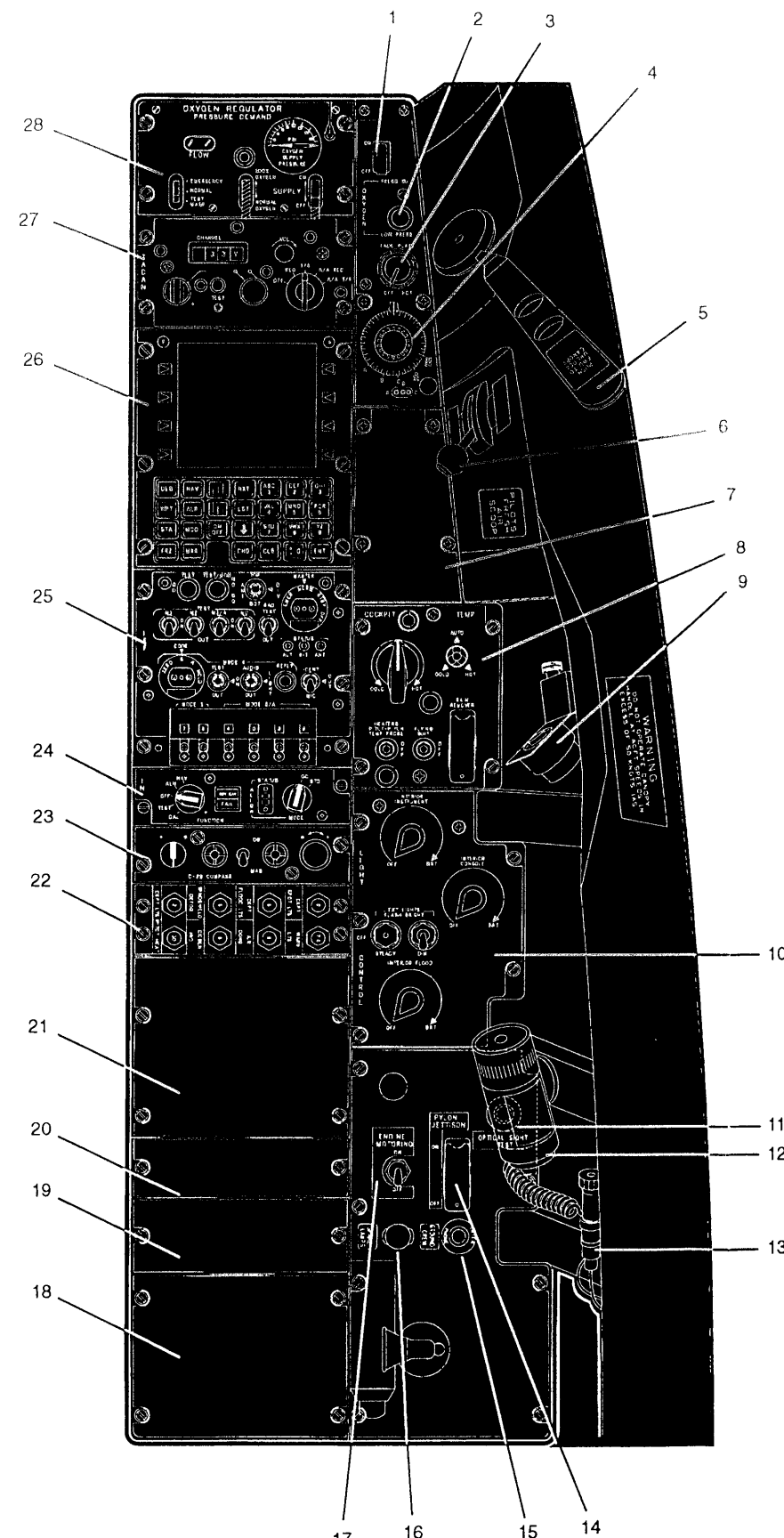

Figure FO-4

FUEL SUPPLY SYSTEM

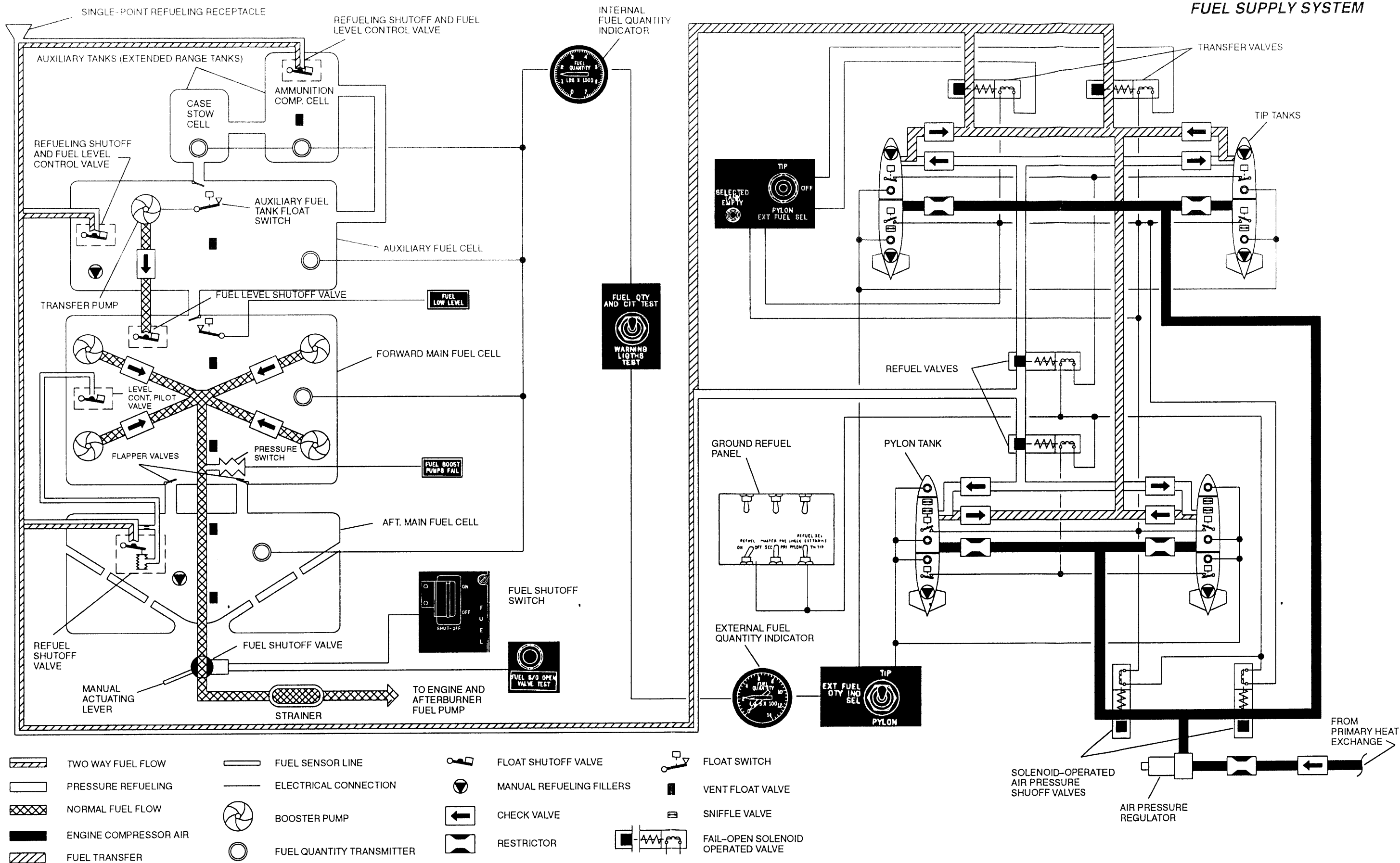

Figure FO-5

FA0263

**AC ELECTRICAL POWER SUPPLY SYSTEM  
NORMAL DISTRIBUTION**

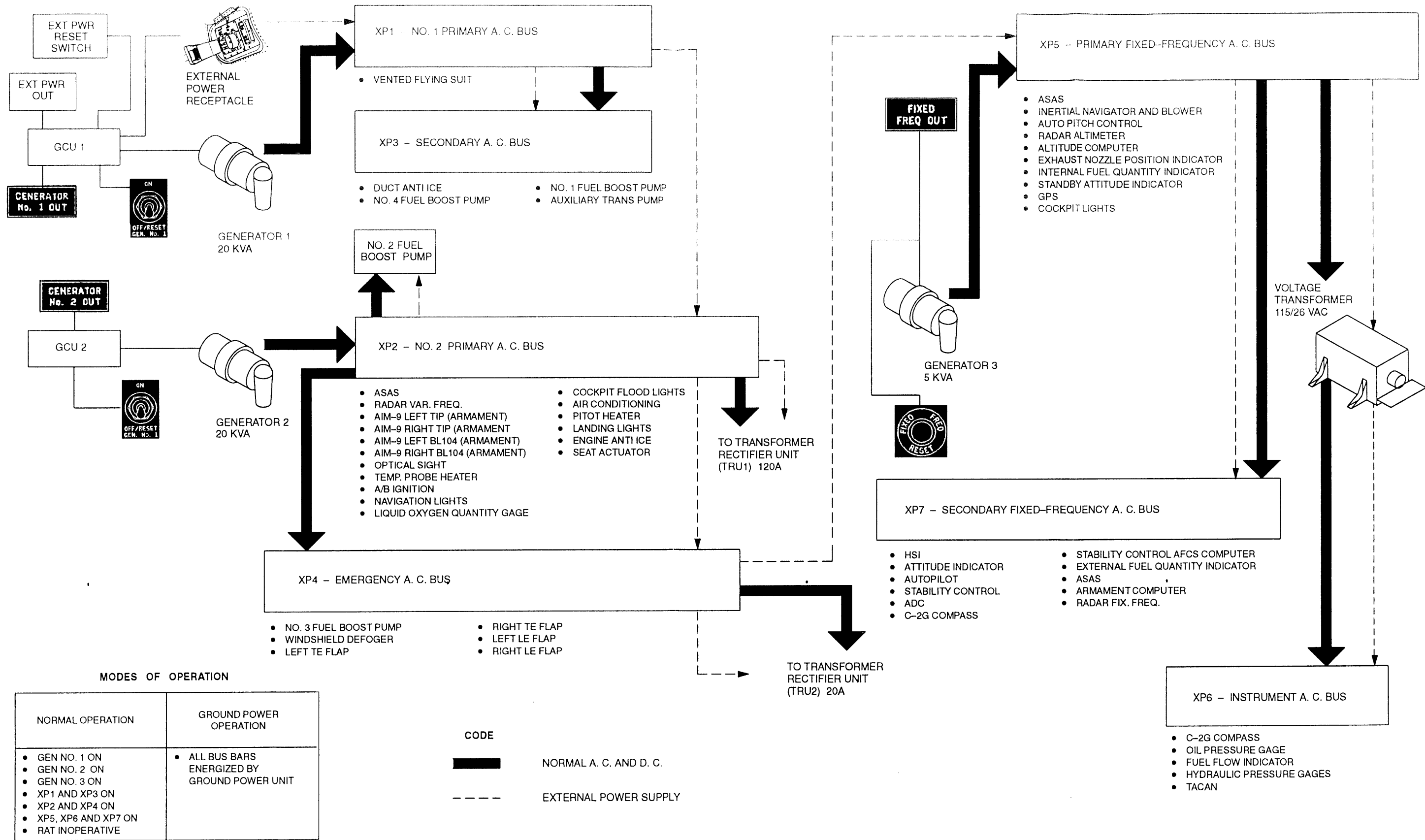
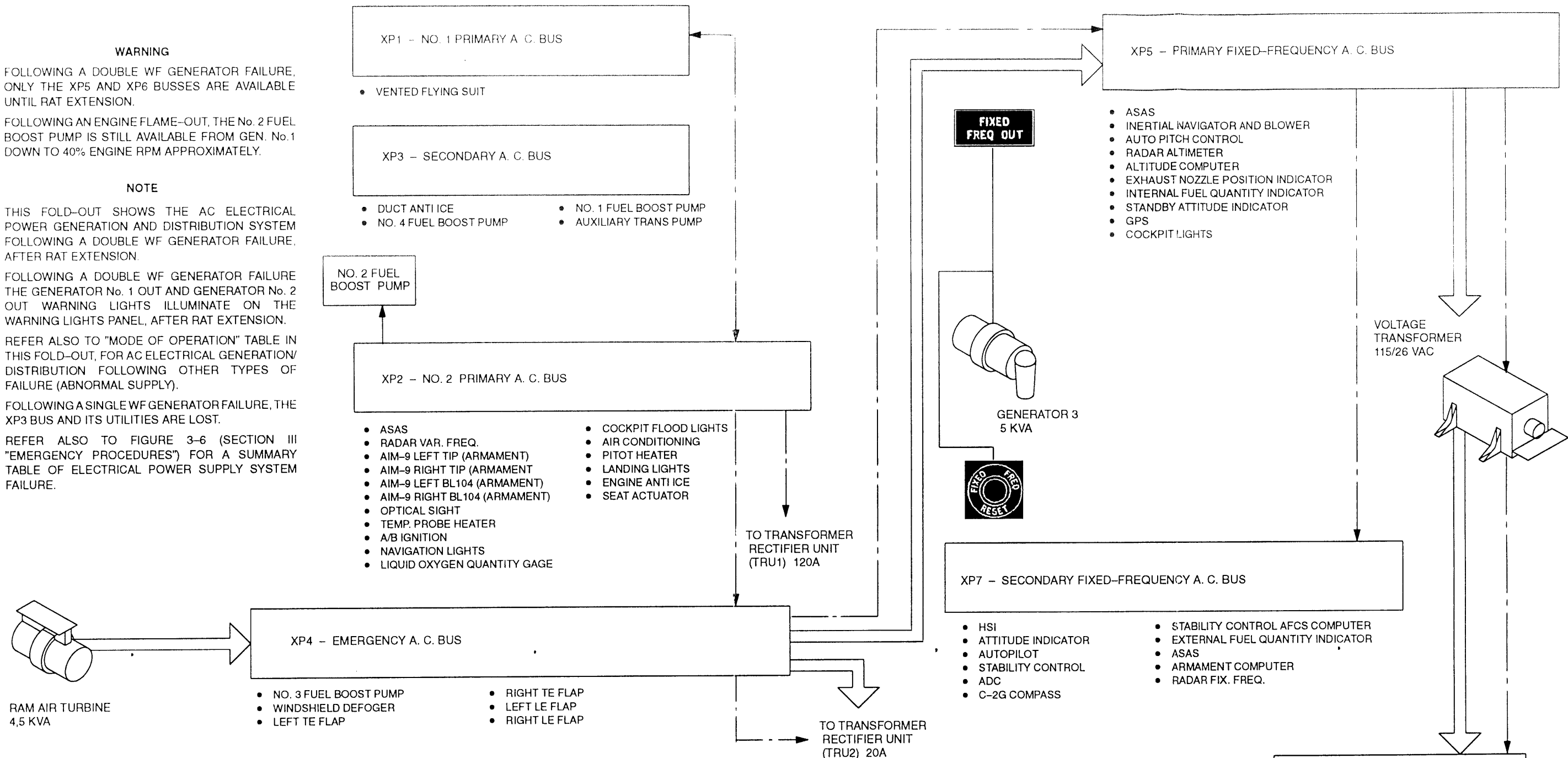

Figure FO-6 (Sheet 1 of 2)

**AC ELECTRICAL POWER SUPPLY SYSTEM  
EMERGENCY DISTRIBUTION**

- WARNING**
- FOLLOWING A DOUBLE WF GENERATOR FAILURE, ONLY THE XP5 AND XP6 BUSSES ARE AVAILABLE UNTIL RAT EXTENSION.
  - FOLLOWING AN ENGINE FLAME-OUT, THE No. 2 FUEL BOOST PUMP IS STILL AVAILABLE FROM GEN. No.1 DOWN TO 40% ENGINE RPM APPROXIMATELY.

- NOTE**
- THIS FOLD-OUT SHOWS THE AC ELECTRICAL POWER GENERATION AND DISTRIBUTION SYSTEM FOLLOWING A DOUBLE WF GENERATOR FAILURE, AFTER RAT EXTENSION.
  - FOLLOWING A DOUBLE WF GENERATOR FAILURE THE GENERATOR No. 1 OUT AND GENERATOR No. 2 OUT WARNING LIGHTS ILLUMINATE ON THE WARNING LIGHTS PANEL, AFTER RAT EXTENSION.
  - REFER ALSO TO "MODE OF OPERATION" TABLE IN THIS FOLD-OUT, FOR AC ELECTRICAL GENERATION/ DISTRIBUTION FOLLOWING OTHER TYPES OF FAILURE (ABNORMAL SUPPLY).
  - FOLLOWING A SINGLE WF GENERATOR FAILURE, THE XP3 BUS AND ITS UTILITIES ARE LOST.
  - REFER ALSO TO FIGURE 3-6 (SECTION III "EMERGENCY PROCEDURES") FOR A SUMMARY TABLE OF ELECTRICAL POWER SUPPLY SYSTEM FAILURE.



**MODE OF OPERATION**

GEN NO. 1 OUT	GEN NO. 2 OUT	GEN NO. 3 OUT	EMERGENCY OPERATION
<ul style="list-style-type: none"> <li>• GEN NO. 2 ON</li> <li>• GEN NO. 3 ON</li> <li>• XP1, XP2 AND XP4 ON</li> <li>• XP3 OUT</li> <li>• XP5, XP6 AND XP7 ON</li> <li>• RAT INOPERATIVE</li> </ul>	<ul style="list-style-type: none"> <li>• GEN NO. 1 ON</li> <li>• GEN NO. 3 ON</li> <li>• XP1, XP2 AND XP4 ON</li> <li>• XP3 OUT</li> <li>• XP5, XP6 AND XP7 ON</li> <li>• RAT INOPERATIVE</li> </ul>	<ul style="list-style-type: none"> <li>• GEN NO. 1 ON</li> <li>• GEN NO. 2 ON</li> <li>• XP1, XP2, XP3 AND XP4 ON</li> <li>• XP3 OUT</li> <li>• XP5, XP6 AND XP7 ARE ENERGIZED BY XP4</li> </ul>	<ul style="list-style-type: none"> <li>• GEN NO. 1 AND 2 OUT</li> <li>• XP1 AND XP2 OUT</li> <li>• XP3 OUT</li> <li>• XP7 OUT</li> <li>• RAT OK</li> <li>• XP4, XP5 AND XP6 ON</li> </ul>

**CODE**

- ===== EMERGENCY A. C.
- ABNORMAL SUPPLY

Figure FO-6 (Sheet 2 of 2)



**DC ELECTRICAL POWER SUPPLY SYSTEM  
NORMAL DISTRIBUTION**

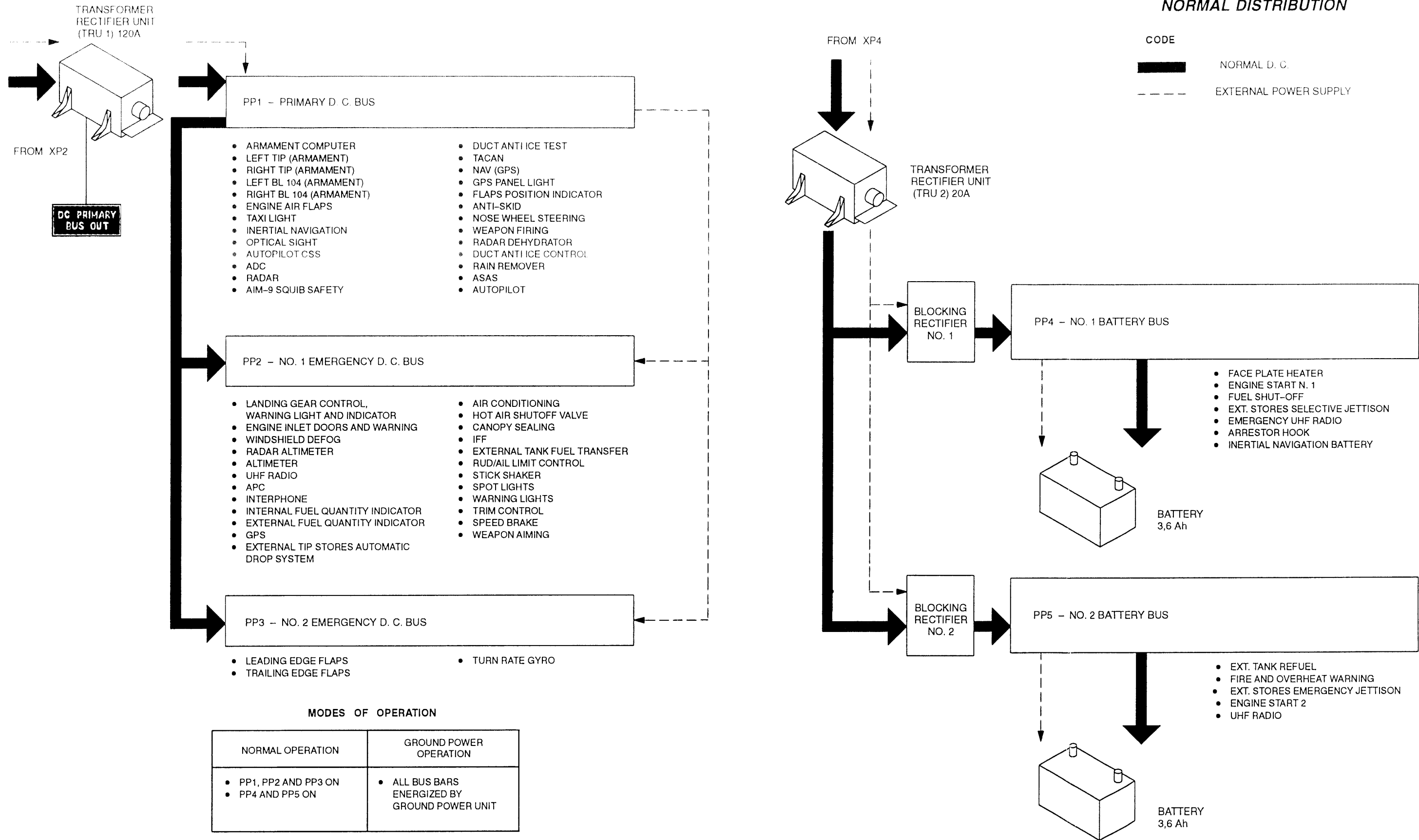
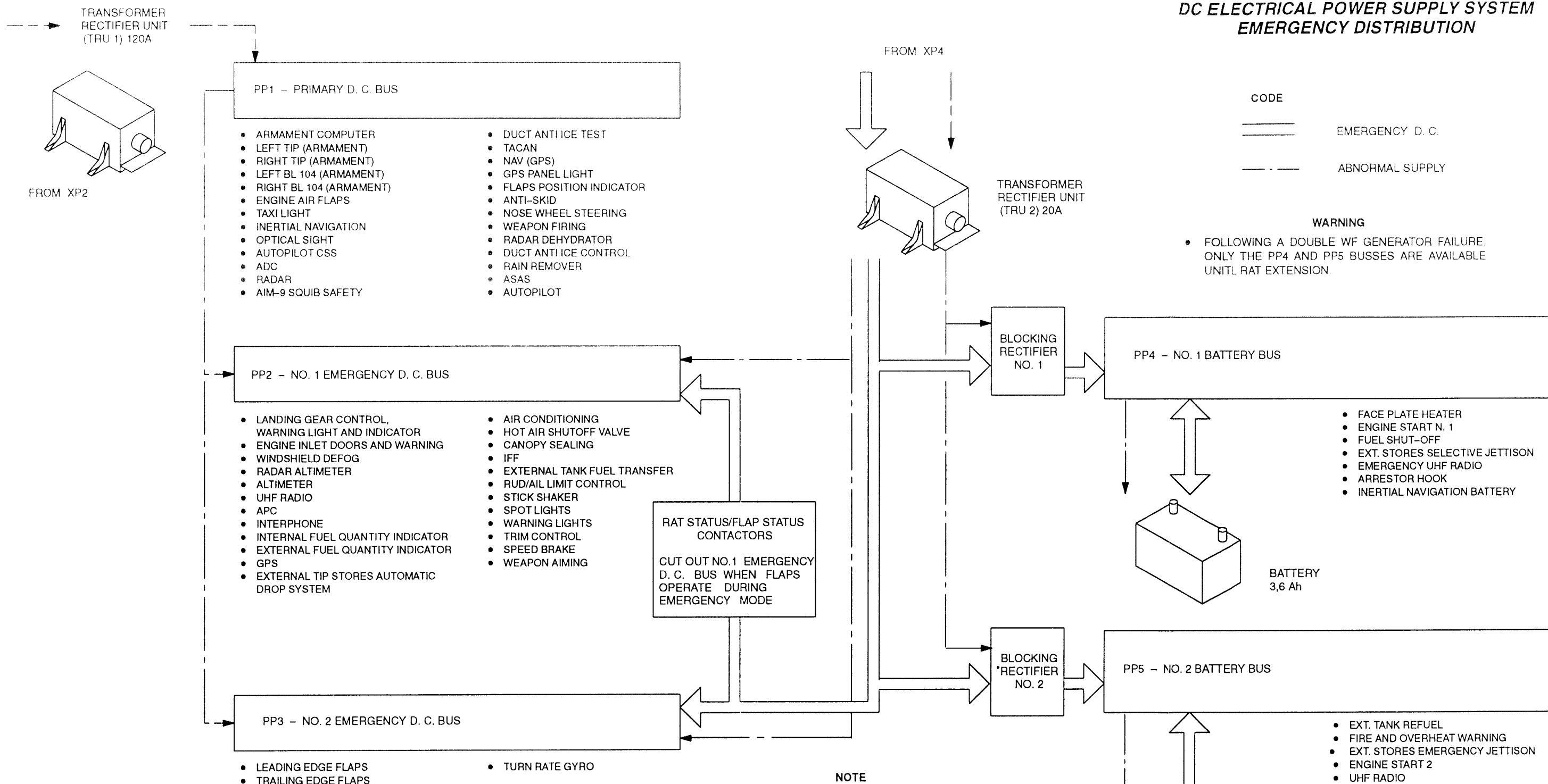

Figure FO-7 (Sheet 1 of 2)

### DC ELECTRICAL POWER SUPPLY SYSTEM EMERGENCY DISTRIBUTION



**WARNING**

- FOLLOWING A DOUBLE WF GENERATOR FAILURE, ONLY THE PP4 AND PP5 BUSSES ARE AVAILABLE UNTIL RAT EXTENSION.

**MODES OF OPERATION**

TRU 1 OUT	TRU 2 OUT	DOUBLE TRU OUT
<ul style="list-style-type: none"> <li>PP1 OUT</li> <li>PP2, PP3, PP4 AND PP5 ON</li> </ul>	<ul style="list-style-type: none"> <li>PP1, PP2 AND PP3 ON ENERGIZED BY TRU 1</li> <li>PP4 AND PP5 ON ENERGIZED BY BATTERIES</li> </ul>	<ul style="list-style-type: none"> <li>PP1, PP2 AND PP3 OUT</li> <li>PP4 AND PP5 ON ENERGIZED BY BATTERIES</li> </ul>

**NOTE**

- THIS FOLD-OUT SHOWS THE DC ELECTRICAL POWER GENERATION AND DISTRIBUTION SYSTEM FOLLOWING A DOUBLE WF GENERATOR FAILURE, AFTER RAT EXTENSION.
- FOLLOWING A DOUBLE WF GENERATOR FAILURE THE DC PRIMARY BUS OUT WARNING LIGHT ILLUMINATES ON THE WARNING LIGHTS PANEL AFTER RAT EXTENSION.
- REFER ALSO TO FIGURE 3-6 (SECTION III "EMERGENCY PROCEDURES") FOR A SUMMARY TABLE OF ELECTRICAL POWER SUPPLY SYSTEM FAILURE.
- REFER ALSO TO "MODE OF OPERATION" TABLE IN THIS FOLD-OUT, FOR DC ELECTRICAL GENERATION/DISTRIBUTION FOLLOWING OTHER TYPES OF FAILURE (ABNORMAL SUPPLY).

Figure FO-7 (Sheet 2 of 2)



HYDRAULIC SYSTEM

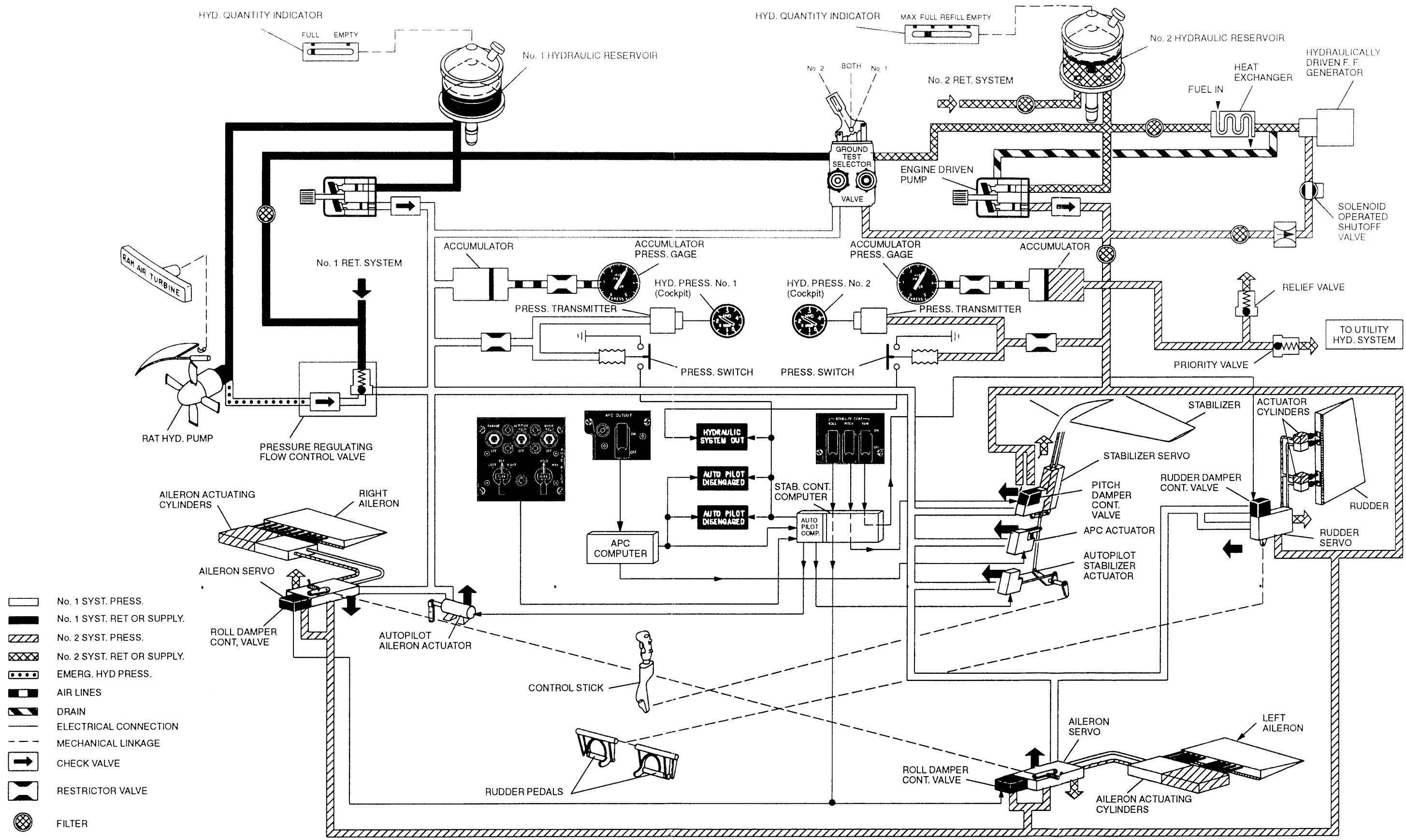

Figure FO-9

FA0276

## UTILITY HYDRAULIC SYSTEM

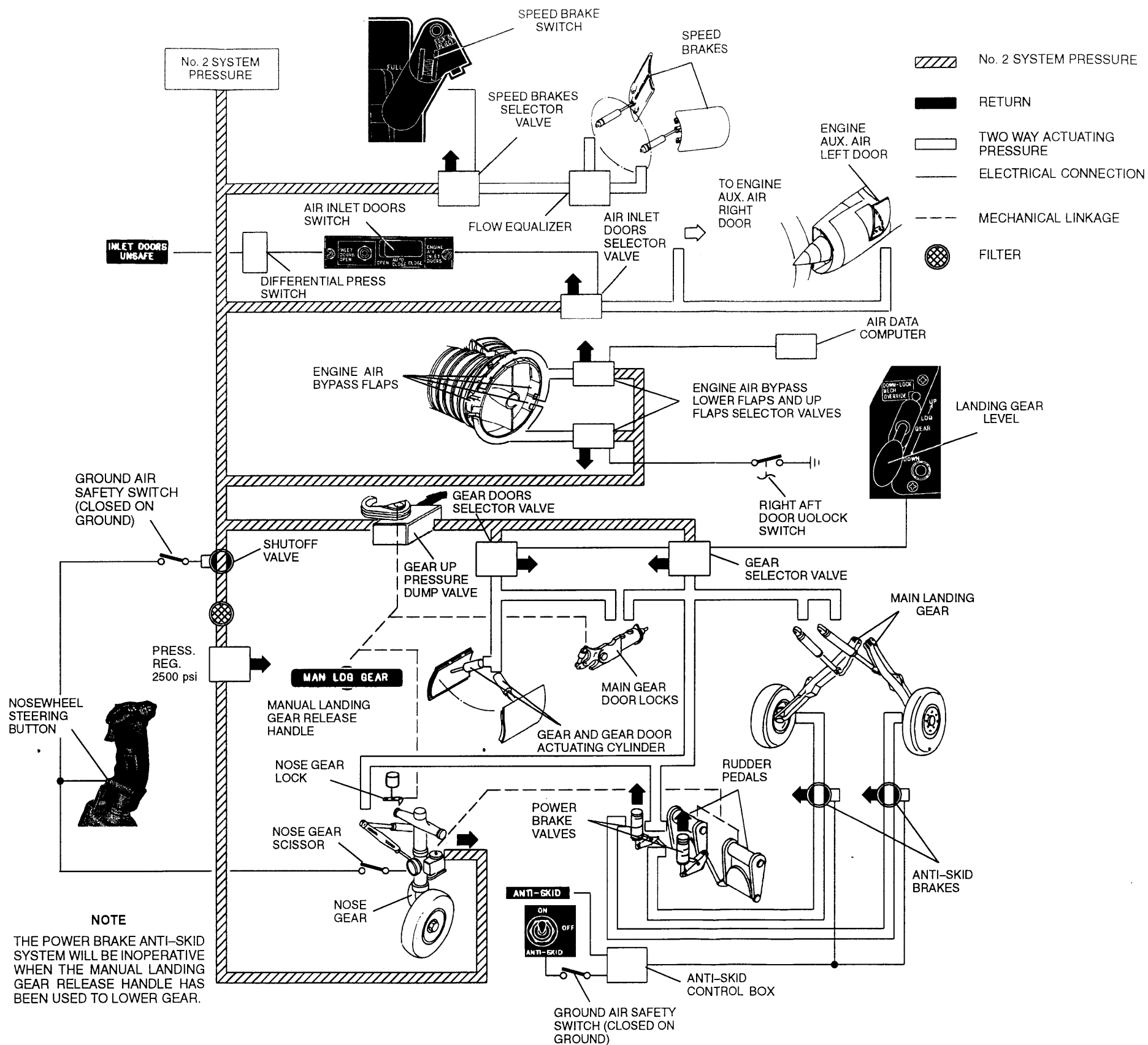
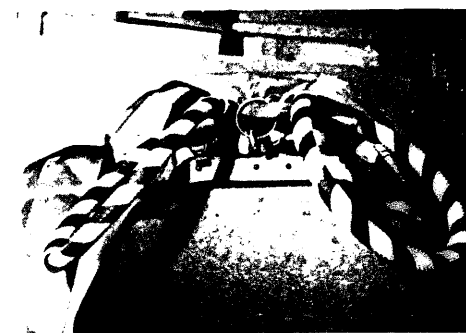

Figure FO-10

FA0262

EJECTION SEAT



DETAIL A

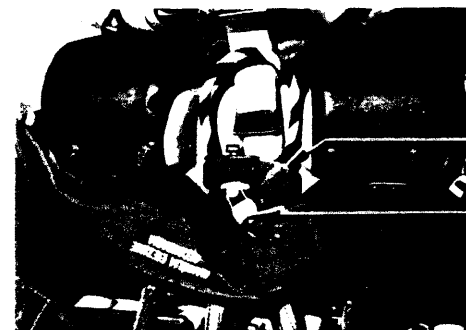

DETAIL B

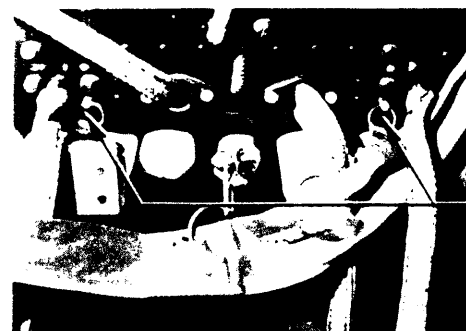

DETAIL C

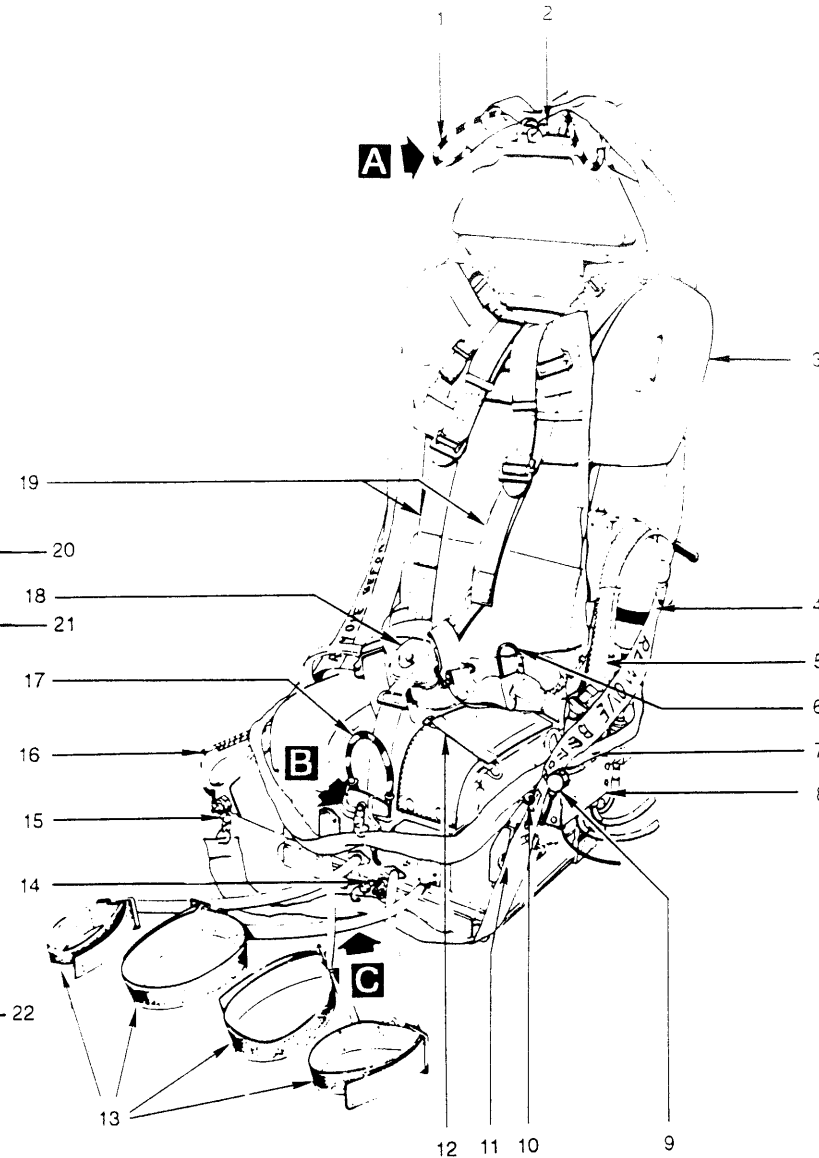

DETAIL H

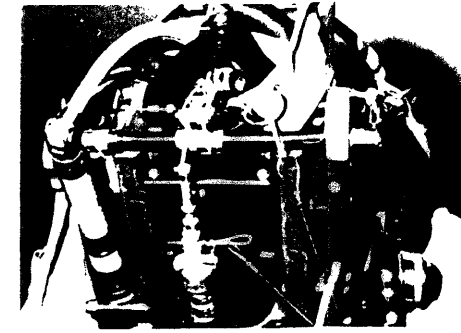

DETAIL D

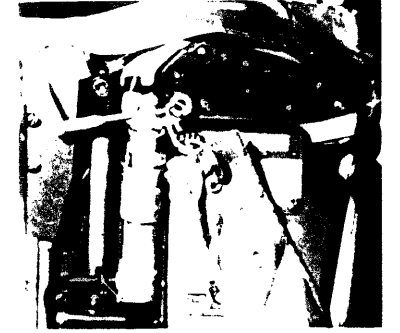

DETAIL E

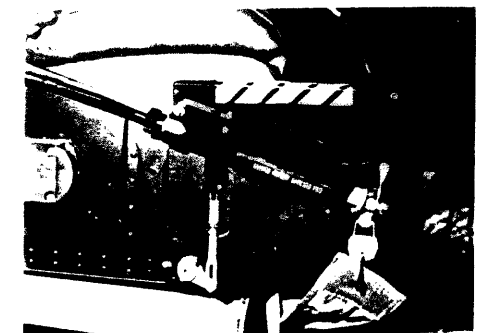
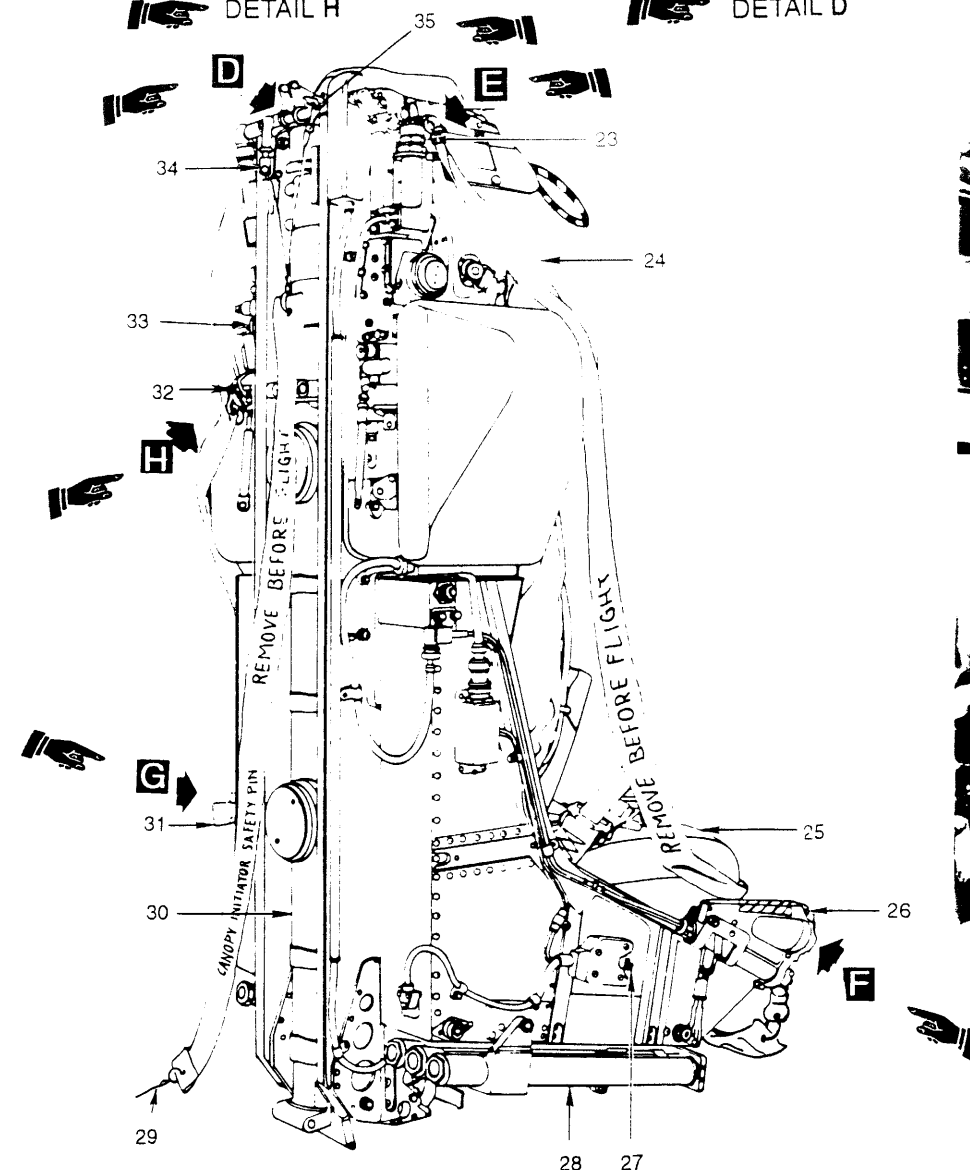

DETAIL F

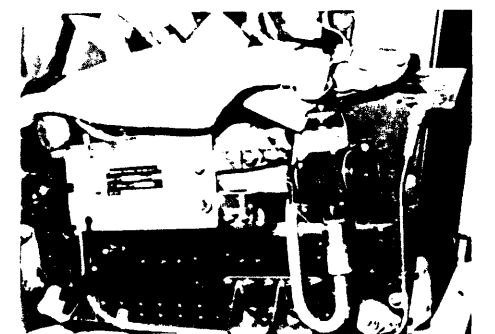

DETAIL G

- 1 PRIMARY FIRING HANDLE
- 2 PRIMARY FIRING HANDLE SAFETY PIN
- 3 PARACHUTE PACK
- 4 EMERGENCY OXYGEN BOTTLE
- 5 OXYGEN HOSE
- 6 D-RING (PARACHUTE)
- 7 PEC-PILOT PORTION
- 8 PEC-SEAT PORTION

- 9 MANUAL RELEASE KNOB (GREEN APPLE)
- 10 GO-FORWARD LEVER
- 11 LEG LINE RELEASE LEVER
- 12 DINGHY LOWERING LINE
- 13 LEG RESTRAINING GARTERS AND STRAPS
- 14 SAFETY PIN (ROCKET PACK INITIATOR)
- 15 SAFETY PIN (GUILLOTINE FIRING UNIT)
- 16 MANUAL OVERRIDE HANDLE

- 17 SECONDARY FIRING HANDLE
- 18 QUICK RELEASE BOX
- 19 COMBINED HARNESS
- 20 SECONDARY FIRING HANDLE SWIVEL GUARD
- 21 SECONDARY FIRING HANDLE SAFETY PIN
- 22 RELEASE RINGS
- 23 SAFETY PIN (POWER RETRACTION)
- 24 DROGUE PARACHUTE CONTAINER

- 25 SURVIVAL PACK
- 26 RELEASE BUTTON
- 27 SEAT ADJUSTMENT ACTUATOR SWITCH
- 28 ROCKET PACK
- 29 SAFETY PIN OF CANOPY EMERGENCY JETTISON INITIATOR (CANOPY RH SIDE)
- 30 MAIN GUN
- 31 OXYGEN RELEASE LEVER SAFETY PIN

- 32 SAFETY PIN (DROGUE GUN)
- 33 SAFETY PIN (ROCKET PACK REMOTE CONTROL)
- 34 SAFETY PIN (CANOPY JETTISON INITIATOR)
- 35 SAFETY PIN (MAIN GUN)

Figure FO-11

FA0609

SEAT EJECTION SEQUENCE

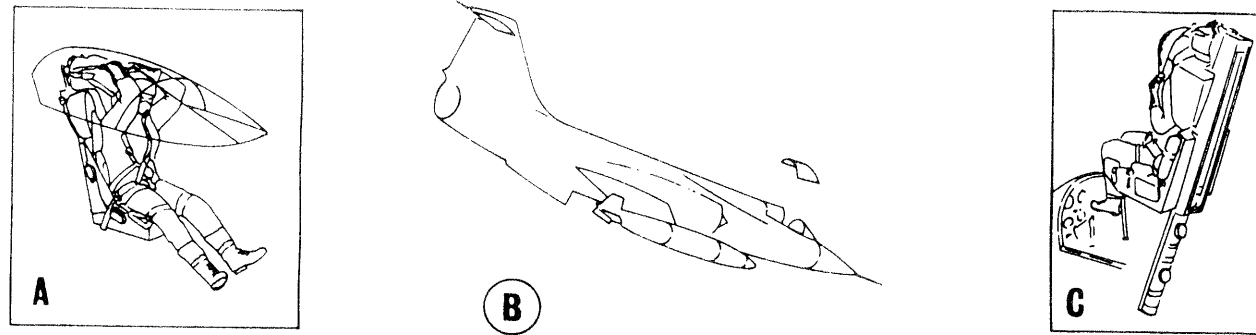

- A PULLING THE FIRING HANDLE (PRIMARY OR SECONDARY), THE EJECTION SEQUENCE BEGINS.
- B WHILE THE CANOPY IS JETTISONED AND THE EJECTION GUN IS ACTUATED, THE HARNESS POWER RETRACTION UNIT OPERATES AND THE PILOT IS BROUGHT TO THE CORRECT EJECTION POSTURE.
- C AFTER FIRING OF EJECTION GUN, AS THE SEAT ASCENDS, THE DROGUE GUN, THE TIME RELEASE UNIT AND THE EMERGENCY OXYGEN SYSTEM ARE OPERATED, AND THE AIRCRAFT PORTION OF THE P.E.C. IS DISCONNECTED. AT THE SAME TIME, THE LEG RESTRAINT CORDS TIGHTEN TO DRAW BACK AND RESTRAIN THE PILOT'S LEGS TO THE FRONT OF THE SEAT PAN.
- D WHEN THE SEAT LEAVES THE AIRCRAFT, THE ROCKET PACK IS FIRED TO SUPPLEMENT THE UPWARD THRUST OF THE EJECTION GUN.
- E 3-4 SEC. AFTER EJECTION, THE DELAY MECHANISM OPERATES AND THE DROGUE GUN IS FIRED DEPLOYING THE DROGUES.
- F THE DROGUES, WHEN FULLY DEVELOPED, STABILIZE AND RETARD THE SEAT AS LONG AS THE CONDITIONS OF HEIGHT AND SPEED ARE SUCH THAT THE BAROSTAT DOES NOT ALLOW THE TIME-RELEASE UNIT TO OPERATE.
- G THE TIME-RELEASE UNIT OPERATES, ALLOWING OPENING OF SCISSOR SHACKLE.
- H THE HARNESS LOCKS, THE LEG CORDS AND THE MAIN PORTION OF THE P.E.C. ARE RELEASED. AT THE SAME TIME, THE DROGUES DEPLOY THE PARACHUTE AND THE PILOT IS LIFTED OUT OF THE SEAT.

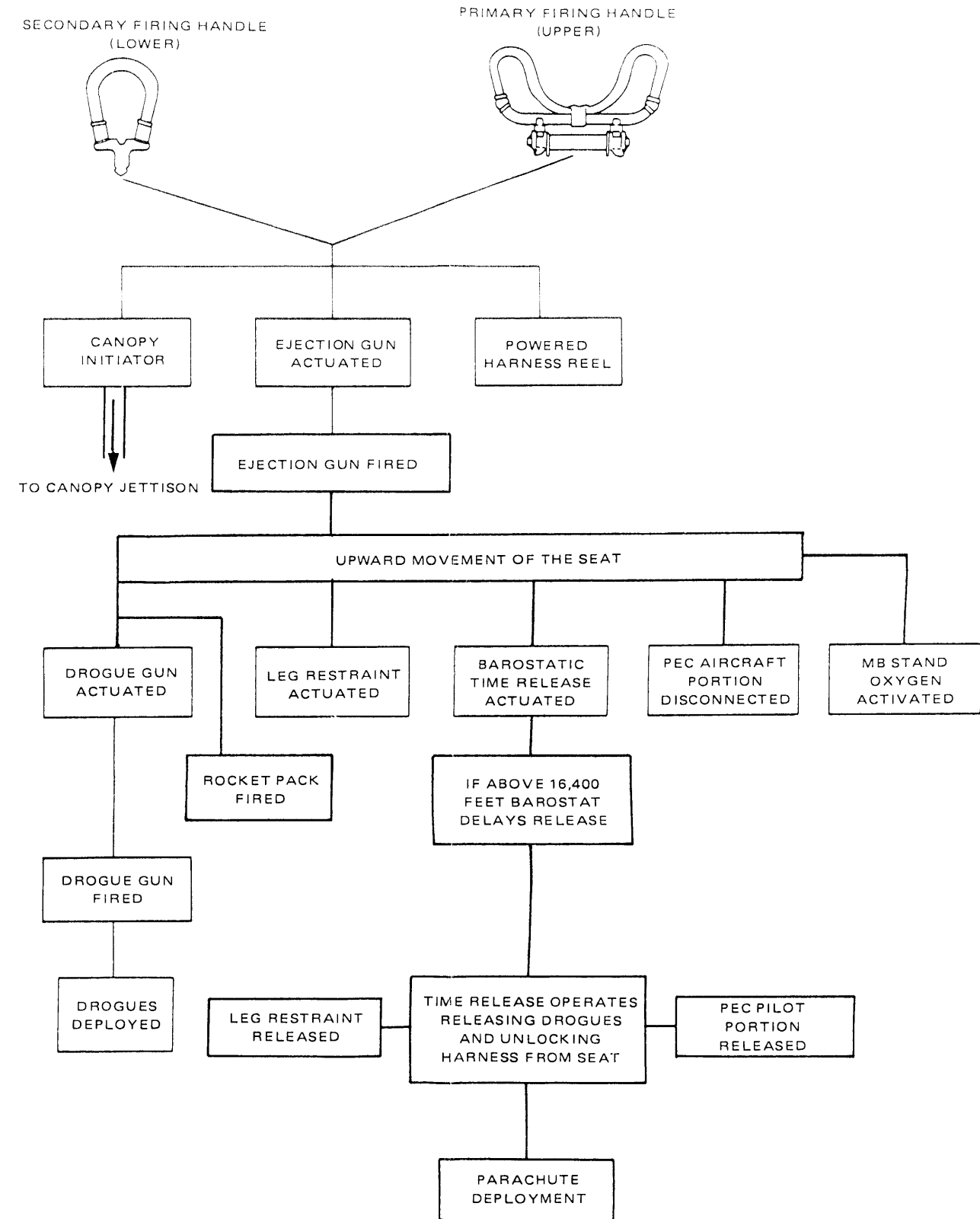
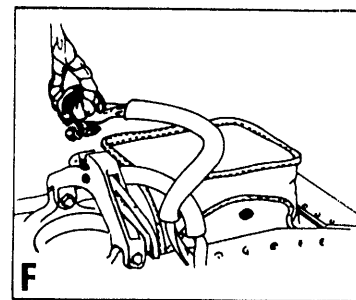
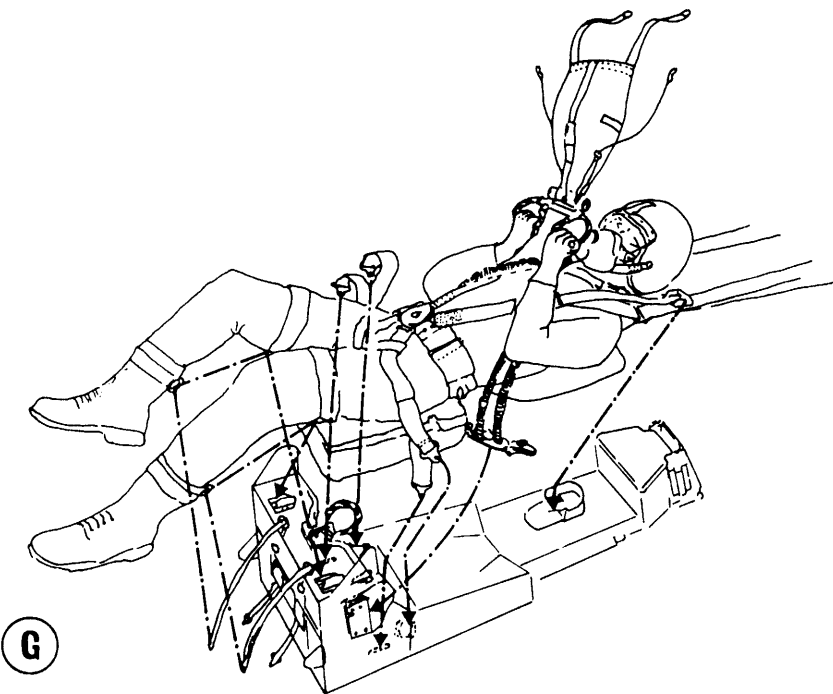
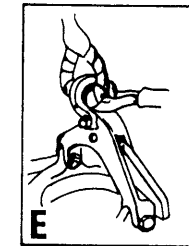
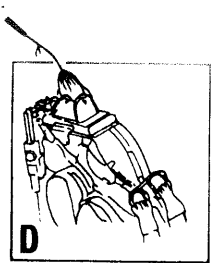

Figure FO-12

**SERVICING DIAGRAM**

SPECIFICATION	
FUEL	JP8 MIL-T-83133 NATO F-34
OIL	MIL-L-7808 NATO-O-148 *
HYDRAULIC FLUID	MIL-H-5606 NATO-H-515
RESERVOIR CAPACITIES	NO. 1 - 0.49 US GAL NO. 2 - 1.83 US GAL
OXYGEN	LIQUID MIL-O-27210
NITROGEN	MIL-N-6011 GRADE A TYPE 1 (WATER-PUMPED OR DRY AIR)
WATER	USE DISTILLED WATER OR DEMINERALIZED WATER

\* WHERE NATO-O-148 (MIL-L-7808) IS SPECIFIED AND IS NOT AVAILABLE, NATO-O-149 MAY BE USED OR MIXED WITH O-148 UP TO 50%. IN SUCH A CASE, WHEN O-148 BECOMES AVAILABLE, THE OIL TANK SHOULD BE DRAINED AND FILLED WITH O-148.

**STARTING AIR REQUIREMENTS**

RATED INPUT	350° F AND 45 PSIA AT 110 LB/MIN
MAXIMUM PRESSURE INPUT	250° F AND 70 PSIA AT 110 LB/MIN

**ELECTRICAL REQUIREMENTS**

115/200 VOLT, 400HZ, 3-PHASE AC; 28V DC

**OXYGEN REQUIREMENTS**

PRESSURE FILLING 30 + 50 PSI

**ARRESTING HOOK ACCUMULATOR AND PRESSURE GAGE**

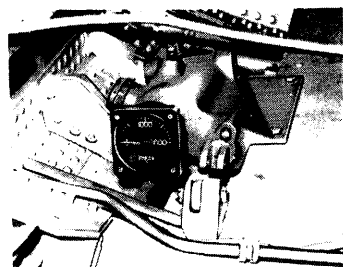

**WATER BOILER FILLER**



**SINGLE POINT REFUELING ADAPTER**

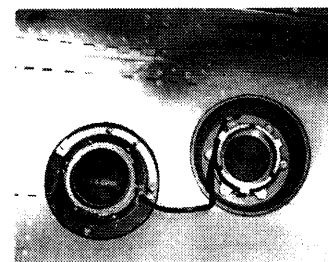

**FILLER WELLS**

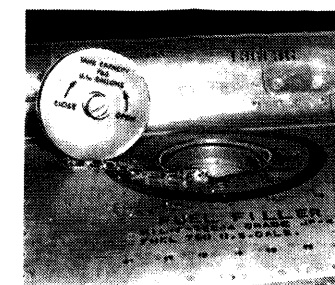

**OIL DIPSTICK**

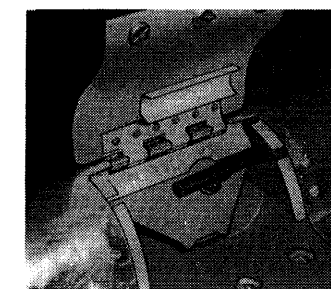

**OXYGEN FILLER (LIQUID)**

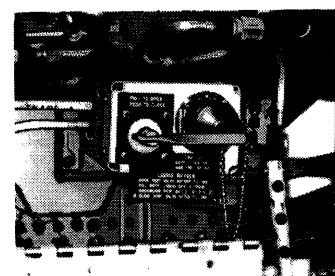

**REFUELING PRECHECK SWITCH PANEL**

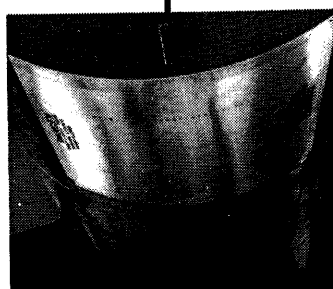
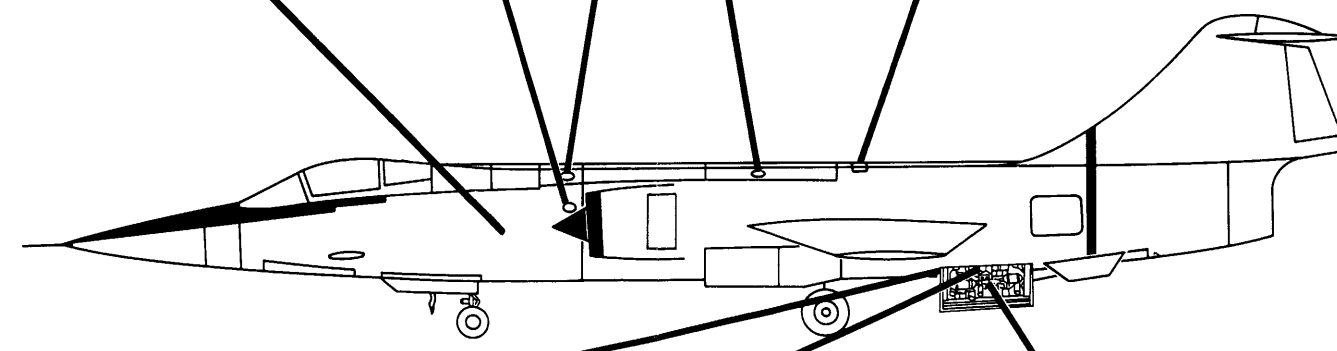
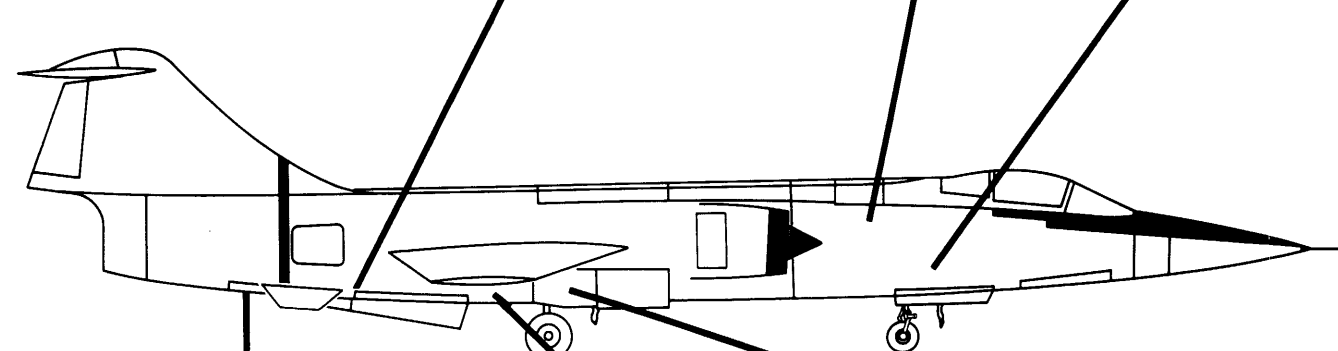
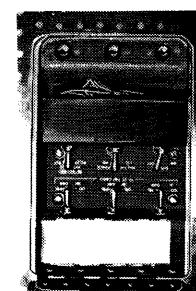

**DRAG CHUTE ACCESS PANEL**

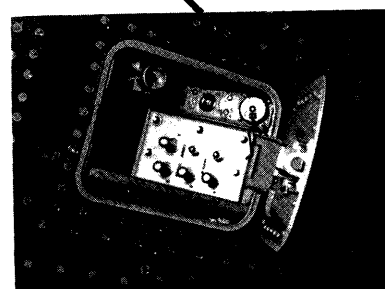

**EXTERNAL ELECTRICAL POWER RECEPTACLE**

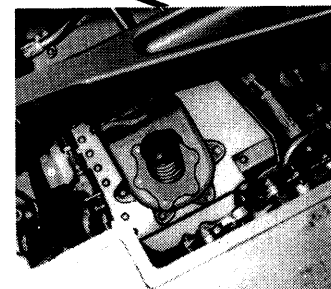

**GROUND TURBINE COMPRESSOR RECEPTACLE**

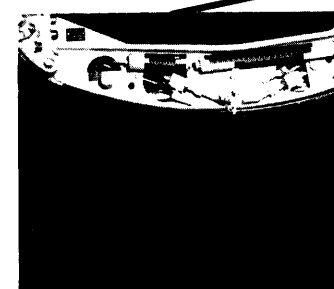

**HYDRAULIC SYSTEM QUANTITY GAGES AND BLEED LINES**

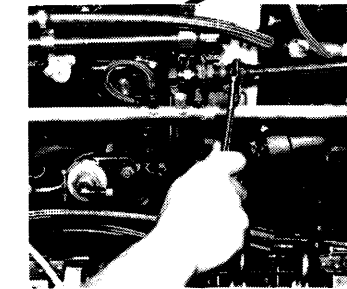

**OIL FILLER**

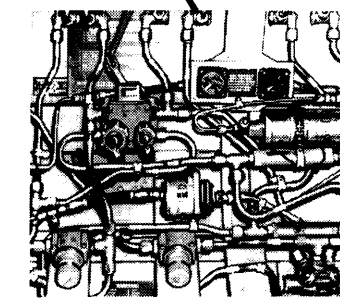

**HYDRAULIC SYSTEM FILLERS, ACCUMULATOR, AND PRESSURE GAGES**

*Figure FO-13*





**IN/CDU NAVIGATION MODING BLOCK DIAGRAM**

**IN/CDU NAVIGATION/LIST MODING**

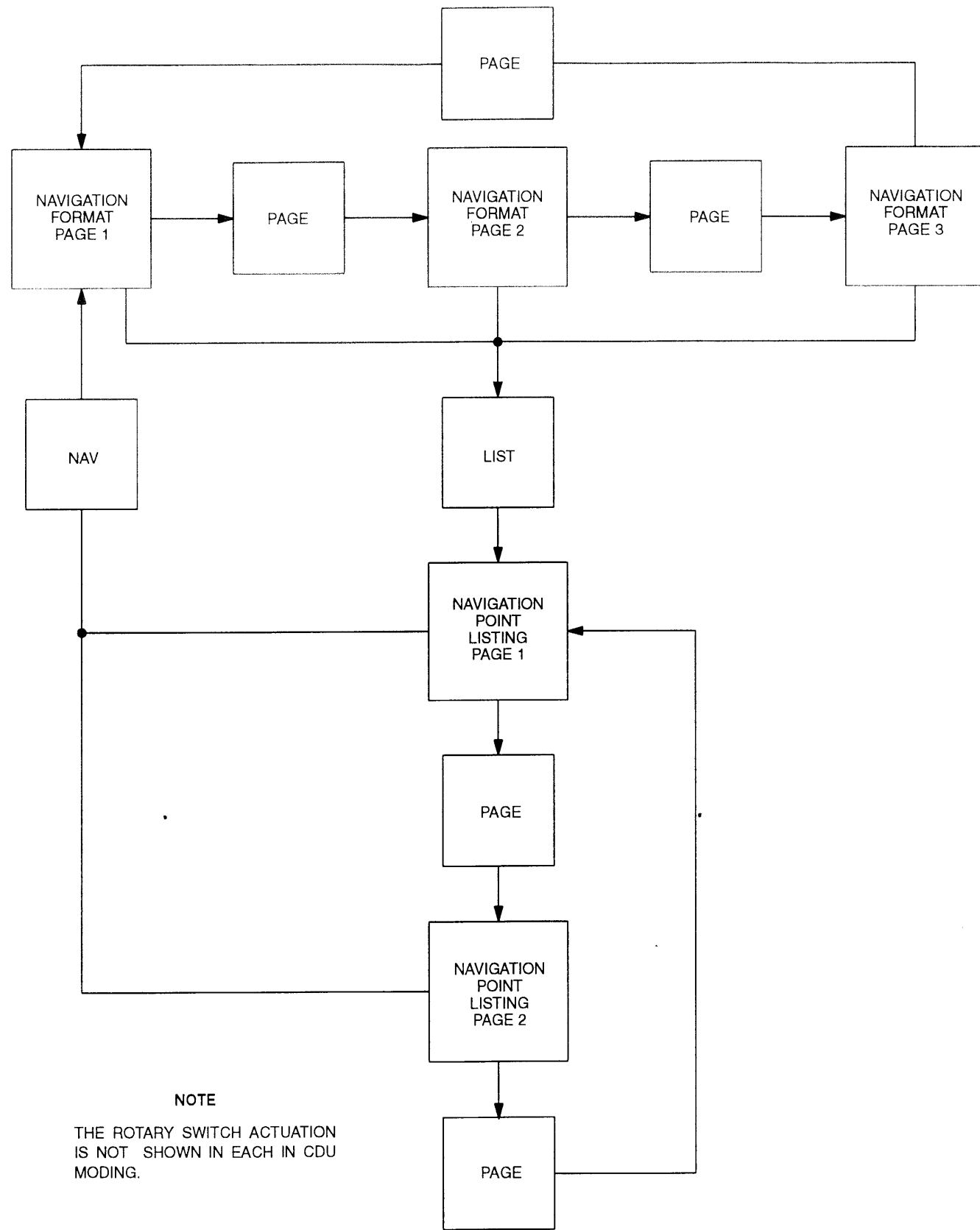

**NOTE**  
THE ROTARY SWITCH ACTUATION IS NOT SHOWN IN EACH IN/CDU MODING.

**IN/CDU ON TOP FIXING**

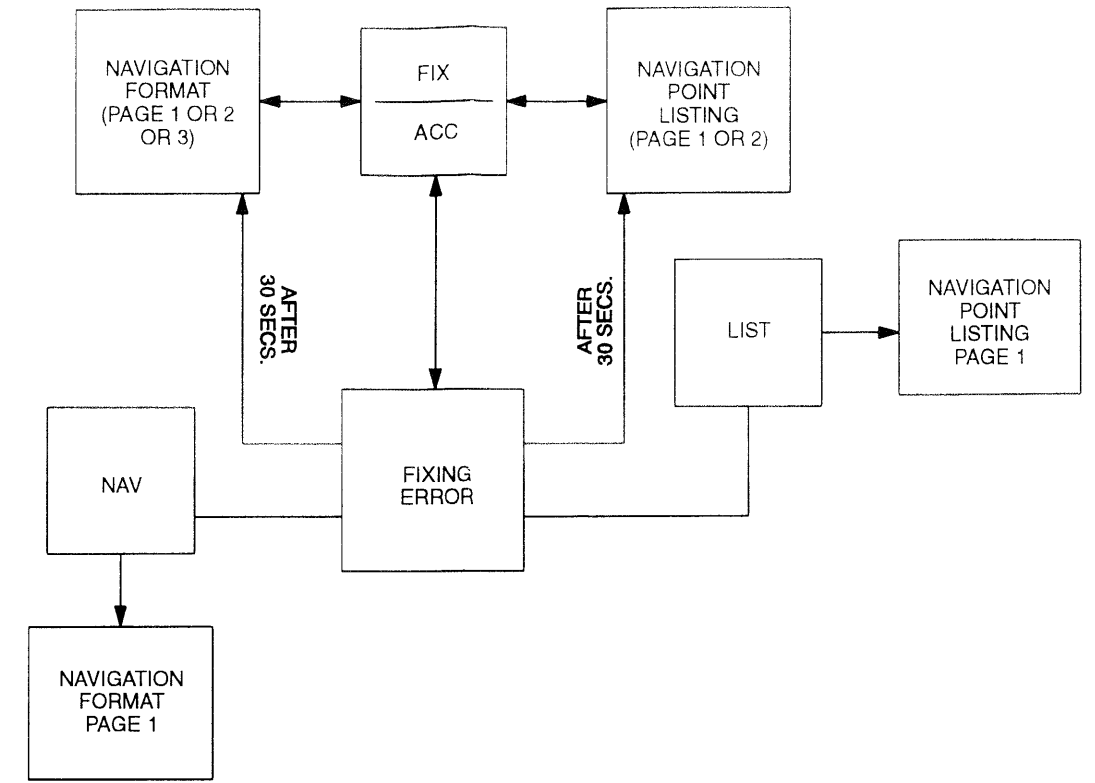

**IN/CDU MARK POINT DATA ACQUISITION**

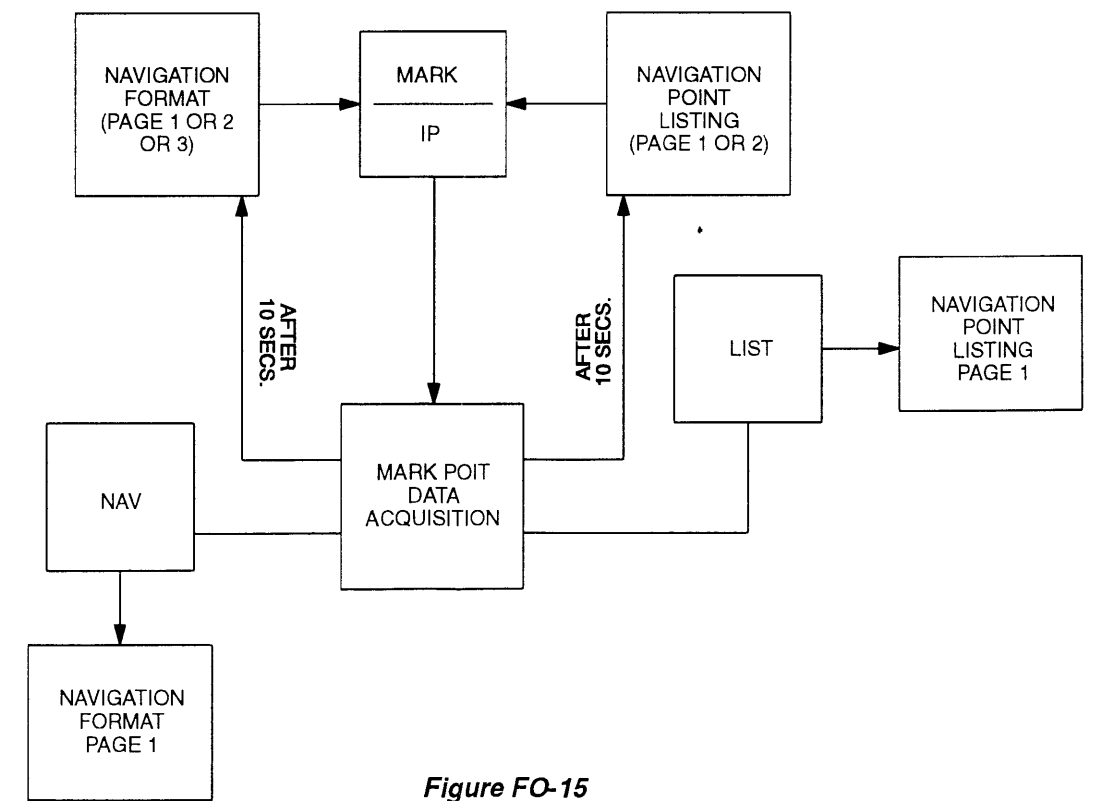

**Figure FO-15**

## ALPHABETICAL INDEX

## A

- Abort/Barrier Engagement . . . . . 3-4
- AC Electric Power Supply . . . . . 1-35
- Accelerated Stalls . . . . . 6-10
- Acceleration Check Distance . . . . . A2-2
- Acceleration Check Speed . . . . . A2-2
- Acceleration Limitations . . . . . 5-12
- Acceleration to Combat Speed . . . . . A10-6
- Acceleration Tolerance . . . . . A2-4
- Accelerometer . . . . . 1-68
- Accumulators . . . . . 1-40
- Active HQ Activation . . . . . 1-100
- Aft Center Fuel Cell . . . . . 1-23
- Aft Main Fuel Cell . . . . . 1-23
- Aft Right and Left Fuel Cells . . . . . 1-23
- After Ejection . . . . . 3-22
- After Landing . . . . . 2-36
- After Seat/Man Separation . . . . . 3-22
- After Shutdown . . . . . 2-38
- After Start Check . . . . . 2-14
- After Takeoff . . . . . 2-25, 7-8
- Afterburner Blowout . . . . . 3-7
- Afterburner Formation Climb . . . . . 6-28
- Afterburner Formation Takeoffs . . . . . 6-28
- Afterburner Fuel Control . . . . . 1-9
- Afterburner Fuel Pump . . . . . 1-9
- Afterburner Fuel System . . . . . 1-9
- Afterburner Fuel-Oil Cooler . . . . . 1-9
- Afterburner Ignition System . . . . . 1-5
- Afterburner On-Off Valve . . . . . 1-9
- Afterburner Operation . . . . . 2-27
- Afterburner Pressurizing Valve . . . . . 1-9
- Afterburner Surge . . . . . 3-7
- Afterburner System . . . . . 1-9
- Afterburning Cruise Performance . . . . . A9-4
- Aileron and Rudder Travel Limiting System . . . . . 1-44
- Aileron and Rudder Unlimited Warning Light . . . . . 1-44
- Aileron Roll Limitations . . . . . 5-12
- Aileron Rolls . . . . . 6-20
- Aileron, Stabilizer, and Rudder . . . . . 1-48
- AIM-7E Sparrow Missile Firing . . . . . 6-25
- AIM-9L Sidewinder Missile Firing From BL-104  
and Wing Tip . . . . . 6-25
- Air Data Computer . . . . . 1-108
- Air Start Attempts During Flame-out Landing Pat-  
tern . . . . . 3-45
- Air Start/Stall Clearing . . . . . 3-12
- Air-Conditioning and Pressurization System . . . . . 1-83
- Aircraft Configuration . . . . . 6-1
- Aircraft Oxygen System . . . . . 1-153
- Airspeed - Mach Number Conversion . . . . . A1-3
- Airspeed - Mach Number Conversion Sample  
Problems . . . . . A1-3
- Airspeed and Altitude Errors . . . . . 6-1
- Airspeed and Mach Number Indicator . . . . . 1-65
- Airspeed Compressibility Correction . . . . . A1-4
- Airspeed Correction Sample Problem . . . . . A1-4
- Airspeed Limitations . . . . . 5-5
- Airspeed Position Error Correction . . . . . A1-2
- Airspeed System Failure . . . . . 3-42
- Alert Cocking Procedures . . . . . 2-38
- Alert Scramble Procedures . . . . . 2-40
- ALIGN Mode - "ALN" . . . . . 1-115
- Alignment Phase . . . . . 1-141
- Alignment Status Indicator . . . . . 1-111
- Altimeter . . . . . 1-66
- Altimeter Position Error Correction . . . . . A1-3
- Altitude Computer (CPU-46A). . . . . 1-68
- Altitude Encode Out Warning Light. . . . . 1-68
- Altitude Hold Switch. . . . . 1-148
- Altitude Vent Valve . . . . . 1-25
- AN/AIC-18 Interphone . . . . . 1-100
- Antenna Selector Switch . . . . . 1-97
- Antenna System . . . . . 1-93
- Anti-G Valve Test Pushbutton . . . . . 1-159
- Anti-Icing Systems . . . . . 1-90
- Anti-Skid Light . . . . . 1-61
- Antiskid Switch . . . . . 1-61
- APC Cutout Switch . . . . . 1-48
- APC Meter . . . . . 6-29
- Approach and Landing . . . . . 7-9
- Approach and Landing Emergencies . . . . . 3-42
- Approach-End Arrestment . . . . . 3-42
- Arresting Hook . . . . . 1-64
- Artificial Feel System . . . . . 1-43
- ASPIDE Missile Firing . . . . . 6-25
- Asymmetric BL 75/BL 104 Pylon Store . . . . . 6-27
- Asymmetric External Tank Fuel Load . . . . . 6-26
- Asymmetric Flaps . . . . . 3-49
- Asymmetric Tip Tank Fuel Load . . . . . 3-43
- Asymmetric Wing Tip AIM-9L Missile . . . . . 6-27
- Attitude Indicator . . . . . 1-68
- Auto Trim Indicator . . . . . 1-150
- Auto-Pitch Control System Failure . . . . . 3-15
- Automatic Flight Control System (AFCS) . . . . . 1-146
- Automatic Fuel Transfer Shutoff . . . . . 1-25
- Automatic Leg Restraint . . . . . 1-79
- Automatic Pilot Disengage Switch . . . . . 1-150
- Automatic Pitch Control (APC) . . . . . 6-6
- Automatic Pitch Control System . . . . . 1-46
- Automatic Pitch Control System Indicator . . . . . 1-48
- Automatic Pitch Trim . . . . . 1-150
- Automatic Start . . . . . 2-13
- Autopilot Control Panel . . . . . 1-148
- Autopilot Disengage Warning Light . . . . . 1-150

Autopilot Interface ..... 1-146  
 Autopilot Operation ..... 1-150  
 Auxiliary Inlet Door Malfunction ..... 3-7  
 Auxiliary Inlet Doors ..... 6-4  
 Auxiliary Relief Valve ..... 1-25  
 Auxiliary Tanks ..... 1-24  
 Auxiliary Trim Control Switch. .... 1-49  
 Auxiliary Trim Selector Switch. .... 1-49

**B**

Bail-Out Without Ejection Seat ..... 3-22  
 Barrier Engagement ..... 3-43  
 Base Leg Turn ..... 2-29  
 Batteries ..... 1-39  
 Battery Start ..... 2-13  
 Before Ejection ..... 3-20  
 Before Entering Cockpit ..... 2-2  
 Before Entering the Aircraft ..... 7-6  
 Before Exterior Inspection ..... 2-2  
 Before Landing ..... 2-28  
 Before Leaving the Aircraft ..... 7-8  
 Before Starting Engine ..... 2-8, 7-6  
 Before Takeoff ..... 2-20, 7-7  
 Before Taxiing ..... 2-17  
 Belly Landing ..... 3-43  
 BL 75 Pylon Jettison Switch ..... 1-35  
 Bleed Air Duct Separation/False RPM Reset ... 3-16  
 Boundary Layer Control (BLC) System ..... 1-52  
 Boundary Layer Control Malfunction ..... 3-44  
 Boundary Layer Control Valve ..... 1-52

**C**

C-2G Directional Gyro System ..... 1-125  
 Cabin Altimeter ..... 1-86  
 CALIBRATE Mode – "CAL" ..... 1-116  
 Canopy ..... 1-73  
 Canopy Open/Loss/Broken during Takeoff ..... 3-8  
 Canopy Breaking Tool ..... 1-78  
 Canopy Defogger Knob ..... 1-88  
 Canopy External Jettison Handle ..... 1-78  
 Canopy External Locking Lever ..... 1-75  
 Canopy Full Open Lock Release ..... 1-75  
 Canopy Internal Jettison Handle ..... 1-78  
 Canopy Internal Locking Lever ..... 1-75  
 Canopy Open/Loss/Broken during Flight ..... 3-17  
 Canopy Seal ..... 1-75  
 Canopy Unsafe Warning Lights ..... 1-78  
 CAUTION Light ..... 1-70  
 CDP Limiter ..... 1-14  
 Center-of-Gravity Limitations ..... 5-14  
 Channel Selector Switch. .... 1-102  
 Channel Selector. .... 1-95  
 Channel Window. .... 1-117  
 Channel/Frequency Display. .... 1-97

Channel/Frequency Indicator ..... 1-97  
 Channel/Mode Selector Knobs. .... 1-119  
 Circuit Breakers ..... 1-39  
 CIT Sensor ..... 1-14  
 Climb ..... 2-26, 6-14  
 Climb Control Charts ..... A3-1  
 Climb Control Index ..... A3-1  
 Climb Performance ..... A3-2, A3-3  
 Climb Speed Schedules ..... A3-1  
 Clock ..... 1-69  
 Cockpit Air Conditioning ..... 1-83  
 Cockpit Pressurization ..... 1-83  
 Cockpit Pressurization Malfunction ..... 3-17  
 Cockpit Temp Mode Selector Switch and Cockpit Heat Rheostat ..... 1-84  
 Cold Weather Operations ..... 7-6  
 Combat Ceiling ..... A3-2  
 Combat Climb ..... A10-8  
 Combat Fuel ..... A10-8  
 Combat Turn ..... A10-6  
 Communications and Navigation Equipment .... 1-93  
 Compensated Pitot-Static Head Position Error Corrections ..... A1-2  
 Compressor and Variable Stator Operation ..... 1-12  
 Compressor Inlet Temperature ..... 5-1  
 Compressor Inlet Temperature (CIT) Warning System ..... 1-12  
 Compressor Inlet Temperature Gage ..... 1-12  
 Configuration Drag Index ..... A1-1  
 Configuration Drag Index – Sample Problem .. A1-2  
 Configuration Drag Index and Loaded Gross Weight ..... A10-3  
 Control Stick ..... 1-43  
 Control Stick Aileron and Stabilizer Trim Switches 1-49  
 Control Stick Steering ..... 1-147  
 Control Stick Steering (CSS) Failure ..... 3-41  
 Core Burner System ..... 1-10  
 Corrected RPM ..... 1-12  
 Crosswind Landing ..... 2-30  
 Crosswind Limitation ..... 5-8  
 Crosswind Takeoff ..... 2-25  
 Cruise ..... 2-26  
 Cruise and Transonic Speeds ..... 6-18  
 Crypto-Computer (Provision only) ..... 1-102  
 Current Transformers ..... 1-36

**D**

DC Electric Power Supply ..... 1-38  
 Defogger and Rain-Remover Systems ..... 1-88  
 Defogger System ..... 1-88  
 Descent ..... 2-27  
 Descent Performance ..... A7-1  
 DG-MAG Selector Switch. .... 1-125  
 Dihedral Effect ..... 6-2  
 Diluter Demand (MB-Stand Ox) ..... 1-156, 1-158

Dimensions	1-2
Disengage Limiter	1-147
Diving	6-21
Double AC (WF) Generator Failure	3-27
Downwind	2-28
Drag Chute System	1-61
Drogue Gun and Drogue System	1-79
Droppable Stores Release Button	1-33

## E

Effect of Flaps Lever and Gear Position on APC Operation	1-46
Effect of Free Air Temperature on Climb Performance	A3-2
Effect of Runway Slope	A8-2
Effect of Runway Surface Conditions	A8-2
Effect of Wind – Crosswind Conversion	A8-2
EGT Limits	5-5
Ejection	3-20
Ejection – General Consideration	3-18
Ejection Altitudes	3-20
Ejection Attitudes	3-18
Ejection Clearance	3-18
Ejection Gun and Guide Rails	1-78
Ejection Seat	1-78
Ejection Speed	3-20
Ejection Versus Flame-Out Landing	3-18
Electrical Fire	3-23
Electrical Power Supply System	1-35
Electrical Power Supply System Failure	3-24
Electrically Heated Windshield	1-92
Electronics Compartment Cooling	1-86
Emergency AC Power Supply	1-38
Emergency Entrance	3-2
Emergency External Stores Jettison Button	1-33
Emergency Hydraulic Power Supply System	1-41
Emergency Jettison	1-32
Emergency Nozzle Closure Handle	1-20
Emergency Operation of Cockpit Air-Conditioning and Pressurization System	1-87
Emergency Operation of Defogger and Rain-Remover Systems	7-4
Emergency Oxygen System Operations	1-158
Emergency Pressure Relief Door	1-16
Emergency UHF Radio	1-101
Emergency UHF Radio Control Panel	1-101
Emergency Wing Flap Operation	3-49
Empennage	6-2
Endurance Data Presented	A5-1
Engage Switch.	1-148
Engine	1-2
Engine Anti-Icing Operation Limits	5-5
Engine Auxiliary Air Inlet Doors	1-17
Engine Auxiliary Air Inlet Doors Open Light.	1-17
Engine Auxiliary Air Inlet Doors Switch.	1-17
Engine Auxiliary Air Inlet Doors Unsafe Warning Light.	1-17
Engine Bleed Air Anti-G Suit System	1-158
Engine Check	2-20
Engine Compressor Stalls	1-14
Engine Control System	1-2
Engine Exhaust Nozzle Locks	1-20
Engine Failure during Flight	3-32
Engine Failure during Takeoff	3-8
Engine Fire Detector Warning System	1-72
Engine Fuel Control Unit	1-8
Engine Fuel Pump	1-5
Engine Fuel System	1-5
Engine Ignition Systems	1-5
Engine Limitations	5-1
Engine Motoring Switch.	1-5
Engine Oil Level Low	3-9
Engine Oil Level Low Warning Light	1-23, 5-5
Engine Oil Pressure	1-21
Engine Oil Supply System	1-21
Engine Oil System Malfunction	3-35
Engine Operation in Flight	7-8
Engine RPM Control Features	1-13
Engine RPM Lock Up PWR On	1-17
Engine RPM Lockup System	1-17
Engine Shutdown	2-37
Engine Stall/Flame Out – High Altitude Subsonic.	1-15
Engine Starter and Ignition Systems	1-2
Engine Starter System	1-2
Engine/Duct Anti-Ice On Warning Light	1-92
Engine/Duct Anti-Ice Switch	1-90
Engine/Duct Anti-Icing System Operation	1-92
Engine/Duct Anti-Icing Systems	1-90
Exhaust Gas Temperature Gage	1-21
Exhaust Nozzle Emergency Closure System	1-20
Exhaust Nozzle Fails Open without Indication of Engine Oil System Malfunction (Afterburning)	3-10, 3-33
Exhaust Nozzle Fails Open without Indication of Engine Oil System Malfunction (Non-Afterburning)	3-33
Exhaust Nozzle Fails to Mechanical Schedule or Severe Nozzle Fluctuations Occur (Afterburning)	3-34
Exhaust Nozzle Fails to Mechanical Schedule or Severe Nozzle Fluctuations Occur (Non-Afterburning)	3-34
Exhaust Nozzle Flap Actuators	1-20
Exhaust Nozzle Position Indicator	1-21
Exterior Inspection	2-2
Exterior Lighting	1-151
External Fuel Quantity Indicator	1-28
External Fuel Quantity Indicator Selector Switch	1-28
External Fuel Tanks	1-25
External Fuel Transfer Failure	3-30
External Fuel Transfer System	1-26
External Power Supply	1-39
External Store Jettison System Controls and Indicators	1-33

External Stores Emergency/Selective Jettison . . . 3-9, 3-29  
 External Stores Jettison Limits . . . . . 5-8  
 External Stores Jettison System . . . . . 1-32  
 External Stores Selector Buttons and Indicator  
 Lights . . . . . 1-33  
 External Tank Fuel Selector Switch . . . . . 1-28  
 External Tanks Refuel Selector Switch. . . . . 1-30  
 External Tip Stores Automatic Drop System . . . . . 1-30  
 External Tip Tank Asymmetric Fuel Load . . . . . 3-30

**F**

Face Plate Heat Rheostat . . . . . 1-93  
 Face Plate Heat System . . . . . 1-93  
 False, Hanging, Idle Overspeed or Hot Start Proce-  
 dures . . . . . 2-13  
 Final . . . . . 2-29  
 Fire . . . . . 3-29  
 Fire during Start . . . . . 3-2  
 Fire during Takeoff . . . . . 3-10  
 FIRE Warning Lights . . . . . 1-73  
 Fixed Frequency Generator Control Unit. . . . . 1-36  
 Fixed-Frequency Reset Button. . . . . 1-38  
 Fixed-Frequency-Out Warning Light. . . . . 1-38  
 Flame-Out Landing . . . . . 3-44  
 Flaps Failure . . . . . 3-48  
 Flight and Steering Parameters Displaying . . . . . 1-143  
 Flight Characteristics . . . . . 2-27  
 Flight Control System . . . . . 1-43  
 Flight Controls . . . . . 6-3  
 Flight Planning . . . . . 2-1  
 Flight Restrictions . . . . . 2-1  
 Flight with Asymmetrical Load . . . . . 6-26  
 Flight with External Stores . . . . . 6-22  
 Floodlights . . . . . 1-151  
 Fly-To Function . . . . . 1-145  
 Formation Flying . . . . . 6-28  
 Formation Takeoff . . . . . 5-11  
 Forward Main Fuel Cell . . . . . 1-23  
 Fresh Air Scoop Lever . . . . . 1-86  
 Fuel and Fuel Density . . . . . A1-1  
 Fuel Boost Pump Failure Warning Light . . . . . 1-29  
 Fuel Boost Pumps . . . . . 1-24  
 Fuel Control Panel . . . . . 1-26  
 Fuel Flow Indicating System . . . . . 1-8  
 Fuel Flow Indicator. . . . . 1-8  
 Fuel Low-Level Warning Light . . . . . 1-29  
 Fuel Manifolds and Spray Bars . . . . . 1-10  
 Fuel Nozzles . . . . . 1-8  
 Fuel Quantity Indicating System . . . . . 1-28  
 Fuel Quantity System Test Switch . . . . . 1-28  
 Fuel Shut Off Valve Open Test Light . . . . . 1-29  
 Fuel Shut-Off Switch . . . . . 1-26  
 Fuel Supply System . . . . . 1-23  
 Fuel System Failure . . . . . 3-30

Fuel Tank Pressurization and Vent System . . . . . 1-25  
 Full Power Irreversible Control System . . . . . 1-43

**G**

GCI Recovery . . . . . 7-3  
 General Comments . . . . . A10-3  
 Generator Switches. . . . . 1-36  
 Generator-Out Warning Lights. . . . . 1-36  
 Global Positioning System (GPS) . . . . . 1-119  
 Go-Around . . . . . 2-34, 6-17  
 Go, No-Go Distance . . . . . A2-2  
 Go, No-Go Speed . . . . . A2-3  
 GPS Operation . . . . . 2-43  
 GPS Steering Mode . . . . . 1-143  
 GPS Steering Mode Selection . . . . . 2-43  
 GPS System Controls and Indicators . . . . . 1-122  
 GPS System Operation . . . . . 1-122  
 GPS System Switch-on and BIT/AFI Function . . . 1-125  
 Gravity Refueling . . . . . 1-30  
 Gross Weight . . . . . 1-2  
 Ground Abandonment . . . . . 3-4  
 Ground Check Prior to Flight Under Icing Conditions 7-4  
 Ground Effect . . . . . 6-11  
 Ground Emergencies . . . . . 3-2  
 Ground Operation . . . . . 2-14  
 Ground Run Distance . . . . . A2-2  
 Ground Test Selector Valve. . . . . 1-40  
 Guided Expansion Exhaust Nozzle System . . . . . 1-15  
 Gyrocompass Alignment . . . . . 2-40  
 Gyrocompassing – "GC" . . . . . 1-115

**H**

Have Quick (HQ) Facility . . . . . 1-98  
 Heading Switch. . . . . 1-148  
 Heavyweight Landing . . . . . 2-31  
 Height Pointer. . . . . 1-109  
 High Corrected RPM and RPM Cutback . . . . . 1-13  
 Holding . . . . . 7-2  
 Horizontal Situation Indicator (HSI) . . . . . 1-138  
 Horizontal Situation Indicator Controls and Indi-  
 cators . . . . . 1-138  
 Hot Weather and Desert Operations . . . . . 7-8  
 HQ Training Loading . . . . . 1-99  
 Hydraulic Panel . . . . . 1-40  
 Hydraulic Power Supply Systems . . . . . 1-40  
 Hydraulic System Failure . . . . . 3-31  
 Hydraulic System Out Warning Light . . . . . 1-41  
 Hydraulic Systems Pressure Gages . . . . . 1-41  
 Hydraulically Driven Fixed-Frequency Generator  
 Out . . . . . 3-28  
 Hydraulically Driven Fixed-Frequency Generator  
 Out (MRAAM Operation) . . . . . 3-29  
 Hydraulically-Driven Fixed-Frequency Generator  
 (GEN.3) . . . . . 1-36

**I**

Ice and Rain	7-3
Identification Switch	1-104
Identification-of-Position Operation	1-107
IFF Control Panel	1-102
IFF Modes System Operation	1-105
IFF System	1-102
IFF System Operation	1-105
IFF System Self-Test	1-108
IGV Closure	3-33
IN Steering Mode	1-142
In-Flight Emergencies	3-12
IN/CDU Controls and Indicators	1-130
IN/CDU Mode of Operation	1-132
IN/CDU Mode of Operation during Alignment Procedures	1-132
IN/CDU Navigation Data Presentation	2-42
IN/CDU Navigation Moding	1-133
IN/CDU Operation	2-41
IN/CDU Station Point Listing	2-42
IN/CDU System Operation	1-132
Inertial Nav Homing	1-150
Inertial Navigation Control Display Unit (IN/CDU)	1-130
Inertial Navigation System (INS)	1-111
Inflight Operation	1-145
Inflight Procedure	7-5
Initial	2-28
INS Alignment Procedure	2-40
INS Control Panel	1-111
INS Controls and Indicators	1-111
INS Failure	3-41
INS Mode of Operations	1-115
INS Operation	1-117
Instrument Climb	7-1
Instrument Cruising Flight	7-2
Instrument Flight Procedures	7-1
Instrument Takeoff	7-1
Instruments	1-65
Instruments and Console Panel Lights	1-151
Interior Checks	2-4
Interior Lighting	1-151
Internal Fuel Quantity Indicator	1-28
Introduction	A9-1
Inverted Spin Recovery	3-39
Inverted Spins	6-12

**J**

Jet Penetration	7-2
-----------------	-----

**K**

Key Point, Combat, Return and Reserve	A10-8
---------------------------------------	-------

**L**

Landing	2-29, 7-8
Landing and Taxi Lights	1-151
Landing Gear Emergency Extension	3-50
Landing Gear Lever	1-55
Landing Gear Lever Downlock Malfunction	3-11
Landing Gear Lever Override Button	1-55
Landing Gear Lever Unsafe Warning Light	1-56
Landing Gear Lever Uplock Button	1-55
Landing Gear Position Indicator Lights	1-56
Landing Gear Retraction Failure	3-11
Landing Gear System	1-53
Landing Gear Warning Signal	1-58
Landing on Slippery Runways	2-34
Landing Technique	2-30
Landing with TAKEOFF Flaps	A8-3
Level Flight Characteristics	6-17
Level Flight Speed Acceleration	6-19
Lighting System	1-151
Lineup Allowance	A2-4
Liquid Oxygen Quantity Gage	1-156
Low and High-Level Force Optoswitches	1-147
Low Corrected RPM (High T2 Override)	1-13
Low Speeds	6-17
Low-Level Index and Low Level Warning Light	1-109

**M**

Mach Hold Switch	1-148
Mach Number Correction	A1-2
Main Gear Flat Tire Landing	3-51
Main Landing Gear	1-53
Main Oil Cooler	1-8
Main Parachute and Combined Harness	1-79
Maneuvering Boundaries	5-12
Maneuvering Flaps	6-2
Maneuvering Flight	6-20
Manual Frequency Selector Knobs	1-95
Manual Landing Gear Release Handle	1-55
Manual Override Handle and Guillotine System	1-79
Manual Separation From Seat After Ejection	3-22
Manual Start	2-9
Mark Point Acquisition	2-42
Mark Point Data Acquisition	1-146
Mark Point Data Acquisition Format	1-134
Mass and Balance	2-2
Maximum Allowable Airspeed	5-8
Maximum Endurance Performance	A5-1
Maximum Endurance Performance Sample Problem	A5-1
Maximum Glide	3-51
Maximum Performance Landings	A8-3
Maximum Range Performance	A4-1
Maximum Speed Pointer	1-66
Maximum Thrust	5-1

Maximum Thrust Climb Control . . . . . A9-2  
 Maximum Thrust Fuel Consumption . . . . . A9-4  
 Maximum Thrust Level Flight Acceleration . . . . . A9-1  
 Maximum Thrust Turning Performance . . . . . A9-2  
 Maximum Range – Constant Altitude Sample Problem . . . . . A4-1  
 Microphone Buttons . . . . . 1-97, 1-102, 1-105  
 Miles per Pound Chart Index . . . . . A6-1  
 Miles per Pound Chart Sample Problem – Military Thrust . . . . . A6-4  
 Miles per Pound Chart Sample Problem – Range . . . . . A6-2  
 Miles per Pound Charts . . . . . A6-1  
 Military Thrust . . . . . 5-1  
 Military Thrust Climb . . . . . A10-6  
 Military Thrust Fuel Consumption . . . . . A9-5  
 Minimum Run Landing . . . . . 2-31  
 Minimum Run Takeoff . . . . . 2-24  
 Missed Approach . . . . . 7-3  
 Missile Firing . . . . . 6-25  
 Mission Planning . . . . . A10-1  
 Mission Planning Example . . . . . A10-1  
 MRAAM Firing Envelopes . . . . . 5-14

**N**

Nautical Miles per Pound Sample Problem – Endurance . . . . . A6-3  
 NAVIGATE Mode – “NAV” . . . . . 1-116  
 Navigation Format . . . . . 1-133  
 Navigation Lights and Switches . . . . . 1-151  
 Navigation Mode . . . . . 1-125  
 Navigation Sub-System . . . . . 1-138  
 Navigation Sub-System Functionality under Failure Conditions . . . . . 1-145  
 Navigation System Functions . . . . . 1-141  
 Negative Dihedral . . . . . 6-2  
 Negative or Zero “G” Flight . . . . . 5-11  
 Night Flying . . . . . 7-6  
 No. 1 and No. 2 Hydraulic Systems Out . . . . . 3-32  
 No. 1 Hydraulic Power Supply System . . . . . 1-40  
 No. 1 System Out . . . . . 3-31  
 No. 2 Hydraulic Power Supply System . . . . . 1-40  
 No. 2 System Out . . . . . 3-31  
 Normal Landing . . . . . 2-30  
 Normal Operation of Cockpit Air-Conditioning and Pressurization System . . . . . 1-87  
 Normal Operation of Defogger and Rain-Remover System . . . . . 7-4  
 Normal Oxygen System Operation . . . . . 1-158  
 Normal Performance with Drag Chute . . . . . A8-1  
 Normal Performance Without Drag Chute . . . . . A8-2  
 Normal Takeoff . . . . . 2-22  
 Nose Gear Flat Tire . . . . . 3-51  
 Nose Gear Up Landing . . . . . 3-53  
 Nose Landing Gear . . . . . 1-55  
 Nosewheel Shimmy . . . . . 3-11

Nosewheel Steering and Microphone Button . . . . . 1-58  
 Nosewheel Steering System . . . . . 1-58  
 Nozzle Area Control System . . . . . 1-17  
 Nozzle Pump . . . . . 1-20

**O**

Obstacle Clearance Takeoff . . . . . 2-25  
 Oil Pressure Gage . . . . . 1-23  
 On Top Fix . . . . . 2-42  
 On Top Fixing Procedure . . . . . 1-145  
 On-Ground Operation . . . . . 1-98  
 On-Top Fixing (OTF) Format . . . . . 1-134  
 One Main Gear Up or Unlocked . . . . . 3-53  
 Optimum Cruise Altitude . . . . . A3-4  
 Outbound Fuel . . . . . A10-3  
 Oxygen Control Panel . . . . . 1-153  
 Oxygen Diluter Lever. . . . . 1-153  
 Oxygen Flow Indicator. . . . . 1-156  
 Oxygen Low Pressure Lamp . . . . . 1-156  
 Oxygen Normal/Emergency Lever. . . . . 1-156  
 Oxygen Pressure Suit Switch . . . . . 1-156  
 Oxygen Supply Lever. . . . . 1-153  
 Oxygen Supply Pressure Gage. . . . . 1-156  
 Oxygen Supply System . . . . . 1-153  
 Oxygen Supply System Controls and Indicators . . . . . 1-153  
 Oxygen System Failure . . . . . 3-36  
 Oxygen System Preflight Check . . . . . 1-156

**P**

Penetration Procedure . . . . . 7-2  
 Performance Capabilities . . . . . 6-12  
 Performance Data Basis . . . . . A1-1  
 Performance Envelope . . . . . 6-14  
 Personal Equipment Connector (PEC) . . . . . 1-81  
 Pilot Induced Oscillations . . . . . 6-22  
 Pilot/Crew Chief Check . . . . . 2-14  
 Pitch-Up Recovery and Spin Prevention . . . . . 3-38  
 Pitch-Up Recovery and Spin Prevention/Spin Recovery . . . . . 3-38  
 Pitchup and Spins . . . . . 5-8  
 Pitchup/Spin Recovery . . . . . 6-11  
 Pitchup/Spins . . . . . 6-11  
 Pitot Pressure and Static Systems . . . . . 1-65  
 Pitot-Pitch and Temperature Probe Heaters . . . . . 1-92  
 Pointer Mask. . . . . 1-109  
 Power Brake/Anti-Skid System . . . . . 1-60  
 Power Brake/Anti-Skid System Malfunction . . . . . 3-54  
 Power Retraction Unit . . . . . 1-79  
 Practice Stalls . . . . . 6-10  
 Pre-Flight Operation . . . . . 1-99  
 Precautionary High RPM/Thrust Pattern . . . . . 3-56  
 Precautionary Partial Power Pattern . . . . . 3-54  
 Precautionary Straight-In Pattern . . . . . 3-56  
 Precheck Test Switches. . . . . 1-30



Preflight Check	2-2
Preparation for Flight	2-1
Pressure Refuelling System	1-29
Pressure Regulator	1-25
Pressurizing And Drain Valve	1-8
Primary DC Bus Failure/TRU1 Failure	3-29
Primary DC Bus-Out Warning Light	1-39
Prohibited Maneuvers	5-8
Purpose of Chartes	A6-1

## R

Radar Altimeter	1-108
Radar Altimeter Preflight Check	1-109
Radar Approach	7-3
Rain-Remover System	1-88
Ram Air Turbine Extension Handle	1-41
Range Data Presented	A4-1
RAT Extended Flight	3-36
Rat Extension Limits	5-8
Rate of Climb Available for Go-Around	A8-3
Ready Navigation Lamp.	1-111
Recommended Constant Mach Climb Speed	A3-1
Refuel Switch.	1-30
Refueling Switch Panel	1-30
Refusal Distance	A2-2
Refusal Speed	A2-2
Restricted Maneuvers	5-11
Return and Reserve Fuel	A10-3
Rocket Pack	1-78
Roll And Pitch Attitude Stabilization	1-148
Roll, Pitch and Yaw Damper Switches	1-44
RPM Hangup.	1-15
RPM Lock-up Failure during Start	3-2
RPM Lockup	3-57
RPM Lockup Override Switch	1-17
RPM Reset Landing	3-57
Rudder	6-3
Rudder Pedals	1-43
Rudder Trim Switch.	1-49
Runway Marking System	A2-4
Runway Wind Component	A2-4

## S

Safety Pins	1-81
Sample Problem Tentative Flight Profile	A10-1
Satellites Detection Status	1-125
Scope and Arrangement	A1-1
Seat Adjustment Mechanism	1-81
Secondary Airflow Supply	1-16
Selected Tank Empty Light	1-28
Selection of Destination Waypoint (Fly To Function)	2-41
Selective External Stores Release Selector Switch	1-33
Selective Jettison	1-32
Servicing Data	1-159

Simulated Flame-Out Landing	3-45
Single AC (WF) Generator Failure	3-24
Single-Point Refueling	1-29
Smoke or Fumes in Cockpit	3-22
Speed Brake System	1-53
Speed Brakes	6-4
Speed Brakes Switch.	1-53
Spin Recovery	3-38
Spotlights	1-153
Squelch Switch.	1-97
Stability Augmentation System	1-44
Stability Augmentation System Failure	3-39
Stability Augmenters	6-3
Stabilizer	6-3
Stabilizer Trim Marker	1-49
Stabilizer, Aileron, and Rudder Takeoff Trim Indicator Lights	1-49
Stalls	6-6
Standard Altitude Table	A1-4
Standard Emergency Oxygen Supply System (MB-Stand Ox)	1-83, 1-153
Standard Units Conversion Chart	A1-4
Standby Attitude Indicator	1-69
Standby Compass	1-68
Standby Master Brake System	1-61
Start Switches.	1-5
Starter Limitations	5-5
Starting Engine	2-9, 7-6
Station Point Listing Format	1-134
Steer-Damper Unit	1-58
Stick Shaker Failure	3-16
Stick Shaker Stall Warning	1-47
Stopping the Engine	7-8
Stored Heading - "STO"	1-115
Stored Heading Alignment	2-41
Strange Field Procedures	2-38
Stuck-Throttle Landing (Alternate Procedure)	3-58
Subsonic 1 "G" Flight	6-11
Subsonic Accelerated Flight	6-11
Subsonic Stall.	1-14
Supersonic Flight	6-11, 6-19
Supersonic Formations	6-28
Supersonic Stall.	1-15
Survival Pack	1-73
Symbols and Definitions	A1-1
Synchronizing Knob.	1-125

## T

TACAN Control Panel	1-117
TACAN Operation	1-119
TACAN Station Approach from a Desired Radial	1-119
TACAN Steering Mode	1-142
Tachometer.	1-2
Tactical Air Navigation (TACAN) System	1-117
Takeoff	2-22, 7-7, 7-8

Takeoff (Maneuvering) Flaps Extended . . . . . 5-12  
 Takeoff and Landing Data Card . . . . . 2-1  
 Takeoff Characteristics . . . . . 6-5  
 Takeoff Emergencies . . . . . 3-4  
 Takeoff Flaps Landing . . . . . 2-34  
 Takeoff Planning and Charts . . . . . A2-1  
 Takeoff Planning Problem at Heavy Weight . . . . . A2-5  
 Takeoff Planning Problem at Light Weight . . . . . A2-4  
 Takeoff Speed Schedules . . . . . A2-1  
 Takeoff with Asymmetric Loads . . . . . 2-25  
 Taxiing . . . . . 2-18  
 Taxiing Instructions . . . . . 7-7  
 Temperature Amplifier . . . . . 1-19  
 The Aircraft . . . . . 1-1  
 Throttle . . . . . 1-9  
 Throttle Control System Malfunction . . . . . 3-40  
 Thrust and Drag . . . . . 6-12  
 Thunderstorm Lights . . . . . 1-151  
 Time Release Mechanism . . . . . 1-79  
 Tip Tank Oscillations . . . . . 6-27  
 Tire Failure . . . . . 3-12  
 Tire Pressure . . . . . 1-159  
 TOD Acquisition . . . . . 1-100  
 TOD TRANSMISSION . . . . . 1-100  
 Total Distance to Clear a 50-Foot Obstacle . . . . . A2-4  
 Touch-and-Go Landings . . . . . 2-34  
 Trailing Edge Flap Asymmetry Detection System . . . . . 1-50  
 Trailing Edge FLAP ASYMMETRY Warning Light . . . . . 1-52  
 Transition Time and Fuel Allowances . . . . . A3-1  
 Trim Control System . . . . . 1-48  
 Trim Failure or Runaway Trim . . . . . 3-39  
 Turbulence and Thunderstorms . . . . . 7-5  
 Turn Switch. . . . . 1-150  
 Turning Performance . . . . . 6-21

**U**

UHF AN/ARC-150 (HQ) Control Panel . . . . . 1-95  
 UHF AN/ARC-150 (HQ) Operation . . . . . 1-97  
 UHF Have Quick System Operation . . . . . 1-98  
 UHF RADIO AN/ARC-150 . . . . . 1-93  
 Unaccelerated Stalls . . . . . 6-8  
 Use of Miles per Pound Charts . . . . . A6-1

**V**

Vane Closure Actuator . . . . . 1-12  
 Vane Closure Valve . . . . . 1-12  
 Variable Stator Actuators . . . . . 1-12  
 Variable Stator System . . . . . 1-11  
 Vent Float Valves . . . . . 1-25  
 Vertical Stall Recovery . . . . . 6-12  
 Vertical Velocity Indicator . . . . . 1-69  
 Volume Control Knob. . . . . 1-95, 1-102, 1-117

**W**

Warmup and Ground Check . . . . . 7-7  
 Warning Light . . . . . 1-115  
 Warning Light Test System . . . . . 1-72  
 Warning Lights . . . . . 1-105  
 Warning Lights Dimming System . . . . . 1-70  
 Warning Lights Panel System . . . . . 1-70  
 Warning Lights System . . . . . 1-70  
 Weight Limitations . . . . . 5-14  
 Wheel Brake System . . . . . 1-60  
 Wild Frequency Engine-Driven Generators . . . . . 1-35  
 Wild Frequency Generator Control Unit (1 and 2) . . . . . 1-35  
 Wind Component . . . . . A2-1  
 Wing Flap System . . . . . 1-50  
 Wing Flaps Lever . . . . . 1-52  
 Wing Flaps Position Indicators . . . . . 1-52  
 Wing Flaps Retracted . . . . . 5-12  
 WOD Check . . . . . 1-100  
 WOD Loading . . . . . 1-98  
 WOD Recall . . . . . 1-99  
 WOD/MWOD Erasing . . . . . 1-99

**Z**

Zoom Climbs . . . . . 6-14