

CONVAIR

880/600

Jet Airliners





FOREWORD . . .

The new Convair 880 and 600 Series airliners will soon take their place in the jet transportation age, fully equipped to meet the challenge of present and future requirements for fast, economical performance in medium and long range operation.

These newest commercial jet airliners have been designed to fulfill specific requirements of the airlines for speed, economy, safety, and utility of operation with minimum of maintenance.

Combining the ultimate in structural integrity and "fail-safe" design, that has characterized every Convair-built airplane for the past 34 years, the "880" and "600" Series jet airliners also possess a versatility that permits operation from most present-day, world-wide airports designed for propeller-driven aircraft.

The many combinations of seating arrangements offer the airline operator a flexibility never before available; yet no feature has been overlooked in decorative interiors and in luxurious appointments to achieve passenger appeal, comfort, convenience, and acceptability.

**Reprint from CONVAIR TRAVELER
September 1958**

THE CONVAIR

880 JET AIRLINER



The Convair 880 jet airliner is a medium range airplane with long range capabilities. This airliner, with its sister-ship, the Convair 600, are the two fastest jet airliners in the world.

The "880" is powered by four General Electric CJ805-3 turbojet engines equipped with sound suppressors and thrust reversers, permitting operation from present day airports designed for propeller-driven aircraft.

The "880" interiors are designed for a wide variety of seating arrangements. The seating configuration can be readily converted from first-class to combinations of first class and tourist accommodations, thus offering airline operators a versatility and flexibility never before available.

Direct operating costs have been calculated to be \$1.22 per airplane statute mile for first class operation over route segments of 1500 statute miles or longer. The economic advantages of four-across seating have been demonstrated by public preference.

CONVAIR 880 INTERIORS

TYPICAL SECTION WITH STANDARD SEATING

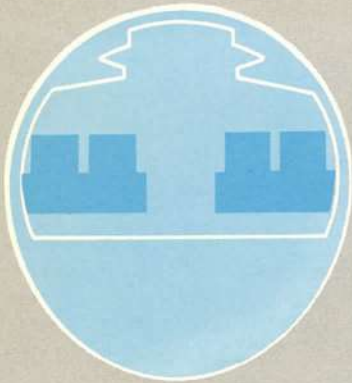

TYPICAL SECTION WITH COACH SEATING

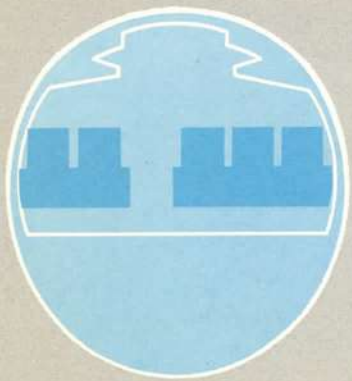

- A** BUFFET
- B** SERVICE DOOR-EMERG. EXIT
- C** EMERGENCY EXIT
- D** PILOT COMPARTMENT
- E** COATS
- F** STEWARDESS
- G** LAVATORY
- H** MAIN ENTRANCE-FWD
- I** MAIN ENTRANCE-AFT
- J** CLUB AREA

FIRST-CLASS SEATING ARRANGEMENT — 88 PASSENGERS

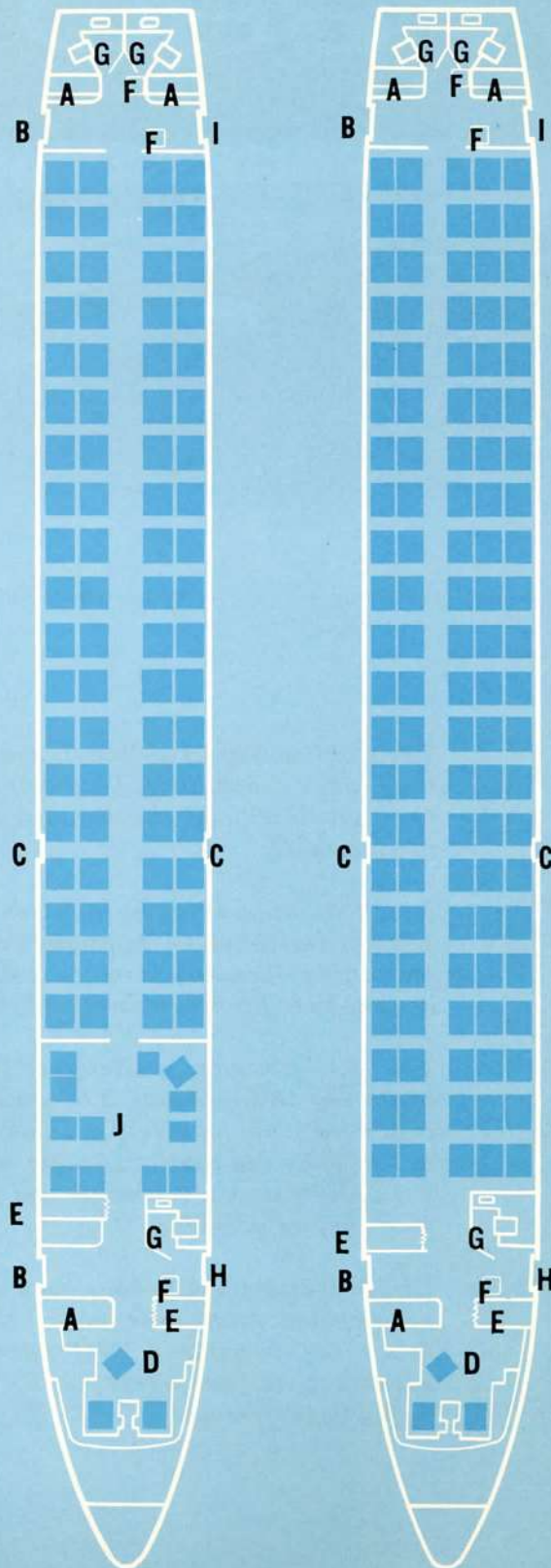

ALL-COACH SEATING ARRANGEMENT WITHOUT FWD RH BUFFET AND COAT CLOSET
110 PASSENGERS — 5-ACROSS SEATING

The Convair 880 cabin is readily convertible from first-class to tourist seating and combinations of first-class and tourist seating arrangements. These arrangements offer airline operators a versatility and flexibility of operation never before available.

Design objective has been to create interesting groupings in the passenger cabin and to avoid the "tunnel" effect sometimes seen in conventional airplanes. This has been achieved by varying the ceiling levels to compartmentalize the passenger cabin without the use of partitions. To further enhance interior decor, and to create a feeling of division, each alternate block of three rows of seats is upholstered in a shade of contrasting or harmonizing color. This conforms to the grouping achieved by the varying ceiling levels.

The cabin may also be divided by inserting coat-closet dividers at any of six points, according to

seating arrangement required for a particular flight. A club compartment, accommodating 12 persons, adds to the overall feeling of spaciousness, yet requires no more area than does conventional seating.

Luxury plus comfort were designed into the interiors by nationally-known industrial designers and stylists. Advanced sound-proofing techniques were developed to further enhance the smooth quiet flight of the Convair 880.

Indirect lighting, from fluorescent covers in the ceiling, tends to compartmentalize the area. There is additional indirect lighting at panels above each pair of windows. Windows, instead of being curtained, are equipped with tinted glass to filter the brighter sunlight encountered at altitudes seven miles above the earth. In addition, complete outside light may be eliminated by glare shield controls or shades at each individual window.



STRUCTURAL DETAIL OF THE 880 FUSELAGE

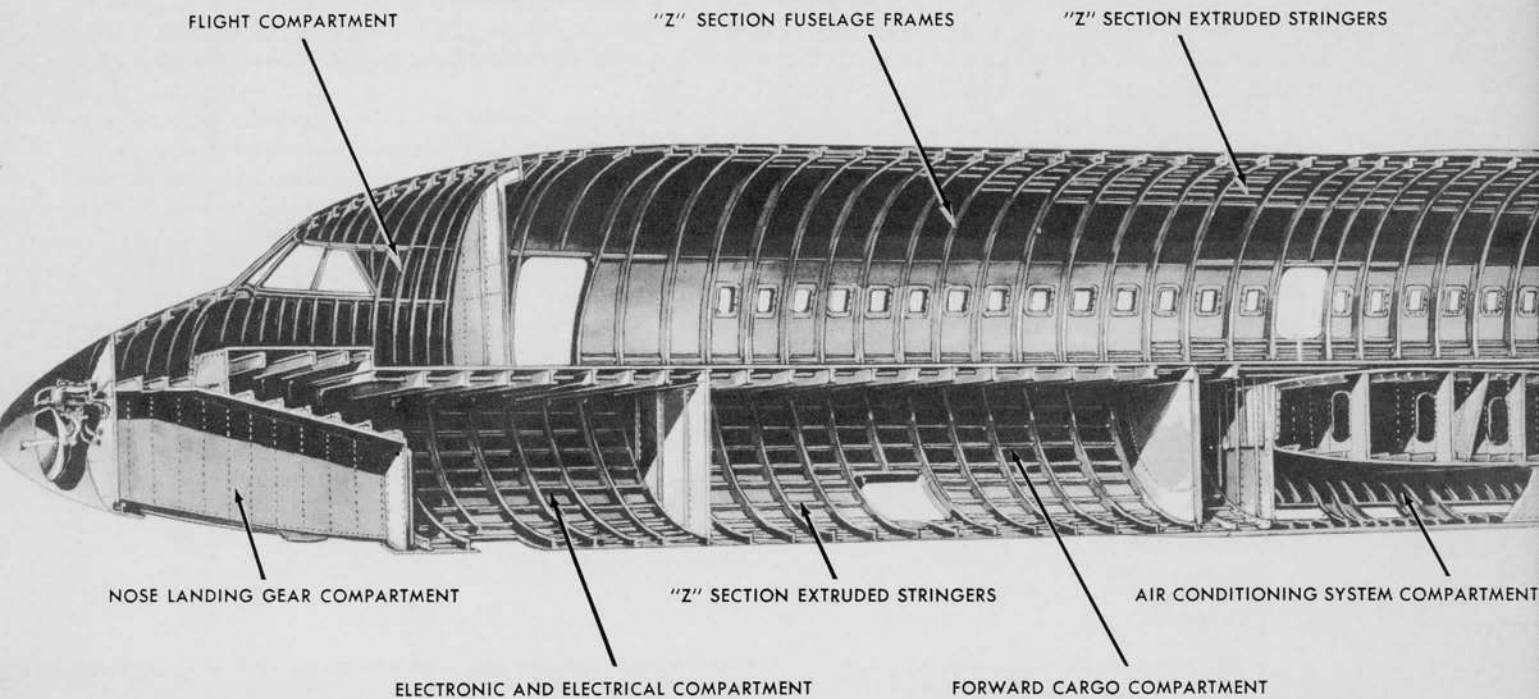

PASSENGER WINDOW DETAIL

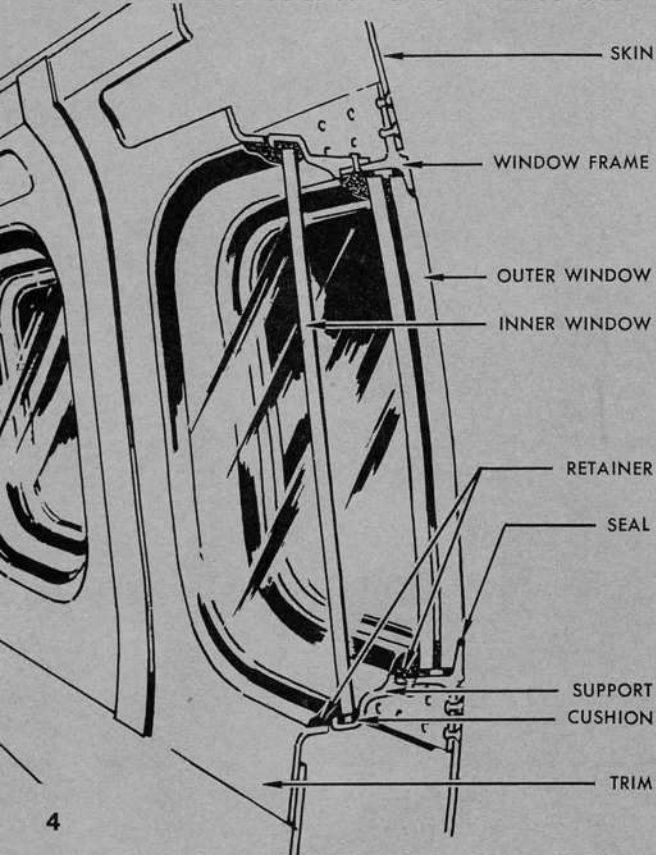

"Fail-Safe" design techniques were applied to all features of construction throughout the Convair 880 fuselage to achieve positive structural integrity. From acoustic attenuation to bird-proofing, and from wind tunnel testing to water tank immersion cycling, all major fuselage components have undergone rigorous testing to ensure an operationally sound airplane.

In addition to maximum quiet, vibration-free flight, and the ultimate in seating comfort, the Convair fuselage structure offers extra measures of safety. Due to the extra heavy fuselage skins (.063 to .100), it is expected that skin stresses in the Convair 880 will be low enough to preclude fatigue cracks throughout the life of the airplane.

An additional safety feature has been designed into the plug-type loading door, designed exclusively for pressurized high-altitude aircraft. With this design, increasing cabin pressure has a tendency to increase the security and retention of the door under any flight condition.

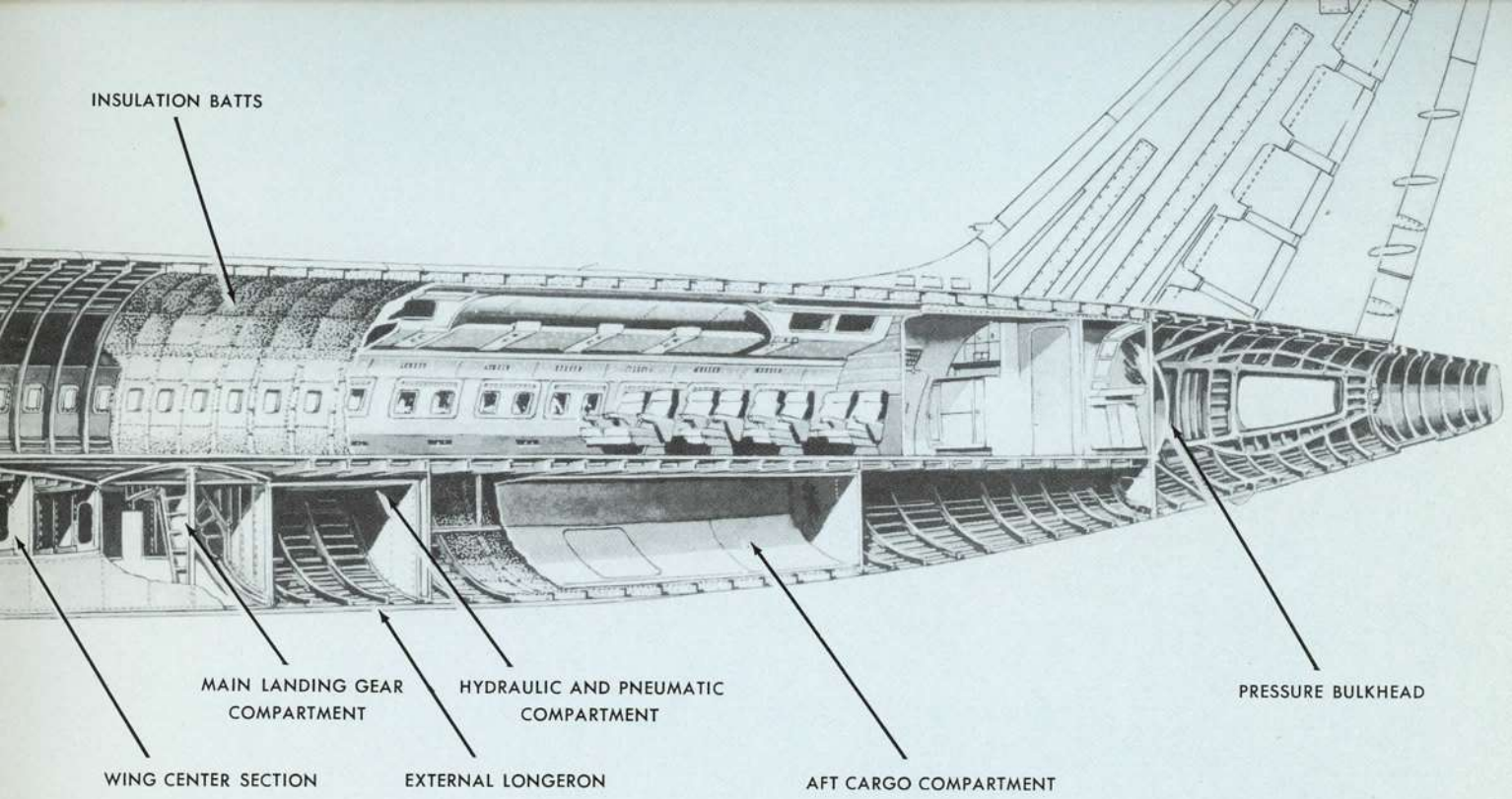

FAIL-SAFE DOOR DESIGN

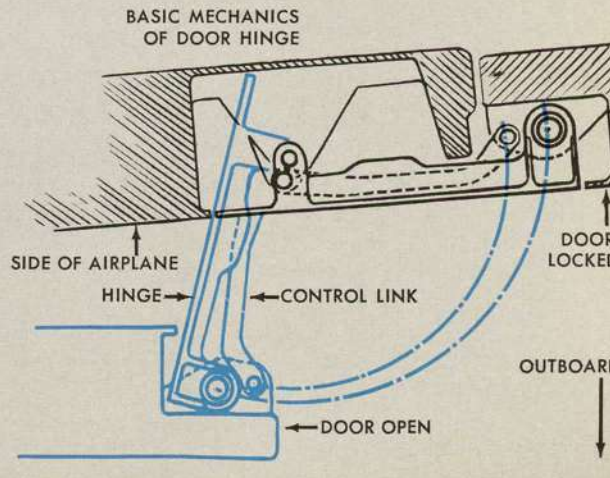
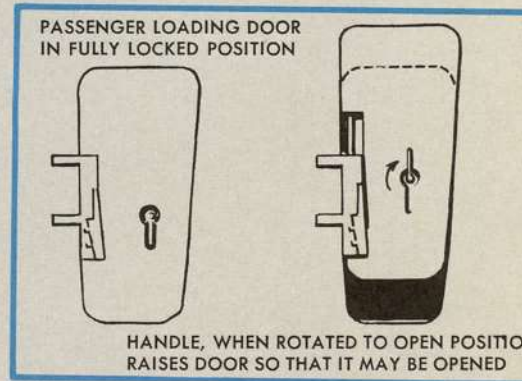
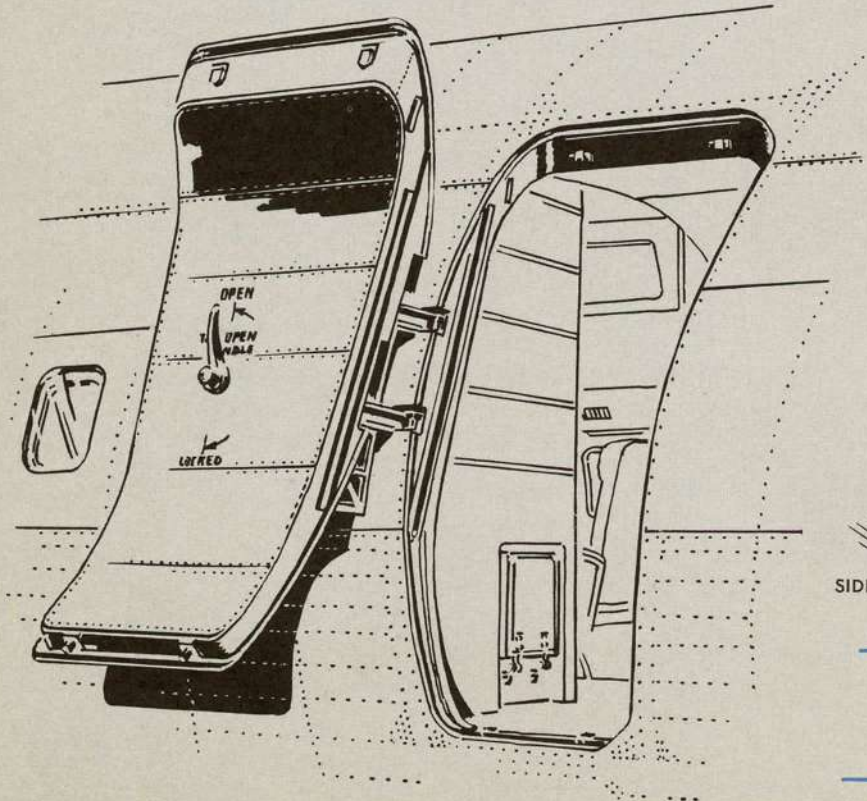

THE 880 WING STRUCTURE

TOP VIEW

BOTTOM VIEW

FRONT SPAR

REAR SPAR

BULKHEADS

OUTBOARD SPOILER

CENTER SPAR

INBOARD SPOILER

AUXILIARY SPAR

INBOARD FLAP

AILERON

OUTBOARD FLAP

HINGED ACCESS DOORS

FUEL TANK
ACCESS DOOR (18)

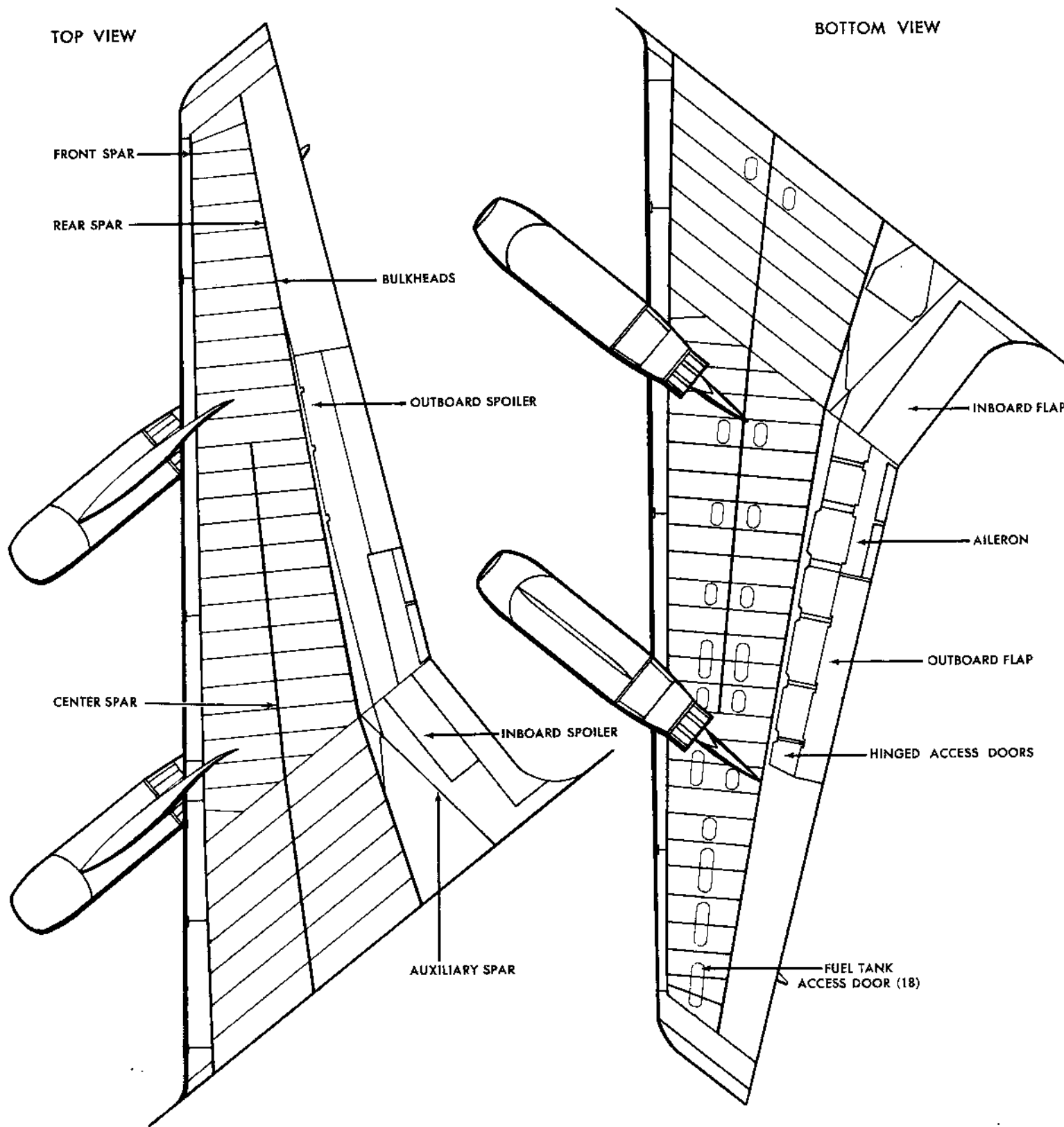

Structural integrity in the wing of the Convair 880 has been achieved through the incorporation of a multitude of "fail-safe" design features. "Fail-Safe" design is accomplished by load and stress distribution throughout the structure so that failure of any given part will not compromise the overall integrity of the wing.

Wing design is of the front, center, and rear spar type with web stiffeners and truss-type bulkheads forming an integral box-like structure. An auxiliary spar, for support of the main landing gear, is joined to the wing box structure and fuselage to maintain maximum integral load and stress distribution.

Employment of the Scotch-Weld adhesive bonding process in the integral wing fuel tanks culminates more than 23 years of advancement in fuel tank design by Convair. The Scotch-Weld process ensures leakproof construction, and contributes a bonus in structural strength and corrosion resistance.

Use of the Scotch-Weld process on the Convair-built F-102 and F-106 supersonic all-weather Air Force jet interceptors has proved its superiority over other methods now employed in the aircraft industry. Its use on the integral wing fuel tanks of the Convair 880 will assure equal maintenance-free, leak-proof operation under all conditions of jet flight.

UPPER & LOWER WING SURFACES

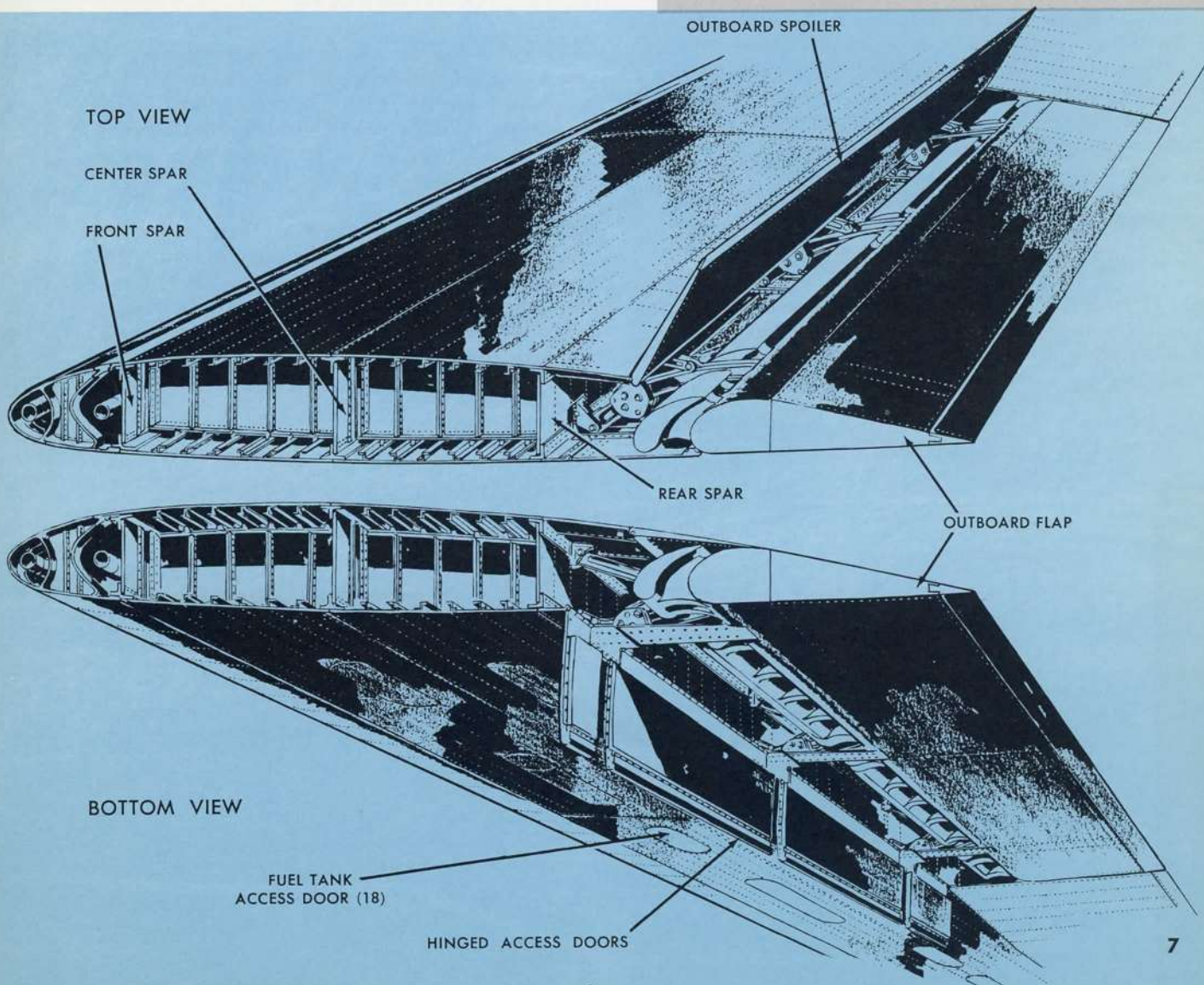

CABIN PRESSURIZATION

The Convair 880 is equipped with an air conditioning and pressurization system that is not only the most efficient available today, but one that is also virtually fail safe.

The "880" air conditioning and pressurization system is composed basically of two separate and independent subsystems, pneumatically-driven by bleed air from the four CJ805-3 engines. Each subsystem consists primarily of a ram air supercharger (bleed air turbine-driven compressor), an air-to-air heat exchanger, and a vapor cycle Freon refrigeration unit.

Under normal operation, one subsystem supplies fresh air for the cabin; the other supplies air for the flight deck. Each subsystem is controlled separately but, if one subsystem becomes inoperative, the other will supply comfortable air conditioning and pressurization for both the cabin and flight deck for continuation of the flight.

The vapor cycle refrigeration unit is essentially a Freon loop system that uses Freon 114 (dichlorotetrafluoroethane), a stable, non-toxic fluid. The Freon loop contains a compressor and drive, condenser, evaporator, and the necessary control valves. Moisture, present in the air passing through the Freon evaporator, condenses on the cool surfaces of the evaporator, forming large drops that are drained and dumped overboard. Thus, moisture, in the form of either liquid or fog, will not enter the cabin.

During ground air conditioning operations, the vapor cycle system effects a rapid pull-down of cabin air temperature without the use of large external cooling carts. Ground operations are further im-

proved by recirculating part or all of the cool cabin air through the Freon evaporator, instead of dumping it overboard. Consequently, load on the system and time required to lower the cabin temperature are reduced.

An electrically-driven vapor cycle Freon system is available as an optional installation. This system is basically the same as the pneumatic-driven system except that the Freon condenser fan and compressor are driven by an electric motor. Also, in the electrically-driven system, an electric heater is employed in the cabin and flight deck main distribution line for ground heating.

Cabin pressurization is automatically regulated by two cabin pressure regulator outflow relief valves, and a cabin pressure outflow control and indicator. One pressure regulator outflow valve is located in a pressurized area at the aft end of the airplane; the other is located in a plenum chamber containing electrical equipment, at the forward end of the airplane.

Each valve functions independently, offering an extra margin of protection. In the event of malfunction of one valve, the remaining outflow valve is capable of maintaining normal control of cabin pressure. A flow equalizer control is incorporated to divide the total cabin flow through each valve.

The Convair 880 pressurization system is designed to provide sea level comfort at altitudes up to 20,500 feet; at 40,000 feet, cabin air pressure will be the same as that which exists at 8,000 feet; humidity at a level compatible with temperature will be maintained. Automatic controls will prevent any sudden changes in pressurization during rapid climb or descent.

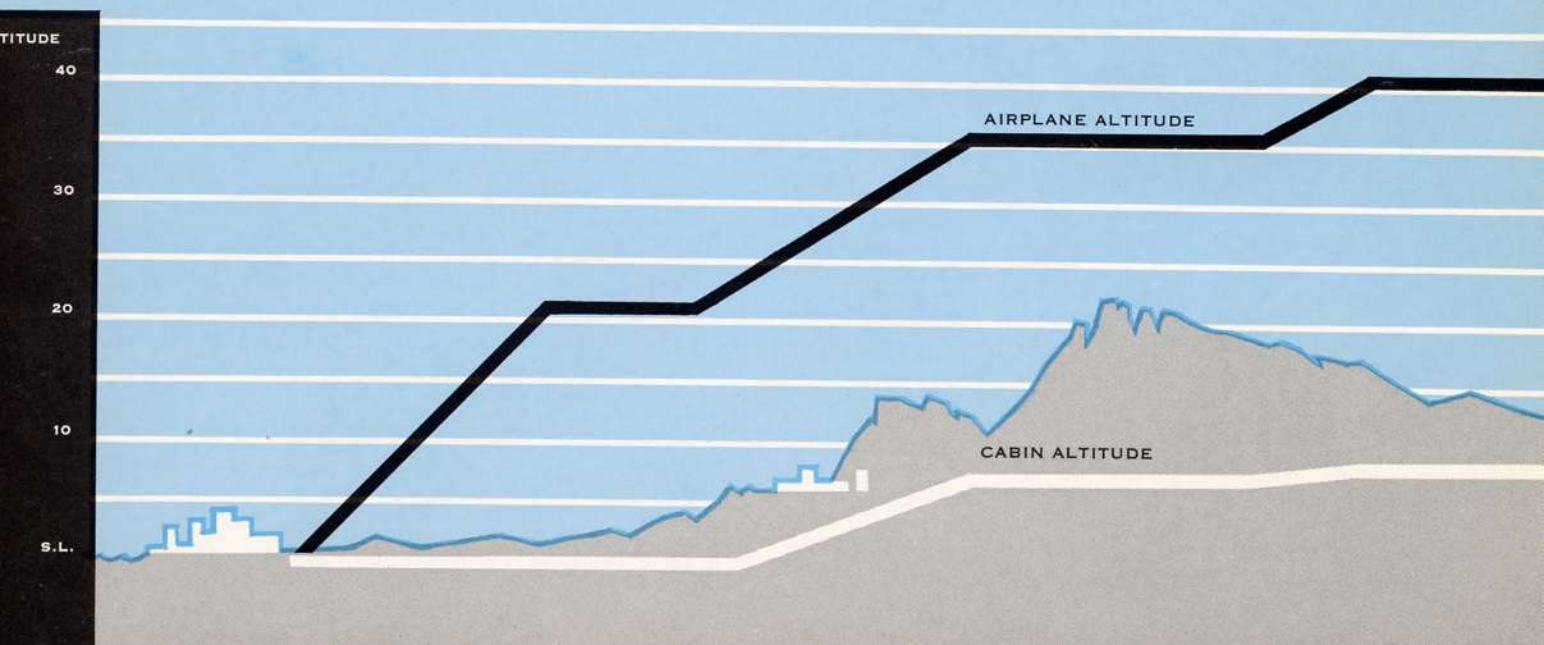

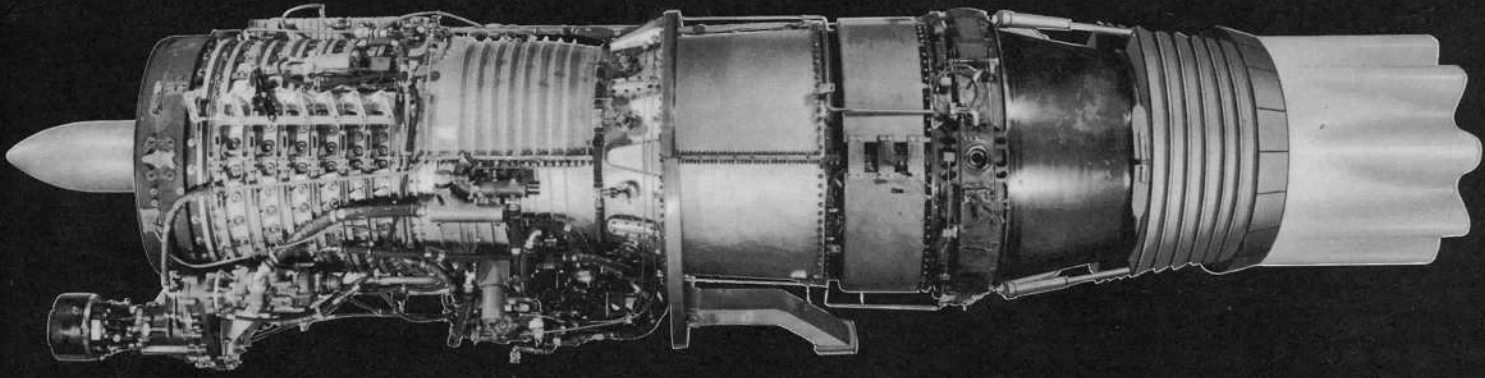

THE 880 POWER PLANT CJ805-3

The Convair 880 is powered by four CJ805-3 General Electric engines, installed in pods attached to pylons suspended from the wings. This powerful engine is a single-spool, axial-flow, high-pressure-ratio turbojet with thrust reverser and sound suppressor.

The CJ805-3 is characterized by unusual simplicity of design, light weight, low-specific fuel consumption, and maximum accessibility for servicing, line maintenance, and overhaul.

Removal and replacement of an engine can be accomplished in approximately 30 minutes. A unique feature of the engine and pod design is the use of only three engine mounting points . . . a stabilizing mount at the forward top of the engine, and two main trunnion-type mounts on the horizontal centerline in the plane of the engine turbine case. The turbine, combustion, and compressor sections are structurally surrounded by removable casings of horizontally split-type construction, which facilitate access when performing internal inspections and/or repairs.

Turnaround servicing ordinarily will not require raising the side panels of the pod. Doors are provided in the cowlings alongside the pylon for access to the upper pod area and, on the right-hand side, for access to the oil tank fill ports for checking oil levels and

refilling. When the panels are raised, all lines and accessories are immediately accessible, not only for inspection but also for replacement of accessories and components in line maintenance.

The CJ 805-3 is designed to provide maximum thrust on either JP-4 or kerosene fuels. The engine fuel system uses pump discharge fuel for hydraulic operation of variable compressor stator actuators and as coolant for engine lubricating and constant-speed drive oil.

The two principal pilot controls for each engine are the power and reverse thrust lever, and the engine start and fuel shutoff lever. A significant and highly advantageous feature of the General Electric engine is its instantaneous acceleration with power lever advance.

A thrust reverser, incorporating a gate-like mechanism that alters the direction of exhaust gas flow to a forward direction, is mounted on the aft end of the engine turbine frame and is utilized as a braking device during the landing roll of the aircraft. A sound suppressor is installed on the aft face of the thrust reverser and forms the aft portion of the engine exhaust section. The suppressor reduces engine noise by providing an exhaust exit configuration that enlarges the area in which the exhaust gases mix with the surrounding air.

CONVAIR 880 PERFORMANCE

	MODEL 22
MAXIMUM DISPATCH WEIGHT	185,000 LB.
ARRIVAL WEIGHT—	
FIRST-CLASS	121,150 LB.
ARRIVAL WEIGHT—	
COACH-CLASS	125,355 LB.
FUEL RESERVES	9,600 LB.
MAXIMUM FUEL TANKAGE	10,770 GAL.
PLACARD SPEED	375 KTS. EAS

ALTITUDE FOR OPTIMUM SPEED OPERATION 22,500 FT.

(BASED ON OPTIMUM COST OPERATION)

COST BASIS—1955 ATA METHOD MODIFIED TO INCLUDE: ZERO WIND, MANUFACTURER'S GUARANTEED MATERIAL COST, 1000 HOURS BETWEEN ENGINE OVERHAUL, 10-YEAR DEPRECIATION PERIOD, 50% ENGINE SPARES COST

CRUISE MACH NO. = 0.84 AT 35,000 FT

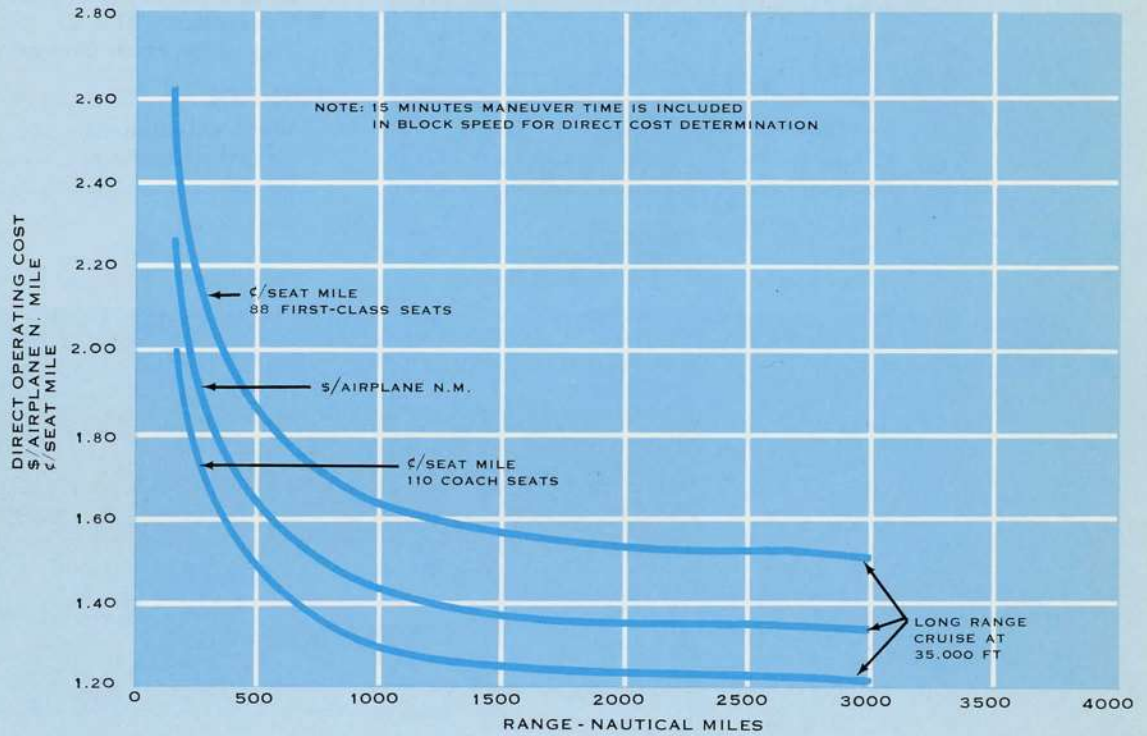

BASED ON:

165 LB/PASSENGER
40 LB BAGGAGE/PASSENGER
CARGO @ 10 LB/CU FT

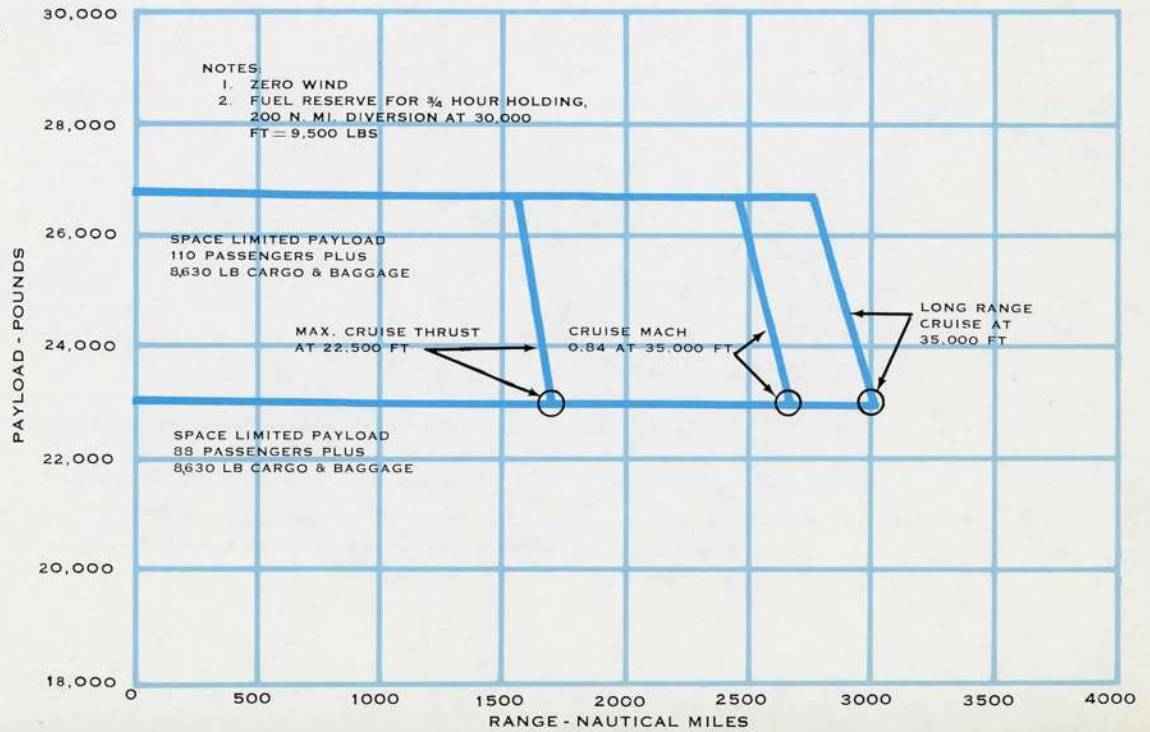

WHEELS UP—WHEELS DOWN
CONVAIR 880—MODEL 22

NOTES:

1. OPTIMUM SPEED CASE—
MAXIMUM CRUISE THRUST
AT 22,500 FT
2. ISA & ZERO WIND

CHICAGO
TO
KANSAS CITY

352 N. MILES
44 MINUTES

SAN FRANCISCO
TO
CHICAGO

1,611 N. MILES
3 HOURS 6 MINUTES

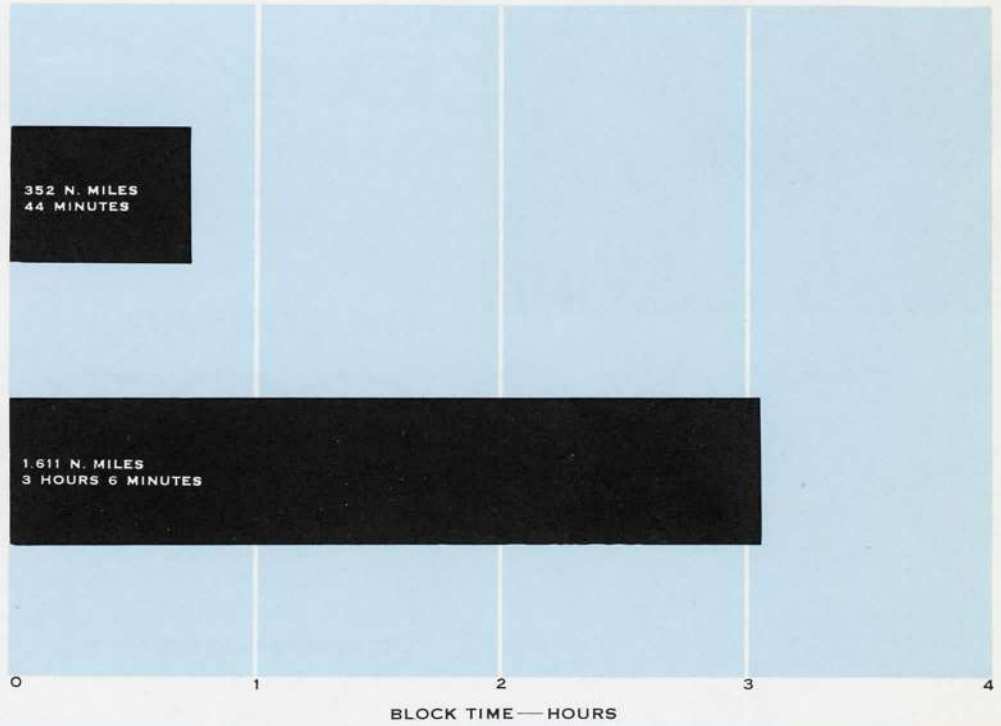

BLOCK SPEED
CONVAIR 880—22

NOTES:

1. DOMESTIC FIRST CLASS
CONFIGURATION
2. MANEUVER ALLOWANCE—15 MINS

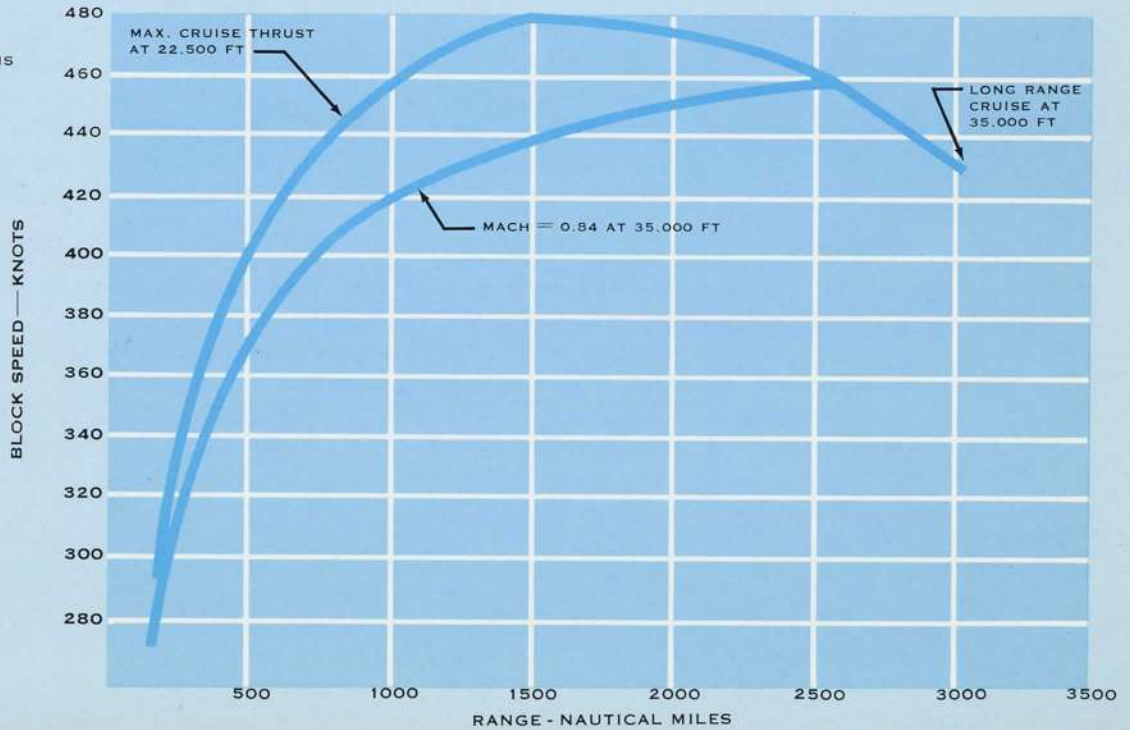



THE CONVAIR
600
JET AIRLINER...

the world's newest

and fastest passenger transport

with a cruising speed of

635 miles per hour.



THE CONVAIR 600 . . .

The world's fastest passenger transport, the Convair 600 jet airliner is the first transcontinental airliner designed for operation at near sonic speeds.

The Convair 600 will be powered by four General Electric CJ805-21 aft-fan engines. Like the CJ805-3 engine, the -21 was developed from the Air Force J79 turbojet which powers the world's fastest B-58 "Hustler" bomber. The CJ805-21 provides greater thrust and lower cost of operation through utilization of the bypass air and fan principle.

The Convair 600 offers, for the first time in a jet transport, an economical four-across seating arrangement. Luxurious cabin interiors with a wide variety of seating arrangements in both first class and tourist accommodations, and sea-level cabin pressurization at high altitudes, assures the maximum in passenger comfort and safety combined with economical operation.

Estimated long range operating costs have been calculated at \$1.28 per airplane statute mile for first-class domestic operation at ranges of 2500 statute miles or more. Low turnaround time is another factor that characterizes the Convair 600.

The Convair 600 has been specifically designed for operation from airports presently designed for propeller-driven aircraft.

CONVAIR 600 INTERIORS

TYPICAL SECTION WITH
STANDARD SEATING

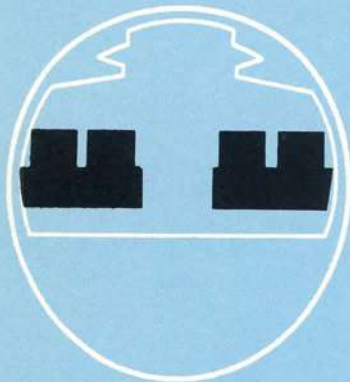

TYPICAL SECTION WITH
COACH SEATING

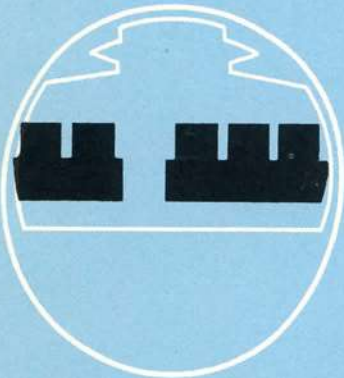

- A** BUFFET
- B** SERVICE DOOR-EMERG. EXIT
- C** FLIGHT DECK
- D** OBSERVER'S SEAT
- E** MAIN ENTRANCE-FWD
- F** MAIN ENTRANCE-AFT
- G** EMERG. EXIT EACH SIDE
- H** LOUNGE
- I** COAT CLOSET
- J** LAVATORIES

FIRST-CLASS SEATING ARRANGEMENT — 96 PASSENGERS

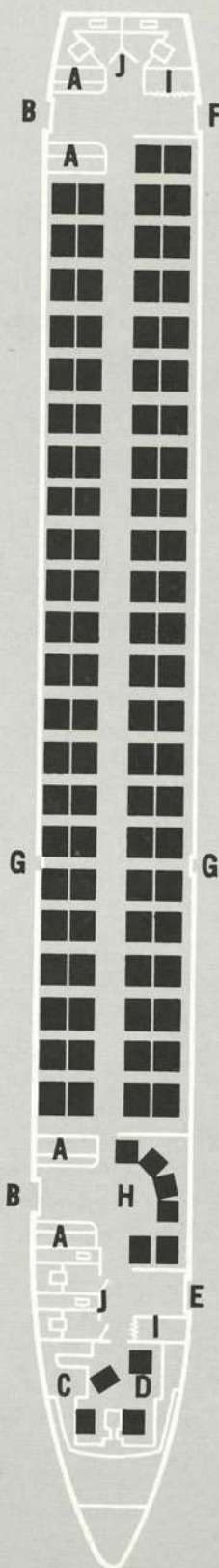

ALL-COACH SEATING ARRANGEMENT — 121 PASSENGERS

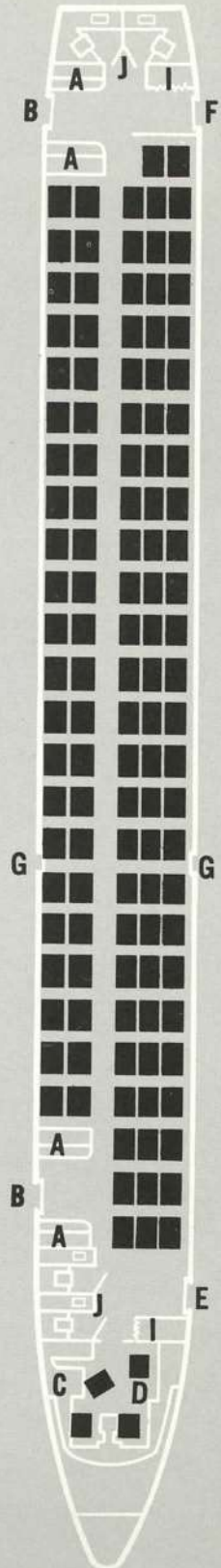

The Convair 600 provides new standards in comfort, convenience, and safety. The interesting interior design is enhanced by roominess, the cabin being designed with "two-on-the-aisle" seating. In the coach version, three abreast seating is used only on one side of the aisle.

Interior groupings and a feeling of compartmentation are obtained by varying ceiling levels and interior decor without the need for partitions. This interior planning eliminates the tunnel effect sometimes seen in conventional airliners.

In the tourist configuration, passengers will find the same emphasis on spaciousness and comfort. In the five-abreast seating arrangement, arms and shoulder room will be the same as in many present-day deluxe seating arrangements.

For each passenger, there is a built-in folding tray for food service. The hinged tray is available at a touch of the passenger's fingers. The tray may be used also as a surface for writing. There are four buffets, two forward and two aft. There are two lavatories at each end of the main cabin. A lounge in the forward section provides deluxe seating for six in formal groupings.

The cabin furnishings and interiors are designed with fine textured surfaces for ease of cleaning and maintenance. Fluorescent lighting in ceiling coves provides indirect lighting. Additional indirect lighting at panels above each pair of windows tends to add to the compartmentation effect. Windows, instead of being curtained, are equipped with tinted glass to filter the brighter sunlight encountered at altitudes seven miles above the earth.

COACH CLASS - FIVE-ACROSS SEATING

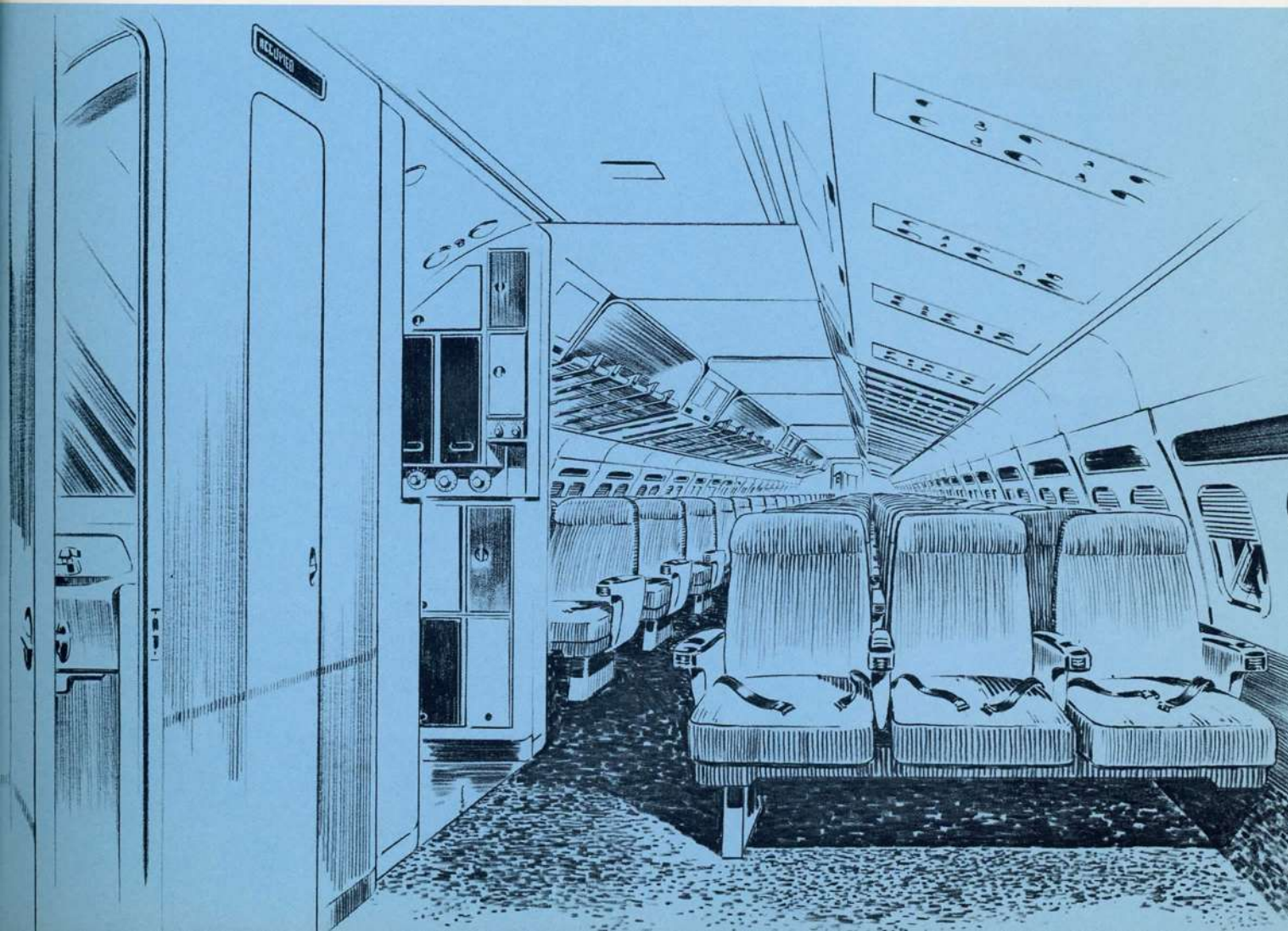

STRUCTURAL DETAIL OF THE 600 FUSELAGE

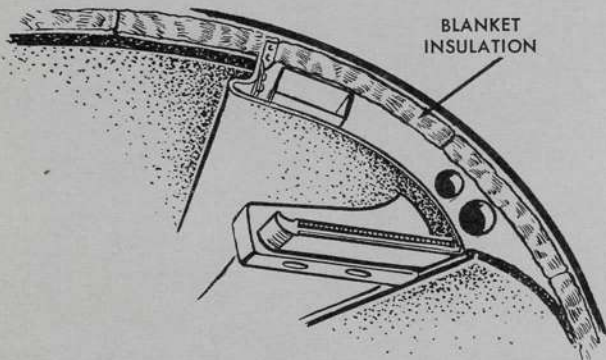
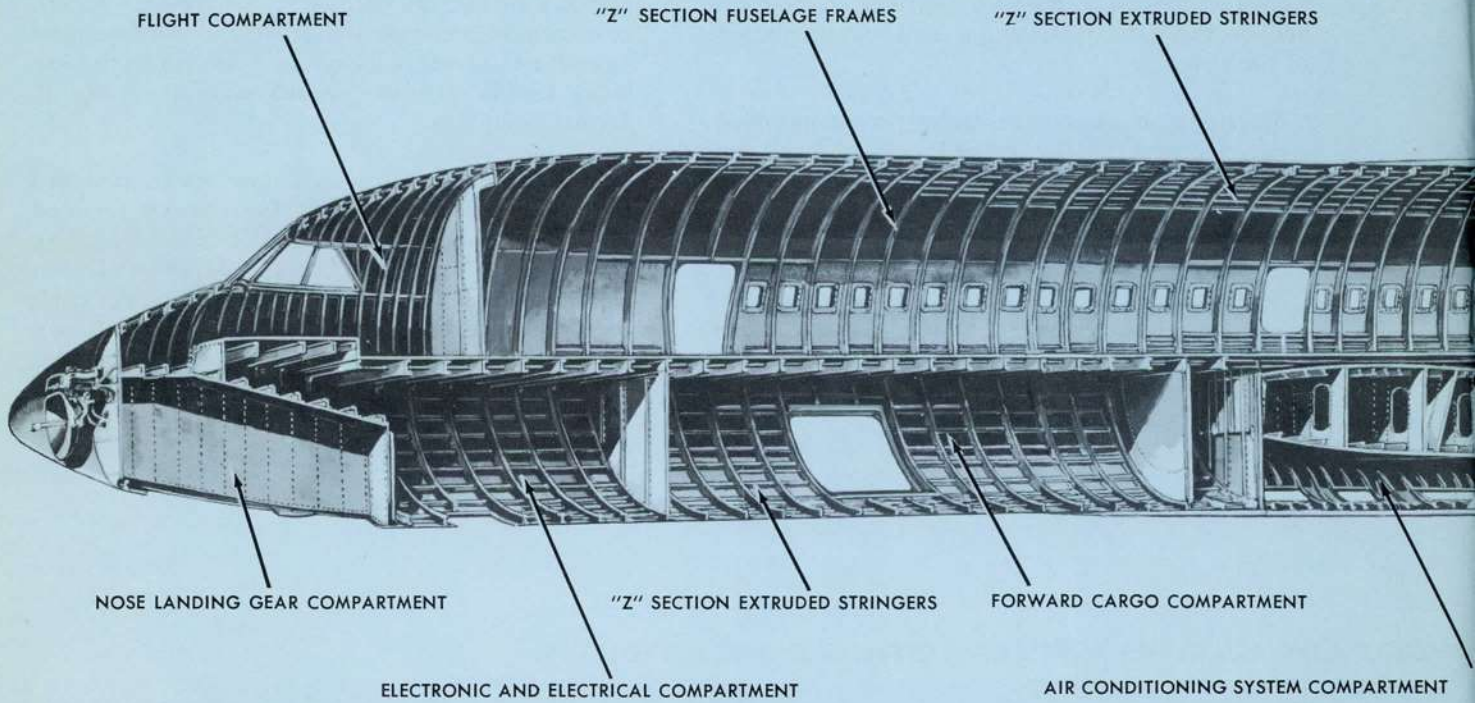

INSTALLATION OF BLANKET

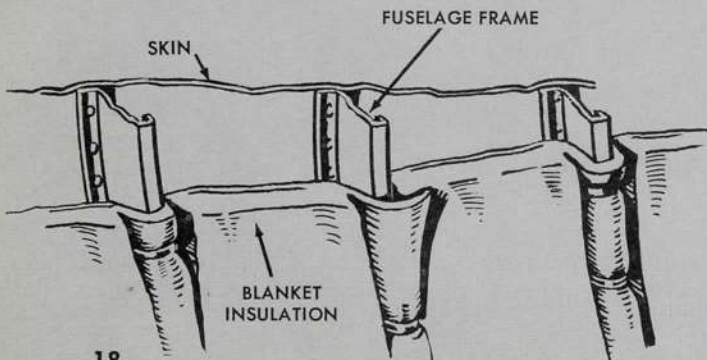

The fuselage of the Convair 600 is of semimonocoque construction, incorporating transverse frames and longitudinal stiffeners, with aluminum alloy sheet covering. The extra thick skins on the fuselage serve a dual purpose. In addition to decreasing the noise level in the cabin, the use of heavier skins eliminates the need for stringers over a considerable area. This results in lower pressurization-induced stresses, and in weight reduction. By this design approach, it is expected that skin stresses in the fuselage will be low enough to preclude fatigue cracks throughout the life of the airplane.

A machined keel member ensures structural continuity in a region where the normal fuselage structure is interrupted by the wheel wells and, to a lesser extent, by the wing center section. The use of transverse floor beams, without use of vertical floor support members, reduces landing shock in the event of a wheels-up landing.

The plug-type loading doors and the window design carry out the fail-safe approach that is used throughout the airplane structure.

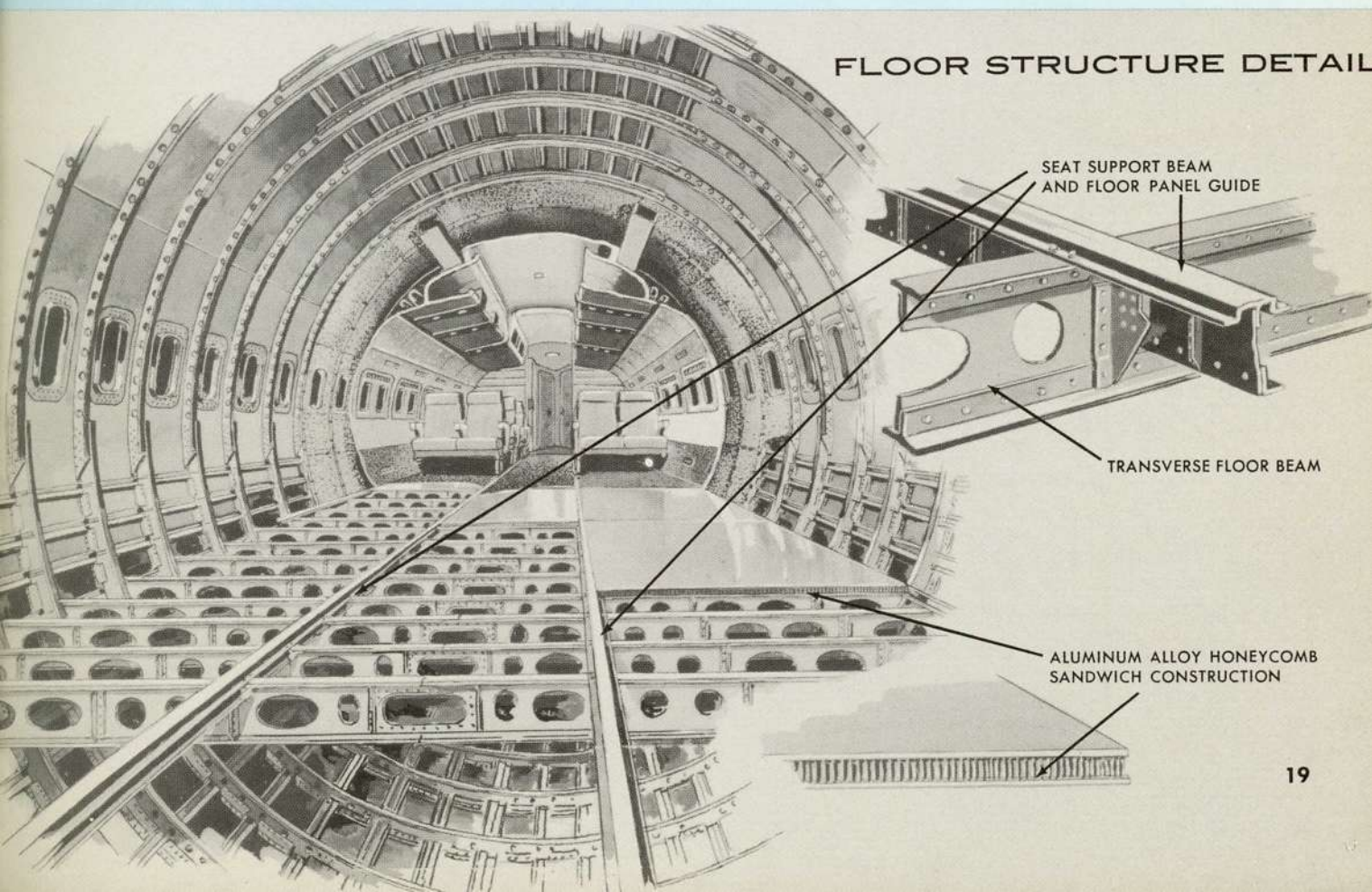
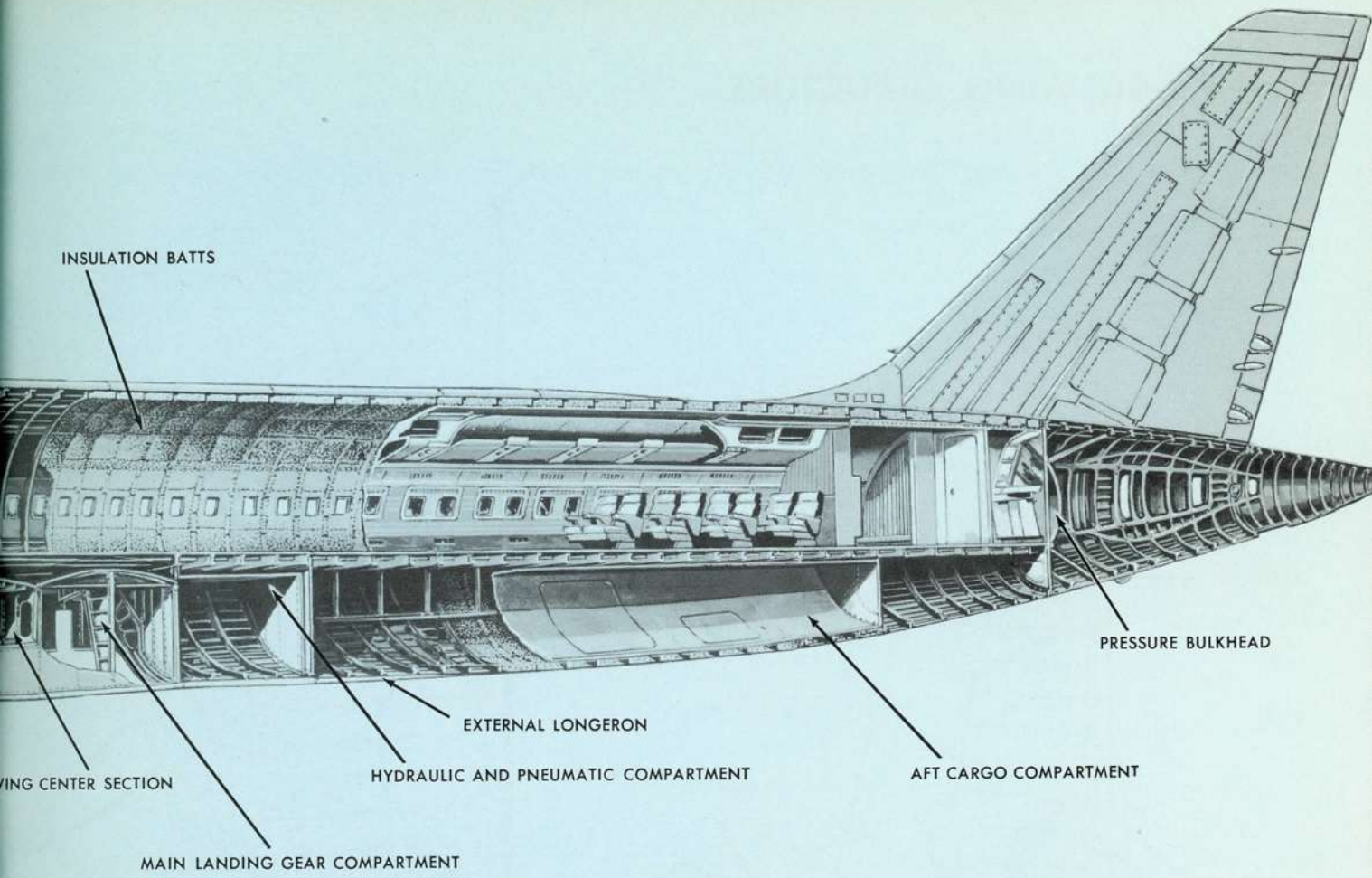

THE 600 WING STRUCTURE

TOP VIEW

BOTTOM VIEW

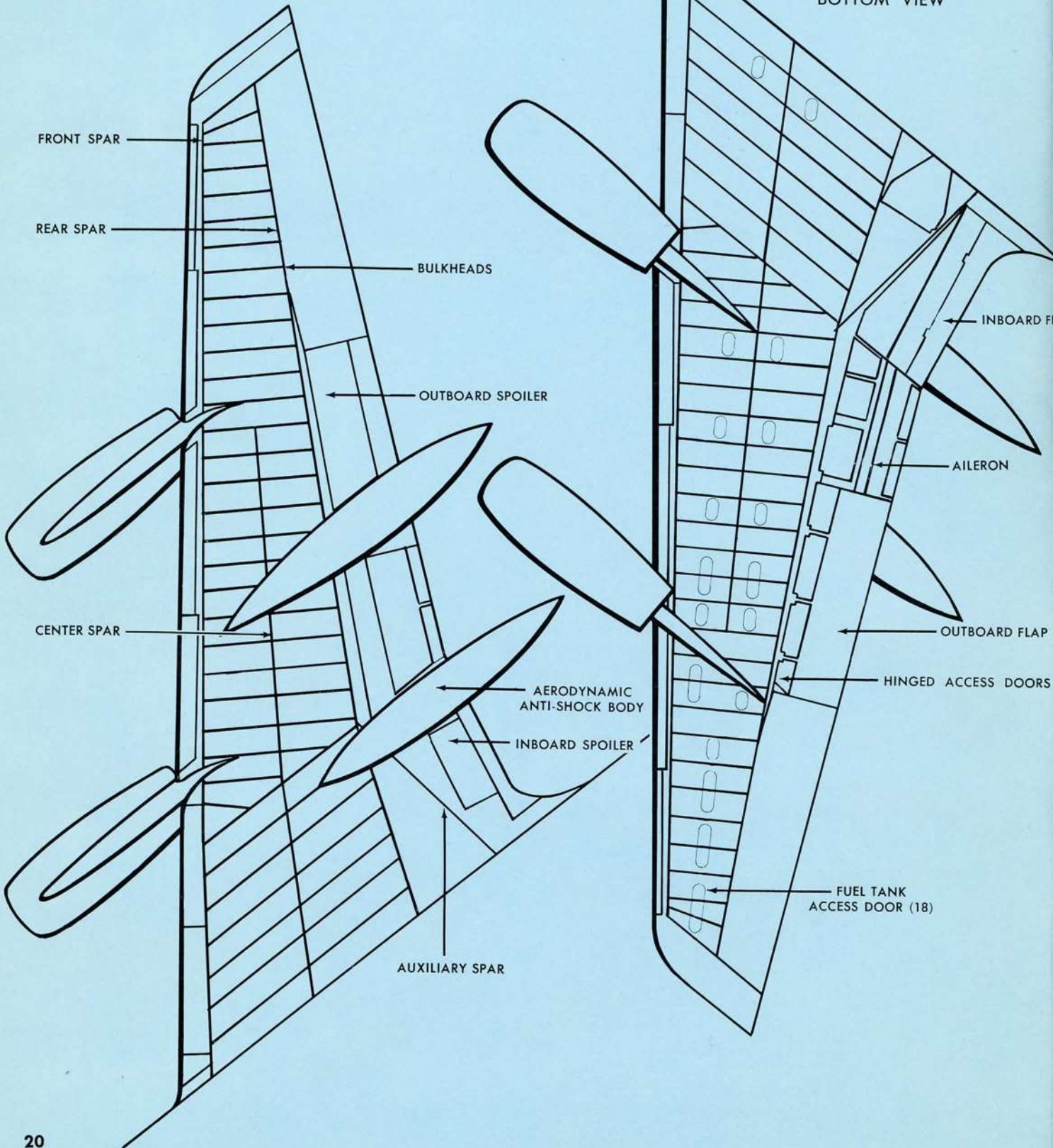

Wing design of the Convair 600 consists of multiple spanwise spar members, ribs and bulkheads of truss and web-type construction, with plate-stringer type upper and lower surfaces. This box-type structure incorporates the ultimate in "fail-safe" construction by providing equal distribution of flight and landing loads.

Scotch-Weld adhesive bonding is used in the wing and wing fuel tanks to seal and strengthen the structure. This process was pioneered by Convair and has proved itself in military use in F-102 and F-106 interceptors.

Wings sealed with Scotch-Weld provide strong, leakproof construction. The bonding adds a bonus not only in structural strength but in fatigue and corrosion resistance, and is satisfactory for use with any present-day jet fuel, at temperatures from -65° to 250° F.

Convair-designed anti-shock bodies, mounted on the upper surface of the wing, dissipate shock wave buildup on the wing during operation in the higher Mach ranges. This design and the advanced aerodynamic contouring of the wing, are principal factors in making the "600" the fastest commercial jet transport available.

Fuel capacity for long-range operation is provided in the anti-shock bodies and in tanks in the wing box structure.

Leading edge slats — flap-like extensions of the leading edge that permit high wing angle-of-attack — combine with the flaps to yield high lift at low speeds. Spoilers, flaps, and slats, and advanced wing design, make possible efficient operation at high gross weights from runways now utilized by propeller-driven aircraft.

UPPER & LOWER WING SURFACES

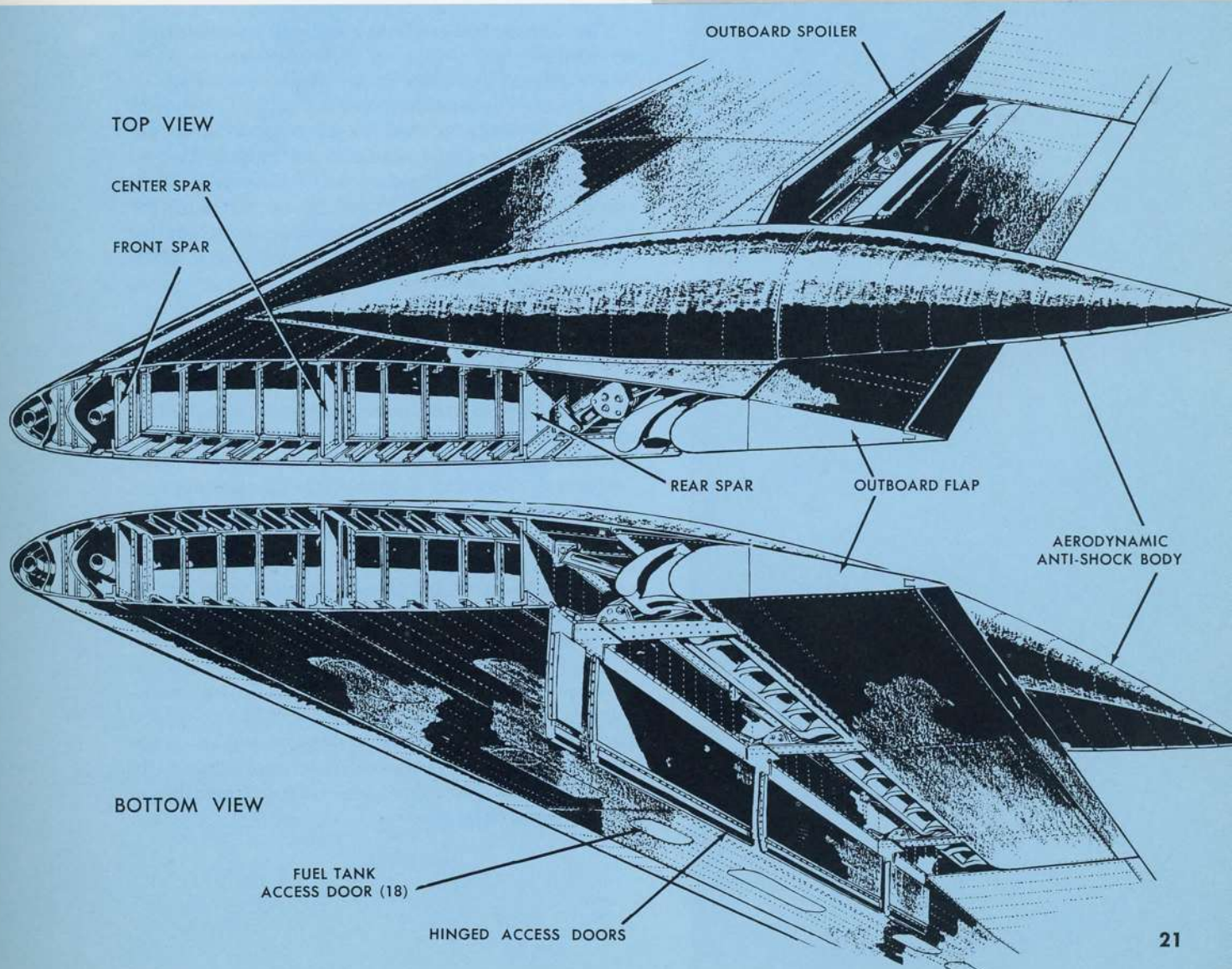

CABIN PRESSURIZATION

The Convair 600 air conditioning and pressurization system is designed to supply all occupied compartments of the airplane with an air flow of 160 pounds of air per minute at sea level, and 120 pounds per minute at 35,000 feet.

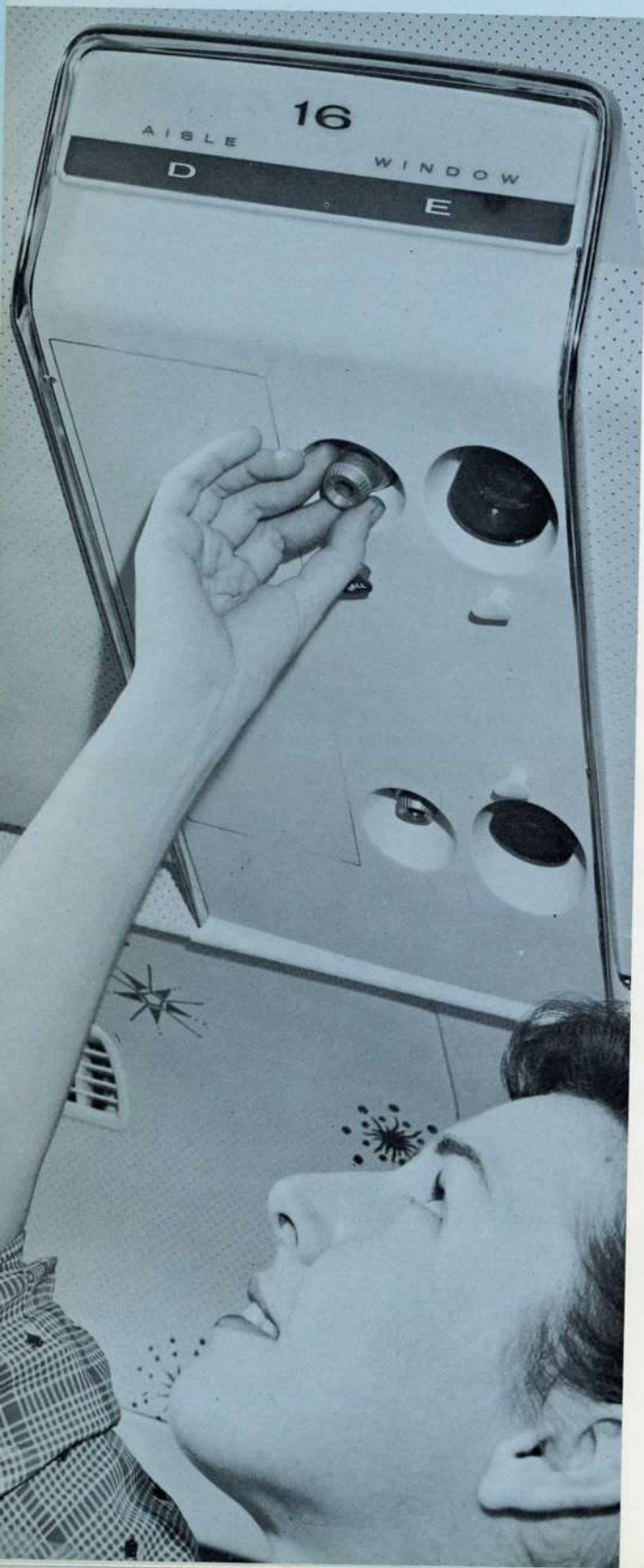

The air conditioning system supplies circulating fresh air, heated or cooled, as conditions require. A complete change of air is delivered to the cabin every 2½ minutes and to the flight deck every minute.

The cabin maintains a temperature of 75°F in flight under all ambient temperature conditions and a maximum of 80°F on the ground. At all outside air temperatures . . . whether 100°F or -40°F . . . the air conditioning system keeps passengers comfortable without unpleasant air surges or annoying drafts.

Each passenger has a silent individual cold-air inlet to provide direct airflow, if desired. All air entering the cabin through the outlets below the hatracks is discharged through the side panel floor exit ducts, and then is dumped overboard.

Heating and cooling of baggage compartments and of electrical and electronic equipment is also provided by the air conditioning system.

The Convair 600 can hold a sea level cabin altitude up to an airplane altitude of 20,500 feet, and an 8,000 foot cabin altitude up to an airplane altitude of 40,000 feet. The maximum normal cabin differential operating pressure is $8.2 \pm .10$ psi. In event of failure to both cabin pressure regulator sections of the outflow valves, the relief valves will relieve at a differential pressure of $8.5 \pm .10$ psi. Signal lights on the flight deck control panel will indicate the respective valve failure, and a warning horn will sound when cabin altitude exceeds 10,000 feet.

Presetting of the rate of change of cabin pressure control permits operating at rapid rates-of-climb and descent with a minimum rate-of-change of cabin altitude. Flow is maintained automatically against all normal loads imposed upon the system by the ever-changing demand for pressurization and ventilation.

The rate of cabin pressure change is selectable from 2000 ± 200 fpm to 65 ± 35 fpm. The nominal calibration is $500 \text{ fpm} \pm 10$ per cent. Deviation from selected cabin pressure rate-of-change during transient conditions will not be greater than ± 25 fpm.

The basic air conditioning system is composed of two separate and independent subsystems, pneumatically-driven by bleed air from the CJ805-21 engines. Each subsystem consists primarily of a ram air supercharger (bleed air turbine-driven compressor), an air-to-air heat exchanger, and a vapor cycle Freon refrigeration unit.

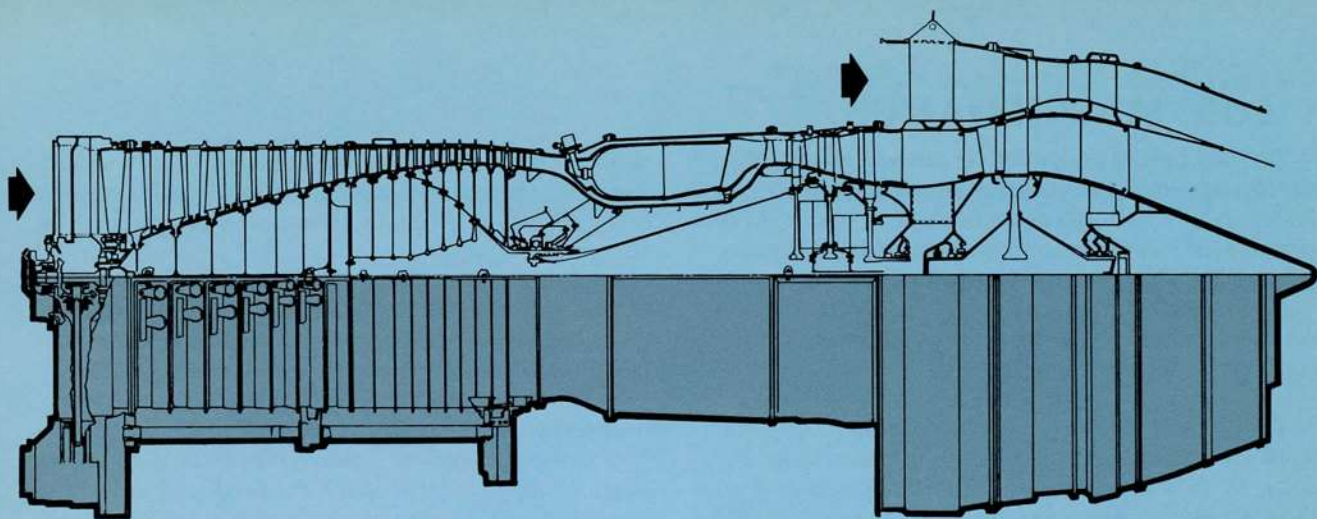

THE 600 POWER PLANT CJ-805-21

The General Electric CJ805-21 aft-fan engine is the newest available modification of the jet engine principle, combining the best elements of jet and propeller operation.

The aft fan, as its name implies, is driven by exhaust gases aft of the compressor turbine at comparatively high speed. The fan blades are turbine buckets at the root half, compressor blades at the tip half. The fan has the effect of driving a greatly increased volume of air aft, at a somewhat slower speed than the jet blast, adding to the engine's overall thrust.

The propulsive efficiency of aircraft power plants is determined by the ratio of gas velocity to aircraft speed, whether the power plants are propeller, jet, or fan types. Ideal obtainable efficiency is reached when jet velocity is $1\frac{1}{2}$ to 2 times aircraft velocity, which is approximated by the fan engine design.

The CJ805-21 is designed for ideal efficiency in the Mach .8 to Mach .9 speed range. At this cruise range, the jet-to-aircraft velocity ratio is approximately 1:7.

The CJ805-21 has the highest bypass ratio of any turbine fan currently being offered — 1.56:1. This bypass ratio was selected because it gives optimum specific fuel consumption for the design cruise range. In addition, the high bypass ratio provides a

substantial improvement in takeoff thrust without the need for increased turbine temperature over the straight turbojet.

The aft fan of the CJ805-21 is free-floating. It is supported fore and aft by its own bearings, and is not connected to the basic compressor/turbine rotor. It is a single-stage fan with integral turbine and compressor sections.

The aft-fan front and rear frames have eight all-steel struts. The outer struts are anti-iced at the leading and trailing edges.

Possibly the most important single advantage of the CJ805-21 aft-fan engine is its low cost of operation. The CJ805-21 engine uses the same gas generator as does the CJ805-3 — the simplest offered today. The -21 engine provides the same ease of inspection, assembly and disassembly, and the same economy of maintenance and overhaul as does the CJ805-3.

A thrust reverser, producing up to 50% engine thrust in the reverse direction, is a part of the engine assembly.

The takeoff and climb thrust of the CJ805-21 has very important advantages: it gets aircraft to altitude faster, minimizing the noise problem in communities surrounding airports; and it permits takeoff from shorter runways at high gross weight.

600 MAINTENANCE

Design of the Convair 600 jet airliner was planned to effect the maximum utilization of current facilities and ground handling equipment and a minimum of maintenance. New equipment items needed for support of the airplane are electrical power and pneumatic compressor units at route stations. All other servicing functions can be accomplished by existing equipment, with little or no modification.

The Convair 600 may be towed forward or backward by any tug capable of towing other large aircraft. A power source at the tug is required to provide light and communication power, and for operation of the aircraft emergency hydraulic pump to assure adequate brake pressure. The nose wheel steering disconnect permits a 360-degree swivel of the nose wheel.

In taxi operations, the "600" compares advantageously with large propeller-driven transports. With a wheel tread of 20 feet, 1 inch, and a wheel base of 57 feet, 1¼ inches, the "600" has a turning radius of 61 feet with a nose wheel steering angle of 70 degrees. No expansion of existing parking, loading, and taxi-way areas is necessary.

Built-in structural integrity of the "600" has been carefully calculated to minimize maintenance, and to provide an ease of maintenance unparalleled in the jet transport field. This has been achieved through the utilization of bonus features which have become an integral design characteristic throughout the structure of the "600."

Convair has developed an integral method of fuel tank construction which eliminates fuel tank leaks.

Sealing of the fuel tanks by the Scotch-Weld method not only eliminates leaks, but eliminates corrosion, and provides a bonus in structural strength within the wing.

The selection of a General Electric "package" electrical system, tailored to the requirements of the "600" jet transport, is expected to simplify maintenance, thus minimizing service man-hours and stop-over time. By obtaining the complete electrical system from one vendor, a ready supply of such spare parts as may be needed will be assured, and problems involving the system can be given concentrated attention.

The CJ805-21 power plant is characterized by unusual simplicity of design. The turbine, combustion, and compressor sections are structurally surrounded by removable casings of horizontally split-type construction, which facilitate rapid access when performing internal inspection and adjustments. Removal and replacement of the engine can be accomplished in approximately 30 minutes.

Turnaround servicing ordinarily will not require raising the side panels of the pod assembly. Doors are provided in the cowlings alongside the pylon for access to the oil tank fill ports for checking oil level and filling. When the panels are raised, all lines and accessories are immediately accessible, not only for inspection but for replacement of accessories and components in line maintenance.

Service doors are so located that servicing of the aircraft does not interfere with cargo and passenger loading.

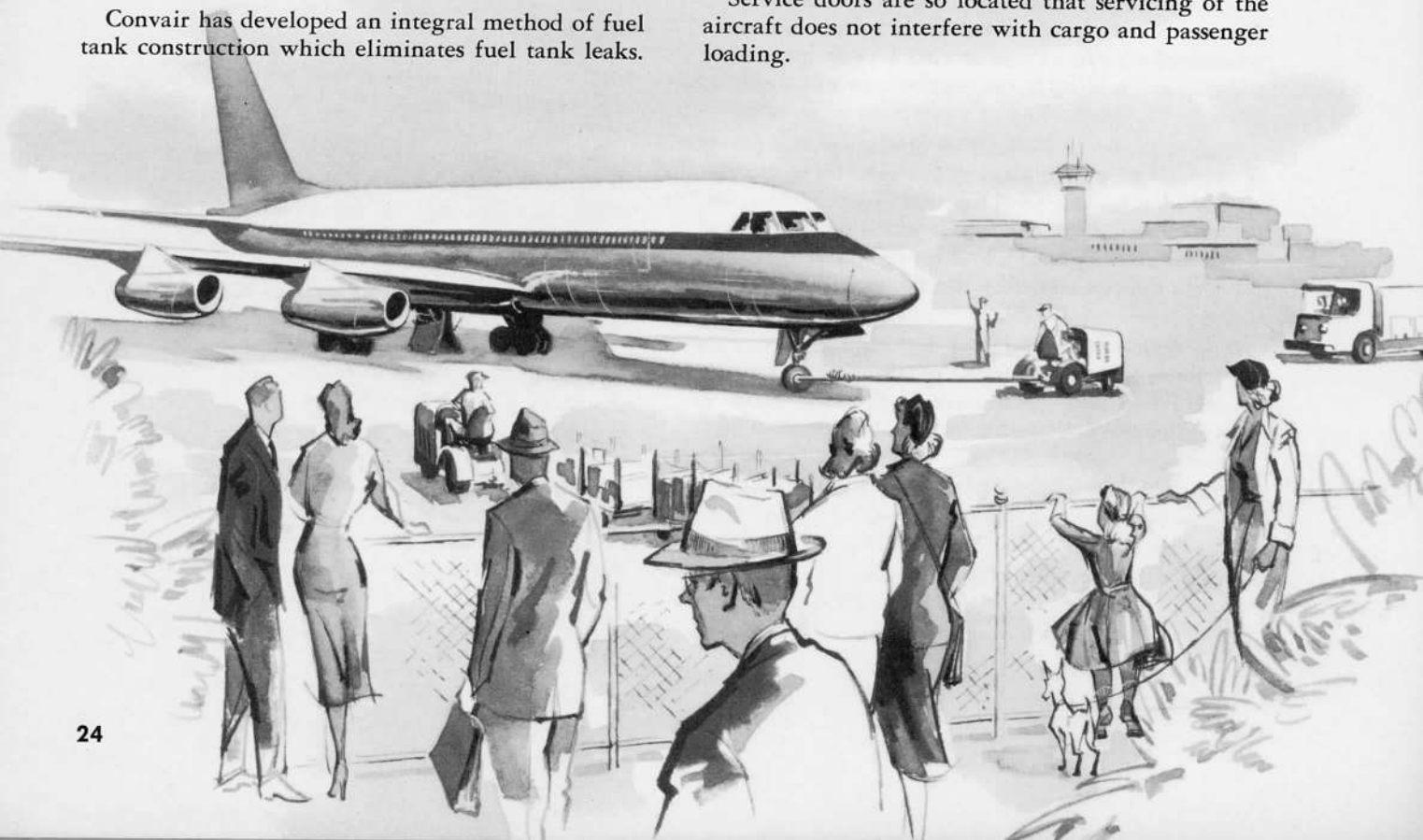

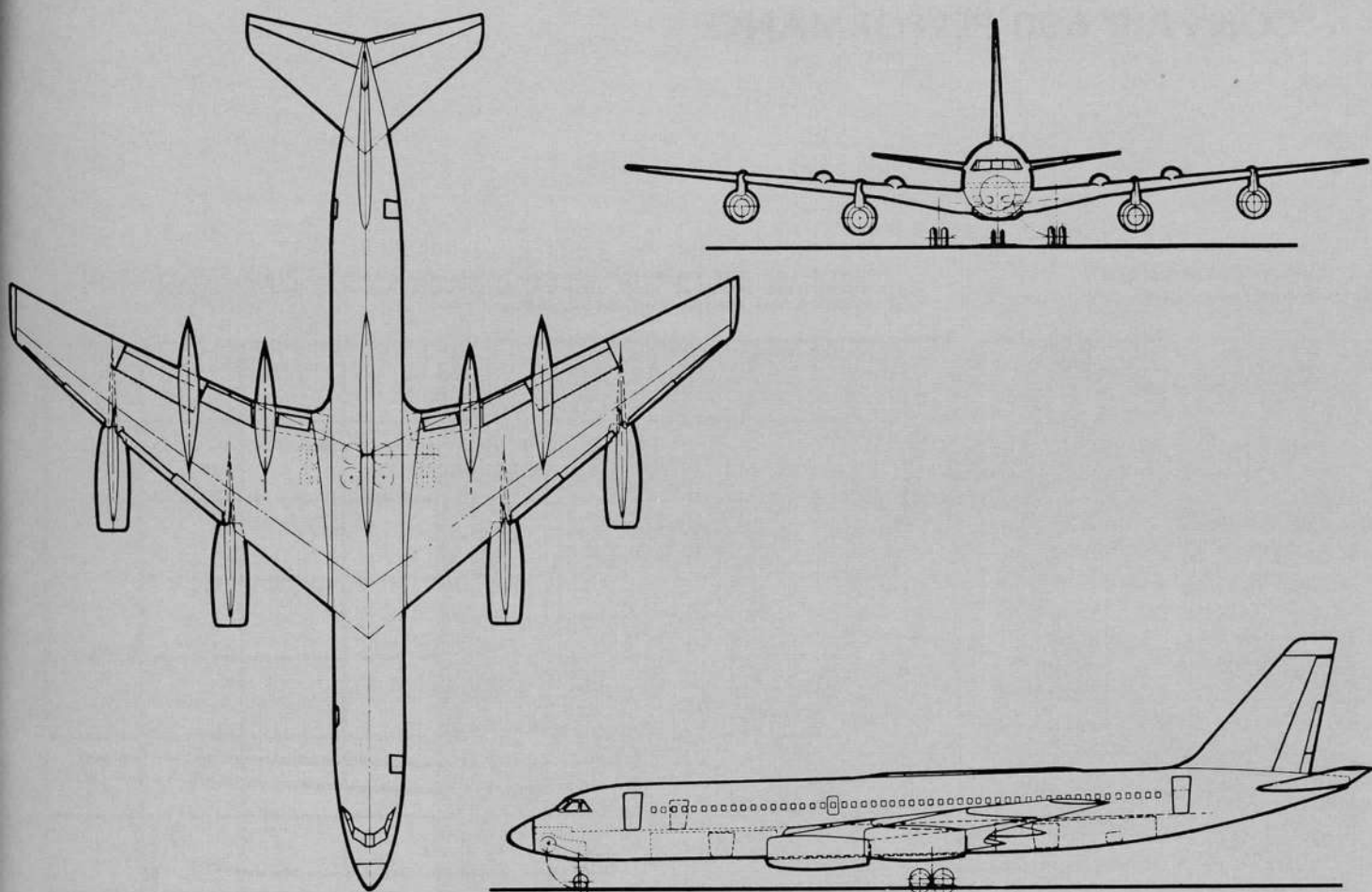

3 - VIEW

PRINCIPAL DIMENSIONS

WING

Span — Overall.....	120 feet
Area — Total.....	2250 sq ft
Root Chord	29 ft 1.8 in
Tip Chord	8 ft 10 in
Dihedral	7°
Aspect Ratio	6.2
Sweepback (28% C).....	35°
M.A.C. (true)	20 ft 9.7 in
Flaps — Type.....	Double-Slotted
Leading Edge Device.....	Extensible

TAIL

HORIZONTAL

Area	449 sq ft
Dihedral	7° 30'
Sweepback (26.4% C).....	35°

VERTICAL

Area	295 sq ft
Sweepback (30% C).....	35°
Top of Fin From Ground.....	39 ft 6.1 in

FUSELAGE

Width (Maximum)	11 ft 6 in
Height (Maximum)	12 ft 5 in
Length	135 ft 5 in

CONVAIR 600 PERFORMANCE

DIRECT OPERATING COST
(BASED ON OPTIMUM COST OPERATION)

COST BASIS—1955 ATA METHOD MODIFIED TO INCLUDE: ZERO WIND, MANUFACTURER'S GUARANTEED MATERIAL COST, 1000 HOURS BETWEEN ENGINE OVERHAUL, 10-YEAR DEPRECIATION PERIOD, 50% ENGINE SPARES COST

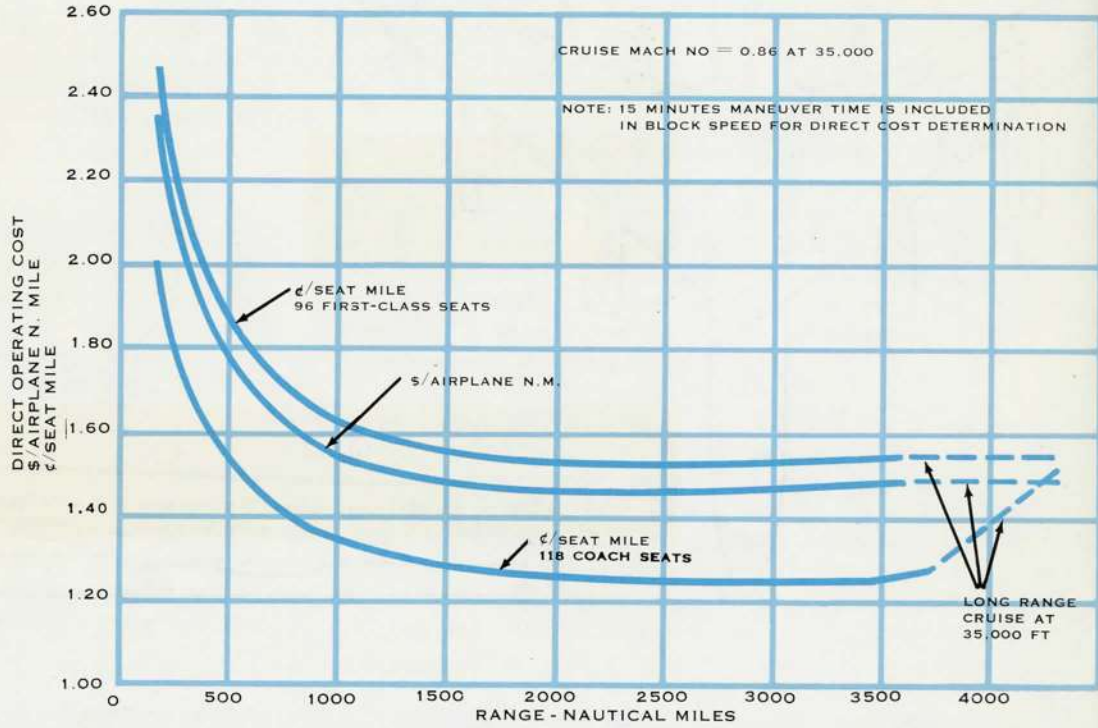

PAYLOAD VS RANGE

- NOTES:
1. ZERO WIND
 2. FUEL RESERVE FOR ¼ HOUR HOLDING, 200 N. MI. DIVERSION AT 30,000 FT = 10,800 LB

BASED ON:
165 LB/PASSENGER
40 LB BAGGAGE/PASSENGER
CARGO @ 10 LB/CU FT

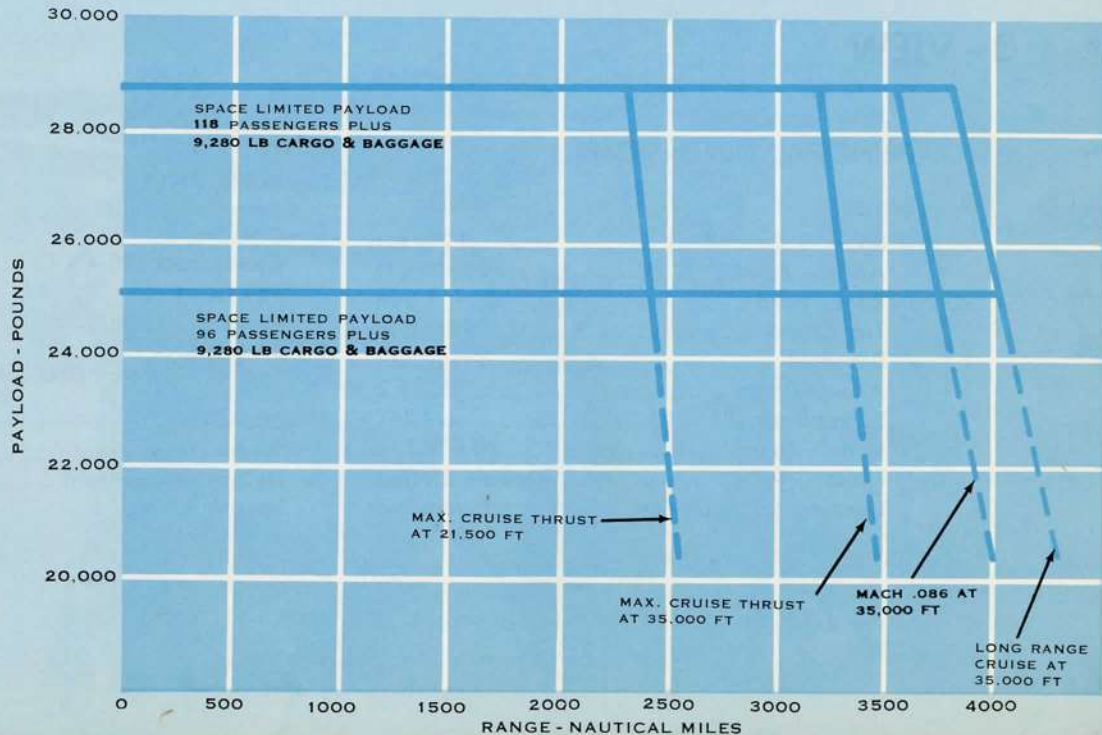

**WHEELS UP—WHEELS DOWN
CONVAIR 600—MODEL 30**

NOTES:

1. OPTIMUM SPEED CASE —
MAXIMUM CRUISE THRUST
AT 21,500 FT
2. ISA & ZERO WIND

**CHICAGO
TO
MIAMI**

1,028 N. MILES
1 HOUR 55 MINUTES

**BOSTON
TO
LOS ANGELES**

2,248 N. MILES
4 HOURS 8 MINUTES

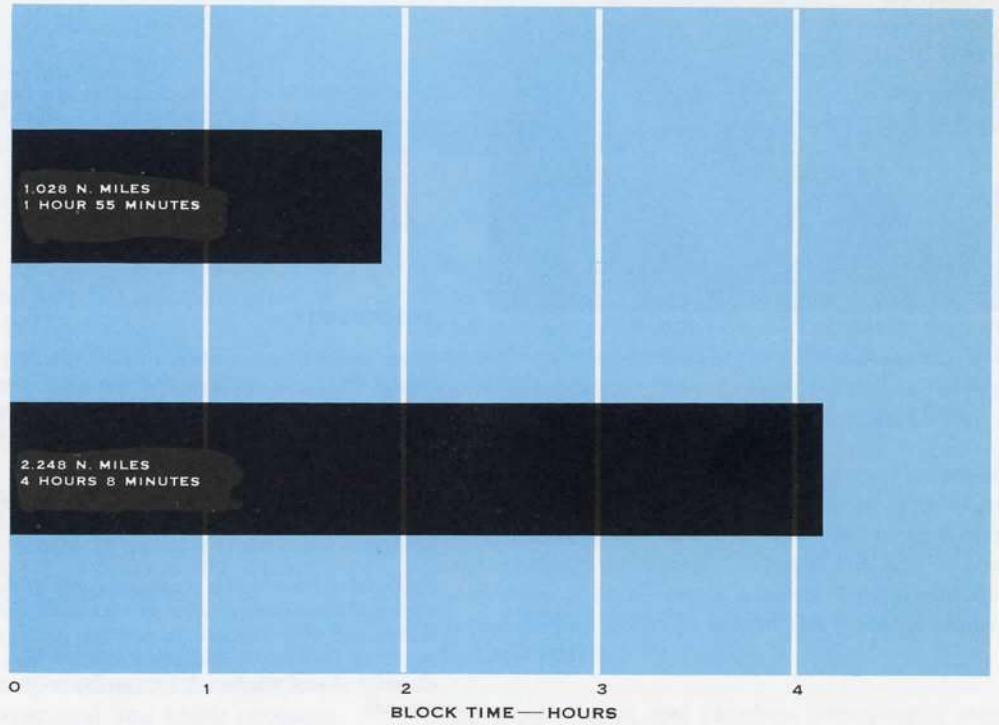

**BLOCK SPEED
CONVAIR 600**

NOTES:

1. DOMESTIC FIRST CLASS
CONFIGURATION
2. MANEUVER ALLOWANCE=15 MINS

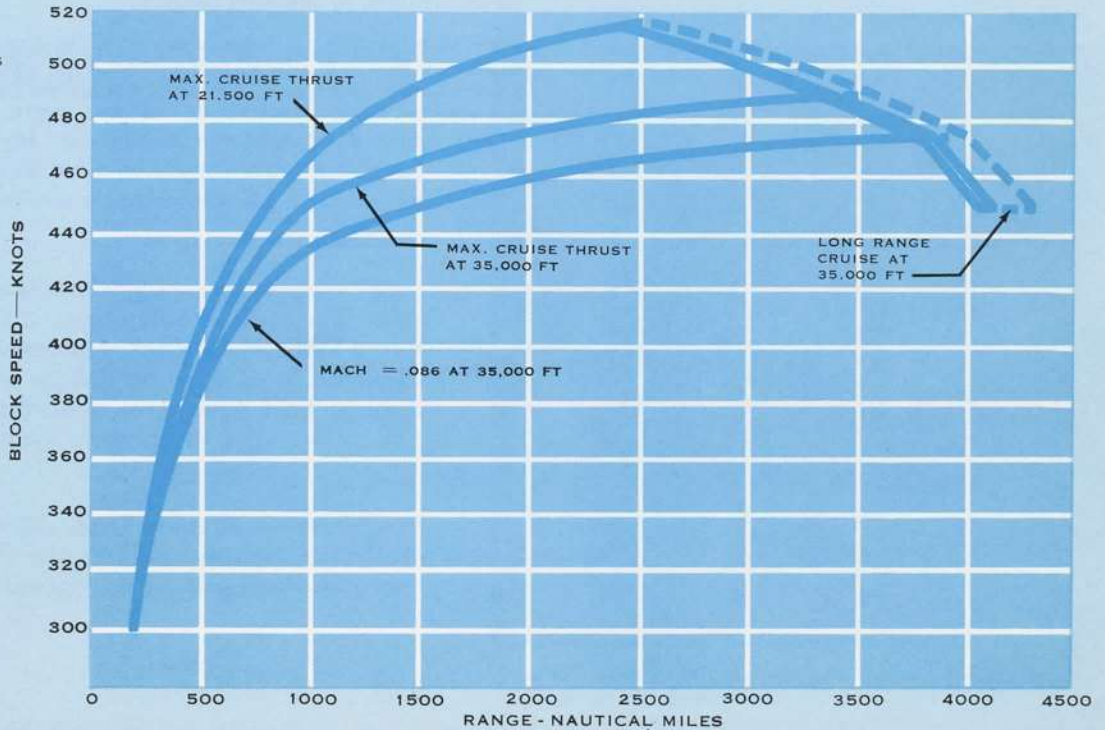



FOREWORD

From acoustic attenuation to bird-proofing, and from wind tunnel testing to water tank immersion fatigue testing, every fuselage component of the Convair 880 jet transport is undergoing comprehensive tests which will insure a structurally sound airplane.

End result of this intensive testing program will be the world's fastest commercial jet transport, embodying the most advanced safety features known to structural engineers.

Aside from carrying its passengers safely, the "880" will offer such additional advantages as maximum quiet, vibration-free flight, and the ultimate in seating comfort — all of them a result of Convair experience acquired from three-and-a-half decades of manufacturing top quality military and commercial aircraft.

From the moment he enters the airplane through the passenger loading door, which is designed exclusively for pressurized high-altitude aircraft, until the wheels of the airplane touch the strip at his destination, the "880" passenger's flight will be underwritten by structural integrity.

How that integrity is being achieved in the Convair 880 fuselage is told in this issue, supplementing the article in the December Traveler which discussed the structural integrity of the wing.

Reprint from **CONVAIR TRAVELER**
January 1958

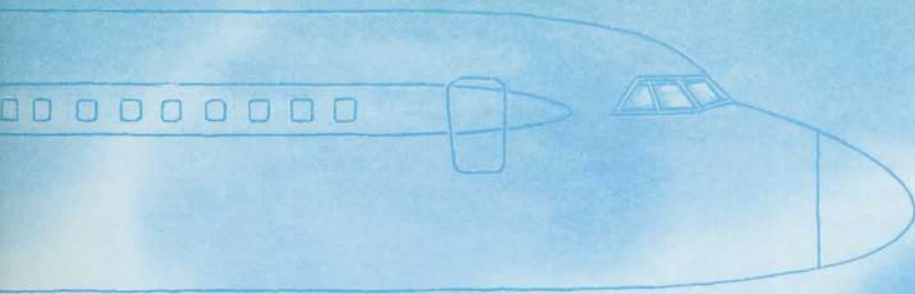

STRUCTURAL INTEGRITY of the CONVAIR "880" FUSELAGE

The term "fail-safe" has been synonymous with Convair aircraft since the first 240 transport came off the production line in 1947.

Convair has long been aware of the importance of repeated load testing as an essential part of developing the fatigue-resistance of an aircraft structure, and the tests conducted during the past several years on 240 and 340 aircraft have been directed toward that end. Only by extensive fatigue tests can the designer be sure that the preliminary safety measures he has incorporated will actually be effective.

Developments in the "880" structural test program to date include preliminary testing of cabin windows and windshields, and structural and crack propagation tests of the fuselage structure. High- and low-speed wind tunnel testing of five scale models was also conducted to determine air loads and their distribution.

Although subassembly tests are the principal tool of fatigue investigations, a structure without any fatigue critical areas can be guaranteed only by fatigue tests of the structure as a whole. Such tests provide a means of more accurately reproducing all the stresses that act simultaneously within the airframe.

In recognition of this fact, a comprehensive "880" fuselage test will be conducted in a water tank with a complete fuselage and stub wing assembly. To this specimen will be applied many cycles of combined pressurization and flight loads, with landing loads interspersed between programs of flight cycles.

It is expected that skin stresses in the fuselage of the Convair 880 will be low enough to preclude fatigue cracks throughout the life of the airplane.

Nevertheless, Convair, being aware that fatigue is not the only phenomenon that may start a skin rupture, has undertaken an extensive test program to demonstrate that such ruptures, if they should occur, will not result in a major failure under normal operating conditions prior to their detection by inspection.

A series of fail-safe tests were conducted in which various members were cut, and loads applied to demonstrate that the "880" structure or section considered retained its integrity. Emphasis was placed on very low rates of crack growth. In no case did explosive failure occur in any of the fuselage frames and panels tested.

The most drastic test involved dropping a steel javelin through the fuselage skin of a test section under pressure. Although a substantial cut was made, there was no evidence of additional structural failure.



A test section of fuselage skin under pressure is subjected to the javelin test.

Research in sound suppression is currently centered in the new Convair Acoustics Laboratory, where Convair engineers are developing the quietest passenger cabin possible for the "880." The tests are being conducted to determine the selection of proper skin panel damping materials and methods, and to measure the differences in sound decay with and without damping materials.

The philosophy of employing acoustic mass attenuation by applying thick skins (.063 inch to .100 inch) to the fuselage has been utilized. In one of the laboratory units at the Convair acoustical facility, a test panel is placed in an opening provided in the partition between a reverberation chamber and an echo-free chamber.

Electronic noise generators, amplifiers and loudspeakers project the required volume and frequency of sound into the reverberation room. The sample under test reflects, transmits, or absorbs this sound in varying degrees. The amount of noise that escapes through the sample into the anechoic chamber is measured.

All kinds of noise — the complete audible spectrum from 15 to 15,000 cycles per second, or any desired single frequency or band of frequencies — are projected into the reverberation room through loudspeakers. Its modular concrete walls break up

standing sound waves and thus create a uniform audio field in which specimens can be tested. Almost all the sound projected into the room is reflected by walls, ceiling and floor.

In the anechoic chamber, on the other side of the test panel, reflected sound is reduced to an absolute minimum. Sound radiates in all directions from a source, and the glass fiber wedges, which form the interior surfaces of the room, trap and absorb any sound transmitted through the test specimen into the chamber. The fiber itself attenuates high frequencies, and the wedge shapes, into which it is formed, absorb the low frequencies. A removable floor grating allows engineers to walk into the chamber to set up tests and instrumentation.



Research in sound suppression and noise measurement takes place at the Convair Acoustics Laboratory.



A specimen section of the "880" cabin, later to be subjected to strenuous fail-safe tests, nears completion.



Noise escaping through a fuselage test panel is measured in the Acoustic Laboratory's anechoic chamber.

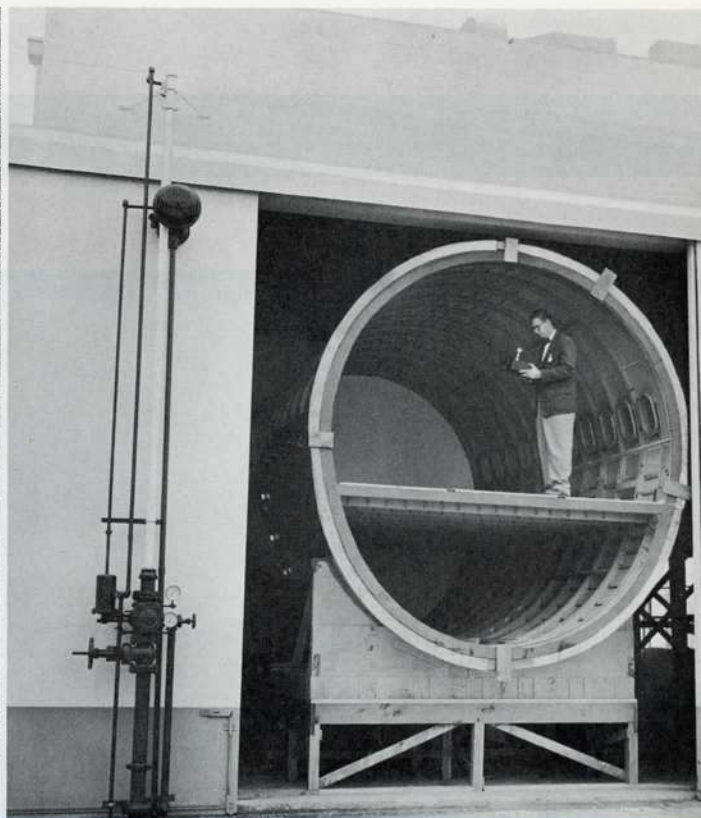

A full-scale, 19-foot specimen of the cabin constant section awaits acoustical testing in the reverberation chamber.

A window for an "880" jet transport can be mounted in the test opening and subjected to the "white" noise (all audible frequencies) produced by the CJ-805 turbojet engines, electronically simulated. Instruments in the anechoic chamber then can measure accurately the amount of jet engine noise each window would admit to the "880" passenger cabin.

Two panes of stretched Plexiglass 55, separated but formed into a single outer unit, plus an inner window pane mounted in rubber, make up the window itself. Structural load can be absorbed by either of the two outer panels.

Other preliminary testing of cabin windows has been completed. Window installations were subjected to structural tests involving forces such as shear, torque, tension, and compression.

Placement of windows in the "880" allows two windows per seat row on each side, or four for each cabin bay. Windows are approximately 9 x 12½ inches in size, and the frames are a single-piece aluminum alloy forging. Support for the frames is supplied by the heavy skin, which eliminates the need for longerons around windows.

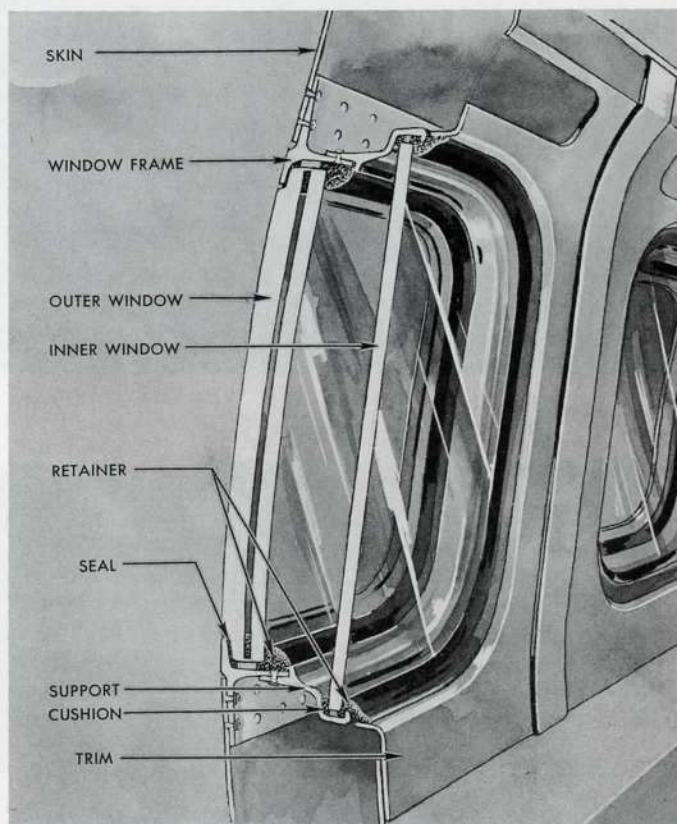

Typical Cabin Window Installation

SECTIONAL VIEW SHOWING STRUCTURAL DETAIL of

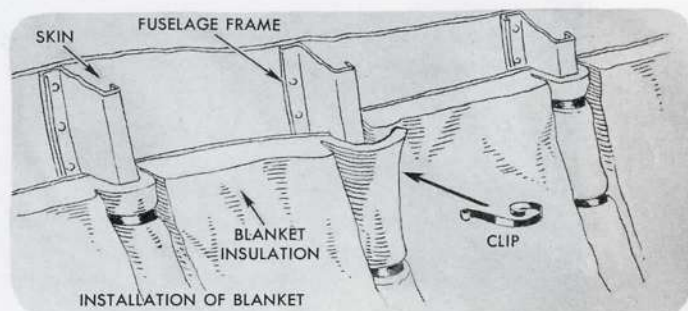
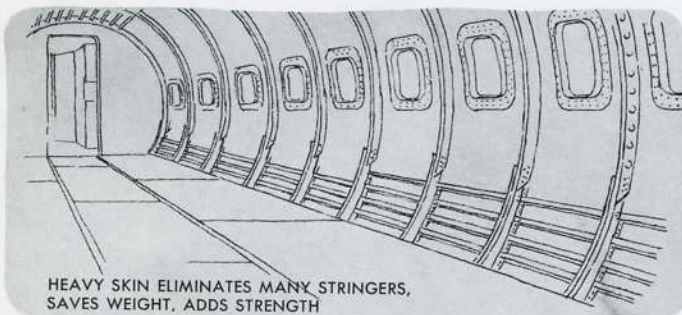
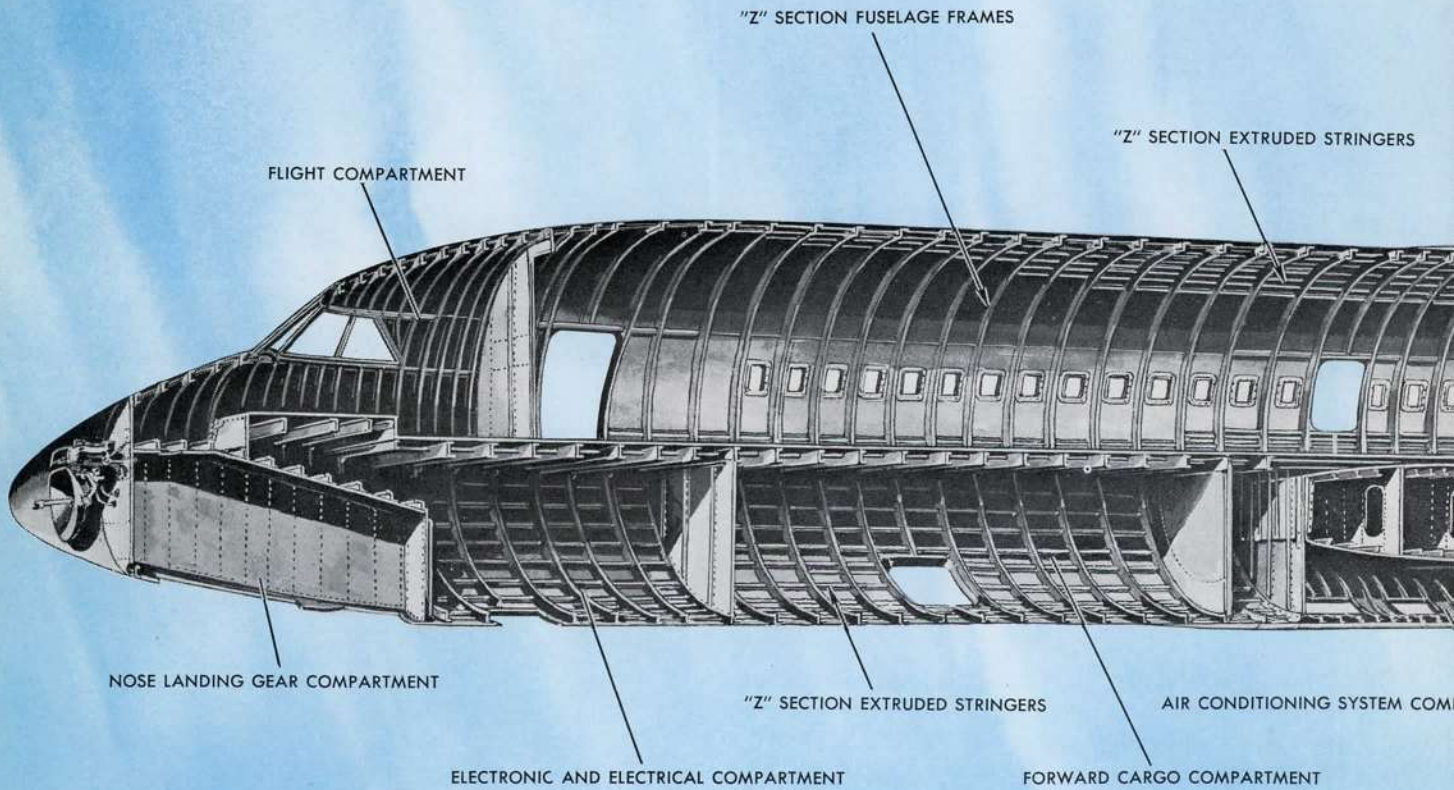

CONVAIR "880" FUSELAGE

The structural soundness of the Convair 880 fuselage is exposed in detail in this over-all nose-to-tail sectional drawing.

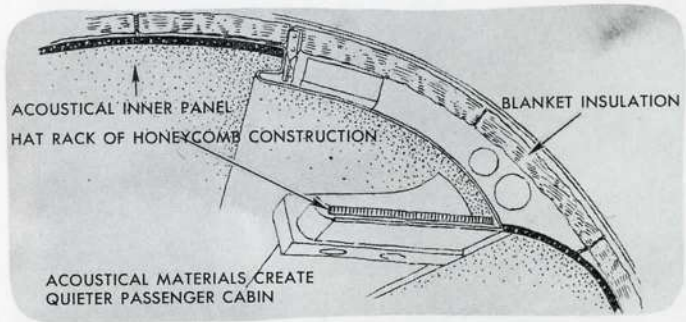
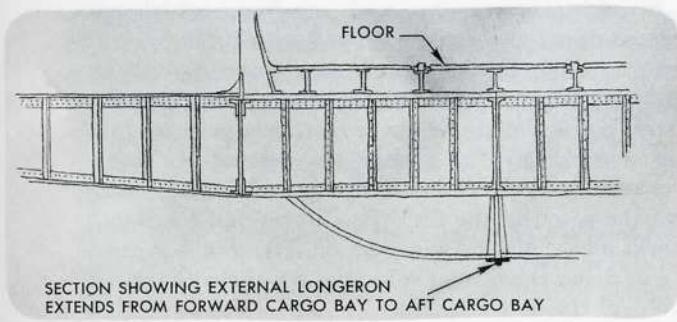
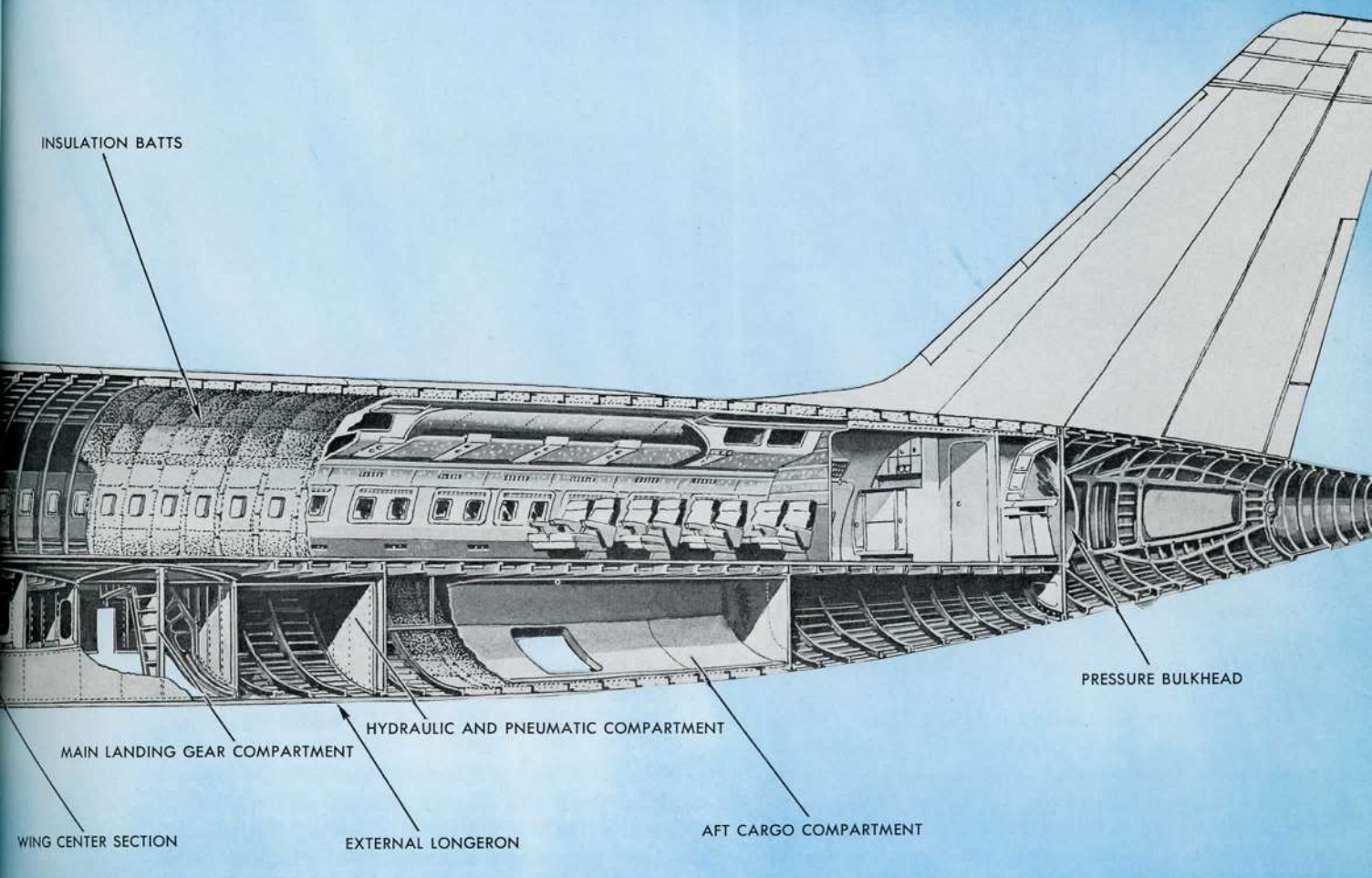

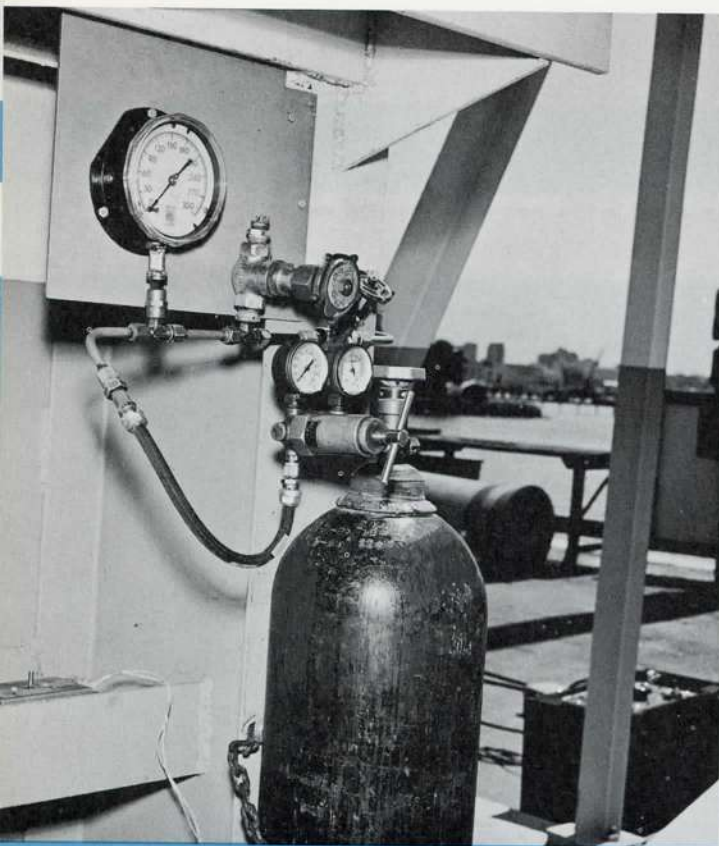

Nitrogen under pressure is used as a propellant in windshield bird-proofing tests employing an air gun.

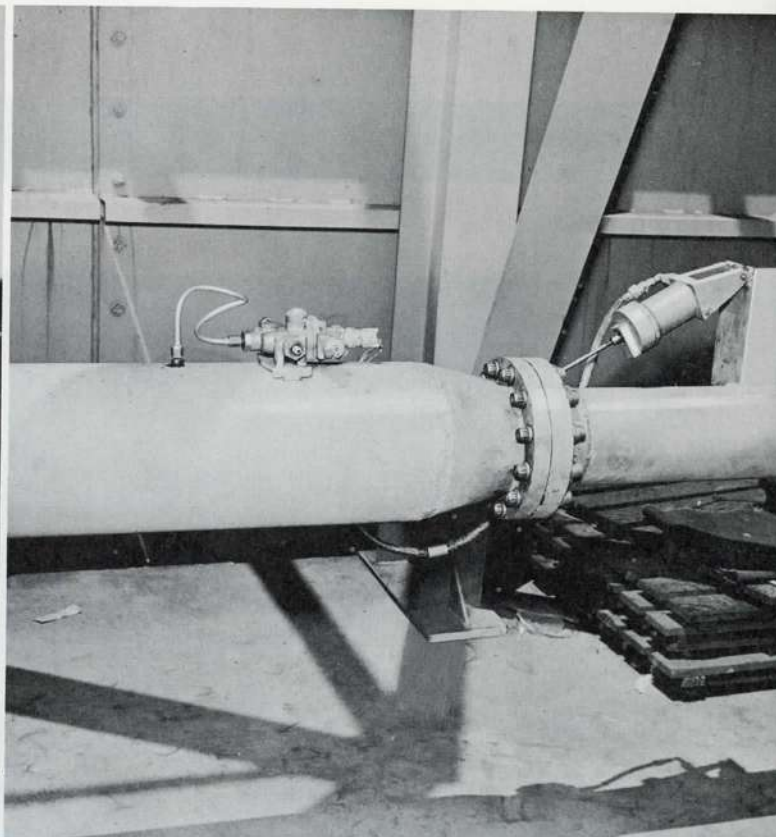

A solenoid valve is triggered to release the chamber pressure which accelerates the chicken through the gun barrel.

The net result is that heavier skin in the "880" fuselage will reduce the amount of acoustical tape, glass fiber, and other soundproofing agents required, and will insure added protection against explosive decompression with no significant weight penalty.

Preliminary bird-proofing tests on the main windshield have also been completed. Purpose of these tests was to satisfy the bird-proof strength requirements of the windshields, which will be incorporated in the "880," and to prove the structural integrity of the windshield panels. Actual tests involved use of an air gun installed at the Convair Structures Ramp Facility in San Diego.

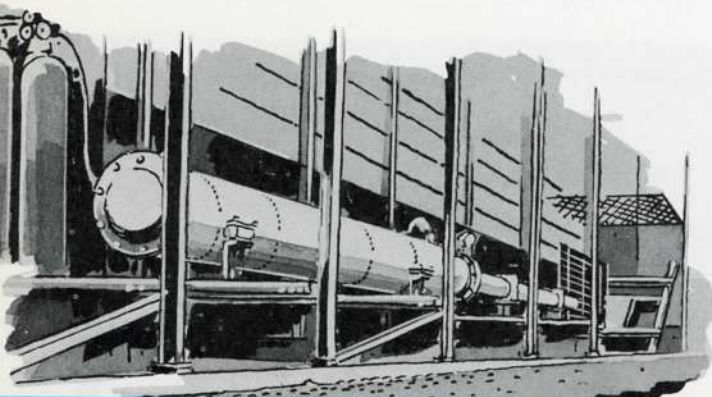

Windshield bird-proofing tests are conducted at the Convair Structures Ramp Facility.

A chicken weighing approximately four pounds was chloroformed just prior to each test, and encased in a transparent polyvinyl alcohol bag. The bag containing the chicken was inserted in the barrel of the gun at the breech. Mylar diaphragms of the proper thickness were set in a recess between the chicken and a pressure chamber, to which the barrel was bolted.

Nitrogen under pressure was bled into the pressure chamber until the desired pressure was reached. A solenoid valve was triggered, allowing this pressure chamber to activate a knife-ended plunger which ruptured the diaphragm and released the chamber pressure to accelerate the chicken down the barrel.

Windshields were mounted in a frame which was located transversely to the desired position in front of the gun. The speed of the chicken was computed by analysis of high-speed films taken at the end of the barrel while the chicken was traveling between gun and windshield. The distance it traveled per frame was read from a calibrated board in the background, and the speed of the film was determined by timing marks made by a pulse generator. The gun was capable of firing the bird at velocities far above the cruise speed of the new airplane.



Chicken's speed as it contacts the frame-mounted test windshields is computed by analysis of high-speed films.

Advanced bird-proofing tests on center and main windshields have just been completed, with final selection of the "880" windshield to be made from panels tested.

These various tests have given Convair design engineers the knowledge to design a passenger cabin for the high-speed, high-altitude Convair 880 — a passenger cabin that has insured protection against structural fatigue which might otherwise cause explosive decompression.

Aluminum alloy 2024, noted for its superior resistance to crack propagation, is used throughout for the fuselage skin. Its gauge ranges from .063 to .100. The minimum skin gauge in the pressure cabin is .063, and the maximum gross hoop tension stress is 8500 psi at 8.2 psi cabin pressure. Above the cabin floor line where the windows and most openings are located, the heavier gauges will be used.

Use of the heavier skin also eliminates the need for stringers over a considerable area. This will result in lower pressurization-induced stresses, and in weight reduction.

Typical stringers are .050 gauge, and generally are 7/8-inch deep, extruded 7075 aluminum alloy Z-sections. Stringers numbered 9 to 17, approximately centered on the floor line, are 2024, and spacing is approximately six inches. Below this region, spacing is nine inches, except in areas fore and aft of the wing. Above the area of greatest radius, stringers are eliminated up to a point varying from approximately 15 to 40 inches from the top center line. Width of stringer installation in this top area is greatest over the wing.

Fuselage frames in the "880" are stretch-formed 7075 Z-sections, and a typical frame is 3 1/8 inches deep and of .050 gauge.

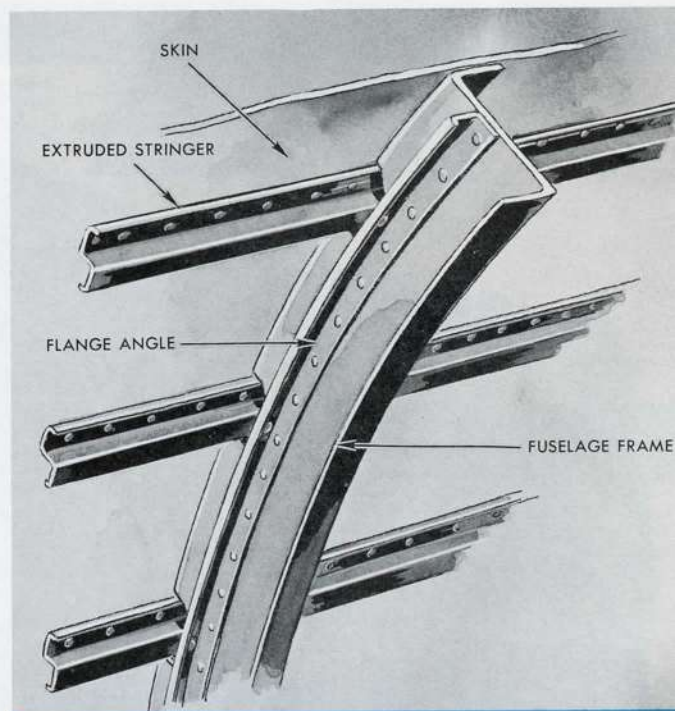

Typical Fuselage Frame and Stringer Intersections

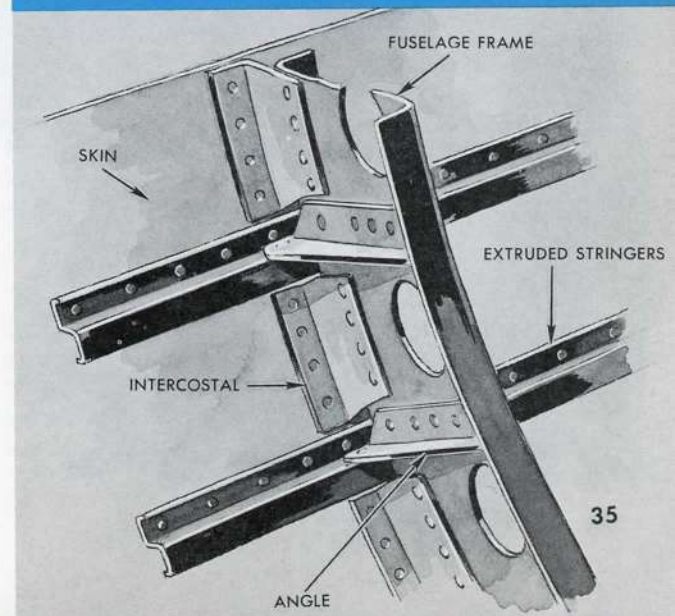

The aft pressure bulkhead is located forward of the horizontal stabilizer so as to eliminate sealing problems, because this surface is adjustable.

At the plane of symmetry on the fuselage bottom, a heavy built-up keel member insures structural continuity in the region where the normal fuselage structure is interrupted by the wheel wells and, to a lesser extent, by the wing center section.

The under fuselage compartmentation aft of the weather-mapping radar nose includes the nose wheel well, the electronic and electrical sections, the forward cargo area, the air conditioning system (under

the wing center section), the main landing gear wells, the hydraulic-pneumatic section, and the rear cargo compartment, in that order.

The cabin floor of aluminum alloy honeycomb sandwich construction is supported by transverse floor beams at each frame. A more resilient belly structure for wheels-up landing is achieved by the elimination of vertical members to support these floor beams. Use of vertical members could transmit shock to the cabin floor structure at the time of a wheels-up landing.

Another feature to be incorporated in the Convair 880 fuselage includes a passenger loading door whose

DETAIL OF CONVAIR "880" FLOOR STRUCTURE

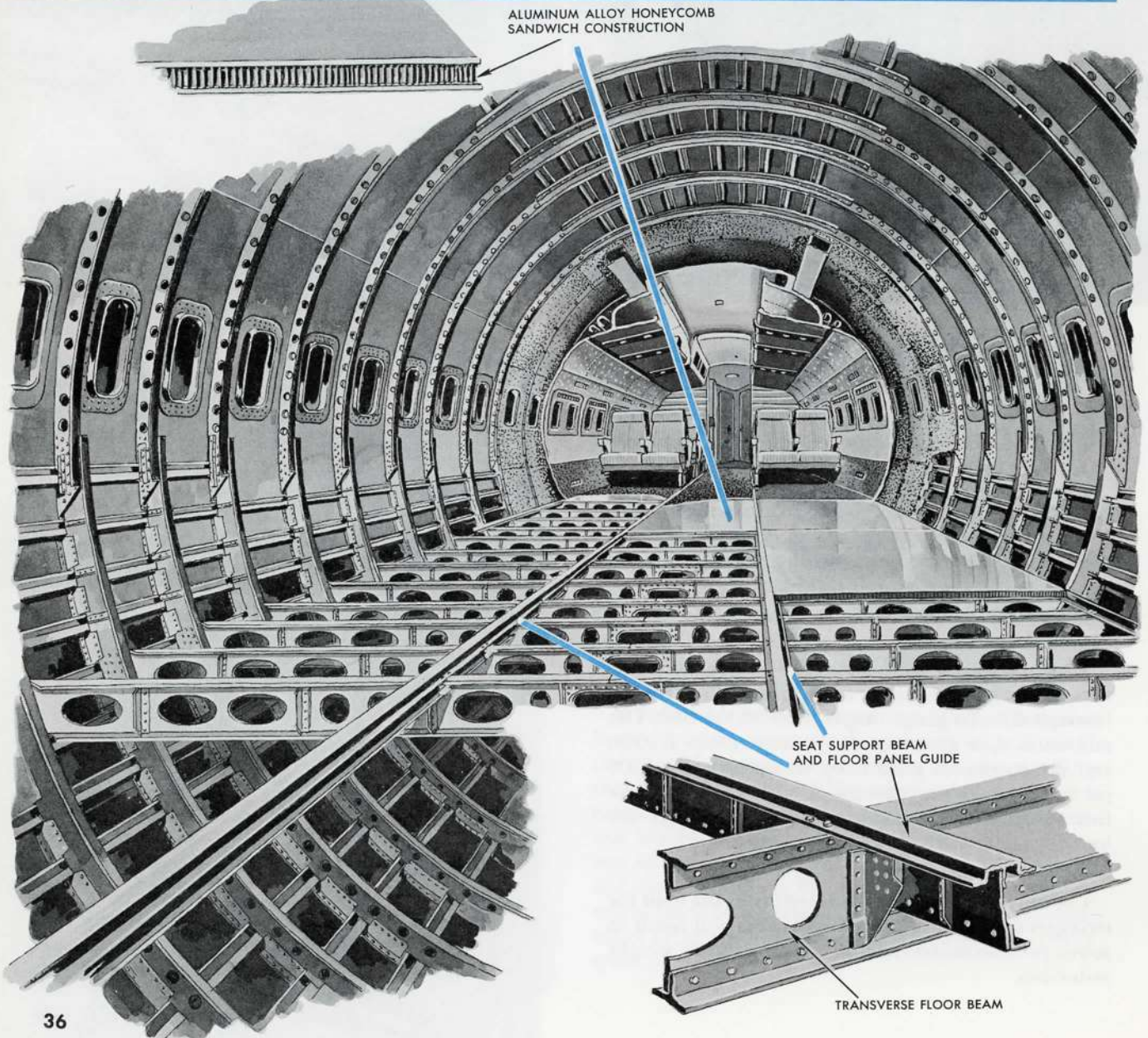

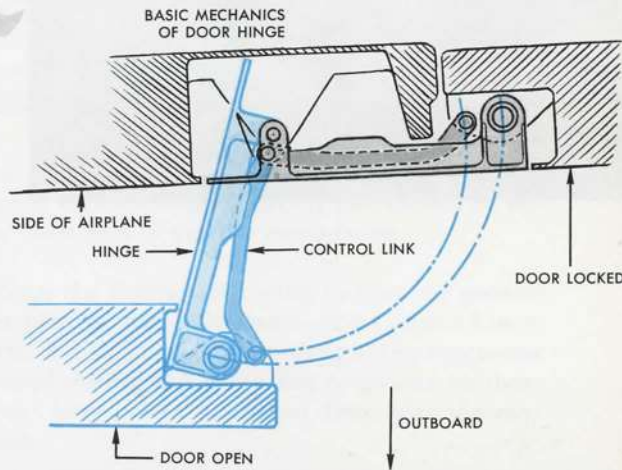
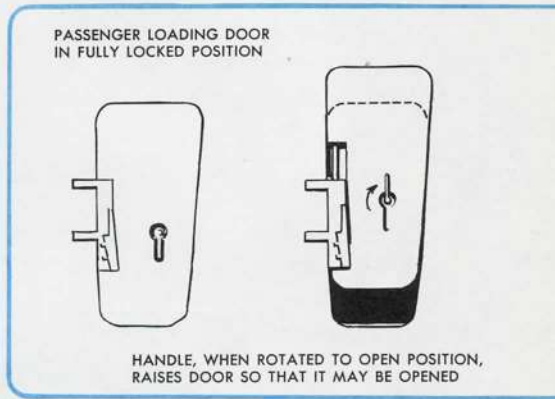

FAIL-SAFE DOOR DESIGN for the "880"

mandatory design requirements incorporate adoption of the following safety features:

1. The door is of the plug-type, and does not depend on latches to restrain it from outward movement under any flight or cabin pressure condition. Increasing cabin pressure acts to increase the security and retention of the door.
2. The door hinges are designed to stow the door externally, well out of the entrance, in the open position.
3. The door can be opened from inside or outside, even though persons may be crowding against door from the inside.
4. The means of opening is simple, and is so arranged and marked that the door can be readily opened, even in darkness.
5. Provisions are made to minimize the possibility of jamming the door as a result of icing conditions, seal vulcanization, or fuselage damage due to minor crash landing. This is required because openings normally used for passengers also serve as emergency exits.

6. The door is capable of being operated by one person under any wind condition normally encountered in ground operations.

The "880" door is of an upward-sliding, side-hinged configuration. The edge adjacent to the hinge and the opposite edge are slanted to form a wedge-shaped door narrower at the bottom than at the top. Shear ledges along each edge of the door fit in recesses in the opening frame and are the load-carrying members. A mechanism incorporating a door weight counterbalance spring, actuated by the handle, provides the initial upward motion of the door. Hinges located at the forward edge of the door control the door during opening.

To open, the operator rotates the handle to the "open" position. This slides the door upward parallel to the hinge line. In this position, the shear ledges along the aft door edge will clear the mating recesses. The door can then be swung open, allowing the shear ledges adjacent to the hinge to rotate out of their mating recesses.



FOREWORD

The new Convair 880 jet transport, which two years from now will be transporting airline passengers at speeds in excess of 600 mph, is designed to withstand the many loads subjected to it, with a safety factor to spare.

All the knowledge of fail-safe construction and fatigue-resistant design which Convair has gained from 34 years of building military and commercial aircraft is now being applied to the "880."

When the first of these sleek transports goes into service late in 1959, the Convair 880 will not only be known as the world's fastest commercial jet transport, but will justify a companion reputation as the world's safest airplane.

Reprint from **CONVAIR TRAVELER**
December 1957

STRUCTURAL INTEGRITY of the CONVAIR 880 WING



"Built-in safety" is one of the most important factors in the design and subsequent operation of an airplane. Configuration, speed, comfort, and ease of maintenance all contribute to saleability, performance, and acceptance of an airplane, but without assured structural safety, it may as well remain in the planning stage.

A fail-safe design is one that will allow surrounding structure to assume the load of a failed member in the event that fatigue failure or other failure takes place.

Fatigue failure is the reaction of metals to repetitive stress. For example, fatigue failure is experienced any time a wire is bent back and forth in an effort to break it in two. If a load, which induces tension stress, is repeatedly applied, failure will occur at considerably less than the ultimate strength of the material. The higher the applied load, the fewer times it can be applied before the material will fail.

In the design of the Convair 880 jet transport, scheduled for delivery in 1959, Convair has incorporated fail-safe and fatigue-resistant features on a scale unparalleled in the history of aircraft manufacture. These features are based on the concept of "co-existence" of all structural members; thus should any single unit fail, structural integrity is not jeopardized.

The "880" wing is a culmination of all the features of the Convair-Liners and F-102 Interceptor, plus the increased knowledge gained through the most extensive testing of complete wings ever undertaken by an aircraft manufacturer. The details of design, such as rivet patterns, splices, and access doors, reflect the knowledge gained from extensive wing panel fatigue tests conducted by Convair during the past several years. These tests of actual structural assemblies fur-

nished information concerning the interaction of structural elements—information that cannot be obtained from tests of smaller components.

Because the Convair 880 wing follows the general design plan of its predecessors—the Convair-Liners and the F-102 Interceptor—design improvements developed during the many test programs on these airplanes have been transmitted directly to the new airplane.

In one of these tests, a Convair-Liner wing panel, being static-tested at the end of the long fatigue testing program, withstood more than the required fail-safe load, with nearly one-third of the lower

Full-scale structural mockup of wing box section provides pattern for "880" wing fabrication.



surface cracked through. In other tests, stringers and spar rails, sawed part way through in advance, were induced to fail under loads up to 71 per cent of ultimate design without producing failure of skin, spar webs, or other structure. Since the "880" wing follows the general design plan of other Convair aircraft, design improvements developed during these wing test programs will be incorporated in the "880" design.

The primary wing structure of the Convair 880 is a box beam consisting of spars, plating, and stringers, similar to the type used on current Convair aircraft. This arrangement distributes the structural load among many relatively small members, minimizing the importance of each.

The "box section" wing incorporates three built-up type spars, plate-stringer skin panels, and built-up bulkheads. The spars have extruded machined rails, extruded stiffeners, and roll-tapered webs. They are assembled with rivets, and a special Scotchweld bonding method is used in the faying surfaces of all parts.

From the fuselage to a point outboard of the outboard engine, a three-spar arrangement is utilized . . . front, center, and rear spars. The purpose of the three-spar arrangement is to provide a fail-safe structure in the event any one of the three spars should fail. The center spar in the thin "880" wing provides intermediate support for wing bulkheads. Outboard of the outer engine, only front and rear spars are used. In this area, trailing and leading edges are designed to provide a fail-safe structure.

BASIC "880" WING STRUCTURE

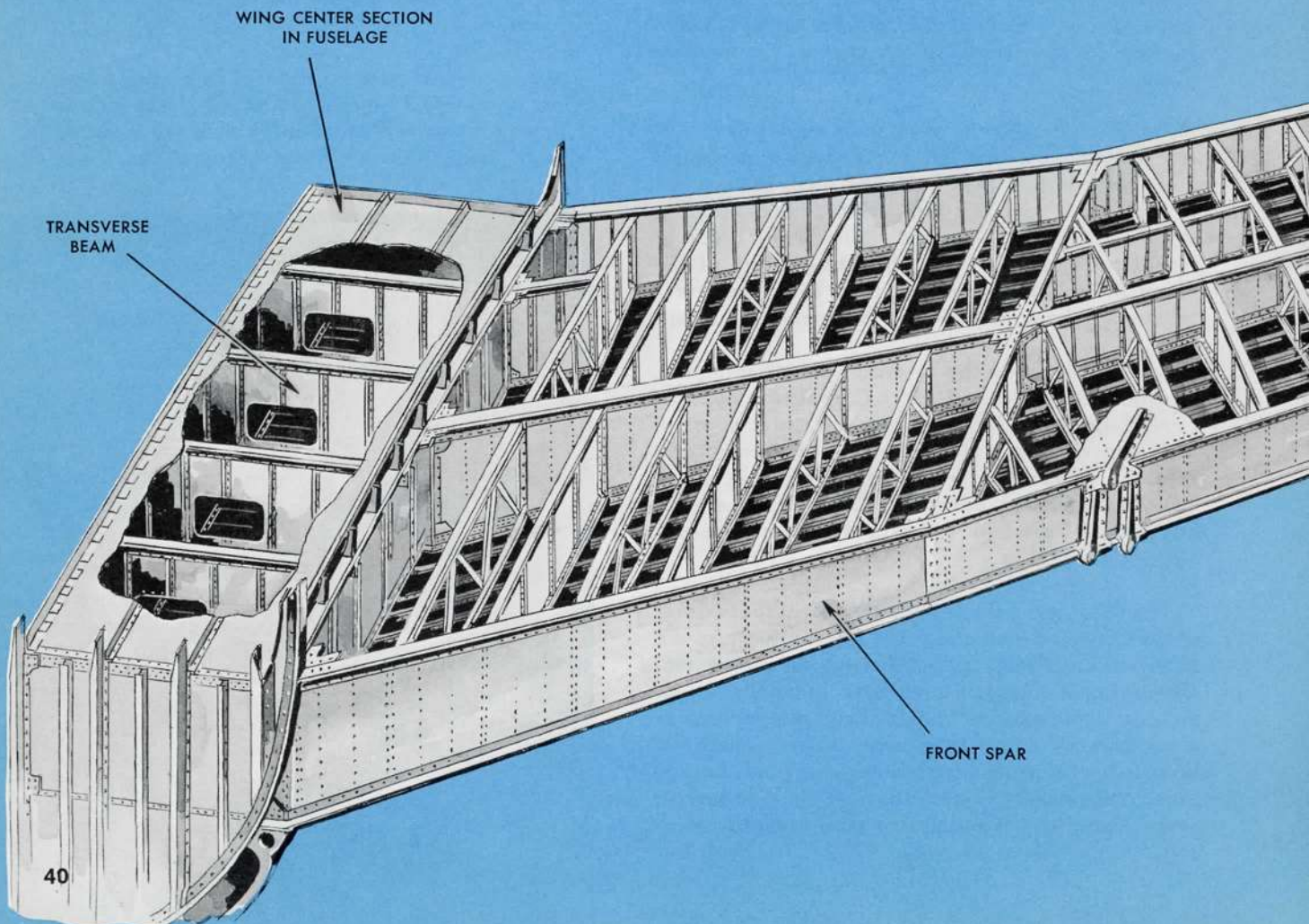

DETAIL OF WING STRUCTURE

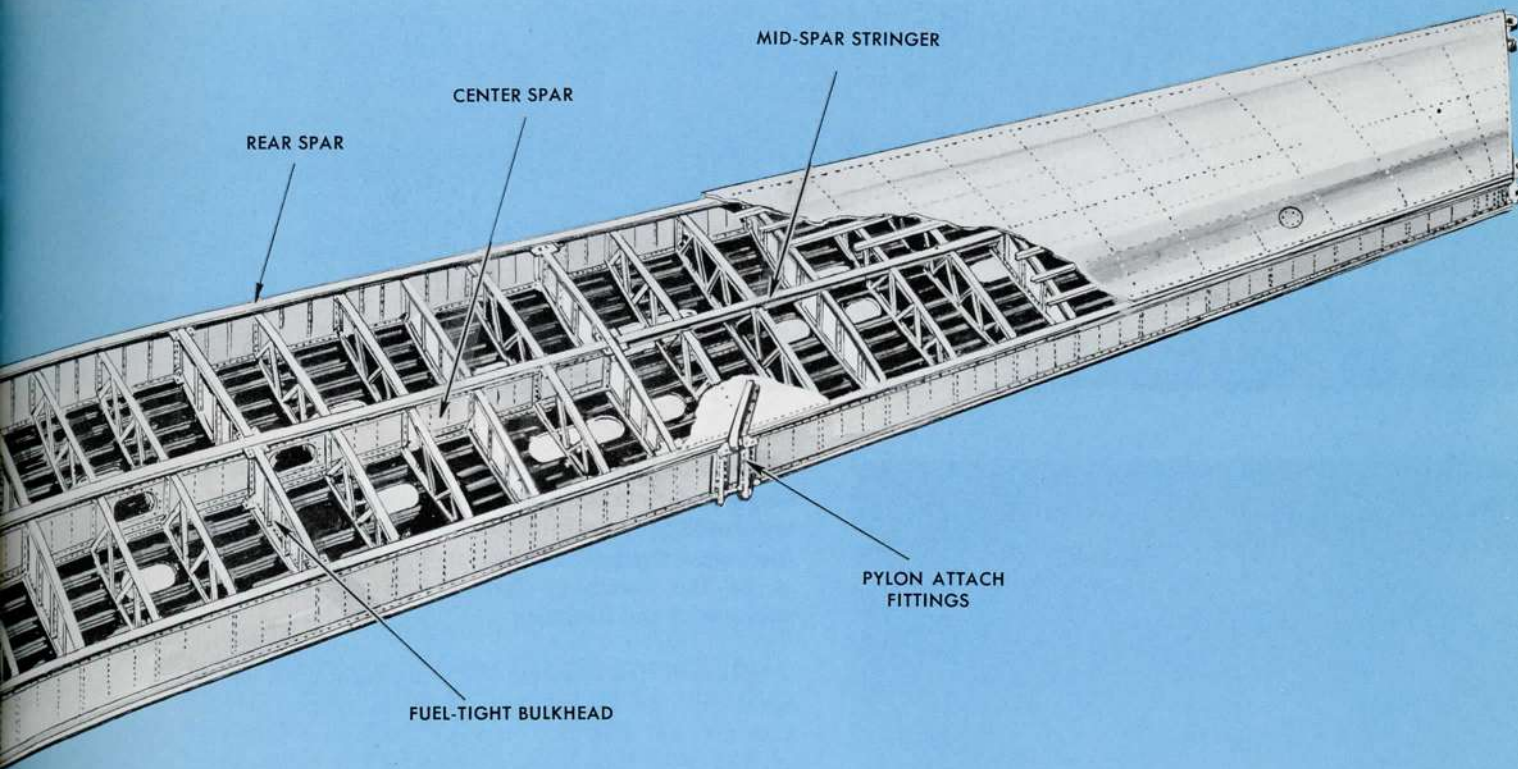
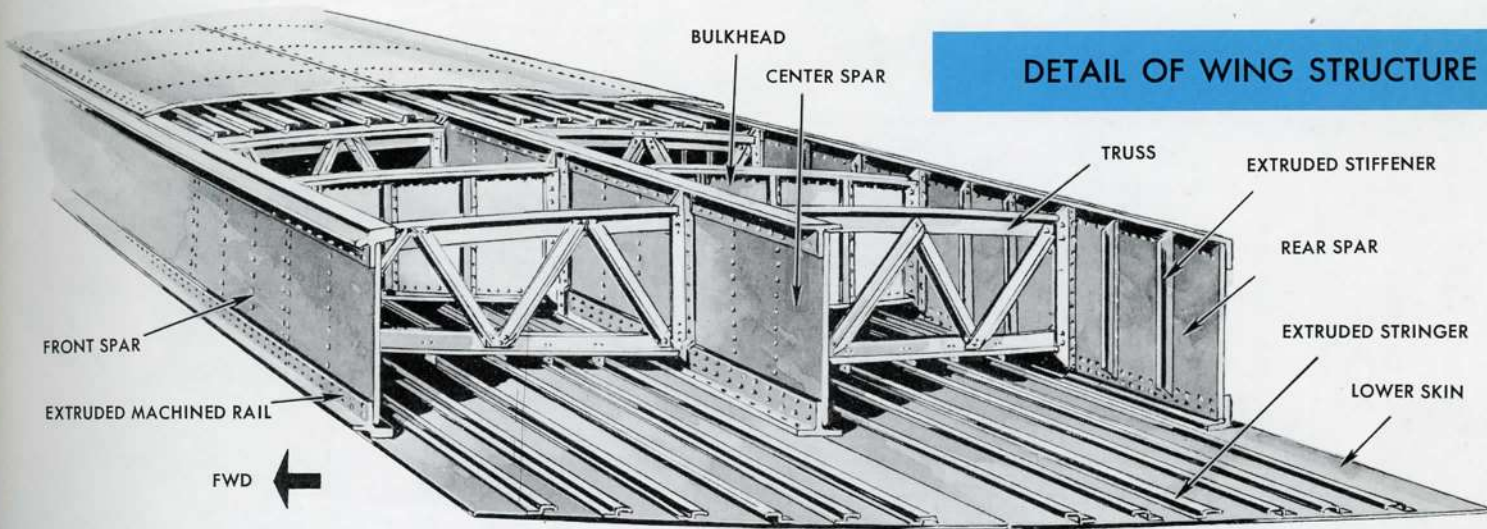

Stringers and upper spar caps are of 7178-T6, except for the front spar rail, which is of 2024-T4. This material was chosen for the front spar rail because contour of the wing provides relatively low front-spar stresses, and ductility of the material affords good resistance to forward-acting fuel loads in the integral tanks, in the event of sudden deceleration.

In addition to the three main spars in the wing, an auxiliary spar is used for support of the main landing gear. The auxiliary spar is supported jointly by the fuselage and wing structures. Detail design of the local structure is intended to permit the landing gear to break free of the wing without rupturing the fuel tanks in event of a crash landing. It is intended also that the pods and pylons break free of the wing without rupturing the fuel tank in a crash landing.

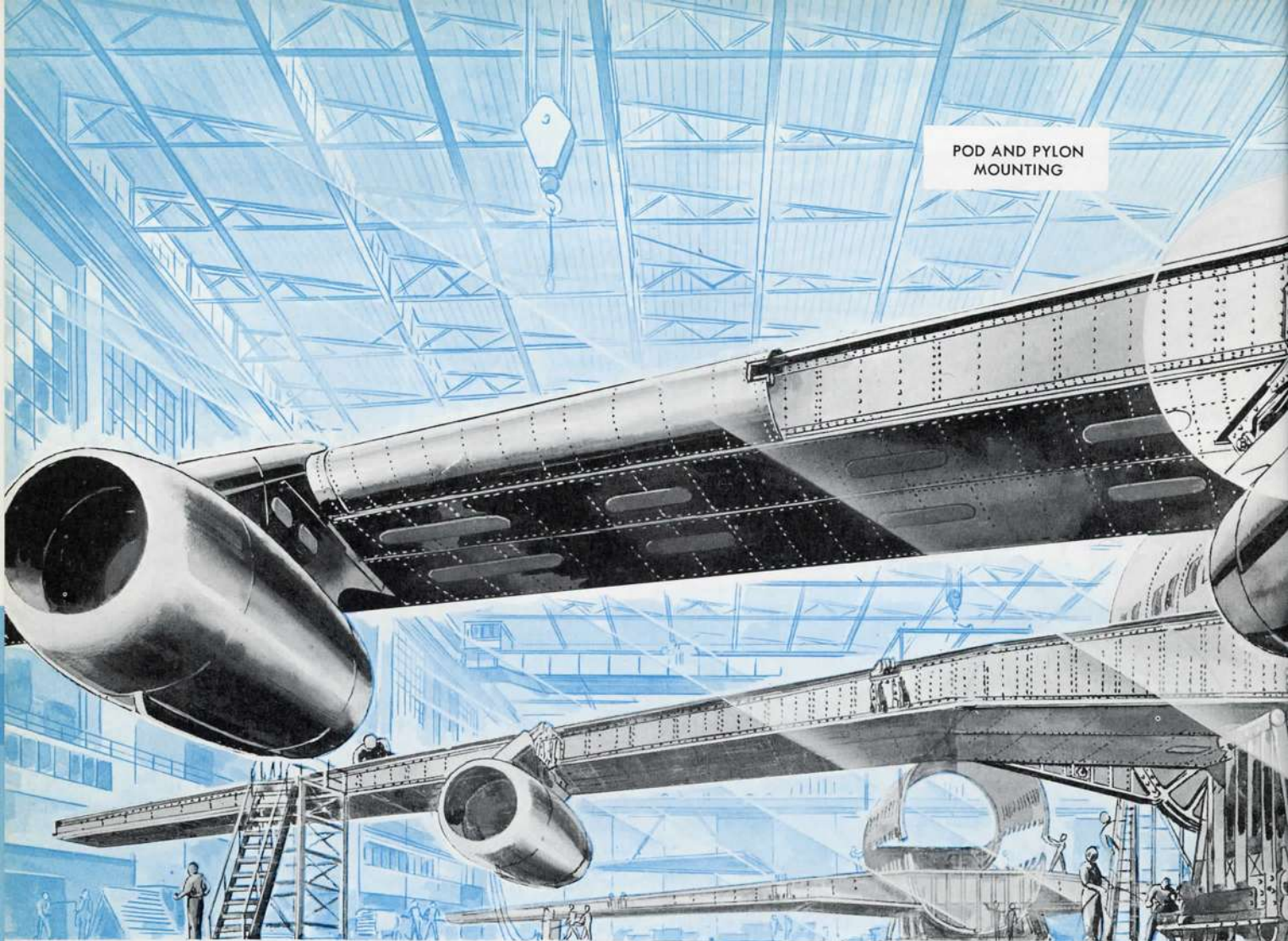

POD AND PYLON
MOUNTING

Wing leading edge skin is dynamically etched to provide channels for anti-icing heat.

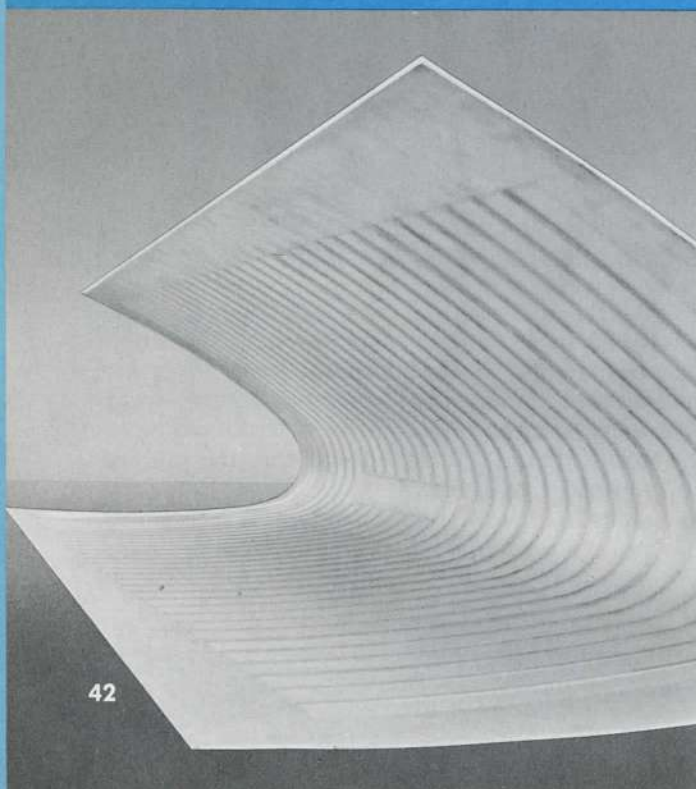

The wing center section beneath the fuselage incorporates four transverse beams between the front and rear spars. Each of these beams is bolted to the fuselage frames. Failure of any one of these beams or of the attaching frames will not jeopardize strength of the structure.

Splices in the Convair 880 wing have been developed through knowledge gained in cycling of the Convair 240 and 340 wings. Through additional cycling tests, each splice element in the "880" wing will be proved, thus insuring that all stringer ends, doors, doublers, and splice members will give long service life.

All wing bulkheads are of conventional web stiffener of truss type construction.

Skins on the upper and lower wing surfaces of the "880" are of heavier aluminum alloy than are those utilized on Convair-Liners. The high compression yield of 7075 aluminum alloy makes it suitable for the wing upper surface, where fatigue is not critical; the lower surface utilizes 2024, where fatigue is the primary consideration.

LANDING GEAR ATTACHMENT
TO WING AUXILIARY SPAR (A)
AND REAR SPAR (B)

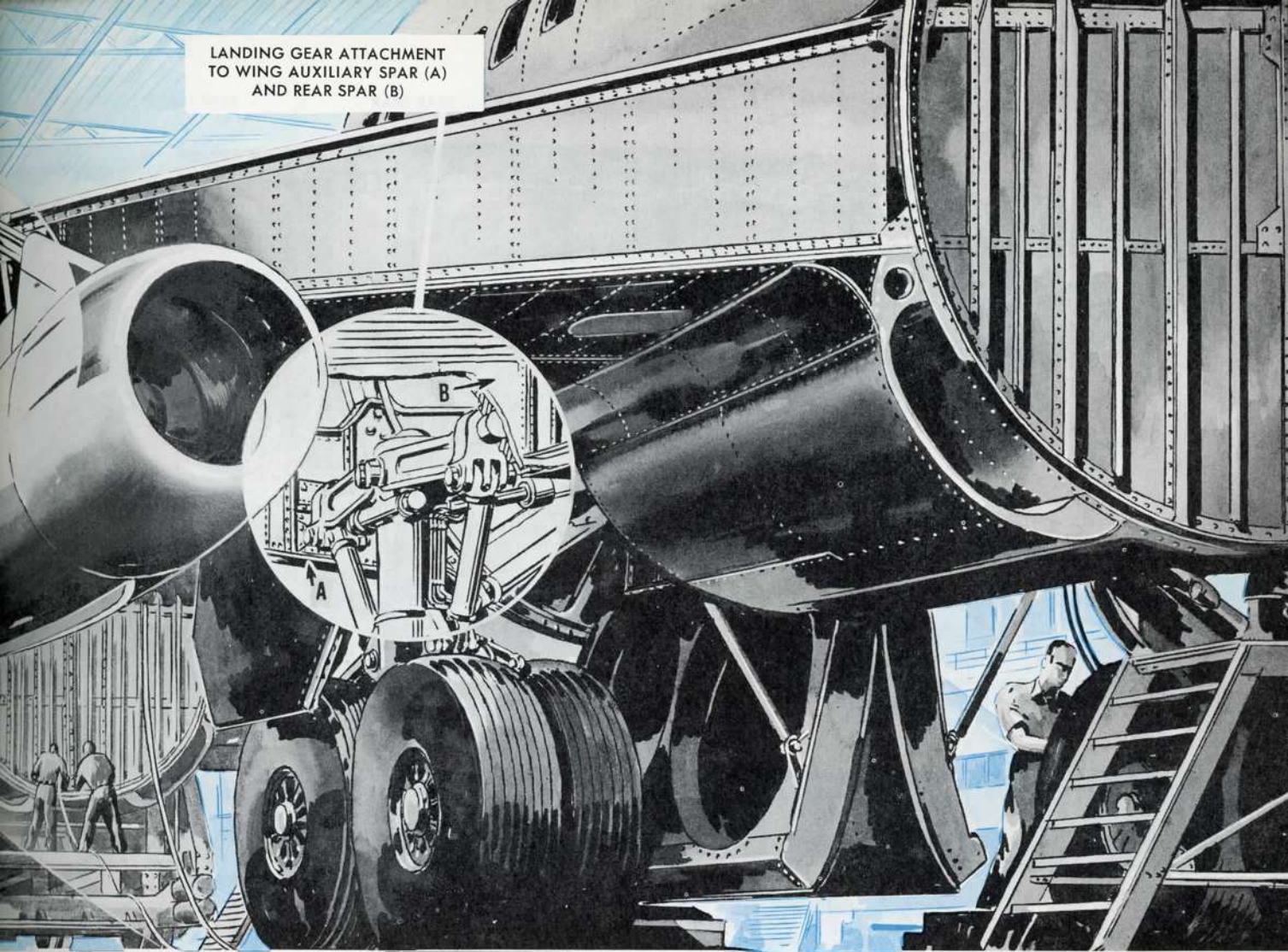

The skin on both surfaces is roll-tapered, varying in thickness, spanwise. This roll-taper provides the necessary structural strength at minimum weight in areas where it is needed. Extruded stringers are used on upper and lower surfaces.

The leading edges of the "880" wing are unique in structure and in the ability to provide anti-icing protection. There are two thicknesses of skin — a heavy gauge outer skin and a thin gauge inner skin. The outer skin, formed from material of approximately .100 inch thickness, is dynamically etched, after forming, to provide recesses approximately two inches wide and from .04 to .08 inch deep, chordwise around the leading edge. These recesses are separated by raised lands, $\frac{3}{8}$ inch wide. The inner skin is wrapped inside the outer skin and the two are riveted together. The lands between recesses provide for attachment of the inner skin and nose ribs.

Heat, in the form of bleed air from the engine compressor, is fed into the channels, which are formed by the lands, through titanium tubes. The result is an almost perfect heat exchanger that has

Leading edge sections from outboard engine to fuselage are hinged for quick easy access.

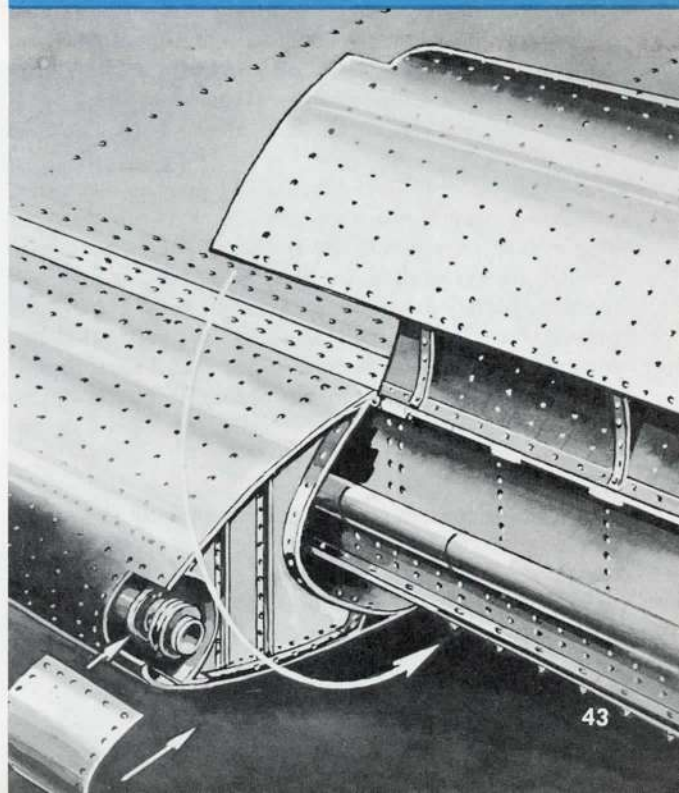

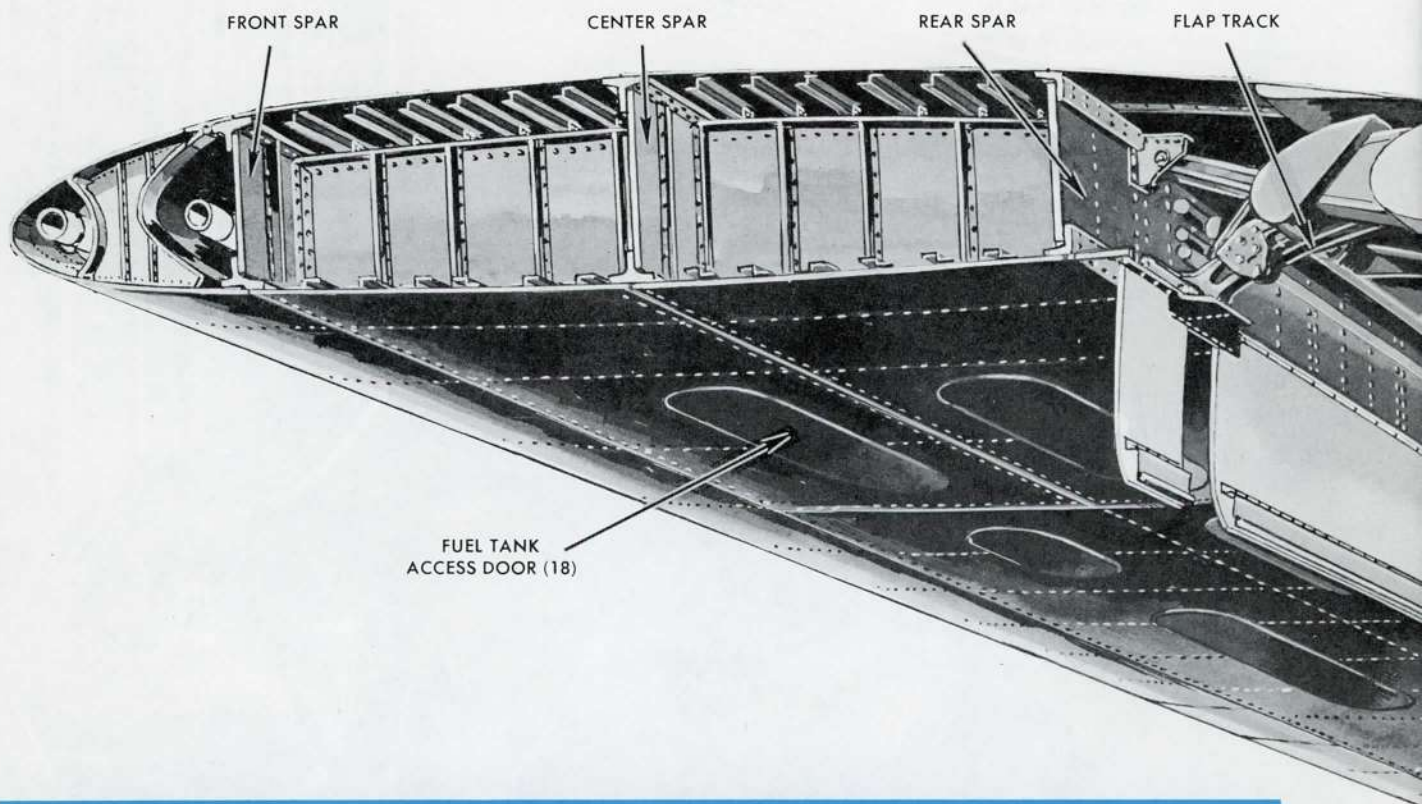

WING LOWER SURFACE SHOWING ACCESSIBILITY

proved 85 to 90 per cent efficient. Under limit cruise load tests, no wrinkles appeared on the leading edge structure, and a perfectly smooth surface was maintained up to design limit load.

The trailing edge, flaps, ailerons, and spoilers are of bonded honeycomb construction, developed to decrease the fatigue effects of sonic vibrations. This structure was developed after extensive testing in the facilities maintained by the test lab at Convair.

A siren for developing pressure impulses was used for development work on the honeycomb panels. The siren operates on the principle of compressed air passed through a plenum chamber to a siren motor, which converts compressed air power to sound power. From this stage, the sound is propagated by means of an acoustic matching horn, and then piped through a sonic tunnel. Power for the test program is provided by a 140-hp industrial engine driving an Allison supercharger turbine.

The test acoustic pressures generated by the siren result in 400 pounds or more dynamic drive over a test panel 22" x 44". These are accelerated test conditions and greatly exceed the sound pressures expected for Convair 880 operations.

Considerable attention has been given to accessibility for maintenance and inspection purposes. A full-size mockup of the wing was built for the express purpose of working out a combination of access doors, hand holes, and locations for equipment, so as to provide maximum accessibility with minimum effort.

The entire lower surface, forward of the flaps and aft of the fuel tank, is hinged to give access to equipment located along the rear spar. The leading edges from the outboard engine to the fuselage are hinged for quick, easy access and to prevent damage to leading edges during maintenance operations on equipment in the leading edges. The wing tips are attached with only four bolts and are easily removable.

Fail-safe design has been followed throughout the wing structural box, which incorporates the integral fuel tanks. The Scotchweld process, developed by Convair in cooperation with Minnesota Mining and Manufacturing Company, utilizes a metal-to-metal adhesive for fuel-tighting of structural members and skins in these areas.

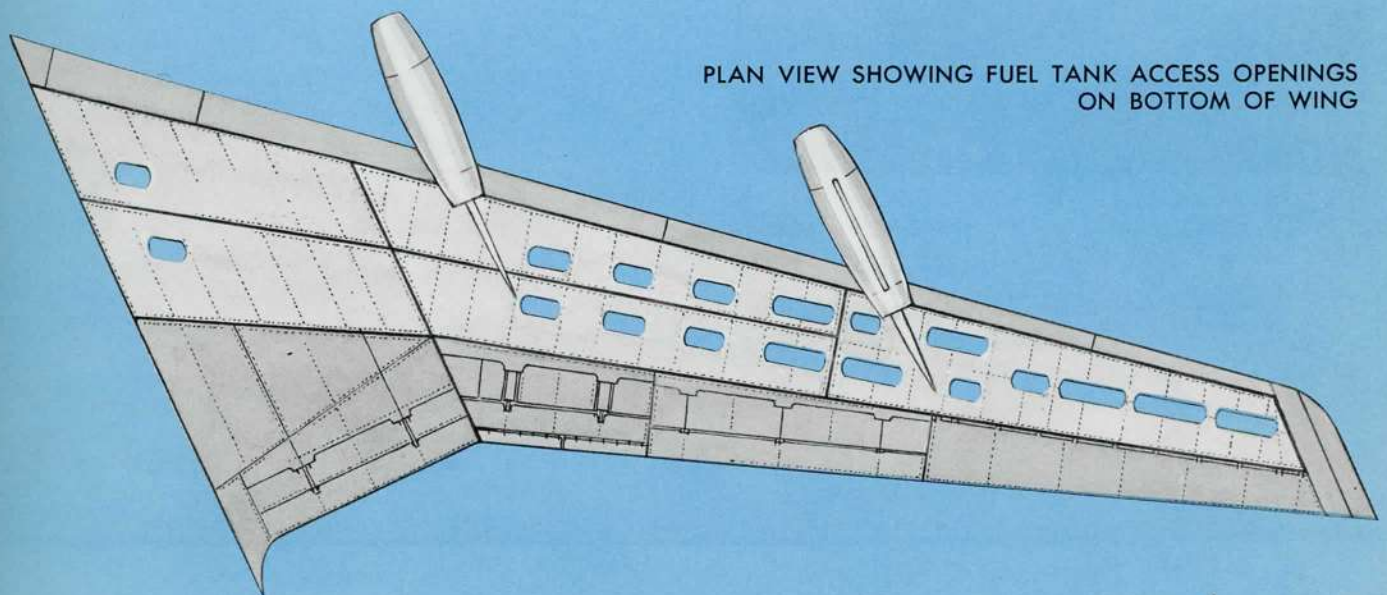
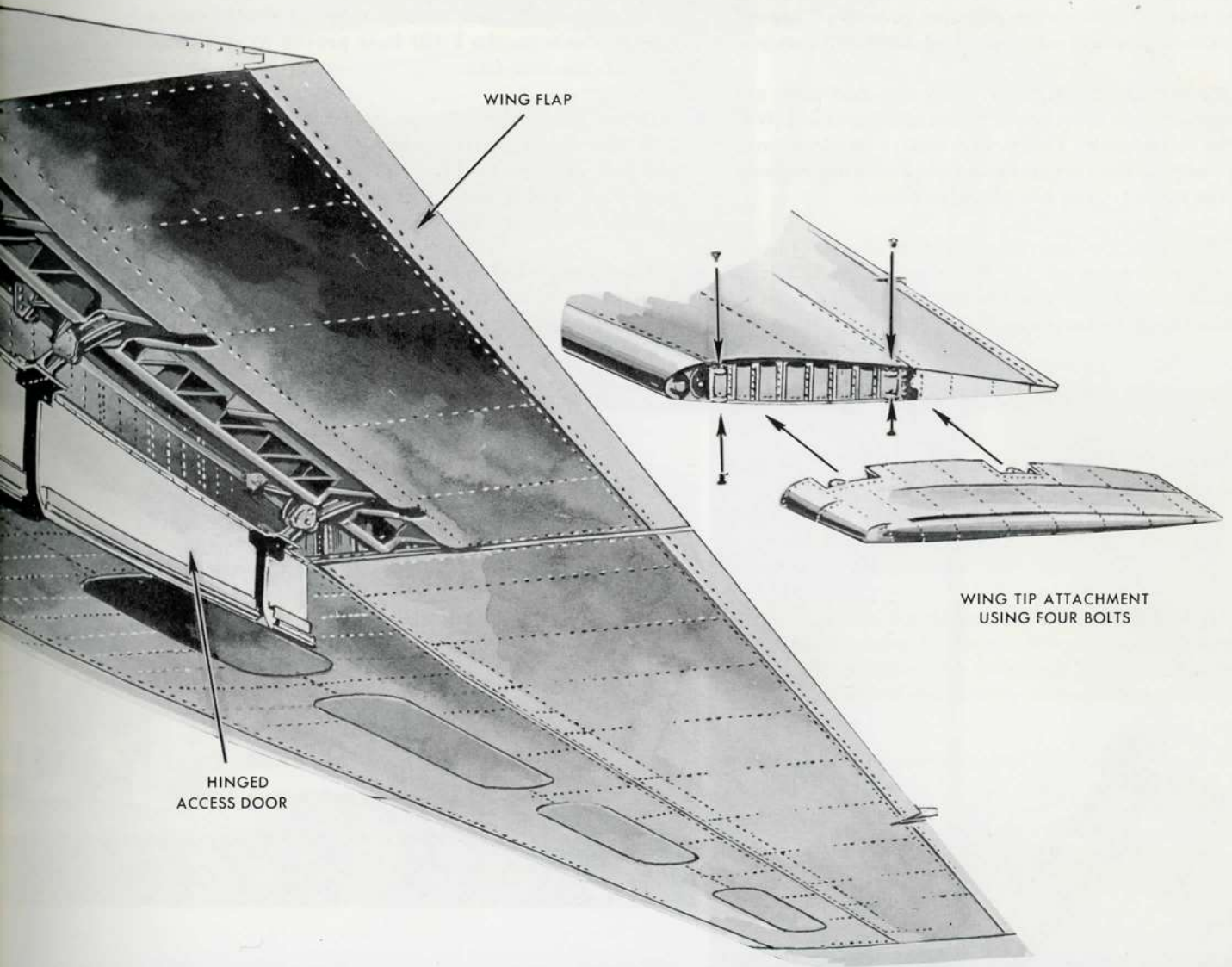

In addition to conventional riveting at all joints and splices, Scotchweld adhesive provides "bonus" structural strength and increased fatigue resistance.

All surfaces of all parts inside the fuel tank are sprayed with a Scotchweld prime and cured at 150°F prior to assembly. This prime insures freedom from corrosion in the fuel tanks and on the faying surfaces of the tanks for the life of the structure.

The wing, after assembly, is placed in a large oven at a temperature of 320°F for one hour. After a cooling period, the adhesive becomes cured so that it is unaffected by fuels and chemicals.

This is the same type leak-proof construction that is so successfully used on the Convair F-102 Interceptor. Tanks on the F-102 have proved to be virtually maintenance-free.

Other advantages of this type construction are: 1) it develops shear strengths of approximately 4000 psi; 2) it excludes fuel from all faying surface structure; 3) it "welds" the entire structure into a homogeneous mass that is leak-proof and maintenance-free.

The Convair 880 wing integral fuel tank has been thoroughly tested, utilizing a full-scale section of the wing. This test specimen "wing" was a truly repre-

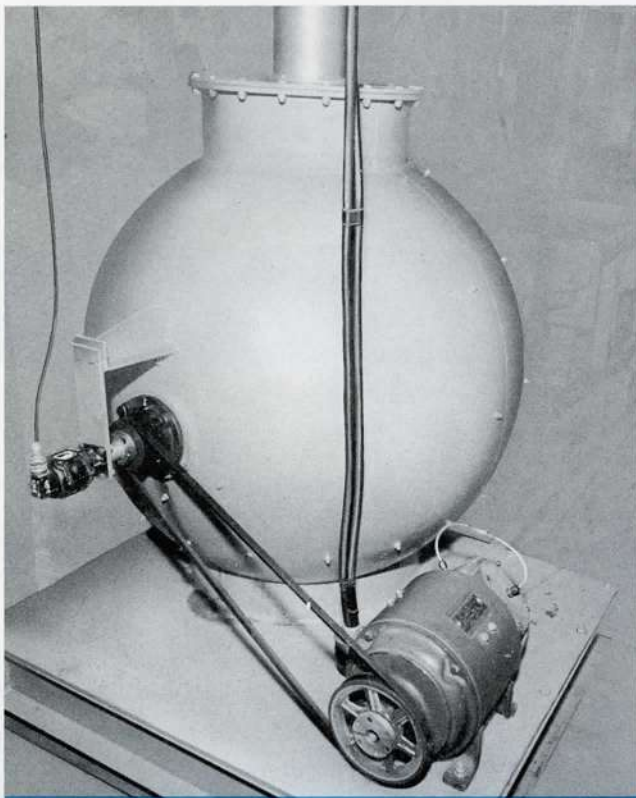

Siren is used to study high-energy sound effect on "880" honeycomb structures.

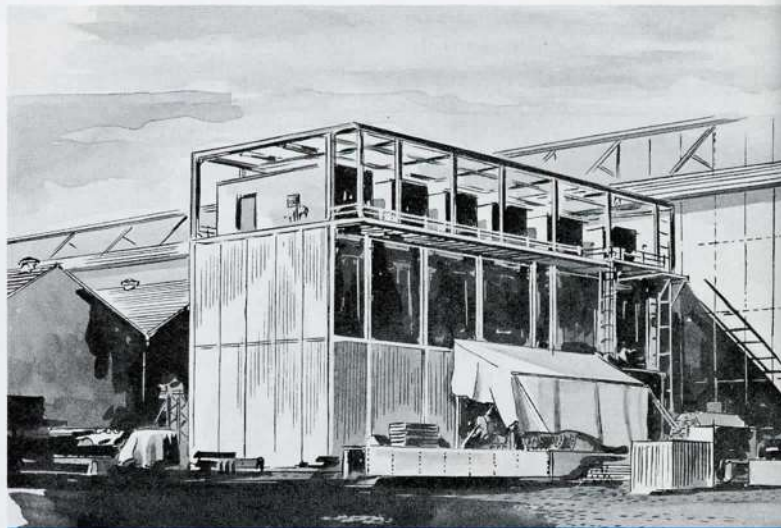

Nearing completion is Scotchweld oven used in leak-proof construction of wing fuel tanks.

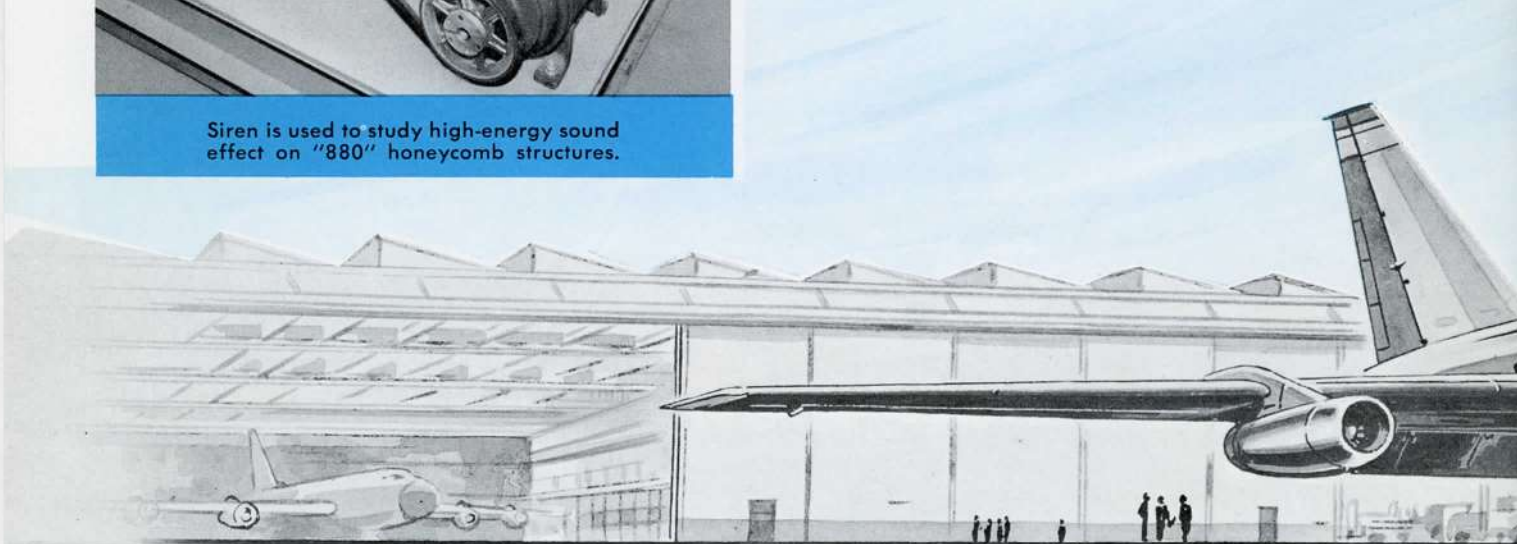

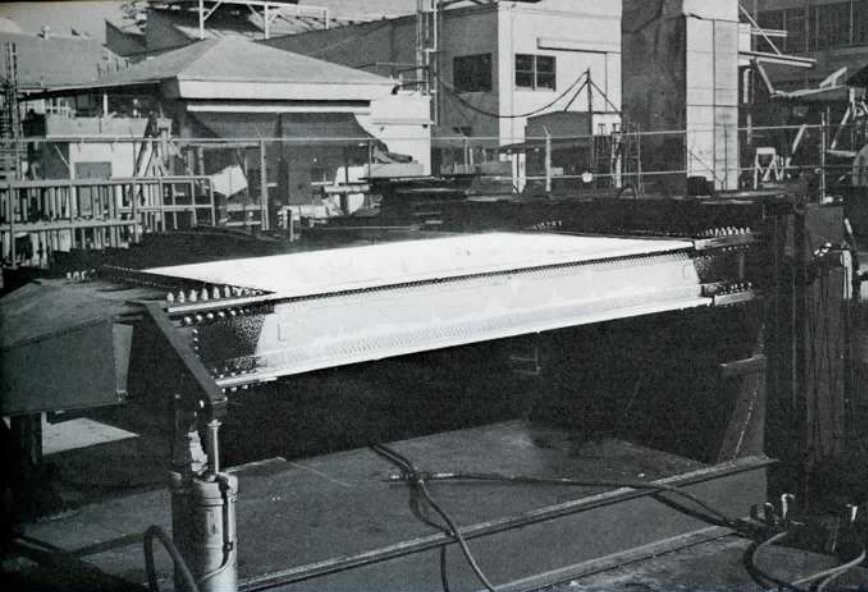

Low-temperature test on wing panel produces frost and freezes fuel, but fails to create leaks.



Wing section in test facility is subjected to many loads to prove structural integrity.

sentative section of the wing, embodying all proposed fasteners, structural elements, and other details as represented in the finished wing. The purpose of building this 20-foot test tank was to prove the integrity of the fuel tank and all materials used or proposed for use in the "880" tank.

An exhaustive test program was instigated whereby a test tank was subjected to torsional, bending, and thermal stresses far in excess of expected service operating conditions. The tank, while filled with fuel and pressurized to 10 psi, was cycled through a load spectrum covering normal conditions encountered in airline operation.

The cycling program included a phase of low and high temperatures. The low-temperature cycling occurred at temperatures of -65°F and -70°F for

a period of 48 hours. Near the conclusion of the cold tests, temperatures had to be moderated because of freezing of the fuel.

The high temperature tests followed, with temperatures ranging from 72°F (ambient) to 180°F for 48 hours. At the conclusion of this rigorous test program, the test log failed to show a single leak or even a stained rivet. No structural failure occurred and no evidence of the severity of the tests was noted.

Considerable developmental testing of the "880" wing detail has already been completed. All tension critical joints and splices are being tested and will undergo fatigue cyclic loading patterns until failure. The valuable data gained from this fatigue test program are being reflected in the final product.





FOREWORD

Some innovations in the Convair 880 empennage flight controls were described in the *Traveler* for August 1958. The flight controls in the wing, described in this issue, are no less interesting.

Jet age power and speed demand new concepts in lateral controls. A jet transport must be designed for flight at high Mach numbers, and yet be adaptable for low speed and high lift for takeoff and landing.

This issue is concerned with Convair 880 and 600 lateral controls; with deceleration and dive braking; and with the flaps and extensible leading edge provisions that enable Convair's jet airliners to take off and land at today's airports.

**Reprint from CONVAIR TRAVELER
December 1958**

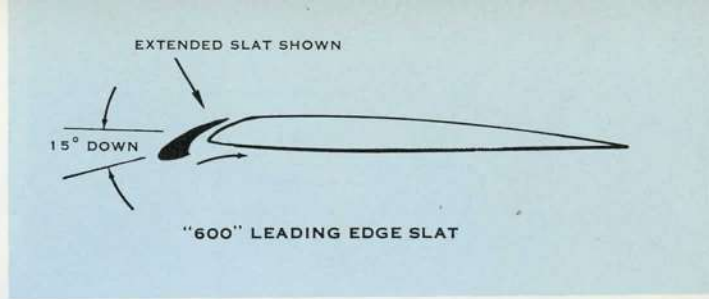
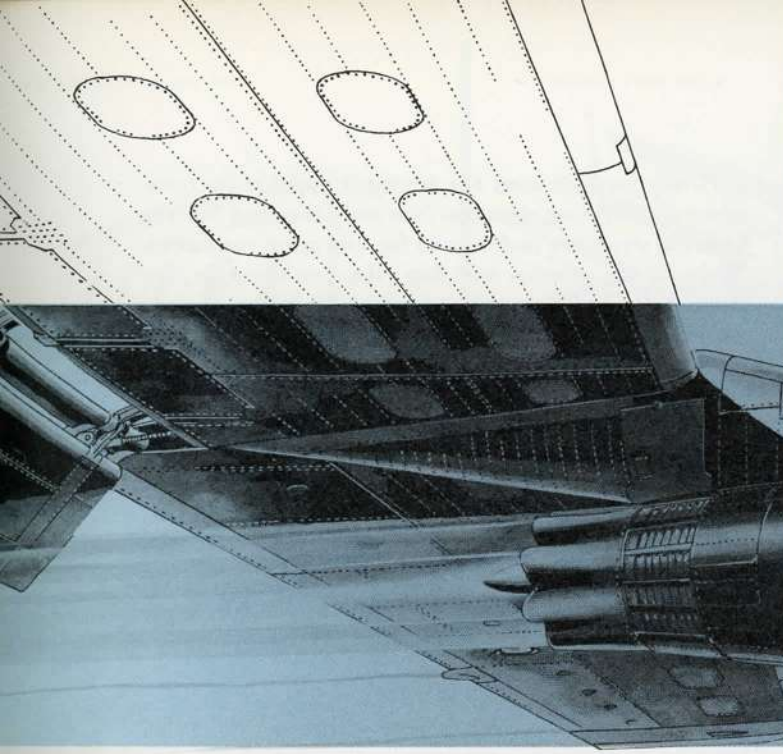

CONVAIR 880-600 WING FLIGHT CONTROLS

The wing flight controls in the Convair 880 and 600 jet airliners differ markedly from the configuration that has for some years been standard on propeller-driven aircraft. Ailerons have been brought far inboard and are relatively small in area. Spoilers, mounted on the upper wing surface near the trailing edge, have taken over much of the aileron function and also may be operated as speedbrakes.

Flaps are double slotted type, each with a fore flap and main flap. One is inboard and one outboard of the aileron. On the "600" airplane, leading edge slats along with the flaps are extended for more effective lift at takeoff and landing speeds.

Wing structure is fundamentally the same in both aircraft. The "600" has, however, more wing surface; the leading edge extends farther forward, and approximately 25 inches has been added along most of the trailing edge. Appearance of the "600" wing is altered by the addition of anti-shock bodies — two contoured pods faired into the upper surface of each wing. The aerodynamic function of the anti-shock bodies is to apply one aspect of the "area rule" in the "600" wing design.

Primary flight controls — rudder, elevators, ailerons and spoilers — are similar in the "880" and "600." The "600" empennage controls differ from those of the "880," described in a previous Traveler, in having a slightly larger horizontal stabilizer, and in having a hydraulic boost for additional rudder power; otherwise, they are essentially the same.

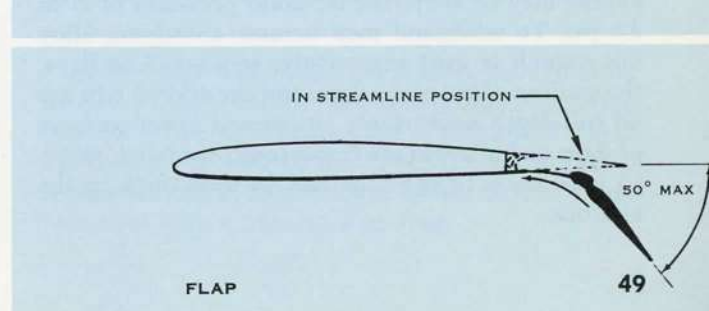
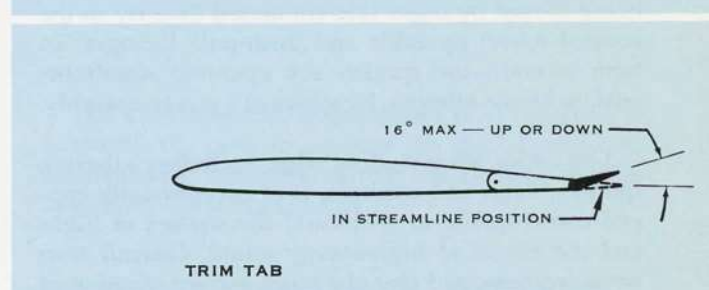
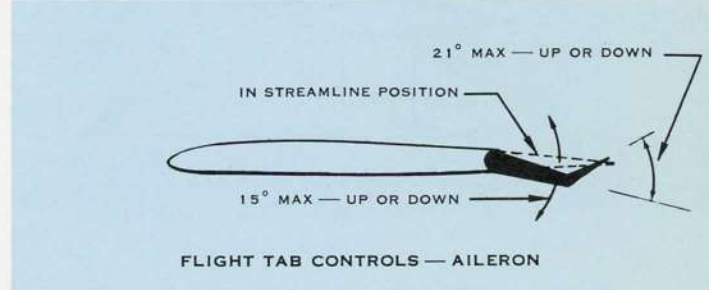
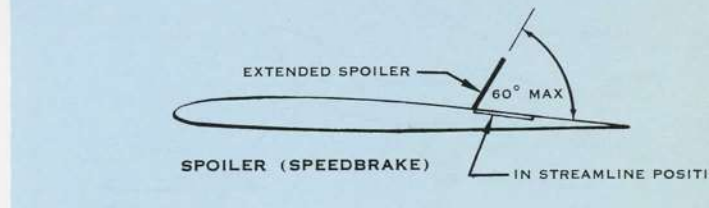

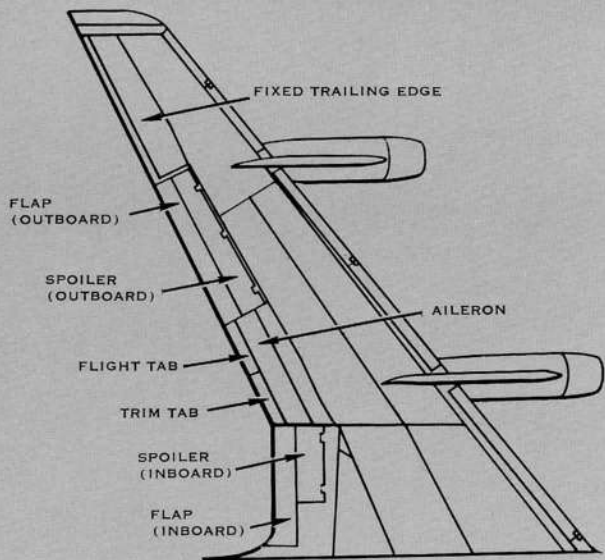

"880" WING CONTROL SURFACE LOCATIONS

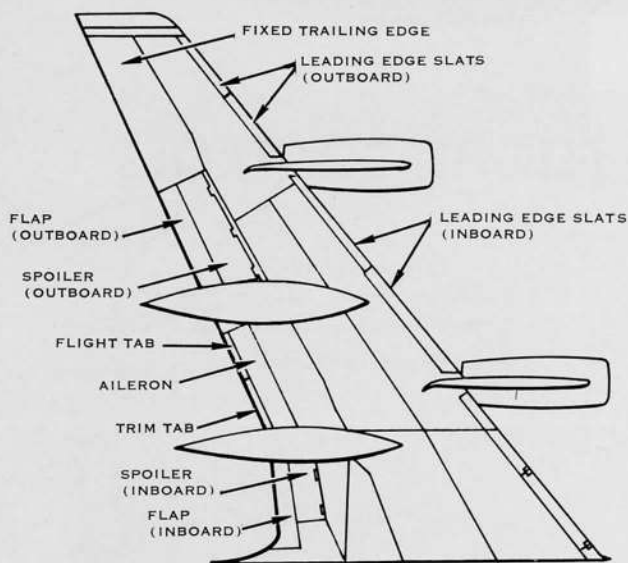

"600" WING CONTROL SURFACE LOCATIONS

Aileron control is conventional, with the ailerons being moved by flight tabs connected directly to the control wheel by cable and push-pull linkages. In both aircraft, the spoilers are operated simultaneously with the ailerons, by means of a mixer assembly.

The entire wing trailing edge, including ailerons, spoilers, flaps, and controls, is of exceptionally rugged construction, to withstand the stresses of flight and the effects of high-energy sound. Convair tests have demonstrated that the wing surface aft of a jet engine may be subjected to sound pressures of .5 to 2.5 psi. To withstand such stresses, aluminum alloy honeycomb is used extensively; spoilers, fore flaps, the trailing edges of the flaps, and the aileron tabs are all full-depth honeycomb. Upper and lower surfaces of flaps and ailerons are honeycomb sandwich skins, $\frac{1}{2}$ inch thick in the flaps and $\frac{3}{8}$ inch thick in the ailerons.

Honeycomb is used for strength and for its resistance to vibration damage. Not only the skin but the internal structure is designed for vibration resistance. Webs in the aileron and flap ribs, for example, are three-ply bonded metal laminates, in place of conventional single-thickness sheet.

Spoilers, flaps, and the "600" slats are hydraulically actuated. Each actuator is powered by both No. 1 and No. 2 hydraulic systems; either system alone provides sufficient power to operate these controls. A dual cable system in the fuselage, and dual push-pull rods through the ailerons to the flight tabs, provide protection against failure of mechanical elements in the aileron control.

Safeguards and warning devices protect the pilot from inadvertent or overspeed actuation of the hydraulically-powered controls. Although the spoiler-speedbrakes may be extended at any speed, design of the actuators permits "blowdown" of the surfaces when airspeeds are too great. Speedbrake extension at takeoff is restricted by an interconnect linkage between the No. 1 engine power control system and the speedbrake control, so that the power lever cannot be advanced to takeoff position with speedbrakes extended.

Speedbrake and flap control levers drop into detents at the retracted position and must be pulled up for extension, preventing inadvertent extension

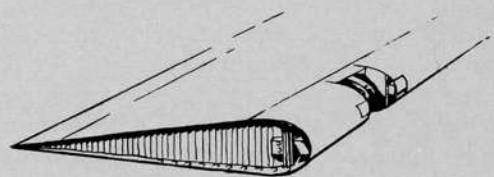

FULL DEPTH HONEYCOMB USED ON SPOILERS, FLAPS AND AILERON TABS

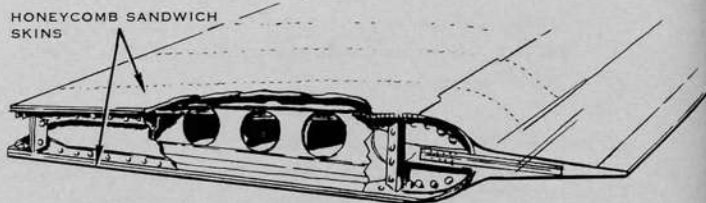

HONEYCOMB SANDWICH SKINS USED ON FLAPS AND AILERONS

3-PLY BONDED LAMINATES

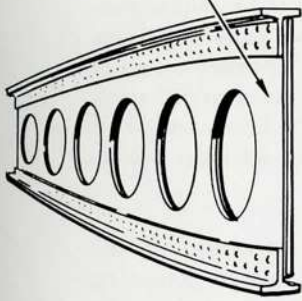

LAMINATED WEBS OF AILERON AND FLAP RIBS

TORQUE TUBE DRIVE FORE FLAP

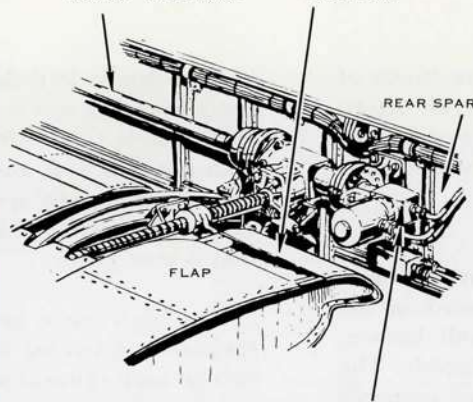

FLAP TORQUE DIFFERENTIAL SWITCH

SPEEDBRAKE CONTROL LEVER FLAP CONTROL LEVER

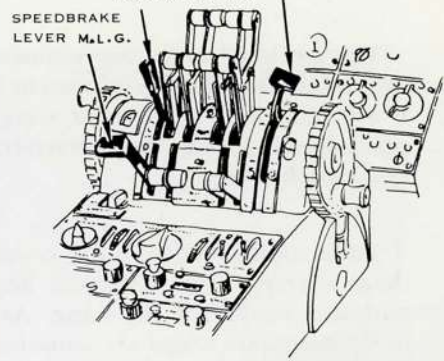

SPEEDBRAKE AND FLAP CONTROLS

PILOTS' PEDESTAL CONTROL

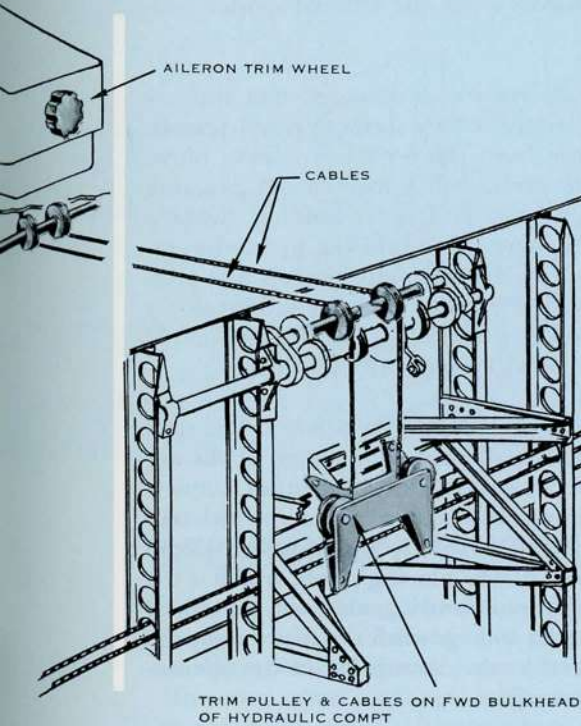

TRIM PULLEY & CABLES ON FWD BULKHEAD OF HYDRAULIC COMPT

TRIM TAB JACKSCREW CONTROL ASSEMBLY

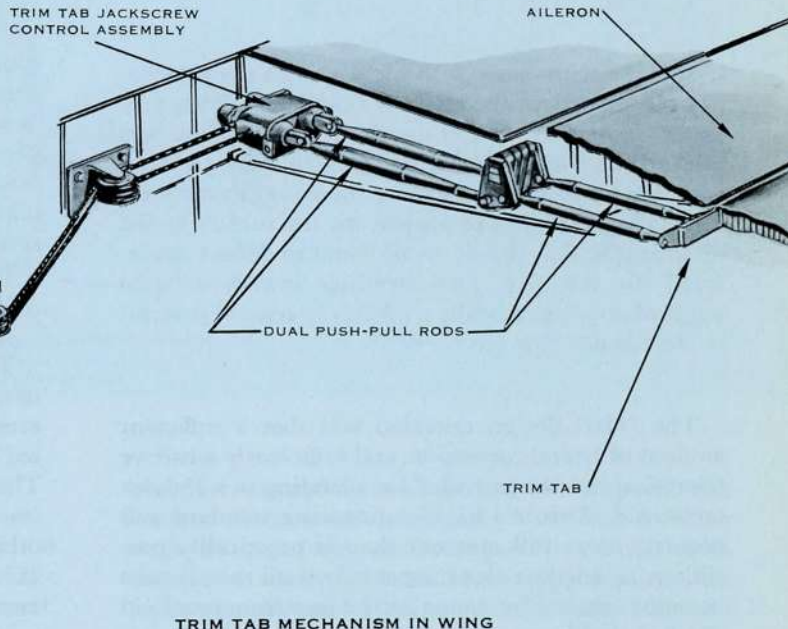

TRIM TAB MECHANISM IN WING

by bumping the levers. A flap position warning horn sounds, should a takeoff be attempted in other than takeoff position.

The "fail-safe" principle governs design of the mechanical elements of the hydraulically-operated controls. Disconnection in a flap linkage, or excessive resistance in one wing, is prevented from causing asymmetric flap extension by torque differential switches at the ends of the flap torque shafts that cut off hydraulic power to the actuators. Any malfunction of one spoiler linkage leaves the other spoilers operable as required for stable flight. Should a disconnect occur in the spoiler system, the valves are springloaded to spoiler-down streamline position.

The aileron-spoiler interconnect is so designed as to permit the pilot to override the spoiler actuation mechanism if necessary, so that the airplane may be controlled by ailerons alone.

LATERAL CONTROL SYSTEM

In the "880" and "600," the aileron, though designated a primary control, has dropped to a secondary role. Its principal functions are 1) to provide a manual backup, capable of providing control in case of spoiler failure; 2) to provide pilot feel; and 3) to provide trim with a minimum of drag.

The spoilers furnish approximately two-thirds of the roll control. This development in aircraft design is attributable to the greater wing loads at jet airplane speeds, and to the characteristics of a sharply swept-back wing.

To be most effective in roll control with the least drag, ailerons have heretofore been placed in the outboard section of the wing. As is well known, modern aircraft wings are remarkably flexible. The flexure in a long, straight wing has, since airspeeds have approached the speed of sound, had a pronounced effect on the reliability of roll control response. A wingtip aileron, at high speeds, may function as a flight tab; that is, it may cause sufficient torque moment to twist the wing tip to the point of control reversal.

When a wing is swept back as it is in the present-day jet transports, the effect is aggravated. This may be understood by imagining the wing as a plane parallel to the line of flight. Bending of a swept wing from lift air loading will cause the wing tip not only to bend upward, but to present the top surface to the airstream so that the tip would tend to deflect downward. In actuality, such bending lowers wingtip angle of attack so that the tendency to control reversal is increased.

The "880" design criterion was that a sufficient amount of lateral correction, and sufficiently sensitive control, should be provided for a landing in a 25-knot crosswind. This is a high engineering standard and requires more roll moment than is practicably possible with ailerons alone, especially with the ailerons brought inboard far enough to be free from torsional reversal problems.

A spoiler, by its deflection action and by simultaneously lowering one wing's lift, does provide a large roll moment. The "880" and "600" spoilers are more than two feet wide and can be extended to 60° trailing-edge-up at any speed up to 200 knots IAS. Full extension is obtainable within two seconds; retraction is even faster.

The high force required for operation of the spoilers is provided by hydraulic piston actuators, two on each inboard spoiler and two on each of the two sections of the outboard spoiler. Each actuator is powered by both hydraulic systems. There is one dual selector valve for the inboard spoiler and one for the outboard, with mechanical followups to stop the flow to the actuators when the selected spoiler position is reached.

The selector valves are so designed that there is some constant hydraulic flow through them, permitting reverse flow from the actuators during blowdown. When the aerodynamic load on the actuating pistons exceeds the hydraulic force holding them extended, the fluid flows back into the hydraulic systems. Should one of the hydraulic systems lose pressure, hinge moment will be reduced and blowdown will occur at lower speeds; but full deflection will still be possible at 150 knots IAS or below.

Trim control is provided in the aileron. The trim tab, approximately half the trailing edge of the aileron, is operated by a screwjack mechanism, connected by cables directly to a trim wheel on the pedestal. The trim tab may be moved 16° up or down; aileron travel is 15° up or down. The flight tab, which is the other half of the aileron trailing edge, may be moved 21° up or down. Its linkage with the flight compartment is explained in the description of the aileron-spoiler mixer assembly.

CONTROL REVERSAL — LONG FLEXIBLE WING WITH OUTBOARD AILERON

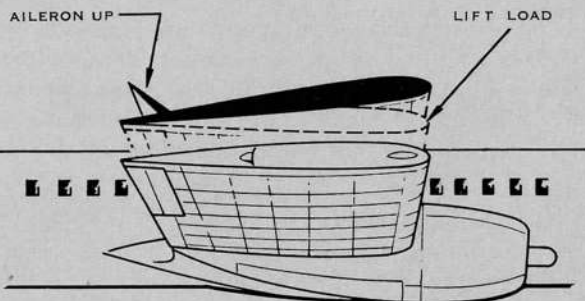

EFFECT OF LIFT LOADS ON ANGLE OF ATTACK AT WINGTIP OF SWEEP WING

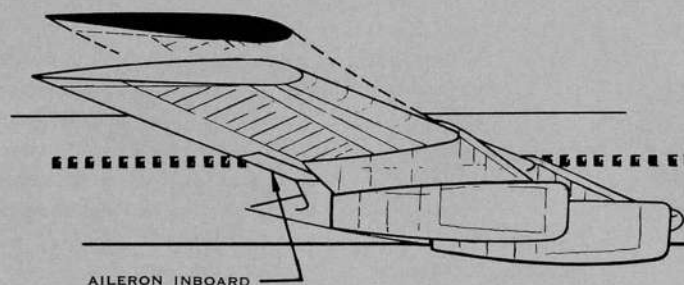

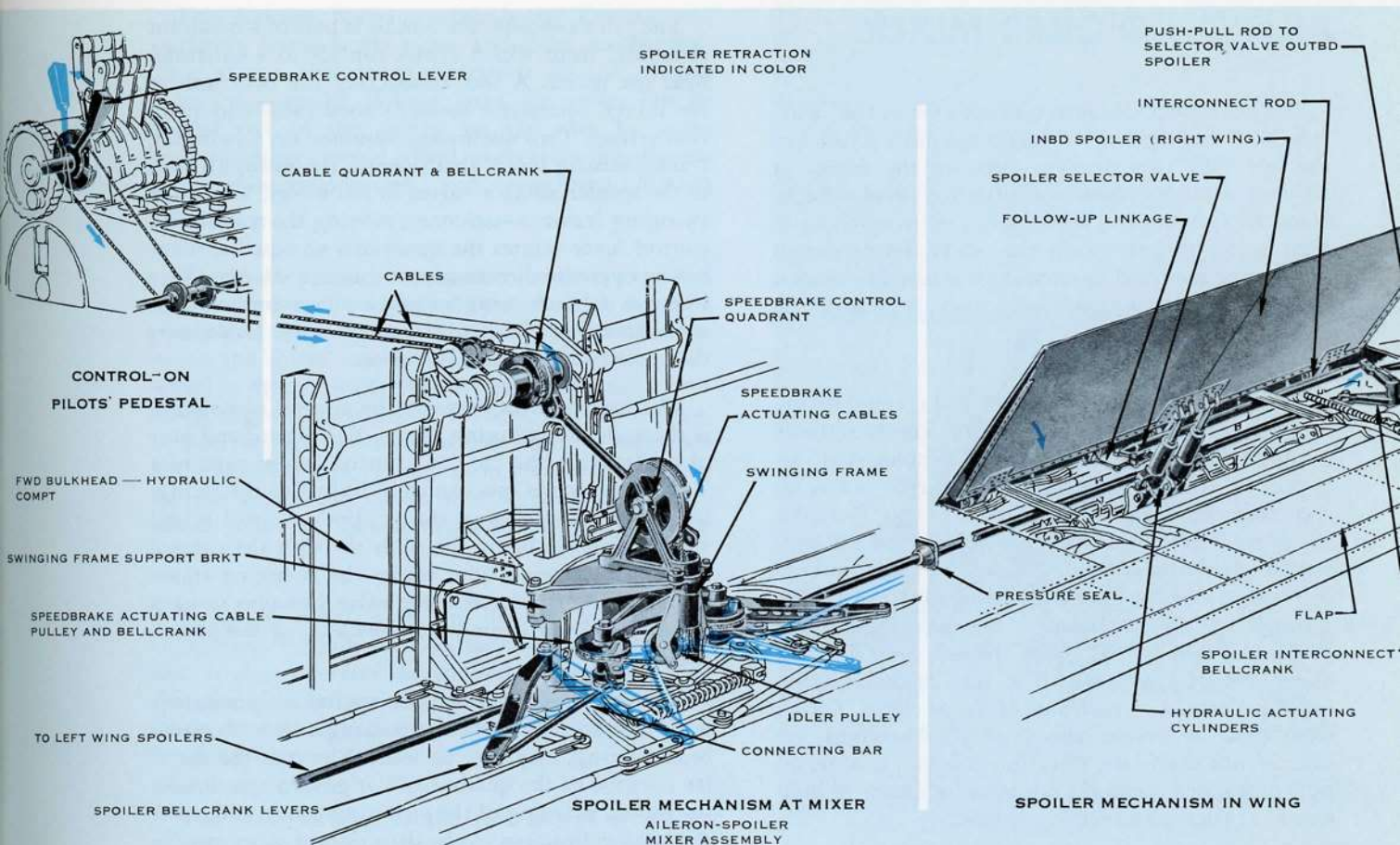

SPEEDBRAKE SYSTEM

Speedbrakes have not ordinarily been required on propeller aircraft because the propeller, when not exerting positive thrust, is an effective brake itself. However, some high-performance propeller-driven transports have found it necessary to drop the landing gear for deceleration purposes or for rapid descent at constant speed. The need for more drag is acute in jet aircraft. Besides having no propeller and being aerodynamically cleaner, a jet airplane in a holding pattern must stay at high altitude, and must be able to come down quickly without building up dive speeds. The common occasion for rapid deceleration is "gust penetration" — slowing down for turbulent air.

The "880" and "600" obtain the necessary drag from both landing gear and spoiler action. The spoilers, when used as speedbrakes, move up and down symmetrically and simultaneously. This control is by movement of a lever on the left-hand side of the pedestal beside the throttle levers.

Since the spoilers may be used for lateral control and as speedbrakes at the same time, the mixer assem-

bly must sum up the two inputs from the speedbrake lever and the control column. With spoilers flush with the upper wing surface, as an aileron moves up, the spoiler on that side will move up; with spoilers full open, the spoiler on the down-aileron side will retract. At any intermediate setting of the speedbrake lever, one spoiler will move up and the other down.

An indicator beside the speedbrake control lever is calibrated in knots IAS. The indication marks the speed at which blowdown from the speedbrake setting may be expected. A spring in the mixer assembly provides pilot feel which increases as a function of spoiler extension.

As has been noted in Traveler descriptions of the landing gear, the main gear may be extended for additional braking effect. The relative amount of air drag is less than from spoiler action, and the time required is some seconds longer. But, since the main landing gears do not "blow down," and can be extended at any airspeeds up to 375 knots IAS, they add appreciably to braking effect in the middle speed range. The pilot control for MLG extension for use as an airbrake is located adjacent to the speedbrake lever.

AILERON-SPOILER MIXER

The aileron-spoiler interconnect unit in the "880" and "600" is a mechanical mixer assembly located in the hydraulic compartment between the wings. It receives its input from the pilot's control wheels, from the speedbrake control lever, or from an autopilot motor mounted near the mixer. Its operation can best be analyzed by considering first the aileron and speedbrake functions separately, and then the interconnecting action.

Aileron control itself is direct and comparatively simple. Turning the pilots' control wheels actuates pushpull rods and bellcranks (interconnected between the control wheels), and a pair of cables on each side transmits the movement aft to T-cranks. Only the T-crank on the left (pilot's) side is connected to aileron control; the copilot's aileron control is thus exercised via the left-hand pair of cables, through the interconnection between the control columns. Pushpull rods from the left-hand T-crank move vertical levers, which in turn actuate aileron input bellcranks on each side of the assembly. Cables from these bellcranks pass through the wings, via idler cranks where the direction changes; dual pushpull rods move the flight tab horn by means of bellcranks at aileron and tab hinge lines.

The aileron tab control is reversible, so that aerodynamic forces acting on the tab are transmitted back through the mixer to the control wheels. A torsion bar in the mixer adds to pilot feel and acts as a centering spring. To maintain equal surface displacement, the ailerons are interconnected by a pushpull rod linkage.

The pilot's speedbrake handle is part of a quadrant assembly, from which cables run aft to a bellcrank near the mixer. A rod, connecting the bellcrank to the mixer, operates a second closed cable-and-quadrant system. Two quadrants, mounted on a swinging frame, actuate levers that operate the pushpull rods to the spoiler selector valves in the wings. When the swinging frame is stationary, moving the speedbrake control lever rotates the quadrants an equal amount but in opposite directions, causing the selector valve linkages to each wing to move either outboard simultaneously or inboard simultaneously. This moves the spoilers up or down in unison.

The interconnect between the aileron and spoiler is through the swinging frame. The right-hand pair of cables from the copilot's control wheel runs to a T-crank which is mechanically linked to the swinging frame. Turning of the copilot's control wheel (by the copilot, or by the pilot through the control column interconnection) causes the swinging frame to pivot; the spoiler selector valve linkages to each wing are moved right simultaneously, or left simultaneously.

How the mixer programs spoiler displacement with reference to aileron input, regardless of speedbrake setting, may now be seen. Whatever the angular position of the quadrants that govern speedbrake operation, pivoting of the swinging frame will move the spoiler linkages in the direction of more spoiler displacement on one side and less on the other.

Because speedbrakes may be fully open or fully closed, the movement of the selector valve linkages may affect the flow through only the valves in one wing. This is possible because the selector valves are designed to permit an unusual amount of overtravel in either open or closed valve positions.

CONTROLS IN FLIGHT COMPARTMENT

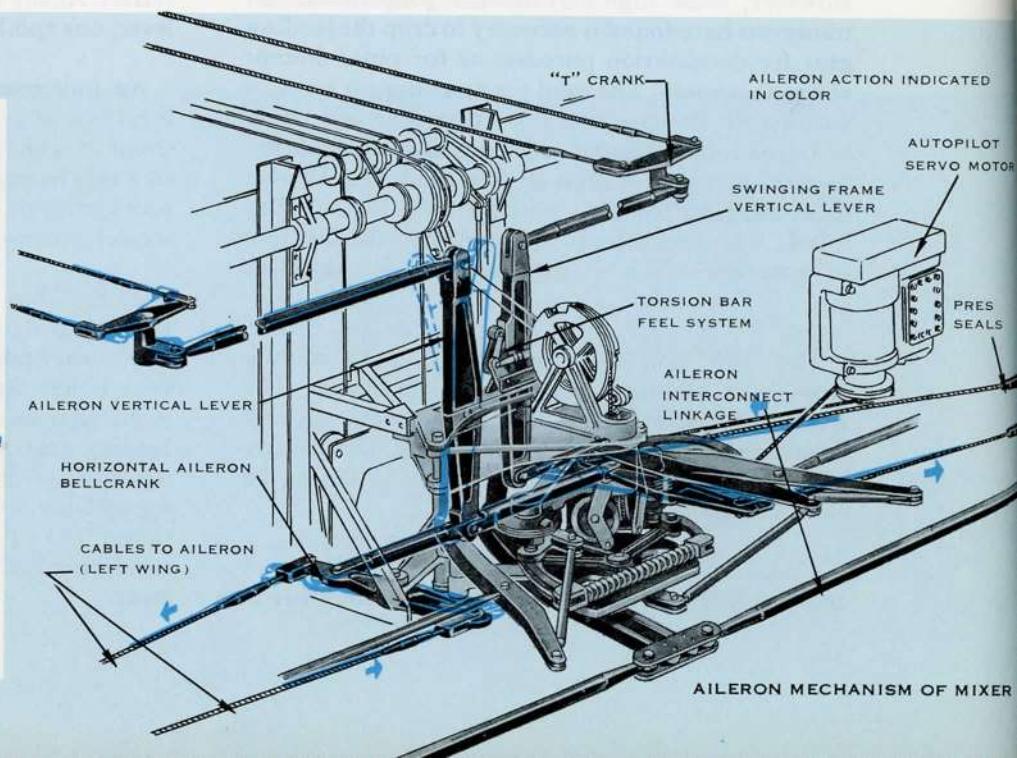
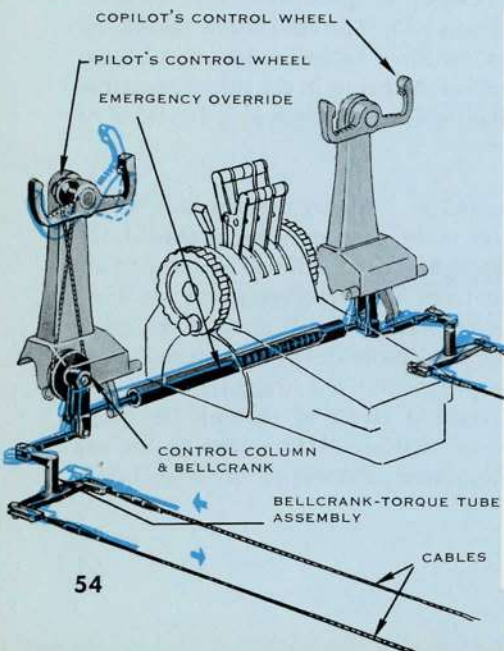

The linkage between right-hand T-crank and swinging frame is via a cam-and-roller mechanism. This allows emergency operation of the aileron alone; if a spoiler linkage jams, the roller can be moved out of the detent on the cam by extra force on either control wheel, overriding the aileron-spoiler interconnection and providing aileron control.

Should an aileron mechanism jam, the spoilers may be operated for lateral control. This is made possible by a spring link in the interconnection between the pilots' control columns. Since the pilot's wheel is mechanically tied to the aileron tabs, jamming might immobilize this wheel. But the copilot, by exerting enough force on his wheel to overcome the interconnecting spring, could operate the spoilers via the right-hand cables that connect his control wheel with the cam-and-roller mechanism in the mixer.

Autopilot input is to the linkage between the right-hand T-crank and the cam-and-roller mechanism. It thus operates the spoilers immediately, but the aileron more remotely, via the cables to the flight compartment and back through the left-hand (pilot's) control cables.

The interworking of the two means of spoiler control requires that there be no motion feedback from the aileron system; i.e., aileron movement must not change speedbrake setting. Also, the speedbrake feel spring must be prevented from retracting the spoilers. Therefore, the speedbrake control is irreversible. In the cable-and-quadrant assembly that operates the selector valve linkages, the driving quadrant incorporates an irreversible mechanism.

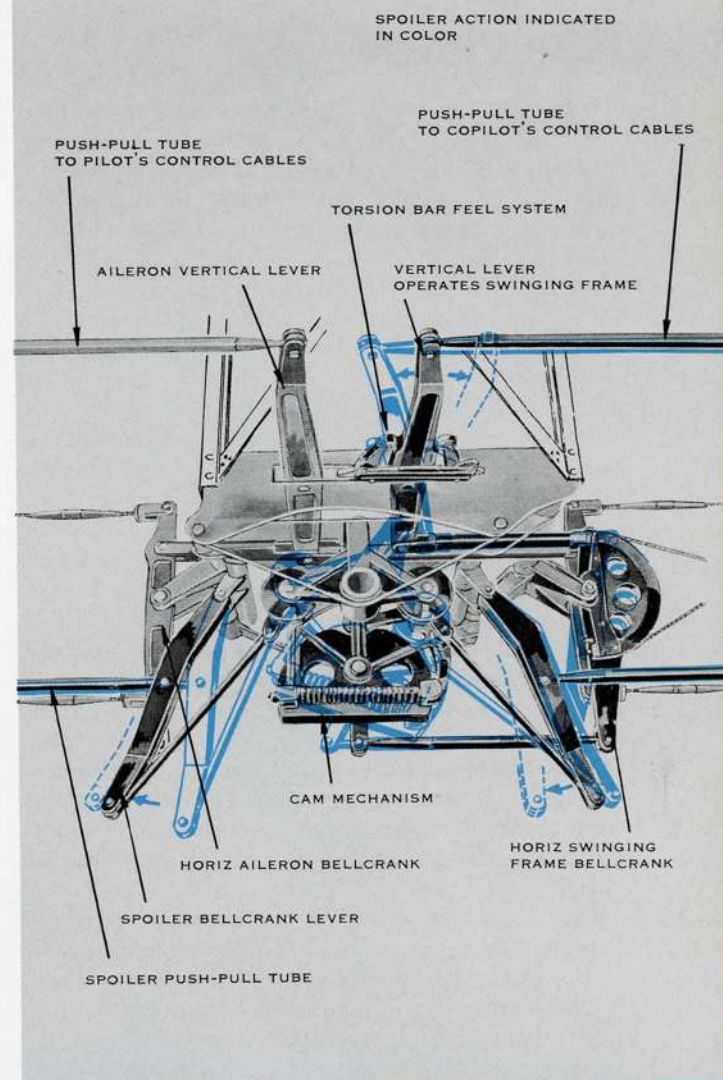

DETAIL OF SPOILER CONTROL TUBE ACTION AND OVERRIDE MECHANISM OF SWINGING FRAME TO OPERATE AILERONS

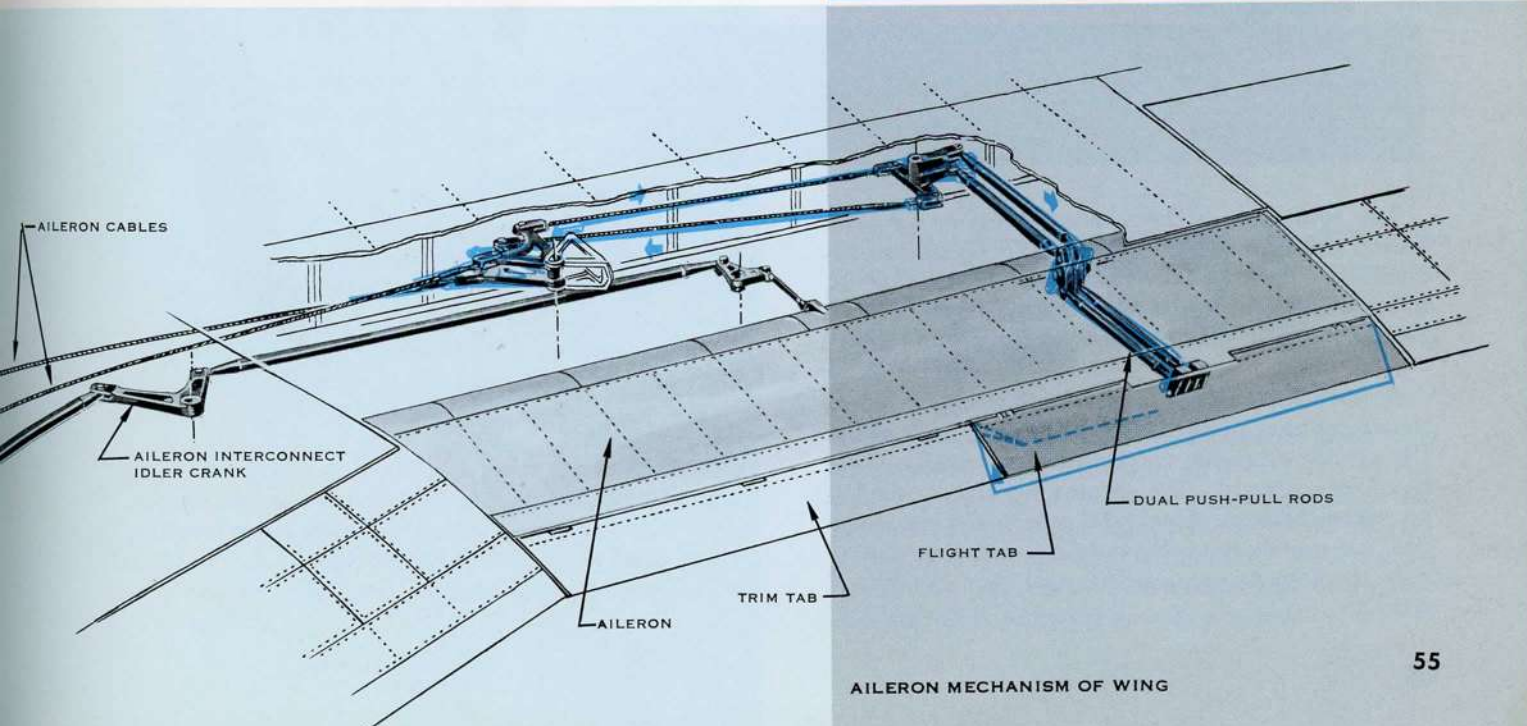

FLAP SYSTEM

The "880" and "600" flaps are similar to the conventional type in use on propeller-driven aircraft. There is an inboard and outboard flap on each wing. The inboard extends from fuselage to aileron; the outboard extends approximately 15 feet outboard from the aileron. All flaps are double slotted type. Each flap is mounted on tracks by means of carriage roller assemblies. Carriages at the ends of each flap are actuated by screwjacks that control extension and retraction.

Maximum extension is in an arc to approximately 50° downward. The "600" flaps extend a little farther aft from the wing before descending in an arc.

The principal difference between Convair's new jet transport flaps and the "440" flap system is that, instead of being provided with a gearbox in each wing, all "880" and "600" flaps are operated from one gearbox, located just below the aileron-spoiler mixer, at the airplane centerline. Two hydraulic motors, one for each hydraulic system, are coupled to the gearbox. Either motor will operate the flaps although, if one hydraulic system fails, extension will be somewhat slower. Torque rods connect the gearbox with the screwjack mechanisms that extend the flaps.

One advantage of the centerline location of the flap gearbox is that it permits direct manual control of the hydraulic selector valve. The pilot control is a lever, connected by cables to a dual hydraulic control valve. Enough overtravel is permitted in the valve for the pilot to move the lever immediately to the desired flap position. A follow-up lever on the valve stops flap travel at the selected extension.

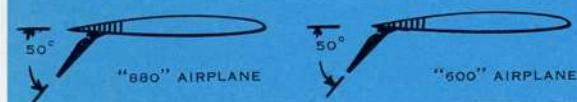

The pilot control lever has detents at sea-level takeoff and approach positions. Markings on the pedestal beside the lever show extension in 5° increments, to assist the pilot in selecting the intermediate positions.

A dual flap indicator on the instrument panel shows position of the outboard flap in each wing. Permissible airspeeds for flap-extended positions are listed on a placard. The warning horn for takeoff is connected between flaps, MLG struts, and the throttles, and sounds if a pilot should attempt to take off with the flaps in any position other than the takeoff setting.

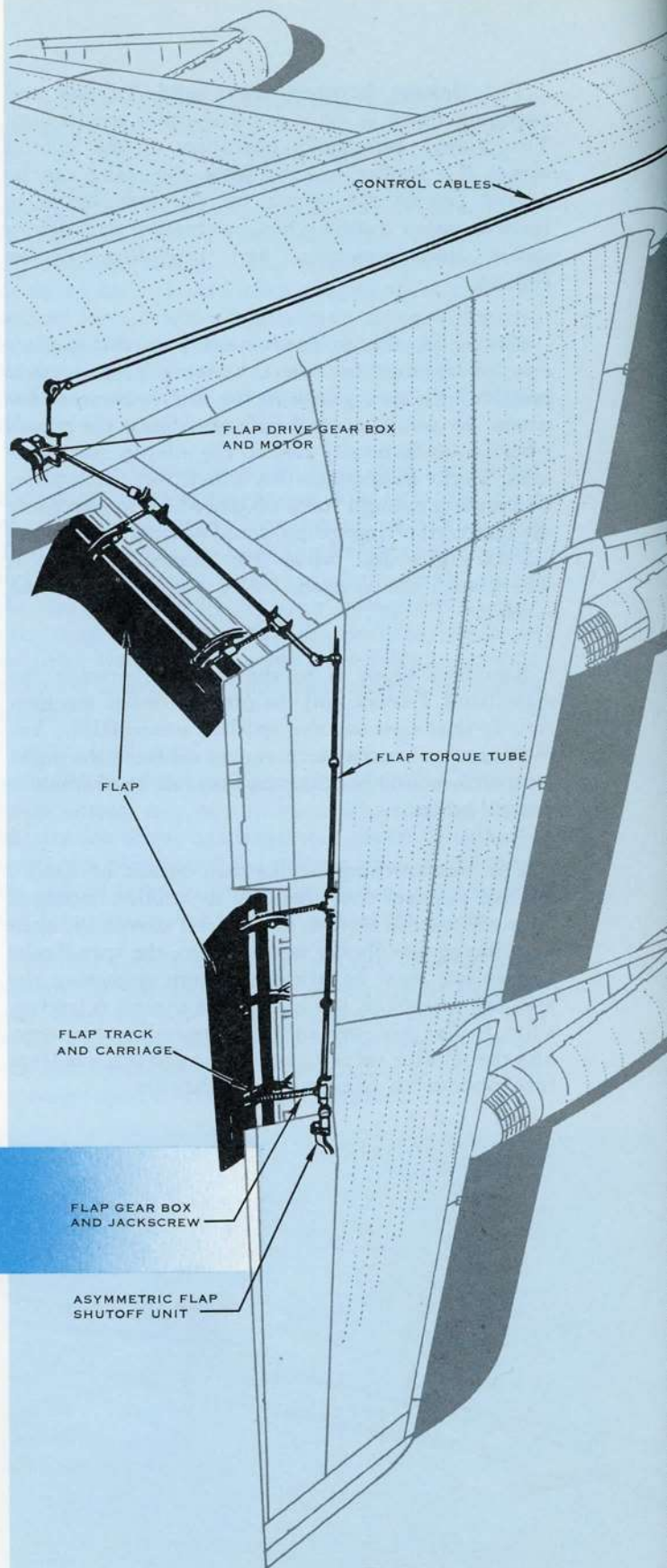

FLAP CONTROL SYSTEM
FLAPS SHOWN EXTENDED

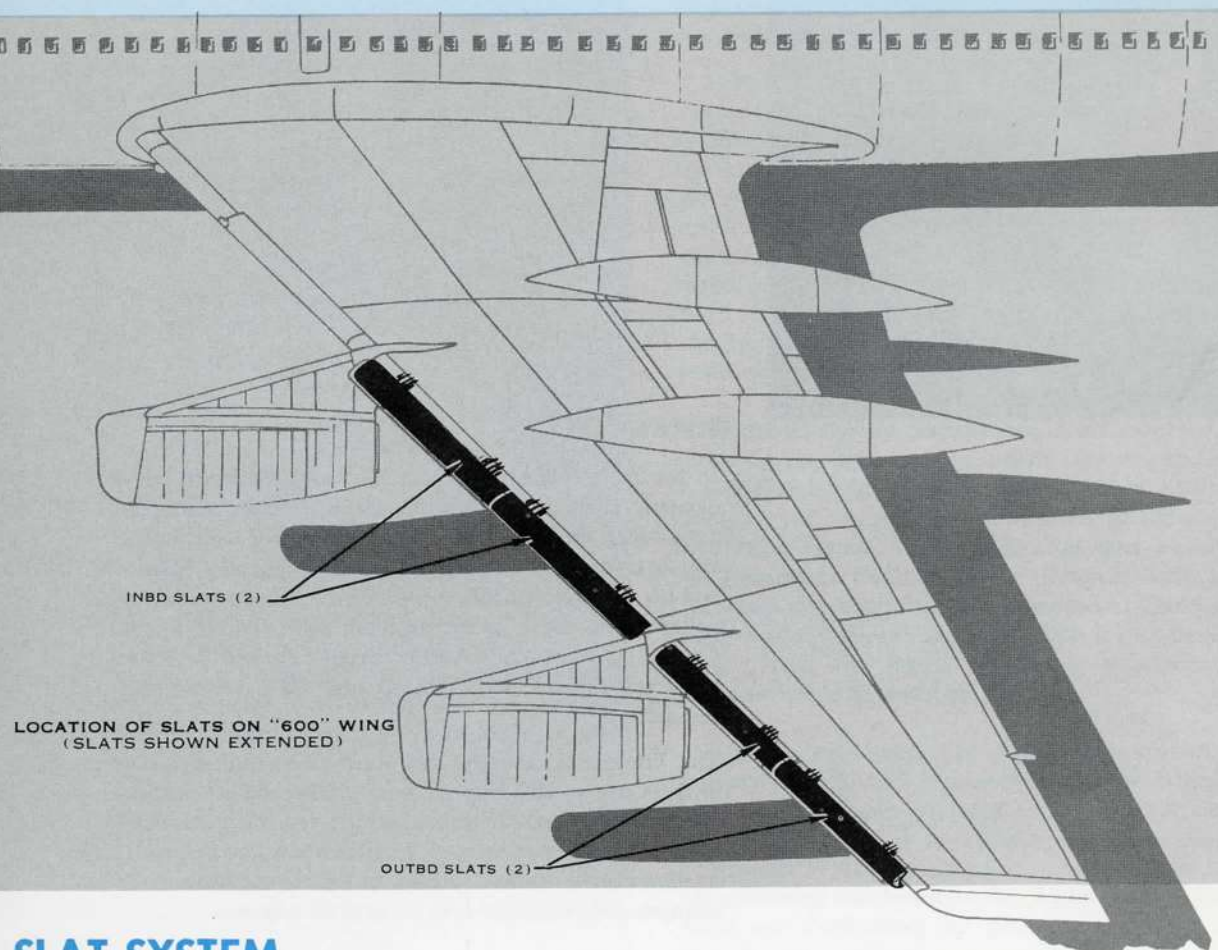
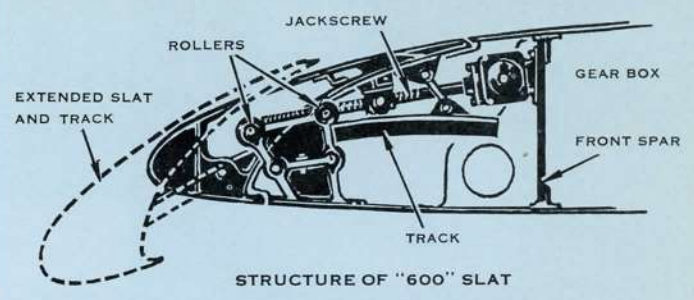
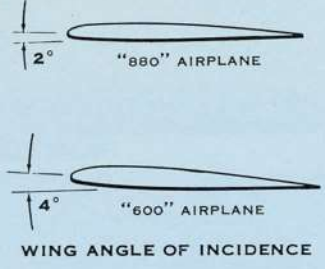
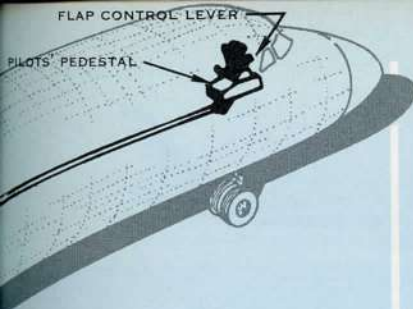

SLAT SYSTEM

The "600" airplane, larger and heavier than the "880," has additional lift for landing provided by slats in the wing leading edges.

The aerodynamic effect of slats is to increase the wing angle of attack for useful lift, thus increasing effective lift at low takeoff and landing speeds. To take advantage of this lift increase, the "600" landing gears are somewhat longer than are those in the "880," and wing incidence — wing fore-and-aft angle with reference to the fuselage — is greater. The "880" angle of incidence is 2°; "600" angle is 4°.

There are four slats in each wing, two between the engines and two outboard of the outboard engine. They are of two-spar torque box type construction. The external skin, like that of the wing leading edge, is laminated for anti-icing by circulation of hot engine bleed air.

Each slat is extended by a pair of screwjacks. The slats, like the flaps, ride on rollers on curved tracks. They move forward and down in a 15° rotational movement.

All four screwjacks are operated by one torque tube, turned by dual hydraulic motors at the airplane centerline. In event of a failure of the slat actuating mechanism, protection is provided against asymmetric slat extension.

The same pilot control lever operates both flaps and slats together, although slats may not extend until the flaps have reached a certain position. The cables from the flight compartment to the flap selector valve also operate a dual selector valve for the slat motors. There is no intermediate slat setting; the slats are either retracted or fully extended.



FOREWORD

In the progression from propeller to jet aircraft, aerodynamic characteristics of the airplane have undergone major changes. Within a very short span of time, cruise speeds are doubling; wings sweep back, altering balance and lift patterns; jet thrust has different effects from propeller thrust. All these factors affect flight control design. Control surfaces are smaller, forces required to move them are greater, and trim control has been radically revised.

The Traveler is devoting this entire issue to description of the Convair 880 empennage flight controls — vertical and horizontal stabilizers, rudder and elevator control and trim. Structure, and operating mechanisms, are described in some detail, to show specifically how Convair has built strength and reliability into the control system.

**Reprint from CONVAIR TRAVELER
August 1958**



880 EMPENNAGE FLIGHT CONTROLS

The flight control systems on the Convair 880 are designed for the wide range in speed and altitude of Convair's new jet transport. In external appearance, and in most operating characteristics, these controls are similar to those of any high-speed transport airplane; but there are some basic differences.

The primary flight control system consists of elevator, rudder, and aileron controls. Main surfaces of these controls are operated by flight tabs, controlled manually by the pilot through bellcrank and cable linkages. Flight tab movement is opposite to control deflection. Right-hand deflection of the rudder tab, for example, moves the rudder to the left, giving the pilot a large mechanical advantage to move the main surfaces. This manual operation, besides being simple and reliable, has the advantage of providing reversible controls; that is, the air pressures acting on the flight tabs are transmitted back to the pilot's controls, so that he has direct feel of the aerodynamic resistance to deflection.

The secondary flight controls are the trim systems, the wing flaps, and the spoiler-speedbrakes. These are all actuated hydraulically or by manually-operated screw-jack mechanisms, and so are irreversible controls. Spoiler-speedbrakes, innovations in transport aircraft, are movable flaps on the top wing surface that can be deflected upwards to break airflow across the wing. Since they operate in conjunction with the aileron, to this extent spoilers are part of the primary aileron control system. They can also be used as secondary controls to slow the airplane in flight.

This issue describes the empennage controls — vertical and horizontal stabilizers, rudder and elevator systems, and the directional and longitudinal trim systems. Aileron, spoiler-speedbrake, and flap systems will be discussed in a future issue of the *Traveler*.

Following are general characteristics and some of the considerations that governed the design of the "880" flight control systems.

Special emphasis has been placed on making control linkages simple and as friction-free as possible. There are no pulleys in main control cable lines, for example, and, at points where the cables must change direction, they ride on idler cranks. Centering springs, to bring the controls back to trim neutral

when the cockpit controls are released, are preloaded to provide enough force to overcome all friction in the linkages.

Longitudinal control is designed to $2\frac{1}{2}$ G's at 120 pounds maximum force applied by the pilot; that is, a 120-pound pull on the control column will cause approximately a $2\frac{1}{2}$ -G pull-up. Design limit forces on rudder and elevator controls are 300 pounds, applied by either pilot, or 225 pounds by each pilot simultaneously, applied either in conjunction or in opposition. Control cable tension is set to be at least half the differential load on the cable system resulting from maximum operation load at any flight condition. Cable tension regulators are not required.

Pilot and copilot controls are interconnected, with stops on the flight compartment controls and at the rudder and elevators. Self-contained hydraulic damper mechanisms, not connected to the airplane hydraulic system, serve as ground gust protection. At streamline position, these dampers have no inhibiting effect on control movement. Damping is progressively greater as the surface is displaced and, at 2° from the limits of surface movement, the dampers serve as snubbers.

Rudder, elevators, and flight tabs are all mass balanced with steel counterweights for flutter prevention. The main surfaces are sufficiently aerodynamically balanced to reduce hinge moments to acceptable limits. For an additional margin of safety, all actuating rod linkages for flight tab control surfaces are duplicated for protection against screw thread or nut failure.

Where necessary, metal laminates and honeycomb construction are utilized, both for sound damping and for strength.

The high speed capability of the "880," and design requirements for jet aircraft, made necessary two departures from the control systems that have been standard on transports such as the Convair-Liners: 1) provisions for extra "feel" combined with limitation of control deflection at high speeds, and 2) a major redesign of the elevator trim system, involving trim movement of the entire stabilizer-elevator assembly.

The structure of the stabilizers and control surfaces, and the operation of the rudder, elevator, and trim systems, are described in separate detail following.

EMPENNAGE STRUCTURE

Both horizontal and vertical stabilizers, like the wing, have a 35° sweepback at the 30 percent chord line. The horizontal stabilizer has 7° dihedral. The stabilizers are of spar box construction, utilizing extruded rails, stiffeners, and webs. The vertical stabilizer tip is 36 feet from the ground, more than 20 feet above the fuselage. The horizontal stabilizer is approximately 39 feet in span. It is somewhat aft of the fin, so that the horizontal stabilizer tips are 5 feet aft of the fin tip.

The vertical stabilizer is replaceable as a unit. It attaches to the fuselage at six points, three on each side of the centerline. There are three main spars and an auxiliary, or leading edge, spar which is the point of attachment for the removable leading edge assembly. The main spars have rails of extruded 7075T6 tees with aluminum webs and stiffeners. The auxiliary spar has extruded tee rails of 2024T4, with cross-bracing and no web. The six forged fuselage attach fittings are at the lower ends of the three main spars, and attach to fittings at fuselage frames.

The tip assembly is a high-frequency broadcast and receiving antenna. It is shielded from the spar box by a 10-inch-wide structure of fiberglass, attached to four fittings at the upper ends of spars 1 and 3. The VHF navigational antenna, and two HF couplers, are inside the upper portion of the spar box.

The leading edge assembly is in three sections, attached with screws to the auxiliary spar rails, and sealed between sections with silicone rubber seals. The assemblies are built-up sections consisting of 2024T4 formed ribs covered with skins laminated for anti-icing. An internal skin of 2024T4 is riveted to the ribs. Bonded to the outside of this skin is a plastic layer approximately .037 inch thick, in which are embedded electrically-heated wires. The external surface is stainless steel, providing a smooth leading edge with no exposed rivets.

Antenna tip, fiberglass insulating shield, and the leading edge assemblies, are removable and interchangeable parts.

Three large plate access doors are provided on the spar box left side for interspar access. A removable fiberglass honeycomb plate covers the VHF antenna, and a hinged door gives access to the couplers. In the trailing edge, five hinged aluminum honeycomb shroud panels cover the rudder balance boards.

The rudder has a single main spar, near the leading edge, and two auxiliary spars. These, with horizontal ribs and formers, comprise a structural box. Except for the upper tip, the skin is in effect a double laminate. A reinforcing doubler of aluminum alloy is

bonded to Alclad skin over much of the skin area, with cutouts in the doubler between the formers. The upper tip, because it extends up into the interference zone of the fin tip antenna, is fiberglass construction with fiberglass honeycomb core.

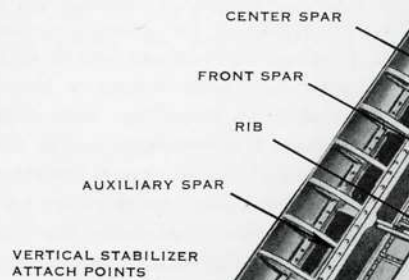
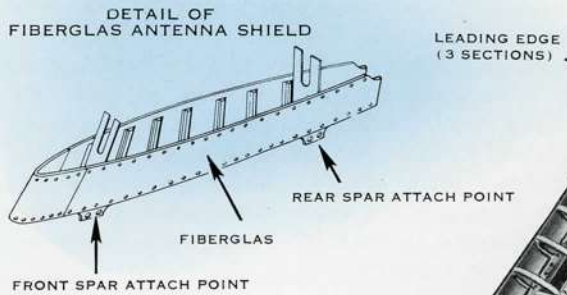

Cutaway View Showing "Fail-Safe" Structure of Empennage

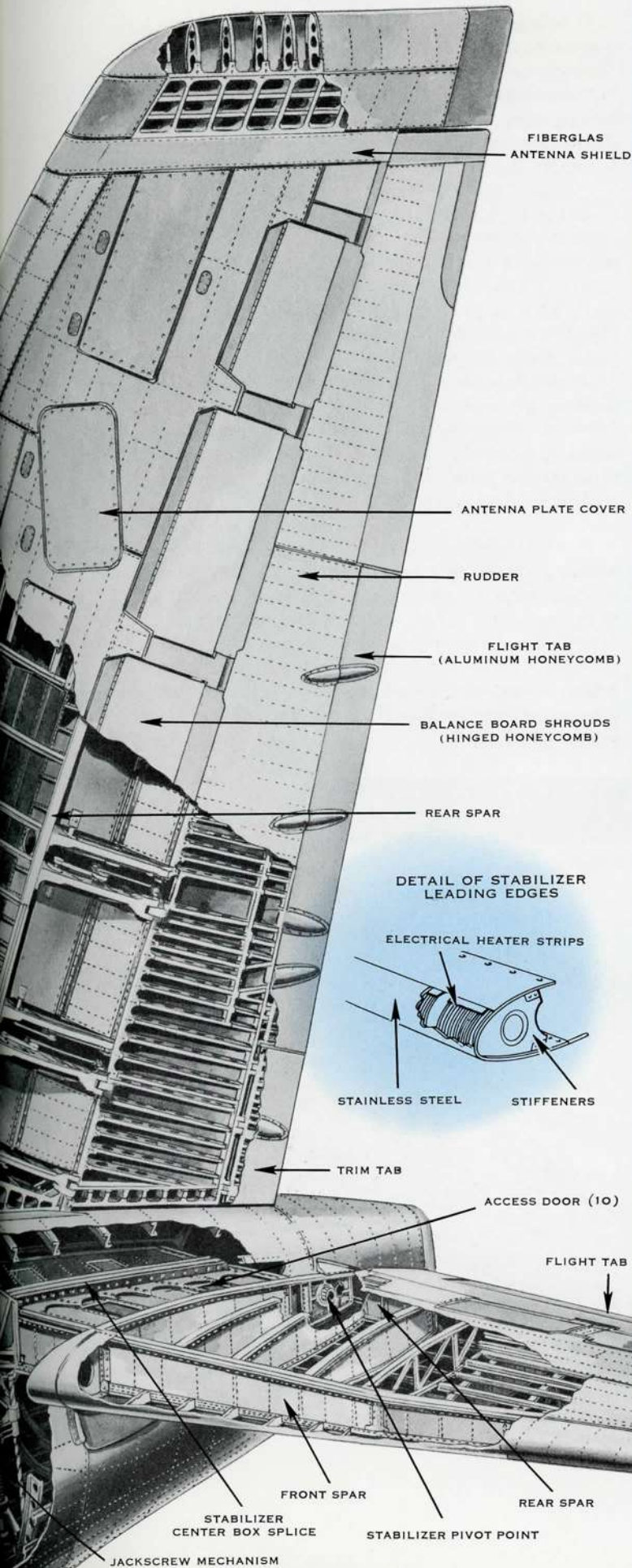

This non-metallic honeycomb structure continues approximately 24 inches down the aft portion of the rudder trailing edge, and also extends up the stabilizer antenna to the tip. Purpose is to eliminate precipitation static discharge in the area where it would interfere with HF radio operation.

The remainder of the rudder trailing edge above the servo flight tab is of full depth aluminum alloy honeycomb, as are both flight and trim tabs. The flight tab extends nearly half the length of the rudder, somewhat below the center vertically; the trim tab is just below the flight tab. The tabs taper in width from approximately 16 inches at the bottom of the trim tab to 10 inches at the top of the flight tab.

The horizontal stabilizer is a two-spar box structure, spliced at the airplane centerline so that either half may be removed and replaced. Two roll-tapered 2024T4 panels cover the upper surface of the spar box. Three skin panels of 7075T6 Alclad, also roll-tapered, cover the lower surface. All skin panels are butt-jointed and attached with flush rivets.

Each leading edge assembly, comprising three sections, is attached to the front spar. The leading edges are laminated for anti-icing and are removable like those in the vertical fin.

Ten plate-type access doors in each horizontal stabilizer permit access to all areas inside the spar box. Four of the doors, two top and two bottom, are in the center section inside the fuselage. The other six are dynamically-etched aluminum doors, outboard of the fuselage on the bottom surface. Hinged honeycomb shroud panels cover the three balance boards on each side.

Rubber seals, attached to the leading edge of the interspar structure, provide an aerodynamic seal between the stabilizer and fuselage during stabilizer movement. Vertical seal blades cover the stabilizer cutout slot in the fuselage.

Structure of the elevators is similar to that of the rudder. Single built-up front spars and channel rear spars, with ribs and formers, make structural boxes. The skin, like that of the rudder, is clad aluminum alloy bonded to a doubler. The servo flight tabs, and the trailing edges of the elevators, aft of the tab hinge lines, are of aluminum alloy honeycomb.

The rudder is controlled by movement of the pilot's or copilot's pedals. Forward movement of a pedal pulls a bellcrank aft, rotating an interconnect rod between the pilot's and copilot's pedals, and moving the other pair of pedals in unison. Another arm of the torque tube actuates the flight tab actuating cables, one on each side of the cockpit.

These cables pass aft through pressure seals, via idler cranks, to an idler-quadrant assembly. The quadrant of this assembly is part of the autopilot control system. From the idler, through a linkage that includes a pedal force limiter, cable movement is transmitted aft through dual rods to a rudder hinge bellcrank, from which another pair of dual rods runs to the flight tab horn.

The pedal force limiter, a compression spring cartridge, is preloaded to an equivalent pedal force of 180 pounds. The controls are so rigged that at 225 knots IAS, 180 pounds pressure will give full flight tab deflection (21°). When pedal pressure exceeds this, the spring compresses at a rate of approximately 45 pounds per inch as measured at the pedals.

Just aft of the overload spring, "Q" pressure is applied as a force in the linkage, via a rod actuated by a feel cylinder diaphragm. The "Q" pressure is admitted at the base of the fin through a 3/4-inch inlet, electrically heated to prevent icing. "Q" pres-

sure is conducted to one side of the feel cylinder diaphragm; the other side is vented to ambient through flush openings on each side of the fin. This "Q" force has two functions: it augments the pilot's rudder feel, and it limits deflection at high speeds. These are safety measures, added because of the moderate flight tab forces felt at the rudder pedals.

At the high speeds of which the "880" is capable, excessive pedal pressure could conceivably cause an overstress of the fin, due to excessive rudder deflec-

tion. This is prevented through an interaction of "Q" force with overload spring compression in the pedal force limiter. "Q" pressure is added to the counteracting force transmitted from the flight tab, causing the overload spring to compress and thus lessen tab deflection, to a degree determined by indicated airspeed. No matter how hard the pilot may push on the pedal, deflection of the tab and rudder will be held within safe limits.

The bellcrank on the rudder hinge is connected to a spring centering mechanism. Preload on this centering spring is 7 pounds at the pedal. Static friction at the pedal, by design requirement, must not exceed 5 pounds. Thus, the centering spring provides enough force to return the flight tab to streamline with respect to the rudder, whenever the cockpit controls are released, and the rudder will blow back into streamline.

RUDDER CONTROL SYSTEM

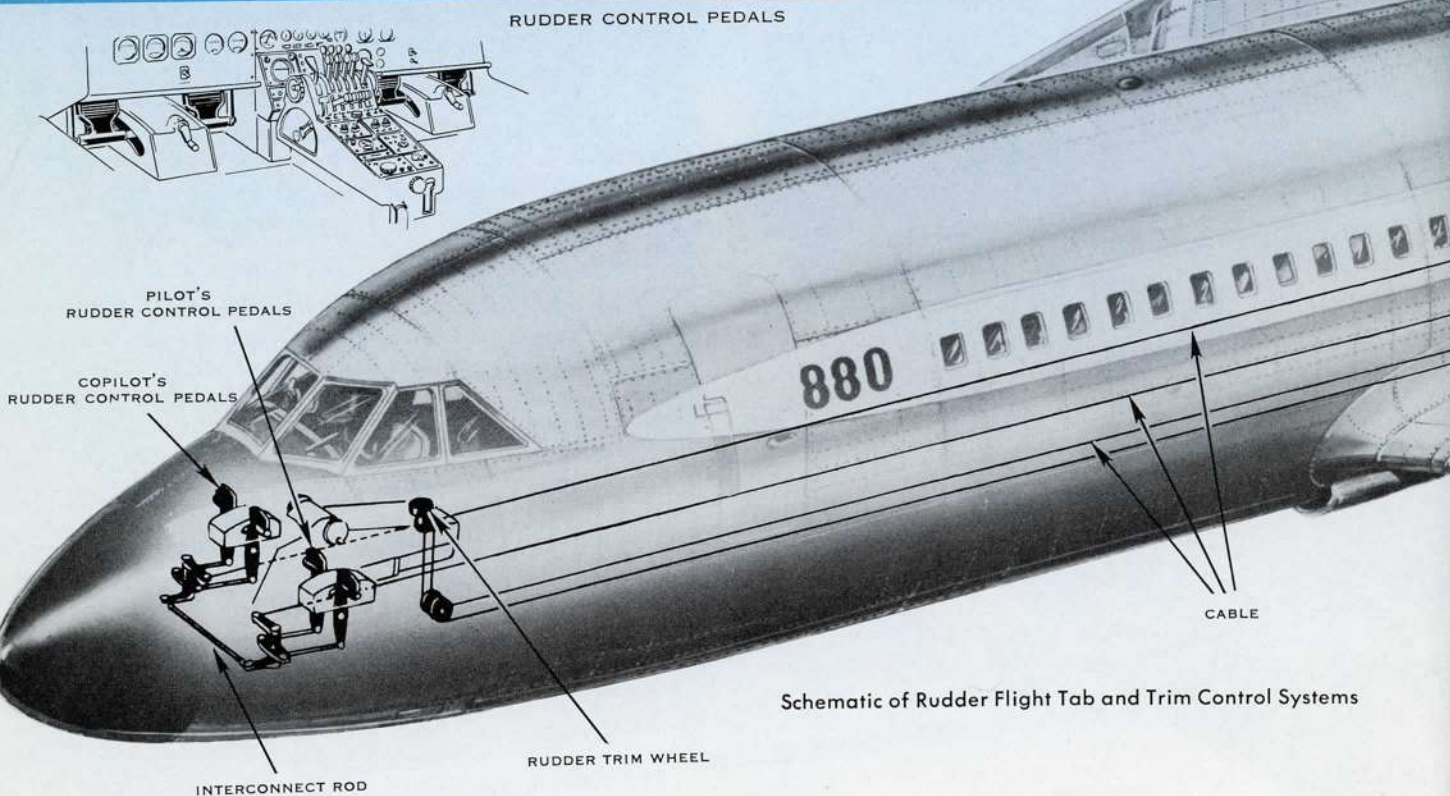

Schematic of Rudder Flight Tab and Trim Control Systems

Maximum deflection of the flight tab is 21° ; maximum rudder deflection is 19° . Rudder pedal travel, due to maximum flight tab travel, is $1\frac{3}{8}$ inches forward and aft from neutral; pedal travel, due to combined rudder and flight tab travel, is $2\frac{5}{8}$ inches forward and aft from neutral. The pedals are adjustable within a 7-inch range. Stops are provided on pedals and trim cables, and on the rudder and flight tab, to limit travels to the amounts set.

To insure sufficient rudder deflection, a series of five balance boards are attached to the rudder along the vertical leading edge. These boards move in compartments in the trailing edge of the vertical stabilizer. The compartments are sealed except at the aft end, where there is a $\frac{3}{4}$ -inch gap between rudder and stabilizer skins. Deflection of the rudder to the left will cause a buildup of pressure on the left side at the rudder hinge line, with a resultant positive pressure on the left surface of the balance boards, and with a simultaneous negative pressure on the right side from venturi effect.

The boards are attached to the rudder by a parallelogram type of mechanism, so that the differential of air pressures on each side of the boards exerts a boost force to help deflect the rudder. The parallelogram attachment has been found more effective than having the board affixed directly to the rudder. Wind tunnel tests on actual parts have shown that at 10° rudder deflection, a fifth of the operating hinge

moment is provided by the balance boards; at full deflection, the boards provide nearly half the hinge moment.

The boards themselves are a sandwich type of construction, two aluminum alloy sheets separated by a $\frac{1}{4}$ -inch-thick spacer.

In addition to the pilot input during manual flight, the rudder flight control tab receives inputs from the autopilot servo motor, which is controlled by the yaw damper-turn coordinator. Yaw rate is sensed by the primary autopilot control (rate gyros

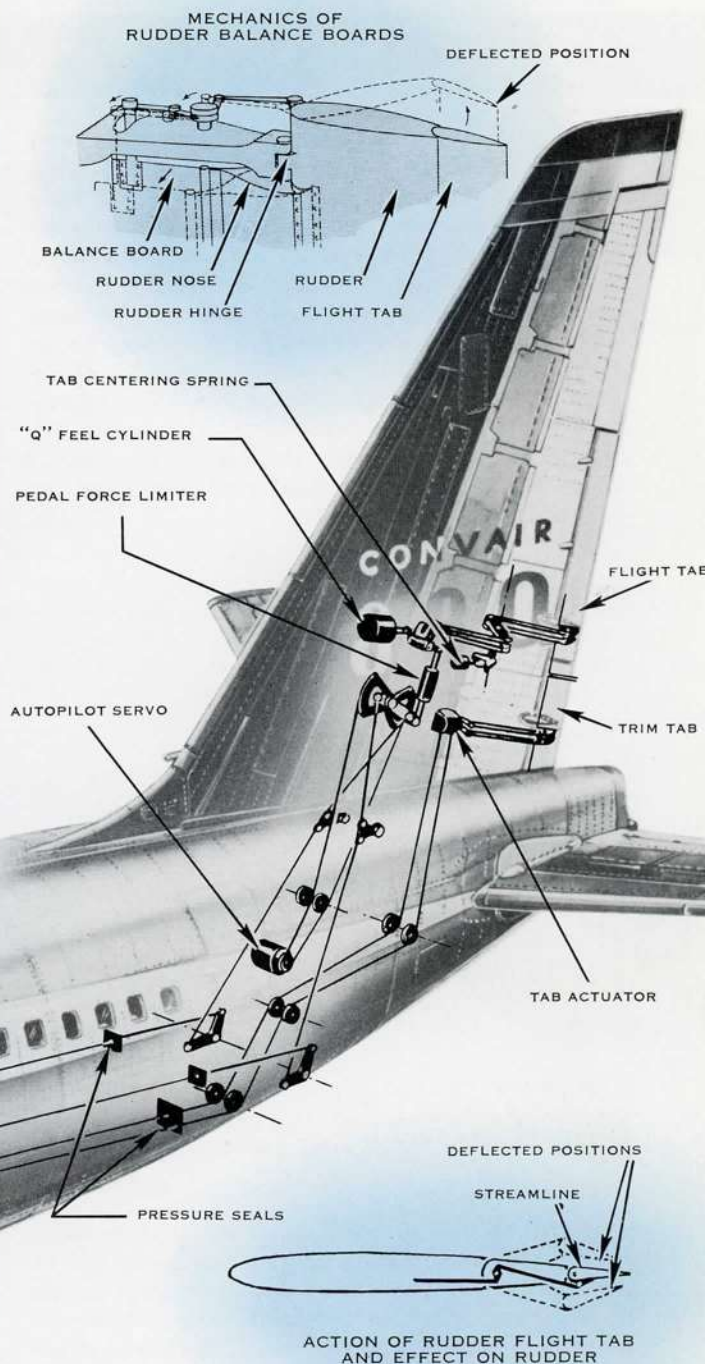

in the Bendix PB-20 autopilot, accelerometers in the Sperry SP-30 autopilot). The signal from the sensors directs a rudder movement proportioned to the yaw disturbance. Steady-state turn coordination will hold sideslip and lateral acceleration to less than 0.05 G.

The yaw damper-turn coordinator and the autopilot are controlled by one three-position switch in the flight compartment. The switch is normally turned from off position to the yaw damper-turn coordinator setting before takeoff, and is left in that position for normal flight.

ELEVATOR CONTROL SYSTEM

Right- and left-hand elevators are completely separate, the only interconnection between them being the push-pull linkage that controls the flight tabs. The elevator flight tabs are controlled by push-pull movement of the control columns. This movement is transmitted to tee cranks, which are interconnected so that the two control columns will move in unison. From each tee crank, two cables run aft through cabin pressure seals to a scissors crank assembly. Push-pull rods from the scissors cranks, through bellcranks, operate levers that move the linkage between the two elevators. This linkage moves the tabs through dual push-pull rods and bellcranks.

ELEVATOR CONTROL COLUMNS

BELLCRANK

CABLE

TEE CRANKS

INTERCONNECT ROD

Elevator and Flight Tab Control Systems

Autopilot input is at one of the bellcranks between the scissors cranks and the interconnecting linkage between the elevator flight tabs.

Maximum deflection angles, for both the elevators and the tabs, are 26° elevator trailing edge up (flight tab down) and 13° elevator trailing edge down (flight tab up). Control column travel is 4 inches aft of neutral and 2 inches forward to obtain maximum tab deflection, and 8 inches aft and 4 inches forward for combined elevator and flight tab travel. Stops on the control column are set at 5 inches forward of neutral, and at a point that limits aft travel to that required to obtain maximum up elevator with 120 pounds force on the control column. Stops are provided on the flight tab linkage. Elevator stops are designed to withstand maximum gust loads in excess of those absorbed by the gust dampers.

A feature of the elevator system which deserves mention is a device to counteract nose-up moment when landing gears are extended.

For speed braking, the "880" has, in addition to the spoiler-speedbrakes on the wings, provisions for extending the main landing gears. This has an effect of increasing the lift forward of the center of gravity, causing a definite nose-up tendency. Pilots have noted this pitch moment to a lesser extent in propeller transports when landing gears are extended. In the "880," the pitch is more pronounced, and would require the pilot to hold the control column forward with some force.

To counteract this, a corrective mechanism has been added in the main wheel well. Pressure builds up in the well when the gears are extended. The added pressure acts upon a diaphragm, attached by a linkage to the elevator flight tab cable, to provide a boost in the down-elevator direction. The amount of boost is thus directly dependent upon airplane speed; hence, the mechanism may be so rigged that the amount of boost is proportionate to the amount required to compensate for the upward pitch tendency. This input may be as much as an equivalent to 70 pounds force applied at the control column.

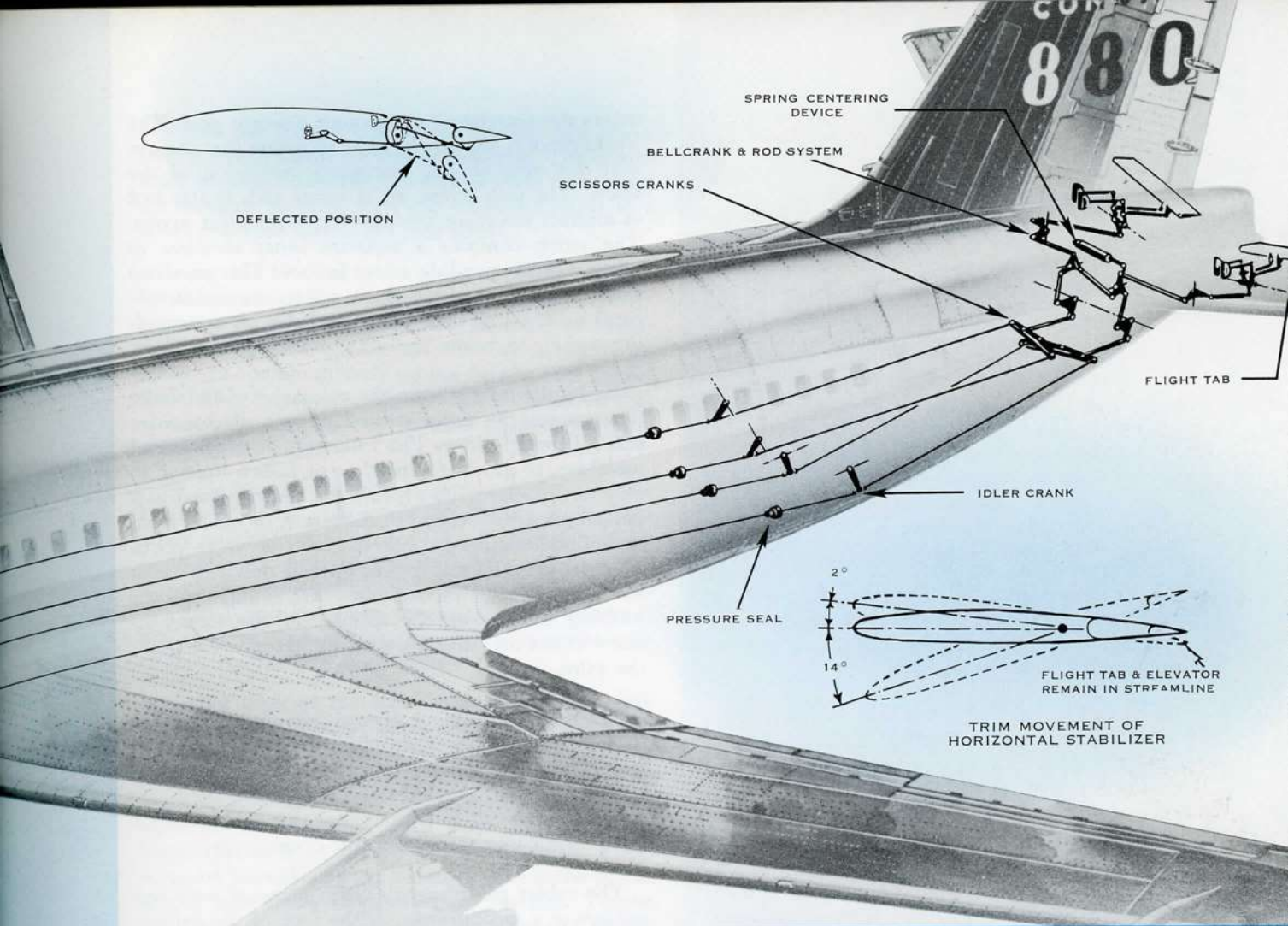

TRIM SYSTEMS

Comparison of the rudder and elevator centering mechanisms will reveal a significant difference. The rudder tab centering spring is mounted within, and attached to, the rudder; the elevator centering spring is mounted on the fuselage structure.

At rest, on the ground, should the rudder be deflected by hand, the centering spring will cause the tab to move with the rudder; but, if the elevator is moved in this manner, the centering spring action will cause the flight tab to be moved even farther in the same direction. A glance at the schematic will show why this occurs. If the elevator hinge bellcrank is held motionless when the elevator moves, downward movement of the elevator will pull the flight tab down.

In flight, deflecting forces may act on the elevator, as from the downwash when flaps are extended, causing the airplane to nose down. The tab action, however, tends to deflect the elevators up again. The effect is minor, but it does help in maintaining airplane trim.

The rudder trim system, of conventional design, is operated through dual push-pull rods by an irreversible screwjack mechanism, mounted in the vertical stabilizer. The tab linkage is so devised that upon deflection of the rudder, the trim tab is also automatically deflected to provide aerodynamic boost to rudder movement.

The trim actuating mechanism is controlled by cables that run through pulleys to the flight compartment. A single 3-inch rudder trim wheel, and a trim indicator, are mounted on the aft portion of the pedestal. Turning the wheel operates a gearbox, the output shaft of which operates the cables. Movement of the wheel also positions the indicator. Rudder trim wheel travel for manual trim (16° left or right) is five turns left or right from neutral.

The all-movable horizontal stabilizer is the feature of the "880" empennage that is the largest departure from conventional transport construction. The stabilizer is hinged aft of the rear spar, and moves up and down as a unit in a "slot" in the fuselage to provide longitudinal trim.

The reason for this design is the comparatively small tail of the "880." Tail area of the "880," relative to wing area, is approximately half that of the Convair 440 Metropolitan, for example. The smaller tail, with less drag, is possible in jet-powered aircraft because the airplane aerodynamic balance and the effectiveness of the controls are less affected by power setting; there is no propwash over the tail surfaces.

However, the "880" speed range and allowable center-of-gravity shift require a longitudinal trimming moment comparable to that of the "440." At "880" cruise speed, trimming by elevator tabs would result in an undesirable increase in drag. Moving the entire stabilizer provides the large trim moments necessary at takeoff and landing, and the design is aerodynamically clean at cruise.

Trim range of the stabilizer is 14° trailing edge up to 2° trailing edge down. The stabilizer pivots on spindles mounted on the fuselage, one on each side. It rotates on roller bearings, secured to the spindles by split-tapered bushings and nuts.

The leading edge of the stabilizer is moved by a screwjack mechanism. Normally, the screwjack is operated by a hydraulically-powered nut mounted on a universal pivot on the stabilizer front spar; in emergency, it is operated by mechanical rotation of the screw, either by an electric motor or manually.

The screw has square Acme-type threads, both for extra reliability over the ball-nut installations sometimes used for such purposes, and for assurance that the action will be irreversible. A hydraulic motor

drives the traveling nut through a worm gear. The worm drive is also irreversible, to insure that the nut will not turn during emergency operation of the screw. The jack screw, at its lower end, is attached to aircraft structure through universal joint pivots. The screw contains a separate inner member to guard against possible screw failure. The universal joints at the base of the screw and at the nut attachment on the stabilizer are provided with surrounding sockets to insure against universal joint failure.

Hydraulic power from the primary hydraulic system operates the motor, controlled by a selector valve and follow-up screw. The follow-up screw has dual members, to guard against loss of follow-up due to structural failure. This screw is a shaft splined in a helical pattern; rotation of the screw, by cables from the pilots' controls, opens the selector valve ports. As the hydraulic nut moves up and down the jack screw, the selector valves moves with it, and a splined bushing rotated by the splines on the follow-up screw closes the valve ports at the setting selected by the pilot.

The pilot controls for normal trim operation are a pair of 5¾-inch-diameter wheels located on the forward right and left sides of the pedestal. The two wheels are on a common shaft, which is geared to a cable drum. Autopilot input is at this point, from a servo motor that turns the cable drum.

The cables pass through cabin pressure seals and pulleys to a second drum at the base of the follow-up screw. Control wheel travel to obtain full stabilizer travel (16°) is 12 turns.

STABILIZER TRIM SYSTEM

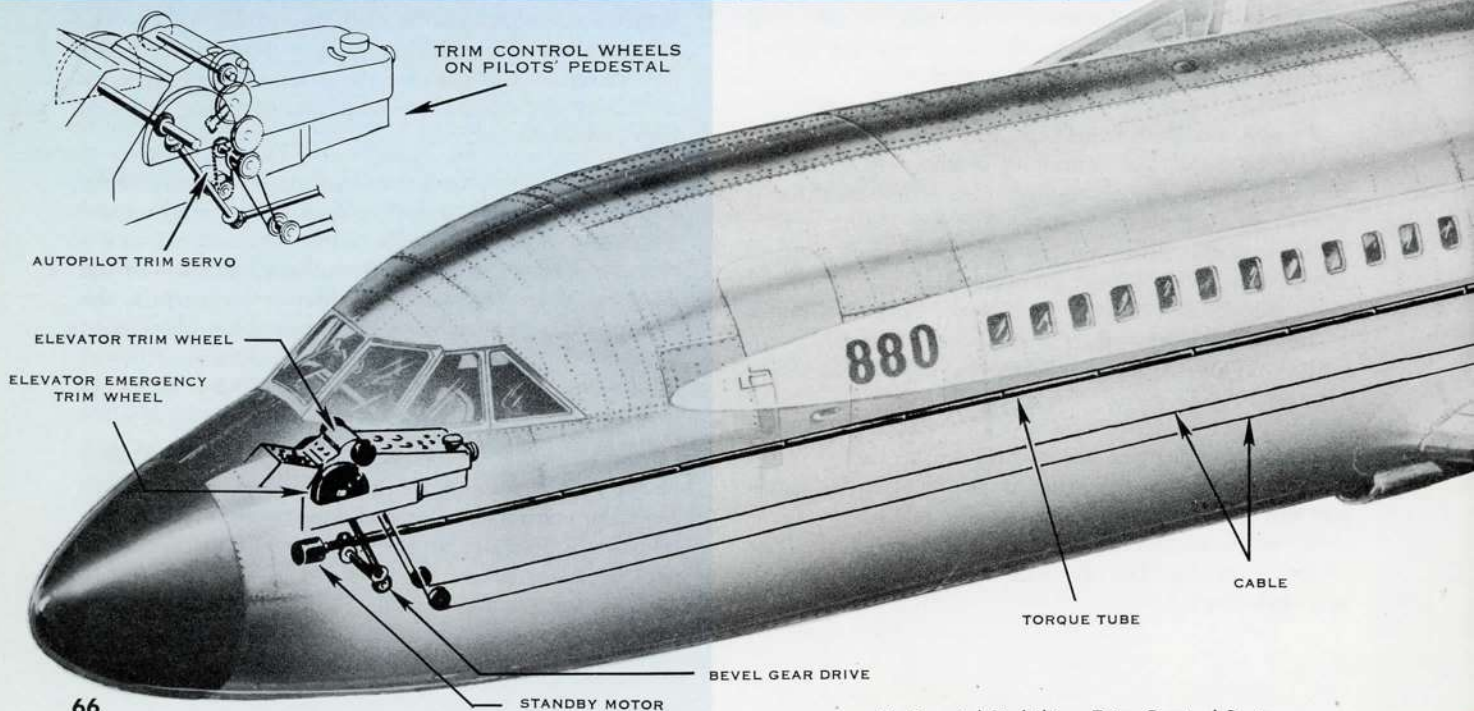

Horizontal Stabilizer Trim Control System

Below the normal trim control wheel is a crank with a 5-inch throw for emergency trim. The crankshaft is geared directly to a torque shaft that passes aft through pressure seals and universal joints to a bevel gear that rotates the jack screw.

It requires 20 turns of the crank to obtain a degree of stabilizer travel. Therefore, to make emergency trim comparable to normal trim in speed of operation, a 200-volt, 3-phase, reversible a-c motor is installed to operate directly on the fore-and-aft torque shaft. This motor operates through a clutch, so that it can be overridden by manual operation of the crank by the pilot.

At the base of the jack screw is a device to make the action of the jack screw irreversible, so that the screw will not rotate during normal operation of the hydraulic nut. Accessible to the pilot only is a means to lock the stabilizer emergency trim control cranks in rigged position when operation of the cranks is not required. Operating the crank automatically releases the locking mechanism.

Design limit of the trim crank is approximately 100 pounds applied by one pilot, or 75 pounds applied by both simultaneously, either in conjunction or in opposition. Design limit of the normal trim wheel is approximately 65 pounds applied by either pilot, or 50 pounds by each pilot simultaneously. Stops that will withstand the normal trim wheel force are provided on the control cables at the points where trim deflection limits are reached. Torque type stops are also provided at the screwjack assembly. Breakout force of the normal trim wheel is 2 pounds maximum.

The maximum rate of trim change that will be required is at extreme trailing-edge-up trim, particularly on landing. If a pilot has trimmed for landing, for example, and then must make a go-around, he must reduce trim about 4° in order to keep in trim during climb-out. Allowance for this is made in design of the selector valve, so that stabilizer trim travel rate in normal trim is varied as a function of stabilizer position.

This is done by means of a linkage, controlled by stabilizer position to vary the amount of hydraulic flow delivered by the selector valve to the hydraulic actuator. At streamline, stabilizer travel is at the rate of $.1^\circ$ per second. This rate increases until, at 10° or more deflection, travel rate is $.4^\circ$ per second.

At the "880" top cruising speeds, the "tuck-under" tendency, which is a standard aerodynamic characteristic of transsonic flight, is encountered. The "880" incorporates an automatic compensating feature to relieve the pilot of the trim changes necessary at high speeds. At Mach .8, a Mach-number sensing device operates a small electric motor to give a stabilizer trailing-edge-up trim change that varies with Mach number. The motor is mounted at the base of the follow-up shaft, in such a manner that its input is separate from that given by the cables from the pilot controls. Maximum deflection by this motor is 1.6° .

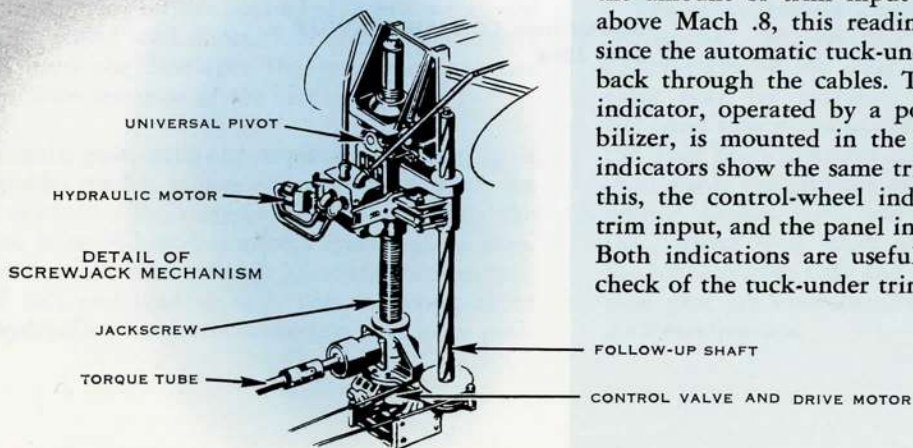
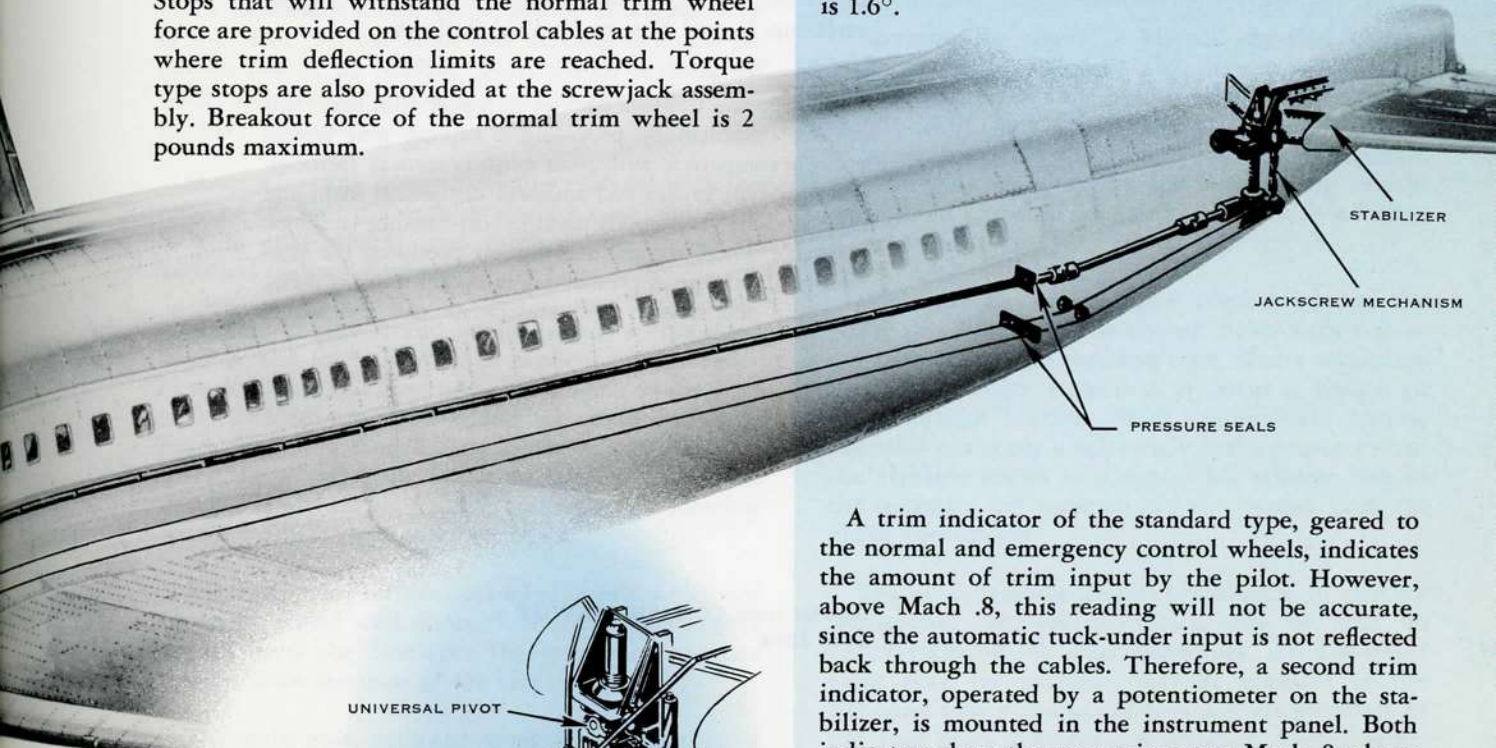

A trim indicator of the standard type, geared to the normal and emergency control wheels, indicates the amount of trim input by the pilot. However, above Mach .8, this reading will not be accurate, since the automatic tuck-under input is not reflected back through the cables. Therefore, a second trim indicator, operated by a potentiometer on the stabilizer, is mounted in the instrument panel. Both indicators show the same trim up to Mach .8; above this, the control-wheel indicator shows the pilot's trim input, and the panel indicator shows total trim. Both indications are useful in making a preflight check of the tuck-under trim system.



FOREWORD

One of the conditions confronting airline operators preparing to enter the commercial jet transport field is that of adapting their present runways and ramps to jet operation. Safety, economy, and passenger convenience demand landing fields of adequate length and rugged surfacing, located close to terminal facilities.

Design of the Convair 880 jet transport eliminates this operator problem by providing a landing gear system entirely compatible with most existing runway facilities. The disc-type brakes and anti-skid devices on main and nose landing gear wheels permit short-distance landings; equitable wheel weight distribution precludes the possibility of damage to present-day ramp and runway areas. The anti-skid devices also underwrite tire and wheel safety.

These and some of the other features that make the "880" landing gear system unique are described in this issue.

Reprint from **CONVAIR TRAVELER**
June 1958



the CONVAIR "880" LANDING GEAR

The Convair 880 has been designed to meet the needs of many of today's airlines for a modern high-speed transport with maximum performance flexibility, combined with adaptability to present day airport facilities.

For operators and passengers alike, this means economy and convenience, and eliminates the necessity for costly alterations and revision of routes.

An important factor contributing to adaptability of the "880" for use at already existing operator facilities lies in its landing gear, which is designed with simplicity, strength, and dependability as primary considerations.

Shorter landing distances can be realized with the help of efficient disc-type brakes on nose and main landing gear wheels, and through the use of an anti-skid control system.

Maximum takeoff and landing loads are handled capably and safely with dual tandem wheel assemblies on each main gear, and dual wheels on the nose gear. The oleo struts used on the main and nose gears are of the hydraulic-pneumatic type, and incorporate a metering device to absorb high-speed impacts safely during takeoffs and landings, assuring maximum passenger comfort.

All three gears retract into wheel wells which are closed by wheel well doors. The main gears retract inward into the fuselage; the nose gear retracts forward into the nose of the airplane.

The main gear, designed to permit positioning of the double trucks, allows the rear wheels of the truck to contact the runway surface first when the airplane is landed, and it allows "rocking" to compensate for airplane attitude changes during taxi, takeoff roll, and landing roll. This is accomplished by a hydraulic-pneumatic centering device, or posi-

tioner. This device also positions the double trucks so that they will be in the correct attitude within the main wheel wells upon gear retraction.

Fore and aft brake links are installed to eliminate any pitching tendencies that might occur as a result of excessive braking, and to equalize load distribution on both forward and aft trucks when brakes are applied. An emergency air cylinder is installed to supply emergency braking power.

Through the use of a Hytrol anti-skid system, brake control is automatic. This permits reduction of the landing roll to a theoretical minimum, regardless of pilot skill. As a result, overcautious use of brakes to prevent skidding during landing is eliminated, and there is no tendency for overbraking which, without an anti-skid device, could result in a locked wheel condition.

With the automatic brake control system, the "880" can land safely on shorter fields with wet or dry runways and, at the same time, obtain maximum braking efficiency regardless of airplane weight or coefficients of friction. With the anti-skid system, the pilot can apply a full steady brake pressure until the airplane comes to a stop. This relieves him of the necessity for determining the proper time for brake application.

The main landing gear is constructed of quickly replaceable components, which may be used on either right or left gear assemblies. An assembled right gear, for example, may be installed on the left-hand side if the upper fore and aft members of the drag brace assembly are reversed. Among interchangeable components of the main gear are struts, wheels, brakes, tires, and anti-skid units. In addition, wheel well doors and door mechanisms are interchangeable. Left and right components of the nose gear are interchangeable as are the doors and door mechanisms.

Precisely machined, high heat-treat steels and high-strength aluminum alloys are used in the construction of both main and nose landing gear assemblies. All non-rotating joints have electrofilmed bearing surfaces; all rotating joints have chrome-plated bearing surfaces. Replaceable bushings are provided at all points.

All components of the "880" landing gear system have been designed to function perfectly in all climatic conditions, without adverse effects being created by water, snow, sleet, hail, ice, salt spray, sand, and dust. The entire system is designed to accommodate disassembly, reassembly, and servicing, utilizing tools and replacement components which are available as commercial standard.

Special attention has been given to ease of lubrication throughout the landing gear system, and all those areas that may be susceptible to the entry of foreign matter have been sealed. Pressure lubrication fittings are provided at all points that are subject to friction and wear through the movement of mechanical parts.

Basic landing gear assemblies are manufactured to Convair design specifications by the Cleveland Pneumatics Tool Company. These units, plus Good-year wheels and brakes and Hytrol anti-skid control units, are delivered as a "roll-under" package by the landing gear manufacturer.

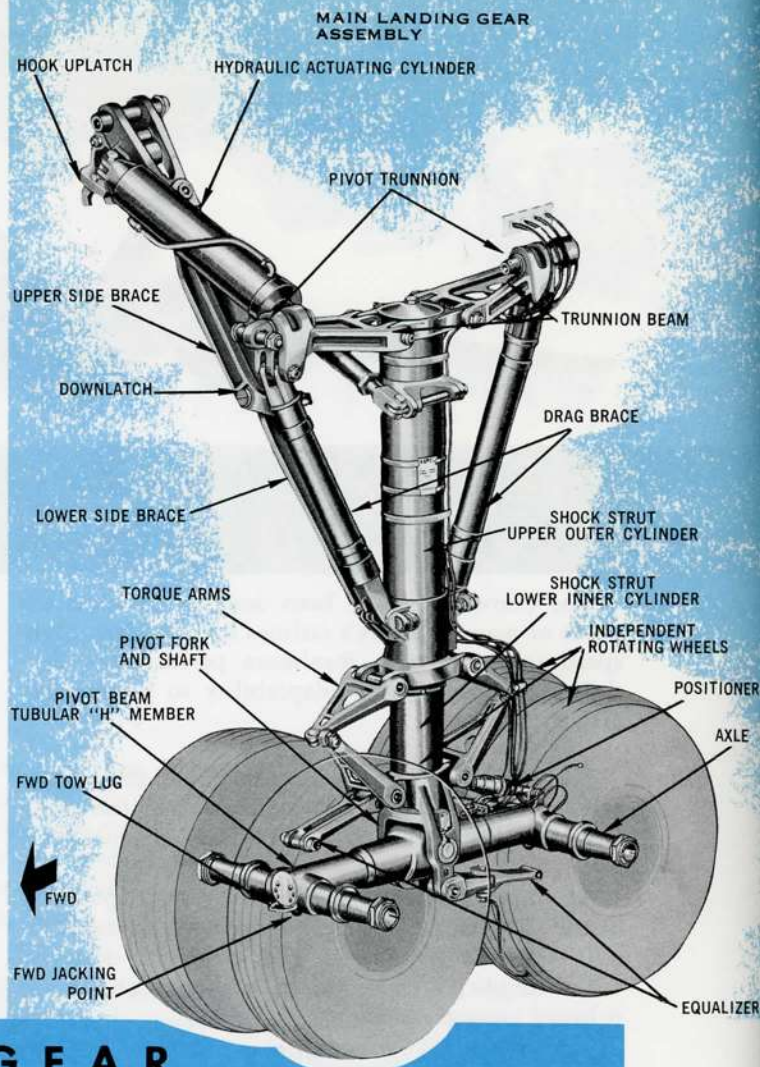

MAIN LANDING GEAR

The main landing gear incorporates eight wheel and brake assemblies, four on each gear. The wheels on each side are mounted in tandem pairs. All wheels rotate independently, each incorporating an individual brake assembly. The four wheels are mounted on axles inserted in a tubular "H" member which, in turn, is suspended in a fork that forms the lower end of the shock strut inner cylinder. The truck thus formed can rock in fore and aft angular relationship to the shock strut.

The shock strut, which is of the hydraulic-pneumatic type, consists of an upper outer cylinder and a lower inner cylinder. Both upper and lower cylinders are machined and shot-peened tubular steel forgings. The lower cylinder has two lugs which adapt the shock strut to the truck beam assembly; the upper cylinder provides attach points for the drag and side braces.

The degree of shock strut compression is dependent on airplane gross weight and loading for center of gravity location. Full stroke of the shock strut is 16 inches.

The drag strut, the outer cylinder of the shock strut, and the trunnion beam form a pin-ended "A" frame which distributes the load along the axis of each member. This method of construction braces the gear and increases structural integrity.

Outward movement of the landing gear is restricted by a double-link side brace which is attached at its lower end to the main shock strut, and at its upper end to the wing structure. The side brace assembly, which consists of aluminum alloy brace members and a steel downlock mechanism, also provides rigid support to the gear structure and positively locks the gear in the extended position.

The gear is suspended from two pivot trunnions, located in the fore and aft ends of an inverted triangle, formed by the trunnion beams and two tubular drag braces. The drag braces are attached fore and aft between the trunnion beam and main shock strut. Thus, during landing gear extension or retraction, the gear moves at right angles to the longitudinal axis of the airplane.

The gear is actuated hydraulically by means of a cylinder which is attached to a lug on the shock strut and to a point below the pivoted upper end of the side brace. Pressure supplied to the outboard side of the cylinder causes inward movement of the piston.

The mechanical advantage gained by the location of the actuating cylinder attach points causes the center pivot of the two side brace sections to move upward, pulling the shock strut and double-truck assembly inboard.

The main landing gear is designed for use as an alternate speedbrake at speeds up to 375 knots. When used as a speedbrake, the main landing gear *only* is extended.

The main landing gear doors are designed to close when the gear is extended in flight so as to decrease

drag. A sequencing device is incorporated in the door mechanism to open and close the doors when the gear is retracted or extended.

A complete cycle of main landing gear operation includes doors open, two seconds; gear extended, six seconds; doors closed, two seconds. Total time required is 10 seconds. Gear actuation is described elsewhere in this issue.

Each main gear truck has three jacking points: one located between each of the wheel pairs, and another at the bottom of the strut. Because of suspended double-truck design, it is possible to jack either main wheel pair without raising the other pair. This feature permits use of a small capacity jack, and facilitates tire and wheel maintenance. Tow lugs are provided on the forward and aft ends of each main gear axle beam assembly.

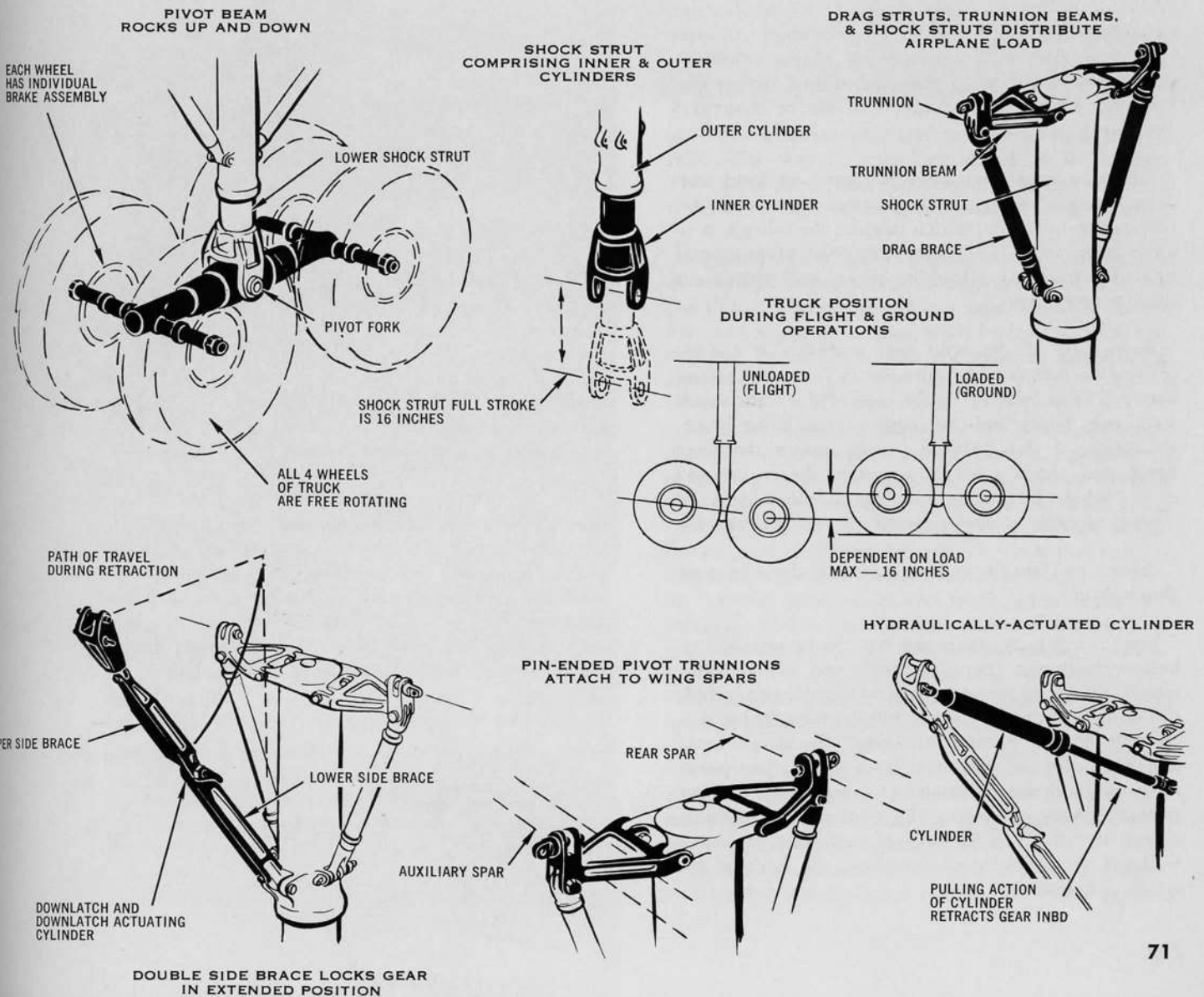

NOSE LANDING GEAR

The hydraulically-retractable nose landing gear is of dual wheel design, incorporating co-rotating steerable wheels, brakes, and anti-skid features. The assembly, when retracted, is enclosed by doors on the fuselage structure and by a fairing on the strut.

The doors are designed to remain closed at all times in flight to reduce noise level, except when the gear is in transit. The doors are closed when the gear is extended; however, means are provided for opening these doors on the ground for access to the nose wheel well area. If the doors are inadvertently left open, prior to takeoff (after having been opened for ground access) normal retraction of the gear will cycle the doors to the closed position, and they will remain closed with the gear up.

Similar structural concepts used in the main gear are applied to the nose gear assembly. Identical side bracings are pin-ended, forming an inverted "A" frame on each side of the shock strut. This feature provides a load path directly into the support structure, and eliminates bending across the trunnion beams. As in the main gear, maximum load is distributed within the members to assure structural integrity.

The nose gear wheels are mounted on fixed stub axles, integral with the shock strut lower end. An internal torque tube, which couples the wheels, provides co-rotation. This feature has the advantage of utilizing standard wheel bearings, and eliminates fatigue problems.

Retraction of the nose gear assembly is accomplished by means of a hydraulic cylinder connected between arms attached to the tops of the right shock strut side brace and the right upper drag brace. Extension of the cylinder piston rotates the drag brace and shock strut in opposite directions and causes the drag brace to "break at the knee" and the wheels to move up and forward into the wheel well.

There is a single jacking point under the nose shock strut.

For towing purposes, a tow bar can be attached to hollow bushings (cups) at each end of the nose wheel axle. With torque arms and lines disconnected, the nose strut can be turned 360 degrees. Quick disconnect features permit "breaking" the torque arms and hydraulic and electrical lines at the apex point so as to facilitate maintenance operations. During normal towing operation, the airplane is capable of being turned up to 90 degrees each side of center without the necessity of detaching the lines at the quick disconnects.

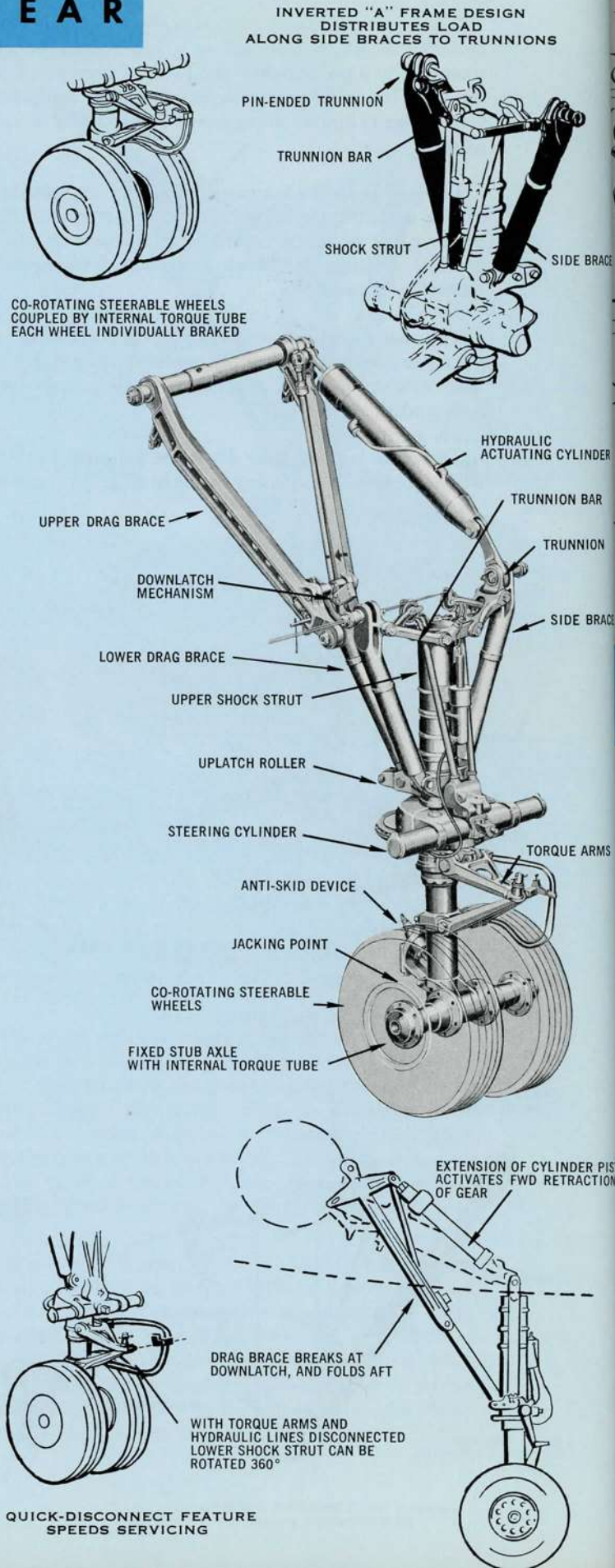

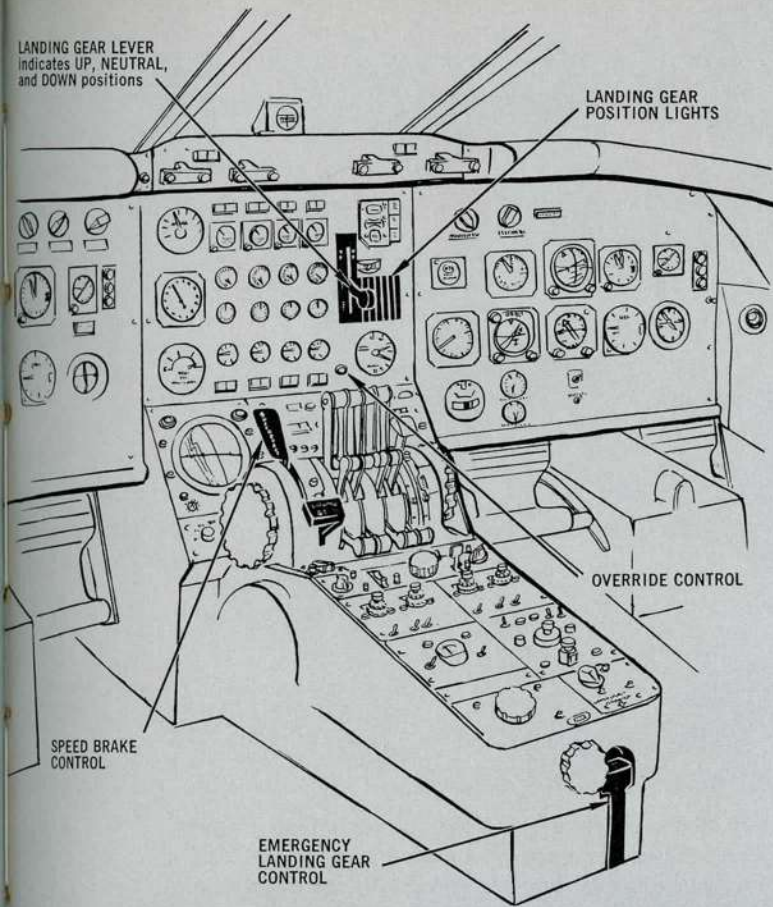

GEAR EXTENSION and RETRACTION

Gear extension and retraction is controlled by a single lever located on the right-hand side of the center instrument panel. The lever has three positions: Up (retracted), NEUTRAL, and DOWN (extended). In flight, the landing gear lever is placed in the NEUTRAL position to remove hydraulic pressure from the system. When the airplane is on the ground, the landing gear control lever is mechanically safetied in the DOWN position by action of a solenoid safety circuit from the landing gear to the safety lock solenoid.

Whenever the shock struts are compressed (airplane on the ground), the solenoid is deenergized, and the solenoid pin is allowed to extend, preventing the landing gear control lever from being inadvertently moved to the NEUTRAL or UP position. When the load is removed from the landing gear shock struts, as in flight, the solenoid is energized, retracting the pin. An override button on the solenoid pin permits raising the control lever in the event of solenoid failure.

The main landing gear truck assembly must assume an optimum attitude in relation to the horizontal plane, prior to landing. It must also assume the correct position for gear retraction, and it must be allowed to "rock" to compensate for airplane

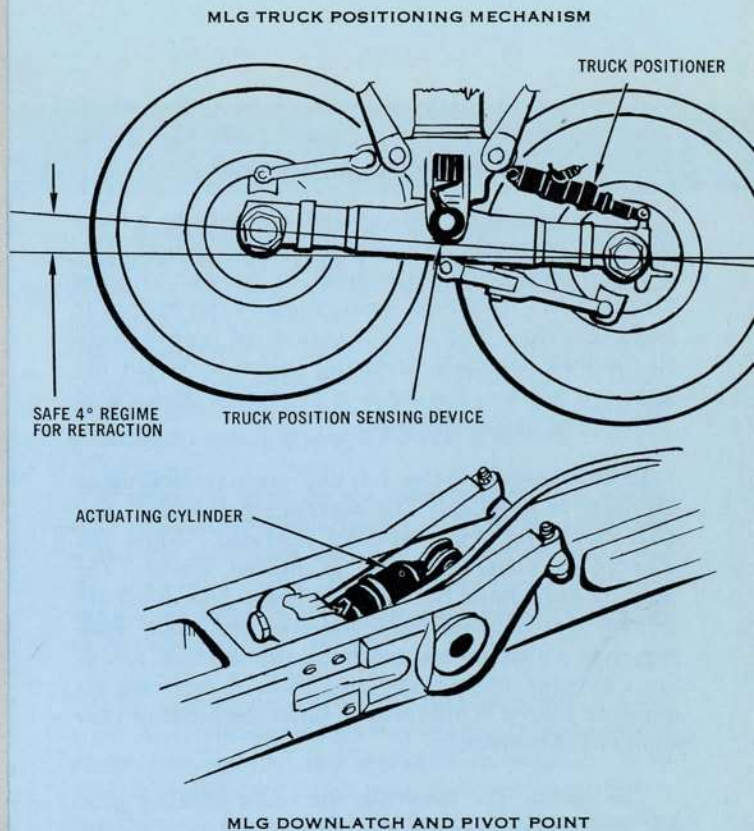

attitude changes during taxi, and takeoff and landing rolls. The overall "rock" permitted is 16 degrees. The optimum regime has been established with the truck at an angle of 4 degrees, nose up.

Proper positioning is accomplished by installation of a hydraulic-pneumatic centering device, called a positioner. The positioner is a small cylinder assembly that is partially filled with hydraulic fluid and charged to 1600 psi for a combined cushioning effect.

In order that the pilot may know when the truck is in proper position for gear retraction, a positioner indicating system is installed. The system consists of a rotary type switch mounted on the shock strut inner cylinder which, by means of a linkage, senses the angular position of the main truck pivot shaft. The switch actuates a signal which indicates a "safe" or "unsafe" position of the truck. In addition, an interlock circuit prevents movement of the landing gear selector to the UP position unless the truck is in the "safe" 4-degree regime. An override is provided to cancel action if the gear must be retracted in an emergency flight condition.

The latches automatically lock in the DOWN position when the joints in the side brace of the main landing gear and in the drag brace of the nose landing gear are straightened. Release of the downlatch is accomplished by a combination of hydraulic and mechanical forces in that a mechanical release

linkage is actuated by a hydraulic cylinder, which in turn is energized by pressure transmitted to the UP side of the main actuating cylinder.

The nose landing gear uplatch operates by a combination of mechanical and hydraulic action. Mechanical movement of the hook, by contact with the upcoming roller on the strut, triggers the hydraulic locking action. The hook is connected by a linkage to the lock assembly actuating cylinder. When the gear is extended, the hook is always in position to receive the upcoming gear.

In an emergency, free fall and positive locking of the gear is provided. The emergency system is mechanically and pneumatically operated. When the emergency control handle is moved toward the landing gear down position, the main gear doors are pneumatically opened and the nose and main landing gear uplatches are mechanically opened, allowing the gear to free fall and lock. A separate air pressure source is provided to open the landing gear doors in this event.

The handle for lowering the main landing gear for speedbrake operation is located adjacent to the speedbrake/spoiler control. Aft movement of this handle actuates a differential mechanism which moves only the system of cables that will actuate the main landing gear control valve for the landing gear actuator. Although the speedbrake control connects into the landing gear system, it does not affect any of the interlock, warning, or emergency systems.

If the landing gear speedbrake handle is in the extended position, retraction of the normal landing gear handle will raise only the nose gear. The speedbrake handle is spring-loaded to ensure return to the RETRACT position after operation. To raise the main gear, after extension as speedbrakes, the normal landing gear lever is moved from NEUTRAL to UP position, then again returned to NEUTRAL. This action opens the main gear doors, retracts the gear, and again closes the doors.

To extend the nose gear, when the main gear has been extended for speedbrake operation, it is necessary to operate the normal landing gear lever on the pilots' instrument panel to ALL GEAR DOWN position.

GEAR INSTRUMENTATION

Landing gear position lights are installed on the right-hand side of the center instrument panel, near the landing gear control lever. A dual-bulbed warning light system is provided and a double warning indication is available for the main gear. The signal system is connected to the landing gear locks in such

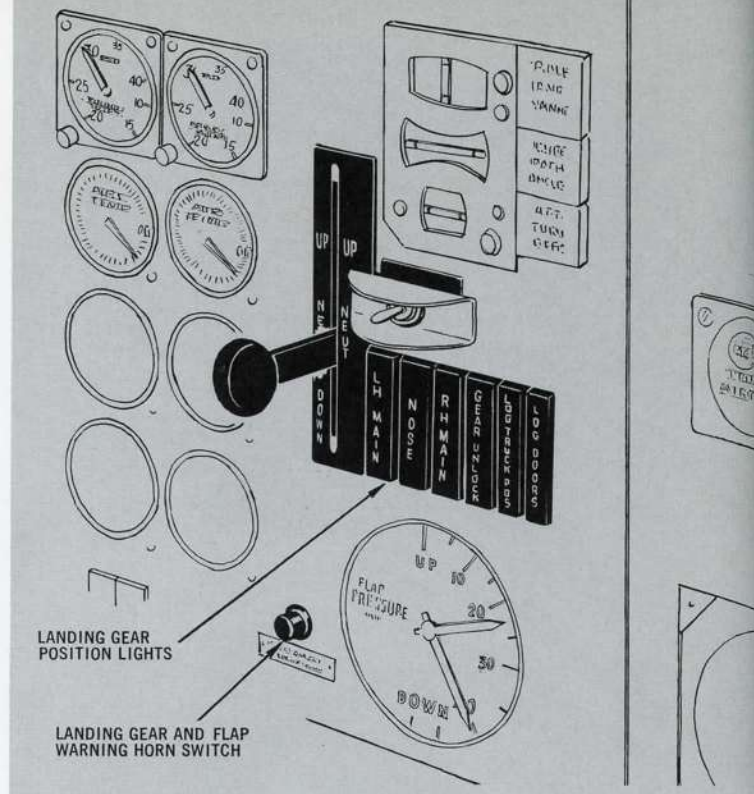

a way that a single green light for each gear is illuminated when the gear is extended and locked. The main gear doors cannot be closed until the main gear downlock mechanically actuates the door sequencing valve. Unless the sequence valve is actuated, the door light will remain on. In addition, the main gear "unsafe" light will remain on, indicating that the door is open and the gear is in an unsafe condition for landing.

The nose gear door is connected directly to the nose gear mechanism; therefore, gear-down-and-locked-position indication only is available. A covered hole for viewing the nose gear downlock is provided in the bulkhead web in the aft end of the nose wheel well. Access to the viewing hole is through a floor panel in the flight compartment.

When the landing gear is extended and locked for speedbrake purposes, a green light for each main gear is illuminated to indicate that the main gear is down and locked; the red "gear unsafe" light is illuminated to indicate that the nose gear is still in the retracted position.

In addition to the lights, a horn is installed in the pilots' compartment to sound a warning to indicate that the gear is not fully extended and locked, when any one power lever is reduced below the 25 percent thrust position, and the flaps have not been extended for landing position.

The electrical components for the position indicating system are sealed and protected against entry of water, ice, and foreign materials. They are located and protected to guard against damage from ground handling equipment.

NOSE LANDING GEAR STEERING

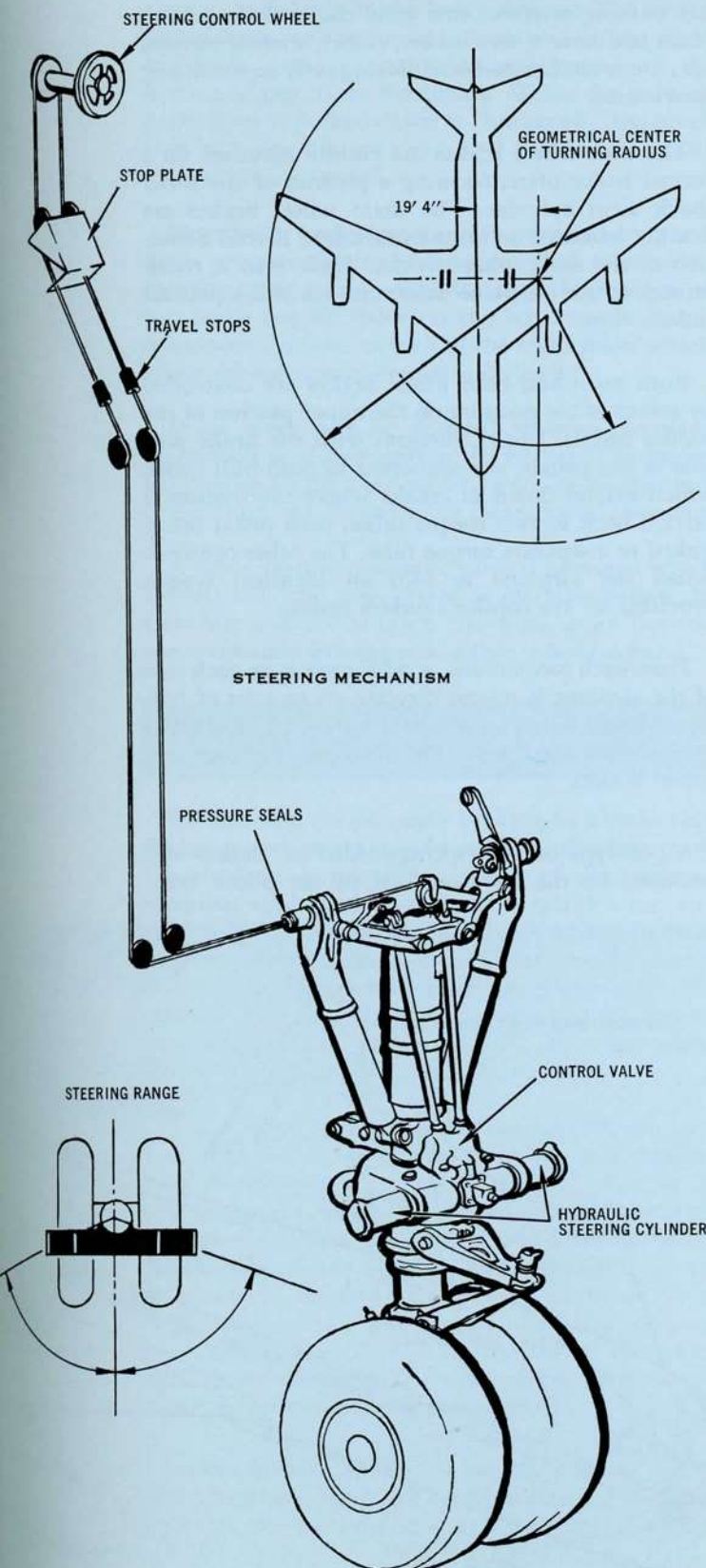

A hydraulically-operated steering unit, with a powered steering range of 70 degrees each side of center, is installed on the nose landing gear. The geometrical center of the turning radius is 19 feet 4 inches outboard of the airplane centerline, and is located on a line through the centerline of the main landing gear oleo struts. The radius of the wing tip about the turning point is 83 feet 3 inches.

A centering cam on the nose landing gear shock strut returns the nose wheels to the centered position when the weight of the airplane is off the gear and the strut is extended, thus insuring that the wheels are always centered when the gear is being extended or retracted.

The steering unit is of the rack-and-pinion type, completely enclosed to protect against contamination from dust, splash, and exposure to weather. This hydraulically controlled and actuated assembly is mounted on the cylinder of the shock strut. Stationary "wear bushings," keyed to the strut, provide maximum strut protection from steer-collar wear. Adjustment is provided to take up end wear on steering collar bushings.

The assembly consists of a control valve, actuated by a chain and cable system from a cockpit steering wheel, and a dual actuating cylinder assembly. The mounting of the hydraulic control valve directly onto the actuator has the function of follow-up action by closing the valve flow. The lower member of the torque arm assembly is attached to the inner cylinder of the shock strut, which rotates within the outer cylinder. On the inner cylinder and axle assembly are suspended the dual wheels, which are limited to a 140-degree total steering travel.

A hand wheel, located on the left-hand console within easy reach of the pilot, controls the steering unit. A shutoff attachment automatically releases the brake if the nose wheel is turned beyond five degrees. The neutral position of the gear is indicated on the wheel.

The steering cable arrangement is so designed that a directional sense of control is evident to the pilot.

Pressure for hydraulic steering is obtained from the No. 1 hydraulic system, with provisions for automatic closure of the steering circuit from the main system whenever the gear is retracted. Loss of nose wheel steering pressure automatically renders the nose wheel brakes inoperative. In this event, steering is possible by differential braking.

BRAKES

Main gear brakes are "free floating" on the axles. This design eliminates the multiple bolt flange arrangement for connecting the brake to the shock strut. Brake equalizer bars on the main landing gear transmit brake loads into the shock strut to prevent pitching the brake loads onto the front pair of wheels in the truck.

Air scoops are provided on each brake carrier to provide air flow to the brake, through vent holes in the brakes and wheels.

Because of the intense heat generated during some emergency brake applications, brake linings of improved materials are used. The tri-metallic brakes, constructed of three basic materials, consist of rotating and stationary friction discs. Rotating discs, alternately stacked with stationary discs, are keyed to the outer rim of the brake assembly; the stationary discs are keyed to the inner rim. When the discs are forced together, compressing the stack so that all faces are contacting, braking action is imposed on the wheel.

Compression of the stack is accomplished by means of interconnected hydraulic pistons. When pressure is applied, the pistons impinge on one side of the pressure plate, forcing the opposite side to contact the rotating discs of the stack. When pressure is released, a ring of tension spring cartridges, attached to the pressure plate, releases the pressure plate, freeing the disc stack, thereby returning the pistons to neutral.

Because the brakes are self-releasing through spring action, no adjustments are necessary. Friction components are readily disassembled by removing the ring of "brake bolts" which penetrate the assembly housing portions that hold the brake together. Main and nose wheel brakes, rotors, stators, pistons, etc., are interchangeable, differing only in mounting provisions.

The nose wheel brakes are rigidly mounted on a forged brake plate, forming a portion of the inner shock strut cylinder. The main wheel brakes are flexibly mounted on large bushings to permit deflection of the main wheel trucks. Their load is transmitted to the airplane structure via the equalizer links.

Both main and nose wheel brakes are controlled by means of toe pressure on the upper portion of the rudder pedals. Levers, integral with the brake portion of the pedals, are connected to push-pull tubes, which extend down to cranks where the motion is carried back to two torque tubes, each pedal being linked to a separate torque tube. The tubes continue across the airplane to join an identical system provided for the copilot's rudder pedals.

From each torque tube, a cable system on each side of the airplane is routed directly aft to a set of pulleys, located in the main wheel well. Push-pull tubes from the pulleys operate control valves for the main wheel brakes.

A pull-type handle (spring-loaded to "brakes off" position) on the left-hand side of the pilots' com-

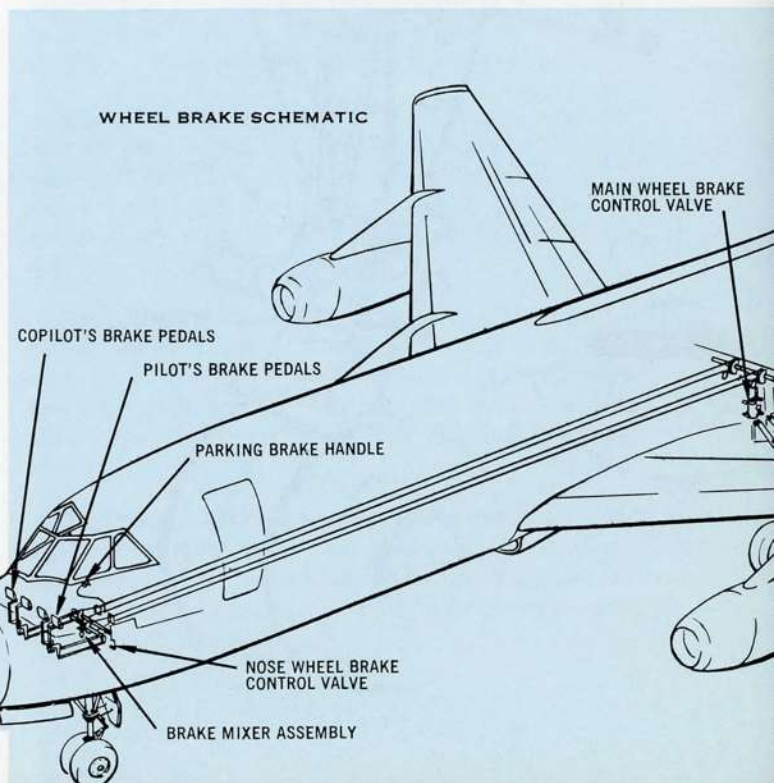
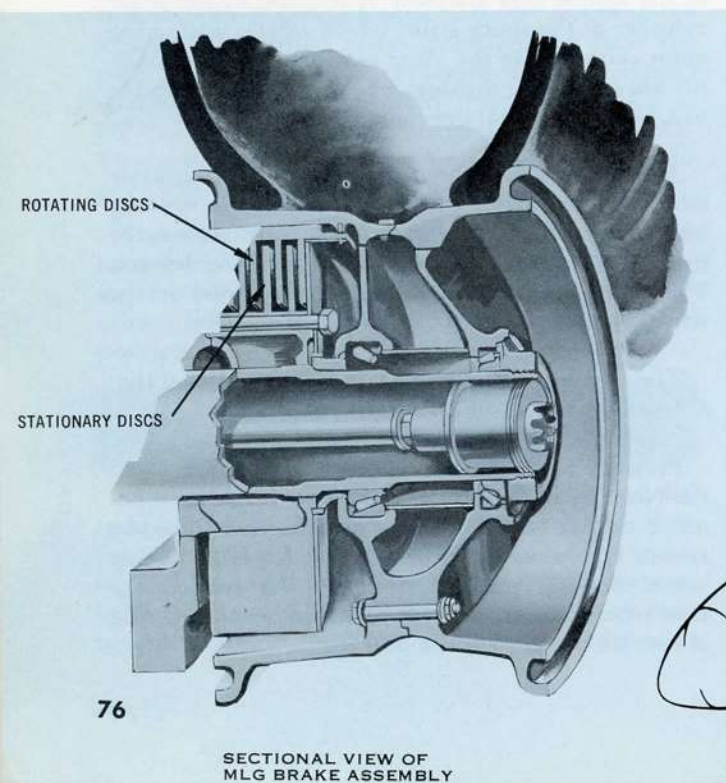

partment panel is used to lock the brakes for parking. To set the parking brake, it is necessary for either the pilot or copilot to depress both brake pedals and then pull the handle. This action engages a notch with a pin in the brake linkage. The spring return force, on the brake linkage and on the parking brake linkage, maintains engagement of the notch and pin to set the brakes. When the parking brake lever is pushed down to "brakes off," the notch and pin are disengaged and the main brake mechanism is released.

Emergency brake operation is provided by pneumatic pressure obtained from an air flask mounted in the nose gear wheel well. Rotational movement of the brake control valve on the left console meters pneumatic pressure to each of the eight main wheels when the emergency system is utilized.

Brake wear may be checked without removing the wheels or disassembling the brakes. The brakes are provided with a self-releasing spring mechanism, eliminating the necessity for clearance adjustments.

A safety feature hydraulic valve is provided which renders only the nose brakes inoperative, when the steering control rotates the nose gear beyond approximately five degrees, either side of neutral.

ANTI-SKID DEVICE

An anti-skid device assists braking by eliminating skidding and/or wheel sliding after touchdown of the airplane. It provides a means of detecting an incipient skid condition of the airplane tires, and thereupon functions to control the brakes in time to prevent a prolonged locked wheel from occurring under all landing conditions. Brake pressure is available for metering upon touchdown and spin-up of any braked wheel, without locking any other wheel that might not be contacting the runway.

The Hytrol anti-skid unit functions in conjunction with the main and nose landing gear brakes. The system consists of a wheel skid detector, a control box, a specially-designed solenoid-operated three-way valve for each wheel, and a control panel for the pilot. A sensing unit for the main gear wheels is located in the end of each axle (eight units); a single unit for the nose gear is located in the nose gear jack pad bracket, just forward of the inner shock strut cylinder. The nose gear unit is driven from the nose wheel axle torque shaft.

As the braked wheels decelerate in an incipient skid condition, the skid detector transmits a skid signal to the control box which, in turn, closes the

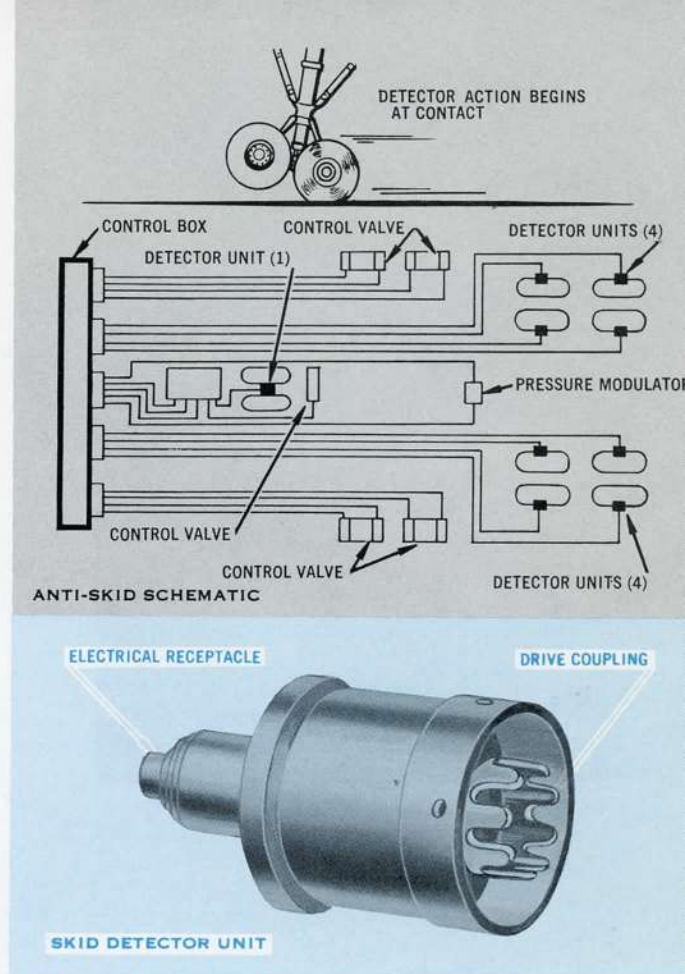

circuit to energize the solenoid-operated three-way valve. The solenoid valve, when energized, releases the brake pressure and allows the wheels to recover synchronous speed.

Corrective action over excessively metered brake pressure is accomplished by a pressure modulator on the main wheels only. The metered pressure allows a gradual reduction or increase in pressure to match the skid or increasing wheel load, as the case may be.

A fail-safe device in the control box assures that any electrical failure or short circuit will not cause loss of braking. In such an event, the control box will deenergize the solenoid valve, thus transferring direct control of braking to the pilot. Failure of the system on any one of the wheels is indicated to the pilot on the pilot's control panel.

Operation of the brakes through the anti-skid device is accomplished by using the same controls that govern the main brakes. A separate air source, not operating through the anti-skid device, provides emergency braking in the event of failure of the hydraulic brake system. The emergency brake system is effective on the main landing gear wheels only.

For simplicity and interchangeability, the same anti-skid detector is used on any main wheel or nose wheel, without the need for changing rotational direction of the unit.



FOREWORD . . .

Convair's new "880" and "600" jet transports are the first commercial airplanes to make use of General Electric's CJ805 series engines, commercial adaptations of the J79.

The J79 has proved itself in military aircraft, including Convair's supersonic B-58 bomber, and currently holds world records for both speed and altitude.

The CJ805 was designed specifically for outstanding performance at high subsonic cruise speeds. Its remarkably light weight, high power rating, and economy of operation and maintenance have aroused intense interest.

This issue of the Traveler describes two versions of the CJ805, standard equipment of "880" and "600" aircraft. Simple, sturdy design, installation in the airplane, and characteristic patterns for servicing and maintenance are also discussed.

Reprint from **CONVAIR TRAVELER**
October 1958

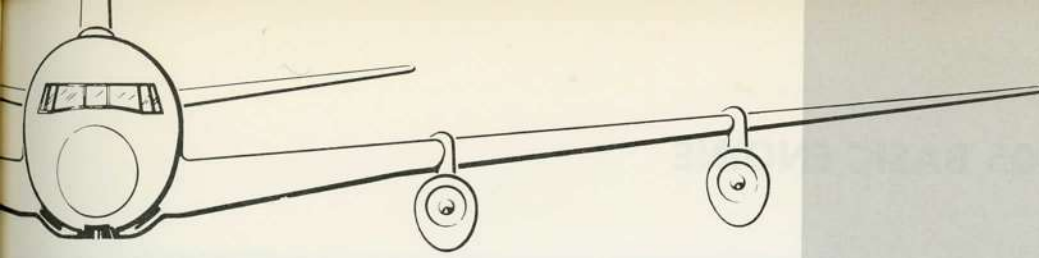

CONVAIR "880" AND "600" POWER PLANTS

Convair's "880" and "600" jet transports are powered by four General Electric CJ805 engines, installed in pods suspended on pylons below the wings. The "880" engine is the CJ805-3 turbojet; the "600" has the CJ805-21 aft fan. The two versions are similar in the compressor, combustion, and turbine sections — approximately the forward two-thirds of the engine. The "880" engine exhaust section consists of thrust reverser and sound suppressor; the "600" has a fan aft of the turbine section, with a target-type thrust reverser aft of the fan.

The CJ805 is a single-spool axial-flow high-pressure-ratio engine, characterized by unusual simplicity of design, extremely low weight, low specific fuel consumption, and maximum accessibility for servicing and maintenance.

The aft fan, newest modification of the jet engine principle, represents another solution to the problem of combining the best elements of propeller and jet propulsion. Propellers are most effective in dense air and at low speeds; jets develop their best thrust at high speeds and altitude.

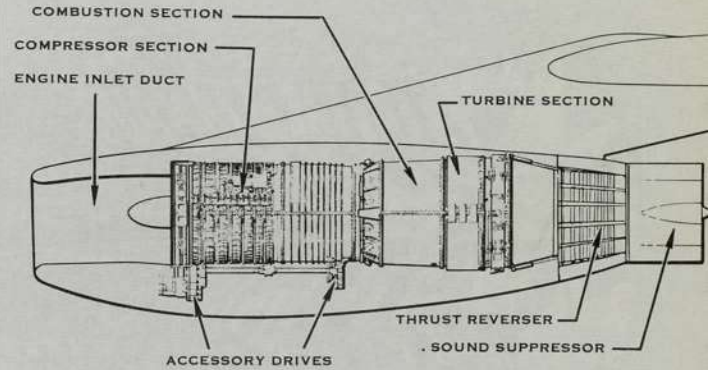

"880" ENGINE INSTALLATION

"600" ENGINE INSTALLATION

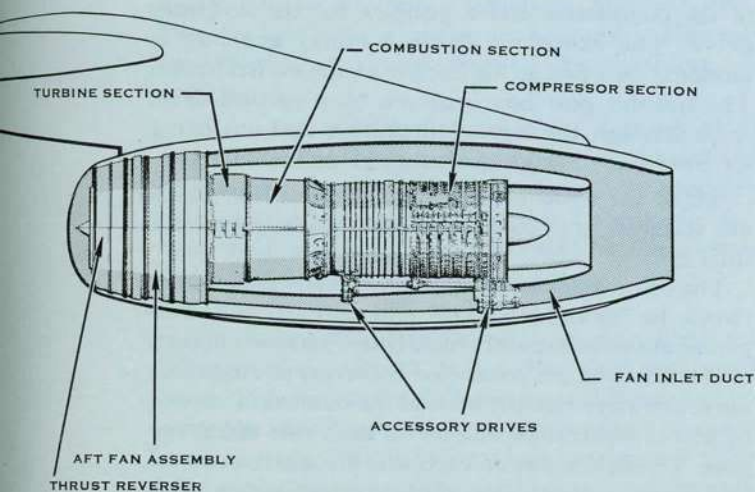

The aft fan is a turbine-driven fan. The turbine, in the CJ805-21 engine, is driven by exhaust gases at comparatively high speed. Outside the turbine blade radius, extending outside the engine combustion section, are fan blades that are extensions of the turbine blades. This fan drives aft a greatly increased volume of air, at somewhat slower speed than the jet blast, but in sufficient volume to add to the engine's thrust at slower speeds and in denser air.

Since the "880" and "600" engines are identical in the forward portion, the description of the engine components herein applies to both versions, except where specifically noted as applicable to one or the other.

The main sections of the -3 engine are: 1) a 17-stage axial compressor, in which the inlet guide vanes and first six stages of stators are variable; 2) a cannular combustion section with ten combustion liners, and inner and outer casings; 3) a three-stage turbine; and 4) an exhaust section, including thrust reverser and sound suppressor. The forward portion of the -21 engine is the same; a redesigned turbine frame, an aft fan housing, and target type thrust reverser complete the -21 engine.

STRUCTURE OF CJ805 BASIC ENGINE

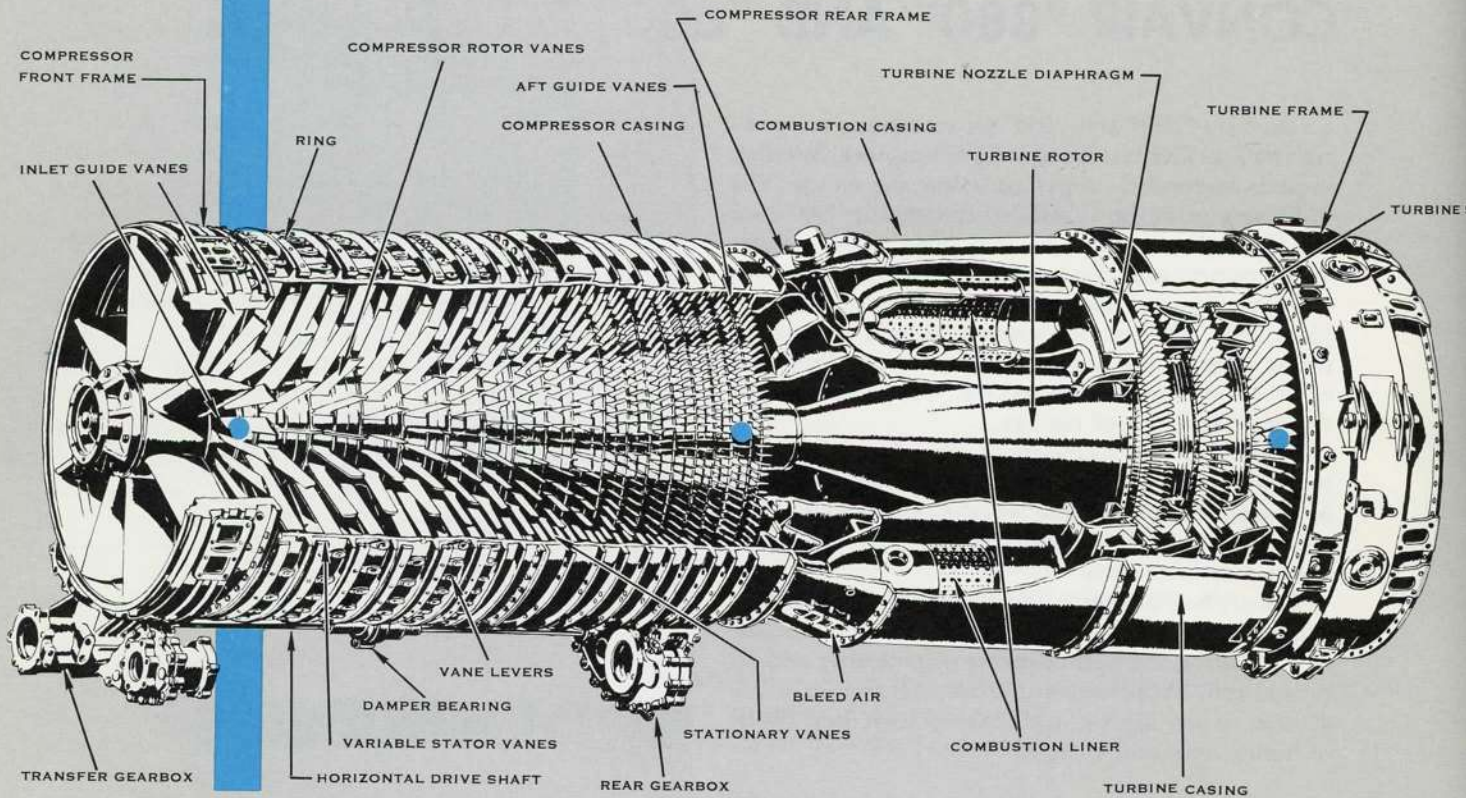

● ENGINE MAIN BEARINGS

Total weight of the -3 engine, including all accessories, ducts, thrust reverser and sound suppressor is approximately 3500 pounds. Weight of the -21 engine and reverser is approximately 4200 pounds. This light weight was obtained by use of a load-carrying outer skin, conical construction of support members, and weldment type construction. Also, the single-spool compressor requires fewer bearings and support structures than have been necessary with other designs.

Variable stators allow a high-mass flow of air with a comparatively small diameter compressor and small frontal area. This has made possible an aerodynamically clean engine pod. The compressor is designed for optimum performance at cruise speed and above.

The compressor front frame, the forward structural member of the engine, is a machined magnesium casting consisting of an outer shell connected to an inner hub by eight streamlined hollow struts,

equally spaced. The hub houses the forward bearing of the compressor and a gearbox for the accessory drive. The accessory drive transfer gearbox is mounted on a pad at the bottom of the vertical strut. The transfer gear box is driven by a vertical drive shaft through the strut. Lubrication and anti-icing air lines run through the struts to the hub.

Aft of the struts are 20 sets of stators, 7 of which are variable, so as to afford a variable incidence for inlet air.

The compressor stator case is vertically divided between the 7th and 8th stages, and split and bolted together at the horizontal center line. The vanes in each of the six rows are connected by levers to rings that move circumferentially around the outer skin, moved by sets of bellcranks, one set on each side of the engine. The bellcranks on each side are interconnected by a master rod to assure vane synchronization. The second bellcrank on each side is a master bellcrank and is connected to a hydraulic actuator.

DETAIL OF VARIABLE STATOR LINKAGE

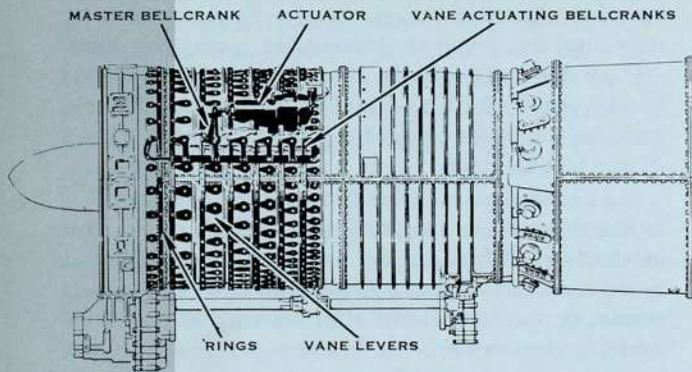

DETAIL OF AFT FAN AND THRUST REVERSER

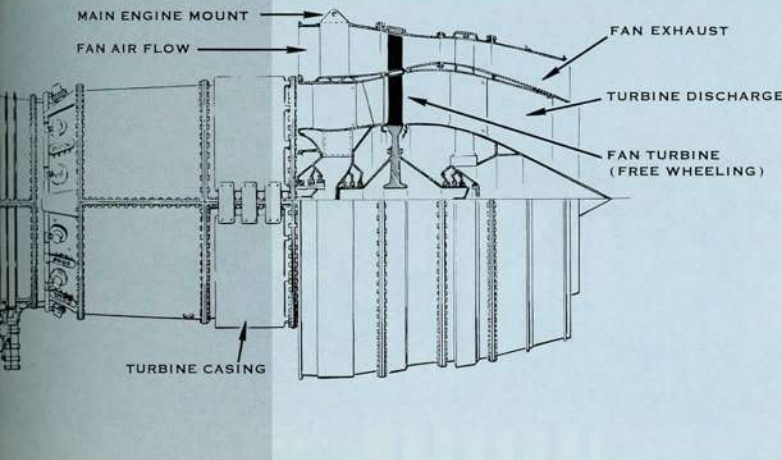

The four sections of the compressor stator case are removable for internal inspection; however, since they are load-carrying elements, only one section may be removed at a time without disassembling the engine.

The compressor rotor consists of a series of 17 stages of blades, discs, and spacers, bolted in sections. Stub shafts at each end of the spool are internally splined to receive, at the forward end, the engine forward gear case horizontal shaft and, at the aft end, the forward end of the turbine shaft.

The compressor rear frame is the mid-structural member of the engine. It is a sheet steel weldment, consisting of an outer shell and inner diffuser section, with ten equally-spaced struts supporting the center main bearing. This is a thrust ball bearing and transmits to the rear frame the axial loads from the compressor as well as radial loads imposed by the rotating parts.

Two manifolds on the inner surface of the diffuser collect compressor discharge air and route it to the surface through struts Nos. 2, 4, 7, and 9. The bleed air manifold is attached to pads on the outer shell at the ends of these struts.

The compressor rear frame has brackets inside the outer shell for attaching the forward ends of the ten combustion liners, and is also the mounting for the fuel ring and nozzles. The combustion liners are mounted in a concentric annulus between inner and outer combustion casings. Either half of the outer casing may be removed for inspection of the liners.

Each combustion liner is a double-walled sheet steel cylinder, with the inner liner ceramic-coated. A fuel nozzle is inserted into a self-aligning eyelet in the forward end of each liner, and all liners are interconnected by cross-ignition ducts.

The inner shroud of the first stage turbine nozzle diaphragm is bolted to the rear flange of the inner combustion case. Second and third stage nozzle diaphragms are in a stator assembly consisting of a turbine casing, which is split along the horizontal center line, the two nozzle diaphragms, interstage air seals, and two turbine shrouds.

Second and third stage nozzles, and the honeycomb turbine shrouds, slip into grooves on the inner surface of each half of the casing, and are secured by pin bolts. Interstage air seals, while part of the stator assembly, are not split into halves, but are assembled with the turbine rotor and secured by a pin and slot arrangement to the inner band of the turbine nozzles. A turbine bucket containment ring, split in halves along the centerline and bolted together, surrounds the stator casing.

The turbine frame is the aft structural member of the engine. It is a sheet steel weldment, with an outer shell and an inner hub that contains the third main bearing, and serves as a diffuser for exhaust gases. Seven radial struts connect outer shell and hub.

Thrust reverser and sound suppressor sections will be described in a future issue of the Traveler.

In the -21 engine, the aft turbine fan is attached to the rear of the turbine frame. In this, the fan is a single unit, turning freely on its own bearings. Since it is not connected to the other rotors in any way, it has little effect on engine starting torque or operation at idle speeds.

AIR-FLOW SYSTEM

The major part of the 17th-stage compressor discharge air supply is used for supporting combustion and for cooling the combustion components by keeping air flowing over their surfaces. A portion of the supply is bled off through the compressor rear frame struts to operate cabin air conditioning and pressurization equipment and for wing anti-icing. The 17th-stage air is also used for direct cooling of first and second stage turbine nozzles, the first stage turbine rotor shroud, the mounting bases of the first and second stage turbine blades, and for engine anti-icing.

Engine anti-icing flow is bled through a port in the outer diffuser wall and ducted forward to the compressor front frame struts.

Air temperature at the 17th stage is approximately 730°F at takeoff power, sea level static conditions. Cooler air than this, under less pressure, is collected

at the 7th and 9th stages for cooling the rotor and pressurizing the bearing sumps.

Air is bled inward through holes around the 7th-stage torque ring into ducting in the center of the rotor. Bleed holes allow the air to pressurize the discs between the vane stages, thus adding strength by reducing the pressure differential across the discs. Aft, air flows through the center of the stub shaft and turbine rotor shaft, and is directed against the fore and aft faces of the turbine discs and the inner surface of the torque rings.

An external manifold collects air on the upper half of the compressor rear casing at the 9th stage. This air is ducted through the struts of the compressor rear frame, and of the turbine frame, into jackets surrounding the center and after bearing sumps, pressurizing the carbon seals. Leakage past the seals aids in sump pressurization.

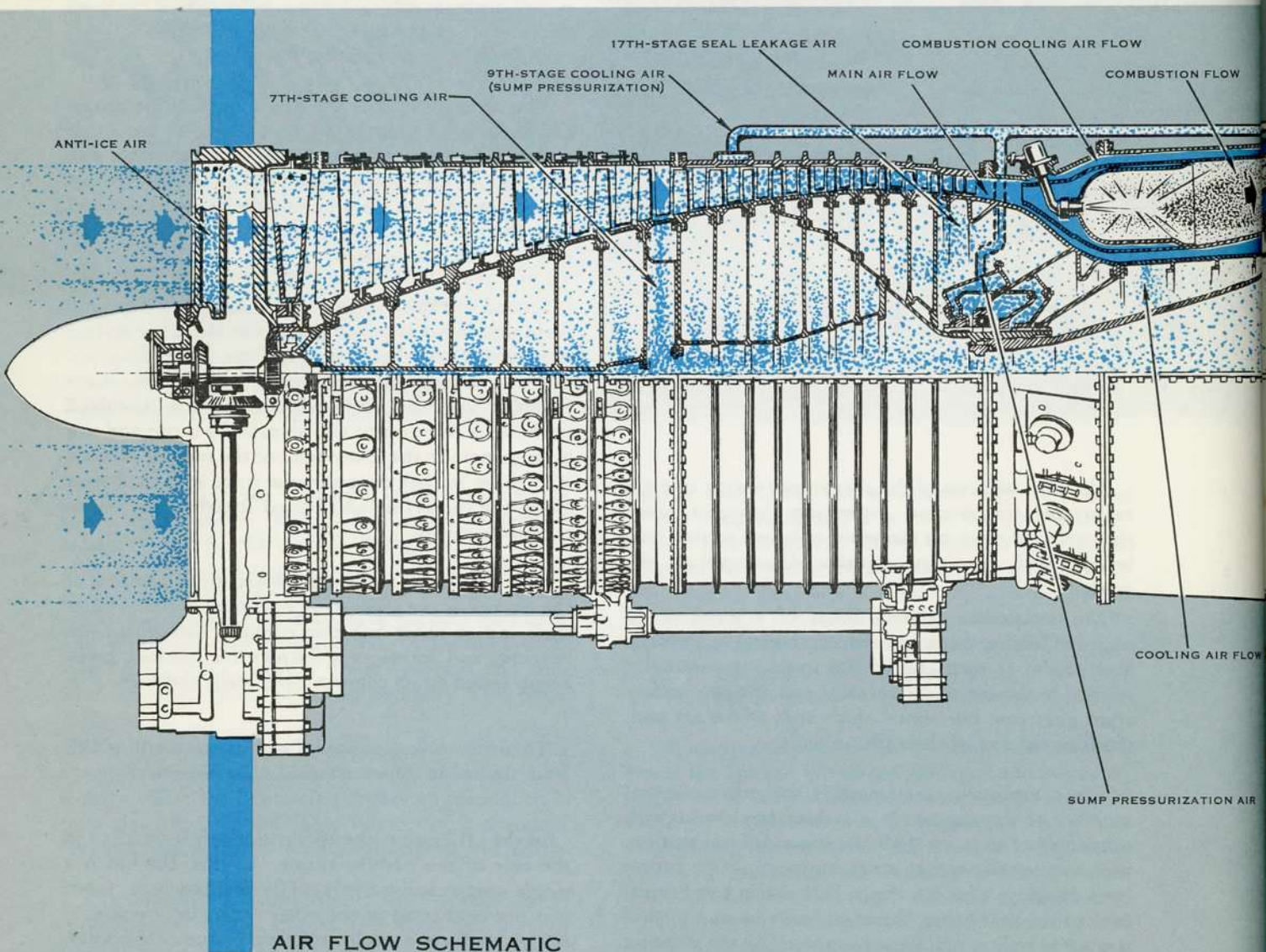

AIR FLOW SCHEMATIC

ACCESSORY DRIVES

A vertical shaft through the compressor front frame lower strut, geared to the compressor stub shaft, drives two gearboxes mounted beneath the engine, one a transfer gearbox mounted at the end of the strut on the compressor front frame, and the other mounted on the rear half of the compressor casing. A horizontal shaft runs from the transfer gearbox to the rear gearbox, through a damper midway between the gearboxes.

Both gearboxes have power takeoffs on forward and aft faces. The starter is mounted on the transfer gearbox forward face. Beside the starter is a mounting for the hydraulic pump. The fuel pump, constant-speed drive and generator, and a scavenge oil pump are on the aft face of the gearbox.

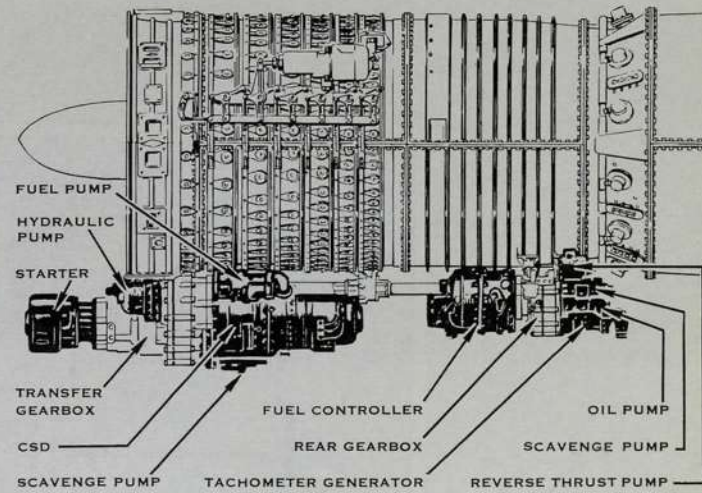

The main fuel control is mounted on the forward face of the rear gearbox. On the aft face is a hydraulic pump for reverse thrust actuation; main oil pump; tachometer generator; electrical load switch; and a scavenge oil pump.

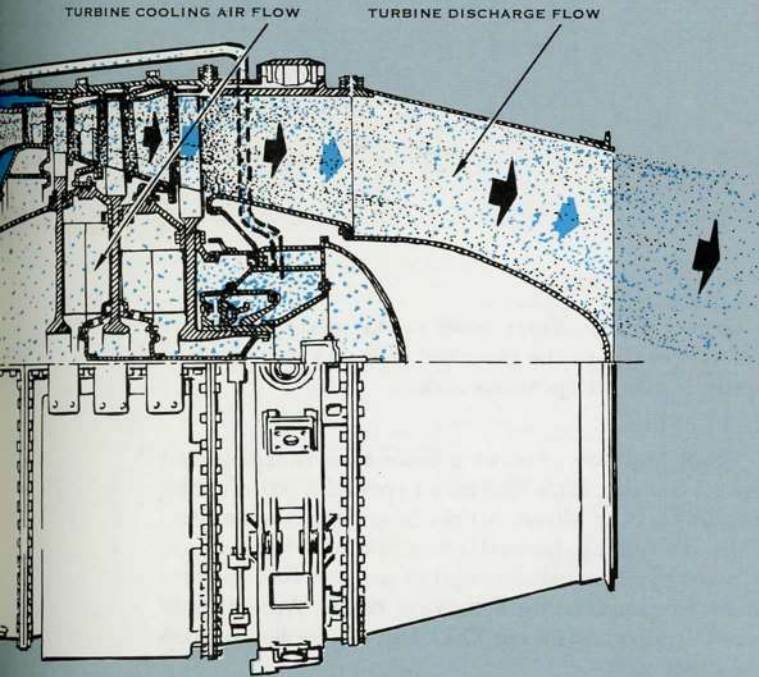

FUEL SYSTEM

Besides scheduling fuel quantity necessary for operating the engine from start to maximum takeoff power, the CJ805 fuel system provides for use of pump discharge fuel for hydraulic operation of the variable stator actuators, and metered fuel as coolant for engine lubricating and constant-speed drive (CSD) oil.

The fuel boost pumps in the wings deliver fuel to the engine at low pressure. In the engine fuel pump, a centrifugal boost element raises pressure, and two gear-type positive-displacement elements further increase the pressure to operating level, depending on flow requirements. The elements are separate, and incorporate a shear section between them. In event of failure of one element, the other element will supply sufficient fuel for all normal aircraft operation.

From the pump, the fuel is routed to the fuel control through a 40-micron filter and a heater. The fuel control is a hydro-mechanical metering device that performs the following functions: 1) provides engine speed control, 2) schedules variable stator vane angle to control air flow into the engine, 3) provides surge

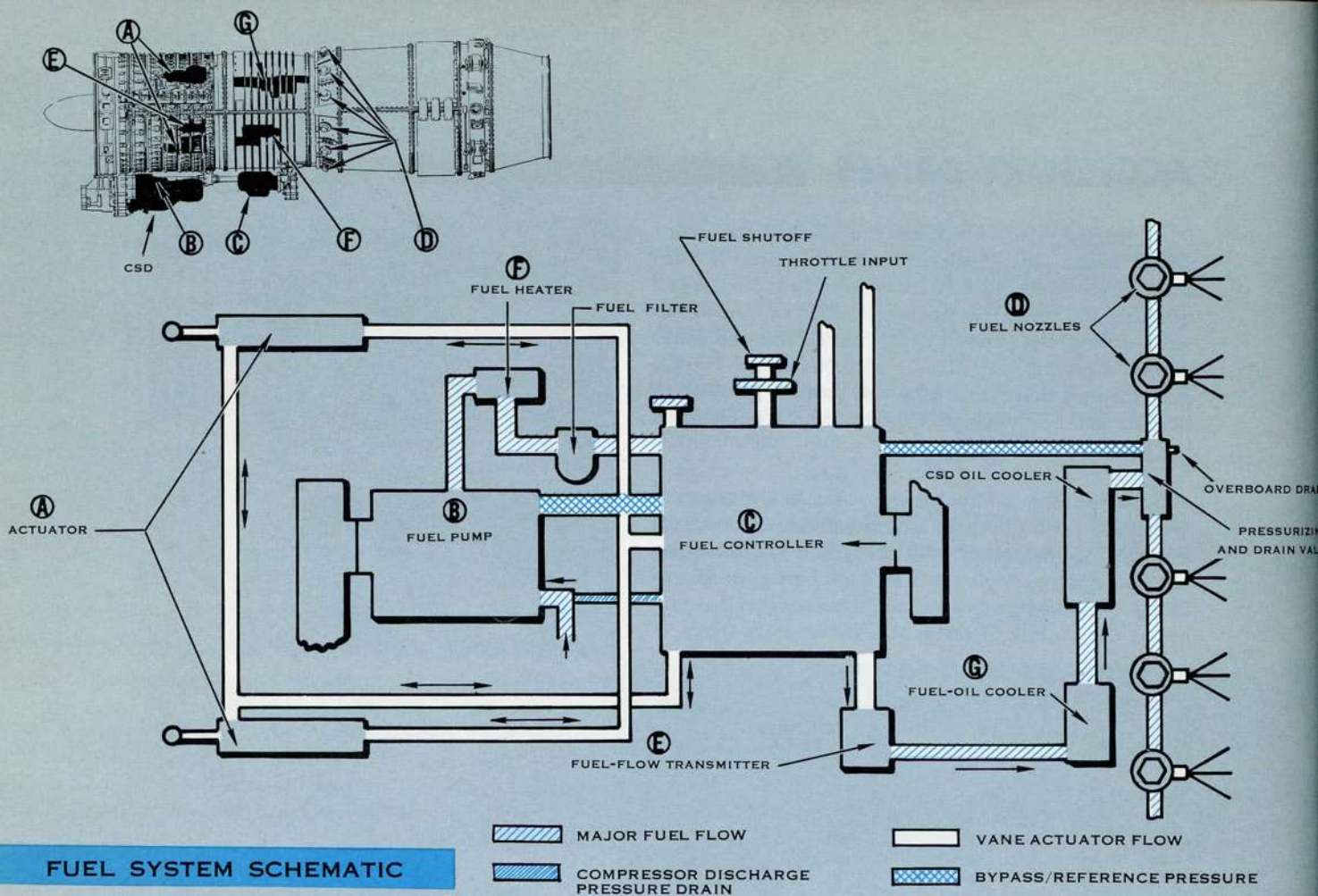

FUEL SYSTEM SCHEMATIC

protection, 4) limits turbine inlet temperature, and 5) provides a positive fuel shutoff. To perform all these tasks, the fuel control is necessarily complex in design, and a detailed description is beyond the scope of this article.

To meter fuel, the compressor inlet temperature, compressor discharge pressure, engine speed, and pilot's power lever setting are used as parameters. The metered flow is passed through engine and CSD oil coolers enroute to the fuel nozzles.

From the oil coolers, the fuel is routed to the nozzles through a pressurizing and drain valve. This valve has two functions: 1) it prevents fuel flow to the nozzles until pressure in the fuel control is sufficient to operate the servo assemblies, which compute the fuel quantity and variable-stator schedules; and, 2) it vents the fuel in the manifold into a collector can after shutdown to prevent nozzle coking and post-shutdown fires.

The nozzle in each combustion liner is a duplex type. At low pressures, fuel passes through a small drilled passage in the stem; as pressure rises, a flow divider valve opens and allows fuel to pass through

a larger passage. Entry ports to the mixing chamber are tangential to the chamber walls, so that the fuel spray is given a spinning action.

Since fuel flow is often greater than that required for oil cooling, some fuel may bypass the coolers. The engine fuel can absorb all the heat from engine scavenge oil during normal operation. A thermostatic control bypasses sufficient oil to prevent fuel temperature from exceeding operating limits. An airframe air-oil cooler assists the CSD fuel-oil cooler to keep the oil cool.

The fuel controller also directs unmetered fuel flow at pump discharge pressure to the compressor variable stator actuators. These are single-ended hydraulic cylinders, in which the piston is driven in either direction by fuel pressure. The piston has a bleed orifice so that a constant flow of fuel will cool the actuators.

Three field adjustments are provided on the fuel controller, one for idle rpm, one for maximum rpm, and one for fuel specific gravity. The CJ805 is designed to afford maximum thrust on either JP-4 or kerosene fuels.

LUBRICATION

The lubricating oil supply tank is mounted on the right-hand forward compressor casing. MIL-L-7808C oil is used for lubrication. A vertical bulkhead divides the oil tank into two sections: one for engine oil and the other for the hydraulic oil that powers the CSD unit and operates the thrust reverser. Sufficient oil capacity is provided in the engine oil and CSD tanks for operation well beyond maximum range.

Near the top of the tanks are screened gravity fill ports with dipsticks attached to the filter caps.

Oil flows from the engine compartment of the tank to the lube supply pump; thence, through filters to the three main bearings and to transfer and rear accessory drive gearboxes. Scavenge pumps in the bearing sumps, gearboxes, and CSD unit return the oil through filters, air and fuel-oil coolers, and de-aerators to the tanks. A sump pressurizing system, utilizing bleed air across the bearing seals into the sumps, regulates pressure in the tank, gearboxes, and sumps. The sumps and gearboxes are manifolded and vented into the upper air-expansion space in the engine

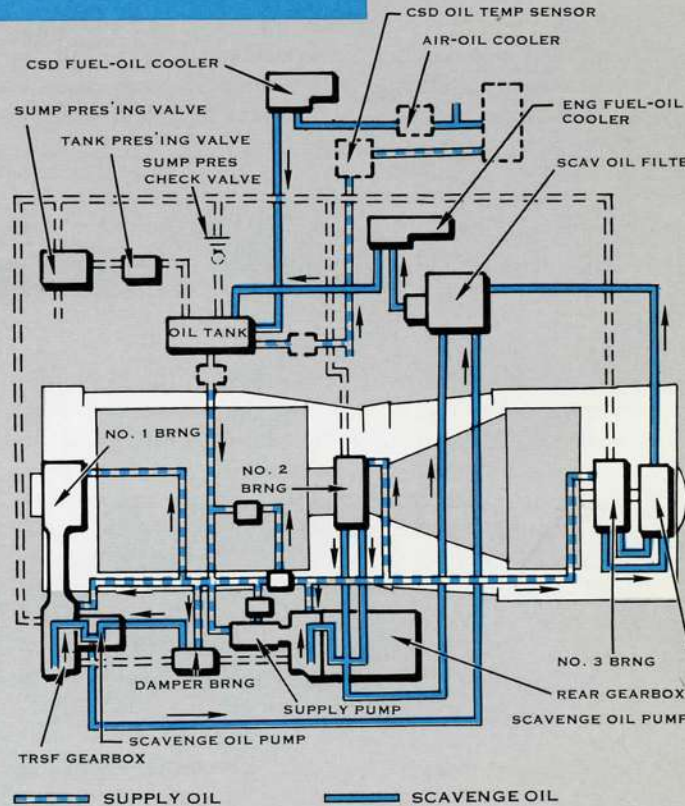

IGNITION SCHEMATIC

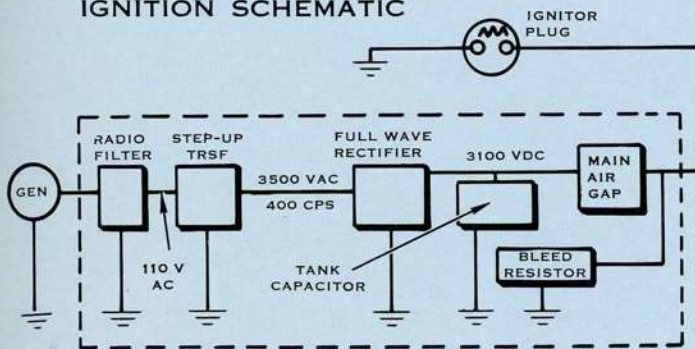

compartment. A tank pressurizing valve maintains a tank pressure above ambient pressure. At 20,000 feet altitude, a sump pressurizing valve begins to build up pressure and, at 28,000 feet and above, the tank and sump pressurizing valves combined hold pressure in oil tank and sumps above ambient.

A pressure relief circuit protects instrumentation from excessive pressures in cold weather starts.

IGNITION AND STARTING

The starter is an AiResearch air turbine motor, mounted on the front pad of the forward accessory drive gearbox. It may be actuated either by a ground supply unit or by bleed air from other engines. Starting time is approximately 40 seconds. The starter cuts out automatically at 3500 rpm.

An arc from the ignitor plug ignites fuel in the No. 4 combustion liner. This flame spreads through crossfire tubes to the remaining combustion liners. An additional ignitor is optional for installation in the No. 5 combustion liner.

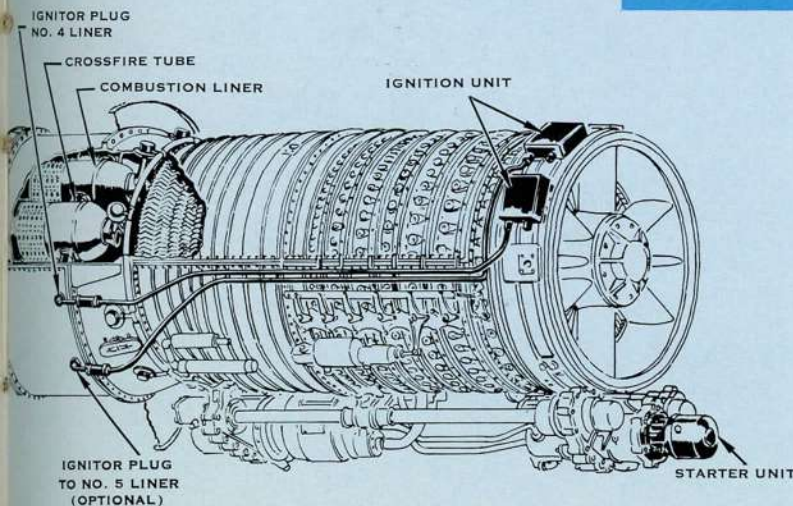

The ignition circuit uses 110-volt, 400-cycle ac, stepped up by transformer to 3500 vac, and then rectified to dc. This is fed to a relatively large capacitor which discharges approximately four times a second, providing an intermittent high-temperature arc across the ignitor plug.

ENGINE CONTROLS

The two principal pilot controls for each engine are the power lever and reverse thrust lever assembly, and the engine start and fuel shutoff lever. These are mounted on the pedestal so as to be accessible to pilot and copilot. The power and fuel controls operate rods and cranks to a closed cable system below the flight compartment floor. The cables run to torque boxes in the pylons, from which teleflex push-pull cables transmit rotation to torque boxes on the engine fuel control. An automatic tension regulator at the wing front spar centerline maintains cable tension at 30 ± 15 pounds to all engine controls.

The fuel shutoff lever has two detent positions, OFF and RUN. When the lever is moved from OFF to RUN, it actuates the ignition control switch and opens the fuel shutoff valve. After the engine reaches 3500 rpm, the starter automatically cuts off ignition. Returning the lever from RUN to OFF cuts off fuel to the engine.

The power lever moves forward from idle rigged position. At extreme forward position, takeoff rpm is available.

To rotate the cable quadrant, the power lever operates a push-pull tube and bellcrank assembly. The first element of the push-pull linkage is one half of an L-shaped lever, the thrust reverse control lever (see schematic). When the power lever is pushed forward, the thrust reverse lever is locked in place by an overcenter link so that it is a rigid part of the power control linkage. When the power lever is pulled back to idle position, the overcenter link becomes a fixed tension link. The thrust reverse (L-shaped) lever can then be pulled back, imparting additional rotation to the cable quadrant. A mechanical lock prevents use of the thrust reverse lever when the power control is not in idle.

The input shafts at the engine fuel controller are concentric, the fuel shutoff shaft being the inner of the two. Arc of travel of the pilot's forward thrust lever causes slightly more rotation of the engine power shaft than does the thrust reverse lever.

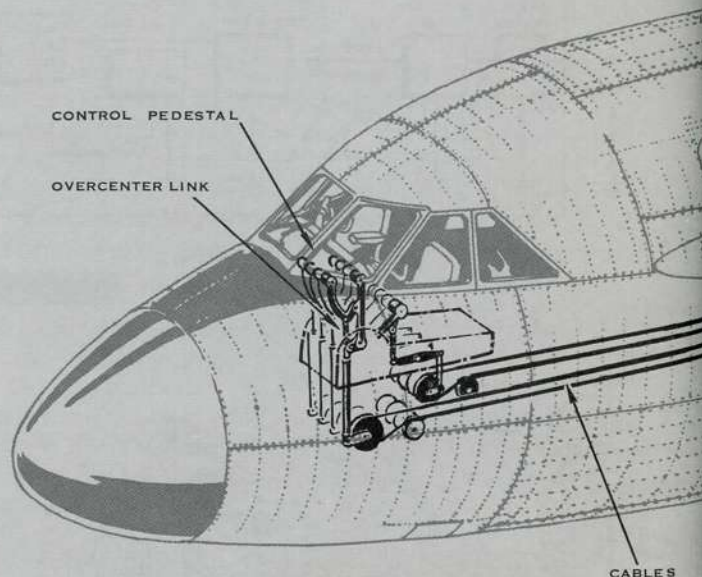

SKETCH SHOWING POSITIONS OF ENGINE CONTROLS

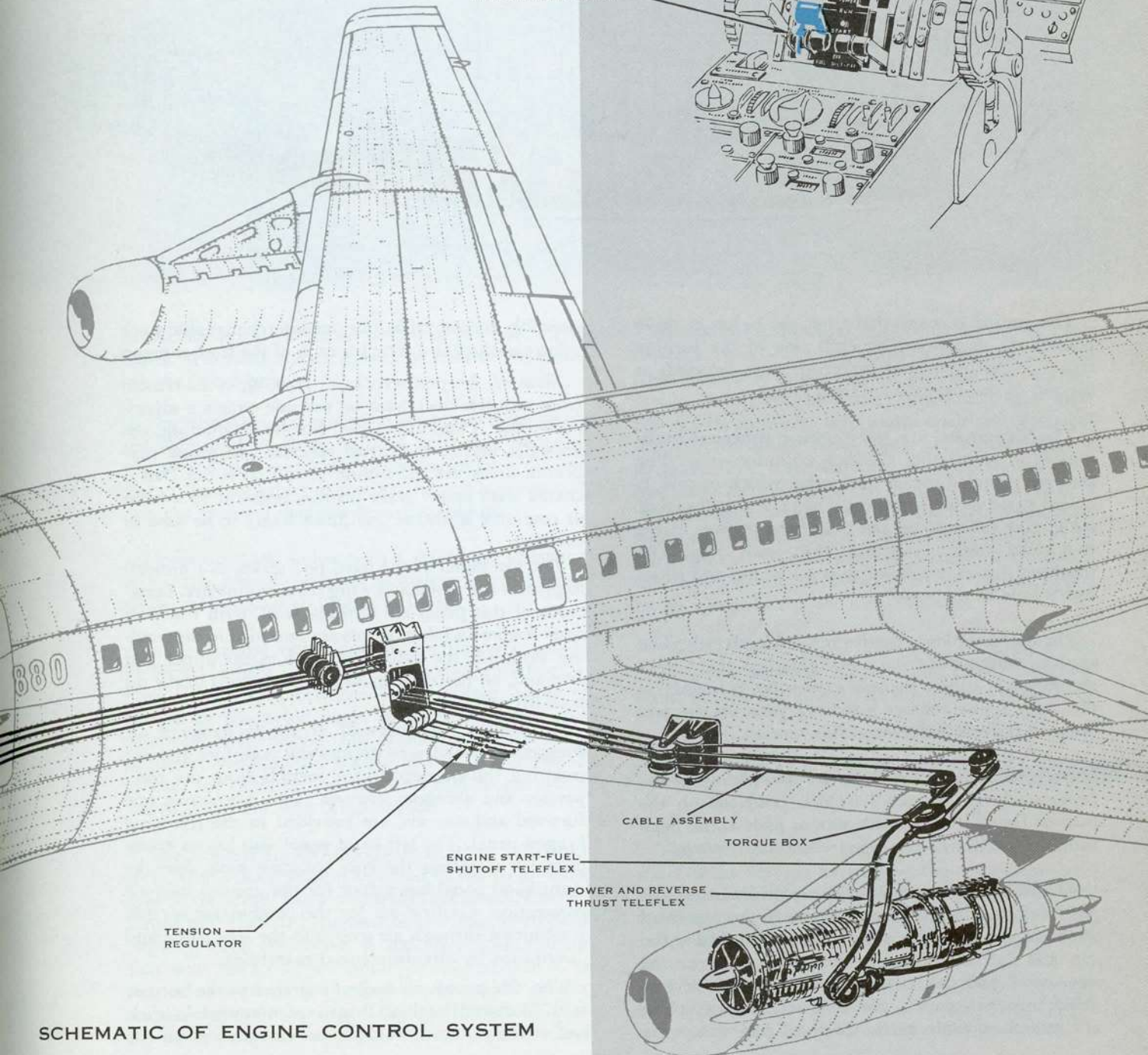
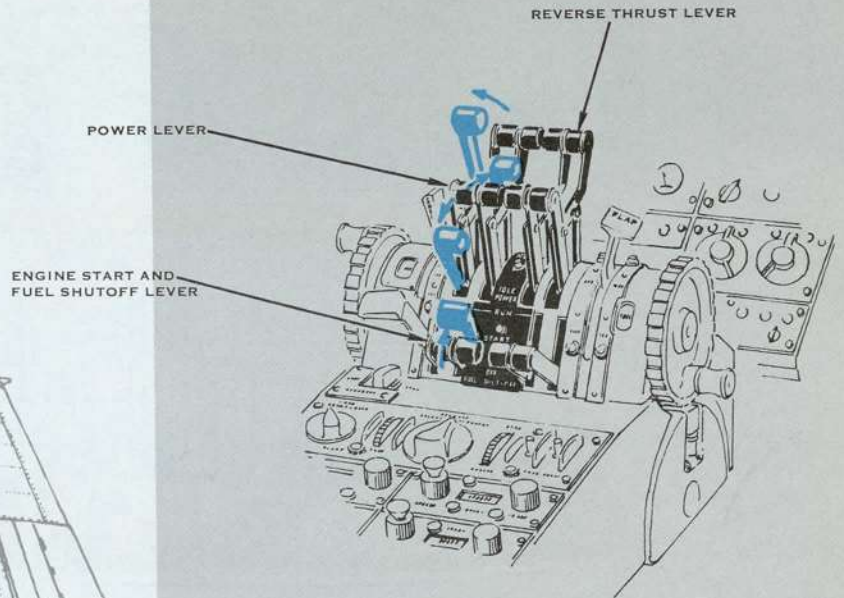

SCHEMATIC OF ENGINE CONTROL SYSTEM

"880" POD AND PYLON

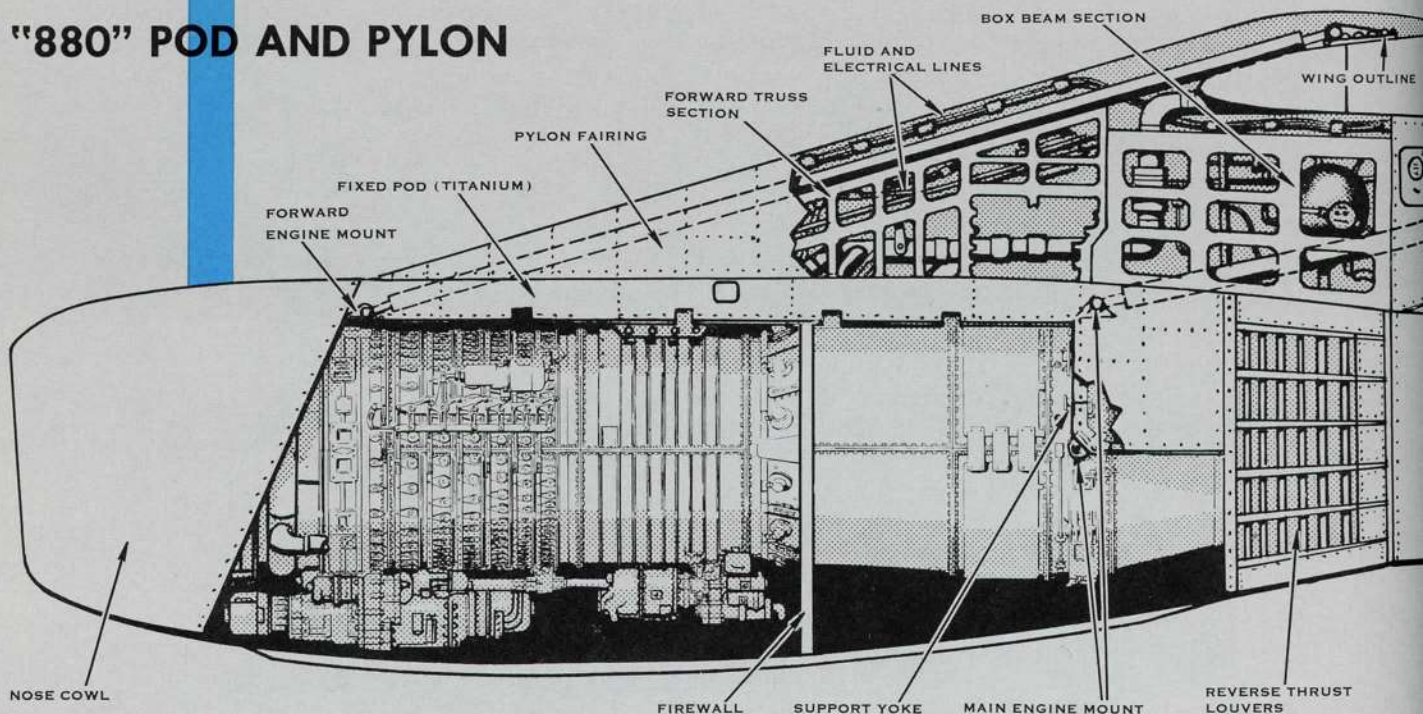

The engine is suspended from the pylon at three points: aft, at mounts on each side of the turbine frame at the horizontal centerline and, forward, at the top of the compressor front frame.

The aft mounts are self-aligning spherical bushings into which slip 1¼-inch trunnion pins. The pins are clamped into a steel yoke, which in turn is bolted to the pylon structure. The yoke absorbs all of the engine's thrust. At the top of the turbine frame is a third mount to absorb side loads only. The trunnion pin in this bushing is a free pin and slides into a hole in the yoke.

The forward mount carries vertical loads only. The engine is suspended from a swinging link that allows the necessary engine thermal expansion. Side pads on the front frame contact matching pads on the pod doors to prevent differential side motion.

For ground handling there are two fittings at approximately the 5 and 7 o'clock positions on the turbine frame, and two side mount pads at the horizontal centerline on the compressor front frame.

The pod consists of five major assemblies: the fixed pod (saddle), covering approximately the top third of the engine; two side panels (doors), hinged at the top and latched together along the bottom; the nose cowl; and the cowling that covers the reverse thrust unit. Side panels, nose cowl, and after cowling are interchangeable parts; the fixed pod and pylon

assembly is removable, but not interchangeable since wing attachment differs for each of the four engines.

Most of the pod structural framing is fabricated from stainless steel. Skin on the side panels is aluminum alloy. Titanium is used for the air ducting, the firewalls, and in the thrust reverser and sound suppressor areas. All aluminum alloy that is not clad is coated with epoxy resin primer, resistant to solvent or corrosive action of any fluids likely to be used in the area.

The top panel of the fixed pod serves as a firewall to protect the pylon and wing from engine fire. Longons of this panel are stainless steel, with titanium cross-frames and skin. Doors are provided in the cowling alongside the pylon for access to the upper pod area and, on the right-hand side, for access to the oil tank fill ports.

A stainless steel firewall at the aft flange of the compressor rear frame divides the pod, fore and aft, isolating the burner-turbine section from the compressor and accessory systems. Two fire doors, one forward and one aft, are provided in the left-hand hinged panel. The left-hand panel also has an access door for servicing the fuel collector tank, and the right-hand panel has a door for the ground start air connection. Cooling air for the combustion section is admitted through air scoops in the side panel and distributed by circumferential manifolds.

The side panels are locked together at the bottom with Hartwell latches. Props are mounted at each end of the panels to hold the panels open; when not

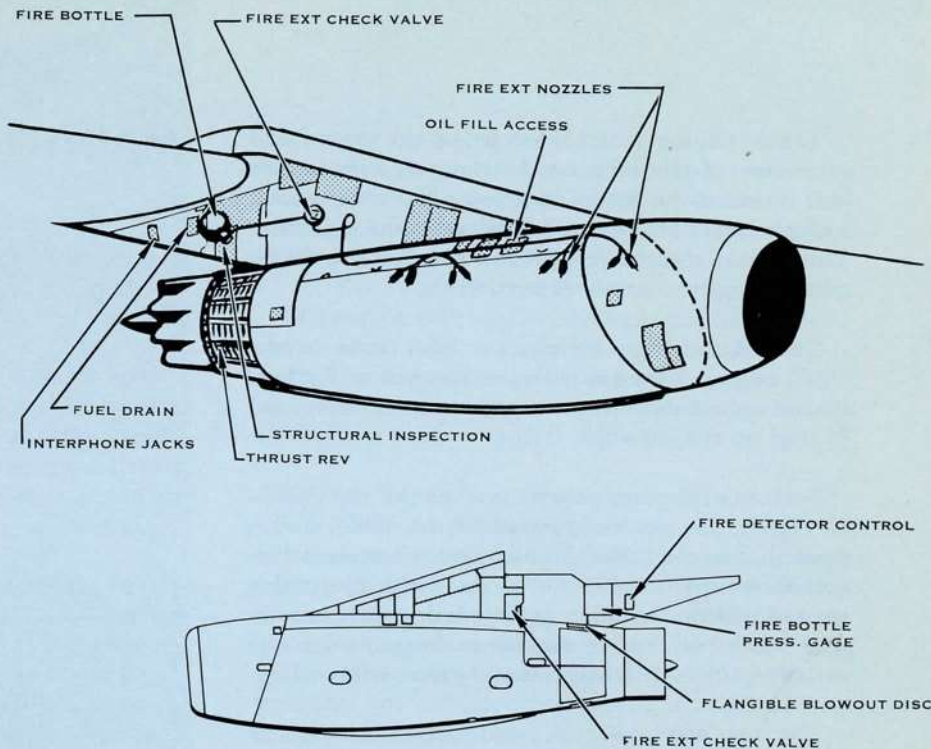
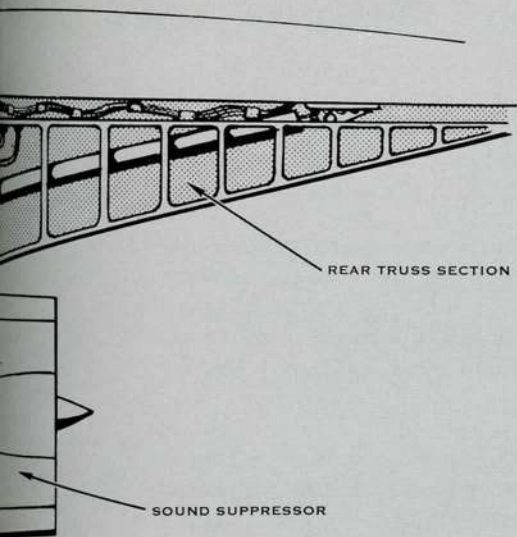

FIRE EXTINGUISHING SYSTEM AND ACCESS DOORS

in use, the props swivel up to clip to the side of the panel. If desired, the panels can be removed by pulling the hinge pins.

The nose cowl is attached to the forward flange of the fixed pod by three bolts. A stub duct between engine and cowl is attached to the engine by a V-band clamp. The stub duct is manifolded to admit ram air into the forward compartment for cooling.

Drain lines and holes, with a minimum diameter of $\frac{3}{8}$ inch, provide drainage at various points during all normal ground and flight attitudes.

A fire warning loop is installed on the inner surface of each cowling side panel. To extinguish engine fires, a 6.5-pound bromotrifluoromethane bottle is carried in the pylon, with associated controls and plumbing into the pod. The plumbing on each wing is interconnected; the bottles in No. 1 and No. 2 pylons, for example, can both be used to put out a fire in either No. 1 or No. 2 engine.

The pylon is divided into three sections, a forward truss, a box beam section attached to the front main spar of the wing, and a rear truss that attaches to the center spar (inboard engines) or rear spar (outboard engines). The box beam is the main load-bearing structure; the aft engine mount yoke attaches to it, so that it supports the major part of the engine weight and transmits all the thrust. The box beam itself consists of two shaped castings of 2014 aluminum alloy.

All electrical and fluid lines come up through the forward truss—the electrical harnesses from the right-hand side of the engine, and the fuel and hydraulic lines from the left-hand side. The fluid lines run aft through the box beam, with the electrical lines routed above them. Both are separated by a partition. The bleed air lines come up through the box beam section. Since this area of the box beam is open through the firewall into the engine compartment, titanium is used in the framing, and an extra horizontal titanium firewall separates this area from that housing the fluid and electrical lines. Ventilation is supplied to the fluid line area.

There are eight access doors on the left-hand side of the pylon and four on the right, giving complete access to lines and control linkages in the pylon.

"600" POD AND PYLON

The CJ805-21 main engine mount is located forward of the vertical firewall on the compressor rear frame, and just forward of the engine bleed air ports and fuel nozzles. A top centerline spherical bushing mates with a vertical pin that is part of the pod and pylon structure to take thrust and side loads. Vertical load is taken by two attachments at approximately the upper 45° positions on each side, mated with tangential links attached to the pylon structure.

The aft engine mount is located on the top vertical centerline of the turbofan housing. A fore-and-aft bolt connects the mount to a swivel bracket, which has spherical bushings and attaches to the structure. This mount absorbs vertical and side loads and also permits engine thermal expansion aft.

Ground handling fittings are like those in the "880" engine. There are side mount pads at the horizontal centerline on the compressor front frame, and fittings on the turbofan frame.

Because of the engine mount system of the CJ805-21 engine, the pylon structure of the "600" differs from that in the "880." The engine is mounted further forward with reference to the wing. The pod is streamlined and similar in external appearance to the "880" pod but is somewhat larger, since the turbofan air is ducted aft inside the external cowl.

The nose cowl surrounds and extends forward of the engine inlet. The turbofan air flow is from outside the engine inlet, aft through ducting built into the side panels, to a stub duct attached to the fan housing. The fan-driven airstream surrounds the engine exhaust cone and mingles with the jet stream aft of the engine.

MAINTENANCE

Accessibility, for servicing, line maintenance, and overhaul, is an outstanding feature of the CJ805 engine.

Turnaround servicing will ordinarily not require raising the side panels. Access doors are provided for checking oil levels and refilling, if necessary. If the panels are raised, all lines and accessories are immediately accessible, not only for inspection but for replacement.

This accessibility makes possible replacement of an unusually large proportion of accessories and components in line maintenance. With a relatively small stock of assemblies, such items as fluid lines, generators, fuel and lubricating pumps and controls, fuel nozzles (except the upper two) can be exchanged without removing the engine from the pod. If a handling cart is available for engine removal, halves of the compressor, combustion, and turbine casings can be removed for inspection, replacement of combustion liners, or minor repairs of rotating or combustion elements.

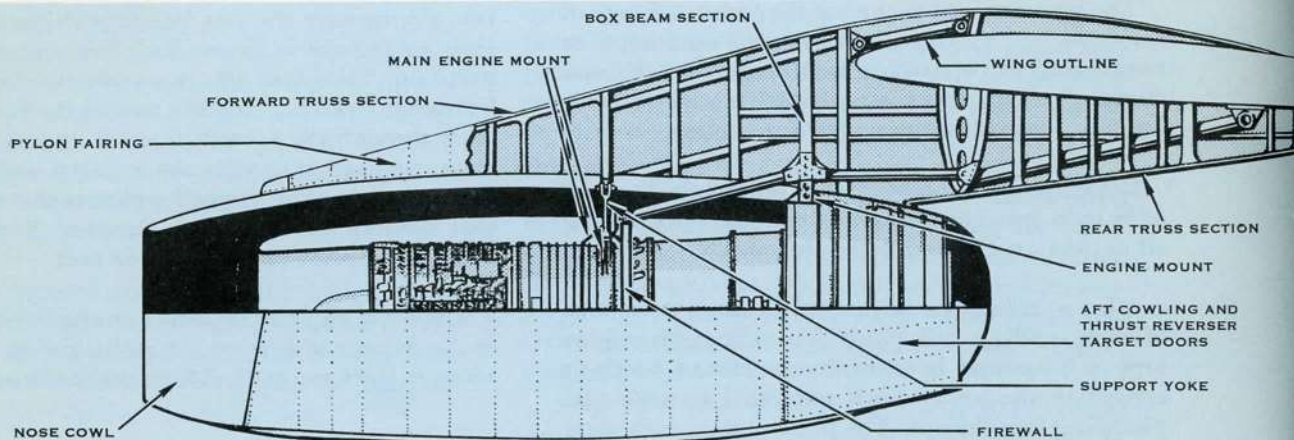

DETAIL SHOWING MOUNTINGS OF CJ805-21 ENGINE

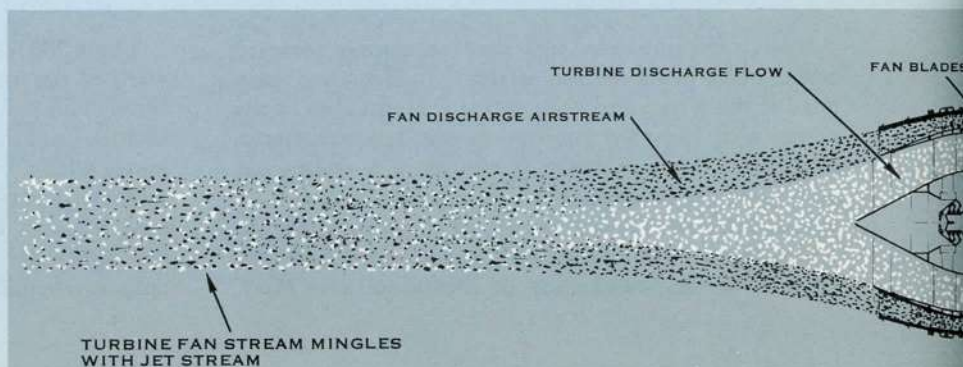

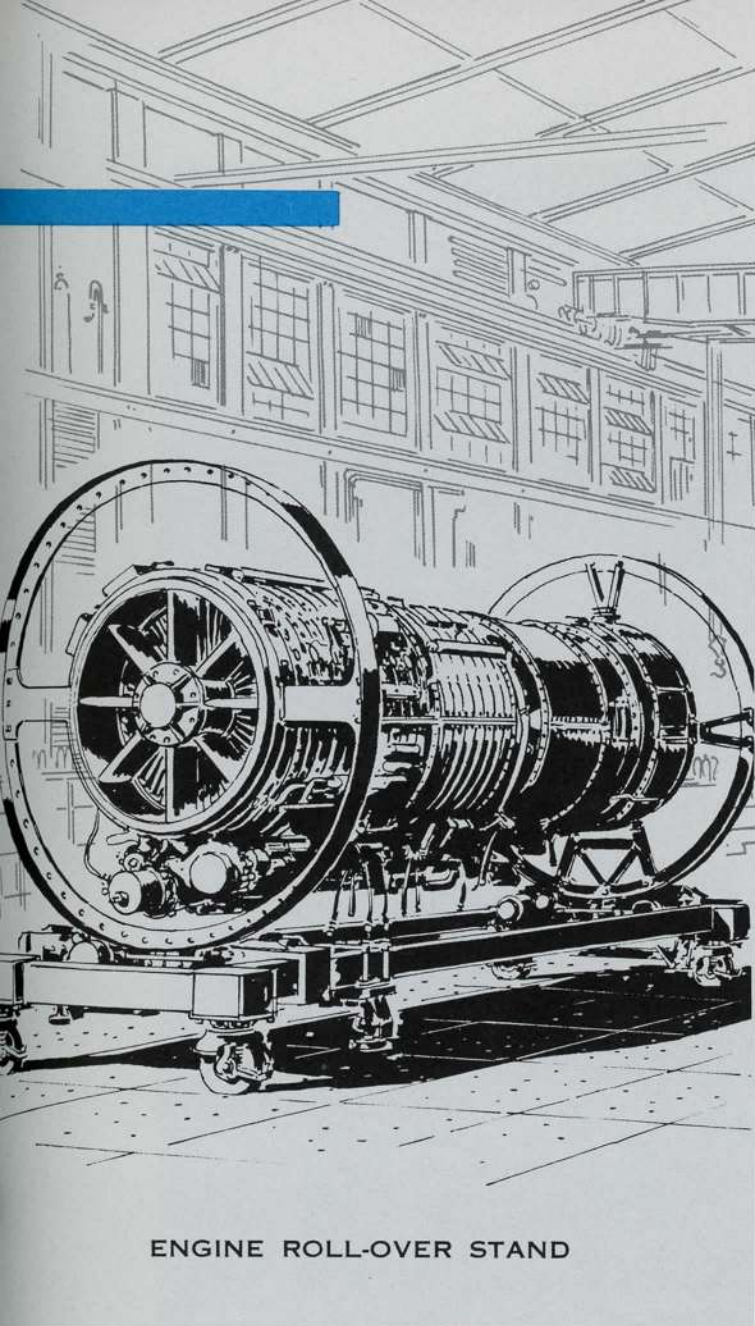

ENGINE ROLL-OVER STAND

When a CJ805-3 engine is to be removed, these steps are required: 1) remove lower half of tail cowl in reverse thrust area; 2) remove two bolts at each side mount, and the forward mount trunnion bolt; 3) disconnect five electrical harness plugs, the pressure ratio line, and two drain fittings at right-hand disconnect panel; 4) disconnect three hydraulic lines, one fuel line, and two drain fittings at left-hand disconnect panel; 5) disconnect bleed air manifold at top of engine, and starter bleed air line at forward end, by removing V-band clamps; 6) uncouple the two quick-disconnects in the two engine teleflex controls; 7) disconnect an electrical plug between nose cowl and engine.

The installation was designed for removal and replacement of a -3 engine in 30 minutes. The diameter of the engine is slightly less than that of most

comparable jet power plants. The adapters needed to utilize standard jet engine handling carts and roll-over stands for the CJ805 are available from suppliers of the equipment.

The engine may be disassembled in either the horizontal or vertical position, or in a combination of both. The manufacturer has found that the vertical position has advantages for complete disassembly during overhaul.

For special tools and equipment needed for the CJ805-3, the manufacturer lists approximately 140 items, about half of them for overhaul only. A large percentage of these are items that will be found, or fabricated at need, in any shop equipped for overhaul: various mountings for indicators for checking rotors or bearings; peculiar shapes of pliers or wrenches for certain components; lifting and handling yokes and brackets. In a shop equipped for jet engine overhaul, many such items as pullers, carts, or stands for working on components, will be usable or adaptable to the CJ805.

The tools peculiar to the CJ805 include tool sets for 1) overhauling the gear boxes, variable stators, and control rigging, and 2) the adapters for use with standard rotor balancing machines. Heavy equipment — hoists, machine tools, degreasing and paint facilities and the like — are those found in any airline overhaul facility. Test equipment needed is largely standard equipment used with other reciprocating or jet engines and accessories, with only a few items peculiar to the CJ805.

It may be noted that one major domestic airline has found that at least ninety percent of the equipment and facilities that it maintains for overhaul of its other jet engines can be applied directly to the CJ805-3.

Time required for complete overhaul is estimated at 750 manhours for the CJ805-3. This breaks down as follows:

- 47 hours disassembly
- 24 hours cleaning
- 380 hours rework
- 190 hours rebuilding
- 109 hours accessory overhaul, inspection, preparation for shipment.

The total time (750 hours) is materially lower than the estimated time on most other jet engine overhauls. Principal reason for this is the simplicity of design. The single-spool, single-shaft, single-turbine-unit rotating element runs on only three main bearings; is less complex in lubrication and cooling requirements; and is comparatively simple to align.



FOREWORD

Many months before assembly of the first Convair 880 began, Convair ran exhaustive tests on wing and tail leading edge specimens to determine the best method for keeping these areas free of ice.

From Convair laboratories, the project moved to New Hampshire's Mt. Washington, where wing, tail, and engine and nacelle systems were tried out in the subzero temperatures of "the world's worst weather." Early last year, full six-foot wing and tail sections went to the NACA icing tunnels, to be subjected to all icing conditions that can conceivably be encountered in flight.

The program is still going on, now in actual flight test. To date, these tests have proved that the "880" and "600" aircraft are well protected in adverse weather conditions. This issue of the Traveler tells why, in describing the anti-ice, de-icing, rainclearing, and anti-fog systems of Convair's new jet airliners.

Reprint from **CONVAIR TRAVELER**
January 1959

all weather protection

CONVAIR 880/600



ENGINE AND NACELLE TESTS
MT WASHINGTON, N. H.

anti-ice, anti-fog, rainclearing

Rain, snow, and ice are transportation's ancient enemies. Flying has added a new dimension, particularly with respect to ice. At the high speeds of new jet transports, under certain atmospheric conditions, ice can build rapidly on airfoils and air inlets.

Three means to prevent or control ice formation are commonly used in aircraft today: 1) heating surfaces by hot air, 2) heating by electrical elements, and 3) breaking up ice formations, usually by inflatable boots. A surface may be "anti-iced," either by keeping it dry by heating to a temperature that evaporates water upon impingement; or by heating it just enough to prevent freezing — maintaining it

"running wet"; or the surface may be "de-iced" by allowing ice to form and then removing it.

All of these means are utilized in providing icing protection for the Convair 880 and 600 aircraft. Under icing conditions, wing surfaces and engine inlet ducts are heated by engine bleed air to vaporize any moisture on contact. Engine inlet struts and guide vanes, and the windshields, are maintained running wet — the struts and guide vanes by bleed air, and the windshield by electrical heating.

Bleed air is ducted to the base of the windshields and directed across their external surfaces to keep them clear of rain. By means of a low-density electrically heated coating, the inner windshield panels are kept warm enough at all times to prevent interior

fogging. A de-icing pneumatic boot for the radome nose, which houses the antenna for C-band weather radar, is supplied at the option of the customer.

Empennage leading edges are electrically de-iced. Instrument pitot intakes, the "Q" intake for the rudder feel cylinder, and an underwing ventilating scoop for the wing front spar passageway, are kept from icing by electrical heating elements. The "Q" intake heater is energized whenever electrical power is on the airplane.

Control switches for all the systems (except the "Q" and spar ventilating scoops) are located on the pilots' overhead panel. Windshield anti-fog, rainclearing, and pitot heat must be turned on manually. Windshield anti-ice coatings, tied into the ice detector circuit, operate automatically. Engine inlet, wing, tail, and radome systems may be turned on manually, or the panel switches can be set for automatic operation. Overheat of wing and tail systems in ground automatic operation is prevented by routing the circuitry via a ground safety switch activated by the main landing gear.

In normal operation, the controls are set for automatic anti-ice and de-ice before takeoff. Then, the systems will be energized when ice is sensed by the detector system.

The detectors are pairs of impact pressure probes, mounted in each engine inlet duct. Each probe has a series of small holes in its forward face, and smaller ones on the aft face. One of each pair is constantly heated by an electric element, so that ice will not form on it. When the airplane encounters icing conditions, ice will form quickly and plug the holes on the second unheated probe. The differential in ram air pressures between the two probes triggers an electric contact, operating relays that energize the anti-icing systems for engine, wing, windshield, tail, radome, and front spar ventilating scoop.

engine and nacelle anti-ice

The strut and inlet vane anti-icing systems are part of the engine assembly. Seventeenth-stage bleed air is taken directly from a port on the aft compressor frame and is ducted forward to the two horizontal and two 45°-up struts. An a-c solenoid-operated pressure regulating and cutoff valve, opened by the detector interpreter signal or by a manual switch, maintains a maximum pressure of 20 psig downstream of the valve. The bleed air path is through the four

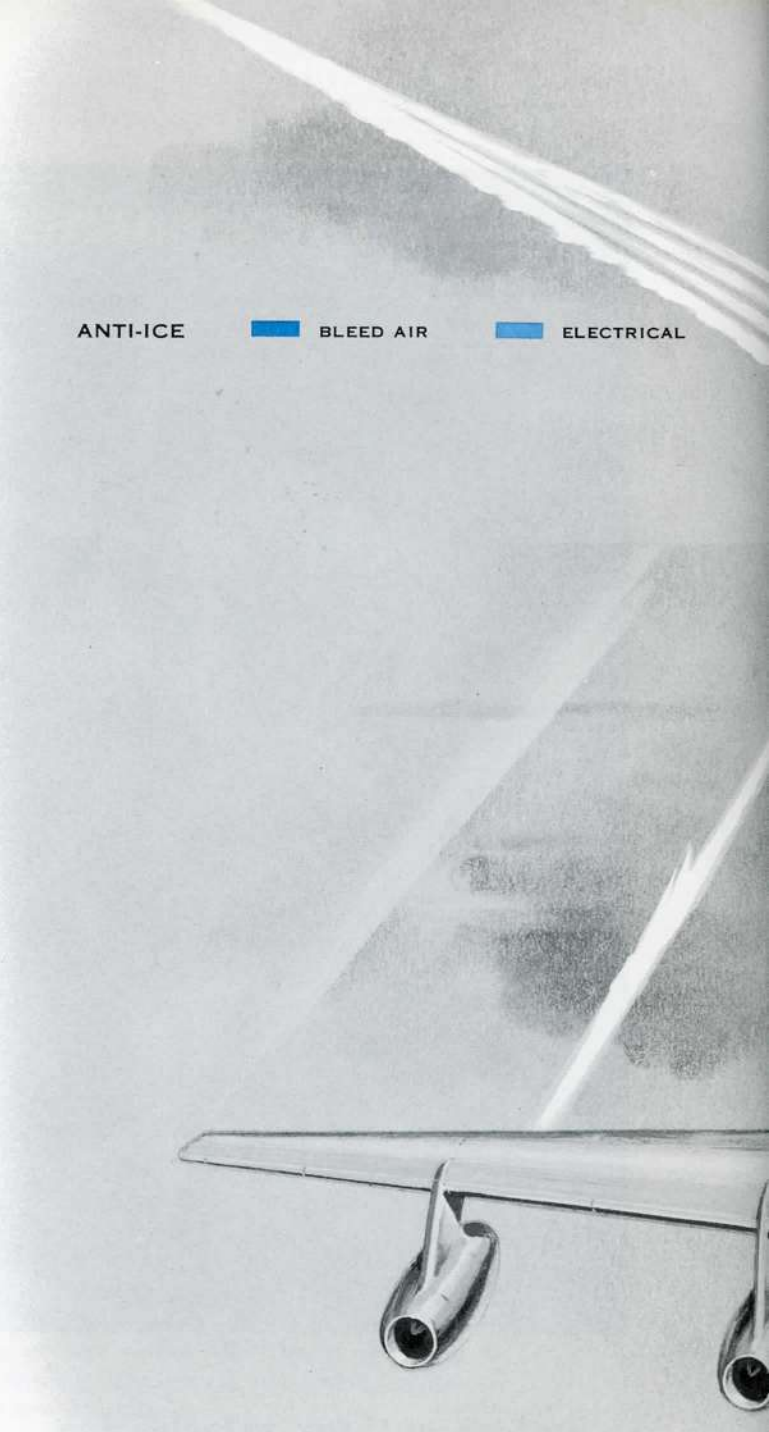

ANTI-ICE ■ BLEED AIR ■ ELECTRICAL

struts into a manifold, and outward through the four other struts and through the 20 inlet guide vanes, discharging into the engine inlet air flow.

From the manifold, air is also ducted forward into the nose cone fairing — "bullet-nose." Flow is directed to the fairing nose and aft through a corrugated-type double skin, discharging at the base into the airstream.

ANTI-FOG

ELECTRICAL

DE-ICE

ELECTRICAL

PNEUMATIC

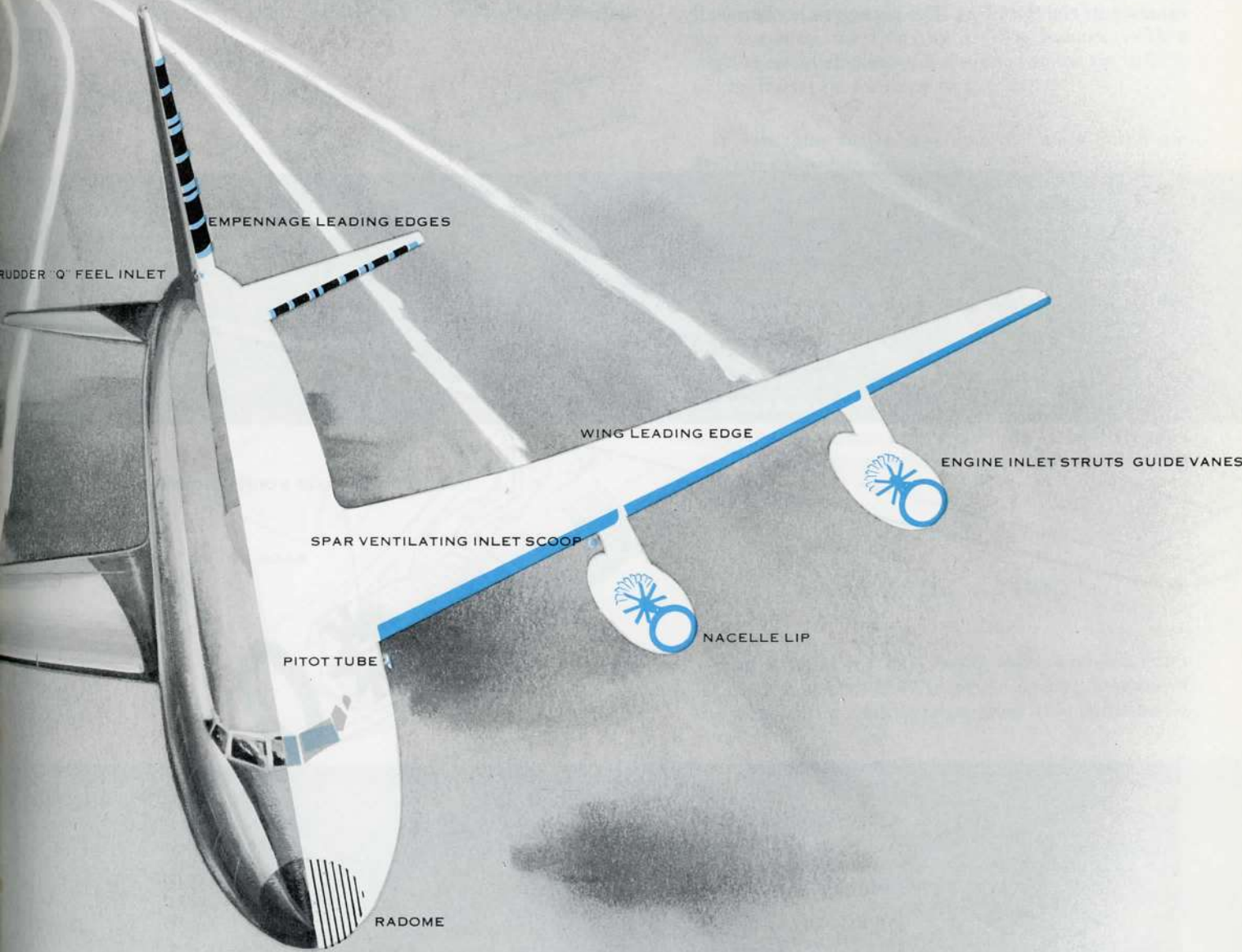

"880" ANTI-ICE AND ANTI-FOG

Struts, vanes, and nose cone are maintained running wet under all icing conditions.

Air for anti-icing the nacelle lips is tapped from the bleed air distribution duct. A d-c solenoid-controlled pneumatically-actuated valve regulates pressure to approximately 12 psig. The flow is to a modified "D" ring around the leading edge, and aft through a double skin to discharge ports on the inside surface of the duct lips. The passages are chemically

milled, with half-inch-diameter bosses for attachment of the inner skin, leaving a narrow-gap high-efficiency passage for the hot air.

The "600" airplane has two inlet duct fairings, one at the forward end of the nacelle and a second inner fairing that divides airflow between compressor and aft fan. Anti-icing in both is like that already described, with a common bleed duct supplying both sets of lips.

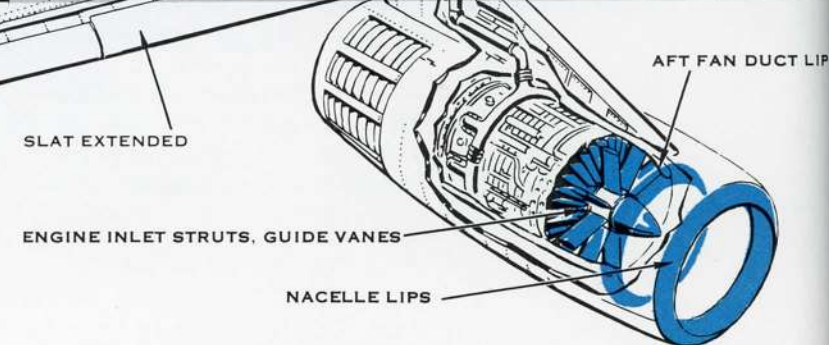
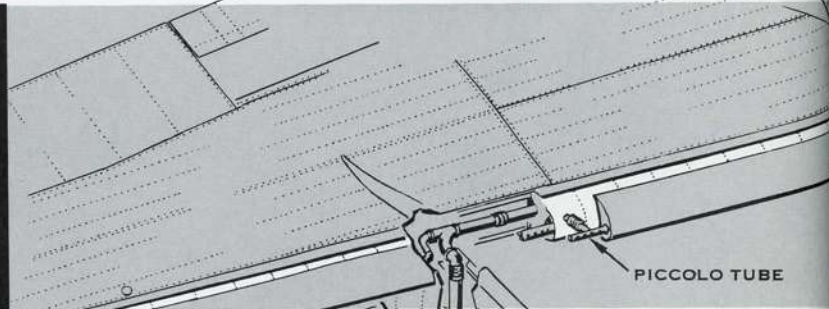
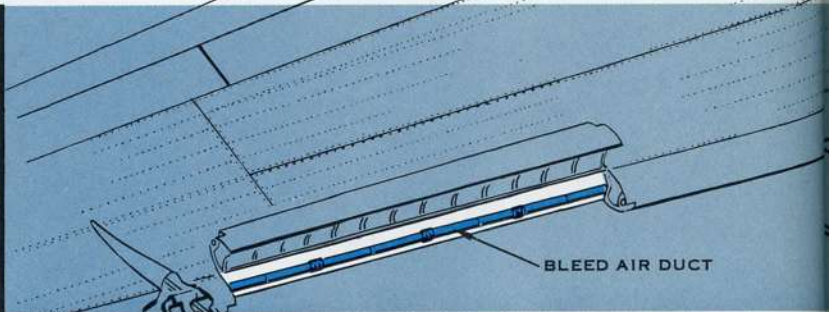
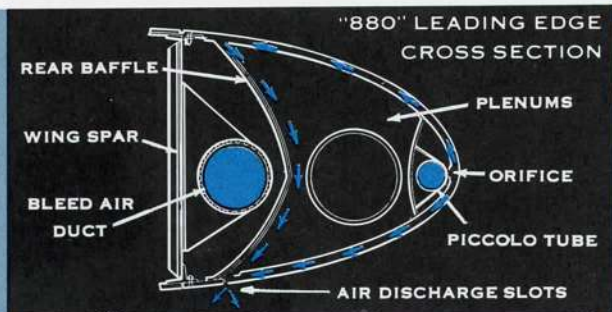

wing anti-ice "880"

The wing is protected by a double-skin hot air anti-icing system in the leading edge, forward of the front spar. The main bleed pressure regulating valves, between each engine bleed air manifold and the main bleed air ducts, reduce pressure to 40 psig in the main duct. Air is ducted to each of three wing sections (inboard, center, and outboard) through valves, one

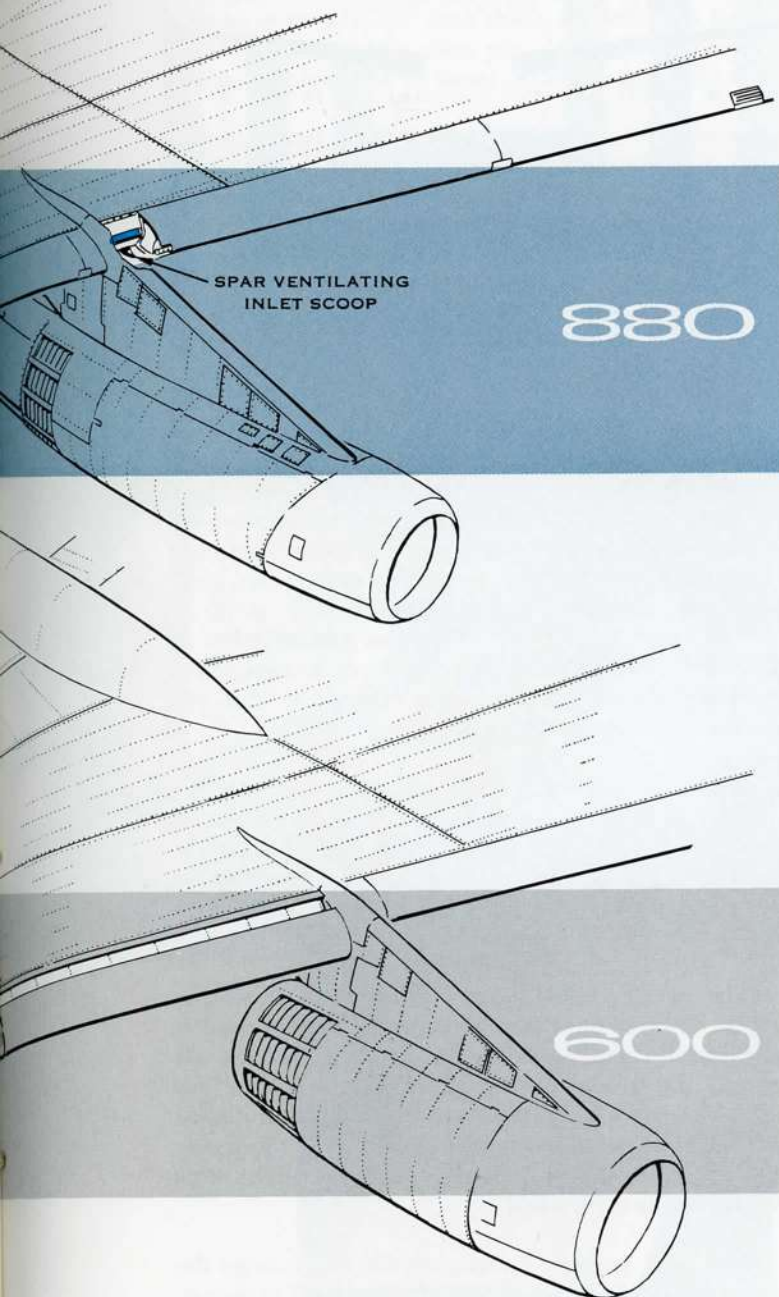

to each section, which further reduce pressure to approximately 13 psig.

The ducts feed piccolo tubes. Baffles aft of the piccolo tubes make the forward portion of each leading edge section a plenum for the piccolo tube air distribution. The inner surface of the outer skin of the leading edge is chemically milled in chordwise strips, approximately $1\frac{3}{4}$ inches wide and 0.040 to 0.050 inch deep, separated by .350-inch-wide strips for attaching the inner skin. This passage, with a high thermal efficiency, is designed to use up to 95% of the initial heat energy of the air.

A Fiberglass baffle separates the main bleed air ducting from the forward piccolo plenum, forming a discharge plenum. The air flows from the chem-milled passages into the discharge plenum and is vented overboard through underwing slots. Back pressure from the underwing slots keeps air pressure in the leading edge approximately two psig above ambient.

The area between wing spar and rear baffle, through which the bleed air duct runs, is ventilated by ram air introduced through a flush inlet on the wing lower surface inboard of the inboard pylon. This inlet scoop is anti-iced by an electrical heating element.

wing anti-ice "600"

Anti-icing of the "600" wing leading edge is similar to that in the "880" in principle but, because of the slats in the leading edge, somewhat different in detail.

The slats are flap-like airfoils that in ordinary flight form the wing leading edge, but extend forward and downward for increased effective lift at low speeds. With slats extended, the airstream flows through the slot between leading edge and slat; therefore, the leading edge behind the slot must be anti-iced, as well as the slat itself.

Leading edge anti-icing is similar to that in the "880," with hot air flowing through chem-milled passages in the outer skin. The slat itself is anti-iced in the same manner: bleed air flows through a telescoping duct into a piccolo tube in the lower, forward portion of the slat, which is isolated from the rest of the interior by a baffle. The outer skin is chem-milled to direct air aft into the rear space, whence it discharges into the slipstream.

empennage de-icing

Several considerations determined the choice of the cyclic electrical system employed in the empennages of the "880" and "600" aircraft. Utilizing an electrical rather than hot-air system eliminated the need for ducting bleed air aft through a 90-foot length of the fuselage. However, an electrical evaporative system is impractical, because of the amount of power required; and a running-wet leading edge is undesirable because of freezing of runback. Therefore the empennage is de-iced rather than anti-iced.

The system in the "880" and "600" empennages may be described as de-icing in segments. Leading edges of the left-hand and right-hand horizontal stabilizer, and of the fin, are each divided into six areas. The 18 areas, each approximately three feet long, are de-iced in sequence once every three minutes by electrically-heated blankets in the skin. De-icing sequence is from tips to fuselage — left-hand stabilizer tip, right-hand stabilizer tip, vertical tip, then the next three inboard sections, and so on.

The heating blankets consist of .003-inch ribbons, sandwiched between .012-inch layers of resin-impregnated Fiberglas. An outer stainless steel .005-inch skin is bonded to the heating blankets, and the blankets are bonded to an .025-inch aluminum inner skin. Current supply is three-phase 200-volt line-to-line a-c from the No. 2 essential load bus. Each heating blanket has three circuit elements, one for each phase. Power is switched from one blanket to another by a control unit.

Between blankets are 1-inch-wide parting strips that are continuously heated to prevent ice formation. This separates ice accretions into blocks. When the skin under the block is heated, it melts a thin layer of ice, separating the ice block from the wing surface. Since empennage leading edges have approximately 40° sweepback, the aerodynamic forces are sufficient to remove the accumulation.

One of the requisites of a de-icing system is that enough ice must be permitted to collect for good shedding. Detailed studies and tests determined that three to four minutes is the best interval for de-icing. That much time allows sufficient buildup without causing too much drag. Therefore, the system is set to cycle once each 3 to 3½ minutes, allowing 12 seconds maximum for each blanket area.

The time required for de-icing each area usually varies from 1 to 10 seconds. However, if the area is de-iced within 2 seconds, for example, continued

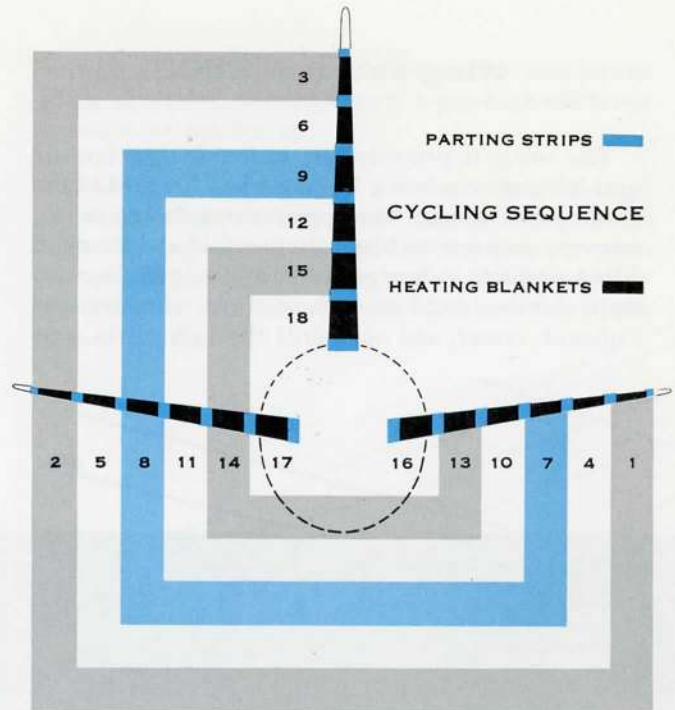

application of heat would have the undesirable effect of keeping the area above freezing for another half minute or so, and during this time the intercepted water could run back and refreeze. To prevent this, a temperature sensor is imbedded in each cycled area. When the surface temperature reaches 50° to 60°F, the control cuts power to that area and switches to the next. After all 18 areas have been heated, there will be a "dwell" period long enough so that 180 seconds will elapse between cycling.

If the temperature cutoff point is not reached within 12 seconds, the controller will switch to the next section. The controller also provides circuit overload protection; if one heating element is shorted out, the controller will disconnect that area and proceed to the next.

The parting strips operate at low heat on single-phase current. Overheat is rarely a problem; nevertheless, thermal switches are mounted on the aft side of the left-hand inboard stabilizer strips, to cut off power at a temperature of 90°F. A short-circuit in one strip would cut off one phase of the three-phase current supply, leaving two-thirds of the areas with parting-strip heat.

The total power requirement for empennage de-icing is from 7.38 to 9.22 kva for the cycled elements, and from 2.5 to 3.15 kva for the parting strips. The primary electrical circuit is routed through a ground safety switch, so that it cannot be operated on the ground.

windshield anti-ice, anti-fog and rainclearing

There are seven multi-layered glass panels in the flight compartments of the "880" and the "600" airplanes: a center windshield, two main windshields directly ahead of pilot and copilot, and a sliding window and aft window on each side.

All of these have three glass plies separated by vinyl plastic. The main windshields, for example, have an outer ply .187 inch thick, an .080-inch layer of vinyl, a .312 center glass ply, a second vinyl layer .300 inch thick, and an inner .312-inch glass ply.

Only center and main windshields are anti-iced; sliding and aft windows are at such an angle to the airstream that droplets are not likely to strike the surface. The entire areas of the center windshield, and the major portion of the main windshields, are heated by a high-density electrical coating on the inner surface of the outer ply, keeping the wind-

shield running wet under all flight icing conditions.

The entire areas of center and main windshields, and most of the sliding and aft panel areas, have a low-density coating on the inner surface of the center glass ply, which maintains the inside surfaces at a temperature above the flight deck dewpoint.

Control switches for windshield anti-fog are on the overhead panel. In the typical "880" panel illustrated, all five switches — three ANTI-ICE and two ANTI-FOG — are normally turned on at takeoff. This energizes the anti-fog coating in all seven windshields. When icing is encountered, the automatic detector system deactivates anti-fog and activates anti-ice in center and main windshields, regardless of the position of the main switch in the ANTI-ICE panel.

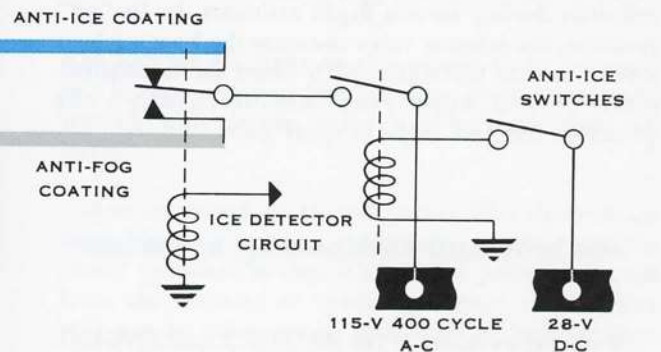
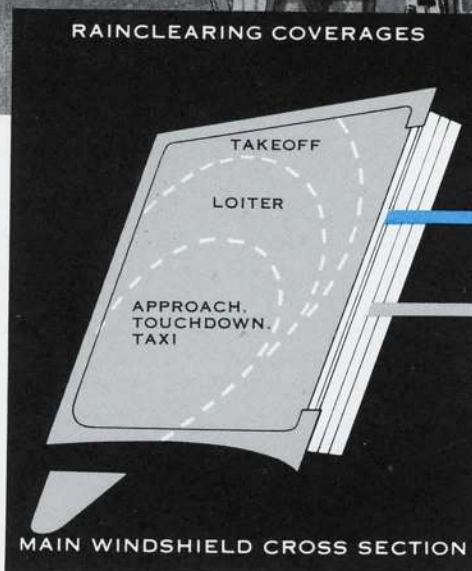

ANTI-ICE, ANTI-FOG SIMPLIFIED SCHEMATIC

An important reason for having anti-fog activated is that warming the vinyl layer adds materially to the ultimate yield strength of the windshield. In the event of a bird strike, the vinyl supplies the plasticity and resilience to make the windshield shatterproof and to insure against sudden cabin decompression. The effectiveness of the vinyl is greatest at 90° to 100°F, the temperature which the anti-fog coating maintains.

Temperature sensors imbedded in all windshield coatings allow external controllers to maintain the desired temperatures on all windshields.

The "880" and "600" utilize an airblast rainclearing system that was first developed by Convair for F-102 interceptors and has now been proved in service over several years of all-weather operation. Bleed air is ducted to the lower forward corners of pilot's and copilot's windshields and released through nozzles that direct a flat, high-velocity flow across the outer surface. The air blast forms a barrier that prevents raindrops from striking the windshield surface.

radome de-icing

The boot optionally supplied for de-icing the radome covers the forward 24 inches (surface distance) of the nose. Ice will form on only the forward 16 inches. Aft of the boot the radome is protected by a coating of neoprene.

The boot contains inch-wide passages connected to a manifold tube that is pressurized by bleed air. An electro-mechanical timer operates a selector valve that admits 18 psi pressure for 5-second periods at 4-minute intervals.

Between pressurized periods, and at all other times during flight, a suction force of 6 inches of mercury is applied to the boot tubes, preventing partial boot inflation during certain flight attitudes. In its "off" position, the selector valve connects the boot with an ejector nozzle through which bleed air is continuously forced, supplying suction through the principle familiar in paint spray guns.

control and indicating systems

With the switches of the ANTI-ICE and ENGINE ANTI-ICE overhead panels in AUTO position, all airplane anti-icing protection will be automatic. The

ANTI-ICE switch has an ON position which bypasses the detector system. This ON position is useful principally for ground check of the separate systems on that panel. The TAIL switch TEST position allows cycling of the control unit. The ENGINE ANTI-ICE switches have an ON position that overrides the automatic detection or automatic cutoff control systems.

When the airplane enters icing conditions, the first detector probe signal illuminates the blue ANTI-ICE ON light on the center panel. Then, if any anti-ice switch is not in automatic position, the red ICE light illuminates to warn the pilot.

Should any wing anti-ice valve remain closed when it is supposed to be open, a malfunction switch in the valve illuminates the appropriate wing-position CLOSED light in the ANTI-ICE panel. ENGINE ANTI-ICE panel CLOSED lights illuminate when engine anti-ice bleed air valves remain closed in spite of a signal to open. Malfunction lights are

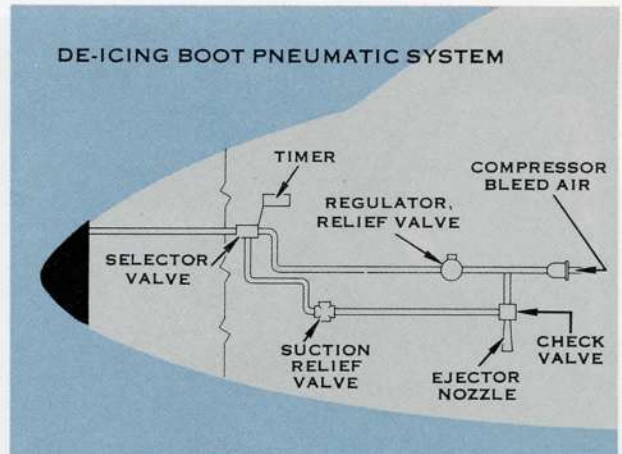

provided for the radome and empennage de-icing systems.

In each wing, a pair of skin temperature sensors are mounted in the leading edge of each of the three anti-ice sections. One sensor acts to close the wing anti-ice valve at a skin temperature of approximately 315°F, and to open it when temperature drops to 115°F. The other sensor is connected to the LEADING EDGE TEMP panel beside the ANTI-ICE panel, so that the pilot may monitor leading edge skin temperatures. The six upper positions of the selector switch are each connected to one wing anti-ice section; the remainder of the selector switch positions are for monitoring temperatures in the bleed air duct spaces in wings and fuselage. The red

WING ANTI-ICE
AND
BLEED AIR
TEMPERATURE
MONITORING

ANTI-ICE VALVE CONTROL SENSORS

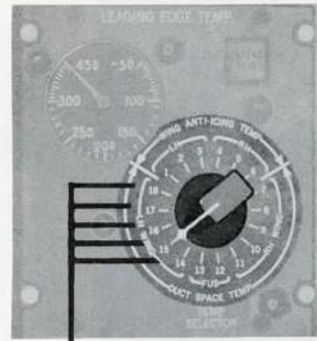

BLEED AIR DUCT SPACE SENSORS

ANTI-ICE VALVE CLOSED WARNING*

SKIN TEMPERATURE INDICATING SENSORS

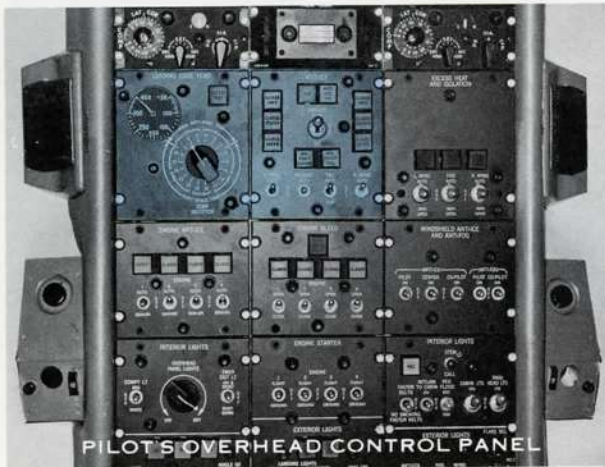
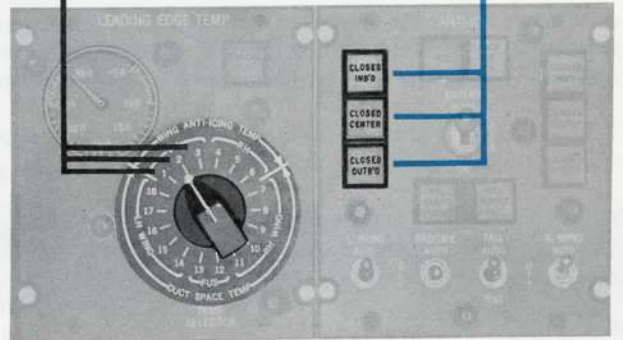

EXCESS HEAT light on this panel serves primarily as a backup warning light in event of an inoperative sensing unit in the other anti-ice and bleed air circuits.

Anti-ice bleed air shutoff valves, like those of the other bleed air systems, are spring-loaded toward the closed position, so that if electrical power is cut off from the solenoid or operating motor, the airplane will not be subjected to uncontrolled heat or pressure. Electrical circuits are protected by circuit-breakers, thermal cutoffs, and overvoltage and overcurrent sensors in the control boxes.

almost mandatory with the advent of jet-powered transports. Space and weight required for d-c generators, of a size to provide enough power for a 100-passenger 600-mile-an-hour transport, are prohibitive.

For aircraft use, the generator must be both lightweight and rugged. The generator in the "880" and "600" weighs only 76 pounds, while a 40-kva industrial generator weighs half a ton. This is possible

A-C power supply

The generator in each engine nacelle is driven by a constant-speed-drive (CSD) unit mounted on the aft face of the forward (transfer) gearbox. The gearbox is powered directly from the engine by a shaft geared to the compressor rotor.

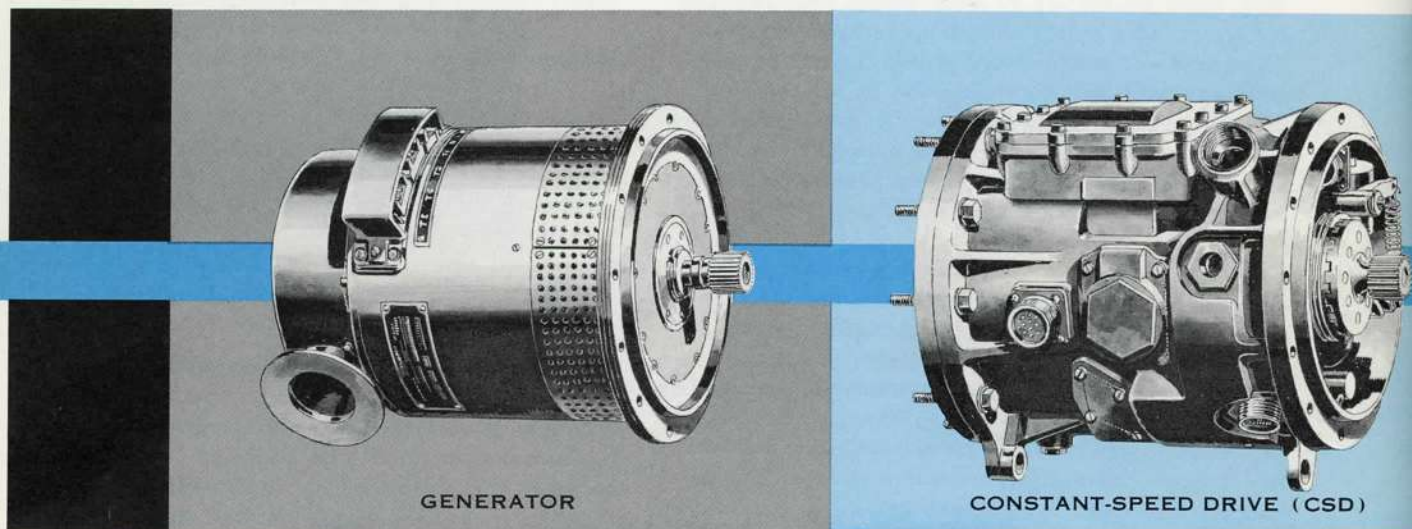

GENERATOR

CONSTANT-SPEED DRIVE (CSD)

because the aircraft generator has higher speed, higher frequency, and is blast air-cooled.

The breakthrough that has made possible a parallel a-c system came with the comparatively recent introduction of constant-speed drives. Constant voltage can be maintained in either a-c or d-c generators by electrical regulation; but parallel a-c systems must maintain a constant frequency as well, obtainable only by regulation of rotor speed. This regulation must be within fine tolerance for capacitance-inductance elements of the airplane as well as for parallel operation of the generators. A constant-speed drive was developed for holding rpm within limits to allow paralleling.

The constant-speed drives developed for the "880" and "600" will maintain the generator rotors at 6000 rpm within 1 percent tolerance, at all engine speeds from idle to maximum. This has made possible a sophisticated electrical system, automatic in normal operation, highly flexible in possible manipulation of load distribution when required, and with multiple safeguards against malfunction or system failure.

The CSD unit is a hydraulic, rather than mechanical, coupling. To describe it briefly and in the most general terms, the input and output drives consist of ball pistons moving in eccentric and elliptical races. One ball drive serves as a pump, the other as a hydraulic motor. Hydraulic flow varies, of course, with speed of the input shaft; it may also be varied by varying the eccentricity of the input race, which can be displaced by a lever actuated by a flyweight type governor.

Gross control is provided by the governor; for fine control, additional input is received from a current-sensing electrical component, the load controller. At 4300 input shaft rpm, hydraulic flow will be sufficient to drive the output shaft at 6000 rpm, and the flow rate can be held constant at all input speeds up to 7760 rpm.

To prevent a runaway generator, in the event of a malfunction of the CSD unit, a solenoid-operated trip will completely disconnect the CSD from the drive pad by disengaging a clutch.

The generator is made up of fixed stator windings, from which power is taken, and a rotor containing a

series of electromagnetic field windings. On the same shaft is a permanent-magnet generator (PMG) field of 32 small magnets mounted around a disc. The PMG stator supplies approximately 300 watts of 1600-cycle single-phase current, which is rectified for use as a power supply for the control circuits, and also for "flashing" of the main generator field. After initial excitation, the rotor electromagnetic field is supplied by rectified a-c from the main output through the static exciter.

Slip rings are of monel for increased wear. Brushes and bearings are designed to last 2000 hours under "880" and "600" operating conditions. Expected life of the windings is 5000 hours.

The generator in the "880" and "600," designed for strength and durability in normal operation, will supply 150% of rated load for five minutes, and double load for five seconds, to withstand momentary overloading.

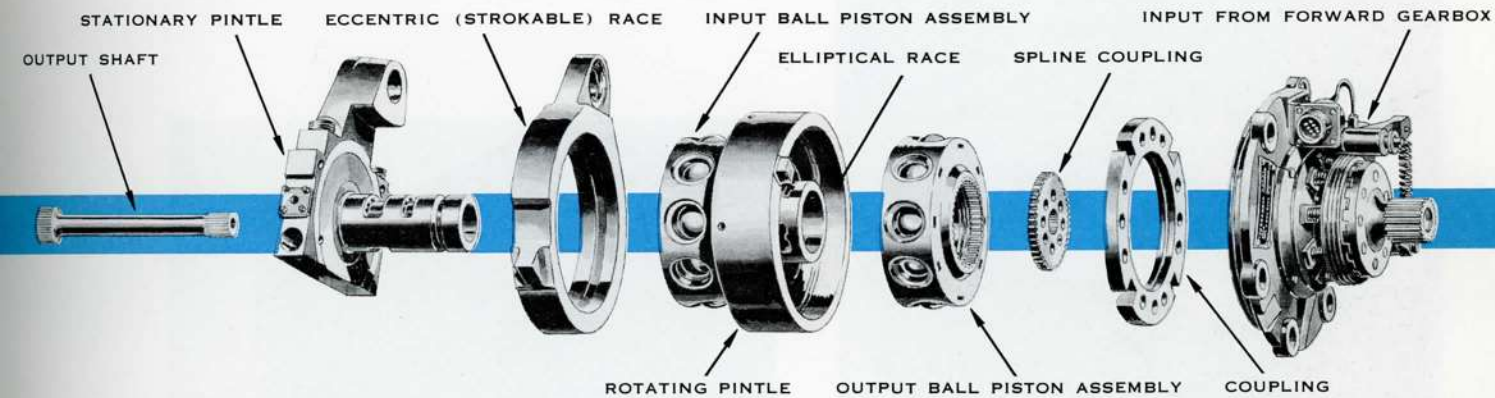

CSD EXPLODED VIEW

generator controls

The two principal controls for each generator are the static exciter and the voltage regulator.

The heart of the static exciter is a saturable-current potential transformer, a transformer with four windings (see schematic).

Initial flashing of the generator starts current flow in the primary winding, and transformer action causes current to flow in the rectified winding that supplies the generator field. This "feedback" current continues to increase, and voltage continues to rise until some limiting action is imposed.

The saturating winding is fed with d-c power from the voltage regulator. As the unidirectional field of this winding builds up, inductive coupling between the other windings diminishes. The voltage regulator thus limits generator voltage by reducing both primary-secondary coupling and generator field current.

Also, a change in load further affects generator output; if more current should flow through the secondary because of a heavier load, the secondary will, with reference to the rectified winding, become a primary and induce more current in the generator field. With a fixed terminal voltage, the higher the load, the greater will be the feedback.

The static exciter is, to a certain extent, self-regulating and, under steady-state loads, the voltage regulator provides very little control. The regulator acts as a vernier, and provides additional forcing for rapid changes in system load.

The voltage regulator obtains power from the permanent magnet generator. A transformer-rectifier provides a supply of direct current at approximately 28 volts. The reference voltage, however, is provided by Zener diodes — silicon diodes that have the property of maintaining a constant voltage drop across the terminals, regardless of moderate changes in the voltage applied. A sensing circuit picks up phase volt-

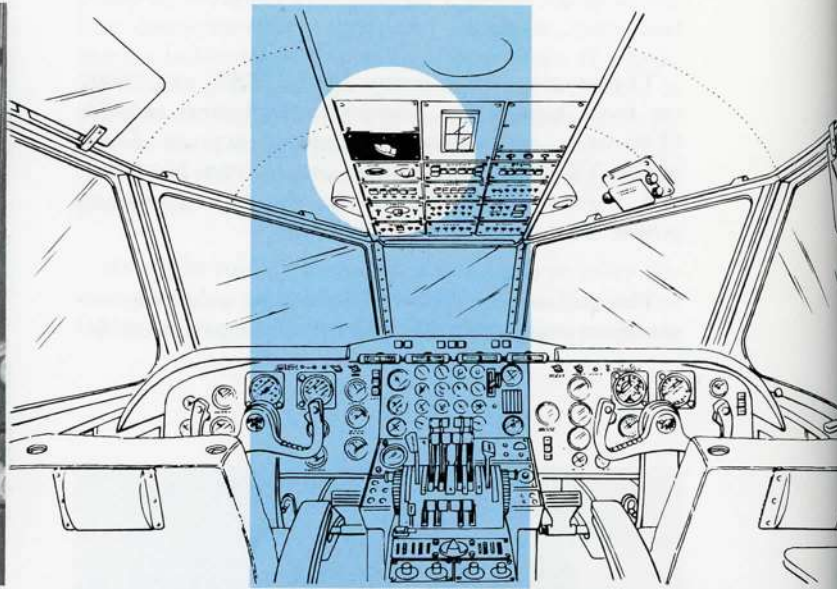

PILOT'S ESSENTIAL BUS CONTROL PANEL

will be held open by protective relay circuits. External power is now available throughout the airplane a-c and d-c electrical systems.

Since the generators are designed to have no residual magnetism during engine start, they will show no voltage. The generator field will not be energized until the engine comes up to idling speed. Then, the field is automatically flashed. The bus tie contactor automatically opens, removing external power from the load bus; the generator line contactor closes, so that the generator is connected to its load bus. When all four engines are started, the generators are carrying the full airplane load.

The flight engineer will turn the external power switch first to OFF and then to GEN PARALLEL. The No. 1 generator bus tie contactor will close, energizing the synchronizing bus from this generator; the Nos. 2, 3, and 4 generators will automatically parallel, and the bus tie contactors will close. The paralleling may also take place via the generator line contactors, if paralleling is necessary in subsequent manipulation.

An autoparalleling circuit prevents paralleling when frequency difference between incoming generator voltage and synchronizing bus voltage is more than 8 cps ($400 \text{ cps} \pm 1\%$), and when phase difference is greater than 90° . Should random paralleling

occur, however, no damage would ensue. The only effect would be a momentary transient in line voltage, with perhaps a perceptible flicker of lights.

When the generators are in parallel operation, real and reactive loads are divided among them. The real load sensing components bias the CSD governors to increase or decrease generator torque so as to correspond with the others. Reactive load is similarly divided by biasing the voltage regulators to increase or decrease excitation. The loads are sensed by current transformers, connected into series loops on like phases of all generators in parallel.

In addition to the four load busses indicated on this panel, there is a fifth, the pilot's essential a-c bus. The control for this is a selector switch in the pilot's overhead panel. If the switch is in EXT PWR position, with or without external power connected, the pilot's essential bus receives its power from synchronizing bus. In other positions of the switch, the bus is energized by the generator selected. The lines to the individual generators bypass the bus tie and generator line contactors, so that multiple faults in the busses, feeders, distribution system, or contactors will not cut off power from this bus.

It may be noted that all this operation is automatic; after turning on the main switches, the flight engineer has manually operated only the external power

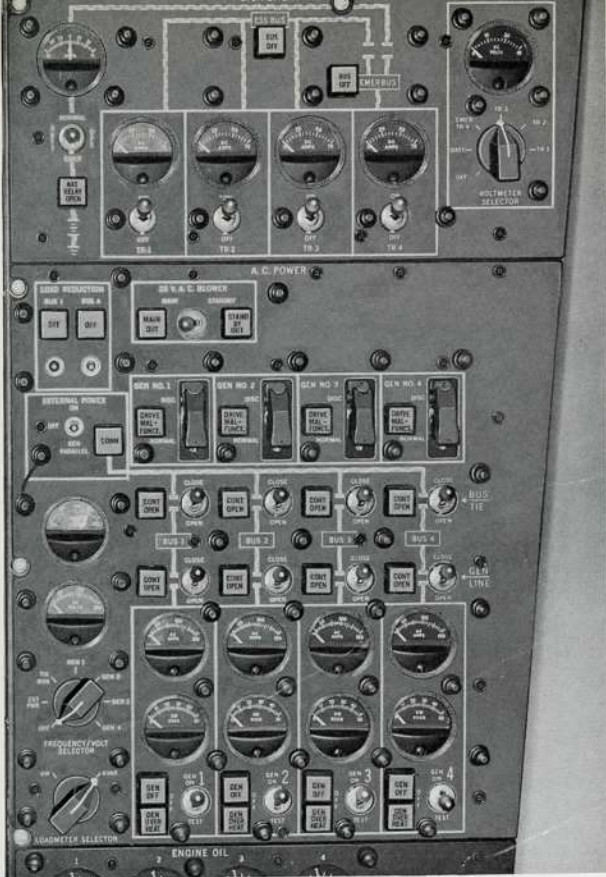

FLIGHT ENGINEER'S PANEL

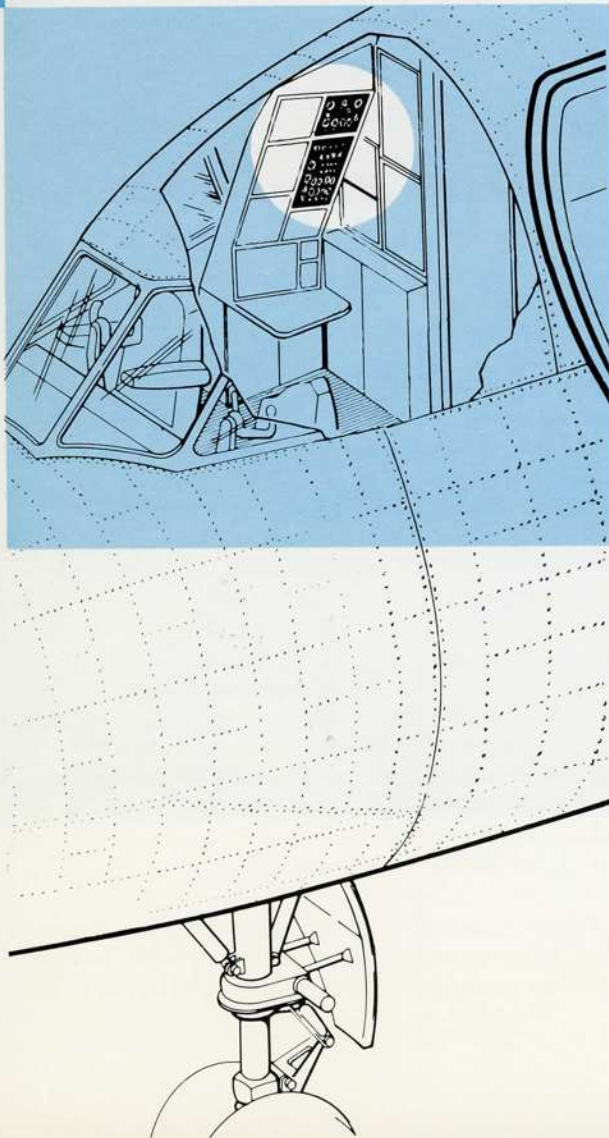

switch, first to ON and then through OFF to GEN PARALLEL.

No. 2 and No. 3 generators supply essential busses; No. 1 and No. 4 supply non-essential busses. On the control panel, above the external power switch, are two load-reduction switches to remove load from the non-essential busses. To the right is a switch for main and standby 26-volt transformers.

Above the a-c panel is the d-c control panel. An ammeter is provided to show rate of charge and discharge of the battery. It also indicates state of charge of the battery, through interpretation of charging current. A voltmeter with a selector switch indicates battery or transformer-rectifier voltage, as selected.

Warning lights for generator line and bus tie contactors illuminate when the contactors are open; the external power light is on when the external power contactor is closed.

emergency operation

The design of the electrical power supply system is such that a number of malfunctions would have to occur before an airplane emergency would exist.

Some tracing of the electrical schematic will quickly illustrate this feature. These points should be noted:

1. Closing generator line and bus tie contactors will put any generator on the synchronizing bus, and the total synchronizing bus current will be available to the load busses.
2. Opening any generator line contactor removes the generator from both load and synchronizing busses, and leaves that generator's load bus energized by the synchronizing bus.
3. Opening any bus tie contactor takes that load bus off the synchronizing bus, leaving the generator supplying its own load bus.
4. Opening both generator line and bus tie contactors removes all power from that load bus.
5. Opening the load-reduction switches removes all power from the non-essential load busses, leaving the No. 1 and No. 4 generators free to supply the essential busses.
6. The pilot's essential bus can be supplied from any generator, whatever the status of the bus tie and generator line contactors, or from the synchronizing bus.

Summed up, any generator, or combination of generators, can be used to supply any load bus through the synchronizing bus; and any generator can supply the pilot's essential bus directly or through the synchronizing bus. The d-c system has the same flexibility, since the TR units derive their power from

three a-c load busses and from the pilot's essential bus.

Individual generator safeguards have been mentioned. The synchronizing bus also has protective circuitry against line-to-neutral, line-to-line, or 3-phase faults. Open phases, under- or overspeed generators, unbalanced loads between generators, or unstable operation of a drive or voltage regulator, will cause the faulty generator to be removed from the synchronizing bus, and its own protective circuits will remove it from the load bus. Some types of malfunction will remove all generators from the synchronizing bus; when the malfunctioning unit has been isolated, the others can be reparalleled.

Since No. 1 and No. 4 bus loads are non-essential, and since either or both generators can be utilized for No. 2 and No. 3 essential busses, complete failure of any two generators would not constitute an airplane emergency. All normal controls and functions would remain. Power could be switched to non-essential busses for any desired special task.

Should three generators go out, the pilot's essential bus would be switched to the remaining generator. This bus would use less than one-eighth of one generator's output, and 35 kva would still be available for essential functions. The battery switch would be turned to EMER, not primarily to provide current, but rather to reduce the load on the remaining TR units by disconnecting the d-c essential bus from the emergency bus. While one generator will not carry all normal loads on both essential busses, it will supply all emergency loads for safe and controlled flight and for landing.

Failure of all four generators — statistically inconceivable — would leave d-c power available from the battery. The d-c emergency bus would supply radio, essential engine controls, emergency warning systems, and fire extinguisher control, for a period of approximately one-half hour. Emergency flight controls require no electrical power.

Both tests and experience have proved that aircraft generators have a trouble-free service life extending into thousands of hours of operation. This integrity has been engineered into the generators of the "880" and "600" series airplanes. Integrity of components throughout the "880" and "600" electrical systems are consistent with that of the generators.

In addition, fail-safe design in the functional arrangement of the electrical systems precludes ultimate failure in all foreseeable areas affecting safety of flight. An eventuality which would dictate the possibility of complete reliance upon the capabilities of the 13.5-ampere-hour battery is inconsistent with the design reliability of the electrical systems.

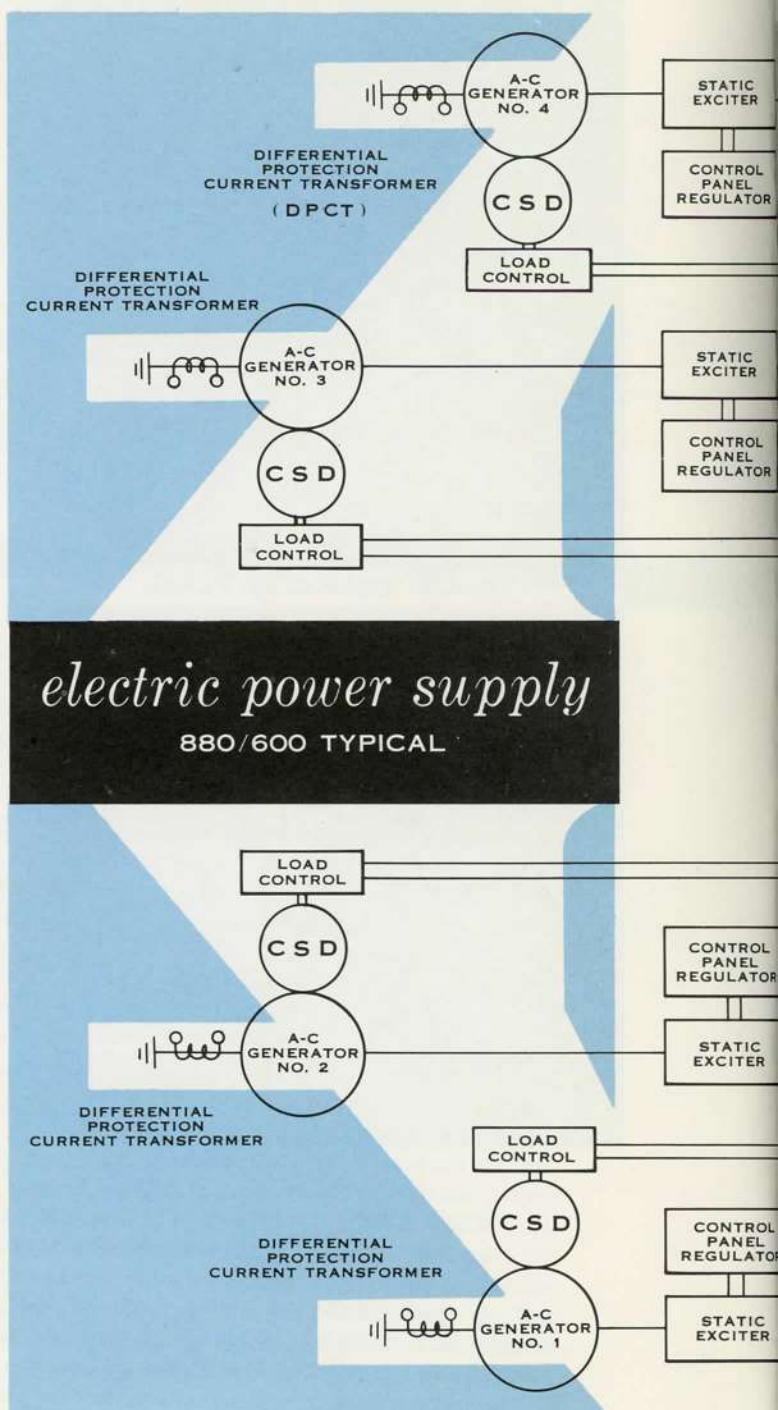

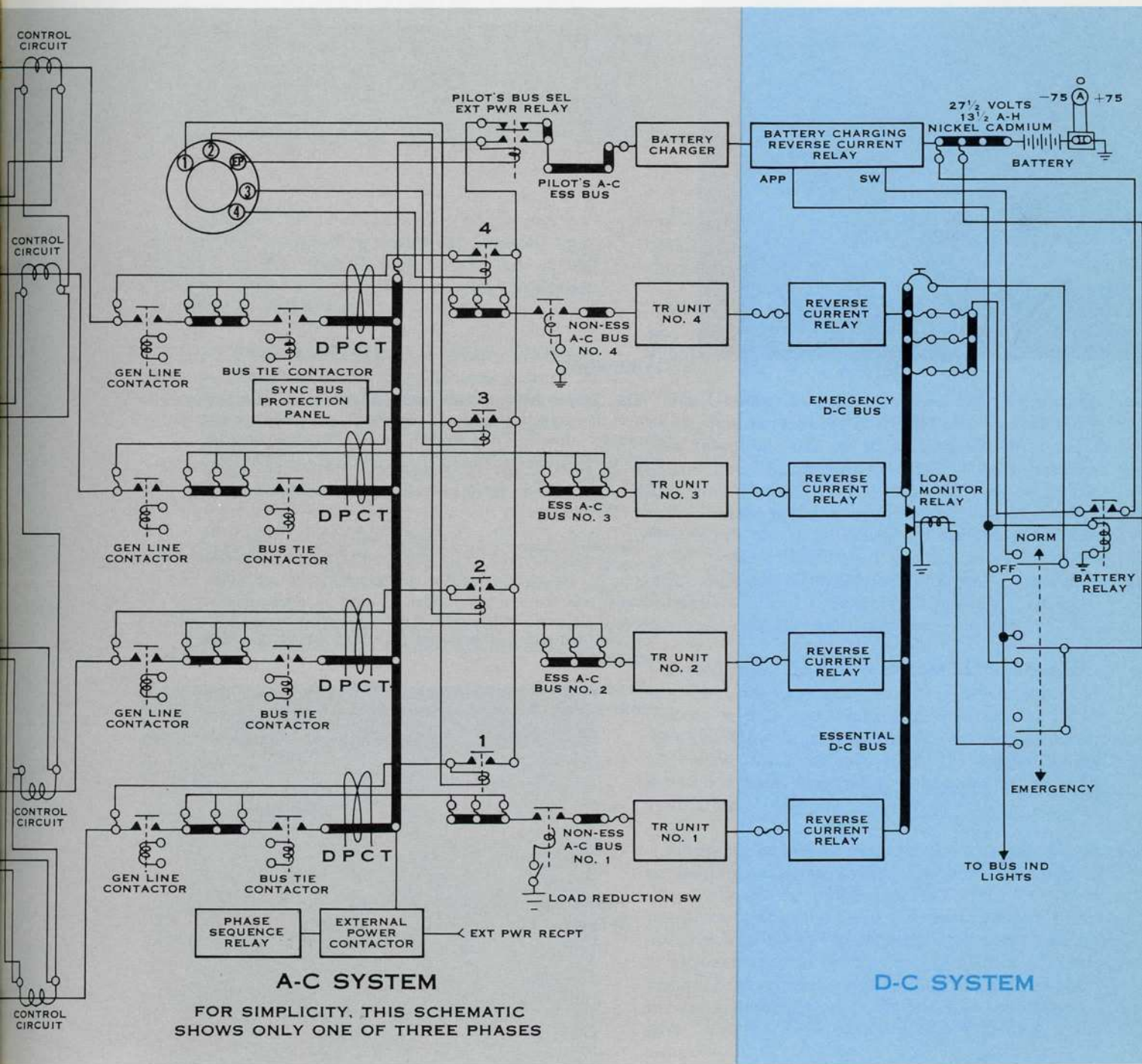



FOREWORD

The Convair 880 air-conditioning and pressurization system is designed to provide "living-room" comfort to every passenger aboard. From takeoff time to landing, a cabin atmosphere of ideal temperature, pressurization, and humidity will prevail. Regardless of outside weather, "880" passengers will be assured of a maximum ground temperature of 80°F, and 75° in flight.

The pressurization system will provide sea level comfort at altitudes up to 20,000 feet; cabin air pressure at 40,000 feet will be the same as that which exists at 8,000 feet. Automatic controls will prevent any sudden changes in pressurization during rapid climb and descent. A vapor cycle Freon refrigeration unit will maintain humidity at a level compatible with temperature.

How these systems will operate and the conditions under which they will function are discussed in this issue.

Reprint from **CONVAIR TRAVELER**
February 1958

AIR CONDITIONING and PRESSURIZATION SYSTEM for the CONVAIR 880



The Convair 880 air conditioning and pressurization system is designed to supply all occupied compartments of the airplane with an air flow of 160 pounds of air per minute at sea level, and 120 pounds per minute at 35,000 feet.

The air conditioning system supplies circulating fresh air, heated or cooled as conditions require. A complete change of air is delivered to the cabin every 2½ minutes and to the flight deck every minute.

The cabin maintains a temperature of 75°F in flight under all ambient temperature conditions and a maximum of 80°F on the ground. At all outside air temperatures . . . whether 100°F or -40°F . . . the air conditioning system keeps passengers comfortable without unpleasant air surges or annoying drafts.

Each passenger has a silent individual cold-air inlet to provide direct airflow, if desired. All air entering

the cabin through the outlets below the hatracks is discharged through side panel floor exit ducts, and then is dumped overboard.

Heating and cooling of baggage compartments, and electrical and electronic equipment is also provided by the air conditioning system.

The Convair 880 holds a sea level cabin altitude up to an airplane altitude of 20,000 feet, and an 8000-foot cabin altitude up to an airplane altitude of 40,000 feet. The maximum normal cabin differential operating pressure is $8.2 \pm .10$ psi. In event of failure to both cabin pressure regulator sections of the out-flow valves, the relief valves will relieve at a differential pressure of $8.50 \pm .10$ psi. Signal lights on the flight deck control panel will indicate the respective valve failure, and a warning horn will sound when cabin altitude exceeds 10,000 feet.

Presetting of the rate of change of cabin pressure control permits operating at rapid rates-of-climb and descent with a minimum rate-of-change of cabin altitude. Flow is maintained automatically against all normal loads imposed upon the system by the ever-changing demand for pressurization and ventilation.

Surges in the cabin pressure altitude during takeoff or landing will not exceed the normal regulated rate-of-change by more than 150 fpm. The cabin pressurization system will prevent negative cabin differential pressures in excess of 10 inches of water, at airplane rates of descent of 25,000 fpm with the normal cabin air source shut off. The cabin pressurization system will accommodate a rate-of-climb of 3000 fpm and a rate-of-descent of 7000 fpm, while maintaining cabin pressure schedule tolerances.

The rate of cabin pressure change is selectable from 2000 ± 200 fpm to 65 ± 35 fpm. The nominal calibration is 500 fpm ± 10 per cent. Deviation from selected cabin pressure rate-of-change during transient conditions will not be greater than ± 25 fpm.

Individually-controlled cold-air inlets provide direct air flow as desired.



The basic air conditioning system is composed of two separate and independent subsystems, pneumatically-driven by bleed air from the four CJ-805 engines. Each subsystem consists primarily of a ram air supercharger (bleed air turbine-driven compressor), an air-to-air heat exchanger, and a vapor cycle Freon refrigeration unit.

An electrically-driven vapor cycle Freon system is available as an optional installation. This system is basically the same as the pneumatic-drive system except that the freon condenser fan and compressor are driven by an electric motor. Also, in the electrically-driven system, an electric heater is employed in the cabin and flight deck main distribution line for ground heating.

Under normal operation, in either the pneumatic or electrically-driven systems, one subsystem supplies the air for the cabin, and the other supplies air for the flight deck. Each subsystem is controlled separately, but if one subsystem fails, the other will supply adequate air conditioning and pressurization for both the cabin and flight deck for the continuation of the flight.

A vapor cycle Freon system provides full cooling in flight without increasing the load on the superchargers that provide the cabin pressurization and ventilating air. This becomes increasingly important in high-speed jet aircraft, because cooling is required during a greater portion of the flight regime.

The vapor cycle refrigeration unit is essentially a Freon loop system that uses Freon 114 (dichlorotetraethane), a stable, nontoxic fluid. The Freon loop contains a compressor and drive, condenser, evaporator, and the necessary control valves. With this type system, moisture, in the form of either liquid or fog, will not enter the cabin. Moisture present in the air passing through the Freon evaporator will condense on the cool surfaces of the evaporator. This condensation forms large drops which can be easily drained and dumped overboard.

During ground air conditioning operations, the vapor cycle system effects a rapid pull-down of cabin air temperature without the use of large external cooling carts. Ground operations are further improved by recirculating part or all of the cool cabin air through the Freon evaporator instead of dumping it overboard. Consequently, the load on the system and the time required to lower the cabin temperature are reduced.

The entire Freon loop system is packaged so that the unit can be removed for maintenance and servicing by removing three bolts and disconnecting three ducts.

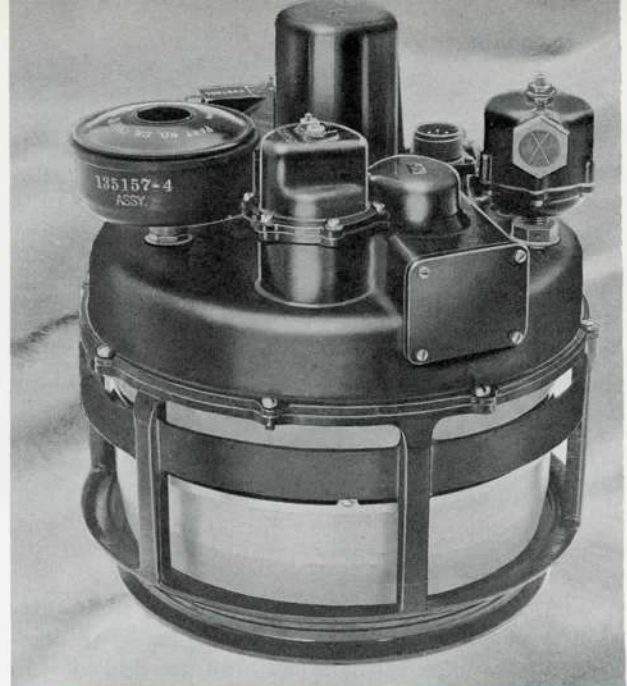

Above: Cabin pressure regulator outflow valve. Below: Cabin pressure regulator outflow control and indicator.



Cabin pressurization is automatically regulated by two cabin pressure regulator outflow relief valves, and a cabin pressure outflow control and indicator. One pressure regulator outflow relief valve is located in a pressurized area at the aft end of the airplane; the other is located in a plenum chamber containing electrical equipment, at the forward end of the airplane.

Each valve is a dual purpose outflow and safety valve to provide both cabin pressure relief and vacuum relief. In addition, each valve operates both mechanically and electrically.

Each outflow safety valve includes a filter, pneumatic relay, pressure relief mechanism, and an electro-mechanical actuator. The venturi serves as a vacuum sink for the pneumatic relay to provide power to operate the system at low cabin to ambient pressure.

The pressure balanced poppet-type outflow valve is operated either pneumatically by a diaphragm, or electrically by an electromechanical actuator, with switches located on the flight deck panel.

Each valve functions independently, offering an extra margin of protection. In the event of malfunction, the valves are designed to fail safely in the closed position so that one valve failure cannot result in cabin depressurization. Should one unit fail, the remaining outflow valve is capable of maintaining normal control of cabin pressure. A flow equalizer control is incorporated to divide the total cabin flow through each valve.

The forward outflow valve, located in the electrical compartment below the cabin floor, exhausts cabin air overboard after it has been utilized for cooling the electronic and electrical equipment.

Either of the pressure regulator outflow relief valves is capable of maintaining normal cabin pressure schedules as selected by the pilot.

Under normal operations, 50 ± 10 per cent of the total airflow passes through the outflow unit of each pressure regulator outflow relief valve. The outflow valve control incorporates a cabin altitude selector knob and indicating dial, permitting the selection of any cabin pressure altitude within the range of

—1000 feet to +10,000 feet. During isobaric operation (constant cabin altitude), the variation in cabin pressure altitude will not exceed ± 150 feet at a maximum rate-of-change of 50 fpm.

Controls and instrumentation on the flight deck panel permit preselection of cabin pressure change rates and cabin pressure altitudes. Cabin differential pressure and altitude gages give a visual indication of the pressurization system operation. A secondary means is provided for cabin pressure regulation by two toggle switches which individually control each regulator by means of an electric motor mounted on each outflow valve. The outflow valve control incorporates a barometric pressure adjustment to correct for airport barometric pressure variations at time of takeoff and landing. On landing, a landing gear switch energizes the electrical actuators on the outflow valves to open the valves and release cabin pressure. During takeoff, the procedure is reversed.

In operation, ram air enters the air conditioning compartment plenum chamber through two ram air intakes, located on the lower surface of the "880" fuselage, near the leading edge of the wing. Ram air is introduced into two turbine-driven cabin superchargers which operate by bleed air from the main bleed air duct manifold in the ram air plenum compartment. The compressed ram air from the supercharger is then routed through a supercharger flow-control sensor and into an air-to-air heat exchanger,

Schematic of cabin pressurization system and sectional views of cabin pressure regulator outflow valve and cabin pressure regulator outflow control and indicator.

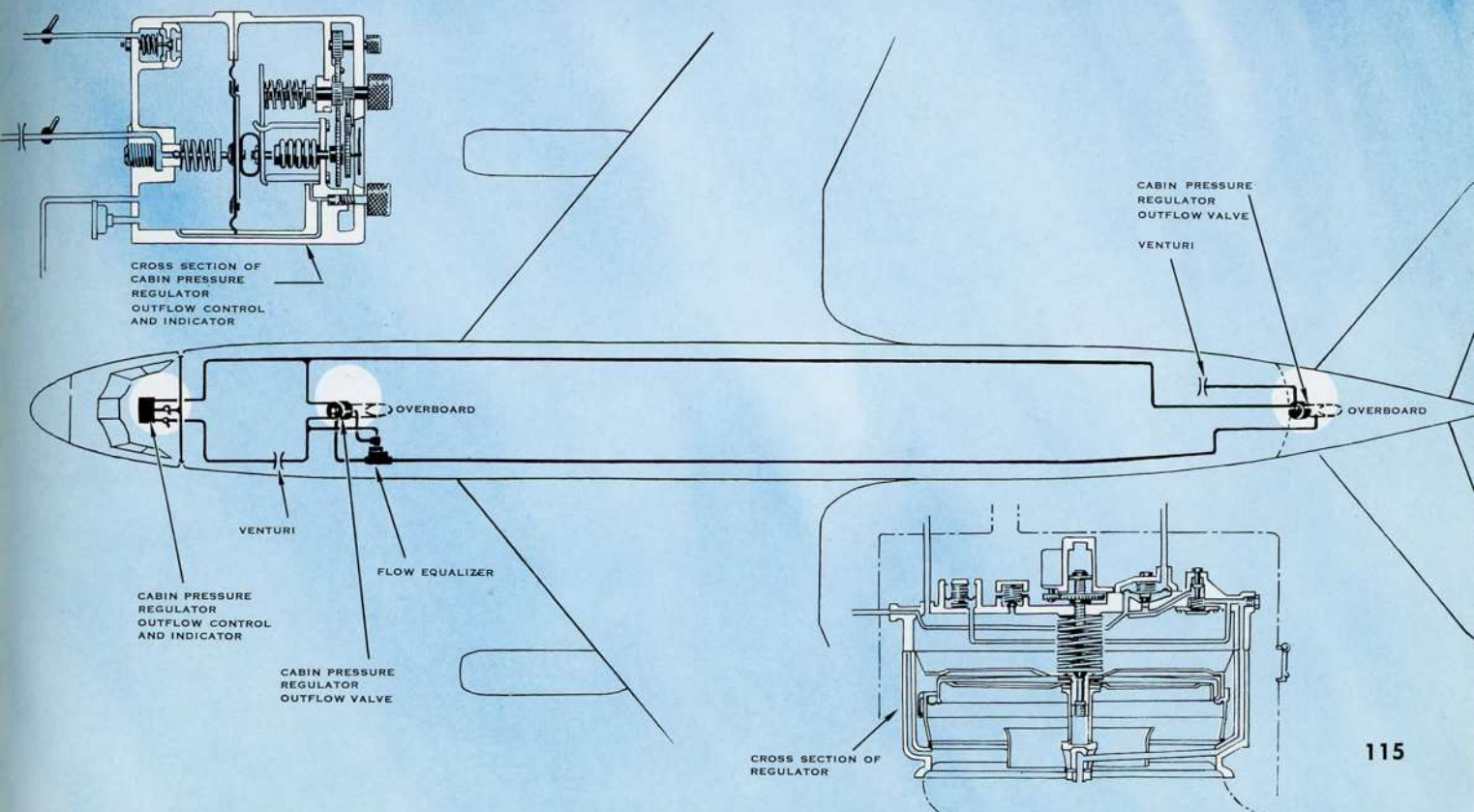

AIR CONDITIONING and PRESSURIZATION SYSTEM for the

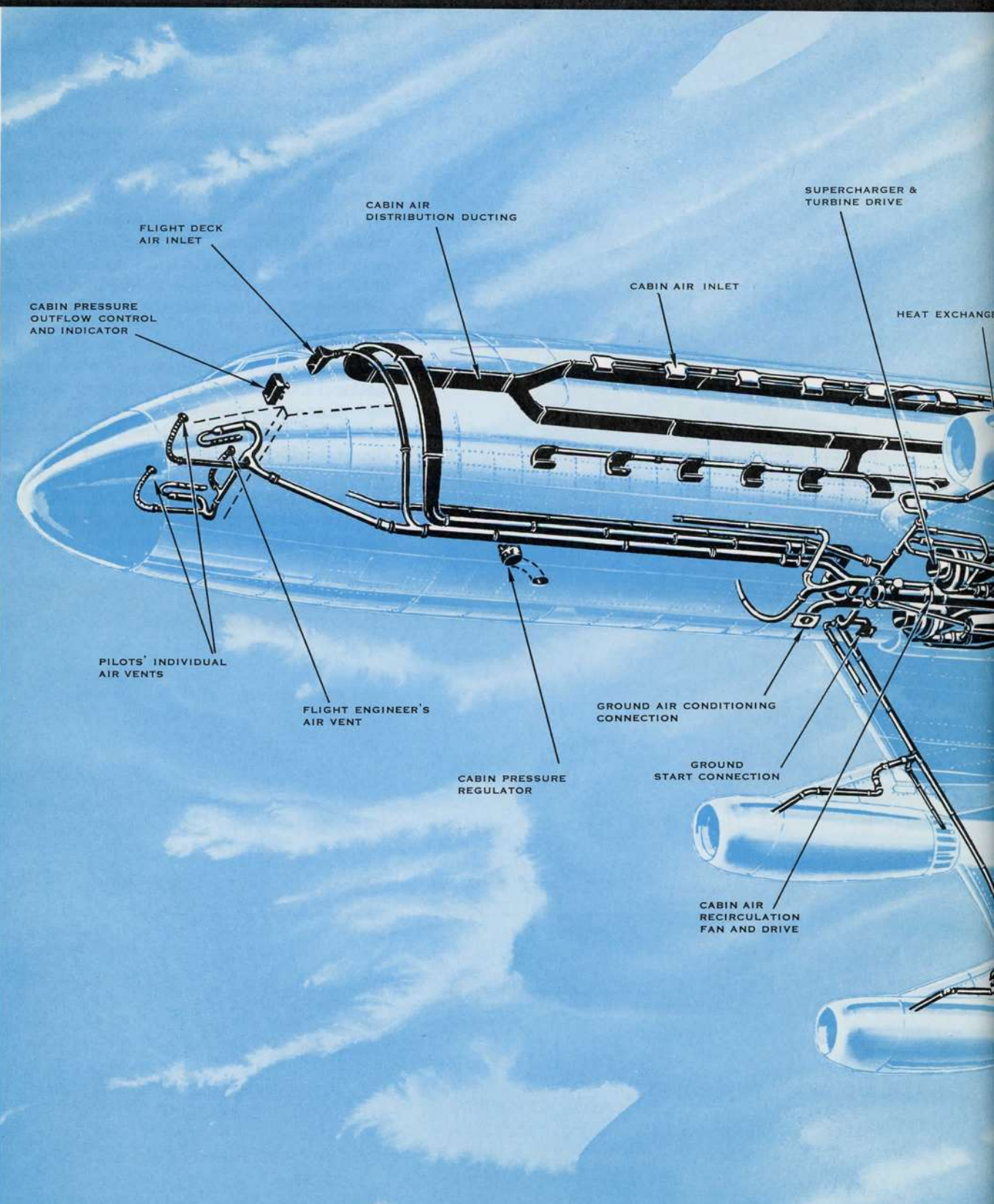

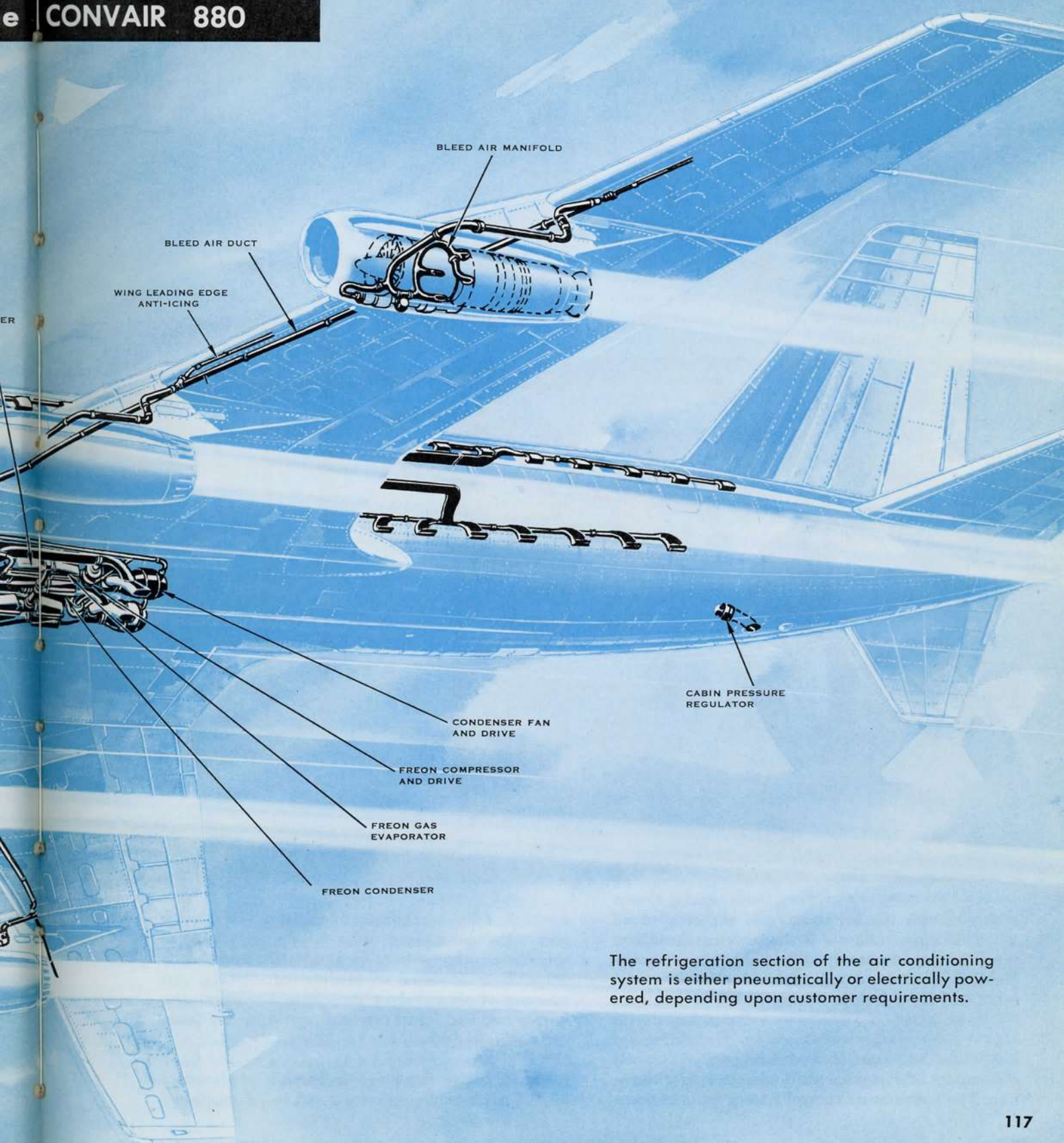

The refrigeration section of the air conditioning system is either pneumatically or electrically powered, depending upon customer requirements.

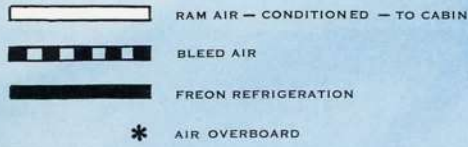

The basic air conditioning system is composed of two separate and independent subsystems, pneumatically-driven by bleed air from the four CJ-805 engines.

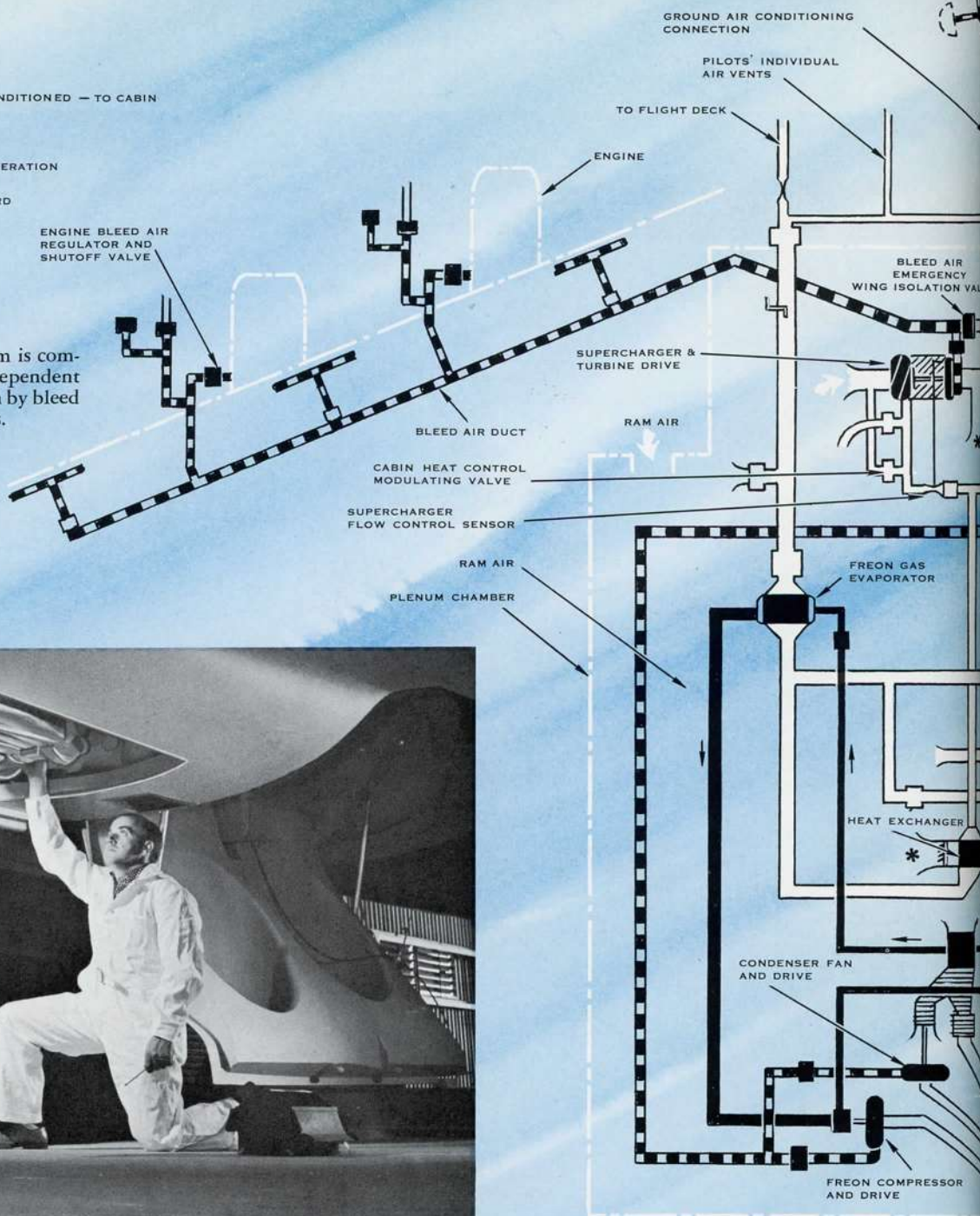

The entire Freon system is packaged so that it may be removed for servicing.

which reduces the temperature of the compressed air. This compressed air is then ducted through a Freon gas evaporator which further reduces the temperature of the air to the required demands of the cabin and flight deck.

A cabin heat control modulating valve controls the amount of supercharger discharge air recirculation. The temperature control system initiates a sig-

nal to the cabin heat control modulating valve, to the heat exchanger cooling air modulating valve, and to the Freon compressor drive modulating and shutoff valve. By a sequence of modulating, closing, and opening of these valves, any desired temperatures within required limits can be obtained for the cabin and/or flight deck.

Engine compressor bleed air provides an air source of 237 psig maximum pressure and 867°F maximum

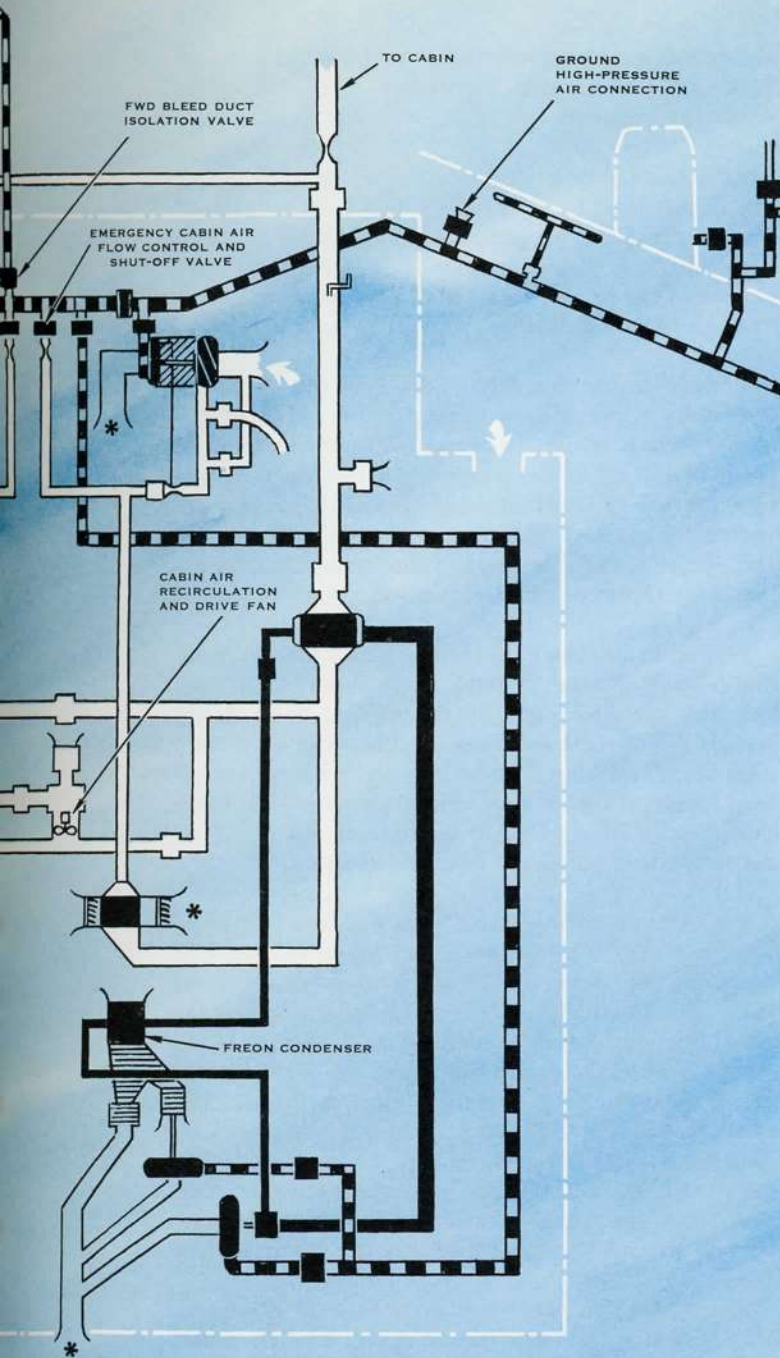

Schematic of cabin pressurization and air conditioning system.

temperature. The engine bleed air pressure regulator "tops off" bleed air pressure to a maximum of 50 psig and acts as a check valve to allow engine starting. The regulator also provides a means for shutting off bleed air at the source.

Bleed air, manifolded from each engine bleed air port through a bleed air pressure regulator, is ducted into the bleed air manifold duct in the wing leading edge between the forward spar and a fiberglass anti-

icing discharge air baffle. This space is purged with ram air in flight. The ram air flow serves to remove the heat dissipated from the bleed air lines and insures that a maximum temperature of 200°F is not exceeded in that area.

After the compressed ram air from the superchargers is cooled through the Freon evaporators, it is carried in respective lines to the cabin and flight deck through respective flow limiters. A manifold duct connects the cabin and flight deck lines together, upstream of the flow limiters. This manifold duct allows the excess air flow, above the needs of the flight deck, to divert to the cabin line. The conditioned air to the flight deck is distributed to the pilot, copilot, and flight engineer through a system of individual adjustable outlets, resembling piccolo tubes, and a compartment inlet. The conditioned air to the cabin is distributed to the passengers through openings below the hatracks on each side of the cabin, above alternate cabin windows. Individually-adjusted outlets are provided in the hat rack panels and in the buffet and each lavatory.

During steady-state operation, a thermostatic expansion valve allows Freon liquid to enter the evaporator at a rate which insures complete vaporization of the liquid before it leaves the evaporator. The vaporized Freon is then ducted to the compressor which increases the pressure and temperature of the gas. The compressed gas is directed to the condenser where the heat is removed by cool ram air flow. The cooling action condenses the Freon gas back to the liquid. The liquid Freon leaves the condenser, according to the demands of the thermostatic expansion valve, thus completing the cycle.

An alternate source of ram air is provided for an unpressurized flight condition in the event both superchargers or both Freon systems fail. During unpressurized flight at 250 knots IAS and 8000 feet altitude, the ram air flow to the cabin and flight deck will not be less than 140 pounds per minute. No heat is supplied during this operation.

In the event both superchargers should fail at an altitude necessitating pressurization, the bleed air emergency system will be used. Bleed air for the system is taken from two places in the main bleed air duct, located in the ram air plenum compartment. One bleed air line connects into the flight deck supercharger outlet and the other line connects into the cabin supercharger outlet. A flow-control and shutoff valve is provided in each bleed air line. A check valve is provided in each supercharger outlet line upstream of the bleed air line connection into the supercharger outlet. This prevents the bleed air from flowing out of the superchargers if emergency bleed air pressurization is required.

To accommodate wing bending and thermal expansion in the wing leading edge bleed air manifold line, a compression bellows system is used.

Marman type LJ-11 duct joint couplings are utilized throughout the bleed air system. A special safety strap is also provided over the coupling "T" bolt. Because the safety strap cannot be latched until the proper torque has been applied to the "T" bolt nut, this strap presents a positive visual inspection point for each joint.



Quick-Disconnect duct joint couplings are used throughout the bleed air system.

The complete bleed air system is covered with a 1/2-inch thick fluid-tight insulation, fabricated from fibreglas batting, and two layers of resin-impregnated fibreglas cloth. The bleed air duct joints also have a resin impregnated cover. The covers are split to allow installation and ready inspection of the bleed air joints. The ends of the covers are clamped to the duct insulation, providing a fluid-tight seal.

The following indicators and controls for the cabin and flight deck superchargers are located on the flight engineer's control panel: overspeed trip warning light, rpm indicator, bearing temperature indicator, air flow indicator, and ON-OFF control switch.

Also on the flight engineer's panel are indicators and controls for the cabin and flight deck Freon systems: Failure warning light, ON-OFF control switches, and ON-CABIN-OFF-FLIGHT DECK OFF control switches.

The following controls and indicators are utilized for cabin pressurization on the flight engineer's control panel: barometric pressure correction control knob, cabin pressure rate-of-change control knob, cabin altitude selector knob, cabin low-altitude warning horn, cabin rate-of-climb indicator, cabin altimeter, cabin differential pressure indicator, a four-position AUTO-OFF-CLOSE-OPEN switch for each pressure regulator (the CLOSE and OPEN positions

are momentary positions only), and FWD FAIL and AFT FAIL indicator lights for each respective pressure regulator.

Switches are provided on the overhead panel in the flight deck for individual ON-OFF control of each engine bleed air pressure regulator. Adjacent to each switch is a malfunction light which indicates closure of the pressure regulator valve when it should be open and modulating.

Both the cabin and flight deck have the following temperature controls: a three-position AUTO-OFF-MAN switch which provides for manual or automatic operation of the temperature control system, a two position MAN HOT — MAN COLD momentary switch for manual operation, and an INCREASE — DECREASE variable control for completely automatic operation of each temperature control system.

Five additional switches are provided for the pneumatic-drive Freon system, and three additional switches are provided for the electric-drive Freon system. All of these switches are three-way units with AUTO-OFF-MAN-ON positions and adjacent excess-heat indicator lights. The switches are used for isolation control of applicable sections of the bleed air duct system in the event of a malfunction.

For example: if a failure occurs in the left wing bleed air duct, a continuous wire overheat detector automatically closes the bleed air pressure regulator valves on the No. 1 and No. 2 engines, and closes the wing emergency isolation valve on the left side. At the same time, the excess-heat indicator light next to the respective wing isolation switch lights. The valves remain "closed" and the light remains "on" until the switch is moved to the OFF position. With the switch in the OFF position, the valves are still closed but the light is out. The valves may be re-opened by turning the switch to the ON position.

If an overheat condition still exists, the excess-heat indicator light will go on again, but the valves will not close until the switch is manually returned to the OFF position. The temperature in the space adjacent to the bleed air ducts can be checked for abnormal conditions by a temperature indicator and rotary selector switch connected to individual space temperature pickups at several locations in each wing, and in the fuselage plenum chamber.

An extensive test program, consisting of a functional check of the complete "880" air conditioning system, has been underway for several months. Tests have been performed by simulating operation of the air conditioning system in the cabin, flight deck, and baggage compartments, to determine system compliance with Convair 880 design specifications.

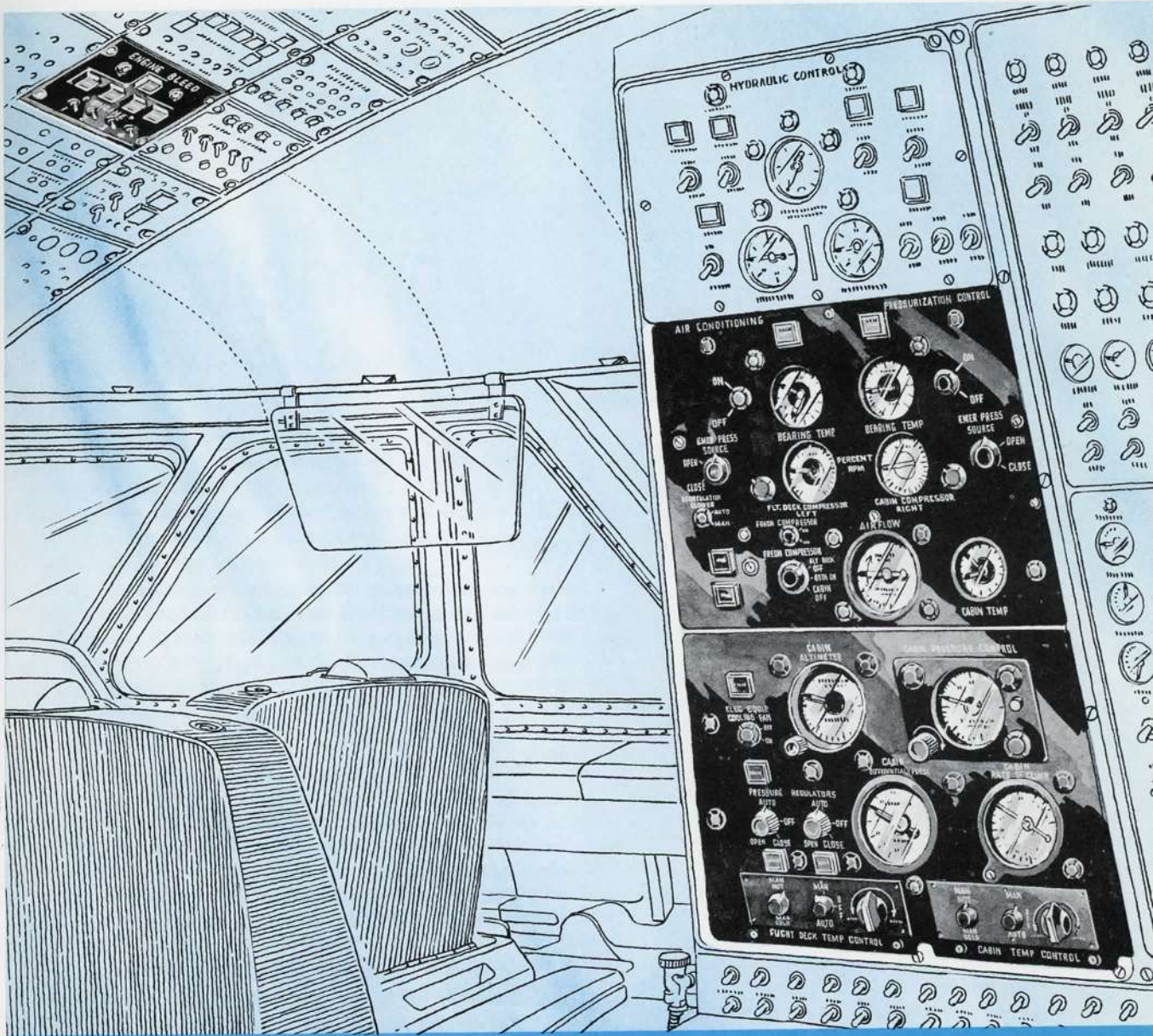

Engine bleed control panel and flight engineer's cabin pressurization and air conditioning control panel are conveniently located on flight deck.

Tests to insure a balanced air flow were conducted in the full-scale mockup of the complete airplane. Air distribution ducts were installed and calibrated to give optimum performance under all anticipated conditions of normal operation, using various instruments to determine air velocities, noise levels, and temperature gradients.

Air conditioning tests were also performed in a full-scale cabin constant section of the Convair 880. The section was 19 feet long and completely equipped with upholstery, carpeting, seats, hat racks, and insulating materials. The entire section was sealed and placed in an environmental test chamber to simulate

actual temperature conditions as they would occur at an airport on a very hot day or at altitudes up to 40,000 feet. Temperatures in the test chamber were varied from -65°F to $+160^{\circ}\text{F}$.

Structural endurance tests were run to determine bleed air duct reliability. Stainless steel duct specimens from the wing leading edge were subjected to a pressure-cycling test at 800°F , and a 20,000-cycle bending test. The bending of the duct simulated the maximum wing flexure encountered during flight conditions. Further testing involved high-mach air flow through the duct at various temperatures up to 700°F .



FOREWORD

Today's air passenger is undoubtedly the most pampered traveler in history. He is enticed aloft by hot meals and cold champagne, served by some of the most personable young ladies in the world. Skimming above the weather in the smoothest ride ever achieved by man, he may doze in a reclining chair, play bridge in the lounge, or just sit and watch a thousand square miles of terrain roll by six miles below.

To supply the qualities of luxurious comfort and gracious living, in an airplane where every ounce of weight saved is literally more precious than so much gold, and every inch of space at a comparable premium, is a considerable feat of engineering.

This issue of the *Traveler* offers some glimpses of the behind-the-scenes techniques in designing for the highest standards in airline travel. It describes interiors and furnishings for passenger and crew in the new Conqair 880 and 600 jet airliners.

Reprint from **CONVAIR TRAVELER**
March 1959

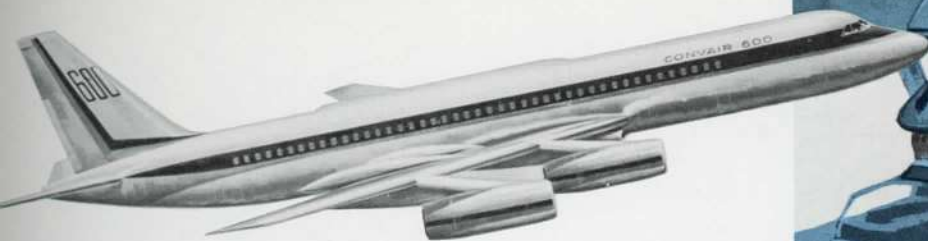

Furnishings

CONVAIR 880 / 600

When a passenger first steps into one of the new Convair jet airliners, his first impression, particularly if he is a seasoned traveler, will probably be of spaciousness — space to walk in, elbow-room, enough room to stretch out a little and relax.

It is no trick of decor. In the four-abreast 88-passenger version of the Convair 880, the passenger probably has the most move-about room ever designed into a standard transport. Aisles are a full two feet wide; seats are as wide between armrests as the ordinary parlor chair. The ceiling is more than seven feet above the aisles.

Along with the feeling of spaciousness the traveler will sense the quiet, cheerful air of a well-planned living-room. It is a bright interior; colors are used expertly, in careful harmony with overall color scheme and the interior plan of the cabin.

Lighting is indirect and soft. The bustle of loading passengers and stowing packages will be subdued. Voices nearby will be clear, but noise won't travel far. Once the doors close, trucks and motors outside will be almost inaudible. The passenger will have entered into the little world in which he will spend the next two to five hours.

It is important that the passenger like this little world and that he feel both comfortable and safe in it. Convair, the airlines, and specialists in various fields of engineering and interior design have expended much effort and money to be sure that he does like it. From the ashtray at his elbow to the "breaks" in the aisle ceiling lines, everything has been tailored to make the passenger feel that he is not just one mere unit of traveling public, but an individual guest of the airline.

Convair retained Harley Earl, Inc., for the interior design, and Dorothy Draper, Inc., for basic color



styling. However, in the furnishings of a commercial transport, the customer exercises a considerable option. The operator has the final say on color and many materials for interior finish, and may arrange for appointments for buffets and lavatories, and for such extra items as fire extinguishers, service trays, and the like.

There is, however, an "880"-600" standard from which the deviations are comparatively minor. The description herein is of the elements that are common to "880" aircraft that will be going into service during the next two years.

CABIN INTERIOR

The fuselage structure is essentially a double-wall tube, of which the upper half (a little more than half, actually) is the cabin. The inside of the thick outer skin, aft of the wing, is covered with sound-damping acoustical tape, in multiple layers as necessary. Insulating Fiberglas blankets several inches thick fill the space between inner trim and outer skins. The stretched-Plexiglas windows are double-paned, with an insulating air space between, and a second air space between inner and outer windows.

The cabin is thus completely surrounded by soundproofing and partially sound-isolated with tape. The second line of defense against noise is the floating shell treatment of interior trim and floor, accomplished by shock-mounting all panels and components of the cabin interior. Floor, wall, and ceiling panels are all designed to keep out or absorb external and internal noise by means of sound barriers, sound absorption, or a combination of both.

Wainscot panels are sandwiches of Spongex polyvinyl chloride foam between Fiberglas, bracketed to beltframes and mounted on rubber grommets. Under the wool carpeting is a polyurethane foam pad. The canopy above the hatrack is Fiberglas.

Ceiling panel surface is a layer of perforated Fiberglas fabric. Above this is aluminum alloy honeycomb sandwich between layers of coarse-mesh Leno cloth. This is backed with a compressed Fiberglas wool blanket, covered with aluminum alloy sheet. The outside aluminum sheet serves as a sound barrier against outer noise; the material beneath absorbs interior noise.

CROSS-SECTION OF CABIN — TYPICAL SHOWING INSULATION AND SOUNDPROOFING

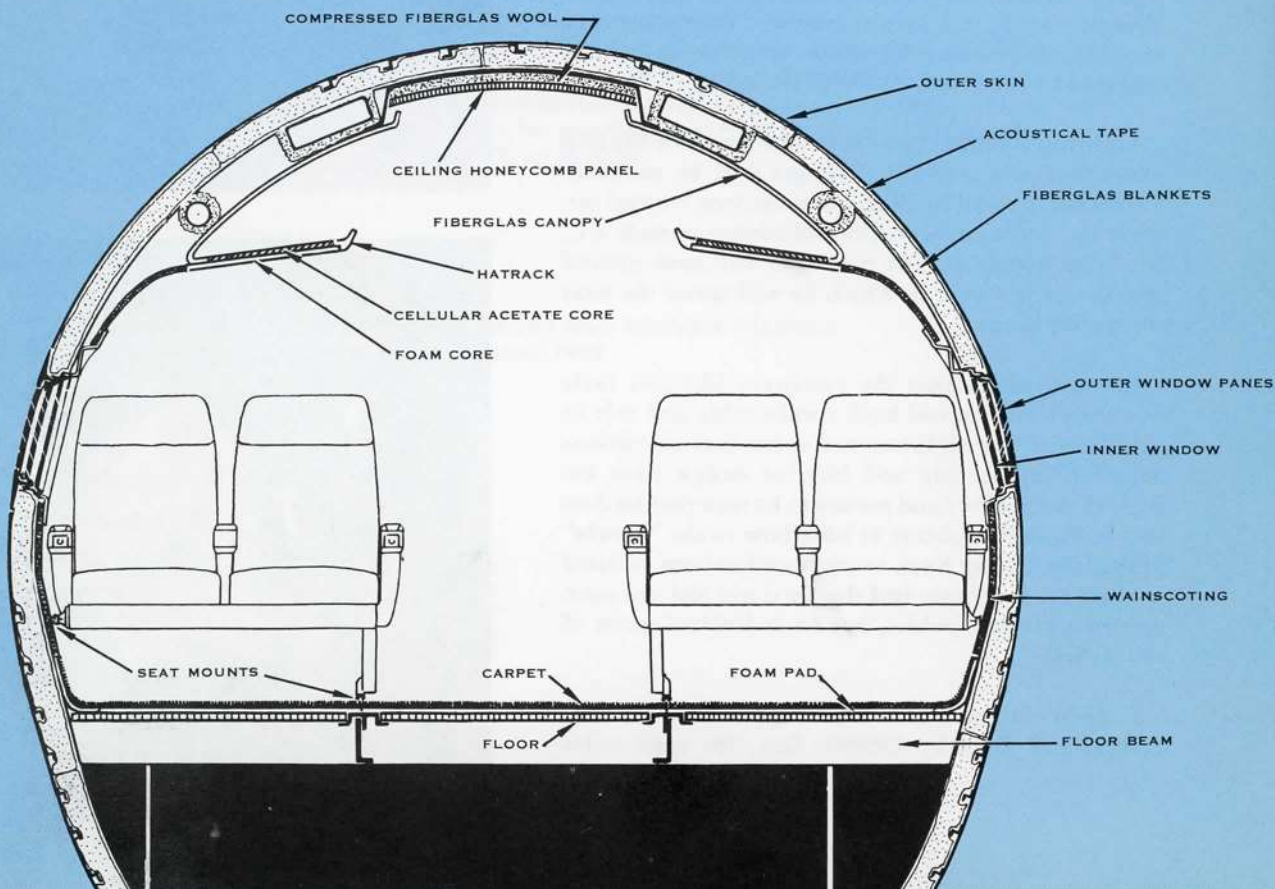



Lower surface of the hatrack has a perforated Boltaron decorative face, with an absorptive polyurethane foam core. The shelf above consists of a sandwich panel of cellular cellulose acetate between Fiberglas sheets.

The "tunnel effect" — the perspective of the long row of seats exaggerated by the arched cabin shape — is effectively diminished by several decorative devices. In every 20 feet of ceiling, a five-foot length is dropped approximately three inches. Upholstery colors are varied between blocks of seats to accentuate the compartmentalization effect. The continuity of the line of hat racks is broken by stowage bins placed at intervals, each bin provided with a door.

Standard first-class 88-passenger seating arrangement has 19 four-abreast rows and a 12-place lounge forward. This can be converted to five-abreast seating in almost any desired combination of first-class and coach arrangements, with or without lounge, up to a maximum passenger capacity of 110.

Seats are made to Convair and customer specifications by the National Seating Company. They are lightweight but sturdy, cushioned with molded polyurethane pads and covered with fabric of customer-specified weight and color. Coverings are slipcover type and can be readily removed for cleaning.

Cushioned five-inch-wide armrests divide the seats, leaving $20\frac{1}{4}$ inches between armrests. In the five-abreast coach seats, armrests are three inches wide and the space between is 18 inches. The coach seats, it may be seen, are roomier than many present-day first-class seats, and aisle width is still more than $1\frac{1}{2}$ feet.

Center armrests may be removed by simply lifting them out. Seat back angle is adjustable from 15° to 38° ; to lean back, the passenger squeezes a release catch on the forward face of the fixed armrest. Bottom cushions are readily removable. With bottom cushions out, the seat back can be folded down below the armrest level for storage purposes.

Seats attach at four points, in most versions at two fittings on the wall and on two clevis-type fittings at the inboard end on the floor. The fittings are secured by ball-lock type shear pins. Seat removal is hence a matter of seconds rather than minutes.

Coach seats utilize the same airframe fittings; therefore, the 19 rows aft of the lounge, all or in part, can be quickly converted to five-abreast seating when desired. In some versions, seats are mounted on rails to allow variation in fore-and-aft spacing. Standard spacing is 38-inch seat pitch.

INTERIOR ARRANGEMENT - 880

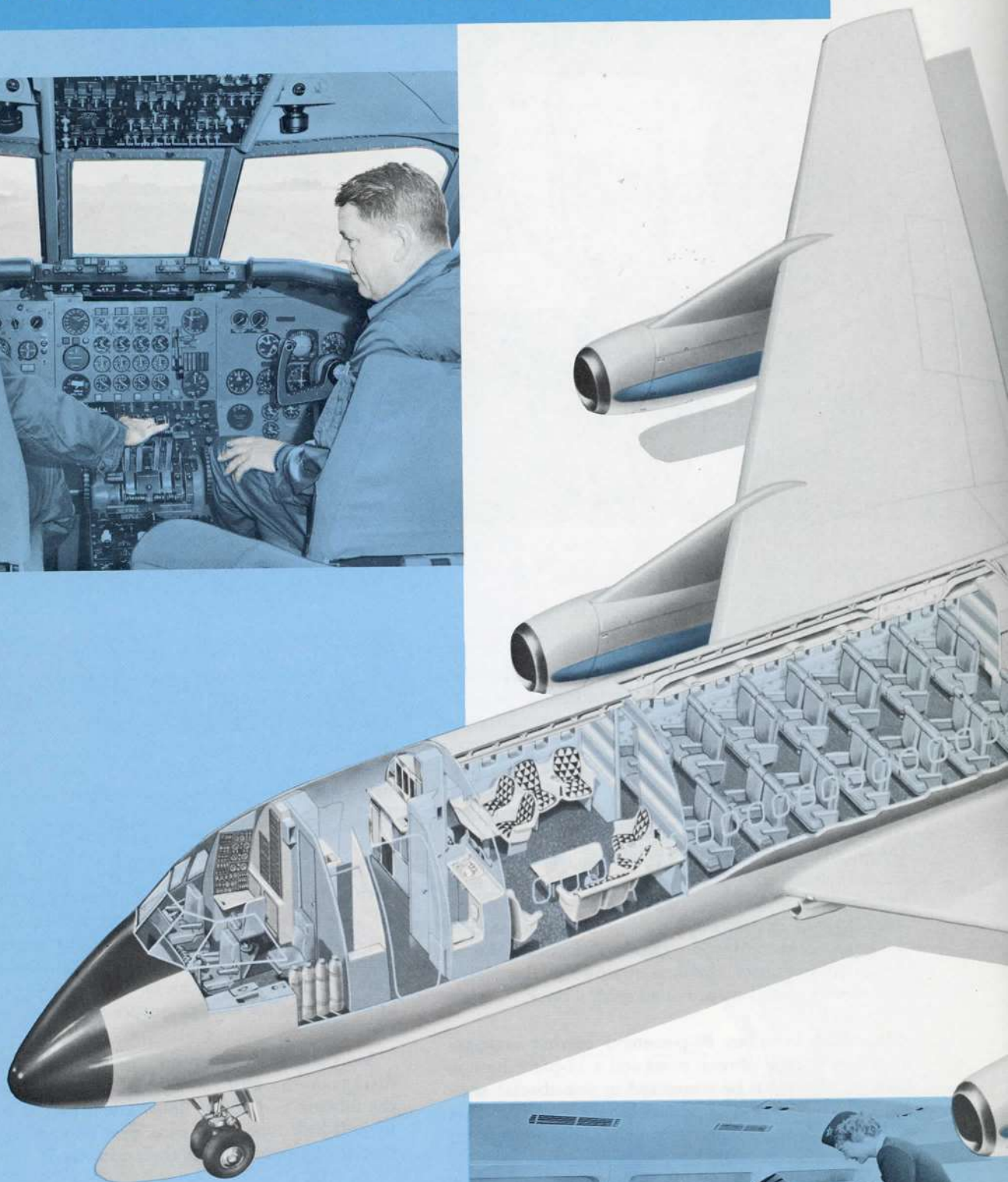



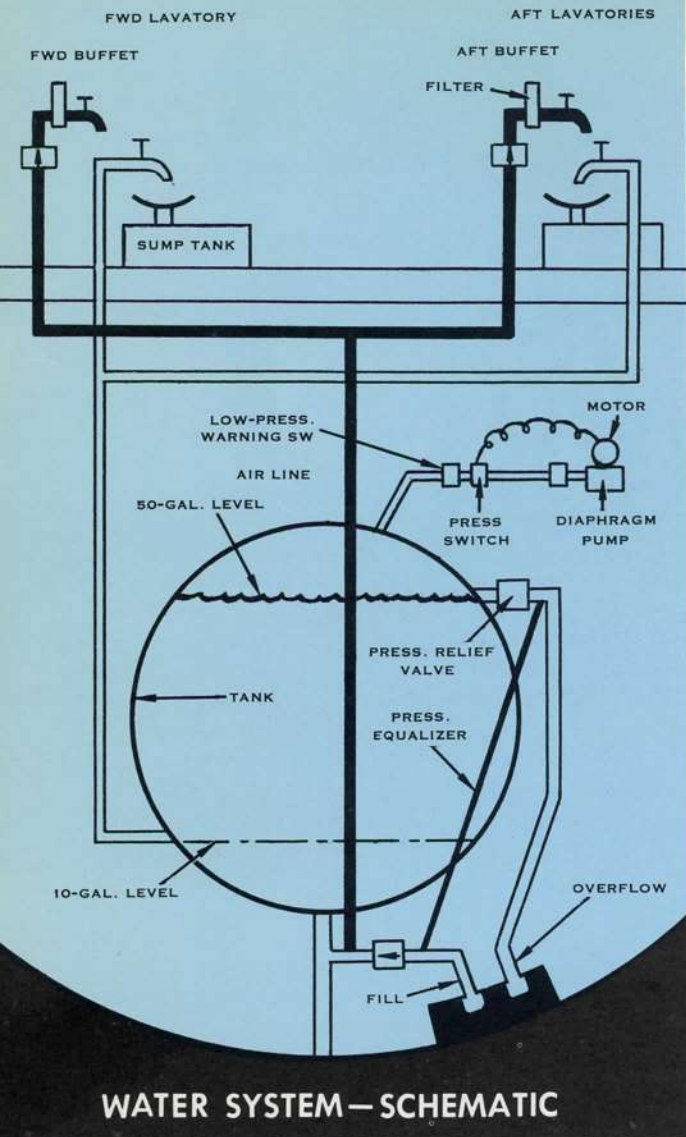

WATER SYSTEM—SCHEMATIC

The standard footrest is made up of a pair of aluminum tubes, one padded, simply contrived for use or for swinging out of the way. Remainder of the space under the seat, a minimum of 10 inches high, is available for stowing packages.

The back of the seat holds a food tray, stowed by swinging it up into the back and latching. Unlatched, the tray and support arms swing back, and the tray folds down to level position. Since the tray has a flat surface, it is equally well adapted for use as a writing desk. Trays can be attached to lounge and front row seats by special attachments.

Ashtrays are in outboard and inboard armrests. Reading lights, call buttons, and air and oxygen outlets are all overhead. The reading light is a soft-focus lamp adjustable within the necessary range. Fresh air outlets are standard ball type. An inconspicuous panel covers the oxygen masks, more fully described later herein.

General cabin illumination is indirect, by fluorescent lamps alongside the ceiling, concealed from view by the inboard edge of the canopies above the hat-rack. Aisle lights illuminate the width of the aisle only. All lamps, and the reading-lamp sockets, are replaceable without removing finish covering or using special tools.

Two passenger coat compartments are regularly provided, one forward and one aft, although some airlines have added others. Additional coat closets may be used as class dividers, by removing a row of seats. The closets may be attached at rows 4, 6, 8, 10, and 12 (numbering the rows as in first-class lounge configuration). A coat closet on each side may serve to divide the cabin into two, or even three, sections.

A magazine rack is located forward and another aft. At each seat, a pocket for books or magazines is attached just below the food tray in the seat back.

WATER SYSTEM AND LAVATORIES

The water system is centralized, one tank supplying potable water for all purposes. The tank is serviced through an external access door and may be filled at a rate of 10 gpm. Pressurization is by a diaphragm air pump, rated for continuous duty operation, with an air space to act as a pressure reservoir. Water is piped to forward and aft buffet coffee-making and drinking water outlets, and to the three lavatories, one of which is forward and two aft.

Standard airline lavatory appointments are provided—mirror, call button, electric razor outlets, stowage cabinets, and dispensers for towels, soap, etc. Toilets have standard airline connections for ground flushing and charging without entering the lavatory compartment. Illuminated OCCUPIED - VACANT signs, visible to the passengers, are installed at each lavatory. The door lock also displays an OCCUPIED sign when the door is locked.

BUFFETS

Design, size and number of buffets varies with each airline. Two are usually installed forward and one or two aft. They are carefully designed to provide maximum utility in minimum space.

Hot water may be provided by electric heating elements, or cold water by dry ice refrigeration. Storage space is provided for food or food trays, or for beverage containers, liquor, glassware, or whatever the individual airline may desire. Cooking and/or roll-warming ovens are usually provided.

STEWARDESS FACILITIES

Attendants' seats are usually mounted on the bulkheads forward of the entrances, facing aft, or on coat compartment bulkheads beside the buffets. These seats have shoulder harnesses as well as seat belts.



The stewardess call bell is a single-stroke chime, audible throughout the cabin. Three call lights, visible from the cabin, indicate whether the summons is from the passenger compartment, from a lavatory, or from the flight deck.

Handsets are installed at forward and aft stations, for communication with the flight deck or with the

attendant at the opposite end of the cabin. A public address system may be used by the flight crew for announcements. The stewardess, by requesting the flight crew for the proper connection, can also make use of the public address system.

FLIGHT COMPARTMENT

Convair jet airliners are as considerate of the comfort of flight personnel as of the passengers. Pilot and copilot, for probably the first time in history, have as standard equipment contoured reclinable seats.

The fundamental seat framework is similar to that of the usual bucket-type seat; contouring is effected by shaping a cushion base of polyvinyl chloride foam, an energy-absorbing material that can be formed by use of ordinary woodworking machine tools. The shaped seats and backs are cushioned with polyether foam, making a seat soft enough for comfort, but with undiminished strength and shock resistance.

The seat has armrests, adjustable through a small angle. The entire seat is mounted on tracks and is adjustable through a seven-inch range fore and aft, and through five inches vertically. Shear pins, operated by fingertip controls, hold the seat in the selected positions. A counterbalancing spring, capable of lifting the seat weight, allows the occupant to adjust seat height without leaving his station. Pilot and copilot seats are interchangeable.

By squeezing a catch on the armrest, the occupant may push the seat back to a 30° reclining angle. The seat back has provisions for a headrest if desired.

The flight engineer's seat is similar and is adjustable through the same ranges. Also, this seat swivels through 270° to face right, forward, or left. The tracks on which it is mounted are at a 45° angle with the airplane centerline, so that if desired the flight engineer may move up toward the center just behind the pilots and reach pedestal controls.

Pilot, copilot, and flight engineer seats are provided with seat belts, crotch strap, shoulder harness, and inertial reel. Belt, strap, and harness all fasten at one central fitting. Release catches are manipulated by a knob on the fitting; a twist of the knob, in either direction, unfastens all three.

If the airplane carries only one observer's seat, it can be placed back of the pilot and elevated, so that the observer may command a view of instrument panels and through the windshields. If provision must be made for a fifth man in the cockpit, the observer's seat may be moved inboard or outboard, and one of the seats may be designed to fold out of the way for access to the area.

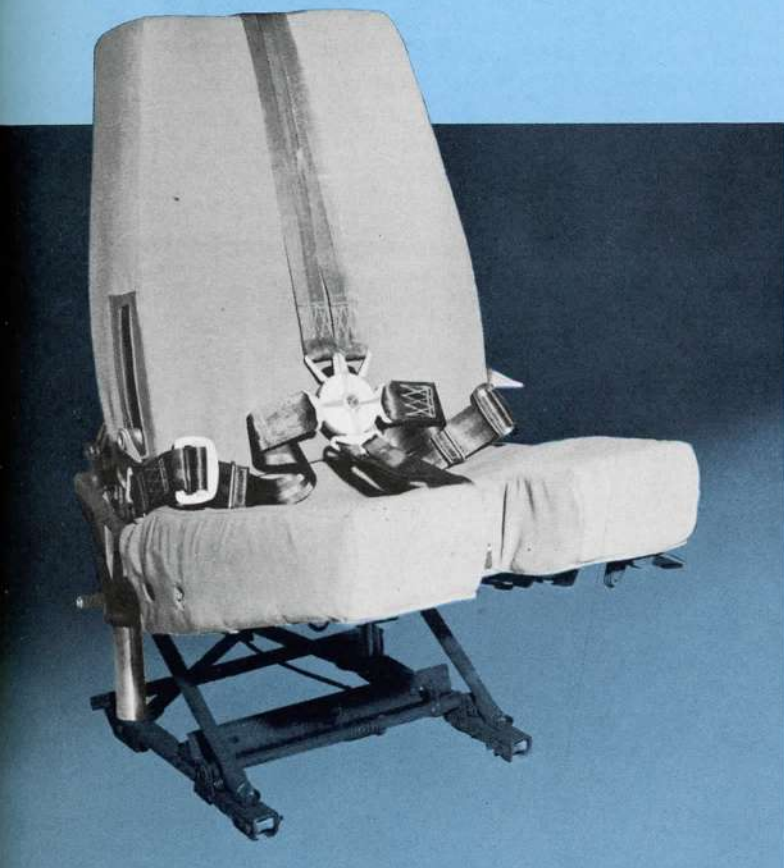

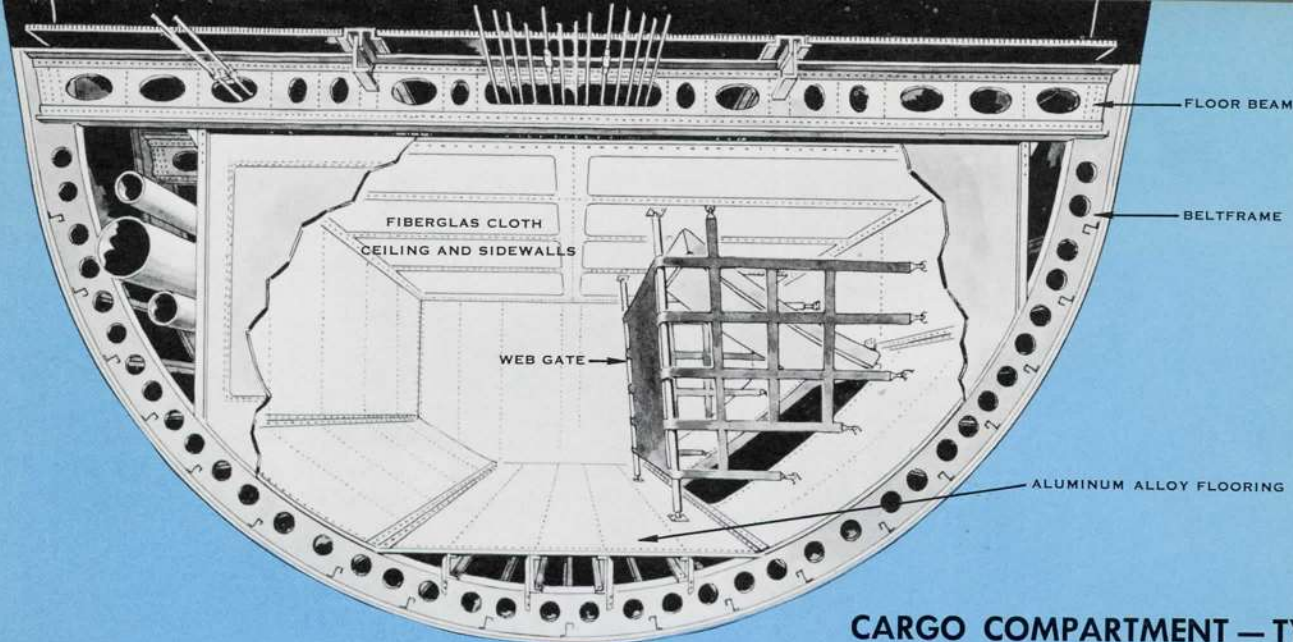

CARGO COMPARTMENT — TYPICAL



CARGO COMPARTMENTS

Two luggage and cargo compartments are provided, one forward and one aft of the wing. Since each airline has different requirements, Convair does not supply tiedowns, shelving, or compartment dividers except when requested.

Stowage space available depends on the configuration specified, but is usually more than 800 cubic feet in both compartments. The weight-bearing floor of the compartment is aluminum alloy sheet. Ceiling

and side walls are neoprene-coated Fiberglas cloth. Access panels in this cloth are closed with special airtight zippers. The cargo holds are, except for very small pressure-equalizing openings, airtight and hence incapable of supporting combustion in the event of fire breaking out in the cargo.

The compartments are reached through plug-type, inward-opening doors. Web gates keep the door areas clear.

OXYGEN SYSTEM SCHEMATIC

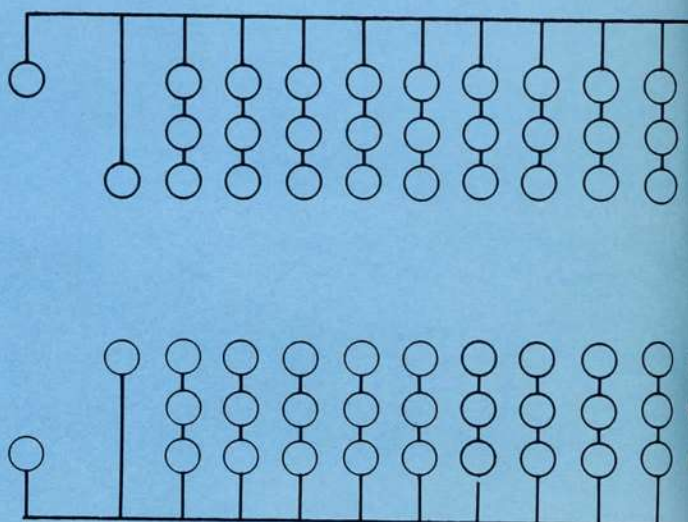
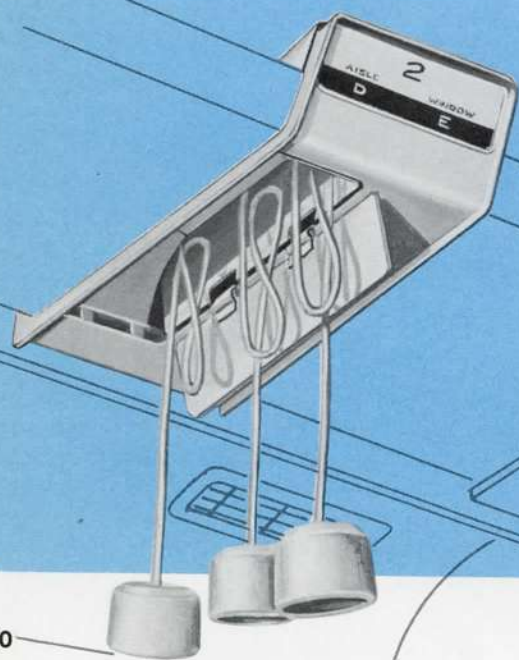

OXYGEN SYSTEM

The oxygen system presently being installed on "880" aircraft is the high-pressure gaseous type. A liquid oxygen system was originally planned for Convair jet airliners, but air terminal facilities are not yet generally equipped for liquid oxygen servicing and Convair customers have specified gaseous systems.

Provisions are made for stowing four oxygen cylinders, each approximately 30 inches high and 9 inches in diameter, along the left-hand wall of the flight compartment. Oxygen capacity and number of outlets are governed, in general, by Civil Air Regulations which have recently been revised. Under present requirements, three cylinders will meet CAR specifications, and also will provide capacity for full protection of crew and passengers in "880" aircraft.

Of the three cylinders, the forward one is connected directly to flight crew plumbing; the other two cylinders are primarily for cabin use but also are teed into the flight deck lines for crew use if required.

Since one member of the crew must be on oxygen at all times above a certain altitude, by CAR requirement, the forward cylinder will be replaced frequently. The other cylinders, being for emergency use only, need be replaced only as needed to maintain sufficient supply.

Pilot, copilot, and flight engineer have diluter demand masks, or, for emergency, full-face smoke masks that utilize 100% oxygen. Observers, attendants, and passengers have lightweight disposable masks with reservoir bags.

Passenger masks are stowed overhead behind small panels. There is one outlet for each passenger in any seating configuration, plus the extra outlets specified in CAR requirements. Two outlets are provided in each lavatory and one at each attendant station.

Passenger masks are released when pressure is admitted to the oxygen lines. The flow is governed by pressure regulating and reducing valves, one for each of the cylinders for cabin use, mounted near the cylinders within reach of the pilot. The valves are opened automatically by aneroid controls if cabin pressure drops below a specified altitude level. If desired, the valves can be opened by a manual override.

When the control valve is opened, pressure in the oxygen lines operates pneumatic latches on the overhead panels. The panels fall open and the masks drop to a few inches above and forward of the passengers' heads. There is no flow of oxygen through a mask until the passenger pulls it down far enough to use it. The pull opens a rotary valve.

Passenger outlets are continuous-flow type. Line pressure is automatically regulated by the aneroid controls in the pressure reducing and regulator valves, so that oxygen flow is governed by cabin pressure. The mask is of plastic and soft rubber, designed to cover nose and mouth. It has check valves for inhalation and exhalation, and an additional spring-loaded check valve to allow dilution when rate of breathing is faster than oxygen flow. The reservoir bag holds a reserve supply in case of full, rapid inhalation.

PASSENGER OUTLETS

PASSENGER BOTTLES

CREW BOTTLE

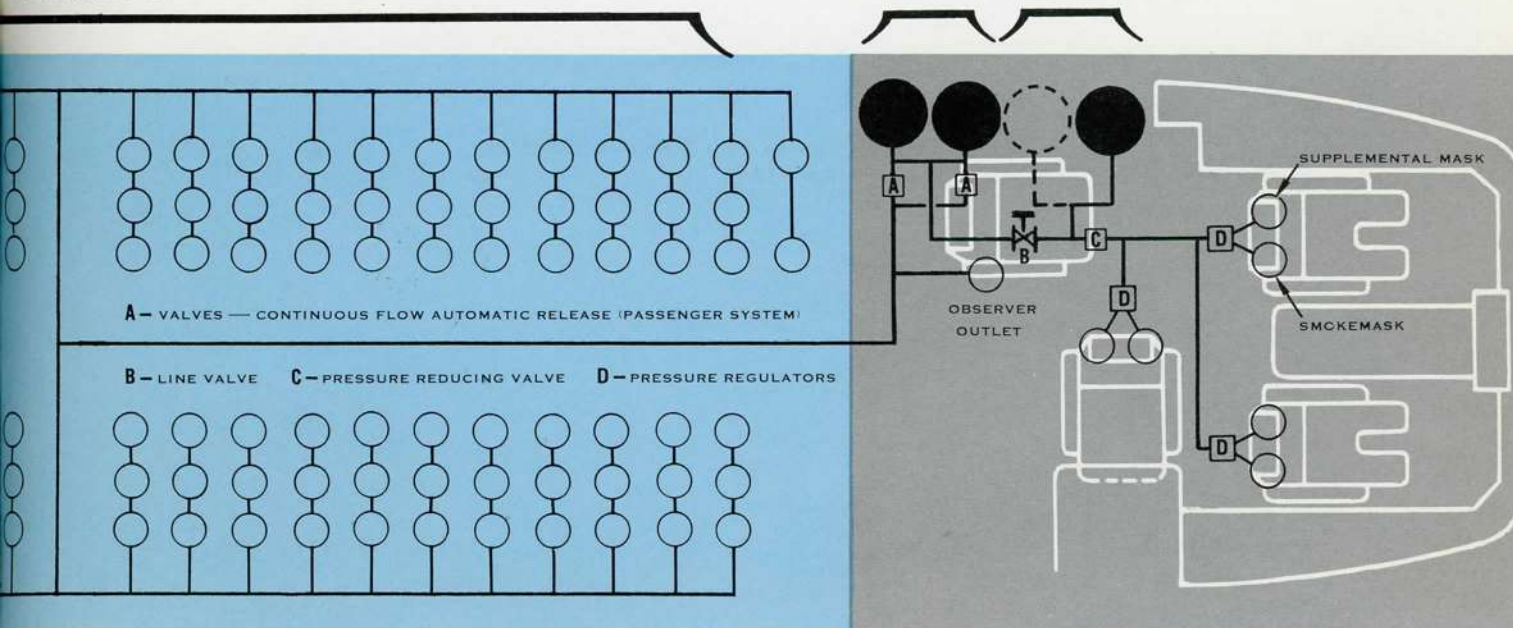



FOREWORD

This Traveler consists almost exclusively of dimensions.

Though an uninformed casual reader might find it dry fare, the Traveler will hazard a guess, based on experience with other such issues about other aircraft in the past, that copies of this month's issue will be carefully hoarded for some time to come.

The dimensions belong to the Convair 880, now in flight test and soon to be flying the world's airways. They are presented for the convenience of personnel who have an interest in Convair's new jet airliner.

Reprint from **CONVAIR TRAVELER**
April 1959

Convair 880

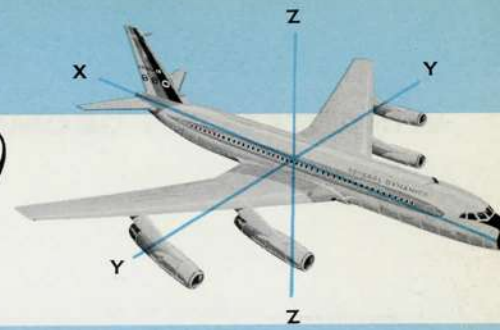

DIMENSIONS



STATIONS AND STATION GEOMETRY



ACCESS DOORS AND SERVICE POINTS

On pages 4 through 15 following are a number of dimensioned drawings of the Convair 880 jet airliner. Three kinds of information are presented:

1. Some basic orientation geometry, for general reference and for making clear the station nomenclature used in locating airplane positions in the "880." For example, there are six kinds of stations called out in wing drawings; on page 4 will be found basic reference and cross-reference points, with sufficient angular data for trigonometric use if desired. A center spar station at the spar centerline, for example, can be converted to fuselage buttock line by the formula

$$(C S Sta) (\cos 7^\circ) (\cos 34^\circ 8' 12'')$$

and to fuselage station by

$$818.128 + (C S Sta - 271.540) (\sin 34^\circ 8' 12'') (\cos 2^\circ).$$

2. Structural and access door data. On page 5 will be found major wing bulkhead stations, with bulkheads numbered as they are on Convair drawings. Principal structure and mechanism access panels and doors are shown, also numbered according to the Convair drawing system.

3. Exterior dimensions. On pages 10 and 11, the conventional three-view drawings give data that establish terminal or hangar space requirements for an "880." On pages 14 and 15, service point locations are given with reference to airplane centerline, together with their approximate heights above ground.

Much of this data has been requested by operators planning servicing and terminal facilities for the "880." It is believed that as "880" aircraft go into service, these illustrations will provide a handy guide for quick reference.

CONVAIR 880 DRAWING NUMBERING SYSTEM

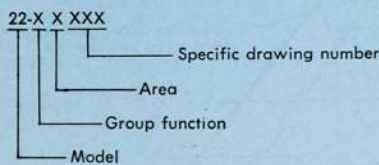

22-0 GENERAL (proposals, specifications, general airplane)

- 22-1 WING AND EMPENNAGE
- 11 Horizontal stabilizer
 - 12 Elevator
 - 13 Dorsal
 - 14 Vertical stabilizer
 - 15 Rudder
 - 16 Wing
 - 17 Aileron
 - 18 Flaps
 - 19 Wing tip and spoilers

22-2 POWER PLANT & AIR CONDITIONING

- 21 Wing (power plant)
- 22 Engine assembly
- 23 Engine inst and removal
- 24 Pylon

- 25 Pod
- 26 Fuselage (power plant)
- 27 Bleed air and ducting
- 28 Low pressure ducting
- 29 Major air cond components

22-3 ELECTRONICS

- 31 Electronics compt - fwd
- 33 Electronics compt - aft
- 34 Wing and nacelles
- 35 Vertical stabilizer

22-4 CONTROLS

- 41 Fuselage - nose
- 42 Fuselage - intermediate
- 43 Fuselage - aft
- 44 Wing
- 45 Nacelles
- 46 Vertical stabilizer and rudder
- 47 Horizontal stabilizer and rudder
- 48 Nose gear
- 49 Main gear

22-5 ALIGHTING GEAR

- 51 Main gear
- 52 Nose gear
- 55 Doors and mechanisms - gear
- 57 Doors and mechanisms - fuselage

22-6 ELECTRICAL

- 61 Fuselage - nose

- 62 Fuselage - under cabin floor
- 63 Fuselage - cabin
- 64 Wing and pylon
- 65 Engine pod
- 66 Empennage and aft fuselage

22-7 FUSELAGE

- 71 Nose section
- 72 Fwd constant section
- 73 Overwing section
- 74 Aft constant section
- 75 Tail section

22-8 HYDRAULICS, H-P PNEUMATICS

- 81 Fuselage - nose
- 82 Fuselage - intermediate
- 83 Fuselage - aft
- 84 Wing
- 85 Nacelles
- 86 Vertical stabilizer & rudder
- 87 Horizontal stabilizer
- 88 Nose gear
- 89 Main gear

22-9 FURNISHINGS & GROUND SUPPORT

- 91 Flight compartment
- 92 Fwd cabin
- 93 Passenger cabin
- 94 Aft cabin
- 95 Under-floor area
- 99 Ground support equipment

WING BULKHEADS AND UNDERWING ACCESS DOORS

NOTES

1. Circled numbers refer to bulkheads.
2. Numbers not circled refer to wing tank removable panels and trailing edge access doors.
3. Other panels are keyed as follows:
 BA – bleed air duct bellows
 BP – boost pump
 TP – transfer pump
 FS – float switch
 ID – Inspection doors
 AS – air scoop access (upper surface)
 TD – tube disconnect (upper surface)
 FG – flux gate compass (upper surface RH wing only)

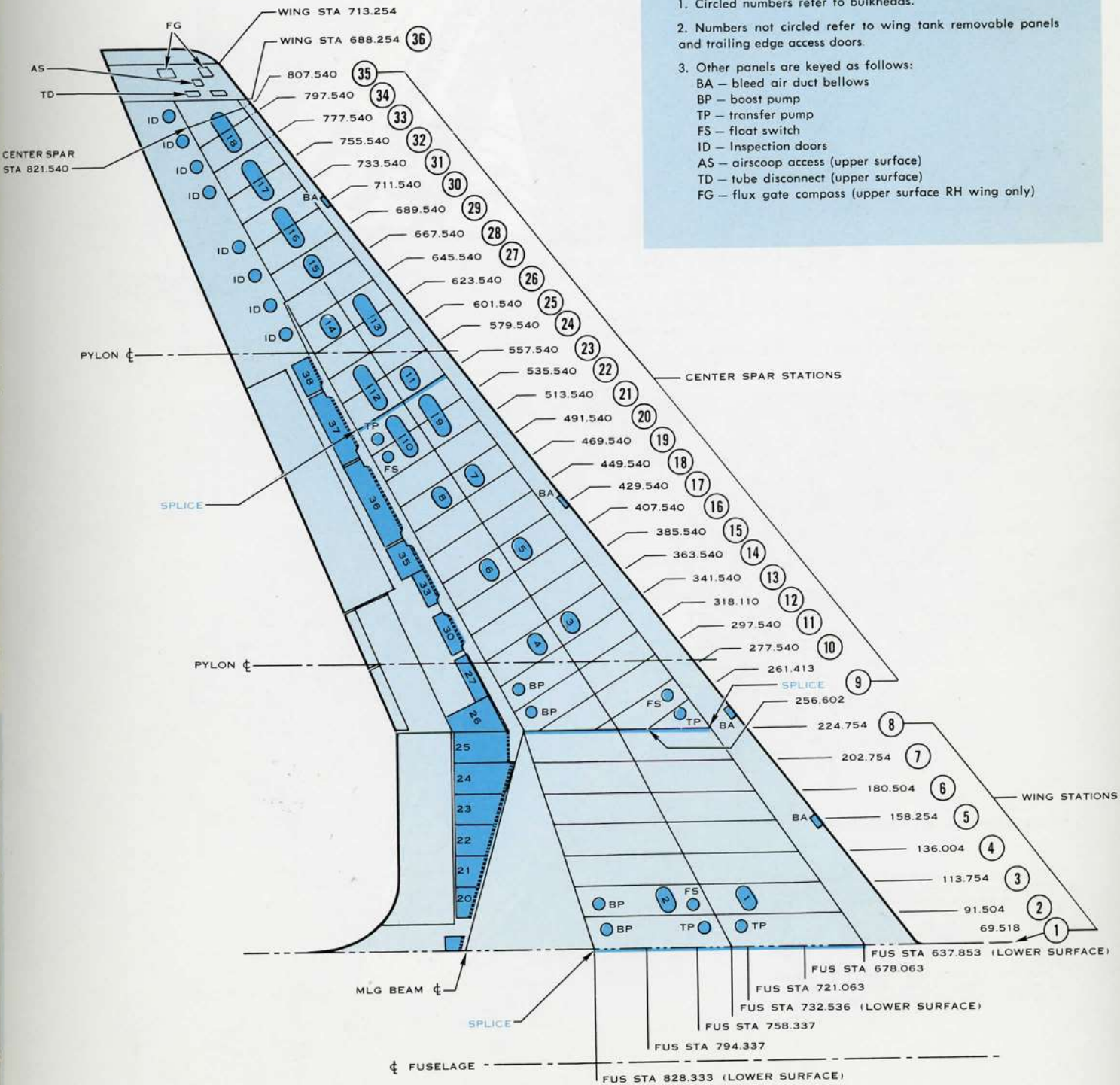

WING STATION GEOMETRY

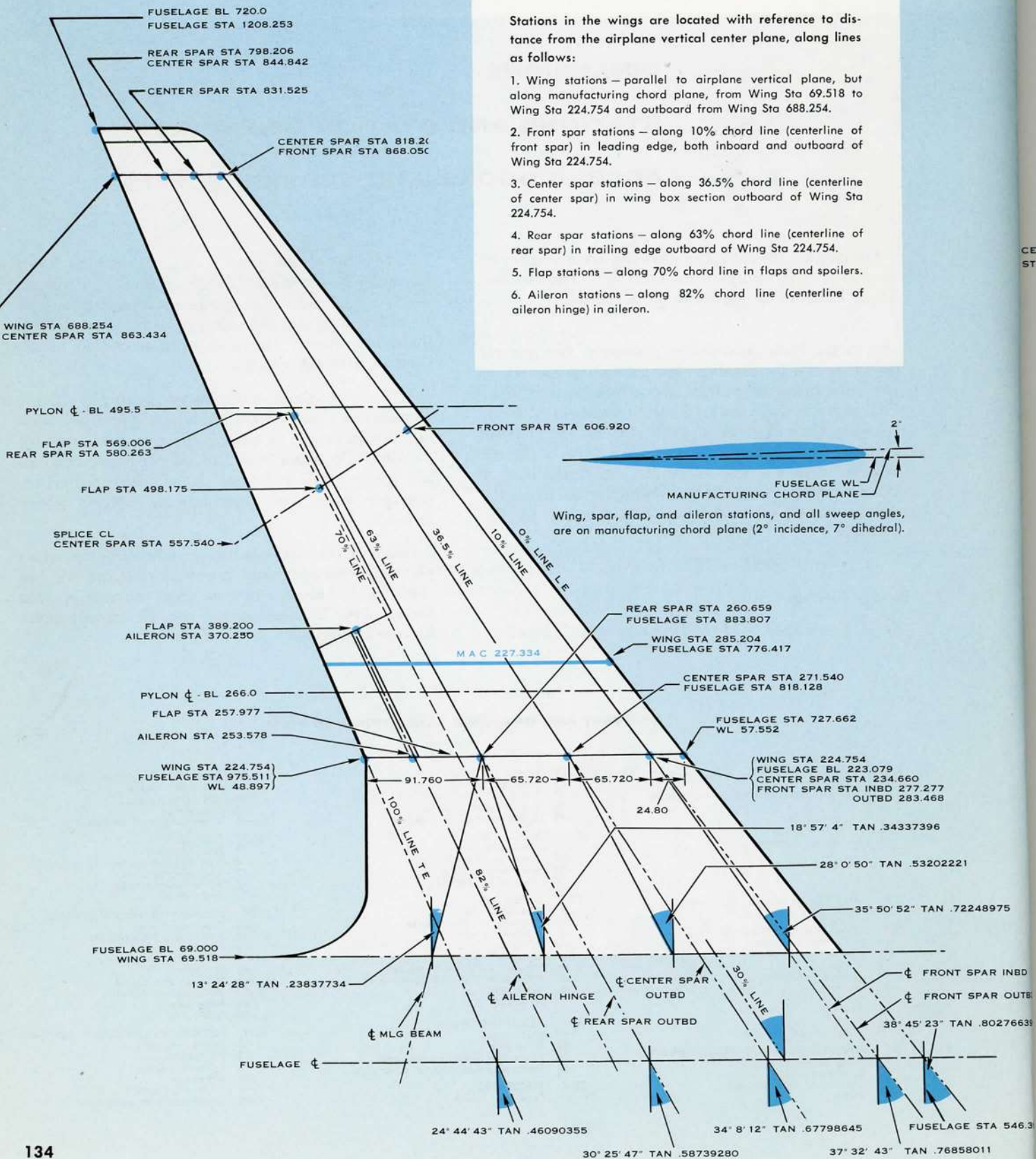

EMPENNAGE GEOMETRY AND REFERENCE POINTS

VERTICAL STABILIZER

Spar station dimensions are measured from points above WL 135.0 indicated on drawing.
 Rudder stations for lower six ribs are measured from WL 135.0 along 82.267% chord line. Rudder stations above Rib 6 are measured from WL 135.0 along the 94% (tab hinge) line.

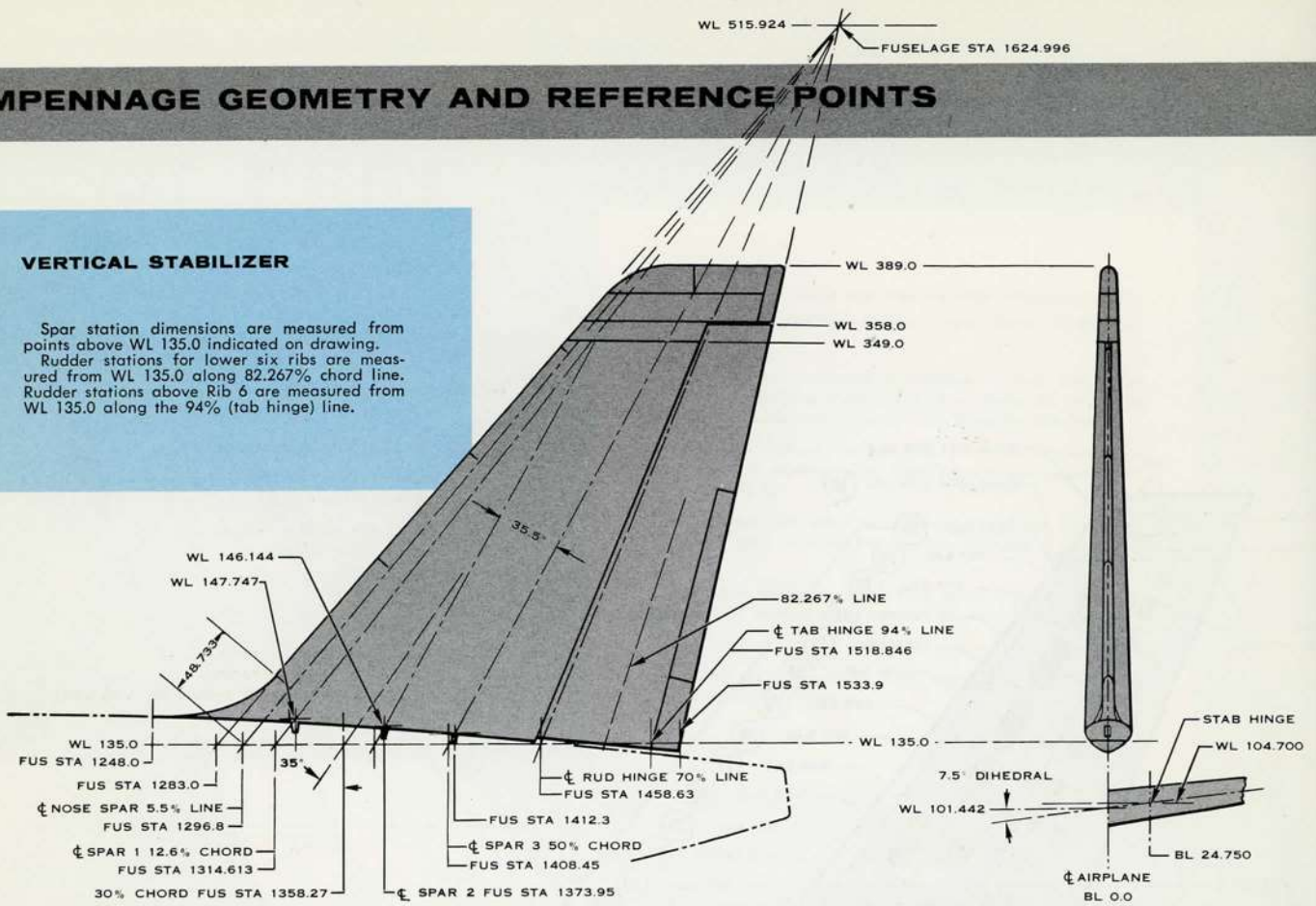

HORIZONTAL STABILIZER

All horizontal stabilizer station dimensions are on manufacturing chord plane ($7\frac{1}{2}^\circ$ dihedral).
 Leading edge stations outboard from Front Spar Sta 118.922 are measured from airplane vertical center plane along the 10% chord line. Front spar measurements inboard of Front Spar Sta 118.922 are measured from BL 9.078 at spar centerline.
 Spar box, elevator, and trailing edge stations are measured from airplane vertical center plane along 50%, 75%, and 95% lines respectively.

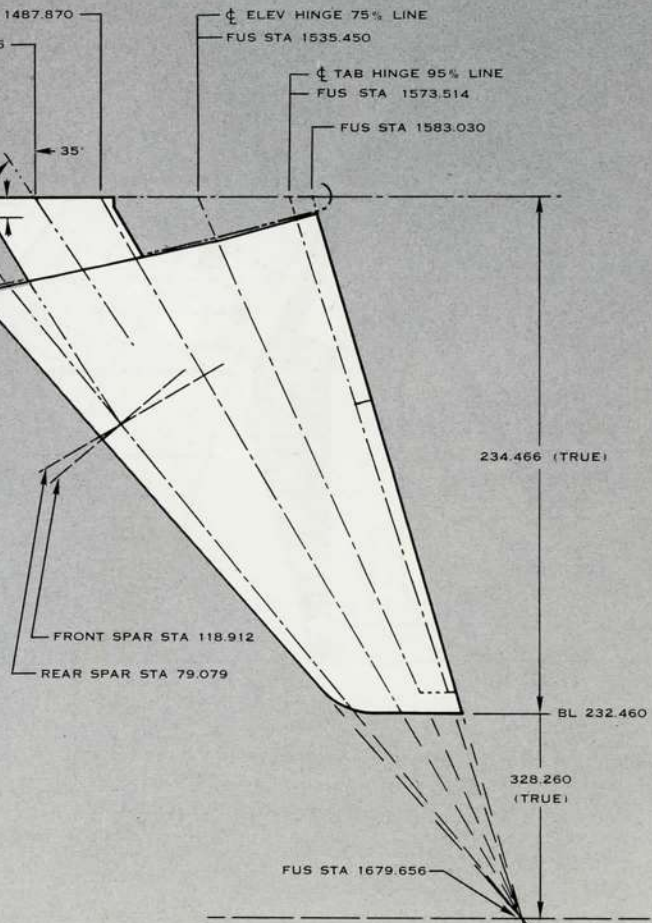

RIB STATIONS AND ACCESS DOORS

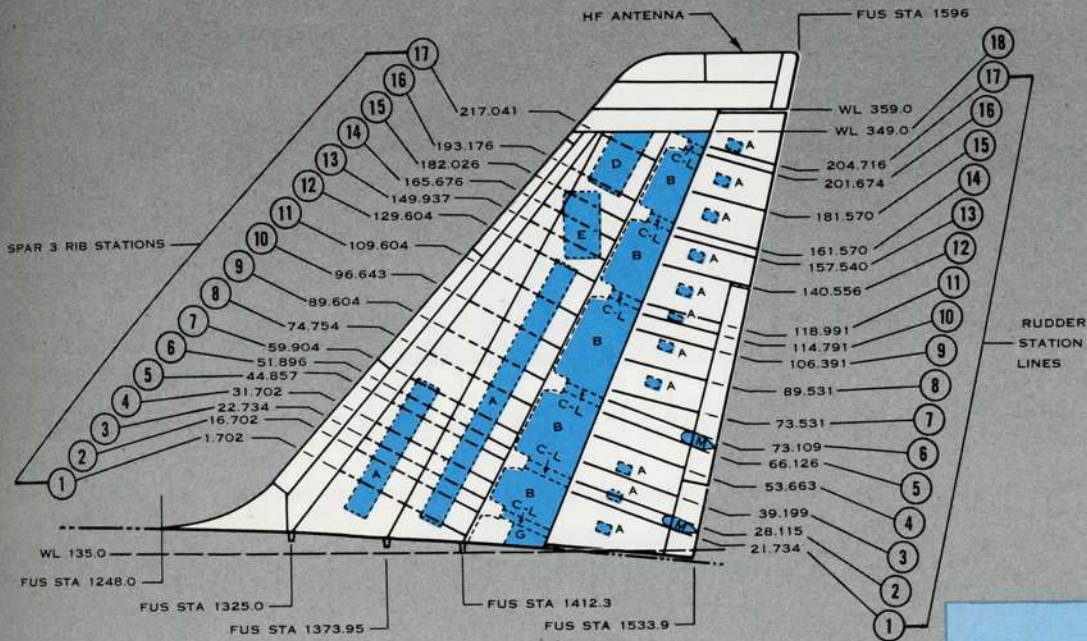

ACCESS DOORS

- A - Structural inspection and access
- B - Balance board shrouds
- C - Balance bd mechanism, hinge support rib
- D - Antenna tuner
- E - VHF antenna
- F - Stabilizer pivot
- G - Gust damper
- H - Controls
- J - Stabilizer hinge bearing
- K - Elevator leading edge and hinges
- L - Hinge support rib
- M - Tab actuator
- N - Counterbalance weights
- P - Elevator nose
- Q - Torque tube universal joint
- T - Tab hinges

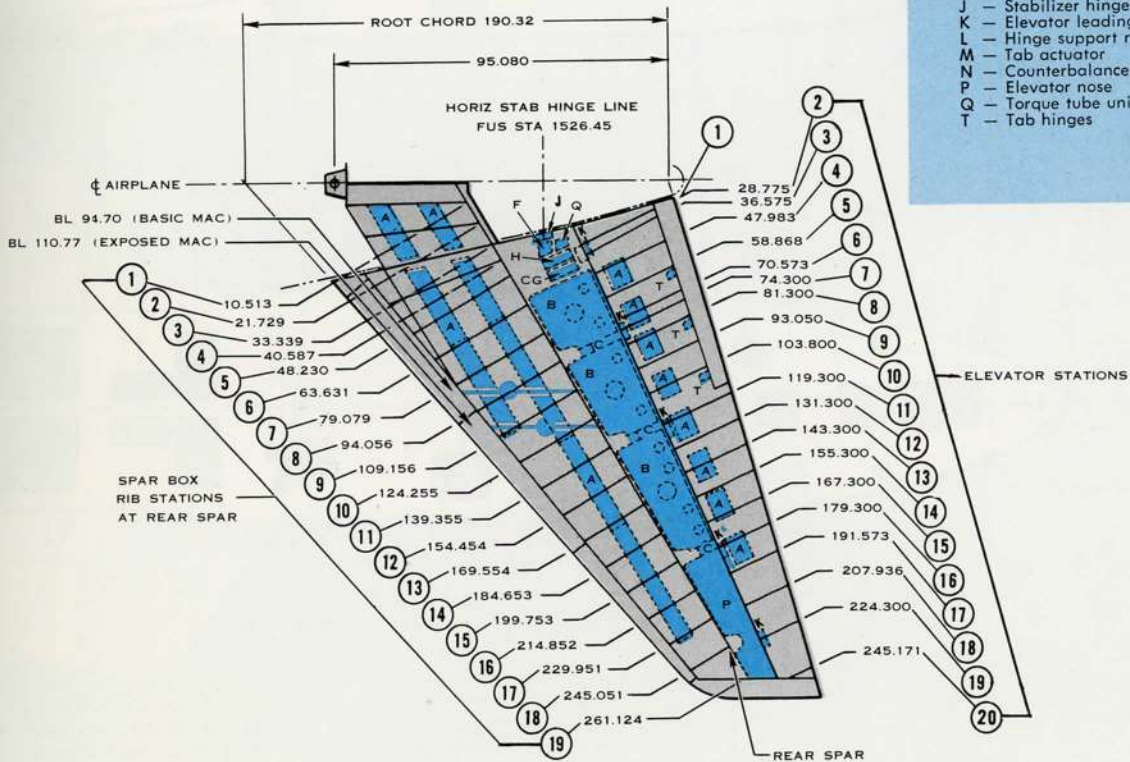

FUSELAGE STATIONS AND ACCESS DOORS

NOTE: Station number appears on beltframes at airplane centerline or at 45° from centerline.

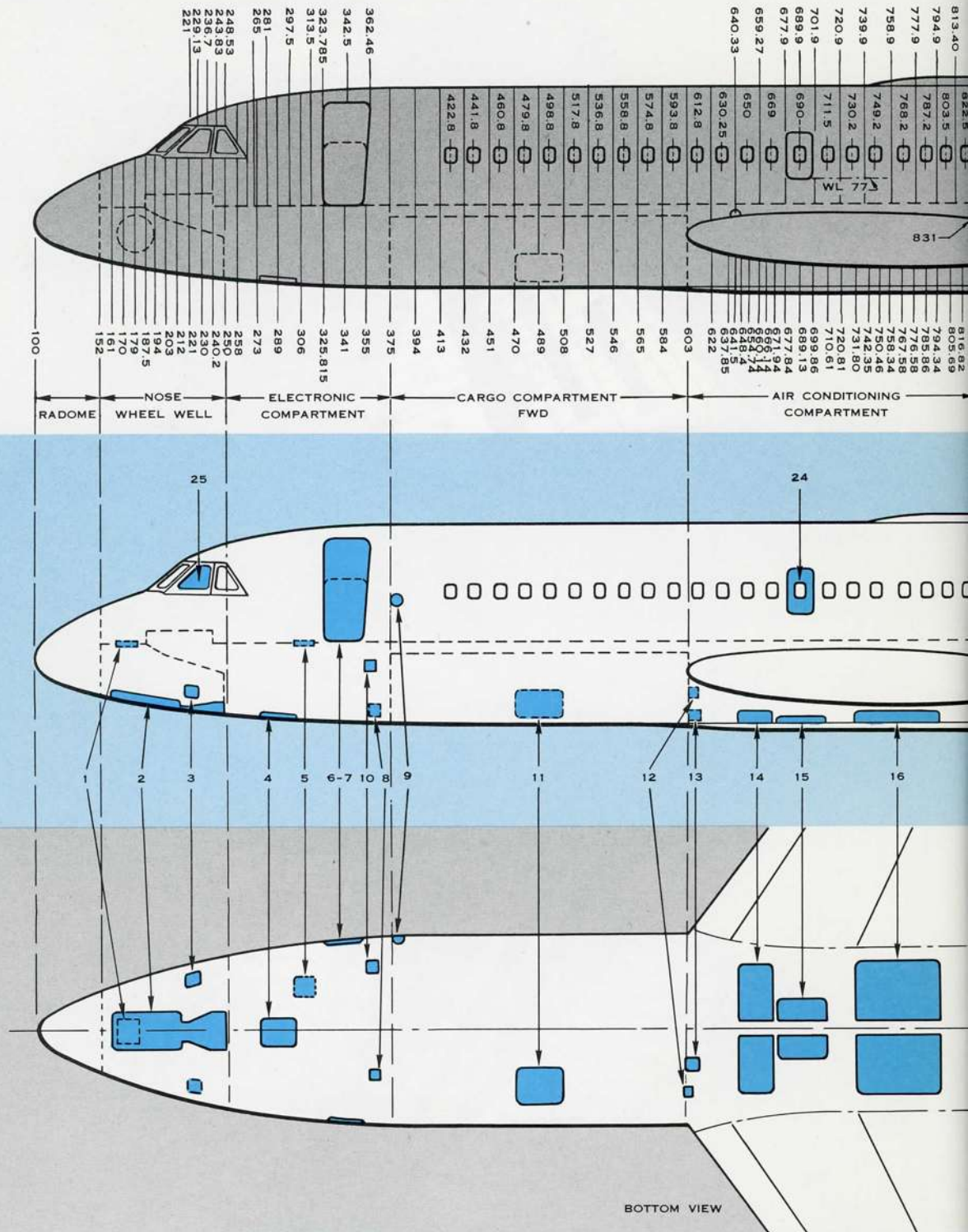

- 1 - Instrument panel access (from NWW)
- 2 - Nose wheel well
- 3 - Electrical compartment (LH and RH)
- 4 - Electrical and electronic (ground access)
- 5 - Electrical and electronic (in-flight access)

- 6 - Fwd main entrance door (LH side)
- 7 - Fwd service door (RH side)
- 8 - External AC power receptacle
- 9 - Loading ramp receptacle
- 10 - Lavatory service panel (fwd and aft)

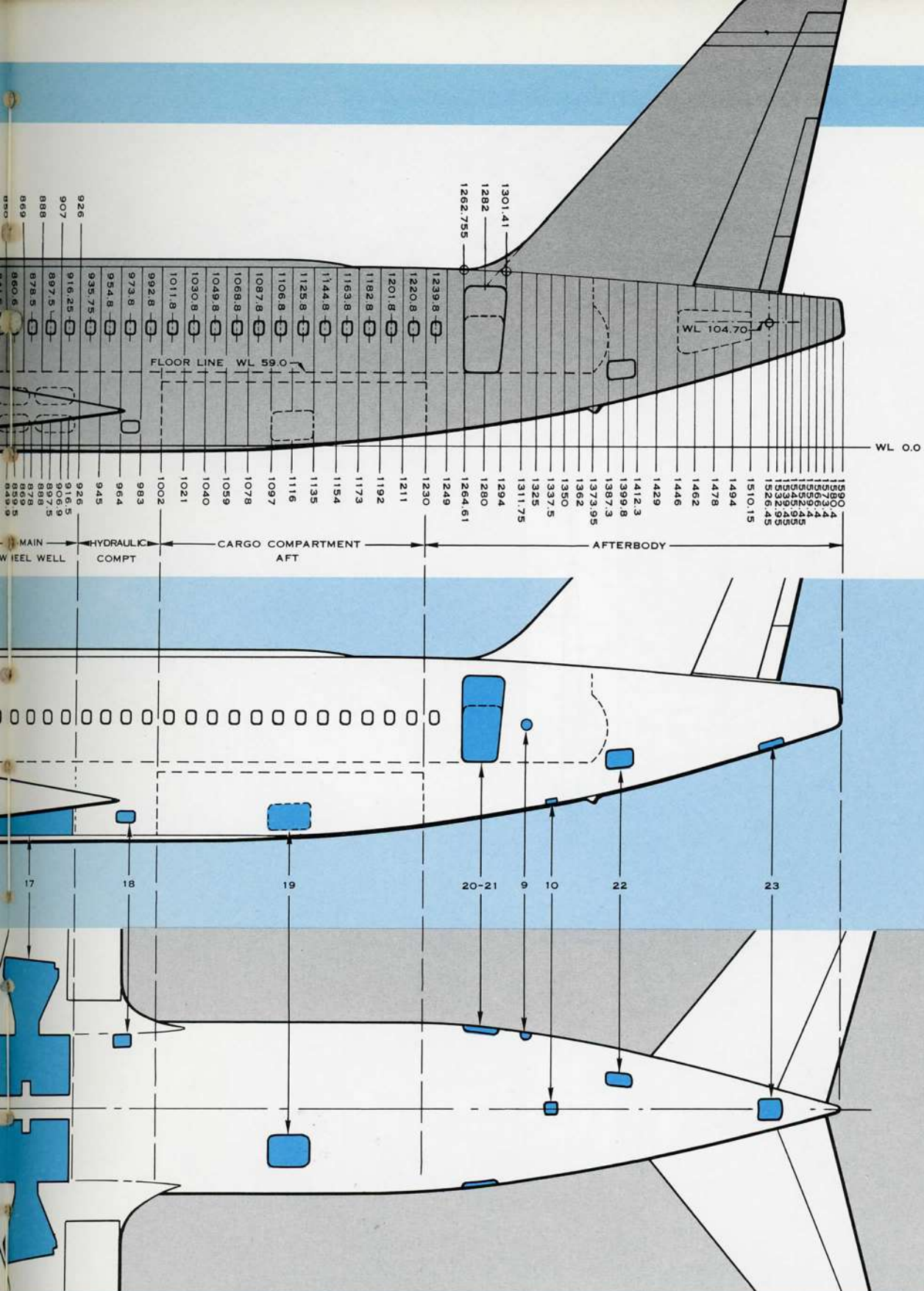

- 11 - Fwd cargo compartment
- 12 - Water service panel
- 13 - Ground air conditioning connection
- 14 - Air conditioning compressor (LH and RH)
- 15 - Heat exchanger (LH and RH)

- 16 - Freon package (LH and RH)
- 17 - Main wheel well
- 18 - Hydraulic compartment
- 19 - Rear cargo compartment
- 20 - Rear main entrance door (LH side)

- 21 - Rear service door (RH side)
- 22 - Stabilizer screwjack
- 23 - Aft fuselage access
- 24 - Cabin emergency escape door
- 25 - Flt compt emergency escape window

AIRPLANE OVERALL DIMENSIONS AND CLEARANCES

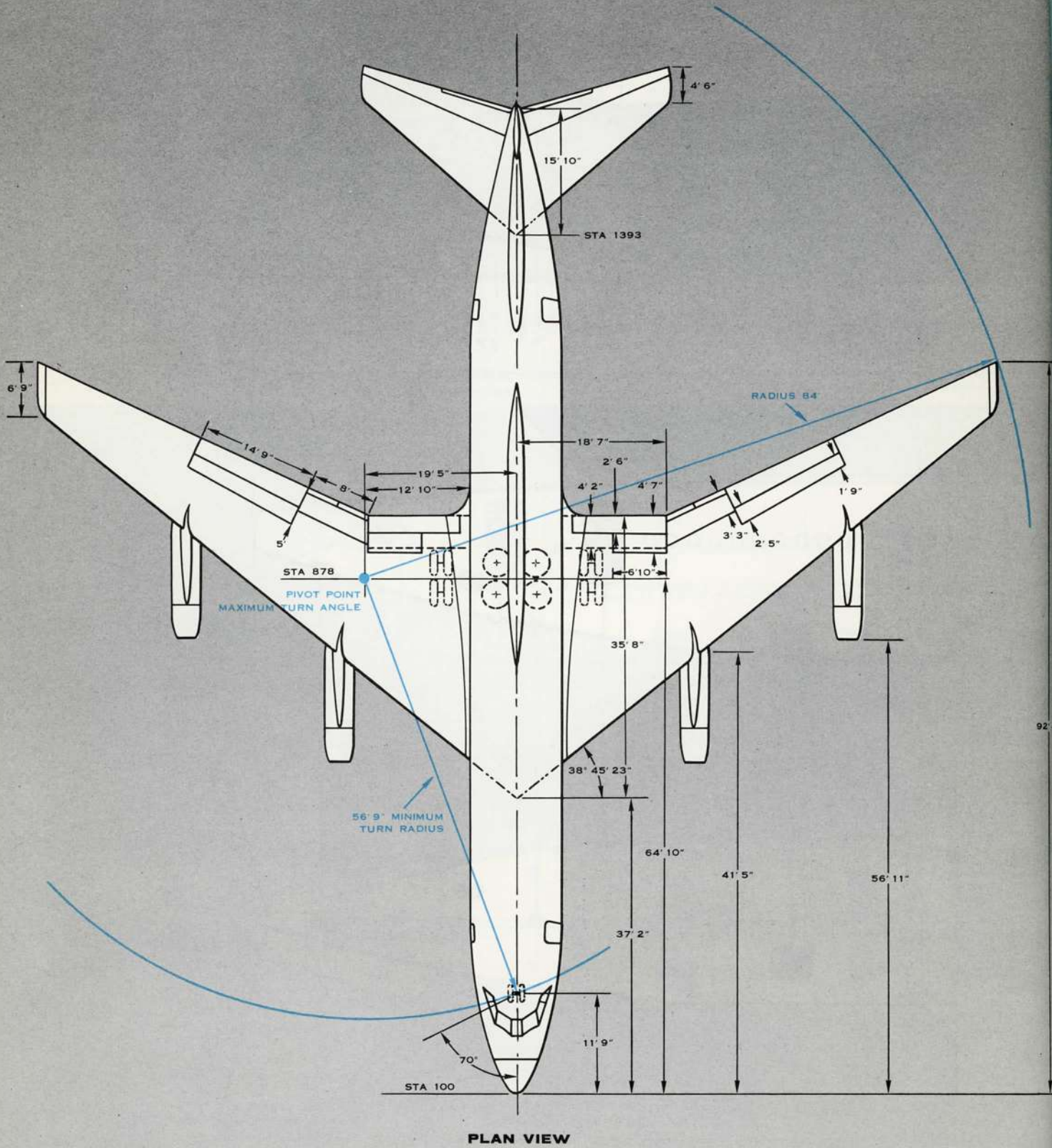

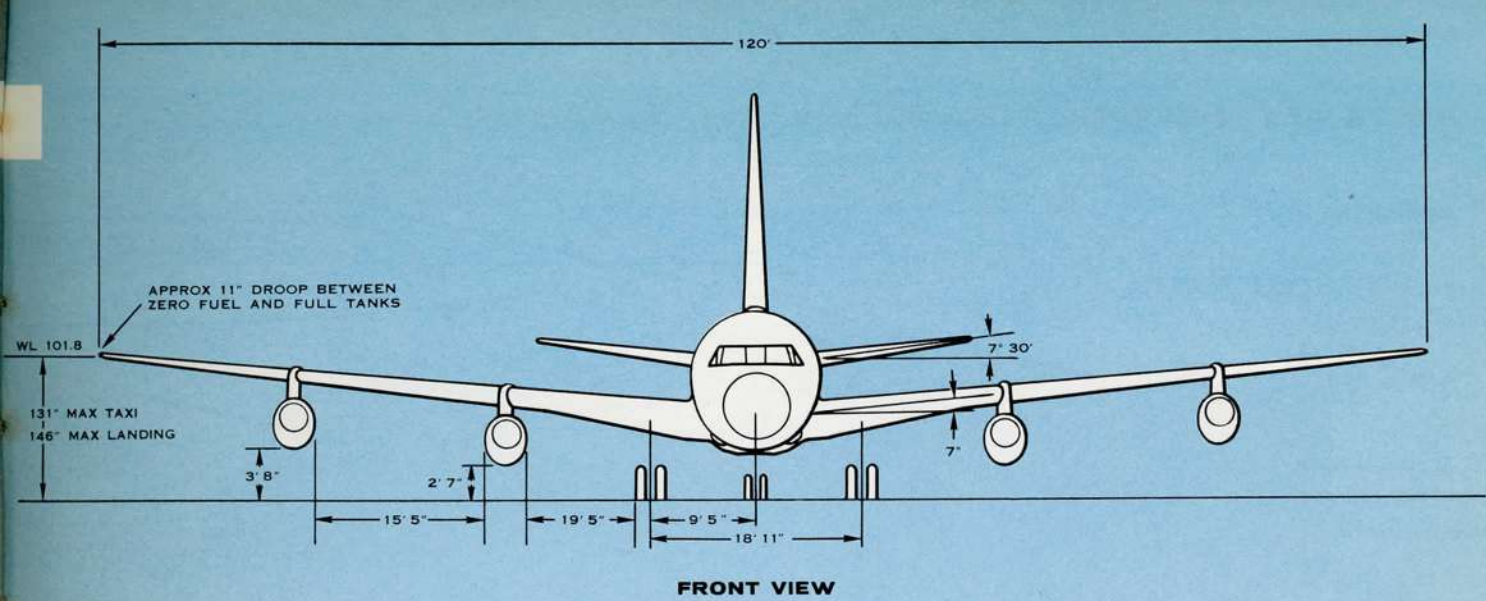

FRONT VIEW

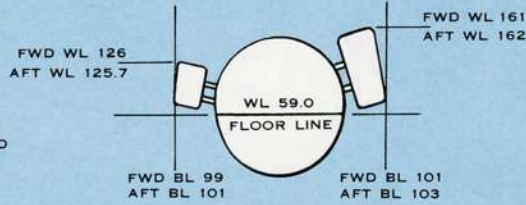
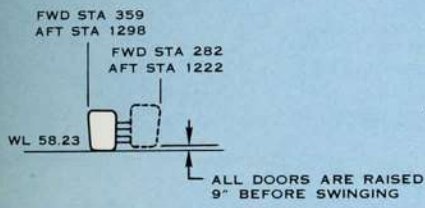

DOOR CLEARANCES

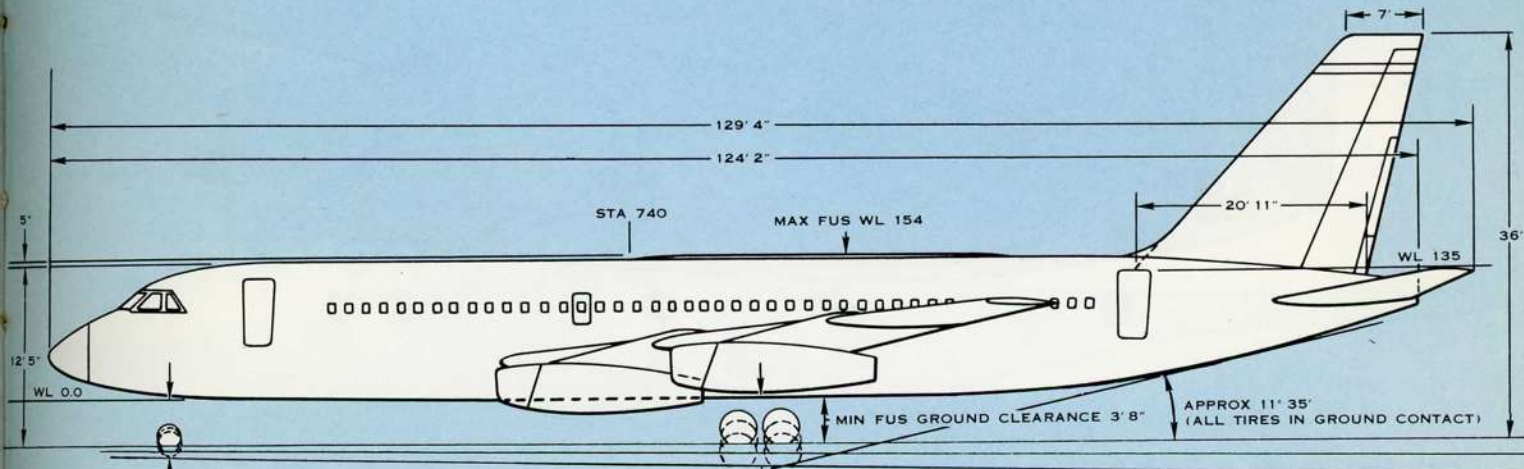
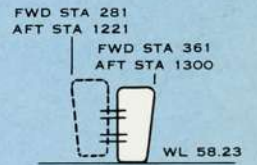

CG MOST FWD	CG MOST AFT		CG MOST FWD	CG MOST AFT
53"	56"	MAXIMUM TAXI WEIGHT 185,000 LB	50"	50"
54"	60"	MAXIMUM LANDING WEIGHT 132,800 LB	52"	51"
57"	62"	ZERO FUEL WEIGHT 86,730 LB	55"	55"

SIDE VIEW

NOTES

All dimensions and stations on pages 10 and 11 are to nearest inch only. Stations are fuselage stations, measured from 100 inches forward of the airplane nose.

Heights from ground are with airplane fully loaded and fueled, 185,000 lb maximum taxi weight, nominal center of gravity.

PODS AND PYLONS

GEOMETRY

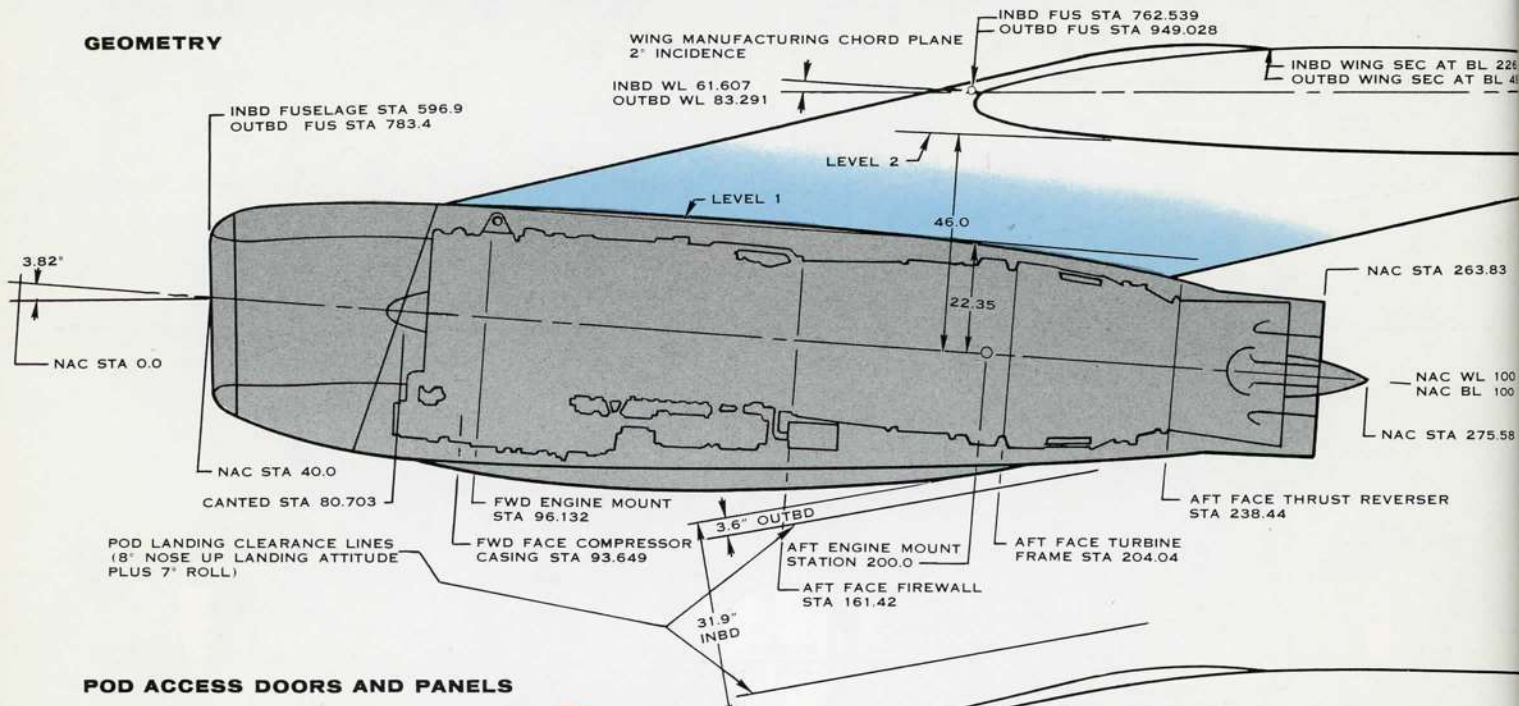

POD ACCESS DOORS AND PANELS

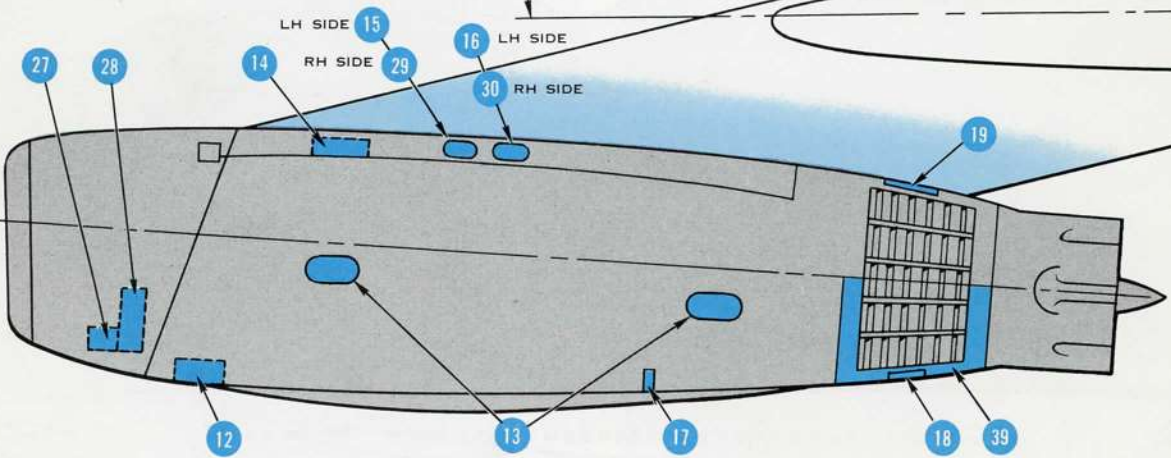

POD AND PYLON ACCESS PANELS, SERVICE POINTS, AND DRAINS

- | | | | | | |
|----|--|----|-------------------------------|----|------------------------------------|
| 1 | Hoist lug | 13 | Engine fire access | 28 | Vortex destroyer valve |
| 2 | Hydraulic filters | 14 | Oil gravity fill | 29 | Electrical and door hinge |
| 3 | Bleed air regulator | 15 | Fluid lines and door hinge | 30 | Electrical and door hinge |
| 4 | Fluid and electrical lines | 16 | Fluid lines and door hinge | 31 | Hoist attach |
| 5 | Power control unit | 17 | Fuel drain tank ground drain | 32 | Fire detector control units |
| 6 | Fluid lines | 18 | Rigging door, thrust reverser | 33 | Oil tank access |
| 7 | Fire ext. check valve and bleed air duct | 19 | Rigging door, thrust reverser | 34 | Fire extinguisher line drain |
| 8 | Fire bottle removal (large panel) | 20 | Fluid and electrical lines | 35 | Fragible blowout disc, fire bottle |
| 9 | Fire bottle removal (small panel) | 21 | Fluid and electrical lines | 36 | Fuel tank drain |
| 10 | Fire bottle pressure gage | 22 | Interphone jack | 37 | Pylon draft seal removable panels |
| 11 | Refuel panel | 23 | Structural inspection | 38 | Hydraulic filter view holes |
| 12 | Engine ground start (inbd pod or pods) | 27 | Anti-icing valve | 39 | Removable tail cowl |

PYLON ACCESS PANELS

NO. 1 AND NO. 2 PYLONS

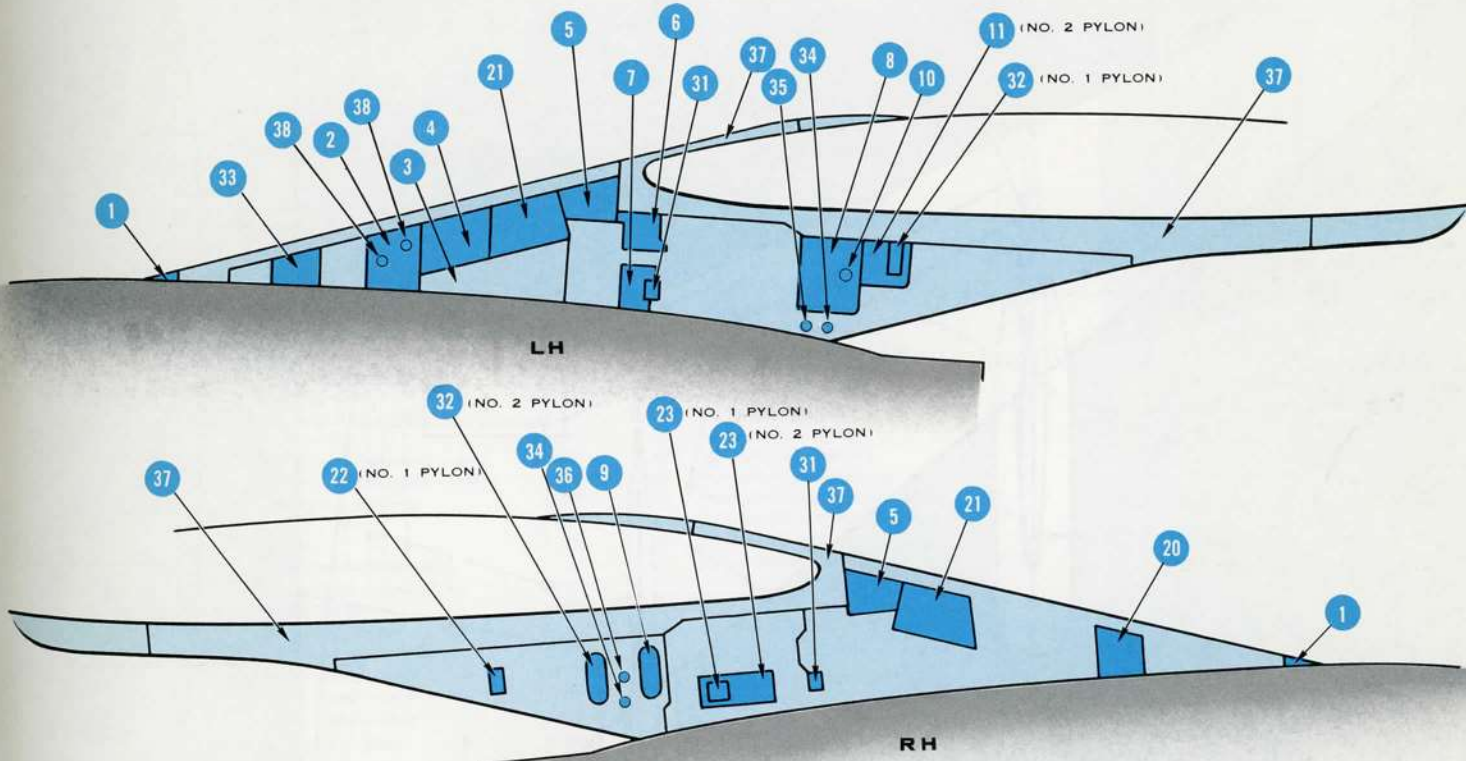

NO. 3 AND NO. 4 PYLONS

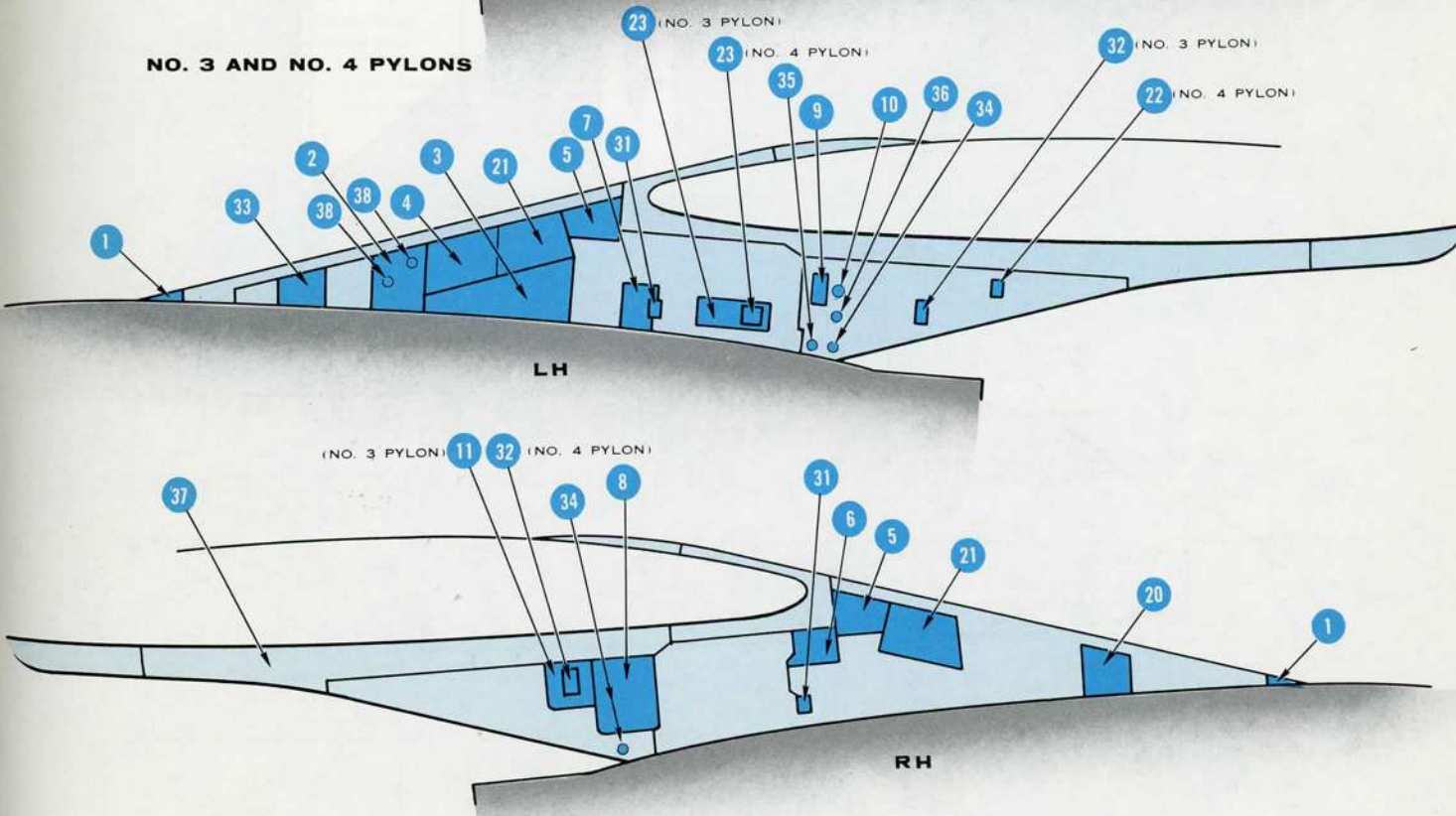

ACCESS DOORS AND SERVICE CONNECTIONS

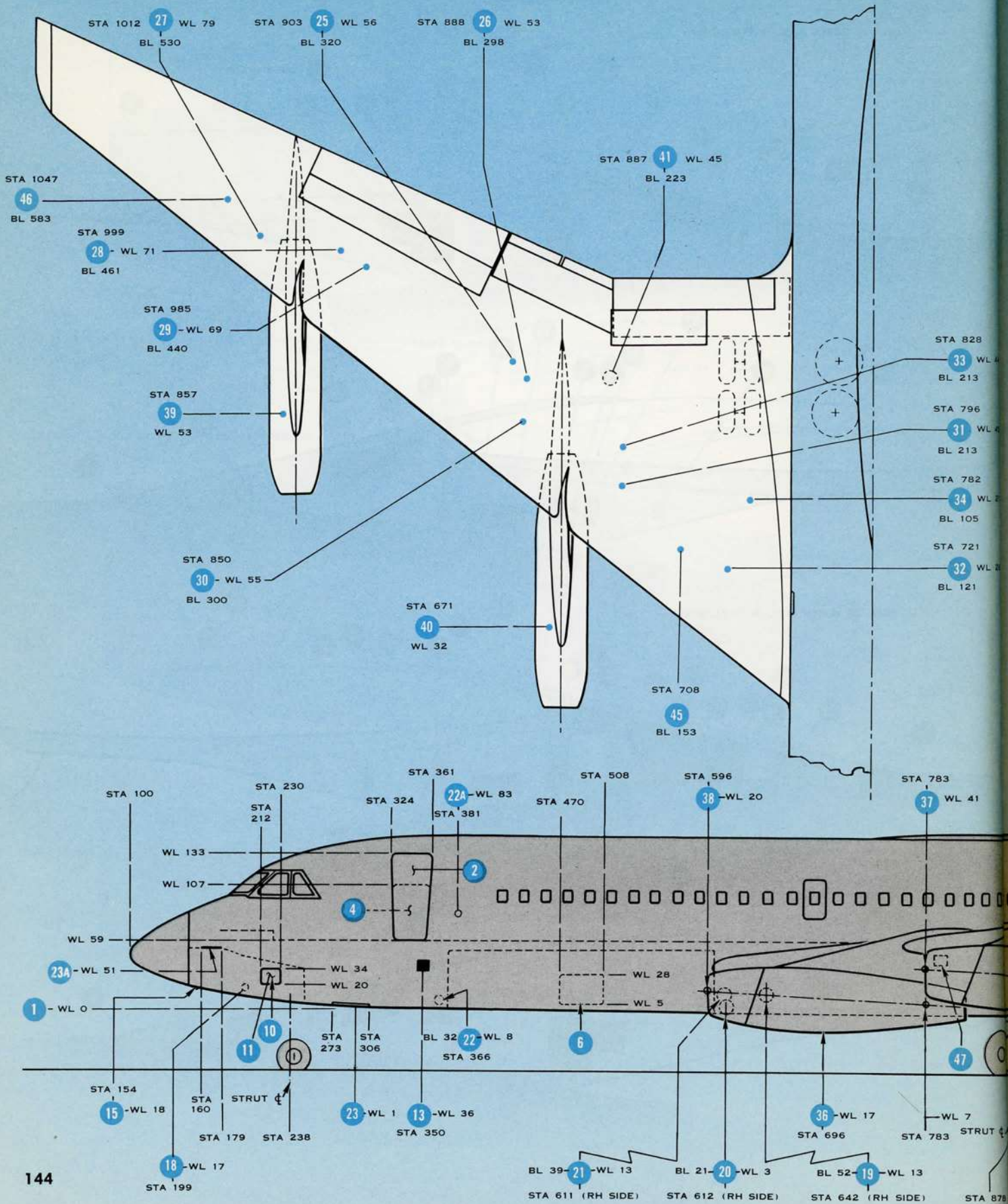

LOCATIONS AND ELEVATIONS

APPROXIMATE HEIGHTS FROM GROUND AT MAXIMUM TAXI WEIGHT

1	Fuselage	3' 8"	30	Dripstick - outbd main	8' 7"
2	Main entrance door - fwd	9' 6"	31	Dripstick - inbd replenish	7' 11"
3	Main entrance door - aft	9'	32	Dripstick - inbd replenish	6' 6"
4	Service door - fwd	9' 6"	33	Dripstick - inbd main	7' 10"
5	Service door - aft	9'	34	Dripstick - inbd main	6'
6	Cargo door - fwd	4' 9"	35	Engine pod - outbd	3' 10"
7	Cargo door - aft	4' 7"	36	Engine pod - inbd	2' 8"
8	Tail cone door - fwd	8' 8"	37	Engine CL fwd end outbd	7'
9	Tail cone door - aft	10' 6"	38	Engine CL fwd end inbd	5' 10"
10	Elec equip door - LH	6' 4"	39	Oil filler caps outbd	8'
11	Elec equip door - RH	6' 4"	40	Oil filler caps inbd	6' 10"
12	Hydraulic door	4' 11"	41	Jack points - wing	7' 10"
13	Lavatory service panel - fwd	7' 6"	42	Vertical stabilizer tip	36'
14	Lavatory service panel - aft	6'	43	Horizontal stabilizer tip	14' 8"
15	Jack point - fuselage	6' 2"	44	Horizontal stab pivot point	12' 6"
16	Tail skid	6' 10"	45	Gravity fill refueling inbd	9' 6"
17	Tail cone	11' 2"	46	Gravity fill refueling outbd	12'
18	Pneumatic air Model 22-2	6'	47	Refuel panel inbd pylons	7' 8"
19	Pneumatic air Model 22-1	5' 5"			
20	Preconditioned air	4' 8"			
21	Water filler access	5' 6"			
22	External power receptacle	5' 3"			
22A	Loading ramp recept - fwd	11' 5"			
22B	Loading ramp recept - aft	11' 2"			
23	Electronic equip door	4' 8"			
23A	NLG well top door	8' 9"			
24	Wing tip	10' 11"			
25	Press refueling outbd	8' 7"			
26	Press refueling inbd	8' 5"			
27	Dripstick - outbd replenish	9' 11"			
28	Dripstick - outbd replenish	9' 6"			
29	Dripstick - outbd main	9' 5"			

NOTES: Door dimensions refer to door sill elevations.
All dimensions, stations, buttock lines and waterlines are to nearest inch.

