

**AIRCRAFT МиГ-25ПД**

***FLIGHT AND COMBAT  
EMPLOYMENT  
TRAINING MANUAL***

---

The present Manual may be used as a guide for training of the pilot personnel on the МиГ-25ПДС aircraft.

---

---

**Important.**

Check the insets for availability.

The book contains 578 pages and 7 insets:

Inset 1, between pages 40-41, secret;

Inset 2, between pages 40-41, secret;

Inset 3, between pages 560-561, secret;

Inset 4, between pages 562-563, secret;

Inset 5, between pages 562-563, secret;

Inset 6, between pages 564-565, secret;

Inset 7, between pages 564-565, secret.

3

C 17

## INTRODUCTION

The present Manual is intended for the flying personnel of the air defence units equipped with the МиГ-25ПЦ (МиГ-25ПДС) aircraft, as well as for the control (direction) post crews, controlling the fighters when conducting an aerial combat.

The main purpose of the Manual is to aid the flying personnel in mastering the МиГ-25ПЦ (МиГ-25ПДС) aircraft.

The present Manual covers recommendations for the command personnel on organization, methods and realization of the training procedure, accomplishment of separate flight elements. The book deals with the methods and techniques used for training. The Manual sets forth the major problems involved in training the flying personnel in piloting the МиГ-25ПЦ (МиГ-25ПДС) aircraft, air navigation under various flight conditions with complex employment of the airborne and ground navigation aids, as well as combat employment under a complicated air situation when a potential enemy uses various means of radioelectronic suppression.

The Manual consists of two parts:

- P a r t O n e - flying technique and air navigation;
- P a r t T w o - combat employment.

The First Part contains a separate chapter presenting basic aerodynamic peculiarities of the МиГ-25ПЦ (МиГ-25ПДС) aircraft which will enable the flying personnel to use within the full scope the combat capabilities of the fighter in the course of aircraft mastering.

The Second Part outlines peculiarities of flights for aerial combat at various altitudes and airspeeds when performing front cone and rear-cone attacks with the use of the different operating modes of the armament system. The Manual contains the recommendations and peculiarities of conducting the service firing of the different types under firing ground conditions.

The suggested flying personnel training procedure may vary to some extent depending on particular conditions. Therefore, the commanders of the air units who organize and conduct flight training should bear in mind that only creative approach to training, discovering new ways, methods and procedures can provide high quality of flight training and flight safety. In all cases, basic attention should be given to training a pilot as a fighter.

**BRIEF INFORMATION ON AIRCRAFT INTERCEPTION  
COMPLEX МиГ-25-40Д (МиГ-25-40ДС)**

Aircraft interception complex МиГ-25-40Д (МиГ-25-40ДС) is designed for destruction of aerial targets of strategic and tactical aviation and cruise missiles in the daytime and at night under VFR and IFR conditions (in clouds) including conditions of radiocontrast cloudiness and organized counter-measures both in the free airspace and against the surface background.

The МиГ-25-40Д (МиГ-25-40ДС) complex comprises:

(1) the МиГ-25ПЦ (МиГ-25ПЦС) fighter;

(2) the G-25 armament control system consisting of:

- airborne radar SAPFIR-25 provided with continuous illumination channel, an integrated direct vision display system, an integrated target designation system for the selected type of missiles, a moving target indication channel and a built-in joint check device;

- analog computer АВМ-25;

- heat direction finder ТП-26Ш1;

- equipment for objective check of the process of conducting an aerial combat throughout all its stages;

(3) the armament system comprising four missiles Р-40Д furnished with the radar and heat seeking heads, four close combat missiles Р-60 (Р-60М) suspended from the outboard pylons instead of two missiles Р-40Д, units for coupling with the SAPFIR-25 airborne radar, launchers, adapters and the launch automatic control system;

(4) the СР0-2 aircraft transponder and aircraft interrogator BRONZA;

(5) airborne direction and target designation equipment 5Y15K-11 with radio receiving device BEKAS;

(6) integrated navigation and landing system POLJOT-1M consisting of:

- short-range radio navigation and landing system РСЕН-6С;
- aircraft automatic flight control system САУ-155ПДБ on aircraft МИГ-25ПЦ or САУ-155ПДБ on aircraft МИГ-25ПЦС coupled with the С-25 armament control system and equipment 5Y15K-11;
- twin directional/vertical gyro system СКВ-2НЛ-2;
- air data computer system СВС-ПН-5А;

(7) the test system, consisting of the ПАУ-473 gun camera and the TESTER-У3-Л recorder, intended for checking the crew actions and operation of equipment;

(8) ground means for preparing the complex for combat employment (integrated systems intended for the automated check of the airborne equipment serviceability, repair of the С-25 armament control system, checking and preparation of missiles).

The МИГ-25-40Д (МИГ-25-40ПС) complex cooperates with the following ground means:

- existing and perspective direction systems in the ground automatic control system network;
- radio aids system POLJOT.

*Part One*

**FLYING TECHNIQUE  
AND AIR NAVIGATION**

## Chapter 1

# AIRCRAFT AERODYNAMICS

### 1. AERODYNAMIC CHARACTERISTICS

#### 1.1. Aircraft Aerodynamic Configuration

Aerodynamic configuration of aircraft implies rational selection of configuration and geometrical dimensions of the wing, tail unit and fuselage, as well as their mutual arrangement to obtain the required flight performance and to provide flight safety in all flight operating conditions. Selection of the appropriate aerodynamic configuration is determined by the purpose of the aircraft, its tactical and technical specifications.

The aerodynamic configuration of the MiG-25M aircraft is selected with the view of meeting the requirements of supersonic aerodynamics to the maximum.

The aircraft is a monoplane with an all-metal fuselage, moderate sweep wing, low-set movable stabilizer, vertical tail of twin-finned layout and side air intakes.

The wing of the aircraft is a swept wing of a tapered shape in plan view. The wing sweepback amounts to  $42^{\circ}30'$  with reference to its leading edge and  $9^{\circ}30'$  with reference to its trailing edge. The wing aspect ratio amounts to 3.20.



The use of the moderate sweepback wing with relatively high aspect ratio ensures high lift coefficient in the take-off/landing conditions. Besides, this type of the wing makes it possible to increase its net volume for arranging the wing tanks.

High aerodynamic efficiency of the aircraft at supersonic airspeeds is ensured by a thin symmetrical profile with a sharp leading edge installed in the wing root section. Relative thickness of the profile amounts to 3.7% MAC.

To avoid early stalls at high angles of attack and subsonic airspeeds, the wing tips are made of high-lift cambered profiles with a relative thickness amounting to 4.7% MAC.

The relatively thin wing of moderate sweepback makes it possible to obtain good aerodynamic and maneuvering characteristics of the aircraft within a wide range of airspeeds and altitudes of flight.

For better longitudinal control at high angles of attack and subsonic airspeeds, the upper surface of the wing carries two stall fences having a relative height of 4% MAC.

To ensure adequate lateral dynamic stability, use is made of a wing with a dihedral angle of  $-5^{\circ}$ .

The lower surface of the wing carries the pylons for suspension of missiles.

The wing tips are provided with booms carrying anti-flutter weights.

The wing is provided with the flaps having a maximum angle of deflection of  $25^{\circ}$  at take-off and landing. Installed on the wing tips are the ailerons with a maximum angle of deflection of  $\pm 25^{\circ}$ .

Employment of high-wing monoplane configuration in combination with high-lift lateral air intakes and flat-wide fuselage, which does not require auxiliary fillets and fairings, entails minimum losses of aerodynamic efficiency of the aircraft.

The horizontal tail of the aircraft is a differentially controlled horizontal stabilizer with a sweep angle of the leading edge amounting to  $50^{\circ}22'$ . The differentially controlled stabilizer is designed to control the aircraft in pitch and roll.

The deflection angles of the stabilizer leading edges measured normally to the axis of rotation are:  $+12^{\circ}$  upwards and  $-33^{\circ}$  downwards.

The stabilizer consists of two halves. Each half rests by two bearings on a boom arranged in the tail section of the aircraft fuselage.

The stabilizer axis of rotation has a sweep angle of  $45^{\circ}$  and passes through a point corresponding to 33% MAC.

The stabilizer shape (in a plan view) is manufactured with a slight cut of the trailing edge. It is done to increase efficiency of anti-flutter weights and critical flutter speed. The angle between the stabilizer tip chord and the aircraft plane of symmetry is equal to  $38^{\circ}$ .

To exclude the effect produced by the gas flow of the engines on the stabilizer hinge moments, its trailing edge in the root section is cut at an angle of  $15^{\circ}$  to the aircraft axis of symmetry.

For better longitudinal control and stability characteristics, the horizontal tail is brought beyond the zone of the maximum flow braking behind the wing and positioned 14% MAC below the wing. It leads to a certain increase of the longitudinal control efficiency within the whole range of Mach-number, as well as to a material backward displacement of the aircraft gross aerodynamic centre at high angles of attack and subsonic airspeeds.

The vertical tail is a swept-back type. It consists of two fins cambered out at an angle of  $8^{\circ}$  to the plane of symmetry. Such an arrangement prevents the rudder of the fin from the supersonic stall effect of the other fin, improves the tail fuselage lines, and decreases drag coefficient.

Besides, the vertical tail is made so as to exclude shading of the fins by the fuselage and to provide required efficiency of the stabilizer, which may be screened by the fin under certain conditions. The vertical tail leading edge sweep-back amounts to  $54^{\circ}$ .

The two-finned layout of the vertical tail provides perfect directional stability of the aircraft at high Mach-number with a certain excessive efficiency of the directional control at subsonic airspeeds.

To increase critical flutter speed at a minimum weight of the fins, the shape of the fins (in plan) has a deviation from a tapered one. The angle between the fin tip chord and fuselage datum line amounts to  $28^{\circ}30'$ .

To decrease drag coefficient, the fin is made of a set of modified profiles with a sharp leading edge. The relative thickness of the profiles is equal to 4 - 4.5%.

Installed at the bottom of the aft fuselage are two ventral fins acting as additional fins; the total area of the ventral fins amounts to 3.55 m<sup>2</sup>.

The rudders of the riveted structure are attached to the fins in three points. The rudder maximum angle of deflection normally to the axis of rotation amounts to  $\pm 25^\circ$ . To damper oscillation, each rudder is provided with a hydraulic damper located in the root section of the fin.

The fuselage of the MiГ-25M aircraft is a monocoque manufactured without fuselage-break joints by welding.

The fuselage nose section consists of two compartments: a radio transparent cone and a nose compartment. The assembled fuselage nose section is joined with the forward fuselage by means of attachment bolts.

The remaining part of the fuselage has a cross-section close to a rectangular shape. Arranged in the middle fuselage section are the integral tanks manufactured from stainless high-tensile steel.

The fuselage tail section accommodates two turbojet engines P15EM-300 supplied with air through lateral two-dimensional air intakes.

Installed at the bottom of the fuselage tail section are two ventral fins. Installed on the left ventral fin is a rod for automatic deployment of the drag chute. The drag chute is accommodated in the container arranged in the upper part of the rear fuselage.

The upper and lower surfaces of the fuselage tail section mount two air brakes, 2.3 m<sup>2</sup> in total area. The maximum angles of deflection of the lower and upper air brakes amount to  $45^\circ$  and  $43^\circ 30'$ , respectively.

At Mach-number equal to or less than 1.5, only the upper air brake is extended. Both air brakes are extended at Mach-numbers exceeding 1.5. The extension of the air brakes is automatically interlocked with the aid of a special Mach-number relay.

The air intakes of the aircraft are lateral, two-dimensional, with a sharp leading edge and variable geometry. The air intake geometry is controlled with the aid of high-lift

horizontal ramps. Employment of the system of three oblique and one normal shock waves ensures minimum losses of the engine thrust with the surge-free operation within a wide range of airspeeds and angles of attack.

The air intakes of this structure make it possible to increase the aerodynamic efficiency of the aircraft as well as to decrease excessive longitudinal static stability at supersonic airspeeds.

The air intake duct is of a rectangular shape within the zone of adjustable shutters and of a round shape at the engine inlet.

The air intake lip is sharp and is skewed downward and backward.

Variation of the air intake duct area and the total angle of air flow deceleration is accomplished by changing the position of the ramp front and rear shutters.

Up to Mach number  $M = 1.5$  the ramp is in the retracted position and uncontrollable. The ramp is controlled by the reduced engine RPM when the Mach number is more than 1.5 according to the linear law, making a correction with respect to the aircraft angles of attack.

For equalizing the velocity field, the provision is made for a turbulator mounted on the rear shutter of the ramp and a special duct for boundary-layer air bleed located between the fuselage and side slots of the air intakes. Boundary-layer suction is ensured due to the use of a perforated front shutter of the ramp.

The lower shutter (lip) of the air intake has two fixed positions and the automatic control linear program. To decrease the losses of the total pressure during take-off up to the moment the landing gear is retracted, the shutter is set to the lower position ( $20^\circ$ ).

After the landing gear is retracted, the shutter is automatically shifted to the second position and deflected upwards through  $3^\circ$ . During acceleration (at  $M > 1.9$ ) the shutter position is controlled automatically within the range of  $+3^\circ$  to  $+15^\circ$  with respect to the reduced engine RPM, making a correction by referring to the aircraft angle of attack.

## 1.2. Aerodynamic Characteristics of Aircraft

The aircraft flight performance is determined mainly by

a drag (required thrust) and available thrust value of the power plant.

Required thrust. The required thrust for a sustained level flight counterbalances the drag. Numerically it is equal to it:

$$P_{\text{req}} = Q.$$

Drag force  $Q$  is determined from the following formula:

$$Q = 0.7p_{\text{ram}} M^2 S c_x,$$

where:  $0.7p_{\text{ram}} M^2$  - is the ram;

$S$  - is the wing area;

$c_x$  - is a dimensionless drag coefficient depending on the aircraft geometry, Mach-number of flight and lift coefficient.

Coefficient  $c_x$  is equal to the sum of non-induced and induced drags. Components  $c_{x_0}$  and  $c_{x_{\text{ind}}}$  are of different physical nature. Coefficient  $c_{x_0}$  is a drag coefficient at zero lift. It takes into account the profile drag of friction and pressure. Coefficient  $c_{x_{\text{ind}}}$  is the induced drag coefficient taking account of an increment of the drag due to the lift. Hence, drag is divided into two components: induced and non-induced, i.e.

$$Q = Q_0 + Q_{\text{ind}}.$$

Magnitudes  $Q_0$  and  $Q_{\text{ind}}$  are determined from the following formulas:

$$Q_0 = 0.7p_{\text{ram}} M^2 S c_{x_0};$$

$$Q_{\text{ind}} = 0.7p_{\text{ram}} M^2 S c_{x_{\text{ind}}}.$$

Non-induced drag. It depends on coefficient  $c_{x_0}$  and ram.

Coefficient  $c_{x_0}$  practically depends on the Mach-number only (Fig. 1). At Mach-numbers being less than critical value ( $M < 0.85$ ), coefficient  $c_{x_0}$  remains constant, and for the МиГ-25ПД aircraft it is equal to 0.0258.

Due to the shock waves originating at the Mach-numbers higher than 0.85, coefficient  $c_{x_0}$  sharply increases. At the Mach-number of  $M = 1.15$ , coefficient  $c_{x_0}$  reaches its maximum value of 0.041. When the Mach-number continues increasing, the shock waves become oblique, their intensity diminishes, and coefficient  $c_{x_0}$  decreases.

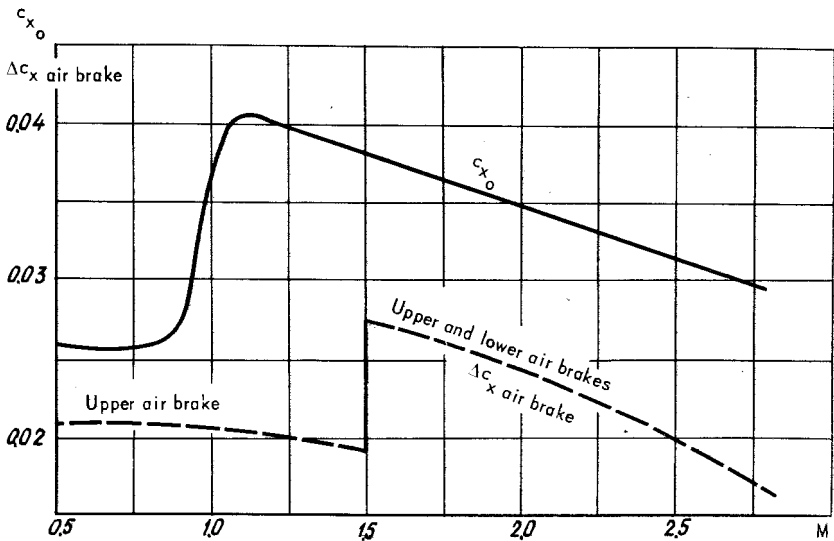

FIG. 1. NON-INDUCTIVE DRAG COEFFICIENT  $c_{x_0}$  VERSUS MACH NUMBER  
(aircraft carries no missiles and pylons)

Thus, until the shock stall appears, the non-induced drag increases proportionally to square of the Mach-number. The shock stall results in an intensive increase of  $Q_0$ . At supersonic airspeeds the rate of  $Q_0$  decreases due to the decrease of coefficient  $c_{x_0}$ . As the flight altitude increases, the non-induced drag diminishes proportionally to the atmospheric pressure.

Induced drag. The induced drag depends on the ram and coefficient  $c_{x_{ind}}$  which is determined from the following formula:

$$c_{x_{ind}} = A c_y^2.$$

The formula proves that  $c_{x_{ind}}$  depends on coefficient A and square of lift coefficient. Coefficient A, in its turn, is a function of Mach-number. In addition, at subsonic air-speed it depends on the wing aspect ratio and construction of the wing leading edge.

On the МГ-25ИИ aircraft at subsonic flow-past coefficient A remains constant and amounts to 0.175, while at supersonic flow-past it increases approximately proportionally to the Mach-number. It reaches its maximum value of 0.58 at the Mach-number of  $M = 2.8$ .

The induced drag in the level flight may be determined from the following formula:

$$Q_{\text{ind. } 1/f} = \frac{AG^2}{0.7P_{\text{ram}} M^2 S}$$

The formula proves that the induced drag in a level flight, with coefficient A being constant, decreases in inverse proportion to the square of the Mach-number. At supersonic flow-past, irrespective of an increase of inductance index A, value  $Q_{\text{ind}}$  continues diminishing but slightly, since the increase of the Mach-number produces greater effect than the increase of coefficient A.

As g-load increases, the induced drag increases proportionally to the square of g-load:

$$Q_{\text{ind}} = Q_{\text{ind. } 1/f} n_y^2.$$

As the flight altitude increases, the induced drag, all other things being equal, will also increase in inverse proportion to the atmospheric pressure.

Thus, the flight altitude and Mach-number produce an opposite effect upon the non-induced and induced drags. At low airspeeds and high altitudes the induced drag prevails within the total balance of drags, while the non-induced drag is a prevailing one at high airspeeds and low altitudes.

A boundary at which  $Q_0 = Q_{\text{ind}}$  is the most advantageous Mach-number. In this case, the total drag, and hence, the required thrust are minimum.

Relation between the drag and the flight speed at a given altitude plotted on the diagram is called the required thrust curve. Fig. 2. presents the required thrust curves of the МГ-25ИИ aircraft. The figure illustrates that the advantageous Mach-number increases together with the increase of the altitude (the curve minimum is shifted to the right).

The required thrust of the aircraft at the most advantageous Mach-number is minimum. The required thrust will increase no matter whether the Mach-number increases or decreases.

Within the subsonic range the most advantageous Mach-numbers for the МиГ-25ПД aircraft will correspond to indicated airspeeds of 500 to 550 km/h.

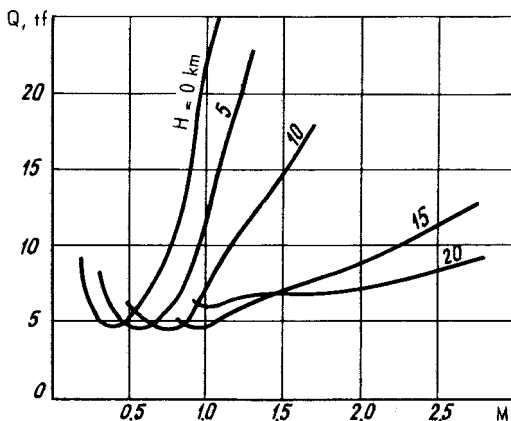

FIG. 2. REQUIRED THRUST CURVES Q

The required thrust curves are true for any ambient air temperature.

When flying the aircraft at low airspeeds it is necessary to remember that g-load unduly affects the required thrust due to a sharp increase of the induced drag during maneuvering.

The available thrust is the maximum thrust which may be obtained under specific flight conditions.

The available thrust should not be equated with the maximum test bench engine thrust since the engines mounted on the aircraft run under the specific arrangement conditions. These conditions may substantially differ from those of the engine being tested on a bench.

Available thrust  $P_{av}$  of two engines П15БД-300 installed on the aircraft, with the losses in the nozzles and ducts taken into account, is determined from the following formula:

$$P_{av} = (2P_{en} - \Delta P) (1 - \Delta \bar{P}_{int}) (1 - \Delta \bar{P}_{noz}),$$

where:  $P_{en}$  - thrust of one engine;

$\Delta P$  - additional thrust losses due to an inlet pulse of incoming air;



$\Delta \bar{P}_{\text{int}}$  - air intake internal thrust losses;  
 $\Delta \bar{P}_{\text{noz}}$  - nozzle thrust losses.

The thrust losses depend on the power setting of the engines, as well as on flight altitude and airspeed. The total sum of the losses may amount to 500 - 1000 kgf. The available thrust curves for two engines with the losses taken into account are presented in Fig. 3.

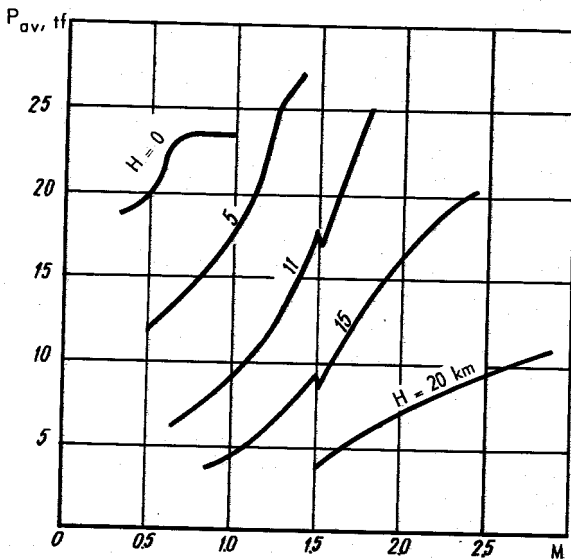

FIG. 3. AVAILABLE THRUST CURVES  $P_{av}$

At the estimated power settings of the engines within the operational range of airspeeds the thrust increases together with an increase of the Mach-number and decreases as the flight altitude increases.

The decrease of the ambient air temperature with reference to the standard one by 1% entails the decrease of the thrust by 2% approximately.

At altitudes less than 6000 m and high indicated airspeeds the engine thrust at augmented power settings is limited by the capacity of the afterburner fuel pumps. This phenomena is

determined by a typical sharp bend plotted on the available thrust curves.

At  $M = 1.5$  the REHEAT II (II ПОРЦАЖ) power setting is selected. This process is accompanied by a thrust drop followed by its more intensive rise.

### 1.3. First and Second Flight Regimes

For a sustained flight it is necessary to observe the equality of forces acting on the aircraft:

$$P = Q \pm G \sin \theta,$$

where:  $P$  - is the engine thrust;  
 $Q$  - is the aircraft drag;  
 $G \sin \theta$  - is the component of the aircraft weight (with sign "+" at climb and with sign "-" at descent).

In a sustained level flight this equation is as follows:  
 $P = Q.$

The balance of forces may be steady or unsteady; depending on it there are the first and second flight regimes.

At a certain altitude, with the throttle control lever fixed, the equation of the available thrust and drag takes place at two points which correspond to two values of the flight speed.

When throttling the engines, there comes a point where the equation of the available thrust and drag is at one point corresponding to an airspeed located on the boundary between the first and second flight regimes.

Depending on a position of the throttle lever the regimes of the sustained level flight are determined by the points of intersection of the required thrust curve with the respective curve of the available thrust. For example, when the throttle lever is set to a position corresponding to the engine RPM of 90%, the sustained level flight of the МиГ-25ИИ aircraft carrying four missiles is possible at two indicated airspeeds:

$V_1 = 740$  km/h and  $V_2 = 325$  km/h (points 1 and 2 in Fig. 4).

If the pilot maintains an indicated airspeed of 740 km/h at a constant altitude, a positive thrust excess appears in case the indicated airspeed inadvertently decreases. This positive thrust excess restores the initial flight speed. It proves that the flight is accomplished at the first regime.

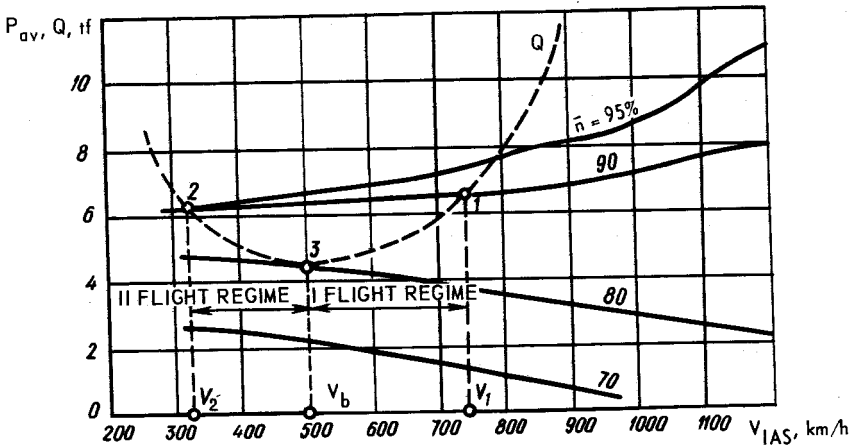

FIG. 4. CURVES OF REQUIRED AND AVAILABLE THRUSTS OF AIRCRAFT CARRYING FOUR MISSILES P-40.1 AT NON-REHEAT POWER SETTING (H = 5000 m)

Point 2 on the graph corresponds to the second regime, since the thrust excess, which entails further increase of the airspeed, arises as the airspeed exceeds 325 km/h. To maintain the initial flight speed, it is necessary to decrease the engine thrust first and then increase it, i.e. double displacement of the throttle lever will be required.

Point 3, at which the available thrust curve corresponding to the engine RPM of 80% touches the required thrust curve, is a boundary of the first and second regimes. The indicated airspeed at this point is equal to 500 km/h (boundary airspeed  $V_b$ ).

Thus, at an altitude of 5000 m and at indicated airspeeds exceeding 500 km/h the flight will be performed at the first regime, whereas at indicated airspeeds of less than 500 km/h it will be accomplished at the second regime.

The most advantageous airspeed, which amounts to 500 - 550 km/h for the ММГ-25ИИИ aircraft, may be considered with an adequate accuracy as a boundary dividing the first and second flight regimes. Thus, for the ММГ-25ИИИ aircraft the maneuvering speed at subsonic airspeeds is within the second flight regime.

The first and second flight regimes are typical not only for subsonic but also for supersonic airspeeds.

Possibility of the engine thrust control from the minimum to the full reheat has involved unstable equilibrium of the longitudinal forces, i.e. origination of the second regime of flight within the supersonic range of airspeeds at high altitudes and in the stratosphere.

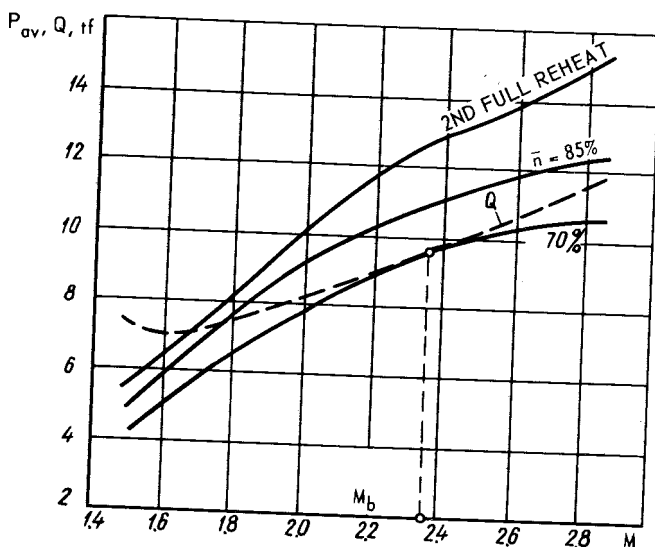

FIG. 5. CURVES OF REQUIRED AND AVAILABLE THRUSTS OF AIRCRAFT CARRYING FOUR MISSILES P-401 AT REHEAT POWER SETTING ( $H = 18,000$  m)

Fig. 5 illustrates the curves of the available thrust at various degrees of thrust augmentation and the required thrust curve of the MmT-25M aircraft carrying four missiles at an altitude of 18,000 m. The boundary of the first and second regimes is determined by the tangency point of the required thrust and the partial reheat thrust curves.

The subsonic second flight regimes are characterized by the following peculiarities:

(a) the flight is accomplished at high angles of attack, i.e. the less flight speed and the higher altitude, the greater angle of attack;

(b) variation of the airspeed at the sustained level flight generates a need for a continuous manipulation of the throttle levers and the aircraft control stick to maintain the preset flight regime;

(c) decrease of the airspeed during level flight results in a rapid increase of drag and further progressing drop of the airspeed;

(d) stability and controllability characteristics of the aircraft somewhat deteriorate.

The supersonic second regime characteristics possess the same peculiarities but they correspond to small angles of attack and high airspeeds, that is why they are not dangerous.

In flight practice the second regimes may develop in the following cases:

- an attempt to climb at a low speed or at an excessively great climb angle;
- pulling up the aircraft after passing the inner beacon;
- near non-reheat ceiling when performing maximum range or maximum endurance flight;
- a failure of one engine with the landing gear and flaps extended.

When flying at the second regime, more attentively check the airspeed and select it in due time by displacing the throttle levers. It is important not to allow an airspeed less than the maneuvering one (especially when performing steady turns), since in case of considerable loss of the airspeed its further recovery may become impossible due to absence of the thrust excess. In this case, to increase the airspeed it is required to bring the aircraft to the descent attitude which is somewhat dangerous at low altitudes.

#### 1.4. Range of Flight Altitudes and Airspeeds

The maximum and minimum airspeeds of a sustained level flight at a preset position of the throttle lever and at various altitudes may be judged by referring to the graph of the required and available thrust curves (Fig. 6). A sustained flight at a given altitude will be possible if the required thrust is equal to the available thrust.

The greatest airspeed at which these thrusts are equal is called as the **m a x i m u m a i r s p e e d** of the sustained level flight. Each power setting has its maximum airspeed.

As an altitude rises, the maximum airspeed increases and may exceed the maximum permissible speed.

An airspeed interval at which the sustained level flight is possible is assumed as the level flight airspeed range.

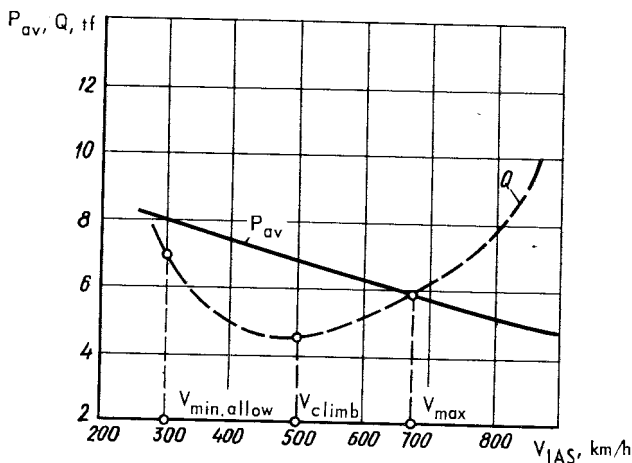

FIG. 6. CURVES OF REQUIRED AND AVAILABLE THRUSTS OF AIRCRAFT CARRYING FOUR MISSILES P-401  
(non-reheat power setting,  $n_{en} = 80\%$ ,  $H = 0$ )

For the МиГ-25ПД aircraft the level flight airspeed range is limited by the maneuvering indicated airspeed, selected from the conditions providing normal controllability when maneuvering, and the maximum permissible speed.

Fig. 7. presents the altitude and airspeed range of the МиГ-25ПД aircraft for various variants of external stores.

The maximum permissible indicated flight speed is limited with reference to the aircraft strength, as well as by a probability of flutter and it amounts to 1200 km/h to an altitude of 17,000 m.

The maximum Mach-number is limited with respect to thermal strength of the engines and it amounts to 2.83. For the same reason, the flight endurance at Mach-numbers exceeding 2.4 equals 15 min (at Mach-numbers  $M = 2.65$  it amounts to 5 min, maximum). The flight time at Mach-numbers of  $M = 2.4$  and less is not limited.

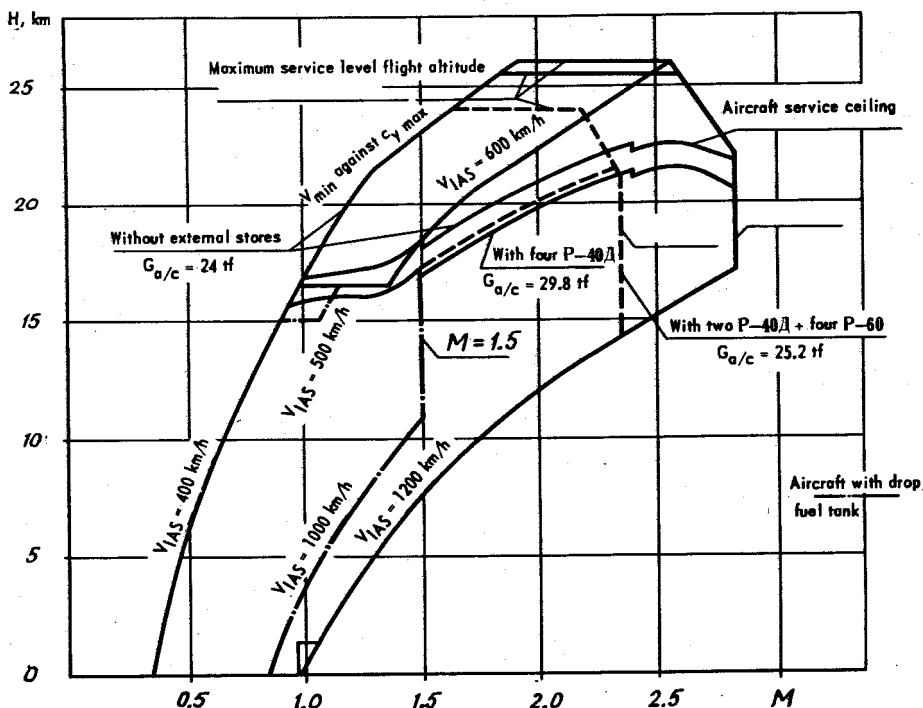

FIG. 7. ALTITUDE AND AIRSPEED RANGES OF AIRCRAFT МиГ-25ИИ

For the aircraft carrying two missiles P-40И and four missiles P-60 the maximum Mach-number is limited due to the stability and controllability considerations, and it amounts to 2.35.

The maneuvering indicated airspeed of flight, with the permissible variants of missiles carried, is equal to 400 km/h at altitudes up to 16,500 m and 600 km/h at altitudes over 16,500 m.

Additional airspeed limitations are established for the aircraft carrying the drop fuel tank. The maximum permissible indicated airspeed is 1000 km/h, maximum  $M = 1.5$ , and the maneuvering airspeed is equal to 500 km/h at altitudes of 15,000 to 16,500 m.

The service ceiling of the aircraft carrying four missiles P-40И at the full reheat power setting is 21,500 m. In this case, the aircraft mass at the service ceiling equals 25,800 kg and the remaining fuel amounts to 3300 kg.

The minimum time of gaining an altitude of 20,000 m at  $M = 2.35$  is equal to 8.9 min for the aircraft carrying four missiles P-40Д and 8.7 min, when carrying two missiles P-40Д and four missiles P-60 (from the moment of the takeoff run).

### 1.5. Takeoff and Landing Characteristics of Aircraft МиГ-25ПД

The takeoff and landing characteristics are determined by the aerodynamic characteristics of the aircraft, its thrust-to-weight ratio, condition of the runway, as well as wind direction and velocity.

The thrust-to-weight ratio, in turn, depends on the aircraft mass, engine power setting, temperature and pressure of ambient air.

Takeoff characteristics. The basic takeoff characteristics are: the aircraft unstick speed and takeoff run.

The u n s t i c k s p e e d is a speed at which the sum of the lift force and vertical component of thrust counteracts the aircraft weight. Hence, the aircraft unstick speed depends on a takeoff mass, angle of attack and engine available thrust during takeoff.

Under standard atmosphere conditions unstick speed  $V_{unst}$  of the МиГ-25ПД aircraft is determined from the following formula:

$$V_{unst} = 14.4 \sqrt{\frac{G_{unst} - P_{av} \sin(\alpha_{unst} - \varphi_{en.set})}{c_{y\ unst} S}}$$

- where:  $G_{unst}$  is the aircraft weight at unstick moment ( $G_{unst} = mg$ );  
 $P_{av}$  is the engine available thrust;  
 $\varphi_{en.set}$  is the engine setting angle which is equal to  $40^\circ$ ;  
 $c_{y\ unst}$  is the aircraft lift coefficient with the ground effect taken into account (it is a function of the unstick angle and the flap deflection angle);  
 $S$  is the aircraft wing area which amounts to  $61.73 \text{ m}^2$ .

At an assigned angle of attack and constant available thrust, the unstick indicated speed depends only upon the aircraft takeoff weight.



The normal unstick speed of the ММГ-25П aircraft when taking off from the concrete runway is equal to 350 to 360 km/h without missiles and 360 to 370 km/h with missiles (four missiles P-40П or two missiles P-40П and four missiles P-60) at a pitch angle of 10 to 11°.

After unsticking the aircraft is stable, the effectiveness of the control surfaces is adequate. The takeoff procedure with permissible missile suspension variants has no peculiarities.

The takeoff run is a distance passed by the aircraft up to the moment of unsticking.

It depends on an average acceleration value during the takeoff run and on the unstick speed:

$$L_{\text{run}} = \frac{v_{\text{unst}}^2}{2j_{\text{av. acc}}}$$

The average acceleration value during the takeoff run is determined from the following formula:

$$j_{\text{av. acc}} = \frac{g}{G_{\text{av}}} [P_{\text{av}} - f_{\text{fr}} G_{\text{av}} - 0.25\rho S (c_{x \text{ run}} - f_{\text{fr}} c_{y \text{ run}}) v_{\text{unst}}^2]$$

where:  $G_{\text{av}}$  is the average weight during the takeoff run ( $m_{\text{av}}g$ );  
 $g$  is the free-fall acceleration;  
 $\rho$  is the air density;  
 $f_{\text{fr}}$  is the friction coefficient during takeoff running;  
 $c_{x \text{ run}}$ ,  $c_{y \text{ run}}$  are the coefficients of drag and lift of the aircraft during the takeoff run.

The takeoff run of the aircraft carrying no missiles when taking off from the concrete runway is 1100 m, while with four missiles P-40П it is increased by 150 m.

#### Effect of various factors on takeoff characteristics.

Proceeding from the above formulas it is evident that the takeoff characteristics are affected by:

- aircraft mass;
- angle of attack;
- engine power setting;
- temperature and pressure of ambient air;
- wind direction and velocity;
- condition and gradient of the runway.

Increase in the takeoff mass entails decrease in the average takeoff acceleration, increase in the unstick speed and takeoff run. The average takeoff acceleration decreases due to a drop of the thrust-to-weight ratio of the aircraft and increase of the friction forces.

With the engine average thrust being constant, an increase of the aircraft mass by 1% results in an increase of the takeoff run by 2% on the average.

An increase of the angle of attack during takeoff involves a rise of the lift force coefficient, and hence, a decrease of the unstick speed and takeoff run.

A delay in lifting the nose wheel and in creating the optimum takeoff angle results in the aircraft unstick at a greater speed and increase of the takeoff run.

A decrease of the angle of attack by  $1^\circ$  increases the takeoff run by 8 to 9%. That is the cause of the takeoff distance spread when taking off on one and the same aircraft under the same conditions. Comparatively small inaccuracies in maintaining the takeoff angle lead to a change of the takeoff run by 100 m and more.

The takeoff of the МиГ-25ПД aircraft is accomplished at the FULL REHEAT power setting, and at the maximum power setting in case of 50% fuelling.

The temperature and pressure of the outside air affect its density on which the engine thrust, coefficients of the aircraft drag and lift and hence the unstick speed and takeoff run depend.

As the temperature rises, the air density decreases and the unstick speed increases. Simultaneously, the engine thrust and average acceleration decrease. It entails an increase in the takeoff distance. In this case, variation of the engine thrust produces greater effect on the takeoff distance than on the unstick speed.

An increase of the atmospheric pressure leads to a rise of air density, decrease of the unstick speed, increase of the engine thrust and average acceleration. As a result, the takeoff run decreases.

An increase of the outside air temperature by  $15^\circ\text{C}$  or decrease of the pressure by 30 mm Hg results in an increase of the unstick speed by 2.5%. A decrease of the atmospheric pressure by 30 mm Hg or increase of the outside air temperature by  $10^\circ\text{C}$  from the standard values increases the takeoff run by 10%.

The wind changes the takeoff run. Irrespective of the wind velocity and direction, the unstick is performed at a definite airspeed. But the aircraft speed relative to the ground at the moment of the unstick at headwind is less, while at tail wind it is greater. Therefore, the takeoff run and time are less at headwind and are greater at tail wind than in still air.

Depending on the wind direction the unstick ground speed will change by value  $\pm U$  or its component directed along the runway centre line. Sign "plus" is taken at tail wind, and sign "minus" at headwind.

Generally, for calculating the takeoff time and run it is necessary to take into account wind velocity or its component directed along the runway centre line.

The formula for calculating the takeoff run will be as follows:

$$L_{\text{run}} = \frac{(v_{\text{unst}} \pm U)^2}{2j_{\text{av. acc}}}$$

The time of takeoff run at a wind can be determined from the formula:

$$t_{\text{run}} = \frac{v_{\text{unst}} \pm U}{j_{\text{av. acc}}}$$

Cross wind blowing at a speed of up to 10 m/s at an angle of  $90^\circ$  to the runway centre line practically does not affect the takeoff. Accomplishment of the takeoff at a cross wind of more than 10 m/s in speed has some peculiarities. It is dictated by the following reasons.

Cross wind initiates the cross-wind force which is counteracted by friction forces of the wheels during takeoff (Fig. 8).

The МиГ-25ПД aircraft has a well-developed vertical tail unit; therefore, the cross-wind force is applied behind the main wheels. It tries to drift the aircraft downwind and to turn it upwind, especially during the second half of the takeoff run with the nose wheel lifted. The pilot should counteract the moment created by the cross-wind force by applying the brakes and deflecting the rudders, i.e. he should try to keep the aircraft from turning upwind. The rudder margin of the МиГ-25ПД aircraft is enough for maintaining the direction at a cross-wind component of up to 15 m/s.

Since the cross-wind force is applied above the longitudinal axis, it tends to roll the aircraft. In this case, one landing gear leg is unloaded, while the other one is loaded. Friction forces ( $F_x$ ) of the wheels will change in magnitude and create a moment turning the aircraft nose downwind. Thus, this moment will try to weaken the moment of the crosswind force.

Depending on the nose wheel lifting rate and creation of the takeoff angle at a cross wind of more than 10 m/s, the magnitude of the above moments may considerably change.

When the angle of attack increases rapidly, the moment created by the friction forces of the main wheels rapidly decreases, and the aircraft experiences a turning moment. Besides, if the pilot fails to have a chance to deflect the ailerons when unsticking from the ground, the aircraft will experience a rolling moment.

Hence, when taking off with the cross-wind, the pilot should create the takeoff angle at somewhat slow rate. In this case, the unstick speed and takeoff running time slightly increase.

Slightly increased time of the takeoff run is required for the pilot not only for creating the takeoff angle of attack at a slow rate but also for trimming the aircraft with the aid of the aileron and rudders. Thus, a safe unstick of the aircraft from the runway and further climb are provided.

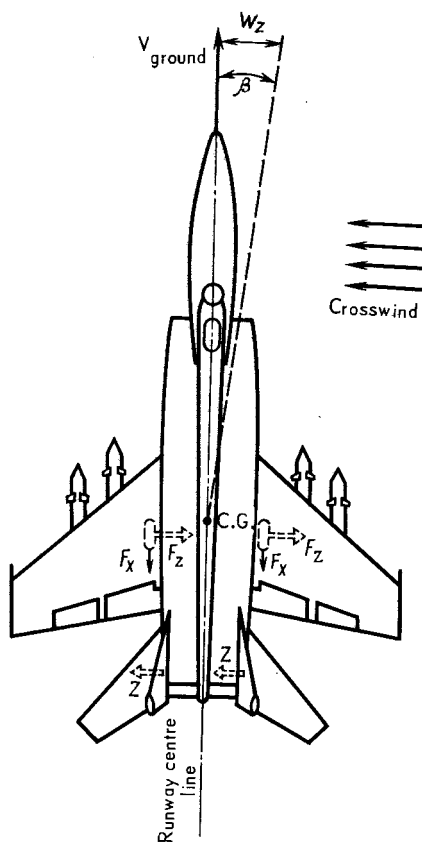

FIG. 8. ADDITIONAL FORCES AFFECTING AIRCRAFT DURING TAKEOFF AT CROSSWIND

Condition of the runway directly exerts an effect on the friction coefficient during takeoff. For the dry runway with concrete pavement the friction coefficient for calculations is equal to 0.03. An increase of the friction coefficient leads to a decrease of acceleration during takeoff, increase of the takeoff time and run when taking off and vice versa.

When taking off from the runway, having inclination angle  $\theta$ , an additional force, i.e. the longitudinal component of weight (it amounts to  $G \sin \theta$ ), will act along the aircraft longitudinal axis.

Due to this force the positive or negative acceleration (depending on an angle of inclination of the runway) is added to the horizontal takeoff acceleration. Hence, when the takeoff is performed downhill, the takeoff run and time decrease, while when it is accomplished uphill, they increase. It is necessary to notice that the role of the runway inclination increases as the aircraft mass rises.

Usually, the angles of inclination of the runway are rather small (1 to  $1.5^\circ$ ); their effect on the takeoff run can be disregarded since it is insignificant.

Landing characteristics. The major landing characteristics of the aircraft are the landing speed and landing roll.

The landing speed (in km/h) of the ММГ-25ПД aircraft is determined from the formula:

$$V_{\text{land}} = 14.4 \sqrt{\frac{G_{\text{land}}}{c_{y \text{ land}} S}}$$

where:  $G_{\text{land}}$  is the landing weight of the aircraft;  
 $c_{y \text{ land}}$  is the lift coefficient of the aircraft with the ground effect at the touchdown moment taken into account; it is a function of the landing angle and flap deflection angle.

At a normal landing profile the landing speed of the ММГ-25ПД aircraft (carrying no missiles) at a remaining fuel of 3000 kg and less amounts to 280 - 300 km/h.

The landing roll is one of the important characteristics affecting the selection of the optimum dimensions of the runway for the given type of the aircraft. It is determined from the following formula:

$$L_{\text{roll}} = \frac{v_{\text{land}}^2}{2j_{\text{av. roll}}}$$

The average deceleration rate during landing roll is determined as follows:

$$j_{\text{av.roll}} = \frac{1}{2} g \left( \frac{1}{K_{\text{av.roll}}} + f_{\text{fr}} \right),$$

where:  $g$  is a free-fall acceleration;  
 $K_{\text{av.roll}}$  is the average efficiency at landing roll;  
 $f_{\text{fr}}$  is the rolling friction coefficient (for a dry concrete runway, it is equal to 0.03 without applying the brakes and 0.28 with applying the brakes).

The landing roll for the МиГ-25ПД aircraft in the standard atmosphere conditions with the remaining fuel of 3000 kg with employment of drag chute and application of the wheel brakes amounts to 800 m. When the drag chute is not used, it is equal to 1550 m.

Effect of various factors on landing characteristics.

The above formulas prove that the following factors exert an effect on the landing speed and roll:

- aircraft mass;
- outside air temperature and pressure;
- wind direction and velocity;
- landing angle;
- degree of employment of the deceleration means.

The effect produced by the aircraft mass on the landing speed may be followed by the change of a specific load on the wing which varies from 390 (at a landing mass of 24,000 kg) up to 470 kgf/m<sup>2</sup> (at an aircraft limit landing mass of 29,000 kg). At such a change of the specific load on the wing the landing speed of the aircraft will increase from 290 to 320 km/h.

Thus, as the aircraft mass increases, the landing speed increases and, hence, the landing roll distance increases, too. Approximately we may assume that a change of the landing weight by 1% involves a change of the landing roll distance also by 1%.

The air density and, hence, the landing speed will depend on the air temperature and pressure.

The landing speed and roll distance vary inversely with the air density, i.e. inversely as the pressure and directly as the temperature.

An increase of the outside air temperature by 15°C or decrease of the atmospheric pressure by 30 mm Hg from the

standard values will lead to the increase of the landing speed by 2.5% and the landing roll distance by 5%.

The effect produced by wind on the landing speed and roll distance is the same as on the unstick speed and takeoff run. When calculating the landing roll, the landing speed should be considered with wind taken into account;

$$L_{\text{roll}} = \frac{(v_{\text{land}} \pm U)^2}{2j_{\text{av.dec}}}$$

where:  $j_{\text{av.dec}}$  is the average deceleration rate in landing;  
 sign "plus" is taken at the tail wind, while  
 sign "minus" is taken at the headwind.

The deceleration rate during the landing roll depends on the lateral component of wind. The average deceleration rate decreases by 30 to 35% at a wind lateral component of 10 m/s with the drag chute used automatically. This decrease takes place due to the fact that it is impossible to use the brakes fully when maintaining the direction during landing roll. As a result of this the length of the braking portion of the landing roll increases and, hence, the total length of the landing roll increases.

The wind lateral component which amounts to 10 - 15 m/s increases the landing roll distance by 10 to 15%.

The aircraft angle of attack at the end of holding-off directly affects the landing speed and landing roll distance. A low landing speed corresponds to a high landing angle of attack and vice versa.

After touchdown the angle of attack should ensure the maximum total drag. The greater angle of attack during the landing roll, the greater drag, but the lesser pressure on the runway and frictional drag of the wheels.

When landing is performed into a wind or on a slippery runway, it is recommended to effect the landing roll with the nose wheel kept lifted as long as possible. In case of the down-wind landing and if effective braking is possible, it is necessary to lower the nose wheel earlier and start energetic braking.

The normal landing angle of the ММГ-25ИИ aircraft amounts to 10 - 11°.

The use of the braking means produces a decisive effect upon the landing roll distance.

To shorten the landing roll distance, the МиГ-25ПД aircraft employs the drag chutes and brake system of all the wheels.

At high landing speeds the drag chutes offer great effect; they decrease the landing roll distance by 40 to 50%.

The speed of the wheel braking start of the aircraft is limited by 235 km/h. Therefore, on the first portion of the landing roll braking is effected due to the drag and deployment of the drag chutes, while on the second portion, due to the effective use of the brakes.

A delay in applying the brakes in speed by 15 km/h (braking is started at a speed of 220 km/h) will increase the landing roll distance by 100 m.

## 2. AIRCRAFT MANEUVERING CHARACTERISTICS

### 2.1. General

Depending on the stability and controllability characteristics, as well as available normal g-loads permitted by the strength conditions, the МиГ-25ПД aircraft is a semi-aerobatic one.

The m a n e u v e r a b i l i t y is an ability of the aircraft to change its attitude in space by varying the airspeed in magnitude and direction during a definite time.

Finally, the characteristics of various maneuvers depend on what accelerations may be imparted to the aircraft in flight. Apart from the force of gravity which may either assist or hinder maneuvering, the accelerations are created by the same external forces as the g-loads. Therefore, the generalized indices of the aircraft maneuverability are the maximum possible (available) g-loads.

### 2.2. Available G-Loads

The magnitudes of the available g-loads and the range of operational airspeeds determine the possibility of performing the assigned maneuvers (aerobatics), as well as indices of these maneuvers (duration, radii, angular velocities, etc.).



Vertical g-load  $n_y$  is created by the lift.

If when flying at a given altitude and at a preset air-speed one uses the aircraft capabilities in creating the lift, a g-load is achieved which is called an available g-load:

$$n_y \frac{Y_{av}}{G} = \frac{0.7c_{y av} S p M^2}{G}$$

where:  $Y_{av}$  is the available lift force;  
 $G$  is the aircraft weight;  
 $c_{y av}$  is the available lift coefficient;  
 $S$  is the wing area;  
 $p$  is the pressure at the given altitude.

From the formula it is obvious that the available g-load should increase as the Mach-number increases. But it does not occur within the transonic speed region due to an abrupt drop of the lift coefficient (Fig. 9). Therefore, the available g-load decreases even though the Mach-number rises at these airspeeds (Fig. 10).

At great Mach-numbers  $C_{y max}$  practically remains constant and the available g-load increases as the Mach-number rises, but it is limited by the maximum deflection angle of the stabilizer.

As the altitude increases the available g-load decreases. It is proportional to air pressure at a preset Mach-number and with the weight being unchanged:

$$\frac{n_{y av 1}}{n_{y av 2}} = \frac{P_1}{P_2}$$

Proceeding from this relation, one can determine the available g-load for any flight altitude knowing its initial magnitude.

In all cases the g-load should not exceed the maximum g-load permitted by strength.

Fig. 11 illustrates the maximum and minimum permissible g-loads of the ММГ-25П aircraft depending on a remaining fuel.

When maneuvering at a vertical g-load exceeding  $lg$ , the ММГ-25П aircraft is stable in g-load until achieving the critical angle of attack. Pronounced buffeting precedes at-

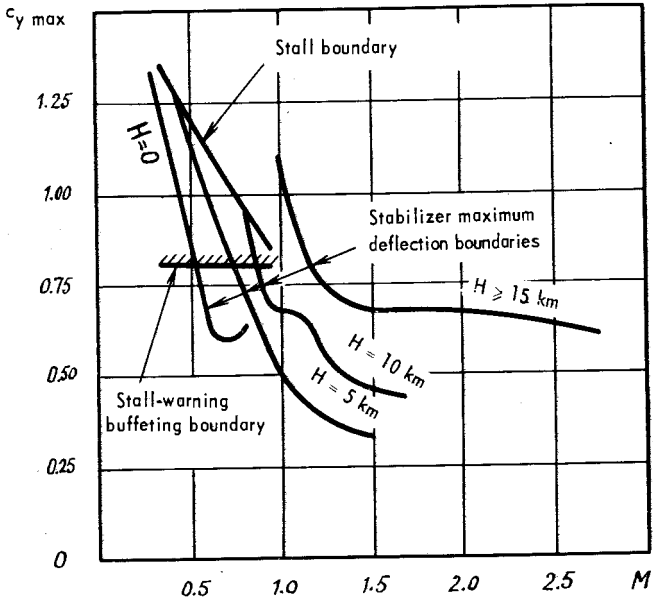

FIG. 9. MAXIMUM LIFT COEFFICIENT  $c_{y \max}$  VERSUS MACH NUMBER (aircraft carries four missiles P-40A)

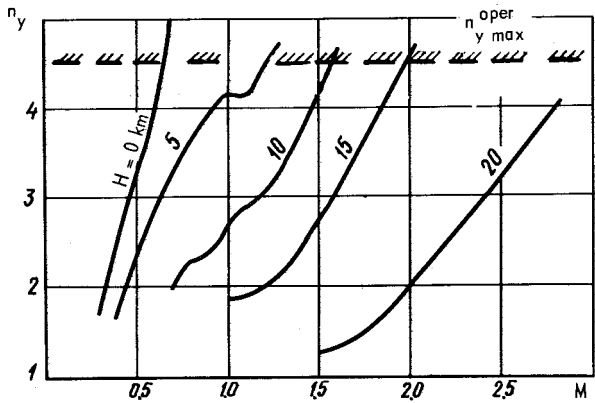

FIG. 10. AVAILABLE G-LOADS OF AIRCRAFT VERSUS MACH NUMBER AND ALTITUDE OF FLIGHT ( $G = 30 \text{ ft}$ )

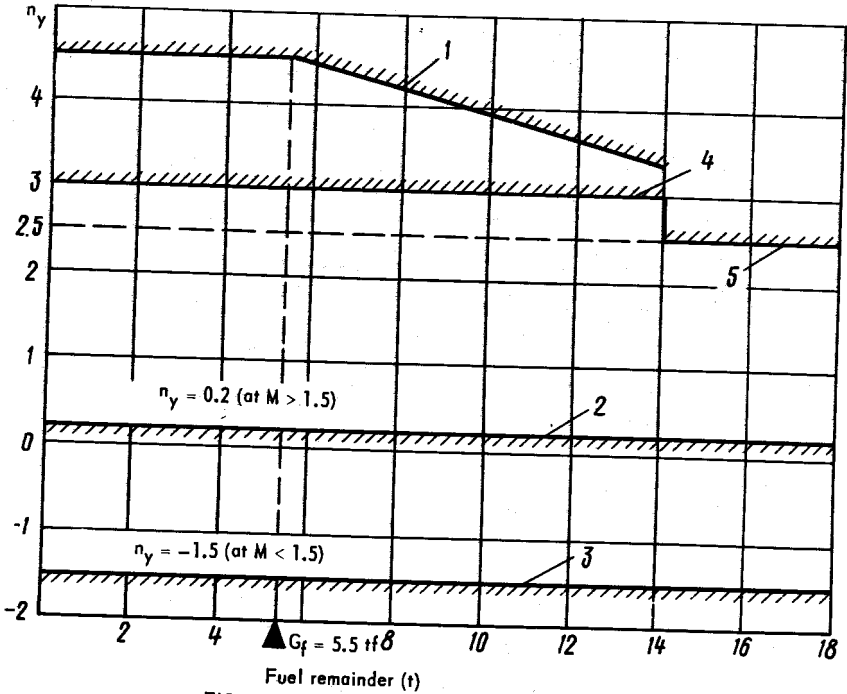

FIG. 11. MAXIMUM PERMISSIBLE G-LOADS  $n_y$

1 - aircraft without drop fuel tank; 2 - minimum permissible g-load at  $M > 1.5$ ;  
 3 - maximum permissible negative g-load at  $M < 1.5$ ; 4 - aircraft with empty  
 drop fuel tank; 5 - aircraft with fuelled drop tank

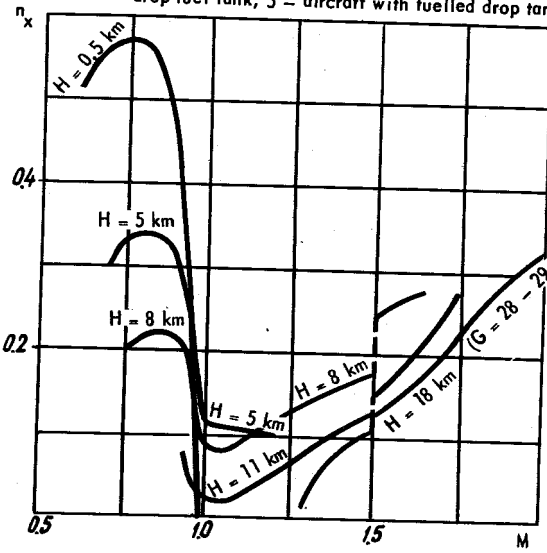

FIG. 12. LONGITUDINAL G-LOADS  $n_x$   
 IN ACCELERATION AT FULL  
 REHEAT POWER SETTING  
 (aircraft carries four missiles  
 P-40J,  $G = 34 \text{ tf}$ )

taining the critical angles of attack. In addition, when approaching the critical angles of attack, the yellow pilot lamp on the MN-155 g-load indicator lights up and the "Limit maneuver" voice information is delivered.

Longitudinal g-load  $n_{x \text{ av}}$  is obtained when the total available thrust is used in flight. For the level flight ( $n_y = 1$ ) it is determined from the following formula:

$$n_{x \text{ av}} = \frac{P_{\text{av}} - Q}{G} = \frac{\Delta P}{G},$$

where:  $P_{\text{av}}$  is the available thrust;

$Q$  is the required thrust;

$\Delta P$  is the thrust excess;

$G$  is the aircraft weight (mg).

The longitudinal g-load value depends on the flight mass, airspeed and altitude. Besides, the available longitudinal g-load is affected by the vertical g-load. The greater the vertical g-load (angle of attack), the greater the drag and, hence, the lesser the available longitudinal g-load.

With the aircraft mass being constant, the longitudinal g-load varies in compliance with the same law as the thrust excess (Fig 12). As the flight altitude increases, a decrease of the excessive thrust and longitudinal g-load within the subsonic speed region takes place, while the positive thrust excesses and positive longitudinal g-loads are originated within the supersonic region.

At a Mach-number of  $M = 1.5$  a jump of the longitudinal g-load occurs due to the selection of the REHEAT II (II ФОР-САХ) power setting.

The longitudinal g-load is mainly affected by the temperature of the ambient air. If it is higher than the standard, one, the available thrust at this altitude decreases and, hence, the longitudinal g-load drops. It leads to deterioration of the acceleration characteristics of the aircraft and its rate of climb.

### 2.3. Maneuverability of Aircraft in Horizontal Plane

Maneuverability of an aircraft in the horizontal plane is evaluated by referring to the characteristics of the 360-deg coordinated turn, acceleration and deceleration.

A 360-deg turn is a curvilinear flight of the aircraft in the horizontal plane with a turn through  $360^\circ$ .

If in the course of a 360-deg turn the bank angle and flight-path trajectory do not change, this banked turn is referred as a 360-deg steady banked turn. If it is performed without slipping, it is called as a 360-deg coordinated turn. The forces acting upon the aircraft during the 360-deg coordinated turn are shown in Fig. 13. The 360-deg banked turn is the basis of the curvilinear maneuvers in the horizontal plane.

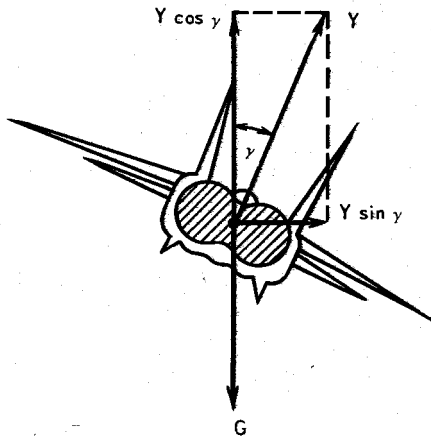

FIG. 13. FORCES ACTING ON AIRCRAFT IN  $360^\circ$  COORDINATED TURN

The 360-deg steady banked turn is characterized by the following relations:

1.  $P - Q = 0$  or  $n_x = 0$  (condition of the speed constancy);
2.  $Y \cos \gamma - G = 0$  or  $n_y \cos \gamma = 1$  (condition of the altitude constancy);
3.  $Y \sin \gamma = \text{const}$  (condition of the 360-deg banked turn constancy).

When performing the 360-deg banked turn the condition of the altitude constancy proves that  $n_y = \frac{1}{\cos \gamma}$ . Thus, g-load during the 360-deg coordinated turn depends on a bank angle. Quantitatively, this relation is presented in Table 1.

Bank $\gamma^\circ$	0	15	30	45	50	55	60	65	70	75	80	85
G-load $n_y$	1	1.04	1.15	1.41	1.56	1.74	2	2.37	2.92	3.86	5.76	11.47

Table 1 illustrates that the normal g-load required for the 360-deg banked turn first increases slowly (as the bank angle increases), and then it rises rapidly. As the bank angle approaches  $90^{\circ}$ , the g-load tends to infinity. But accomplishment of the 360-deg coordinated turn with an infinitely great g-load is impossible since an infinitely great thrust is required and due to the g-load limitations. Therefore, the МиГ-25ПД aircraft is able to perform 360-deg steady banked turns at bank angles of up to  $70^{\circ}$  at non-reheat and reheat power settings of the engines.

When on a 360-deg banked turn, as the bank increases, pull the aircraft control stick backward to increase the attack angle so that the g-load corresponds to the bank. Simultaneously with the increase of the attack angle it is necessary to increase engine thrust so as to preserve constancy of speed.

In the course of a 360-deg steady banked turn the outer half-wing moves at a greater wing tip speed than the inner one, and the centre of pressure is displaced from the plane of symmetry towards the outer side, thereby producing an additional rolling moment. Therefore, the pilot should maintain the bank angle and manipulate the controls in a coordinated manner so as to avoid slipping. The greater the bank angle, the more exactly it should be kept since at great bank angles even its minor increase requires great rise of the vertical g-load. For example, increase of bank during a 360-deg banked turn from  $70$  to  $75^{\circ}$  requires increase of the g-load nearly by unity.

If the pilot does not increase the g-load in compliance with the bank, the lift vertical component appears to be less than the aircraft weight, and the flight path starts deviating downwards. When the vertical g-load is increased up to the required magnitude, the drag may overcome the thrust force and the 360-deg banked turn will be accomplished with a loss of speed.

Hence, exact bank holding is most important when performing a 360-deg banked turn.

If the relation between the bank and g-load is other than that specified in Table 1, the 360-deg banked turn path will go upwards (at an excessive g-load) or downwards (at an excessive bank).

Thrust-limited 360-deg banked turns. Specific parameters of a 360-deg banked turn correspond to each magnitude of the available thrust at this or that altitude and airspeed of flight.

Increase of the bank angle (normal g-load) at a 360-deg coordinated turn should be accompanied by a growth of the aircraft lift which results in increase of drag. Increment in drag should be counteracted by increasing the thrust.

When the bank is being increased, the maximum available thrust of the engines will correspond to its certain magnitude.

Hence, the capabilities of the aircraft engines are the major limiting factor during performance of a thrust limited 360-deg banked turn.

Each airspeed and altitude value will be associated with definite bank angle and normal g-load values, which are also called thrust limited values.

If the pilot in performing a 360-deg banked turn pulls a g-load (banks the aircraft) in excess of the thrust limited value, the aircraft will lose speed even at full engine thrust. Therefore, the thrust limited g-load (bank) is the g-load (bank) involved in a continuous turn at the assigned airspeed.

The greater the available thrust, the greater will be the limit values of the bank angle and normal g-load.

Presented in Tables 2 through 5 are the characteristics of the thrust limited 360-deg turns under various conditions.

It is seen from the above tables that during engine operation at the MAXIMUM power setting within the entire range of altitudes and airspeeds of the MmГ-25ПД aircraft carrying four missiles (or carrying no missiles) with any fuel remainder the thrust limited normal g-load in a 360-deg turn will not exceed the maximum operational g-load. At FULL REHEAT power setting, with the aircraft proceeding at low and medium altitudes, the thrust limited normal g-load, depending on the fuel remainder, will reach the maximum operational value at indicated airspeed of 600 to 650 km/h, but at high altitudes and in stratosphere the thrust limited normal g-load does not exceed the maximum operational g-load.

The radius of a 360-deg banked turn (in m) is determined from the following formula:

Table 2

H, m	G <sub>f</sub> , kgf	V <sub>IAS</sub> , km/h																	
		550		600		650		700		750		800		850		900		950	
		n <sub>y</sub>	γ°	n <sub>y</sub>	γ°	n <sub>y</sub>	γ°	n <sub>y</sub>	γ°	n <sub>y</sub>	γ°	n <sub>y</sub>	γ°	n <sub>y</sub>	γ°	n <sub>y</sub>	γ°	n <sub>y</sub>	γ°
500	11500	2.32	64.0	2.40	65.0	2.47	65.7	2.54	66.4	2.62	67.5	2.70	68.3	2.78	69.0	2.86	69.5	2.96	70.5
	8500	2.52	66.0	2.62	67.0	2.73	68.5	2.84	69.5	2.94	70.3	3.04	71.0	3.14	71.7	3.22	72.2	3.30	72.6
	5500	2.70	68.0	2.86	69.5	3.01	71.0	3.16	71.7	3.28	72.5	3.40	73.3	3.51	74.0	3.60	74.4	3.66	74.5
	2500	2.92	70.0	3.12	71.5	3.30	72.5	3.47	73.5	3.64	74.4	3.77	75.0	3.90	75.5	3.99	75.8	4.03	76.0
2000	11500	2.00	59.3	2.14	61.5	2.26	63.0	2.35	64.3	2.41	65.0	2.37	64.2	2.30	63.5	2.20	62.4	2.07	60.0
	8500	2.23	62.5	2.38	64.5	2.52	66.0	2.63	67.5	2.70	68.2	2.70	68.2	2.62	67.2	2.49	66.0	2.36	64.3
	5500	2.48	66.0	2.66	67.5	2.82	69.0	2.95	70.5	3.04	71.0	3.05	71.0	2.97	70.6	2.86	69.5	3.67	67.7
	2500	2.72	68.3	2.94	70.0	3.11	71.5	3.26	72.5	3.37	73.0	3.40	73.4	3.32	72.7	3.18	72.0	2.96	70.5
5000	11500	1.38	40.0	1.60	50.5	1.74	54.0	1.70	53.0	1.62	51.0	1.49	47.0	+	+	+	+	+	+
	8500	1.54	48.5	1.84	56.0	1.98	59.0	1.98	59.0	1.92	57.5	1.82	55.5	+	+	+	+	+	+
	5500	1.73	54.0	2.05	60.0	2.22	62.5	2.25	63.0	2.22	62.5	2.18	62.0	+	+	+	+	+	+
	2500	1.93	58.0	2.26	63.0	2.47	65.5	2.50	66.0	2.53	66.5	2.53	66.5	+	+	+	+	+	+
8000	11500	1.19	28.0	1.26	33.0	1.27	33.5	+	+	+	+	+	+	+	+	+	+	+	+
	8500	1.36	39.5	1.43	43.5	1.45	45.0	+	+	+	+	+	+	+	+	+	+	+	+
	5500	1.52	48.0	1.62	51.0	1.65	51.5	1.60	50.0	+	+	+	+	+	+	+	+	+	+
	2500	1.69	53.0	1.80	55.5	1.83	56.0	1.78	55.0	+	+	+	+	+	+	+	+	+	+

Note. In Tables 2 through 5 sign "+" means that the performance of the thrust-limited 360-deg banked turn is impossible due to the thrust lack developed by the engines, while sign "X" designates that the accomplishment of the thrust-limited 360-deg banked turn is impossible due to exceeding the maximum permissible g-load ( $n_{y \text{ op max}}$ ).







Table 5

H, m	G <sub>f</sub> , gf	V <sub>IAS</sub> , km/h																									
		500		550		600		650		700		750		800		850		900		950		1000		1050		1100	
		n <sub>y</sub>	γ°	n <sub>y</sub>	γ°	n <sub>y</sub>	γ°	n <sub>y</sub>	γ°	n <sub>y</sub>	γ°	n <sub>y</sub>	γ°	n <sub>y</sub>	γ°	n <sub>y</sub>	γ°	n <sub>y</sub>	γ°	n <sub>y</sub>	γ°	n <sub>y</sub>	γ°	n <sub>y</sub>	γ°	n <sub>y</sub>	γ°
500	11500	2.45	66.0	2.70	68.5	3.05	70.5	X	X	X	X	X	X	X	X	X	X	X	X	X	X	X	X	X	X	X	X
	8500	2.70	68.5	3.00	70.5	3.35	72.5	X	X	X	X	X	X	X	X	X	X	X	X	X	X	X	X	X	X	X	X
	5500	3.00	70.5	3.30	72.5	3.75	74.5	X	X	X	X	X	X	X	X	X	X	X	X	X	X	X	X	X	X	X	X
	2500	3.40	73.0	3.70	74.0	X	X	X	X	X	X	X	X	X	X	X	X	X	X	X	X	X	X	X	X	X	X
2000	11500	2.30	64.0	2.60	67.5	2.85	69.5	3.15	71.5	X	X	X	X	X	X	X	X	X	X	X	X	X	X	X	X	X	X
	8500	2.50	66.5	2.85	69.5	3.15	71.5	3.45	73.0	X	X	X	X	X	X	X	X	X	X	X	X	X	X	X	X	X	X
	5500	2.80	69.0	3.15	71.5	3.50	73.5	3.85	75.0	X	X	X	X	X	X	X	X	X	X	X	X	X	X	X	X	X	X
	2500	3.10	71.0	3.50	73.5	3.90	75.0	X	X	X	X	X	X	X	X	X	X	X	X	X	X	X	X	X	X	X	X
5000	11500	2.10	61.5	2.30	64.0	2.50	66.5	2.70	68.5	3.00	70.5	3.20	72.0	X	X	X	X	2.65	68.0	2.55	67.0	2.50	66.5	2.45	66.0	2.40	66.5
	8500	2.30	64.0	2.50	66.5	2.70	68.5	2.95	70.0	3.30	72.5	3.60	74.0	X	X	X	X	2.90	70.0	2.80	69.0	2.75	68.5	2.70	68.5	2.65	68.0
	5500	2.55	67.0	2.75	68.5	3.00	70.5	3.20	72.0	3.65	74.0	X	X	X	X	X	X	3.25	72.0	3.10	71.0	3.05	70.5	3.00	70.5	2.95	70.0
	2500	2.85	69.5	3.10	71.0	3.35	72.5	3.70	74.5	X	X	X	X	X	X	X	X	3.65	74.0	3.45	73.0	3.40	73.0	3.35	72.5	3.30	72.5
8000	11500	1.65	53.0	1.85	57.0	2.10	61.5	2.30	64.0	2.35	65.0	1.85	57.0	1.80	56.0	1.90	58.5	1.95	59.5	2.00	60.0	2.05	61.0	2.10	61.5	2.15	62.5
	8500	1.85	57.0	2.05	61.0	2.30	64.0	2.50	66.5	2.60	67.5	2.05	61.0	2.00	60.0	2.05	61.0	2.15	62.5	2.20	63.0	2.25	63.5	2.30	64.0	2.35	65.0
	5500	2.00	60.0	2.25	63.5	2.55	67.0	2.80	69.0	2.85	69.5	2.25	63.5	2.20	63.0	2.30	64.0	2.35	65.0	2.40	65.5	2.50	66.5	2.55	67.0	2.60	67.5
	2500	2.25	63.5	2.55	67.0	2.85	69.5	3.10	71.0	3.20	72.0	2.55	67.0	2.50	66.5	2.55	67.0	2.65	68.0	2.70	68.5	2.80	69.0	2.85	69.5	2.90	70.0
11000	8500	+	+	1.65	53.0	1.40	44.5	1.35	29.5	1.45	46.5	1.50	48.0	1.60	51.5	1.70	54.0	1.85	57.0	1.95	59.5	2.10	61.5	2.15	62.5	2.20	63.0
	6500	+	+	1.75	55.0	1.50	48.0	1.45	46.5	1.55	50.0	1.60	51.5	1.70	54.0	1.80	56.0	1.95	59.5	2.10	61.5	2.20	63.0	2.25	63.5	2.30	64.0
	4500	+	+	1.90	58.5	1.60	51.5	1.55	50.0	1.65	53.0	1.70	54.0	1.80	56.0	1.90	58.5	3.10	61.5	2.25	63.5	2.35	65.0	2.40	65.5	2.45	66.0
	2500	+	+	2.05	61.0	1.75	55.0	1.70	54.0	1.80	56.0	1.85	57.0	2.00	60.0	2.10	61.5	2.30	64.0	2.45	66.0	2.60	67.5	2.65	68.0	2.70	68.5
15000	6500	+	+	+	+	+	+	+	+	+	+	1.15	29.5	1.30	40.0	1.50	48.1	1.65	53.0	1.80	56.0	2.00	60.0	2.15	62.5	2.15	62.5
	4500	+	+	+	+	+	+	+	+	+	+	1.25	37.0	1.40	44.5	1.60	51.5	1.75	55.0	1.95	59.5	2.15	62.5	2.35	65.0	2.35	65.0
	2500	+	+	+	+	+	+	+	+	+	+	1.35	42.0	1.55	50.0	1.75	55.0	1.90	58.5	2.10	61.5	2.35	65.0	2.50	66.5	2.50	66.5
18000	6500	+	+	+	+	+	+	+	+	+	+	1.05	17.0	1.15	29.5	1.30	40.0	1.40	44.5	1.55	50.0	1.55	50.0	1.40	44.5	+	+
	4500	+	+	+	+	+	+	+	+	+	+	1.10	24.5	1.25	37.0	1.40	44.5	1.55	50.0	1.65	53.0	1.65	53.0	1.50	48.0	+	+
	2500	+	+	+	+	+	+	+	+	+	+	1.20	33.5	1.35	42.0	1.50	48.0	1.65	53.0	1.80	56.0	1.80	56.0	1.60	51.5	+	+
20000	6500	+	+	+	+	+	+	+	+	+	+	+	+	1.05	17.0	1.10	24.5	1.05	17.0	+	+	+	+	+	+	+	+
	4500	+	+	+	+	+	+	+	+	+	+	+	+	1.15	29.5	1.20	33.5	1.15	29.5	+	+	+	+	+	+	+	+
	2500	+	+	+	+	+	+	+	+	+	+	+	+	1.10	24.5	1.25	37.0	1.30	40.0	1.25	37.0	+	+	+	+	+	+

$$r_{b.\text{turn}} = \frac{v_{b.\text{turn}}^2}{g \operatorname{tg} \gamma}$$

or

$$r_{b.\text{turn}} = \frac{v_{b.\text{turn}}^2}{g \sqrt{n_y^2 - 1}}$$

It is evident from the formulas that the higher speed on a 360-deg banked turn, the greater will be the radius and vice versa. At a constant airspeed the greater g-load (bank) is associated with the smaller radius of a 360-deg turn.

The time required for accomplishing a 360-deg banked turn is determined as a relation between the flight path length and speed of flight:

$$t_{b.\text{turn}} = \frac{2\pi r_{b.\text{turn}}}{v_{b.\text{turn}}} = \frac{2\pi v_{b.\text{turn}}^2}{g v_{b.\text{turn}} \operatorname{tg} \gamma} = 0.64 \frac{v_{b.\text{turn}}}{\operatorname{tg} \gamma}$$

or

$$t_{b.\text{turn}} = 0.64 \frac{v_{b.\text{turn}}}{\sqrt{n_y^2 - 1}}$$

It is more convenient to use the first formula when the bank angle is known, and the second formula when the g-load is known.

For the ММГ-25М aircraft, the turns and the 360-deg banked turns at high indicated airspeeds are characterized by the considerable time and radius required for their accomplishment.

Acceleration of the aircraft occurs under the action of positive thrust excess. The greater the thrust at a constant weight the faster will be acceleration.

Intensity of acceleration is characterized by the rate of longitudinal acceleration:

$$j_{\text{long}} = g \frac{P-Q}{G} = gn_x.$$

If acceleration takes place in the inclined plane, its intensity is affected by acceleration produced by the weight longitudinal component (positive acceleration in descent and negative one in climb).

Then the total acceleration is as follows:

$$j_{\text{long}} = gn_x \pm g \sin \theta = g (n_x \pm \sin \theta),$$

where:  $g$  is the free fall acceleration;  
 $\theta$  is the flight path angle of inclination.

The time of acceleration and the distance covered are determined by the following formulas:

$$t_{acc} = \frac{V_{end} - V_{start}}{j_{mean \text{ long}}}; S = V_{mean} t_{acc}.$$

Figs 14 and 15 present acceleration characteristics of the ММГ-25ПД aircraft carrying four missiles Р-40Д at the FULL REHEAT power setting for altitudes of 8 and 18 km, respectively.

The ММГ-25ПД aircraft has a great power-to-weight ratio and it may rather easily exceed the IAS and Mach-number limitations. Especially it is typical for altitudes of up to 5000 m. In level flight at these altitudes, with the engines running at the FULL REHEAT power setting, at an IAS of nearby 1000 km/h the speed increment amounts to 15 - 20 km/h for 1 s.

Behaviour of the ММГ-25ПД aircraft during acceleration within the entire range of the operation altitudes and air-speeds does not have peculiarities, but at  $M = 0.85$  to 1.15 the aircraft experiences a certain instability in speed.

Angle-of-attack stability (when exceeding  $M = 1$  during acceleration) materially increases due to considerable displacement of the aerodynamic centre backwards.

Deceleration of the aircraft is effected due to negative thrust excess which may be attained when disengaging the afterburners, throttling the engines at reheat and non-reheat power settings and extending the air brakes.

When extending the air brakes the aircraft trim somewhat varies. When only the upper air brake is extended, a nose-up moment appears, which may be counteracted by moving the control stick forward.

During deceleration when passing the sonic speed, a nose-up moment also arises, which results in spontaneous increase of the  $g$ -load with the control stick fixed. To keep the  $g$ -load constant within the specified range of Mach-number, push the control stick forward.

When flying at  $M > 2.2$ , it is prohibited to throttle the engines lower the MAXIMUM stop since unsteady operation of

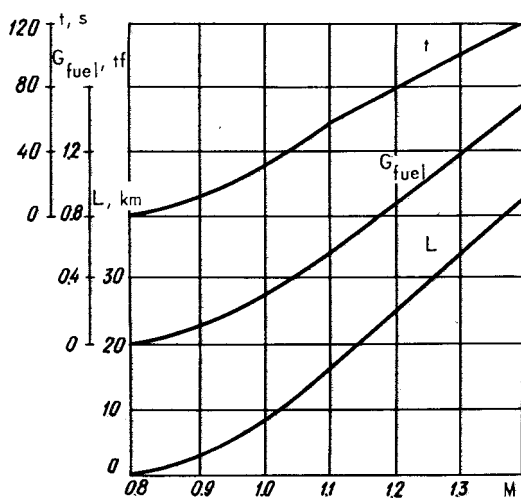

FIG. 14. ACCELERATION CHARACTERISTICS OF AIRCRAFT CARRYING FOUR MISSILES P-40 AT FULL REHEAT POWER SETTING  
( $H = 8000$  m,  $G = 30$  tf)

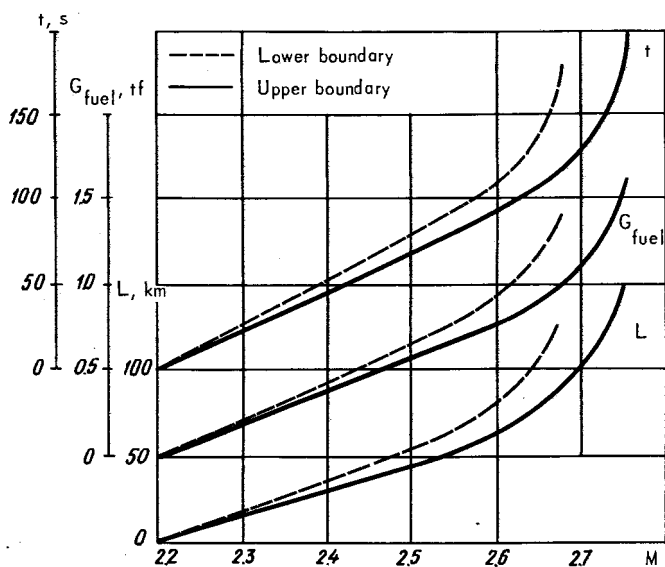

FIG. 15. ACCELERATION CHARACTERISTICS OF AIRCRAFT CARRYING FOUR MISSILES AT FULL REHEAT POWER SETTING  
( $H = 18,000$  m,  $G = 25$  tf,  $n_{en} = 100\%$ )

the air intakes and unsteady running of the power plant may occur. When flying at  $M < 2.2$ , it is allowed to throttle down the engines up to the IDLE (МАЛЫЙ ГАЗ) stop.

#### 2.4. Maneuverability of Aircraft in Vertical Plane

The major maneuvers in the vertical plane permitted for the МиГ-25ПД aircraft are: zoom, diving and chandelle.

Curving of the flight path in the vertical plane takes place as a result of the centripetal force affecting the aircraft:

$$R_{c.f} = Y - G \cos \theta,$$

where:  $Y$  is the aircraft lift force;

$G$  is the aircraft weight;

$\theta$  is the flight-path inclination angle.

The flight path curvature depends on a relation between the vertical g-load and cosine of the flight-path angle.

A zoom is a maneuver accomplished to reduce the time of climbing to the assigned altitude, as well as to intercept the targets flying at altitudes higher than that of the fighter.

When the engine thrust is less or equal to the drag, the aircraft gains the altitude only at the expense of kinetic energy, i.e. due to loss of the speed at the zoom.

The МиГ-25ПД aircraft enters the zoom from level flight by applying the maximum permissible g-load at the reheat power settings of the engines.

Upon attaining the assigned angle of zoom the pilot maintains it until the recovery speed is reached. The greater the zoom angle, the higher should be the speed of recovery.

Fig. 16 presents the zoom limit angles during the aircraft entry into the zoom at an airspeed close to the maximum permissible speed versus altitude of flight, while the indicated airspeeds of the zoom recovery are given in Fig. 17. In all cases, the recovery start speed is selected so as to bring the aircraft into the level flight at an airspeed which is not lower than the maneuvering one.

When the МиГ-25ПД aircraft performs zooms at limit angles with four missiles Р-40Д and without missiles, the altitude gain with the entry effected from altitudes of 500 to 1000 m amounts to 6000 - 6500 m and 2500 to 3000 m from altitudes of 17,000 to 17,500 m.

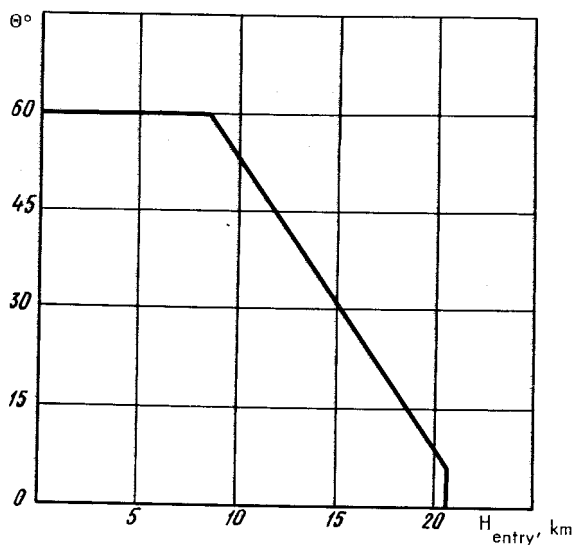

FIG. 16. LIMIT ZOOM ANGLES  $\theta$  VERSUS ALTITUDE OF FLIGHT (entry altitude  $H_{\text{entry}}$ )

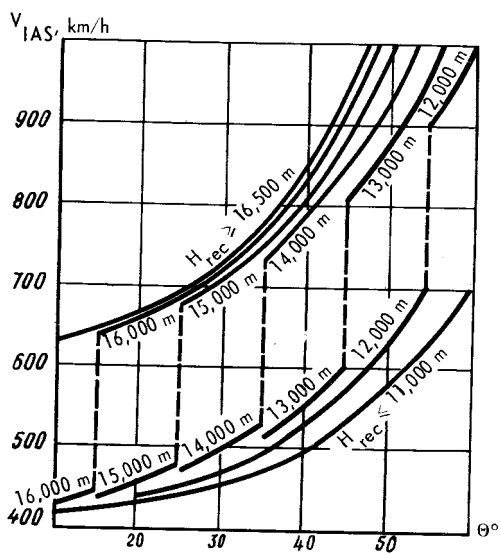

FIG. 17. INDICATED AIRSPEED  $V_{\text{IAS}}$  OF ZOOM RECOVERY INITIATION VERSUS ANGLE OF ZOOM  $\theta$  AND ALTITUDE OF RECOVERY INITIATION  $H_{\text{rec}}$



It is recommended to recover the aircraft from the zoom by making a 90-deg turn or two successive half-rolls. Straight-flight recovery from the maneuver is accomplished at low climb angles only.

A dive is used for intensive loss of the altitude and aircraft acceleration by transforming its potential energy into kinetic one.

The МиГ-25ПД aircraft may be brought into a dive at angles of up to  $45^\circ$  from a turn, with the engines running at idle power setting.

When carrying out practical calculations of the vertical maneuvers involving climbing to the assigned altitude, it is most important to determine loss of altitude during dive recovery, especially when the maneuver is terminated at low and extreme low altitudes (Fig. 18).

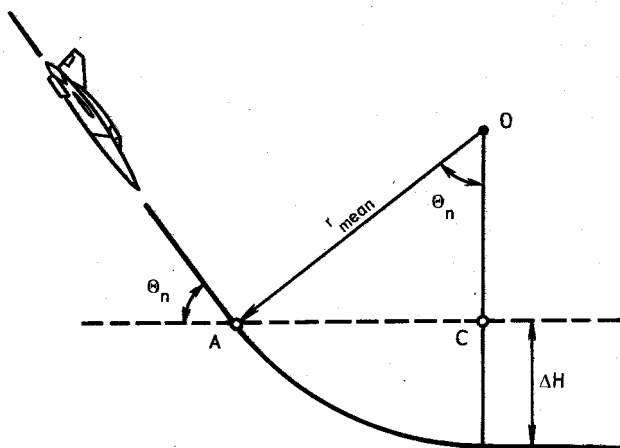

FIG. 18. DETERMINING LOSS OF ALTITUDE  $\Delta H$  DURING RECOVERY FROM DIVE

Curvature radius  $r_{\text{mean}}$  of the flight path at dive recovery may be determined from the following formula:

$$r_{\text{mean}} = \frac{v_{\text{aver}}^2}{g (n_{y \text{ mean}} - \cos \theta_{\text{mean}})},$$

where:  $V_{aver}$  is the average speed at dive recovery (it is assumed equal to the recovery start speed);

$\theta_{mean} = \frac{\theta_{dive}}{2}$  is the mean angle at dive recovery.

Loss of altitude during the recovery from a dive is determined from the formula:

$$\Delta H = r_{mean} - r_{mean} \cos \theta_{dive} = \frac{V_A^2 (1 - \cos \theta_{dive})}{g (n_{y mean} - \cos \frac{\theta_{dive}}{2})}$$

where:  $\theta_{dive}$  is the maximum dive angle;  
 $V_A$  is the recovery start speed.

It is evident from the formula that the lower the speed at the beginning of recovery and the greater the mean g-load, the lesser will be the loss of altitude during recovery from a dive.

The recovery from the dive of the МПГ-25ПД aircraft should be performed at an airspeed which is 100 to 150 km/h below the maximum permissible speed since energetic speed increment occurs in the course of dive recovery.

Aircraft recovery from a dive is effected at a maximum permissible g-load applied within 3 to 5 s.

When recovery from a dive is accomplished at an angle of  $45^\circ$  at altitudes of 3000 to 2500 m, altitude loss reaches 1500 m.

When recovering the aircraft from a dive with deceleration up to  $M \approx 1.0$ , the aircraft experiences "tuck-in" which is easily counteracted by applying the control stick forward.

### 3. AIRCRAFT STABILITY AND CONTROLLABILITY

#### 3.1. General

The aircraft s t a b i l i t y is an ability of an aircraft to maintain the preset flight regime independently without interference of the pilot.

The c o n t r o l l a b i l i t y is an ability of an aircraft to respond to deflection of the aircraft controls, i.e. to change the initial flight regime.

The stability and controllability are closely associated with each other and in practice both of them are judged by referring to one and the same criteria.

To ensure simple, handy and accurate piloting, the stability and controllability characteristics should be within the specified limits set forth for each type of the aircraft.

The aircraft stability is integrally connected with its trimming, i.e. counteracting all the moments affecting the aircraft. Equilibrium is considered relative to three axes passing through the centre of gravity and in this connection equilibrium is divided into equilibrium about pitching axis, equilibrium about rolling axis and equilibrium about yawing axis.

Under the action of various factors (atmospheric turbulence, accidental deflection of the control surfaces followed by their recovery, etc.) the aircraft equilibrium may be disturbed.

An ability of the aircraft to create stabilizing moments tending to restore equilibrium disturbed are referred as *s t a t i c s t a b i l i t y*.

Equilibrium is not restored gradually since it is associated with the aircraft oscillation which results in the inertia and damping moments. At a certain combination of these moments the aircraft may not restore its equilibrium. In case of adequate damping the aircraft oscillation is damped rapidly and the initial equilibrium is restored. An ability of the aircraft to restore the initial equilibrium is usually called the *d y n a m i c s t a b i l i t y*.

When analyzing stability and controllability, the motion of the aircraft is divided into longitudinal and lateral ones. In some particular cases there is an intimate cooperation between these motions. In this case such conventional division is impermissible.

### 3.2. Longitudinal Stability and Controllability

Aerodynamic forces and moments of the aircraft longitudinal motion are determined by an angle of attack (g-load) and flight airspeed. Under the action of various disturbing factors upon the aircraft, the above parameters vary in flight: an angle of attack (g-load) changes more rapidly than an airspeed. Since these parameters vary in a different way and not simultaneously, it is very important to know how the aircraft responds to a change of each of them. The aircraft

longitudinal stability is distinguished respectively by angle-of-attack and speed stability.

Angle-of-attack stability. The aircraft is considered stable in the angle of attack if in case the longitudinal stability is disturbed it has a tendency to retain the initial flying regime g-load at a constant airspeed without pilot's interference.

Angle-of-attack stability is determined by a position of the aircraft aerodynamic centre relative to the aircraft C.G. position. If the aerodynamic centre is behind the aircraft C.G., the aircraft is stable in the angle of attack since in case of inadvertent variation of the attack angle, aerodynamic forces and their moments occur. These forces and moments contribute to the restoration of the initial attitude (Fig. 19, a). If the aerodynamic centre is ahead of the C.G.,

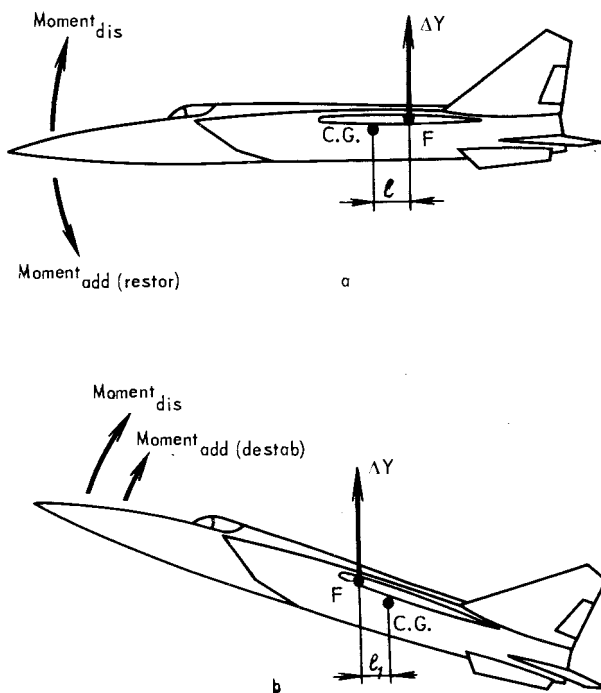

FIG. 19. AIRCRAFT ANGLE-OF-ATTACK STABILITY

a - steady aircraft; b - unsteady aircraft

the aircraft is unstable in angle of attack since in case the longitudinal equilibrium is disturbed a destabilizing moment arises. This moment contributes to greater deviation of the aircraft from the initial attitude (Fig. 19, b).

The major criterion used for evaluating the longitudinal stability of the aircraft is the angle-of-attack longitudinal static stability margin which determines the distance between the aerodynamic centre and the aircraft C.G. expressed in per cent (fractions) of the wing mean aerodynamic chord (MAC):

$$\bar{X}_{c.g.} - \bar{X}_F,$$

where:  $\bar{X}_{c.g.}$  and  $\bar{X}_F$  are the co-ordinates of the aircraft C.G. and aerodynamic centre, respectively, expressed in relative unities: fractions or per cent of MAC.

If the angle-of-attack stability minimum margin is negative and it is within a range of 3 through 12 to 15 per cent MAC, the aircraft is considered stable and controllable.

The position of the aerodynamic centre of the  $M_{\text{M}}\Gamma-25\Pi\Pi$  aircraft carrying four missiles P-40\Pi (with the engines running) versus Mach-number is presented in Fig. 20. It is evident from the chart that the aircraft flying within the range of the subsonic airspeeds (up to  $M = 0.8$ ) has a minimum angle-

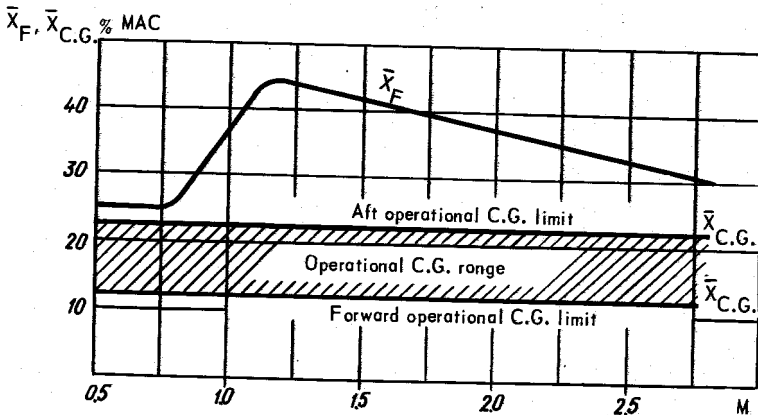

FIG. 20. DISPLACEMENT OF GROSS AERODYNAMIC CENTER  $X_F$  VERSUS MACH NUMBER OF FLIGHT (the aircraft carries four missiles P-40\Pi, with engines running)

of-attack stability margin (2.25 per cent MAC). It proves that the aircraft stability within these airspeeds is insufficient.

In further increase of the Mach-number the minimum angle-of-attack stability margin essentially increases due to considerable displacement of the aircraft aerodynamic centre backward. At  $M = 1.2$  the minimum angle-of-attack stability margin may reach 23.5 per cent MAC which indicates that there is an excess of the angle-of-attack stability margin. Within the range of high supersonic speeds due to a wing twist and increase of lifting ability of its root section the aerodynamic centre starts moving forward and the angle-of-attack stability margin decreases. At  $M = 2.8$  it amounts to 8.5 per cent MAC.

It is necessary to take into account that the actual angle-of-attack stability margin is considerably higher than the minimum one, since takeoff of the aircraft carrying a great amount of fuel and flight within the range of subsonic speeds with great fuel remainders result in increase of actual angle-of-attack stability margin up to 8 - 10 per cent MAC.

Engagement of the pitch damper also entails increase of the angle-of-attack stability margin which is experienced by the pilot by increase of the required deflections of the control stick when pulling a g-load.

The minimum angle-of-attack stability margin with the pitch damper engaged in the pre-landing gliding conditions at aft C.G. operational limit amounts to 2.8 per cent MAC.

Variation of the angle-of-attack stability margin with due account for fuel utilization at subsonic speeds, with the pitch damper engaged, is shown in Fig. 21.

It is evident from the above said that the МиГ-25ИД aircraft carrying permissible external stores or carrying no external stores features adequate angle-of-attack stability within the entire range of operational airspeeds and altitudes of flight. This fact proves the nature of trimming ratios of stabilizer deflection versus lift coefficient at constant Mach-numbers (Fig. 22). Negative inclination of the curves proves that the aircraft possesses adequate angle-of-attack stability.

Jettison of missiles carried by the МиГ-25ИД aircraft results in increase of the angle-of-attack stability margin both due to displacement of the aircraft C.G. forward and due to

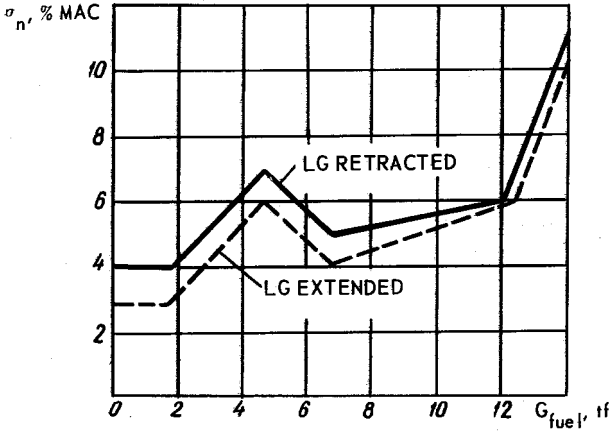

FIG. 21. VARIATION OF AIRCRAFT ANGLE-OF-ATTACK STABILITY MARGIN  $\sigma_n$  WITH FUEL UTILIZATION TAKEN INTO ACCOUNT  
 (pitch damper is engaged, aircraft carries four missiles P-40.1,  $M_{\text{act}} = 0.8$ )

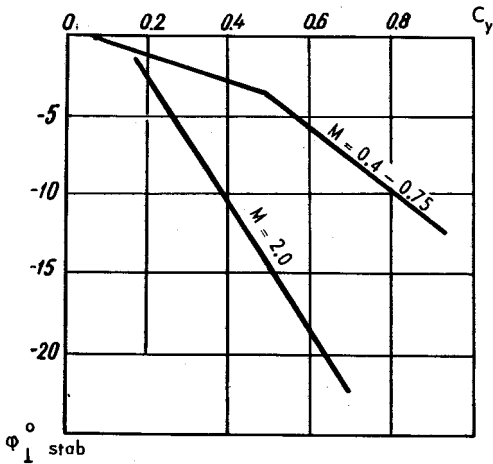

FIG. 22. STABILIZER DEFLECTION TRIMMING DEPENDENCE ON LIFT COEFFICIENT. AIRCRAFT CARRIES FOUR MISSILES P-40.1  
 ( $\bar{X}_{\text{C.G.}} = 19\% \text{ MAC}, G = 30 \text{ tf}$ )

displacement of the aerodynamic centre backward. In this case an additional nose-down moment is originated, which is counteracted by deflecting the control stick backward.

Velocity stability. The aircraft is considered to be stable with respect to velocity if it tends to maintain the initial airspeed of flight independently, without interference of the pilot.

The velocity stability is determined by the nature of lift variation with respect to airspeed: if the lift force grows as the flight airspeed increases and vice versa, the aircraft features adequate velocity stability.

The aircraft possesses velocity stability if in level flight as the airspeed increases, the control stick deflects forward to ensure longitudinal trim (decrease of pull forces or increase of push forces). If the pilot has to pull the aircraft control stick backward (as the airspeed increases in the level flight to provide longitudinal trim (increase of pull forces or decrease of push forces), the aircraft features inadequate velocity stability.

The aircraft velocity stability may be judged by the curves illustrating relation between the stabilizer deflection angles versus Mach-number and the altitude of flight (Fig. 23). It is evident from the curves that the ММГ-25П aircraft features adequate velocity stability within the entire range of operational altitudes and airspeeds of flight except  $M = 0.85$  to  $1.15$  where an insignificant instability occurs which does not practically exert an effect on piloting technique in the level flight.

Velocity instability within the given range of flight airspeeds is explained by energetic displacement of the aerodynamic centre backward which creates a nose-down moment. In this case the aircraft trimming is disturbed and the aircraft starts decreasing an angle of attack. It results in decrease of the lift force coefficient. As a result, irrespective of the speed increase the lift force decreases and the aircraft starts descending, tending to increase the airspeed more materially.

When the Mach-number decreases from  $1.15$  to  $0.85$  the aerodynamic centre will move forward, the aircraft will experience a nose-up moment which increases the angle of attack. As a result, the aircraft starts climbing and loses airspeed



more materially. Thus, within the range of  $M = 0.85$  to  $1.15$  the МиГ-25ПД aircraft has a minor velocity instability.

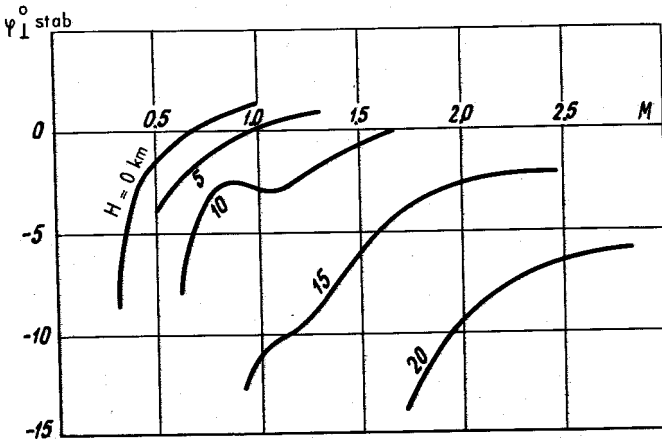

FIG. 23. DIAGRAM OF STABILIZER DEFLECTION ANGLES  $\psi_{st}$  REQUIRED FOR STRAIGHT-AND-LEVEL FLIGHT VERSUS MACH NUMBER. AIRCRAFT CARRIES FOUR MISSILES P-40Д ( $\bar{x}_{C.G.} = 19\%$  MAC,  $G = 30$  tf)

The disturbed motion of the aircraft instable in velocity in contrast to the aircraft which features inadequate angle-of-attack stability always develops slowly and the pilot has enough time to interfere with the aircraft control and counteract the disturbances originated by an appropriate deflection of the control stick. Experience proves that small degrees of velocity instability involve some difficulties for the pilot in the process of tight flying only and practically they are not always noticed by the pilot during ordinary control of the aircraft.

But during deceleration of the МиГ-25ПД aircraft a speed "pick-up" may occur when passing the sonic speed range, which results in increase of the g-load even if the control stick is fixed. A speed "pick-up" is caused by:

(a) abrupt decrease of the angle-of-attack stability margin during deceleration due to displacement of the aero-

dynamic centre forward in the course of transition from the supersonic wing flow to subsonic one;

(b) restoration of the stabilizer effectiveness at Mach-numbers less than 1.0 (local supersonic zones disappear on the stabilizer surface);

(c) barometric instrument indication lag and, hence, the pilot response lag during transition from the supersonic speeds to the subsonic speeds of flight.

The "pick-up" intensity is determined by a rate of the aircraft deceleration and magnitude of the vertical g-load during deceleration when  $M = 1.0$  is being passed.

When the aircraft is being decelerated in the level flight and descent, the effect of the speed "pick-up" practically is not evident. The pilot of the МиГ-25ПД aircraft clearly senses the "pick-up" effect when recovering from a dive with deceleration up to  $M = 1$ .

In case of excessive back stick pressure during entering into or recovering from vertical maneuvers, energetic maneuvering (chandelle, banked turn) performed within the range of the subsonic airspeeds of flight, the aircraft may experience a stall "pick-up" as inadvertent increase of the g-load with the control stick fixed.

The nature of this effect consists in that when the aircraft attains the above-mentioned flight regimes the outer wing tip stall occurs. As a result, the aerodynamic centre displaces forward and is found to be ahead of the aircraft C.G., thus motivating the angle-of-attack instability and inadvertent tendency for increase of g-load by 1.5 to 1.7 per second.

Undue detection of this effect may result in excess of the g-load exceeding the permissible value for 2 to 3 s. Therefore, to avoid the stall "pick-up", control the aircraft by smooth coordinated motions, taking care not to overpull the control stick (to avoid the supercritical angles of attack) and constantly follow the readings of the ИИ-155 g-load indicator.

The pilot should also account for peculiarities of operation of the АРУ-9 automatic transmission radio controller. When the airspeed increases from 400 to 700 km/h the stabilizer deflection angle decreases in the same position of the control stick, and vice versa, when the airspeed decreases

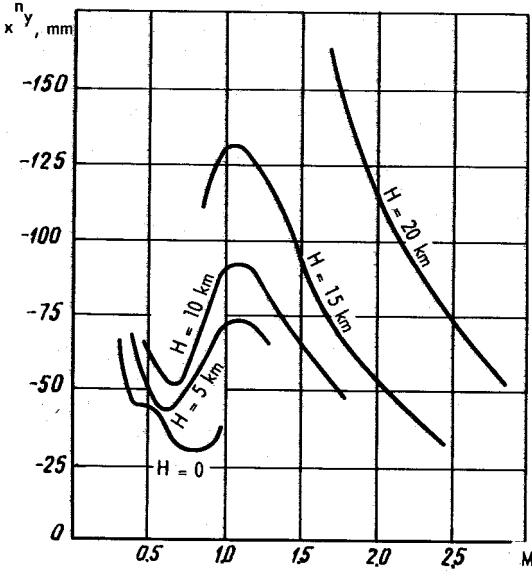

FIG. 24. DIAGRAM OF STICK TRAVEL  $x^ny$  REQUIRED FOR PRODUCING G-LOAD OF 1G VERSUS MACH NUMBER. AIRCRAFT CARRIES FOUR MISSILES P-40I ( $\bar{x}_{C.G.} = 19\% MAC, G = 30 \text{ tf}$ )

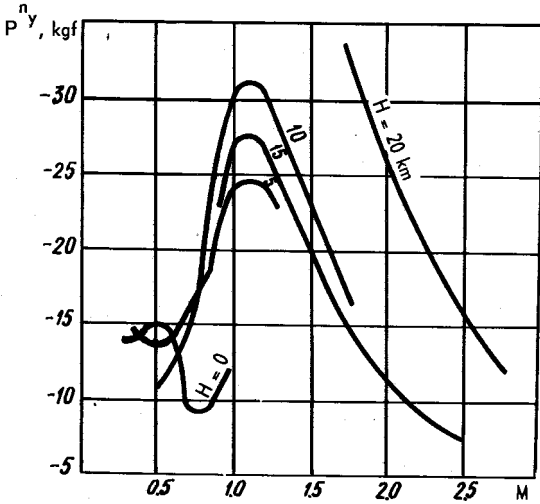

FIG. 25. DIAGRAM OF STICK FORCE  $P^ny$  REQUIRED FOR PRODUCING G-LOAD OF 1G VERSUS MACH NUMBER. AIRCRAFT CARRIES FOUR MISSILES P-40I ( $\bar{x}_{C.G.} = 19\% MAC, G = 30 \text{ tf}$ )

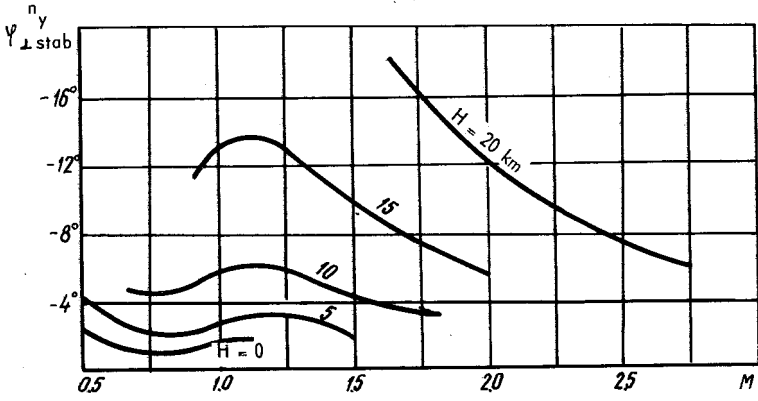

FIG. 26. DIAGRAM OF STABILIZER DEFLECTION ANGLES  $\psi_{\Delta \text{stab}}^{n_y}$  REQUIRED FOR PRODUCING G-LOAD OF 1G VERSUS MACH NUMBER. AIRCRAFT CARRIES FOUR MISSILES P-40I ( $\bar{X}_{C.G.} = 19\% \text{ MAC}$ ,  $G = 30 \text{ tf}$ )

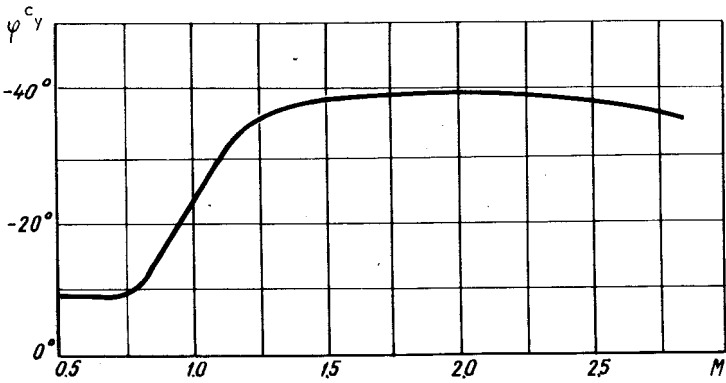

FIG. 27. VALUE  $\psi^c$  VERSUS MACH NUMBER (aircraft carries four missiles P-40I)

from 700 to 400 km/h the stabilizer deflection angle increases (at altitudes from 0 to 6000 m). Therefore, when maneuvering in the range of indicated airspeeds from 400 to 700 km/h, with the control stick fixed in the back position, the stabilizer deflection angles will increase with the reduction of the airspeed and, hence, the angle of attack will also increase reaching the critical values under certain conditions. In this case, the more is the control stick back travel the greater is the stabilizer deflection angle and the greater is the angle of attack.

Maneuvering with high g-loads at the above-mentioned airspeeds and flight altitudes and failure in making allowance for the mentioned peculiarities specified by the operation of the APY-9 controller may result in aircraft stalling and entry into a spin.

Therefore, as the airspeed decreases under the above-mentioned conditions, the pilot should timely and energetically apply the forward stick, checking the amount of g-load and precluding aircraft buffeting.

Longitudinal controllability. The more stable the aircraft with reference to g-load, the greater deflections of the control surfaces and forces are required to recover the aircraft from equilibrium and vice versa.

The basic characteristics of the aircraft longitudinal controllability are the relations between control stick travel  $x^ny$  and forces  $P^ny$  required for increasing the g-load per unity versus the Mach-number of flight (Figs 24 and 25). Both characteristics depend on effectiveness of the stabilizer under specific conditions of flight.

The peculiarity of the ММГ-25НД aircraft longitudinal controllability is a presence of great forces applied to the control stick in a number of the flight regimes, which are determined by the characteristics of the artificial feel unit and the APY automatic transmission ratio controller. Great forces applied to the control stick are selected so as to ensure flight safety at high indicated airspeeds at low and medium altitudes of flight. Decrease of forces applied to the control stick may result in inadvertent excess of strength-permitted g-load in a number of the flight regimes or undesirable hunting at high subsonic speeds and medium altitudes with the aircraft aft C.G. position.

When maneuvering at high supersonic speeds the time required for accomplishing the assigned maneuver is the determining factor since even at small forces (8 to 10 kgf) the pilot feels fatigue after 30 to 40 s. Therefore, even small forces applied to the control stick are recommended to trim out by means of the trimming mechanism.

Engagement of the pitch dampers increases the required deflections of the control stick when pulling the g-load. In so doing, the required forces also increase.

Depending on the flight conditions, stabilizer deflection angles  $\varphi_{1st}^{ny}$  and  $\varphi_{1st}^C$  required for increasing the g-load and lift coefficient by unity vary within the wide range (Figs 26 and 27). The particularly great variation of the required angles of the stabilizer deflection is experienced during transition from the subsonic speed to the supersonic one. This fact is explained by an essential increase of the angle-of-attack stability margin.

In the flight configuration (with the landing gear and flaps retracted) at  $M = 0.5$  to  $0.6$  the MiG-25III aircraft may experience the nearstall angles of attack at  $c_y \approx 0.7$ , whereas in the takeoff configuration (with the landing gear and flaps extended) the nearstall angles of attack will be attained at  $c_y \approx 0.78$  at the same Mach-numbers. Attaining the nearstall angles of attack is accompanied by perceptible stall-warning buffeting and great travels of the control stick.

At supersonic airspeeds of flight, attainment of great angles of attack and maximum available g-loads is impossible even at full deflections of the control stick backward.

Combination of the aerodynamic characteristics of the flat air intakes and the wing results in displacement of the aircraft aerodynamic centre at high supersonic airspeeds. Displacement of the aerodynamic centre forward decreases the magnitude of the longitudinal static stability margin at high supersonic airspeeds and compensates drop of effectiveness of the longitudinal control as the Mach-number increases. It enables the pilot to trim the aircraft at great angles of attack and obtain the high lift coefficient (0.5 - 0.6) at Mach-number close to the limit values.

Practically, the behaviour of the aircraft at low and medium altitudes, as well as during takeoff and landing does not differ from the behaviour of the aircraft of other types.

Launching of missiles, extension of the landing gear and flaps, variation of the engine power setting do not appreciably affect the longitudinal stability and controllability of the aircraft.

Extension of two air brakes at  $M > 1.5$  results in minor-nose-up moment.

At  $M < 1.5$  only the upper air brake is extended. When the upper air brake is extended at transonic airspeeds, vibration of the rudders may occur. It may be caused by unsteady local transonic flow between the fins. Therefore, it is prohibited to extend the upper air brake at altitudes lower 7000 m within the Mach-numbers of 0.85 to 1.1.

It is necessary to remember that under certain conditions the МиГ-25ПД aircraft may experience a longitudinal oscillation.

The longitudinal oscillation may occur when the missiles are launched separately at high altitudes and limit Mach-numbers at a g-load exceeding unity, as well as during automatic landing approach at altitudes lower than 50 m.

The cause of the longitudinal oscillation is a coincidence of the natural oscillation of the aircraft depending on an altitude and airspeed of flight, stiffness of the aircraft structure, degree of air turbulence and angle-of-attack stability margin with a frequency of the forced oscillation.

The forced oscillation may be initiated by abrupt motions of the control stick to counteract an inadvertent g-load pulse during extension of the air brakes, engagement and disengagement of the afterburner, sharp reduction of the engine RPM. As a consequence, afterserveral motions of the control stick the aircraft resonance longitudinal oscillation is originated which is characterized by a rapid growth of an amplitude and alternating vertical g-load. As a rule, this phenomenon appears suddenly for the pilot.

To avoid the longitudinal oscillation at a low angle-of-attack stability margin and high effectiveness of the stabilizer, restore the preset regime in airspeed (Mach-number) more gradually, do not manipulate the control stick and throttle levers abruptly, avoid extension of the air brakes and disproportionate motions of the control stick for counteracting the g-load.

If the longitudinal oscillation occurs, it is necessary to stop manipulating the control stick and fix it in the position which is close to the neutral one (trimming position).

Under the action of the available stability margin, the aircraft will make several decaying oscillations and restore the initial flight regime.

### 3.3. Lateral Stability and Controllability of Aircraft

The lateral movement of the aircraft is a combination of two rotary motions (relative to axes OX and OY) and one progressive motion (along axis OZ).

There is no separate rotation of the aircraft around longitudinal axis OX and vertical axis OY. These movements are interrelated and determine the lateral movement. In addition, interaction of these two movements depends on the aircraft angle of attack and Mach-number of flight.

Stability of the lateral movement is conventionally divided into the directional and lateral stability.

Directional stability. The aircraft is considered to feature adequate directional stability if it tends independently, without interference of the pilot, to restore the initial attitude in case the directional stability is disturbed.

The МиГ-25ПД aircraft is stable in direction within the entire range of the Mach-numbers. The forces and moments exerting an effect on the aircraft in case of disturbance of the directional stability are presented in Fig. 28. The figure illustrates that the restoring yawing moment, ensuring a static directional stability, is basically created by the aircraft fin. As a rule, the fuselage produces a distabilizing effect.

This is an angle of attack which affects the directional stability significantly. At high angles of attack the fin may be blanked by the fuselage and wing. It decreases the aircraft directional stability.

Besides, further deterioration of the directional stability is possible at great angles of attack since the fins come into the vortex zone formed due to pressure differential under the wing and fuselage and over them. The restoring moment from the fins decreases. But under these conditions the total



restoring moment of the aircraft will remain approximately constant at the expense of the false keels.

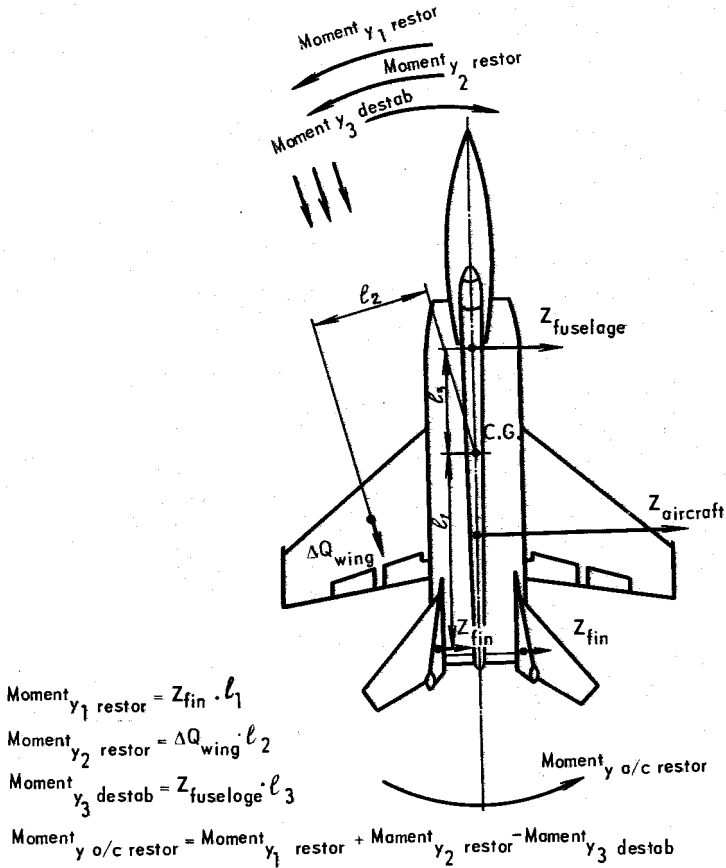

FIG. 28. FORCES AND MOMENTS ACTING UPON AIRCRAFT WHEN EQUILIBRIUM ABOUT YAWING AXIS IS DISTURBED

Generally, the directional stability of the МиГ-25ПД aircraft possessing a two-finned layout of the tail unit and false keels is not considerably affected by increase of the angle of attack.

The margin of the direction static stability is characterized by coefficient  $m_y^\beta$  (Fig. 29).

At subsonic speeds the directional static stability margin grows as the Mach-number increases, while at supersonic speeds

it smoothly decreases. Variation of the directional static stability margin is explained by the fact that as the Mach-number increases within the range of subsonic speeds, force  $Z$  of the vertical tail unit increases and considerably exceeds force  $Z$  of the fuselage, which creates the destabilizing moment. At Mach-numbers exceeding 1.2 to 1.3, force  $Z$  of the vertical tail unit starts decreasing, while force  $Z$  of the fuselage does not depend on the Mach-number and is nearly constant.

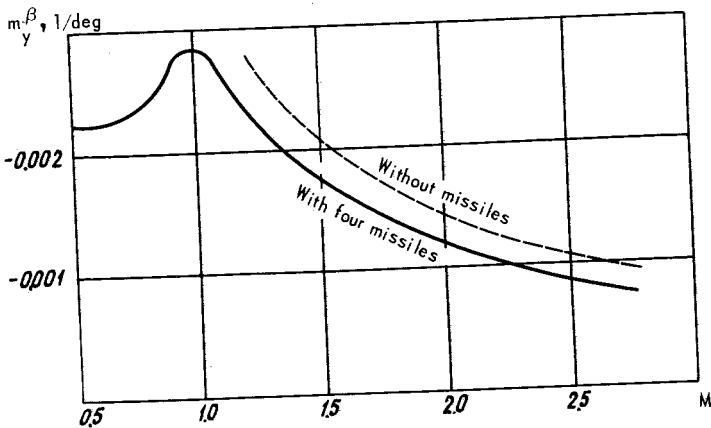

FIG. 29. STATIC DIRECTIONAL STABILITY COEFFICIENT OF AIRCRAFT VERSUS MACH NUMBER

Therefore, at  $M = 1.2$  to  $1.3$  the difference between the forces of the vertical tail unit and fuselage starts decreasing. In turn, it will result in decrease of the restoring moment and aircraft directional stability. At Mach-numbers exceeding 2.2 the restoring moment is smallest. Therefore, the pilot should check constantly to see that there is no slipping and to counteract it by deflecting the pedals, if required.

Rolling stability. The aircraft is considered to feature an adequate rolling stability if it tends independently, without interference of the pilot, to eliminate the inadvertent bank after disturbing a rolling-moment balance.

The МиГ-25ПД aircraft possesses an adequate rolling stability within the entire range of airspeeds and altitudes of flight.

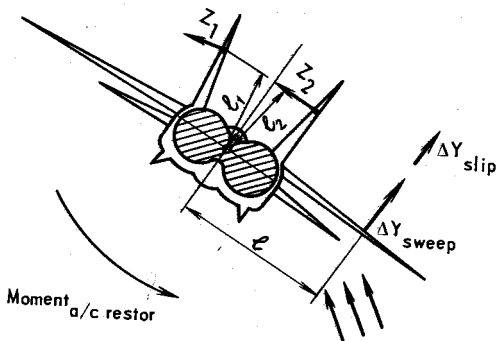

FIG. 30. FORCES AND MOMENTS ACTING UPON AIRCRAFT WHEN EQUILIBRIUM ABOUT ROLLING AXIS IS DISTURBED

Fig. 30 shows the forces and moments affecting the aircraft in case the rolling stability is disturbed. The figure illustrates that the disturbed rolling stability is restored under the action of the following moments:

- (a) moment of lift force increment  $\Delta Y_{slip}$  due to different conditions of flow over the half-wings;
- (b) moment of increment of lift force  $\Delta Y_{sweep}$  due to change of an effective sweep of the half-wings during slipping;
- (c) moment from a lateral force on the fins.

The determining factor for the aircraft with a swept wing is the restoring moment from the lift force increment due to variation of the half-wing effective sweep. The magnitude of this moment may be excessively high.

To obtain optimum rolling stability the wing of the МиГ-25ПД aircraft is provided with negative dihedral which amounts to  $-5^\circ$ . The margin of the rolling static stability is characterized by coefficient  $m_x^\beta$ , which changes directly with the angle of attack (Fig. 31).

The rolling static stability margin within the Mach-number range of  $M = 0.9$  to  $1.3$  is less than the directional static stability margin by 20 to 50 percent.

At  $M = 1.3$  to  $2.83$  the rolling static stability margin prevails over the directional static stability margin. It is proved by relation between  $m_x^\beta$  and  $m_y^\beta$  which is equal to  $1 - 2$ .

At supersonic airspeeds the aircraft responds to slipping (uncoordinated deflection of the rudder, asymmetric suspension

of missiles, etc.) in bank to a greater extent than at subsonic airspeeds. The rolling angular velocity will sharply increase with the growth of g-load.

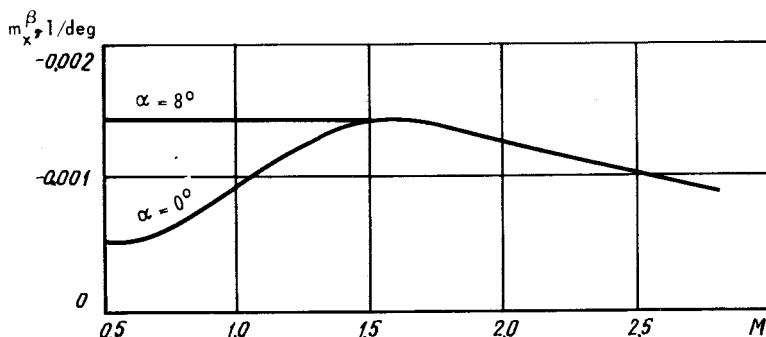

FIG. 31. AIRCRAFT LATERAL STATIC STABILITY COEFFICIENT  $m_x^\beta$  VERSUS MACH NUMBER

Effect of the directional and rolling stability margin on the aircraft lateral stability. Increase of the Mach-number considerably changes all aerodynamic characteristics and especially the magnitude of the relation between the directional and rolling static stability.

The magnitude of slipping angles and the behaviour of the aircraft under the action of lateral disturbances depend on the magnitude of the directional and rolling static stability margin. As it is known, the greater the rolling stability margin, the greater the angle of attack. At angles of attack close to zero the rolling stability margin numerically equals the directional static stability margin.

Since the flight at  $M > 2.0$  is performed at high altitudes, where angles of attack in level flight amount to  $3 - 6^\circ$ , the total margin of the rolling static stability, as the Mach-number increases, decreases more slowly than the directional static stability margin.

As the rolling stability decreases, the rolling oscillations occur. Their period and amplitude increase. The minimum magnitude of the rolling stability margin, ensuring flight safety at great Mach-numbers, corresponds to rolling oscillations with a period being not over 5 to 5.5 s.

Variation of the relation between the directional and rolling components of the lateral stability results in variation

of relation between the oscillation amplitudes of the aircraft roll and yaw rates in case of lateral disturbances. If the directional stability margin is higher than the rolling one by 2 to 3 times (at  $M \approx 1$  to 1.5), the lateral disturbances of the aircraft involve yawing; in this case the aircraft banking is insignificant. At a low directional static stability margin, when the lateral component becomes equal to the directional one or exceeds it, yawing is accompanied by oscillations in roll. In this case, a roll angle repeats variation of the slip angle with a certain delay.

At  $M > 2.0$  the presence of even small slip angles, corresponding to the lateral out-of-trim condition of 0.5 - 1 diameter of a ball, results in increase of the magnitude and rate of roll.

When the vertical g-load is being created, the slip angles increase due to gyroscopic torque, and the angular rates and roll angles increase, respectively.

As the flight altitude increases, the damping properties of air become weakened and therefore the rolling stability of the aircraft deteriorates.

To reduce oscillating motions at high altitudes and Mach-numbers, the use is made of the dampers of the CAV automatic flight control system. They deflect the control surfaces within a limited range proportionally to the applied disturbances.

At high altitudes and Mach-numbers exceeding 2.2, when creating the vertical g-loads of 2g and more with the dampers disengaged, the aircraft features increased roll response to the deflection of the rudders (creation of slipping). In this case, the roll is developed with a certain delay which is typical for high altitudes. Effectiveness of the ailerons decreases as the g-load increases; therefore, the aircraft vigorously rolls to the side which is opposite to slipping (to the side opposite to that of the ball drift). In case of asymmetrical thrust, the aircraft rolls to the side of the engine with lesser thrust.

The roll angular rate increases as the vertical g-load rate grows.

Proceeding from this, it is necessary to perform all the maneuvers coordinately, avoiding slipping. Prior to performing a maneuver, make sure that the aircraft is trimmed in direction with the aid of the rudder trimmer.

With the dampers engaged, the aircraft roll response to side-slipping considerably decreases. Therefore, flights at high altitudes and Mach-numbers exceeding 2.2. should be performed with the dampers engaged. It greatly facilitates the aircraft handling.

At altitudes less than 8000 m and high airspeeds the МиГ-26ПД aircraft displays an increased rolling stability margin.

Productional-technological asymmetry of some aircraft may cause an involuntary banking ("wingheaviness") at a rate of 6 to 8°/s when flying at altitudes of 3000 to 8000 m and indicated airspeeds over 850 km/h. As a rule, the aircraft experiences a left "wingheaviness".

In case the aircraft carries one missile or missiles are suspended asymmetrically, the aircraft is affected by the additional disturbances produced by the missile. Weight of the missile and its drag create the rolling and yawing moments towards the missiles. Besides, aerodynamic interaction of the missile with the pylon, wing, fuselage and tail of the aircraft involves an additional aerodynamic moment of rolling and yawing.

Magnitude of the aerodynamic moments, affecting the aircraft due to the missile relative to the longitudinal and vertical axes, depends on the flight altitude, Mach-number and vertical g-load. In this case, variation of the moments for the missiles arranged on the inboard and outboard pylons are not similar.

If the missiles are suspended symmetrically, the rolling and yawing moments experienced by the aircraft compensate for each other. Suspension of missiles results in deterioration of the aircraft maneuvering performances due to increase of moments of inertia and drag, as well as due to a certain loss of the directional stability margin.

When the missiles are launched separately, the aircraft is affected by a short-time rolling moment produced by the operation of the launched missiles motor and a constantly applied moment originated due to liftoff of one missile.

Lateral controllability of aircraft. To obtain adequate characteristics of lateral controllability within a wide range of airspeeds and altitudes, the МиГ-25ПД aircraft is provided

with a combined lateral control in all flight conditions (simultaneous control of the ailerons and the stabilizer deflected differentially).

When the control stick is deflected fully, the differential stabilizer is deflected through an angle of  $3^{\circ}15'$  at right angles relative to its hinge axis.

To improve the lateral controllability characteristics at high indicated airspeeds and low and medium altitudes, the APV-9B controller is installed in the aircraft control system roll channel.

The МиГ-25ПД aircraft features adequate controllability within the all flight conditions. But it is necessary to distinguish two major regions of the flight conditions where aerodynamic characteristics differ from the ordinary ones. These aerodynamic characteristics involve some peculiarities in flying the aircraft.

The first region is the region of high altitudes (over 15,000 m) and great Mach-numbers (over 2.0). It includes the major flight conditions typical for the МиГ-25ПД aircraft in which the flight of long duration is possible.

Increased requirements for the lateral trim in the flight at great Mach-number involve the necessity of a constant check of the position of the sideslip indicator ball. In case of sideslipping the pilot should counteract it by deflecting the rudders. Since the deflection of the pedals is associated with great forces to be applied to them, it is necessary to use the trimming mechanism to trim the aircraft.

To counteract the sideslipping moments, an additional aileron deflection is required. As the altitude increases, the aileron deflection required to counteract the sideslipping moments also increases.

Thus, to avoid undesirable roll oscillations, the flight at great Mach-numbers should be performed without sideslipping. When doing so, keep the ball of the sideslip indicator within the centre by actively applying the rudders. This requirements should be also fulfilled with the automatic control modes switches on, since no provision is made for stabilization of the sideslip angles (lateral g-load) by the CAV-155 automatic flight control system.

At high airspeeds the aircraft slowly gains the steady rotation regime. At the short-time deflections of the rudders

the angular velocities do not reach the maximum magnitudes. If it is required 1.5 - 2 s to create the assigned roll at an altitude of 5000 m, at an altitude of 18,000 m the same roll may be created during 5 to 8 s only.

Employment of the dampers at high altitudes and great Mach-numbers promotes damping of forced oscillations and provides for reasonable characteristics of controllability. Forces applied to the control stick, in this case, rather increase.

The second region is the region of altitudes less than 8000 m and high indicated airspeeds. It corresponds to the maximum g-loads applied to the aircraft.

The flights performed within this region are characterized by an increased rolling stability margin and decrease of the available roll rates.

The maximum magnitude of the available roll creation rates of the МиГ-25ПД aircraft is attained at altitudes up to 10,000 m and within the range of indicated airspeeds of 500 to 800 km/h, where the available roll creating range amounts to 150 - 170°/s with the control stick deflected fully (Fig. 32).

As the flight indicated airspeeds increase, the roll available rate decreases and reaches a minimum magnitude of 37°/s at an indicated airspeed of 1200 km/h within the altitude range of 0 to 500 m.

Decrease of the available roll rates is dictated by the following causes:

(1) Decrease of the aileron effectiveness. As the indicated airspeeds grow and dynamic heads increase, the elastic deformations of the wing and ailerons increase, wing twist to decrease the angle of attack occurs due to misalignment of the flexural centre and centre of pressure (the flexural centre is ahead of the centre of pressure).

Increment of lift on the wing with the lowered aileron will be less than as expected. As a result, the roll rate decreases when the ailerons are deflected through 1°.

Besides, the effectiveness of the ailerons decreases due to development of the shock stall at high flight speeds.

In this case the function of the differentially controlled stabilizer becomes the decisive one.



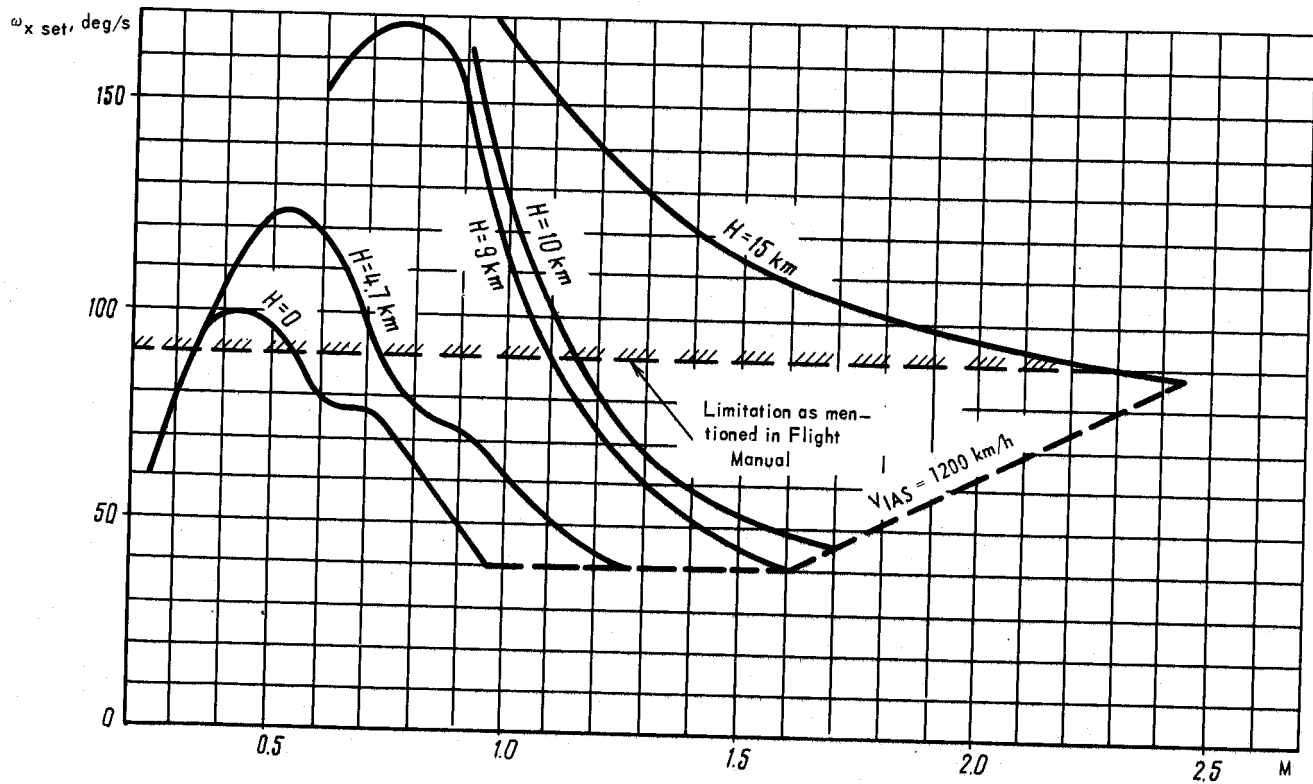

FIG. 32. MAXIMUM AVAILABLE AIRCRAFT RATE OF ROLL

(2) Decrease of the available aileron deflection angles. The available deflection angles of the ailerons at high indicated airspeeds are limited by the booster power.

For example, at altitudes up to 5000 m and indicated airspeeds exceeding 750 km/h the available aileron deflection angle amounts to  $12.5^\circ$ . As the flight altitude increases (with the constant Mach-number) and the Mach-number decreases (with the constant altitude), the available aileron deflection angles increase.

If, when flying at altitudes of 3000 to 8000 m and at an indicated airspeed which is close to the maximum permissible one a trimming deflection of the control stick in roll exceeds  $\pm 10$  mm, the aircraft should be trimmed on the ground by setting "misalignment" of the stabilizer halves. "Misalignment" of the stabilizer halves improves lateral controllability of the aircraft at high indicated airspeeds and does not affect the piloting technique during takeoff and landing.

At high indicated airspeeds within the altitude range of 5000 to 8000 m the effectiveness of the rudder is small in roll control. For example, at an altitude of 5000 m and at an airspeed of 1100 km/h the available rate of the rudders amounts to  $5 - 6^\circ/\text{s}$ .

Asymmetrical suspension of the missiles will result in additional deflection of the ailerons and rudders to counteract the roll and yaw moments.

When flying at  $M < 1.0$ , a minor deflection of the rudders is required to counteract these moments. As the Mach-numbers grow, the amount of deflection of the ailerons and rudder for trimming also increases. Within the range of  $M = 1.0$  to 2.4 the asymmetry on the outboard pylons produces greater effect on deflection of the rudders than asymmetry on the inboard pylons.

At  $M > 2.4$  the rolling and yawing moments produced by the outboard missile decrease, while those of the inboard missile increase, and asymmetry on the inboard pylons produces more greater effect on the trimming deflections of the rudders.

In case of asymmetry on the outboard pylons, the maximum trimming deflections of the ailerons and rudders correspond to flights at altitudes of 8000 to 12,000 m and at an indicated airspeed of 1200 km/h. Asymmetry on the inboard pylons when flying at  $M = 1.5$  to 1.6 does not involve great lateral out-

of-trim of the aircraft. As the Mach-numbers increase from 1.5 to 2.83, the rudder deflections required to counteract the yawing moments produced by the inboard missile increase and reach the maximum value at altitudes of 17,000 to 20,000 m and  $M = 2.83$ .

For instance, at  $M = 2.5$  the lateral g-load produced by the inboard missile (if not counteracted by the rudders) reaches  $0.3g$  (four diameters of the sideslip indicator ball). Counteraction of a roll produced by such a great lateral g-load would require for deflection of the ailerons through an angle greater than  $25^\circ$ , which exceeds the available angle of their deflection. Therefore, for automatic compensation of the moments produced by launching the missiles from the inboard pylons at  $M > 2.4$  the disturbance autocompensator comes into actions. Its principle of operation consists in creation of "misalignment" of the stabilizer at the moment of the missile launch irrespective of an initial position of the aircraft control stick.

Liftoff of the missile from the right inboard pylon will result in deflection of the port half of the stabilizer with the leading edge upwards and starboard half downward through an angle of  $2^\circ 15'$  from the initial position. Liftoff of the missile from the left pylon involves opposite deflections of the stabilizer halves. If the missile is suspended only from one of the inboard pylons and the compensation system is set to any extreme position, "misalignment" of the stabilizer is eliminated after launching of the missile, i.e. the compensation system returns to the neutral position. Besides, the pilot's cabin is provided with the toggle switch labelled BANK ZERO (ОБНУЛ. КРЕНА). With the toggle switch turned on, the system is forced to the neutral position.

The autocompensation system operates only in presence of the signal indicating that the air-intake doors are set to the third position and when launching of the inboard missiles or in case of their asymmetrical suspension.

### 3.4. Interaction of Longitudinal and Lateral Motions

In flight it is not always possible to divide the aircraft motion into longitudinal and lateral ones. Cross coupling between the longitudinal and lateral moments originating

when changing the attack angle or Mach-number along with variation of the longitudinal moment will result in change of the rolling and yawing moments.

Such interaction is dictated by the following reasons:

(a) distribution of masses over the entire length of the fuselage at a low wing span;

(b) great change of the longitudinal, lateral and directional static stability margins when performing the maneuver within the entire range of airspeeds and angles of attack; their different variation depending on the altitude and air-speed in maneuvering what in most cases leads to their unfavourable interaction;

(c) considerable variation of effectiveness of the aircraft control surfaces versus attack angle and slipping.

The major types of interaction of the longitudinal and lateral motions of the aircraft are kinematic, aerodynamic and inertia interactions.

K i n e m a t i c i n t e r a c t i o n is expressed as the angle of attack converted into the sideslip angle or the sideslip angle converted into the angle of attack in the course of a turn of the aircraft about its longitudinal axis.

A e r o d y n a m i c i n t e r a c t i o n is caused by the change of the aircraft lateral and directional stability moments with changing the angles of attack and sideslip during rotation.

I n e r t i a i n t e r a c t i o n is conditioned by action of inertia forces and moments to the aircraft during rotation, when the axis of rotation is not coincident with the aircraft longitudinal axis. If the aerodynamic forces and moments of the steady aircraft are stabilizing ones, i.e. they are directed to decrease the angles of attack and sideslip, the inertia forces and moments are destabilizing ones.

The aerodynamic moments of the static stability do not depend on the rotation speed, whereas the inertia moments are directly proportional to the square of the roll rate. At small roll rates the inertia moments are considerably less than the aerodynamic moments of static stability, but as the roll rate increases, they may be equal to or even higher than the aerodynamic moments. The roll rate, at which the aerodynamic and inertia moments are equal, is called as a critical one. When approaching this rate, the aircraft features peculiarities in its behaviour.

As a rule, the critical roll and yaw rates are not equal to each other. The determining rate is the critical rate lesser in magnitude; it is referred to as the first critical rate.

When the aircraft rotates at a great roll rate approaching the critical one, the rotation is accompanied by great variations of the attack and sideslip angles in time. The developing sideslip angles become great so much that the roll rate of sideslipping will be determining one. In this case, deflection of the ailerons to the neutral position or against the rotation will not change the roll rate and the aircraft will continue rotating at the same rate. Such a rotation is called the inertia rotation.

In actual flight the critical roll rate may be obtained not in all the regimes of the flight, and not always the rotation at roll rates exceeding the critical ones results in loss of motion stability and entry into the inertia rotation. The ММГ-25ИИ aircraft at altitudes less than 8 km does not experience the inertia rotation since the rotation stops when the controls are set to the neutral position.

The ММГ-25ИИ aircraft has the most favourable inertia characteristics. This is achieved due to a moderate sweep of the wing, wide fuselage and spaced engines.

As a result of flight research two zones of possible, inertia interaction are distinguished. Common for both zones is that the available roll rate is greater than the first critical one.

The first zone is within the speed range from the maneuvering speed to an airspeed corresponding to  $M = 1.02$  at altitudes higher than 8000 m.

The second zone is limited by the Mach-numbers ranging from 2.3 to the maximum one which amounts to 2.83 at altitudes over 17,000 m.

Besides, as a result of mathematic modelling the third region of possible inertia rotation of the ММГ-25ИИ aircraft is revealed. This region is within the Mach-numbers ranging from 1.6 to 2.3 at altitudes higher than 18,000 m.

Combination of a number of factors practically rules out the possibility of inertia rotation of the ММГ-25ИИ aircraft even in the first region of the flight regimes which is considered to be the worst region according to the theory.

On the one hand, presence of a great available roll rate does not require for its realization in flight for the roll control; on the other hand, it is the distinguished region where the high available roll moments allow to decelerate the speed of rotation initiated by external factors, such as: failure of the engine, asymmetrical suspension of missiles, getting into a wake, etc.

Within the zone considered the available roll rates may be attained from the lateral control system during more than 6 s with the control stick fully deflected. The available rotation rate in level flight within the first zone amounts to 100 - 120°/s. The aircraft may reach this rotation rate when it performs not less than two turns about longitudinal axis. In this case, as the normal g-load becomes more than unity, the available roll rate decreases, while at negative normal g-loads the available rotation rate exceeds 200°/s.

Roll response to deflection of the rudder (and to sideslipping) at positive normal g-loads is direct and reverse at the negative g-loads.

Controllability in roll is maintained even at a rotation rate of 200°/s. With the ailerons deflected to the neutral position or in the direction opposite to that of rotation it stops after 4 to 6 s.

At high supersonic airspeed at  $M > 2.3$  (the second zone) the beginning of the essential manifestation of the inertia interaction is possible only in case of rotation with sideslipping if the following factors simultaneously coincide: the roll moment from sideslipping is directed along the rotation, a roll rate is more than 90°/s and the lateral g-load exceeds 0.3g (the ball of the electric turn indicator is stopped in the corner). At high normal g-loads the inertia interaction may be initiated even at roll rates less than 90°/s.

With the dampers of the automatic flight control system turned on, energetic maneuvers with turns through less than 180° do not result in inertia rotation.

Thus, when flying the МиГ-25П aircraft within the zones of possible interaction of longitudinal and lateral motions, it is recommended to do the following:

- (a) take care not to allow a roll rate to exceed 90°/s;
- (b) in case of increase of the normal or lateral g-load during rotation, do not allow the control stick to be deflected

in pitch; it is necessary to place the pedals and ailerons to the neutral position, avoiding abrupt deflections of the control surfaces;

(c) take care to prevent sideslipping; counteract it by deflecting the rudders up to the maximum deflection angles;

(d) perform the flights with the dampers of the automatic flight control system switched on.

## Chapter 2

# AIRCRAFT AUTOMATIC FLIGHT CONTROL SYSTEM

### 1. GENERAL

Aircraft МиГ-25ПД (МиГ-25ИДС), depending on the retrofiting series, have two modifications of the automatic flight control system: САУ-155ИДБ and САУ-155ИЛДБ, respectively. During preparation for flight the pilot should consider the particular modification of the automatic flight control system which he will employ during execution of the flight mission and be well familiar with its peculiarities.

The automatic flight control system is designed for automatic and director control of the fighter under all flight conditions as well as for improving the flight safety and characteristics during manual piloting.

The automatic flight control system has autonomous and external control modes:

(a) the autonomous (autopilot) modes of the automatic flight control system are as follows:

- damping of the aircraft short-period oscillations in roll, pitch and yaw;
- stabilization of the angles of roll (heading) and pitch with the control stick relieved of forces;
- aircraft levelling from any attitude with subsequent stabilization of the flight altitude and heading;

(b) the external modes of the automatic flight control system are as follows:

- ground direction with climb and descent according to the basic program with shaping of the discrete commands for controlling the engine operation in descent;



- homing and breakaway;
- recovery from the limit altitude by a signal from the radio altimeter;
- en-route flight;
- return to a programmed airfield;
- landing approach to a programmed airfield;
- landing approach to a non-programmed airfield;
- repeated landing approach to a programmed airfield.

Moreover, the automatic flight control system ensures:

- (1) limitation of a normal g-load and selected roll angle in compliance with the permissible values for the assigned flight conditions during automatic and director control;
- (2) calculation of the permissible values of a normal g-load, angle of attack, maximum and minimum indicated airspeeds with shaping of signals announcing their approach to the limit values;
- (3) compensation for momentary disturbances caused by missile launching in the DAMPER mode in the entire range of combat employment, and up to a Mach number of 2.5 during automatic control.

The flight director indicator is used for indication of the present angles of roll, pitch and slip.

Arranged in the upper part of the flight director indicator is a horizontal dotted scale and a vertical bar (lateral channel position bar) indicating the position of the assigned flight path relative to the aircraft longitudinal axis in the horizontal plane.

The central circle is considered to be the longitudinal axis of the aircraft and the left (right) edge of the circle is considered to be the first dot.

In different modes the readings of the lateral channel position bar relative to the dotted scale (the 5th dot scale) correspond to:

- (a) a deviation of the assigned flight path in the horizontal plane within  $\pm 30^\circ$  in the ground direction mode, en-route flight, return, repeated approach and heading stabilization mode;
- (b) an aiming error of  $\pm 60^\circ$  in azimuth in the homing mode;
- (c) a deviation from the localizer beacon equisignal zone within  $\pm 2^\circ$  during landing approach.

Arranged in the left part of the flight director indicator is a vertical dotted scale and a horizontal bar (longitudinal channel position bar) indicating the position of the assigned flight path relative to the longitudinal axis of the aircraft in the vertical plane.

In different modes the readings of the longitudinal channel position bar relative to the dotted scale (the 5th point scale) correspond to:

- (a) ground direction mode, en-route flight:
  - prior to the illumination of the SEL ALT LVL-OFF (CXOH H<sub>зад</sub>) lamp - a deviation from the programmed Mach number by 0.3;
  - after the illumination of the SEL ALT LVL-OFF lamp - a deviation from the altitude selected on the altitude and air-speed selector by 1200 m;
- (b) homing mode - a vertical sighting error of  $\pm 60^\circ$ ;
- (c) return to a programmed airfield, landing approach prior to the interception of the radio glide slope, repeated approach - a deviation from the 600-m altitude;
- (d) landing approach after the interception of the radio glide slope - a deviation from the glide-slope beacon equisignal zone within  $\pm 1^\circ$ .

Arranged in the centre of the flight director indicator are the following command bars:

- (a) a vertical bar which is a roll command bar of the lateral channel, indicating a deviation from the selected roll computed by the automatic flight control system;
- (b) a horizontal bar which is a pitch command bar of the longitudinal channel, indicating a deviation from the selected g-load computed by the automatic flight control system.

The readings of the flight director indicator are duplicated on the aircraft radar display screen in the ground direction and homing modes as follows:

- (1) the error ring (a greater-diameter ring) duplicates the readings of the position bars;
- (2) the command marker (a smaller-diameter ring) duplicates the readings of the command bars of the flight director indicator.

The combined course indicator is designed for indication of the present heading, preset course, relative bearing of the

radio station (beacon) and the aircraft position relative to the equisignal zones of the landing beacons.

When the P/SET COURSE AUTO - MAN (КУРС ЗАДАН. АВТОМ. - РУЧН.) selector switch is set to the AUTO (АВТОМ.) position the present heading and preset course become slaved. When the external modes are engaged, the preset course signal is delivered from equipment 5V15K-11 or PCEH-6C.

The position bars of the combined course indicator show the position of the equisignal zones of the landing beacons relative to the aircraft axis.

## 2. USE OF AUTONOMOUS MODES OF AUTOMATIC FLIGHT CONTROL SYSTEM

### 2.1. Damping of Aircraft Short-Period Oscillations

The damping mode is intended for improvement of the aircraft stability characteristics during automatic, director and manual control.

The damping mode may be used in the entire range of flight altitudes and airspeeds excluding altitudes below 150 m at any airspeed and altitudes from 150 to 300 m at airspeeds exceeding 750 km/h.

Engagement of the damper results in improvement of the angle-of-attack stability.

When flying at high altitudes and Mach numbers equal to or exceeding 2.2 with a normal g-load, the aircraft features a higher roll response to deflection of the rudders (slipping). In this case, roll develops with a certain delay characteristic of high altitudes, while efficiency of the ailerons decreases with an increase of the g-load.

When the dampers are engaged, the aircraft roll response to slipping will significantly decrease. Therefore, all flights at high altitudes ( $H > 10,000$  m) should be performed with the damping mode engaged, which will considerably simplify the aircraft handling under these conditions.

When the Mach number exceeds 1.5 and voice message "Engage damper" is delivered, the pilot should enable the damping mode.

The damping mode is enabled by the DAMPER (ДЕМП.) light-button on the AFCS control panel. The light-button lights up after it is depressed. The damping mode is also automatically

enabled when the pilot depresses the AUTO CTL (АВТ. УПР.) light-button arranged on the AFCS control panel or the LEVELLING ON (ВКЛ. НРВБ. ГОРВЗ.) light-button located on the control stick.

The damping mode is disabled by depressing the AUTOPILOT OFF (ВЫКЛ. АП) button arranged on the control stick. In response, the DAMPER light-button goes out and the rods of the servo units return to the neutral position, which may sometimes result in partial untrimming of the aircraft.

## 2.2. Stabilization of Aircraft Attitudes

The stabilization mode is intended for automatic maintaining of the selected angles of pitch and roll (heading) with the control stick relieved of forces.

The stabilization mode may be used in the entire range of flight altitudes and airspeeds, excluding altitudes below 150 m at any airspeed and altitudes from 150 to 300 m at airspeeds exceeding 750 km/h.

The stabilization mode is enabled by a short-live depression of the AUTO CTL light-button and is checked with reference to illumination of the AUTO CTL and DAMPER light-buttons arranged on the AFCS control panel.

The automatic flight control system ensures stabilization of the aircraft attitudes up to  $\pm 80^\circ$  in roll, up to  $\pm 85^\circ$  in pitch and within 0 to  $360^\circ$  in yaw at angles of roll within  $\pm 7^\circ$  and angles of pitch within  $\pm 40^\circ$ .

In case the angle to roll is beyond  $\pm 7^\circ$  or the angle of pitch is beyond  $\pm 40^\circ$  at the moment when the stabilization mode is enabled, the system stabilizes the aircraft roll rather than yaw.

Preparatory to enabling of the stabilization mode, the pilot should trim the aircraft with the help of the trim mechanisms.

In the stabilization mode the pilot may use combined control of the aircraft.

In order to change the flight conditions (yaw, roll and pitch) when the stabilization mode is enabled, the pilot should deflect the control stick to create the required angles of roll and pitch (when the control stick force is applied, the stabilization mode gets disabled and the AUTO CTL light-button goes out), trim the aircraft with the help of the trim mechanisms and relieve the control stick of forces.

In the course of combined control, autotrimming is disengaged in the control channel which is associated with application of the control stick force (in this case, the damping mode is still enabled).

After the control stick is relieved of forces, the AUTO CTL light-button lights up again and the automatic flight control system ensures stabilization of the newly selected aircraft attitude till the next interference of the pilot with the control.

In order to maintain the selected flight conditions, the pilot may slightly change the angle of pitch by depressing the pitch trim selector switch without application of the control stick force.

The stabilization mode is disabled by the AUTOPILOT OFF button arranged on the aircraft control stick. In this case, the AUTO CTL and DAMPER light-buttons go out on the AFCS control panel.

### 2.3. Levelling Mode

The levelling mode is intended for levelling the aircraft from any attitude when the pilot loses spatial orientation.

This mode may be used during long-time straight-and-level flying for stabilization of the altitude and heading at altitudes of not less than 500 m over the ground relief.

The system operation in the levelling mode is based on bringing the aircraft to the zero values of roll and flight path angle. The levelling mode is enabled by depressing the LEVELLING ON light-button arranged on the control stick.

After the levelling mode is enabled, the aircraft is brought to the zero roll angle.

When the roll exceeds  $80^\circ$ , stabilization of the angle of pitch occurs. When the aircraft is brought to a roll within  $\pm 80 \pm 5^\circ$ , the system starts simultaneous levelling of the aircraft in pitch and roll to a straight flight path.

13 to 17 s after the aircraft is brought to the angles of pitch from  $-5$  to  $+15^\circ$ , the heading and altitude stabilization mode is enabled.

In order to enable the levelling mode, the pilot should depress the LEVELLING ON light-button on the control stick, with the pedals set to neutral, and relieve the control stick

of forces. Check enabling of the levelling mode with reference to the illumination of the LEVELLING ON light-button on the control stick as well as of the AUTO CTL and DAMPER light-buttons on the AFCS control panel (provided they have been dead).

When the levelling mode is enabled, all modes (including the director control modes) get disabled (except the damping mode).

The aircraft levelling is ensured:

- (a) from roll at a rate of 15 to 25 deg/s (depending on the altitude at which the mode is enabled);
- (b) from pitching-up at a g-load of not less than +0.35 g;
- (c) from diving at a g-load of not more than +3 g.

It is not recommended to control the aircraft by the control stick and pedals when the levelling mode is enabled.

If the pilot interferes with the control when the aircraft is being levelled, the AUTO CTL light-button goes out on the AFCS control panel, the levelling rate decreases, and subsequently the levelling mode may discontinue altogether.

In case the levelling mode is enabled when the aircraft is in a strictly inverted position, the pilot should start levelling manually by deflecting the control stick in roll for a short time. After reaching an angular rate of 5 to 10 deg/s, the pilot should return the control stick to the neutral position.

In order to stabilize the altitude, it is recommended to enable the levelling mode at a zero vertical velocity of climb or descent.

In the barometric altitude and heading stabilization mode the position bars of the flight director indicator will read:

- (a) the lateral channel position bar - a deviation from the stabilized heading;
- (b) longitudinal channel position bar - a deviation from the stabilized altitude.

The levelling mode is disabled by the AUTOPILOT OFF button arranged on the control stick. In response, the LEVELLING ON light-button arranged on the control stick and the AUTO CTL and DAMPER light-buttons arranged on the AFCS control panel go out.

### 3. USE OF EXTERNAL MODES OF AUTOMATIC FLIGHT CONTROL SYSTEM

#### 3.1. Ground Direction Mode

The ground direction mode is intended for bringing a fighter by the ground direction system to an area in which the target detection and lock-on by the aircraft radar will be performed with the greatest degree of probability.

On the ground direction stage the aircraft climb and descent are performed in the longitudinal channel (Fig. 33) according to the basic program which shows the relation between the flight altitude and airspeed

$$M_{ind} = f(H_{true}).$$

The pilot should be well aware of the following. If the selected  $M_{lvl-off}$  and  $H_{lvl-off}$  are set on the altitude and airspeed selector,  $M_{lvl-off}$  selected on the altitude and airspeed selector is the first to be stabilized in climbing. When the levelling-off altitude is gained, stabilization of  $M_{lvl-off}$  discontinues and the system starts stabilizing the levelling-off altitude selected on the altitude and airspeed selector.

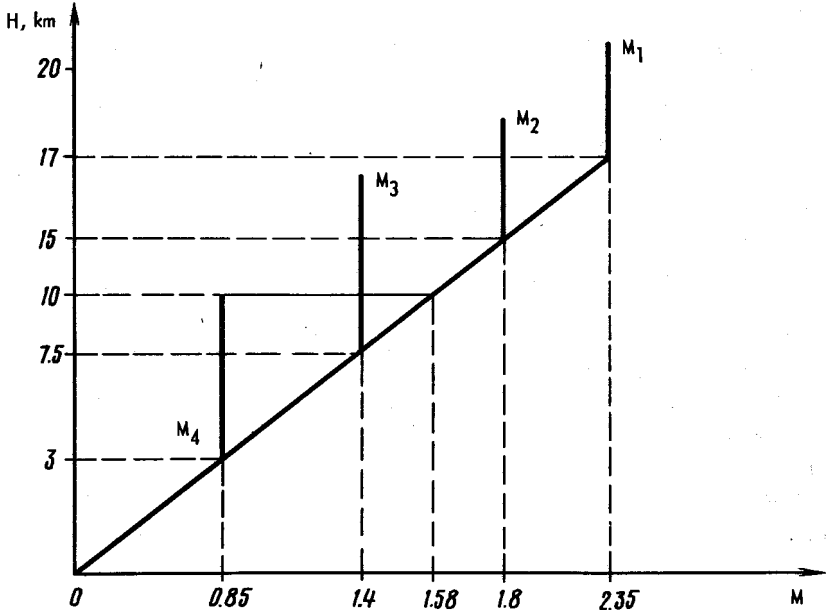

FIG. 33. CLIMB PROGRAM

On the ground direction stage the horizontal position bar of the flight director indicator indicates a deviation from  $M_{lvl-off}$  selected on the altitude and airspeed selector. If the position bar is located at the top, the Mach number exceeds the selected value; if the position bar is at the bottom, the Mach number is less than the selected value.

The horizontal command bar of the flight director indicator shows a g-load required for interception of the assigned flight path.

The smaller diameter ring of the indicator screen duplicates the readings of the pitch command bar of the flight director indicator.

The vertical position bar of the flight director indicator shows a deviation from the preset course. The vertical command bar shows the value of roll which is to be created in order to intercept the preset course.

The selected roll is within:

+60° in programmed climbing;

+40° in descent;

+30° at altitudes below 1500 m with the RECOVERY (JBOH) switch cut in on the AFCS control panel.

On the ground direction stage the lateral channel is controlled by the preset course signal delivered by the ground automatic control system and computed by the ground computer proceeding from the coordinates depending upon the relative position of the fighter and target.

#### Climbing Program in Flight for Aerial Combat

In a flight for aerial combat the following basic programs are used for gaining the selected altitude and airspeed:

- reheat (short-range) program used in case of close interception to obtain the maximum rate of climb at the minimum time available for fulfilment of the combat mission;

- combination (medium-range) program used in case of long-range interception at a supersonic final airspeed when the time available for interception of a target allows employment of a subsonic cruise air leg for increasing the range of destruction of an aerial target;

- cruise (long-range) program used in case of long-range interception at subsonic airspeeds to ensure the maximum range of destruction of an aerial target.



When the fighter is flying according to one of the above programs, the ground automatic control system delivers to the aircraft the value of the programmed airspeed and the time when the afterburner must be engaged.

The programmed airspeeds (Mach numbers) have the following discrete values:

$$V_1 = 2500 \text{ km/h } (M_1 = 2.35);$$

$$V_2 = 1900 \text{ km/h } (M_2 = 1.8);$$

$$V_3 = 1500 \text{ km/h } (M_3 = 1.4);$$

$$V_4 = 1000 \text{ km/h } (M_4 = 0.85),$$

that are shown by a triangular index on the JCO-M1 instrument.

In response to the "Reheat" command the aircraft gains altitude according to the reheat program. If the "Reheat" command is not applied, the aircraft gains altitude either according to the combination program or according to the cruise program.

The climbing program is entered at an altitude of not less than 300 to 500 m and airspeed of not less than 600 to 650 km/h.

To gain altitude in the director and automatic control modes, proceed as follows:

(a) according to the reheat program of the wartime, set  $H_{1vl-off} = 29.9$  km and the selected value of the airspeed on the altitude and airspeed selector.

Perform flight on the full reheat power;

(b) according to the reheat program of the peacetime, set  $H_{1vl-off} = 29.9$  km on the altitude and airspeed selector and set the wafer switch to the H10 position.

Climb on the full reheat power to an altitude of 10,000 m.

The climb is performed according to the program with stabilization of  $M = 0.85$ . When the altitude of 10,000 m is approached, the SEL ALT LWL-OFF lamp will light up and the "Selected altitude levelling-off" voice message is delivered.

Subsequently, in the course of acceleration at the altitude of 10,000 m, set the following selected values of the airspeed on the altitude and airspeed selector:

$M_3 = 1.4$  at the airspeed corresponding to  $M = 1.3$ ;

$M_2 = 1.8$  or  $M_1 = 2.35$  at the airspeed corresponding to  $M = 1.4$ .

CAUTION. IN THE COUSE OF ACCELERATION, PREPARATORY TO ENTRY TO THE BASIC PROGRAM ( $M_{\text{entry}} = 1.58$ ), CHECK THE INDICATED AIRSPEED SO THAT IT SHOULD NOT EXCEED 1150 km/h. IN CASE THE AIRSPEED EXCEEDS THIS VALUE, BRING THE AIRCRAFT TO CLIMBING BEFORE THE PROGRAM IS ENTERED.

Note. In case supersonic flights at the altitude of 10,000 m are prohibited, accomplish the climbing program in the manual control mode;

(c) according to the combination program, set  $H_{\text{lvl-off}} = 29.9$  km on the altitude and airspeed selector and the wafer switch to the H10 position.

Take off on the full reheat power and disengage the afterburner when the airspeed of 600 km/h is reached.

Enter the AFCS program and gain the altitude with the engines running at the maximum power.

Engage the full reheat power on the command of the direction post, gain the altitude of 10,000 m, and perform further flight as prescribed by the reheat program of the peacetime;

(d) according to the cruise program, set  $H_{\text{lvl-off}} = 29.9$  km and  $M_{\text{lvl-off}} = 0.85$  on the altitude and airspeed selector.

Take off on the full reheat power and disengage the afterburner when the airspeed of 600 km/h is reached.

Enter the AFCS program and gain the altitude with the engines running at the maximum power.

When flying for aerial combat with the drop fuel tank suspended, the programmed climb may be performed in the automatic, director or manual control mode observing the effective limitations imposed for a flight with the drop fuel tank suspended.

#### Climb to Target Attack Altitude

Upon reception of the command, the aircraft gains the selected altitude and airspeed for the target attack.

Climbing to the target attack altitude is performed within the minimum time. Instrument YCO-M1 receives the value of the final airspeed ( $V_f$ ) delivered by equipment 5V15K-11.

Depending on the target altitude displayed on the YBO-M1 indicator and stepped-up vertical separation selected by the pilot in view of the attack conditions, set the levelling-off altitude on the altitude and airspeed selector and stepped-up vertical separation of the fighter relative to the target with the aid of the  $\Delta H$  selector switch.

### 3.2. Homing Mode

The homing mode is intended for homing the fighter by the commands of the SAPPFR-25 airborne radar to an area (relative to the target) wherefrom the target can be destroyed by guided missiles with the greatest degree of probability.

The mode is enabled automatically once the target is locked on by the airborne radar and the "Attack" command is transmitted (the indicator screen displays the ATK signal). In this case, the SEL ALT LVL-OFF lamp goes out. On the indicator screen the command marker duplicates the readings of the command bars of the flight director indicator when attacking with long-range missiles. In case the attack involves launching of missiles P-60 (P-60M), after the target is locked on a greater diameter ring (target blip) appears instead of the command marker, and the GUID (HABREI.) light-button goes out on the AFCS control panel. In this case, the pilot should disable the automatic control mode by the AUTOPILOT OFF button arranged on the control stick.

When the attack is performed in the automatic control mode, the pilot should continuously check the aircraft response to the commands of the command marker of the smaller diameter ring.

When the Z signal is displayed in the director control mode, the pilot should carry out the aiming zoom, aligning the smaller diameter ring with the centre of the electronic cross-hairs. As soon as the Z signal is displayed, the smaller diameter ring moves vertically, excluding the HMA-4H mode of the airborne radar where it is zeroed vertically.

In the course of the attack in the automatic control mode, the pilot should check the illumination of the ATK, Z, BREAK-AWAY signals and the aircraft response to the commands of the command marker, i.e., the smaller diameter ring (the command bars of the flight director indicator).

**WARNING. WHEN THE MISSILES ARE LAUNCHED AT MACH NUMBERS EQUAL TO OR EXCEEDING 2.5 WITH THE DAMPER MODE ENABLED, THE MODE CANNOT BE DISABLED BY THE BUTTON ARRANGED ON THE CONTROL STICK. THE MODE CAN BE DISABLED ONLY AT A MACH NUMBER LESS THAN 2.5.**

After the "Break-away" command discontinues, the GUID light-button goes out on the AFCS control panel. The LOG and GS flags appear on the flight director indicator and the command bars settle in the centre of the miniature airplane circle. When the automatic control mode is enabled, the levelling mode will get automatically enabled.

In the homing mode the flight director indicator will display the following:

(a) the lateral channel position bar will indicate the direction errors in the horizontal plane;

(b) the longitudinal channel position bar indicates the direction errors in the vertical plane.

The selected roll is within:

$\pm 70^\circ$  at an altitude above 1500 m;

$\pm 30^\circ$  at an altitude below 1500 m.

The assigned g-load is limited (Fig. 34) by function

$$n_y \text{ perm} = f(G_f).$$

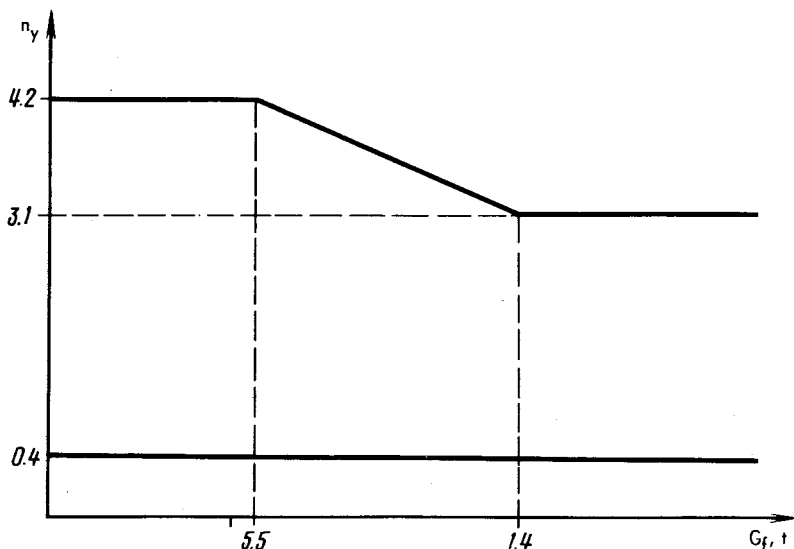

FIG. 34. PROGRAM FOR LIMITATION OF ASSIGNED G-LOAD

### 3.3. Limit Altitude Recovery Mode

The limit altitude recovery mode is intended for recovery of the aircraft from limit altitudes in response to the "Limit altitude" signal delivered by the REPER-M radio altimeter. The aircraft is recovered to an altitude exceeding the limit one (selected on the radio altimeter) by 50 to 100 m.

The conditions for enabling of the limit altitude recovery mode are as follows:

- enabling of the direction mode on the AFCS control panel;
- availability of the "Radio altimeter reliable" command;
- availability of the  $H < 1.5$  km command delivered from the C-25 armament control system;
- availability of the "Limit altitude" command delivered by the radio altimeter (the value of limit altitude is to be set manually on the radio altimeter indicator).

Enabling of the limit altitude recovery mode occurs in descent only in the direction mode provided the RECOVERY switch is cut in on the AFCS control panel. Enabling of the mode is accompanied by the "Limit altitude" voice message.

The aircraft is levelled to a zero roll and recovered from the limit altitude with a  $g$ -load of up to 3  $g$  and a pitch angle of  $12^\circ$ . At a vertical speed of descent of 15 to 30 m/s the aircraft mushing amounts to 150 to 180 m (Fig. 35).

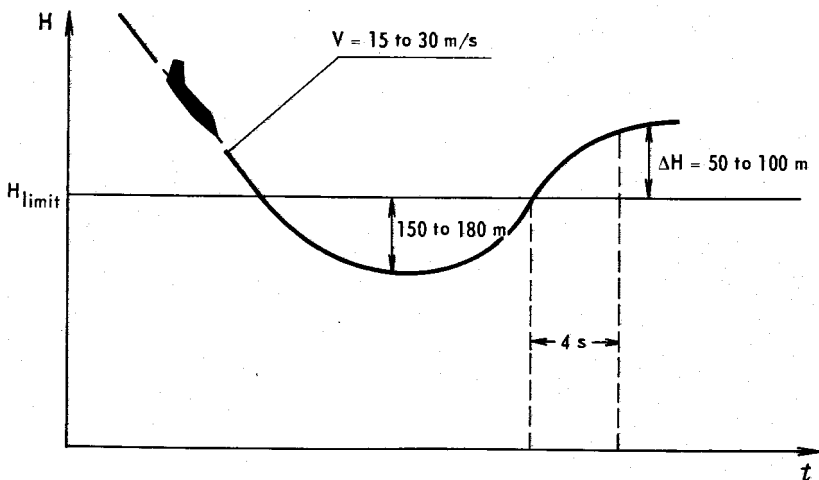

FIG. 35. FLIGHT PATH IN LIMIT ALTITUDE RECOVERY MODE

After recovery from the limit altitude the aircraft is levelled within 4 s at a g-load of at least +0.35 g.

In case of the radio altimeter failure, it is prohibited to use the automatic flight control system at low altitudes.

#### 3.4. En-Route Flight

A flight along a selected route is performed by a directional method with the use of route turning points (RTP). The route is programmed in the short-range radio navigation and landing system before flight.

If an en-route flight is to be performed with the use of the automatic flight control system, take off and climb to 200 m in the manual control mode. Starting from 200 m fly the aircraft with reference to the lateral channel command bar of the flight director indicator keeping it within the circle.

Disengage the afterburner at an airspeed of not less than 600 km/h. At an altitude of 500 m zero the command bars and the longitudinal channel position bar, trim the control stick by the roll and pitch trim mechanisms, then relieve the control stick of forces and enable the automatic control mode.

If the climb involves levelling-off to a selected altitude, when the aircraft approaches the selected altitude the SET ALT LVL-OFF lamp lights up and the aircraft is automatically brought to the level flight.

When the distance to the RTP is 40 km, the D LESS THAN 40 KM (И МЕНЬШЕ 40 КМ) lamp lights up on the control panel of the short-range radio navigation and landing system. When the lamp lights up, the pilot should depress the light-button of the next RTP. The aircraft will automatically turn to the next RTP. In this case, the roll angle will not exceed  $45^{\circ}$  at supersonic airspeeds and  $30^{\circ}$  at subsonic airspeeds.

If the flight mission involves flying over a RTP, the pilot (without disabling the automatic control mode) should set the P/SET COURSE AUTO - MAN selector switch to the MAN (РУЧ.) position. Having flown over the RTP, the pilot should depress the light-button of the next RTP and set the P/SET COURSE AUTO - MAN selector switch to the AUTO position. It is necessary to place the preset course selector switch to the MAN position to preclude the aircraft oscillations in roll ( $\pm 5^{\circ}$ ) at a distance of less than 25 km to the RTP in the automatic control mode.

When the SHORAN (PCEH) light-button goes out on the AFCS control panel, the system will automatically proceed with stabilization of the aircraft attitude (roll, yaw and pitch angles) that have been established at the moment of the lamp extinguishing. On this occasion, the pilot should proceed as follows:

- change over to the manual control mode (without disabling the automatic control mode by the AUTOPILOT OFF button);
- depress the SHORAN light-button on the AFCS control panel and make sure that it is alive;
- set the command bars within the circle and relieve the control stick of forces.

Throughout the en-route flight the command bars and position bars of the flight director indicator will indicate the following:

(a) the lateral channel position bar will indicate a deviation from the assigned flight path (in heading);

(b) prior to the illumination of the SEL ALT LVL-OFF lamp the longitudinal channel position bar will show a deviation from the programmed Mach number; after the illumination of the SEL ALT LVL-OFF lamp the bar will show a deviation from the selected flight altitude.

The selected roll is within  $\pm 30^\circ$  at Mach numbers less than 0.95 and within  $\pm 42^\circ$  at Mach numbers more than 0.95.

The selected g-load is within 0.35 to 3 g.

### 3.5. Return to Programmed Airfield

In the lateral and longitudinal channels the aircraft is controlled by the signals of the PCEH-6C short-range radio navigation and landing system.

To fly the aircraft during return to a programmed airfield either in the automatic or director control mode, the pilot should depress the AFLD (A3P) and RETURN (BO3BPAT) light-buttons (the CORR. (KOPP.) lamp should be alive) on the control panel of the short-range radio navigation and landing system. The P/SET COURSE AUTO - MAN selector switch should be set to the AUTO position. Depress the SHORAN light-button on the AFCS control panel.

If the aircraft proceeds at an altitude of higher than 9500 m and at a distance of more than 250 km from the airfield, the pilot should descend, controlling the aircraft manually in

the longitudinal channel so that the aircraft is brought to the altitude of 9500 m at a distance of 120 to 250 km from the airfield. In the course of descent, the pilot should control the aircraft in the lateral channel with reference to the vertical command bar.

After the aircraft is brought to the cruise altitude of 9500 m, the pilot should set the command bars of the flight director indicator within the circle and enable the automatic control mode.

At a distance of from 90 to 120 km, check the commencement of the break-through mode with reference to the deviation of the horizontal pitch command bar and longitudinal channel position bar of the flight director indicator and to the aircraft change-over to descent. While descending along the break-through path, the horizontal position bar of the flight director indicator will be located below the circle between the second and third dots, and the pitch command bar will be located in the centre of the circle. At an altitude of 600 m the aircraft will smoothly change over to a level flight and subsequently arrive at the area of either the base leg turn or the final turn depending on the return heading and landing heading.

In case the return mode is enabled when the aircraft is positioned above the break-through path in the area of the airfield, the preset course will be computed by the PCEH-6C system to a point located along the runway axis and set off beyond the prelanding maneuver area to such a distance that the angle of the descent path should not exceed  $9^{\circ}$ . In this case, the aircraft may turn even away from the airfield.

This being the case, the automatic flight control system does not provide either for automatic or for director altitude control.

As the aircraft descends, the off-set point moves along the axis towards the runway and as the aircraft intercepts the break-through path, the flight is performed similarly to the return according to the descent program.

Under these conditions, the break-through path is intercepted manually with the aircraft controlled in the lateral channel with reference to the commands of the vertical command bar. After the break-through path is intercepted, set the command bars within the circle and enable the automatic control mode.



WARNING. IF THE RETURN MODE IS ENABLED AT AN ALTITUDE ABOVE THE BREAK-THROUGH PATH, IT IS PROHIBITED TO USE THE AIRCRAFT DIRECTOR CONTROL IN THE LONGITUDINAL CHANNEL AND TO ENABLE THE AUTOMATIC CONTROL MODE UNTIL THE BREAK-THROUGH PATH IS INTERCEPTED. OTHERWISE, THE AIRCRAFT WILL DESCEND WITH HIGH PITCH ANGLES AND AT A GROWING SPEED, WHICH IS FRAUGHT WITH DANGER.

The return mode terminates with the aircraft arrival at the estimated point of the prelanding maneuver at the altitude of 630 m with the PCBH-6C system and automatic flight control system changing over to the landing mode.

While proceeding in the return mode, the lateral channel position bar shows a deviation from the assigned flight path in heading and the longitudinal channel position bar shows a deviation from the programmed flight path in altitude that is computed in the PCBH-6C system.

The selected roll angle is within  $\pm 30^\circ$  when the Mach number is less than 0.95 and within  $\pm 42^\circ$  when the Mach number is more than 0.95.

The selected g-load is within 0.35 to 3 g.

### 3.6. Landing Approach to Programmed Airfield

The given mode is enabled at the final stage of the return mode. Preparatory to the fighter arrival to the estimated point at the altitude of 630 m, the pilot should check to see that:

- the RETURN light-button and the AFLD light-button (of a respective airfield) are depressed on the control panel of the short-range radio navigation and landing system;
- the CORR. lamp is alive;
- the  $\psi + 180^\circ$  selector switch is set to the position corresponding to the selected landing heading;
- the MISSED APPROACH, LH - RH (ПОБТ ЗАХ. ЛЕБ. - ПРАВ.) selector switch is set in compliance with the selected direction of the missed approach;
- the SHORAN light-button is alive on the AFCS control panel;
- the readings of the combined course indicator and flight director indicator comply with the flight program.

Fly to the starting point of the turn to the landing heading keeping the command bars of the flight director indicator within the circle (in the manual or automatic control mode).

In the process of the turn to the landing heading performed with a roll of up to  $30^{\circ}$ , set the airspeed equal to 450 km/h.

Preparatory to interception of the landing heading, check to see that the landing mode has been automatically enabled with reference to the following:

- first the LOC flag and then (at a distance of not less than 20 km) the GS flag have dropped out on the flight director indicator;

- the LANDING (ПОСАДКА) light-button has illuminated on the AFCS control panel (the command bars oscillate in this case for 2 or 3 s);

- the vertical bar of the combined course indicator has deflected from the indicator centre, showing the position of the equisignal zone of the localizer beacon relative to the aircraft;

- the horizontal bar of the combined course indicator has abruptly moved upwards, showing the position of the equisignal zone of the glide-slope beacon;

- the preset course pointer of the combined course indicator points to the landing heading.

Bring the aircraft within the equisignal zone of the localizer beacon (and make sure that it keeps within this zone), maintaining the altitude of 550 to 700 m up to a distance of 12 to 14 km (until the equisignal zone of the glide slope beacon is crossed).

After the fighter intercepts the landing heading, beginning from the distance of 14 to 16 km the horizontal bar of the combined course indicator will start smoothly moving downwards to the centre of the indicator. When the horizontal bar of the combined course indicator approaches the central circle, the aircraft enters the glide slope.

At a distance of 12 km the pilot should check to see that the aircraft has started descending with a vertical speed of 5 to 7 m/s and that it keeps within the equisignal zone of the glide slope beacon.

To check the descent mode, the pilot should well remember the relation between the flight altitude and the distance to the runway.

Altitude, m	600	400	200	100	50
Distance, km	12 to 14	8 to 9	4	2	1

At an altitude of 50 m disable the automatic control mode by depressing the AUTOPILOT OFF button and change over to manual control. Visually check the landing approach planning and land the aircraft.

- WARNING:**
1. IF DURING THE PRELANDING MANEUVER (AT A DISTANCE OF MORE THAN 12 TO 14 KM) THE STABILIZED ALTITUDE FAILS TO BE MAINTAINED WITHIN 550 TO 700 M, DISENGAGE THE AUTOMATIC FLIGHT CONTROL SYSTEM BY THE AUTOPILOT OFF BUTTON AND CHANGE OVER TO MANUAL CONTROL. PRIOR TO INTERCEPTION OF THE RADIO GLIDE SLOPE, THE AIRCRAFT CONTROL IN THE LATERAL CHANNEL SHOULD BE PERFORMED WITH REFERENCE TO THE VERTICAL COMMAND BAR OF THE FLIGHT DIRECTOR INDICATOR AND IN THE LANGITUDINAL CHANNEL THE AIRCRAFT SHOULD BE CONTROLLED WITH REFERENCE TO THE READINGS OF THE YBO-M1 INSTRUMENT. AFTER INTERCEPTION OF THE RADIO GLIDE SLOPE (THE HORIZONTAL BAR OF THE COMBINED COURSE INDICATOR MOVES DOWNWARDS THROUGH THE CENTRE AND APPROACHES THE LOWER EDGE OF THE CENTRAL CIRCLE), WITH THE DIRECTOR CONTROL MODE BEING O.K., ENABLE THE AUTOMATIC CONTROL MODE BY DEPRESSING THE AUTO CTL LIGHT-BUTTON ON THE AFCS CONTROL PANEL.
  2. IN THE COURSE OF LANDING APPROACH IN THE AUTOMATIC CONTROL MODE AS WELL AS DURING EXTENSION OF THE LANDING GEAR AND FLAPS, THE PILOT SHOULD TIMELY CORRECT THE ENGINE POWER SETTING IN COMPLIANCE WITH THE VARIATIONS OF THE FLIGHT CONDITIONS, AVOIDING LOSS OF AIRSPEED.

The automatic flight control system compensates for the nose-down moment (created as a result of speed reduction) by deflecting the stabilizer and maintains the selected angle of pitch to maintain the assigned flight path.

In the course of further speed reduction the aircraft (with the help of the automatic flight control system) will tend to maintain the assigned flight path by increasing the angle of attack up to the critical values.

When the landing gear is lowered, the angle-of-attack limitation circuit is disengaged.

Note. When aircraft MiG-25M is on the glide path and the GS or LOC flag drops in on the combined course indicator, the LANDING light-button will go out and the LEVELLING mode will be automatically enabled. In this case, the LEVELLING ON light-button will light up on the control stick and the "Glide slope failure" voice message will be delivered. In this event, the pilot should disable the levelling mode by the AUTOPILOT OFF button and decide whether he should proceed with the landing approach or perform the go-around maneuver.

In the course of the landing approach the indications of the position bars of the flight director indicator will be as follows:

(a) the lateral channel position bar will indicate a deviation from the localizer beacon equisignal zone;

(b) prior to the interception of the radio glide slope the longitudinal channel position bar will indicate a deviation from the 630-m altitude and after the radio glide slope is intercepted, the bar will indicate a deviation from the equisignal zone of the glide slope beacon.

The selected roll is within  $\pm 30^\circ$ .

The selected g-load is within 0.8 to 1.7 g.

The vertical and horizontal position bars of the combined course indicator show a deviation of the aircraft from the equisignal zone.

### 3.7. Landing Approach to Non-Programmed Airfield

If it is necessary to perform the landing approach to a non-programmed airfield, the pilot should enable the mode of the landing approach to a non-programmed airfield by the RESET (CEPOC) light-button on the PCEH-6C system control panel. In this mode, the navigation circuit of the PCEH-6C system does not deliver control signals to the automatic flight control system.

Controlling the aircraft manually, the pilot should bring the aircraft to the coverage zone of the localizer and glide slope beacons with reference to the radio compass, the values of present heading and landing heading.

After the LOC flag drops out on the combined course indicator, it is necessary to select manually a landing heading by the selected course knob of the combined course indicator and enable the mode by the LANDING light-button on the AFCS control panel.

The aircraft is controlled in the lateral channel in a way similar to that used during the landing approach to a programmed airfield.

Prior to the interception of the descent path, stabilization of the altitude selected on the altitude and airspeed selector takes place in the longitudinal channel.

To perform the landing approach to a non-programmed airfield, the pilot should proceed as follows:

- depress the RESET and RETURN light-buttons on the PCEH-6C system control panel;
- select the channels of the navigational and landing beacons of the landing airfield by the NAVIGATION (НАВИГАЦИЯ) and LANDING (ПОСАДКА) knobs;
- set the P/SET COURSE AUTO - MAN selector switch to the MAN position;
- select the landing heading by the selected course knob of the combined course indicator;
- in the course of the turn to the landing heading or while descending from the level flight at an altitude of 600 m and at a distance of 19 to 21 km turn on the LANDING switch on the PCEH-6C system control panel;
- after the LOC flag drops out on the combined course indicator, depress the LANDING light-button on the AFCS control panel;
- check to see that the SHORAN and LANDING light-buttons are alive on the AFCS control panel and that the roll and pitch flags have dropped out on the flight director indicator;
- after the command bars of the flight director indicator settle within the circle, depress the AUTO CTL light-button on the AFCS control panel and perform the landing approach in the director control mode similarly to the landing approach to a programmed airfield.

Prior to the interception of the radio glide slope, the automatic flight control system stabilizes the altitude at which the LANDING light-button is pressed on the AFCS control panel.

In the process of the landing approach the indications of the position bars of the flight director indicator will be as follows:

(a) the lateral channel position bar will indicate a deviation from the localizer beacon equisignal zone;

(b) prior to the interception of the radio glide slope the longitudinal channel position bar will indicate a deviation from the altitude selected on the altitude and airspeed selector; after the interception of the radio glide slope the bar will indicate a deviation from the equisignal zone of the glide slope beacon.

The selected roll is within  $\pm 30^\circ$ .

The selected g-load is within 0.8 to 1.7 g.

### 3.8. Missed Approach Mode

The missed approach mode is effective only for the landing approach to a programmed airfield, since the automatic flight control system controls the aircraft in the lateral and longitudinal channels by the signals of the PCEH-6C system computed for the return to a programmed airfield.

The PCEH-6C system supplies a preset course signal to the lateral channel of the automatic flight control system to turn and fly along the flight path with a reciprocal heading at a distance of 8 to 9 km from the runway centre line. The flight path is plotted relative to the navigational beacon of the short-range radio navigation and landing equipment of the given airfield.

Starting from the distance of 19 to 21 km (the beginning of the base leg turn), the PCEH-6C system operates in the same way as in case of a prelanding maneuver in the return mode. At the beginning of the base leg turn the MISSED APPROACH light-button goes out on the AFCS control panel and the automatic landing approach is accomplished in a way similar to that used in the return mode.

In the longitudinal channel the automatic flight control system stabilizes the altitude of 630 m of the prelanding maneuver.

In case of a go-around maneuver, arrival at the altitude of 630 m cannot be performed automatically. Therefore, the automatic control mode can be enabled only after the aircraft has arrived at this altitude. In the missed approach mode the indication and limitation of the control signals are similar to those in the return mode.

#### 4. AUTOMATIC FLIGHT CONTROL SYSTEM AND FLIGHT SAFETY

The following technical solutions which are aimed at ensuring flight safety are realized in the design of the automatic flight control system:

- the automatic control modes of the automatic flight control system can be enabled only if the DC and AC voltages are supplied and pressure is built up in one of the hydraulic systems;
- director control in the external modes can be enabled only if the aircraft radio and radar systems (associated with the automatic flight control system) are operable;
- possibility of combined control in the automatic modes;
- limitation of the selected g-load and selected roll in the automatic and director control modes depending on the flight conditions;
- automatic or director control of the aircraft recovery from the limit altitude zone selected on the radio altimeter in the ground direction and homing modes;
- availability of the automatic control modes disabling button and the LEVELLING ON light-button on the aircraft control stick;
- disabling of the previously enabled mode after the LEVELLING ON light-button is depressed;
- neutralization of the rods of the servo units when the automatic modes of the automatic flight control system are disabled;
- coupling of the automatic flight control system actuating units with the aircraft control system ensures the maximum safety in case of possible failures of automatic control;
- in the external modes of automatic control the operation of the automatic flight control system can be checked with reference to the deflection of the command bars of the flight director indicator. If the automatic flight control system functions properly, the command bars should oscillate about the middle position;

- operation of the automatic flight control system safety circuit throughout the flight.

The automatic flight control system safety circuit is connected with the help of the GAY LIMIT (ОГРНИЧ. ГАУ) circuit breaker before each flight.

Throughout the flight (with the landing gear retracted) the automatic flight control system safety circuit computes the limit values of:

- the angle of attack;
- the normal (vertical) g-load;
- the maximum indicated airspeed;
- the minimum indicated airspeed.

#### 4.1. System for Limitation of and Warning about Maximum Permissible Angle of Attack

The angles of attack are limited when the automatic control mode is enabled.

The positive angle of attack is limited to the following values:

- 13° when the Mach number is less than 0.65 and more than 1.1;
- 9° when the Mach number is more than 0.65 but less than 1.1.

The negative angle of attack is limited to -1.5°.

The MI-155-2 indicator starts warning the pilot when the following maximum permissible angles of attack are attained:

- +15° when the Mach number is less than 0.65 and more than 1.1;
- +11° when the Mach number is more than 0.65 but less than 1.1;
- +0.5° when the Mach number is more than 1.5 (when changing over to descent);
- 2.5° (negative angle of attack) when the Mach number is less than 1.5.

#### 4.2. System for Computation of and Warning about Maximum Permissible G-Load

The maximum permissible positive g-load is computed as a function of the fuel load (see Fig. 34).

The red sector of the MI-155-2 indicator shows the maximum permissible positive g-load.

When the current g-load (angle of attack) reaches the maximum permissible value, the warning lamps of the MI-155-2 indicator will light up and the "Limit maneuver" voice message will be delivered to the pilot's earphones (Fig. 36).



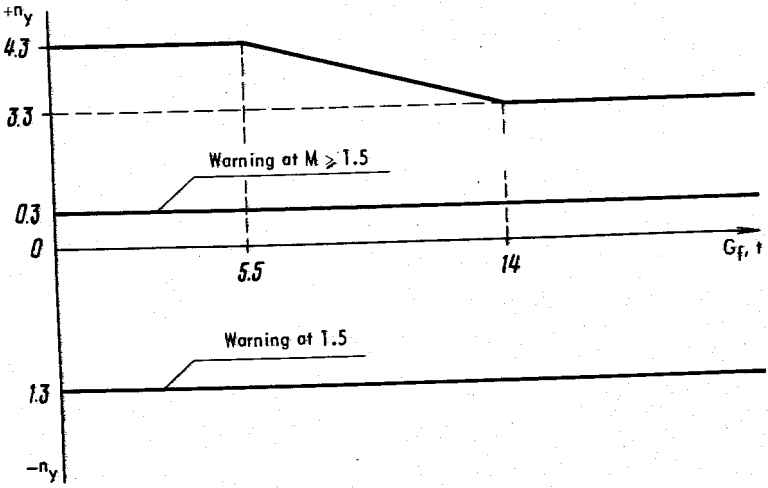

FIG. 36. PROGRAM FOR COMPUTATION OF AND WARNING ABOUT MAXIMUM PERMISSIBLE G-LOAD

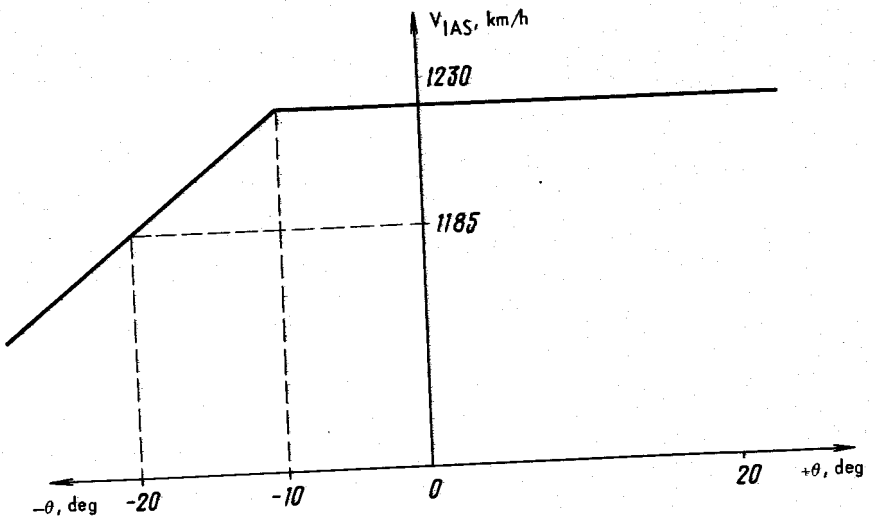

FIG. 37. PROGRAM FOR COMPUTATION OF LIMITATION OF MAXIMUM INDICATED AIRSPEED

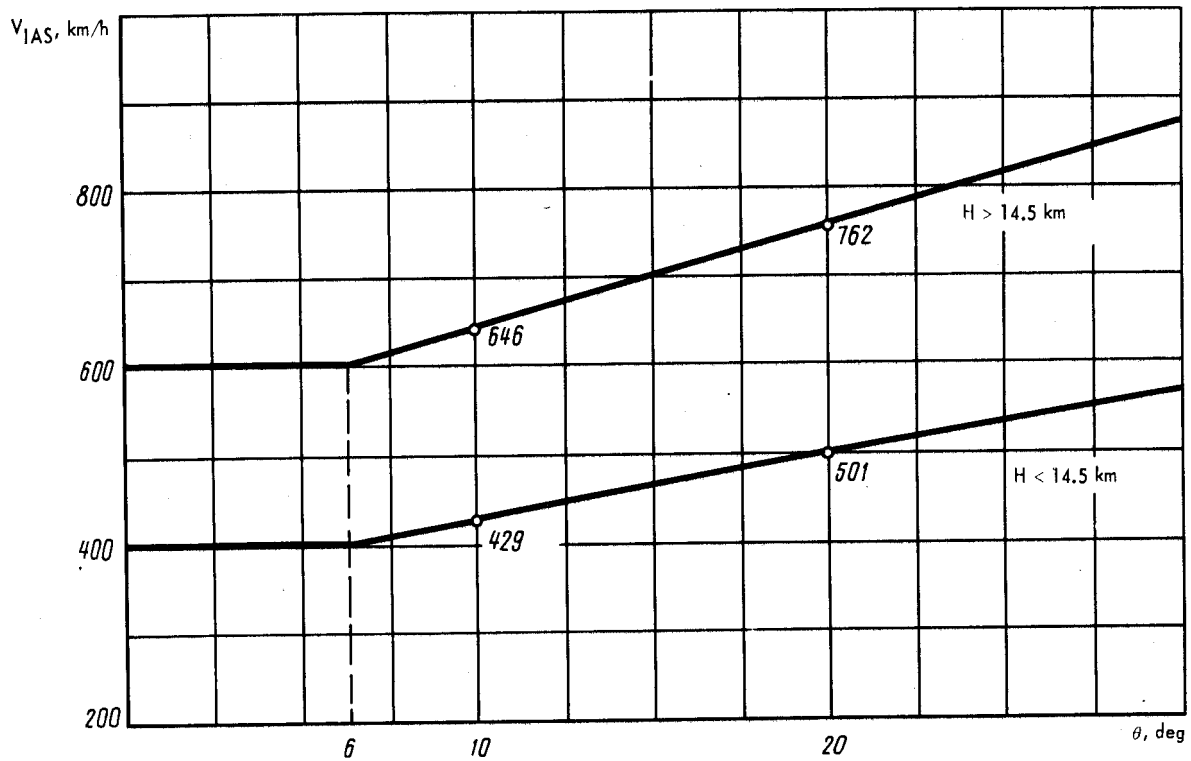

FIG. 38. MAXIMUM PERMISSIBLE INDICATED AIRSPEEDS PROGRAMMED IN AUTOMATIC FLIGHT CONTROL SYSTEM VERSUS PITCH ANGLE

The system for limitation of and warning about the maximum permissible g-load (angle of attack) starts functioning after the landing gear is retracted.

#### 4.3. System for Limitation of Maximum Indicated Airspeed

The system is intended for giving light warning (to the screen of the SAPFIR-25 radar indicator) and audio warning (either to equipment И-591 or to equipment РИ-65Е) of the fact that the aircraft has attained the maximum permissible value of indicated airspeed. Audio warning is given when the aircraft has attained definite airspeeds and angles of pitch (Fig. 37).

#### 4.4. System for Limitation of Minimum Indicated Airspeed

The system is intended for giving audio warning of the fact that the aircraft has attained the minimum permissible indicated airspeed.

Audio warning of the fact that the aircraft has attained the minimum permissible airspeed is given at definite angles of pitch corresponding to definite indicated airspeeds (Fig. 38).

## *Chapter 3*

### **DAYLIGHT FLYING UNDER VFR CONDITIONS**

#### 1. GENERAL

Mastering the daylight VFR flying technique is the primary stage of handling the aircraft.

Flying technique is the basis of flight training. High quality of flying technique ensures successful mastering of the elements of air navigation and combat employment in various conditions. Besides, it is one of the factors determining flight safety.

Flying technique training is aimed at forming firm habits of the pilots in handling the aircraft and engines at all stages of flight from take-off to landing. High individual proficiency in flying technique within the entire range of operational altitudes and airspeeds with the proper use of aerodynamic characteristics of the aircraft is the fundamental principle required for training of a pilot as a fighter.

All actions of the pilot in handling the aircraft and controlling the engines should be based on profound and fundamental knowledge of aerodynamic characteristics of the aircraft, operational limitations and peculiarities involved in flying technique of the MiG-25M aircraft.

The pilots acquire the necessary knowledge and habits of flying in the course of theoretical training, exercises on simulators and cockpit drills, as well as during familiarization, check and training flights performed for mastering flying technique.

Practical training of the МиГ-25ПД aircraft pilots in flying technique under daylight VFR conditions includes circling flights, maneuvering flights, instrument flights, as well as flights at supersonic airspeeds and flights in stratosphere.

## 2. CIRCLING FLIGHT

### 2.1. General

The elements of flying technique practised in the course of circling flight are the major components of any flight. Success in further mastering of the flying technique and combat skill depend on successful and proficient mastering of the circling flight elements.

The training circling flights consolidate the habits of the pilot in performance of take-off, estimation of landing and landing proper, as well as in handling of the aircraft during flight. Besides, in the course of circling flights the pilot acquires habits in employment of the airborne and ground navigation aids during landing approach. The initial stage of training landing approach includes complex employment of the two-beacon landing system and ground-controlled approach system, and further, use of the POLJOT-1M system.

### 2.2. Pilot's Actions at Different Stages of Preparation for and Execution of Circling Flight

Preparatory to starting the engine the pilot must:

- (1) give the "Close the canopy" command to the aircraft technician (the technician will remove the safety pins, show them to the pilot and help the pilot to close the canopy);
- (2) close the canopy;
- (3) move the lock control handle to the extreme forward position;
- (4) check to see that:
  - the safety pins are removed;
  - the canopy is closed;
  - the locking pins are visible in the holes of the canopy-carrying panel;
  - the LOCK CANOPY (ЗАПРМ ШОПАРЬ) lamp is dead;
- (5) don the oxygen mask (close the pressure helmet visor);
- (6) turn on the HELMET VENT ON (БЕШТМЛ. ШИЕМА БКЛ.) switch;

(7) establish communication with the technician over the intercom system;

(8) request clearance for starting the engine;

(9) check to see that:

- communication over the intercom system is O.K.;
- engine starting is cleared;

(10) give the "Starting" command and receive the acknowledgement;

(11) check the throttle lever for easy travel and reliable fixing at the stops and set it to the STOP (СТОП) position;

(12) turn on the FUEL PUMP NITROG (ТОПЛИВ. НАСОС АЗОТ) and БИА circuit breakers;

(13) check to see that:

- the circuit breakers and switches are turned on;
- the NO FUEL FEED (НЕТ ПОДЖ. ТОПЛ.) lamp in the annunciator is dead;

- the WATCH BOOST SYS PRESS (СЛЕДИ ДАВЛ. БУСТ. СИСТ.), WATCH MAIN SYS PRESS (СЛЕДИ ДАВЛ. ОБЩ. СИСТ.), DC GEN OFF (ГЕНЕР. = ВЫКЛ.) (two lamps), AC GEN OFF (ГЕНЕР. ≈ ВЫКЛ.) (two lamps), STAB FOR LDG (СТАБИЛИЗ. НА ПОСАД.) and ROLL FOR LAND (КРЕН НА ПОСАД.) lamps should be alive in the annunciator.

When starting the engines the pilot must:

(14) give the "Clear the engines" command to the technician and receive the acknowledgement;

(15) set the throttle lever of the right engine to the idling position;

(16) press the stopwatch button;

(17) press the GROUND STARTING RH (ЗАПУСК НА ЗЕМЛЕ ПРАВ.) button for 1 or 2 s;

(18) check to see that:

- the TS DOORS OPEN (СТВОРКИ ТС ОТКР.) lamp is alive;
- the IGNIT OFF (ЗАЖИГ. ВЫКЛЮЧ.) lamp is alive;
- the ENG AUTO DUPL (ДВУБЛИР. АВТОМ. ДВИГ.) lamp is alive;
- the engine spinning-up is started (inform the technician of the fact);
- the oil pressure is built up when the engine speed is from 10 to 15 per cent;
- the bleed valve opens (the BLEED VLV OPN (ЛЕНТА ОТКРЫТА) lamp is alive) when the engine speed does not exceed 20 per cent;
- the exhaust gas temperature is not more than 840°C;
- the IGNIT OFF lamp goes out when the engine speed is 29 to 31 per cent;

- the pressure rises in the hydraulic systems (the WATCH BOOST SYS PRESS and WATCH MAIN SYS PRESS lamps go out);
- the ENG AUTO DUPL lamp goes out when the engine speed is 34 per cent;
- the starting cycle takes not more than 55 s;
- (19) check the idling power parameters and make sure that:
  - the engine speed is 40 to 43 per cent;
  - the exhaust gas temperature is not more than 650°C;
  - the oil pressure is not less than 1.7 kgf/cm<sup>2</sup>;
  - the pressure in the main hydraulic system is not less than 150 kgf/cm<sup>2</sup>;
  - the pressure in the booster hydraulic system (with the control stick being fixed) is not less than 200 kgf/cm<sup>2</sup>;
- (20) after the right engine is started, start the left engine proceeding in the above sequence;
- (21) give the "Disconnect power" command to the technician;
- (22) check the following:
  - the technician's acknowledgement;
  - extinguishing of two DC GEN OFF lamps and two AC GEN OFF lamps;
  - the aircraft mains voltage of 28 to 29 V.

WARNING. 1. THE REPEATED STARTING OR CRANKING OF THE ENGINE MAY BE PERFORMED ONLY AFTER THE ROTORS HAVE COME TO A STOP AND NO SOONER THAN 2 MIN AFTER THE GROUND STARTING BUTTON IS DEPRESSED DURING THE PREVIOUS STARTING.

2. START THE RIGHT ENGINE FIRST.

3. PREPARATORY TO THE ENGINE STARTING FROM THE STORAGE BATTERIES, PROCEED AS FOLLOWS:

- TURN ON THE GRND SUP ACFT BAT (АЭРОД. ПИТ. БОПТ. АКК.) SWITCH AND THE ПТО START (ЗАПУСК ПТО), VHF RADIO (УКВ РАДИО) AND FUEL PUMP NITROG CIRCUIT BREAKERS;
- CHECK THE VOLTAGE AGAINST THE VOLTMETER (IT SHOULD BE NOT LESS THAN 22 V);
- TURN ON THE DC GEN LH, RH AND AC GEN LH, RH AND EMA CIRCUIT BREAKERS;
- START THE RIGHT ENGINE;

- ADDITIONALLY CHECK THAT THE ENG AUTO DUPL LAMP IS ALIVE;
- NO SOONER THAN IN 14 S START THE LEFT ENGINE;
- AFTER THE ENGINES BECOME ACCELERATED TO THE IDLING POWER TURN ON THE REMAINING CIRCUIT BREAKERS ON THE CENTRAL PANEL OF THE CABIN STARBOARD.

After the engines are started, check the aircraft systems:

- (23) set the engine speed to 50 per cent;
- (24) check the operation of the hydraulic systems, proceeding as follows:
  - check to see that the WATCH BOOST SYS PRESS and WATCH MAIN SYS PRESS lamps are dead;
  - displacing the control stick diagonally with the maximum possible speed make sure that the pressure in the main and booster hydraulic systems does not drop below  $180 \text{ kgf/cm}^2$ ;
  - extend the flaps and air brake;
  - check their extension with reference to the indication on the L.G. and flaps position indicator and by the report of the aircraft technician;
  - retract the air brake and flaps;
  - check their retraction with reference to the indication on the L.G. and flaps position indicator and by the report of the technician;
- (25) check the aircraft control system, proceeding as follows:
  - check to see that the STAB FOR LDG and ROLL FOR LAND lamps are alive;
  - the STICK (РУЧКА) and STAB (СТАБИЛИЗАТОР) indices of the AFC indicator are located at the bottom;
  - deflect the control stick to the left, to the right, forward and backward and deflect the pedals;
  - make sure that the control stick and pedals are free from jerks and jamming;
  - relieve the control stick and pedals of forces;
  - check to see that the control stick and pedals return to the trimmed position;
- (26) check the operation of the trim mechanism, proceeding as follows:



- first pull and then push the trim knob on the control stick. In response, the released control stick should deflect in the direction of movement of the trim knob;
  - set the trim mechanism to the neutral position;
  - check to see that the STAB TRIM (ТРИММ. СТАБИЛИЗ.) lamp is illuminated in the annunciator;
  - press the aileron trim knob first to the left and then to the right;
  - check to see that the released control stick displaces in the direction of movement of the knob;
  - set the aileron trim mechanism to the neutral position;
  - check to see that the ROLL TRIM (ТРИММ. КРЕНА) lamp is illuminated in the annunciator;
  - press the rudder trim knob first to the left and then to the right;
  - check the respective deflection of the pedals;
  - set the rudder trim mechanism to the neutral position;
  - check to see that the RUD TRIM (ТРИММ. Р.П.) lamp is illuminated;
  - with the help of the technician make sure that the rudders are set to the neutral position;
- (27) perform the following operations:
- fully depress the brake lever on the control stick;
  - check the pressure against the pressure gauge which should read 105 to 120 kgf/cm<sup>2</sup>;
  - alternately deflect the pedals;
  - make sure that the main wheels get positively braked and unbraked;
- (28) check the operation of the voice message equipment, proceeding as follows:
- depress the SPEECH INFORM CHECK (ПРОВЕР. РЕЧЕВОЙ ИНФОРМ.) button;
  - check that the "Limit g-load" voice message is delivered;
  - depress and release the SPEECH INF COM RPT (ПОВТ. КОМ. РЕЧ. ИНФ.) button;
  - check that the voice message is repeated;
  - depress the RADIO (РАДИО) button on the throttle lever for a short time;
  - check that the voice message delivery is stopped;
- (29) successively accelerate the engines to the maximum power (for 5 to 10 s);

- while the engines are being accelerated to the maximum power, check to see that the bleed valves get closed when the engine speed is from 74 to 76 per cent (the BLEED VLV OPN lamp goes out), and when the engine speed exceeds 76.5 per cent, the AIR INT MONIT L R (КОИТП. ВХОДА ЛЕВ., ПРАВ.) lamp lights up;

(30) with the engines running at the maximum power, check to see that:

- the speed of the engines does not exceed 94.5 per cent;
- the exhaust gas temperature is not more than 820°C;
- the oil pressure is not less than 3.5 kgf/cm<sup>2</sup>;
- the jet nozzle flaps close (to be checked with reference to an intensive growth of the exhaust gas temperature);
- the TS DOORS OPEN lamps go out;

(31) set the throttle lever to the IDLE (МАЛЫЙ ГАЗ) stop.

Note. The engine run-up should be performed at the beginning of the flying day.

After the engines are started, proceed as follows:

- (1) request clearance for taxiing;
- (2) having been cleared for taxiing, brake the wheels and order the technician to remove the chocks;
- (3) having received the technician's acknowledgement, tell him "Over" and accelerate the engines up to 55 to 60 per cent;
- (4) release the braking lever and start taxiing;
- (5) after the aircraft gains sufficient speed, move the throttle levers of the engines to the IDLE stops;
- (6) prior to starting a turn, depress the STR (MPK) button on the control stick when the pedals are neutral, and then smoothly deflect the pedals in the direction of the turn;
- (7) the taxiing speed should not exceed 30 km/h;
- (8) during the turns the speed should not exceed 15 km/h;
- (9) the distance between the taxiing aircraft should be at least 200 m; at a wind velocity of 10 m/s and higher, the distance should be at least 250 m;
- (10) while taxiing, avoid abrupt turns at a high speed;
- (11) while taxiing, pay special attention to proper operation of the directional system, automatic direction finder, short-range radio navigation and landing system, navigation instruments.

Prior to taxiing out to the runway, the pilot must:

- (1) turn on the ПВД, ДВА HEATING (ОБОГР. ПВД. ДВА) circuit breaker;

- (2) lock the harness;
- (3) check to see that:
  - the pointers of the JBO-M1 indicator read zero;
  - the pressure in the main and booster hydraulic systems is normal;
  - the engine parameters are normal;
  - there are no glowing lamps in the emergency annunciator;
  - the pressure in the pneumatic systems (both main and emergency) is normal;
- (4) taxi out to the runway;
- (5) taxi 5 to 10 m straight and align the aircraft with the runway centre line;
- (6) smoothly brake the aircraft, fully depress the braking lever;
- (7) check to see that:
  - the present heading read by the combined course indicator complies with the takeoff heading;
  - the ADF pointer shows the direction to the outer marker beacon;
- (8) depress the flaps extension button and check their extension with reference to the lamp of the L.G. and flaps position indicator;
- (9) actuate the nosewheel brake;
- (10) start the clock;
- (11) turn on the LANDING switch on the PCBH-6C system control panel and check to see that the LOC flag drops out;
- (12) turn off the LANDING switch;
- (13) request clearance for takeoff;
- (14) set the throttle lever to the MAXIMUM (МАКСИМАЛ) position;
- (15) check to see that:
  - the bleed valves are closed (the BLEED VLV OPN lamps go out);
  - the turbostarter doors are closed (the TS DOORS OPEN lamps go out);
  - the AIR INT MONIT L R lamps go out;
  - the engine speed complies with the maximum power setting;
  - the gas temperature does not exceed the maximum permissible value but is not less than 600°C (the jet nozzle flaps are closed).

### Takeoff

The pilot must do the following:

(1) having been cleared for takeoff, set the throttle lever to the REHEAT (ДОПСАЖ) position;

(2) check to see that:

- the REHEAT (ДОПСАЖ) lamps light up;
- the exhaust gas temperature is not less than 600°C;
- the engine speed drops for a short time and then rises;
- shocks characteristic of the reheat power engagement rate are present;

(3) release the braking lever;

(4) in the first half of the takeoff run, maintain the direction by operating the pedals and brakes.

Transfer attention as follows:

- direction;
- speed - within 100 km/h;
- direction.

Apply 2/3 of back stick at a speed of 220 to 240 km/h.

Transfer attention as follows:

- direction;
- determining the moment of nosewheel lift-off (at a speed of 280 to 290 km/h);
- direction;

(5) set and fix the takeoff angle by the control stick;

(6) maintain the direction by operating the pedals.

Transfer attention as follows:

- direction;
- takeoff angle - the horizon is projected on the lower base of the windshield, and the flight director indicator reads a pitch angle of 10 to 11°;
- speed (it approaches 350 km/h);
- engine operation (to be checked aurally);

(7) having determined the aircraft separation from the runway, maintain the takeoff angle and shift the glance on the ground looking through the left front glass panel;

(8) make sure that the height is 10 to 15 m;

(9) maintaining the takeoff angle constant, throw the landing gear control valve catch up and set the landing gear control valve for retraction.

Transfer attention as follows:

- flight director indicator (pitch angle is 10 to 11°, roll angle is zero);
- airspeed indicator (airspeed is about 400 km/h);
- altitude indicator (altitude keeps growing);
- flight director indicator (pitch, roll angles are equal to zero);

(10) at an altitude of more than 100 m depress the flaps retraction button, shift the finger on the FLAPS EXT (ЗАКРЫЖКИ ВМП.) button and keep it there until the FLAPS DOWN (ЗАКРЫЖКИ ВМНУЖЕНЫ) lamp goes out on the L.G. and flaps position indicator;

(11) check to see that the L.G. retraction position lamps light up;

(12) set the landing gear control valve to the neutral position;

(13) throw the catch of the landing gear control valve down.

Transfer attention as follows:

- flight director indicator (roll, pitch);
- airspeed;
- altitude;
- flight director indicator;

(14) at an airspeed of 450 km/h check the following:

- illumination of the LOWER DOOR 2ND PSN (ОБЕЧАЙКА 2-Е ПОЛОЖ.) lamp;
- upward displacement of the AFC indices;
- extinguishing of the STAB FOR LDG and ROLL FOR LAND

lamps;

(15) at an airspeed of at least 600 km/h successively shift the throttle lever to the MAXIMUM position;

(16) check to see that:

- the REHEAT lamps go out;
- the engine speed corresponds to the maximum power;
- the exhaust gas temperature does not exceed the maximum permissible value and is not less than 600°C.

### Route Plotting

At an altitude of 1000 m after disengagement of the afterburners look round and perform the turns on the crosswind and downwind legs with a bank of 30° at an airspeed of 600 km/h in close succession. In the course of the turn continue climbing.

Let us consider a wide pattern at an altitude of 2000 m with subsequent descent to an altitude of 600 m. Figs 39 and 40 present the route plotting and circling flight pattern.

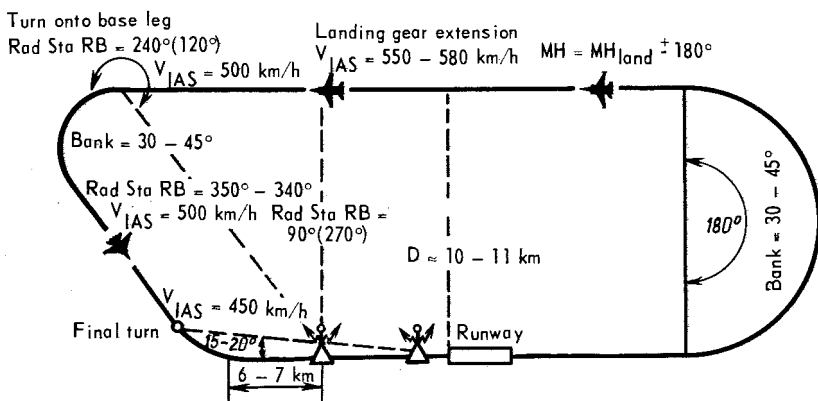

FIG. 39. ROUTE PLOTTING FOR CIRCLING FLIGHT

At 100 to 150 m to the assigned altitude start gradually decreasing the climb angle and engine speed. At an altitude of 2000 m maintain the airspeed of 600 km/h. An engine speed of 78 to 80 per cent corresponds to the airspeed 600 km/h.

The moment of the turn recovery is determined by referring to the combined course indicator and visually.

After reversing the course double your attention and make sure that other aircraft do not interfere with further circling.

Besides, continuously analyse the radio contact between the flight control officer and other pilots being in air. It allows to estimate indirectly the air situation within the area of the airfield.

When other aircraft perform circling flight, to provide for flight safety and normal landing approach, it is necessary to maintain the preset distance to a leading aircraft. As a rule,

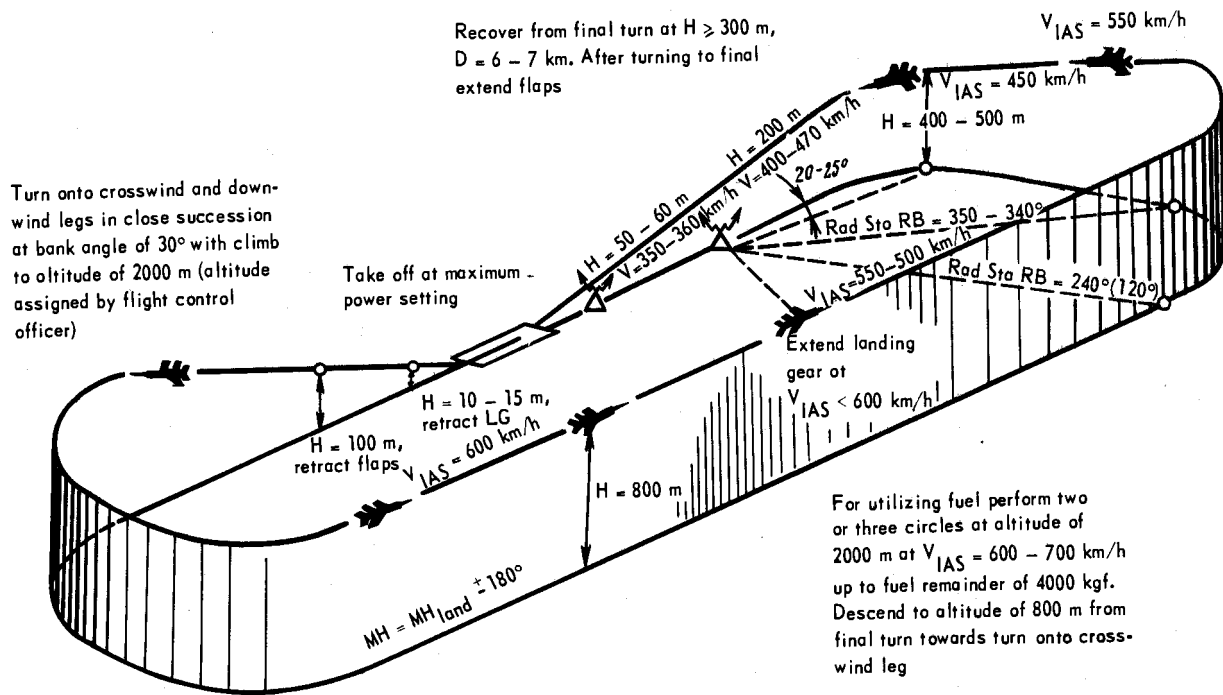

FIG. 40. CIRCLING FLIGHT PATTERN

in this case, the pilots radio the flight control officer about the turns being effected.

At an altitude of 2000 m perform the circling flight until the fuel load amounts to 4000 kgf (or assigned by the commander). After that perform landing approach on permission of the flight control officer.

To perform landing approach, descend from an altitude of 2000 m to 600 m when flying from the final turn to the turn on the crosswind leg. While descending, maintain a progressive speed of 600 km/h and a vertical speed of 15 m/s down to an altitude of 1000 m. When descending from an altitude of 1000 m to 600 m, maintain a descent rate of 10 m/s.

At an altitude of 600 m bring the aircraft into level flight. To maintain an airspeed of 600 km/h, an engine speed of 75 to 78 per cent is required.

The turns on the crosswind and downwind legs should be performed in close succession at a bank angle of  $30^{\circ}$  to intercept the course opposite to the landing heading.

From the turn on the downwind leg to the turn onto the base leg the aircraft should fly in parallel with the runway; the side distance amounts to 10 km. The side distance is checked by referring to the ПМД-2 distance indicator and typical landmarks.

When abeam the outer marker beacon (Rad Sta RB =  $270^{\circ}$  with the left-hand traffic circuit or Rad Sta RB =  $90^{\circ}$  with the right-hand traffic circuit), reduce the airspeed to 550 km/h. After that place the landing gear control valve knob to the DOWN position and throw the valve catch down.

Check the extension of the landing gear by illumination of the green pilot lamps and restoration of the pressure in the hydraulic systems up to  $210 \text{ kgf/cm}^2$ , the position of the drag chute control switch (in first solo flights the switch should be in the MAN (РУЧ.) position), the engagement of the wheel brake control automatic unit, the engagement of the nosewheel brake. The wheel brakes should be released, the air pressure in the main and emergency systems should be 100 to  $130 \text{ kgf/cm}^2$ .

The landing gear control valve knob should remain in the extension position until the aircraft is parked.

With the landing gear extended, set an airspeed of 500 km/h. In this case, the engine speed will be within the range of 75 to 78 per cent.



Landing Approach and Estimation  
for Landing

Before turning onto the base leg it is necessary to look round, request clearance for landing and at Rad Sta RB =  $240^{\circ}$  ( $120^{\circ}$ ) perform the turn onto the base leg through an angle of  $100$  to  $110^{\circ}$  at an airspeed of  $500$  km/h with a bank of  $30$  to  $45^{\circ}$  in the horizontal plane.

Recovery from the turn onto the base leg should be completed at Rad Sta RB =  $345$  to  $340^{\circ}$  with the left-hand traffic circuit or at Rad Sta RB =  $15$  to  $20^{\circ}$  with the right-hand traffic circuit.

After turning onto the base leg, bring the aircraft into a descent at a vertical rate of  $5$  to  $7$  m/s, set the engine speed of  $74$  to  $76$  per cent and extend the flaps. In this case, make sure that the airspeed is  $450$  km/h. Accuracy in maintaining the airspeed is corrected by changing the engine speed within  $1$  to  $2$  per cent.

Check the extension of the flaps by referring to illumination of the FLAPS DOWN pilot lamp. If the wing flap extension causes energetic rolling of the aircraft, immediately retract the flaps, report the matter to the flight control officer and go around.

In this case, perform landing with the wing flaps retracted.

After turning to the base leg, descend the aircraft so as to enter a turn to final at an altitude of  $400$  to  $450$  m and at an airspeed of  $450$  km/h.

The final turn is performed at an airspeed of  $450$  km/h at a runway sighting angle of  $15$  to  $20^{\circ}$  so that the recovery from the turn is completed at an altitude of not less than  $300$  m at a distance of  $6$  to  $7$  km from the runway.

Accuracy of interception of the runway centre line is adjusted by changing the bank in the course of the turn. In case of inaccurate interception of the landing heading, it is necessary to correct the error before flying over the outer marker beacon by turning the aircraft to the left or to the right through an angle of not more than  $15^{\circ}$ . If it is impossible to correct the error before flying over the outer marker beacon, the pilot must go around, report the matter to the flight control officer and effect a repeated approach with the errors made during the first approach taken into account.

After the final turn gradually bring the aircraft to the descent attitude at a vertical rate of 5 to 3 m/s. Depending on the direction and force of the wind, as well as on the fuel remainder, select an engine speed of 68 to 70 per cent. In this case, fly over the outer marker beacon at an airspeed of 420 to 400 km/h at an altitude of 200 m.

### Landing

After flying over the outer marker beacon, the pilot should proceed as follows:

- (1) align the flight heading with the runway centre line;
- (2) direct the aircraft so as to descend at the beginning of the runway;
- (3) select the engine speed of 66 to 68 per cent;
- (4) look through the canopy:
  - estimate the direction of gliding and the aircraft descent angle;
  - maintain the flight along the runway centre line and descend at the beginning of the runway;
- (5) shift the glance inside the cabin and watch the following:
  - airspeed indicator (check the amount and rate of the airspeed change);
  - altimeter (check the present altitude);
  - vertical-speed indicator (the vertical speed of descent amounts to approximately 5 m/s);
  - glide slope deviation bar (deviation from the glide slope);
- (6) while flying up to the inner marker beacon, distribute your attention as prescribed in Items (4) and (5). Operate the control stick and pedals to descent along the runway centre line into the flare-out point;
- (7) at an airspeed of 370 km/h accelerate the engines to 70 per cent;
- (8) at an airspeed of 360 km/h select the engine speed of 72 per cent;
- (9) operating one throttle lever (within  $\pm 2$  per cent), maintain the gliding speed of 350 to 360 km/h up to the inner marker beacon;
- (10) when passing over the inner marker beacon, check the following:

- direction (along the runway centre line);
- descent to a point located 150 to 200 m from the runway;
- airspeed of 350 to 360 km/h;
- altitude of 60 to 50 m;

(11) decelerate one of the engines by approximately 2 per cent to ensure the airspeed of 340 km/h by the moment of flare-out;

(12) 500 m from the runway check the airspeed (the airspeed should be 350 to 340 km/h) and change the engine power, if necessary;

(13) shift the glance onto the ground, looking through the left glass panel of the fixed canopy;

(14) estimate the flight altitude when the flare-out procedure is initiated;

(15) starting from the height of 8 to 10 m, smoothly deflect the control stick to decrease the angle of descent so as to finish the flare-out procedure before the runway not higher than 1 m over it;

(16) smoothly set the throttle lever to the IDLE stop;

(17) as the aircraft approaches the ground, smoothly and proportionally apply back stick to decrease the vertical speed of descent, creating an appropriate landing angle of attack (10 to 11°);

(18) after touch-down, hold the control stick and check the speed;

(19) at an airspeed of not more than 330 km/h deploy the drag chute;

(20) shift the glance forward to check the direction;

(21) keep the control stick fixed until the aircraft lowers the nose wheel;

(22) prior to lowering of the nose wheel, set the pedals neutral;

(23) after the nose wheel is lowered, maintain the direction by smoothly deflecting the pedals;

(24) brake the aircraft taking into consideration the runway length and landing roll speed by smoothly depressing the braking lever;

(25) prior to taxiing out from the runway, proceed as follows:

- retract the flaps;
- disengage the nosewheel brake;

- release the drag chute;
- clear the runway and report the fact;
- turn off the IBD, JVA HEATING circuit breaker.

### Taxying-In

The pilot must act as follows:

(1) taxi up to the technical inspection post and depress the braking lever (on the command of the technician) to stop the aircraft. Keep the braking lever depressed until the inspection is completed;

(2) set the trim mechanisms to the neutral position.

Check to see that the STAB TRIM, ROLL TRIM and RUD TRIM green lamps are alight;

(3) keeping the braking lever depressed with the left hand, depress the RM (PO) light-button on the PCBH-6C system control panel with the right hand. Turn off the LANDING switch (if it has been turned on).

Check to see that:

- the landing mode of the short-range radio navigation and landing system has been disabled;

- the RETURN lamp has gone out;

- the RM lamp is alight;

(4) having been cleared by the technician for further taxiing, set the engine speed to 60 per cent.

Check to see that:

- the technician is safely away from the aircraft;

- no obstacles are ahead;

(5) release the braking lever and, having increased the speed to a value required for taxiing, throttle the engines;

(6) in further taxiing maintain the direction by deflecting the pedals towards the required turn, and the taxiing speed, by varying the engine speed and applying the brakes.

Check the following:

- direction of taxiing;

- obstacles ahead;

- safe taxiing speed;

(7) when taxiing in to the parking ground, make sure that there are no obstacles and aircraft with started engines in the way (in case of any obstacles, stop the aircraft).

Check to see that:

- there are no obstacles ahead;

- taxiing is cleared (by referring to the green light of the ground traffic signal lights or by the command of the zone attendant).

On the command of the aircraft technician, taxi into the parking ground at the minimum speed. Smoothly brake the wheels and stop the aircraft.

Check to see that:

- the technician is safely away from the aircraft;
- collision is avoided, the aircraft is stopped.

#### Shut-Down

The pilot must act as follows:

(1) shut down the engines by pressing the STOP catches and shifting the throttle levers of both engines to the STOP position (fully backwards);

(2) turn off the FUEL PUMP NITROG circuit breaker.

Check to see that:

- the BLEED VLV OPEN lamps in the annunciator are dead;
- the NO FUEL FEED (HET ПОЖК. ТОПИМБА) lamp lights up;

(3) disconnect the helmet ventilation unit and remove the oxygen mask (open the pressure helmet visor);

(4) switch off all power consumers except the GRND SUP ACFT BAT switch and ITO START circuit breaker that should be switched off one minute after the throttle levers are set to the STOP position;

(5) having assured that the aircraft is stopped (the chocks are installed), release the braking lever.

### 2.3. Typical Errors Made By Pilots in Circling Flight and Their Remedy

Positioning of the aircraft at an angle with respect to the runway centre line before take-off results in deviation of the aircraft towards the edge of the runway as the aircraft starts the take-off run. To correct the error it is necessary to stop further deviation of the aircraft by smoothly applying the appropriate pedal. When doing so, do not try to align the aircraft with the runway centre line, but maintain the straight take-off run by keeping the aircraft from further deviation.

The lift-off angle of the nose section of the fuselage is small. This error may occur due to the fact that the pilot stops pulling the control stick backward at the moment of the nose-wheel lift-off. The aircraft continues running with a low-lifted nose wheel (a pitch angle as read off the flight director indicator is less than  $10^{\circ}$ , the horizon is projected above the lower base of the canopy windshield). It will cause the aircraft to unstick at an increased speed and an increased load will be applied to the main wheels.

To correct his error, the pilot should deflect the control stick backward smoothly to increase the pitch angle so that the horizon is projected to the lower base of the windshield of the canopy.

The climb angle after the aircraft unsticks from the ground is insufficient. The climb angle is set and maintained with the aid of the flight director indicator. Failure to maintain the assigned pitch angle, especially when taking off at the augmented power setting, may result in an energetic increase of the airspeed in excess of 700 km/h before the complete retraction of the landing gear.

To correct this error, the pilot should manipulate the control stick to set the assigned pitch angle by referring to the flight director indicator and trim out the control stick by means of the stabilizer trim mechanism.

Failure to maintain the assigned gliding speed after flying over the outer marker beacon. This error occurs in case the engine speed does not correspond to the assigned gliding speed. It results in that the airspeed will be higher or lower than the assigned one after the aircraft passes the outer marker beacon.

Elimination of this error by the ММГ-25Н aircraft has the following peculiarities: at the initial moment after the engine speed decreases (increases) the airspeed decreases (increases) slowly, and then starts changing energetically. Due to this, double movement of the throttle levers is required. As the airspeed decreases, it is necessary to increase the engine speed by 3 to 4 per cent first, and as soon as the airspeed starts increasing, reduce the engine speed by 1 to 2 per cent. While the airspeed increases, set the engine speed of 65 to 66 per cent; as soon as the airspeed starts dropping, increase the

engine speed by 1 to 2 per cent. Thus, the pilot should check not only the airspeed, but constantly notice the tendency for its variation.

Low pull-up. This error is a result of late elimination of undershooting. The low pull-up forces the pilot to decrease the gliding angle or bring the aircraft into the level flight at a low altitude at a considerable distance from the flare-out starting point.

Usually, in such cases the aircraft approaches the beginning of the runway at an increased airspeed and a height of more than 1 m.

It may result in more serious errors in landing approach estimation and landing proper. Hence, the pilot should decide to go around and eliminate the error in due time before the aircraft descends to an altitude of 50 m.

Ballooning or bouncing of the aircraft into the air during landing. This error may occur when approaching the runway at an excessive airspeed due to the low flare-out and abrupt movement of the control stick backward effected to recover the aircraft from the gliding angle, as well as due to the fact that the pilot's glance is directed too far forward.

In case of ballooning or bouncing of the aircraft into the air at a high speed it is necessary, first, to stop further lift-off of the aircraft from the ground by short double manipulations of the control stick. Then, as the aircraft approaches the ground, bring the aircraft to the runway by smoothly pulling the control stick backward and avoiding rolling. When doing so, it is prohibited to push the control stick forward to place the aircraft to the descent attitude after ballooning.

When ballooning at a low speed, it is necessary to hold the control stick in the position in which it was at the moment when the aircraft lifted off the ground and take care to avoid rolling. In this case it is also prohibited to push the control stick forward. As the airspeed decreases and the aircraft approaches the ground, it is necessary to pull the control stick smoothly backward to effect normal landing. The back stick pressure rate should correspond to the descent rate of the aircraft.

### 3. MANEUVERING FLIGHTS

#### 3.1. General

Maneuvering flights are intended for the flying personnel to acquire firm habits in maneuvering required when practising combat employment and to use more effectively combat capabilities of the ММГ-25ПД aircraft.

The ММГ-25ПД aircraft carrying missiles or having no missiles may be used for performing the following maneuvers:

- 360° turns;
- zooms;
- chandelles;
- diving;
- rolls;
- spirals with various banks, ascending and descending maneuvers at the maximum permissible g-load indicated by the movable sector of the ИИ-155 g-load indicator.

A peculiarity involved in flying the aircraft within the maneuvering area consists in that abrupt changes in trimming characteristics of the aircraft at variations of the airspeed and engine power settings result in the necessity of constant use of the stabilizer trim mechanism in order to decrease pressure applied to the control stick of the aircraft.

Sound knowledge of the peculiarities involved in the maneuvering flights on the ММГ-25ПД aircraft allows the flying personnel to master handling of the aircraft within a considerably short time and avoid such blunders that may result in wrong evaluation of the aircraft and its high flight performance.

During the initial stage of training, the flying technique should be practised at the optimum airspeeds and altitudes at which the maneuvering procedure is rather simple and it allows the pilot to become sufficiently skilled in handling the aircraft. Then, as the flying personnel acquire the habits in handling the aircraft, the pilots should master the flying technique within the entire range of permissible altitudes and airspeeds of flight.

#### 3.2. 360° Turn

The ММГ-25ПД aircraft performs 360° turns within the wide range of airspeeds and altitudes. The power setting of the engines in a turn is selected in compliance with the airspeed required.



360° steady turns may be effected at bank angles of up to 70° both at non-reheat and reheat power settings. Fig. 41 illustrates the relation between the g-load at a 360° steady turn and the airspeed and altitude of flight at the FULL REHEAT and MAXIMUM power settings.

With the engines running at the FULL REHEAT power setting, execution of 360° steady turns on the aircraft carrying missiles or having no missiles is possible at altitudes of 10,000 to 16,000 m; at altitudes below 10,000 m a 360° steady turn may be performed by the aircraft carrying four missiles P-40 only.

When the aircraft carries no missiles, 360° steady turns are performed at altitudes below 10,000 m with both engines running at non-reheat power setting or with one of the engines running at the maximum power setting and the other at full reheat or partial reheat power setting. When performing 360° steady turns with the engines running at different power settings, it is recommended that the outer (with respect to the direction of the turn) engine should run at the reheat power setting, whereas the inner one should run at the maximum power setting.

There is no difference involved in performing left and right 360° steady turns.

In training flights 360° turns at medium altitudes at bank angles of up to 60° are executed at an indicated airspeed of 650 to 700 km/h.

During entry into a turn the MiG-25M aircraft tends to lower the nose; therefore, it is necessary to relieve the control stick of pulling forces by the stabilizer trim mechanism simultaneously with creating a bank.

As the bank and the angular rate increase, the engine speed should be increased so as to correspond to the assigned airspeed of the 360° turn by the moment the aircraft reaches the assigned bank. Slow entry into the 360° turn and early increase of the engine speed result in increase of the airspeed in the 360° turn. Energetic entry into the turn and late increase of the engine speed result in certain decrease of the airspeed during the turn.

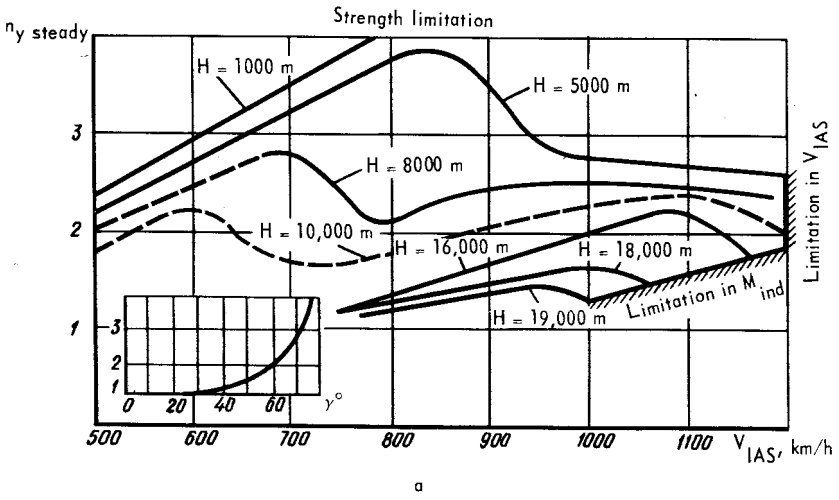

a

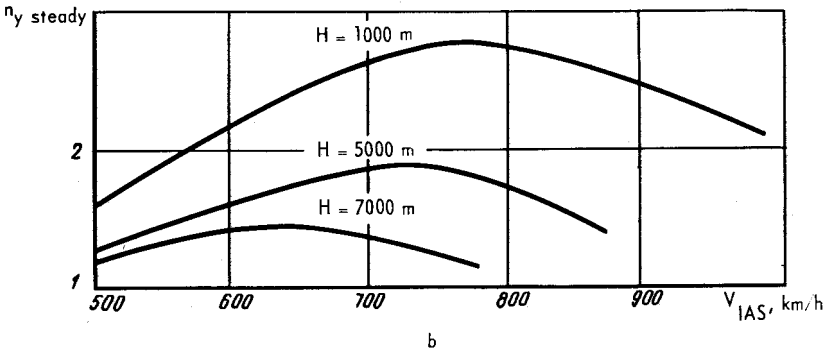

b

FIG. 41. G-LOAD  $n_{y \text{ steady}}$  IN STEADY  $360^\circ$  TURN VERSUS  $V_{IAS}$  AND FLIGHT ALTITUDE  $H$

a - at FULL REHEAT power setting; b - at MAXIMUM power setting

It is necessary to check proper execution of the  $360^\circ$  steady turn by referring to the flight instruments and the position of the canopy front section with respect to the natural horizon.

When recovering from the  $360^\circ$  turn, take into account the fact that the aircraft tends to increase the pitch angle. Therefore, it is necessary to trim out push forces from the control stick with the aid of the trim mechanism of the stabilizer with simultaneously decreasing the bank angle.

In addition to the  $360^\circ$  steady turns executed at non-reheat or reheat power setting of the engines, the MiG-25M aircraft is capable to perform  $360^\circ$  unsteady (accelerated) turns.

The technique involved in performing a  $360^\circ$  accelerated turn somewhat differs from that of performing a  $360^\circ$  steady turn. The  $360^\circ$  accelerated turn involves a loss in airspeed and g-loads exceeding the maximum values with respect to thrust.

When executing the  $360^\circ$  unsteady turns, the g-loads should not exceed the maximum permissible ones indicated by the MiG-155 g-load indicator movable sector.

Check the approach to the limit angles of attack by referring to the illumination of the yellow warning lamp on the MiG-155 indicator.

Relieve the control stick of pulling forces or move the control stick a bit forward in case of intensive growth of buffeting.

At altitudes higher than 5000 m and  $M > 1.0$ , the  $360^\circ$  unsteady turns are accomplished with the control stick deflected fully back or close to the back position.

#### 45° Banked Turn

Preparatory to the turn proceed as follows:

- (1) select an airspeed of 700 km/h and engine speed of about 80 per cent at the selected altitude (up to 5000 m);
- (2) trim the aircraft by the trim mechanism;
- (3) determine the entry direction;
- (4) note the position of the horizontal line on the flight director indicator with respect to the miniature airplane and compare its readings with the readings of the vertical-speed indicator and aircraft position relative to the natural horizon.

### Turn Entry :

(5) proportionately deflect the control stick and pedals in the turn direction to create a roll of  $45^{\circ}$  and simultaneously increase the engine speed in compliance with the selected air-speed;

(6) to preclude dropping of the aircraft nose in the process of turn entry, apply such an amount of back stick as to maintain the altitude;

(7) transfer attention as follows:

- flight director indicator (roll, pitch, slipping);
- vertical-speed indicator (absence of vertical speed);
- altitude (constant);
- flight director indicator (roll, pitch, slipping);
- airspeed (selected);
- flight director indicator (roll, pitch, slipping).

### Execution of Turn :

(8) with the help of the control stick maintain the constant altitude and roll angle of  $45^{\circ}$ ;

(9) eliminate slipping by deflection of the pedals, maintaining the ball in the centre;

(10) control the airspeed by changing the engine speed;

(11) transfer attention as follows:

- flight director indicator (roll, pitch, slipping);
- vertical-speed indicator (absence of vertical speed);
- altitude;
- flight director indicator;
- vertical-speed indicator;
- airspeed;
- flight director indicator;
- vertical-speed indicator;
- combined course indicator (the present heading approaches the recovery heading);
- flight director indicator;
- vertical-speed indicator;
- engine speed;
- flight director indicator.

### Recovery from Turn :

(12)  $20^{\circ}$  before the selected reference point or entry heading read by the combined course indicator, proportionately

deflect the pedals and control stick in the direction opposite to that of the roll to recover the aircraft from the turn;

(13) while recovering from the roll, apply such an amount of forward stick as to maintain the altitude;

(14) when the roll angle is  $0^{\circ}$ , set the control stick and pedals neutral;

(15) after the aircraft recovery from the turn, select the engine speed for level flight;

(16) transfer attention as follows:

- flight director indicator;
- vertical-speed indicator;
- combined course indicator;
- flight director indicator;
- vertical-speed indicator;
- airspeed;
- altitude;
- flight director indicator.

#### $60^{\circ}$ Banked Turn

Preparatory to the turn, proceed as follows:

(1) select the airspeed of 700 km/h at the assigned altitude;

(2) trim the aircraft with the help of the trim mechanism;

(3) determine the direction of entry;

(4) note the position of the horizontal line on the flight director indicator relative to the miniature airplane and compare its readings with the readings of the vertical-speed indicator and aircraft position relative to the natural horizon.

#### T u r n   E n t r y :

(5) proportionately deflect the control stick and pedals in the turn direction to create a roll;

(6) when the roll angle reaches  $45^{\circ}$ , simultaneously with further increase of the roll angle apply back stick, increasing the pull rate as the roll angle is growing;

(7) in the course of the turn entry, increase the engine speed to maintain the airspeed of 700 km/h;

(8) transfer attention as follows:

- flight director indicator;
- vertical-speed indicator;
- altitude;
- flight director indicator;

- g-load;
- flight director indicator;
- vertical-speed indicator;
- airspeed;
- flight director indicator;

Execution of Turn:

(9) as the roll angle of  $60^{\circ}$  is attained, slightly deflect the control stick in the direction opposite to that of the roll and set it to the position close to the neutral one (in roll);

(10) in the course of the turn maintain the roll angle of  $60^{\circ}$ ;

(11) maintain the assigned altitude by slightly decreasing (or increasing) the roll angle and varying the angle of attack, if necessary;

(12) eliminate slipping by deflection of the pedals, maintaining the ball in the centre;

(13) change the engine speed to maintain the constant airspeed;

(14) transfer attention as follows:

- flight director indicator;
- vertical-speed indicator;
- g-load (2.1 g);
- flight director indicator;
- altitude;
- flight director indicator;
- vertical-speed indicator;
- airspeed;
- flight director indicator;
- vertical-speed indicator;
- combined course indicator;
- flight director indicator;
- vertical-speed indicator;
- engine speed;
- g-load;
- flight director indicator.

Recovery from Turn:

(15) 20 to  $25^{\circ}$  before the selected reference point or turn entry heading read by the combined course indicator, proportio-

nately deflect the control stick and pedals in the direction opposite to that of the roll and recover the aircraft from the turn;

(16) while recovering from the roll, apply such an amount of forward stick as to maintain the altitude;

(17) as the roll angle of  $0^\circ$  is attained, set the control stick and pedals neutral;

(18) after the aircraft recovery from the turn, select the engine speed for level flight;

(19) transfer attention as follows:

- flight director indicator;
- vertical-speed indicator;
- combined course indicator;
- flight director indicator;
- vertical-speed indicator;
- airspeed;
- altitude;
- flight director indicator.

#### Thrust-Limited Turn

Preparatory to the turn, proceed as follows:

(1) select an airspeed of 800 km/h at the assigned altitude;

(2) trim the aircraft with the help of the trim mechanism;

(3) determine the direction of entry.

(4) note the position of the horizontal line on the flight director indicator relative to the miniature airplane and compare its readings with the readings of the vertical-speed indicator and aircraft position relative to the horizon.

#### T u r n   E n t r y :

(5) proportionately deflect the control stick and pedals in the turn direction to create a roll;

(6) in the process of the turn entry, increase the engine speed to the maximum power and apply such an amount of back stick as to maintain the altitude;

(7) when the angle of roll reaches  $60^\circ$ , engage the after-burner;

(8) when the roll angle of  $70^\circ$  is attained, set the control stick to a position close to the neutral one (in roll);

(9) transfer attention as follows:

- flight director indicator;
- vertical-speed indicator;

- flight director indicator;
- airspeed;
- flight director indicator;
- g-load;
- flight director indicator;
- altitude;
- flight director indicator.

#### Execution of Turn:

(10) increase (or decrease) the roll angle and maintain the constant g-load to correct the altitude;

(11) maintain the airspeed by changing the g-load and deflecting the control stick, if necessary;

(12) transfer attention as follows:

- flight director indicator;
- vertical-speed indicator;
- airspeed;
- flight director indicator;
- vertical-speed indicator;
- g-load;
- flight director indicator;
- vertical-speed indicator;
- altitude;
- flight director indicator;
- reference point;
- flight director indicator.

#### Recovery from Turn:

(13) 30° before the selected reference point or with reference to the combined course indicator, deflect the control stick and pedal to decrease the roll;

(14) as the roll angle decreases, apply some amount of forward stick;

(15) in the course of recovery from the turn, reduce the engine speed to the assigned value;

(16) transfer attention as follows:

- flight director indicator;
- vertical-speed indicator;
- combined course indicator;
- flight director indicator;
- vertical-speed indicator;



- airspeed;
- altitude;
- flight director indicator.

#### Typical Errors Made during 360° Turn

Aircraft sinking at entry. The main causes of the aircraft sinking at entry are the following:

- failure of the g-load to correspond to the aircraft roll angle;
- excessive deflection of the pedal in the direction of the turn;
- entry into the turn with a vertical velocity of descent available;
- considerable pulling forces applied to the control stick, which are not trimmed out by the pilot with the aid of the stabilizer trim mechanism.

As a rule, the aircraft performs a spiral descent at a great roll and g-load. In this case, the translational speed and vertical velocity continuously increase.

The pilot's attempt to stop descending at great roll angles by pulling the control stick results in increase of the angular rate (g-load) and contributes to further sinking of the aircraft.

If the vertical velocity of descent is not more than 10 to 15 m/s, decrease the roll angle and stop the descent by pulling the control stick. This done, continue executing the turn. In case the vertical velocity of descent is 15 m/s and more, eliminate the roll completely, bring the aircraft into level flight and repeat entry into the 360° turn.

Failure to maintain the assigned airspeed and altitude in the course of executing the 360° turn. This error is typical for the initial stage of the flying technique training.

Excessive pulling of the control stick. This error may result in exceeding the g-load limitations and bringing the aircraft to the critical angles of attack. When entering the critical angles of attack, the aircraft energetically stalls and then enters a dive. When the pilot timely pushes the control stick beyond the neutral position, the aircraft performs an inverted roll and its airspeed sharply decreases. Prior to stalling, a typical aerodynamic buffeting of the aircraft occurs.

In case of excessive pulling of the control stick (intensive buffeting arises), it is necessary to release back stick pressure (apply forward stick pressure) and reduce the angular rate.

Further on, watch the readings of the VII-155 g-load indicator more attentively and manipulate the controls more smoothly.

### 3.3. Dive

On the MiG-25M aircraft, dives are permitted at angles of up to  $45^\circ$  within an altitude range of 5000 to 15,000 m, with the engines running at the idle power setting.

For training purposes, dives are practised at medium and high altitudes, at angles of  $20^\circ$ ,  $30^\circ$  and  $45^\circ$  successively, at an entry airspeed of 450 to 500 km/h.

As a rule, dive entry for training purposes is accomplished from a turn, since in this case it is easy to set the assigned dive angle and avoid a negative g-load. Besides, when entering the dive from a turn the minimum altitude loss and a lower rate of airspeed rise are obtained.

It should borne in mind that it takes a long time for the MiG-25M aircraft to enter a dive, which results in a great loss of altitude.

During the initial training stage, when entering the dive, the roll angles should not exceed  $60^\circ$ , whereas during further mastering of the flying technique the dive may be entered at roll angles of up to  $80^\circ$ . The greater the roll at entry, the lesser the altitude loss and airspeed increment during the time of establishing the assigned dive angle.

In the course of diving, it is necessary to avoid banking or slipping. Carry out the check by referring to the landmark, gyro horizon on the flight director indicator and sideslip indicator.

The dive recovery should be started at an indicated airspeed of 800 km/h and at a maximum permissible g-load read by the VII-155 g-load indicator movable sector, which should be created during 3 to 5 s.

Due to a long time of the engine acceleration, it is recommended to increase the engine speed well in advance in the course of diving in compliance with the further flight conditions.

When recovering from the dive, pay special attention to absence of banking or slipping and follow the g-load raising

rate. Abrupt pulling of the control stick may result in increase of the g-load in excess of its maximum permissible value read off the movable sector of the WI-155 g-load indicator.

The typical errors likely to be made during execution of the dive consist in failure to maintain the preset dive angle and diving accompanied with a roll.

#### Dive Technique

Preparatory to the dive, the pilot must proceed as follows:

- (1) determine a reference point (landmark) for dive entry;
- (2) select on airspeed of 500 km/h and engine speed of 70 per cent at the assigned altitude.

#### D i v e   E n t r y :

- (3) enter the turn with a roll angle of  $45^{\circ}$ ;
- (4) when approaching the selected reference point (or heading), increase the roll angle up to  $60$  to  $90^{\circ}$ ;
- (5) create a dive angle of  $30^{\circ}$  by applying forward stick and deflecting the pedal in the entry direction;
- (6) recover from the roll;
- (7) fix the dive angle;
- (8) increase the engine speed to the maximum power;
- (9) transfer attention as follows:
  - flight director indicator (pitch angle is  $30^{\circ}$ , roll and slipping are absent);
  - airspeed is growing;
  - reference point (or combined course indicator);
  - flight director indicator;
  - engine speed (corresponds to the maximum power);
  - flight director indicator.

#### D i v e :

- (10) as the airspeed is growing, increase the push force applied to the control stick to maintain the assigned angle of dive;
- (11) eliminate roll and slipping with the help of the control stick and pedals;
- (12) transfer attention as follows:
  - flight director indicator (roll and slipping are absent, pitch angle is  $30^{\circ}$ );

- airspeed (approaches 800 km/h);
- flight director indicator;
- altitude;
- flight director indicator;
- airspeed;
- flight director indicator;

#### D i v e R e c o v e r y :

(13) as the airspeed of 800 km/h is attained, apply back stick and create a g-load to 3 g within 3 to 5 s;

(14) as the aircraft approaches the horizon, reduce the pull force so as to recover to level flight at an airspeed of 900 km/h;

(15) when the aircraft is recovered to level flight, slightly deflect the control stick beyond the neutral position and fix the angle of pitch;

(16) transfer attention as follows:

- flight director indicator;
- g-load;
- flight director indicator;
- airspeed;
- altitude;
- flight director indicator;
- vertical-speed indicator;
- flight director indicator;
- airspeed;
- flight director indicator.

#### 3.4. Zoom

Zooms on the ММГ-25ПД aircraft are performed at the reheat and non-reheat power settings.

Entry into a zoom is allowed from level flight at airspeeds (Mach-numbers) of up to the maximum permissible ones and altitudes of up to 18,000 to 19,000.

The altitude gained in the course of a zoom depends on the airspeed, zoom entry altitude, engine power setting and the zoom angle. When executing a limit zoom from altitudes of 500 to 600 m, the aircraft climbs to an altitude of 6000 to 6500 m, whereas from altitudes of 17,000 to 17,500 m, the aircraft

gains an altitude of 2500 to 3000 m. The limit zoom angles versus the flight altitude are presented in Fig. 42.

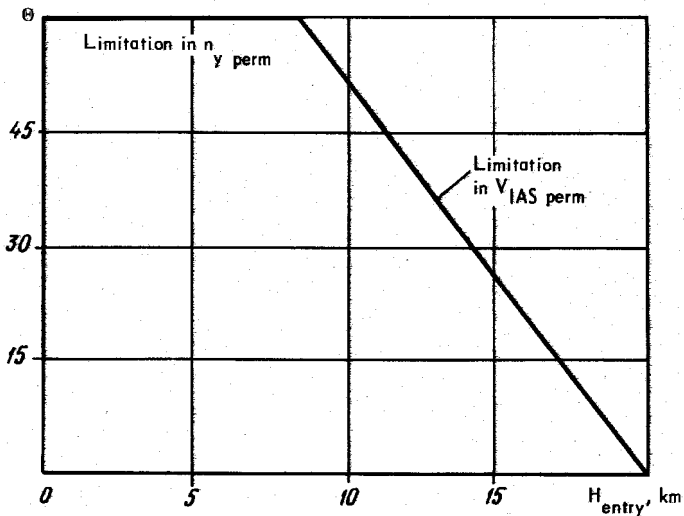

FIG. 42. ZOOM LIMIT ANGLES

For training purpose it is necessary to enter the zoom at an indicated airspeed of 850 to 900 km/h (the Mach-number should not exceed 0.9) at the reheat power setting of the engines. It is advisable to accelerate the aircraft with a descent or ensure the attaining of the assigned airspeed on the descending leg of the maneuver which precedes the zoom.

When the zoom is entered at altitudes of 7000 to 8000 m and  $M = 0.97$  to 1.2, the available vertical  $g$ -load decreases to 2.5 to 3.5  $g$ .

#### Zoom Technique

##### Z o o m E n t r y :

- (1) while proceeding in level flight at the assigned altitude select an airspeed of 900 km/h;
- (2) move the throttle lever to the **MAXIMUM** position;

(3) smoothly but energetically deflect the control stick to create a g-load of 3 g within 3 to 5 s;

(4) as the pitch angle of  $20^{\circ}$  is attained, slightly release the control stick force;

(5) as the pitch angle of  $30^{\circ}$  is attained, fix it by applying forward stick;

(6) transfer attention as follows:

- flight director indicator (pitch angle increases, roll and slipping are absent);
- g-load (check to see that it does not exceed the maximum permissible value);
- flight director indicator;
- horizon;
- flight director indicator (pitch angle is  $30^{\circ}$ , roll and slipping are absent).

#### Execution of Zoom :

(7) as the airspeed is decreasing, slightly apply back stick so as to maintain the pitch angle constant;

(8) transfer attention as follows:

- flight director indicator (pitch angle is  $30^{\circ}$ , roll and slipping are absent);
- airspeed (approaches recovery airspeed);
- natural horizon;
- flight director indicator;
- airspeed;
- altitude (approaches recovery altitude).

#### Zoom Recovery :

(9) at an airspeed of 600 km/h, proportionately deflect the control stick and pedal to create a roll angle of  $60$  to  $90^{\circ}$  and a g-load of 0.5 to 1 g;

(10) simultaneously with application of forward stick reduce the g-load to 0.4 g;

(11) fix the roll angle of  $60^{\circ}$  as it is attained;

(12) as soon as the aircraft nose approaches the horizon, eliminate the roll and level the aircraft at an airspeed of not less than the maneuvering airspeed;

(13) select the assigned engine speed;

(14) transfer attention as follows:

- flight director indicator;

- airspeed;
- flight director indicator;
- g-load;
- flight director indicator;
- airspeed;
- altitude;
- flight director indicator;
- natural horizon;
- airspeed;
- flight director indicator;
- vertical-speed indicator;
- flight director indicator.

### 3.5. Chandelle

A chandelle is performed at the reheat power setting and at the maximum permissible vertical g-load read by the movable sector of the VII-155 g-load indicator.

The aircraft may enter a chandelle at the maximum permissible airspeed at altitudes of up to 10,000 m. The indicated airspeed of entry into a chandelle at low altitudes should not be less than 800 km/h.

When the aircraft carrying missiles or having no missiles is brought into the maneuver from altitudes of 500 to 1000 m at the maximum permissible airspeed, it will gain an altitude of 6500 to 7000 m.

For training purposes, enter the maneuver from level flight at an indicated airspeed of 850 to 900 km/h (the Mach-number should not exceed 0.9), with the engines running at the reheat power setting.

#### Chandelle Technique

Prior to performing a chandelle, act as follows:

- (1) while proceeding in level flight at the assigned altitude, select an airspeed of 900 km/h;
- (2) select the entry reference point or heading against the combined course indicator;
- (3) increase the engine speed to the maximum power.

Entry into Chandelle:

- (4) engage the afterburner;
- (5) proportionately deflect the control stick and pedals in the entry direction to create the maximum permissible g-load

against the VII-155 indicator within 3 to 5 s and the roll angle of 10 to 15°;

(6) transfer attention as follows:

- flight director indicator (present heading, pitch, absence of slipping);
- airspeed;
- flight director indicator;
- g-load (maximum permissible value);
- flight director indicator;
- altitude;
- flight director indicator.

Execution of Chandelle :

(7) while climbing along an ascending spiral, increase the roll and pitch angles;

(8) when the roll angle of 60 to 65° is attained, slightly deflect the control stick in the direction opposite to that of the roll and back to avoid increase of the roll angle;

(9) transfer attention as follows:

- flight director indicator;
- airspeed;
- flight director indicator;
- altitude;
- flight director indicator;
- airspeed;
- combined course indicator (or reference point);
- flight director indicator.

Recovery from Chandelle :

(10) after the aircraft turns through 120 to 130°, push the control stick diagonally forward and aside to gradually decrease the angles of roll and pitch;

(11) simultaneously with the deflection of control stick, slightly deflect the pedal in the recovery direction;

(12) reduce the roll angle and altitude so as to level the aircraft after it turns through 180° at an airspeed of not less than 500 km/h;

(13) after the aircraft recovers to straight and level flight, set the control stick and pedals neutral;

(14) disengage the afterburner and set the assigned engine speed;



(15) transfer attention as follows:

- flight director indicator;
- airspeed;
- flight director indicator;
- vertical-speed indicator;
- recovery reference point (or combined course indicator);
- flight director indicator;
- altitude;
- flight director indicator.

### 3.6. Horizontal Roll

Horizontal rolls may be performed on the MiG-25ML aircraft carrying missiles or having no missiles at an indicated airspeed of not less than 550 km/h, with the engines running at the reheat and non-reheat power settings.

In training flights, the horizontal rolls are executed at altitudes less than 8000 m and airspeeds of 800 to 900 km/h, within 6 to 10 s.

A typical error likely to be made when performing the roll consists in dropping of the aircraft nose below the horizon in inverted flight as a result of insufficient deflection of the control stick forward when entering the maneuver and backward when recovering from it.

#### Horizontal Roll Technique

Prior to execution of the horizontal roll, proceed as follows:

- (1) select an airspeed of 800 km/h at the assigned altitude;
- (2) trim the aircraft with the help of the trim mechanism.

#### Execution of Roll

(3) apply back stick and create a pitch-up angle of 10 to 15°;

(4) slightly push the control stick forward to fix the pitch-up angle with a positive g-load of not more than 1g;

(5) concentrate your attention on the position of the visible sections of the canopy relative to the horizon;

(6) proportionately deflect the control stick and pedal in the roll direction;

(7) as the aircraft approaches the level flight attitude, set the pedals and control stick neutral;

(8) after the aircraft recovers to level flight, shift the glance inside the cabin and check the following:

- flight director indicator (absence of roll, slipping, pitch);

- vertical-speed indicator;

- airspeed;

- altitude;

(9) select the assigned engine speed.

### 3.7. Spiral

#### Spiral Technique

For training purposes the spiral is executed at an airspeed of 600 to 700 km/h with a roll angle of  $45^{\circ}$ .

#### Entry into Spiral:

(1) select an airspeed of 600 km/h;

(2) proportionately deflect the control stick in the direction of the roll and forward and operate the pedal to enter a descending turn;

(3) simultaneously with creating of a pitch angle, set the throttle lever to the IDLE position, precluding the engine speed drop below 70 per cent;

(4) as the roll angle of  $45^{\circ}$  is attained, set the control stick to a position close to the neutral one and fix the roll;

(5) fix the assigned pitch angle;

(6) transfer attention as follows:

- flight director indicator;

- vertical-speed indicator;

- flight director indicator;

- airspeed;

- flight director indicator;

#### Execution of Spiral:

(7) as altitude is decreasing, control the airspeed by varying the engine speed and pitch angle;

(8) transfer attention as follows:

- flight director indicator;

- airspeed;

- altitude;

- flight director indicator;

- vertical-speed indicator;

- airspeed;

- flight director indicator;
- altitude;
- flight director indicator;
- engine speed;
- flight director indicator.

#### Recovery from Spiral:

(9) when at the assigned altitude, proportionately deflect the control stick and pedals to level the aircraft;

(10) while engaged in levelling the aircraft, increase the engine speed to the assigned value;

(11) apply back stick and recover the aircraft from descent;

(12) transfer attention as follows:

- flight director indicator;
- altitude;
- flight director indicator;
- airspeed;
- altitude;
- flight director indicator;
- engine speed;
- flight director indicator.

One of the most typical errors which may be made during execution of the spiral is increase of the roll with subsequent lowering of the aircraft nose, which results in increase of the airspeed. To correct this error, it is necessary to recover from the roll and then to decrease the descent angle.

### 3.8. Peculiarities Involved in Flying Aircraft at Low and Extreme Low Altitudes

Flights at low and extreme low altitudes are characterized by a number of peculiarities involved. The main peculiarities are as follows:

- limited maneuvering possibilities due to ground proximity;
- weather conditions deteriorating flying conditions (bumpiness, ground haze);
- short time available for landmark detection and identification;
- decreased effective range of the electronic navigation aids, etc.

As a result of the long-time flying at low and extreme low altitudes clearness and rapidity of perception of the landmarks are hampered due to their rapid angular displacement, emotional stress of the pilot considerably increases. All this requires adequate physical and theoretical training, as well as regular practising the flights at low and extreme low altitudes on the part of the pilots.

Mastering flights at low and extreme low altitudes should be started after adequate mastering flying technique at medium and high altitudes by the pilot.

For training purposes, the flights at low and extreme low altitudes are performed at airspeeds of 700 to 800 km/h.

When flying the ММГ-25П aircraft it is necessary to take into account that the aircraft possesses high acceleration characteristics, especially at altitudes less than 5000 m. With the engines running at the FULL REHEAT power setting and at an indicated airspeed of about 1000 km/h, airspeed increment per one second amounts to 15 - 20 km/h. The real probability of exceeding the airspeed limitations occurs.

Energetic reversal of the bank at high subsonic airspeeds of flight at low and medium altitudes with the dampers engaged may result in slight oscillations in yaw at a frequency of about 1 Hz. Therefore, it is not recommended to engage damping mode at altitudes of less than 10,000 m due to possible deterioration of controllability.

At high indicated airspeeds (up to 1200 km/h) for maintaining the level flight practically full forward deflection of the control stick is required; but in this case, the forces on the control stick may be completely relieved by the trimming mechanism.

When flying the aircraft in the maneuvering area at low and extreme low altitudes, special attention should be paid to a coordinated manipulation of the controls and maintaining the flight conditions. Prior to starting maneuvering flights, it is necessary to trim out the aircraft with the aid of the trimming mechanisms of the stabilizer, ailerons and rudders.

At low and extreme low altitudes, trim out the aircraft by means of the stabilizer trimming mechanism so that an insignificant push force remains on the control stick. It ensures transferring the aircraft to climbing attitude in case of inadvertent distraction of attention and easing the forces applied to the control stick.

When performing turns and  $360^\circ$  turns it is necessary to take into account the aircraft tendency to lower the nose spontaneously during entry into the maneuver and to increase the pitch angle during recovery.

For instance, the aircraft may lose up to 100 m of altitude during entry into the  $360^\circ$  turn at a bank angle of  $45^\circ$  which is not permitted at low and extreme low altitudes.

To counteract nose dropping when entering the turn or  $360^\circ$  turn, it is necessary to trim out the control stick by the trimming mechanism simultaneously with entry into the maneuver.

When performing the vertical maneuvers, take into consideration that the aircraft may easily exceed the airspeed and g-load limitations.

The vertical g-load should not exceed the maximum value indicated by the movable sector of the III-155 g-load indicator. It is necessary to continuously check the airspeed against the JC-1600 speed indicator.

Intensive air turbulence makes flying at low altitudes more complicated and it requires an increased attention, as well as counteraction of inadvertent deviations of the aircraft.

The VFR daylight flights at low altitudes, as a rule, are performed visually with a periodical check of the flight conditions against the instruments. It is necessary to gain the initial flight altitude gradually at small vertical velocities. When doing so, it is obligatory to check the altitude against the YBO-M1 instrument and the radio altimeter. Before flight, set the altitude assigned by the mission on the indicator of the radio altimeter. When the aircraft descends below the assigned altitude, the LIMIT ALTITUDE (ОНАЧАЯ ВМCОТА) warning signal is fed to the pilot's earphones.

It is prohibited to use the radio altimeter when flying over a mountainous terrain.

In addition to determining the altitude with the aid of the instruments, the pilot should be able to determine the flight altitude visually with an adequate accuracy. Visual determination and check of altitude are effected by referring to natural and artificial landmarks having vertical dimensions (trees, poles, separate buildings, etc.).

During the first flights the pilot may fail to evaluate visually the altitude of flight correctly due to a lack of adequate habits. But after two or three flights the pilot

acquires enough habits both in visual evaluation of the altitude and in flying the aircraft at low altitudes as a whole.

Under conditions of good visibility of the ground surface and natural horizon, at low and extreme low altitudes the pilot should distribute his attention so that watching the instruments monitoring flight conditions, operation of the engines and various aircraft systems takes the minimum time. For this purpose, the pilot should perfectly know the arrangement of the instruments and units in the aircraft cabin.

Practical flights prove that the pilot satisfactorily trained in flying at low and extreme low altitudes spends 20 to 30% and 80 to 70% of the flight time for the in-cabin and outer-cabin inspection, respectively.

The pilot always determines and checks the flight speed by the instrument.

In case of a sudden decline of visibility or if the aircraft gets into a fog, rain or snowfall, immediately change over to instrument flying and climb to the safe altitude.

### 3.9. Peculiarities Involved in Flying Aircraft with Use of Automatic Flight Control System

When performing the flights for mastering flying technique, the CAY-155 automatic flight control system helps the pilot in handling the aircraft by releasing him from a number of actions associated with controlling the aircraft.

When mastering the flight technique in the maneuvering area, the pilot may use the stabilization of the aircraft spatial attitudes, and at long-time straight-line flights he may use the levelling mode for stabilizing the flight altitudes and heading.

In the course of flight with the attitude stabilization or levelling modes cut in, the pilot should check the aircraft attitude by referring to the flight and navigation instruments and visually. Should the CAY-155 automatic flight control system fail, immediately disengage the AFC system by depressing the AUTOPILOT OFF (БМКЛ. АП) button on the aircraft control stick.

When flying with the stabilization mode engaged, it should be borne in mind that when a force of 1.7 to 1.9 kgf is applied to the control stick in the longitudinal or 1 to 1.2 kgf in the lateral direction, stabilization of the respective air-

craft attitude is interrupted; as a result, the AUTO CTL (ABT. YIP.) light-button goes out. In this case, the automatic flight control system follows the roll, pitch and yaw angles and, after relieving the control stick, the system stabilizes the aircraft attitude which was at the moment of the control stick relieving.

The AFC system stabilizes the angles of:

- roll from  $7^\circ$  to  $80^\circ$ ;
- pitch from 0 to  $\pm 85^\circ$ ;
- yaw from 0 to  $360^\circ$  when the roll angle is less than  $7^\circ$  and the pitch angle is less than  $\pm 40^\circ$ .

Attitude stabilization mode is used in the level flight, climb and descent, as well as when executing the turns and  $360^\circ$  turns.

Level flight. For executing the level flight it is necessary to proceed as follows:

- at a preset altitude, set the P/SET COURSE AUTO - MAN (KVPC 3AJAH. ABTOM. - PYCH.) selector switch to the AUTO position;
- trim out the control stick with the help of the stabilizer and aileron trimming mechanisms;
- then, at a bank angle of not more than  $7^\circ$ , engage the stabilization mode by depressing the AUTO CTL light-button on the automatic flight control system panel; this done, the AUTO CTL and DAMPER (JEMIK.) light-buttons light up, thus indicating that the stabilization mode is engaged.

After selecting the stabilization mode, trim out the control stick. With the control stick trimmed out, the aircraft will be stabilized by the AFC system in the attitude which it has acquired at the moment of the control stick relieving.

If at the moment of control stick relieving the bank angle exceeds  $7^\circ$ , the angles of roll and pitch will be stabilized; should the bank angle be less than  $7^\circ$ , the angle of pitch and aircraft heading will be stabilized.

To change the aircraft heading with the stabilization mode engaged, by manipulating the control stick, turn the aircraft to a new course, recover it from the bank and trim out the control stick.

Execution of corrective turns in the stabilization mode may also be effected with the aid of the course selector (the CS knob) on the combined course indicator. To perform a corrective turn, move the P/SET COURSE AUTO - MAN selector switch to the MAN (PYUH.) position, use the CS knob on the combined course indicator to set the required course. As a result, the aircraft will automatically turn to a new course.

Climb and descent. Transition of the aircraft into the climb or descent with the stabilization mode engaged is effected by the appropriate deflections of the control stick without cutting off the mode.

To bring the aircraft into climb (descent), it is necessary to set the required vertical velocity (pitch angle), trim out the aircraft in the new attitude and relieve the control stick. In this case, this will cause stabilization of the vertical rate (pitch angle) which the aircraft acquires by the moment the control stick is relieved.

Minor corrections of the pitch angle for maintaining the assigned flight conditions are accomplished by short-time depression of the stabilizer trimming mechanism button with no force applied to the control stick.

While climbing or descending, check the airspeed and select the engine power setting in compliance with the assigned airspeed of flight.

360° turns and turns in horizontal plane. A 360° turn (turn) may be entered from the attitude stabilization mode or the manual control mode.

When entering a 360° turn (turn) from the attitude stabilization mode, apply a force of 1 to 1.2 kgf to the control stick in the lateral direction to establish the required bank, trim out the aircraft in the new attitude by the trimming mechanisms and relieve the control stick. This will cause stabilization of the pitch and roll angles which the aircraft acquires by the moment the control stick is relieved.

When entering the 360° turn from the manual control mode, manipulate the control stick to create the assigned bank, trim the aircraft with the aid of the trimming mechanisms and depress the AUTO CTL light-button on the control panel of the CAV automatic flight control system. With the stabilization mode engaged, relieve the control stick.



When performing the 360° turn (turn), check the airspeed by increasing or reducing the engine speed in due time.

Recover from the 360° turn (turn) manually.

Turns performed during climb and descent. For performing the turns in climb or descent, manually set the assigned bank and the vertical climb or descent rate, trim the aircraft with the aid of the trimming mechanisms. After that depress the AUTO CTL light-button on the control panel of the CAF automatic flight control system or relieve the control stick if the maneuver is entered with the aircraft attitude stabilization mode engaged.

The automatic flight control system ensures execution of the turns in climb and descent at bank angles of 7 to 80° and pitch angles of not more than 85°.

To disengage the attitude stabilization mode, depress the AUTOPILOT OFF button on the aircraft control stick. Disengagement is checked by referring to extinguishment of the AUTO CTL and DAMPER light-buttons on the control panel of the automatic flight control system.

Levelling mode. The levelling mode is engaged to bring the aircraft into level flight in case the pilot loses spatial orientation. Besides, it is recommended to use this mode in a prolonged straight and level flight for stabilizing the aircraft altitude and heading.

The levelling mode is engaged by depressing the LEVELLING ON (BKJI. HPMB. FOPMB.) light-button on the aircraft control stick. Check engagement of the mode by referring to lighting-up of the LEVELLING ON light-button, as well as the AUTO CTL and DAMPER light-buttons on the AFCS control panel.

Straight-and-level flight with the levelling mode engaged for stabilization of the altitude and heading is prohibited to be performed at altitudes of less than 300 m over the terrain and at an airspeed exceeding 750 km/h. This mode should be engaged within the pitch angle range of -2 to +10°. At larger angles of pitch the levelling mode is followed with altitude variation.

The levelling mode is switched off by depressing the AUTO-PILOT OFF button on the control stick; as a result, the LEVELLING ON, AUTO CTL and DAMPER light-buttons stop glowing.

The automatic flight control system recovers the aircraft to level flight from the roll angles of up to  $\pm 180^\circ$  and pitch angles of up to  $\pm 85^\circ$ .

The aircraft is recovered to level flight in two stages:

- stage I - aircraft recovery to the roll angles of  $\pm 80^\circ$   $\pm 5^\circ$ .

In this case, the aircraft is levelled in roll only, while in the longitudinal channel the system stabilizes the pitch angle;

- stage II - aircraft recovery to level flight in roll and trajectory inclination zero angle.

The aircraft is levelled in roll at various angular velocities depending on the initial roll angle, altitude and air-speed:

(a) with an angular velocity of 30 deg/s at flight altitudes of up to 10,000 m;

(b) with an angular velocity of 6 deg/s at an altitude of 20,000 m.

The aircraft is levelled in pitch with a limited normal g-load:

(a) from diving - positive  $n_{y \text{ sel}} = 3.0g$ ;

(b) from pitch-up - negative  $n_{y \text{ sel}} = 0.35g$ .

#### 4. FLIGHTS AT HIGH ALTITUDES AND IN STRATOSPHERE AT SUPERSONIC AIRSPEEDS

##### 4.1. General

In compliance with the major purpose of the M $\mu$ I-25III aircraft, mastering supersonic flights at high altitudes and in stratosphere is one of the most important tasks of flight training of the units and subunits equipped with these aircraft.

During these flights the flying personnel should master climbing to the altitude of the non-reheat flight ceiling, acceleration and climbing to the service ceiling and zoom altitude of the aircraft, flying technique in stratosphere at supersonic airspeeds, as well as acquire firm habits in handling the cabin interior with the high-altitude pressure suit on.

Acceleration and climbing to the aircraft service ceiling are effected according to the specified program. If the pilot fails to maintain this program, the climbing time, distance covered and fuel consumption will increase.

Both during acceleration and in flights at the maximum Mach-numbers the MiG-25M aircraft features good stability and satisfactory controllability.

At high altitudes and supersonic airspeeds the damping of the aircraft oscillation slows down materially due to decrease of air density. With the dampers engaged, the lateral and longitudinal oscillations are damped more rapidly.

When flying at high altitudes and  $M > 2.2$ , with the dampers off and vertical g-loads amounting to 2.0, the aircraft features increased bank response to deflection of the rudders (creation of slipping). In this case, the bank develops with a certain delay typical for high altitudes. As the g-load increases, effectiveness of the ailerons decreases. Therefore, when introducing the vertical g-load, the aircraft energetically banks to the side which is opposite to the slip (the side which is opposite to deviation of the ball). In case of an asymmetrical thrust of the engines, the aircraft banks to the side of smaller thrust.

As the rate of the vertical g-load increases, the rate of roll also increases. Proceeding from this, the turns ( $360^\circ$  turns), zooms and other maneuvers with g-loads should be performed in a coordinated manner, never permitting the aircraft to slip. Prior to performing the maneuver, trim out the aircraft in yaw attitude with the aid of the rudder trimming mechanism.

If the pilot fails to manipulate the controls in the coordinated manner when the aircraft performs the maneuver with the vertical g-load, this may result in failure to recover the aircraft from the bank and inadvertent nose dropping. If the aircraft fails to recover from the bank and lowers the nose, the pilot should proceed as follows:

- (a) cut off the engine afterburners and decrease the vertical g-load up to 1.0;
- (b) do not interfere with the aircraft nose dropping by pulling the control stick backward;
- (c) eliminate slipping (bring the ball to the centre);
- (d) as the g-load decreases, recover the aircraft from the bank.

When the dampers are engaged, the aircraft roll response to slipping considerably decreases. Therefore, fly at high altitudes and  $M > 2.2$  with the dampers engaged that considerably simplifies handling the aircraft.

Besides, flying the aircraft at high altitudes and in stratosphere is also characterized by a number of other peculiarities the most typical of which are:

- decrease of the airspeed range;
- decrease of the aircraft angles of attack;
- deterioration of the conditions of visual orientation and visibility of the natural horizon as a result of which the pilot has to perform air navigation and flying mainly with the aid of instruments;
- decrease of the aircraft capabilities with respect to g-load which results in considerable increase of the radius and time for performing turns ( $360^\circ$  turns).

#### 4.2. Flight to Ceiling

Flights for gaining the aircraft ceiling are performed within the airfield area according to the established pattern.

Fig. 43 presents a variant of the pattern used for climbing to the ceiling. When effecting flights to the ceiling with the use of the POLJOT-1M system, it is necessary to program the flight route.

When climbing to the ceiling, the aircraft may be controlled manually and with the aid of the CAV-155 automatic flight control system in the director or automatic mode.

Climb to Ceiling in Automatic Control Mode. Preparatory to the flight, it is necessary to set  $H_{1vl-off} = 29.9$  km on the altitude and airspeed selector and the wafer switch to the H10 position. Depress the first route turning point (RTP-1) button on the PCBH-6C system control panel and the SHORAN light-button on the AFCS control panel.

Take off at the reheat power setting. After the landing gear and flaps are retracted at an airspeed of not less than 600 km/h, disengage the afterburner. At an altitude of at least 300 m smoothly deflect the control stick and pedals to "zero" the command bars on the flight director indicator, avoiding reduction of the altitude. After that trim the control stick and pedals by the trim mechanisms and depress the AUTO CTL light button on the AFCS control panel. The pilot should remember that if the control stick is not relieved of forces, the automatic control mode will not get enabled.

After the automatic control mode is enabled, the aircraft will be controlled automatically. In this case, the aircraft

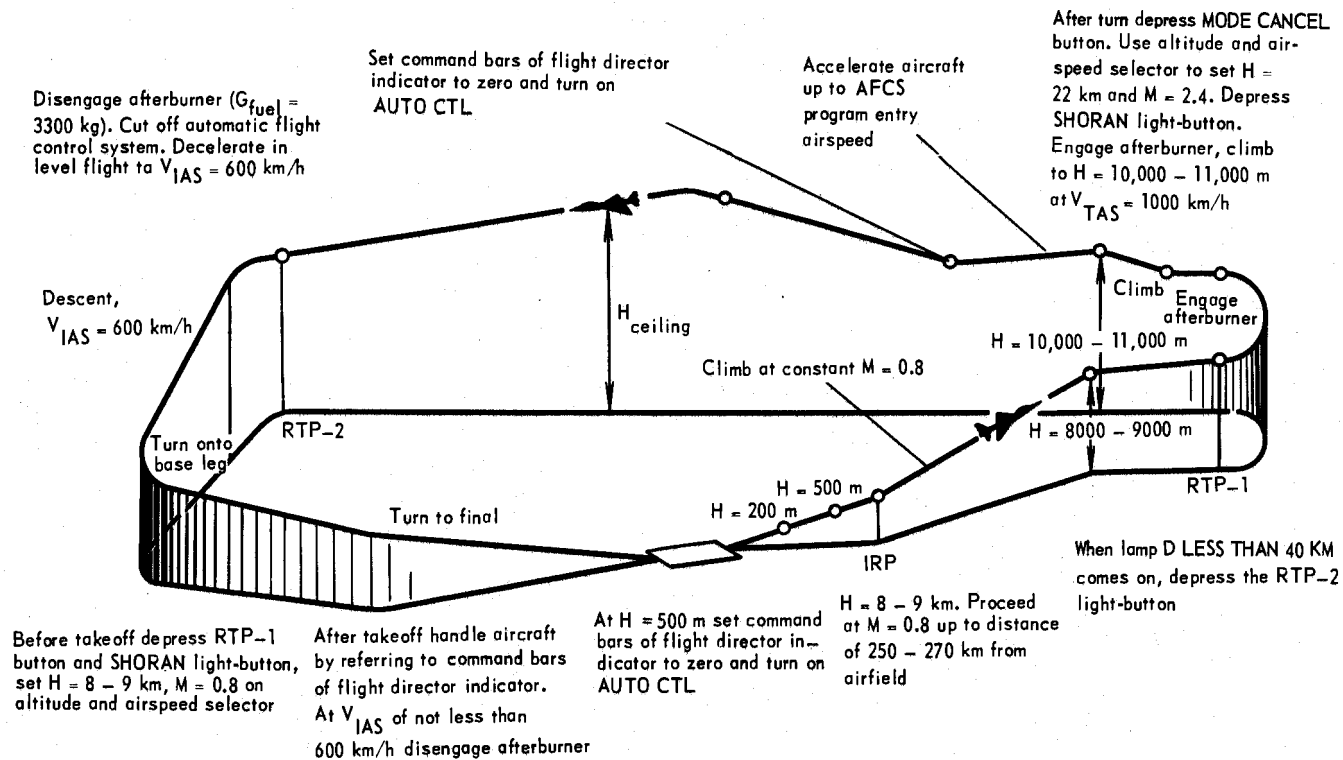

FIG. 43. FLIGHT TO SERVICE CEILING WITH USE OF AUTOMATIC MODE OF CAY-155ПДБ AUTOMATIC FLIGHT CONTROL SYSTEM

will climb to the altitude of 3000 m with acceleration up to a Mach number of 0.85 and will further climb at the constant Mach number of 0.85.

When approaching the altitude of 10,000 m the SEL ALT DVL-OFF lamp lights up. The automatic flight control system stabilizes the altitude of 10,000 m, and the Mach number of 0.85 is to be maintained by varying the engine speed.

At a distance of 40 km from the route turning point, the D LESS THAN 40 KM lamp lights up on the PCEH-6C system control panel. After that, depress the light-button of the next RTP. The pilot may also depress the button of the next RTP at an estimated distance from the initial route point by referring to the IIII-2 distance indicator.

If the mission requires flying over the RTP-1, the RTP-2 light-button should be depressed 3 to 5 km (by referring to the IIII-2 distance indicator) before the RTP-2, since depressing the RTP-2 light-button at a close-to-zero distance may result in aircraft swinging in roll within  $\pm 10^\circ$ . If it is required to make a turn after flying over the RTP-1, it is necessary to disable the automatic control mode over the RTP-1 and depress the RTP-2 light-button at the estimated distance. After that enable the aircraft automatic control mode again.

When the readings of the IIII-2 distance indicator pass zero, the preset course pointer turns through  $180^\circ$ .

If the aircraft turns towards the next RTP at subsonic air-speed in the automatic control mode, the roll angle does not exceed  $30^\circ$ . Accelerate the aircraft in response to the command from the control post (or from the estimated line).

To this end, proceed as follows:

- disable the automatic control mode by the AUTOPILOT OFF button arranged on the control stick;
- enable the damping mode by the DAMPER light-button on the AFCS control panel;
- select  $M = 2.35$  on the altitude and airspeed selector;
- check to see that the AIR INT MONIT L R lamps are alight and engage the afterburner.

Check to see that the afterburner is engaged, check the exhaust gas temperature (it should be not more than  $820$  and not less than  $600^\circ\text{C}$ ) and the fuel remainder that should amount to the estimated one. Select a true airspeed of  $1000$  km/h and climb at this airspeed to an altitude of  $11,000$  m. Proceeding

at this altitude bring the aircraft to level flight and accelerate it to the airspeed required for entering the automatic flight control system program (altitude of 11,000 m, Mach-number of 1.62). 20 to 30 km/h before the program-entry indicated airspeed (1120 km/h), smoothly apply back stick to bring the aircraft to climbing.

As soon as the pitch position bar of the flight director indicator approaches the centre of the circle, relieve the control stick and pedals of forces by the trim mechanisms and enable the automatic control mode.

Subsequently check the automatic climbing mode with acceleration to  $M = 2.35$ .

While accelerating to  $M = 2.35$ , check to see that:

- the second afterburner is engaged at  $M = 1.5$  (by the engine speed increase to 98.5 to 100 per cent);
- the air intake ramps start extending at  $M = 1.5$  to 1.7;
- the LWR DOOR 2ND PSN lamp goes out in the annunciator at  $M = 1.9$ .

At an altitude of more than 15 km check the operation of the automatic transmission ratio controller by referring to the illumination of the STAB FOR LDG and ROLL FOR LAND lamps and deflection of the indicator pointers to the lower position.

Perform the flight at the aircraft ceiling at a stabilized Mach-number of 2.35.

At a fuel remainder of not less than 3300 kg (at a distance of not more than 200 km from the airfield) disengage the afterburners of the engines, disable the automatic control mode, enable the damping mode and descend.

Climbing to Ceiling in Director Control Mode. Preparatory to takeoff, select  $H_{\text{lvl-off}} = 29.9$  on the altitude and airspeed selector and set the wafer switch to the H10 position.

Depress the RTP-1 light-button on the PCBH-6C system control panel and the SHORAN light-button on the AFCS control panel.

Take off at the reheat power setting. After the landing gear and flaps are retracted, fly the aircraft from the altitude of 300 m with reference to the command bars, keeping them within the circle of the flight director indicator.

When the airspeed is more than 600 km/h, disengage the afterburners of the engines and proceed climbing at the maximum power, keeping the position bars within the centre of the circle of the flight director indicator.

The SEL ALT DWL-OFF lamp will light up at an altitude of 10,000 m. While climbing, check  $M = 0.85$ . In level flight maintain  $M = 0.85$ , selecting a respective power setting. En-route flying is similar to flying in the automatic control mode. Keep the position bars in the centre of the circle of the flight director indicator by operating the control stick.

Following the command from the control post (or on the assigned line) engage the afterburner. Check the engagement of the afterburner and the engine parameters. Climb to an altitude of 11,000 to 11,500 m at a true airspeed of 1000 km/h. When the altitude is gained, level the aircraft and accelerate it to the airspeed required for entry into the automatic flight control system program ( $H = 11,000$  m,  $M = 1.62$ ). When the indicated airspeed is 1100 km/h, smoothly apply back stick to bring the aircraft to climbing. Keeping the position bars in the centre of the circle of the flight director indicator, perform further climb with acceleration to  $M = 2.35$ . When the Mach number is 2.35, climb to the service ceiling.

Sequence of Pilot's Actions and Order of Attention  
Distribution during Climb to Service Ceiling in  
Director Control Mode

P r e p a r a t o r y   t o   F l i g h t :

- (1) select  $H_{lvl-off} = 29.9$  on the altitude and airspeed selector;
- (2) set the wafer switch to the H10 position.

P r e p a r a t o r y   t o   T a k e o f f :

- (3) depress the RTP light-button on the PCEH-6C system control panel;
- (4) depress the SHORAN light-button on the AFCS control panel.

A f t e r   T a k e o f f :

- (5) disengage the afterburner at an airspeed more than 600 km/h;
- (6) at  $H = 300$  m smoothly deflect the control stick and pedals to "zero" the command bars of the flight director indicator without losing the altitude.



### In Climbing :

(7) keep the command bars within the circle of the flight director indicator;

(8) climb to the non-reheat ceiling. Enable the DAMPER mode at an altitude of 10,000 m;

(9) by the command from the control post (or starting from the estimated line) accelerate the aircraft. To this end, proceed as follows:

(10) select  $M = 2.35$  on the altitude and airspeed selector;

(11) depress the DAMPER light-button on the AFCS control panel;

(12) engage the afterburner;

(13) check to see that:

- the afterburner is engaged;
- the exhaust gas temperature does not exceed  $820^{\circ}\text{C}$ ;
- the engine speed corresponds to the maximum power;
- the fuel remainder amounts to the estimated one;

(15) at a true airspeed of 1000 km/h climb to an altitude of 11,000 m;

(16) at the altitude of 11,000 m apply forward stick to level the aircraft;

(17) accelerate the aircraft to an indicated airspeed of 1100 km/h;

(18) bring the aircraft to a climb, keeping the horizontal command bar in the centre of the circle of the flight director indicator;

(19) transfer attention as follows:

- flight director indicator (roll, pitch);
- airspeed;
- altitude;
- flight director indicator;
- vertical-speed indicator;
- check the engine parameters;
- airspeed;
- flight director indicator.

### Climbing :

(20) climb at a constant indicated airspeed with the Mach-number increasing to 2.35. If  $V_{\text{IAS}} = 1100$  km/h,  $M = 2.35$  can be attained at an altitude of 16 to 18 km;

(21) avoid slipping by maintaining the ball in the centre with the help of the pedals;

(22) check the following:

- at M = 1.5 - engagement of the second afterburner;
- at M = 1.5 to 1.7 - initiation of the air intake ramp extension;
- at M = 1.9 - extinguishing of the LWR DOOR 2ND PSN lamp in the annunciator;
- at H = 15000 m - operation of the automatic transmission ratio controller by referring to the illumination of the STAB FOR LDG and ROLL FOR LAND lamps and deflection of the indicator pointers to the lower position;

- the exhaust gas temperature (does not exceed 820°C);

(23) transfer attention as follows:

- flight director indicator (roll, pitch);
  - airspeed (indicated airspeed is constant, Mach-number is growing);
  - engine speed (at M = 1.5 the engine speed has increased to 98.5 to 100 per cent);
  - flight director indicator;
  - exhaust gas temperature (does not exceed 820°C);
  - oil pressure (3.5 to 4.5 kgf/cm<sup>2</sup>);
  - flight director indicator;
  - extension of the air intake ramps;
  - APV-9 controller;
  - combined course indicator;
  - flight director indicator;
  - annunciator (no lamps are illuminated in the warning annunciator);
  - flowmeter, fuel gauge, indication of fuel consumption;
  - flight director indicator;
- (24) climb to the ceiling at a Mach-number of 2.35 up to a vertical speed of 3 to 5 m/s.

#### F l y i n g   o n   C e i l i n g :

(25) keep the command bars within the small diameter circle of the flight director indicator;

(26) transfer attention as follows:

- flight director indicator;
- vertical-speed indicator;
- combined course indicator;
- flight director indicator;
- airspeed;
- altitude;
- flight director indicator;
- engine speed;
- exhaust gas temperature;
- oil pressure;
- flight director indicator;
- air intake ramp position indicator;
- flowmeter, fuel gauge, indication of fuel consumption;
- flight director indicator;

(27) when the fuel remainder is less than 3300 kg (the aircraft is not more than 200 km away from the airfield), set the throttle levers to the MAXIMUM position and check to see that the afterburner is disengaged.

#### D e s c e n t :

(28) smoothly applying back stick, maintain level flight to an indicated airspeed of 750 to 800 km/h;

(29) apply forward stick to bring the aircraft into descent at an angle of pitch of 8 to 10°;

(30) pushing (pulling) the control stick, maintain the indicated airspeed of 750 to 800 km/h down to an altitude of 15 to 16 km;

(31) transfer attention as follows:

- flight director indicator (roll, pitch);
- vertical-speed indicator;
- airspeed;
- flight director indicator;
- altitude;
- ramp position (ramps are retracting);
- engine speed (maximum);
- exhaust gas temperature;
- airspeed;
- warning annunciator;
- flight director indicator;

(32) at an altitude of 17 km smoothly apply back stick and level the aircraft at an altitude of 15 to 16 km;

(33) at  $M = 1.5$  check to see that:

- the engines have changes over from the 2nd to 1st maximum power;

- the ramps have fully retracted;

- the STAB FOR LDG, ROLL FOR LAND lamps have gone out and the LWR DOOR 2ND PSN lamps is alight at an altitude below 15 km;

(34) smoothly applying back stick, maintain level flight to an indicated airspeed of 600 km/h;

(35) apply forward stick to set a descent angle of 8 to  $10^{\circ}$  with a simultaneous reduction of the engine speed to the idling power;

(36) vary the angle of pitch to maintain the indicated airspeed of 600 km/h;

(37) at an altitude of 11 to 11.5 km, check to see that the aircraft has changed over to a subsonic airspeed;

(38) transfer attention as follows:

- flight director indicator;

- airspeed;

- vertical-speed indicator;

- altitude;

- flight director indicator;

- engine parameters;

(39) at an altitude of 9.5 km increase the engine speed and apply back stick to level the aircraft;

(40) depress the RETURN light-button on the PCEH-6C system control panel;

(41) depress the SHORAN light-button on the AFCS control panel;

(42) Perform the descent and landing approach with the use of the POLJOT-1M system.

Climb to Ceiling in Manual Control Mode. When mastering flights for supersonic climb to the ceiling in the manual control mode (without employment of the CAY-155 automatic flight control system), the pilot should take off at the full reheat power setting. At an indicated airspeed of at least 600 km/h successively disengage the afterburners of the engines by setting the throttle levers to the MAXIMUM position.

If the aircraft carries four missiles, the pilot should accelerate the aircraft to a true airspeed of 920 km/h up to an altitude of 1000 m; if the aircraft carries no missiles, it should be accelerated to a true airspeed of 960 km/h. Further climb should be performed at the respective gained true airspeeds.

To relieve the control stick of forces in climbing, make use of the stabilizer trim mechanism.

At an altitude of 10,000 m depress the DAMPER light-button.

Upon gaining the altitude of the subsonic service ceiling, level the aircraft and proceed with ceiling flight at  $M = 0.85$  as fuel is being consumed.

While flying level at a distance of 250 to 270 km from the airfield (or in response to a command from the control post), switch on full reheat and climb to an altitude of 11,000 to 11,500 m at a true airspeed of 1000 km/h.

Upon gaining this altitude, level the aircraft and accelerate it to an indicated airspeed of 1070 km/h. At the end of acceleration the fuel remainder should amount to not less than 6000 kg.

Turn towards the airfield with a roll of  $45^{\circ}$  and with climbing. In climbing maintain the indicated airspeed of 1070 km/h until a Mach-number of 2.4 is attained. Climb further maintaining  $M = 2.4$  until the vertical speed becomes equal to 3 m/s.

With the fuel remainder being not less than 3300 kg, disengage the engine afterburners. In this case, the aircraft should be not more than 200 km away from the landing airfield. If the distance exceeds 200 km, the engine afterburners should be disengaged earlier with due account of the fact that every additional 100 km require 700 kg of fuel.

#### 4.3. Flight for Aircraft Acceleration to Maximum Mach-Number

The flight for the aircraft acceleration to the maximum Mach-number should be planned after the pilot has accomplished the flight to the service ceiling.

Fig. 44 presents an approximate pattern of the flight for the aircraft acceleration to the maximum Mach-number.

The flight for the aircraft acceleration to the maximum Mach-number is performed with the engines running at the reheat

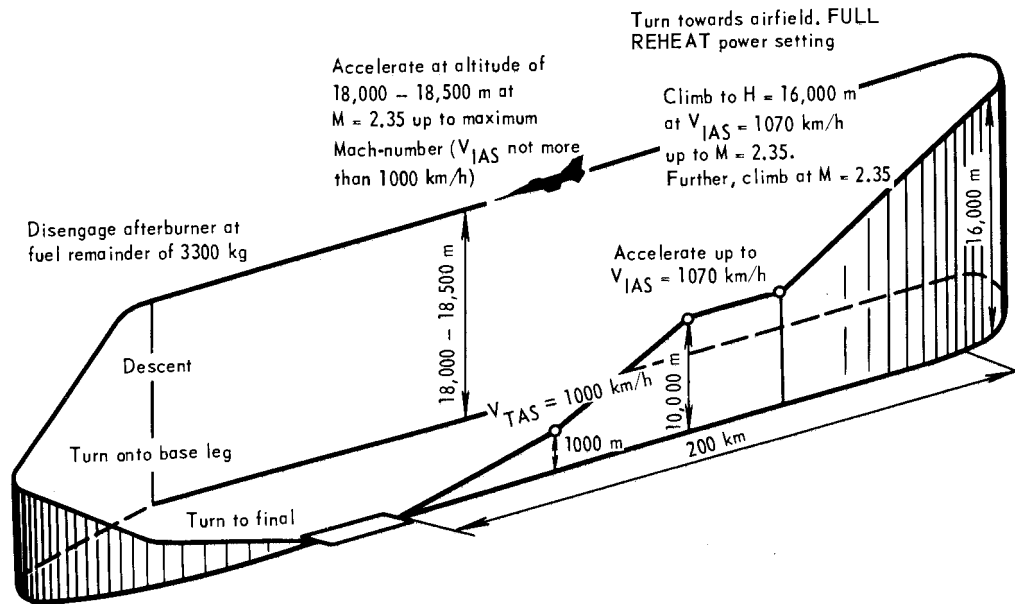

FIG. 44. PATTERN OF FLIGHT WITH ACCELERATION TO MAXIMUM MACH-NUMBER

power setting. After taking off, climb to an altitude of 1000 m with acceleration of the aircraft to a true airspeed of 1000 km/h. Perform further climbing to an altitude of 10,000 to 11,500 m at the constant true airspeed of 1000 km/h. At an altitude of 10,000 m enable the DAMPER mode.

At an altitude of 11,000 to 11,500 m bring the aircraft into level flight, accelerate the aircraft up to an indicated airspeed of 1070 km/h, trim out the aircraft with the aid of the trim mechanism and bring it into a climbing attitude.

When climbing at  $M = 1.5 \pm 0.1$ , check the engagement of the REHEAT II power setting by referring to increase of the exhaust gas temperature (it should not exceed  $820^{\circ}\text{C}$ ) and smooth increase of the engine speed up to 98.5 to 100 per cent. Besides, at  $M = 1.5$  to 1.7 the pilot checks the beginning of extension of the air intake ramps and at  $M = 1.9$ , the extinguishing of the LWR DOOR 2ND PSN lamp.

Check the operation of the automatic control system of the air intakes and the position of the ramps by referring to the УИЭС-34 indicator and two AIR INTAKE CONTROL DUPLICATION (ДУБЛИР. УИР. ВХОД) lamps in the annunciator. When the automatic control system operates normally, the above-mentioned lamps are dead.

At an altitude of more than 15,000 m the STAB FOR LDG and ROLL FOR LAND lamps should be alight, and the pointers of the rudder and stabilizer transmission ratio mechanism indicator should go down.

Gain an altitude of 16,000 m at an indicated airspeed of 1070 km/h until  $M = 2.35$  is attained. In this case the distance from the airfield should be not more than 200 km.

At an altitude of 16,000 m start turning in the direction of the airfield. When turning, climb at  $M = 2.35$ .

If during the turn the Mach-number starts decreasing, reduce the vertical climb speed or turn even with a descent (especially when the aircraft carries missiles), if necessary.

The aircraft attitude in climb is checked with the aid of the gyro horizon on the flight director indicator, whereas the flight conditions are checked by the Mach-number indicator, vertical speed indicator and altimeter.

After performing the turn, at an altitude of more than 16,000 m move the throttle levers to the position of partial reheat. This is required not to exceed the time of continuous operation of the engines at the full reheat power setting.

Wait for one minute and shift the throttle levers to the FULL REHEAT position and in level flight at an altitude of 18,000 to 18,500 m continue accelerating the aircraft up to the maximum Mach-number.

In the course of acceleration check the indicated airspeed avoiding its increase in excess of 1100 km/h. Disengage the engine afterburners when the fuel remainder amounts to 3300 kg.

When the radar indicator starts blinking (in case the radar is enabled) and the "Limit speed" voice message is heard in the earphones, check the current airspeed so as to avoid exceeding the airspeed limitations:

(a) in performing level flight or climb, turn off the afterburners and bring the aircraft into climb (increase the angle of climb) at a  $g$ -load of up to 2.5  $g$ ;

(b) in descending, bring the aircraft into the level flight attitude at a  $g$ -load of up to 2.5  $g$ , throttling the engines simultaneously (at a Mach-number not exceeding 2.2).

#### 4.4. Flight at Maximum Rate of Climb

Flight at a maximum rate of climb should be performed at the full reheat power setting as follows. After taking off, climb to an altitude of 1000 m with the aircraft acceleration to a true airspeed of 1000 km/h. Then climb to an altitude of 11,000 to 11,500 m and maintain a constant true airspeed of 1000 km/h by changing the climb angle.

At an altitude of 11,000 to 11,500 m level off the aircraft and, without changing the engine power setting, accelerate the aircraft to an indicated airspeed of 1150 km/h. In the course of acceleration it is necessary to constantly check the airspeed increment rate, since in level flight at the reheat power setting and at an indicated airspeed of about 1000 km/h the airspeed increases by approximately 15 to 20 km/h per one second. Therefore, it is necessary to bring the aircraft into climbing somewhat in advance, at an airspeed which is 20 to 30 km/h less than the assigned one.

As an indicated airspeed of 1150 km/h is attained, bring the aircraft into climbing.

Climb to an altitude of 13,000 m at this airspeed.

When approaching the altitude of 14,000 m, increase the climb angle to establish an indicated airspeed of 1070 km/h and



proceed climbing at this airspeed until a Mach-number of 2.35 is attained. Climb to an altitude of 20,000 m at the constant Mach-number of 2.35.

#### 4.5. Flight to Dynamic Heights

Flights to dynamic heights are performed according to the pattern specified for a particular airfield. When an altitude of 18,000 to 18,500 m is reached, accelerate the aircraft with the engines running at the full reheat power setting until the maximum Mach-number is achieved and bring the aircraft into climb at a g-load of  $n_y = 1.5$  to 1.75 g. When climbing, to maintain  $n_y = 1.5$  g, smoothly deflect the control stick backward. As an altitude of 22,000 to 22,500 m is reached, gradually decrease the g-load to 1.0 g. At  $n_y = 1.0$  g the aircraft continues climbing with the pitch angle decreasing. As soon as the pitch angle decreases to 10 to 15°, apply back stick pressure again to avoid descending. When doing so, it is necessary to take into account the fact that in case of premature deflection of the control stick backward, the aircraft rapidly loses the airspeed, lowers its nose with the control stick fully deflected backward and starts descending.

Late deflection of the control stick backward will result in the aircraft nose dropping and acceleration. Further deflection of the control stick backward somewhat slows down increase of the airspeed and results in energetic loss of the altitude.

When at the dynamic height, proceed with level flight for 20 to 30 s, decelerating the aircraft to an indicated airspeed of 600 km/h.

When performing runs, deceleration increases and the time of flight at dynamic heights decreases. At great roll angles the airspeed energetically drops; therefore, it is necessary to bring the aircraft into descent avoiding the airspeed dropping below the maneuvering one.

When the fuel remainder amounts to not less than 3300 kg, it is necessary to disengage the afterburners and start descending. Disengage the afterburners at an airspeed of not less than the maneuvering one.

The major flight parameters of the  $M_{\text{M}}\Gamma-25\Pi\Pi$  aircraft carrying four missiles are presented in Table 6.

Table 6

Parameter	Value of parameter in time t, s						
	0	20	40	50	60	70	78.5
Mach-number	2.75	2.66	2.45	2.37	2.33	2.30	2.28
$V_{true}$ , km/h	2916	2626	2592	2520	2469	2437	2416
Altitude, m	18,000	19,000	22,000	23,700	24,800	25,400	25,600
G-load	1.5	1.5	1.5 to 0.5	0.5	0.5	0.5	-
$V_y$ , m/s	0	50	150	170	114	55	20
L, km	0	15.6	30.4	37.3	44.1	50.9	56.6
Fuel consumption, kg	0	176	312	354	390	422	443
Pitch angle, deg	0	0.7	15	11.4	7.6	3.5	0

The table shows that it takes 78.5 s for the aircraft to gain an altitude of 25,600 m beginning from an altitude of 18,000 m. By the end of the climb the Mach-number amounts to 2.28. The engine afterburners are disengaged when the fuel remainder amounts to 3300 kg and the distance to the airfield does not exceed 200 km.

#### 4.6. Aircraft Deceleration and Descent from Service Ceiling

In level flight, after accomplishment of the mission, disengage the engine afterburners. To disengage the afterburners when flying at  $M > 2.2$ , proceed as follows:

- shift the throttle levers from the FULL REHEAT position to the MINIMUM REHEAT stop;
- then depress the latches and move the throttle levers to the MAXIMUM stop. Check the disengagement of the afterburners by referring to extinguishing of the REHEAT (ПОПЧАК) lamps in the annunciator and decrease of the exhaust-gas temperature.

In case of failure to disengage the afterburners by shifting the throttle levers to the MAXIMUM stop (the REHEAT lamp in the annunciator does not go out), disengage them using the appropriate switch labelled REHEAT on the left-hand console.

After the afterburners are disengaged, decelerate the aircraft to an indicated airspeed of 750 to 800 km/h proceeding in level flight with the engines running the 2nd maximum power.

Descend to 15,000 to 16,000 m at this airspeed. At an altitude of 17,000 m smoothly apply back stick and level the aircraft at an altitude of 15,000 to 16,000 m. Smoothly apply back stick to maintain level flight until the indicated airspeed becomes equal to 600 km/h.

With the Mach-number decreasing, check the following:

- at  $M = 1.9$  - illumination of the LWR DOOR 2ND PSN lamp;
- at  $M = 1.5$  - change-over of the engines from the 2nd to 1st maximum power.

At an indicated airspeed of 600 km/h bring the aircraft to descent at an angle of pitch of  $8$  to  $10^\circ$  and set the throttle levers to the IDLE position.

At an altitude of not less than 15,000 m check to see that the STAB FOR LDG and ROLL FOR LAND lamps go out. The effectiveness of the stabilizer will grow with descent due to a change in the nature of airflow.

At supersonic airspeeds the required angles of the stabilizer deflection are greater than at subsonic airspeeds. Therefore, when passing by the sonic speed ( $M = 0.95$  to  $0.97$ ) with the stabilizer deflected for pitch-up, a short-time increase of the g-load may occur ("tuck-in" mode).

In straight-line descent, the aircraft experiences a slight "tuck-in" which practically manifests itself as a slow nose-up of the aircraft. This phenomenon takes place due to smooth deceleration.

At altitudes higher than 10,000 m a "tuck-in" is dangerous because of a possible increase of the g-load involving a loss of the airspeed, whereas at altitudes lower than 10,000 m the aircraft may attain the limit g-load. When descending, it is necessary to trim out push forces by means of the stabilizer trim mechanism in due time and move the control stick forward in case of a "tuck-in".

#### 5. RECOMMENDATIONS TO COMMANDER (INSTRUCTOR) ON TRAINING AND MASTERING OF FLYING TECHNIQUE

The sequence of training and mastering the pilots in flying technique on the MiG-25M aircraft is prescribed by the Combat Training Course.

Pilot training includes instruction, practising and mastering of the skill in flying acquired in the course of training, as well as restoration of the habits lost due to long-time breaks in flying practice.

When training the flying personnel in flying technique, introductory circling flights and flights in maneuvering area are of great importance. The introductory flights are obligatory in the primary training, for restoring the habits lost due to long-time breaks in flying practice, as well as in case the pilot commits blunders or systematically repeated errors.

When performing the introductory flights, the instructor uses various methods and procedures of training of the pilot which are as follows:

- (a) demonstration of the aircraft flying technique elements;
- (b) practising in performing the demonstrated element, maneuver or the whole flight carried out under the supervision of the instructor;
- (c) prompt, explanation, instructions and remarks over the intercom system in the course of performing and exercise;
- (d) introduction of an improvised situation to the pilot for checking assimilation and skill of the trainee to handle the aircraft under adverse conditions.

Demonstration of the flying technique elements is used when the trainee practises this or that element of flight for the first time, when the instructor is not sure whether the trainee is able to perform this element independently or when the pilot fails to effect this or that element of the maneuver.

Demonstration flight is carried out either by the instructor himself or together with the trainee. When the demonstration is completed, the trainee should repeat obligatorily the flying technique element which has been demonstrated.

Practice is used for acquiring, consolidating and mastering the habits by the trainee in flying and handling the aircraft.

To create the adequate conditions for the trainee, which ensure effectiveness of his training, the instructor should not interfere with handling the aircraft if the trainee makes errors in piloting which are within the "satisfactory" mark, and if the trainee is able to notice and correct the error committed. In case when the trainee fails to fly the aircraft within the "satisfactory" mark limits and makes errors which do not pro-

vide the flight safety, the instructor must immediately interfere with handling the aircraft and correct an error committed by the trainee.

Prompt, explanations, instructions and remarks over the intercom system are used for developing the correct sequence of actions of the trainee in distribution and transfer of attention during handling the aircraft, mastering coordinated manipulation of the controls when executing and maintaining the assigned flight conditions, handling the aircraft equipment and look-out.

Prompt should be instructive (i.e. how to act) without detailed analyzing the cause of this or that error committed by the pilot; a comprehensive analysis of the errors committed should take place after the flight. When performing the complex flight maneuvers (takeoff, estimation, landing, landing approach with the use of navigation means), which require much attention, the directions of the instructor must be very brief. When prompting, the instructor should take into account that the trainee listening to the directions may distract his attention and aggravate the errors made. Therefore, a prompt should concentrate the pilot's attention on correcting the errors being committed at the given moment.

The pilot should repeat this or that element of the flight in the course of practising an exercise until the element is firmly mastered and the pilot is able to perform it independently without any help of the instructor.

The method used by the instructor during training depends on the flight training level of the trainee.

If during the primary training the instructor mostly demonstrates each new element to be practised, restoration of the lost habits includes training and prompting.

When performing introductory flights, the instructor should take into account that during the first flights for mastering new elements the pilot lacks enough attention due to which he may make blunders. Therefore, in these flights the instructor must concentrate the pilot's attention on the major, most important elements. In this case, it is good practice for the instructor to operate some equipment in the cockpit and conduct radio communication.

As the pilot acquires the appropriate habits, it is necessary to increase the volume of his actions; decrease the instructor's interference with the aircraft control, handling the cabin equipment and prompting so that by the end of the introductory flights the trainee is able to perform independently the whole scope of operations required for handling the combat aircraft.

When performing introductory flights, besides the general flight training level of the trainee, the instructor should take into account the specific habits acquired by the pilot on the other type of the aircraft before conversion which may have a detrimental effect on handling the ММГ-25ИИ aircraft.

After the pilot has accomplished the required number of introductory flights and acquired firm habits in performing the elements mastered, the commander examines him.

The check flights are performed to check the flying technique after the introductory flight program is finished or after a break in flights, correctness of the training method and determining causes of errors committed by the pilot during solo flights.

Only pilots who are able to conduct the solo training flights for performing the given type of training (according to the instructor's opinion) are admitted to the check flights. These flights should be performed as training ones: the inspector does not interfere with the aircraft control, follows the actions of the pilot, flight conditions and accuracy of executing the mission assigned for the flight.

As a rule, the check flights are performed under supervisions of the commander who did not take part in training of the given pilot so as to evaluate the pilot's training level more unprejudicedly.

When checking the flying technique before the first solo flight, evaluate execution of the following flight elements:

- takeoff;
- climb;
- route pattern;
- 360° turns at bank angles of 30 and 45°;
- divings and zooms at an angle of 20 to 30°;
- chandelles and spirals;
- landing approach and landing proper.

The pilot is certified for the solo flight and further training on the combat aircraft in case he has demonstrated firm habits in handling the aircraft in the maneuvering area and during circling flight.

Check readiness of the pilot for the solo flight on the day when the first flight on the combat aircraft is performed so that the pilot performs his first flight in the conditions under which he has been checked or under more simple weather conditions.

The cabin drills with the ground power supply connected are of great importance in preparation for the first solo flight.

When preparing for the first solo flight, the instructor concentrates the pilot's attention on a strictly definite and required number of the flight elements and manipulations with the cabin interior, as well as on the pilot's action in emergency cases. Dealing with the cabin equipment of minor importance for the given flight, watching the secondary instruments, as well as additional tasks and variations of the flight conditions differing from those of previous check flights may adversely affect the first solo flight.

A great moral and physical strain of the pilot in the first flight makes it inexpedient to perform more than two solo flights this day. Besides, an increased number of flights performed on the first day (solo flight and flight with assistance of the instructor) without detailed analysis of errors made during the flights may complicate the way of their elimination.

Before the solo flight of the pilot, the instructor should check preparation of the cabin interior and the aircraft equipment, the sequence of the pilot's actions during preparation for the flight and help him in due time to analyze the errors committed.

A successful performance of the first solo flight depends on the level of the pilot's preparation for this flight as far as the flying technique is concerned and his morale. During the introductory flights the task of the instructor consists in that he should inculcate firm habits to the trainee in performing all the elements of the flight, teach him to correct the errors committed in due time and develop his firm confidence in successful execution of the flights on the МиГ-25ПД aircraft.

If the pilot has committed serious errors during the first flight, he should carry out additional introductory (check) flights on a combat trainer. In these flights special attention should be paid to mastering the elements of the flight which were performed with errors.

As the pilot acquires the habits in performing the simplest flying elements, the missions assigned for the flight specified by an exercise should be made more complicated so as to meet all the requirements of this exercise and to attain its aim.

Prior to performing the flights to the service ceiling and to the maximum Mach-number, it is necessary to check whether the pilot knows all limitations and nature of the aircraft behaviour at supersonic airspeed.

During the flight the instructor watches how the pilot operates the cabin interior and aircraft equipment, draws his attention on variation of the control forces applied to the controls and sequence of the aircraft trimming with the aid of the trimming mechanisms, variation in the readings of the instruments when the aircraft enters the supersonic airspeed and the order of distribution of the pilot's attention at this moment, peculiarities involved in climbing to the service ceiling and flying at service ceiling, as well as during deceleration of the aircraft after disengagement of the afterburners.



## Chapter 4

# AIR NAVIGATION

### 1. GENERAL

The main peculiarities of air navigation of the МиГ-25ПМ aircraft are determined by the high airspeed of flight, wide range of altitudes, possibility of flying with an alternating profile, as well as possibility of complex employment of the flight-control and navigation equipment. Adequate knowledge of technical capabilities of this equipment and its efficient use in flight in combination with dead-reckoning and visual orientation ensure an accurate target (the interception line) approach at the assigned time under various conditions of the navigational and tactical situation.

As a rule, air navigation effected by the pilot in flight is supplemented by the control produced from the command and direction posts. For successful interception of air targets the pilot should exactly maintain the assigned flight conditions (course, airspeed and altitude), quickly and in due time execute the commands delivered from the command post by voice or over the radiotelemetry line.

A great power-to-weight ratio of the МиГ-25ПМ aircraft allows the pilot to perform the flights with an alternating profile. Such a flight is accompanied by variation of the flight condition which complicates air navigation. Besides, it makes the flying personnel to quickly transfer from air navigation effected with the help of radio aids to the visual air navigation and vice versa. During preparation for the flight, all this requires a thorough study of the procedure of complex employment of the airborne air navigation aids and methods of

their use for each stage of the route depending on the flight conditions, navigational and tactical situation.

## 2. COMPLEX SYSTEM "POLJOT-1M" AND ITS EMPLOYMENT

### 2.1. General

The POLJOT-1M system is a complex of an airborne interconnected flight-control and navigation equipment which incorporates the following systems:

- short-range radio navigation and landing system PCBH-6C;
- automatic flight control system CAY-155;
- directional/vertical gyro system CKB-2HJ-2;
- air data computer system CBC-1H-5A.

The POLJOT-1M system when operating in conjunction with the PCBH-4H rho-theta radio beacon and the ПРМГ-4M landing radio beacon group provides for execution of the following flight tasks under the VFR and IFR conditions in the automatic and director control modes:

- (1) programmed climb with subsequent levelling-off and stabilization of the assigned altitude or Mach-number;
- (2) return to the airfield of departure or to one of the three programmed landing airfields;
- (3) enroute flight involving three programmed route turning points and four airfields;
- (4) break-through clouds from the cruising altitude up to the prelanding maneuver;
- (5) execution of the prelanding maneuver;
- (6) landing approach to a height of 50 m;
- (7) missed approach procedure.

Throughout the flight the pilot is able to check the position of the aircraft relative to the radio beacon of the selected airfield, determine aircraft attitude, check whether the assigned parameters of the flight are maintained and interfere with the automatic control, if necessary.

In case of failure of the CAY-155 automatic flight control system, the POLJOT-1M system ensures execution of the enroute flight, return to the landing airfield and landing approach with the manual control of the aircraft.

The system provides for approaching the programmed route point at a mean radial error of 3.75 km, maximum, when flying

at an altitude of 10,000 m within the zone of radio correction and at a distance of 150 to 175 km from the PCBH-4H rho-theta radio beacon.

Deviations of the aircraft from the equisignal zones of the IIPMT-4M landing radio beacons (with the glide-slope beacon installed in front of the runway approach end at a distance of 130 m) at a distance of about 1000 m and altitude of 50 m in the automatic and director control of the aircraft are:

- 1.5 to 4.5 m in the longitudinal channel;
- 8 to 15 m in the lateral channel.

For solving navigational problems the POLJOT-1M system uses the great-circle system of co-ordinates.

The PCBH-6C system is provided with the modified great-circle system of co-ordinates (Fig. 45).

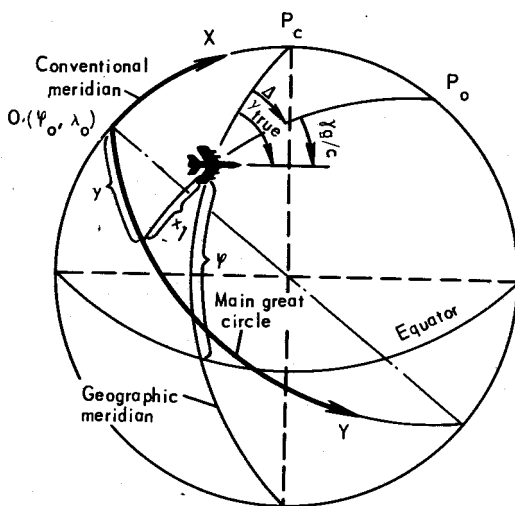

FIG. 45. GREAT-CIRCLE SYSTEM OF COORDINATES

X - conventional meridian; Y - great-circle equator (main great circle);  
 O - point of origin with coordinates:  $\psi_0$  - latitude;  $\lambda_0$  - longitude;  $x$ ,  
 $y$  - great-circle coordinates of aircraft fix;  $\Delta$  - meridian convergence  
 angle;  $\gamma_{true}$  - true heading;  $\gamma_{g/c}$  - great-circle course

In this system of co-ordinates the conventional meridian aligned with the geographical one and passing through the point of the origin is assumed as axis X. The rules of readout of heading, conventional latitude (co-ordinate x) and conventional longitude (co-ordinate y) are given in compliance with the geographical system of co-ordinates. The positive direction of axis X is the north, whereas that of axis Y is the east.

Origin of co-ordinates  $O (\varphi_0, \lambda_0)$  is selected so that the system covers the flight area (the battle area). Sometimes, the point corresponding to the location of the home airfield is assumed as the point of origin. In this case, the point of origin should be at a distance of not less than 20 km (along the X and Y axes) from the place where the home airfield beacon is installed.

The position of the aircraft is determined by great-circle co-ordinates z and y, where: x is the distance from the aircraft to the main great-circle course along the conventional meridian, whereas y is the distance along the main great-circle course from the point of co-ordinate origin to the spherical perpendicular dropped from the point of the aircraft position.

Fig. 45 shows that the great-circle course ( $\gamma_0$ ) differs from the true course ( $\gamma_{\text{true}}$ ) by the map angle. In the PCEH-6C equipment this angle is termed as the meridian convergence angle which is marked with  $\Delta$ . It is an angle between the North direction of the geographical meridian in the point where the PCEH beacon is installed and the North direction of axis X (great-circle meridian). Angle  $\Delta$  is read out from the geographical meridian towards the great-circle meridian in the clockwise direction (Fig. 46).

If the radius of the flying area does not exceed 750 to 800 km, the great-circle system of co-ordinates is plotted on the flight maps as interperpendicular straight lines as presented in Fig. 47.

## 2.2. Employment of System CBC-III-5A

The POLJOT-1M system uses the Mach-number for shaping the g-load limitation signals during manual flying, computation of the magnitude of deviation of the flight director indicator commands bars during director control, as well as for shaping the control signals during climb.

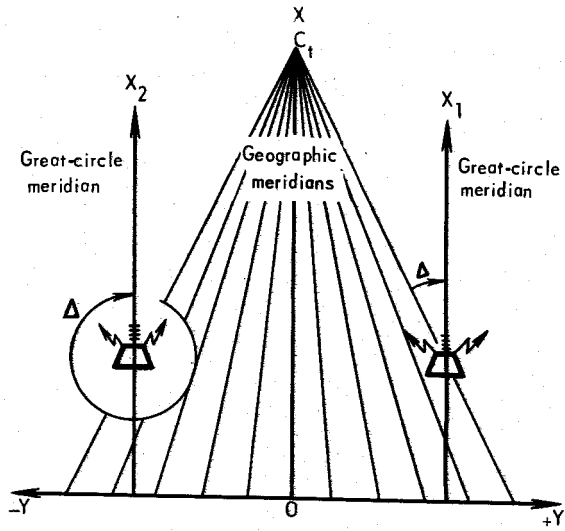

FIG. 46. DETERMINATION OF MERIDIAN CONVERGENCE ANGLE

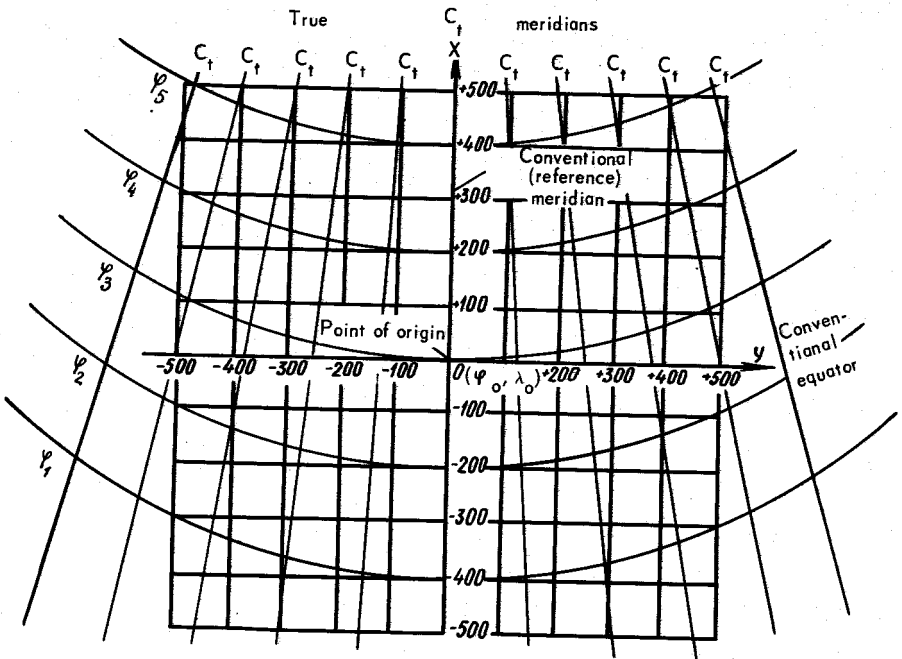

FIG. 47. EXAMPLE OF PLOTTING COORDINATE GRID FOR FLYING AREA

The true airspeed is used for dead-reckoning and controlling the flight conditions.

The true barometric altitude is used for correcting the autopilot gain and obtaining the control signals during climb, while the relative barometric altitude is used for shaping the control signal in the clouds break-through conditions and for checking the altitude at the ground command post.

The signals proportional to deviation of the true barometric altitude from the assigned value are used for stabilization of the aircraft altitude.

### 2.3. Employment of System CKB-2HI-2

The CKB-2HI-2 directional/vertical gyro system is designed for determining and continuous delivery of the roll and pitch angles and great-circle course, required for flying and solving the navigational problems, to the consumers.

The above parameters are applied to the combined course indicator, flight director indicator, as well as to the CAV automatic flight control system, PCEH short-range radio navigation and landing system and the C-25 armament control system. The roll and pitch angles and course are delivered without limitations with an accuracy of not more than  $\pm 2^\circ$ .

### 2.4. Employment of Short-Range Radio Navigation System PCEH-6C

Purpose and problems solved. The PCEH-6C short-range radio navigation and landing system is the navigation and landing airborne equipment of the POLJOT-1M system.

The PCEH-6C airborne equipment is a conjugated complex of the radio navigational and independent systems of determining the coordinates used for shaping the trajectory of flight and control signals in compliance with the assigned program during automatic or director control of the aircraft.

The radio navigational equipment of the PCEH-6C system operates in conjunction with the PCEH-4H ground rho-theta radio beacons, while in the landing mode it operates with the ПРМТ-4М landing radio beacon group which includes: the runway localizer (KPM), glideslope beacon (ГРМ) and distance retransmitter (РД). The radio navigational equipment serves for determining the polar co-ordinates of the aircraft, i.e. measuring the azimuth

and range with respect to the PCEH beacon, and on its basis it corrects the data of the independent system.

The independent equipment of the PCEH-6C system estimates the data for the flight, using the present course of the aircraft and the true airspeed.

Principle of Operation. The navigational problems are solved by the PCEH-6C short-range radio navigation and landing system on the basis of the independent dead-reckoning of the coordinates of the aircraft position by the signals of the true airspeed and great-circle course corrected by the radio beacons.

The radio navigational equipment of the PCEH-6C system possesses a high accuracy in determining the aircraft co-ordinates, but it is not protected against jamming and features a limited radius of action.

The independent system features a high reliability, has a great radius of action. Besides, it is not subjected to jamming but it has a low accuracy.

The combined operation of the radio navigational and independent systems ensures high accuracy in determining the co-ordinates, high reliability, jamproofness and great radius of action.

The in-flight remote control of the PCEH-6C system airborne equipment in all modes is ensured from the control panel arranged on the starboard side of the cabin. Arranged on the control panel are the following controls and indicating lamps (Fig. 48):

- four light-buttons labelled AFLD1, AFLD2, AFLD3 and AFLD4 which are intended for the in-flight selection of the programmed airfield;
- three light-button labelled RTP1, RTP2, and RTP3 which serve for selecting the programmed route turning point;
- the RADIO MARKER (RM) light-button which becomes energized in using any of the programmed radio beacon of the short-range radio navigation and landing system or airfield as a route turning point;
- the RETURN (BO3BPAT) light-button which is intended for changing over the equipment to the mode, ensuring the flight of the aircraft to the programmed airfield and landing;

- the RESET (СБРОС) light-button which serves for canceling the previously furnished data of all the programmed radio beacons of the PCEH system and the ИРМГ radio beacon group. Upon resetting, the equipment can be manually tuned in flight to the channels of the radio beacons of the PCEH system and the ИРМГ radio beacon group of the non-programmed airfields;

- the LANDING (ПОСАДКА) selector switch which is intended for manually changing over the navigation equipment to the channel of the ИРМГ-4М radio beacon group during landing on a non-programmed airfield;

- the  $\psi + 180^\circ$  selector switch which becomes energized (occupies the upper position) when the aircraft is going to land on the programmed airfield with a heading which is reverse to the programmed one;

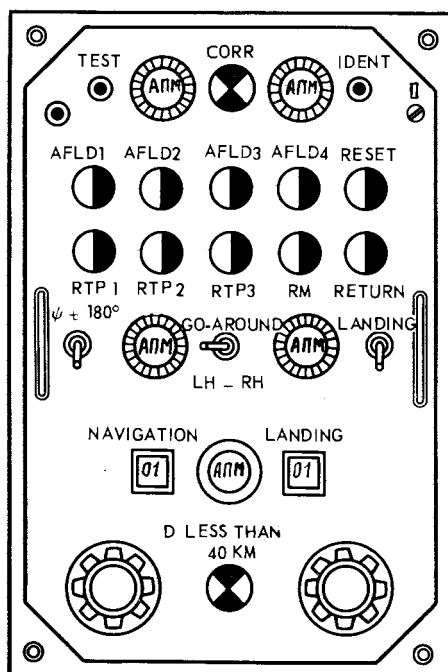

FIG. 48. CONTROL PANEL OF SHORT-RANGE RADIO NAVIGATION AND LANDING SYSTEM PCBII-6C



- the GO-AROUND: LH - RH (ПОБТ. ЗАХ. ЛЕБ. - ПРАБ.) selector switch which is used for selection of the RH or LH traffic circuit during repeated approach;

- the NAVIGATION (НАВИГАЦИЯ) channels selector switch which is used for selection of the required channel when flying to a non-programmed airfield equipped with the PCEH short-range radio navigation and landing system radio beacon;

- the LANDING (ПОСАДКА) channels selector switch which is used for selecting the required channel when landing on a non-programmed airfield equipped with the ПРМГ-4М radio beacon group;

- the D LESS THAN 40 KM lamp which lights up when the distance to the route turning point is less than 40 km, thus indicating that it is necessary to switch over to other route turning point;

- the CORR lamp which indicates operation of the PCEH-6C system in the radio correction mode;

- the TEST (КОНТРОЛЬ) button which enables the pilot to check the serviceability of the PCEH-6C system. Pressing on this button must cause the combined course indicator and the ИИИ-2 distance indicator to reproduce the check azimuth and distance values, respectively. The check azimuth value accounts for  $177^{\circ}$ , and the value of the distance is equal to 291.5 km;

- the IDENT (ОПЗН.) button which is used to ensure individual identification of the aircraft displayed on the plan position indicator of the PCEH ground short-range radio navigation and landing system;

- the AZIMUTH (АЗ) button and the ZERO slotted screw which are used for the equipment adjustment (setting of azimuth zero).

The output parameters processed in the PCEH-6C system are displayed on the combined course indicator, flight director indicator, and distance indicator.

## 2.5. Preparation For Flight With Use of POLJOT-1M System

The preparation for flight should be effected in accordance with the general rules with the due regard to the characteristic features of the POLJOT-1M system.

In the course of the preparation for flight the pilot should:

- (a) plot the great-circle coordinate system;
- (b) plot and calculate the flight route;
- (c) determine the great-circle coordinates of the route turning points and the radio beacons of the short-range radio navigation and landing system, angular corrections, track angles, and the initial flight data for the automatic landing approach;
- (d) make up a program for en-route flight and landing on the main and alternate airfields;
- (e) introduce the initial data (program) for the en-route flight and landing on the main and alternate airfields.

Flight route selection and plotting should be effected with due account of the tactical and navigational situation as well as of the capabilities of the POLJOT-1W system which makes it possible to program seven route points, namely, three route turning points and four radio beacons of the short-range radio navigation and landing system. The procedures for plotting the flight route are given in Fig. 49. To be marked first are the basic route points, that is, the initial route point, route turning point, target, and terminal route point. Then, these points, with due regard to the turning radius, should be connected with the geodetic lines which form the course line.

The geodetic lines marked on the modified polyconic projection maps having a scale of 1:1,000,000 and composed of nine sheets may be substituted by straight lines.

Upon completion of flight route plotting, make flight calculations involving determination of the flying distance and time, track angles at each flight route stages, total flight endurance, flying time reserve, takeoff time to ensure timely target interception, and fuel reserve.

The great-circle coordinates of the preselected route points and the radio beacons of the short-range radio navigation and landing system should be determined by way of measuring the distance along axes X and Y with the use of a scale rule. The distances are to be determined only within the limits of a single square of the great-circle coordinate system grid. Further on, the measured coordinate corrections should be added to the values of the basic scale marks. If the above grid is

not available, the great-circle coordinates should be determined in accordance with the general procedures.

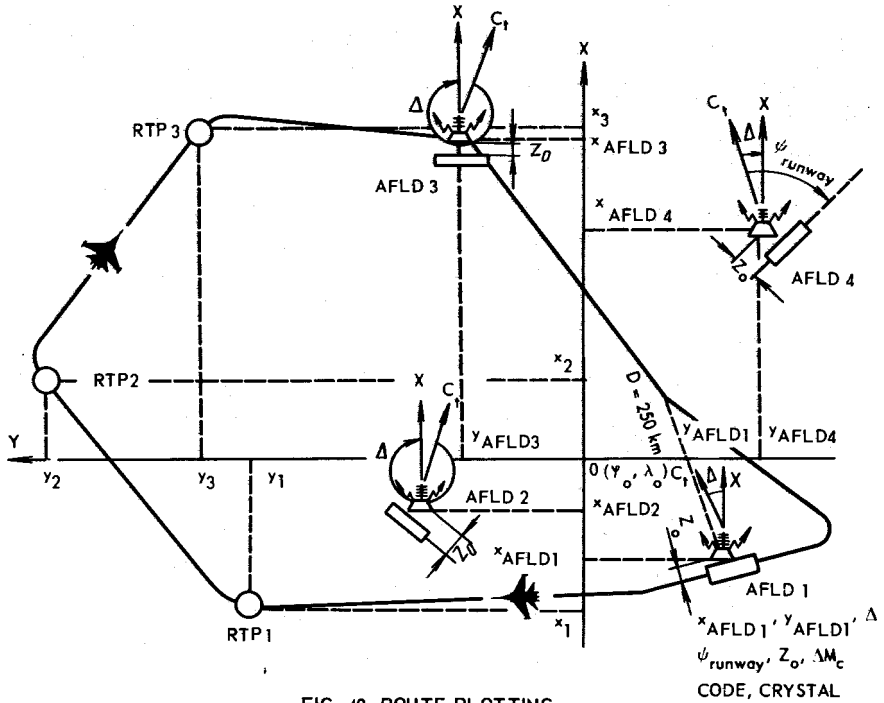

FIG. 49. ROUTE PLOTTING

When flying in an area the radius of which does not exceed 750 to 800 km, the great-circle coordinates may be substituted by rectangular cartographic coordinates which can be easily measured with the use of a protractor and scale rule. If axis  $X$  is in full alignment with the geographical meridian in the point of origin of the coordinates, the great-circle coordinates of the preselected points in flight to a distance of more than 750 to 800 km should be calculated by the following formulae:

$$\sin x^0 = \sin \varphi \cos \varphi_0 - \cos \varphi \sin \varphi_0 \cos (\lambda - \lambda_0) \text{ and}$$

$$\sin y^0 = \frac{\cos \varphi \sin (\lambda - \lambda_0)}{\cos x}$$

where:  $x^0, y^0$  - great-circle coordinates of the preselected points;

$\varphi_0, \lambda_0$  - geographical coordinates of the point of origin;

$\varphi, \lambda$  - geographical coordinates of the preselected points.

Values  $x$  and  $y$  expressed in degrees should be determined with reference to the tables of trigonometric functions (accurate to a fourth decimal place) or with the aid of a slide (computer) rule.

The great-circle coordinates of the preselected points in terms of kilometres may be determined with the aid of the following formulae:

$$x = \frac{x^{\circ}}{57.3^{\circ}} \cdot 6372.9 \text{ and } y = \frac{y^{\circ}}{57.3^{\circ}} \cdot 6372.9.$$

Determination of angular corrections and track angles. To perform an en-route flight with the use of the POLJOT-1M system, determine the following angular corrections:

(a) convergence angle  $\Delta$  for the radio beacons of the short-range radio navigation and landing system;

(b) conventional magnetic declination  $\Delta M_c$ .

The convergence (map) angle is the true track angle of axis X of the modified great-circle coordinate system in a given point.

With axis X being in alignment with the geographical meridian in the point of origin of the coordinates, the convergence angle may be calculated with the aid of the following formula:

$$\sin \Delta = \frac{\sin \varphi_0}{\cos x^{\circ}} \sin (\lambda - \lambda_0)$$

$$\text{or } \sin \Delta = \frac{\sin \varphi_0}{\cos \varphi_0} \sin y^{\circ}$$

where:  $\varphi_0, \lambda_0$  - geographical coordinates of the point of origin;

$\varphi, \lambda$  - geographical coordinates of the ground short-range radio navigation and landing system;

$x^{\circ}, y^{\circ}$  - great-circle coordinates of the ground short-range radio navigation and landing system.

The convergence angle may also be measured with the use of a protractor and the map as it is clear from Fig. 50.

The convergence angle values are inserted into the navigation computer for the purpose of solving the following two problems:

(a) transformation of the coordinates during the introduction of corrections;

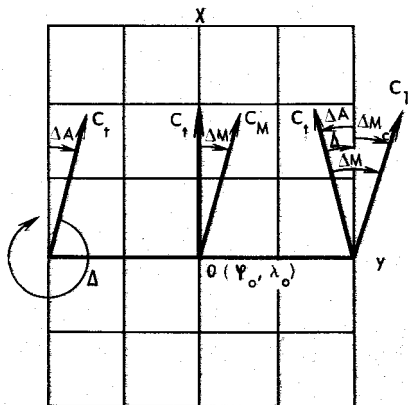

FIG. 50. DETERMINATION OF MERIDIAN CONVERGENCE ANGLES  $\Delta$  AND CONVENTIONAL MAGNETIC DECLINATION  $\Delta M_C$  ( $\Delta A$  - AZIMUTH CORRECTION)

(b) obtaining of the true course during return to the airfield from a point located at a distance of 250 km and during landing approach.

The conventional magnetic declination data are put into the KM-5 compensating mechanism of the directional/vertical gyro system to cause directional gyro erection. It is measured within the range of 0 to  $\pm 180^\circ$  (the positive sign stands for clockwise measurement and the negative sign, for counterclockwise measurement). The magnitude and sign of the conventional magnetic declination are an algebraic total resulting from addition of azimuth correction  $\Delta A$  and magnetic declination  $\Delta M$  in a given point:

$$\Delta M_C = \Delta A + \Delta M.$$

The magnetic declination is determined with reference to the map with the use of the isogonals marked on it.

The azimuth correction should be calculated within the range of 0 to  $\pm 180^\circ$ . In order to determine this correction, use the convergence angle with which the azimuth correction is associated through the following relationships:

$$\Delta A = -\Delta, \text{ if } \Delta < 180^\circ \text{ and } \Delta A = 360^\circ - \Delta, \text{ if } \Delta > 180^\circ.$$

When flying the aircraft in an area which is limited by a circumference having a radius of 750 to 800 km, with the difference between the longitudes not exceeding 10 to 12 $^\circ$ , the azimuth correction may be calculated with the use of a simplified formula:

$$\Delta A = (\lambda_0 - \lambda) \sin \varphi_0,$$

where:  $\varphi_0, \lambda_0$  - geographical coordinates of the point of origin;  
 $\lambda$  - longitude of the preselected point.

With the point of origin of the coordinates aligned with the airfield or a point located at a distance of 20 to 30 km from the airfield, the conventional magnetic declination is equal to the airfield magnetic declination if axis X coincides with the geographical meridian in the point of origin.

The great-circle track angles (G-CTA) may be determined by way of direct measurement if the great-circle coordinate system grid is available on the map. This being the case, it is necessary to measure the angle between the conventional meridian (axis X) and the track line with the use of a protractor (Fig. 51, a).

If the great-circle coordinate system grid is not marked, the great-circle track angles should be determined (Fig. 51, b) with the aid of the following formula:

$$\text{G-CTA} = \text{TTA} + (\pm \Delta A).$$

Determination of initial data for automatic landing approach. To ensure automatic landing approach to a base and three alternate airfields, determine the following initial data:

- (a) true runway (landing) headings ( $\psi_{\text{runway}}$ );

$$\psi_{runway} = MH_{runway} + \Delta M$$

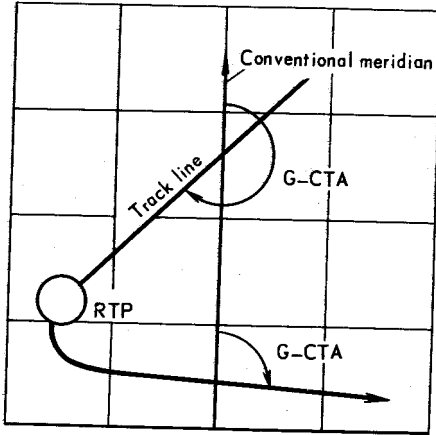

a

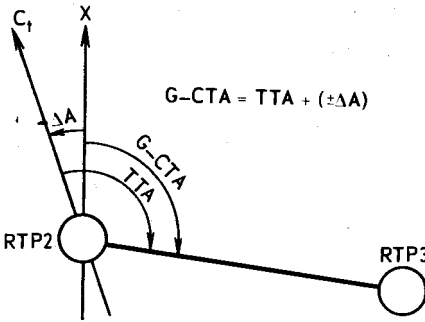

b

FIG. 51. DETERMINATION OF GREAT-CIRCLE TRACK ANGLE (G-CTA)  
 a - measurements taken with use of map; b - calculation with reference to TTA and  $\Delta A$

(b) lateral offset of the radio beacons with respect to the runway centre line ( $Z_0$ );

(c) frequency-code navigation and landing channels.

The true runway heading should be determined as a total of the magnetic runway heading and the magnetic declination of the programmed airfield (Fig. 52).

$$\Psi_{\text{runway}} = MH_{\text{runway}} + \Delta M.$$

The magnetic runway heading should be selected from the Airdrome Navigation Data Manuals and Radio Communication Means and Radio Support Lists and Schedules. The magnetic declination data is obtained with reference to the map.

It is necessary that the true runway heading data corresponding to the main landing direction should be inserted into the landing computer.

The true heading ranging from  $0$  to  $179^\circ$  correspond to the main landing direction. The turn headings within the limits of  $180$  to  $359^\circ$  correspond to the reverse direction.

Lateral offsets  $Z_0$  of the radio beacons of the short-range radio navigation and landing system with respect to the runway centre lines of the main and alternate airfields should be selected from the Airdrome Navigation Data Manuals.

If the radio beacon is located on the left side with respect to the runway centre line when landing in the main direction, the amount of the radio beacon lateral offset should be taken with a positive sign. When the beacon is on the right side relative to the runway centre line, it should be taken with a negative sign. The values corresponding to the lateral offsets of the radio beacons should be inserted into the landing computer.

The frequency-code navigation and landing channels must be selected from the Airdrome Navigation Data Manuals and

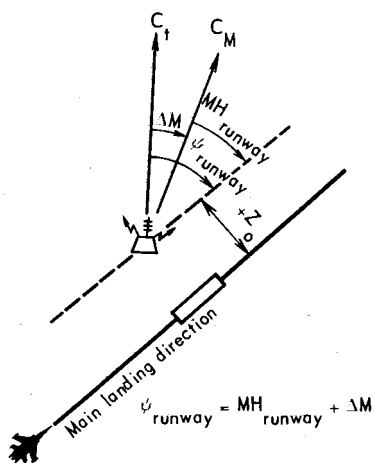

FIG. 52. DETERMINATION OF TRUE RUNWAY HEADING



Radio Communication Means and Radio Support Lists and Schedules. The information pertaining to the positions of the CRYSTAL (KBAPL) and CODE (KOD) selector switches can be obtained with reference to the tables available in the technical description of the PCBH-6C airborne short-range radio navigation and landing system.

Knowing the numbers of the navigation and landing channels, one can find the crystal and code numbers without searching for them in the above-mentioned tables. If the channel number is less than 4, the crystal number will be equal to 1, and the code number is equal to the channel number. Should the channel number be equal to or more than 4, the crystal number should be determined by dividing the channel number by 4. The resulting quotient should be rounded off to the nearest greater integer. The code number is equal to the remainder of division. If the division produces an integer, the code number should be assumed equal to 4. Let us assume, for example, that the channel number is equal to 33. Hence, the crystal number will be equal to 9 and the code number, to 1.

The program for en-route flight and landing on the main and alternate airfields should be worked out during the period of preliminary preparation. To be included in the program are the following initial data:

- (a) great-circle coordinates of the four short-range radio navigation and landing system beacons located at the airfields and the three route turning points;
- (b) convergence angles of the meridians for the four airfields;
- (c) latitude of great-circle coordinates origin;
- (d) true headings corresponding to the main direction of landing on the four airfields;
- (e) lateral offsets of the radio beacons for the four airfields;
- (f) numbers of the frequency-code channels for the beacons of the short-range radio navigation and landing system and the ПРМГ-4 radio beacon group at the main and alternate airfields;
- (g) medium latitude of flight area or the latitude of the takeoff airfield (during local flights);
- (h) takeoff airfield conventional magnetic declination.

All these initial data are to be entered in a special blank sheet which is used for flight programming. The initial data program should be made up by the pilot under the supervision of the squadron navigator, and checked out for correctness by the chief navigator of the air regiment.

The initial data on the units of the PCEH-6C system are set by a radio and electronic equipment specialist.

### 3. PERFORMING EN-ROUTE FLIGHT

#### 3.1. Performing Assigned-Route Flight in Automatic Control Mode

Takeoff and climb to an altitude of 200 m shall be effected manually.

On attaining an altitude of 200 m the aircraft should be piloted in the director control mode.

On attaining an altitude of at least 500 m the pilot, keeping the command bars within the limits of the circle, should trim out the stick forces and enable the automatic control mode by depressing the AUTO CTL light-button located on the control panel of the automatic flight control system and ascertain that it has come on.

After the automatic control mode has been enabled the aircraft in-flight control becomes automatic. The engine operation control shall be effected by the pilot.

The flying speed and the engine power setting will depend on the climb program set on the altitude and airspeed selector.

In both the subsonic and supersonic climbing, when the aircraft approaches the selected altitude, the SEL ALT LVL-OFF lamp located on the instrument board comes on and glows for 3 to 5 s after which the aircraft is automatically recovered to level flight at the selected altitude on the preset course. Apart from this, the attainment of the selected altitude by the aircraft should be checked with reference to the longitudinal channel position bar which should cover the distance between the upper stop and the lower edge of the circle across the centre of the scale.

As the fuel is being consumed in subsonic flight at a constant altitude, the pilot should maintain the airspeed corresponding to a Mach number of 0.85 by gradually decreasing the engine speed.

To ensure a more smooth levelling-off after attaining the selected supersonic flight altitude, on flashing-up of the SEL ALT LVL - OFF lamp the pilot should place the throttle lever to the MINIMUM REHEAT (МИНИМАЛЬНЫЙ ФОРСАЖ) position and in level flight establish an airspeed corresponding to a Mach-number of 2.35.

In straight flight, both at sub-sonic and supersonic airspeeds, the aircraft is steadily held on the assigned path. The command bars and position bars of the flight director indicator at the time should be within the limits of the respective circles.

The preset course pointer settles in the direction of the route turning point.

With the takeoff airfield radio beacon up-dating ensured, the CORR indicator lamp located on the control panel of the PCEH-6C system flashes up and the RB pointer on the combined course indicator will show the relative bearing of the radio beacon.

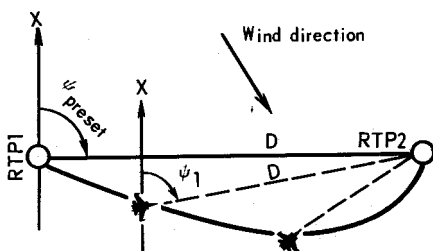

FIG. 53. AIRCRAFT FLIGHT PATH WHEN FLYING TO ASSIGNED POINT BY DIRECTIONAL METHOD IN WIND WITH RADIO UP-DATING ENSURED

Assigned point (RTP) interception flight under wind conditions, with the dead-reckoning up-dating ensured by the short-range radio navigation and landing system radio beacon, should be effected with the use of the directional method involving the radio beacon up-dating procedure, as shown in Fig. 53.

When flying the aircraft beyond of the zone of coverage of the short-range radio navigation and landing system radio beacon in the

independent dead-reckoning mode, the flight path is essentially a straight line as shown in Fig. 54.

When at a distance of 40 km from the RTP, the D LESS THAN 40 KM lamp located on the control panel of the PCEH-6C system comes on. Upon flashing-up of this lamp or after attaining a distance specified in the flight assignment, depress the light-button of the next RTP. Depressing of the above button results in the automatic turning of the aircraft, with the roll not exceeding  $42^\circ$  and  $30^\circ$  under supersonic and subsonic conditions, respectively.

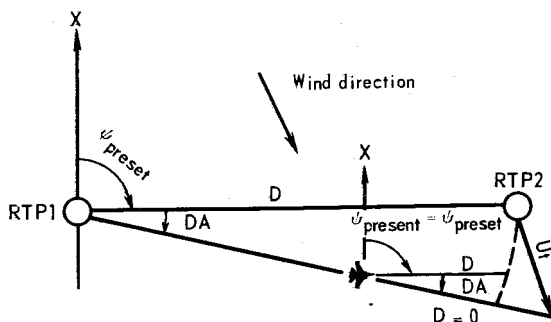

FIG. 54. AIRCRAFT FLIGHT PATH WITH INDEPENDENT DEAD-RECKONING OF COORDINATES IN WIND

Upon illumination of the light-button of the next RTP the preset course pointer of the combined course indicator shows the heading relative to this RTP and the ПДУ-2 distance indicator shows the distance from this RTP. The flight director indicator lateral channel command bar and position bar will deflect towards the preset course.

It is recommended that the throttle lever should be placed to the FULL REHEAT (ПОЛННЙ ФОРСАЖ) position when the aircraft is turned at a supersonic speed and returned to the original position upon completion of turning.

With the flight mission involving flying over the route turning point, proceed as follows:

- at a distance of 25 km disable the automatic control mode by depressing the AUTOPILOT OFF button on the control stick;

- change over to manual control and maintain the present heading;

- when the distance readings presented by the IIII-2 distance indicator become equal to zero, depress the light-button of the next RTP, start to turn the aircraft manually, set the command bars in the centre of the circle, and enable the automatic control mode.

Upon completion of turning the aircraft with the purpose of intercepting the preset course, the command bars and position bars should be within the limits of the respective circles.

In case the radio beacons of the short-range radio navigation and landing system, or en-route radio beacons, or beacons of the radio navigation points programmed in the system are used as route turning points, depress the AFLD and RM light-button located on the PCEH-6C system control panel. The subsequent procedures to be followed by the pilot are similar to those involved in flight to the RTP.

On getting beyond the zone of coverage of the takeoff airfield short-range radio navigation and landing system beacon (the CORR lamp located on the PCEH-6C system control panel does not glow) or intercepting the points specified in the navigator's flight chart, depress on the light-button of the next programmed radio beacon into the coverage zone of which the aircraft will enter.

When performing an en-route flight in the automatic control mode, a pilot must effect the engine operational control, check the correctness of the present heading indications, check the combined course indicator pointers and the flight director indicator position bars and command bars for correct positioning, note the readings presented by the IIII-2 distance indicator, check the flight director indicator for correct roll and pitch indications, and check the illumination of the SHORAN light-button located on the AFCS control panel.

The fading-out of the SHORAN light-button results in the dropping-in of the roll and pitch flags on the flight director indicator and causes the automatic flight control system to stabilize the aircraft attitude registered at the moment of the light-button fading-out. This being the case, the pilot should

change over to manual control without disabling the automatic control mode by means of the AUTOPILOT OFF button, ascertain that the CORR lamp located on the PCEH-6C system control panel has come on, depress the SHORAN light-button, set the command bars within the limits of the circle, and trim out the stick forces.

If the CORR lamp is dead, the return to the landing airfield should be effected by the use of the APK-19 automatic direction finder by placing the SHORAN - ADF (PCEH - APK) selector switch to the ADF position. Upon setting the selector switch to this position, ascertain that the combined course indicator RB pointer readings vary by not more than 6 to 8° at a distance of more than 40 km to the landing airfield.

Besides, in the course of en-route flight and return to a programmed airfield, the pilot, especially when in doubt about the properness of functioning of the short-range radio navigation and landing system must periodically check the flight direction with the use of the APK-19 automatic direction finder, and the distance to the airfield, by using the information given from the control post.

### 3.2. Performing En-Route Flight in Director Control Mode

After takeoff the pilot should proceed as follows:

(1) on attaining an altitude of 200 m the pilot should depress the SHORAN light-button on the control panel of the automatic flight control system;

(2) check to see that:

- the SHORAN light-button on the control panel of the automatic flight control system is illuminated;
- the preset course pointer of the combined course indicator indicates the direction to the RTP-1;
- the distance indicator reads the distance to RTP-1;
- the flight director indicator lateral channel command bar and position bar have deflected towards the RTP-1;
- the flight director indicator longitudinal channel command bar has deflected below the circle and the position bar, above the circle;

(3) keeping the lateral channel command bar within the circle, apply proportionately the stick and pedals to enter a turn;

(4) while climbing, accelerate the aircraft to  $M = 0.85$  and smoothly move the control stick to zero the longitudinal channel command bar;

(5) fly with reference to the flight director indicator keeping the indicator command bars within the circle.

Transfer attention as follows:

- flight director indicator (pitch, roll, slipping, command bars within the circle);
- airspeed ( $M = 0.85$ );
- altimeter (climbing to the assigned flight level);
- combined course indicator (preset course to the RTP-1);
- flight director indicator (pitch, roll, slipping);
- engine instruments;
- fuel flowmeter, annunciator (normal sequence of fuel consumption);
- direct-reading distance indicator IIII-2 (decrease of distance to the RTP-1);
- flight director indicator (command bars within the circle).

When performing flight, the pilot must proceed as follows:

(1) as the SEL ALT LVL-OFF lamp lights up, smoothly apply forward stick to level aircraft at the assigned flight level;

(2) decrease the engine speed to keep the Mach-number equal to 0.85;

(3) make sure that the D LESS THAN 40 KM lamp on the control panel of the short-range radio navigation and landing system is illuminated when the distance to the route turning point becomes less than 40 km. Depress the light-button of the next route turning point;

(4) make sure that:

- the distance to the route turning point is indicated by the distance indicator;
- the command bar and position bar of the flight director indicator lateral channel are deflected in the direction of the selected route turning point;
- the preset course pointer of the combined course indicator indicates the course to the next route turning point;

(5) smoothly deflect the aircraft control stick to enter a turn keeping the command bars within the circle;

(6) after the aircraft is turned to the preset course set the command bars and position bars within the circles of the flight director indicator.

Transfer attention as follows:

- flight director indicator (pitch, roll, slipping, command bars within the circle);
- airspeed (maintaining the selected Mach-number);
- altimeter (assigned flight level);
- combined course indicator (preset course to the next route turning point);
- flight direct indicator (pitch, roll, slipping);
- engine instruments;
- fuel flowmeter, annunciator (normal sequence of fuel consumption);
- control panel of the short-range radio navigation and landing system (the CORR lamp, AFLD and selected RTP light-buttons are illuminated);
- flight director indicator (pitch, roll, slipping, command bars and position bars within the circles);

(7) on accomplishing the en-route flight mission, depress the AFLD (landing airfield) and RETURN light-buttons on the control panel of the short-range radio navigation and landing system;

(8) make sure that:

- the distance indicator indicates the distance to the landing airfield;
- the command bar and position bar of the flight director indicator lateral channel are deflected in the direction of the landing airfield;
- the combined course indicator preset course pointer reads the course to the short-range radio navigation and landing system beacon (to the beginning of the base-leg (final) turn) on the landing airfield;
- the CORR lamp and the AFLD (landing airfield) and RETURN light-buttons are illuminated on the control panel of the short-range radio navigation and landing system;

(9) smoothly deflect the aircraft control stick to enter a turn to intercept the preset course.



### 3.3. Peculiarities of Performing En-Route Flight in Manual Control Mode

The manual control mode should be made use of in the event of failure of both the automatic and director control modes. In this case, the pilot may use the preset course and radio beacon relative bearing readings presented by the combined course indicator. Upon depressing the SHORAN light-button on the AFCS control panel the pilot may also make use of the indications presented by the longitudinal channel position glide-slope deviation) bar of the flight director indicator when flying in the RETURN mode in response to the commands from the PCBH-6C system.

During the performance of an en-route flight in the manual control mode the preset course indicator pointer of the combined course indicator should be set to the required position by the use of the course selector knob and the P/SET COURSE AUTO - MAN selector switch, to the MAN position.

The monitoring of the navigational parameters delivered by the POLJOT-1M system and use of the equipment in the manual control mode should be effected in the same scope and sequence as in the automatic or director control mode.

### 3.4. Landing Approach to Programmed Airfield with Use of POLJOT-1M System

#### Director Control Mode

After the mission is accomplished the pilot should proceed as follows:

- (1) check the radio up-dating (the CORR lamp is illuminated);
- (2) set the P/SET COURSE AUTO - MAN selector switch to the AUTO position;
- (3) depress the AFLD and RETURN light-buttons on the control panel of the short-range radio navigation and landing system (the AFLD and RETURN light-buttons will come on);
- (4) check the position of the  $\psi + 180^\circ$  selector switch;
- (5) depress the SHORAN light-button on the AFCS control panel;
- (6) after enabling of the director mode the pilot should:

- zero the command bars of the flight director indicator by proportionate deflection of the aircraft control stick and pedals;

- trim out the control forces by the trim mechanism;

(7) in level flight the pilot should transfer attention as follows:

- flight director indicator (roll, pitch, command bars within the small-diameter circle);

- radio up-dating;

- combined course indicator (present heading is in compliance with preset course);

- flight director indicator;

- vertical-speed indicator;

- airspeed;

- flight director indicator;

- engine instruments;

(8) at a distance of 250 km from the airfield smoothly deflect the aircraft control stick and pedals to keep the flight director indicator vertical command bar within the small-diameter circle;

(9) at a distance of 90 to 120 km from the airfield proceed as follows:

- push the aircraft control stick keeping the horizontal command bar within the small-diameter circle;

- decelerate the engines to the idle speed;

- slightly vary the pitch and extend (retract) the air brakes to set up an airspeed of 600 km/h;

(10) during descent transfer attention as follows:

- flight director indicator (pitch, roll, command bars within the small-diameter circle, pitch angle is  $6^{\circ}$ , approximately);

- vertical-speed indicator (vertical speed of descent is 35 to 40 m/s);

- combined course indicator (present heading is in compliance with preset course);

- flight director indicator;

- airspeed (600 km/h);

- engine speed (idle speed);

- flight director indicator;

- altitude;

- airspeed;
- flight director indicator;

(11) at an altitude of 1000 m establish an engine speed of 75 per cent and prepare for pulling the aircraft out of descent;

(12) keeping the flight director indicator command bars within the small-diameter circle, bring the aircraft to level flight at an altitude of 550 to 700 m;

(13) adjust the airspeed of 600 km/h by the engine speed;

(14) after bringing the aircraft to level flight, extend the landing gear and decrease the airspeed to 500 km/h;

(15) when approaching the base-leg turn at a distance of 19 to 21 km, enter a turn with a bank of  $30^\circ$  keeping the vertical and horizontal command bars within the flight director indicator small-diameter circle.

(16) decrease the airspeed to 450 km/h;

(17) while turning, transfer attention as follows:

- flight director indicator (pitch, roll, command bars within the small-diameter circle);
- vertical-speed indicator;
- combined course indicator (variation of the present heading towards the preset course, ADF readings, disappearance of the LOC flag);

- flight director indicator;

- airspeed (450 km/h);

- altitude (550 to 700 m);

- flight director indicator;

(18) prior to intercepting the runway heading, make sure that the LANDING mode is enabled. The LANDING lamp should light up on the control panel of the automatic flight control system;

(19) after intercepting the runway heading, set the RB, SHORAN - ADF (KYP, PCBH - APK) selector switch to the ADF (APK) position;

(20) when on the runway heading, keep the command bars within the small-diameter circle on the flight director indicator;

(21) at a distance of 15 to 16 km extend the flaps and decrease the airspeed to 430 km/h;

(22) transfer attention as follows:

- flight director indicator (pitch, roll, command bars within the small-diameter circle);

- vertical-speed indicator (no vertical speed);

- combined course indicator (positions of the course and glide-slope deviation bars);
- flight director indicator;
- airspeed (430 km/h);
- combined course indicator;
- flight director indicator;
- vertical-speed indicator;
- altitude;
- combined course indicator;
- flight director indicator;

(23) as soon as the horizontal bar approaches the centre of the circle on the combined course indicator, start descending at a vertical speed of 5 to 7 m/s keeping the bar of the combined course indicator in the centre;

(24) set up an engine speed of 68 per cent;

(25) maintain the following descent conditions:

Distance read off distance indicator, km	12	10	8	6	4	2
Altitude, m	600	500	400	300	200	100

(26) decrease (increase) the engine speed to adjust the airspeed so as to pass the outer marker beacon at an airspeed of 400 to 420 km/h.

#### Automatic Control Mode

After the mission is accomplished the pilot should proceed as follows:

- (1) monitor the radio up-dating (the CORR lamp is illuminated);
- (2) set the P/SET COURSE AUTO - MAN selector switch to the AUTO position;
- (3) depress the AFLD and RETURN light-buttons on the control panel of the short-range radio navigation and landing system (the AFLD and RETURN light-buttons will light up);
- (4) check the position of the  $\psi + 180^\circ$  selector switch;
- (5) depress the SHORAN light-button on the control panel of the automatic flight control system. In this case:
  - the SHORAN light-button will light up;
  - the preset course pointer will indicate the preset course;
  - the LOC and GS flags will drop out;
  - the vertical command bar of the flight director indica-

tor will show the deviation from the assigned roll (in the direction of the deflection of the vertical position bar and preset course pointer of the combined course indicator);

- the horizontal command bar of the flight director indicator will show the deviation from the assigned g-load (in the direction of the deviation from the altitude of 9500 m and deflection of the horizontal position bar of the flight director indicator);

- the vertical position bar of the flight director indicator will show the deviation (in heading) from the assigned flight path;

- the horizontal position bar of the flight director indicator will show the deviation from the altitude of 9500 m;

- the direct-reading distance indicator reads the distance to the beacon.

After the director mode is enabled the pilot should proceed as follows:

- (1) zero the command bars of the flight director indicator;

- (2) trim out the aircraft control stick forces by means of the trim mechanisms;

- (3) depress the AUTO CTL light button on the control panel of the automatic flight control system;

- (4) make sure that the AUTO CTL and DAMPER light-buttons are illuminated;

- (5) relieve the control stick of forces.

In level flight check:

- radio up-dating;

- operation of the command bars;

- preset course indication;

- deflection of the position bars;

- operation of the autopilot.

At a distance of 250 km the pilot should check the deflection of the preset course pointer of the combined course indicator, position bar and command bar of the flight director indicator in the direction of the base-leg (final) turn. The aircraft enters the turn automatically.

At a distance of 90 to 120 km from the airfield the pilot should check the beginning of the break-through procedure:

- (1) the horizontal position bar of the flight director indicator deflects downward and settles below the circle between the second and third dots;

(2) the longitudinal channel command bar deflects downward;

(3) the aircraft starts descending at a pitch angle of  $6^{\circ}$ ;

(4) the vertical speed of descent is 35 to 40 m/s.

The pilot must proceed as follows:

(1) decelerate the engines to the idle speed;

(2) set up an airspeed of 600 km/h.

Beginning from the altitude of 3000 m the pilot should check the decrease of the pitch angle and smoothly accelerate the engines. At an altitude of 1000 m the engine speed should be increased to 75 per cent.

On descending to an altitude of 550 to 700 m the pilot should check the aircraft recovery to level flight. For this purpose he should make sure that:

(1) the horizontal position bar of the flight director indicator settles in the centre of the circle;

(2) the aircraft proceeds in accordance with the deflection of the command bar and automatically levels off;

(3) the stabilized level flight altitude is from 550 to 700 m.

After levelling off the aircraft the pilot should extend the landing gear and decrease the airspeed to 500 km/h.

While approaching the base-leg turn at a distance of 19 to 21 km the pilot should make sure that:

(1) the preset course pointer of the combined course indicator and the vertical position bar of the flight director indicator have deflected towards the turn;

(2) with the vertical command bar of the flight director indicator kept in the appropriate position, the aircraft has automatically entered the turn at a roll of not more than  $30^{\circ}$ .

In the course of the turn the pilot should decrease the airspeed to 450 km/h. Interception of the runway heading is checked by comparing the readings of the automatic direction finder and indications of the present heading.

Prior to bringing the aircraft to the runway heading, make sure that the LANDING mode is enabled automatically:

(1) the LANDING lamp has illuminated on the control panel of the automatic flight control system;

(2) the command bars hesitate during 2 to 3 s;

(3) on the combined course indicator the LOC flag was the first to disappear and at a distance of 20 km, minimum, the GS flag became also out of view;

(4) the vertical bar of the combined course indicator has deflected towards the equisignal zone of the localizer beacon;

(5) the horizontal bar has jumped up;

(6) the preset course pointer of the combined course indicator indicates the runway heading.

On the runway heading the pilot should set the RB, SHORAN - ADF selector switch to the ADF position and make sure that:

(1) the vertical position bar of the flight director indicator deflects towards the equisignal zone of the localizer beacon;

(2) the horizontal position bar indicates the deviation from the altitude of 550 to 700 m;

(3) the vertical bar of the combined course indicator deflects towards the equisignal zone of the localizer beacon;

(4) the horizontal bar of the combined course indicator is in the extreme upper position;

(5) the roll and pitch command bars are in the centre of the flight director indicator circle;

(6) with the command bars of the flight director indicator kept in the centre of the circle the aircraft performs the maneuver in the direction of the deflected position bars.

At a distance of 15 to 16 km the pilot should extend the flaps and establish an airspeed of 430 km/h.

At a distance of 14 to 16 km the pilot should make sure that:

(1) the combined course indicator bar moves downwards;

(2) as the combined course indicator bar passes the central circle, the horizontal command bar deflects downwards;

(3) following the movement of the horizontal command bar of the flight director indicator the aircraft starts descending automatically;

(4) the vertical speed of descent is 5 to 7 m/s.

The descent is checked as explained for the director control mode.

At an altitude of 50 m the pilot should discontinue automatic flight by depressing the AUTOPILOT OFF button, make sure that automatic control is disabled and change over to manual control.

Notes: 1. If the aircraft flies at an altitude higher than the cruising return altitude (9500 m) and at a distance of more than 250 km from the airfield, the pilot should disable automatic control by depressing the AUTOPILOT OFF button located on the control stick and depress the RETURN light-button.

Further, the pilot should control the descent manually by referring to the lateral channel command bar so as to attain an altitude of 9500 m at a distance of 120 to 150 km from the airfield.

On attaining the cruising altitude of 9500 m, the pilot should accelerate the aircraft to the assigned airspeed and enable automatic control having previously set the command bars of the flight director indicator within the circle.

2. To return at an altitude of lower than 9500 m the pilot should proceed as follows:

- disable automatic control by depressing the AUTOPILOT OFF button;
- depress the AFLD (landing airfield) and RETURN light-buttons;
- fly level keeping the flight director indicator command bar and lateral channel position bar within the circles. The flight director indicator longitudinal channel position bar and command bar are above the respective circles and move towards the centre as the aircraft approaches the assigned descent path;
- as the command bar and longitudinal channel position bar approach the centres of the respective circles, enable automatic control and further on check the aircraft descent along the assigned path. Bring the aircraft to the runway heading in the vertical plane with the aid of the POLJOT-1M system as illustrated in Fig. 55.

3. If an en-route flight has been performed beyond the radio up-dating zone, return to the programmed airfield proceeding as follows:

- disable automatic control by depressing the AUTOPILOT OFF button;
- depress the AFLD (landing airfield) and RETURN light-buttons located on the PCEH-6C system control panel;
- depress the SHORAN light-button on the AFCS control panel;
- place the command bars within the circle on the flight director indicator, controlling the aircraft manually;
- depress the AUTO CTL light-button on the AFCS control panel and relieve the control stick of forces.

#### Position Control Mode

The pilot should proceed as follows:

- (1) perform a circling flight at an altitude of 600 m;
- (2) extend the landing gear when abeam of the outer marker beacon;



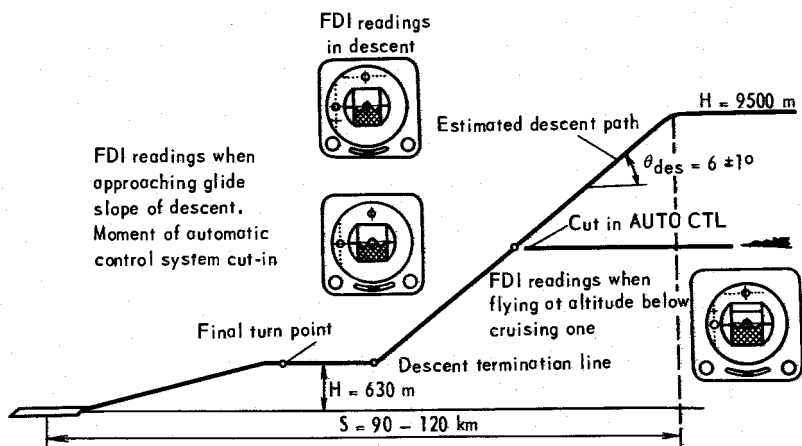

FIG. 55. BRINGING AIRCRAFT TO LANDING HEADING IN VERTICAL PLANE WITH USE OF "POLJOT-III" SYSTEM

- (3) set up an airspeed of 500 km/h;
- (4) fly to the base-leg turn at the altitude of 600 m;
- (5) at a distance of 19 to 21 km enter a turn at a roll of  $30^\circ$ ;
- (6) decrease the airspeed to 450 km/h;
- (7) while turning, transfer attention as follows:
  - flight director indicator (roll, pitch, slipping);
  - vertical-speed indicator;
  - combined course indicator (present heading, relative bearing);
  - airspeed (450 km/h);
  - altitude (600 m);
  - flight director indicator;
- (8) on approaching the runway heading, turn on the LANDING switch on the PCEH-6C system control panel;
- (9) maintain the airspeed of 450 km/h and altitude of 600 m;
- (10) check the enabling of the LANDING mode;
- (11) perform the turn so as to have the vertical bar of the combined course indicator aligned with the tail of the RB pointer before the bar enters the central circle;

(12) as the vertical bar of the combined course indicator enters the circle, smoothly reduce the deviation from the runway heading to select a heading on which the vertical bar is kept within the circle;

(13) extend the flaps at a distance of 15 to 16 km and decrease the airspeed to 430 km/h;

(14) transfer attention as follows:

- flight director indicator (roll, pitch, slipping);
- vertical-speed indicator;
- combined course indicator (position bar, RB, present heading);
- airspeed (430 km/h);
- altitude;
- flight director indicator;
- engine speed;
- flight director indicator;

(15) control the aircraft by referring to the flight director indicator, position bars of the combined course indicator, readings of the combined course indicator course selector, automatic direction finder and direct-reading distance indicator;

(16) at a distance of 12 km start descending at a vertical speed of 5 to 7 m/s, keeping the bars of the combined course indicator in the centre of the circle;

(17) if the combined course indicator bars deflect from the centre of the circle, first correct the deviation from the localizer beam and then from the glide-slope beam.

### 3.5. Peculiarities of Performing Flight to Non-Programmed Airfield with Use of POLJOT-1M System

During the performance of an en-route flight there may arise a necessity in landing the aircraft on a non-programmed airfield.

When clear of the zone of coverage of the non-programmed airfield short-range radio navigation and landing system beacon, the aircraft should be flown first on the estimated course. Upon entry into the zone of coverage of this beacon

the aircraft must be piloted in the direction of the short-range radio navigation and landing system beacon.

Upon receiving a command or making an independent decision on landing the aircraft on a non-programmed airfield, the pilot must act as follows:

- when at a long distance from the landing airfield, that is when clear of the zone of coverage of the short-range radio navigation and landing system beacon, approximately determine the aircraft fix on the desired course proceeding from the distance to the next route turning point;

- visually determine the great-circle course to the landing airfield with reference to the map;

- use the radio set to request the team at the control (direction) post for the present distance and inbound course data and report the amount of fuel remaining in the tanks;

- disable automatic control by means of the AUTOPILOT OFF button;

- depress the MODE CANCEL (СЕР. ПЕК.) button and check to see the SHORAN light-button located on the AFCS control panel has faded out;

- perform a turn to intercept the desired course and climb to an altitude corresponding to the maximum flight range;

- set the P/SET COURSE AUTO - MAN switch to the MAN position; set the combined course indicator to the estimated inbound course by means of the course selector knob; perform corrective turns to align the preset course pointer with the fixed triangular index and fly the aircraft to the airfield;

- depress the RESET and RETURN light-buttons on the PCBH-6C system control panel; engage the operating channels of the short-range radio navigation and landing system beacon and radio beacon group with the aid of the NAVIGATION and LANDING channel selector switches;

- establish radio contact with landing airfield control post and report the new control team readiness to assume control to the previous control (direction) post;

- to start the airfield beacon up-dating, set the SHORAN-ADF selector switch to the SHORAN position and check the combined course indicator for proper relative bearing indications and the ПИИ-2 distance indicator, for correct reading of the distance to the radio beacon;

- set the RADIO - COMPASS (РАДИО - КОМПАС) selector switch to the COMPASS (КОМПАС) position and listen to the

call signs of the landing airfield short-range radio navigation and landing system beacon; ascertain that they are correct, return the above selector switch to the RADIO (РАДМО) position and perform an inbound flight;

- depress the SHORAN light-button on the AFCS control panel;

- proceed on an inbound course, keeping the lateral channel command bar in the centre of the circle and checking the flight direction with reference to the relative bearing pointer;

- at a distance of 120 to 100 km from the airfield start manual descent so as to be able to pass the radio beacon at a flight pattern altitude; take into account the landing airfield pressure;

- after flying past the radio beacon effect landing approach in accordance with the flight pattern adopted at a given airfield.

Under VFR weather conditions the inbound course should be intercepted at a circling flight altitude.

To land the aircraft on a non-programmed airfield, follow the procedures given below:

(1) set the combined course indicator to the great-circle landing course with due regard to the conventional magnetic declination of the takeoff airfield;

(2) when on a final leg or at a distance of 20 km from the airfield, with the view of performing a straight-in approach, turn on the LANDING switch on the PCEH-6C system control panel;

(3) check the combined course indicator localizer flag for dropping out and depress the LANDING light-button on the AFCS control panel;

(4) check to see the SHORAN light-button flashes up and the roll and pitch flags drop out on the flight director indicator;

(5) set the command bars of the flight director indicator within the circle and depress the AUTO CTL light-button;

(6) check to see how the aircraft performs automatic landing approach to a height of 50 m. On descending to this height, disable automatic control and manually carry out the landing operations.

It should be borne in mind, that non-programmed airfield approach should be effected on the great-circle course deli-

vered by the directional/vertical gyro system. The true heading data are computed by the PCEH-6C system only in the mode of return to the programmed airfield.

### 3.6. Using POLJOT-1M System during Flight to Air Alert and Independent Search Zones

During flight to the air alert zone or to the training flying area the POLJOT-1M integrated system is commonly used only for guiding the aircraft to above areas, returning it home, and performing landing approach (Fig. 56).

To get into the zone, determine the great-circle coordinates of a definite point (maneuver initial point) and insert these data into the program unit of the PCEH-6C system carrying a definite RTP number. Prior to takeoff depress the AFLD 1 light-button and that pertaining to the respective RTP on the PCEH-6C system control panel. After takeoff proceed on the course to intercept the assigned maneuver initial point in the same manner as in case of intercepting the assigned route point.

Keep a constant check on the aircraft fix in the assigned area by using the estimated headings (bearings), flight time, and distance to the programmed point during the performance of the mission in the zone.

The mission in the zone accomplished, the pilot can intercept the inbound course and perform landing approach in the automatic control mode from any point. To this end, he should depress the AFLD 1 and RETURN light-buttons on the PCEH-6C system control panel.

In case the aircraft is expected to be landed on any programmed airfield and not on the takeoff one, the pilot should depress the light-button which is pertinent to the respective airfield.

The pilot can bring the aircraft to the aerial target independent search area, perform a maneuver in the assigned area, and fly to the landing airfield in the automatic control mode with the use of the POLJOT-1M system at all stages of flight (Fig. 57). To accomplish the above procedures, determine the great-circle coordinates of the route turning points and insert these data into the program unit of the PCEH-6C system.

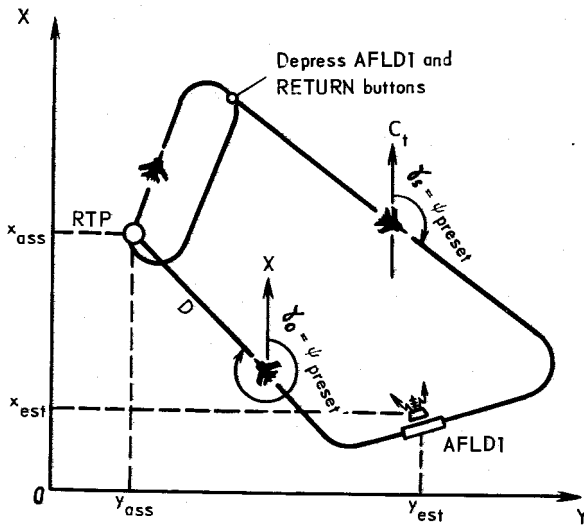

FIG. 56. EMPLOYMENT OF "POLJOT-III" SYSTEM WHEN FLYING TO AIR ALERT ZONE (TRAINING FLYING AREA)

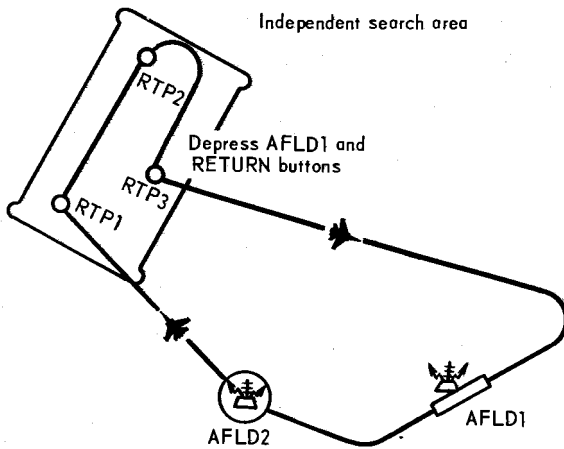

FIG. 57. PERFORMING MANEUVER IN INDEPENDENT SEARCH AREA WITH USE OF "POLJOT-III" SYSTEM

### 3.7. Employment of Automatic Direction Finder for Air Navigation Purposes

The MmP-25NM aircraft is provided with the APK-19 automatic direction finder (the MmP-25NMC employing the APK-10 automatic direction finder) which is intended for solving the problems of air navigation with the use of homing and broadcasting radio stations as well as for performing aircraft landing with the use of the two-beacon landing system in the event of failure of the ground or airborne short-range radio navigation and landing system.

The APK-19 automatic direction finder makes it possible to solve the following problems:

- perform the inbound and outbound flights, with the combined course indicator presenting visual indication of the relative bearing of a certain radio station;
- determine the relative bearing of the radio station;
- perform landing planning and approach with the use of the two-beacon landing system;
- receive and reproduce the signals transmitted by the homing and broadcasting radio stations.

Besides, the automatic direction finder may be used as a standby receiver.

To ensure reception of the marker beacon call signs the pilot should turn on the ADF (PK) switch on the control panel of radio set P-862 and set the COMPASS - ANTENNA (KOMI. - AHT.) selector switch on the control panel of automatic direction finder APK-19 to the ANTENNA (AHT.) position.

To ensure reception of the flight control officer's commands by means of the APK-19 automatic direction finder, the pilot should proceed as follows:

- turn on the ADF switch on the control panel of the P-862 radio set;
- set the COMPASS - ANTENNA selector switch on the control panel of the APK-19 automatic direction finder to the ANTENNA position and the RB, SHORAN - ADF selector switch to the ADF position.

Flying the aircraft on the inbound course with the use of the APK-19 automatic direction finder may be accomplished by the passive, heading stabilization or active methods.

In the passive method of flight on the inbound course the pointer of the direction finder should be kept at zero.

Under wind conditions the aircraft heading will vary. As a consequence of this, the aircraft will move along a curve which is also known as a radio course line. An increase of the aircraft heading is indicative of left-hand drift while a decrease of the heading is an evidence of right-hand one.

The heading stabilization method is used when the aircraft is to take the inbound course under the conditions when the automatic direction finder fails to present steady readings and the distance from the airfield is great (up to 200 km).

To intercept the inbound course with the use of the heading stabilization method, set the ADF pointer of the combined course indicator to zero, note the aircraft heading, and maintain it for a certain period of time. In the event of steady pointer deflection off the zero mark, perform a corrective turn to reset it to zero and maintain a new heading, etc. The direction of drift should be determined by a change in the heading, the same principle being involved in the passive method of flight on the inbound course. Namely, an increase in the aircraft heading indicates left-hand drift while a decrease is indicative of right-hand one.

The active method of flight on the inbound course is commonly used in en-route long-distance flights.

With this method being used, it is necessary that the pilot should maintain the heading and such a relative bearing of the radio station at which the desired inbound course interception is ensured. Upon interception of the desired course, perform a corrective turn to take the course with due account of the drift angle. As a result, the movable heading dial will present the heading with the drift angle taken into account and the ADF pointer will deflect from the zero mark by the amount of the drift in the direction opposite to that of the drift. Keeping the combined course indicator pointers in the above positions ensures flight on the desired course, with the aircraft axis turned through the amount of the drift with respect to the course line.

Flight on the outbound course in the assigned direction should be performed with the estimated course. The position of the aircraft relative to the desired course line should be checked with reference to the automatic direction finder.



When proceeding on the desired course, the ADF pointer will indicate RB =  $180^{\circ}$  only at zero drift. In flight the aircraft is subject to drift practically at all times. The existence of drift can be determined either by the left-hand or right-hand deflection of the ADF pointer relative to the  $180^{\circ}$  mark. To intercept the desired course, perform a corrective turn with reference to the movable heading dial in the direction of the ADF pointer deflection. The amount of the turn should be equal to the double drift angle.

Upon completion of the corrective turn, the pilot will find the ADF pointer deflected by the triple drift angle from the position corresponding to  $180^{\circ}$ . Further it is necessary that the heading should be maintained constant until the pilot intercepts the desired course. At the moment of the desired course interception the ADF pointer will deflect through the double drift angle from the position corresponding to  $180^{\circ}$ . Further on, perform a corrective turn so that the course correction should be equal to one drift angle.

#### 4. PECULIARITIES INVOLVED IN AIR NAVIGATION UNDER VARIOUS CONDITIONS

##### 4.1. Peculiarities Involved in Air Navigation at Low Altitudes

The low-altitude flights are characterized by the following peculiarities:

- (1) decreased effective range of the radio navigation and communication aids;
- (2) hampered visual orientation owing to high velocity of landmark displacement and short time available for landmark identification;
- (3) considerable increase of fuel consumption;
- (4) limited possibilities in using the aircraft maneuvering capabilities;
- (5) increased emotional and psychological stress which results in rapid fatigue of the pilot;
- (6) as a rule, there is no possibility of using the automatic control system in flight.

Difficulties in air navigation at low altitudes arise primarily due to a decrease in the effective range of the radio navigation and communication aids. When in flight at an altitude of 200 m, for example, the effective range of the PCEH-6C

short-range radio navigation and landing system does not exceed 20 km, and that of the radio communication, 50 km. Such a limitation generates a need for dead-reckoning versus airspeed and time in combination with a thorough visual orientation. The visual orientation is, in turn, considerably hampered.

Within the field of vision of the pilot there is a limited number of landmarks, the rate of displacement of which is so great that the pilot is provided with only a few seconds for identification of these landmarks. When flying the aircraft at a speed of 720 km/h, for example, the available visual orientation time at an altitude of 400 m accounts for 10 s, whereas at an altitude of 200 m this time amounts to 5 s. From the tactical considerations, it is practical that a low-altitude flight be performed at high indicated airspeeds. As a consequence, the possibilities of visual orientation are limited even more.

It is common knowledge that fuel consumption increases considerably with decrease of the flight altitude. The minimum fuel consumption per kilometer in near-ground flight is approximately twice as great as that at an altitude of 8000 m. Such an intensive consumption rate considerably reduces the operational radius of the fighter and flight endurance. It is, therefore, necessary that the pilot varies the flight profile, whenever possible, in order to successfully accomplish a combat mission assigned.

The maneuvering capabilities of the aircraft are improved with decreasing the altitude. However, the proximity of the ground (water) surface forces the pilot to limit the amount of vigorous turns, give constant attention to the flying altitude and coordinated manipulation of the controls in order to ensure flight safety. Such a condition prevents the pilot from making the best of the aircraft maneuvering capabilities at low and especially extreme low altitudes. The flying experience shows that even highly proficient pilots are capable of performing maneuvers at a bank of not more than 45 to 50° when flying the aircraft at low altitudes in day-time under VFR weather conditions. In so doing, the flight altitude maintaining accuracy accounts for ±50 to 70 m.

Proceeding from the above-mentioned peculiarities, the low-altitude flight routes should be plotted for the training purposes along the typical landmarks, if possible, or along the reference lines, with the route having a minimum number of legs.

As a rule, the departure airfield (outer beacon) or a landmark which can be easily reached after takeoff is chosen as the initial route point.

With a typical reference line available, the aircraft should be routed in such a manner as to be flown in parallel with the linear landmark at a distance at which this landmark can be clearly visible. For a flight altitude of 200 to 300 m such a distance accounts for 1 to 3 km.

Flight route shall be selected with due regard to the radio aids available in the flight area. The flight route should be plotted so as to ensure the effective range of these radio aids.

Prior to flight, it is necessary that the pilots thoroughly familiarize themselves with the configuration of the ground landmarks, terrain elevations of more than 50 m high, as well as the obstacles available within the flight strip of  $\pm 25$  km in width. It is necessary that the hills existing within the above-mentioned strip be marked on the map and the flight path be divided in legs depending on the terrain irregularity. It is also necessary that a barometric flight altitude be determined for each leg so that the absolute altitude corresponds to the pre-established one. Safe altitude must also be calculated by means of the barometric altimeter.

It is expedient to use the map of 1:500,000 in scale to plot the flight route for low-altitude flight.

The most practical method for intercepting the desired course in the low-altitude flight should be considered a visual method of intercepting the course determined on the basis of the pilot-balloon wind data.

If the flight route begins in the area, where the PCEH short-range radio navigation and landing system beacon or homing beacon is located, the interception of the desired course should be effected with the use of the preset azimuth or radio bearing.

The distance covered by the aircraft is checked with reference to the reference line attained, target range (flying time), or reference landmark. The reference line attained must be determined by visual dead-reckoning with respect to the reference line, which is at right angles to the course line, or when abeam the side landmark as well as by the bearing perpendicular to the track line.

Directional control is effected by maintaining the flight course and by determining the distance-off-track visually or by means of the radio aids.

Even insignificant departure from the selected course presents certain difficulties in reference landmark detection and identification which may lead to considerable errors in determining the aircraft location and loss of orientation which may occur in extraordinary conditions. For example, proceeding on the course with an error of  $5^{\circ}$  for 5 min at an altitude of 100 m and flying speed of 900 km/h may result in cross track error of 6.6 km, thus precluding the identification of the route turning point or a non-linear landmark.

The flight course is maintained primarily through accurate interception of the desired course line after crossing the initial route point and subsequent constant detailed visual orientation. In low-altitude flight the wind factor is usually taken into account by introducing corrections into the course on the basis of the actual amounts of off-track distance upon completion of their visual determination.

Thus, the successful solution of the low-level air navigation problems can be obtained through a comprehensive employment of the radio aids and training the pilot personnel for methods of constant detailed visual orientation.

### 3.2. Peculiarities Involved in Air Navigation at Supersonic Speeds in Stratosphere

The stratosphere flight can be effected on the MiГ-25III aircraft with the engines running at augmented power settings only. Running the engines at augmented power settings results in the increased fuel consumption rate and, as a consequence, decrease of flight range and endurance. Deterioration of the aircraft maneuvering capabilities, particularly in near-ceiling flight, causes a considerable increase in time required for turning and establishment of the preset flight conditions.

The stratosphere flight presents the most favourable conditions for the complete solution of the air navigation problems by means of the radio aids, as their effective range is maximum practically at these altitudes. The visual orientation in stratosphere, however, is considerably hampered by a haze which is particularly thick at dawn, late hours, and at night. As a result, conditions of navigation measurements are hampered and air navigation accuracy is decreased. Apart from this, the pilot performs the supersonic stratosphere flight in a high-

-altitude outfit which considerably limits the visual orientation. Consequently, adequate air navigation in stratosphere can be ensured only by proper use of the capabilities of the airborne electronic navigation aids.

Considering the above-mentioned peculiarities, the stratosphere supersonic flight route should have the minimum number of legs and should be plotted so as to ensure flight safety during crossing of airways and corridors. When preparing for flight, one should calculate and plot on the map the preselected climb and descent lines, as well as the lines at which the engine afterburners must be cut in and turned off. The coordinates for each of these lines are computed by the PCBH-4H rho-theta radio beacon.

The engineering and navigational calculations must be effected before each flight. Fuel consumption and remaining fuel data for each stage of flight should be marked on the flight map.

The instances of interception of the turning points or the pre-established lines are commonly determined with the use of the electronic navigation aids. The afterburners should be cut in and off and the engine power settings changed in accordance with the data calculated on the ground.

The en-route stratosphere flight in a general case consists of the following stages:

- (a) takeoff and climb to the preset altitude;
- (b) maximum-range level flight;
- (c) acceleration to the assigned Mach number during straight or turning climb at a constant indicated airspeed;
- (d) straight or turning climb at a constant Mach number;
- (e) return to the home airfield at a preset altitude with subsequent descent for landing.

In each separate case some of the above-mentioned flight stages may be omitted.

Interception of the terminal route point and the landing approach course is usually effected at a subsonic speed in the direction of the homing beacon, the PCBH-4H rho-theta radio beacon or the landing approach estimated point.

#### 4.3. Peculiarities of Air Navigation at Night

In night en-route flight, the greatest part of the flying time is taken by instrument flying which limits the possibilities of visual orientation.

Particular attention should be given to selection of the turning and check points. It is practical that the homing beacon, light beacon, radio direction finder, or, when they are not available, some other artificially lit or clearly visible landmark be selected as initial and terminal route points.

To successfully complete the night en-route flight, the pilot must commit to memory the flight navigation plan, en-route data, data on the location and operation of the electronic navigation aids, actual outlines of light landmarks and their characteristic features, as well as the peculiarities of the light equipment installed at the home and alternate airfields.

Before night en-route flight the weather data should be thoroughly studied since it is extremely difficult to estimate these data in flight.

During weather study the particular attention must be given to the type of clouds, height of cloud base, and thickness of clouds. Weather conditions should be evaluated from the point of view of the necessity in preventing the aircraft from entering the conditions which endanger flight safety (thunderstorm charged clouds, icing hazard, etc.).

The initial route point may be intercepted by the heading-and-time-hold method, flying the aircraft in the direction of the homing beacon (radio beacon) or radio direction finder, as well as by visual orientation provided that a light beacon or a landmark, well visible at night, is taken as the initial route point.

The en-route flight may be effected either in the automatic or director, or manual control mode in accordance with the pre-established turning point program and involves mandatory visual orientation procedures (if landmarks are visible) for checking the aircraft track.

The terminal route point and landing airfield interception must be effected with the use of the electronic navigation aids.

The primary condition for the successful accomplishment of the night air navigation procedures is the ability of the pilot to maintain the estimated flight regime throughout the en-route flight stages as regards the heading, flying speed and altitude, banking in turns as well as to skilfully combine the visual orientation and operation of the electronic navigation aids for the track checking and correction purposes.

#### 4.4. Peculiarities of Air Navigation when Flying for Air Combat

When performing the flight for an air combat pilots take off with no plotted and estimated route data at hand, since for in most cases flight missions are assigned when the aircraft is aloft, the flight regime is determined by the combat control officer at the control post and altered very frequently. Such a peculiarity demands high proficiency in air navigation from the flying personnel and control post combat control officers, necessitates the use of the simplest and sufficiently reliable methods of air navigation which make it possible to appropriately use both the airborne and ground electronic navigation aids. In the air combat flight the pilots are sometimes deprived of the possibility for position finding. Upon completing the air combat, however, the pilots must rapidly find the position and intercept the landing airfield. This is dictated by a limited amount of the remaining fuel. Under such conditions a thorough ground preparation is a guarantee that the pilots will be able to find the position.

When preparing for an air combat, it is necessary to thoroughly study the combat area, the data obtained by the aid of the radio-and-light navigational means and the procedures for their in-flight use, as well as to practise the cooperation with the team of the control (direction) post.

The airfield and combat areas should be studied by the pilots so that they are capable of unmistakably identifying the characteristic landmarks by memory, without consulting the map, from various altitudes and in approaching them from various directions.

When studying the combat area, the pilot should use large-scale maps and mockups.

Knowing the layout of the main radio-and-light navigational aids facilitates orientation when the ground landmarks are out of visibility. In the combat area the pilot must study and well know the location and distance to the front line (frontier), nature of the terrain, location of magnetic anomalies, arrangement of the airfield network, the operational data and layout of the radio-and-light navigational aids and broadcasting stations, as well as the procedure of position finding in the given area.

The pilot personnel must irreproachably know the airfield network, since the air-combat flights may be effected at maximum ranges and involve transfer of control to the control posts of the cooperating units and landing at the nearest airfield.

Satisfactory results in individual training for properly using the electronic navigation aids, ability of their correct selection for air navigation and skill in making necessary navigational calculations from memory to a sufficient degree of accuracy and during the minimum time can be obtained through systematic navigation drills during preliminary preparation.

The pilot must plot the axial routes with calm weather data and the track on the flight map. Tracks should be laid with respect to the characteristic landmarks located in the combat area. Presence of the prepared flight routes facilitates the return to the home airfield.

Preparation of the pilot personnel for flights is commonly performed together with the combat control officers. Joint preliminary preparation for flights, flight critique or drills, during which the pilot personnel get familiar with the basic direction rules and the combat control officer working conditions, promotes mutual understanding between the pilot and the combat control officer, facilitates revealing of the actual causes of errors committed when conducting the air combat and makes it possible to generalize the experience gained by the pilots and the combat control officers.

Using the flight map in the guidance stage of flight without employment of the automatic flight control system is extremely limited, and when flying in the clouds it is excluded at all, since the entire pilot's attention is concentrated on maintaining the prescribed flight regime, keeping of the spatial attitude in operating the controls, armament system, as well as on the radio communication and solution of the tactical problems pertaining to destruction of aerial targets.

Under the ECM conditions, the position of the fighters can be determined by the aid of the radio direction finders, short-range radio navigation system, as well as the navigational triangle method.

The combat control officer observes the process of closure between the fighter and the target, warns the pilot about the changes in the air situation and gives an assistance to the pilot in returning to the landing airfield.



The landing airfield interception is effected mostly upon the commands of the combat control officer. The air-combat flight conditions are so complicated and diverse, however, that the pilot may be forced to independently solve this problem. Therefore, on the ground the pilot has to study not only the problems of independent target search and destruction but the procedure of flying the aircraft to any of the airfields available in the battle area upon accomplishment of the combat mission assigned.

Only thorough preparation for each flight, profound knowledge of the general air navigation rules and proper employment of the air navigation means reliably ensure maintaining the orientation and successful accomplishment of the flight mission as a whole.

#### 5. RECOMMENDATIONS TO COMMANDER (INSTRUCTOR) ON TRAINING PILOTS IN AIR NAVIGATION

The air navigation accuracy largely depends on the pilot's training level in flying technique, that is the skill in maintaining the estimated course, flying speed, altitude, and banks during turns, as well as on his readiness to use the airborne flight and navigation equipment in the full scope. En-route flights, therefore, must be preceded by mastering the flying technique in the definite conditions.

The mastering and improvement of skill in air navigation are effected both on the ground in the cabin or by the use of the flight simulator and other training equipment and in the air on the combat trainers and combat aircraft.

In the course of ground training pilots must acquire skill in air navigation which is indispensable in flight.

In flight the pilot is deprived of the opportunity to do graphical work on the map and to use navigational aids. He must be able to determine angles and distances by sight and make necessary dead-reckoning and mental flight data calculations. The accomplishment of this objective may be obtained by systematic cabin drills, using the training equipment and studies in the navigational training classrooms.

The fact that the МиГ-25ПД aircraft is equipped with modern flight-and-navigation and radio-and-electronic equipment to a greater extent enhances the importance of the cabin drills and those with the use of the training equipment. During cabin drills pilots must acquire a profound skill in

using the POLJOT-1M integrated system in various stages of flight. This, however, does not exclude the necessity in acquiring good skill in prompt and accurate determination of heading corrections by reference to the APK-19 automatic direction finder during flight off the beacon in the prescribed direction and active flight towards the beacon, as well as the skill in checking the correctness of the picked up heading by the aid of the combined course indicator, automatic direction finder, and the radio direction finder.

It is recommended that the general cabin drills involving the entire flying personnel should be combined with the individual drills with separate pilots in accordance with the individual plans for the purpose of acquiring skill in using the separate air navigation means, navigational visual estimation and doing mental arithmetic.

The initial stage of the air navigation training on the given type of aircraft should be commenced from medium-altitude en-route flights.

When practising the air navigation at medium altitudes, the pilot must completely master the POLJOT-1M system to be able to perform en-route flights with the use of the programmed turning points (alternate airfields), flight to the home airfield, and landing approach in the automatic and director control modes.

It is not wise to impose a great amount of work on a trainee when performing first en-route flights. A flight mission must be simple and involve those air navigation means in using of which the pilot keeps the best hand. As the pilot gains experience, i.e. as his skill improves, there arises a necessity in teaching the trainee how to comprehensively use all the navigational means installed on the aircraft, all the methods of intercepting the initial route point and course line, as well as the methods of track monitoring and correction.

When preparing for the maximum endurance flight involving landing on other than home airfields, the flying personnel must be given a training course in accordance with the specially selected subject program.

To be discussed in the first hand are such matters as the influence of flight altitude, speed, and external stores on the fuel consumption per kilometre and hour, peculiarities involved in air navigation when flying the aircraft at supersonic speeds,

the methods of programming flight, the capabilities of both the ground and airborne short-range radio navigation and landing systems, and the procedure of using the radio and electronic aids in en-route flight.

In the course of training for low-altitude en-route flights the particular attention should be given to the accurate maintaining of the altitude and course, performance of visual orientation, and introduction of corrections into the course to accurately intercept the route turning point.

Low-altitude flights are always associated with an increase in the emotional and psychological stress sustained by the pilot. Such a load may result in an excessive stress and fatigue. The lower the flight altitude and the more scarce the experience in flying the aircraft under such conditions, the heavier the stress.

Air navigation training should be commenced from flying a combat trainer at an altitude of 500 to 300 m above the terrain. A subsequent descent must be effected with due regard to the individual properties of the pilot.

Only those who are highly proficient in piloting the aircraft at low altitudes and medium-altitude air navigation can be permitted to perform independent low-altitude en-route flights.

Upon completion of the training course on the combat trainer, the instructor should allow a trainee to perform first en-route flights on the combat aircraft at an altitude of at least 500 m. The flight route should be plotted so as to enable the personnel on the ground to continuously follow the aircraft aloft by means of the electronic navigation aids available at an airfield of departure. In further flights, gradually decrease the altitudes and increase the flying speeds.

When performing the flights beyond the effective range of the ground electronic navigation aids installed at the airfield of departure, periodically increase the flying altitude to 1000 - 1500 m for 30 - 40 s to enter the zone of coverage of the above means and ensure flight control from the ground.

## *Chapter 5*

### **DAYLIGHT FLYING UNDER IFR CONDITIONS**

#### 1. PECULIARITIES INVOLVED IN INSTRUMENT FLIGHTS

Training flying personnel for performing flights under IFR weather conditions is one of the basic components of the combat training of the fighter pilots. The commanders of all ranks must treat this problem in a constructive manner and with due regard to the attained level of pilot proficiency and individual properties of each pilot.

Profound theoretical background and proper methods of training personnel for performing flights in clouds with subsequent landing approach at the predetermined weather minimum is a guarantee of future success in solving the problems of the combat employment of a fighter under IFR weather conditions.

The major peculiarity involved in instrument flights is that over the entire or greater part of the flight time period the pilot flies the aircraft beyond the field of vision of landmarks and natural horizon, determining the spatial position of the aircraft by reference to the flight and navigation instruments, and the location according to the data obtained by means of the ground and airborne electronic navigation aids.

The difficulties involved in an instrument flight consists in that the pilot has to continuously consult the instruments, take the readings, analyze the data obtained, and bring the aircraft with the use of the controls into such a position which appropriately corresponds to the preselected flight conditions. Practically during the entire instrument

flight, the pilot has to either maintain the preselected flight conditions or change them by manipulating the controls. The rarer the flight regime is altered and disturbed, the easier it is for the pilot to fly the aircraft on instruments.

The flight regime change-over frequency is determined by the character of flight or mission. Any inadvertent change in the flight regime is associated with the properties of the aircraft (stability, controllability and balance), atmospheric conditions, and quality of piloting.

The quality of flying the aircraft on instruments is determined by such factors as the arrangement of the instruments on the instrument board and the necessity in operating the equipment installed in the aircraft cockpit, all this being of attention-diverting character.

The flight in clouds is one of the most complicated kind of the instrument flight. When flying under the hood, the pilot has no visual perception of ambient medium and concentrates his attention on the piloting procedures, while flying the aircraft in clouds the pilot's attention is partially diverted by the visible parts of the aircraft and the phenomena taking place in the ambient media, for example, the changing density and colour of clouds, rain, snow, etc. The effects produced by the excitators may prove so strong that a definite disturbance of the attention distribution and transfer procedures to which the pilot has accustomed during hooded flights may occur. All this in the long run considerably decreases the quality of aircraft piloting. Under such conditions, the pilot must do his best to concentrate his attention primarily on the flight and navigation instruments in order to be able to maintain the required flight regime.

In a hooded flight, the pilot may remove the curtain and start visual flight at all times. When flying the aircraft in clouds, the pilot is deprived of such an opportunity and thus may find himself in an inconvenient situation if he is not sufficiently skilled in blind flying.

When flying in clouds, there is no any possibility for visual orientation and look-out. It is therefore necessary to make the most use of the airborne and ground radio aids and strictly maintain the prescribed airspeed, altitude, course, and time irrespective of flight nature. It is of primary importance that the pilot be able of timely locating a failure of an instrument

or group of instruments and change over to piloting the aircraft by reference to the duplicating instruments. Apart from this, a flight in clouds is frequently accompanied by bumpiness and icing conditions which require greater caution on the part of the pilot for maintaining the prescribed flight conditions. The existence of bumpiness in breaking to bottom of clouds, in clouds, or below clouds at low altitudes presents considerable difficulties for the pilot in maintaining the prescribed flight conditions and at the same time enhances the requirements for accurate maintaining the assigned flight conditions.

When flying the aircraft in clouds under ice hazard conditions, the pilot is forced to distract his attention, as he has to periodically inspect the canopy glazing and the visible parts of the aircraft. As soon as ice occurs on the aircraft surfaces, the pilot must immediately get clear of the ice zone.

When flying the aircraft under the hood on instruments, and especially in clouds, the pilot is subject to illusions associated with the vestibular apparatus excitation as regards the spatial attitude of the aircraft. A change of flying speed in level flight, for instance, particularly that involving energetic accelerations and decelerations, may give rise to the illusory perception of diving or pitching-up, and in climb, a decrease or increase in the pitch angle. Presence of slipping during instrument flight may give rise to a false sense of roll.

Sensory illusions may be caused by prolonged intervals in instrument flights, incorrect distribution of attention during flight in clouds, mixed piloting involved both in visual and instrument flight, improper transfer from visual to instrument flying, a prolonged distraction of the attention from the artificial horizon, abrupt movements of the control surfaces, strain, etc.

Should sensory illusions occur, do not believe your feelings and cold-mindedly evaluate the situation. Relying on the instrument readings is the most important condition for overcoming illusions. The responsibility of the pilot is to calmly continue flight and concentrate his entire attention on the instrument readings, the artificial horizon being in the first place. The correctness of the readings taken from the artificial horizon should be checked by reference to the DA-200 combined instrument.

If sensory illusions as to the aircraft attitude persist, the pilot should make use of the automatic modes of the CAY automatic flight control system, simplify the flight, whenever possible, to break on top or to bottom of clouds, compare the readings presented by the artificial horizon with those on the electronic horizon on the display screen of the radar sight. Apart from the above remedies, the pilot may take advantage of the already known practical methods of suppressing illusions, namely: vigorous head movements, inclination of body, relaxation of muscles, etc.

The above mentioned peculiarities involved both in flying the aircraft on instruments and in clouds and affecting the quality of piloting of aircraft give rise to a necessity in placing the more stringent requirements on the training methods and the procedures for the admission of flying personnel for flights under such conditions.

Apart from the general pilot proficiency level, one shall take into account the self-command, quick thinking, neatness, reaction to changes in air situation, and physical training level of the pilot undergoing the test for permission to IFR flights. It is also of particular importance that the pilot be convinced in that the pilot shall be ready to give a true-to-fact and timely report on troubles occurred during flight, lack of confidence in self-properties, and illusions which may occur in flight. According to the pilot's report, it is necessary to determine the causes of errors and blunders correctly and outline the further IFR flight training programme.

## 2. PRINCIPLES OF PILOT'S ATTENTION DISTRIBUTION DURING INSTRUMENT FLIGHTS

One of the most important elements of the top-quality flying in clouds is the capability of correct distribution of attention to the flight and navigation instruments and transfer of attention from one instrument to another. In flying the aircraft on instruments, it is beyond the pilot's capability to simultaneously evaluate the readings presented by several instruments at a time. This is explained by the physiological properties of a human organism. Proper evaluation of readings given by this or that instrument is possible when the pilot concentrates the entire attention on a given instrument. To correctly evaluate the readings presented by several instruments, the pilot should

transfer his attention from one instrument to another in a certain consecutive order.

Level flight regime is characterized in maintaining of constant airspeed, altitude, and direction of flight.

To maintain the assigned level flight conditions, in a general case, the pilot must keep at a constant level certain initial values, flying speed, altitude, and direction being derivatives thereof, rather than flight condition determining parameters.

When flying the aircraft at a constant altitude, for example, it is necessary to maintain the aircraft longitudinal axis (pitch angle) in such a position so as to ensure the horizontal direction of the speed vector, to maintain a constant direction of flight, to prevent the aircraft from rotating with respect to its vertical axis, that is to prevent aircraft rolling and slipping. Maintaining of speed at a constant level is ensured by the respective thrust developed by the engines.

In practice, however, it is difficult to maintain the aircraft in level flight with a sufficient degree of accuracy by reference to the artificial horizon only, for its reading accuracy does not satisfy the requirements. The amount of roll and pitch angles may be determined with the maximum accuracy not exceeding  $2 - 3^{\circ}$ .

Maintaining of the aircraft bank at a constant level of  $2^{\circ}$ , when flying at a true airspeed of 900 km/h, causes a change in the aircraft heading by  $5^{\circ}$  only for one minute of flight. The departure of the speed vector by  $2^{\circ}$  from the horizon for the above period of time causes a change by 500 m in the flying altitude. Such an accuracy in maintaining the flight altitude by the aid of the artificial horizon is not apparently sufficient at all. It is therefore recommended to use the rate-of-climb indicator which ensures a vertical speed measurement accuracy of up to 1 m/s for the purpose of maintaining the assigned flying altitude.

Thus, upon establishment of the engine power setting corresponding to the assigned level flight speed, the pilot must concentrate his attention on the artificial horizon and the rate-of-climb indicator.

But maintaining the level flight only with the use of the above method can not guarantee high precision, as the roll and



pitch angle reading errors with time give rise to the accumulation of a certain error in all the three parameters which determine the flight regime. In order to prevent or eliminate a considerable variation of the preset parameters in proper time, the pilot must from time to time check the flight regime by reference to the airspeed indicator, altimeter and direction finder and bring the aircraft to the preset flight regime by premeditatedly varying the roll and pitch angles (vertical speed).

It is clear from the above example that the five instruments used for sustaining level flight fulfil different functions. The first two instruments, namely the artificial horizon and rate-of-climb indicator, serve to maintain the flight conditions, while the other three instruments, that is the airspeed indicator, altimeter and direction finder, are used for monitoring the assigned parameters of the flight conditions. It is also obvious that in order to maintain the prescribed flight conditions to the required degree of accuracy, one should give particular attention to the readings presented by the first two instruments. The latter three instruments should be referred to from time to time.

Thus, instrument flying comprises two parallel processes, namely maintaining flight conditions (piloting proper) and flight conditions monitoring. The process of piloting is of continuous character while the process of monitoring flight parameters is periodic in character. Such a sequence of distributing attention ensures precise maintaining of the assigned flight conditions with the minimum efforts on the part of the pilot.

The rate and sequence of transfer of attention from the flying instruments to the monitoring instruments will depend on the accuracy of flying regime holding. This accuracy depends on the flying skill of the pilot, aircraft trim, weather conditions (bumpiness, icing, clouds) and other factors. The smaller the amount of, the rarer and the shorter in time the deviations of the roll and pitch angles (vertical speed) from the initial values, the less frequently has the pilot to transfer his attention to the monitoring instruments and the greater the amount of time available for accomplishment of other operations in the aircraft cockpit.

The sequence of attention transfer is determined by the tendency in reading deviations of the instruments by the use of which the required flight conditions are maintained.

It is apparent that when performing a definite flight mission the nature of attention distribution and transfer to the instruments is affected by the peculiarities involved in the mission assigned. For example, in level flight at a medium or high altitude the pilot has to consult the altimeter much less frequently than when flying at lower altitudes, for the necessity in a more stringent monitoring of the flight altitude in the latter case arises directly from the requirements for flight safety.

At transitional (unsteady) flying regimes, and also when correcting considerable deviations from the assigned flight conditions, the checking procedure for a short period of time becomes practically compatible, as the piloting procedure. As a consequence, the pilot has to exert considerable energy.

Proceeding from the above statements, it is possible to formulate the basic principles underlying the sequence of the pilot's attention distribution and transfer at any regime and phase of instrument flight.

1. Piloting the aircraft on instruments involve two parallel processes, i.e. the process of flying regime holding (flying proper) and the process of flying regime monitoring.

2. Under steady flying conditions, the process of piloting the aircraft is of continuous character while the regime monitoring is periodic.

3. The rate of attention transfer and the duration of the monitoring instrument reading period are mostly determined by the accuracy of flying and on the tendency of the flight instruments for deviation, as well as the nature of the mission assigned, the phase of the flight, and present weather conditions.

4. At unsteady flying regimes and when correcting the considerable deviations of the aircraft from the assigned mode the process of instrument monitoring assumes continuous character.

Proceeding from the above basic principles, it is possible by way of preliminary analysis to determine the general pattern of the pilot's attention distribution for any flight conditions. The pattern should answer the following questions: which of the instruments should be used for holding and monitoring the flying regime, and which of the monitoring instruments at the particular phase of flight should be given major attention with a view to ensuring greater accuracy of regime holding, executing the flying mission at this regime and providing safety of flight.

The sequence of attention transfer in each definite case should be based on the general pattern, with due consideration of the specific flying conditions:

- (a) probability of use of the automatic flight control modes of the CAJ system;
- (b) spontaneous banking of the aircraft caused by poor trimming;
- (c) condition of atmosphere;
- (d) nature and rate of permissible deviations from the assigned flight regime;
- (e) volume of additional information which may divert pilot's attention (operating the radar sight controls, radio communication, illumination of indicator lamps, etc.);
- (f) psychological readiness of the pilot for flight.

The correctness of the selected attention transfer pattern to be followed during instrument flight in clouds may be judged by the flying regime holding accuracy throughout the entire flight, reserve of time required for accomplishment of the cockpit operations not associated with the aircraft piloting, and the degree of fatigue of the pilot upon completion of flight mission.

### 3. FLIGHTS IN MANEUVERING AREA FOR PRACTISING INSTRUMENT FLYING TECHNIQUE

Flight to maneuvering zone to practise the flying technique in clouds usually includes the following elements: a level flight, climbing, descent, turns, and 360° turns.

Level flight. To perform the level flight, it is necessary to establish the required air speed and accelerate the engine to the respective speed on attaining the assigned altitude and memorize the pitch angle by reference to the miniature aeroplane of the flight director indicator and the flight course.

The sequence of the pilot's attention transfer to the instruments in level flight is shown in Fig. 58. It is recommended to follow the attention distribution pattern given below:

- (1) FDI - IIA-200 combined instrument;
- (2) FDI - indicated airspeed indicator - altimeter;
- (3) FDI - IIA-200 combined instrument - true airspeed indicator;
- (4) FDI - CCI - FDI.

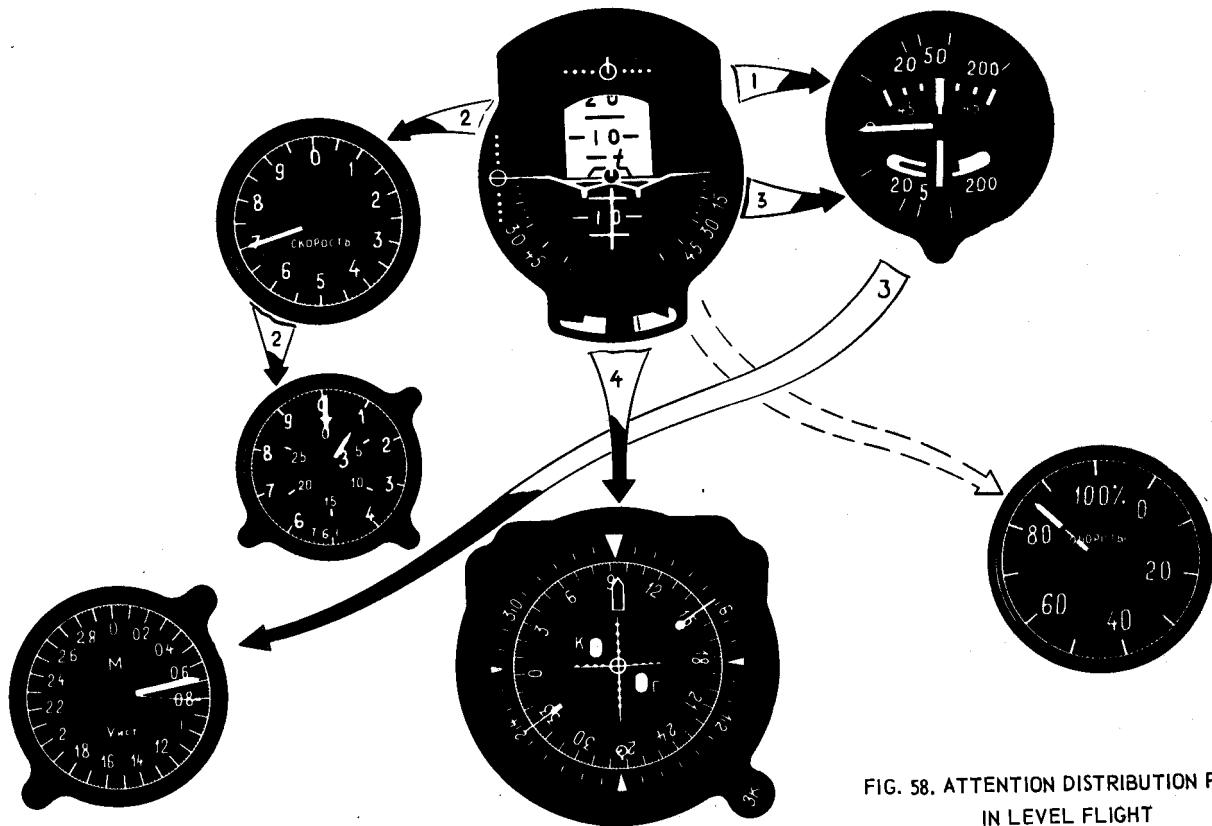

FIG. 58. ATTENTION DISTRIBUTION PATTERN  
IN LEVEL FLIGHT

This pattern may be slightly altered depending on flight conditions. In certain cases it is unnecessary to refer to the indicated and true airspeed indicators at one and the same time. In high-altitude and stratosphere flights, particular attention should be given to the true airspeed and Mach-number indicators, whereas at medium and low altitudes the major attention must be given to the indicated airspeed indicator.

In bumpy air conditions, the rate-of-climb indicator will present unsteady readings, i.e. its pointer will continuously deflect in both directions from zero, although the position of the aircraft longitudinal axis remains unchanged. In this case, particular attention should be given to the artificial horizon and airspeed indicator.

Even during first instrument flights the pilot must practise checking the artificial horizon against the readings of the turn indicator. In the event of disagreement in the readings of the artificial horizon and the sideslip-and-turn indicator during flying the combat trainer under the hood, the pilot should remove the hood and determine the cause of this trouble. When flying in clouds, the pilot should ascertain by reference to the combined course indicator which of the instruments gives erroneous readings and make a decision on further continuation of the flight on the basis of the data obtained.

Level flight practice shall be alternated with practising in performing climb, descent, turns, and other elements of the flying technique.

Climb. Steady climb is characterized at the assigned engine power setting by constant vertical and translational speeds and flight direction.

When flying the ММГ-25ПД aircraft, climbing is to be performed at a true airspeed of 920 km/h, with the engines running at maximum power setting.

When maintaining and monitoring the climb, the pilot should adhere to the following sequence of referring to the instruments (Fig. 59):

- (1) FDI - ДА-200 combined instrument - true airspeed indicator;
- (2) FDI - indicated airspeed indicator - altimeter;
- (3) FDI - CCI - FDI.

Periodically check the operation of the aircraft engines, systems, and equipment.

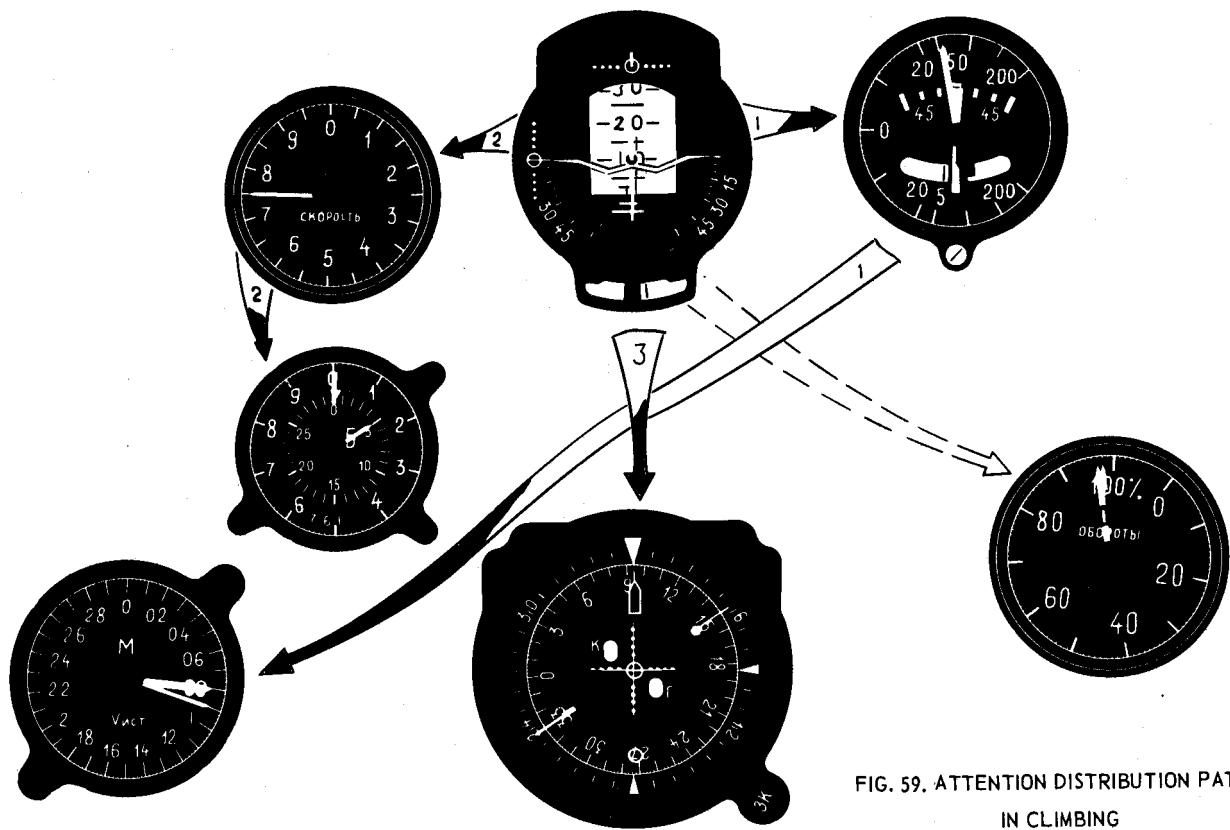

FIG. 59. ATTENTION DISTRIBUTION PATTERN  
IN CLIMBING

In level-flight transition (from 200 - 400 m to the assigned altitude), smoothly reduce the rate of climb to zero and set the flight director indicator miniature aeroplane to a position corresponding to level flight.

Descent. Descent should be effected at an indicated airspeed of 550 to 700 km/h. To perform a descent, bring the aircraft into level flight at an assigned altitude and establish the assigned airspeed. Then, smoothly deflecting the control stick forward, bring the aircraft into a descent and reduce the engine speed.

In descent, the pilot should keep watch of such instruments as the artificial horizon, indicated airspeed indicator, rate-of-climb indicator, engine instruments. As the aircraft approaches the assigned altitude, particular attention should be given to the readings of the artificial horizon and altimeter, with the aircraft maintaining the assigned translational speed and flight direction.

It is recommended to use the following attention distribution pattern in descent (Fig. 60):

- (1) FDI - IIA-200 combined instrument;
- (2) FDI - indicated airspeed indicator - true airspeed indicator;
- (3) FDI - altimeter;
- (4) FDI - IIA-200 combined instrument;
- (5) FDI - CCI - FDI.

Periodically check operation of the aircraft engines, systems, and equipment.

To bring the aircraft to level flight, apply a smooth backstick pressure at 200 - 300 m from the assigned altitude level to decrease the rate of descent and simultaneously accelerate the engines to maintain the translational speed and set the miniature aeroplane of the flight director indicator to a position corresponding to level flight.

Turns and 360° turns in clouds are recommended to be performed at banks up to 60° and indicated airspeed of 600 to 700 km/h.

To perform a turn or 360° turn, select and memorize the direction of entry into a turn (with respect to the heading or the relative bearing of the radio station).

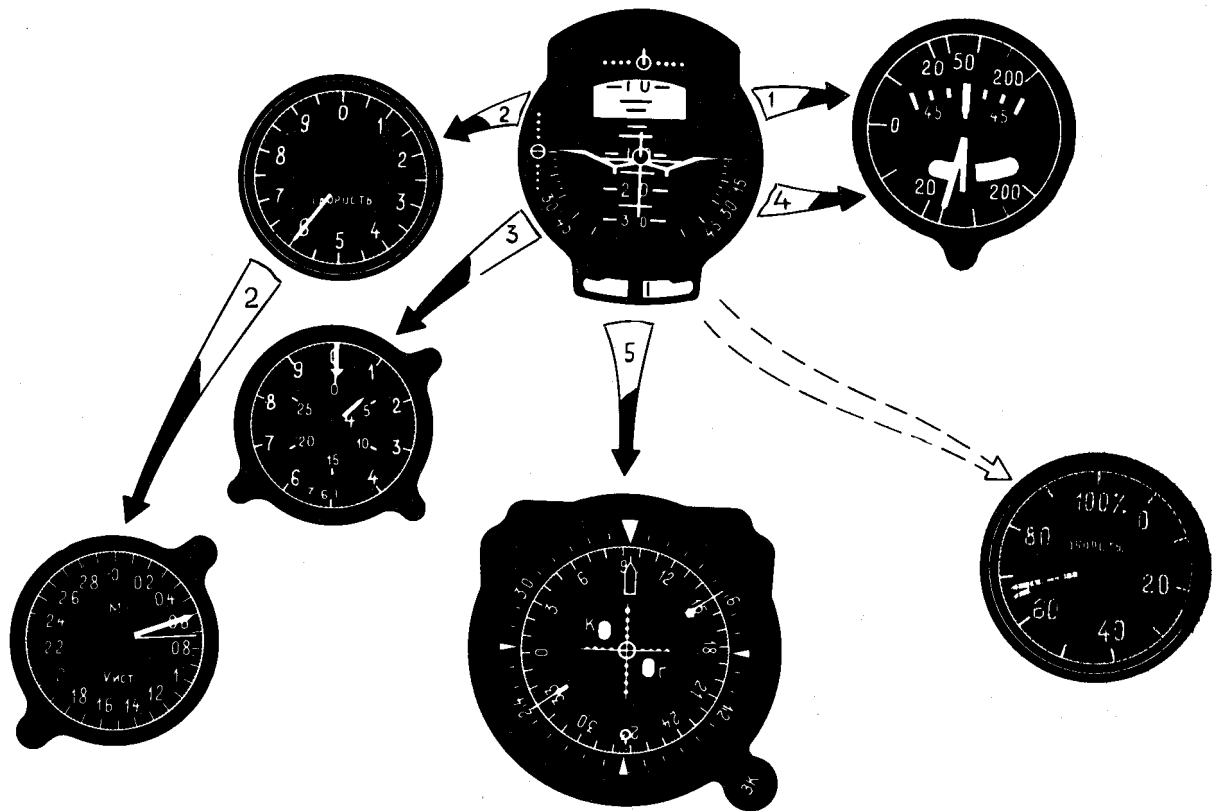

FIG. 60. ATTENTION DISTRIBUTION PATTERN IN DESCENT



The quality of performance of the  $360^\circ$  turn largely depends on the accuracy of the  $360^\circ$  turn entry. If the rate of descent (climb) amounts to 10 - 15 m/s during entry into a  $360^\circ$  turn, never attempt to restore the assigned flight regime. It is necessary to bring the aircraft to level flight and repeat the  $360^\circ$ -turn entry.

In order to maintain the prescribed flying conditions when performing a  $360^\circ$  turn (turn), the pilot should refer primarily to such instruments as the flight director indicator, ИА-200 combined instrument, indicated airspeed indicator, altimeter, and combined course indicator. The degree of importance of each of the above instruments varies with various stages of a  $360^\circ$  turn (turn).

It is recommended to use the following attention distribution pattern during entry into a  $360^\circ$  turn (Fig. 61):

- (1) FDI - ИА-200 combined instrument;
- (2) FDI - airspeed indicator;
- (3) FDI - CCI - ИА-200 combined instrument;
- (4) FDI - airspeed indicator - altimeter.

Fig. 62 illustrates the attention distribution pattern to be followed when performing a  $360^\circ$  turn:

- (1) FDI - ИА-200 combined instrument;
- (2) FDI - airspeed indicator;
- (3) FDI - altimeter;
- (4) FDI - CCI.

The attention distribution pattern to be followed in recovery from a  $360^\circ$  turn is slightly different (Fig. 63):

- (1) FDI - CCI;
- (2) FDI - ИА-200 combined instrument;
- (3) FDI - altimeter;
- (4) FDI - airspeed indicator.

Do not fail to check the operation of the aircraft engines, systems, and equipment from time to time.

If during performance of a  $360^\circ$  turn the flight altitude has changed insignificantly, establish a vertical speed of 3 to 5 m/s against the rate-of-climb indicator and maintain a new pitch angle by reference to the artificial horizon until the assigned altitude is attained. Should any change in the flying speed occur when performing a  $360^\circ$  turn at a constant flying altitude, restore the assigned airspeed by gradually varying the engine speed. Should a rapid change in the flight altitude occur, bring the aircraft to level flight as soon as possible.

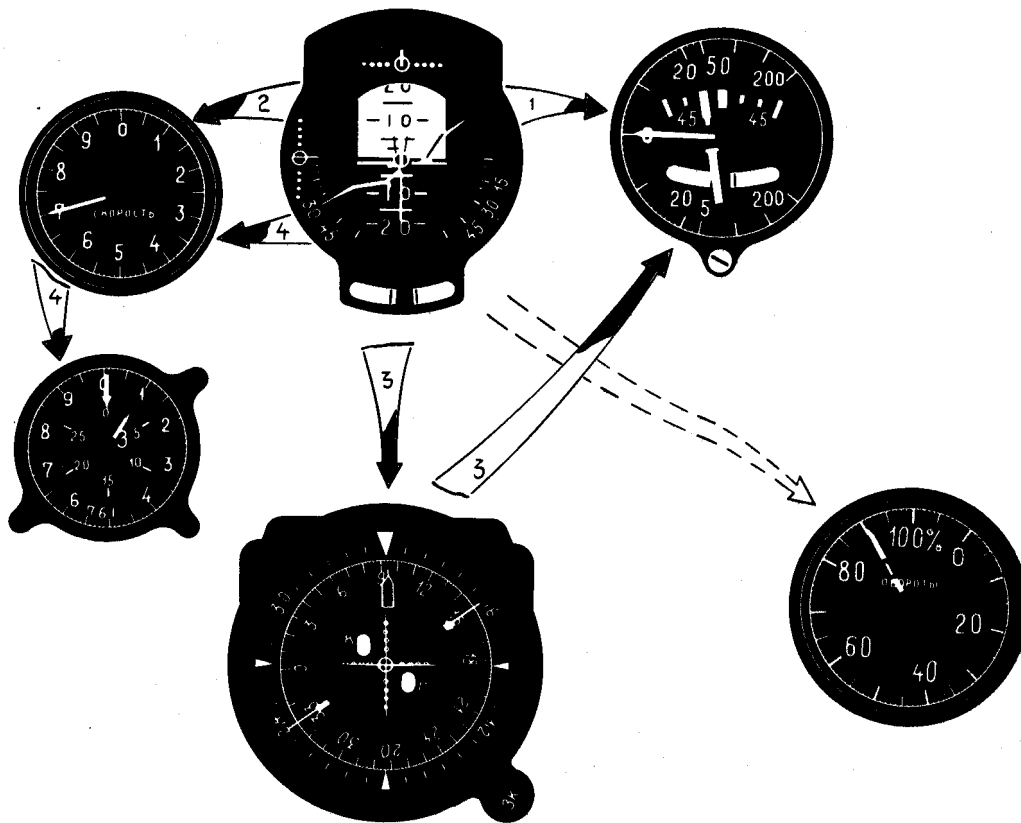

FIG. 61. ATTENTION DISTRIBUTION PATTERN WHEN ENTERING 360° TURN

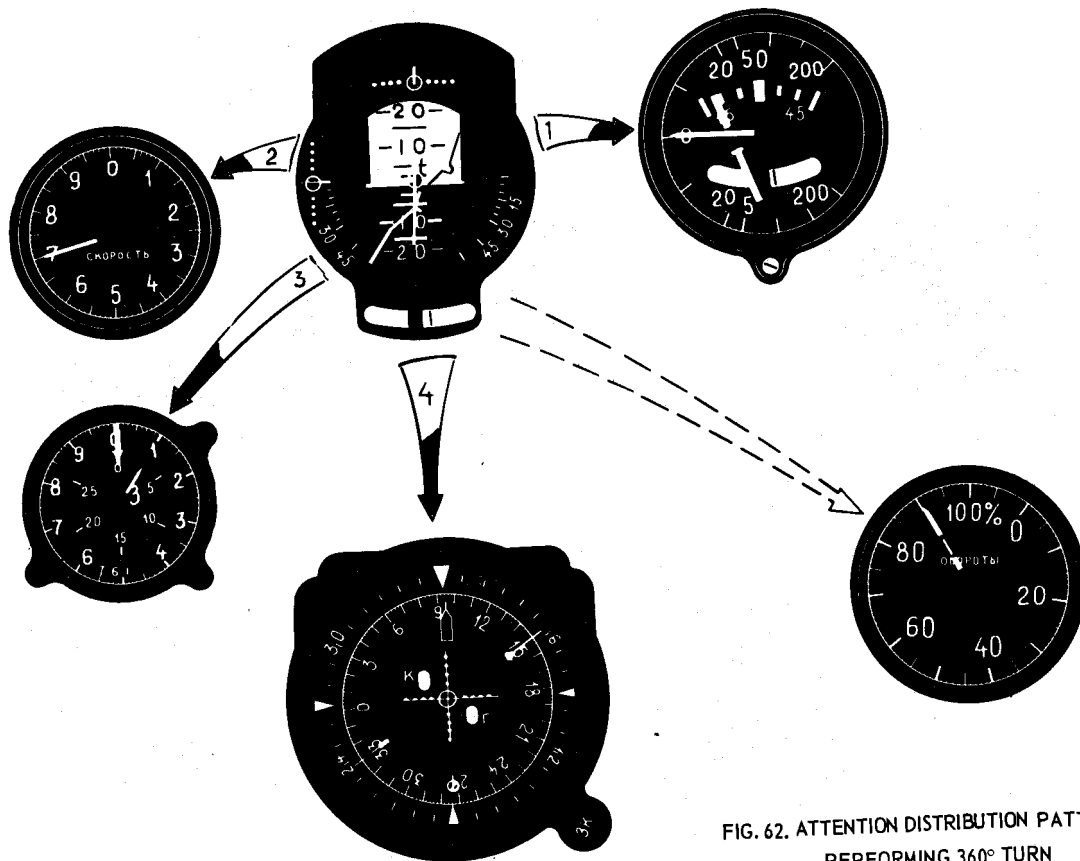

FIG. 62. ATTENTION DISTRIBUTION PATTERN WHEN PERFORMING 360° TURN

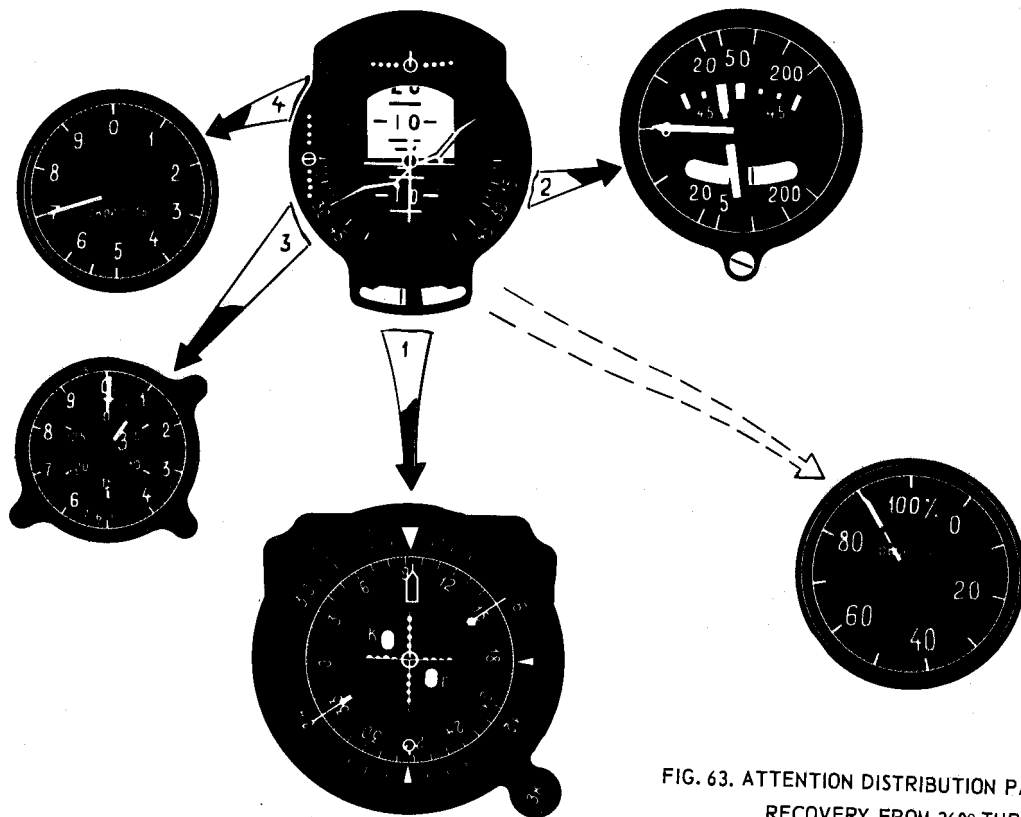

FIG. 63. ATTENTION DISTRIBUTION PATTERN DURING RECOVERY FROM 360° TURN

When performing a climbing or descending turn, first establish the assigned rate of climb or descent and then enter into a turn at a constant translational and vertical speeds. In so doing, particular attention must be given to maintaining the pitch and roll angles, as well as the assigned vertical and translational speeds.

The sequence of attention transfer to the instruments when performing either a climbing or descending turn are similar to those involved in performance of turns in the horizontal plane.

#### 4. AIRCRAFT RECOVERY FROM ABNORMAL ATTITUDE

The automatic flight control system installed in the ММГ-25ПД aircraft makes it possible to perform recovery from abnormal attitude.

The aircraft abnormal attitude is characterized by two parameters, i.e. by the roll and pitch angles. The aircraft heading is of no importance for aircraft recovery from abnormal attitude.

The entry of the aircraft into abnormal attitude in IFR flight is commonly associated with the diverting of a pilot's attention from the instruments, first of all from the artificial horizon. If the pilot's attention has been diverted for a short time, the aircraft deviation from the initial flying mode will be insignificant. The aircraft may take an extremely abnormal attitude when performing vertical maneuvers terminating in an abrupt entry into clouds.

Aircraft abnormal attitudes are usually characterized by high roll and pitch angles, energetic increase or decrease of the flight altitude and speed.

To recover from abnormal attitude, first determine the direction and amount of bank by reference to the artificial horizon and the sideslip-and-turn indicator and roll the aircraft out. Then bring the aircraft into level flight and establish the assigned flying regime by referring to the artificial horizon (pitch angle) and rate-of-climb indicator in conjunction with the airspeed indicator and altimeter.

In addition, when recovering the aircraft from abnormal position, the following peculiarities should be taken into account:

1. If the pitch-up angle is considerable, recovery from the zoom should be performed not through the straight line, but with

a turn; particular attention should be paid to checking the translational speed.

2. If the diving angle and airspeed are great, decrease the engine speed and extend the air brakes for a short time in the course of recovery; if the pitch-up angle is great, and the engine speed is decreased, increase the engine speed to the maximum value.

3. When recovering the aircraft from a dive or pitch-up, watch the flight altitude and speed, never permitting the aircraft to exceed the g-load limitations.

#### 5. PERFORMING FLIGHT ON DUPLICATING INSTRUMENTS

Duplicating instrument-flying training is intended to make personnel profoundly skilled in timely determination of failures and enable them to safely land the aircraft under such conditions.

In duplicating instrument-flying training, it is necessary in the first place to familiarize the pilot with the symptoms of the probable failures of the CAV automatic flight control system and the likely behaviour of the aircraft in the events of failure of the above system in both the automatic and director control modes.

The responsibility of the pilot is to correctly determine the fault introduced into the automatic flight control system by the instructor, cut off the system by depressing the AP DISENGAGE button on the control stick, and report the nature of failure and the measures taken to the instructor.

What is peculiar about the МиГ-25ПД fighter is the provision of this aircraft with the CBC air data computer system and the CKB directional/vertical gyro system the failure of which will result in failure of the entire group of instruments. Therefore, a pilot must properly know the symptoms and nature of failures of the above systems and be capable of flying the aircraft on duplicating instruments.

The failure of the CBC-ПН-5А air data computer system may be determined by the following symptoms:

- (1) fluctuation of pointers of the YCO-M1 and YBO-M1 indicators or the setting of separate pointers to extreme positions;
- (2) considerable disagreement of the readings of either the YCO-M1 or YBO-M1 indicator with those presented by the YCO-1600 airspeed indicator, the YB6CK duplicate pressure-al-

titude indicator, and the ДА-200 combined instrument, the power settings of the engines, and the aircraft flight profile.

If the aircraft was flown with the use of the CAV automatic flight control system, the pilot must press on the MODE RESET button on the automatic flight control system panel and continue manually piloting the aircraft by reference to the YC-1600 and YB6CK indicators (at altitudes below 10,000 m).

Maintaining flight speed by reference to the YC-1600 air-speed indicator presents no difficulties.

Flying altitude should be determined by referring to the YB6CK duplicate pressure-altitude indicator only at altitudes exceeding 1000 m due to considerable reading errors and difficulties encountered in reading the instrument. The instrument reading error may amount up to 100 m. Every 1000 m division is numbered. The scale graduation value accounts for 100 m. Therefore, at altitudes below 1000 m as well as during landing approach, the pilot must use the readings of the radio altimeter to determine flying altitude.

The failure of the CKB-2HJ-2 directional/vertical gyro system may be either partial or complete. At partial failure of the system only one component of the system fails to function. It should be noted that vertical gyro failure usually causes the failure of the directional part of the system.

The basic symptoms of failure of the CKB-2HJ-2 system directional component are as follows:

- (1) the aircraft effects maneuvers not planned in the flight programme both in the automatic and director control modes;
- (2) chaotic displacements or immobility of the combined course indicator heading dial during turns.

Failure of the directional component of the CKB-2HJ-2 directional/vertical gyro system determined, follow the procedures given below.

- (1) cut off the CAV automatic flight control system by depressing the AP DISENGAGE button located on the control stick and press on the MODE RESET button on the CAV system control panel;
- (2) set the D/VG STBY - MAIN (KB. ЗАПАС.-ОЧОБЕ.) selector switch to position D/VG STBY and ascertain that the roll and pitch readings of the flight director indicator remain practically unchanged;

(3) request over the radio the home flight course. Upon obtaining the required information, check the combined course indicator for correct course indications.

Upon setting of the indicator pointer to present correct course readings, switch on the automatic flight control system, continue the accomplishment of the mission assigned or fly the aircraft to the landing airfield depending on the conditions which have been resulted from the change-over to the stand-by directional and vertical gyro.

Never turn on the CAV automatic flight control system when in doubt about the correctness of the course indications.

To ensure landing approach, the pilot must take the readings from the automatic direction finder and periodically recheck flight direction by requesting ground-based radio direction finder data.

If the course indicator fails in flight and there is no possibility in using the automatic direction finder, the pilot may effect turns through the preselected angles with sufficient accuracy, maintaining roll and constant true flight speed. To succeed in this, one must know the angle through which the aircraft is turned per time unit during banked turn with the given parameters.

During turn at a true airspeed of 600 km/h and bank angle of  $30^{\circ}$  the angular rate will be equal to 2 deg/s and the time required for effecting a turn through any angle will be twice as less. Thus, the time required for effecting a turn through an angle of  $30^{\circ}$  will account for 15 seconds,  $90^{\circ}$  turn requires 45 seconds, and so forth.

The failure of the vertical gyro subsystem of the CKB-2HJ-2 system is testified by the following symptoms:

(1) changes in aircraft roll, pitch, and yaw attitudes not specified in the flight programme both in the automatic and director control modes;

(2) disagreement between the roll and pitch readings of the flight director indicator and the actual aircraft attitude;

(3) lighting-up of the CAGE (APPETMP) button-lamp located on the front panel of the flight director indicator.

Failure of the vertical gyro subsystem of the CKB-2HJ-2 system determined, follow the procedures given below:



(1) cut off the CAY automatic flight control system by manipulating the button on the control stick and depress the MODE RESET button located on the CAY system control panel (the moment the CAGE button-lamp lights up the CAY automatic flight control system switching-off and mode resetting are effected automatically);

(2) set the D/VG STBY - MAIN selector switch to position D/VG STBY;

(3) ascertain that the roll and pitch indicator presents correct reading;

(4) request the homing course over the radio and make sure that the combined course indicator course readings are correct.

If the flight director indicator and the combined course indicator present steady pitch/roll and course readings, respectively, switch on the CAY automatic flight control system and, depending on the existing conditions, continue accomplishment of the flight mission assigned or fly the aircraft to the landing airfield. If the above indicators fail to given stable roll/pitch and course readings, fly the aircraft to the DA-200 combined instrument in conjunction with the altitude and speed indicators and maintain the flight direction by reference to the radio compass, periodically requesting the heading from the direction finder. In this case, the turn-and-slip indicator, airspeed indicator, and rate-of-climb indicator are the main instruments, while the rest of the instruments are of secondary importance. By reference to the respective instruments the pilot is capable of precisely determining the aircraft attitude and maintaining the preselected flight conditions.

The DA-200 combined instrument indicator dial has three divisions corresponding to the amounts of roll of 15, 30 and 45°. Nevertheless, the position of the indicator pointer being at one of the above said divisions will correspond to the respective amount of roll provided that TAS accounts for 500 km/h.

The angular rate decreases with increasing flight speed and, consequently, the turn indicator pointer deflects by a shorter distance.

The readings presented by the turn indicator during turns at various banking angles are given in Fig. 64.

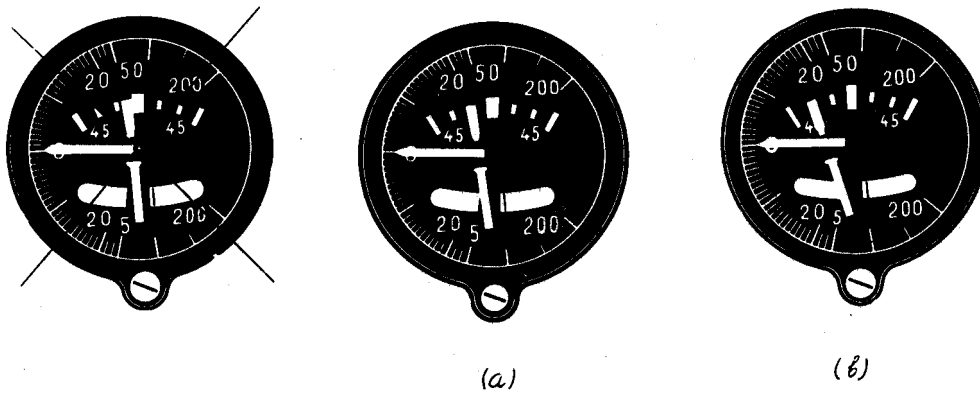

FIG. 64. READINGS OF TURN INDICATOR WHEN PERFORMING TURN AT TRUE AIRSPEED  
OF 650 - 700 km/h

a - at a bank of 15°; b - at a bank of 30°; c - at a bank of 45°

## 6. LANDING APPROACH TO PROGRAMMED AIRFIELD WITH USE OF "POLJOT-1M" SYSTEM

### 6.1. General

The main method for landing approach on the ММГ-25ПД aircraft is considered to be the method of approach with the use of the POLJOT-1M system in the aircraft automatic control mode. However, it is recommended to train the personnel in piloting the ММГ-25ПД fighter in emergency cases involving landing approach in the director and manual control modes. The training course involving landing approach with the use of the POLJOT-1M system shall be carried out in accordance with the special pattern established at a given airfield.

Fig. 65 illustrates the pattern of bringing the aircraft onto a runway landing course in azimuth. It is evident from Fig. 65 that the point of final turn A (21;0) is located on the line of the runway landing course and at a distance of 21 km from the runway centre.

Points  $A_1$  (21; 8) and  $A_2$  (21; -8) of entry into the turn on to a base leg are arranged symmetrically with respect to the line of landing course and lie on the perpendicular line intersecting point A. The radius of the aircraft turn at a banking angle of  $30^\circ$  is assumed to be equal to 4 km.

The aircraft is brought to the point of the final turn if the aircraft heading in the RETURN mode at a distance of 250 km differs from the runway landing course by less than  $90^\circ$  (positions II and III). If the aircraft heading differs from the runway landing course by more than  $90^\circ$ , the aircraft is brought to the point of turn on to a base leg (positions I and Ia).

The equipment is changed over to reproduce the selected course towards the predicted point of the final turn 4 km before the predicted point of the turn on to the base leg. During the changeover the preselected course pointer turns unevenly passing through  $30^\circ$  at a time.

On entering a corridor of  $\pm 4$  km wide (with respect to the runway axis) the predicted point of the final turn in respect to which the selected course is effected starts to displace along the line of the landing course in the direction of the runway at such a speed that the distance between the aircraft and this point along axis S be equal to 2.5 km (Fig. 66). The aircraft moves along the "pursuit" curve to follow the moving point. Thus, the aircraft flight path is smoothly conjugated with the line of the landing course.

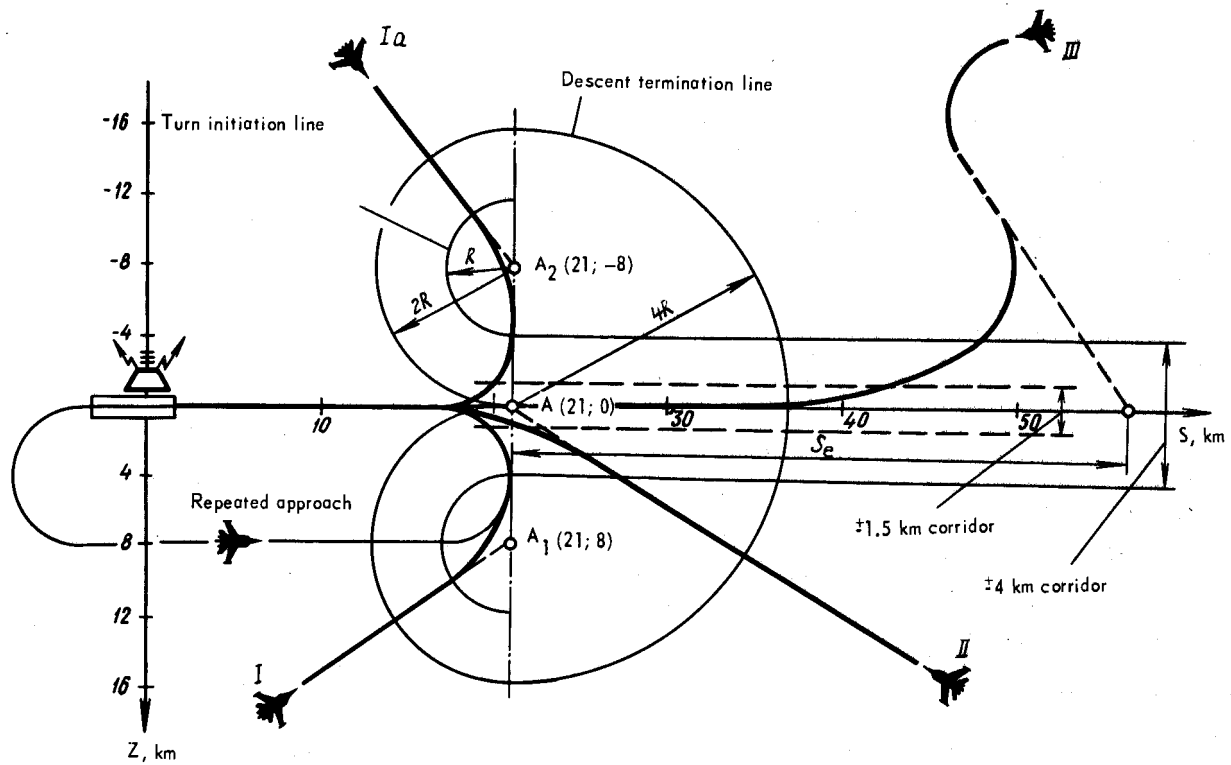

FIG. 65. INTERCEPTION OF LANDING COURSE BY AIRCRAFT IN HORIZONTAL PLANE

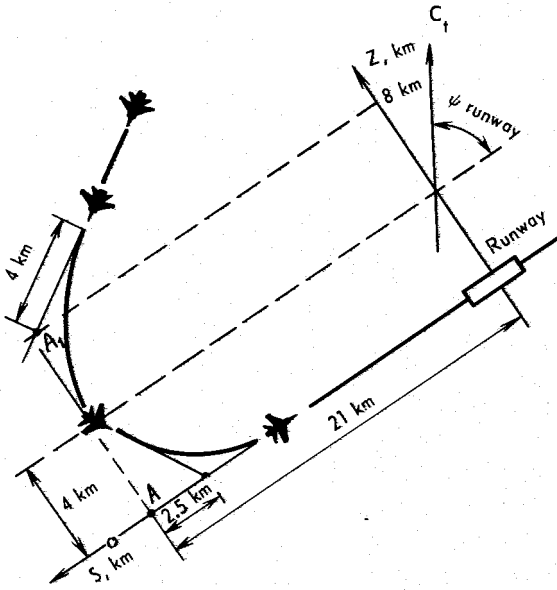

FIG. 66. DISPLACEMENT OF FINAL TURN POINT

An aircraft entering a corridor of  $\pm 1.5$  km in width (relative to the runway axis) brings about an automatic change-over of the equipment to operate in conjunction with the НРМГ-4М radio beacon group. This change-over also causes the operation of the localizer blinker of the combined course indicator and the flashing-up of the LANDING (ПОСАДКА) button-lamp on the CAV automatic flight control system panel.

The ППД-2 range indicator reads the distance to the range finder retransmitter. Within a range of not less than 20 km the glide slope blinker of the flight director indicator closes and both bars of the combined course indicator begin to operate. The course bar of the combined course indicator deflects either to the left or to the right, thereby indicating the position of the localizer beacon equisignal line with respect to the aircraft, while the combined course indicator glide-slope bar deflects abruptly upward, thereby indicating the position of the glide-slope beacon equisignal line.

The selected course pointer on the combined course indicator reads the true runway landing course.

In the automatic control mode, when approaching an altitude of 550 to 700 m, see that the aircraft is smoothly brought into level flight at a distance of 20 to 37 km from the runway. When in level flight, extend the landing gear, ascertain that the landing gear has actually been extended and report the matter to the flight control officer. Establish an airspeed of 500 km/h, and, at a distance of 19 to 21 km from the runway, check the automatic entry of the aircraft into the turn at a bank angle of up to  $30^{\circ}$ .

During the turn on to a base leg, maintain the airspeed of 500 km/h. Upon completion of the turn on to a base leg, gradually decrease the airspeed up to 450 km/h and perform the final turn at this speed.

When accomplishing the final turn, make sure that the landing mode has been automatically engaged by referring to lighting-up of the LANDING button-lamp located on the CAV automatic flight control system panel. After engagement of the landing mode, deflection of the director pointers occurs for a period of 2 to 3 seconds.

Apart from the above, check automatic engagement of the landing mode by the following symptoms:

(1) the localizer blinker on the combined course indicator is closed and the combined course indicator localizer bar deflected from the centre of the circle either to the left or to the right, thereby indicating the position of the localizer beacon equisignal line with respect to the aircraft;

(2) at a distance of at least 20 km the glide-slope blinker of the combined course indicator closes and the glide-slope bar deflects abruptly upward, thereby indicating the position of the glide-slope beacon equisignal line;

(3) the selected course pointer on the combined course indicator reads the runway landing course.

Furtheron, the aircraft enters the glide-slope beacon equisignal zone what is evidenced by the following readings of the flight director and the combined course indicators:

(1) the director pointers of the flight director indicator are within the instrument circle;

(2) the flight director indicator glide-slope pointer settles within the limits of the instrument circle, thereby indicating that the aircraft is at the stabilization altitude or descends along the glide-slope on entering it within a range of 12 to 14 km;

(3) the combined course indicator glide-slope pointer smoothly displaces from top downward to the centre of the instrument and comes into alignment with the centre of the instrument circle after entering the glide-slope within a range of 12 to 14 km;

(4) the localizer pointer of the combined course indicator as well as that of the flight director indicator deflects from either the left or right side towards the instrument centre and comes into alignment with the instrument circle centre on aircraft entering the localizer beacon equisignal zone.

Extend the wing flaps at a distance of 15 to 16 km, report this to the flying control officer, and check the aircraft starting to descend at a vertical speed of 5 to 7 m/s after it has entered the glide-slope beacon equisignal zone. Maintain the desired flying speed by varying the engine power settings during descent.

During glide-slope descent, maintain the following relationship between the flight altitude and the runway range:

H = 600 m - range of 12 to 14 km;

H = 400 m - range of 8 to 9 km;

H = 200 m - range of 4 km;

H = 100 m - range of 2 km;

H = 50 m - range of 1 km.

Switch off the automatic control system by depressing the AP DISENGAGE button on the control stick at an altitude of 50 m to the runway, change over to the manual control mode, visually verify approach and estimation for landing and perform landing.

If in the course of the prelanding maneuver, the altitude being stabilized is more than 700 m or less than 550 m, disengage the automatic control mode by pressing on the AP DISENGAGE button located on the control stick, and change over to manual control. Before entering the glide-slope beacon equisignal zone, effect the side channel control by reference to the flight director indicator director pointer, and the longitudinal channel control by reference to the YBO-M1 altitude indicator.

Upon completion of the final turn and aircraft entry into the glide-slope beacon equisignal zone, provided that the director pointers of the flight director indicator are within the circle, switch on the automatic control system by depressing the AUTO CONT (ABT. YHP.) button located on the CAY automatic flight control system panel.

If the return or repeated approach has been effected in the director control mode, upon closing of the combined course indicator localizer warning flag and lighting-up of the LANDING button-lamp on the CAY automatic flight control system panel, set the director pointers of the flight director indicator within the limits of the instrument circle and engage the automatic control mode by pressing on the AUTO CONT button on the CAY automatic flight control system panel.

If the landing mode fails to be automatically cut in (the warning flags of the combined course indicator not closed), manually engage the landing mode by using the LANDING selector switch on the controlpanel of the PCBH-6C short-range radio navigation and landing system, and then change over to the automatic control mode. Prior to this operation, set the director pointers to zero positions on the flight director indicator.

In the director control mode the aircraft shall be piloted in accordance with the position of the flight director indicator director pointers, maintaining them at the centre of the instrument circle.



## 6.2. Return to Programmed Airfield

Upon completion of the mission or on having received a flying control officer's command to return to the home airfield, the pilot should depress the AFLD (A3P) (landing airfield) and RETURN button-lamps on the PCEH-6C system control panel.

Prior to landing approach to the programmed airfield, ascertain that:

- (1) button-lamps labelled RETURN and AFLD (A3P) pertaining to the airfield of landing are depressed;
- (2) the CORR lamp is on;
- (3) the  $\Psi + 180^\circ$  selector switch is set to the position corresponding to the assigned landing course;
- (4) the MISSED APPROACH L - R (ПОБТ. ЗАХ. ЛЕБ. - ПРАВ.) selector switch is set to position corresponding to the direction of approach (the switch should be to the L or R position);
- (5) the SHORAN button-lamp is depressed;
- (6) the readings presented by the flight director and combined course indicators are in compliance with the flight programme.

Perform the flight to the turn initiation point to intercept the landing course at a speed of 550 km/h, holding the director pointers of the flight director indicator in the centre of the instrument circle. Extend the landing gear at an altitude of 600 m, report the matter to the flying control officer, and establish an airspeed of 500 km/h.

By referring to deflection of the assigned course pointer on the combined course indicator, bring the aircraft into the turn at a bank angle of  $30^\circ$  to intercept the landing course. During the turn, hold the director pointers at the centre of the instrument circle.

Before placing the aircraft on the landing course, decrease the airspeed to 450 km/h, and ascertain that the landing mode has been automatically engaged by making use of the same symptoms involved in the automatic approach.

Insofar as the engagement of the landing approach mode is followed by oscillation of the flight director indicator director pointers for 2 - 3 s, it is necessary to continue turning at a previous bank angle until the aircraft is brought onto the landing course.

Director pointers settled, arrange them within the instrument circle, manipulating the aircraft controls. It should be borne in mind that the director pointers become more sensitive in the landing approach mode.

Given in Fig. 67 are the readings of the flight director and combined course indicators in the horizontal plane after intercepting the landing course.

In level flight, the aircraft is on the right side to the line of the landing course in point a. The position of the landing course line with respect to the aircraft and the amount of deviation are indicated by the localizer position bars of the flight director and combined course indicators. The vertical director pointer of the flight director indicator is also deflected to the left, thereby indicating the necessity in a left bank turn to the landing course. In the director control mode, the aircraft must be brought into the turn at such a bank as to make the director pointer of the flight director indicator remain in the centre of the instrument circle (position b). As the aircraft approaches the line of the landing course, decrease the bank angle and, furtheron, completely roll out the aircraft (position c) to maintain the director pointer in the centre of the circle. Since the closure rate of the aircraft with respect to the course line is great for the given cross track error, the vertical director pointer of the flight director indicator starts to deflect rightward. To maintain it in the centre of the instrument circle, bring the aircraft into the right bank (position d). Furtheron, if the cross track error exists and the speed of closure of the aircraft with the course line decrease, the director pointer will deflect leftward, thereby indicating that the aircraft should be recovered from the right bank.

Transition to the steady straight flight without a bank, with the localizer bar and the director pointer being in the centre of the circle, means that the aircraft follows the course line (position e).

When approaching the selected course line, the localizer position bars of the flight director and combined course indicator indicate gradually decreasing deviations.

Thus, the pilot should know the following:

(1) the director pointers of the flight director indicator never inform the pilot about the aircraft attitude in respect to the selected course line; for this purpose, there are the position bars on the flight director indicator;

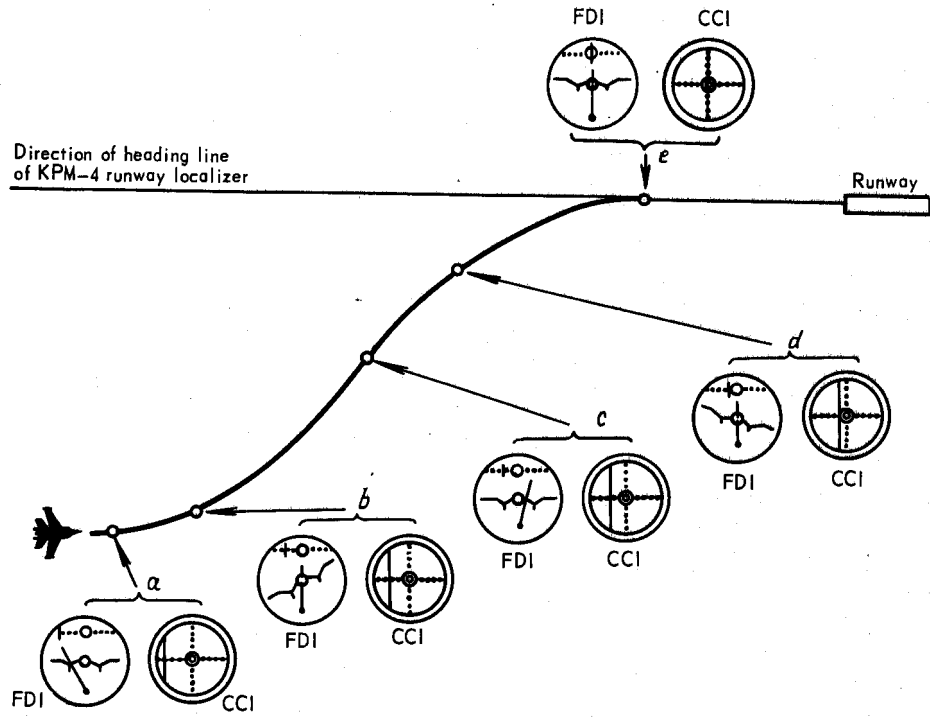

FIG. 67. READINGS OF FLIGHT DIRECTOR INDICATOR AND COMBINED COURSE INDICATOR AT INTERCEPTION OF LANDING COURSE IN HORIZONTAL PLANE

(2) during flight to the selected course line, the aircraft follows the path of a curved trajectory;

(3) the moment of aircraft approach to the selected course line is determined by reference to the flight director and combined course indicators, with the director pointers and the position bars of the flight director indicator being at the centres of the instrument circles and the localizer position bar of the combined course indicator being also in the instrument centre point. The glide-slope position bar settles against the instrument centre only at a distance of 12 to 14 km.

Manual control mode is made use of in the events of failures of the CAJ automatic flight control system, that is when the director pointers of the flight director indicator are inoperative. Flight to the base leg and final turn points as well as the landing approach in the manual control mode are effected by reference to the position bars of the flight director indicator and the selected course pointer of the combined course indicator (RETURN and AFCS circuit breakers are turned off). After bringing the aircraft to an altitude of 600 m, establish the predetermined airspeed and extend the landing gear. As the combined course indicator selected course pointer starts deflecting, bring the aircraft into the turn at a bank of  $30^{\circ}$  for intercepting the landing course. When performing the turn, check to see that the landing mode has been automatically engaged by reference to lighting-up of the LANDING button-lamp, closure of the combined course indicator warning flags, and the assigned course pointer reading the landing course. If the LANDING button-lamp fails to light up, close the LANDING switch on the PCBH short-range radio navigation and landing system control panel. After intercepting the landing approach course, perform corrective turns for precise entry into the localizer beacon equisignal zone by placing the localizer position bar within the centre of the instrument circle. If the localizer position bar displaces off the instrument centre, perform a corrective turn through  $3 - 5^{\circ}$  in the direction of the bar offsetting and proceed on a new course until the bar starts moving toward the centre of the circle. Furtheron, select such a flight course at which the vertical position bar could be held within the instrument center.

Maintain an altitude of 600 m until intercepting the glide-slope beam, by retaining the glide-slope bar on the flight director indicator within the centre of the circle.

As the range decreases, the combined course indicator glide-slope position bar moves downward and settles at the instrument centre at a distance of 12 to 14 km. From this time, it is necessary to bring the aircraft into descent at a vertical speed of 5 - 7 m/sec.

If the glide-slope position bar deflects from the instrument centre, select such a vertical descent speed as to bring it to its center position.

Check descent with reference to the glide-slope in the same sequence and within the same scope as when performing a landing approach in the director control mode.

The repeated landing approach to the programmed airfield is accomplished after a go-around or immediately after a take-off if this is planned by the flight programme.

To accomplish a repeated landing approach when proceeding on the landing course, switch off the automatic control system by means of the AP DISENGAGE button (provided that the landing approach has been performed in the automatic control mode) and ascertain that the RETURN and AFLD button-lamps of the landing airfield are depressed and the positions of the  $\Psi + 180^\circ$  and MISSED APPROACH L-R selector switches correspond to the landing course and the direction of landing approach.

When climbing and performing a turn at a bank of  $30$  to  $40^\circ$ , depress the MISSED APPROACH button-lamp on the CAV automatic flight control system panel and ascertain the respective mode has been engaged by reference to its lamp which must light up.

Depress the MISSED APPROACH button-lamp when the CORR lamp is glowing on the control panel of the PCBH-6C short-range radio navigation and landing system. Perform a turn at a bank of up to  $30^\circ$ .

Check to see that the course selector of the combined course indicator reads a reciprocal course.

After climbing to an altitude of 600 m, set the director pointers within the circle of the combined course indicator and proceed to the automatic control mode.

When proceeding from the second to the third turn, make sure that the selected course pointer indicates a reciprocal course and the position bars and the director pointers of the flight director indicator are within the circles. The flight course may differ from the assigned one by the amount of the drift angle. Make sure that the CORR lamp on the short-range

navigation and landing system control panel glows, check the flight altitude which must be within the limits of 550 to 700 m. Maintain an airspeed of 600 km/h prior to landing gear extension. Extend the landing gear when flying abeam the outer marker beacon and establish a flying speed of 500 km/h.

When performing a turn on to a base leg at a distance of 19 to 21 km, make sure that the selected course pointer of combined course indicator, the position bar and the director pointer of the side channel of the flight director indicator display entry into the turn, and the MISSED APPROACH button-lamp on the CAV automatic flight control system panel is dead.

Upon recovery from the turn on to the base leg, establish a flying speed of 450 km/h. In 10 - 15 s, a command for performing the final turn will be automatically given, at the end of which the landing mode will be automatically engaged (the LANDING button-lamp on the CAV automatic flight control system flashes up).

Subsequent instrument readings and actions of the pilot are similar to those involved in the landing approach in either the automatic or director control mode.

#### 7. INSTRUMENT APPROACH WITH USE OF AUTOMATIC DIRECTION FINDER

The automatic direction finder ensures landing approach and estimation for landing under the IFR conditions in the event of failure of the POLJOT-1M system components as well as landing on airfields unequipped with the PCBH-4H rho-theta radio beacons.

The principle method for performing landing approach with the use of the automatic direction finder is the straight-in approach method.

Apart from the above method, the pilots must be well trained in such methods of landing approach as approach from estimated line (line of beginning of descent), approach by two 180-degree turns, and extended rectangular pattern approach.

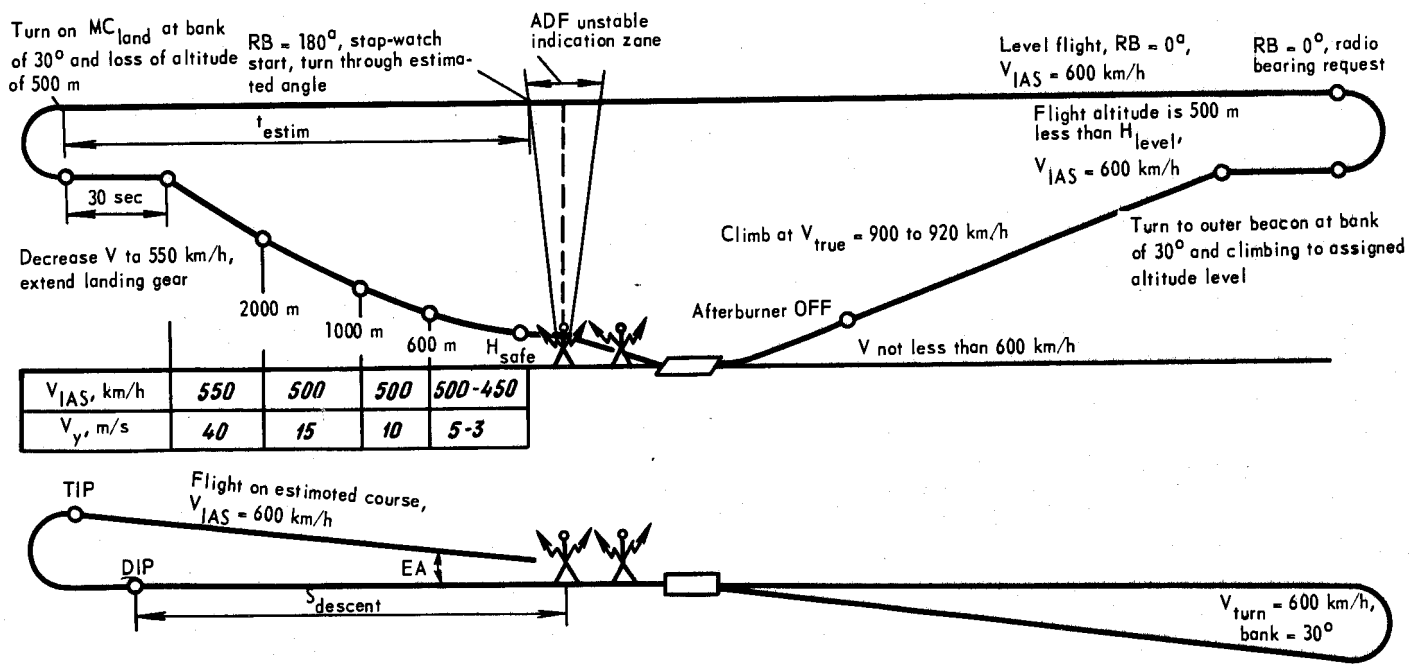

FIG. 68. STRAIGHT-IN LANDING APPROACH PATTERN

Straight-in landing approach. The straight-in landing approach pattern is shown in Fig. 68.

Flight to the descent initiation point (Fig. 69) involves the following maneuvers:

- (a) turn to the estimated angle;
- (b) 180-degree turn;
- (c) circling over the radio beacon;
- (d) turn in the direction of the least angle.

Turn to the estimated angle is effected during approach to the outer beacon with a heading which differs from the reciprocal landing course by not more than  $-45^{\circ}$ .

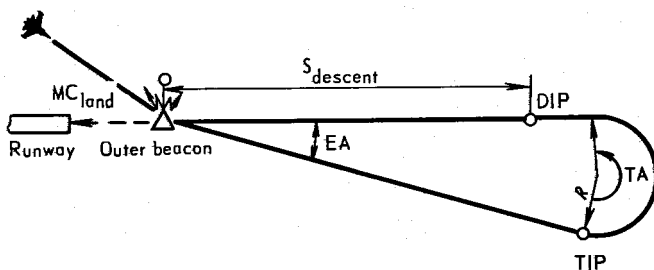

FIG. 69. INTERCEPTION OF DESCENT INITIATION POINT BY TURNING THROUGH ESTIMATED ANGLE

To change over the indicators from the POLJOT-1M system to the automatic direction finder, follow the procedures given below:

- (1) depress the MODE RESET button on the automatic flight control system panel;
- (2) set the SHORAN - ADF (PCBH - APK) selector switch to position ADF;
- (3) move the COURSE SELECT AUTO - MAN selector switch to position MAN;



(4) manipulate the setting knob on the combined course indicator to set the selected course pointer to the landing course.

When flying the aircraft in the direction of the outer beacon, maintain  $RB = 0^\circ$  and the assigned flight level. To check the correctness of the flying towards the outer beacon, request the relative bearing which must correspond to the flight course. Correct maintenance of the assigned inbound course shall be checked by reference to the airspeed indicator, altimeter, rate-of-climb indicator, radio compass, and the automatic direction finder.

Being in the zone of unstable readings of the radio compass, the pilot must maintain the straight level flight without changing the course by reference to the combined course indicator. The moment of flying past the outer beacon is determined by the 180-degree deflection of the radio compass pointer.

On determining the moment of flying over the outer beacon, start the stop-watch, accomplish a corrective turn through the estimated angle and proceed to the turn initiation point at an indicated airspeed of 600 km/h.

The course and time of flight to the point of turn to the landing course are radioed to the pilot by the flying control officer according to Table 7.

T a b l e 7

Level, m	Turn angle (EA), deg	Time of flight to turn initiation point, min, s
2,000	20	2.40
3,000	21	2.55
4,000	21	3.00
5,000	23	3.00
6,000	26	2.35
7,000	23	2.51
8,000	20	3.20

Given in Table 7 are the values of the estimated turn angles and the estimated flight time after crossing the outer beacon during straight-in approach.

If necessary, the estimated angle (EA) is determined by the navigator on duty at the control post.

After intercepting the estimated course, the instrument reference procedures are the same as during interception the outer beacon. Of particular importance, however, during this stage of flight are the following two factors, i.e. flying time and speed which determine the distance between the outer beacon and the turn initiation point, and consequently, the descent initiation point.

Flying the estimated course, the pilot should periodically check the aircraft bearing to ensure accurate interception of the estimated point.

Upon expiration of the estimated time, perform a turn to the landing course at a bank of  $30^{\circ}$  and with a loss of an altitude of 500 m.

To ensure rapid evaluation of the course and automatic direction finder readings for correction of errors which may occur during flight to the landing course by varying a bank, the following rules are recommended:

(a) if the pointer of the automatic direction finder moves to zero faster than the selected course pointer deflecting towards the reading index, the bank should be decreased;

(b) if the automatic direction finder pointer displaces toward the zero mark slower than the selected course pointer moving to the index line, bank should be increased.

After intercepting the landing course, fly level for a period of 30 s. During this time, establish an airspeed of 550 km/h, extend the landing gear and bring the aircraft into descent on obtaining the respective permission of the flying control officer.

It is important that the vertical descent speed of 40 m/s at a translational speed of 550 km/h be maintained up to an altitude of 2000 m.

On attaining an altitude of 2200 m, start gradually decreasing the angle of descent so as to enable the aircraft to pass an altitude of 2000 m at a constant vertical speed of 15 m/s, with the translational speed of 500 km/h. Gradually decrease the vertical speed to 10 m/s at an altitude of

1100 m, maintaining the indicated airspeed at a level of 500 km/h. To this end, slightly increase the engine speed. Maintain this flight regime up to an altitude of 600 m. From an altitude of 600 m to the safe altitude, establish a vertical descent speed of 3 - 5 m/s, and gradually decrease the translational speed so that it is equal to 450 km/h on attaining a safe altitude.

Readings of instruments both in descent and level flight at a safe altitude are given in Figs 70 through 74.

Amongst the main instruments to be referred to in maintaining the descent mode are the gyro horizon on the flight director indicator, rate-of-climb indicator, airspeed indicator, and the combined course indicator (course and RB). Initially, watch the altimeter from time to time. The rate of glance to the altimeter must be increased as the aircraft descends to a descending mode change altitude.

Departures which may occur in descent are to be eliminated by making corrective turns in the respective direction at a bank angle of 15 to 30° (depending on the amount of departure) without changing the vertical and translational speeds.

The procedures for correcting course errors are illustrated in Fig. 75. If the present course is in excess of the landing one, with  $RB = 0^\circ$ , this means that the aircraft is flown slightly to the left with respect to the runway centre line. To ensure strict alignment of the aircraft with the runway, perform a corrective turn to the right by the amount of double error. As the automatic direction finder pointer nears the selected course pointer (landing course), start a left turn, aligning the pointers at the index line.

The error is corrected identically when the present course is less than the landing one, i.e. the aircraft is flown to the right relative to the runway centre line, with  $RB = 0^\circ$ . Corrective turns are effected in the leftward direction in this case.

Whenever the aircraft course is equal to the landing one and the radio compass pointer deflects to the left (right), it is necessary to perform a corrective turn in the direction of the automatic direction finder pointer deflection until it assumes the middle position between the selected course pointer and the triangular index. As the automatic direction

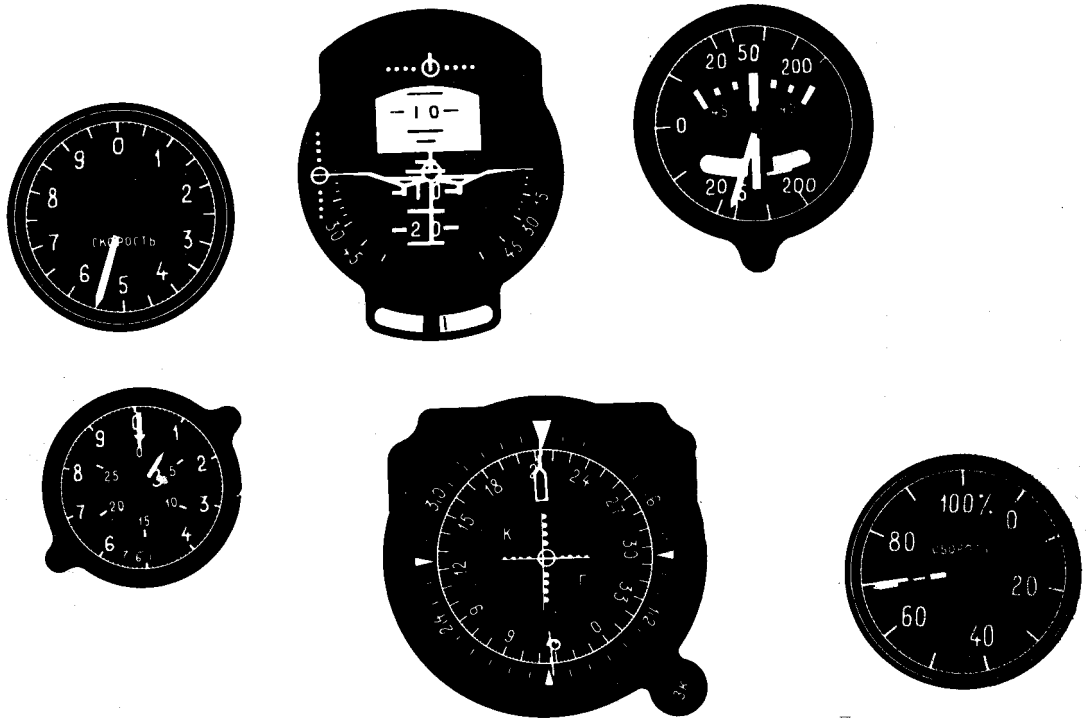

FIG. 70. INSTRUMENT READINGS CORRESPONDING TO GLIDESLOPE DESCENT TO ALTITUDE OF 2000 m WITH LANDING GEAR EXTENDED



FIG. 71. INSTRUMENT READINGS CORRESPONDING TO GLIDESLOPE DESCENT FROM ALTITUDE OF 2000 m TO 1000 m WITH LANDING GEAR EXTENDED



FIG. 72. INSTRUMENT READINGS CORRESPONDING TO GLIDESLOPE DESCENT FROM ALTITUDE OF 1000 m TO 600 m WITH LANDING GEAR EXTENDED

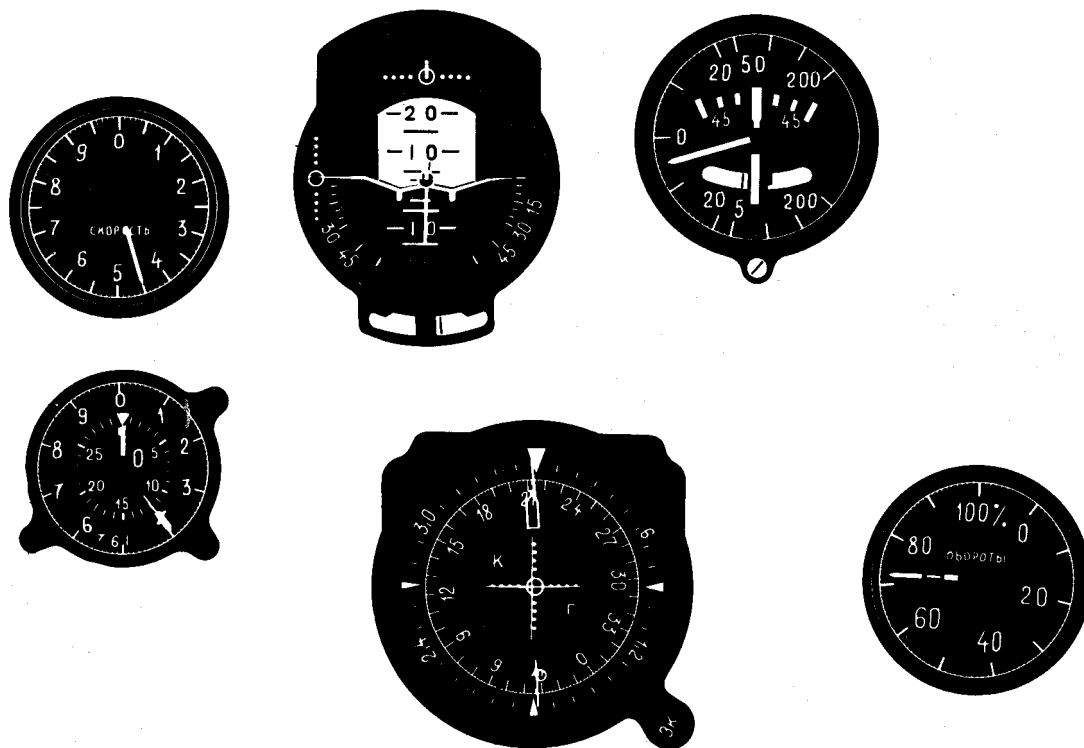

FIG. 73. INSTRUMENT READINGS CORRESPONDING TO GLIDESLOPE DESCENT FROM ALTITUDE OF 600 m TO SAFE ALTITUDE WITH LANDING GEAR EXTENDED

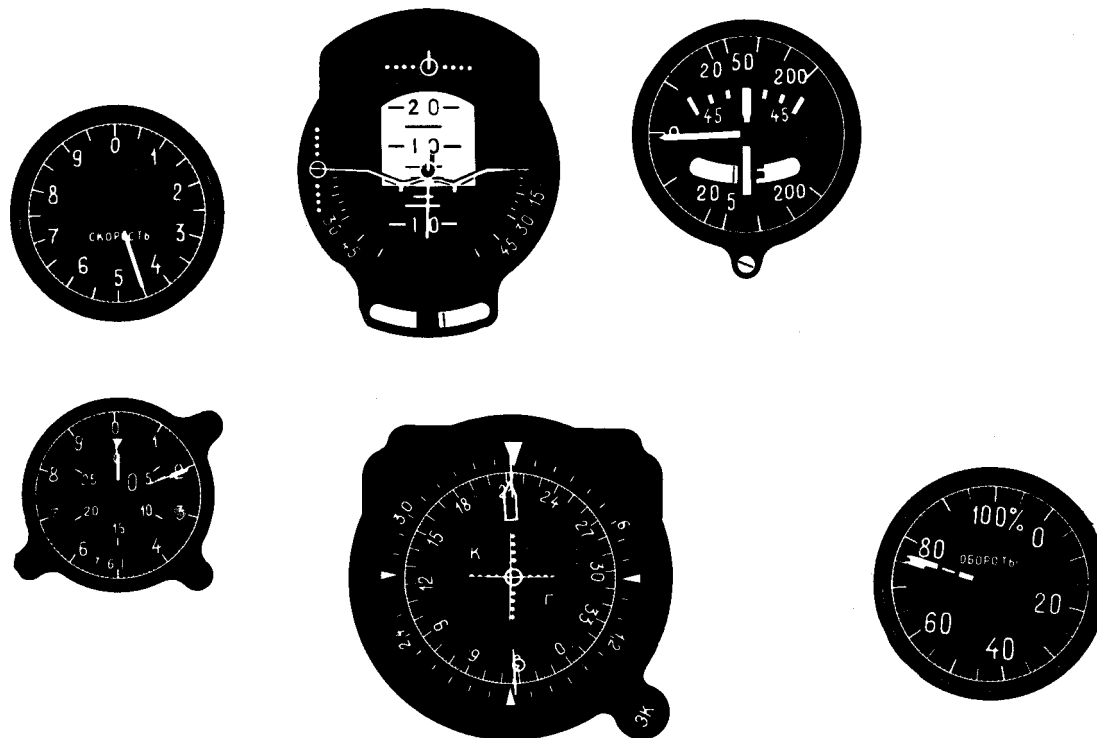

FIG. 74. INSTRUMENT READINGS CORRESPONDING TO LEVEL FLIGHT AT GLIDESLOPE SAFE ALTITUDE WITH LANDING GEAR AND FLAPS EXTENDED



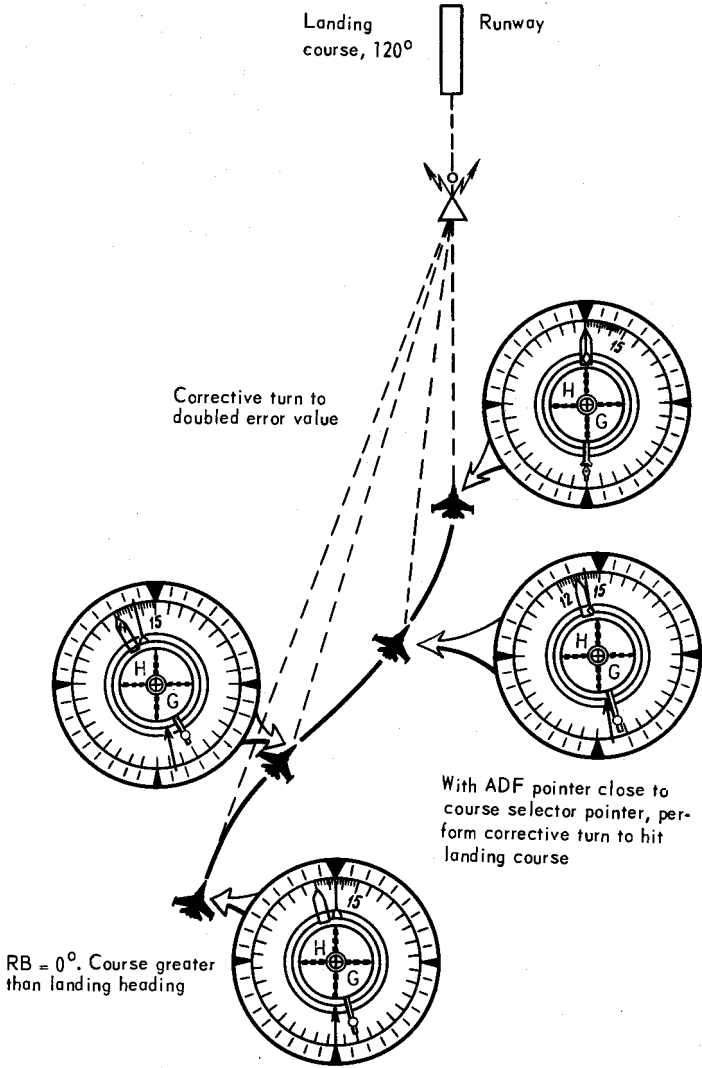

FIG. 75. CORRECTION OF ERROR WHEN HITTING LANDING APPROACH COURSE

finder pointer approaches the selected course pointer, perform a turn to the landing course, aligning the pointers below the index mark.

The landing approach is effected in an active manner, i.e. on the course corrected by amount of the drift angle. The direction of the landing course drift and its likely amount should be estimated well before takeoff on the basis of weather data and the report submitted by the weather reconnaissance officer. Insofar as flight conditions may vary even within a short period of time, the pilot must be well trained in determining the amount of drift angle directly in the course of descent. To this end, the pilot must decide whether the flight course increases or diminishes, with  $RB = 0^\circ$ . An increase in the course causes an aircraft leftward drift. If the course decreases, an aircraft rightward drift takes place. The amount of drift may be judged approximately by the rate of change in the course.

In the event of leftward drift, the automatic direction finder pointer must be maintained from the left-hand side with respect to the index mark by the amount of the drift angle, and the flight course must exceed the landing approach course by the drift angle. In the event of the rightward drift, the automatic direction finder pointer should be maintained from the right to the index mark by the amount of drift angle. Accordingly, the flight course must be less than the landing approach one by the amount of drift angle.

To introduce corrections, try to obtain such a condition when the automatic direction finder and the selected course pointers be just opposite the index mark. At this moment, the aircraft will be within the runway plane and its longitudinal axis will be pointed at the outer beacon. Then, perform a break-off upwind turn through the drift angle. As a consequence, the automatic direction finder and the selected course pointers will simultaneously shift by the same angle in one direction with respect to the index mark. If the drift angle is selected correctly, the pointers will never change their position.

At a distance of 15 to 16 km to the runway, extend the wing flaps, intercept the outer beacon at a speed of 420 to 400 km/h.

On attaining the safe altitude, stop counteracting the drift, establish  $RB = 0^\circ$ , and maintain it strictly. Check the flight course from time to time in order that the direction of the corrective turn to the landing course after flying over the outer beacon could be determined in advance.

In the course of descent, it is necessary to introduce corrections into the values of vertical speed and flight course in response to the commands delivered from the ground-controlled approach system.

Particular attention should be given to strictly maintain the flight altitude, never permitting an altitude less than 200 m. Absence of bank will ensure a precise maintaining of flight direction at  $RB = 0^\circ$ .

A premature transition to visual flying is not allowed, especially in cloud breaking at a long distance from the outer beacon, as the pilot attempting to detect the runway or familiar landmarks distracts his attention from the instruments. All this gives rise to a risk of losing control over flight altitude and speed. This is of particular danger under uneven-cloud-bottom-edge and limited visibility. Therefore, in each case when the flight is performed under limited visibility minima, instrument flight shall be effected before reaching the outer beacon.

When flying over the outer beacon, check the automatic direction finder for change-over to the inner marker beacon, perform a corrective turn to  $RB = 0^\circ$ , establish the required engine power setting, and bring the aircraft into descent. Further on, head the aircraft for the inner beacon, maintaining  $RB = 0^\circ$ . After flying over the inner beacon, perform the corrective turn to the landing approach course, recheck the direction of the landing approach, flight altitude and speed and proceed to the VFR flying with reference to the instruments.

The above described actions to be taken by the pilot beginning from the point of turn to the landing approach course and before reaching the inner beacon are pertinent to other types and maneuvers involved in straight-in approach.

A 180 - d e g r e e t u r n may be used in cases when the approach course to the homing beacon approximates the landing approach one (Fig. 76).

After determining the moment of flying over the outer beacon by reference to the automatic direction finder, bring

the aircraft into the turn to the course reverse to the landing approach one.

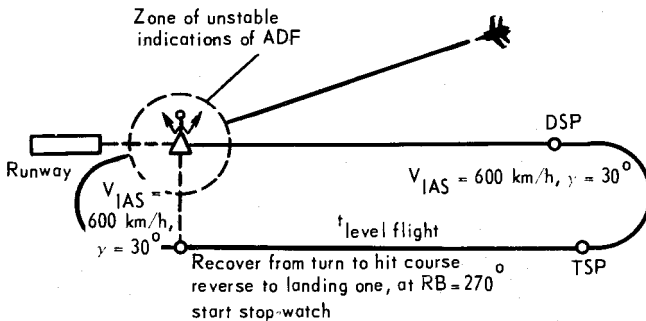

FIG. 76. 180-DEGREE TURN LANDING APPROACH PATTERN

When flying abeam the outer beacon ( $RB = 270^\circ$  in left turn or  $RB = 90^\circ$  in right turn), start the stop-watch, and proceed until the estimated time has expired. On expiration of the estimated time, carry out a 180-degree turn at a bank angle of  $30^\circ$  in view of intercepting the landing course. The turn should be performed at an airspeed of 600 km/h and loss of an altitude of 500 m.

After intercepting the landing course, further procedures are similar to those involved in straight-in approach.

Circling over the homing beacon is used in approach to the outer beacon at an angle approximating  $90^\circ$  with respect to the landing course (Fig. 77).

To accomplish a maneuver, having determined flying over the outer beacon, bring the aircraft into the turn at a bank of  $30^\circ$ , and watch the readings of the automatic direction finder pointer. As soon as the pointer comes close to mark  $RB = 270^\circ$  (during left turn), reduce the bank angle to  $15^\circ$  and,

maintaining the above-mentioned relative bearing, proceed in performing a turn for intercepting the course reverse to the landing course. After intercepting the reciprocal course, start the stop-watch, and proceed to the turning point initiation.

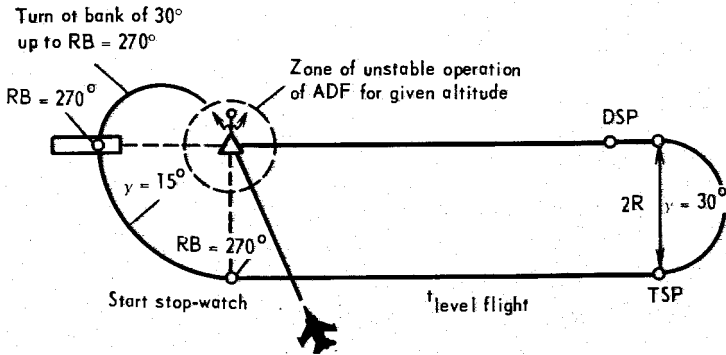

FIG. 77. LANDING APPROACH PATTERN INVOLVING METHOD OF "CIRCLE OVER HOMING STATION"

Accomplish a turn to the landing approach course at a bank of  $30^\circ$  upon expiration of the estimated time or in response to command given by the officer of the ground-controlled approach system.

Further approach and estimation for landing are similar to those used in straight-in approach.

Turn towards minimum angle is used in the same cases as circling over the radio beacon, but involves simpler maneuvering and takes shorter time required for the aircraft to reach the turning point (Fig. 78).

The essence of the maneuver consists in that once over the outer beacon the pilot must perform a turn which is reverse to the landing approach course towards the minimum angle, and proceed on this course to the turning point.

The flight time to the turning point is determined by the navigator on duty at the control tower. The turn for

intercepting the landing course can also be carried out in response to the command given by the ground-controlled approach system officer.

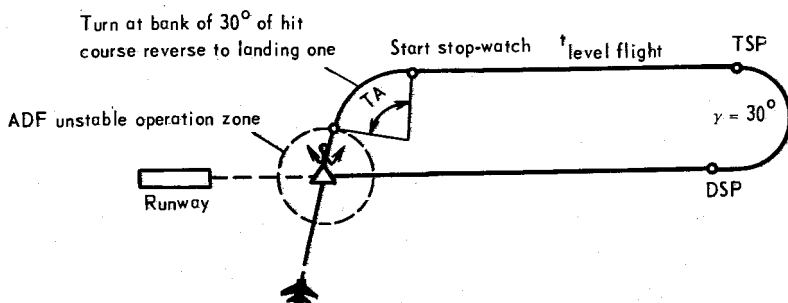

FIG. 78. LANDING APPROACH PATTERN INVOLVING METHOD OF "TURN TOWARDS LEAST ANGLE"

Further approach and estimation for landing are similar to those involved in straight-in approach.

Landing approach from estimated line. The flight pattern in the landing approach from estimated line must be plotted on the shortest route and effected on the commands from the control post on the basis of the radar data.

The pilot is provided with such direction and descent speed parameters as to enable the aircraft to attain an altitude of 2000 m at the point of turn to the landing approach course (Fig. 79).

On attaining the estimated line of descent the controller at the command post gives command "Estimated line" and specifies the translational and descent speeds as well as the distance to the point of turn to the landing course.

In the course of descent along the descending path to an altitude of 2000 m the pilot must maintain the assigned flight course and regime. The rate of descent may be varied,

if necessary, upon commands from the command post or ground-controlled approach station. On attaining an altitude of 2000 m, bring the aircraft into level flight, establish an airspeed of 600 km/h, and perform a turn for intercepting the landing course at a bank of  $30^\circ$  on the command furnished from the ground-controlled approach station.

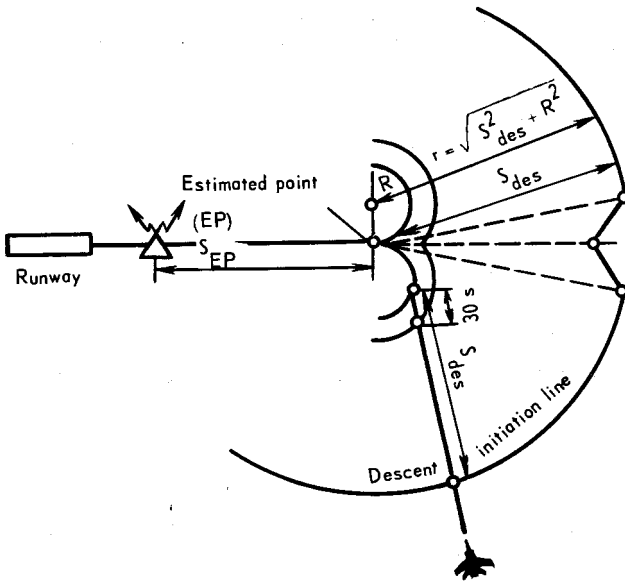

FIG. 79. PATTERN OF LANDING APPROACH FROM DESCENT INITIATION LINE

When on the landing approach course, reduce the speed to a level of 550 km/h, extend the landing gear and, on obtaining a permission for descent, let the aircraft down to perform landing approach.

Whenever the height of the bottom edge of cloud train exceeds 800 m and aircraft landing is planned to be performed from a circling maneuver, it is advisable that the descent from the estimated line be effected in the direction of the outer beacon. After breaking off in the region of the outer beacon, visually locate the airfield, enter the traffic circuit, and carry out a circular approach.

Landing approach by two reverse turns is used after go-around and because of the errors committed in straight-in approach or approach from the estimated line in view of minimizing the time required for accomplishing a repeated approach.

The procedure for landing approach aftergo-around (Fig. 80) is as follows.

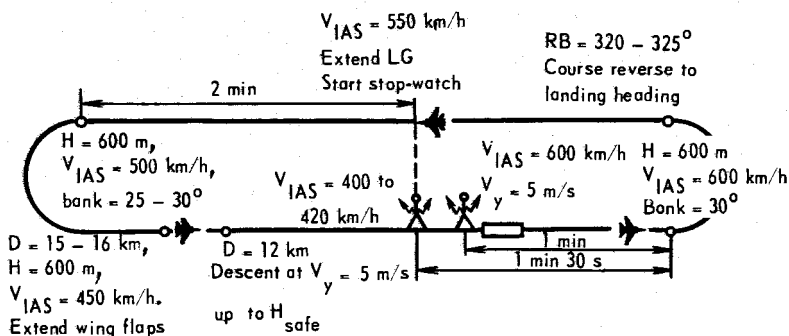

FIG. 80. PATTERN OF LANDING APPROACH WITH TWO 180-DEGREE TURNS

When gliding at an altitude of not less than 100 m, accelerate the engines to the maximum speed, smoothly put the aircraft into climbing, and retract the landing gear and flaps.

Climbing to an altitude of 600 m should be effected at an indicated airspeed of 600 km/h and rate of climb of 5 m/sec. Start performing the first turn at a bank of  $30^\circ$ , altitude of 600 m, and airspeed of 600 km/h one and a half minute after flying over the outer beacon or a minute after flying over the inner beacon.

When performing the turn, most of the pilot's attention should be given to the readings presented by the gyro horizon and the rate-of-climb indicator. Particular attention should be given to the procedures for maintaining a bank of  $30^\circ$  and



airspeed of 600 km/h, as any change in these parameters may disable the aircraft to intercept the estimated point of the turn on the downwind leg.

If the turn on the cross-wind leg is performed correctly under calm-wind conditions, the relative bearing of the radio station at the moment of aircraft taking the course reverse to the landing approach one must be equal to  $320 - 325^\circ$  during LH turn or  $35$  to  $40^\circ$  during RH turn.

When flying abeam the outer beacon, start the stopwatch, extend the landing gear, and establish an airspeed of 500 km/h.

Start the accomplishment of the turn on the downwind leg two minutes after flying abeam the outer beacon. Prior to entering the turn on the downwind leg, request the control post for the radio bearing to recheck the aircraft attitude with respect to the estimated point.

Perform the turn on the downwind leg at a bank of  $25$  to  $30^\circ$ . While performing the turn on the downwind leg, the procedures for changing aircraft roll attitude and landing approach estimation are similar to those involved in straight-in approach. The turn shall be performed without altitude loss.

After intercepting the landing course, at an altitude of 600 m extend the wing flaps and establish an airspeed of 450 km/h. To a distance of 12 km flight should be conducted at an altitude of 600 m and airspeed of 450 km/h. On attaining the distance of 12 km, bring the aircraft into descent at a vertical speed of 5 m/s. Further descent and landing procedure is similar to that used in straight-in approach.

Extended rectangular pattern landing approach may be carried out after a go-around (Fig. 81). Perform the turn on the crosswind leg through an angle of  $90^\circ$  at a bank of  $30^\circ$ , airspeed of 600 km/h, and altitude of 600 m.

Upon completion of the turn on the crosswind leg, the course readings presented by the combined course indicator should differ from the landing approach course by  $90^\circ$ . This course should be maintained until the radio compass pointer reads  $RB = 240^\circ$  during LH circling or  $RB = 120^\circ$  in case of RH circling. Furtheron, perform the 90-degree turn on the downwind leg at a bank of  $30^\circ$  and proceed on the course reverse to the landing one. As the aircraft comes closer to the position abeam the outer beacon, notice the readings of the automatic direction finder as frequently as possible.

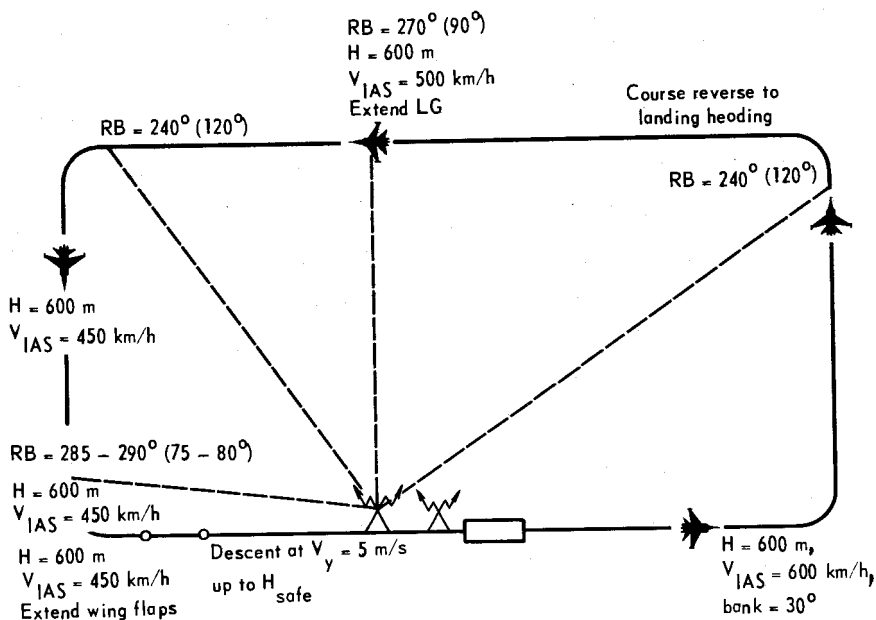

FIG. 81. WIDE LANDING APPROACH PATTERN

When abeam the outer beacon (with  $RB = 270^\circ$  during IH circling or  $RB = 90^\circ$  during RH circling), extend the landing gear and establish an airspeed of 500 km/h.

With  $RB = 240^\circ$  (in IH circling) or  $RB = 120^\circ$  (RH circling), accomplish the turn onto base leg through an angle of  $90^\circ$ , reduce the airspeed to 450 km/h and, with  $RB = 285$  to  $290^\circ$  (in IH circling) or  $RB = 75$  to  $80^\circ$  (in RH circling) start performing a turn at a constant altitude to intercept the landing course. A precise interception of the landing course may be obtained through varying the amount of bank during turning.

In level flight, at an altitude of 600 m extend the wing flaps and proceed to the point of a twelve-kilometre distance at an airspeed of 450 km/h. On attaining a distance of 12 km, bring the aircraft into descent at a vertical speed of 5 m/s, bring the aircraft on the course to the outer beacon, and perform landing.

## 8. LANDING APPROACH WITH USE OF GROUND-BASED RADIO DIRECTION FINDER

Landing approach with the use of the ground-based radio direction finder is to be performed for training purposes. Apart from this, the method for landing approach under discussion may be utilized in the events of failure of the PCBH-6C short-range radio navigation and landing system and the automatic direction finder.

Having ascertained that the POLJOT-1M system and the automatic direction finder can not be used for landing approach, report this to the flying control officer and request for the radio bearing to ensure a precise approach to the ground-based radio direction finder at the assigned altitude.

Place the aircraft on the course to the ground-based radio direction finder making use of the obtained radio bearings. In the course of flight, request the radio bearings at an interval of 1.5 to 2 minutes to introduce due corrections into the flight course.

Flying over the radio direction finder is determined by the wireless operator who gives a FLY-OVER command or by the reversing of the radio bearings.

While flying over the radio direction finder, start the stopwatch, establish the course predetermined by the flying control officer, and proceed on this course for the estimated time. Flight course and time are estimated by the controller on duty at the takeoff control point with due allowance for the location of the radio direction finder.

After flying over the radio direction finder, request for two or three times the direction finder bearing to maintain the correct turning angle.

On expiration of the estimated time, perform a turn to place the aircraft on the landing course. Request the radio bearing and correct the aircraft course with respect to the runway line in the second half of the turn. After intercepting the landing course within a 30-sec leg, extend the landing gear and establish the required rate of descent.

As the aircraft descends, periodically request the radio bearing from the operator and introduce corrections into the landing course. The procedure for making landing course corrections is as follows. On obtaining data from the radio

direction finder, detect the error and then determine the direction of aircraft departure from the runway line. Further, perform a corrective turn towards the runway line by the amount of doubled error. The corrective turn should be performed to the right, if the radio bearing is in excess of the landing course, and to the left, if the radio bearing is less than the landing course. When proceeding on a new course, request radio bearings. If the difference is from 2 to 3°, effect a corrective turn to intercept the landing course.

The tolerances for the translational and vertical speeds during landing approach with the use of the ground-based radio direction finder are the same as in the case of the straight-in approach with the use of the automatic direction finder. The pilot should remember that the direction finder does not solve the magnetic declination.

#### 9. RECOMMENDATIONS TO COMMANDER (INSTRUCTOR) ON TRAINING PILOTS IN FLYING UNDER IFR CONDITIONS

Before proceeding to flights under IFR weather conditions, the regiment (squadron) commander must organize training of senior flying personnel as instructors.

Instructors are to be trained in the course of combat training plan flights or at refreshment courses. A pilot-instructor undergoing a course of preparation for training flying personnel for flights under IFR weather conditions should be perfectly skilled in piloting the aircraft in cloudy weather for intercepting the landing course at a weather minima established for the combat aircraft and handling the combat trainer from the instructor's cabin under the respective meteorological conditions. To this end, the instructor must be qualified upon completion of the programme of the Combat Training Course.

The methods and techniques used by the instructor during training flying personnel for instrument flights are similar to those involved in flight training under VFR weather conditions.

What matters much during training for handling the aircraft under cloudy weather conditions is the sequence of the training exercises and maintaining a constant rate of advance. Training procedures demand strictly individual approach to

each trainee, that is morale, physical properties, pilot proficiency, experience gained from piloting other types of aircraft, and the degree of actual readiness for accomplishment of missions assigned in IFR weather conditions must all be taken into consideration.

The responsibilities of the instructor to be observed during training flying personnel for instrument flights are as follows:

(1) capability to perfectly pilot the combat trainer from both cabins and readiness to demonstrate or precisely repeat any of the flight elements;

(2) willingness to study and knowledge of personal qualities and capabilities of trainees; strict adherence to the requirements of the individual approach to pilots under training;

(3) competence and readiness to explain every flight element to a trainee in a simple, definite, and object manner;

(4) adherence to the principle NEVER ORDER WHAT A PILOT CAN NOT CARRY OUT; strict observance of the principle of sequence of training exercises;

(5) adherence to the notion that best results are obtained through applied flying rather than a lecture;

(6) never interfere with aircraft control, if not necessary, for overassistance may nip pilot's initiative and inspire uncertainty;

(7) be exacting and considerate in respect of each charge; be able to determine the optimum "loading" for a flying shift to be imposed on a trainee with due regard to his individual properties;

(8) be always ready to notice flight technique errors at proper time; be capable of determining the causes of troubles; help a trainee in correction of faults;

(9) constantly and systematically study and improve training methods and techniques on the basis of his personal experience and that gained by other instructors.

Flight training in IFR weather conditions, as well as flying training under VFR weather conditions comprises lectures, training with the view of keeping hand in aircraft flying, and improvement of flying skill acquired, and restoration of skill lost as a result of prolonged intervals.

Before proceeding to flights under IFR weather conditions, the commander must consider the degree of pilot proficiency of each trainee.

It is advisable that the pilots to be involved in instrument flight training for the first time start the training course from hooded flights at medium altitudes. Such flights not associated with turbulence, variation in the illuminance and colour of clouds, flickering of breaks in clouds, raining or icing are easier to handle, do not divert attention from piloting, cause no nervous overstrain, and provide for the possibility of proper acquiring of the first instrument flight skill.

Planning the flying personnel preparation for flights under IFR weather conditions must be conducted with strict adherence to the principle of individual approach.

Prior to flights, it is necessary that pilots be checked for knowledge of the subject and, if required, undergo a course of lectures on the following subjects;

- (1) physical aspects of instrument flight;
- (2) meteorological conditions of flight;
- (3) principle of operation and readings of the flight-control and navigation instruments and other aircraft equipment which is indispensable in instrument flight;
- (4) procedures for distribution and transfer of pilot's attention during instrument flight;
- (5) flying technique to be involved in instrument flight;
- (6) instrument flight radio aids and methods of piloting aircraft with the use of the above-mentioned equipment with the landmarks being out of sight;
- (7) ground and airborne equipment of the systems which ensure instrument landing approach;
- (8) patterns and procedures for cloud breaking in the vertical direction established for a given type of aircraft in landing approach;
- (9) probable errors in piloting aircraft during instrument flight and method of correction.

When taking the ground cockpit drill training course, it is practical that trainees study the arrangement of the flight-control and navigation equipment, the peculiarities in the readings of newly introduced flight-control and navigation instruments, and the principles of distribution and

transfer of the pilot's attention in flight. Sequence of handling the cockpit equipment should also be mastered.

The effectiveness of the cockpit drill depends on what purposes are pursued, i.e. on its relevancy to the pilot's actions to be taken during each definite flight leg. Adequate organization of the ground preparation and use of all the trainer equipment make it possible to save efforts and resources during instrument flight training.

The course of training flying personnel for daylight flights under IFR weather conditions includes as follows: training for instrument flying in clouds (hooded flight), training for acquiring skills for performing landing approach with the use of the landing systems, training for breaking clouds, join-up and break-up of formations in over-the-top flights.

Preparation of flying personnel for flights under IFR weather conditions must be carried out in the most favourable time of the year. To ensure systematic training for flights under IFR weather conditions in the absence of such at a given period of time, it is necessary to schedule and carry out hooded flights which are an almost entirely simulation of flying aircraft in clouds.

Training personnel for flying aircraft in IFR weather conditions should be conducted to a sufficient degree of intensity in order to enable trainees to acquire stable skills for instrument flying. Starting from the first introductory flights in clouds (hooded flights) a trainee should be given all opportunities to show his best without any interference. An instructor should never interfere with the aircraft control unless a trainee fails to carry out a training exercise satisfactorily. A trainee should be provided with an opportunity to notice and correct his mistakes by himself.

Keeping an attentive eye on the readings of the instruments and the trainee's actions, the instructor draws the pilot's attention to the persistent or neglected error, if the necessity arises. One of the responsibilities of the instructor is to demand from the trainee the strict observance of flight discipline, attendance to maintain the assigned flight regime, proper keeping of time intervals, observance of rules of radio communication, perfect handling of cockpit equipment, all this being a guarantee of safety and success in accomplishment of flights in clouds.

Introductory flights in clouds can be also carried out at the weather minima determined by the instructor. Under such conditions, the instructor must aid the trainee in descent and landing approach and, if necessary, take over aircraft control completely by himself.

Within the maneuvering area, the instructor usually confines himself to prompting and interferes with the control only in cases of emergency whenever a necessity in the immediate change in the flight regime arises.

During landing approach descent, the instructor should explain both orally and practically to the trainee what he must do to maintain the assigned regime.

In response to the instructor's commands, the trainee should memorize the readings presented by the flight-control and navigation instruments and those of the indicators which monitor the operation of the aircraft engines and systems, which correspond to the main flight regimes.

Another responsibility of the instructor is to deliver upon completion of each flight a brief postflight critique of a trainee's actions, point out the most serious errors committed during flight, and briefly note the actions to be taken by the trainee in order to prevent and eliminate these errors.

It is also practical sometimes that the trainee be given an opportunity to criticise himself and give an explanation as to the causes of the errors committed in flight. The instructor evaluates the correctness of the analysis made by the trainee and judges the degree of the mental and physical stress exerted by the trainee and the reserve of the pilot's attention during piloting the aircraft in clouds.

It is expedient that the first landing approach with the use of the landing system be accomplished visually so as to enable the trainee to compare the readings presented by the instruments and the actual position of the aircraft with respect to the runway. In subsequent flights, when the cloud ceiling is high, the instrument landing approach should be performed under the hood. As the trainee acquires appropriate skill, the hood should be removed at a lower altitude.

Initial training flights in clouds (above clouds) should be performed under the most favourable meteorological conditions, namely: absence of raining and icing conditions, calm cloud cover of moderate thickness, etc.



Proceeding from the specific conditions, nature and height of clouds, degree of visibility under the clouds as well as the individual capabilities of the trainee and his experience gained during flights under IFR weather conditions on other types of aircraft, the squadron or regiment commander assigns each trainee a cloud base to practise piloting of the aircraft in clouds.

The most difficult stage of training pilots for flying aircraft under IFR weather conditions is training for performing a landing approach and estimation for landing at the predetermined weather minima. In order to prevent overexpanding of the training course due to the absence of real IFR weather conditions, it would be practical to conduct series of hooded introductory flights with the use of the combat trainer.

The hood must be removed during landing approach glide at an altitude of 100 to 150 m. Such substitution flights to a considerable extent reduce the required number of flights under real IFR weather conditions.

Pilots are allowed for flights under IFR weather conditions in the combat aircraft at a predetermined weather minima if they are well skilled in piloting the combat trainer at a weather minima under real IFR weather conditions.

Training for the purpose of improving pilot proficiency covers the greater part of the total of flying hours. It must involve repetitions of the earlier mastered drills.

The regularity of pilot training should be such as to preclude losing of the acquired flying skill after intervals between flights. The principle of determining the regularity of flights should be based on the degree of complicity of exercises. Instrument flying skill, for example, is likely to be lost quicker than that acquired during visual flights. During instrument flight intervals skill gained in flying aircraft on landing course during instrument landing approach is likely to be lost first of all, especially at the predetermined weather minima. As a consequence, training for adequate performance of flights or flight elements involving flying technique which are hard to keep hand in should be at a higher rate of repetition.

It should also be noted that the repetition of a more complex flight, as a rule, precludes the necessity in repeating the flight involving simpler operations.

To keep hand in performing landing approach with the use of the landing systems, trainees should be trained for instrument landing approach techniques with the use of both combat and combat trainer aircraft.

Flying skill restoration. Prolonged flying intervals in general and, especially, those in instrument flights, reduce pilot proficiency of trainees. Loss of instrument flying skill after an interval in the airwork manifests itself in the paralysis of the pilot's attention and concentration of his attention on the readings of a restricted number of instruments. The pilot's actions become disproportionate, sweeping, and abrupt. All this may result under certain circumstances in blunders in flying technique.

The duration of the intervals which may lead to a loss of flying skill depends on the personal psychological properties of the pilots, complicity of flight programmes and aircraft under use. This relationship should be taken into consideration by commanding officers. Referring to the Flight Manual and Combat Training Course as a guide and taking into account the individual properties of each pilot, commanders are to determine the sequence of flying skill restoration exercises to be carried out after intervals between flights.

The flying skill restoration course as well as training must be conducted with high degree of intensity.

When accompanying the pilot in check flight after a prolonged interval, the instructor should bear in mind that the readings presented by the instruments are not always the evidence of loss of flying skill, especially when check flight is effected under simplified conditions. In order to avoid erroneous conclusions and admittance of the pilot for piloting the aircraft with unrestored flying skill, the pilot should be checked for pilot proficiency in instrument flying with the same degree of complexity involved in pilot training prior to intervals between flights.

The pilot must carry out, if necessary, at least two check flights with the instructor in order to enable the latter to most objectively evaluate the degree of flying skill loss and contemplate the right ways of restoration of flying skill.

## Chapter 6

### FORMATION FLIGHTS

#### 1. GENERAL

Training of pilots for proper conducting of formation air fighting should be effected in two-plane elements and flight sections.

When training flying personnel for team flying of two-plane elements and flight sections, major attention must be given to conducting combat actions in loose formations which most fully satisfy the requirements of modern formation combat and ensure flight safety in maneuvering.

It is recommended that instructors follow the below-given sequence of methods of training flying personnel for the MvT-25M fighter formation flights:

(1) training for mastering pair echelon formation team flying with the following parameters: distance of 150 to 200 m, interval of 70 to 100 m, and vertical separation (elevation) of a wingman ranging from 10 to 30 m (Fig. 82, a);

(2) training for mastering pair echelon formation team flying at increased distances and intervals, with the distance between aircraft being from 200 to 500 m and at an angle of sight of 20 to 30° with respect to the leader (Fig. 82, b);

(3) training for mastering team flying in pair echelon and V-formation section flight with the following parameters: distance between pairs in the section is from 600 to 800 m at an angle of sight of 20 to 30° with respect to the leading pair (Fig. 83).

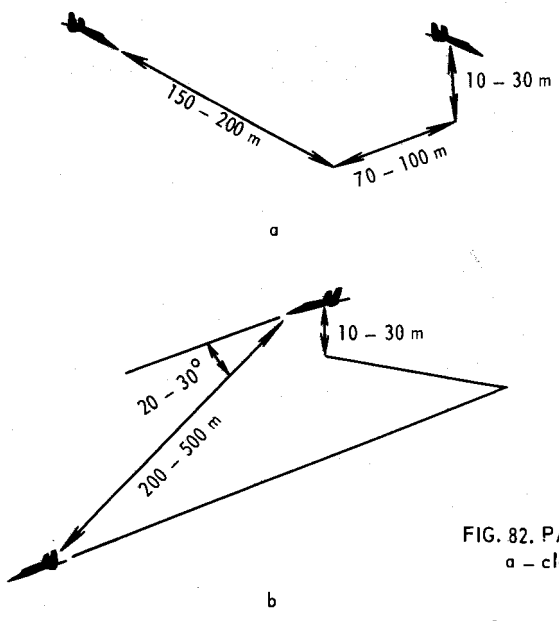

FIG. 82. PAIR ECHELON FORMATION  
a - close; b - loose

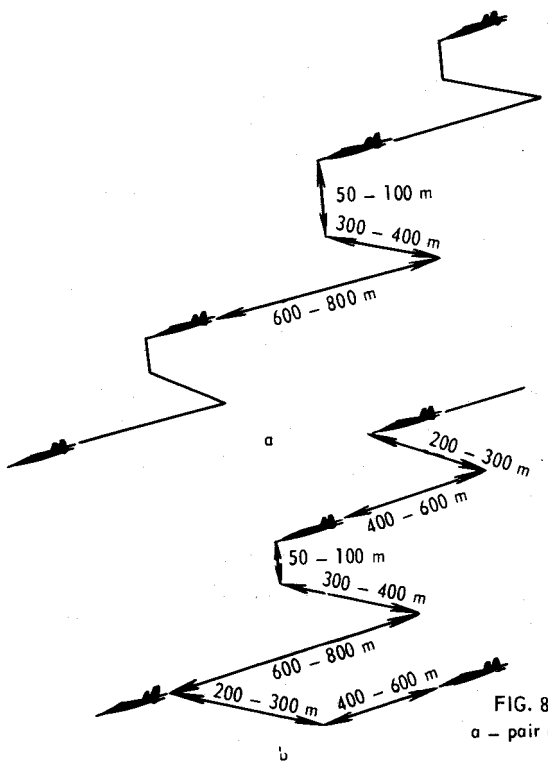

FIG. 83. SECTION FORMATIONS  
a - pair echelon formation; b - V-formation

The high level of team flying may be attained through the irreproachable individual flying skill of each pilot, mutual understanding and trust, experience gained by a formation leader, and strict flight discipline.

## 2. TWIN FLIGHT

### 2.1. General

During twin flights with the aim of mastering the crew cooperation, the pilots should practise the following flight elements, i.e. takeoff, climb, maneuvering, regrouping, landing approach, and landing.

### 2.2. Wingman Activity at Various Stages of Twin Flight

1. Taxi out to either left or right side of the runway depending upon the takeoff bearing. Move the pedals smoothly, use the brakes and refer to the marker receiver to position the aircraft at a distance of 30 to 40 m and interval of 15 to 20 m relative to the leader. This done, brake the aircraft so that the nose wheel is not turned to the left or right (operation of the brakes should ensure braking the aircraft without any turn) and the aircraft is positioned in parallel with the leader (this position of the aircraft is determined by reference to the leader and runway center line).

#### Wingman Takeoff Procedure

2. Report on readiness for takeoff.
3. Accelerate the engines similarly to the leader in response to the "RPM" command of the leader (the rate of acceleration is indicated by the leader during pre-flight planning).
4. Transfer attention as follows:
  - engine speed (94.5 per cent);
  - exhaust gas temperature (820°C, maximum);
  - absence of emergency signals on the panel;
  - the aircraft is held by the brakes;
  - the leader aircraft (to determine the engine setting by position of the nozzle shutters and starting moment).

5. Depress the afterburner catch triggers in response to the "Reheat" command of the leader and set the throttle lever to the FULL REHEAT position (the REHEAT (ФОРСАЖ) lamps should illuminate). As soon as the leader aircraft starts running, release the braking lever smoothly to start running simultaneously with the leader.

6. In the first half of the takeoff run maintain the runway alignment by operating the pedals smoothly, and the distance, by using the brakes.

The direction of the takeoff is determined by side viewing the left (right) runway boundary and the centre line and referring to a mark selected on the horizon.

7. As soon as the leading edge of the leader aircraft stabilizer is deflected downward, make sure that the speed of your aircraft is 220 to 240 km/h and pull the control stick through two thirds of its travel.

8. As soon as the nose wheel lifts off, transfer the sight onto the horizon keeping the leader aircraft in view, set and fix the amount of the nose-wheel lift-off by the aircraft control stick.

9. When running with the nose wheel lifted off, transfer attention as follows:

- the leader;
- direction of run;
- speed (approaching the lift-off speed, i.e. 350 to 360 km/h);
- amount of the nose wheel lift-off of your aircraft (pitch angle is equal to 10 to 11°);
- operation of the engines (by listening).

10. After the lift-off, proceed as follows:

- fix the aircraft takeoff angle;
- transfer your attention to the leader;
- make sure that the aircraft climbs smoothly.

11. Maintain the interval by coordinated deflection of the aircraft control stick and operation of the pedals. The bank of more than 15° is intolerable.

12. As soon as the leader starts retracting the landing gear, check the altitude visually once more and set the landing gear cock to the L.G. RETRACTED (НАСМ ВЕРАХО) position at an altitude of 10 to 15 m.

13. Retract the flaps at an altitude of 100 m.

14. Set the landing gear cock to the neutral position. In response to the "Turn off afterburner" command of the leader, depress the afterburner catch triggers by the left hand and set the throttle levers to the MAXIMUM position referring to the leader aircraft afterburner flame-out.

15. Report to the leader: "Turned off, neutral". Decrease the engine speed by 5%, turn away in the safe direction at a bank of 10 to 15° and assume stepped-down vertical separation of 20 to 50 m by pushing the aircraft control stick.

As the interval between the leader and your aircraft becomes 75 to 100 m, level the aircraft and at a distance of 150 to 200 m increase the engine speed up to maximum. In climb, maintain the interval by coordinated movement of the aircraft control stick and operating the pedals, and the distance, by increasing or decreasing the engine speed by 3 to 10% and extension (retraction) of the air brakes. Maintain the vertical separation by operating the aircraft control stick.

Note. If during take-off run the wingman overruns the leader, he must inform the leader about it by radio and proceed with the takeoff strictly maintaining the direction. In this case, the leader must maintain the takeoff direction, transfer the sight to the wingman and proceed with the takeoff as a wingman.

#### Turns (360° Turns) Towards Leader

1. As soon as the leader starts the turn, the wingman must increase the engine speed by 5 to 7%, pull the aircraft control stick and concurrently with the leader roll rate enter the turn so as to maintain the distance and interval as assigned and stepped-down vertical separation of 20 m.

#### Maintaining Distance (Fig. 84)

2. As the distance increases, retract the air brakes (if extended) and increase the engine speed by 3 to 5%. As soon as the distance stops increasing and starts decreasing, decelerate the engine by 3 to 5%.

3. As the distance decreases, decelerate the engine by 3 to 5% and extend the air brakes, if required. As soon as the distance stops decreasing, retract the air brakes (if extended) and increase the engine speed by 3 to 5%.

Maintaining Interval (Fig. 84).

4. With the interval decreasing, decrease the bank by 5 to  $10^\circ$  and more (depending on the rate of interval decreasing). After the disturbed interval is restored, roll the aircraft as assigned visually referring to the leader and flight director indicator.

5. With the interval increasing, increase the bank by 3 to  $5^\circ$ . After the interval is restored, roll the aircraft as assigned.

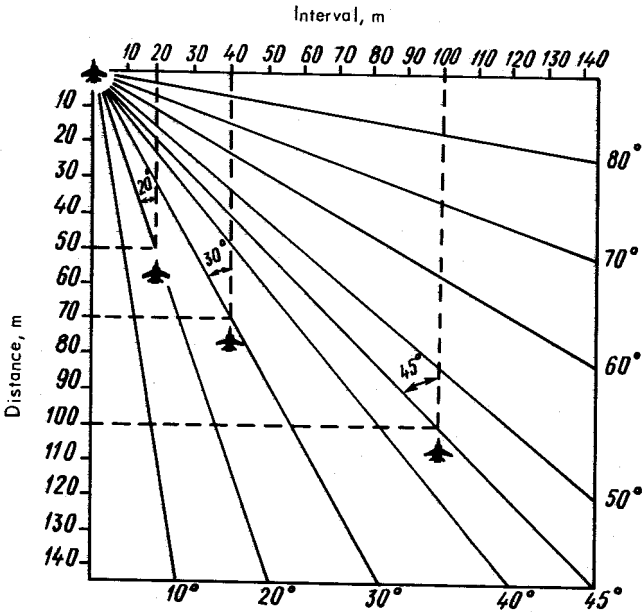

FIG. 84. SIGHTING ANGLE VERSUS RELATIONSHIP BETWEEN DISTANCE AND INTERVAL WITH RESPECT TO AIRCRAFT FLYING AHEAD



### Recovery from Turn

6. As the present course approaches the assigned one (or as the aircraft approaches a landmark) the wingman must pay particular attention to determination of the beginning of the the recovery from leader's turn. As soon as the leader starts recovery from the turn, the wingman must decrease engine speed by 5 to 7% and simultaneously operate the aircraft control stick and pedals in concord to recover from the turn. During aircraft recovery from the turn, the wingman should maintain the assigned intervals and distance. The recovery is accomplished with a stepped-down vertical separation of 50 m.

### Turns (Bank Turns) Towards Wingman

1. As soon as the leader starts the turn, the wingman must decelerate the engine by 5 to 10% and simultaneously push and deflect the aircraft control stick towards the turn to enter the turn. The rate of entering the turn should be determined with reference to the leader. Entering the turn is accomplished in the same plane with the leader at a distance of 200 m and interval of 75 to 100 m.

### Maintaining Distance

2. With the distance changing, the activity of the pilot is similar to the one during turns towards the leader.

### Maintaining Interval

3. With the interval increasing, the wingman must decrease the bank by 5 to 10° and acceleration slightly. After the disturbed interval is restored, roll the aircraft as assigned visually referring to the leader and flight director indicator.

4. With the interval decreasing, the wingman must increase the bank by 5 to 10° and more (depending upon a rate of interval decrease).

5. After the interval is restored, roll the aircraft as assigned.

### Recovery from Turn

6. As the present course approaches the assigned one (or as the aircraft approaches a landmark), the wingman must pay

particular attention to determination of the beginning of the leader's recovery from turn.

7. As soon as the leader starts recovery from the turn the wingman must accelerate the engines by 5 to 7% and simultaneously operate the pedals and deflect the control stick in the direction of recovery from the turn. During the recovery, maintain the assigned interval, distance and stepped-down vertical separation.

8. Transfer of attention is similar to the one during the turns towards the leader.

### Diving

#### Entry into Dive by Turning Aircraft Towards Leader

1. As soon as the leader enters the turn, accelerate the engines by 5 to 7%. Use the control stick and pedal to roll aircraft at a rate maintained by the leader so that the turn is accomplished at an interval of 75 to 100 m, distance of 200 m and stepped-down vertical separation of 20 m.

#### Entry into Dive by Turning Aircraft Towards Wingman

2. As soon as the leader enters the turn, decelerate the engines by 5 to 7%. Use the control stick and pedal in concord to enter the turn at a rate of the leader. The turn is accomplished in the same plane with the leader at an interval of 75 to 100 m and distance of 220 m.

3. During the turn, establish the assigned dive angle simultaneously with the leader and recover from the turn at an interval of 75 to 100 m, distance of 200 m and stepped-down vertical separation of 20 m.

4. Dive recovery is accomplished with reference to the leader maintaining the assigned interval, distance and stepped-down vertical separation.

### Zoom

1. Accelerate the engines up to the maximum in response to the "RPM" command of the leader. Produce the required acceleration simultaneously with the leader and enter the zoom at an assigned pitch angle.

### Maintaining Distance

2. In case of distance increase, turn on the afterburners. In case of distance decrease, turn off the afterburners, decelerate the engines by 5 to 10%. If required, extend the air brakes.

### Maintaining Interval

3. In case of interval increase, use the control stick and pedal in concord to roll the aircraft through 5 to 10° towards the leader. Level the aircraft and after assuming the assigned interval, roll the aircraft off the leader. After the closing is stopped, level the aircraft.

4. In case of interval decrease, use the control stick and pedal in concord to roll the aircraft towards the leader. Adjust bank depending upon a rate of distance decrease. After the assigned interval is assumed, roll the aircraft off the leader and after the assigned interval is assumed, level the aircraft.

### Maintaining Stepped-Down Vertical Separation

5. The stepped-down vertical separation is maintained by pushing or pulling the aircraft control stick.

### Recovery from Zoom Towards Wingman

6. Simultaneously with the leader, operate the respective pedal and deflect the control stick in concord in the direction of recovery to roll the aircraft so as to ensure recovery in the same plane with the leader.

7. Simultaneously with the leader, roll the aircraft out of turn at an interval of 75 to 100 m, distance of 200 m and stepped-down vertical separation of 20 m relative to the leader.

### Chandelle

1. In response to the leader's command "RPM" ("Reheat"), accelerate the engines to the maximum power (turn on the afterburners). Simultaneously with the leader, establish a pitch angle of 10 to 15°. When performing the chandelle towards the wingman, operate the respective pedal and deflect the control stick in concord in the direction of turn to roll the aircraft. Establish the rate of aircraft roll referring to the leader.

Enter the turn in the same plane with the leader at an interval of 75 to 100 m and distance of 200 m.

2. When performing the chandelle towards the leader, enter the turn simultaneously with the rate of leader roll maintaining the assigned interval and distance and with the stepped-down vertical separation of 20 m. Operations for maintaining the distance interval and stepped-down vertical separation are similar to those during the turn.

3. Recover from the chandelle simultaneously with the leader. The recovery procedure is similar to the one applicable for recovery from turn ( $360^\circ$  turn).

### Spiral

1. Start descending simultaneously with the leader. Establish an idle speed. Use the control stick and pedal in concord to enter the turn at the rate of the leader maintaining the assigned distance and interval.

2. When performing the spiral towards the wingman, fly the aircraft in the same plane with the leader. In this case, fly with a stepped-down vertical separation of 20 m. Performing the spiral is similar to performing the  $360^\circ$  turns.

3. As soon as the leader starts recovering from the spiral, use the control stick and pedal in concord to recover from the spiral and simultaneously accelerate the engines.

The wingman should remember that the "blind" aircraft-to-aircraft closing rates imperceptible visually are the following:

14 to 18 km/h (4 to 5 m/s), at an interaircraft distance of 100 m;

57 to 79 km/h (16 to 22 m/s), at an interaircraft distance of 200 m.

Therefore, to avoid collision, the wingman should look at the leader every 3 to 4 s, maximum (safe time of attention destruction) for the discussed twin flight maneuvers.

The best conditions for perception of the minimum movements are created when the leader is observed at an angle from  $10^\circ$  to  $50^\circ$  from the wingman flying at an interaircraft distance flying in pair of 300 m, maximum.

If the angle of sight to the leader is less than  $10^\circ$ , the "blind" closing rates imperceptible by the pilot increase considerably. If the angle of sight is more than  $50^\circ$ , the wingman

hardly flies the aircraft in parallel to the leader. Non-parallelism of the flight results in high closing rates.

### 2.3. Pair Break-Up for Landing and Landing

The pair break-up is intended to ensure the assigned distance required for performing landing in single aircraft. The amount of this distance depends on meteorological conditions and the pilot proficiency in performance of landing at a minimum time interval. The landing interval is established by the commander. It must be selected with the view of precluding any possibility of getting into the aircraft wake, as well as ensuring safety during landing roll.

To break up for landing, the leader must regroup the wingman either in the left or right echelon in advance depending on the traffic circuit. In case of the right traffic circuit, the echelon should be left and vice versa. The leader brings the pair of aircraft slightly to the left or to the right with respect to the runway on the landing course at a traffic circuit altitude or at the altitude determined by the flying control officer. When approaching the runway, the leader must request the flying control officer for permission to break up for landing. On obtaining the permission, the leader gives a command to break up, performs a 180-degree turn and proceeds towards the area of the turn onto base leg.

In the initial training stage, the leader ought not to perform a break-up for landing earlier than when abeam the beginning of the runway so as to give the wingman an opportunity to correctly estimate the route by referring to the runway.

After the leader has accomplished a turn-away, the wingman continues a straight flight for the half of the safe time interval assigned for landing and then follows the leader. The wingman must give particular attention to other aircraft which may enter the traffic circuit on a tangent to the turn on the downwind or base leg.

Breaking-up completed, the pilots should independently proceed on the landing course and perform landing in single aircraft.

### 3. SECTION FLIGHTS

#### 3.1. Takeoff and Join-Up

Section takeoff may be accomplished either in single aircraft or in pairs depending on the width of the runway, meteorological conditions, and pilot proficiency of flying personnel.

Prior to takeoff, the pilots of the section taxi the aircraft onto the runway and occupy the positions at the preestablished intervals and distances between aircraft (Fig. 85).

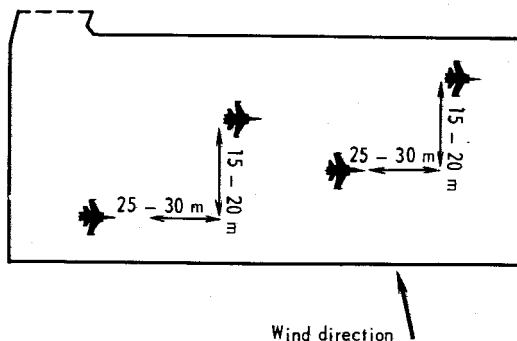

FIG. 85. ARRANGEMENT OF AIRCRAFT ON RUNWAY PREPARATORY TO TAKEOFF IN SECTION

All the pilots should report readiness for takeoff to the section commander in a consecutive order.

Takeoff in single aircraft. On obtaining the readiness report of the second pair wingman, the section commander requests takeoff clearance from the flying control officer. On obtaining the permission, the section commander performs takeoff in accordance with the routine procedures. The wingman pilots start to increase the engine speed to the maximum value beginning from the moment of the fore aircraft starting a takeoff run and wait for the flying control officer to give a command for takeoff, holding the aircraft on the brakes. The flying control officer

gives a command for takeoff of the next aircraft at the assigned time interval. On obtaining the command for takeoff given by the flying control officer, the wingman pilots perform takeoff in a consecutive order.

Join-up is effected first in pairs and then in the section. To this end, the leaders decrease the aircraft speed after takeoff and give an opportunity to the wingman pilots to join up. The section commander gains altitude at a small rate of climb, slightly extending the route towards the turn on the cross-wind leg so as to be able to effect it at an altitude of 1500 to 1800 m and bank of not more than  $25 - 30^{\circ}$ . Join-up of the pair completed, the leader of the second pair slightly increases the engine speed and joins up the leading pair. Should there be no possibility to join up the leading pair in straight flight up to the turn on the cross-wind leg, the leader of the second pair should increase a bank angle, take a short route, and join up the leading pair in straight flight leg upon completion of the turn on the cross-wind leg. In order not to lose the leading pair out of sight, the wingman pair should effect a turn with a stepped-down vertical separation of 75 to 100 m with respect to the leading pair.

Takeoff in pairs. On obtaining the respective permission, the leading pair effects takeoff in accordance with the routine procedures. The pilots of the wingman pair hold the aircraft on the brakes and accelerate the engines to maximum power setting beginning from the moment the leading pair starts taking off. The flying control officer must give commands allowing takeoff at the assigned time interval. On these commands the wingman pair performs takeoff.

After takeoff, the wingman pair pursues the leading pair and joins it up.

After the specified position in the section formation has been taken the leader of the second pair reports this to the section commander.

### 3.2. Maneuvering and Regrouping of Section

Section flying is associated with certain difficulties which are most likely to be encountered by the wingman pair and consisting in that in order to keep one's place in the formation, the pilots should more frequently and vigorously vary the

engine speed, use the air brakes and maintain the required vertical separation (elevation) in regrouping, maneuvering, etc.

Each wingman trying to maintain his position in the formation as correctly as possible frequently changes the direction of flight and moves the throttle levers. Therefore, outer wingmen should not react to all minor changes in the attitudes of the leading aircraft. Otherwise, they will have to continuously vary the engine power settings, manipulate pedals and use the air brakes. They are to react only to such changes in flight conditions that result in a considerable change in the assigned distances and intervals or endanger flight safety. All changes in attitude and maneuvers are to be effected by the section in the same manner as by the pair but more smoothly. Apart from the above said, the speed reserve left for the outer wingman should be more than that required for pair maneuvering in order to maintain the combat formation of the section in maneuvering.

In training flights, regrouping from one combat formation into another should be effected in a definite sequence.

The sequence from regrouping the aircraft of a combat V-formation, when the wingman pair is on the right side with respect to the section commander and his wingman is on the left side, into a right pair echelon is as follows. The wingman pair increases the distance and interval relative to the leader by 300 to 400 m leaving space for the section commander's wingman who assumes the required stepped-down vertical separation and brings the aircraft to the right side. This completed, the wingman pair establishes the prescribed distance and interval.

To regroup the aircraft from the combat V-formation into the left pair echelon formation, the leader of the second pair shifts to the left at a distance of at least 200 m and stepped-down vertical separation of 30 to 50 m with respect to the wingman of the first pair and assumes the position in the formation initially at increased distance and interval. His wingman also assumes the position with a stepped-down vertical separation of 30 to 50 m with respect to his leader. After the regrouping of the second pair wingman into the left echelon has been completed, the leader must take his place in the combat formation of the section.

Regrouping of aircraft from the left pair echelon into the right one is effected by shifting the aircraft to the right in a consecutive order beginning from the section commander's



wingman. To regroup the aircraft, all the wingmen assume a distance of 200 to 500 m and then shift to the opposite side. When regrouping the aircraft from right pair echelon into a combat V-formation, the section commander's wingman only shifts to the left. The succeeding pair keeping to the right establishes the assigned distance and interval.

### 3.3. Section Break-Up for Landing

The section landing is performed in single aircraft. Prior to a landing break-up, the section commander regroups the flight into either a right or left pair echelon in advance depending on the traffic circuit.

The section should approach the landing break-up point at either the traffic circuit altitude or altitude established by the flying control officer.

When approaching the runway boundary on a landing course, the section commander must request the flying control officer for permission to perform break-up for landing. On obtaining the respective permission the section commander gives a "Break-up" command and performs a 180-degree turn toward the area of the turn onto base leg. The wingman pilots proceed on the straight flight course for a half of the assigned time interval for landing. On expiration of half of the time interval each pilot performs a 180-degree turn towards the area of the turn onto base leg, independently flies the route and performs landing.

In order to prevent the succeeding aircraft getting into the wake produced by the leading aircraft upon completion of the final turn as well as aircraft collision during landing roll, the section pilots performing landing in single aircraft at the minimum time intervals are advised to follow the procedure given below:

(a) under headwind conditions the leaders of both pairs are to glide along the left-hand side of the runway and their wingmen along the right side;

(b) in crosswind (left or right) conditions all the section aircraft must glide along the runway centre line;

(c) after touchdown, each pilot must deploy drag chutes, decelerate the aircraft to a speed of 80 to 120 km/h, and start gradually shifting at this speed close to the centre line of that half of the runway from which the aircraft is going to be taxied out. Thus, the outer half of the runway is left clear to

provide for the landing safety of the aircraft rolling at an increased speed as well as in the event of drag chute deployment failure or rupture.

#### 3.4. Peculiarities Involved in Pair and Section Flights at Supersonic Speeds

Flights in stratosphere at supersonic speeds in the pair and section formations as compared to the flights at low, medium, and high altitudes present considerable difficulties which arise due to the following:

- (1) deterioration of aircraft maneuverability;
- (2) increase of aircraft sluggishness;
- (3) existence of shock wave;
- (4) limited thrust reserve for wingman pilots required for maintaining the assigned position in the combat formation;
- (5) limited visibility for all the pilots of the formation when flying in pressure helmets;
- (6) slightly increased excitability of pilots (as a rule);
- (7) limited vertical visibility and deteriorated visual orientation conditions;
- (8) increased fuel consumption and, as a consequence of this, the necessity in constantly checking fuel remainder.

In view of the limited maneuverability of the aircraft and increased aircraft sluggishness, the pilots of the succeeding aircraft should be more attentive in following the changes in the leader attitude and react to these changes in due time in order to maintain the position in the formation. The assigned interval must be maintained in formation flight at supersonic speed by coordinated movements of the ailerons and rudders. Turns at supersonic speed must be effected with a slight decrease in the preset intervals and, if necessary, changing one's place in the course of a maneuver.

Formation flights at supersonic speeds are characterized by the existence of shock waves following the aircraft. The strongest effect of the shock waves is sensed as shocks and "shaking" when overtaking the leading aircraft.

G-loads imposed on the aircraft and pilot as a consequence of the shock wave effect are insignificant. Shaking also has a negligible effect on the aircraft control. Nevertheless, shock waves may deteriorate the steady operation of the powerplant.

In this connection, overtaking of a fore flying aircraft at an interval of less than 200 m is not allowed.

When flying the aircraft in the pressure helmet the leader pilot is practically deprived of the opportunity to visualize the wingman. This places a stringent responsibility on the wingman in the sense of keeping the assigned position in the formation and providing for the formation flight safety.

Supersonic flights must be performed in accordance with the pattern adopted for a given airfield. The formation must enter the acceleration initiation point in loose formation at a non-reheat ceiling of the group. On attaining the point of acceleration starting the CP combat control officer given a command to turn on the afterburners. Having checked the group for maintaining the assigned combat formation, the leader gives command "Reheat". The wingmen turn on the afterburners at the command given by the section commander, not by the CP combat control officer, and report the matter to the formation leader.

After the turning-on of the afterburners, the leader moves the throttle levers through about a quarter of the adjustable reheat travel in order to leave the wingman (wingmen) the thrust reserve required for maintaining the position in the combat formation. The wingman (wingmen) maintains the distance in the combat formation by moving the throttle levers within the limits of the partial augmented rating and extending the air brakes.

Afterburners should be turned off by the command of the leader. Afterburners cut off, the leader starts to descend, decreasing the indicated speed.

#### 4. FORMATION FLIGHTS UNDER IFR CONDITIONS

From the viewpoint of both the methods of training and flying technique formation flights under IFR weather conditions present the greatest difficulties for those under combat training. To succeed in performing IFR formation flights, the flying personnel must be perfectly skilled in piloting aircraft in clouds as well as in the combat formation under VFR weather conditions.

Safety of formation flight under IFR weather conditions is ensured by the following:

- (1) strict maintaining of takeoff and break-up time intervals;
- (2) maintaining of the required speed, direction, and amount of bank during turns;
- (3) maintaining assigned engine power settings during cloud break-through (upward);
- (4) maintaining of vertical and translational speeds during downward cloud break-through;
- (5) adequate condition of aircraft;
- (6) proper actions of formation leaders and flying control officers;
- (7) reliable operation of the airborne and ground equipment;
- (8) high sense of responsibility of both the flying and command personnel for preparation and safety of flights.

Safety of flights under IFR weather conditions during the sequential breaking of clouds by a single aircraft or pairs along one and the same preset trajectories is ensured through maintaining the assigned time interval.

The safe time interval must preclude any possibility of overtaking the aircraft (pair) flying in clouds. The amount of the safe time interval  $t_{\text{safe}}$  is determined with the aid of the following equation:

$$t_{\text{safe}} = \frac{2\Delta V}{V} t,$$

where:  $\Delta V$  - maximum possible deviation of the flight speed from the assigned speed, km/h;

$V$  - translational speed of climb (descent), km/h;

$t$  - time from the moment of takeoff (beginning of cloud break-through) till the moment of attaining the altitude of the assigned flight level or time from the moment of beginning of descent until reaching the outer beacon, s.

In calculating the safe time interval one should take into account not only the amount of mistakes made by the pilot but also make allowance for the airspeed indicator reading error which may exceed that committed by the pilot when flying at high speed. Considering this fact it is recommended for all categories of flying personnel that the amount of maximum deviation of flying speed from the assigned one be assumed as equal to 50 km/h

in upward break-through and 35 km/h in downward break-through. Lower indicated speeds in descent correspond to lesser error values.

Table 8

Flight altitude, m	$t_{\text{safe}}$ (upward), s	$t_{\text{safe}}$ (downward)
1000	15	30
2000	20	30
3000	20	30
4000	20	40
5000	30	40
8000	40	50

Given in Table 8 are the values of the safe time intervals (in seconds) to be observed in both upward and downward cloud break-through. The figures given in the table are carried over to the nearest whole numbers for practice purposes.

For downward cloud break-through the above given values of the safe time interval between aircraft should be maintained in the event of break-up at the preselected line. In the event of the formation break-up on the course reverse to the landing one, each subsequent aircraft starts a turn to intercept the landing course on expiration of the time period equal to half the safe time interval.

#### 4.1. Twin Flight

The upward cloud break-through on the MiГ-25ND aircraft can be performed in pair subsequently in single aircraft or in pair in loose formation.

Upward cloud penetration subsequently in single aircraft is commonly conducted in the initial stage of training flying personnel for performing twin flights under IFR weather conditions as well as for performing takeoff under minima or below the assigned weather minima.

The wingman should start a takeoff run on the command of the flying control officer and on expiration of the assigned safe time interval beginning from the moment of the leader takeoff run start. Failure to maintain the assigned takeoff inter-

vals is a typical mistake. On attaining an altitude of 1000 m both pilots turn off the afterburners and continue climbing at maximum power setting. When climbing, the pilots of the pair must maintain one and the same heading and translational speed.

On breaking through clouds and attaining an assigned altitude, the pilots establish level flight conditions and report the matter over the radio. A typical mistake committed is failure to maintain the assigned speed and direction during upward cloud penetration. Wingmen sometimes intentionally decrease the translational speed of avoid overtaking of the leader or slightly depart from the cloud break-through course. This may result in a considerable increase in the time required for join-up.

Pair join-up in over-the-top flights is effected either in a loop or by varying the airspeed.

To perform join-up in the loop, on receiving the report of the wingman about gaining an altitude 500 m below the assigned flight level, the leader gives command "Left (right) turn" and starts to turn the aircraft to intercept the course to the outer beacon, climbing to the assigned flight level. The wingman must perform a turn towards the outer beacon on expiration of the time equal to a half of the safe time interval without gaining an altitude and counting the interval beginning from the moment of obtaining the "Turn" command (Fig. 86).

In the course of the turn or upon completing it the wingman must detect the location of the leader and perform regrouping on a straight line.

Climbing to an altitude of the assigned flight level by the wingman is allowed only after the leader has been detected. Pair join-up should be reported by the leader to the flying control officer or the command post.

A typical error usually committed when performing join-up in a loop is the wingman failure to maintain the assigned time interval on receiving the "Turn" command as well as failure to hold flight altitude due to the diversion of the wingman's attention while he is in search for the leader.

To join up by varying flight speed, on breaking through clouds and climbing to the assigned join-up level, the leader starts to fly level at an indicated speed of 500 to 550 km/h. On breaking through clouds the wingman starts to fly level at an altitude of 500 m below the assigned

flight level and true airspeed of 900 km/h (with join-up level being less than 6000 m) or 1000 - 1100 km/h (with join-up level being above 6000 m). To detect the leader in performing join-up by varying the airspeed, the wingman may use the radar sight. On visually detecting the location of the leader, the wingman should decrease the flying speed and join him up. Pair join-up completed, the leader must report this to the flying control officer or to the command post.

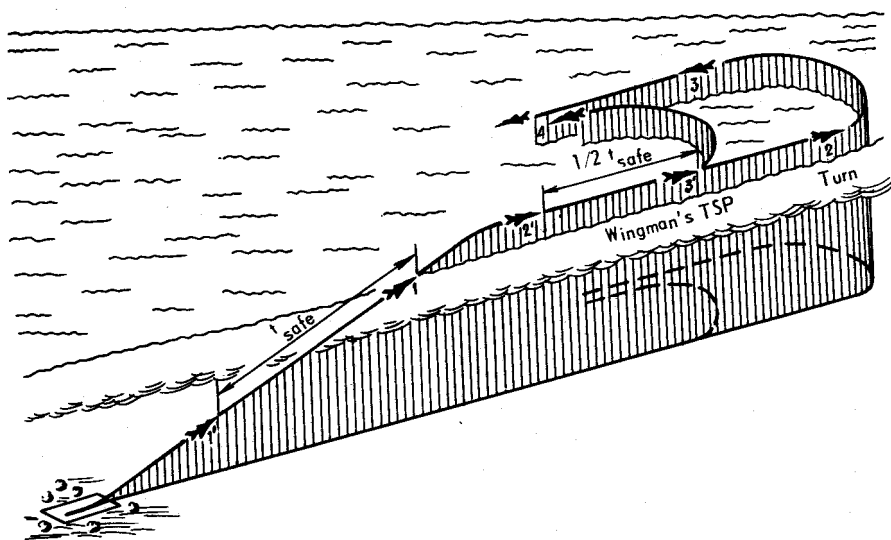

FIG. 86. PAIR JOIN-UP IN LOOP DURING UPWARD CLOUD PENETRATION SUCCESSIVELY IN SINGLE AIRCRAFT IN SAME DIRECTION

Cloud breaking in pair in loose formation is used provided that the pilots involved are sufficiently experienced in performing formation flights under IFR weather conditions and in weather not below the assigned minima. Perform takeoff in pair. On attaining an altitude of 150 to 200 m and retracting the landing gear and the wing flaps the wingman must perform an outside turn through an angle of  $15^\circ$  and report this to the leader. Climbing should be effected by both pilots at the assigned speed. On attaining an altitude of 1000 m the pilots must turn off the afterburners. At an altitude of 3000 m the wingman

must perform a corrective turn to intercept the course parallel to that of the leader.

Breaking through clouds and attainment of the assigned altitude should be reported to the flying control officer. On making the report the pilots must level off the aircraft. In this case, the wingman should fly the aircraft at an altitude 500 m below the leader's flying altitude. On visually detecting the leader, the wingman must perform regrouping. Very thick clouds, bumpiness, and etc., considerably diminish the probability of join-up. In view of such conditions, the CP combat control officer must always be ready to render help to the pilots to speed up their join-up by giving appropriate commands.

#### 4.2. Pair Break-Up Beyond Clouds

The assigned mission accomplished, it is necessary to approach the line of descent or the outer beacon and fly the maneuver to ensure pair break-up and subsequent downward cloud penetration in single aircraft. Break-up of the pair of the МиГ-25ПД aircraft beyond clouds may be effected either in the loop or on the descent initiation line.

Break-up of pair when executing the loop is effected during landing approach by performing the maneuver "turn to the estimated angle" (Fig. 87). The outer beacon passed and the turn to the estimated angle completed, the leader should start the stop-watch and perform a joint flight to the point of turn to hit the landing course. On expiration of the estimated time, the leader should give the "Break-up" command and further execute the assigned maneuver to perform a straight-in approach. The wingman performs the corrective turn to intercept the course reverse to the landing one, starts the stop-watch on the "Break-up" command and performs the turn to intercept the landing course on expiration of the time period equal to the half of the safe time interval. Landing course turn completed, the wingman should increase the duration of the level flight leg by the half of the safe time interval.

The turn to intercept the landing course must be effected by both pilots at a bank of  $30^\circ$ .

Break-up of pair on descent line may be effected for the purpose of breaking through clouds from any direction relative to the runway centre line or for break-through to hit the estimated glideslope point.



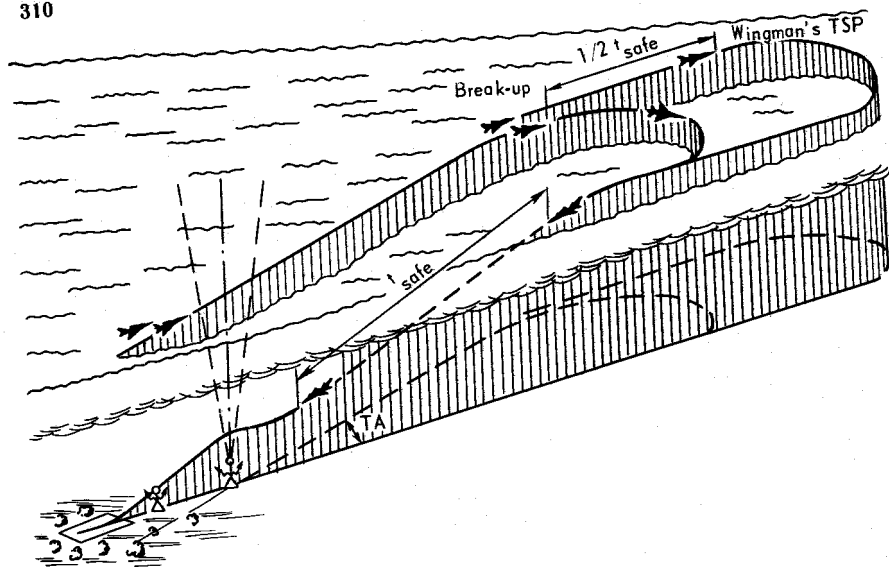

FIG. 87. PAIR BREAK-UP IN LOOP

To ensure pair break-up for break-through from any direction with respect to the runway centre line, the command post controller must lead the pair to the break-up line after having ascertained that the pair proceeds in the combat formation appropriate for break-up (Fig. 88).

On obtaining the command to proceed to the break-up line, the leader establishes an indicated speed of 600 km/h. At a distance of 20 to 25 km to the break-up line the CP combat control officer gives the pair a command to perform a turn to  $RB = 90^\circ$  ( $270^\circ$ ) at a bank of  $45^\circ$ . On attaining  $RB = 90^\circ$  ( $270^\circ$ ), the leader gives the "Break-up" command, performs a corrective turn rightward (leftward) to take the course to the outer beacon and establishes the assigned descending mode, maintaining  $RB = 0^\circ$ .

The wingman continues flying at  $RB = 90^\circ$  ( $270^\circ$ ) for a period of time equal to the safe time interval and then repeats the actions of the leader.

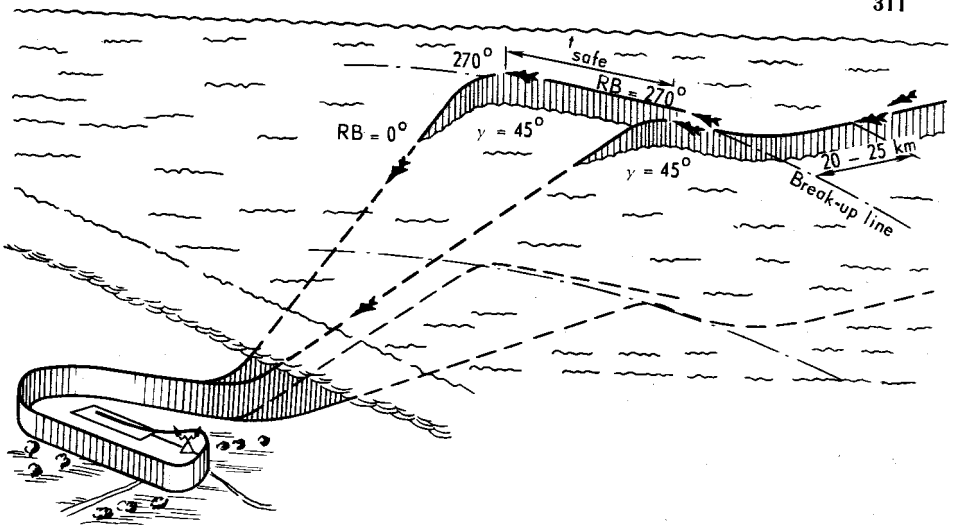

FIG. 88. PAIR BREAK-UP ON DESCENT LINE FOR DOWNWARD CLOUD PENETRATION FROM ANY DIRECTION

After downward cloud penetration the leader must visually detect the airfield and join the circuit to hit the nearest turn.

This method is used in case of high cloud bottom with the maximum elevation of the terrain in the area of flights taken into consideration.

To ensure pair break-up for break-through to hit the estimated point of glideslope descent, at a distance of 20 to 25 km to the break-up line the CP combat control officer given the pair a command to perform the turn to hit the course perpendicular to that of descent upon completion of regrouping the pair into the respective echelon formation (Fig. 89). Further, the leader gives a "Break-up" command, takes the assigned course and establishes the rate of descent. Breaking-up completed, the wingman proceeds along the straight line for a period of time equal to the safe time interval, and then performs a turn to intercept the break-through course assigned by the CP combat control officer. Furtheron, the wingman repeats the actions of the leader.

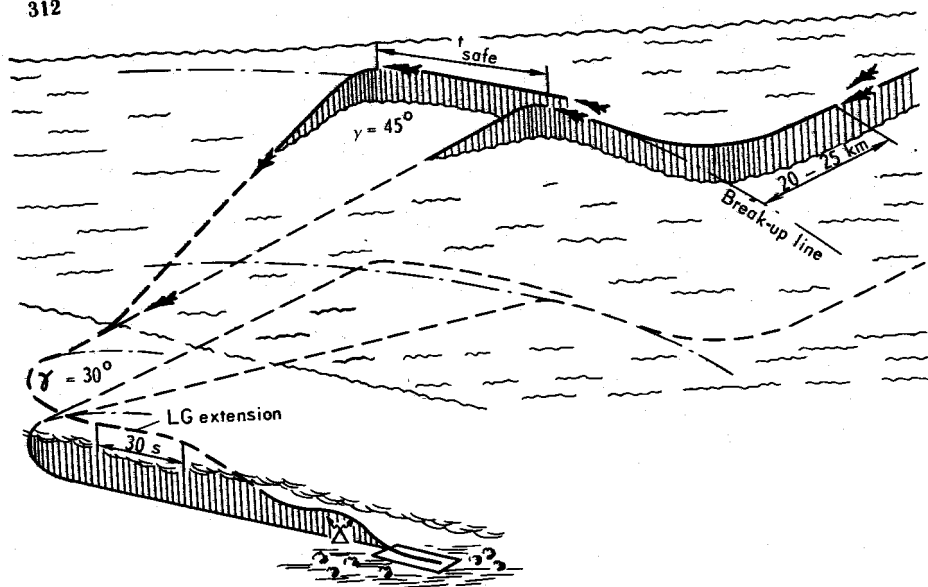

FIG. 89. PAIR BREAK-UP ON DESCENT LINE FOR DOWNWARD CLOUD PENETRATION TO HIT ESTIMATED POINT

As the pair descends the CP combat control officer (ground-controlled approach team) should introduce corrections in the heading and rate of descent of the aircraft proceeding to the estimated point.

The landing gear should be extended after performing a turn to hit the landing course within a 30-s leg.

#### 4.3. Section Flights

Upward cloud penetration is effected by a section of the МиГ-25ПД aircraft successively in single aircraft or in pairs in the loose combat formation.

Upward cloud penetration successively in single aircraft is commonly made use of in takeoff under weather minima or below the weather minima, as well as under such circumstances when the condition of the runway makes it impossible to carry out takeoff in pairs. Such being the case, the section should take off in single aircraft at a safe time interval.

On attaining an altitude of 1000 m the pilots should turn off the afterburners and continue climbing at maximum power setting. After break-through beyond the clouds and gaining an assigned altitude the pilots bring their aircraft into level flight and report the matter over the radio.

When joining up in a loop, on obtaining the report from the wingman of the second pair on attainment of the assigned altitude, the section leader gives the "Left (right) turn" command and performs a turn towards the outer beacon and climbs to the assigned flight level (Fig. 90). The wingman of the section leader performs a turn to the outer beacon on expiration of a time period equal to the half of the safe time interval. For the leader and his wingman of the second pair the waiting time is increased by 50% and the total safe time interval, respectively.

In the course of the turn or upon completion of the turn the wingmen must find the preceding aircraft and join them up on the straight line successively.

Upward cloud penetration successively in pairs in loose formation is performed as follows. The section takeoff is performed in pairs at a safe time interval. When aloft, each pair performs cloud penetration in loose combat formation, with the wingman performing an outside turn through an angle of  $15^{\circ}$ .

Section join-up beyond the clouds is initially effected in pairs. Furtheron, the succeeding pair should join up the preceding pair in a loop or by varying the flight speed (Fig. 91).

To ensure the section join-up in the loop, the preceding pair on attaining the assigned altitude continues flight over a period of time equal to the half of the safe time interval and then performs a turn to the outer beacon. The succeeding pair on climbing to an altitude 500 m below that of the preceding pair performs a turn to the outer beacon in the horizontal plane. When performing the turn or after it the pilots of the succeeding pair must visually detect the preceding pair and join them up on a straight line. Section join-up completed, the section leader reports this to the flying control officer or the command post.

To ensure section join-up by varying flying speed, the preceding pair proceeds in level flight at an indicated speed of 500 to 550 km/h on breaking through the clouds and climbing to the assigned flight level. The succeeding pair must climb to an altitude 500 m

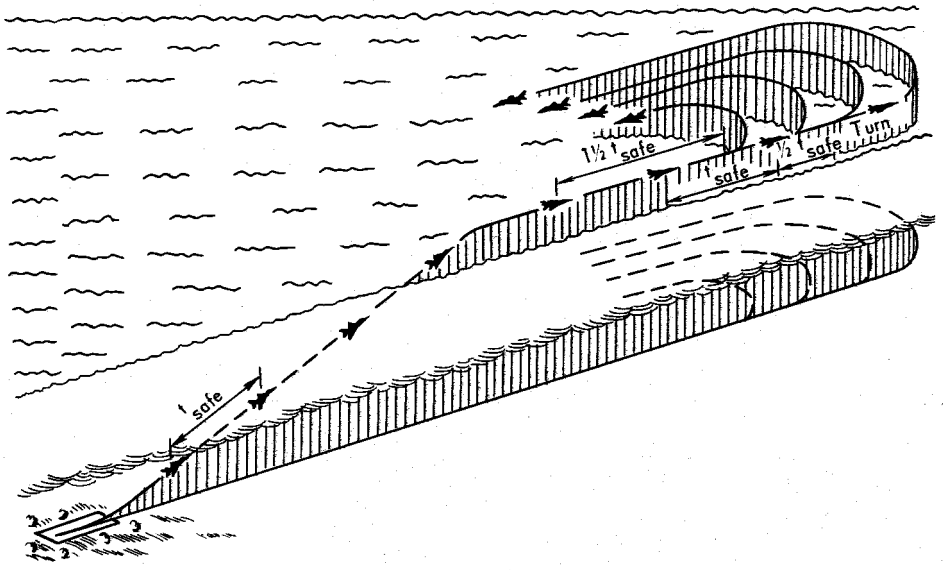

FIG. 90. SECTION JOIN-UP IN LOOP DURING UPWARD CLOUD PENETRATION IN SINGLE AIRCRAFT IN CONSECUTIVE ORDER IN SAME DIRECTION

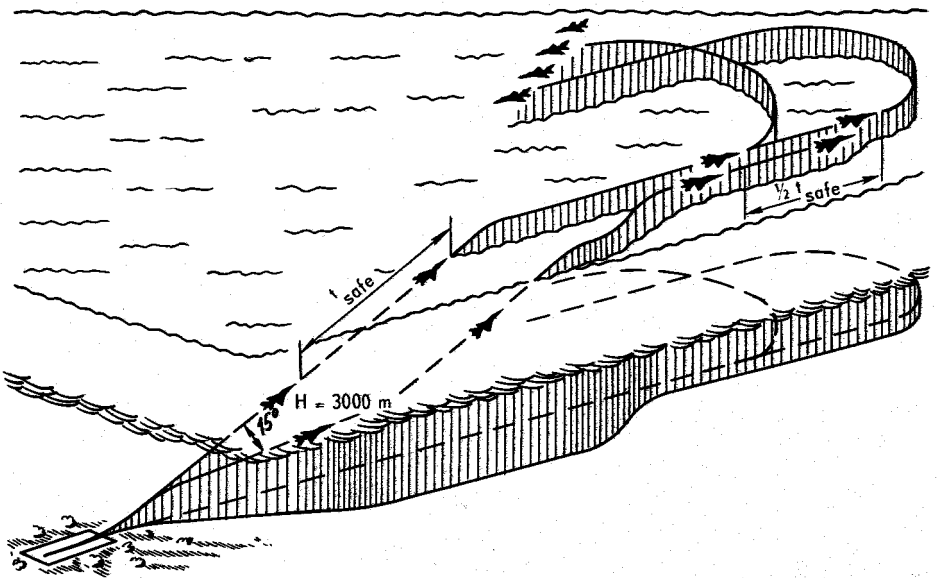

FIG. 91. SECTION JOIN-UP IN LOOP DURING UPWARD CLOUD PENETRATION SUCCESSIVELY IN PAIRS, IN LOOSE FORMATION AND IN SAME DIRECTION

below the preceding pair establishes a true airspeed of 900 km/h in level flight (with the join-up level being less than 6000 m) or 1000 - 1100 km/h (with the join-up level established being above 6000 m).

The preceding pair visually detected, the succeeding pair decreases the flying speed and joins up the preceding pair.

#### 4.4. Section Break-Up Beyond Clouds

The mission accomplished, the section commander leads the formation either to the descent initiation line or to the outer beacon and executes a maneuver to perform section break-up and further downward cloud penetration in single aircraft. The procedure for section break-up beyond the clouds is similar to that involved in the pair break-up in the loop or on the descent initiation line.

Section break-up in a loop is used during landing approach by performing maneuver "turn to estimated angle" (Fig. 92). On flying over the outer beacon and turning to the estimated angle, the section commander must start the stop-watch, perform a corrective turn to hit the course reverse to the landing one on the expiration of the estimated time and give the "Break-up" command. Furtheron, he performs the assigned maneuver to ensure straight-in approach.

The wingman of the section commander starts the stop-watch upon completion of the turn to hit the course reverse to the landing one and receiving the "Break-up" command. On expiration of half of the safe time interval he repeats the maneuver effected by the section commander.

The pilots of the succeeding pair should start the stop-watches at the moment of the preceding aircraft turning to the landing course. The pilots of the succeeding pair must always proceed on the landing course for a time equal to half of the safe time interval relative to the preceding aircraft and then perform a maneuver for straight-in approach.

All the pilots perform the landing course turn with the same bank angle.

After completing a turn to the landing course, the wingman of the section commander proceeds flying in level flight for a period of time equalling half of the safe time interval. The leader of the second pair should proceed in level flight for

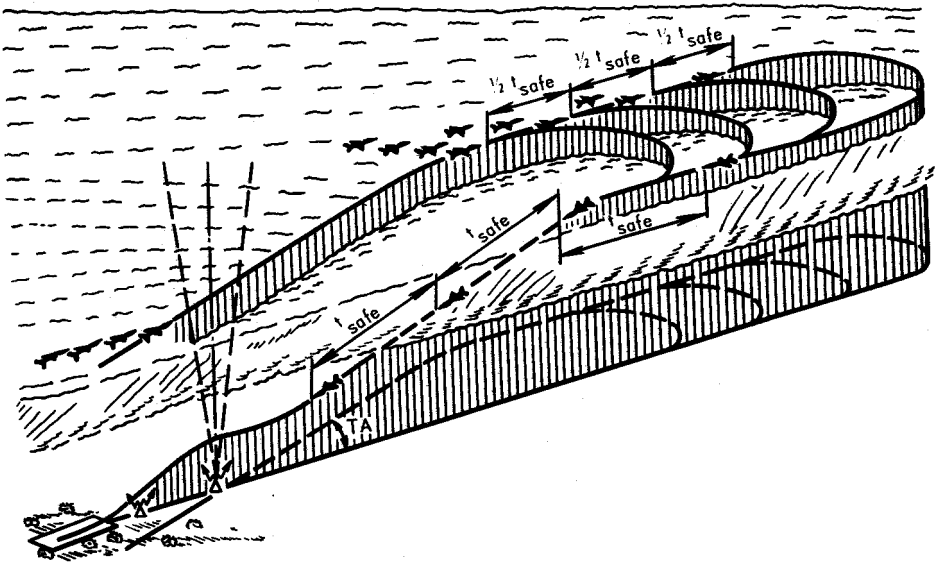

FIG. 92. SECTION BREAK-UP IN LOOP DURING LANDING APPROACH INVOLVING "TURN TO ESTIMATED ANGLE" MANEUVER

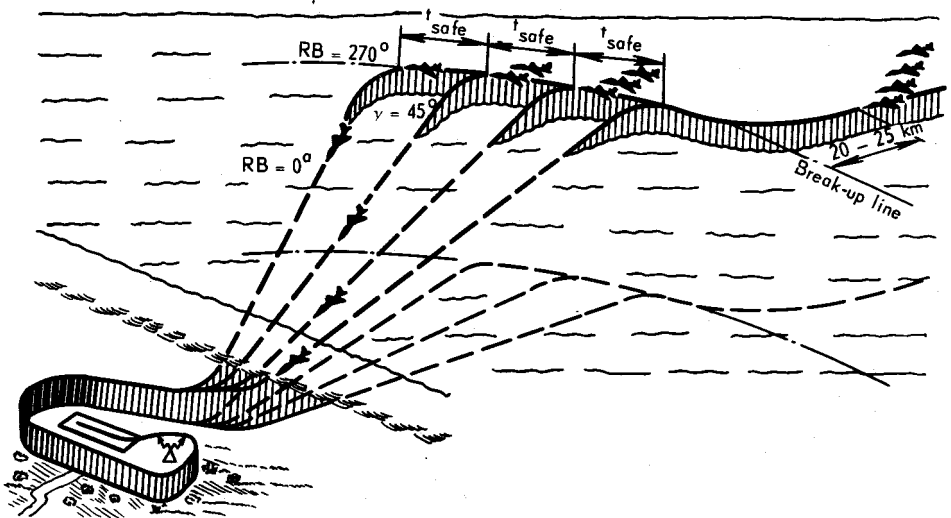

FIG. 93. SECTION BREAK-UP ON DESCENT LINE FOR DOWNWARD CLOUD PENETRATION FROM ANY DIRECTION

a period of time equal to the safe time interval, whereas his wingman, for a time equal to one and a half of the safe time interval. On expiration of the above said time the pilots must successively extend the landing gears, establish an airspeed of 550 km/h, and bring the aircraft into descent at the assigned flying regime.

Section break-up on the descent initiation line is performed to break clouds from any direction relative to the runway centre line or to break through clouds to hit the estimated point of glideslope descent.

To accomplish section break-up for breaking clouds from any direction with respect of the runway line, the CP combat control officer gives a course to ensure section approach to the break-up line in an appropriate combat formation (Fig. 93). The section commander should regroup the section into the required echelon formation and establishes an indicated airspeed of 600 km/h.

At a distance of 20 to 25 km from the break-up line the CP combat control officer gives command "Left (right) turn to RB =  $90^{\circ}$  ( $270^{\circ}$ )". In response to this command, the section must make a turn at a bank of  $45^{\circ}$ . With the instrument readings equal to RB =  $90^{\circ}$  ( $270^{\circ}$ ), the section commander gives the "Break-up" command, makes a corrective turn towards the outer beacon and establishes the assigned rate of descent. On performing downward cloud penetration beyond the clouds the section commander should visually detect the airfield and enter the traffic circuit to the nearest turn.

The wingman pilots proceeding on the course of RB =  $90^{\circ}$  ( $270^{\circ}$ ) successively perform turns towards the outer beacon at the safe time intervals with respect to the preceding aircraft and then repeat the actions of the section commander.

This method is used when the cloud ceiling is high with due regard to the maximum terrain elevation in the flying area.

To accomplish section break-up for breaking through clouds to intercept the estimated point of glideslope descent, the CP combat control officer brings the section to the break-up line. At a distance of 20 to 25 km from the break-up line the CP combat control officer gives a command to the section to make a turn to hit the course perpendicular to the descent course. Further, the CP combat control officer gives a command to break up and indicates the cloud penetration course (Fig. 94). Break-



ing up completed, the section commander performs a turn to intercept the assigned course and establishes the rate of descent. The wingman pilots proceed on the straight line for a period of time equal to the safe time interval with respect to the preceding aircraft. On expiration of this period, the succeeding pilots successively perform a turn to hit the course assigned by the CP combat control officer, and then repeat the actions of the section commander.

In view of the fact that in the course of formation flight at the break-up line the distance from the estimated point is commonly variable, the assigned flight courses and the vertical speeds of descent to the estimated point may differ from each other. Therefore, the CP combat control officer (ground-controlled approach post) must correct the flight course of each aircraft of the formation and the descent regime in the course of the formation descent to the estimated point.

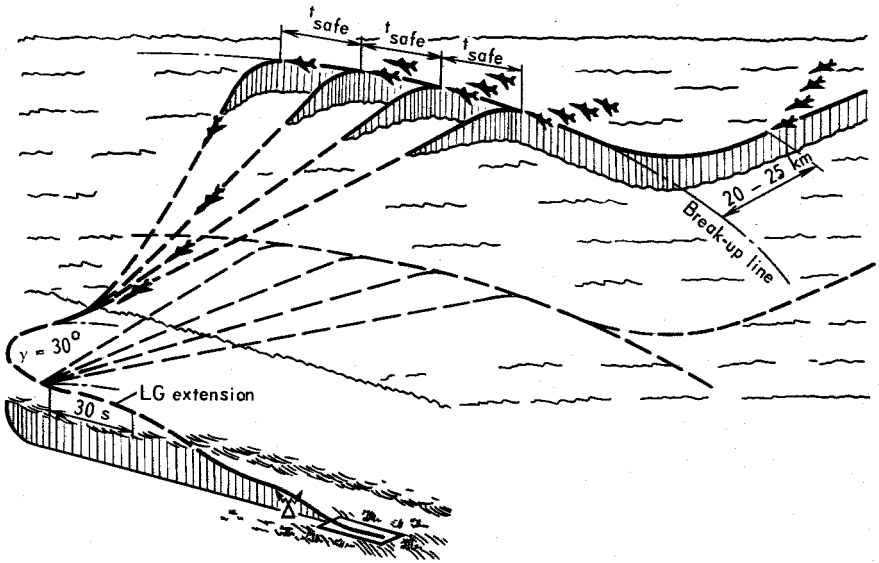

FIG. 94. SECTION BREAK-UP ON DESCENT LINE FOR DOWNWARD CLOUD PENETRATION TO HIT ESTIMATED POINT

## 5. RECOMMENDATIONS TO COMMANDER (INSTRUCTOR) ON TRAINING PILOTS IN FORMATION FLIGHTS

A successful accomplishment of a formation flight depends on the pilot proficiency of each pilot of the formation and the leadership of the formation leader.

The leader (commander) must:

- (a) know the level of pilot proficiency of the wingman pilots and personally check their readiness to accomplish each formation flight;
- (b) strictly maintain the assigned flight profile and regime; give distinct commands over the radio about changes in flight regime and maneuvers to be done prior to changing attitude;
- (c) conduct continuous orientation, watch the actions of the wingmen and keep control over them;
- (d) keep check of the fuel remainder in the aircraft of the formation;
- (e) correctly evaluate the meteorological and air situation; take skilful decisions;
- (f) carry out leadership during formation break-up and landing approach;
- (g) effect thorough critique upon completion of the formation flight and point out all the mistakes committed during flight, especially those which have made the air situation more complicated or endangered the flight safety.

When training flying personnel for team flying, the task of the wingman pilots is reduced to obtaining skill in coordinated and purposeful actions corresponding to those of the leader. These actions will allow the pilot to maintain his position in the combat formation and maintain the assigned flight regime and to accomplish the required maneuver.

The successful accomplishment of formation flight is largely determined by a thorough ground drill in observing the procedures and sequence of performing all the flight elements.

The object of the combat formation flight training is to make each pilot properly know the following:

- (a) the sequence of engine starting, taxiing procedure and arrangement of aircraft prior to takeoff;
- (b) takeoff sequence, climbing (cloud penetration) and join-up procedure;

- (c) sequence of carrying out the mission assigned and engine power settings with reference to the stages of formation flight;
- (d) maneuvering and regrouping procedures during formation flight;
- (e) procedure of look-out and distribution of observation zones in air;
- (f) break-up procedure and landing sequence;
- (g) organization of formation flight control and rules of radio communication;
- (h) actions to be taken in formation flight under emergency conditions.

When preparing for formation flight particular attention should be given to the organization and ensurance of flight safety. Formation flight safety largely depends on the capability of each pilot to strictly maintain his position in the combat formation, rapidly response to the changes in the air sutuation, coordinate his actions with those of the rest of the pilots of the combat formation in order not to put them in an awkward situation.

During the training flights for acquiring skill in visually determining the assigned intervals and distances, it is necessary that the aircraft on the airfield be arranged in accordance with this or that combat formation. During training course, the pilot should remember the position, linear dimensions, and angles of sight of the characteristic parts of the neighbouring aircraft with respect ot the various points (lines) of the canopy of his own cabin.

It is recommended that the formation flight training be terminated by playing the flight in a "flying on foot" manner.

In formation flight, the wingmen must given most of their attention to following the actions of the leader and visualization of the assigned air space. The time left for taking the readings off the instruments and manipulating the controls in the cabin is considerably reduced. Therefore, the pilot undergoing a formation flight training should systematically improve his skill in handling the equipment arranged in the cabin under the conditions when the greatest part of his attention must be given to the observation of the air space and the leader.

The methods of training flying personnel for piloting aircraft in pair (section) combat formations must be in compliance with the basic principle of training, that is a constant rate of advance should be maintained at all times. Experience and skill gained by the pilots in team flying on the previously mastered types of aircraft should also be taken into consideration.

Training of flying personnel who are going to master the combat formation flying technique for the first time should be commenced from twin flights with the use of a combat trainer.

The trainee is to be admitted for independent flights on a combat aircraft only after it has been established that the trainee has acquired perfect skill in joining up the leader and maintaining the assigned position in the formation at various flying speeds and stages with an accuracy sufficient to ensure flight safety.

In case of prolonged intervals in flights, training formation flights are allowed only after the pilots have restored their skill in solo flying. Check twin flights may also be performed, if necessary.

Skill in team flying at subsonic speeds acquired, the pilots may proceed to training for performing supersonic formation flights.

Only pilots who have successfully completed the supersonic solo flight training course may be allowed for supersonic twin (section) combat formation flights.

During flights in the pressure helmet, the leader's field of vision of the wingman is limited. Apart from this, the leader is too late to notice the mistakes committed by the wingman even during close formation flight. Therefore, the wingman must report his mistakes to the leader.

During first team flying the leader should correctly select the engine power setting, smoothly vary the flight regime, avoid abrupt movements of the throttle levers and out-of-place hastiness in changing aircraft attitude. All this being ensured, the wingman will cope with the first flights and acquire self-confidence. This will also enable him in future to cope with more complicated and vigorous maneuvers at great roll and pitch angles without difficulty.

In the initial stages of training flying personnel in team flying, ground and air control should be effected over the radio.

Prior to effecting each maneuver and before recovery from this maneuver, the wingman must be warned about it by the leader. As the pilots acquire the team flying technique, the commander must do his best in training the wingmen to properly effect twin (section) combat formation flights by visual signals and use radio only in case of necessity.

It is permissible that radio commands be curtailed in flight to a certain degree provided that each pilot can unmistakably distinguish the commander's voice.

## *Chapter 7*

### **INDIVIDUAL NIGHT FLYING UNDER VFR AND IFR CONDITIONS**

#### **1. PHYSIOLOGICAL PECULIARITIES INVOLVED IN NIGHT FLYING**

Mastering night flight with the use of the МиГ-25МД aircraft is one of the vital objectives of training.

A great number of instruments and controls demand from the pilot performing a night flight a profound skill in handling the aircraft equipment arranged in the cabin, distribution and transfer of attention, as well as effecting change-over from instrument to VFR flight and vice versa.

Prior to night flight training, flying personnel must thoroughly study the aircraft night flying equipment in order to be able to properly handle it. To this end, it is essential that personnel systematically conduct purposeful night cabin drills. The cabin drill should involve operating the equipment at all flight stages beginning from the engine starting before takeoff to engine shut-down after landing.

Particular attention must be given to the procedure to be followed in cases of emergency.

The pilot must be trained to such an extent that he be able to manipulate the selector switches, levers, buttons, and other controls automatically.

Proceeding from the above said it is evident that night flight demands from the pilot a great amount of attention and high capacity for work.

## 2. PECULIARITIES OF CIRCLING FLIGHTS

Prior to night flight, check the serviceability of the cabin illumination facilities in addition to a routine check-out. The procedures for checking the lighting equipment with the ground power supply turned on are as follows:

(1) check position of the floodlights and set them to the required position;

(2) manipulate the integral and floodlight dimmer knobs to obtain the desired level of lighting (first, adjust the floodlights);

(3) check the serviceability of the white light with the use of a rheostat;

(4) set the screens of the indicator lamps on the instrument board and panels to the night flying position;

(5) switch on the position lights to operate at constant duty;

(6) check serviceability of the land/taxi lights. To this end, put the land/taxi lights selector switch to position LANDING (НОСАД.) and then to TAXI (ПУЛЕЖ.); ascertain that the direction of the beam is correct; the checkup completed, set the selector switch to RETRD (УБРАЖН) position;

(7) set the anti-dazzle screen in the operating position: (pull it towards yourself) and adjust the screen in height;

(8) close the side anti-dazzle screens on the hinged hood.

Engine starting and run-up should be carried out in the same sequence as in the daytime.

Prior to taxiing out, give command "Remove chocks" over the intercom system and duplicate it by blinking the position lights. After ascertaining that the wheel chocks have been removed and the technician has disconnected the intercom system wire, turn on the land/taxi lights and start taxiing out.

On taxiing out on the runway, position the aircraft strictly in alignment with the runway centre line and switch off the land/taxi lights. Ascertain that the takeoff and side runway lights are projected at the same angle (left- and right-hand) with respect to the nose fuselage.

The takeoff procedures involved in night operation are similar to those to be followed in daylight. The direction of takeoff run should be maintained by reference to the runway lights. In bright night, the position of the fuselage nose during takeoff run is determined by reference to the horizon and the runway

lights. In dark night, orientation is effected by reference to the runway and artificial horizon lights (takeoff lights).

The aircraft lift-off is determined by the pilot by the cessation of bumps of wheels against ground and the downward displacement of the runway lights.

When the wheels have cleared the ground, the pilot should continue climbing, checking the position of the aircraft by reference to the flight director indicator and rate-of-climb indicator without changing the position of the controls.

On attaining an altitude of 15 to 20 m, retract the landing gear, and retract the flaps after reaching an altitude of at least 100 m.

The night circling flight pattern is similar to that of the daylight flight but in addition involves considering the peculiarities of the outlines of landmarks in darkness.

Entry into the final turn should be effected at the moment when the angle of sight with respect to the runway entrance lights account for 20 to 25°.

It should be taken into account that determination of the right moment of the final turn in darkness presents certain difficulties and requires practical skill. Entry into the final turn, therefore, in first flights should be effected a little bit earlier in order to correct the direction of landing approach by decreasing bank rather than by increasing it.

Upon recovery from the final turn and flying over the outer beacon, set such a glide angle so as to enable the aircraft to descend in the runway threshold lights.

The glide angle shall be maintained by reference to the runway lights. To properly maintain the required glideslope, use the inner marker beacon or the code neon beacon (CNB) commonly located in the vicinity of the inner marker beacon. In all the cases the rate of descent should not exceed 5 to 6 m/s.

The procedures of night landing on the runway lit by floodlights have no differences with those used in daylight landing but require excessive look-out. In darkness the distance to the runway or any other lit reference mark seems to be considerably smaller in size than in daylight. Under such circumstances the pilot may experience a desire for premature descent. In this connection it needs to be said that the pilot should check the rate of descent by referring to the instruments as frequently as possible. On attaining an altitude of 30 to 20 m, the pilot must shift his eyes towards the flare-out initiation point.



When above the runway lit by the second floodlight at an altitude of 8 to 10 m, diminish the angle of descent by applying smooth back stick pressure so as to cease descent at a height of not more than 1 m.

At the end of flare-out, smoothly move the throttle levers to IDLE position. As the aircraft descends, apply a back stick pressure to enable the aircraft to assume such a position for landing that it could land on two main L.G. wheels.

On touching down the ground, shift your glance forward in the direction of landing roll, check automatic deployment of the drag chute by typical shock or manually allow it to deploy, and start applying the brakes. The direction of landing roll should be maintained by reference to the side runway lights. Taxiing operations must be carried out with the land/taxi lights on.

### 3. PECULIARITIES INVOLVED IN LANDING ON NON-FLOODLIGHTED RUNWAY, WITH LAND/TAXI LIGHTS SWITCHED ON

The procedures for landing on a non-floodlighted runway with the land/taxi lights switched on present considerable difficulties and require concentration of pilot's attention in determining an appropriate flare-out and holding-off altitude.

The procedures for effecting landing approach with the use of the land/taxi lights are to be followed in the same sequence as in case of landing on the floodlighted runway, the only difference lying in that the gliding and flare-out initiation speed must be by 10 km/h higher.

Accomplishment of night landing on a non-floodlighted runway, with the land/taxi lights switched on, is considerably complicated by the fact that it becomes more difficult to estimate the flare-out point and maintain the glideslope in gliding after flying over the outer beacon. Under such conditions, it is particularly difficult to determine the flare-out initiation height.

Upon completion of the final turn, the glideslope must be the same as in landing approach onto the runway lit by the floodlights.

Switch on the land/taxi lights by setting the above selector switch to LANDING position after flying past the outer beacon.

Upon extension of the land/taxi lights, the luminous flux does not reach the ground surface yet and creates a light screen

in front of the aircraft, thus impeding the visual control over the accuracy of landing approach and flight altitude.

After passing over the inner beacon, descend the aircraft to the flare-out point, taking the runway threshold lights as such. When gliding to a height of 30 m, the aircraft should be piloted by reference to the instruments, checking the direction of landing approach and flight altitude visually by reference to the threshold lights. On reaching a height of 30 to 20 m, shift your glance towards the runway lit by the land/taxi lights and concentrate your attention on determining the flare-out initiation altitude.

As the aircraft descends along a normal glideslope, the luminous intensity of the land/taxi lights grows. At a height of 8 to 10 m, start aircraft flare-out by applying a smooth back stick pressure so as to cease it at a height of 1 m. At the moment of flare-out initiation, the light spot on the ground produced by the land/taxi lights is still weak and blurry. Therefore, in order to determine the height, the pilot must use the left-hand row of the runway lights. In the course of flare-out the brilliancy of the light spot on the ground grows to become perfectly sufficient for the visual determination of height. At the end of flare-out, set the throttle levers against the idle rating limit stops. The procedure for holding-off and landing are similar to those involved in landing on the floodlighted runway.

When performing landing with the land/taxi lights switched on, it is important to maintain the assigned glideslope. Premature descent and pull-up at a low altitude at a small glide angle must be avoided at all times, for the light beam produced by the land/taxi lights in this case is parallel to the surface of the ground and does not illuminate it almost.

It is not recommended to effect landing on the non-floodlighted runway with the land/taxi lights switched on when the force of the cross wind (particularly from the left side) exceeds 7 m/s as the wind drift encountered in gliding and landing till touch-down is counteracted by varying the course. Under such conditions, the pilot turns the aircraft into the wind, thus deteriorating the conditions for visualization of the runway lights and visual determination of the flying altitude. The luminous flux produced by the land/taxi lights as a result will be directed to the side. All this considerably decreases the pilot's possibili-

ties of correctly determining the flare-out initiation altitude and makes landing a more difficult task.

If the necessity in going around arises, the pilot should make the respective decision well before reaching an altitude of 50 m. Before go-around, retract the land/taxi lights after bringing the aircraft into climb.

In dense haze, rain, or snowfall, landing with the land/taxi lights switched on shall be avoided, as an intense light screen in front of the aircraft impedes spatial orientation, perception of the runway lights and landing approach, and thus the flight safety is endangered.

#### 4. PECULIARITIES INVOLVED IN NIGHT MANEUVERING, LOW-ALTITUDE AND STRATOSPHERE FLIGHTS

The flying technique in the maneuvering area and the procedures for distribution and transfer of attention in maneuvering are similar to those used in daylight flight, except that the night flight regime is maintained and checked fully by reference to the instruments.

When flying the aircraft at a bright night, when the horizon is visible, it can be periodically used as a reference for checking the aircraft attitude.

Finding the position of the aircraft in darkness is more complicated due to the difficulties encountered during the estimation of the distance to the light reference marks. Therefore, upon completion of each maneuver, it is necessary to recheck the position in the area by determining the aircraft attitude relative to well distinguishable reference points which are visible in various azimuths.

Radio aids are the primary means used for finding the position of the aircraft in flight. The position of the aircraft in the maneuvering area is determined to the highest degree of accuracy with the use of the PCBH-6C short-range radio navigation and landing system by the distance to the ground radio beacon and the current azimuth. In addition, the pilot should use the automatic direction finder and the information furnished from the command post (ground-controlled approach system) for the purpose.

Prior to each maneuver, it is highly important to establish the assigned flight regime and ensure the appropriate trim of the aircraft. Entry into and recovery from the maneuver should

be effected in the direction of the bright side of the horizon, illuminated reference point or the marker beacon (the PCEH beacon).

During high-altitude night maneuvering flight, it is highly important that the peculiarities associated with the deterioration of the aircraft maneuverability should be taken into consideration.

When flying various maneuvers, it is necessary that the pilot should do his best to attain maximum accuracy in coordinating the movements of the control surfaces and bear in mind that it is much more difficult to correct pilot blunders at night than in daylight.

A comparatively poor or zero vision of the ground, horizon, and sky in night flight considerably complicates visual flying and sometimes makes it completely impossible. Visual determination of the aircraft attitude and flight altitude and direction therefore becomes an extremely difficult matter.

In night flight at low altitude, it is very difficult and even impossible, with no illuminated reference points provided, to carry out visual orientation.

In order to prevent spontaneous loss of height, trim the aircraft with the use of the stabilizer trimming mechanism making allowance for an insignificant pitch-up so as to enable the aircraft to further climb in the event of decrease of the stick pressure.

It is important that the pilot fly the aircraft by consulting the instruments and periodically checking the aircraft position by reference to the natural horizon, if possible. Prior to transition to visual observation, it is necessary that the pilot settles down level flight conditions by reference to the instruments and only after this, shifts his glance beyond the cabin, checking the aircraft attitude by referring to the instruments.

It is an extremely difficult task to visually determine the flight altitude and angle of pitch during night flight. These flight parameters should be determined only with the use of the altimeter and artificial horizon.

To bring the aircraft into a glide, smoothly perform double movements of the control stick, strictly checking the readings of the altimeter and rate-of-climb indicator.

When flying the aircraft at altitudes below 600 m, check the above parameters by reference to the radio altimeter. Prior

to flight, set the radio altimeter indicator to the lowest permissible altitude.

In night flight, the pilot provided with a high-altitude outfit has to face considerable difficulties in operating the equipment installed in the cockpit. This should be taken into account when planning night stratosphere supersonic flights.

When climbing at a subsonic speed, particularly at augmented power setting, the aircraft has such a pitch angle that the natural horizon is screened from the pilot by the nose fuselage. Such a condition demands that even in bright moonlit night the aircraft should be flown on instruments. Check the attitude of the climbing aircraft by reference to the artificial horizon, rate-of-climb indicator, altimeter, and airspeed indicator. The pilot can visualize light reference points in climb only at a high angle with respect to the longitudinal axis of the aircraft. To ensure track monitoring, therefore, it is necessary to select characteristic well illuminated landmarks located off the track line.

When climbing at a supersonic speed, visual orientation is practically impossible. The pilot can check the aircraft attitude only by referring to the instruments. It is not recommended that the pilot divert his attention off the instruments even for a short period of time.

##### 5. PECULIARITIES INVOLVED IN NIGHT FLIGHTS UNDER IFR CONDITIONS

Night flights in clouds, beyond clouds and in low visibility conditions are the most complicated elements of flying technique demanding profound skill in prolonged instrument flying. From these considerations only the pilots skilled in daylight IFR and night VFR flying may be permitted for night flights under IFR weather conditions.

Upward and downward cloud penetration regimes, maneuvering to hit the landing course are the same as in daylight flight. Night flying under IFR weather conditions as compared to daylight flights has some peculiarities.

Under low visibility conditions the outlines of clouds are undistinguishable at night and the surrounding terrain is blurred against the dark background of clouds. The natural horizon is therefore invisible, visual determination of the distance to the ground is impossible, and the pilot is confronted with dif-

difficulties in determining the moment of the aircraft approaching to clouds, as well as the moment of entry into and recovery from the clouds.

In a common case, cloud entry almost always takes the pilot by surprise. Therefore, just after bringing the aircraft into climb and retraction of the landing gear and flaps, the pilot should fly the aircraft only on instruments and be ready for flight in clouds at all times. Determination of the nature of clouds and processes taking place in clouds is commonly impossible.

Flight in clouds may be accompanied by diverting side effects. Bluish intermittent lines and separate splashes aroused due to the emergency of an electrostatic charge may appear on the surfaces of the aircraft canopy. During engine operation at augmented power setting there arises a rather big light screen which expands with growing density of clouds. Insignificant light screen may be produced by the aircraft position lights.

The presence of precipitation in clouds in the form of rain drops may be detected by the water runs on the cockpit glazing. It is practically impossible to visualize ice formation on the canopy glazing.

Due to the above-mentioned peculiarities the pilot is forced to carry out practically the entire night flight under IFR weather conditions only on instruments. An exception is the flight beyond the clouds in a bright moonlit night when it is possible to visually check the aircraft attitude by reference to the natural horizon provided that the top edge of the clouds is even.

The moment of cloud entry in upward cloud penetration is determined by deterioration, and further, by a complete invisibility of the light landmarks, as well as by occurring the light screen produced by the position lights.

Upward cloud penetration is recommended to be carried out in straight flight, especially in the initial stage of the training course. In this case prior to cloud entry, it is necessary to ascertain that the flight and navigation instruments are functioning properly and that the artificial horizon presents correct readings. The latter should be done in the first place.

In flight at high altitudes and in stratosphere beyond the clouds a starry sky may become reflected against the background

of cirrus clouds, thus misleading the pilot as to the actual altitude of the aircraft. The flight even beyond the clouds, therefore, shall be conducted only on instruments. Generally, the pilot flying the aircraft in night clouds may encounter illusions the nature and manifestation of which are identical with those commonly faced during daylight flight in clouds.

In breaking dense clouds to the bottom, especially in a bright night and dusk, the ambient illuminance clear of the cockpit varies as the flight altitude diminishes.

One must give his attention to the fact that the light beams from the light landmarks which are large in area are capable of breaking through even dense clouds and emerge in the form of light spots. Diverting one's attention and waiting for cloud exit in this case shall be avoided. Only when in full confidence that the aircraft has broken clouds to the bottom, should the pilot visually check the direction of landing approach by reference to the light landmarks and runway lights.

The above-mentioned peculiarities involved in night flight under IFR conditions require additional psychological stress which may affect the quality of flight performance and air navigation. Thus, the night flight under IFR conditions is the finishing and most important stage of instrument flight training.

#### 6. RECOMMENDATIONS TO COMMANDER (INSTRUCTOR) ON TRAINING PILOTS IN NIGHT FLYING

Timely and high-quality grounding of instructors guarantees adequate training of personnel for night flying.

Difficulties which may be encountered in night flight may cause nervous overstrain which may adversely affect the quality of piloting. This shall be well understood by the instructors in order that the quality of piloting the aircraft in darkness be ensured and the possibility of its deterioration be reduced to a minimum.

In training personnel, an instructor must strictly adhere to the approved methods and procedures and maintain a constant rate of advance.

When training personnel for night flying, particular attention must be given to training personnel in use of cockpit equipment. Cockpit drill must be conducted in darkness with the ground power supply turned on.

Considering the peculiarities of night flying which make piloting more difficult, the instructor must be particularly exact in evaluating the actions of the pilot in maintaining the preselected flight regimes. In the course of training, it is of particular importance to reveal flying technique blunders committed by the pilot and their causes.

Should the pilot commit errors during the accomplishment of certain maneuver elements, the instructor must draw the pilot's attention to these errors, determine the causes of these errors, and demonstrate, if necessary, how to correctly carry out this or that element of the flight mission assigned.

When proceeding on the landing approach course, the instructor should demonstrate the pilot how to project the leveling-off point in descent during the precision approach planning and how to project the line of the runway landing lights in order to maintain the required direction in descent and ensure accurate touch-down within the landing strip.

In check flight, the commander in charge of the pilot must provide for an unbiased checking and evaluation of the quality with which the pilot has carried out all the elements of flight to maneuvering area and circling flight, the efficiency of the pilot's look-out both on the ground and aloft, trainee's proficiency in handling aircraft, and skill for properly conducting radio communication.

First night training flights should be performed in favourable meteorological conditions, that is in bright moonlit nights and when the natural horizon is clearly visible.

When performing flights involving landing on the non-floodlighted runway, the landing lights system of the airfield must be fully engaged. It is mandatory that an experienced flying control officer capable of giving a help to the pilot should he commit a mistake during estimation for landing and landing proper.

Proceeding from the individual properties and proficiency of the pilot, it is necessary to establish the maximum permissible terms of intervals for each pilot trained for landing the aircraft with the land/taxi lights switched on. If the interval exceeds the established time limits, the restoration of the lost flying skill should be commenced from the check flights on the combat trainer.



The instructor should bear in mind that flight safety in night flying largely depends on the strict maintaining of the assigned flight regime and, especially, flight altitude. Therefore, the instructor must be exact to the pilot in the sense of maintaining the assigned flight regimes both during training on the combat trainer and solo training on the combat aircraft, using the data obtained by the flight data recording equipment, aircraft directing pattern at the command post, remarks made by the flying control officer and the landing signal officer.

*Part Two*

**COMBAT EMPLOYMENT**

## *Chapter 1*

# **COMBAT CAPABILITIES AND MAIN INFORMATION ON ARMAMENT OF FIGHTER МuГ-25ПЦ (МuГ-25ПЦА)**

### 1. COMBAT CAPABILITIES OF FIGHTER МuГ-25ПЦ (МuГ-25ПЦА)

#### 1.1. General

Combat capabilities are a maximum expected result of combat activities intended for destruction of the air enemy under particular combat conditions.

The main factors of combat capabilities are the following:

- factors characterizing the space within the limits of which the fighters carry out the combat missions;
- factors characterizing the expected results of combat activities.

Combat capabilities depend on:

- flight performances of the fighters (maximum speed, maximum maneuvering altitude, available g-loads, rate of climb, flight range and duration);
- capabilities of the airborne radar for detection and automatic tracking of targets;
- capabilities of the missiles relative to launching altitude and range, closing rate, available g-loads;
- characteristics of battle area (nature of terrain, ground echo pattern, distance from the state boundary or front line);
- capabilities of control facilities;
- presence, nature and intensity of jamming, probability of ECM taken by means of technical aids and by using the tactical methods;
- time of the day and weather conditions.

### 1.2. Range of Altitudes and Speeds of Targets To Be Destroyed

The maximum altitude of targets to be destroyed depends upon a maximum maneuvering altitude of fighter ММГ-25ПД (ММГ-25ПДС) and power-ballistic characteristics of the missiles.

The maximum maneuvering altitude is a maximum flying altitude which ensures a combat maneuvering to perform an aiming zoom.

The maximum maneuvering altitude of the ММГ-25ПД (ММГ-25ПДС) fighter is 20,000 m.

The P-40Д missiles have the best power-ballistic characteristics. This missile ensures a successful attack of an air target flying 10,000 to 12,000 m higher than the fighter. Depending upon the fighter altitude, a maximum stepped-up vertical separation of the target relative to the fighter is changed and calculated from the following formula:

$$\Delta H_{\max 1} = \begin{cases} 2 + 0.2 H_{\text{ftr}} & \text{when } H_{\text{ftr}} \leq 10 \text{ km} \\ 4 + 0.8 (H_{\text{ftr}} - 10) & \text{when } H_{\text{ftr}} > 10 \text{ km,} \end{cases}$$

where  $\Delta H_{\max 1}$  is a maximum stepped-up vertical separation (in km) relative to the fighter;

$H_{\text{ftr}}$  is a fighter flying altitude (in km).

If the missile is launched at the end of the aiming zoom, the maximum altitude of the targets being hit both from the front and rear hemispheres is 30,000 m.

The minimum altitude of the targets attacked by the fighter flying below the target is limited by terrain echo, which results in an intensive ground clutter (continuous or spot type) on the radar screen, thus hindering the target detection and lockon.

Amount of the clutter depends upon the altitudes of the target and fighter, target and ground echo pattern.

The minimum altitude of the targets being hit in the rear-cone attack is 500 m.

In the front-cone attack the minimum altitude of the target is limited by the time from the moment of target detection till the missile launch and amounts to 1500 m.

When the target is attacked against the terrain background (the IA (MB) mode), the minimum altitude of the target is limited by the altitude of operation of the missile radio fuse in response to the ground echo and amounts to 50 m.

The P-40II missile ensures the attack launched by the fighter flying with a stepped-up vertical separation relative to the target. The maximum elevation of the fighter over the target when launching the missile is 5000 m.

The maximum elevation of the fighter over the target at which the target destruction is ensured, depends upon the fighter altitude and is calculated from the following formula:

$$\Delta H_{\max 2} = \begin{cases} 1 + 0.4 H_{\text{ftr}} & \text{when } H_{\text{ftr}} \leq 10 \text{ km} \\ 5 & \text{when } H_{\text{ftr}} > 10 \text{ km,} \end{cases}$$

where  $\Delta H_{\max 2}$  is the maximum elevation of the fighter over the target (in km);

$H_{\text{ftr}}$  is the fighter flying altitude (in km).

In the rear-cone attack the maximum speed of the targets being hit depends upon the speed performances and fuel quantity of the fighter which ensure a pursuit and destruction of the target at the assigned interception line with the assigned probability.

This speed is calculated by the following formula:

$$v_{\text{tgt}} = \frac{v_{\text{ftr}}}{1.2},$$

where  $v_{\text{tgt}}$  is the maximum speed of the target being hit;

$v_{\text{ftr}}$  is the fighter speed. At altitudes lower than 11,000 m it is considered equal to the maximum true airspeed, and at altitudes higher than 11,000 m, to the best airspeed of the climb program.

The given relation of the fighter/target airspeeds is the best one. It ensures the most successful direction.

With the above-mentioned limitations taken into consideration, the maximum speed of the target being hit is:

- 1000 km/h at low altitudes;
- 2400 km/h at an altitude from 12,000 to 27,000 m.

In the forward-cone attack the maximum speed is limited by the time required for aiming, available missile g-load, maximum scan rate of the airborne radar antenna and missile homing head, and the maximum relative missile-to-target closing rate (2000 m/s) required for matching the fusing range with the missile warhead.

With the above-mentioned limitations taken into consideration, in the forward-cone attack the maximum speed of the target being hit is 3500 km/h at an altitude from 12,000 to 27,000 m and 1500 km/h at an altitude of 1500 m.

The minimum speed of the target being hit in all operating modes of the airborne radar, except for the LA mode, is not limited. In the LA mode the minimum speed is limited by projection of the target speed vector onto the fighter-to-target sighting line, i.e.

$$V_{\text{tgt proj}} = V_{\text{tgt}} \cos q;$$

$$V_{\text{tgt proj}} \geq 75 \text{ km/h,}$$

where  $\cos q$  is an attack aspect;

$V_{\text{tgt proj}}$  is a target speed vector projection onto the fighter-to-target sighting line;

$V_{\text{tgt}}$  is a target speed, km/h.

The range of altitudes and speeds of the non-maneuvering targets, destructed by the МиГ-25-40Д (МиГ-25-40ДС) complex with a minimum probability of 0.7 without a reliability taken into account and permissible stepped-up (stepped-down) vertical separations of the target relative to the fighter flying altitude when launching the P-40Д and P-40 missiles are shown in Figs 95 and 96, respectively.

### 1.3. Effectiveness Interception of Aircraft Complex МиГ-25-40Д (МиГ-25-40ДС)

The effectiveness of the complex may be evaluated by a probable air target attack, which depends upon the following factors:

- flight performances of the fighter;
- target type (target echo area, dimensions, vulnerability);
- experience and training level of pilots, navigators and engineers;
- capabilities of ground radars, data transmission and air situation display facilities and skill of their teams;
- operational reliability of all the equipment which provide for an aerial combat and attack of the target.

With the reliability of the complex taken into account, the probability of the aerial combat with attack of the target ( $W_{\text{atk}}$ ) is calculated by the following formula:

$$W_{\text{atk}} = C_r W_{\text{dir}} W_{\text{kill}};$$

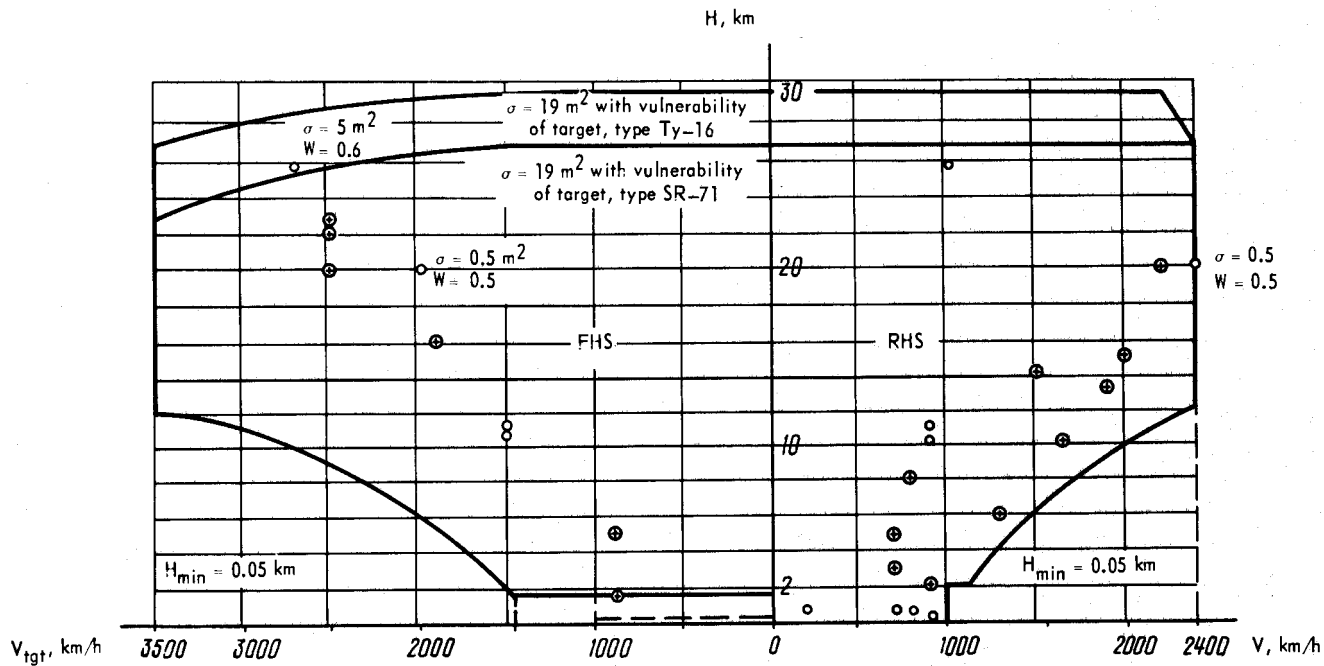

FIG. 95. RANGE OF ALTITUDES AND AIRSPEEDS OF NON-MANEUVERING TARGETS DESTROYED BY COMPLEX  $M_{\text{M}}^{\text{I}}-25-40.1$  ( $M_{\text{M}}^{\text{I}}-25-40.1\text{C}$ ) WITH AT LEAST 0.7 PROBABILITY WITHOUT ACCOUNTING FOR RELIABILITY

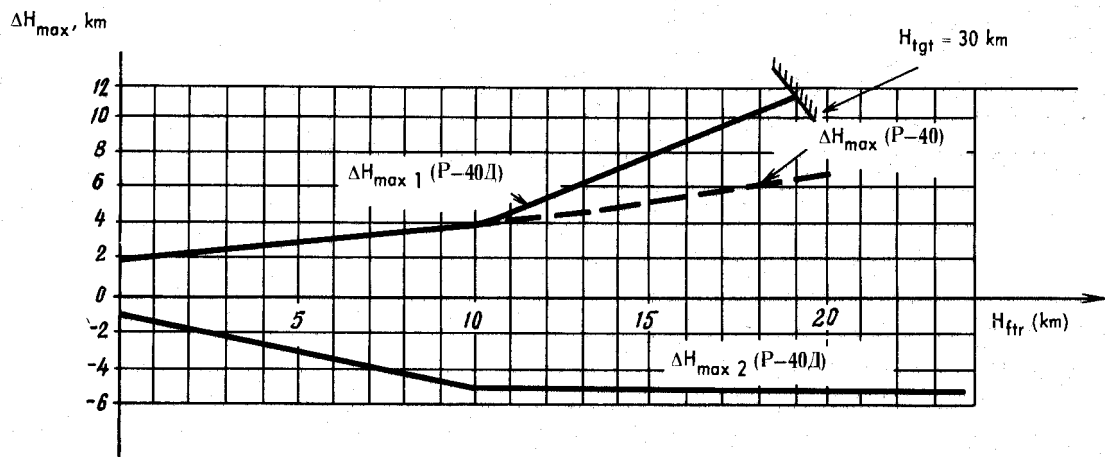

FIG. 96. PERMISSIBLE STEPPED-UP (STEPPED-DOWN) VERTICAL SEPARATIONS OF TARGET RELATIVE TO FIGHTER ALTITUDE IN LAUNCHING OF MISSILES P-40I



- where  $C_r$  is a reliability coefficient of the complex;  
 $W_{dir}$  is a fighter direction probability without consideration for its reliability;  
 $W_{kill}$  is a two-missile kill probability without consideration for reliability of the missiles.

The following results, characterizing the effectiveness of the complex, are obtained by simulation:

- probability of the front-cone attack with the use of two P-40II missiles against the non-maneuvering targets, type Ty-16, at an altitude of 27,000 m and type SR-71 at an altitude of 23,000 m and flying at a speed of 3500 km/h, is 0.7, minimum;

- probability of the front-cone attack of non-maneuvering strategic targets ( $\sigma_{eff} = 19 \text{ m}^2$ ) with vulnerability of the SR-71 and Ty-16 aircraft flying at an altitude of 30,000 m and a speed of 3500 km/h, is the following:

- 0.2 to 0.3 when launching two P-40PII missiles;
- 0.3 to 0.5 when launching two P-40TII missiles;
- 0.5 to 0.65 when launching four P-40II missiles;

- probability of the front-cone attack with the use of two P-40II missiles against small-size non-maneuvering targets ( $\sigma_{eff} = 0.5 \text{ m}^2$ ), flying at an altitude of 20,000 m and a speed of 2000 km/h, as well as the rear-cone attack of the same targets, flying at an altitude of 20,000 m and a speed of 2400 km/h is 0.5, minimum;

- probability of the front-cone and rear-cone attacks with the use of two P-40II missiles against strategic targets ( $\sigma_{eff} = 19 \text{ m}^2$ ) and tactical targets ( $\sigma_{eff} = 3 \text{ m}^2$ ) flying at an altitude of 50 m and a speed of 1000 km/h under continuous radar coverage, is 0.7;

- probability of the front-cone attack at an altitude of 10,000 to 15,000 m with the use of two P-40II missiles against the targets, turning away with an acceleration of 1.5 g at the stage of the airborne direction at a distance of 35 km, maximum, from the maneuver start point and with a proper speed ratio ( $V_{ftr}/V_{tgt}$ ), is 0.8, minimum.

## 2. BRIEF DESCRIPTION AND CHARACTERISTICS OF ARMAMENT CONTROL SYSTEM "C-25"

### 2.1. Purpose and Composition of Armament Control System C-25

Mainly, the C-25 armament control system is intended for:

- fighter direction to the aerial target by the commands of the ground automatic control systems;
- detection and identification of the aerial target;
- lockon and tracking of the target;
- computation of commands and signals required to ensure control of the fighter and employment of the P-40PH, P-40TH, P-40T, P-60 and P-60M missiles;
- display of all commands and signals on the integrated display system indicator;
- transmission of signals and commands to the missiles during preparation for launch;
- illumination of the target during attack with the use of the missiles equipped with the radar homing heads.

The C-25 armament control system is intended to kill the strategic and tactical aircraft as well as airborne cruise missiles at altitudes from 50 to 30,000 m both in front-cone and rear-cone attacks in the daytime and at night under VFR and IFR weather conditions, including the radio contrast cloud and jamming conditions.

The C-25 armament control system consists of the following standard equipment:

- the SAPPFIR-25 airborne radar incorporating a continuous-illumination channel, additional fixed antenna, integrated display system, integrated target designation system for the given type of missiles, moving target selection channel and integrated built-in test unit;
- the ABM-25 analog-digital computer;
- the TH-26M1 heat direction finder;
- the attack objective check equipment.

### 2.2. Radio-Control Equipment SAPPFIR-25

The SAPPFIR-25 equipment consists of the SAPPFIR-25 airborne radar, ABM-25 analog-digital computer and the components of the integrated display system.

## Basic Specifications of Airborne Radar SAPPFIR-25

## Operating Modes of Airborne Radar SAPPFIR-25

The SAPPFIR-25 airborne radar operates in two basic modes: RDR (PI) and ATM (MIX), which may be selected by using a selector switch mounted on the control panel of the airborne radar.

The ATM (ATMOSPHERICS) mode is selected when attacking the aerial targets, flying in passive jamming or radio-contrast clouds.

The RDR basic mode of operation includes four modes: HMA (ECB), HMA- $\Delta H$  (ECB- $\Delta H$ ), MLA (CMB) and LA (MB). These modes are selected for the airborne radar automatically in target tracking or manually in scanning, depending upon the stepped-up (stepped-down) vertical separation and altitude of the fighter in accordance with the conditions listed in Table 9.

Table 9

Mode selection conditions	Airborne radar operating mode				
	HMA	HMA- $\Delta H_2$	HMA- $\Delta H_1$	MLA	LA
Fighter flying altitude, km	$H > 1.5$	$H > 3.5$	1.5 to 3.5	$H < 1.5$	$H < 1.5$
Antenna tilt with respect to horizon ( $\varphi_{\text{tilt}}^*$ ), deg	$\varphi_{\text{tilt}} > +1.0$	$\varphi_{\text{tilt}} < +1.0$	$\varphi_{\text{tilt}} < +2.5$	Limitation of $\pm 1.5$ in scanning	$\varphi_{\text{tilt}} - 1$
Vertical separation $\Delta H$ set by pilot (unit 24), km	From +0.5 to $> 8$	From +0.5 to -5	From +0.5 to -2	From 0 to +2	From -0.5 to -5

Note.  $\varphi_{\text{tilt}}^* = (\varphi_v + \nu - \mu_0)$  deg,

where  $\varphi_v$  is a position of the radar beam in elevation;

$\nu$  is a pitch angle;

$\mu_0$  is equal to  $3^{\circ}52'$ .

In the HMA mode the airborne radar ensures front-cone or rear-cone attack of the aerial target, flying with the stepped-up vertical separation of 1000 to 12,000 m relative to the fighter. In this mode the radar has an increased operating

range of fighter flying at altitude higher than 4500 m due to employment of a parametric amplifier.

In the HMA- $\Delta$ H mode the airborne radar ensures front-cone or rear-cone overhead attack of the target, flying at an altitude of higher than 2000 m when the fighter altitude is 4500 m, minimum. In this case, the maximum elevation of the fighter over the target may be 5000 m.

When the target flies at an altitude from 1500 to 4500 m and the fighter, at an altitude from 3000 to 4500 m, the target may be attacked by the fighter from the rear hemisphere only. In this case, an elevation of the fighter over the target may be 2000 m, maximum. The best attack conditions to obtain the maximum operating range of the airborne radar in the HMA- $\Delta$ H mode are ensured, provided:

$$H_{tgt} \leq H_{ftr} \leq 2H_{tgt} \text{ when } \Delta H = H_{ftr} - H_{tgt} \leq 5000 \text{ m.}$$

In the MLA mode the airborne radar ensures underneath attacks from the rear hemisphere with an elevation of the fighter from 200 to 1000 m over the target, flying at an altitude from 500 to 1500 m, as well as from the front hemisphere when the target flies at an altitude of 1500 to 3000 m, and the fighter, 700 to 1500 m.

In the LA mode the airborne radar ensures the front-cone and rear-cone attacks of large-size targets (type Ty-16) under visual and instrument meteorological conditions at the target aspects of 0.4 to 1/4 and target flying altitudes of 50 to 800 m, while the fighter flies at an altitude of 500 to 1400 m with an elevation of 500 to 800 m over the target.

In the ATM mode the airborne radar ensures the attack of an aerial target, flying in a chaff or radio contrast cloud, when the MLA, HMA and HMA- $\Delta$ H modes can not be used. In this mode the fighter, flying with a stepped-down vertical separation, may attack an aerial target, flying at an altitude higher than 2000 m, both from the front and rear hemispheres. If the target flies at an altitude of 1000 to 2000 m, it may be attacked from astern only with a stepped-down vertical separation of the fighter relative to the target.

Attacks with a stepped-up vertical separation of the fighter relative to the target may be performed when the target altitude is higher than 3000 m and with the fighter stepped-up vertical separation of 1000 to 2000 m relative to the target.

Besides, the SAPPFIR-25 airborne radar provides for detection, lockon and tracking of low-speed aerial targets (helicopters, parachute targets, air balloons, etc.) in all discussed modes of operation when the FHS - LST - RHS (MHC - MCH - 3NC) selector switch set to the LST (MCH) position to disable the moving target indication circuit.

#### Scanning and Tracking Zones

The SAPPFIR-25 airborne radar provides for two antenna (scanning zone) control modes, i.e. manual and automatic. The manual control is effected by means of a direction knob in response to the commands issued by the combat control officer by voice. In this case, the DIRECT: AUTO - MAN (HABEH. ABTOM. PYUH.) selector switch should be set to position MAN. The azimuth and elevation automatic control of the antenna is effected by means of the 5Y15K-11 equipment in response to the commands of the automatic control system, with the DIRECT: AUTO - MAN selector switch set to the AUTO position. Angular characteristics of the scanning and autotracking zones, depending on the airborne radar operating mode and the type of control are given in Tables 10 and 11.

#### Coverage Range of Airborne Radar SAPPFIR-25

The coverage range of the SAPPFIR-25 airborne radar when attacking the aerial targets at various altitudes under visual meteorological conditions (for the ATM mode, under instrument meteorological conditions) when the equipment operates in all modes is characterized by the data given in Table 11.

The curves of dependence of the target detection range versus the target echo area<sup>x)</sup> are shown in Figs 97 and 98.

#### Integrated Display System

##### Purpose and Information on Airborne Radar Screen

The integrated display system is intended to display an information required for the pilot during combat flight. The information displayed by the system enables the pilot to fly the aircraft at the stages of the short-range and long-range direction, detect the target, and lock it on, execute aiming, launch the missiles and to break off from the attack. Depend-

<sup>x)</sup> The curves of dependence of the target detection range versus the target echo area are valid for an attack performed in the free air space when the airborne radar operates in the HMA mode with the enabled parametric amplifier.

Table 10

348

Airborne radar operat- ing mode	Antenna control in scan- ning	Scanning zone, deg				Scanning zone, shift, deg		Tracking zone, deg	
		azimuth		elevation		azimuth	elevation	azimuth	elevation
		FHS	RHS	FHS	RHS				
HMA, HMA-ΔH, ATM	Auto	<u>+15</u>	<u>+20</u>	9	14	<u>+56</u>	+40 to -42	<u>+56</u>	+56 to -42
	Manual	<u>+30</u>	<u>+30</u>	6					
MLA	Auto	<u>+30</u>	<u>+30</u>	6		<u>+56</u>	+1.5 to +40	<u>+56</u>	-1 to +56
	Manual								
LA	Auto	<u>+30</u>	<u>+30</u>	6		No	Fixed, -0.5	<u>+56</u>	+56 to -42
	Manual						to -5		

Table 11

Airborne radar operating mode	Target type	$\frac{H_{tgt}}{H_{ftr}}$ , km	Hemisphere	Detection range, km		Lockon range, km		Remarks
				at P = 0.5 (* - mean)	within limits of	with P = 0.9 (* - mean)	with-in	
HMA	Ty-16	$\frac{7-12}{5-8}$	RHS FHS	100 99 <sup>x</sup>	86 to 114	77 82 <sup>x</sup>	73.5 to 86.5	
	Ty-16	$\frac{4-7}{2-3}$	RHS FHS	62 <sup>x</sup>	43 to 70	53 <sup>x</sup>	40 to 65	Without parametric amplifier
	МиГ-21	$\frac{7-11}{5-8}$	RHS FHS	63 66 <sup>x</sup>	50-49	46 55 <sup>x</sup>	40 to 73	
	МиГ-21	$\frac{4-10}{2-7}$	RHS FHS	44 <sup>x</sup>	30 to 56	36 <sup>x</sup>	29 to 51	Without parametric amplifier
	МиГ-25	$\frac{20-21}{17}$	FHS	90 <sup>x</sup>	74 to 95	58 <sup>x</sup>	51 to 69	Guidance by ACS
HMA-ΔH	Ty-16	$\frac{2-7}{5-10}$	RHS FHS	58 57 <sup>x</sup>	37 to 75	36 47 <sup>x</sup>	32 to 65	
	Ty-16	$\frac{1.5}{3}$	RHS	21.5	21 to 22	18.5	17 to 20.5	Without parametric amplifier

Table 11, continued

350

Airborne radar operatin mode	Target type	$\frac{H_{tgt}}{H_{ftr}}$ , km	Hemi-sphere	Detection range, km		Lockon range, km		Remarks
				at P = 0.5 ( $\bar{x}$ - mean)	within limits of	with P = 0.9 ( $\bar{x}$ - mean)	with-in	
HMA-ΔH	МиГ-21	$\frac{2-9}{5-9}$	RHS FHS	45 46 <sup>x</sup>	37 to 58	32 38 <sup>x</sup>	27 to 49.5	
	МиГ-21	$\frac{1.5-2}{3}$	RHS FHS	18 <sup>x</sup>	10 to 23	15 <sup>x</sup>	10 to 21.5	Without parametric amplifier
LA	Ту-16	$\frac{0.3-0.7}{0.7-1}$	RHS FHS	26.5 26 <sup>x</sup>	20.5 to 29	18 21 <sup>x</sup>	17 to 25.5	
	Ту-16	$\frac{0.5}{1}$	FHS	24 <sup>x</sup>	18 to 28	16 <sup>x</sup>	10 to 21	
	МиГ-21	$\frac{0.3-0.8}{0.7 \text{ to } 1.35}$	RHS	24.5 24 <sup>x</sup>	18 to 28	14 17 <sup>x</sup>	13 to 23	
	МиГ-21	$\frac{0.3-0.5}{0.7-1}$	RHS	18 18.5 <sup>x</sup>	9 to 27.5	8 12 <sup>x</sup>	7 to 19	Over flood plain
	Ми-8	$\frac{0.03-0.5}{0.6-1}$	RHS	18 <sup>x</sup>	14 to 22.5	15 <sup>x</sup>	10 to 21	Set to 1ST position
	МиГ-25	$\frac{0.5}{1}$	RHS	22 <sup>x</sup>	20.5 to 23.5	15 <sup>x</sup>	13 to 19	$V_{tgt} = V_{max}$
	МиГ-25	$\frac{0.5}{1.2-1.4}$	FHS					



Table 11, continued

Airborne radar operating mode	Target type	$\frac{H_{tgt}}{H_{ftr}}$ , km	Hemi-sphere	Detection range, km		Lockon range, km		Remarks
				at P = 0.5 (* - mean)	within limits of	with P=0.9 (* - mean)	with-in	
MLA	Ту-16	<u>1-1.5</u>	FHS	24 <sup>x</sup>	18 to 29.5	18 <sup>x</sup>	12 to 24	
		0.5-0.6	RHS					
	Ту-16	<u>0.5-0.6</u>	RHS	18 <sup>x</sup>	12 to 22	12 <sup>x</sup>	7.5 to 15	
		0.3						
	МиГ-21	<u>0.5</u>	RHS	13 <sup>x</sup>	6.5 to 18.5	9 <sup>x</sup>	5 to 12.5	
	0.3							
МиГ-21	<u>1-1.5</u>	RHS	23	14 to 28.5	13	11 to 22		
	0.5-1	FHS	22 <sup>x</sup>		16 <sup>x</sup>			
МиГ-21	<u>1.5</u>	FHS	22 <sup>x</sup>	20 to 26	17 <sup>x</sup>	12 to 22		
	1							
ATM	Ту-16	<u>2-10</u>	RHS	41	32 to 55	28.5	20 to 42.5	
		3-7	FHS	41 <sup>x</sup>		34 <sup>x</sup>		
	МиГ-21	<u>2-7</u>	RHS	29	22 to 41	20	18 to 34.5	
		2-5	FHS	29.6 <sup>x</sup>		25 <sup>x</sup>		
МиГ-21	<u>1-2</u>	RHS	25.5 <sup>x</sup>	18.5 to 30	19 <sup>x</sup>	15 to 26		
	0.5							
Ту-16	<u>8-10</u>	FHS	54 <sup>x</sup>	53 to 55	-	-		
	5-7							

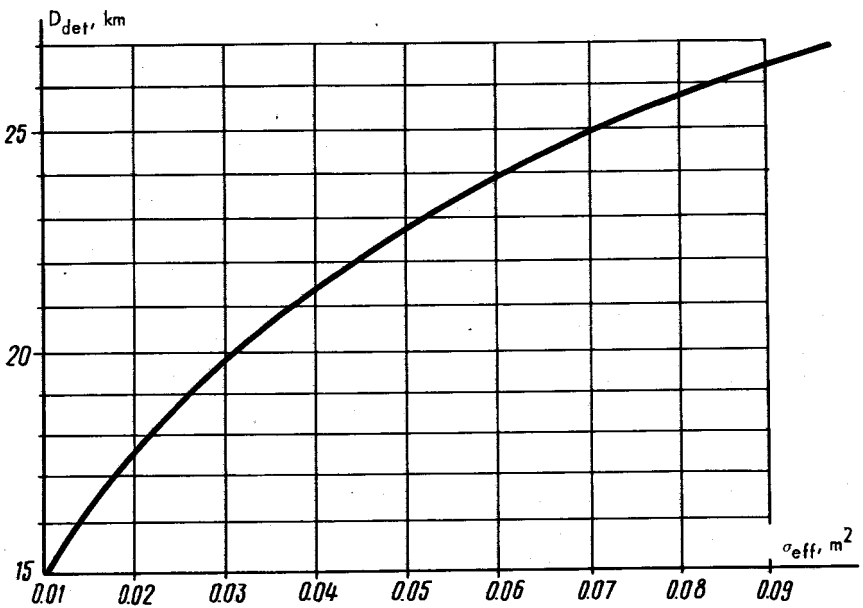
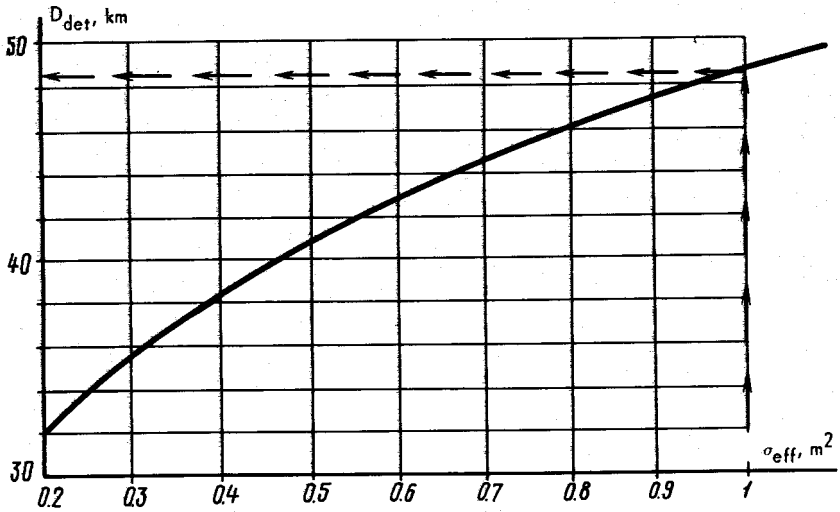

FIG. 97. "SAPFIR-25" AIRBORNE RADAR TARGET DETECTION RANGE VERSUS EFFECTIVE REFLECTING SURFACE OF TARGET ( $\sigma = 0.01$  to  $1 \text{ m}^2$ )

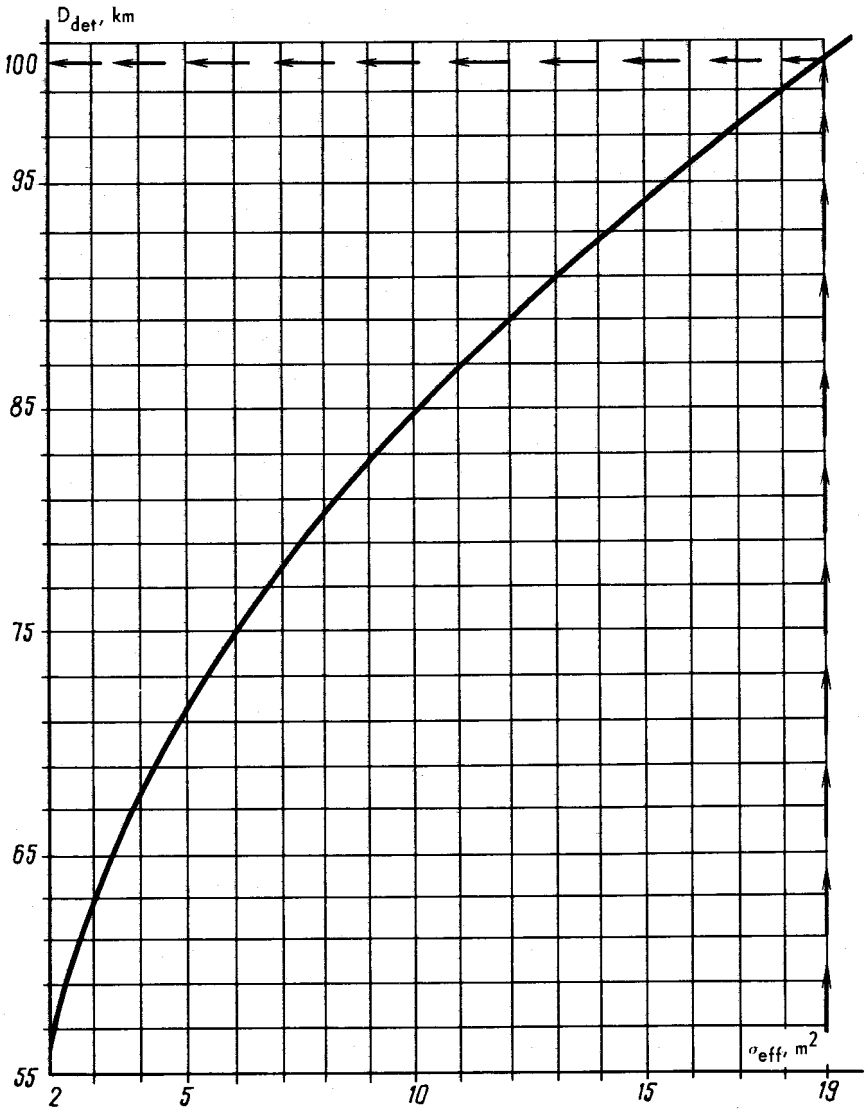

FIG. 98. "SAPFIR-25" AIRBORNE RADAR TARGET DETECTION RANGE VERSUS EFFECTIVE REFLECTING SURFACE OF TARGET ( $\sigma = 2$  to  $19 m^2$ )

ing upon the flying conditions, air combat stage and operating mode of the SAPPFIR-25 radar, the integrated display system displays the radar, heat direction finder and flight director markers, indices, scales and discrete commands.

(a) Flight director and radar markers, indices and scales:

- horizon line in the middle portion of the screen, which indicates the roll ( $\gamma$ ) and pitch ( $\nu$ ) attitude of the fighter;
- electronic crosshairs in all modes, except for the scanning mode in directing by voice;
- small electronic ring (in the automatic or director control mode);
- large electronic ring (in the manual control mode after the target is locked on by the airborne radar or heat direction finder as well as when the P-60 (P-60M) missiles are used);
- range scale in the left portion of the screen. It has one of the following scales: 120, 60 and 30 km. Scale selection procedure is given in Table 12;
- present range marker delivered from the 15Y15K-11 equipment during automatic direction;
- centre dot of the target lockon zone in range (centres of lockon strobes) controlled by the direction knob (unit 44);
- present range marker in the radar lockon mode of operation;
- markers  $D_{\text{perm max}}$  and  $D_{\text{perm min}}$ , indicating the maximum and minimum permissible missile launching ranges, respectively. When attacking in the HDF (TH) mode and when the P-60 (P-60M) missiles are used, no  $D_{\text{perm min}}$  marker is displayed;
- altitude scales within the range of 0 to 30 km in the right portion of the screen when flying at altitudes more than 1.5 km or within the range of 0 to 1.5 km when flying at altitudes less than 1.5 km. The altitude scales are changed over automatically;
- fighter present altitude marker;
- target blip in the range and azimuth coordinates;
- azimuth scale in the lower portion of the screen;
- marker of the antenna beam position in azimuth in the scanning mode displayed in the form of a dot moving fastly on the azimuth scale;
- identification mark;
- lockon strobes in the shape of two horizontal lines (displayed when the LOCKON button located on the fighter control

stick is depressed or when the azimuth gating is enabled). The strobe sizes in azimuth and range are in compliance with Table 13;

- sighting line position mark (the antenna beam in the lockon mode) in the shape of a dot;

- indices 1, 2, 3, 4 indicating the line No. in which the space is scanned presently;

- antenna tilt position markers (above or below the horizon line) in the form of arrows "↑" (up) and "↓" (down);

T a b l e 12

Airborne radar operating mode	Fighter flying altitude, m	Hemi-sphere	Range scale		Remarks
			scanning mode	tracking mode	
HMA, HMA-ΔH <sub>4</sub>	Over 3500	FHS	120	120, 60	Switched over to D < 55 km
		RHS	120	120, 60, 30	Switched over to D < 55 km and D < 26 km
HMA, HMA-ΔH <sub>1</sub>	Less than 3500	FHS	60	60	Switched over to D < 26 km
		RHS	60	60, 30	
ATM		FHS	60	60	Switched over to D < 26 km
		RHS	60	60, 30	
MLA, LA	Less than 1500	FHS, RHS	30	30	

T a b l e 13

Strobe size in azimuth range coordinates	In narrow (manual) gating	In automatic direction without enabling narrow (manual) gating
In azimuth, deg	9 in all operating modes of C-25 armament control system	+15 (HMA, HMA-ΔH, ATM in front-cone attack) +20 (HMA, HMA-ΔH, ATM in rear-cone attack) +30 (MLA, LA)
In range, km	9 (HMA, HMA-ΔH, ATM) 4.5 (MLA, LA)	13.3 (HMA, HMA-ΔH, ATM) 9 (MLA, LA in front-cone attack) 4.5 (MLA, LA in rear-cone attack)

- receiver output mark in the radar lockon mode in the shape of a line or in the shape of a rectangle under jamming conditions. The mark is displayed to the left of the range marker in azimuth.

- "fin" mark in a shape of a line perpendicular to the horizon line; this mark is displayed from the range less than 15 km in the radar lockon mode when the P-60 (P-60M) missiles are used;

(b) Discrete commands:

in the upper portion of the screen:

"!" - redirection;

"<" - left turn;

">" - right turn;

CC - command check (flickering at a rate of command delivery from the 5Y15K-11 equipment);

T - return (end of direction);

<1.5 - target altitude is less than 1.5 km (in the automatic direction mode);

in the left portion of the screen:

Atk - attack;

RHT - reheat;

HDF - target lockon by heat direction finder;

MR - minimum reheat;

M - maximum;

Idle - idle power setting;

PJ - passive jamming;

AJ - active jamming;

in the right portion of the screen:

Z - zoom;

FHS - forward hemisphere;

CIC - operation of continuous illumination channel;

JRF - jamming to range finder;

ARI - automatic range input from the 5Y15K-11 equipment;

C - general check;

in the lower portion of the screen:

B/A - break-away;

1, 2, 3, 4, LP - indices displayed when conditions for missile launching are available;

Rdr - turn off the radar.

The following information delivered from the heat direction finder is also displayed:

- boundaries of the heat direction finder scanning and tracking areas;
- range quasimark when the radar operates in the quasiscanning mode;
- strobes of the heat direction finder (general view and sizes of the strobes differ in the different modes);
- target blip in the azimuth-elevation coordinates.

The marks and indices displayed on the integrated display system indicator screen in the different operating modes of the C-25 armament control system are shown in Fig. 99.

#### I n f o r m a t i o n   G e n e r a t i o n   L o g i c i n   I n t e g r a t e d   D i s p l a y   S y s t e m

Information displayed by the integrated display system with the SYST (CMCT.) selector switch set to the RDR (PII) position as well as its generation logic are presented in Table 14.

The command signals delivered to the integrated display system, operating modes, which involve display of the commands on the indicator and information contained by the command are given in Table 15.

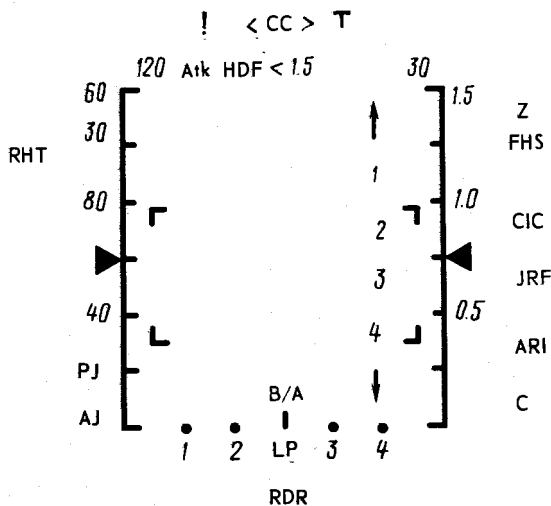

FIG. 99. INFORMATION DISPLAYED ON AIRBORNE RADAR INDICATOR

Table 14

Information or parameter	Range of measurement	Radar display scale	Operating modes which involve information display	Remarks
Horizon line: - pitch, deg - roll, deg	$\pm 20$ $\pm 70$	$28^\circ$ with- in the limits of the half range scale	Scanning and auto-tracking modes. In the lockon mode when the P-60 missiles are used the gyro horizon line pitch control is disabled at a distance less than 15 km	The length of the gyro horizon line is equal to a distance between the corners of the heat direction finder coverage boundary. Deviation of the gyro horizon upward corresponds to the positive pitch and downward, to the negative one
Electronic crosshairs			Automatic direction in the scanning and autotracking modes	In precision flying the small ring is within the limits of the inner diameter of the crosshairs. The large ring is superimposed on to the outer diameter of the crosshairs
Small electronic ring. Deviation of the ring from the centre of the crosshairs:			Scanning in automatic direction and in direction (automatic) fighter control	$\sigma_v$ and $\sigma_h$ are pilot's errors in fighter control longitudinal and lateral channels



Table 14, continued

Information or parameter	Range of measurement	Radar display scale	Operating modes which involve information display	Remarks
- vertical ( $\sigma_v$ )	$\pm 1.5g$	0.15g within the limits of the ring diameter	Autotracking in director (automatic) fighter control	$\sigma_v = \Delta n_y = n_y \text{ assign} - n_y \text{ press}$ $\sigma_h = \Delta \gamma = \gamma \text{ assign} - \gamma \text{ press}$
- horizontal ( $\sigma_h$ ), deg	$\pm 120$	11.6° within the limits of the ring diameter		
Large electro- nic ring, deg Deviation of the ring from the centre of the crosshairs: - vertical ( $\Delta B$ ) - horizontal ( $\Delta \Gamma$ ), deg	$\pm 20$ $\pm 20$	4° with- in the limits of the large ring dia- meter	Fighter manual control mode after target lockon by the radar and when the P-60 (P-60M) missiles are used	$\Delta B$ and $\Delta \Gamma$ are the sight- ing errors in the vertical and horizontal planes. Scale of $\Delta B$ and $\Delta \Gamma$ is $\pm 24^\circ$ per half-screen within the range and altitude scales in the vertical and horizontal planes

Table 14, continued

Information or parameter	Range of measurement	Radar display scale	Operating modes which involve information display	Remarks
Range scale, km	0 to 120  0 to 60  0 to 30	20 km per scale division 10 km per scale division 5 km per scale division	All operating modes of the airborne radar	
Present range marker delivered from the 5Y15K-11 equipment			Automatic guidance in the SCAN mode	The length of the marker is equal to the small ring diameter
Centre dot of target lockon zone in range (centres of lock-on strobes)			Manual guidance in the SCAN mode	The length of the dot is equal to the small ring diameter
Present range marker delivered from the airborne radar range finder			Autotracking mode	The marker length is equal to the small ring diameter

Table 14, continued

Information or parameter	Range of measurement	Radar display scale	Operating modes which involve information display	Remarks
Maximum missile launching range marker			Autotracking mode when the P-40I, P-40T and P-60 (P-60M) missiles are used	The marker length is equal to the large ring diameter. When the target is locked on by the heat direction finder and under conditions of jamming the marker is shaped from the equivalents: $V_{close} = 100 \text{ m/s}$ (rear-cone cone attack): $V_{close} = 1.6V_{ftr}$ (in front-cone attack)
Minimum missile launching range marker			Autotracking mode when the P-40I (P-40T) missiles are used. No marker is displayed when the P-60 (P-60M) missiles are used	The marker length is equal to the small ring diameter
Altitude scale, km	0 to 30	5 km per scale division	In flight at an altitude higher than 1.5 km and in flight at an altitude lower	The fighter altitude signal is delivered from the CBC-NH-5A air data computer system

Table 14, continued

382

Information or parameter	Range of measurement	Radar display scale	Operating modes which involve information display	Remarks
	0 to 1.5	0.25 km per scale division	<p>than 1.5 km with faulty radio altimeter</p> <p>In flight at an altitude lower than 1.5 km with the RAD ALT OK signal displayed</p>	The fighter altitude signal is delivered from the PB-15 radio altimeter
Fighter altitude marker			All modes	The marker size is equal to the small ring diameter
Target blip in the range and azimuth coordinates			When the target is detected in the SCAN mode	The blip is displayed in the LA mode in the shape of a short horizontal line or dot in all other modes
Azimuth scale in the lower portion of the screen, deg	±40	20° between the notches	All modes	<p>Radar indicator screen field between the centre dot of the electronic crosshairs and range/altitude scale in azimuth amounts to:</p> <p>±56° (in all modes, except for the LA mode);</p> <p>±30° in the LA mode</p>

Table 14, continued

Information or parameter	Range of measurement	Radar display scale	Operating modes which involve information display	Remarks
Antenna beam mark in azimuth, deg	+56 in all modes except for the LA one +30 in the LA mode	See RE-MARKS of preceding para	SCAN mode	The mark is displayed in the shape of a moving dot
Identification mark FRIEND			In the scan mode the mark is displayed above the target range mark if the target responds to interrogation by the specified code	The mark is displayed in the shape of a horizontal line above the friendly target
Lockon strobe marks			When the LOCKON button located on the control stick is depressed or when azimuth gating is enabled	In the form of two horizontal lines. The sizes of the line in azimuth and range, depending upon the operating modes of the airborne radar and attack conditions, are given in the table

Table 14, continued

364

Information or parameter	Range of measurement	Radar display scale	Operating modes which involve information display	Remarks
Indices 1, 2, 3, 4, which stand for line No. in which the space is scanned at the present moment			After illumination is enabled in the the SCAN mode	Indices are displayed in the right portion of the screen
Antenna position marks with respect to its tilt upward or downward by referring to the horizon line in the form of arrows "↑" (upward) and "↓" (downward)			After illumination is enabled in the scanning and target autotracking modes	The marks are displayed in the right portion of the screen
Sighting line (antenna beam) position mark in the $\varphi_v$ and $\varphi_h$ coordinates, deg	±56	±70° per half-screen within the range and altitude scales	Autotracking modes	The mark is displayed in the shape of a dot. The dot indicates the position of the target relative to the fighter

Table 14, continued

Information or parameter	Range of measurement	Radar display scale	Operating modes which involve information display	Remarks
Radar receiver output mark			Autotracking mode	The mark is displayed to the left from the present range mark in the shape of a line or rectangle in case of jamming
"Fin" mark			Autotracking mode when the P-60 (P-60M) missiles are used. The mark is displayed from a range less than 15 km	The mark size is equal to the half of the gyro horizon line. The mark is displayed in the shape of a line perpendicular to the gyro horizon line

Table 15

366

Discrete commands	Operating modes which involve display of command on indicator	Information contained in command	Remarks
CC - command check	In the automatic direction mode the radar indicator displays this command, flickering at a rate of command passage from the ground automatic control system (may not be recorded on the gun camera film as the CC index flickers at ar rate of 1.5 to 5 s, and the screen is photographed after every 2.5 s)	Flickering of the CC index proves command passage from the ground automatic control system	
"! " - redirection	The "Redirection" command is delivered from the ground automatic control system during automatic direction	As the "! " command is displayed, the pilot must redirect to another target	
"<" and ">" left and right turns	In the automatic direction mode	Informs the pilot about the left or right turn when the "Maneuver" method of direction is used in the VOZDUH-1M automatic control system	



Table 15, continued

Discrete commands	Operating modes which involve display of command on indicator	Information contained in command	Remarks
T - return	In the automatic direction mode	Informs the pilot about termination of direction and return to the airfield	
"<1.5"	In the automatic direction mode	The target flight altitude is less than 1.5 km	
Atk - attack	This command is displayed in the target automatic tracking mode		The "Atk" command is delivered 1 s after the target lockon and is removed in case of lockon failure
RHT - reheat	The command is displayed: (a) in the automatic direction mode: - when the REHEAT command is delivered from the ground automatic control system;	In response to the displayed "RHT" command the pilot must select the full reheat power setting	

Table 15, continued

Discrete commands	Operating modes which involve display of command on indicator	Information contained in command	Remarks
	<p>- when the ABM-25 computer generates the "Reheat" command. The command is delivered approximately 10 s, before the "Preliminary zoom" command ("Z" without "Atk") and maintained in the "Preliminary zoom" mode;</p> <p>(b) in the automatic tracking mode before or simultaneously with generation of the "Aiming Zoom" command ("Z" with "Atk") by the ABM-25 computer with the "†" index (the target is above the fighter) displayed</p>		
HDF - target lockon by heat direction finder	Displayed after the target is locked on by the heat direction finder	The heat direction finder tracks the target in azimuth	
PJ - passive jamming	In the automatic tracking mode in passive jamming conditions	Informs the pilot about presence of passive jamming	
AJ - active jamming	In the scanning and automatic tracking mode	Informs the pilot about presence of active jamming	

Table 15, continued

Discrete commands	Operating modes which involve display of command on indicator	Information contained in command	Remarks
Z - zoom	In the scanning mode during automatic direction the "Z" command is displayed if the ABM-25 computer generates the "Preliminary zoom" command and no "Attack" ("Atk") command is supplied	Informs the pilot about the "Preliminary zoom" mode in which $\theta = 5^\circ$ is stabilized	The "Preliminary zoom" ("Z" without "Atk") and "Aiming zoom" ("Z" with "Atk") commands are computed by the ABM-25 computer
	In the automatic tracking mode if the "Aiming zoom" command is generated	Informs the pilot about the beginning of direction of the fighter to the aerial target in the HMA and HMA-ΔH operating modes of the C-25 armament control system. In the MLA and LA operating modes, after generation of the "Aiming zoom" command the law of fighter control in the vertical plane is not changed	

Table 15, continued

370

Discrete commands	Operating modes which involve display of command on indicator	Information contained in command	Remarks
FHS - forward hemisphere	<p>In the automatic direction mode the command is displayed in response to delivery of the FHS command from the ground automatic control system</p> <p>In the direction by visual estimation the command is displayed with the FHS - LST - RHS selector switch (on unit 24) set to the FHS and LST positions</p>	<p>In the automatic direction mode it informs the pilot about execution of the front-cone attack. Absence of the FHS command in the automatic direction mode testifies to the fact that the rear-cone attack is executed</p> <p>It informs the pilot about the position of the selector switch on unit 24 in the radar manual control mode. No FHS command displayed on the screen testifies to the fact that the FHS - LST - RHS selector switch is set to the RHS position</p>	

Table 15, continued

Discrete commands	Operating modes which involve display of command on indicator	Information contained in command	Remarks
CIC - continuous illumination channel	When the continuous illumination channel radiates	It informs the pilot about operation (radiation) of the continuous illumination channel	
JRF - jamming to range finder	In case of jamming to the airborne radar range finder channel in the automatic tracking mode	It informs the pilot about jamming to the airborne radar range finder channel	
ARI - automatic range input	Displayed in the automatic direction mode. After the target is locked on by the airborne radar the ARI command is cancelled. During manual gating in the automatic direction mode the ARI command is cancelled		
C - general check	In the check mode selected	It informs the pilot about selection of the check mode	

Table 15, continued

372

Discrete commands	Operating modes which involve display of command on indicator	Information contained in command	Remarks
B/A - breakaway	Displayed in the automatic tracking mode when the ABM-25 computer generates the "Break-away" command in compliance with realized logic	Command to break away the target	
1, 2, 3, 4, LP - launch permitted	Indices 1, 2, 3, 4, LP are displayed in automatic tracking of the target by the airborne radar or heat direction finder as well as in the $\Phi_0$ mode when launch of the respective missiles is permitted. Index LP is displayed if launch of at least one of missiles is permitted	Indices 1, 2, 3, 4 inform the pilot about permission to launch the missiles from the respective stations. Index LP informs the pilot about permission to launch at least one of missiles	The "Launch permitted" command generation logic employs the "In-range" command. When using the heat direction finder and in the $\Phi_0$ mode the "In-range" command is introduced by the pilot manually

Table 15, continued

Discrete commands	Operating modes which involve display of command on indicator	Information contained in command	Remarks
Rdr - turn off radar	Displayed in case of airborne radar failure	It informs the pilot about airborne radar failure. In response to the "Rdr" command the pilot must turn off the radar	

## Indication Features in "HDF" Mode

Displayed information	HDF operating modes					Information display conditions	Remarks
	T-I	T-II	T-III	T- $\phi$ <sub>0</sub> I	T- $\phi$ <sub>0</sub> II		
HDF scanning area boundaries in azimuth and elevation, deg	60x15	15x6	See Remarks	60x15	15x6	In the HDF mode during scanning and after the target is locked on by the heat direction finder	<p>The scanning area of the heat direction finder is shaded from top through 2° and has the following size in the T-I, T-III and T-<math>\phi</math><sub>0</sub>I modes: +4° (up) and -9° (down). Setting of the SYST selector switch to the T-III position in the scanning mode results in maintaining the T-I mode. Lockon failure in the T-III mode results in transition to the T-I mode.</p> <p>In the T-I and T-III modes the heat direction finder tracks the target within the 60x15-deg area. Target lockon in the T-II mode results in automatic transition to the T-III mode. In the T-III mode the scanning is effected in one line only</p>



Table 16, continued

Displayed information	HDF operating modes					Information display conditions	Remarks
	T-I	T-II	T-III	T- $\phi_0$ I	T- $\phi_0$ II		
HDF strobes. Angular values of HDF strobes in azimuth and elevation, deg	7.5-8x 7.5-8	3-4.5x 3-4.5	2x1	3-4.5x 3-4.5	3-4.5x 3-4.5	In the HDF mode during scanning and after the target is locked on by the heat direction finder	In the T-I mode the strobe is presented by two vertical lines. In the T-II mode the strobe is displayed in the center of the screen. In the T- $\phi_0$ I and T- $\phi_0$ II modes the strobes are displayed in the center of the screen. In the T- $\phi_0$ I mode they are presented by two vertical lines each consisting of three segments. In the T- $\phi_0$ II mode they are displayed in the shape of two vertical lines consisting of three dashes
Index HDF in the upper portion of the screen	Yes	No	Yes	No	No	After the target lockon by the heat direction finder	It proves lockon of the target by the heat direction finder
Quasiscanning range marker						After the target lockon by the heat direc-	To obtain the quasiscanning marker in the LA mode the centre dot of the HDF lockon area

Table 16, continued

376

Displayed information	HDF operating modes					Information display conditions	Remarks
	T-I	T-II	T-III	T- $\phi_0$ I	T- $\phi_0$ II		
						tion finder with the high voltage applied to the airborne radar	should be set to a range less than 16 km
Large electro- nic ring				No	No	After the target lockon by the heat direction finder	<p>In the HDF mode the diameter of the large ring is equal to <math>7^\circ</math> and an angle between the range and altitude scales is <math>\pm 36^\circ</math>.</p> <p>Maximum deflection of the large ring is:</p> <p><math>\Delta B = \varphi_v</math> (vertical);</p> <p><math>\Delta \Gamma = \varphi_h</math> (horizontal)</p>

### 3. PURPOSE AND ARRANGEMENT OF CONTROLS OF ARMAMENT CONTROL SYSTEM "C-25"

#### 3.1. Operating and Test Controls of Airborne Radar SAPPFIR-25

The fighter cabin houses the following units:

(1) control panel - unit 24 (Fig. 100), mounted on the instrument board. The unit carries the following manual controls:

(a) the SYST selector switch to select the operating mode of the SAPPFIR-25 airborne radar. The selector switch has the following positions:

- the RDR position which ensures operation of the radar in all its modes (HMA, HMA- $\Delta$ H, MLA, LA);

- the ATM position which ensures operation of the radar under the conditions of radio contrast cloud cover and passive jamming;

- the T-I, T-II and T-III positions which ensure detection, tracking, sighting at aerial targets with the use of the heat direction finder. In this case, the airborne radar antenna follows up the target angular coordinates delivered by the heat direction finder. Target range is displayed on the screen of the radar, operating in the quasiscanning mode;

- the T- $\phi_0$ I and T- $\phi_0$ II which ensure detection of the target by the heat direction finder and alignment of the missile heat seeking head axis with the weapon axis;

(b) the  $\Delta$ H selector switch which ensures manual control of the antenna elevation by generating discrete signals  $\Delta$ H in the analog-digital computer. It has fixed positions 5, 3, 1.5, 0.5 (down) and 0, 0.5, 1, 2, 3, 5, >8 (up) in all operating modes of the airborne radar, except for the LA mode;

(c) the DIRECT: AUTO - MAN selector switch. When set to the AUTO position, it ensures control of the SAPPFIR-25 radar from the 5V15K-11 guidance equipment, and when set to the MAN position, from the airborne radar controls during visual estimation direction;

(d) the ILLUM - DUMMY - OFF (ИЗЛ. - ЭКБ. - БЫКЛ.) selector switch intended for switching on the pulse transmitter of unit O2;

When it is set to the ILLUM or DUMMY position, the radio-frequency signals are transmitted through the power switch either to the antenna or to the dummy antenna, respectively. When the

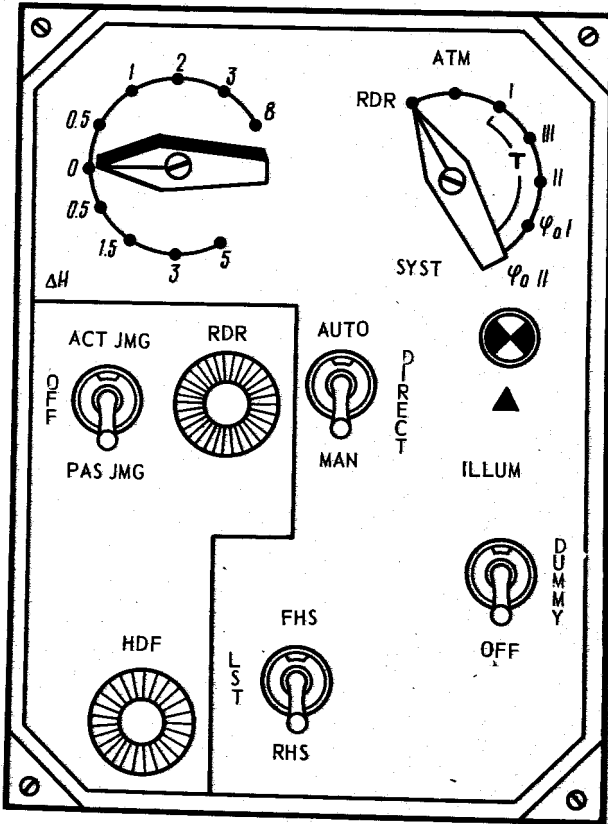

FIG. 100. CONTROL PANEL (UNIT 24)

selector switch is set to the OFF position the high voltage is removed from unit O2;

(e) the ILLUM (ИЗЛ.) pilot lamp (protected with a green cap), which lights up to indicate supply of the high voltage;

(f) the FHS - LST - RHS selector switch to ensure the following operating modes:

- in the LST position it provides for an attack of low-speed targets, as well as an attack at high aspect angles (the moving target indication circuit is disabled);

- in the FHS or RHS position it provides for changing of the range finder search direction (from the larger range to the shorter one or vice versa) in visual estimation direction depending upon a direction of the attack when attacking a passive jammer;

(g) the ACT JMG - OFF - PAS JMG selector switch intended for selection of radar jamming immunity modes.

Setting of the selector switch to the ACT JMG position results in selection of the active jamming immunity mode, and to the PAS JMG position, in selection of the passive jamming immunity mode;

(h) the HDF potentiometer which serves to gain control of the HDF receiver in all operating modes with the ACT JMG - OFF - PAS JMG selector switch set to the PAS JMG position;

(i) the RDR (PI) potentiometer to ensure manual gain control of the radar receiver with the ACT JMG - OFF - PAS JMG selector switch set to the ACT JMG position.

(2) control and test panel - unit 34 (Fig. 101). The panel is intended for connection of the equipment and test of the armament control system by the built-in test circuit. It is mounted on the vertical section of the right console in the cabin. The panel carries the following operating and test controls:

- the RDR - OFF (PI - ВЫКЛ.) switch used for connection of the radar to the fighter electric system;

- the HDF - OFF (TI - ВЫКЛ.) switch used for switching-on of the TI-26M1 heat direction finder;

- the PA - OFF (PV - ВЫКЛ.) switch used for connection of the parametric amplifier in order to increase the radar range coverage. The switch is turned on when attacking an aerial target at a fighter flight altitude of higher than 4.5 km;

- the RDR HEAT - OFF switch used for independently energizing the liquid cooling system;

- the MODE selector switch used for selection of the required test mode, viz. LA, HMA, AUTO, ITS (KCK), SYST., ΔH. In flight the LA and HMA positions are selected;

- the TEST (KOHT.) selector switch used for selection of a definite test type, viz. AIR (BO3Д.), REDUCED (COKP.), 40, EXT (BHEH.), 60;

- the READY (POT.) selector switch used for checking the system channels by the built-in test circuit;

- the READY (POT.) pilot lamp (protected with a green cap) which lights up to indicate serviceability of the system channel selected for the check by the use of the READY selector switch;

- the BITC - RESET (BK - CSPOC) push-button selector switch used for enabling and disabling the built-in test channel.

Depression of the selector switch to the RESET position results in reset of the target lockon (false lockon);

- the STOP - MAN (CTON - PYQH.) selector switch used to shift the reference target in range during tuning of the built-in test channel, to send the "Stop" command and to check the system channel readiness test circuit by the use of the READY selector switch (used by the technicians);

(3) control and guidance knob - unit 44 (Fig. 102). The unit is mounted on the horizontal section of the cabin left console.

It is used for:

- manual azimuth control of the airborne radar search area by moving the knob leftward and rightward and manual elevation control by moving the knob forward and backward;

- control of the range finder lockon area in range (shift of the range strobe in range);

- control of the HDF strobe position in azimuth and elevation when the C-25 system operates in the HS (T) mode;

- enabling of the azimuth gating. The gating is enabled by turning the guidance knob clockwise up to the click. In so doing, the lockon area in azimuth and range is equal to  $9^{\circ}$  in all operating modes of the C-25 system and 9 km in the HMA, HMA-ΔH, ATM modes as well as 4.5 km in the LA, MLA modes, respectively;

- opening of the automatic range (input circuit by depressing the knob downward (used for selection of range strobe manual control);

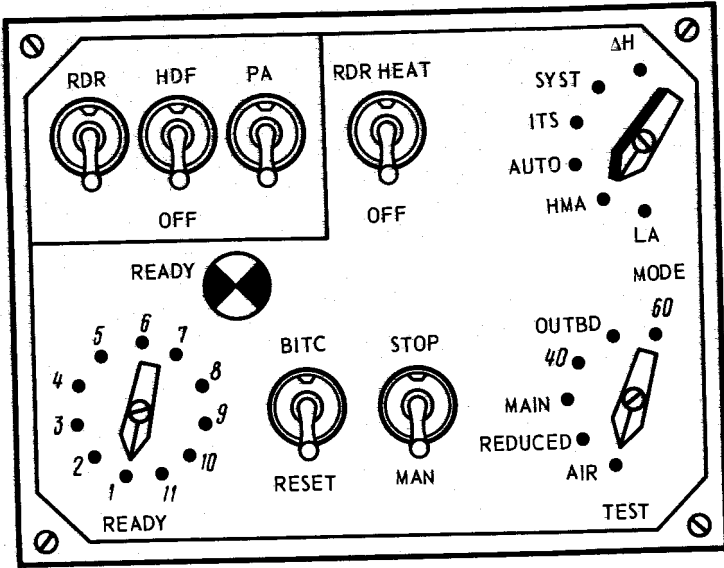

FIG. 101. CONTROL PANEL (UNIT 34)

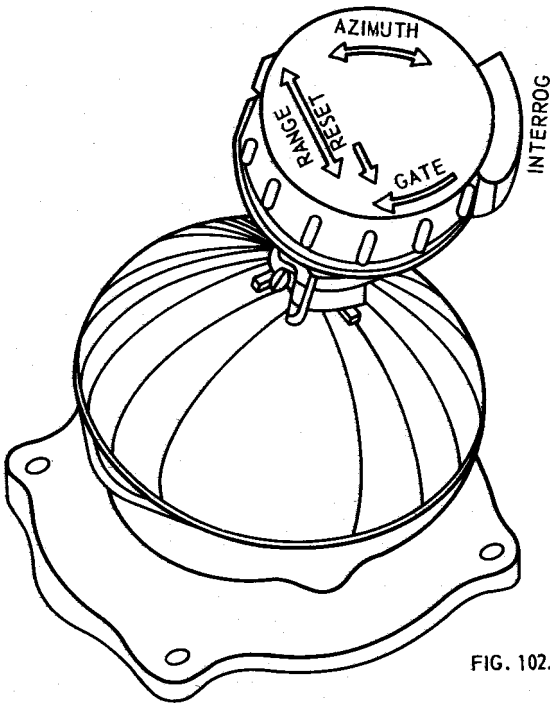

FIG. 102. CONTROL AND GUIDANCE KNOB (UNIT 44)

- lockon reset by pulling the knob up to the stop and depressing it;

- placing the identification system in the INTERROGATION (ЗАПРОС) mode by depressing the INTERROG button located on the guidance knob;

(4) the LOCKON (ЗАХВАТ) button mounted on the fighter control stick and used for changing over the airborner radar or heat direction finder from the scanning mode to the lockon one;

(5) the STR - REL (МПК - СБРОС) button located on the fighter control stick and used for target lockon reset in flight.

### 3.2. Controls and Indicators of Armament System

Mounted on the cabin right console are:

- the MSL EMER JETT: INBD circuit breaker used to energize the emergency jettison circuits of the missiles suspended from the second and third stations (No. 2 and No. 3);

- the MSL EMER JETT: OUTBD circuit breaker used to energize the emergency jettison circuits of the missiles suspended from the first and fourth stations (No. 1 and No. 4);

- the LG, AIR BRAKES, FLAPS SIG circuit breaker installed in the circuit of windings of relays, interlocking with respect to LG;

- the EXT PWR SUP, BAT circuit breaker used to energize the aircraft electric system from the external DC source or from a storage battery.

The cabin left console carries:

- the AIR - GROUND (ВОЗДУХ - ЗЕМЛЯ) switch used for switching the circuit when operating against ground targets;

- the target type POINT - MID - LARGE (МАЛАЯ - СР. - БОЛЬШАЯ) selector switch used to introduce a correction into the fuse depending on the target type;

- the  $\varphi_0$  - WITH RDR -  $\varphi_b$  ( $\varphi_0$  - с РЛС -  $\varphi_1$ ) function selector switch used for operation of the power supply and launch control system in the automatic (with the radar) and manual ( $\varphi_0$ ,  $\varphi_b$ ) modes;

- the FHS - RHS (ПНС - ЗНС) selector switch used to introduce the "Preparation" command manually;

- the MASTER SWITCH (ГЛАВН. ВКЛЮЧ.) switch in the missile combat launch circuit;



- the SINGLE - TRAIN (ОДИН - СЕРИЯ) switch used for selection of the launching variant;
- the INBD - AUTO - OUTBD (ВНУТР. - АВТОМ. - ВНЕШ.) selector switch used for preparation and launch of the missiles suspended from the inboard or outboard stations;
- the MSL SUPPLY (ПИТАНИЕ СС) used in the power supply circuits of the missiles suspended from all four stations;
- the MSL EMER JETT (АВАР. СЕРОС СС) button used in the missile emergency jettison (launch for the P-60 missiles) circuit.

The ИСП-84 indicator mounted on the instrument board carries four pilot lamps signalling suspension of the P-40 missiles from the АПУ-84-46Д launchers and four pilot lamps signalling suspension of the P-60 missiles from the АПУ-60-П launchers.

The cabin left console carries:

- the SIMULAT MP - MSL - LG (ИМИТАЦИЯ MP - СС - ШАССИ) selector switch used for simulation of landing gear retraction during ground checks;
- the ROLL ZERO (ОБНУЛ. КРЕНА) switch used for enabling of the symmetry compensation circuit.

## Chapter 2

# COMBAT EMPLOYMENT OF ARMAMENT CONTROL SYSTEM C-25

### 1. FLIGHT FOR AERIAL COMBAT WITH EMPLOYMENT OF ARMAMENT CONTROL SYSTEM C-25 IN RDR MODE

#### 1.1. Pre-Flight Preparation of Armament Control System C-25

After the pilot takes his seat in the aircraft cabin the controls of the C-25 armament control system should be set to the following positions:

(a) on unit 24:

- the DIRECT: AUTO - MAN (HABED. ABT. - PVQH.) selector switch to the AUTO position during automatic direction or to the MAN position during visual estimation direction;
- the ILLUM - DUMMY - OFF selector switch to the OFF position;
- the  $\Delta H$  selector switch to the 0 position;
- the SYST selector switch to the RDR position;
- the FHS - LST - RHS selector switch to a position depending on the flying mission;
- the RDR and HDF potentiometers to the extreme right position;

(b) on unit 34:

- the RDR and HDF switches to the OFF position;
- the PA - OFF switch to the PA position;
- the RDR HEAT - OFF switch to the OFF position;
- the READY selector switch to position 1;

- the TEST selector switch to the AIR position;
- the MODE selector switch to the HMA or LA position (depending upon in-flight radar functional check mode);

(c) the guidance knob of unit 44 to the middle position and azimuth gating should be disabled;

(d) the  $\varphi_0$  - WITH RDR -  $\varphi_b$  selector switch mounted on the instrument board to the WITH RDR position;

(e) the CAMERA ATTACH (ФОТО ПРИБАТ.) selector switch to the AUTO position;

(f) the target type POINT - MID - LARGE selector switch to a position depending upon the mission.

The controls of other aircraft systems should be set in compliance with the flying mission.

After starting the engines the RDR and HDF switches mounted on unit 34 should be turned on.

The fighter direction procedure may be divided into two stages:

- ground-based direction - from fighter takeoff and reception of direction commands till target lockon by the airborne radar;

- airborne direction - from target lockon by the airborne radar till breakaway.

During the ground-based direction the aircraft and its radar are controlled by the commands transmitted from the control post. The fighter is guided to a tactically advantageous attack position relative to the target with airborne radar cut off for radiation to observe radio-electronic silence. Flight profile at the stage of ground-based direction includes programmed climb in compliance with one of basic programs (reheat, combined, cruise) depending upon the lines of target interception with maintaining the pre-selected course as well as attaining of the assigned altitude and speed required for attack of the target. After radiation is cut in and the target is detected and locked on, the fighter is controlled by the signals and commands generated in the ABM-25 computer depending upon a weapon to be used.

The ground-based direction may be both automatic and visual.

During automatic direction the commands are transmitted to the airborne radar and CAJ-155ПДБ system from the ground automatic control system via the 5V15K-11 airborne direction equipment.

During visual estimation direction the fighter and radar control information is transmitted via the radio set in the form of voice messages.

## 1.2. Automatic Direction

After takeoff and climb to an altitude higher than the assigned "limit" one against (the radio altimeter indicator), the pilot should set the ILLUM - DUMMY - OFF selector switch on unit 24 to the DUMMY position. Having established the radio contact with the control post he should make sure that the 5V15K-11 equipment operates properly by referring to regular flickering of the CC mark on the indicator screen, and climbs in the director or automatic fighter control mode in compliance with the program loaded in the airspeed and altitude setter.

1.5 to 2 min after the airborne radar (or heat direction finder) is switched on, the electronic indicator is also switched on. The indicator displays the following information on its screen (Fig. 103):

- range scale in a scale depending upon flight conditions (see Table 12);
- target present range marker delivered from the 5V15K-11 equipment (to the right of the range scale);
- altitude scale in the scale of 1.5 or 30 km depending upon the fighter flying altitude;
- fighter altitude marker displayed to the left of the altitude scale. The fighter altitude data are transmitted from the radio altimeter if the flying altitude is less or equal to 1.5 km and the "R/alt reliable" command is supplied, or from the CBC-11H-5A system in all other cases;
- electronic cross-hairs;
- command marker (small ring) when the director or automatic fighter control mode is turned on. The command marker duplicates the readings of the flight director indicator command pointers;
- electronic gyro horizon line to identify the aircraft bank and pitch. Tilt of the gyro horizon line to the right corresponds to the fighter right bank.

The command marker (small ring) is aligned with the center of the cross-hairs by fighter maneuvers.

The ARI (automatic range input) and CC (command check) pilot lamps are illuminated and the FHS (front hemisphere), < (left turn), > (right turn) and RHT (reheat) pilot lamps may be illuminated on the annunciator of the indicator.

3 to 5 min after the ILLUM - DUMMY - OFF selector switch is set to the DUMMY position, the high voltage is applied to the

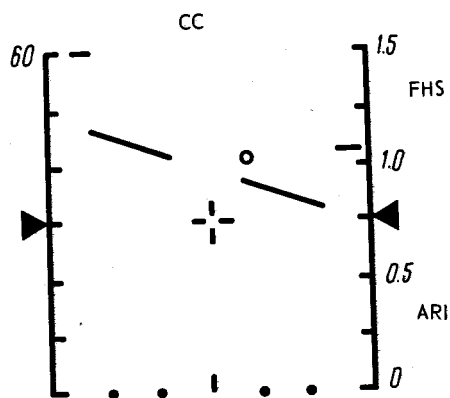

FIG. 103. PICTURE DISPLAYED ON INDICATOR SCREEN IN AUTOMATIC DIRECTION PRIOR TO RADAR ENABLING FOR ILLUMINATION

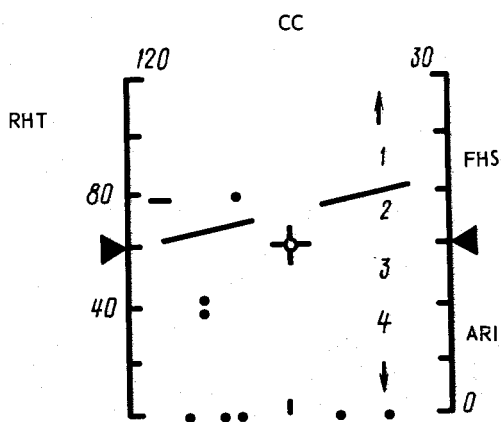

FIG. 104. PICTURE DISPLAYED ON RADAR INDICATOR SCREEN IN AUTOMATIC DIRECTION (illumination ON, modes HMA and HMA-ΔH, INTERROG button is depressed)

pulse transmitter of the airborne radar. The READY pilot lamp located on unit 34 lights up. If necessary, the pilot can check the SAPPFIR-25 airborne radar by the built-in test circuit.

Climb and descent are executed either in the automatic or director mode of fighter control to attain the selected target attack altitude and further to gain the selected speed displayed on the speed indicator.

As the fighter gains the maximum indicated airspeed the indicator screen starts flickering at a rate of 2 Hz and the voice information system delivers the "Limit speed" voice information to the pilot's earphones.

After the fighter attains the preset altitude the SEL ALT LVL-OFF (CXOD H<sub>3AH</sub>) pilot lamp lights up on the instrument board and the voice information system delivers the "Levelling-off to selected altitude" information to the earphones.

When the 5V15K-11 equipment is employed and the target is attacked in the front hemisphere the airborne radar starts radiating automatically and the scanning mode is selected in response to discrete commands "100", "60", "36". If the target is attacked in the rear hemisphere the radar starts radiating and the scanning mode is selected in response to discrete command "36".

As the airborne radar illumination is cut in, the ILLUM (ИЗЛУЧ.) lamp lights up on unit 24. In case of nonpassage of illumination cut-in commands from the 5V15K-11 equipment the pilot may cut in illumination manually by setting the ILLUM - DUMMY - OFF selector switch mounted on unit 24 to the ILLUM position.

In this case, he cuts in illumination in response to a command delivered from the control post through the radio set or at a distance:

- 80 to 90 km when the fighter attacks high-speed and high-altitude targets from the front hemisphere (Fig. 104);
- 40 to 50 km when the fighter attacks subsonic targets from the front hemisphere;
- 30 to 35 km when the fighter attacks high-altitude and medium-altitude targets from the rear hemisphere;
- 15 to 20 km when the fighter attacks low-altitude targets from rear hemisphere (Figs 105 and 106).

As the airborne radar is switched over to the scan mode the pilot flies the fighter referring to the command mark (small ring), keeping it in the centre of the cross-hairs and turns on

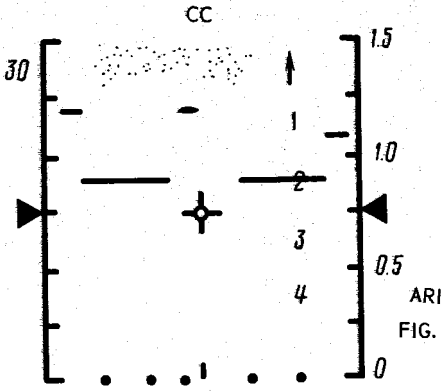

FIG. 105. PICTURE DISPLAYED ON RADAR INDICATOR SCREEN IN AUTOMATIC DIRECTION (illumination ON, mode MLA)

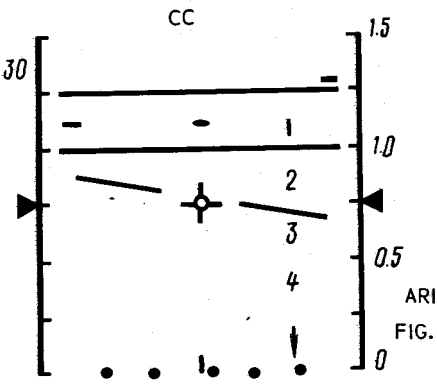

FIG. 106. PICTURE DISPLAYED ON RADAR INDICATOR SCREEN IN AUTOMATIC DIRECTION (mode LA, LOCKON button is depressed)

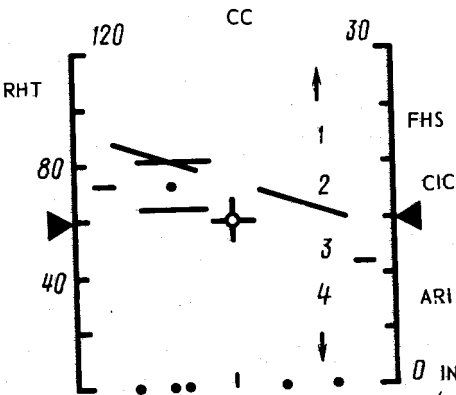

FIG. 107. PICTURE DISPLAYED ON RADAR INDICATOR SCREEN IN AUTOMATIC DIRECTION (modes HMA and HMA-1H, LOCKON button depressed)

the MASTER switch. In combat flights the MASTER switch may be turned on after takeoff.

After the target is detected the pilot should identify it. Depression of the INTERROG button located on the guidance knob (unit 44) results in display of the identification mark similar to the target blip over the friendly target blip (see Fig. 104).

After the target is observed in 2 or 3 scanning cycles it should be locked on. To execute successful lockon of the target it is necessary that it is within the lockon zone in range. In the HMA and HMA- $\Delta$ H modes the lockon zone in range is 13.3 km when the target is attacked from the front hemisphere or 9 km when it is attacked from the rear hemisphere.

In the LA and MLA modes the target lockon zone in range is 9 km in the front hemisphere or 4.5 km in the rear hemisphere.

The centre of the lockon zone in range is determined from the position of the range marker transmitted from the 5V15K-11 equipment. If no other targets are observed in the lockon zone in range within the scan zone in azimuth, the pilot should depress the LOCKON button. It results in display of two horizontal lines on the indicator screen which correspond to the boundaries of the lockon zone in range and azimuth (Fig. 107).

The lockon zone in azimuth is equal to the scan zone in azimuth for the respective operating mode of the airborne radar. The antenna beam goes on scanning till it settles in the selected target direction. This done, the target is locked on in angular coordinates and further in range.

If the target is out of the lockon zone in range or if several targets are displayed at various ranges in the lockon zone, depress the knob of unit 44 prior to depressing the LOCKON button. In so doing, the ARI pilot lamp fades out on the indicator screen and the latter displays two horizontal lines (strokes) similar to those displayed after depression of the LOCKON button which determine the boundaries of the lockon zone. In this case, the lockon zone position depends upon the position of the knob of unit 44 but not the position of the range marker transmitted from the 5V15K-11 equipment. The pilot should move the knob of unit 44 forward and backward to shift the strokes so that the selected target is within the zone (between the lines) and then depress the LOCKON button.

If several targets are observed in the lockon zone at the same range but at various azimuths, the pilot should turn the



knob of unit 44 clockwise until a click is heard to enable the azimuth gating for target selection.

In this case, the lockon zone in azimuth is reduced to  $13 \pm 3^\circ$ , the strobes displayed on the indicator screen are shortened and shifted rightward and leftward within the scan zone in azimuth with the aid of the knob of unit 44 (Fig. 108). Use the knob of unit 44 to apply the strobes in range and azimuth to the target and depress the LOCKON button. After the target is locked on in angular coordinates the antenna beam stops scanning and the target starts being autotracked in angular coordinates. Instead of the strobes the indicator screen displays two dots in azimuth of the locked on target, number of the line in which the target has been locked on and mark "↑" (upward) or "↓" (downward), indicating the position of the antenna beam with respect to the horizon line (Fig. 109). In 1 to 2 s the target will be locked on in range and the autotracking will be effected.

- Notes.
1. When the target is attacked from the front hemisphere and in automatic direction, after radiation cutin the ABM-25 computer may generate the "Preliminary zoom" command if the target elevation over the aircraft is more than 3000 m. In response to this command the Z lamp lights up on the indicator annunciator and the command mark (small ring) jumps upward. Keeping the command mark in the centre of the cross-hairs the pilot starts climbing at an angle of  $5^\circ$ .
  2. If the antenna fails to be controlled in azimuth and elevation by the commands from the 5V15K-11 equipment, the pilot should resort to manual control of the airborne radar by setting the DIRECT: AUTO - MAN selector switch mounted on unit 24 to the MAN position.
  3. If the RDR mark is displayed on the indicator screen, switch off the power supply of the airborne radar at once.

### 1.3. Visual Direction

The profile of the fighter flight for aerial combat during visual direction is similar to the flight profile during automatic direction. The pilot may fly the aircraft in position, director and automatic control modes, using the flight director indicator, combined course indicator and the manual selected course input.

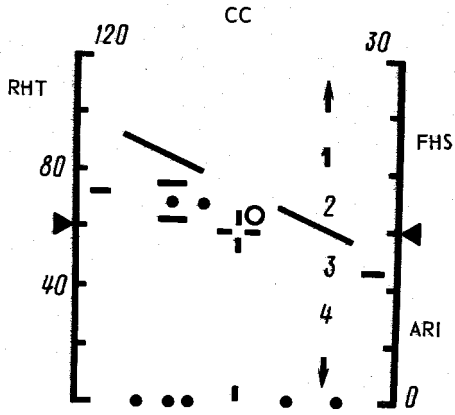

FIG. 108. PICTURE DISPLAYED ON RADAR INDICATOR SCREEN IN AUTOMATIC DIRECTION (modes HMA and HMA- $\Delta$ H, azimuth gating is engaged)

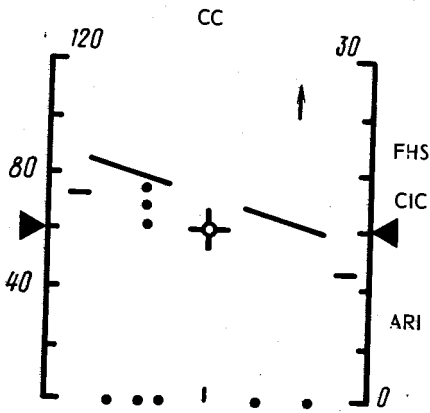

FIG. 109. PICTURE DISPLAYED ON RADAR INDICATOR SCREEN IN AUTOMATIC DIRECTION (target lock on in angular coordinates, mode HMA)

The C-25 armament control system is switched on as it is done in automatic direction. The DIRECT: AUTO - MAN selector switch should be set to the MAN position.

The following information is displayed on the radar screen before radiation is cut in (Fig. 110):

- the range scale without figures;
- the altitude scale with the fighter present altitude marker;
- the electronic gyro horizon line.

As the fighter attains the assigned altitude and gains the assigned speed required for attack of the target, the pilot should set the ILLUM - DUMMY - OFF selector switch to the ILLUM position in response to the command transmitted from the control post. The ILLUM lamp located on unit 24 lights up and the indicator screen displays the following additional information (Fig. 111):

- the range scale up to 120 km if  $H_{ftr} \geq 4.2$  km, up to 60 km if  $1.5 \text{ km} \leq H_{ftr} \leq 4.2$  km, up to 30 km if  $H_{ftr} \leq 1.5$  km;
- the target range manual input mark ( $D_{man. in}$ ) to the right of the range scale;
- indices 1, 2, 3, 4, indicating the line No. in which the antenna beam scans presently;
- marks "↑" (upward) and "↓" (downward);
- antenna azimuth position mark.

The pilot controls the search area of the airborne radar in the HMA, HMA-ΔH, MLA modes manually referring to the information transmitted from the control post through the radio set.

To control the scan area in azimuth the pilot should set the knob of unit 44 to the middle or extreme right or left position. To control the scan area in elevation the pilot should set the  $D_{man. in}$  mark to the expected range of the target on the range scale by moving the knob of unit 44 forward or backward and set the present stepped-up (stepped-down) vertical separation of the target with the aid of the ΔH selector switch of unit 24. In this case, the centre of the search area in elevation is set at an angle calculated from the following formula:

$$\varphi_{\text{search area centre}} = \frac{\Delta H}{D_{\text{man. in}}} = 57.3.$$

In the MLA mode the search area may be shifted only upward from  $+1.5^\circ$  with respect to the horizon line. In the LA mode the search area is not controllable.

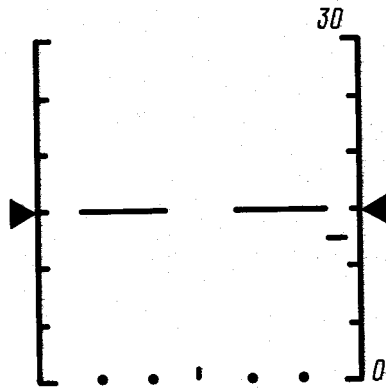

FIG. 110. PICTURE DISPLAYED ON RADAR INDICATOR SCREEN IN VISUAL DIRECTION PRIOR TO RADAR ENABLING FOR ILLUMINATION

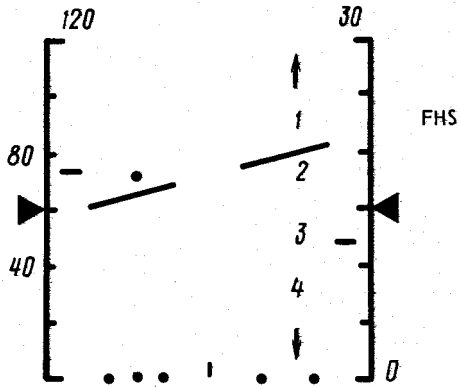

FIG. 111. PICTURE DISPLAYED ON RADAR INDICATOR SCREEN IN VISUAL DIRECTION WITH RADAR ENABLING FOR ILLUMINATION (modes HMA, HMA-ΔH)

The  $D_{man. in}$  mark determines the position of the lockon zone centre in range. The range lockon zone is 4.5 km in the LA and MLA modes and 9 km in all other modes.

With the target detected, it should be identified and locked on. To lock on the target the pilot should set the  $D_{man. in}$  mark to the range of the target by using the knob of unit 44 (not depressing it) and depress the LOCKON button.

If several targets are observed in the lockon zone, the azimuth gating should be enabled. The lockon procedure is similar to that used in the automatic direction.

#### 1.4. Self-Direction of Fighter with Use of Missiles P-4OT, P-4OPД and P-4OTД

After the target is locked on, the ABM-25 computer solves the sighting problem. To control the fighter in the lateral channel, the ABM-25 computer transmits the  $\Delta\Gamma$  sighting error signal and the  $Y_{preset}$  preset bank signal to the CAV-155 automatic flight control system (Fig. 112). The  $\Delta\Gamma$  sighting error is indicated by the vertical position bar of the flight director indicator. The  $Y_{preset}$  signal is used in the CAV-155 system for generating the command signal ( $\Delta Y = Y_{preset} - Y_{present}$ , where  $Y_{present}$  is a present bank of the fighter). The  $\Delta Y$  signal is indicated by the vertical command bar of the flight director indicator.

To control the fighter in the longitudinal channel, the ABM-25 computer delivers the  $\Delta B_2$  sighting error signal (before the "Zoom" command) or  $\Delta B_3$  (after the "Zoom" command) and the  $n_y$  preset preset g-load signal proportional to the  $\Delta B_2$  and  $\Delta B_3$  signals to the CAV-155 system.

The  $\Delta B_2$  ( $\Delta B_3$ ) signal is indicated by the horizontal position bar of the flight director indicator.

The  $n_y$  preset signal is used in the CAV-155 automatic flight control system for generation of the command signal.

$n_y = n_y$  preset -  $n_y$  present, where  $n_y$  present is a present g-load of the fighter.

The  $n_y$  signal is indicated by the horizontal command pointer of the flight director indicator.

While keeping the command pointers of the flight director indicator within the circle the pilot flies the fighter in the horizontal plane to the lead point of target interception by the missile and in the vertical plane until the "Zoom" command is

delivered in response to the stepped-up (stepped-down) vertical separation set by the  $\Delta H$  selector switch relative to the target. After the "Zoom" command the fighter is brought in both planes to the lead point of target interception by the missile.

After the target is locked on the indicator screen displays the following information (Fig. 113):

- range scale of 120 km. If the target range is less or equal to 55 km and less or equal to 26 km, the scale is switched over to 60 km and 30 km, respectively;
  - index Atk (attack), indicating the self-direction stage;
  - altitude scale with the fighter present altitude mark;
  - electronic cross-hairs;
  - electronic gyro horizon line;
  - beam mark in a shape of a dot, which determines the position of the target with respect to the aircraft coordinates ( $\varphi_{\text{hor}}$  is the target azimuth and  $\varphi_{\text{vert}}$  is the target elevation). Flickering of the beam mark at a rate of 2 Hz indicates that the target sighting angles are more than the limit bearing, i.e.  $\varphi_{\text{hor}}$  ( $\varphi_{\text{vert}}$ )  $\gg \pm 45^\circ$ . Maximum deflection of the beam mark from the centre of the cross-hairs within the indicator scales is  $\pm 70^\circ$ ;
  - maximum permissible missile launching range mark ( $D_{\text{perm. max}}$ ) in the shape of a horizontal line, equal to the diameter of the electronic cross-hairs and crossing the range scale;
  - minimum permissible missile launching range mark ( $D_{\text{perm. min}}$ ) in the shape of the horizontal line near the range scale;
  - double mark near the range scale indicating the locked on target range. The right mark (range mark) indicates the range ( $R_{\text{tgt}}$ ) to the target locked on by the range finder of the airborne radar. In the HMA- $\Delta H$  mode (if  $1.5 \text{ km} \leq H_{\text{ftr}} \leq 3.5 \text{ km}$  through the entire reception coverage) in the target range segment of  $\pm 4.5 \text{ km}$  the airborne radar scans the space within the limits of antenna pattern. All targets within this area are displayed as blips (target blips) to the left of the range marker and indicate the ranges to these targets. If the radar locks on only one target, the radar screen displays only one blip to the left of the range marker.
- The target blip may not be coincident with the range marker in range by a value of not more than the thickness of the locked on target blip;

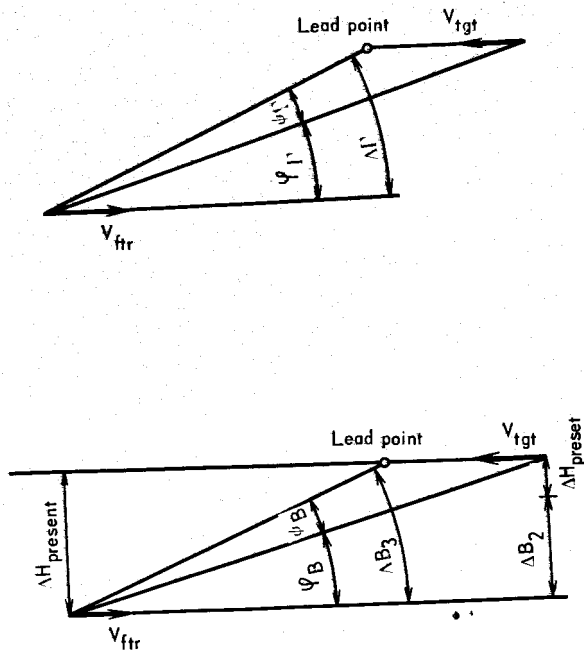

FIG. 112. SHAPING OF AIMING ERRORS

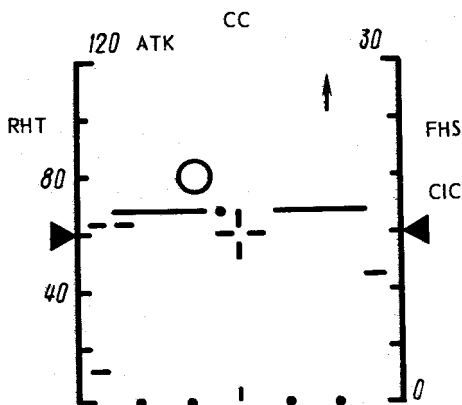

FIG. 113. PICTURE DISPLAYED ON RADAR INDICATOR  
SCREEN AT HOMING STAGE  
(missile P-40.1, fighter position control, mode HMA)

- the command mark (small ring) in coordinates  $\Delta y$  and  $\Delta x$ , which duplicates the positions of the flight director indicator command pointers. With the DIRECTION mode disabled in the CAV-155 automatic flight control system the indicator screen displays the sighting error mark (large ring) in coordinates  $\Delta \Gamma$  and  $\Delta B_2$  ( $\Delta B_3$ ) instead of the command mark. The diameter of the large ring corresponds to  $4^\circ$ . Maximum deflection of the sighting error mark within the indicator scales for signals  $\Delta \Gamma$  (left-right) and  $\Delta B$  (up-down) is  $\pm 24^\circ$  with respect to the cross-hairs;

- mark "↑" (upward) or "↓" (downward) which provides for determining the airborne radar operating mode at the self-direction stage.

The firing zone is limited by the  $D_{\text{perm. max}}$  and  $D_{\text{perm. min}}$  marks and depends upon the fighter altitude and speed, attack aspect angle, fighter-to-target closing rate and sighting errors. The increase of sighting errors decreases the firing zone value.

32 seconds before the fighter reaches the maximum permissible missile launching range at  $\Delta H > 0$  the ABM-25 computer generates the "Reheat" command and the RHT pilot lamp lights up on the indicator annunciator.

The "Zoom" command is generated 22 seconds before the fighter reaches the maximum permissible launching range. As the "Zoom" command is generated, the command mark or the sighting error mark jumps up, if the attack is executed with a stepped-down separation, and the Z pilot lamp lights up on the indicator screen. In the fighter director control mode the command mark is maintained within the cross-hairs by the aircraft maneuvering. In the fighter position control mode the pilot keeps the cross-hairs aligned with the sighting error mark (large ring). Simultaneously with generation of the "Zoom" command the armament control equipment receives the "Preparation" command and the continuous illumination channel is enabled. The CIC pilot lamp lights up on the indicator annunciator. In the nose-cone attack the "Preparation" command is generated and the transmitter of the continuous illumination channel is switched on after the LOCKON button is depressed (Fig. 114).

1.5 second before the fighter reaches the maximum permissible launching range, the "In-range" command is transmitted from the ABM-25 computer to the armament system if the sighting



angle is within  $\pm 45^\circ$ . When the target is locked on by the missile heat seekers or the radar homing missiles are ready for launch, the "Launch permitted" commands are transmitted from the armament control equipment. Indices 1, 2, 3, 4, LP are displayed on the indicator screen for the corresponding missile (Fig. 114).

The missiles are launched with the LP index or at least one of indices 1, 2, 3, 4 illuminated. The launch is effected by depression of the firing button for 2 seconds. The missile lift-off is checked visually and by reference to fadeout of the corresponding pilot lamps indicating the missile station status.

On depressing the firing button the  $D_{\text{perm. max}}$  mark jumps down by the following value:  $D_{\text{perm. max 2}} = 0.7 D_{\text{perm. max 1}}$ .

The next missile is launched at a range of  $D \leq D_{\text{perm. max 2}}$  to increase probability of successful hitting of the maneuvering target.

In response to the "Breakaway" command the voice information system delivers the "Breakaway" command, the BREAKAWAY pilot lamp located on the annunciator of the indicator lights up and the command mark or sighting error mark jumps up and right or up and left, showing the safe direction of breakaway (Fig. 115). The breakaway is performed with a bank of  $70^\circ$ , maximum. When the target is attacked at the fighter altitudes less than 1500 m, the breakaway is performed with a bank of  $30^\circ$ , maximum.

In the automatic control mode the breakaway terminates in levelling the fighter.

Removal of the "Breakaway" command is effected after reset of target lockon (if the target aspect angle is more than  $\pm 56^\circ$  in azimuth and from  $+52^\circ$  to  $-42^\circ$  in elevation) or by the "Homing" or "Redirection" commands delivered from the 5V15K-11 equipment.

In the automatic direction the target illumination by the airborne radar is cut off in response to the "Homing" or "Redirection" commands automatically, and in visual direction, by setting the ILLUM - DUMMY - OFF selector switch to the DUMMY position.

The airborne radar is de-energized by setting the ILLUM - DUMMY - OFF selector switch mounted on unit 24, and then the RDR - OFF selector switch mounted on unit 34 to the OFF position.

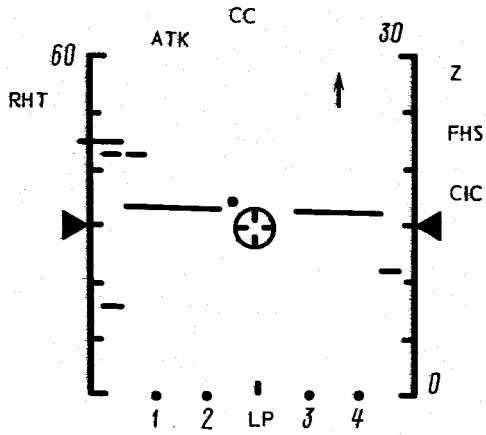

FIG. 114. PICTURE DISPLAYED ON RADAR INDICATOR SCREEN IN HOMING STAGE (missile P-401, fighter position control, mode HMA, launch permitted)

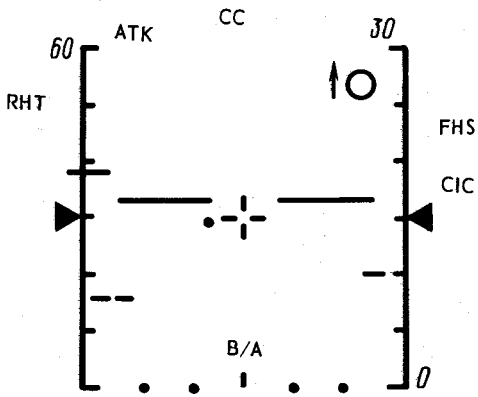

FIG. 115. PICTURE DISPLAYED ON RADAR INDICATOR SCREEN WHEN BREAKING-OFF FROM ATTACK

### 1.5. Fighter Self-Direction with Use of Missiles P-60 or P-60M

During attack of the target with the use of the P-60 (P-60M) missiles the fighter is self-directed in the position control mode only. After the target is locked on the DIRECT button-lamp located on the control panel of the automatic flight control system fades out. If the ground-based direction has been effected in the automatic fighter control mode, the automatic control is disabled by the use of the AUTOPILOT OFF button located on the control stick as soon as the "Atk" (attack) index is displayed on the indicator screen.

After the radar has locked on the target the following information is displayed on the indicator screen (Fig. 116):

- range scale in the scale of 30 km, if the target range is less than 26 km;
- target blip and range marker to the right of the range scale;
- altitude scale with the fighter present altitude mark;
- electronic cross-hairs;
- sighting error mark (large ring) in coordinates  $\psi_{hor}$  (target azimuth) and  $\psi_{vert}$  (target elevation);
- maximum permissible missile launching range mark;
- electronic gyro horizon line.

By flying the maneuvers the pilot keeps the sighting error mark (large ring) aligned with the cross-hairs.

The maximum deviation of the sighting error mark (centre of the ring) from the centre of the cross-hairs within the indicator scales is  $\pm 70^\circ$ .

If the target sighting angle is more than  $\pm 24^\circ$  (limit bearing), the sighting error mark flickers at a rate of 2 Hz.

At a target range less than 15 km the electronic gyro horizon line is zeroed in pitch and the screen displays additionally the "Fin" mark. The miniature aircraft composed of the electronic gyro horizon line and "Fin" mark indicates the present bank of the fighter (Fig. 117).

Display of indices 1, 4 and LP on the indicator screen proves the conditions for launching the P-60 (P-60M) missiles. Besides, the pilot hears a monotone audio signal in the ear-phones.

If the angular velocity of target tracking by the heat seeker of the P-60M missile is more than tolerable one, the

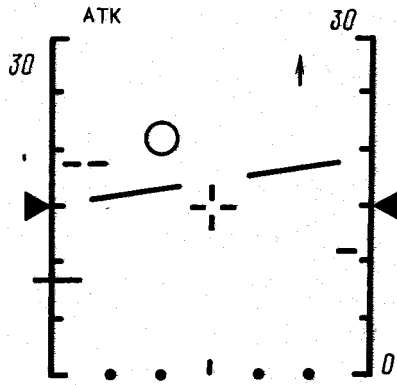

FIG. 116. PICTURE DISPLAYED ON INDICATOR SCREEN  
AT HOMING STAGE  
(missile P-60 (P-60M), mode HMA)

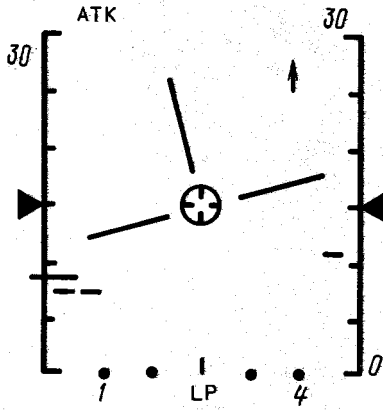

FIG. 117. PICTURE DISPLAYED ON RADAR INDICATOR  
SCREEN AT HOMING STAGE  
(missile P-60 (P-60M), mode HMA, launch permitted)

ABM-25 computer generates the PSE (permissible sighting error) command, which causes flickering of the LP index on the indicator screen. In this case, by flying the maneuver the pilot should decrease the angular velocity of target tracking till the LP index stops flickering; in so doing, he should keep the large ring within the electronic cross-hairs and launch the missiles.

The breakaway is performed by the "Breakaway" command, which is supplied after lift-off of the last missile or at a minimum safe distance:

$$D_{\text{safe}} = 550 \text{ m} + 5.7 V_{\text{close}}$$

where  $V_{\text{close}}$  is a fighter-to-target closing rate in m/s.

As soon as the "Breakaway" command is supplied, the BREAK-AWAY pilot lamp lights up on the indicator and the electronic ring jumps up and right or up and left indicating the safe direction of breakaway (Fig. 118). Simultaneously, the indicator screen displays the beam mark in the shape of a dot indicating direction to the target, i.e. its  $\varphi_{\text{hor}}$  and  $\varphi_{\text{vert}}$  (where  $\varphi_{\text{hor}}$  - target azimuth,  $\varphi_{\text{vert}}$  - target elevation).

After breakaway and removal of the "Breakaway" command the pilot should cut off illumination and de-energize the radar.

## 2. PECULIARITIES OF EMPLOYMENT OF AIRBORNE RADAR "SAPFIR-25" IN ATTACK OF ACTIVE AND PASSIVE JAMMING AIRCRAFT

### 2.1. Attack of Continuous and Discontinuous- Noise Jammer

In the scan mode an active noise jamming initiates a vertical line in noise jammer blip azimuth within the radar coverage. Width of the line is a function of the noise level. In sideslope reception the noise jamming causes additional vertical lines on the screen (Fig. 119). If the noise level is higher than the tolerable one, the indicator screen displays the AJ mark (active jamming) near the range scale. After detection of the active noise jamming the pilot should proceed as follows:

- turn off the parametric amplifier by using the PA - OFF switch mounted on unit 34 if the fighter flying altitude is higher than 4.2 km;

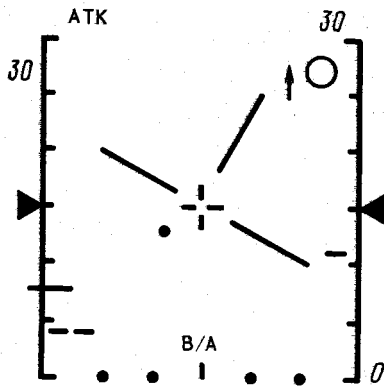

FIG. 118. PICTURE DISPLAYED ON RADAR INDICATOR SCREEN AT HOMING STAGE (missile P-60 (P-60M), mode HMA, breaking off from the attack)

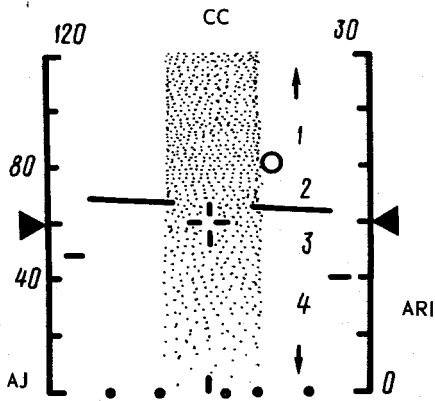

FIG. 119. PICTURE DISPLAYED ON RADAR INDICATOR SCREEN UNDER CONDITIONS OF HIGH-POWER NOISE JAMMING IN SCANNING (mode HMA, automatic direction)

- set the ACT JAM - OFF - PAS JAM (АП - ВЫКЛ. - ПП) selector switch to the ACT JAM position to desensitize the receiving channel and narrow the line;

- turn the RDR (РД) knob located on unit 24 counterclockwise in the HMA-ΔH, LA modes and when the C-25 armament control system operates in the ATM mode to obtain only one vertical line of 3 to 5°, maximum;

- if the lockon zone covers side lines (Fig. 120) or other targets, enable the azimuth gating, align the strobes with the brightest vertical line and depress the LOCKON button.

The target is locked on in azimuth and elevation. With the AJ (active jamming) command supplied the target is not locked on in range. The range finder is disconnected and the indicator screen displays the RFJ (range finder jamming) mark.

The information displayed on the indicator screen corresponds to the self-direction mode (Fig. 121). The target blip is displayed in the shape of a vertical column corresponding to a range of 9 km.

The target range and closing rate information is transmitted to the airborne radar from the direction post through the 5V15K-11 equipment in the automatic direction mode. In this case, the further actions of the pilot are similar to those used in the attack under no-jamming conditions.

In visual guidance with the RFJ signal displayed on the indicator screen the target range is introduced into the airborne radar by the pilot manually by referring to the information transmitted periodically from the direction post through the radio set in the form of voice messages.

For manual target range input into the airborne radar the pilot should use the knob of unit 44 (move it forward or backward) to keep the range marker ( $D_{\text{man. in}}$ ) and target blip displayed symmetrically to it at the required range. In this case, the target closing rate introduced into the ABM-25 computer is taken to be:

- 100 m/s in the rear-cone attack;
- $1.6 V_{\text{ftr}}$  in the front-cone attack,

where  $V_{\text{ftr}}$  is a fighter speed in m/s.

In case of noise suppression or in intervals of the discontinuous noise the AJ and PJ marks fade out on the screen and the airborne radar is switched over to target tracking in

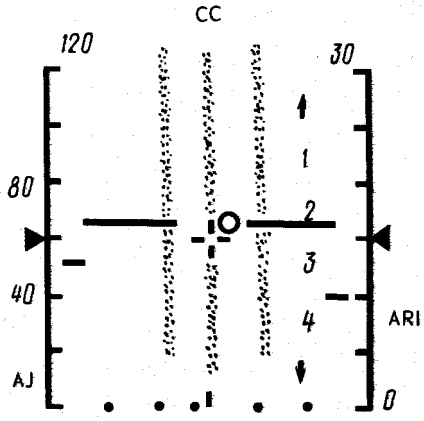

FIG. 120. PICTURE DISPLAYED ON RADAR INDICATOR SCREEN UNDER CONDITIONS OF HIGH-POWER NOISE JAMMING AFTER RECEIVER DESENSITIZATION IS SWITCHED ON (mode HMA, automatic direction)

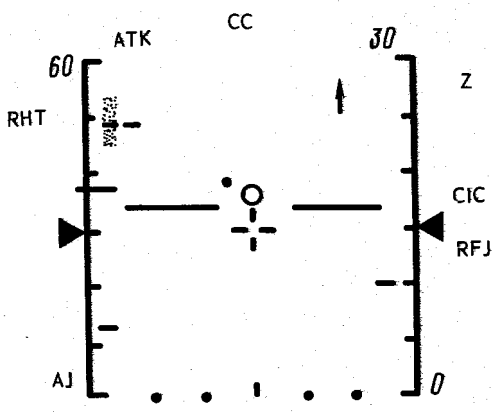

FIG. 121. PICTURE DISPLAYED ON RADAR INDICATOR SCREEN AT HOMING STAGE (attack launched against active noise jammer with missiles P-40P1)



azimuth, elevation and range. Under the noise conditions the automatic/manual range input error should be within the limits of  $\pm 4.5$  km, if otherwise, noise suppression results in target lockon failure.

If the active noise jamming is set after target lockon in range (2.5 s after the "Attack" command), the radar range finder is switched over to target tracking by referring to the memorized closing rate (closing rate memorized at the moment of the "Active jamming" command generation). In this case, the AJ mark is displayed on the indicator screen and the PJ mark fades out.

Range finder operation by the memorized closing rate is limited in time (15 s). After 15 seconds the range finder gets disconnected, which is proved by the RFJ index displayed on the indicator screen. The airborne radar is switched over to the automatic/manual target range input mode depending upon the type of aircraft direction.

For the target tracking mode a provision is made in the equipment for manual disconnection of the range finder in order to ensure automatic input of target range and closing rate from the 5V15K-11 equipment in the automatic direction or manual input of the target range in the visual direction. For this purpose, the ACT JMG - OFF - PAS JMG selector switch should be set to the ACT JMG position. If it is already in the ON position, it should be switched off and then set to the ACT JMG position again. The RFJ mark should get displayed on the indicator screen.

Under active noise conditions the missile launch is carried out in response to the "Launch permitted" command subsequently at various ranges within the permitted launch area to improve probability of successful target destruction.

If there is no radio contact with the direction post, perform the attack of a jammer visually. In this case, set the DIRECT selector switch located on unit 24 to the MAN position.

After the target is locked on, arrange the range marker above the  $D_{perm. max}$  mark. Prior to launching the missiles, introduce the range marker into the permissible launch area in order to obtain the LP signal. The pilot should determine the missile launching moments independently, measuring the target range visually.

During the attack of a jammer in the LA mode and visual direction (the DIRECT selector switch located on unit 24 set

to the MAN position) the equipment is switched over to the LAM (low-altitude mode, manual control) after the RFJ mark is displayed on the indicator screen. This mode is selected if no information about target range and closing rate is transmitted from the direction post. After the LAM mode is selected the pilot should fly the aircraft to an altitude of 700 m, bring it to the level flight and referring to the beam mark position and mark "↓" (downward) make sure that the aircraft flies over the target. The necessary elevation relative to the target is 0 to 650 m. If this condition is not met, the pilot climbs the fighter to 1200 m and attacks the target, maintaining this altitude (Fig. 122). As the concept of the LAM mode is based upon computation of the range with fixed elevation, which differs in general from the real elevation, the missiles should be launched subsequently at various ranges within the permissible launch area to improve probability of successful target destruction.

To cancel the LAM mode as true information about the target is received, the pilot should depress the knob of unit 44 and introduce the range manually while keeping the knob depressed.

Under the noise conditions the safe breakaway is ensured only by visual observation of the target at the end of the attack.

## 2.2. Attack of Repeater Multiple Impulse Noise and Repeater Noise Jammer

In all operating modes of the airborne radar the multiple repeater impulse noise is displayed on the indicator screen in the shape of several parallel marks in the jammer azimuth spaced in range (Fig. 123) and the repeater noise is displayed in the shape of a single or multiple vertical marks similar to the noise marks (Fig. 124). The noise marks are displayed at the ranges more than the real target range. The AJ mark is not displayed in case of multiple impulse or non-overlapping repeater noise.

In the HMA- $\Delta$ H mode under the conditions of non-overlapping repeater noise in scanning the indicator screen displays only leading and trailing edges of the noise jamming if it is within the reception zone.

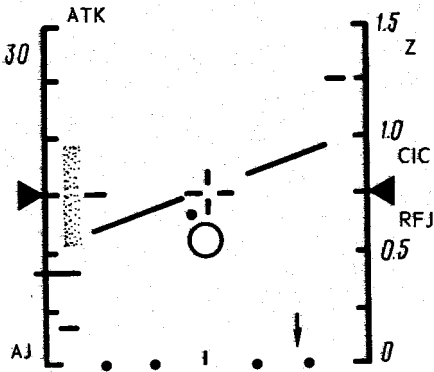

FIG. 122. PICTURE DISPLAYED ON RADAR INDICATOR SCREEN AT HOMING STAGE (mode LAM, fighter position control, missile P-40P1)

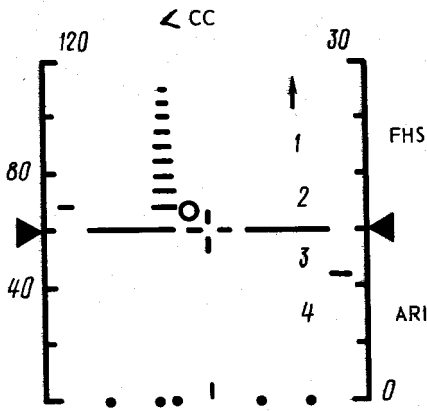

FIG. 123. PICTURE DISPLAYED ON RADAR INDICATOR SCREEN IN AUTOMATIC DIRECTION AND UNDER REPEATER MULTIPLE IMPULSE NOISE JAMMING CONDITIONS IN SCANNING MODE

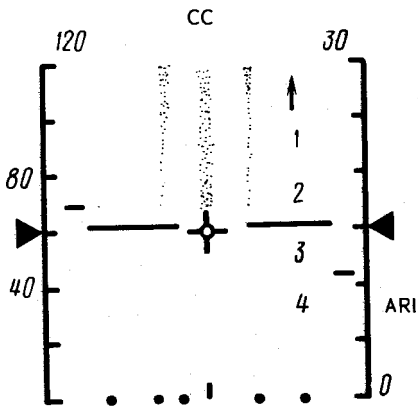

FIG. 124. PICTURE DISPLAYED ON RADAR INDICATOR SCREEN IN AUTOMATIC DIRECTION AND UNDER REPEATER NOISE JAMMING CONDITIONS IN SCANNING MODE

To lock on the multiple impulse or high-level repeater noise jammer, the pilot should proceed as follows:

- set the PA - OFF switch to the OFF position at the fighter altitude higher than 4200 m;
- set the ACT JMG - OFF - PAS JMG selector switch to the ACT JMG position.

This activity prevents sidelobe reception of the noise signals. When the airborne radar is used in the HMA-ΔH, LA, ATM modes the pilot may additionally desensitize the receiver by using the RDR potentiometer located on unit 24 to obtain the narrow noise mark on the indicator screen. It is recommended to lock on the target with azimuth gating enabled. The strobes should be aligned with the target or leading edge of the noise signal if it covers the target blip. To make sure that the target is locked on properly the pilot should refer to the range marker aligned with the leading edge of the target blip. The target mark is displayed in the shape of several horizontal dashes (multiple impulse noise (Fig. 125)) or in the shape of a rectangle (repeater noise (Fig. 126)) within the limits of the range finder search coverage (9 km). In case of unstable lock on of the jammer in range after the target is locked on in azimuth and elevation the pilot should change over to reception of the target range from the 5V15K-11 equipment in the automatic direction or to manual range input in the visual direction. To this end, the pilot should set the ACT JMG - OFF - PAS JMG selector switch to the ACT JMG position. If the selector switch is already in the ACT JMG position, it should be switched off and again set to the ACT JMG position. Check disconnection of the range finder referring to illumination of the RFJ mark on the indicator screen.

After the range marker enters the permissible launch area and one of indices 1, 2, 3, 4 and LP get illuminated, refine aiming and launch the missiles.

### 2.3. Attack of Passive Jammer

In the HMA, HMA-ΔH and MLA operating modes the SAPPFIR-25 airborne radar ensures a 3/4-aspect attack of a passive jammer, dispersing the chaffs in the rear hemisphere. Selection of the ATM mode in this case is not efficient, because it results in double reduction of the radar range coverage. The ATM mode is

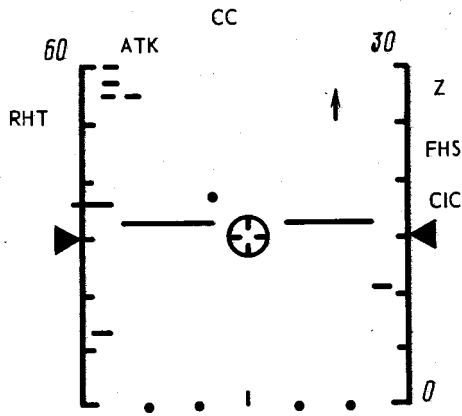

FIG. 125. PICTURE DISPLAYED ON RADAR INDICATOR SCREEN IN ATTACK LAUNCHED AGAINST REPEATER MULTIPLE NOISE JAMMER (fighter position control, missiles P-40P.I and P-40T)

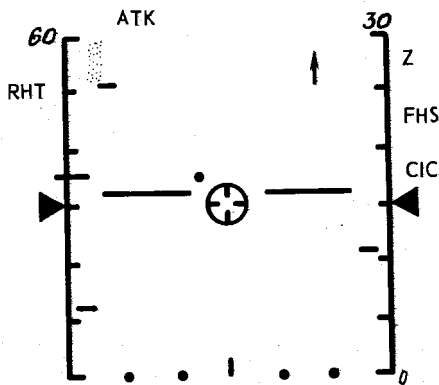

FIG. 126. PICTURE DISPLAYED ON RADAR INDICATOR SCREEN IN ATTACK LAUNCHED AGAINST REPEATER NOISE JAMMER (fighter position control)

selected if it is impossible to discriminate the target in the RDR mode (the radar operates in the HMA, HMA-ΔH modes).

When the airborne radar scans in the HMA and MLA modes, the indicator displays the passive jamming signal in the shape of a trail. The target is in the head of the trail. The passive jamming trail is observed far from the target blip in case of the rear-cone attack (Fig. 127) or close to the target blip in case of the front-cone attack (Fig. 128).

When the airborne radar operates in the HMA-ΔH mode the indicator displays only the outline of the passive jamming trail. If the passive jamming is observed, the pilot should proceed as follows:

- set the ACT JMG - OFF - PAS JMG selector switch to the PAS JMG position;
- set the FHS - LST - RHS selector switch to the FHS or RHS position (in compliance with the attack direction in the visual direction);
- enable the azimuth gating of the target by turning the knob of unit 44 clockwise;
- superimpose the strobes on the head of the trail so that the head is within the range lockon area when the target appears the next time (the target blip is displayed on the indicator screen after every 3.5 s);
- depress the LOCKON button.

Check correctness of the lockon by reference to the position of the range marker relative to the target blip (Figs 129, 130).

If the jammer starts dispersing the chaffs when it has been locked on in range, the indicator can display the PAS JMG index for a short time, the circuit protecting against the passive jamming is enabled automatically and the range finder starts tracking the passive jammer.

When attacking the target at an aspect angle close to 4/4, the airborne radar may start tracking the chaff cloud. In this case, the lockon is reset and the screen displays the PAS JMG index till the LOCKON button is repeatedly depressed, thus indicating the cause of the lockon reset. The pilot should repeat the lockon at a smaller aspect angle.

Note. Do not manipulate the ACT JMG - OFF - PAS JMG selector switch during the nose-cone attack of the passive jammer (the selector switch should be in the middle position).

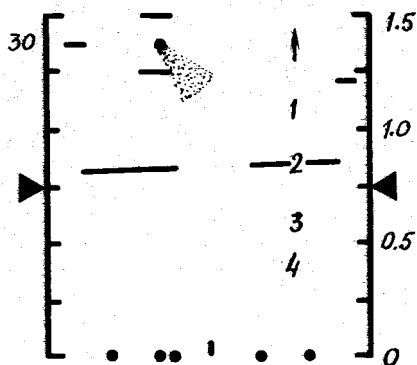

FIG. 127. PICTURE DISPLAYED ON RADAR INDICATOR SCREEN AT VISUAL DIRECTION IN SCANNING MODE (rear-cone attack launched against passive jammer, azimuth gating is switched on)

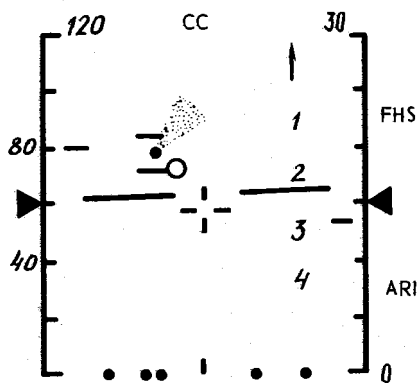

FIG. 128. PICTURE DISPLAYED ON RADAR INDICATOR SCREEN AT AUTOMATIC DIRECTION IN SCANNING MODE (forward-cone attack launched against passive jammer, azimuth gating is switched on)

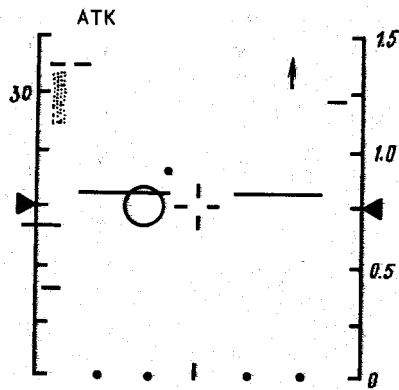

FIG. 129. PICTURE DISPLAYED ON RADAR INDICATOR SCREEN AT HOMING STAGE  
(rear-cone attack launched against passive jammer, fighter position control, mode MLA)

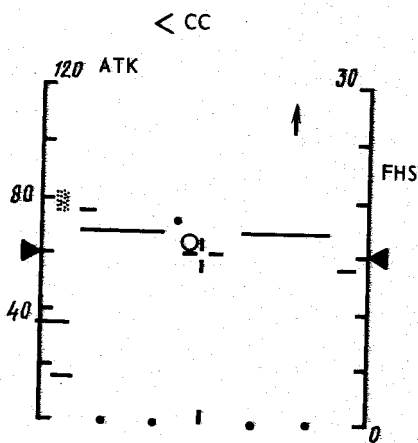

FIG. 130. PICTURE DISPLAYED ON RADAR INDICATOR SCREEN AT HOMING STAGE  
(forward-cone attack launched against passive jammer, fighter director control, mode HMA)



If the target is attacked in the ATM mode, there are no passive jamming blips on the screen. In case of cumulus rain/snow clouds the pilot observes flare spots on the screen which hamper detection and lockon of the target.

When the C-25 armament control system operates in the ATM mode, there are two fixed positions in the range coverage of the airborne radar depending on the position of the range marker delivered from the 5V15K-11 equipment or  $D_{man.}$  in mark in the scan. The detection ranges depend upon the operating mode of the airborne radar (HM1, HM2, HM3). The switching conditions are given in Table 17.

In the ATM mode, the actions of the pilot for detection and lockon of the target are similar to those taken in the RDR mode.

Table 17

Radar operating mode	Detection zone position I, km	Detection zone position II, km	Conditions for selection of detection zone II	Scale, km
HM1	0.3 to 18	10 to 28	$D_{man.}$ in 15 km	30
HM2	0.3 to 29	17 to 46	$D_{man.}$ in 24 km	60
HM3	0.3 to 43	25 to 68	$D_{man.}$ in 37 km	60

#### 2.4. Attack of Combined Jammer (Passive and Active)

During front-cone attack of a combined jammer (passive jamming and non-overlapping repeater noise or multiple impulse noise) in the RDR mode at an aspect angle close to  $0/4$ , the jamming gates on the screen in the scan mode either merge or the passive jamming gates are displayed at an angle relative to the active jamming gates while the target blip is aligned with the lower edge of the gates (Fig. 131). In this case, resort to the azimuth gating for successful target lockon. During the attack, check correctness of the lockon referring to the position of the range marker relative to the target blip. If the range marker is not aligned with the lower edge of the target blip the pilot should switch over to reception of the target distance from the 5V15K-11 equipment or to the manual distance input.

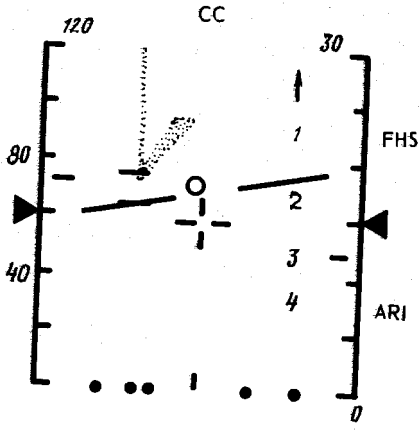

FIG. 131. PICTURE DISPLAYED ON RADAR INDICATOR SCREEN AT AUTOMATIC DIRECTION IN SCANNING MODE (forward-cone attack launched against combined jammer, azimuth gating is switched on)

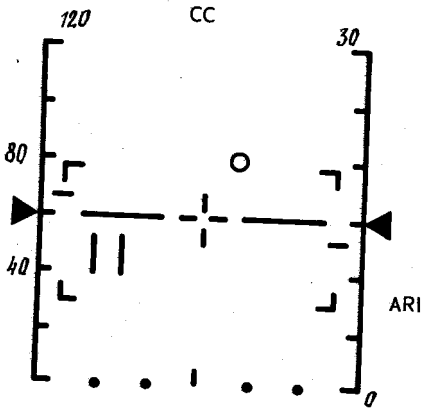

FIG. 132. PICTURE DISPLAYED ON RADAR INDICATOR SCREEN AT AUTOMATIC DIRECTION (mode T-1, prior to target detection)

In other cases, the target is detected either in the ATM mode or in the T-I, T-II, T-III modes to minimize the effect of the passive and active jammings.

In case of the combined jamming (passive and active), it is recommended to use the missiles with the heat seeking heads.

### 3. AERIAL COMBAT FLIGHT WITH EMPLOYMENT OF C-25 ARMAMENT CONTROL SYSTEM IN MODES T-I AND T- $\varphi_{OI}$

For operation of the C-25 armament control system in mode T-I, the controls of the SAPFIR-25 airborne radar should be set to the positions similar to those in the RDR mode depending upon guidance and aircraft control mode. The SYST selector switch mounted on unit 24 should be set to the T-I position. The  $\varphi_o$  - WITH RDR -  $\varphi_b$  selector switch located on the instrument board should be set to the WITH RDR position.

After starting the engines, the pilot should turn on the RDR and HDF switches arranged on unit 34. After takeoff, the ILLUM - DUMMY - OFF selector switch located on unit 24 should be set to the DUMMY position. The information displayed on the indicator screen is similar to the one in the RDR mode before the illumination is cut in in compliance with the guidance type (Figs 132, 133) plus the boundaries of the heat direction finder distance coverage and its strobes. Position of the HDF strobes depends upon a position of the knob of unit 44.

After the fighter attains an altitude assigned for the attack of a target, the pilot should detect the target with the use of the heat direction finder. The target on the indicator screen is displayed in azimuth and elevation as a dot (Fig. 134).

To lock on the target, the pilot should align the strobes of the heat direction finder with the target blip by using the knob of unit 44 and depress the LOCKON button. After the target is locked on, the indicator screen displays the HDF and  $D_{perm. max}$  (maximum permissible missile launching distance mark) marks and in the automatic direction mode, it displays the sighting error mark (large ring) in target azimuth  $\varphi_{hor}$  and target elevation  $\varphi_{vert}$  instead of the command mark (small ring). In response to the signals of the heat direction finder, the antenna reflector is directed to the locked on target. Marks  $\uparrow$  (upward) and  $\downarrow$  (downward) indicate the position of the target with respect to the horizon line (Fig. 135). In visual guidance,

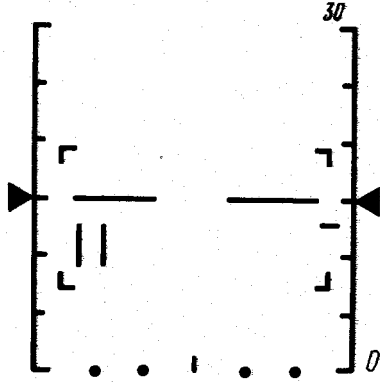

FIG. 133. PICTURE DISPLAYED ON RADAR INDICATOR SCREEN AT VISUAL DIRECTION (mode T-1, prior to target detection)

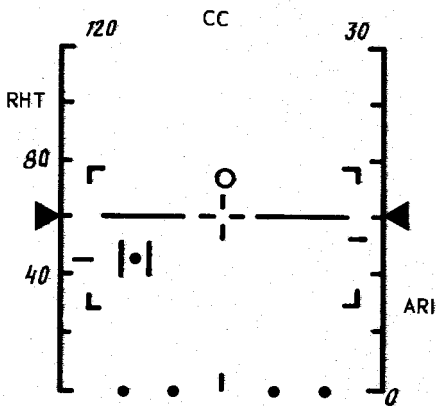

FIG. 134. PICTURE DISPLAYED ON RADAR INDICATOR SCREEN IN AUTOMATIC DIRECTION (mode T-1, after target detection by heat direction finder)

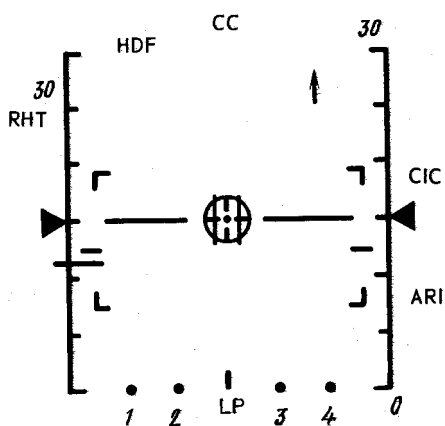

FIG. 135. PICTURE DISPLAYED ON RADAR INDICATOR  
SCREEN IN AUTOMATIC DIRECTION  
(mode T-I, after target lockon by heat direction finder)

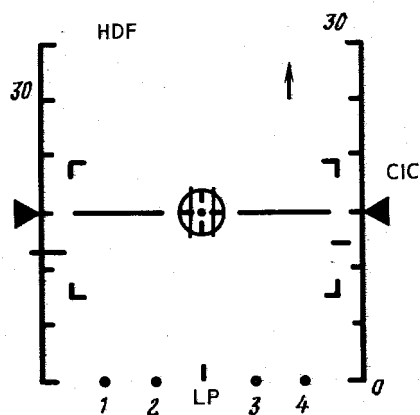

FIG. 136. PICTURE DISPLAYED ON RADAR INDICATOR  
SCREEN IN VISUAL DIRECTION  
(mode T-I, after target lockon by heat direction finder)

the indicator screen displays figures of the distance scale (30 km) and electronic cross-hairs (Fig. 136).

The pilot should check the target distance referring to the distance marker transmitted from the 5V15K-11 equipment in the automatic direction or referring to the information transmitted from the direction post through the radio set in the visual direction.

For computation of the maximum permissible missile launching distance, the ABM-25 computer receives the present speed and altitude of the fighter. The closing rate is taken equal to 100 m/s in the rear-cone attack or  $1.6 V_{\text{close}}$  in the front-cone attack.

The pilot should fly the aircraft keeping the sighting error mark aligned with the cross-hairs. The HDF strobes on the indicator screen automatically follow the target being tracked.

If further work does not envisage switching-over to target tracking by the SAPPFIR-25 airborne radar (to ensure concealment of the attack or under conditions of intensive radiointerference), the  $\varphi_0$  - WITH RDR -  $\varphi_b$  selector switch should be set to the  $\varphi_b$  position not later than 40 s prior to missile launch. At a distance close to the permissible launching distance, the FHS - RHS selector switch should be set to a position depending upon a type of the attack in order to supply the "Preparation" command. In response to the "Preparation" command, the homing heads of the missiles are directed to the locked on target and if the missiles are provided with radar homing heads, the continuous illumination transmitter starts to operate in the illumination mode. The CIC mark is displayed on the indicator screen. The missiles are launched in response to display of at least one of marks 1, 2, 3, 4 and LP regardless of the position of the sighting ring relative to the centre of the cross-hairs.

In case of limited enemy radio interference, the pilot should switch on the airborne radar to operate in the illumination mode by setting the ILLUM - DUMMY - OFF selector switch mounted on unit 24 to the ILLUM position after target lockon by the heat direction finder and concealed approach to the target to a distance close to the maximum permissible missile launching distance. The airborne radar is switched over to the quasi-scan mode (the antenna beam tracks the target by the commands

transmitted from the heat direction finder and pulse transmitter transmits periodically in order to simulate the scan mode).

The quasiscan marker of the target distance pulsating at a rate of 3 s is displayed near the distance scale (Fig. 137).

In the visual direction after the illumination is cut in, an additional mark of manual distance input ( $D_{\text{man. in}}$ ) is displayed near the distance scale. If a target is attacked on the terrain background by the fighter flying at an altitude less or equal to 1500 m, the pilot should set the  $D_{\text{man. in}}$  mark to a distance less than 15 km (should select the airborne radar distance coverage equal to 0.3 to 18 km in the LA mode).

After the quasiscan distance marker is displayed the target can be identified. Depression of the INTERROG button results in display of the FRIEND pulsing mark over the quasiscan target distance marker, if the target is friendly (Fig. 137).

After the target is identified, the pilot should make sure that the quasiscan target distance marker is within the distance lockon area, i.e. within the limits of  $\pm 4.5$  km relative to the distance marker transmitted from the 5V15K-11 equipment (in the automatic direction) or relative to the  $D_{\text{man. in}}$  mark (in visual direction). If required, use the knob of unit 44 to align the  $D_{\text{man. in}}$  mark with the quasiscan mark of the target distance and again depress the LOCKON button.

In the automatic direction, depress the knob of unit 44 to adjust the position of the distance lockon area. The indicator screen displays two marks similar to the distance marker transmitted from the 5V15K-11 equipment near the distance scale. These marks indicate the boundaries of the range lockon area. Move the knob of unit 44 to align the distance lockon area with the quasiscan distance mark and depress the LOCKON button. Switching-over to target tracking by the airborne radar is checked by reference to the change of the indication mode. The information displayed on the screen should correspond to the RDR mode at the self-direction stage, but additionally the screen displays the HDF mark if the target sighting angles are not more than the limit angles of the target tracking by the heat direction finder during the attack (Fig. 138). Further, the pilot should adjust sighting and launch the missiles under the conditions of the RDR mode. In this case, the  $\varphi_0$  - WITH RDR -  $\varphi_b$  selector switch should be set to the WITH RDR position.

In case of partial malfunction of the SAPPFIR-25 airborne radar which prevents antenna control from the heat direction

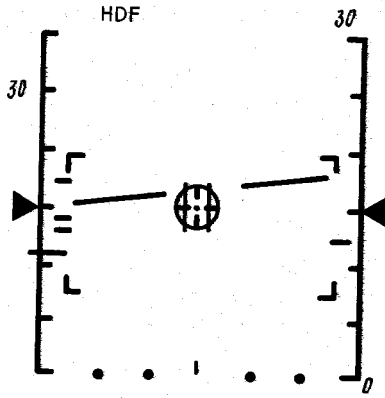

FIG. 137. PICTURE DISPLAYED ON RADAR INDICATOR SCREEN IN VISUAL DIRECTION (mode T-I, illumination ON, INTERROG button is depressed)

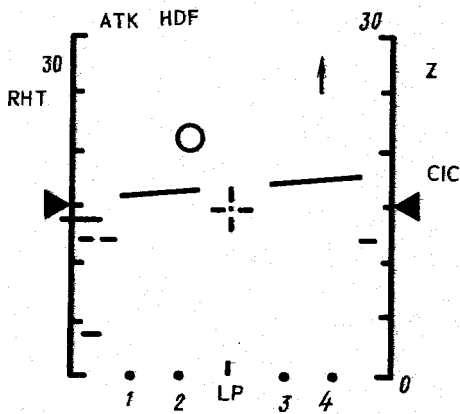

FIG. 138. PICTURE DISPLAYED ON RADAR INDICATOR SCREEN IN VISUAL DIRECTION (mode T-I, after change-over to target autotracking by airborne radar)



finder (in target lockon by the heat direction finder in the T-I mode, the coordinates of the sighting error mark do not correspond to the coordinates of the target blip transmitted from the heat direction finder), the target is attacked in the following modes:

- T- $\varphi_0$ I, at the initial stage of the attack during search and closing (Fig. 139);
- T- $\varphi_0$ II, at the final stage of the attack during sighting and missile launch (Fig. 140).

To ensure operation of the C-25 armament control system in the T- $\varphi_0$ I mode the pilot should set the SYST selector switch mounted on unit 24 to the T- $\varphi_0$ I position and the  $\varphi_0$  - WITH RDR -  $\varphi_0$  selector switch mounted on the instrument board, to the  $\varphi_0$  position. After the target blip transmitted from the heat direction finder is displayed on the indicator screen, the pilot should approach to the target to a distance close to the permissible missile distance. The target distance is checked by reference to the distance marker transmitted from the 5V15K-11 equipment in the automatic direction or by the commands transmitted from the control (direction) post through the radio set in the visual direction. The maximum permissible missile launching distance mark is displayed on the indicator screen just after selection of either T- $\varphi_0$ I or T- $\varphi_0$ II mode. The maximum permissible missile launching distance is determined by the conditions similar to those in the T-I mode after the target is locked on by the heat direction finder.

The pilot should fly the maneuver to bring the target blip in the centre of the heat direction finder coverage before the blip is introduced into the strobes; this done, he should set the SYST selector switch mounted on unit 24 to the T- $\varphi_0$ II position and keep the target blip transmitted from the heat direction finder within the zone between the T- $\varphi_0$ II strobes. The FHS - RHS selector switch located on the instrument board should be set to a position corresponding to the direction of the attack. If the fighter is armed with the missiles provided with the radar homing heads the pilot should switch on the transmitter to operate in the continuous illumination mode. The indicator screen displays the CIC mark and the airborne radar antenna shapes a fixed wide beam ( $\theta = 20^\circ$ ) for target illumination. The missiles are launched within the recommended launching distance limits if one of signals 1, 2, 3, 4 and LP are

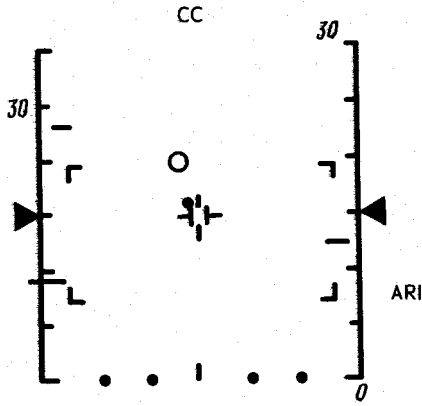

FIG. 139. PICTURE DISPLAYED ON RADAR INDICATOR SCREEN IN AUTOMATIC DIRECTION (mode T- $\psi_0$ I)

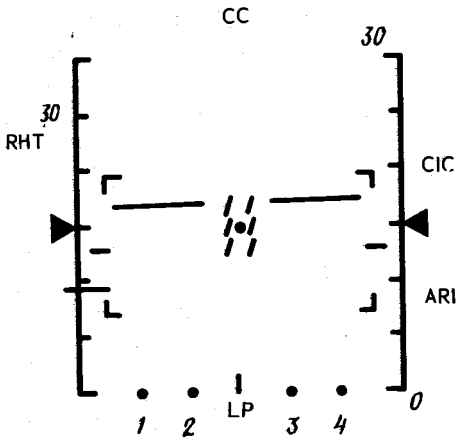

FIG. 140. PICTURE DISPLAYED ON RADAR INDICATOR SCREEN IN AUTOMATIC DIRECTION (mode T- $\psi_0$ II)

displayed on the screen. The direction of breakaway is determined by reference to the position of the target blip transmitted from the heat direction finder in case of zero visibility.

After the missiles equipped with the radar homing heads are launched, the pilot should continue sighting during the time of the missile flight to the target, thus ensuring illumination of the target and then, perform a breakaway.

#### 4. OPERATIONAL CHECK OF ARMAMENT CONTROL SYSTEM "C-25" IN FLIGHT

Operational check of the C-25 armament control system may be performed 3 to 5 min after the airborne radar is switched on. The mode of the check depends upon the selected type of armament (missiles P-40D or P-60) and selected operating mode of the airborne radar (HMA or LA).

The armament type selection is performed by using the INBD - AUTO - OUTBD selector switch located on the armament control panel.

To perform the operational check of the C-25 armament control system in the RDR mode when using the P-40D (P-40T) missiles and operating the airborne radar in the HMA mode (the RAD - HMA - P-40 - AIR test mode), the pilot should proceed as follows:

- set the SYST and DIRECT selector switches located on unit 24 to the RDR and MAN positions;
- set the TEST selector switch located on unit 34 to the AIR position;
- set the MODE selector switch located on unit 34 to the HMA position;
- set the OUTBD - AUTO - INBD selector switch located on the armament control panel to the AUTO position;
- depress the TEST selector switch located on unit 34 to set it to the BITC position.

The indicator screen displays a picture corresponding to the RDR mode in scan (Fig. 141). The T (test) index is illuminated.

The reference target blip is displayed at a distance of 8 km and in an azimuth of  $20^{\circ}$ . The manual distance input mark ( $D_{man. in}$ ) is set at a distance of 8 km. After the reference target is detected, the pilot should depress the LOCKON button.

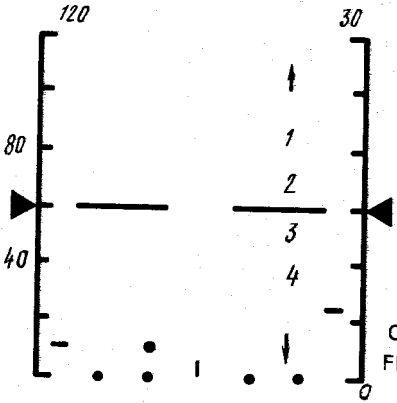

FIG. 141. PICTURE DISPLAYED ON RADAR INDICATOR SCREEN IN "RDR-HMA-P-40-AIR" CHECK MODE (detection of check target)

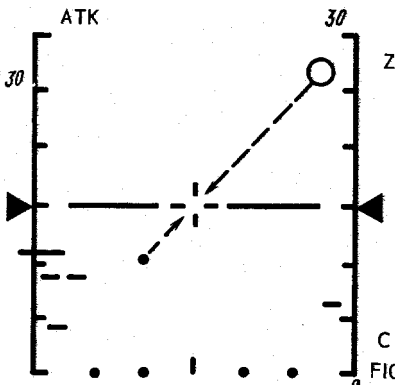

FIG. 142. PICTURE DISPLAYED ON RADAR INDICATOR SCREEN IN "RDR-HMA-P-40-AIR" CHECK MODE (lock-on of check target)

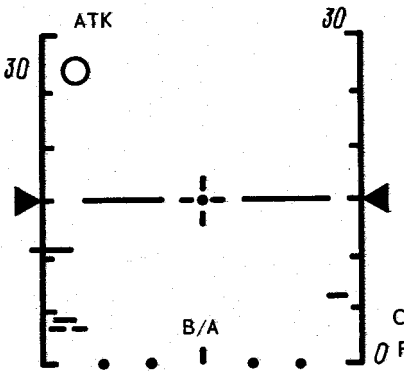

FIG. 143. PICTURE DISPLAYED ON RADAR INDICATOR SCREEN IN "RDR-HMA-P-40-AIR" CHECK MODE AFTER "BREAKAWAY" COMMAND

After the reference target is locked on, the picture should correspond to the selected type of the armament (Fig. 142).

The range is displayed at the scale of 30 km. The  $D_{perm\ min}$  mark is displayed at the level of the second scale division, and the  $D_{perm\ max}$  mark, between the first and second divisions.

The distance marker and target blip move downward. The rate of closing with the reference target is 500 m/s. The sighting error mark (large ring) travels from the right upper quadrant to the centre of the screen and the beam mark, from the left lower quadrant to the centre of the screen.

As the distance marker approaches the  $D_{perm\ min}$  mark, the "Breakaway" command is generated, the B/A mark is displayed on the screen and the large ring jumps to the left upper corner (Fig. 143). To disable the test mode, the pilot should depress the BITC - RESET (BK - CBPOC) selector switch to set it to the RESET position. The equipment should be switched over to the standard mode of operation.

Operational check of the C-25 armament control system when using the P-60 missiles (the RDR - HMA - P-60 - AIR test mode) is performed similarly to the check when using the P-40 (P-40T) missiles but the OUTBD - AUTO - INBD selector switch located on the armament control panel is to be set to the OUTBD position. In this case, prior to generating the "Breakaway" command, the large ring travels to the centre of the screen from the left lower quadrant. In response to the "Breakaway" command, the ring jumps to the left upper corner and the beam mark is displayed near the centre of the screen in the shape of a spot.

To perform operational check of the airborner radar in the LA mode, the controls of the C-25 armament control system should be set similarly to the first case, but the MODE selector switch located on unit 34 should be set to the LA position (the RDR - LA - P-40 - AIR test mode).

In this mode, the displayed picture will be the same as in the RDR - HMA - P-40 - AIR test mode; except for the following:

- the distance is displayed after enabling the test mode on the scale of 30 km;
- after target lockon, the large ring is set between the 4th and 6th divisions of the distance scale above the screen centre. Then, the ring travels downward at a level between the

2nd and 3rd divisions of the distance scale. Then, the ring travels to the screen centre before the "Breakaway" command is generated. After the "Breakaway" command is generated, the test mode should be disabled.

Evaluation of serviceability is performed by the pilot by reference to all the marks on the indicator screen depending upon the mode and stage of the test.

## *Chapter 3*

# **AERIAL COMBAT FLIGHT**

### 1. GENERAL

The aerial combat flight is essentially a continuous process performed for the purpose of destroying hostile air targets. This process involves the following three main stages:

- ground direction;
- airborne direction (homing) followed by missile launching and break-away;
- return to the landing airfield, landing approach, and landing.

The first stage is intended for solving the problem of ground direction. The objective of this stage is to bring the interceptor-fighter into an area which is advantageous in the tactical sense for detecting, locking-on and attacking a target with due regard to the target flight altitude, assigned aspect angle and capabilities of the interceptor-fighter armament.

Ground direction may be effected through the use of instruments (the principal method), when the instrument direction equipment is employed, as well as visually (with the use of the radar plan position indicator) with transmission of control commands over the radio.

During instrument direction the interceptor-fighter systems receive control commands, information on the mutual position of the interceptor-fighter and the target as well as commands for switching on separate components of the armament system from the instrument direction equipment through the telemetering radar system line. In response to these commands the interceptor-

fighter is automatically controlled in the horizontal plane, the airborne radar scanning zone is automatically controlled in azimuth and elevation and the airborne radar irradiation is started.

In the vertical plane the aircraft is controlled by the signals furnished by the programming device of the automatic flight control system. The required flight parameters are set by the pilot on the airspeed and altitude selector.

The aerial combat flight is effected in accordance with the standard airspeed and altitude gain programs realized in the program units of the automatic flight control system.

There are three airspeed and altitude gain programs for the MuT-25M aircraft:

- reheat (short-range) program is used in short-range interception in order to obtain the maximum rate of climb at the minimum time available for execution of the combat mission;

- combination (medium-range) program is used in long-range interception at a supersonic final airspeed when the time available for intercepting the target makes it possible to use the subsonic cruising flight leg to increase the destruction range;

- cruising (long-range) program is used in long-range interception at subsonic airspeeds in order to ensure the maximum destruction ranges.

Depending on whether supersonic flights at altitudes below 11,000 m are permitted or prohibited, use may be made of war-time or peacetime reheat programs.

When performing a flight in accordance with one of the above programs, the programmed airspeed and afterburner engagement signal are transmitted to the aircraft via the 5V15K-11 equipment.

The programmed airspeeds are transmitted in the following discrete values:

$$V_1 = 2500 \text{ km/h } (M_1 = 2.35);$$

$$V_2 = 1900 \text{ km/h } (M_2 = 1.8);$$

$$V_3 = 1500 \text{ km/h } (M_3 = 1.4);$$

$$V_4 = 1000 \text{ km/h } (M_4 = 0.85).$$

These values are shown by the triangular index of the YCO-M1 indicator.

In response to the "Reheat" command (the R (Φ) mark is illuminated) the aircraft climbs in accordance with the reheat



program. With no "Reheat" command transmitted, the aircraft climbs in accordance with the combination or cruising program.

When performing a flight in accordance with the first (reheat) program the airspeed and selected altitude are gained with the engines running at the FULL REHEAT power setting. The flight is performed with a continuous increase in altitude and airspeed. Transition to a supersonic airspeed takes place at an altitude of 3000 to 4000 m. Therefore, the above program can be realized only in combat conditions or in areas where there are no limitations for the supersonic speed transition altitude.

When performing a flight in accordance with the first peacetime program, takeoff and climb to an altitude of 11,000 m are effected at the FULL REHEAT power setting and at a Mach-number of 0.85. At the altitude of 11,000 m the aircraft is further accelerated to the assigned Mach-number with subsequent entry into the program of the automatic flight control system.

The second (combination) program envisages the use of both the reheat and non-reheat power settings of the engines.

When performing a flight in accordance with the second program, takeoff is effected at the FULL REHEAT power setting with subsequent disengagement of the afterburner at an airspeed of 600 km/h, minimum. Further, the automatic flight control system program is entered, and the aircraft climbs at the MAXIMUM power setting with stabilization of the airspeed corresponding to  $M = 0.85$ .

In response to a command transmitted from the control (direction) post the pilot selects the full reheat power, climbs to the altitude of 11,000 m and accelerates the aircraft to a Mach-number suitable for entry into the automatic flight control system program. After entry into the program the pilot goes on climbing and simultaneously accelerates the aircraft to the assigned Mach-number.

A flight in accordance with the third (cruising) program is performed with the engines running at the maximum power setting as in case of the second program. In response to a command transmitted from the control (direction) post the pilot lowers the aircraft to the target attack altitude.

The homing stage commences with the target lock-on by the airborne radar for its automatic tracking. The target lock-on accomplished, the aircraft control in the horizontal plane is effected in response to the signals obtained by the automatic

flight control system from the airborne radar. In the vertical plane the aircraft control is effected by maintaining the step-up (step-down) vertical separation relative to the target, preset by the  $\Delta H$  selector switch. Upon reception of the Z (zoom) signal, the aircraft is controlled in the horizontal and vertical planes in response to the commands given by the ABM-25 analog computer.

As soon as the aircraft enters the zone of possible launching of missiles, the pilot launches the missiles (simulates the launching of the missiles). The ABM-25 analog computer generates the BREAK-AWAY command in response to which the aircraft should break away.

The third stage involves the aircraft return to the landing airfield. This stage commences from the moment of completion of the break-away. Flight to the airfield is effected by the commands from the ground flight control aids.

The aircraft control may be effected at all the stages in automatic, director and manual control modes.

## 2. AERIAL COMBAT AT MEDIUM AND HIGH ALTITUDES

Rear-Cone Target Attack with Use of SAPPFIR-25 Radar (Fig. 144). The principal method of directing the M $\mu$ T-25ПД fighter at air targets is the instrument direction method involving the application of the automatic control systems (ACS). Direction with the use of the automatic flight control system is the most effective one.

Aerial combat flights with the use of the automatic control systems and the aircraft automatic flight control system must be preceded by thorough preparation of the pilot and the combat control officer who is responsible for the direction operations.

During joint training of the flying personnel and the team of the control post (direction post) the following subjects should be mastered and specified:

- (a) procedures for checking the automatic telemetering radar system for passage of commands;
- (b) procedures for reaching the initial direction point by the fighter;

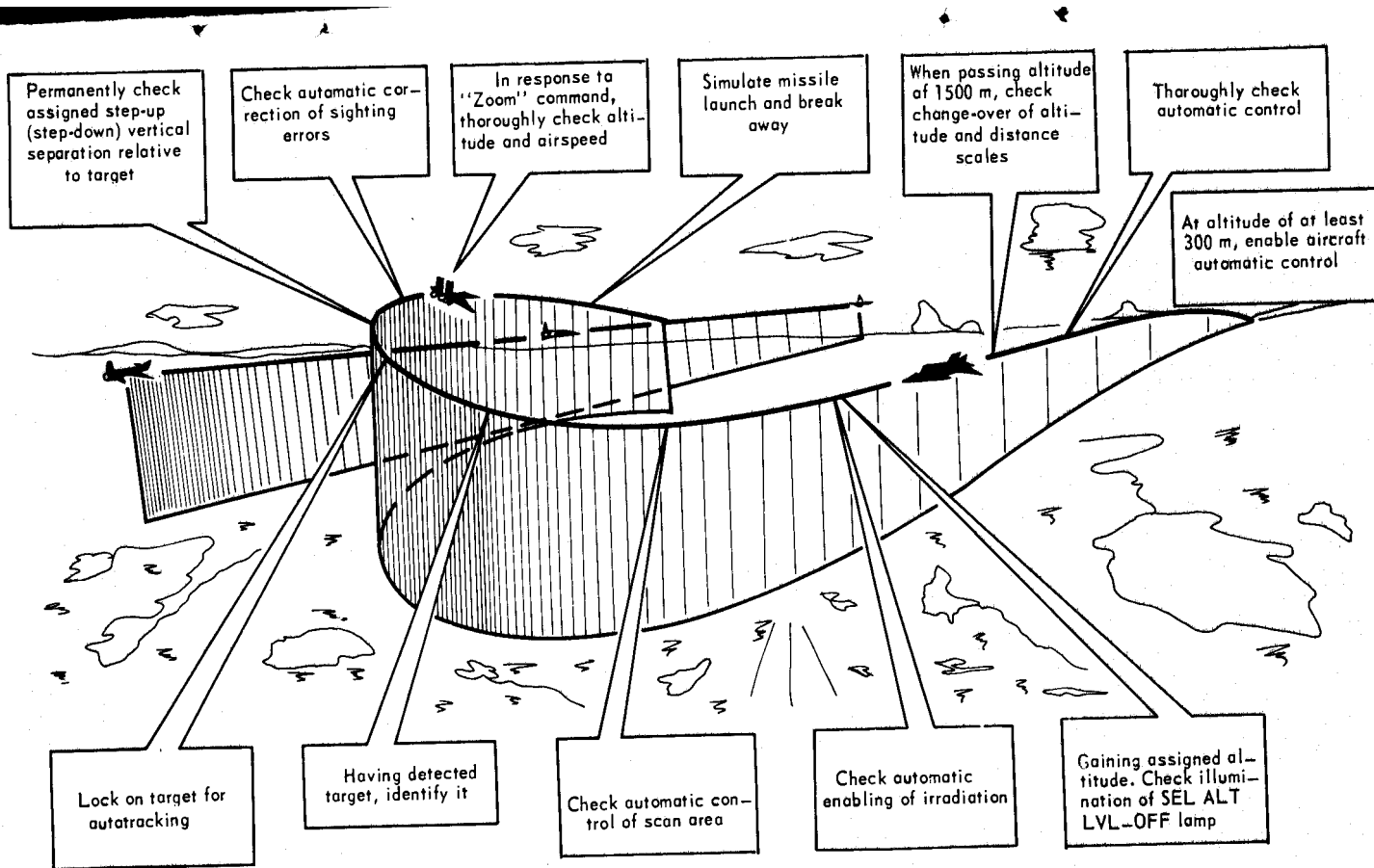

FIG. 144. PATTERN OF REAR-CONE ATTACK WITH USE OF AIRBORNE RADAR

(c) procedures for checking the direction commands for passage to the aircraft systems and supervising the actions taken by the pilot and combat control officer as these commands are received.

In the course of preparation for an aerial combat flight with instrument direction the pilot, on getting into the cockpit, must set the aircraft armament system controls to the following positions:

- the MSL SUP (ПИТАНИЕ СС) switch to the OFF position;
- the MASTER ON (ГЛАВН. ВКЛЮЧ.) switch to the OFF position;
- the  $\varphi_o$  - WITH RDR -  $\varphi_b$  ( $\varphi_o$  - С РЛС -  $\varphi_n$ ) selector switch to the WITH RDR position;
- the OUTBD - AUTO - INBD (ВНЕШН. - АВТОМ. - ВНУТР.) selector switch to the AUTO position;
- the SMALL - MEDIUM - LARGE (МАЛАЯ - СР. - БОЛЬШАЯ) selector switch to the SMALL position (during the attack of a fighter) or to the LARGE position (during the attack of a bomber);
- the FHS - RHS (ПН - ЗП) selector switch to the mid-position;
- the GROUND - AIR (ЗЕМЛЯ - ВОЗДУХ) selector switch to the AIR position;
- the TRAIN - SINGLE (СЕРИЯ - ОДИН) selector switch to the position corresponding to the flight mission;
- the  $\Delta H$  selector switch to the zero position;
- the SYST (СИСТ.) selector switch to the RDR (РЛ) position;
- the ACT JMG - OFF - PAS JMG (АП - ВКЛ. - ПП) selector switch to the OFF position;
- the DIRECT AUTO - MAN (НАВЕД. АВТ. - РУЧН.) selector switch to the AUTO position;
- the RDR (РЛ) and HDF (ТП) rheostats to the extreme right position;
- the FHS - LST - RHS (ПНС - МСЦ - ЗПС) selector switch to the RHS position;
- the IRRAD - DUMMY - OFF (ИЗЛ. - ЭКВ. - ВКЛ.) selector switch to the OFF position;
- the RDR (РЛ) and HDF (ТП) selector switches to the OFF position;
- the PA (ПУ) selector switch to the upper position;
- the RDR HEAT - OFF (ОБОГР. РЛ - ВКЛ.) selector switch to the OFF position. At an ambient temperature of less than

30°C the RDR HEAT - OFF selector switch should be set to the RDR HEAT position 10 min before the radar is switched on by the RDR selector switch. It shortens the warm-up time of the radar after it is energized. The radar heating system is switched off automatically or manually by setting the RDR HEAT - OFF selector switch to the OFF position;

- the MODE (PEK.) wafer switch to the HMA (BCB) position;
- the CHECK (KOHTP.) wafer switch to the AIR (BO3Д.) position;

tion;

- the READY (ГОТОВ) wafer switch to position 1;
- the READY, CHECK and MODE selector switches should be set to the above-mentioned positions in order to perform a self-check of the radar in flight (if required).

Set the engine controls as required for starting the engines.

On switching on the 5Y15K-11 equipment circuit breaker, the pilot should select the assigned operating mode of the equipment by depressing the respective button. Refer to the respective illuminated pilot lamp to make sure that the mode is selected properly.

Use the respective knobs located on the control panel to set the assigned wave, code and spacing. Depress the MAN (PYUH.) button for a short time and check the illumination of the respective wave, code and spacing lamps. Depress the S-CHK (BK) button to check the equipment for proper operation by the self-check circuit. In this case the CC (KK) index flickers for 10 to 15 s. As soon as this time expires the CC index fades out.

Establish radio contact with the combat control officer and check the automatic radio line equipment for serviceability; to this end, make sure that the indicated heading, airspeed and altitude are in compliance with the transmitted commands. Tolerable errors in indication of the heading, airspeed and altitude should be within  $\pm 6^\circ$ ,  $\pm 50$  km/h and  $\pm 300$  m, respectively.

After starting the engines the pilot should set the selected levelling-off altitude and Mach-number transmitted from the control post on the altitude and airspeed selector. Set the RDR and HDF selector switches to the upper position. Turn on the MSI SUP switch and check the missile suspension version with reference to the illumination of the lamps on the external store status indication board.

Long-Range Direction with Use of Ground Automatic Control Systems. The long-range direction stage starts with transmission of the command to start the engines and ends in the target lock-on by the airborne radar.

Aircraft Automatic Control Mode. Prior to taking off the pilot should depress the GUID (HABEJ.) light-button on the control panel of the automatic flight control system. In case of smooth passage of commands over the radio line (regular flickering of the CC index on the indicator annunciator), the triangular index on the altimeter settles against the altitude corresponding to the target altitude. On the airspeed and Mach-number indicator the triangular index settles against the airspeed assigned to the fighter. On receiving the information concerning the target altitude, the pilot should make sure that the leveling-off altitude ( $H_{lvl-off}$ ) is set on the altitude and airspeed selector correctly and differs from the target altitude by a value of assigned step-down (step-up) vertical separation relative to the target.

This step-down (step-up) vertical separation should be set by using the  $\Delta H$  selector switch located on the control panel of the airborne radar.

Takeoff is performed at the FULL REHEAT power setting.

1.5 to 2 min after the RDR switch is turned on the electronic indicator becomes switched on.

The pilot reads the following information on the indicator screen:

- the distance scale up to 60 km (at a flying altitude lower than 1500 m);
- the present target distance mark transmitted from the 5V15K-11 equipment;
- the altitude scale up to 1.5 km (at a flying altitude lower than 1500 m);
- the fighter flying altitude mark;
- the electronic cross-hairs;
- the command mark (small ring);
- the electronic horizon line.

At an altitude of 300 m, minimum, the pilot should make a maneuver to zero the command bars of the flight director indicator, bringing them within the circle, and keep them in this position for 10 to 15 s. As the longitudinal channel position bar of the flight director indicator approaches the center of the circle, the pilot should enable automatic control.

During climb the pilot should constantly make sure that the Mach-number is in compliance with the programmed one. The operation of the automatic flight control system is checked by the aircraft response to the deflection of the flight director indicator position bars and command bars as well as of the small electronic ring on the airborne radar screen.

As the aircraft climbs higher than 1500 m, the distance scale is switched over to 120 km and the altitude scale, to 30 km.

3 to 5 min after the IRRAD - DUMMY - OFF selector switch is set to the DUMMY position, the READY lamp lights up to indicate readiness of the airborne radar to irradiation. If required, the pilot may check the airborne radar by the self-check circuit.

1000 m before the levelling-off altitude set on the altitude and airspeed selector the SEL ALT LVL-OFF lamp lights up. The aircraft gradually decreases the pitch angle and attains the levelling-off altitude. The pilot should check stabilization of this altitude. During direction the operation of the automatic flight control system should be checked in the lateral channel. The pilot should remember that at Mach-numbers less than 1.5 the aircraft automatically performs corrective turns to the preset course at a maximum roll of  $30^{\circ}$  ( $42^{\circ}$ , maximum, at Mach-numbers more than 1.5).

If the roll exceeds the permissible value or if the stabilized altitude is not maintained, the pilot should disable automatic control.

After the radar starts irradiating, the IRRAD (W3JV4.) lamp lights up. In case the irradiation enabling command from the 5Y15K-11 equipment does not pass, the pilot should enable irradiation manually by setting the IRRAD - DUMMY - OFF selector switch to the IRRAD position at a target distance of 30 to 35 km. The target distance is measured by referring to the present distance mark transmitted from the 5Y15K-11 equipment or reported from the control post.

After irradiation is enabled, the indicator screen (RH part) displays additionally figures 1, 2, 3, 4 numbering the line on which the picture is displayed presently as well as indices  $\uparrow$  (upward) or  $\downarrow$  (downward) indicating the position of the antenna beam with respect to the horizon line. If the fighter attacks a target flying below it, the indicator screen displays index  $\downarrow$  (downward) only. The antenna beam position mark is

displayed in the lower portion of the screen in the shape of a dot travelling leftward or rightward. It determines the position of the search area in azimuth ( $\pm 20^\circ$ ). If the fighter flies at an altitude lower than 4200 m (but higher than 1500 m) the distance scale is switched over from 120 km to 60 km.

After irradiation is enabled, the pilot should first of all make sure that the search area is controlled properly in azimuth and elevation.

The position of the search area in azimuth ( $\pm 20^\circ$ ) should correspond to the target position in azimuth, which is known to the pilot either from the assignment or from the control post report. For instance, if the target flies on the left of the fighter and the search area in azimuth (the beam mark displayed in the lower portion of the indicator screen and travelling within  $\pm 20^\circ$ ) is in the right portion of the screen, the radar fails to detect the target.

In this case the IRRAD - DUMMY - OFF selector switch should be set to the IRRAD position, the DIRECT AUTO - MAN selector switch, to the MAN position, and change over to manual control of the search area in azimuth and elevation by using the direction knob.

Evaluate the search area control in azimuth and elevation as follows. When closing with the target, compare the present step-up (step-down) vertical separation of the fighter relative to the target with the one set on the airspeed and altitude selector and selected by the  $\Delta H$  selector switch. The position of the present distance mark transmitted from the 5V15K-11 equipment should correspond to the actual target distance (as reported from the control post). If otherwise, the target may not be detected.

Turn on the MASTER ON switch.

After the target is detected, depress the INTERROG (ЗАПРОС) button located on the direction knob. A friendly aircraft is designated by a twin mark displayed over the target blip. As soon as the target is identified, release the INTERROG button.

Be careful to maintain the selected step-up (step-down) vertical separation relative to the target and the closing speed.

If the target blip is displayed on the first or fourth line, the pilot should use the  $\Delta H$  selector switch or perform a maneuver to get the blip between the second and third lines.

After the target blip is observed during two to three scan cycles, lock on the target for its automatic tracking.



To lock on the target it is necessary to get it within the 9-km lock-on zone (i.e., within  $\pm 4.5$  km from the distance mark transmitted from the 5V15K-11 equipment).

If there are no other targets within the lock-on zone in the area of search in azimuth, the pilot should depress the LOCK-ON (3AXBAT) button located on the aircraft control stick. Two horizontal lines (gates) corresponding to the boundaries of the lock-on zone in distance and azimuth are displayed on the screen. The angle of the lock-on zone in azimuth corresponds to the angle of the scan area in azimuth (equal to  $40^\circ$ ).

If the target is beyond the 9-km lock-on zone or there are several targets within the lock-on zone at various distances, the pilot should first depress the direction knob and then the LOCK-ON button. The ADI (AI) pilot lamp located on the indicator fades out and the gates indicating the boundaries of the lock-on zone are displayed on the screen.

The position of the lock-on zone will depend upon the position of the direction knob rather than the position of the distance mark transmitted from the 5V15K-11 equipment. The pilot should move the direction knob forward and backward to shift the gates so that there is only one target blip between them; this done, he should depress the LOCK-ON button.

If there are several targets within the lock-on zone at the same distance but at different azimuths, the pilot should enable the azimuth gating by turning the direction knob clockwise until a click is heard in order to select the target. In this case the gates become as short as  $13 \pm 3^\circ$  in azimuth.

Move the direction knob to align the gates with the selected target and depress the LOCK-ON button.

First, the target is locked on in azimuth and elevation. Instead of the gates the screen displays three dots in the azimuth of the locked-on target, the number of the line on which the target has been locked on and index  $\uparrow$  (upward) or  $\downarrow$  (downward). In 1 to 2 s the target becomes locked on in distance.

At the long-range direction stage the pilot should constantly correct the errors in the direction procedure.

The horizontal position bar of the flight director indicator shows the deviation from the flying altitude set on the altitude and airspeed selector, whereas the vertical one, the deviation from the course transmitted from the ground automatic control system.

The command bars (the small ring on the indicator screen) indicate the roll and g-load required to intercept the assigned flight path in heading and altitude.

At the long-range direction stage it is recommended that the pilot should transfer attention as follows:

- (1) indicator screen of the airborne radar:
  - the distance mark transmitted from the 5V15K-11 equipment corresponds to the present target distance;
  - the small ring is in the centre of the electronic cross-hairs;
  - the present altitude mark;
  - roll and pitch;
  - discrete commands;
- (2) flight director indicator:
  - deflection of the position bars;
  - deflection of the command bars in the direction of deflection of the position bars;
  - the command bars are in the centre of the circle;
  - present roll is not more than  $30^{\circ}$  in subsonic flight ( $42^{\circ}$  in supersonic flight);
  - present pitch;
- (3) combined course indicator:
  - present roll;
  - preset course;
- (4) airspeed indicators:
  - present airspeed corresponds to the selected one;
  - no tendency to exceed airspeed limitations;
- (5) altitude indicator:
  - present altitude corresponds to the one set on the altitude and airspeed selector;
  - target altitude transmitted from the 5V15K-11 equipment;
  - the assigned step-up (step-down) vertical separation relative to the target is maintained;
- (6) vertical-speed indicator:
  - vertical speed;
  - absence of slipping;
- (7) g-load indicator;
- (8) engine instruments;
- (9) qualitative evaluation of automatic control.

Director Control Mode. In the director control mode the flying procedure is somewhat more complicated than the one in

the automatic control mode. It may be explained by the fact that in the automatic control mode the pilot checks the operation of the automatic flight control system whereas in the director control mode he participates in the aircraft control in addition to operating the sighting equipment and armament.

The cabin equipment and controls should be set to the positions similar to those specified for preparation of the cabin for aerial combat flight with selection of the automatic flight control mode.

After takeoff, at an altitude of 300 m, minimum, the command bars of the flight director indicator should be set within the circle. Make sure that the small ring is in the centre of the cross-hairs. As the airspeed increases, the pilot should relieve the control stick of forces by means of the trim mechanisms. Eliminate possible slipping by deflecting the pedals, while relieving them of forces by means of the rudder trim mechanism. During turns check that the vertical command bar is in the centre of the circle and indicator screen small ring, in the centre of the electronic cross-hairs. In this case the roll should be  $30^{\circ}$ , maximum, at Mach-numbers less than 1.5 and  $42^{\circ}$  at Mach-numbers more than 1.5.

In flight at an altitude of 10,000 m and higher the pilot should depress the DAMPER light-button located on the control panel of the automatic flight control system.

During climb, as soon as the aircraft attains the leveling-off altitude, the pilot should smoothly level the aircraft and enable the required engine power setting, avoiding near-zero g-loads and keeping the command bars of the flight director indicator within the circle (the small ring should be in the centre of the cross-hairs).

In level flight the pilot should constantly check the present step-down (step-up) vertical separation relative to the target, keeping the command bars and horizontal position bar of the flight director indicator in the centre of the circles and the small ring, in the centre of the cross-hairs.

As the "Left turn" or "Right turn" discrete command is supplied (the < or > pilot lamp lights up in the annunciator of the indicator) the pilot should prepare for the respective turn. He should start the turn only when the vertical command bar of the flight director indicator starts deflecting. Variation of the preset course should be checked with reference to the combined course indicator.

The information displayed by the airborne radar indicator after automatic enabling of irradiation is similar to that displayed in flight in the automatic control mode.

After identification of the target it is locked on for automatic tracking.

To check the attitude of the aircraft, the pilot should refer to the electronic horizon comparing its readings periodically with those of the flight director indicator, vertical-speed indicator and altitude indicator. He should pay special attention to maintaining the assigned closing speed and step-down (step-up) vertical separation relative to the target.

#### Homing Stage

Automatic Control Mode. The homing stage starts from the moment of the illumination of the ATK (attack) lamp which indicates the termination of transients from the detection mode to the homing one. The ADI lamp fades out.

The pilot reads the following information on the indicator screen:

- the distance scale up to 120 km. At a target distance less than 55 km, the scale is changed over to 60 km and at a target distance less than 26 km to 30 km;
- index A;
- the altitude scale with the fighter present altitude mark;
- the electronic cross-hairs;
- the electronic horizon;
- the beam mark in the shape of a dot presenting the target position in the aircraft "azimuth-elevation" coordinates of the target;
- the maximum permissible missile launching distance mark ( $D_{\text{prm max}}$ );
- the minimum permissible missile launching distance mark ( $D_{\text{prm min}}$ );
- the twin marks near the distance scale indicating the locked-on target distance. The right mark is the distance mark of the target locked on by the airborne radar range finder. Displayed on the left of the distance mark is the target blip. The distance mark and the target blip may not coincide in distance by a value that does not exceed the target blip thickness;
- the command mark (small ring) which duplicates the indications of the flight director indicator command bars;
- index ↑ (upward) or ↓ (downward).

After the target is locked on for autotracking, the pilot should check automatic correction of the sighting errors in the horizontal plane and maintaining of the step-down (step-up) vertical separation relative to the target, selected by using the  $\Delta H$  selector switch.

The sighting errors in the horizontal plane are determined by the deflection of the flight director indicator vertical position bar. If it deflects from the centre of the circle, the command ring on the indicator screen and the vertical command bar of the flight director indicator should also deflect towards the decrease of the sighting error.

While the small ring on the indicator screen is automatically kept in the centre of the cross-hairs in heading and the vertical command bar of the flight director indicator, in the centre of the circle, the aircraft performs a maneuver to correct the sighting error at a roll of maximum  $70^\circ$ . Flickering of the beam mark indicates that the target sighting angle exceeds the limit bearing in azimuth and elevation ( $\pm 45^\circ$ ).

By referring to the deflected vertical position bar of the flight director indicator the pilot can determine the sighting error in heading at any time. The error in maintaining the step-down (step-up) vertical separation relative to the target, set by using the  $\Delta H$  selector switch, is determined by the deflection of the horizontal position bar of the flight director indicator from the centre of the circle.

If the target is not maneuvering in altitude, the fighter should automatically maintain the selected step-down (step-up) vertical separation relative to the target, keeping the small ring of the indicator screen in the centre of the cross-hairs in altitude and the horizontal command bar of the flight director indicator, in the centre of the circle. The horizontal position bar of the flight director indicator should be also kept in the centre of the circle.

When performing the maneuver in altitude, the horizontal position bar of the flight director indicator deflects upward (downward) from the centre of the circle, thus indicating the error in maintaining the step-down (step-up) vertical separation relative to the target, set with the aid of the  $\Delta H$  selector switch.

32 s before the maximum permissible missile launching distance the RHT lamp located in the indicator annunciator lights

up and an audio signal is reproduced in the earphones. The pilot should check the closing speed and target distance and, if required, engage the afterburner.

22 s before the maximum permissible missile launching distance the Z (zoom) and CIC (KHM) lamps located in the indicator annunciator light up. The aircraft automatically climbs (in an attack with a step-down vertical separation relative to the target), with the command bars of the flight director indicator being kept in the centre of the small-diameter circle and the small ring of the indicator screen, in the centre of the electronic cross-hairs.

The aircraft will fly to the missile-to-target lead point.

The sighting errors are determined by the deflection of the position bars of the flight director indicator.

If the target is locked on by infrared homing missiles or the radar homing missiles are ready for launch, the indicator screen displays indices 1, 2, 3, 4 of the respective missiles and index LP (HP).

The pilot should depress the firing button for 2 s and simulate missile launch. After the firing button is depressed, the maximum permissible missile launching distance mark jumps down. Simulated launch of the second missile should be performed at a distance equal to the second maximum permissible launching distance.

In response to the "Break-away" command the "Break-away" voice message is delivered, the BREAK-AWAY pilot lamp located in the indicator annunciator lights up, the command mark (small ring) jumps up to the right or to the left, indicating the safe direction of break-away. The aircraft automatically breaks away at a roll of  $70^{\circ}$  with subsequent levelling-off.

To disable the LEVELLING mode, the pilot should depress the AUTOPILOT OFF button located on the control stick and make sure that the AUTO CTL, DAMPER and LEVELLING ON light-buttons are dead.

If the aircraft flying altitude is more than 10,000 m, the pilot should repeatedly engage the damper and fly to the airfield in the automatic, director or manual control mode.

Director Control Mode. At the homing stage the information displayed on the radar screen is similar to that displayed in the automatic control mode.

The pilot should fly the aircraft so as to keep the command bars of the flight director indicator in the centre of the small-diameter circle and the small ring of the indicator screen, in the centre of the cross-hairs.

The homing error is determined by the deflection of the vertical and horizontal position bars of the flight director indicator. When performing corrective turns to the target, with the vertical command bar being kept within the small-diameter circle of the flight director indicator, the pilot should make sure that the aircraft roll is not more than  $70^{\circ}$ . If the roll exceeds  $70^{\circ}$ , the pilot should disable the director control mode by depressing the MODE CANCEL button located on the control panel of the automatic flight control system and change over to the manual control mode.

In the director control mode the pilot should bring the aircraft into climbing manually, following the deflection of the small command ring in response to the "Zoom" command. The rate of the maneuver execution should be equal to the rate of travel of the flight director indicator command bar and small command ring. If the command ring travels upward in a brisk manner, the pilot should enter the zoom energetically, creating the required g-load within 3 to 5 s. When performing the zoom, the small command ring should be aligned with the centre of the cross-hairs and the pilot should avoid decrease of the step-down vertical separation relative to the target below the safe one (specified for the mission).

In an attack with a step-up vertical separation relative to the target after delivery of the "Zoom" command the pilot should close with the target and attack it, maintaining the selected step-up vertical separation relative to the target and correcting the sighting errors in roll and pitch.

In an attack with a step-down vertical separation relative to the target after delivery of the "Zoom" command it is recommended to transfer attention as follows:

(1) instrument WH-155:

- present g-load does not exceed the maximum permissible one indicated by the movable sector;

(2) radar screen:

- rate of travel of the small command ring towards the centre of the cross-hairs;

- pitch;

- present roll;

(3) flight director indicator;

- pitch;
- present roll;
- command bars;
- position bars (sighting errors);

(4) airspeed indicator;

- rate of airspeed decrease;

(5) altitude indicator:

- present step-down (step-up) vertical separation relative to the target.

In order to prevent airspeed decrease during the zoom the pilot should accelerate the engines to the maximum speed and, in case of a pronounced airspeed decrease, engage the afterburner in due time.

In so doing, the pilot should be careful to pay special attention to the airspeed indicator to prevent exceeding the maximum airspeed specified for the given flight conditions and disengage the afterburner in due time.

To avoid decrease of the airspeed below the maneuvering one during target interception at an altitude of 3000 to 7000 m, the zoom entry indicated airspeed should be 750 km/h, minimum.

Exceeding the permissible g-load or angle of attack is indicated by the "Limit maneuver" voice message and flickering of two red lamps located on the g-load indicator.

If the maximum g-load or angle of attack exceeds the permissible limits, the pilot should push the control stick to reduce the g-load (angle of attack) or pull the control stick (in case of negative g-load) till the lamps fade out.

If the target is locked on by the infrared homing missiles and the missiles are ready for launch, or if the radar homing missiles are ready for launch, the indicator screen displays indices 1, 2, 3, 4, LP and the "Attention, launch" voice message is delivered.

Depress the firing button for 2 s to simulate missile launching.

In this case the following conditions should be observed:

(1) one of the four lamps (1, 2, 3, 4) and the LP lamp should be illuminated;

(2) the true airspeed should be not less than 700 km/h, the g-load should be within 0.2 to 3.0 g, slipping should not exceed half the ball diameter;



(3) the small command ring should be in the centre of the cross-hairs.

When simulating the launch of the infrared homing missiles, the pilot should break away at once in the direction indicated by the control post navigator.

When simulating the launch of the radar homing missiles, the pilot should keep the small command ring in the centre of the cross-hairs till the "Break-away" command is delivered. As soon as the "Break-away" command is supplied, the small command ring deflects aside, indicating the direction of break-away. The pilot should perform the break-away, keeping the command bars of the flight director indicator within the small-diameter circle and the small command ring in the centre of the cross-hairs and constantly checking the specified step-down (step-up) vertical separation relative to the target.

After breaking away, turn off the MASTER ON, MSL SUP switches and the RDR and HDF selector switches (if no repeated attack is expected).

Perform flight to the airfield in the automatic, director or manual control mode.

### 2.1. Peculiarities Involved in Aerial Combat Flight when Direction Is Accomplished by Voice with Use of Radar Plan Position Indicator

#### Long-Range Direction Stage

**M a n u a l   C o n t r o l   M o d e .** An aerial combat flight when direction is accomplished by voice with the use of the radar plan position indicator features a number of peculiarities. Enabling of the airborne radar irradiation, control of the scan zone in azimuth and elevation should be performed by the pilot manually. Success in the target detection depends upon correct setting of the  $\Delta H$  selector switch, precise information on the target distance and respective setting of the manual distance input mark. The initial positions of the selector switches during the aerial combat flight without instrument direction should be the same as in the automatic control mode, except for the DIRECT AUTO - MAN selector switch which should be placed in the MAN position.

The aerial combat flight should be performed in strict compliance with the commands of the combat control officer, transmitted over the radio to the fighter.

After takeoff, climb to the altitude assigned by the control post (direction post) and accelerate the aircraft in the manual control mode. Before the radar irradiation is enabled, the radar screen will display the following information:

- the unmarked distance scale;
- the altitude scale with the present altitude mark;
- the line of the electronic gyro horizon.

After the fighter gains the assigned attack altitude, set the IRRAD - DUMMY - OFF selector switch to the IRRAD position by the command from the control post (direction post).

In response, the indicator screen will additionally display the following information:

- the distance scale of 120 km if the flight altitude is more than 4.2 km or the distance scale of 60 km if the flight altitude is less than 4.2 km;
- the target distance manual input mark;
- line indices 1, 2, 3, 4;
- index ↑ (up) or ↓ (down);
- the antenna beam azimuth position mark.

The pilot will manually control the radar search zone by referring to the commands supplied from the control post (direction post) over the radio. The scan zone is controlled in azimuth by setting the direction knob to the middle or extreme right or left position. To control the scan zone in elevation, the pilot should move the direction knob either forward or backward to set the target distance manual input mark to the target distance specified by the control post (direction post) and select the assigned step-up (step-down) vertical separation of the fighter relative to the target by the ΔH selector switch.

After the target is detected and identified, perform the target lock-on for its autotracking.

If case several targets are located in the lock-on area, enable azimuth gating and lock on the selected target.

**A u t o m a t i c C o n t r o l M o d e .** After take-off (in case the aircraft is to climb without performing a lot of heading correction turns) the aircraft may be piloted both in the director and automatic control modes with manual selection of the preset course on the combined course indicator.

To do this, the pilot should depress the GUID light-button and set the P/SET COURSE AUTO - MAN selector switch to the MAN position. After the GUID light-button is depressed, the indicator screen, in addition to the information displayed in the manual control mode, will display the command mark (the small ring) and electronic cross-hairs.

Using the knob of the combined course indicator, set the course assigned by the control post (direction post). Preparatory to enabling the automatic control mode, set the command bars within the small-diameter circle of the flight director indicator and the command ring of the indicator screen to the centre of the cross-hairs. Enable the automatic control mode.

In case the actual heading differs from the preset course when the automatic control mode is enabled, the aircraft turns with a roll of up to  $60^{\circ}$  to the course selected by the course selector. When the control post (direction post) command to change the heading is received, smoothly turn the course selector knob to bring the preset course pointer against the assigned course. In response, the aircraft will automatically turn towards the new preset course. The pilot should permanently check to see that the stabilized altitude corresponds to the altitude selected on the altitude and airspeed selector.

The manipulation of the radar controls in the automatic control mode is similar to the manipulation of the radar controls in the manual control mode. In the process of direction by voice with the use of the radar plan position indicator the scope of the pilot's actions can be reduced also through the employment of the automatic flight control system in the stabilization mode. Preparatory to enabling the stabilization mode, it is necessary to place the P/SET COURSE AUTO - MAN selector switch to the AUTO position, trim out the control stick force by the roll and pitch trim mechanisms and depress the AUTO CTL light-button.

After the stabilization mode is enabled, relieve the control stick of forces. To execute the direction commands in heading and altitude with the stabilization mode enabled, the pilot should deflect the control stick to create the required pitch and roll angles, trim the aircraft in the new attitude and relieve the control stick of forces.

### Homing Stage

**M a n u a l C o n t r o l M o d e .** After the target is locked on, the indicator screen will display the sighting error mark (large ring). The sighting error is determined with reference to the deflection of the large ring from the line of the electronic cross-hairs. The pilot should maneuver towards the large ring with a roll and g-load not exceeding the limit values. Keeping the large ring in the centre of the cross-hairs, close with the target to the maximum permissible launching distance. After the illumination of one of lamps 1, 2, 3, 4 and LP lamp and reception of the "Attention, launch" voice message, simulate the missile launch. Upon reception of the "Break-away" command, break away towards the large ring or in the direction specified by the control post (direction post). If another attack is not to be made, cut off the MASTER ON, MSL SUP, RDR, HDF, PA selector switches.

**A u t o m a t i c C o n t r o l M o d e .** In order to enable the automatic control mode after the target is locked on in the manual control mode, the pilot should first enable the director control mode by depressing the GUID light-button on the control panel of the automatic flight control system. The small ring will appear on the indicator screen instead of the large ring. Having aligned the small ring with the centre of cross-hairs and trimmed the aircraft by the trim mechanism, depress the AUTO CTL light-button and relieve the control stick of forces.

Attack the target in the automatic control mode.

### 2.2. Rear-Cone Attack with Combination Use of Armament System (Fig. 145)

After launching of the long-range missiles is simulated, check to see that the long-range missile station status lamps go out in the missile station status annunciator, disable the automatic control mode and further close with the target. In case one or two long-range missile station status lamps are illuminated in the annunciator, set the INBD - AUTO - OUTBD selector switch to the OUTBD position. In response, the GUID light-button will go out on the AFCS control panel. The indicator screen will display the following information:

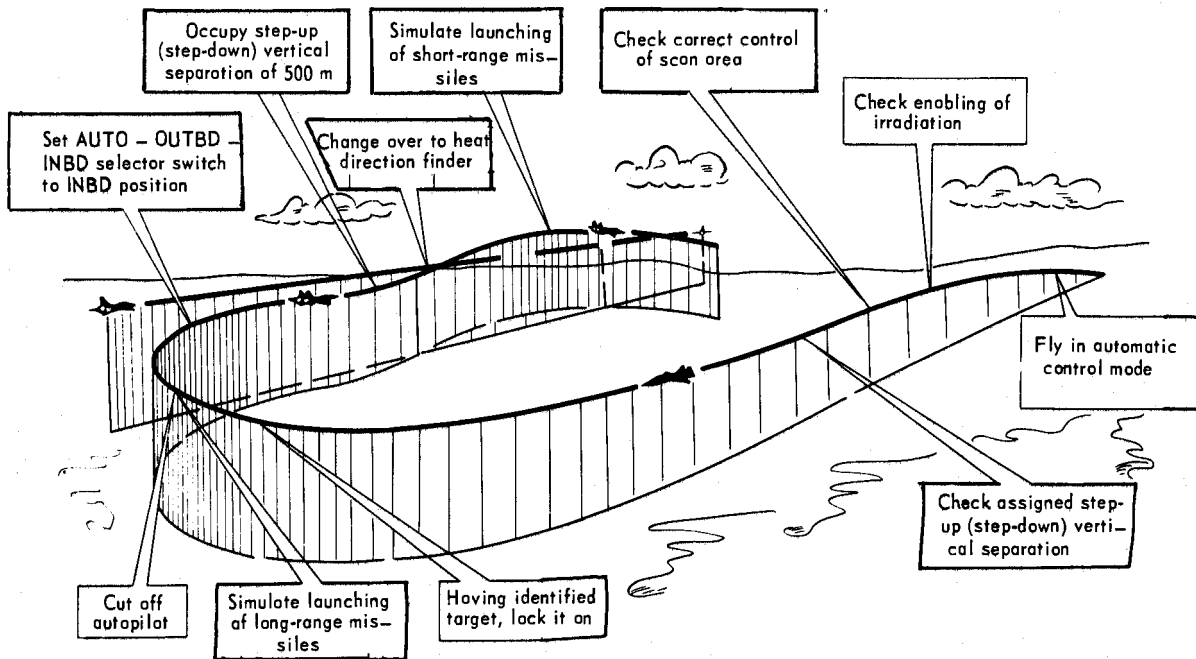

FIG. 145. PATTERN OF ATTACK WITH COMBINATION USE OF ARMAMENT SYSTEM

- the distance scale of 30 km if the target distance is less than 26 km;
- the target blip and distance mark on the right of the distance scale;
- the altitude mark and present altitude mark;
- the electronic cross-hairs;
- the sighting error mark (large ring) in the "azimuth-elevation" coordinates of the target;
- the missile launch maximum permissible distance mark;
- the electronic gyro horizon line.

Maneuver the aircraft to keep the large ring on the cross-hairs, avoiding decrease of the fighter step-down vertical separation relative to the target below 300 m.

The maximum deviation of the ring centre from the centre of cross-hairs within the indicator scales corresponds to  $\pm 70^\circ$ .

If the sighting angle is beyond  $\pm 24^\circ$  (the limit bearing), the large ring starts flickering to inform the pilot of the fact.

When the target distance is less than 15 km, the electronic gyro horizon line becomes zeroed in pitch and the indicator screen additionally displays the "Fin" mark (see Fig. 117).

The miniature airplane shaped by the gyro horizon line and the "Fin" mark indicates the present roll of the fighter.

Display of indices 1, 4 and LP on the indicator screen testifies to the fact that the conditions for launching of missiles P-60 (P-60M) are provided. In addition, a monotonous audio signal is delivered in the pilot's earphones. In case the angular velocity of the target tracking by infrared homing missile P-60M exceeds the permissible value, the LP index starts flickering on the indicator screen. In this case, the pilot should maneuver the aircraft to decrease the angular velocity of the target tracking until the LP index stops flickering, avoiding the deviation of the large ring beyond the notches of the electronic cross-hairs. Simulate the missile launch. Break away upon reception of the "Break-away" command which is transmitted after the last missile launch is simulated or upon reaching the minimum safe distance. The safe distance is calculated from the formula:

$$D_{\text{safe}} = 550 \text{ m} + 5.7V_{\text{cl}},$$

where  $V_{\text{cl}}$  is the target closing speed in m/s.

In response to the "Break-away" command, the BREAK-AWAY lamp will light up on the indicator and the electronic ring will jump up rightward or leftward indicating the direction of break-away. Simultaneously the indicator screen will display the beam mark as a dot indicating the direction to the target in the "azimuth-elevation" coordinates of the target. After the break-away and cancelling of the "Break-away" command, disable the radar irradiation and switch off its power supply.

### 2.3. Rear-Cone Attack with Use of Heat Direction Finder (Fig. 146)

The target attack with the use of the heat direction finder is performed in case of partial or complete failure of the radar, as well as in order to ensure a surprise attack and under intensive countermeasures against the radar.

The air target attack may be made against a simple or complicated background irrespective of the daytime and season in case there are no clouds between the fighter and the target. In case of a simple background, use is made of the T-I and T-III modes. In case of a complicated background, when it is impossible to discriminate the target against the noise background, or in case the pilot is not quite sure of the number of targets, use is made of the T-II mode.

To engage the armament control system in the T-I mode, the pilot should set the radar controls to the positions similar to those used in the RDR mode depending on the direction mode.

Set the SYST (CMCT.) selector switch to the T-I position. Set the  $\varphi_0$  - WITH RDR -  $\varphi_b$  selector switch to the WITH RDR position. After the engines are started, switch on the RDR and HDF switches.

At the stage of long-range direction the indicator screen will display the same information as in the RDR mode prior to enabling of irradiation in compliance with the direction mode. In addition, the indicator screen will display the boundaries of the detection zone and the gates of the heat direction finder (see Fig. 134).

Due to limited scanning of the heat direction finder in elevation ( $4^\circ$  upwards and  $9^\circ$  downwards) the pilot should be well aware of the maximum step-up (step-down) vertical separation relative to the target versus the target distance (Table 18).

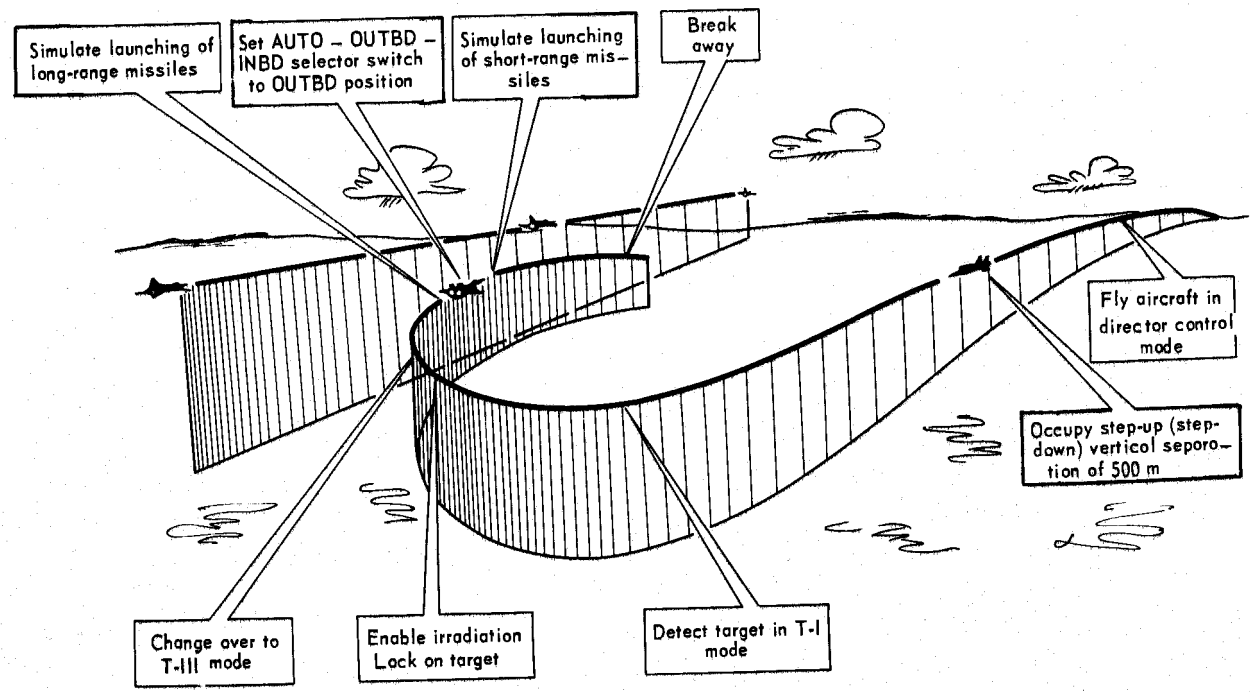

FIG. 146. PATTERN OF REAR-CONE ATTACK WITH USE OF HEAT DIRECTION FINDER



Table 18

Target distance, km	Maximum step-down vertical separation relative to target, km	Maximum step-up vertical separation relative to target, km
100	7	16
90	6	14
80	6	13
70	5	11
60	4	9
50	3.5	8
40	3	6
30	2	5
20	1.4	3
10	0.7	1.5

After the aircraft is brought to the assigned attack altitude, the pilot should search for the target with the use of the heat direction finder. The target blip will be displayed on the indicator screen as a dot in the "azimuth-elevation" angular coordinates.

To lock on the target, the pilot should manipulate the direction knob to superimpose the heat direction finder gates on the target and depress the LOCK-ON button.

After the target is locked on, the indicator screen will display the HDF index and the missile launch maximum permissible distance mark, while during automatic direction the sighting error mark (large ring) will be displayed in the "azimuth-elevation" coordinates of the target instead of the command mark (small ring).

During eye-estimated (visual) direction, the indicator screen will display marking of the distance scale (30 km) and electronic cross-hairs. The target distance should be checked with reference to the distance mark supplied by the 5V15K-11 equipment in case of automatic direction or with reference to the information supplied by the direction post over the radio in case of eye-measuring direction. The missile launch maximum

permissible distance is calculated proceeding from the following conditions: the fighter-to-target closing speed is equal to 100 m/s in case of a rear-cone attack and to  $1.6 V_{cl}$  in case of a forward-cone attack. The pilot should control the aircraft keeping the sighting error mark on the cross-hairs. On the indicator screen the gates of the heat direction finder will automatically follow the tracked target. In case the pilot is not to operate the SAPPFIR-25 radar (to ensure a concealed attack or under conditions of intensive countermeasures), the pilot should set the  $\phi_0$  - WITH RDR -  $\phi_b$  selector switch to the  $\phi_b$  position not later than 40 s prior to simulation of the missile launch. The pilot should resort to the  $\phi_0$  position of the selector switch only in case of visual sighting.

When the target distance is close to the missile launch permissible distance, set the FHS - RHS selector switch depending on the attack conditions for generation of the "Preparation" command.

In response to the "Preparation" command, the homing heads of the missiles will turn in the direction of the locked-on target.

The missile launch should be simulated only if at least one of lamps 1, 2, 3, 4 and LP lamp are illuminated on the indicator screen irrespective of the position of the sighting ring relative to the centre of cross-hairs.

In case the employment of radio interference is limited, after the target is locked on by the heat direction finder and closing with the target is concealed up to a distance close to the maximum permissible one, it is recommended to engage the radar for irradiation. In this case, the radar will change over to the quasiscanning mode (the antenna beam will track the target with reference to the information supplied by the heat direction finder and the pulse transmitter will operate with periodic enabling of irradiation to simulate the scanning mode). A target distance quasimark will appear near the distance scale. The brightness of the quasimark will pulsate with a period of 3 s.

After irradiation is enabled in case of eye-measuring (visual) direction, an additional mark of manual distance input ( $D_{man}$  in )

will appear near the distance scale. After the target distance quasimark appears, the target can be identified. To carry out identification, the pilot should depress the INTERROG button. In case the target is a friendly aircraft, a "Friend" pulsating mark appears over the distance quasimark. The shape of the "Friend" mark is the same as that of the quasimark. After the target is identified, the pilot should make sure that the target distance quasimark is located within the lock-on zone, i.e., within  $\pm 4.5$  km relative to the distance mark delivered by the 5V15K-11 equipment (in case of automatic direction) or relative to the  $D_{\text{man in}}$  mark (in case of eye-measuring direction). If it is necessary to change over to operation with the radar, the pilot should use the direction knob to align the  $D_{\text{man in}}$  mark with the target distance quasimark and once again depress the LOCK-ON button.

To correct the position of the lock-on zone in case of automatic direction, the pilot should press the direction knob down. The indicator screen will display two marks (similar to the 5V15K-11 equipment mark) showing the boundaries of the lock-on zone. Operate the direction knob to align the lock-on zone with the target distance quasimark and depress the LOCK-ON button. Check the change-over to the radar tracking of the target by referring to a change in the indication.

The indication should correspond to the RDR mode at the homing stage with additional display of the HDF index in case the target sighting angles in the process of the attack do not exceed the limit angles of the target tracking by the heat direction finder. After that the pilot should check the sighting and simulate the missile launch under the conditions of the RDR mode. In this case, the  $\varphi_0$  - WITH RDR -  $\varphi_0$  selector switch should be set to the WITH RDR position.

In case partial failure of the SAPPFIR-25 radar does not allow to control the radar antenna by the heat direction finder (in case of the target lock-on by the heat direction finder operating in the T-I mode, the coordinates of the sighting error mark (large ring) do not correspond to the coordinates of the heat direction finder target mark), the target should be attacked in the following modes:

T- $\varphi_{0I}$  - at the initial stage of the attack in the process of the target search and closure;

T- $\varphi_{0II}$  - at the final stage of the attack in the process of sighting and missile launching.

In order to operate in the  $T-\varphi_{OI}$  mode, the pilot should set the SYST selector switch to the  $T-\varphi_{OI}$  position and the  $\varphi_o$  - WITH RDR -  $\varphi_b$  selector switch to the  $\varphi_o$  position. After the heat direction finder target blip appears on the indicator screen, close with the target to a distance close to the missile launch permissible distance.

The target distance should be checked by referring to the 5Y15K-11 equipment distance mark in case of automatic direction or to the information delivered by the control post (direction post) over the radio in case of eye-measuring (visual) direction. The missile launch maximum permissible mark is displayed on the indicator screen immediately after enabling of the  $T-\varphi_{OI}$  or  $T-\varphi_{OII}$  mode. The missile launch maximum permissible distance is determined with reference to the conditions similar to the T-I mode after the target is locked on by the heat direction finder.

The pilot should maneuver the aircraft to bring the heat direction finder target blip in the centre of the heat direction finder field until it is framed by the gates. After that, set the SYST selector switch to the  $T-\varphi_{OII}$  position and keep the HDF target blip in the area framed by the  $T-\varphi_{OII}$  gates. Set the FHS - RHS selector switch to the position corresponding to the direction of the attack.

The continuous illumination transmitter will be switched on in case the aircraft carries radar homing missiles and irradiation is enabled. The indicator screen will display the CIC index and the radar antenna will shape a fixed wide beam ( $\theta = 20^\circ$ ) to illuminate the target. In the recommended missile launch zone the pilot should simulate the missile launch if one of lamps 1, 2, 3, 4 and LP lamp are illuminated.

When out of visual contact with the target, the break-away direction is determined with respect to the position of the target blip on the indicator screen.

When the attack is performed with the use of the heat direction finder and the radar is switched on, the radar homing missiles are launched (or the launch is simulated) without the target relock-on by the radar. When the  $\varphi_o$  - WITH RDR -  $\varphi_b$  and FHS - RHS selector switches are set to the  $\varphi_b$ , RHS (FHS) positions, respectively, the indicator screen will additionally display the CIC index. After the launch of the radar homing missiles is simulated, the pilot should ensure the target illumination.

#### 2.4. Performing Attack Against Air Targets Involving Visual Sighting

The main version of employment of the ММГ-25ПД aircraft armament system is realized when performing an attack involving the operation of the airborne radar and heat direction finder, as a rule, under conditions of absence of visual target visibility. However, in case of complete failure of the airborne radar or heat direction finder, or under conditions when their use is undesirable, the missile launch in the  $\varphi_0$  mode is possible.

In the " $\varphi_0$ " mode, the ММГ-25ПД aircraft may be used for performing an attack with infrared homing missiles under conditions of visual target visibility and a rear-cone attack as well as an attack with radar homing missiles in the HORN ANTENNA mode (with the radar irradiation enabled and RDR switch turned on).

The direction of the fighter into the rear hemisphere of the target to the target visual detection distance is performed by the combat control officer. The target visual detection distance at medium and high altitudes and in stratosphere depends on the transparency of the atmosphere, presence or absence of clouds, the position of the sun relative to the target and fighter and the pilot's visual search proficiency. The average visual detection distance is 6 to 8 km.

The target visual detection distance at low and extreme low altitudes is less than that at medium and high altitudes. The decrease of the visual detection distance at low altitudes is explained by deterioration of transparency of the near-ground layers of the atmosphere. Apart from this, the terrain background rapidly displacing within the pilot's field of vision diverts his attention from searching for an air target. The average visual detection distance at low and extreme low altitudes is 4 to 6 km.

In sunny weather the surfaces of air targets may produce gleams, thus increasing the detection distance up to 10 to 12 km.

To detect the target, the pilot may use the shades produced by the target on the ground, which are considerably more distinguishable than the target by contrast.

In cloudy weather the target visual detection distance against the terrain background is reduced to 3 to 4 km. In broken clouds, greater attention on the part of the pilot is required to detect the target against the background of the shades produced by clouds.

With the target flying over an inhabited area or particoloured terrain having a predominant green colour, the average visual detection distance diminishes to 2 to 3 km.

Air target search in early or late hours is complicated due to the low position of the sun above the horizon and the distortion of shades. With the sun located above the horizon at angles of 20 to 30° and less, conduct target search downsun. Whenever the sun is at high angles with respect to the horizon, it is expedient to perform target search upsun. In this case, gleams may be produced by the target, which facilitates the target detection at an increased distance.

The best conditions for visual detection of the target flying at a low or extreme low altitude are ensured when the fighter is flown at a step-up vertical separation of 800 to 1200 m relative to the expected target flight altitude.

When the target is detected visually, the pilot should assume an initial position for the attack.

The target distance is determined on the basis of the information furnished from the control post and obtained visually with the use of the K-10T collimating sight. To determine the target distance visually, the pilot must know the target span (Fig. 147).

The pilot may deliver a low or high astern attack depending on the target flying altitude. It is recommended to deliver a low astern attack against a target flying at an altitude above 500 m. If the target flies at an altitude of below 500 m, perform a high astern attack. If the target flies over the top of clouds, it is expedient to perform a high astern attack in the "Φ<sub>0</sub>" mode.

To perform the above-mentioned attacks, assume the initial position with a step-down vertical separation of 200 to 500 m or with a step-up vertical separation of 400 to 1200 m relative to the target. The amount of the step-down (step-up) vertical separation depends on the target distance and flight altitude.

In this case, take into account the following peculiarities of using infrared homing missiles:

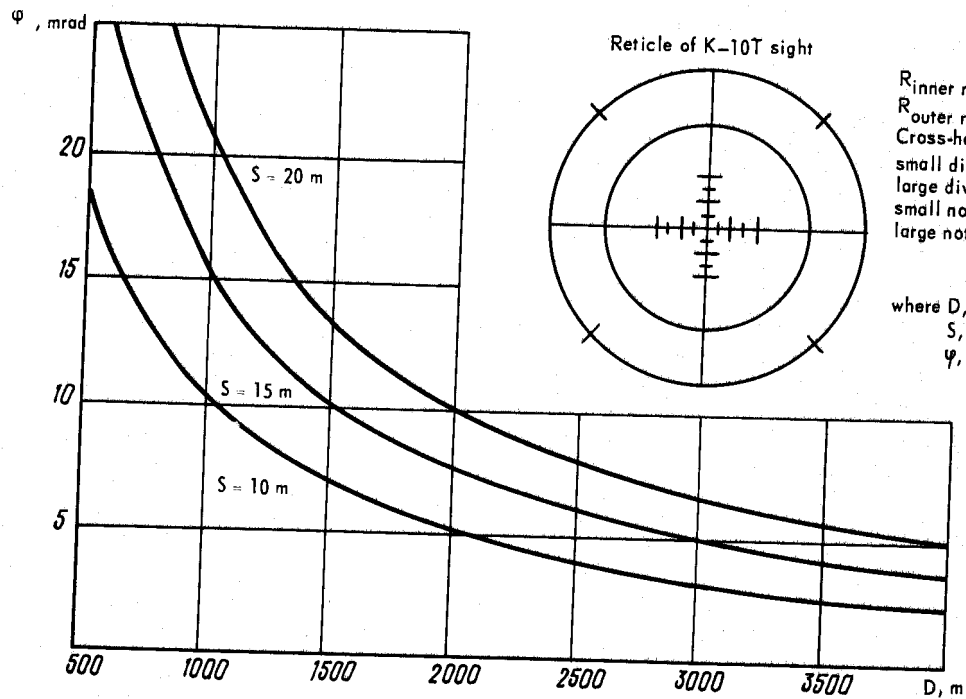

FIG. 147. COLLIMATING SIGHT K-10T

- deliver an attack against the target so that the target is projected against a clear background;
- simulate a missile launch at the target which is against the background of the clouds lit with the sun at a minimum distance and aspect angle of about  $0/4$ ;
- the maximum effectiveness of the infrared homing missiles is achieved at low altitudes when the missiles are launched at pitch-up or dive angles of  $5$  to  $10^\circ$ ;
- when delivering attacks in descent over industrial and inhabited areas, as well as over the coastal line, the infrared homing heads of the missiles may lock on irrelevant heat irradiation sources.

Launching of the missiles should be simulated when the "Launch permitted" command is delivered and lamp 2 or 3 lights up.

Discussed below are the possible variants of delivering an attack against the air target in the " $\varphi_b$ " mode.

#### 2.5. Low Astern Attack

The attack position is as follows: the target distance is 4 to 6 km, the target sighting angle is  $20$  to  $30^\circ$ , the step-down vertical separation relative to the target is 200 to 500 m.

Launching of the radar homing missiles is possible only if the continuous illumination channel is switched on.

The pilot should proceed as follows:

- check to see that the RDR switch is turned on (if launching of the P-4OPM radar homing missiles is to be simulated, switch on the radar for irradiation);
- turn on the MASTER ON switch;

- no sooner than 1 min and no later than 20 min prior to simulation of the missile launch, set the  $\varphi_0$  - WITH RDR -  $\varphi_b$  selector switch to the  $\varphi_0$  position (if the aircraft carries the radar homing missiles and the RDR switch is turned on, the indicator screen will display the CIC index);

- 30 s after the " $\varphi_0$ " mode is enabled, set the FHS - RHS selector switch on the armament control panel to the RHS position;

- maneuver the aircraft to align the target with the cross-hairs of the K-10T sight reticle. The accuracy of sighting should be not worse than  $\pm 20$  mils for the long-range missiles and  $\pm 40$  mils for the short-range missiles. The higher the



accuracy of sighting, the better the conditions for the target lock-on by the missile heads.

The reticle of the K-10T sight will start flickering when the target is locked on by the infrared homing heads of missiles P-40T or P-40TД or when missiles P-40PД are ready for launching.

In the " $\varphi_0$ " mode launching of missiles P-40PД should be simulated at a distance not exceeding 10 to 12 km against a target with the effective reflecting area of  $19 \text{ m}^2$  and not exceeding 6 to 8 km against a target with the effective reflecting area of  $4 \text{ m}^2$ .

After launching of missiles P-40T, P-40TД, P-60 or P-60M is simulated, immediately break away. After launching of missiles P-40PД is simulated, the break-away procedure should be performed after the target is illuminated with due account of the width of the radiation pattern of the fixed horn antenna of the radar continuous illumination channel equal to  $\pm 20^\circ$ .

High astern attack (against a target flying at limit low altitudes).

The attack position should be as follows: the target distance is 4 to 4.5 km; the target sighting angle is  $20$  to  $30^\circ$ ; the step-up vertical separation relative to the target is 400 to 1200 m.

The attack position taken and the armament system prepared for the missile launch in the " $\varphi_0$ " mode, perform a corrective turn to the target at a roll of  $30$  to  $40^\circ$ , simultaneously bringing the aircraft into descent. Accomplish the sighting with the use of the K-10T collimating sight providing for an accuracy of  $\pm 20$  mils.

When sighting, visually determine the target distance. Simulate launching of the missiles at the distances specified above.

After the launch is simulated, break away with climbing to an altitude of 800 to 1000 m.

## 2.6. Forward-Cone Attack with Use of SAPFIR-25 Airborne Radar (Fig. 148)

The main peculiarity of a forward-cone attack against an air target is a high fighter-to-target closing speed and, as a result, lack of time for performing the attack.

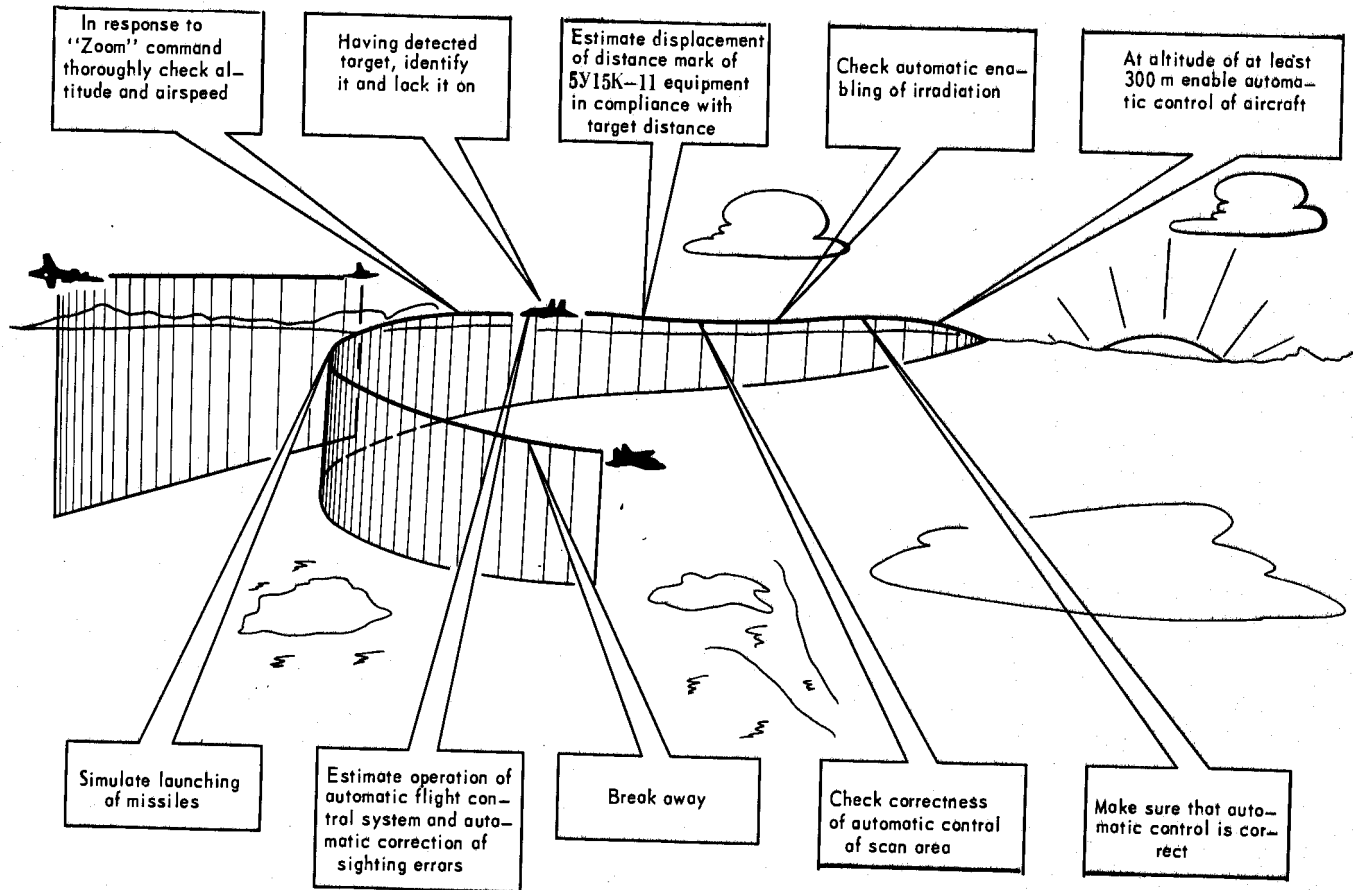

FIG. 148. PATTERN OF FORWARD-CONE ATTACK

Therefore, at all stages of the aerial combat the pilot should act very accurately and minimize the time spent for the target detection, identification, lock-on and sighting. It is of paramount importance in case the attack is performed against point and high-speed targets.

To gain success in a forward-cone attack under lack-of-time conditions, it would be wise to:

- employ instrument direction and automatic control of the aircraft;
- select the optimum step-down (step-up) vertical separation relative to the target;
- resort to automatic gating;
- depress the firing button immediately after the target is locked on.

In case instrument direction is used, sighting errors at the moment of the target lock-on are reduced.

As a rule, in this case the sighting error does not exceed the permissible value. Besides, during instrument direction the SAPFIR-25 airborne radar is controlled automatically, which saves the time due to decrease of the number of operations with the radar controls and employment of automatic gating of the target.

Automatic control of the aircraft allows the pilot to pay more attention to the target search and detection. Furthermore, after the target is locked on, the sighting errors are corrected much quicker than under the conditions of director control.

At the stage of long-range direction the radar furnishes the same indication as in case of a rear-cone attack. During automatic direction the indicator screen additionally displays the FHS signal.

The target detection distance depends upon the effective reflecting surface of the target. Targets having the effective reflecting surfaces of up to  $19 \text{ m}^2$  can be detected at a distance of up to 114 km. The pilot should take into account the fact that the distance of limit displacement of the lock-on zone amounts to 80 km both in the automatic and manual displacement modes. Therefore, the target can be detected at a distance greater than the lock-on zone distance.

In this case, the pilot should go on closing with the target without trying to lock it on until the target blip approaches the lock-on zone distance.

At the stage of long-range direction when the target proceeds at a step-up vertical separation of more than 3 km relative to the fighter (in case the target maneuvers in altitude) and direction is carried out automatically, the "Preparatory zoom" command is generated. The Z lamp lights up on the radar indicator.

In case of the aircraft automatic control, the aircraft will smoothly change over to climbing with a climb angle of  $5^\circ$ . In the director control mode the small ring of the indicator screen and the command bar of the flight director indicator will deflect upwards. To carry out the preparatory zoom, the pilot should set the small ring in the centre of the crosshairs and bring the command bar within the small-diameter ring. Identify the target by depressing the IDENTIFICATION (ОПЗНАВАНИЕ) button.

When the target blip approaches the level of the lock-on zone distance, depress the LOCK-ON button and check to see that the CIC lamp lights up on the indicator screen.

If prior to lock-on the distance mark supplied from the 5V15K-11 equipment is located on different levels with the target or in case the target goes beyond the distance gates after it is locked on with respect to the angular coordinates, the pilot should change over to manual gating by pressing the direction knob down.

After the target is locked on under the eye-measuring (visual) direction conditions, check to see that the FHS signal is displayed on the indicator screen.

Immediately after a point or high-speed target is locked on, depress the firing button. In all forward-cone attacks the missile launch should be simulated at the missile launch maximum permissible distance.

The pilot's actions after the missile launch is simulated are similar to those in a rear-cone attack.

### 2.7. 3/4 to 4/4 Aspect Angle Attack

The armament system of the aircraft enables the pilot to destroy targets in any specified aspect angle attack.

However, an attack at a specified aspect angle can be performed at a strictly definite relation between the airspeeds of the interceptor and target.

Apart from adequate use of technical protective means against the countermeasures set up by the enemy against the airborne radar, of great importance is employment by the pilot of some tactical maneuvers resulting in reduction of efficiency of the radioelectronic countermeasures. One of them is an attack against an air target using active and passive countermeasures at such an aspect angle wherein the electronic countermeasures are weak or absent altogether. This area of the attack is located within the relative bearings corresponding to high aspect angles.

The aspect angle of a target is a relation of the visible size of the fuselage to the actual one expressed in fourth and eighth fractions. The relative bearing of a target is an angle between the target airspeed vector and the fighter-to-target sighting line (Fig. 149).

Therefore, the visible size of the fuselage depends upon the relative bearing of the target:

$$R_t = \sin q,$$

where  $R_t$  is the aspect angle of the target;

$q$  is the relative bearing of the target.

In case of a rear-cone attack the relative bearings of the target are between  $180$  and  $90^\circ$ , while in a forward-cone attack they are between  $0$  and  $90^\circ$ .

The aspect angles expressed in fourth fractions correspond to the following relative bearings of the target:

- $0/4$  -  $0$  to  $7^\circ$  ( $180$  to  $173^\circ$ );
- $1/4$  -  $7$  to  $22^\circ$  ( $173$  to  $158^\circ$ );
- $2/4$  -  $22$  to  $39^\circ$  ( $158$  to  $141^\circ$ );
- $3/4$  -  $39$  to  $61^\circ$  ( $141$  to  $119^\circ$ );
- $4/4$  -  $61$  to  $90^\circ$  ( $119$  to  $90^\circ$ ).

The area of the attack wherein the electronic countermeasures are weak or absent altogether is located within the relative bearings from  $39$  to  $141^\circ$ , which corresponds to aspect angles of  $3/4$  to  $4/4$ .

The following two conditions should be satisfied to successfully carry out a  $3/4$  to  $4/4$  aspect angle attack;

(a) all the time the fighter should be located within the specified area;

(b) the fighter armament system should ensure destruction of the target at any aspect angle.

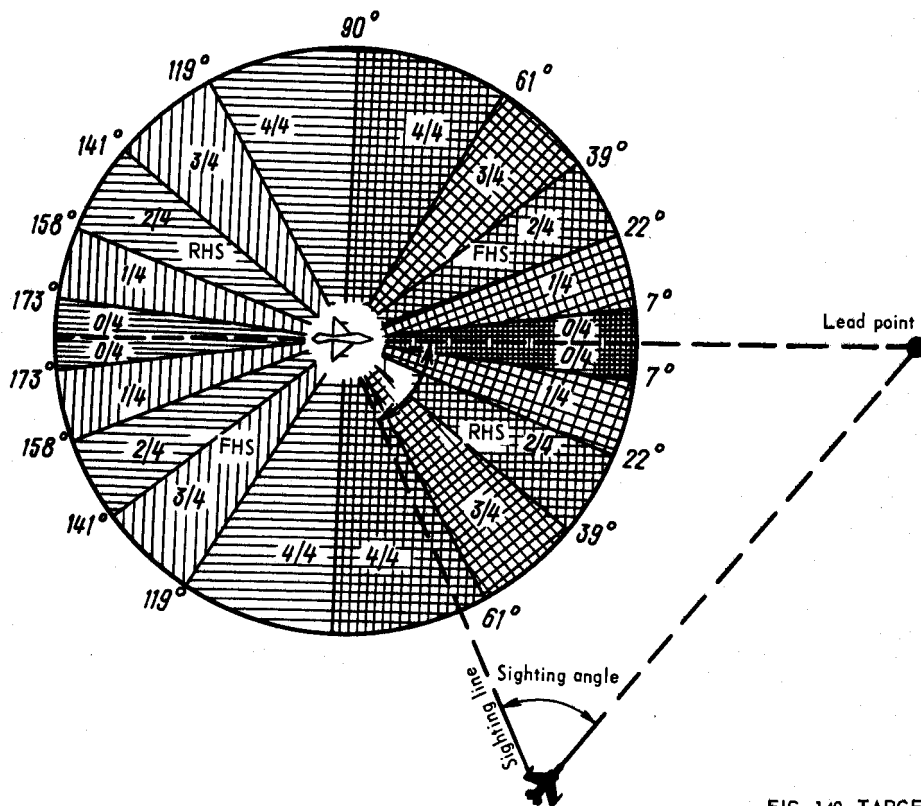

FIG. 149. TARGET ASPECT ANGLE  
DETERMINATION PATTERN

The first condition is satisfied through the fighter direction at the last stage by a method of constant-bearing approach the essence of which resides in that the target sighting line moves translationally in space (Fig. 150).

The method of constant-bearing approach may be considered as a particular case of straight-line approach when the distance of the target approach is equal to zero or is negligibly small as compared with the initial distance.

The best efficiency of a high aspect angle attack is attained when use is made of the fighter automatic control systems.

To carry out a  $3/4$  to  $4/4$  aspect angle attack (Figs 151 and 152), the pilot should adhere to the following procedure.

With the help of the automatic direction post, the aircraft is brought to the area of the most probable target detection under the specified aspect angle.

At the stage of long-range direction the pilot may control the aircraft in the manual, director, or automatic control mode. Special attention should be paid to correspondence of the present airspeeds and headings to those specified by the control post (direction post). In case the pilot is directed by voice with the help of the radar plan position indicator, he should follow the command of the control post (direction post), enable irradiation and set the direction knob to a position corresponding to the direction of the attack.

After the irradiation enabling command is received in the automatic direction mode, check correspondence of the radar antenna beam to the direction of the attack.

In case the target is not detected at the expected distance, change over to manual control of the radar.

To this end, set the IRRAD - DUMMY - OFF selector switch to the IRRAD position and the DIRECT - AUTO - MAN selector switch to the MAN position. The target should be detected at an azimuth of  $\pm 35$  to  $40^\circ$  (the target may be detected and attacked at other azimuth angles depending on the relation of the airspeeds of the fighter and target).

After the target is detected, strictly maintain the specified airspeed and heading.

In the process of the fighter-to-target closing the target blip should not change its position in azimuth. If the pilot maintains the airspeed lower than the specified one, the target blip will move to the centre of the screen (entry into

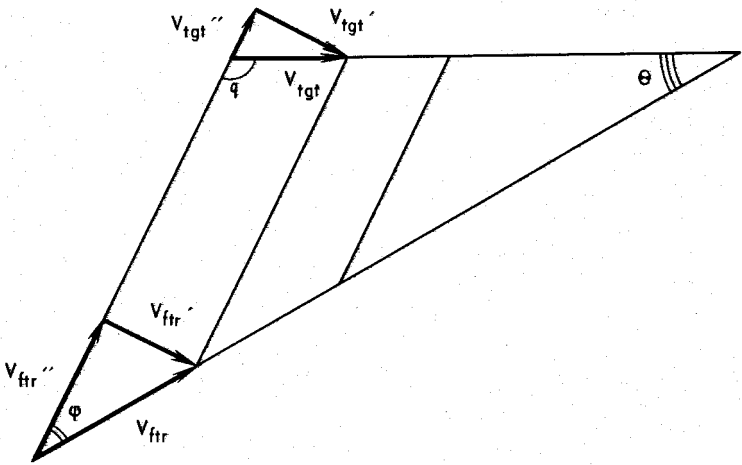

FIG. 150. METHOD OF CONSTANT-BEARING APPROACH



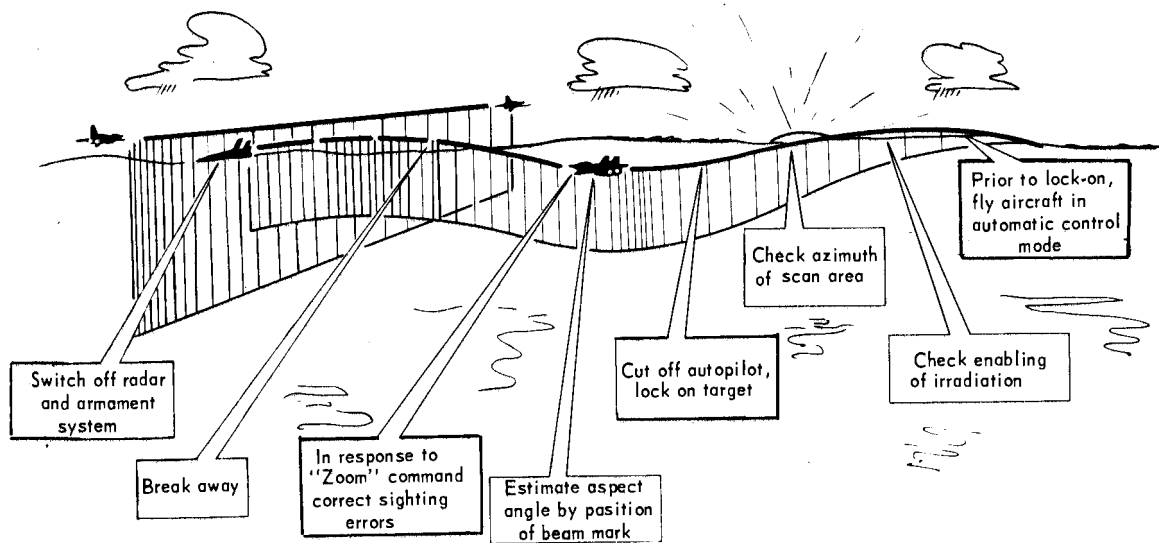

FIG. 151. PATTERN OF 3/4 TO 4/4 ASPECT ANGLE ATTACK

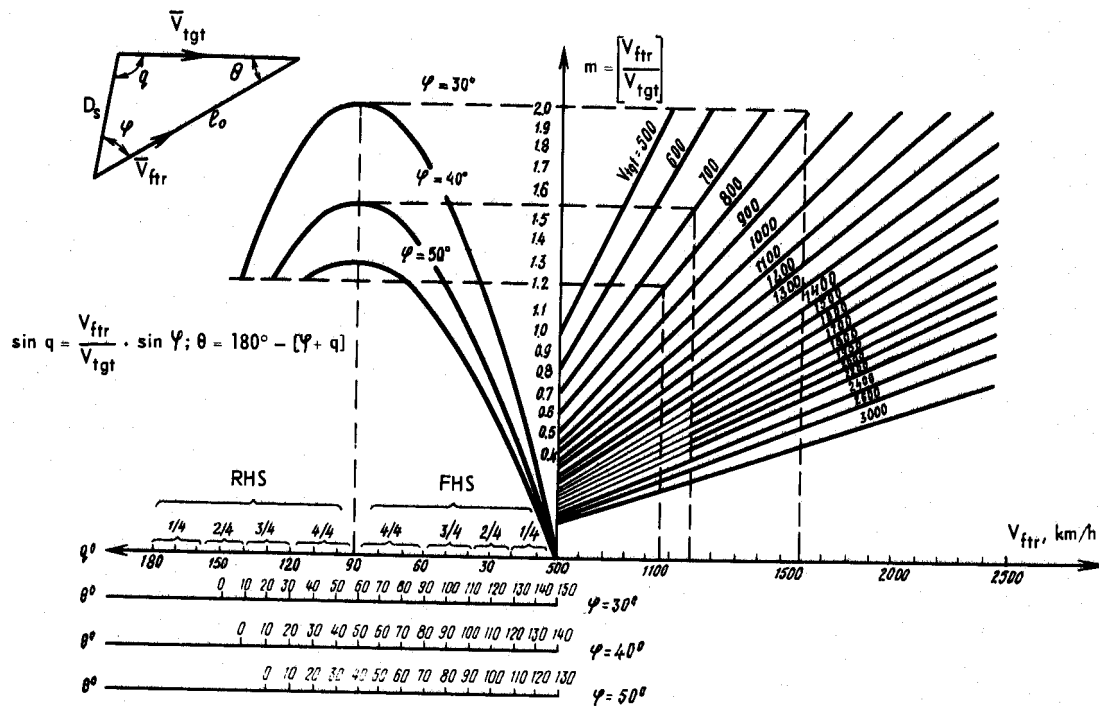

FIG. 152. DIAGRAMS FOR DETERMINATION OF TARGET ASPECT ANGLES

the rear hemisphere). If the pilot maintains the airspeed higher than the specified one, the target blip will move towards the azimuth increase (entry into the forward hemisphere). If the direction errors lead to increase of the radar antenna sighting angle up to  $45$  to  $50^\circ$  or in case the target is lost, the pilot should perform a corrective turn towards the target to decrease the sighting angle down to  $35$  to  $40^\circ$ .

Lock on the target when the distance is 20 km. If proceeding in the automatic control mode, switch off the autopilot preparatory to the target lock-on.

After the target is locked on, maintain the same heading. In this case, as the fighter is closing with the target, the ring will move towards the cross-hairs and the beam mark will stay at a constant azimuth of  $\pm 35$  to  $40^\circ$ .

Turn on the MASTER ON switch.

When the target distance is equal to the distance at which the "Zoom" command is generated, the pilot should zero the command bars of the flight director indicator within the small-diameter circle, set the electronic ring to the centre of the cross-hairs and perform a maneuver to correct the sighting errors.

Special attention should be paid to the position of the centre of the sighting ring relative to the centre of the cross-hairs. The permissible misalignment of the sighting ring relative to the cross-hairs is not to exceed 1.5 of the size of the electronic cross-hairs.

When the "Launch permitted" command is delivered and at least one of the 1, 2, 3, 4 lamps is illuminated, simulate the missile launch. In response to the "Break-away" command, break away in the direction of the sighting ring with a roll of up to  $60^\circ$ .

If a next attack is not planned, cut off the radar and armament system.

#### 2.8. Single Fighter Forward-Cone Attack with Subsequent Entry into Rear Hemisphere (Figs 153, 154 and 155)

Under combat conditions, in case the pilot fails to destroy the target in a forward-cone attack, he should perform a maneuver to enter into the rear hemisphere and attack the target in the rear hemisphere. From the point of view of the fighter control, execution of the maneuver involves no difficulties.

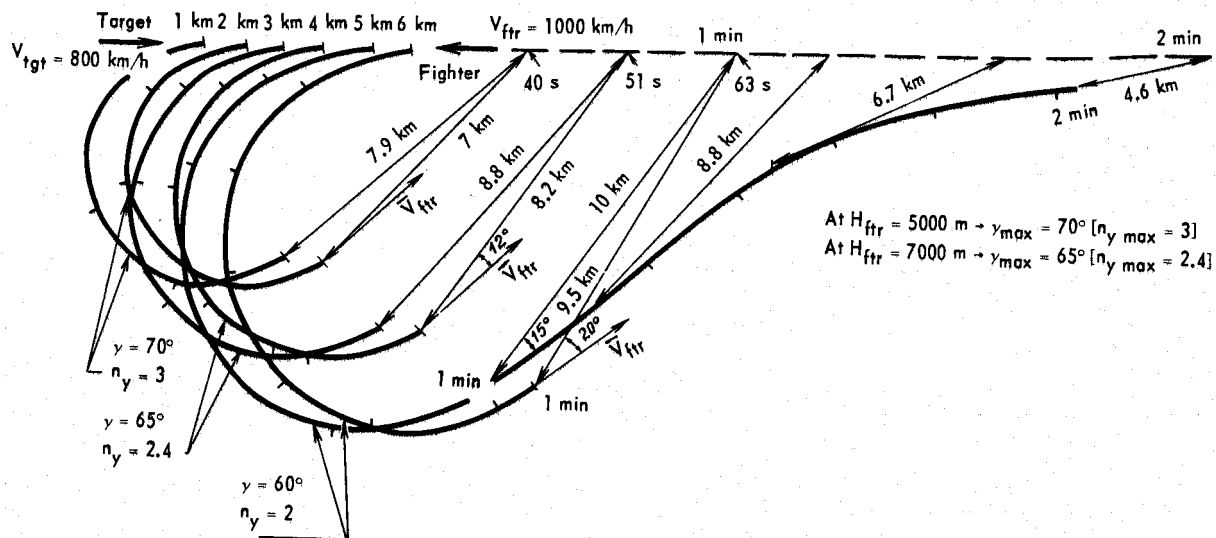

FIG. 153. FIGHTER MANEUVER PATTERN

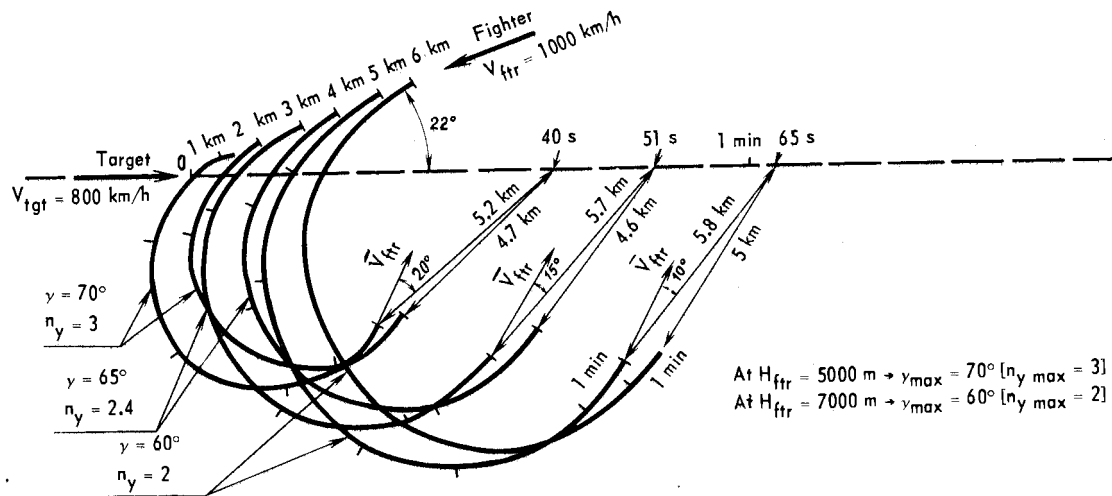

FIG. 154. FIGHTER MANEUVER PATTERN

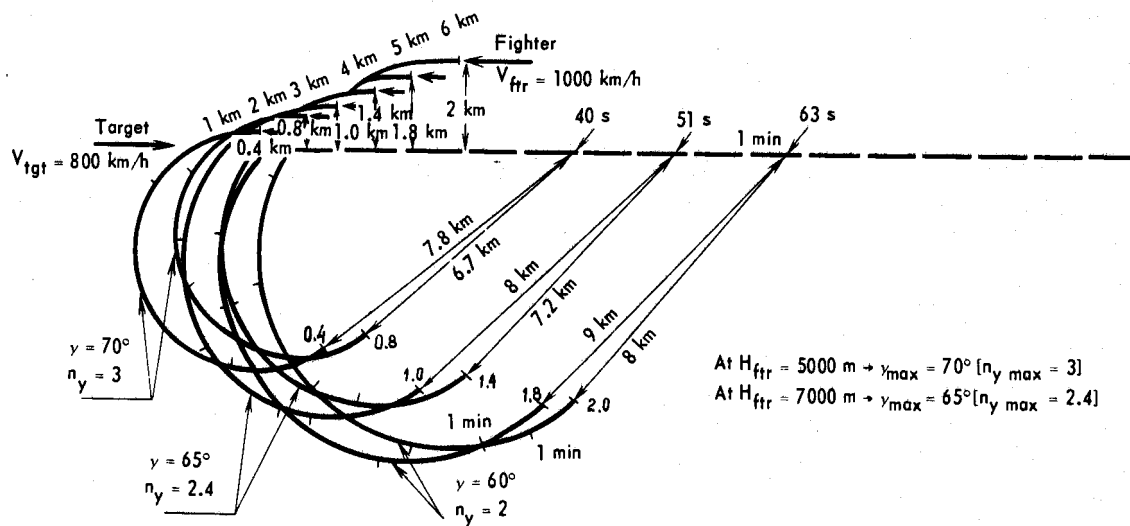

FIG. 155. FIGHTER MANEUVER PATTERN

Success of the maneuver depends upon its timely execution and upon accuracy in maintaining the maneuver parameters (airspeed and roll) by the pilot depending on the airspeeds of the fighter and target.

If the maneuver is not performed in due time, it will result in that the fighter may become a target itself or in that it may enter the rear hemisphere of the target at a distance which does not allow the fighter to close with the target and attack it.

Each airspeed of the target should correspond to the estimated parameters of the maneuver (fighter airspeed, target distance corresponding to the maneuver initiation, specified roll angle).

In order to make the attack concealed, the fighter is directed to the target with the help of the ground automatic control system.

The pilot should maintain a true airspeed of 1000 km/h. After irradiation is automatically enabled, check the position of the scan zone in azimuth and correspondence of the position of the target distance mark delivered by the 5V15K-11 equipment to the present distance. Having detected the target, perform the target identification and lock-on for autotracking. After the missile launch is simulated, proceed closing with the target until the "Break-away" command is delivered. Under these conditions the "Break-away" command will be delivered at a distance of 8 km. In response to the "Break-away" command turn in the direction of the sighting ring through  $220^{\circ}$  with a roll of  $60^{\circ}$ . The amount of the roll depends on the target distance at the initial moment of the maneuver. For example, if the maneuver is performed at the target distance of 4 km, the required roll amounts to  $65^{\circ}$ , if the target distance is equal to 2 km, the roll is equal to  $70^{\circ}$ .

During the turn disable irradiation. If necessary, engage the afterburner. Having turned through  $220^{\circ}$ , enable irradiation. If the maneuver is performed correctly, the target will be located within  $\pm 20^{\circ}$  at a distance of 4.5 to 10 km. Perform a rear-cone attack.

To practise a concealed attack, use may be made of the heat direction finder with subsequent change-over to radar autotracking. To do this, in the process of the turn the pilot should reduce the step-down vertical separation relative to the

target to 500 m. Having turned through  $220^{\circ}$ , select the T-I operating mode and perform the target attack with a combination use of the armament system.

Similarly a forward-cone attack can be performed at a step-up vertical separation relative to the target with subsequent entry into the rear hemisphere.

Figs 153, 154 and 155 illustrate the distances of the fighter entry into the rear hemisphere and the required roll versus the target distance at the initial moment of the turn.

#### 2.9. Forward-Cone Attack by Pair of Fighters with Subsequent Entry into Rear Hemisphere (Figs 156, 157 and 158)

The maneuver performed by a pair of fighters to enter into the rear hemisphere of the target after a forward-cone attack is more difficult as compared with the same maneuver performed by a single fighter and calls for certain skill, habits in team-flying and accurate cooperation with the control post.

The maneuver can be performed both with and without the pair break-up in altitude and direction of the attack.

Making use of the pair break-up during the rear-cone attack, the fighters limit the target maneuver in heading and altitude.

In training flights the optimum flight parameters of the fighters and target are:

- the target altitude - 6000 m;
- the fighters altitude - 5000 m;
- the target airspeed - 800 km/h;
- the fighters airspeed - 1000 km/h.

Under these conditions, in the forward-cone attack the "Break-away" command will be delivered at a distance of 8 km.

The procedure of a training flight is as follows.

Perform the takeoff in pair. The leader should fly the fighter in compliance with the direction commands and the wingman should maintain the assigned combat formation. At the stage of long-range direction the pair should proceed in the echelon formation which ensures freedom of maneuver and cooperation in pair (distance is 150 to 200 m, sighting angle to the leader is  $20$  to  $30^{\circ}$ , step-down vertical separation of the wingman is 20 m).



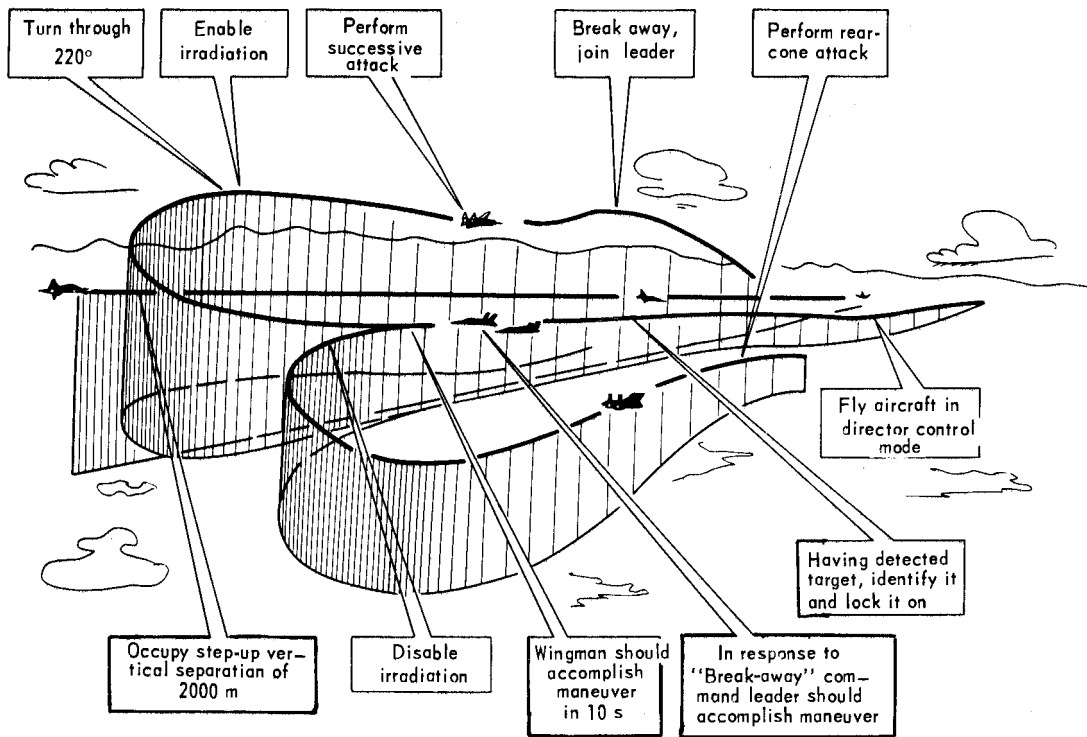

FIG. 156. PATTERN OF MANEUVER PERFORMED BY PAIR OF FIGHTERS

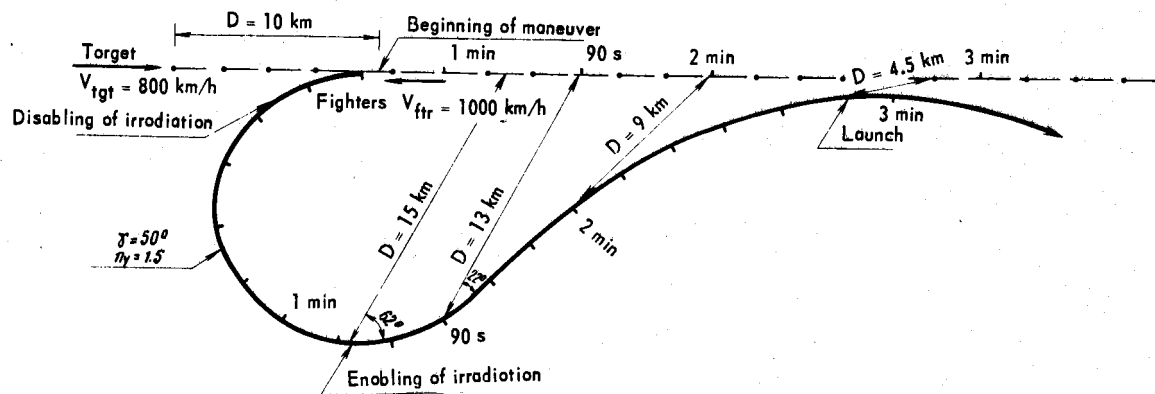

FIG. 157. PATTERN OF MANEUVER PERFORMED BY PAIR OF FIGHTERS

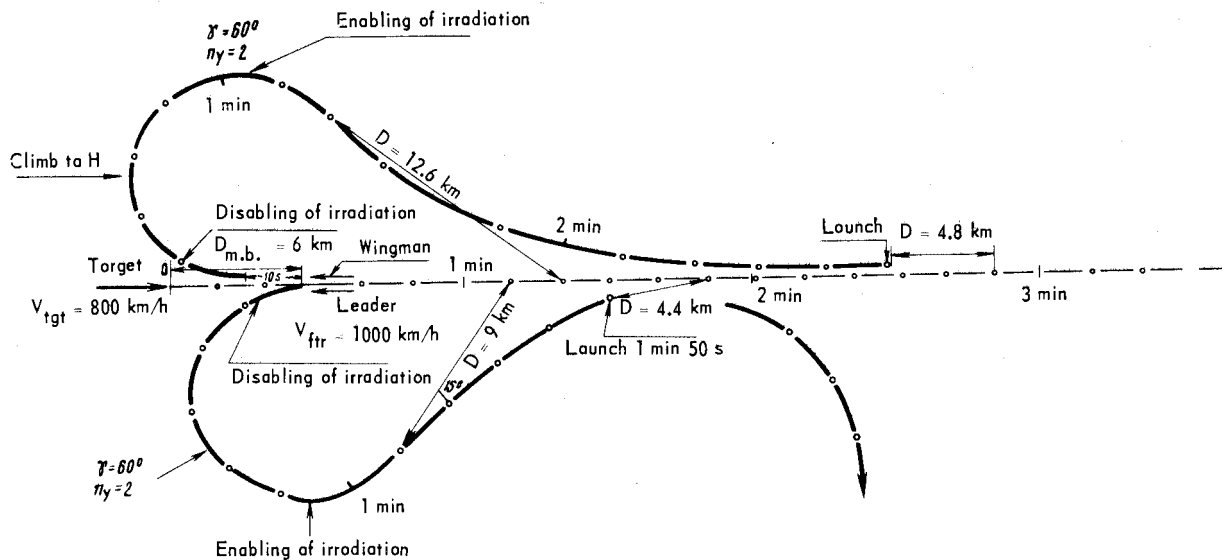

FIG. 158. PATTERN OF MANEUVER PERFORMED BY PAIR OF FIGHTERS

Having intercepted the straight line of the target closing at a distance of 90 km, the wingman should follow the leader's command and occupy the line-abreast formation with an interval of 200 to 300 m and distance of 50 to 100 m. After the radar irradiation is enabled manually or automatically, the leader should command the wingman to enable irradiation. Having detected the target, perform the target identification and lock-on. After the target is locked on for autotracking, the leader should fly the aircraft so that the sighting ring is located in the centre of the electronic cross-hairs, maintaining a step-down vertical separation of at least 1000 m relative to the target. The wingman should perform sighting while strictly maintaining the line-abreast formation.

When the distance permits, simulate the missile launch. When the BREAK-AWAY lamp lights up (at a distance of 7 to 8 km to the target), the leader should issue the "Maneuver" command.

In response to this command the pair should maneuver towards the leader at the altitude of 5000 m to enter into the rear hemisphere of the target. The maneuver should be performed without the break-up and with a roll of  $50^{\circ}$ .

At the beginning of the maneuver the pilots should disable the radar irradiation and enable it again after turning through  $180^{\circ}$ . Having turned through  $220^{\circ}$ , recover the fighters from the turn. Close with the target and perform a simultaneous rear-cone attack maintaining the line-abreast formation.

Practised similarly is a maneuver to perform an attack against a target flying with a step-down vertical separation relative to the fighters. In this case, the flying altitude of the fighters is 7000 m.

When performing a maneuver with the pair break-up, the leader should preliminarily, while proceeding at the stage of ground direction, order the wingman to occupy a respective echelon. In response to the "Break-away" command the leader should issue the "Maneuver" command and turn to the left (if the wingman is flying on the right) or to the right (if the wingman is flying on the left), maintaining a 1000-m step-down vertical separation relative to the target. During the turn the pilots should maintain a roll of  $50^{\circ}$ . Following the "Maneuver" command, the wingman should start the stopwatch and 10 s after the leader started his maneuver turn with a roll of  $50^{\circ}$  away from the leader. Having turned through  $90^{\circ}$ , bring the aircraft to

climbing so that the aircraft additionally gains 2000 m (the step-up vertical separation relative to the target should be 1000 m) by the end of the turn through  $220^{\circ}$ . After the aircraft enter the turn, the pilots should disable the radar irradiation and enable it again after the aircraft have turned through  $220^{\circ}$ .

Having enabled irradiation, the leader should search for the target at a distance of 8 to 12 km and the wingman should perform the target search at a distance of 10 to 15 km. If the maneuver is carried out correctly, the leader will be the first to detect the target at a distance of 10 to 9 km and then the wingman will detect it at a distance of 13 to 12 km. After the target is detected, successively perform a low astern attack (leader) and a high astern attack (wingman). The wingman should attack the target after the leader has broken away. The leader should break away in the direction from the wingman with a roll of  $45^{\circ}$ . After the attack the wingman should break away towards the leader and join up the leader by the command from the control post.

Performed similarly is a forward-cone attack with a step-up vertical separation relative to the target with subsequent entry into the rear hemisphere.

In this case, the leader should perform a turn, maintaining a step-up vertical separation of 1000 m relative to the target and the wingman, after turning through  $90^{\circ}$ , should occupy a step-down vertical separation of 1000 m relative to the target.

In all cases when the target attack altitude is changed, the pilot should set the  $\Delta H$  selector switch to the specified step-down (step-up) vertical separation relative to the target.

To preclude the loss of airspeed during execution of the maneuver, timely resort to the reheat power settings of the engines.

#### 2.10. Peculiarities Involved in Group Target Attacks

At the ground direction stage (until the radar irradiation is enabled) the group target combat flight for the most part does not differ from the single target combat flight. After the airborne radar irradiation is enabled, the performance of a group target attack is characterized by a number of peculiarities associated with the capabilities of the airborne radar and the homing heads of the missiles in selecting (resolving) a single target out of the entire group of targets.

Separate observation of the targets in a group on the radar indicator screen is possible if the distance between the targets does not exceed the specified values (Table 19) which depend upon the operating mode of the radar.

Fig. 159 presents the resolution intervals of a group target. As it is shown in Fig. 159, the heat direction finder features better resolution as compared with the radar. Missile P-40T (P-40TД) also features better resolution as compared with missile P-60 (P-60M).

If the intervals and distances between the targets are less than the azimuth and distance resolution of the radar in the automatic tracking mode, the airborne radar will track not a single aircraft but the power mid-point which is the result of addition of the signals returned from all aircraft of the group.

In this case, performance of an attack against the target in the automatic tracking mode is hampered and the probability of hitting the target by missiles is sharply reduced.

Timely identification of a group target enables the pilot to select the tactically correct method of attacking a target with due account of the capabilities of the armament system. If during operation with the radar the interval or distance between the targets in the group is less than the resolved one, the pilot should use the heat direction finder and, on some occasions, change the radar operating mode for separate observation of the targets in the group. The target nature (either a group target or a single one) can be determined by the information received from the control post and by the target blip on the radar indicator screen.

T a b l e 19

Radar operating mode	Distance scale, km	Distance resolution, m
HMA	120	1400
HMA	60	1000
HMA $-\Delta H_4$	120	1400
HMA $-\Delta H_1$	60	550
ATM	60	550
MLA	30	350
LA	30	350

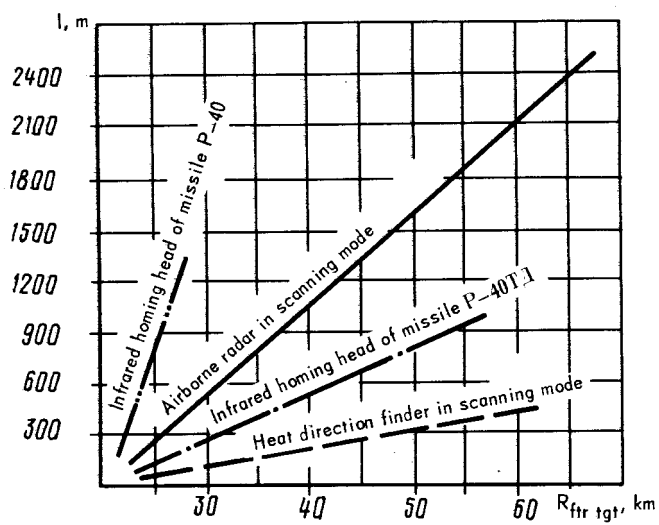

FIG. 159. RESOLUTION OF RADAR, HEAT DIRECTION FINDER AND MISSILES IN AZIMUTH AND ELEVATION

The detection distance for a single target is somewhat less than that for a group target consisting of the same type of aircraft as the single target.

With the distances and intervals between the targets in the group approximating those which are within the airborne radar resolution, it is possible to determine the composition of the group target.

The lock-on of the assigned target of the group is possible if the target is displayed separately on the indicator screen and it is possible to gate it so that the selected target mark is located within the gates and the neighbouring marks are positioned beyond the gates. In this case, as a rule, use is made of manual gating of the target. The target selection with respect to the distance is effected in the following manner:

- when performing a rear-cone attack against the aircraft of the group target, which is the closest to the fighter, apply the gates to the selected target mark so that it is in the upper portion of the lock-on zone;

- when performing a rear-cone attack against the farthest aircraft of the group target, arrange the target mark in the lower portion of the lock-on zone;

- when delivering a forward-cone attack against the farthest aircraft of the group target, it is practically difficult to fulfil the mission at the first attempt. It is therefore recommended to attack the closest target. In this case, bring the lock-on zone gates to the selected mark from a shorter distance so that it is in the upper portion of the lock-on zone.

Should a group target be displayed on the indicator screen in the form of a single mark and the use of the heat direction finder having better resolution with regard to angles is impossible (forward-cone attack, light spots, failure of the heat direction finder, etc.), the gating and lock-on should be carried out in the same manner as in case of a single target. The selection of the target to be attacked will be hampered in this case. As a rule, the closest target lock-on and tracking occur. This is explained by the fact that the target search in distance is started by the airborne radar from a shorter range and proceeds to the longer one. When performing a rear-cone attack, the lock-on and tracking of the target which is the farthest with respect to the fighter can be effected by placing the FHS - LST - RHS selector switch to the RHS position.



With a single target out of the group steadily locked on and tracked, the further attack procedures are similar to those involved in delivering an attack against a single target.

Faster displacements of the beam and command marks and the skipping movements of the present distance mark are indicative of the fact that the airborne radar is tracking several targets at a time (power mid-point). Unsteady tracking of the target by the airborne radar results in unsteady tracking of the target by the homing heads of the missiles. While the beam mark is moving faster than before or the present distance mark is skipping, the LP lamp and 1, 2, 3, 4 lamps may flicker. It is expedient under such conditions to continue closing with the target without cancelling the lock-on mode.

As the distance to the group target becomes shorter, the resolution of the target is effected by the sight at shorter intervals. As a result, the radar may changeover to steady tracking of the single target.

The aircraft automatic control mode should be engaged in delivering an attack against a group target only upon ascertaining that the target tracking is effected steadily. In the event of unsteady target tracking the aircraft will experience rolling and pitching oscillation in synchronism with the oscillating command mark.

The missile launching variant should be selected proceeding from the actual tactical air situation. It should be taken into consideration that the infrared homing missiles ensure a higher hit probability as compared with the radar homing missiles.

If the combat formation of the group target makes it impossible to perform steady lock-on and tracking of a single aircraft, it is necessary to continue closing with the target until it is detected visually and deliver an attack in the " $\varphi_0$ " mode, with the sighting effected by means of the K-10T collimating sight.

The pilot will succeed in delivering an attack against a single aircraft selected out of the group target in the " $\varphi_0$ " mode provided the interval between the aircraft in the group is equal to or in excess of that at which the infrared homing heads are capable of resolving the target.

If enemy aircraft are performing flight in a close combat formation, that is at intervals shorter than those at which the infrared homing heads are capable of resolving the target,

sighting should be performed at one of the aircraft of the group and the missile should be launched as soon as the LP lamp and any of the missile indicating lamps light up. When approaching the group target, the infrared homing head selects a target which irradiates heat most intensively. The pilot in this case is incapable of predicting which aircraft of the group target will be hit. Nevertheless, it should be expected that after at least one aircraft has been hit, the enemy aircraft will be forced to assume a loose combat formation and start maneuvering, thus creating favourable conditions for the attacking fighters to individually select the target.

#### 2.11. Peculiarities of Aerial Combat Flight in Clouds

The peculiarities of aerial combat flight in clouds are conditioned by the necessity of continuously piloting the aircraft by referring to the instruments and by the adverse effect of clouds on the operation of the airborne radar.

When mastering the flying technique in clouds the pilot has to concentrate his attention on the flight and navigation instruments. In aerial combat flight, the pilot has, apart from what has been stated above, to operate the sight controls, attentively listen to or timely read off the direction commands, timely change the flight regime and carry out all operations with the armament controls system prescribed for a given stage of aerial combat in accordance with the readings of the instruments, the sight display, the commands received and the air situation. At the target search and detection stage, for instance, the indicator screen of the sight becomes the primary object of the pilot's attention.

Attempting to detect the target, the pilot should at the same time periodically check the aircraft attitude and the flight regime to be maintained. The electronic gyro horizon available on the screen makes it possible to evaluate the aircraft attitude. It is necessary, therefore, to periodically consult the readings presented by the flight director indicator and other flight and navigation instruments in order to determine more accurately the actual aircraft attitude.

In maneuvering, handle the aircraft with reference to the flight and navigation instruments, periodically transferring attention to the indicator screen of the sight.

The automatic flight control system is of great help to the pilot in performing aerial combat flight in clouds. The application of the automatic flight control system makes it possible to considerably reduce the scope of work to be done by the pilot. If the system is used, the pilot has only to check the flight regime. Besides, he has an opportunity to spare more time to watching the indicator screen.

During aerial combat flight in clouds the ground direction stage should be, as a rule, automatic, and the aircraft should be controlled either in the automatic or director mode.

In case the fighter is controlled by voice over the radio with the use of the airborne radar plan position indicator at the ground direction stage, it is expedient to use the aircraft attitude stabilization mode. This will contribute to mastering the aerial combat flights in clouds, especially at the initial stage of training.

The effect of the clouds on the operation of the airborne radar consists in absorption and reflection of the energy of the radio waves. The tendency of the clouds to absorb the energy of the radio waves emitted by the airborne radar results in attenuation of the return signal, thus causing decrease of the air target detection and lock-on distances. A certain portion of the energy of the radio waves reflected by the clouds is received by the airborne radar receiver and displayed on the sight indicator screen in the form of light spots which blur the target blip, thus impeding its detection, identification and lock-on.

Clouds of different levels and forms feature different radio contrast which depends on the moisture content, density of the clouds and the nature of the atmospheric processes which take place in them.

High-level clouds (cirrus, cirrostratus, cirrocumulus) feature low radio contrast, their moisture content and density are insignificant and optical visibility in these clouds is within 500 to 2000 m. Such clouds, therefore, commonly have no adverse effect on the operation of the airborne radar. The target blip during flight in such clouds is clearly visible and no light spots occur.

Medium-level clouds (altostratus and altocumulus) feature higher radio contrast and their moisture content is 10 to 15 times as high as that of the cirrus. These clouds possess higher density and visibility in them is within 100 to 300 m. Clouds of this type are capable of considerably interfering with

the operation of the airborne radar as compared with high-level clouds.

Dense low-level clouds (stratonimbus, fractostratus, stratus, stratocumulus) possess the highest radio contrast. These clouds have considerable moisture content and density. Visibility in these clouds does not exceed 15 to 30 m.

Dense low-level clouds have the greatest effect on the operation of the airborne radar as compared with the high- and medium-level clouds. When the target is attacked in clouds, lock-on and autotracking of the signals reflected from the clouds is possible.

Indications of false target lock-on are:

- disagreement of the launch actual maximum or minimum permissible distance with the estimated one;
- irregular displacement of the sighting ring or its obvious disagreement with the position of the target;
- change in mutual position of the  $D_{p. \max}$  and  $D_{p. \min}$  marks ( $D_{p. \max} < D_{p. \min}$ );

- slow displacement of the present distance mark towards greater values;

- rapid displacement of the present distance mark to zero;

- disagreement between the position of the beam mark (dot) and actual direction to the target.

Availability of any of the above indications means that the radar has locked on a false target.

If the pilot fails to identify lock-on of a false target in due time, it may result in an abortive attack.

In order to successfully perform a target attack in clouds, preparatory to the flight the pilot should study their nature and possible influence on the operation of the radar.

The most effective attack under the conditions of intensive atmospheric is a target attack with the use of the ground automatic control system, since the pilot can determine the approximate target distance with reference to the position of the distance mark delivered by the 5V15K-11 equipment, which simplifies its detection among the light spots caused by the clouds.

Under the conditions of intensive atmospheric, of great importance for performing an attack against air targets is selection of the radar operating mode. The radar operating mode is selected by changing the flight altitude of the fighter with respective setting of the  $\Delta H$  selector switch to the specified position.

Each operating mode of the radar corresponds to a definite nature of light spots on the indicator screen.

If the flight is performed under VFR conditions with the radar operating in the HMA mode, the indicator screen is practically free from false marks (light spots).

Observation of the target blip and its lock-on for auto-tracking involve no difficulties. In case of insignificant cloudiness, separate marks (light spots) appear on the indicator screen. They allow to correctly discriminate the target blip at a slightly reduced detection distance. In this case, it is expedient to lock on the target for autotracking with employment of gating in the angular position and distance.

Due to the effect of the ground return signal in the HMA- $\Delta$ H mode, displayed on the indicator screen are separate light spots of false marks appearing mainly at the distances exceeding the potential coverage of the radar.

Radiocontrast clouds in the radar scan area affect but little an increase in the number of the false marks but they may result in fading of the target blip on the indicator screen (blanking of the reception path. In this case, the indicator screen will be entirely blank).

Therefore, when the radar operates in the HMA- $\Delta$ H mode, real weather conditions should be determined visually rather than by referring to the light spots on the indicator screen.

In case it is impossible to perform an attack against an air target proceeding in radiocontrast clouds with the radar operating in the MLA, HMA and HMA- $\Delta$ H modes, the pilot should use the ATM mode.

The ATM mode ensures execution of both rear-cone and forward-cone attacks against air targets flying at altitudes above 2000 m at the same altitude with the fighter or flying higher than the fighter. The rear-cone attack is ensured if the target is proceeding at an altitude of not lower than 1000 m with a step-up vertical separation relative to the fighter.

High attacks may be recommended for practical employment only against targets proceeding at altitudes of 3000 m and higher at a step-down vertical separation of 1000 to 2000 m relative to the fighter.

In case of cumulus clouds pregnant with rain and snow, the indicator screen displays a great number of flare spots significantly impeding the target detection and lock-on. Under these conditions, engagement of the parametric amplifier does not result in a noticeable reduction of the number of these flare spots on the indicator screen.

In the ATM mode the capabilities of the sighting system in the target detection and lock-on are significantly less (1.5 to 2 times) and, hence, the complex capabilities are reduced due to decrease of the time available for the attack.

The operation of the airborne radar is greatly influenced by the mutual arrangement of the target and fighter relative to the clouds. When the target is proceeding in the clouds and the fighter is flying beneath the clouds, the intensity of the light spots on the indicator screen is maximum. After the fighter enters the clouds (with the target still proceeding therein), the intensity of the light spots will be reduced.

If possible, the direction of the attack should be selected so that thick cloud cells are located away from the scan area of the airborne radar.

After irradiation of the radar is enabled, estimate the intensity of the light spots and possibility of the target detection against the background of these light spots.

If the target proceeds in the clouds, the fighter should approach it in clouds as well. In this case, the intensity of the light spots on the indicator screen will be less than in case of the target approach beneath the clouds.

Since the possibility of a false target lock-on and relock-on in the radiocontrast clouds is high, it is expedient to change over to the director control mode if the aircraft has been controlled automatically prior to lock-on.

The pilot should bear in mind that the radar may not only lock on a false target, but relock on a false target in the process of autotracking of a true target. In this case, the pilot should change over to the aircraft director control mode (if the flight has been performed in the automatic control mode), reset the lock-on, close with the target to a shorter distance and then repeat the target gating and lock-on.

#### 2.12. Possible Errors Involved in Flight for Aerial Combat on Medium and High Altitudes

Depending on the stage of aerial combat the most typical pilot's errors are as follows.

A t t h e s t a g e o f l o n g - r a n g e  
d i r e c t i o n :

- late execution of the control post commands during instrument direction as a result of wrong distribution of the pilot's attention;

- failure to maintain the flight profile, which results in non-coordinated actions of the pilot and team of the control post and in errors in performing the attacks from the assigned line;

- late beginning of a turn, failure to maintain the rate of turn. These errors are most typical during instrument direction and, as a rule, result in failure of the instrument direction;

- failure to maintain the assigned closing speed. The closing speed is, as a rule, reduced, which results in a shorter permissible missile launch distance;

- disbelief of the pilot in the readings of the electronic gyro horizon. As a result, the pilot diverts attention from the combined indicator very often. This error is associated with inability of the pilot to jointly use the flight director indicator and electronic gyro horizon;

- wrong determination of the nature of the target maneuver. This error results in that the pilot inefficiently parries the target maneuver and loses it. While parrying the target maneuver, the pilot fails to check the position of his own aircraft. In this case, the pilot may create a roll exceeding the permissible value, lose the target and perform an abortive attack.

A t t h e h o m i n g s t a g e :

- attempts to lock on the target without observing the conditions required for the target lock-on by the SAPFIR-25 radar;

- unsighted launch of the missiles. This error most often occur at high closing speeds and short distances when the pilot lacks time for carrying out the sighting procedure;

- the firing button engaged to simulate the missile launch is depressed for a time less than required for lift-off of the guided missile, which results in failure to accomplish the mission;

- early or excessively energetic maneuver for break-away, i.e., shorter time for illumination of missile P-40PД after the firing button is depressed.

During aerial combat flight in clouds the pilot may make the following mistakes:

- the pilots are often late with execution of the commands, especially discrete and heading commands. To compensate for the time delay in execution of the heading commands, the pilot has to considerably increase the roll, which complicates piloting. The pilot should well remember that if he is late to turn following the course selector, he should not increase the roll in excess of  $45^{\circ}$ ;

- after the target is detected, the pilot diverts his attention from the gyro horizon; the aircraft may, therewith, attain a complicated attitude and the target will be lost;

- proceeding in the lock-on mode, the pilots fail to keep the sighting mark in the centre of cross-hairs, especially when the target is maneuvering, which may result in an abortive attack and loss of the target;.

- excessively energetic break-away procedure with increase of the roll in excess of the permissible value, as a result of which the aircraft may attain a complicated attitude.

### 3. PECULIARITIES OF PERFORMANCE OF AERIAL COMBAT FLIGHTS AT SUPERSONIC AIRSPEEDS AND MAXIMUM REFERENCE ALTITUDE

#### 3.1. General

Aerial combat at supersonic airspeeds and maximum reference altitude is characterized by the following peculiarities:

(a) high fighter-to-target closing airspeed during ground direction and performance of an attack, especially in a forward-cone attack;

(b) attainment of dynamic altitudes by the aircraft with a great step-up vertical separation of the target;

(c) deterioration of the aircraft maneuvering characteristics when flying in stratosphere;

(d) the pilot's constraint actions when flying in a high-altitude outfit.

In principle, the procedures of preparing the aircraft cabin for a high-altitude aerial combat flight are similar to those used in aerial combat flights at high and medium altitudes. In order to minimize the time required for manipulating the controls of the airborne radar and the armament system in flight, it would be wise to set certain selector switches to the required positions beforehand on the ground. For instance, the AH selector switch should be set to the position corresponding to the expected step-up (step-down) vertical separation of the target even if the airborne radar control is automatic. This precludes the excess operation in the event of change over to the manual control. The SERIES - SINGLE selector switch may be as well put to the required position on the ground in advance.

Climb to the reference altitude and acceleration to the respective airspeed are to be effected in accordance with the rehear or combination program.

If the flight is performed in accordance with the combination program, the missile lift-off altitude should be set on



the ground. The assigned Mach number only is to be set upon the "Reheat" command.

It is recommended that a reference altitude of 17,000 to 18,000 m should be attained during attacks of the targets flying at altitudes of 21,000 to 23,000 m. It is also recommended that flight at the maximum reference altitude should be performed only during attacks of the targets flying at altitudes of 25,000 to 27,000 m.

When flying at a reference altitude of 17,000 to 18,000 m at an airspeed of 2500 km/h, the fighter proves to have sufficient maneuverability and speed margin required for performance of a zoom (Fig. 160).

Apart from this, the acceleration characteristics at an altitude of 17,000 m are better than those shown at high altitudes.

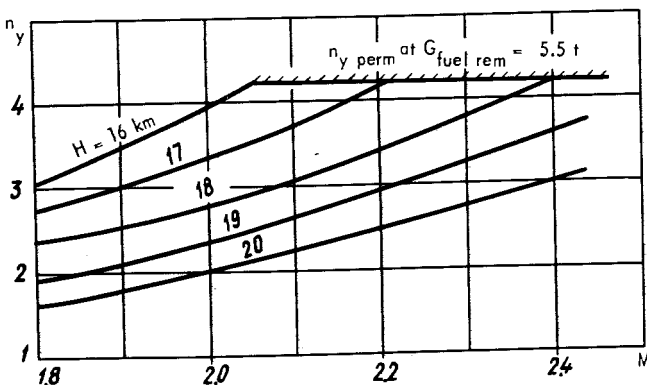

FIG. 160. MAXIMUM AVAILABLE G-LOAD VERSUS FLIGHT ALTITUDE AND AIRSPEED

During target attacks at supersonic airspeeds and maximum reference altitudes the advantages of the aircraft automatic control mode are most fully realized, especially when the programmed altitude and airspeed gain and descent modes are used. Therefore it is recommended that the pilot should conduct the entire flight in the automatic control mode even during direction by voice with the use of the plan position indicator. In the latter case, at the ground direction stage the preset course is to be selected with the aid of the knob located on the combined course indicator, with the P/SET COURSE AUTO - MAN selector switch set to the MAN position.

Upon attainment of the reference altitude and enabling the airborne radar irradiation mode the pilot should routinely carry out the target search, identification and lock-on operations.

The sequence of the pilot's actions in the forward-cone attack is similar to that in an attack at high and medium altitudes provided the target has been detected at a distance of 70 km and more.

If the target is proceeding at a step-up vertical separation of 3 km and more relative to the fighter, the "Preparatory zoom" command is generated.

In response, the aircraft will automatically (if flight is performed in the automatic control mode) or with the help of the pilot (if flight is performed in the director control mode) change over to climbing with a pitch angle of  $5^{\circ}$ .

If a sighting zoom only is performed upon completion of the target lock-on, while the preparatory zoom is not performed, the pilot may have no time to correct the sighting errors in elevation before entering the permissible launch zone. At the same time, the permissible sighting errors diminish as the distance decreases.

If necessary, the pilot may perform a preparatory zoom independently with greater pitch angles and g-loads. In this case, the vertical g-loads ensuring accurate sighting are determined by the required aircraft flight path angles in the vertical plane, which depend on the target step-up vertical separation relative to the fighter and target distance (Fig. 161).

The required vertical g-load will be minimum when performing a zoom without banking. A roll in excess of  $45^{\circ}$  created to correct the sighting errors in azimuth may result in deterioration of the conditions for elimination of elevation errors and additional deceleration of the aircraft due to spending of the vertical g-load for compensating for the roll.

The relationship between the amount of the vertical g-load and aircraft deceleration in zooms performed at reference altitudes of 17,000 to 19,000 m is shown in Figs 162, 163, 164.

When performing a zoom, particular attention must be given to checking of the flying speed. In order to preclude impermissible flying speed loss, the zoom should be performed with the engines operating at a FULL REHEAT power setting only. Should the flying speed of the aircraft in a zoom at a given climb angle be less than the permissible one realized in the maneuver computer, the "Limit pitch" command is generated. Upon this command

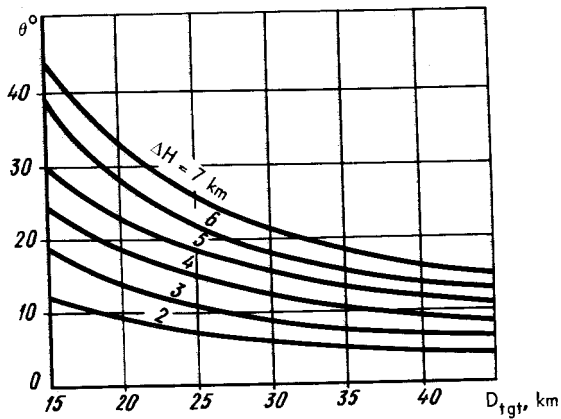

FIG. 161. ZOOM ANGLES  $\theta$  REQUIRED FOR MISSILE LAUNCHING WITH ZERO SIGHTING ERRORS IN VERTICAL PLANE VERSUS TARGET STEP-UP VERTICAL SEPARATION  $\Delta H$  AND TARGET DISTANCE  $D_{tgt}$

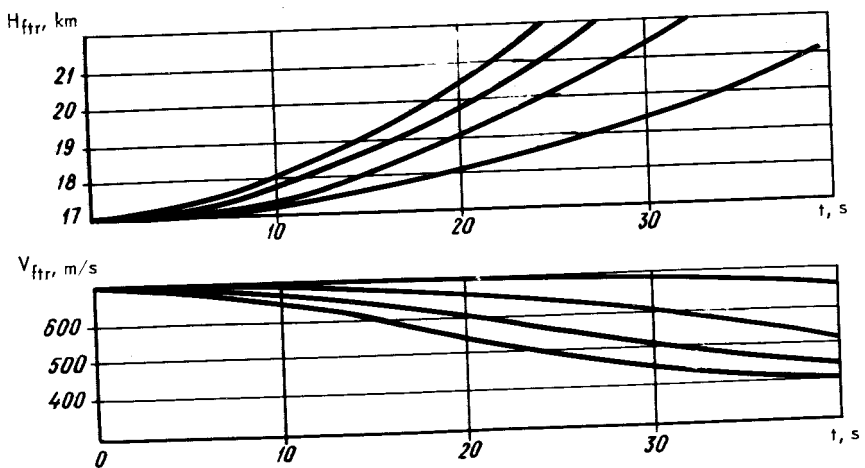

FIG. 162. VARIATION OF FIGHTER ALTITUDE AND AIRSPEED WHEN PERFORMING PREPARATORY ZOOM AT VARIOUS VERTICAL G-LOADS ( $H_{ref} = 17 \text{ km}$ ,  $M = 2.35$ ,  $G = 28.5 t$ ,  $\gamma = 0^\circ$ )

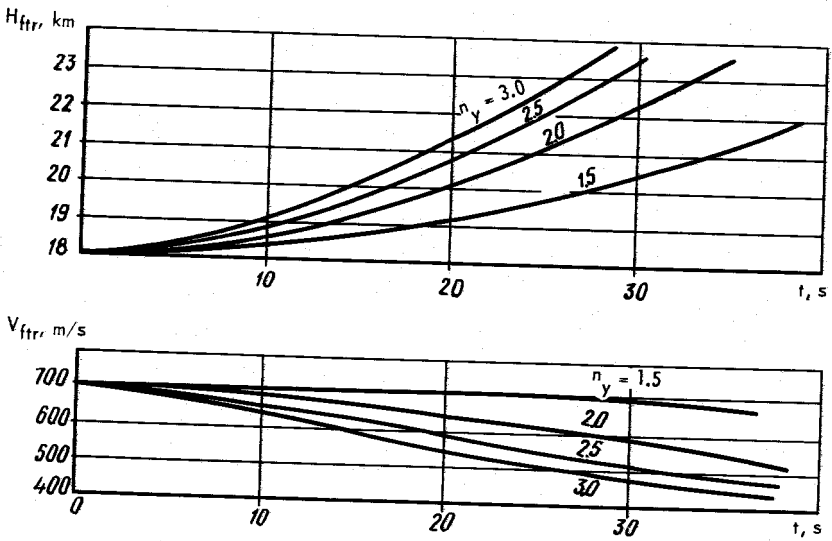

FIG. 163. VARIATION OF FIGHTER FLIGHT ALTITUDE AND AIRSPEED WHEN PERFORMING PREPARATORY ZOOM AT VARIOUS VERTICAL G-LOADS ( $H_{ref} = 18$  km,  $M = 2.35$ ,  $G = 28.5 t$ ,  $\gamma = 0^\circ$ )

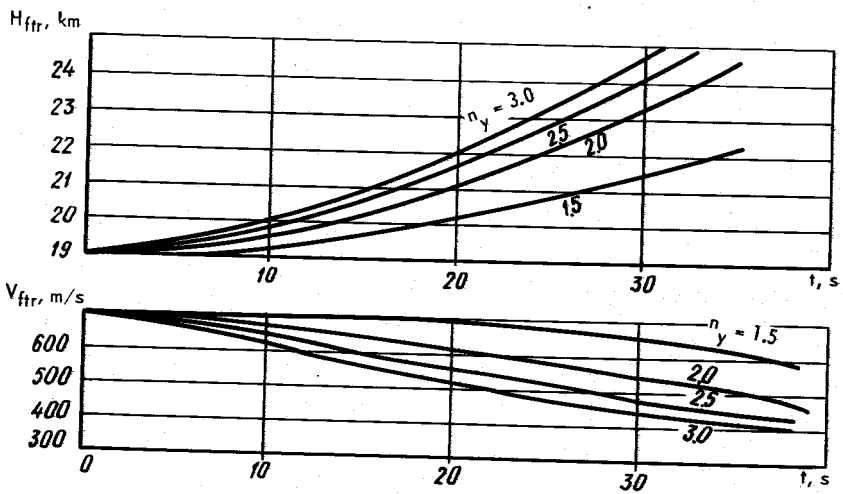

FIG. 164. VARIATION OF FIGHTER FLIGHT ALTITUDE AND AIRSPEED WHEN PERFORMING PREPARATORY ZOOM AT VARIOUS VERTICAL G-LOADS ( $H_{ref} = 19$  km,  $M = 2.35$ ,  $G = 28.5 t$ ,  $\gamma = 0^\circ$ )

the pilot should diminish the pitch angle to a safe value immediately.

If it is impossible to finish the attack due to gross sighting errors, it is necessary to turn away from the target at a roll of 50 to 60° or break away upon completion of two half-rolls.

The pilot should know that in case the indicated airspeed drops below 400 km/h, with the engines running at the reheat power, the engine surge may occur with subsequent shut-down of the engines. Disengagement of the afterburners at this airspeed prevents the engines from running at the non-designed power.

The target flying in the stratosphere should be locked on for autotracking with automatic gating.

In a forward-cone attack the missile launch should be simulated immediately after the target is locked on (the firing button may be depressed together with the LOCK-ON button). When simulating the missile launch, the airspeed, g-load and slipping conditions should be observed.

The pilot may use the heat direction finder in forward-cone attacks against high-speed targets in stratosphere. In this case, the detection distance of a MMR-25 type target amounts to not less than 70 km. However, to detect the target the pilot should maintain a step-down (step-up) vertical separation relative to the target (depending on the target distance) that does not exceed the values presented in Table 18.

### 3.2. Possible Errors Involved in Aerial Combat Flight in Stratosphere

The most typical errors involved in aerial combat in stratosphere are:

(a) in aerial combat performed by a single fighter:

- late engagement of the afterburner. As a consequence, the pilot cannot accelerate the aircraft to the required airspeed, which results in a greater distance of the fighter leading-out to the target and in a long pursuit of the target;
- failure to maintain the flight profile; as a result, the direction time is prolonged and the destruction line is shifted;
- late beginning of the turn, which results in a long pursuit of the target, since an increased g-load in the turn deteriorates the acceleration conditions;
- failure to maintain (reduction) of the assigned fighter-to-target closing speed; this mistake results in a reduction of

the missile launch permissible distance and in prolonged approach;

- failure to observe the missile launch conditions; this mistake is usually made by the pilot due to lack of time caused by the errors made at the direction, target closing and sighting stages;

(b) in aerial combat performed by a pair of fighters:

- the wingman fails to maintain this combat formation. Most often this mistake results in that the wingman lags behind and loses the leader. The error is made because the leader deprives the wingman of thrust reserve or because the wingman fails to timely notice the leader's maneuver;

- the wingman is late in launching missiles in a successive attack. This error may be caused by a high closing speed after the target is locked on, by a longer-than-required staying of the leader in the rear hemisphere of the target after the target is locked on, by a short distance between the aircraft in the process of the attack;

- after the target is locked on, the leader reduces the closing speed, trying to save more time for sighting; as a result, the distance between the fighters in the pair is reduced and, as a rule, the wingman has no time for performing an attack.

#### 4. PECULIARITIES INVOLVED IN LOW-ALTITUDE AERIAL COMBAT FLIGHT

##### 4.1. General

The major peculiarities involved in low-altitude aerial combat are as follows:

- sharp decrease in the target detection and lock-on distances (the detection distance does not exceed 27 km);

- maximum missile launch distances do not exceed 4 to 4.5 km owing to the limitations in the power/ballistic characteristics of the missile heads and lock-on distance. As a result, the time of presence of the fighter in the permissible missile launch area is considerably diminished;

- more stringent requirements to piloting the aircraft. Limitations imposed on the fighter maneuverability due to the ground collision hazard. Such a condition causes a drastic increase in the emotional stress imposed on the pilot;

- decreased capabilities of the target detection and control means. As a result, automatic direction of the fighter to the target is considerably impeded.

Direction of the fighter to a low-altitude target may be accomplished either with reference to the instruments or by voice with the use of the plan position indicator of the ground radar.

Flight to the target area should be performed at an altitude assigned from the control post (direction post). The altitude is selected in accordance with the assigned destruction line and target detection distance, i.e., flight to the target area may be performed at a cruising altitude. In this case, climb to the cruising altitude should be effected either in the automatic or director control mode in accordance with any of the three programs.

#### 4.2. Peculiarities Involved in Attacking Target against Terrain Background

For performing an attack against a target proceeding at a low altitude against the terrain background, use is made of the LA mode. The LA mode is enabled at altitudes less than 1500 m by setting the  $\Delta H$  selector switch to any of the lower positions. In this case, space will be scanned by the airborne radar within  $+30^\circ$  in azimuth and from  $-1.5$  to  $-7.5^\circ$  in elevation.

The elevation and azimuth scan area is uncontrollable. Apart from this, the scan area is limited in distance. The width of the area is 18 km. Change-over of the scan area from the range of 27 to 9 km to the range of 0.3 to 18 km (the dead zone is 300 m) and vice versa is effected when the distance mark supplied from the 5V15K-11 equipment (in the automatic direction mode) or the distance gate centre mark (in the manual mode) passes via the distance of less than 15 km. No targets are detected beyond the 18-km zone. To ensure steady detection of the target, the pilot should constantly align the centre of the search area with the target distance delivered from the control post.

In case spurious light spots do not allow the pilot to lock on the target, the pilot should change over to manual gating by turning the direction knob clockwise as far as it will go.

A design peculiarity of the moving target selection circuit employed in the LA mode is the dependence of the frequency of the target blip appearance on the indicator screen upon the target speed, and, more particularly, upon its radial component.

Depending on this speed, the target blip may appear in each scan cycle, once in two cycles, once in three cycles, etc., and may not appear on the indicator screen at all.

In this mode the fighter will attack the target at a step-up vertical separation relative to it. The optimum step-up vertical separation of the fighter relative to the target is 500 m. In this case, the pilot should avoid flying at an altitude close to the mode change-over altitude (i.e., about 1500 m) and bear in mind that the mode is enabled in response to the altitude signals supplied by the radio altimeter. It is especially important to remember this when flying over a heavily crossed country.

As a rule, the target is locked on steadily. Discontinuation of autotracking is practically improbable. If the radar locks on a false target, the pilot should immediately change over the radar to the scanning mode by depressing the STR REL (СЕР. МРК) button and repeat the target lock-on.

After the target is locked on, do not try to correct the sighting errors in altitude immediately. This maneuver should be carried out 1 to 1.5 km before the  $D_{p. max}$ . Otherwise, the fighter may get at the same altitude with the target if the target is proceeding at an altitude of 500 m and higher, or at the altitude of 500 m if the target is proceeding at an altitude below 500 m.

#### 4.3. Peculiarities Involved in Forward-Cone Attack at Lower Limit of Radar Operation

A low forward-cone attack ( $H_{ftr} = 700$  m) against a target proceeding at an altitude of 1500 m is characterized by a short detection distance (20 to 24 km). The detection distance greatly depends upon the fighter flying altitude and step-up vertical separation of the target relative to the fighter. The less the fighter flying altitude, the greater (as against the maximum distance) the illumination of the radar screen with ground clutter.

The less the step-up vertical separation of the target relative to the fighter, the less the distance at which the target gets into the radar detection area, since the radar detection area does not go below  $+1.5^\circ$  (with reference to the lower line).

The optimum conditions for the target detection at the maximum distance are the fighter altitude of 700 m with a step-down vertical separation of the fighter relative to the target amounting to 700 m.



When correcting the direction mistakes, the pilot should avoid roll angles of more than  $30^{\circ}$ , since otherwise it will result in significant illumination of the radar screen by ground clutter.

The fighter should be brought to the target at an aspect angle of  $0/4$  to  $1/4$  and a sighting angle of  $5$  to  $10^{\circ}$ . Short detection distances, low-altitude attacks, limited time for an attack call for particular attention on the part of the pilot in the aircraft handling and operations with the armament equipment. Besides, at these altitudes the automatic ground direction equipment may function unsteadily in most cases, which imposes additional difficulties upon operation of the combat control officer and pilot.

In order to ensure flight safety, prior to the flight it is necessary to select the "limit" altitude equal to 600 m and cut in the RECOVERY switch on the AFCS control panel when proceeding on the combat run. The piloting (sighting) errors should be corrected only in the horizontal plane while strictly maintaining the flight reference altitude.

As a rule, the target is locked on at the distance where the "Launch permitted" command is delivered.

On this occasion, the indicator screen will display the  $D_{p. \max 2}$  mark, and the present distance mark will be positioned above the  $D_{p. \max 2}$  mark.

Simulate the missile launch at the maximum distance without waiting for the present distance mark to get aligned with the  $D_{p. \max 2}$  mark.

After the missile launch is simulated, break away from the target following the "Break-away" command and ensuring illumination of the target.

#### 4.4. Attack of Air Target Proceeding against Terrain Background (LA radar mode)

The sequence and procedure for preparation of the cabin equipment before flight for attacking an air target proceeding against the terrain background (Fig. 165) are the same as in case of aerial combat flight at medium and high altitudes, except for the position of the  $\Delta H$  selector switch that should be set to any of the lower positions.

The pilot should select the "limit" altitude on the radio altimeter and the assigned altitude and airspeed on the altitude

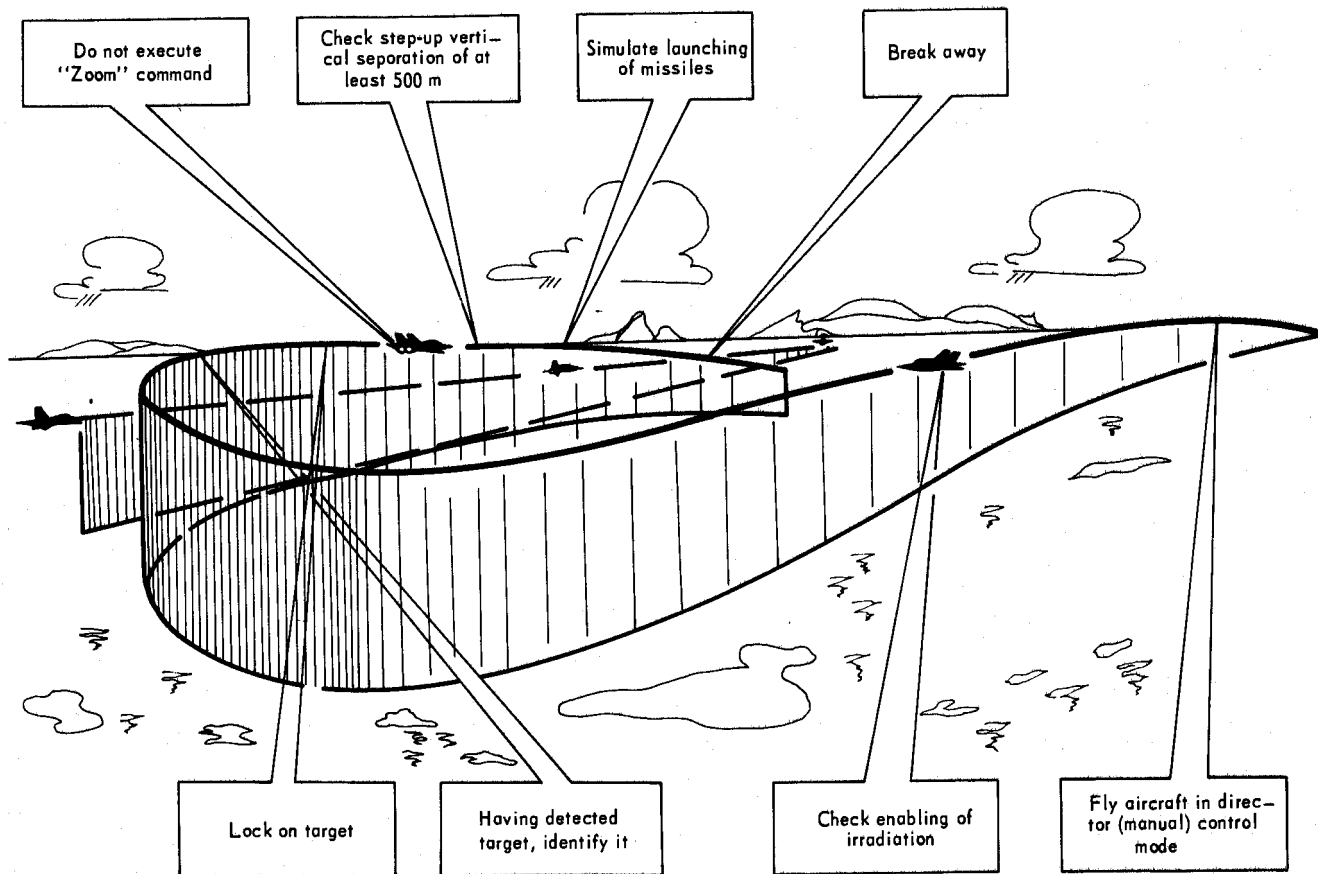

FIG. 165. PATTERN OF REAR-CONE ATTACK AGAINST TERRAIN BACKGROUND

and airspeed selector. He should turn on the RECOVERY switch on the AFCS control panel. The fighter can be directed to the target both with the help of the ground automatic control system and by voice with reference to the radar plan position indicator.

After the aircraft takes off and climbs to 300 m, depress the GUID light-button on the AFCS control panel and check the 5V15K-11 equipment for proper functioning by referring to periodic flickering of one of the <, I, >, CC lamps. Zero the command bars of the flight director indicator (bring them within the circle), relieve the control stick and pedals of forces by the trim mechanisms and enable the automatic control mode (if specified by the assignment).

At the stage of long-range direction up to the enabling of the autotracking mode the aircraft control may be automatic, director, or manual.

The radar irradiation gets automatically enabled in response to the "36" command if the aircraft is directed with the help of the ground automatic control system.

The pilot should check automatic enabling of irradiation by referring to appearance of indices 1, 2, 3, 4 on the radar indicator screen and illumination of the IRRAD lamp. If the aircraft is directed by voice without the use of the ground automatic control system, irradiation should be enabled by the command from the control post.

After irradiation is enabled, proceed to the target search. Having detected the target, the pilot should identify it. When the INTERROG button is depressed on the direction knob, an identification mark similar in shape to the target blip will appear above the target blip if the target is friendly.

After the target blip is observed in 2 or 3 scan cycles, lock it on. The target can be locked on if it is located within the lock-on zone in distance. In a rear-cone attack performed in the LA mode the target lock-on zone in distance amounts to 4.5 km. The centre of the target lock-on zone in distance is determined by the position of the distance mark of the 5V15K-11 equipment. In case no other targets are proceeding in the lock-on zone in distance within the azimuth search area, the pilot should depress the LOCK-ON button. The indicator screen will display two horizontal lines corresponding to the boundaries of the lock-on zone in distance and azimuth. The size of the lock-on zone in azimuth is equal to the size of the scan area in azimuth ( $\pm 30^\circ$ ). The antenna beam will go on moving along the

lines until it stops in the direction of the selected target. After that the target will be locked on in angular coordinates and then in distance. If the target does not get into the lock-on zone in distance or in case several targets are proceeding within the lock-on zone at different distances, the pilot should push down the direction knob prior to depressing the LOCK-ON button. In response, the ADI lamp will go out on the indicator screen and the screen will display horizontal lines (gates) similar to those appearing after the LOCK-ON button is depressed. The horizontal lines show the boundaries of the lock-on zone. In this case, the location of the lock-on zone is determined by the position of the direction knob and not by the position of the distance mark of the 5V15K-11 equipment. The pilot should move the direction knob either forward or backward to shift the gates in distance so that one selected target should be located between them, and depress the LOCK-ON button.

In case several targets are proceeding in the lock-on zone at the same distance but at different azimuth angles, the pilot, in order to select the target, should enable azimuth gating by turning the direction knob clockwise until a click is heard. In this case, the lock-on zone in azimuth diminishes to  $9^\circ$  (the lock-on zone in distance remains the same, i.e., 4.5 km), the gates become shorter on the indicator screen and get displaced to the right or to the left (with the help of the direction knob) within the search area in azimuth ( $\pm 30^\circ$ ).

Operating the direction knob, the pilot should superimpose the azimuth and distance gates onto the target and depress the LOCK-ON button. After the target is locked on in angular coordinates, the antenna beam stops its searching movement, and the radar starts autotracking the target in angular coordinates. Instead of the gates the indicator screen displays two dots at the azimuth of the locked-on target, the number of the line on which the target has been locked on, and index ↓ (down) indicating the position of the antenna beam relative to the horizon line.

In 1 to 2 s the target will be locked on in distance, and the radar will change over to the homing mode.

After the target is locked on for autotracking, the pilot should disable automatic control of the aircraft (if it has been enabled) and close with the target handling the aircraft in the director or manual control mode.

The indicator screen will display the following information:

- the distance scale of 30 km;

- the ATK (attack) index indicating enabling of the homing mode;
- the altitude scale of 0 to 1.5 km with the fighter present altitude mark;
- the electronic cross-hairs;
- the line of the electronic gyro horizon;
- the beam mark (shaped as a dot) showing the position of the target relative to the aircraft coordinates (azimuth and elevation of the target);
- the  $D_{p. \max}$  missile launch maximum permissible distance mark;
- the  $D_{p. \min}$  missile launch minimum permissible distance mark;
- the present distance mark;
- the command mark (small ring) duplicating the position of the command bars of the flight director indicator. If the DIRECTION mode is disabled on the AFCS control panel, instead of the command mark the indicator screen will display the sighting error mark (great ring) duplicating the deflection of the position bars of the flight director indicator.

The ring diameter corresponds to  $4^{\circ}$ . The maximum deflection of the great ring within the indicator scales in azimuth and elevation relative to the centre of the cross-hairs corresponds to  $24^{\circ}$ ;

- index ↓ (down).

The pilot should remember that when the INTERROG button is depressed on the direction unit the target autotracking at the homing stage will be cancelled if the target is friendly.

After the target is locked on for autotracking, the pilot should correct the sighting errors in the lateral channel maintaining the assigned step-up vertical separation of the fighter relative to the target.

The sighting errors are determined by referring to the deflection of the great ring from the centre of the cross-hairs and to the deflection of the position bars of the flight director indicator if the DIRECTION mode is disabled, or by referring only to the deflection of the position bars of the flight director indicator if the DIRECTION mode is enabled.

After the "Zoom" command is generated, check once again, that the assigned step-up vertical separation of the fighter relative to the target is maintained. Simulate the missile launch after one of the 1, 2, 3, 4 lamps and LP index are illu-

minated. Break away in response to the "Break-away" command having ensured the illumination of the radar homing missiles.

If another attack is not planned, switch off the radar and the armament system.

#### 4.5. Aerial Combat Performed by Pair of Fighters with Forward-Cone Attack of Target Proceeding against Terrain Background (Fig. 166)

To perform a forward-cone attack of a low-altitude target proceeding against the terrain background, it is expedient to use the SAPPFIR-25 radar in the LA mode.

The LA mode is enabled automatically when the fighter is proceeding at an altitude less than 1500 m and the  $\Delta H$  selector switch is set to any of the lower positions.

In the scanning mode the antenna scans the space line by line with a narrow beam ( $1.5^\circ$ ) in the area of  $+30^\circ$  in azimuth and from  $-1.5^\circ$  to  $-7.5^\circ$  in elevation. The scan area is not controlled in azimuth and inclination. The index of the distance scale is 30. The position of the upper line of the search area is fixed and equal to  $-1.5^\circ$  (with reference to the beam) relative to the horizon. The radar circuit provides for revealing the target "blind" airspeeds. However, their influence is not entirely eliminated.

The "blind" airspeed is a target airspeed at which the target cannot be detected due to peculiarities of the radar operation in the LA mode. As a result, the target blip occasionally appears on the indicator screen. Depending on the target airspeed and aspect angle of the attack, the target blip may appear on the radar indicator screen in each scan cycle, once in two cycles, once in three cycles, etc., and may not appear on the indicator screen at all.

The main criterion in performing a forward-cone attack of a target proceeding against the terrain background (after the fighter has been directed to the target) is the time for handling the SAPPFIR-25 equipment at short detection distances.

In order to determine the minimum time required for the attack, it is necessary to logically trace the events happening from the moment of enabling the radar irradiation to simulation of the missile launch:

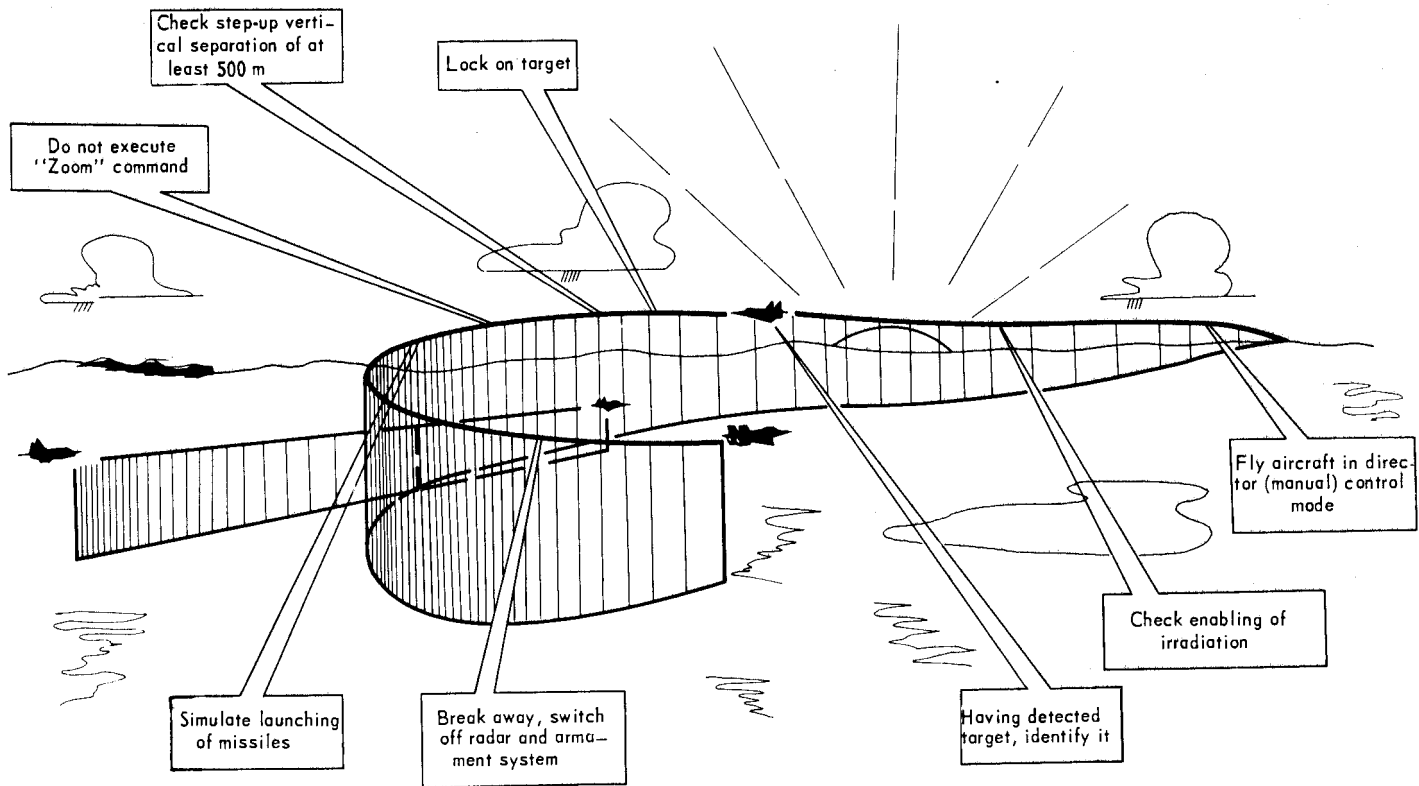

FIG. 166. PATTERN OF FORWARD-CONE ATTACK IN LA MODE

1st scan cycle :

- first appearance of the target blip;
- target identification.

2nd scan cycle :

- second appearance of the target blip (either with or without the "Friend" mark);
- target detection and identification by the pilot;
- target gating;
- enabling of lock-on permission.

3d scan cycle :

- third appearance of the target blip;
- operation of the lock-on units.

In the worst case, when the target gets into the scan area at the end of the cycle, the lock-on units will start operating at the end of the 3d scan cycle. The duration of one scan cycle is 3.5 s.

So, the time required for the target detection is equal to 10.5 s, or 14 s with account of manual gating.

The time expired from lock-on permission till complete lock-on of the target is equal to 6 s.

Thus, the time for performing the attack is equal to:

$$t_{\text{atk}} = t_{\text{det}} + t_{1/o} + t_{\text{fb}} + t_{\text{illum}} = 10.5 + 6 + 1.5 + 17 = 35 \text{ s,}$$

where  $t_{\text{det}}$  is the time required for the target detection;  
 $t_{1/o}$  is the time expired from the moment the LOCK-ON button is depressed up to the moment the target is completely locked on by the radar;  
 $t_{\text{fb}}$  is the time spent for depressing the firing button;  
 $t_{\text{illum}}$  is the time for the target illumination after launching the radar homing missiles.

The greatest probability of hitting the target is attained in a forward-cone attack when the missiles are launched from the outer boundary of the permissible launch area.

If the missiles are launched from the distance of 15 km, the time for the target illumination is 17 s. During this time the fighters will approach the target to a distance of 6.5 km.

Direction of the fighters for the target attack with the target sighting angle of about 5 to 10° and smooth break-away with climbing immediately after the missile launch is simulated ensure a safe attack.



When the closing speed is less than 500 m/s, the time available for the attack is increased.

The sequence and procedure of preparation of the cabin equipment before aerial combat flight with a forward-cone attack of an air target proceeding against the terrain background are the same as before aerial combat flight with a rear-cone attack of a low-altitude target proceeding against the terrain background.

The limit altitude of 1000 m should be selected on the radio altimeter and the RECOVERY switch on the AFCS control panel should be turned on.

Take off in pair. The pair should proceed in the echelon formation with the wingman-to-leader sighting angle of 20 to 30°, distance of 200 to 300 m and step-down vertical separation of the wingman relative to the leader amounting to 20 to 30 m.

To perform training flights, the optimum parameters of the target flight are:

- true airspeed - 900 km/h;
- flight altitude - 500 m over the relief.

The optimum parameters of the fighter flight are:

- true airspeed - 900 km/h;
- flight altitude - 1200 m over the relief.

Having taken off and climbed to an altitude of 1500 m, the leader should depress the GUID light-button on the AFCS control panel and check the 5V15K-11 equipment for proper functioning by periodic flickering of one of the <, |, >, CC lamps.

If the start signals are not delivered, perform the flight in the manual control mode.

The wingman should control the aircraft in the manual mode, maintaining the assigned combat formation.

Following the command from the control post (direction post), descend to an altitude of 1200 m. Upon interception of the combat run, the wingman should execute the leader's command and occupy the line-abreast combat formation at the wingman-to-leader sighting angle of 70°, distance of 200 to 300 m and step-down vertical separation of the wingman relative to the leader amounting to 20 to 30 m.

When the target distance is 30 km, the leader should check enabling of irradiation by referring to appearance of indices 1, 2, 3, 4 and ↓ on the indicator screen. The wingman should enable irradiation manually in response to the command of the leader.

Movement of the distance mark of the 5V15K-11 equipment towards a shorter distance and illumination of the ADI lamp testify to the delivery of the distance direction command.

If irradiation has failed to get enabled automatically, the leader should enable it manually by setting the IRRAD - DUMMY - OFF selector switch to the IRRAD position.

When the radar changes over to the scanning mode, keep the small ring in the centre of the electronic cross-hairs. Turn on the MASTER ON switch. Constantly check the flight altitude.

The wingman should search for the target, strictly maintaining his combat formation.

If the target is steadily detected, identify and lock it on. If the distance mark of the 5V15K-11 equipment does not correspond to the real distance and the target blip is positioned beyond the gates when the LOCK-ON button is depressed, change over to manual gating of the target by pushing down the direction knob.

After the target is steadily locked on, the leader should strictly maintain the reference altitude of 1200 m, correcting the errors in the horizontal plane only.

The wingman should not perform corrective turns in the direction of the sighting ring, but handle the aircraft strictly maintaining the line-abreast combat formation.

When one of indices 1, 2, 3, 4 and index LP are illuminated, report the launch readiness to the leader. In response to the leader's command simulate a simultaneous missile launch from the maximum distance. After the firing button is depressed, the pair of the fighters should break away in a safe direction with a roll of  $45^{\circ}$  if the missile launch is simulated from the distance of more than 10 km, and  $60^{\circ}$  if the missile launch is simulated from the distance of 10 km or less.

In case another attack is not planned after the break-away, switch off the radar and the armament system.

## Chapter 4

# PECULIARITIES OF DIRECTION OF FIGHTERS MиГ-25ПД TO AIR TARGETS UNDER VARIOUS SITUATION CONDITIONS

### 1. FIGHTER DIRECTION FOR PERFORMING ATTACKS AT MEDIUM AND HIGH ALTITUDES

#### 1.1. Fighter Direction to Air Targets for Rear-Cone Attack

The main method of the MиГ-25ПД fighter direction to air targets is direction with employment of ground-based automatic control systems and transmission of the direction commands over the automatic radio link. The method of direction with transmission of the commands in the form of voice radio messages is used under heavy jamming conditions at the frequency of the automatic radio link or in case of automatic flight control system failure.

From the technique viewpoint, direction of the MиГ-25ПД fighter to an air target at medium and high altitudes is the most simple method because it is performed, as a rule, at cold-thrust power and is not associated with altitude and speed maneuvers. In this case, the afterburner is engaged, as a rule, at the final stage of the direction. Hence, the direction by means of ground-based automatic control systems requires definite conditions which ensure implementation of the task by the "maneuver" method.

One of the above-mentioned conditions is the minimum initial distance between the fighter and target in kilometers, which may be calculated from the following formula:

$$D_{\text{init. min}} = S_{\text{stage 1}} + V_{\text{tgt}} (t_{\text{stage 1}} + t_{\text{turn}}),$$

where  $S_{\text{stage 1}}$  is a fighter path at the first stage of direction (2 to 3 min of flight);  $t_{\text{stage 1}}$  is a fighter flying time at the first stage of direction;  $t_{\text{turn}}$  is a fighter turn time.

During direction, the combat control officer should determine the following components: turn initial point, fighter course to this point, moment of delivery of a command to cut in irradiation, fighter airspeed and altitude.

The turn initial point distance to direct the fighter for carrying out the rear-cone attack is calculated from the following formula:

$$D_{\text{turn}} = V_{\text{tgt}} t_{\text{turn}} - D_{\text{lead}} - R_{\text{mean}} \sin \text{TURN},$$

where  $R_{\text{mean}}$  is a mean value of turn radius;  
 $t_{\text{turn}}$  is time of turn to a preset angle.

As the fighter approaches the turn initial point the pilot receives a command to make a turn and information regarding the course of exit from the turn.

At the second stage of direction, the combat control officer makes sure that the pilot is careful to maintain the precise parameters of the assigned turn path and, if required, delivers a command to the pilot to increase or decrease the roll within the tolerable limits.

After the fighter is brought to the rear hemisphere of the target, the direction task is implemented by the "interception" method. To gain necessary closing speed with the target during its attack, it is recommended to engage afterburner. While closing with the target, the combat control officer informs the pilot on the exact target position relative to the fighter and after the pilot reports on target lockon by the airborne radar, the combat control officer checks the process of fighter closing with the target for launching the missiles.

After the attack is executed, the pilot receives a command to break away to the safe side, to engage afterburner (if the latter has been engaged), replies the request for remaining fuel and the fighter is directed to the home airfield.

#### 1.2. Fighter Direction to Air Targets for Forward-Cone Attack

The forward-cone attack has a number of advantages comparing with the rear-cone one. They include the following:

- possibility to destroy the targets on farer lines with the same fuel load;
- possibility to destroy the targets flying at the speeds higher than that of the fighter;
- surprise of the attack;
- insignificant effect of the target speed maneuver on the target destruction line.

Hence, the forward-cone attack has certain limitations. They include:

- limited time for accomplishment of attack due to its fluidity;
- limited possibility and sometimes impossibility to correct the mistakes of direction.

Increase of destruction line distances during the forward-cone attack results in increase of exact radar data distance which is beyond the possibility of the direction radars at present. Therefore, to materialize the maximum fuel reserve destruction lines during the fighter direction to the front hemisphere, it is necessary to make use of the secondary information from remote radars with transition to the primary information received from local radars at the final stage of direction. In case of absence of the secondary information from the remote radars, it is required to transfer fighter control to a cooperating control (direction) post.

The direction initial parameters are estimated in the sequence similar to that during the target rear-cone attack.

The procedures of the fighter direction in the front hemisphere has some peculiarities which impose additional requirements on the training of the control (direction) post teams.

Owing to fluidity of the attack, the pilot sometimes has no possibility of correct the errors of azimuth direction after the target is located and locked on by the airborne radar. Therefore, success of the attack accomplishment depends mostly upon accuracy of ground-based direction. Owing to this fact, the combat control officer should perform direction with the lowest possible errors in azimuth.

The combat control officer should correct the vectoring errors in azimuth at a minimum target distance of 40 km. While correcting the vectoring errors, he should take the target movement into consideration and transmit commands to turn the fighter not to the target but to the lead point where the target

is supposed to be at the moment of missile launch by the fighter.

In the course of the fighter further closing with the target to accomplish the attack, the combat control officer supervises the pilot's activity to prevent dangerous closure during the fighter breakaway.

### 1.3. Fighter Direction to Air Targets for Attacks at High Aspect Angles

Aircraft direction for attack at a high aspect angle (3/4 to 4/4) is the most complicated type of direction. Complication of the direction lies in the fact that the leading of the fighter out onto the target and attack of the target should be performed at one and the same assigned aspect angle.

Direction at the assigned high aspect angle may be performed to a non-maneuvering target only.

In this case, the basic method of direction is "maneuver". Hence, if the target position relative to the fighter ensures the assigned attack aspect angle, the fighter may be directed by the "interception" method. When directing the fighter by the "maneuver" method the initial direction parameters are calculated in the ordinary way.

The navigational computation procedures for interception of air targets and for direction at high aspect angles with employment of the ground flight control system and plan position indicator are similar to those applicable to direction at low aspect angles.

The peculiarity of the fighter direction at the third stage in this case is a necessity of the fighter flight trajectory correction intended to direct the fighter to a lead point in order to intercept the medium missile launching distance making allowance for the assigned lead.

The most important stage of direction is the final one, when the pilot having locked on the target turns the fighter to it on commands of the airborne radar. It should be kept in mind that at the homing stage before the fighter attains the estimated launching distance, the computer of the airborne radar will generate successively various positions of the missile-and-target collision lead point, thus, the trajectory of flight in accordance with these data will be curved till the fighter approaches the rear hemisphere of the target and intersects its flight trajectory.

To avoid such a maneuver, which may result in fighter abandoning the possible attack area, the pilot after target lockon should not transfer to homing but go on executing the commands of the ground-based direction till the zoom is started. In this case, by the moment the fighter approaches the estimated launching distance the target is found on the interception line at the assigned aspect angle.

The length of the straight closing line ( $\ell_0$ ) should ensure correction of vectoring errors, detection, lockon and sighting. The length of the straight closing line is calculated from the formula:

$$\ell_0 = D_{\text{lch mean}} + t_{\text{close}} V_{\text{ftr}}$$

where  $D_{\text{lch mean}}$  is the mean missile launching distance equal to  $\frac{D_{\text{lch min}} + D_{\text{lch max}}}{2}$ ,

$t_{\text{close}}$  is the time required for correction of vectoring errors, detection, lockon and sighting;

$V_{\text{ftr}}$  is the fighter airspeed.

If at the third stage the fighter closes the target at the maneuvering altitude, it is recommended to select the closing time ( $t_{\text{close}}$ ) equal to 1.5 to 2 min.

If by the third stage of direction the fighter flies still lower than the maneuvering altitude, the closing time should be increased by the time required for climbing to the maneuvering altitude.

In case of unsteady computation of the direction problem, the combat control officer should change parameters  $\ell_0$  and R and sometimes the turn direction to obtain normal computation.

When following-up the direction commands at the assigned aspect angle with employment of the plan position indicator and voice radio communication, special transparencies should be used.

At the third stage of the direction, the combat control officer should inform the pilot about the attack aspect angle, target position relative to the fighter and target flight direction. If required, the combat control officer should command the pilot to shift the airborne radar scanning area to the respective side.

At the closing stage, the fighter-to-target airspeed ratio should be:

- in the forward-cone attack: 0.8, minimum, at aspect angles up to  $45^\circ$ ; 1.0, minimum, at aspect angles from  $45$  to  $60^\circ$ , and 1.2, minimum, at aspect angles from  $60$  to  $90^\circ$ ;

- in the rear-cone attack: 1.2, minimum, at any aspect angles.

In case of favourable distance to the assigned line, ground radar coverage, tactical situation, target airspeed and altitude, time available for detection and sighting, the fighter should gain the maximum possible speed relative to that of the target. This ensures more favourable conditions for the fighter to enter the possible attack and missile launching area. When the fighter enters the possible attack area for launching the missiles at high aspect angle, its flight along the flight trajectory may take place at small-curve radius accompanied by the speed loss during sighting. Owing to this, by the moment of missile launch the fighter may prove to be at the low aspect angle relative to the target rear hemisphere and its flight speed may become lower than the target one. It should be also kept in mind, that the fighter speed loss may occur while performing the sighting zoom too. Due to this, prior to performing the attack, the fighter should fly with the least possible stepped-down vertical separation relative to the target and the fighter-to-target airspeed ratio should be maximum.

When the target is attacked at the altitudes close to the non-reheat fighter ceiling with a stepped-down vertical separation of more than 1000 m relative to the target and at a flight speed close to the maximum under the given flight conditions the combat control officer should issue a command the pilot to engage the afterburner 10 to 15 s before the sighting zoom.

#### 1.4. Fighter Direction to Air Targets for Attacks with Maximum Stepped-Up (Stepped-Down) Vertical Separation

The procedures of navigational computations for interception of the air targets and for the fighter direction for attacking the targets with maximum stepped-up (stepped-down) vertical separation by the aid of the ground flight control system and plan position indicator are similar to those applicable to the fighter direction with an optimum stepped-up (stepped-down) vertical separation.

The main peculiarity of the fighter direction for attacking the air targets with maximum stepped-up (stepped-down) vertical separation is a necessity of accurate calculation of the



zoom command distance by the combat control officer and delivery of this command to the pilot for execution of a zoom. At the same time, the fighter pilot should be provided with true information covering the spatial position of the target relative to the fighter (azimuth, distance, altitude). In the progress of the zoom, the combat control officer must check the altitude of the fighter and necessity of decrease of altitude difference between the fighter and target less than the safe one.

When the fighter is directed to the target forward hemisphere, the zoom command should be always delivered by the combat control officer.

#### 1.5. Fighter Direction for Forward-Cone Attack of Maneuvering Target

When the fighter is directed to a maneuvering target, actions of the combat control officer depend upon a type of maneuver, stage of direction and hemisphere of the attack. It should be considered, that the direction to the maneuvering target is rather complicated. As it is impossible to predict the beginning and type of the maneuver, therefore the combat control officer should constantly check the target flight trajectory after each sweep passage and obtain constant information about the target altitude. Change of the target flight direction can be noted by the combat control officer in 20 to 30 s, whereas change of the target air speed can be noted much later depending upon the target acceleration rate. The operator of the radio altimeter can note the altitude change of 300 to 500 m. To direct the fighter to a maneuvering target, the combat control officer should exactly know the target maneuvering capabilities and capabilities of the armament system of the МиГ-25ПД fighter. Besides, he should be able to determine quickly the trajectory of flight, which ensures the fighter direction to the possible attack area.

In the course of direction for forward-cone attack, the most dangerous maneuver of the target is an evasive maneuver which results in increase of the attack aspect angle. In this case, the combat control officer should be able to determine quickly a possibility to direct the fighter onto the target flight path or direct the fighter at the maximum possible aspect angle. When the plan position indicator is used in direction, it may be carried out by means of a transparency; when the

ground flight control system is used in direction, the combat control officer sets new values of the target course and speed, minimum value of  $\ell_0$  and increases the aspect angle up to the maximum value. If the combat control officer sees that the fighter has no time to enter the possible attack area, he takes a decision to direct the fighter for rear-cone attack, if the target air speed provides for attack from this direction.

In case of the target speed and altitude maneuvers, the combat control officer changes the fighter flight trajectory and, if necessary, the flight conditions in accordance with the situation.

Since it is difficult for the combat control officer to determine the target speed maneuver especially during simultaneous direction of two and more fighters, it is necessary to issue a command to the pilot to accelerate the engines to the maximum for the selected altitude either at maximum or reheat power setting after the fighter is led into the target rear hemisphere. The high closing speed does not hamper the attack accomplishment considerably and the speed may be reduced by the pilot quickly, if required.

In the course of the fighter further closing to the target, the combat control officer informs the pilot about position of the target relative to the fighter, supervises operations of the pilot and prevents dangerous closing during the fighter breakaway.

#### 1.6. Direction of Pair of Fighters for Forward-Cone Attack with Subsequent Entry into Rear Hemisphere

The given type of direction is mainly characterized by the fact that during preflight preparation the combat control officer should discuss together with the pilots possible versions of maneuver to enter the target rear hemisphere, procedures of actions during these versions of maneuvers, estimate the distance of the maneuver commencement command delivery for performing various versions of maneuvers. The main versions of the maneuver are shown in Figs 157 and 158.

The navigational computations and direction procedure applicable to accomplishment of forward-cone attack with subsequent entry into the rear hemisphere are similar to those for the forward-cone and rear-cone attacks of the air targets.

After takeoff of the fighters, the combat control officer directs them into the forward hemisphere of the air target in the ordinary way. The fighters fly in the two-aircraft formation. In the course of approach to the target, the combat control officer should inform the pilots about the target distance, its azimuth and angular attitude relative to the fighters and about its altitude. Having detected and locked on the target, the pilots attack it and in response to the "Breakaway" command ( $R_{\text{ftr/tgt}} = 8$  to  $7$  km), perform the maneuvers to enter the target rear hemisphere independently (Figs 157 and 158).

In the first and second versions, the fighters perform the maneuver to enter the target rear hemisphere in two-aircraft formation without break-up at the selected maneuvering altitude. In the third version, to enter the target rear hemisphere, the leader performs the left maneuver at his altitude (the wingman flies to the right of the leader); after 10 s, the wingman performs the right maneuver with climb up to an altitude 1000 m above the target. The combat control officer should supervise performance of the maneuver, altitude of the fighters and target and prevent the decreasing of the altitude difference to less than 1000 m. After the fighters performed a maneuver to enter the target rear hemisphere, the combat control officer should inform the pilots about the position of the target relative to the fighters and about the target altitude.

In the third version of the maneuver accomplishment for entry into the target rear hemisphere, the leader is the first to attack from below, and the wingman performs overhead attack of the target after the leader breaks away. After the target is attacked in the rear hemisphere both by the leader and wingman, the combat control officer should bring the wingman to the leader with a vertical separation of 500 m and having evaluated the remaining fuel, repeat the direction or lead the fighters to the home airfield.

If the leader and wingman have not detected the target at a distance up to 12 km in the forward-cone attack, the combat control officer should issue a command to the pilots to perform the maneuver to enter the target rear hemisphere at a target distance of 9 to 8 km.

If the pilots have not detected the target at a distance of 5 km and have not locked it on at a distance of 3 km in the rear-cone attack, the combat control officer should issue a com-

mand for breakaway. If the cause of the attack failure is not clear, the combat control officer should not direct the fighters to the target repeatedly.

#### 1.7. Direction of Fighters for Performing Attack Against Group Air Target

Formation combat fought by the fighters with enemy aircraft is controlled from the ground and from the air by the group leaders. In this case, in visual contact with the enemy and friendly aircraft, the group is controlled by the group leader, and out of visual contact the group is controlled by the combat control officer on the basis of the commander's concept.

Positive and active actions in control of the air combat ensure a considerable influence upon the combat outcome.

The aims of the air combat control from the control post are as follows:

- direction of the fighters to an initial position tactically advantageous for attack;
- provision of the group leader with continuous information on the air situation in the combat area and its changes;
- provision of the fighters with information on the actions of the air enemy in the combat area and delivery of commands for execution of an advisable maneuver in view of occupying a tactically advantageous position or withdrawal from under a strike;
- continuous supervision of the friendly fighter's actions and rendering help to them in restoring of the combat formation.

The combat control officer should detach a ground radar and a radar altimeter having the best resolution power.

In the course of air combat the combat control officer should permanently know arrangement of the friendly and enemy aircraft and their attitude in space. If the air combat is conducted at low altitudes, the group leader and the combat control officer should account for constant danger of a surprise enemy attack.

In order to preclude a possibility of a secret build-up of the enemy efforts, it is necessary to make use of the information rendered by the warning network and remote radar posts, as well as to forecast the enemy flight route in case information on the enemy is no longer supplied.

The combat control officer should lead out the fighters onto a group target with account for its combat formation. The enemy combat formation can be composed of several tactical groups, i.e. covering groups, air defence neutralization groups, striking groups, etc. The covering groups have the best maneuvering characteristics. The maneuvering capabilities of the air defence neutralization groups and striking groups carrying normal or increased warload are slightly limited until the warload is released.

The main task in combat activities against a group air target is destruction of the striking group aircraft or forcing them to drop the warload prematurely.

This task can be executed through a high speed and surprise gained in the first attack. Depending on the combat formation of the enemy, the fighters should be directed onto the strike group from the side free from the covering group fighters. If possible, this attack is performed at low altitudes with a subsequent gaining of altitude in the process of attack. The breakaway procedure should be accomplished at the airspeed close to the maximum one and performed with a turn towards a direction that is safe for the fighters from getting into the area of possible attacks launched by the fighters of the striking and covering groups of the enemy.

The combat control officer should specify the tactically advantageous direction and altitude for breakaway. If the tactical situation does not allow to launch a surprise attack, a part of the fighters should be directed to the covering group and the main force should be directed to the striking group. The covering and the striking groups should be attacked simultaneously. In this case, the attack launched against the fighters of the covering group will distract them from accomplishment of their primary task.

Defensive maneuvers should be also used to in an air combat.

If the situation permits, the commands should be issued to the pilot to break away in the direction of the Sun, Moon, Earth, in the clouds, or in the direction of other sources of clutter impeding detection of the fighter, missile launch and their homing.

After the fighter has broken off from the attack, the combat control officer should ensure its safety from the enemy surprise attack until the fighter lands on the friendly airfield.

### 1.8. Direction of Fighters for Performing Attacks with Visual Aiming

The main version of employment of the armament system of the ММГ-25ПД fighter is accomplished in attacks with the aid of the airborne radar operating in the autotracking mode and in launching of missiles, as a rule, out of visual contact with the target. However, on some occasions, this version may turn to be of low efficiency.

The effect of interference upon the airborne radar results in deterioration of the target tracking characteristics and even in tracking failure. Apart from it, employment of the airborne radar unmasks the fighter. When the fighter airborne radar is switched on for emission, the enemy, making use of the radar threat warning equipment, can timely resort to a defensive maneuver or electronic countermeasures that results in a lower efficiency of the attack.

A failure of the airborne radar in flight also involves impossibility of using the main employment version of the armament system.

On some occasions, for example, when performing an attack against a group target, destruction of one target (selected from the group) with the help of the heat direction finder is difficult and is possible only with the infrared homing missiles launched at visual aiming, i.e. in the " $\psi_0$ " mode.

An attack by the ММГ-25ПД fighter in the " $\psi_0$ " mode can be performed only by the infrared homing missiles under conditions of visual contact with the target and in the rear hemisphere.

If it is impossible to use the airborne technical means for search of an air target, the pilot should take measures for visual detection of the target.

Efficiency of the visual search depends upon the following:

- illumination conditions (position of the Sun);
- visibility conditions (condition of the atmosphere);
- size and colour of the target;
- condition of the terrain surface on the background of which the target is searched visually;
- target position relative to the fighter (distance, altitude difference, interval);
- pilot's outfit and equipment.

Unfavourable conditions for visual target search correspond to the time when the Sun is near the horizon. It is difficult

to detect the target when the visibility is less than 5 km. Small-size targets (if the size of the wing and fuselage is less than 10 m) can be detected at  $D \leq 5$  km even if the visibility is good.

It is better to search the target on a contrast background, against clouds and sky illuminated with the setting or rising Sun, and on the background of the terrain coloured other than the target. It is difficult to be circumspect and conduct target search in the pressure helmet.

To create necessary conditions for the pilot in conduct of visual search, the combat control officer should:

1. Estimate the air situation, illumination intensity, position of the Sun, conditions of visibility, and direct the fighter to the initial position relative to the target with the optimum spatial parameters.

2. When directing the fighter to targets flying at medium and high altitudes, the combat control officer should remember that the best conditions for target search and detection are created when the fighter is brought to the rear hemisphere of the target from the direction of the Sun (from the dark side of the horizon in twilight) to a distance of 5 to 8 km, with the interval of 2 - 3 km and stepped-down vertical separation of 1 - 2 km. While closing the target up to a range of 2 to 3 km, reduce the interval to 1 - 2 km and the stepped-down vertical separation up to 500 m. If the target is not detected up to a distance of 3 - 4 km, conduct the search performing S-turns with a bank of 15 to 20°.

3. When the target flies at the low or limit altitude, lead the fighter to the rear hemisphere of the target to a distance of 4 - 5 km with an interval of 2 - 3 km and a stepped-up vertical separation of 1000 m with due account to the Sun position and visibility conditions.

During direction, the fighter airspeed should be selected depending on the target airspeed within the permissible range of airspeeds specified for the given altitude. At a distance of 4 - 5 km to the target, the closing speed should not exceed 300 km/h. As the target distance is reduced, the closing speed should be reduced to 100 km/h. When intercepting the low-speed targets, due account should be paid for high closing speed, impossibility to reduce it, and limited search time.

Due to possible closing of the target by the fuselage when the target is searched in air combat at a stepped-up vertical sepa-

ration, the pilot should conduct the search periodically performing a bank of  $45^\circ$  towards the target. If the target is not detected at a distance of 1.5 to 2 km, turn the fighter away from the target to perform another attack.

Starting from the range of 4 - 5 km, the combat control officer should inform the pilot about the target position relative to the fighter in every other turn of the radar direction antenna precluding merging of the target and fighter blips on the plan position indicator.

#### 1.9. Direction of Fighters for Performing Attacks with Use of Heat Direction Finder

The TИ-26М1 heat direction finder is designed for search, detection and autotracking of the targets by their own heat (infrared) emission at any time of the day and at various mutual position of the fighter and target that allows to solve air target interception problems by stealth (with the radar emission being fully switched off or limited in time and space), as well as under conditions of electronic countermeasures with use of the infrared homing missiles.

The procedures for navigation computation and direction of the fighters for performing attacks with the help of the heat direction finder remain the same as in case of the fighter direction for performing attacks with the help of the airborne radar. However, during direction, the combat control officer should account for the following peculiarities:

- the Sun (Moon) relative bearing should be not less than  $30^\circ$ ;
- the fighter should be directed to non-reheated targets only in the rear hemisphere at an aspect angle of  $3/4$ , maximum;
- target detection and lock-on on the background of cumulus clouds are very difficult;
- the scan field of the TИ-26М1 heat direction finder operating in the T-I, T-III, T- $\phi_0$ I modes has the elevation size of  $4^\circ$  up and  $9^\circ$  down. Due to this fact, the optimum vertical stepped-down (stepped-up) separation of the fighter relative to the target is 500 m for an underneath attack and 1000 m for an overhead attack;
- the fighter may be directed to the reheated targets both in the rear and forward hemispheres.



## 2. DIRECTION OF FIGHTERS FOR PERFORMING ATTACKS AT SUPERSONIC AIRSPEEDS AND MAXIMUM REFERENCE ALTITUDE

### 2.1. Direction of Fighters for Performing Rear-Cone Attack

The process of the ММГ-25ПД fighter direction in the stratosphere is more complicated as compared to direction at medium and high altitudes. It is explained by the fact, that in the stratosphere the flight is performed only on the reheat power that complicates the flight profile and significantly limits the airborne time of the aircraft. As a rule, the flight in the stratosphere is performed at a high (maximum) airspeed that results in higher sluggishness of the aircraft and increase of the maneuver time parameters.

Due to short range of the fighter airspeeds exceeding the target airspeed and limited maneuver capabilities of the aircraft at the given altitudes, correction of the direction errors in distance and direction during the target attack in the stratosphere renders great difficulties. Therefore, high requirements, associated with a necessity to attain the maximum direction accuracy, are applied to particular navigation computations and observation of the operation procedure followed by the combat control officer.

To direct the fighters to an air target in the stratosphere, the combat control officer should well know the ММГ-25ПД fighter flight conditions and profiles involved in a rear-cone attack.

After the fighter takeoff (prior to detection of the target by the local radar), particular navigation computations and direction is effected with the help of either direction plotting board or automatic control and direction equipment with reference to the data of the secondary radar information supplied by the remote radars. Once the target is detected by the local radar, the combat control officer will correct the particular navigation computations and proceed with direction. In this case, main attention should be paid to specification of the reheat power engagement distance and turn starting distance that are calculated for the rear-cone attack by the following formulas:

$$D_{rht} = S_{acc} + V_{tgt} (t_{acc} + t_{trn}) - D_{lead};$$

$$D_{trn} = V_{tgt} t_{trn} - D_{lead} - R_{mean} \sin \text{TURN},$$

where  $S_{acc}$  is the track covered by the fighter during acceleration to the assigned (programmed) airspeed;

$V_{tgt}$  is the target airspeed;

$t_{acc}$  is the time for gaining the respective airspeed by the fighter;

$t_{trn}$  is the time of the turn;

$D_{lead}$  is the range to which the fighter is led relative to the target;

$R_{mean}$  is the mean turn radius.

If the pilot has failed to accelerate the aircraft to the assigned airspeed by the beginning of the turn, he should go on accelerating the aircraft during the turn. The roll angle during the turn is determined by the combat control officer in view of ensuring the fighter direction to the specified distance and aspect angle with due account for a possibility to accelerate and climb and ensuring a margin for the aircraft maneuver in roll within  $\pm 10^\circ$ . The roll maneuvering by the fighter is performed, as a rule, at the final stage of the turn to ensure most accurate leading of the fighter to the target in direction.

Due to high closing speeds during direction to the rear hemisphere of the target with a turn through  $180^\circ$ , it is difficult to determine the point for commencing the turn at a constant roll angle. Therefore, it is expedient to turn the fighter by delivering several (two or three) commands for the final course, rather than one command. In this case, the first command is issued for turning to the course perpendicular to the target flight path. While the fighter is turning to this course, mutual position of the fighter and target is specified and conditions for further turn are determined.

The fighter is led to a distance ensuring (at the given closing speed) time required for the following:

- additional climbing to the selected maneuvering altitude;
- attaining of the final airspeed;
- correction of the direction errors;
- pilot's use of the airborne radar;
- performing an attack.

The leading distance is calculated by the formula:

$$D_{\text{lead}} = D_{\text{lnch}} + V_{\text{cl}} t_{\text{cl}},$$

where  $D_{\text{lnch}}$  is the missile launch distance;  
 $V_{\text{cl}}$  is the fighter-to-target closing speed;  
 $t_{\text{cl}}$  is the time for additional climbing to the assigned altitude, correcting the direction errors and launching of attack.

After the command for switching -on the airborne radar emission is given, the combat control officer keeps constantly informing the pilot (up to performing the attack) about the target distance and relative attitude in direction and stepped-up vertical separation.

At the calculated target distance, the combat control officer orders the pilot to zoom. The zoom distance ( $D_{\text{zoom}}$ ) in meters is calculated by the formula:

$$D_{\text{zoom}} = D_{\text{p. max}} + 22 V_{\text{cl}},$$

where  $D_{\text{p. max}}$  is the maximum permissible missile launch distance at the given altitude and closing speed.

While the pilot is zooming, the combat control officer checks the fighter flight altitude and target distance and precludes unsafe closing of the fighter with the target.

The breakaway is performed merely by the pilot to a direction convenient for him or in the direction specified by the combat control officer. The combat control officer checks the fighter breakaway procedure, disengagement of the afterburner and emission by the pilot and directs the fighter to the landing airfield.

In the process of direction, the combat control officer periodically requests the pilot of the fuel remainder (in training flights, he also checks the fuel remainder in the target-aircraft).

## 2.2. Direction of Fighters for Performing Forward-Cone Attack

A forward-cone attack has a number of advantages over the rear-cone attack. The primary advantage is that the pilot can use more fully combat capabilities of the МиГ-25ПД fighter and widen the airspeed distances of the targets to be intercepted.

Apart from it, the forward-cone attack significantly enlarges the maximum fuel endurance target destruction lines and ensures surprise in the attack. In this case, the maximum fuel endurance target destruction lines versus the capabilities of the radar information are ensured only if control is taken over by the cooperating control (direction) post or when use is made of the secondary radar information from the remote radars.

The procedure of direction to the forward hemisphere has a number of peculiarities that impose additional requirements to training of the combat control officer.

Calculation of the initial direction parameters is performed in the same order as in direction to the target rear hemisphere.

Due to rapidness of the attack, sometimes the pilot has no time for correcting the direction errors in direction after the target is detected and locked on by the airborne radar. Therefore, a success in interception greatly depends upon the accuracy of ground direction. Preliminary navigation computations for interception of the target in the forward hemisphere are made for direction by the "interception" method.

The afterburner engagement distance in kilometers is calculated by the formula:

$$D_{\text{rht}} = S_{\text{acc}} S_{\text{H maneuver}} + V_{\text{tgt}} (t_{\text{acc}} + t_{\text{H maneuver}}) + D_{\text{lead}}$$

where  $S_{\text{H maneuver}}$  is the track covered by the aircraft during the time for gaining the maneuvering altitude, km;

$t_{\text{H maneuver}}$  is the time for gaining the maneuvering altitude, m.

Specified in the particular navigation computations are the point wherein the afterburner is to be engaged, the point of a corrective turn to the target flight path, and the zoom distance. If the fighter is directed to the forward hemisphere of the target, in all cases the zoom command should be given by the combat control officer.

The greatest difficulty during the fighter direction to a forward-cone attack is presented by the post-turn fighter interception of the target flight path and maintaining of the path by the fighter. If the fighter deviates from the target flight path, it is necessary to energetically bring the fighter

back to the target flight path or, if the distance does not permit, determine and supply the pilot with the heading to a lead point where the missile will hit the target. Acting himself, the pilot may be late to perform a corrective turn to the lead point after the target is locked on.

In the process of the fighter-to-target approach and target attack, the combat control officer informs the pilot about the target position relative to the fighter checking the pilot's actions and precluding the fighter from unsafe closing with the target in the course of the breakaway procedure. In case the target is not detected and locked on at a target range of 25 km, the combat control officer must give the breakaway command.

### 3. DIRECTION OF FIGHTERS FOR PERFORMING LOW-ALTITUDE ATTACKS

Aircraft direction at low altitudes is one of the most complicated elements of combat control. To make the direction successful, the combat control officer should:

- get thoroughly prepared for direction of the fighters in the given area with due account for the relief and observation of the safety precautions;
- know peculiarities of piloting, navigation and limitations of the МиГ-25ПД fighter at the given altitude;
- timely prepare the control means for the flights.

Direction at low altitudes is characterized by:

- limited size and intermittent character of the radar field that deteriorates target tracking and limits direction capabilities;
- limited command field that calls for special measures aimed at increase of the communication distance;
- increased fuel consumption that calls for a flight profile variable in altitude;
- limited airspeed range that limits a possibility of a rapid attack;
- danger of collision with ground obstacles that calls for higher attention on the part of the pilot and limits possibilities of horizontal and, moreover, vertical maneuvers;
- difficulty in visual detection of the target on the terrain background;

- influence of the ground surface on the operation of the airborne radar and homing heads that limits employment of the missiles in distance, hemisphere and aspect angle of the target;
- limited area of possible attacks.

Aircraft control in direction at low altitudes is ensured by:

- creation of a required network of main and stand-by control and direction posts;
- employment of the communication-relay aircraft, high-altitude arrangement of antennas and transfer of the radio stations to the radar posts with remote control provided;
- use of the radar information supplied by the remote radars employed for the aircraft direction;
- high training skill of the crews of the control (direction) posts and flying personnel.

Direction of the low-altitude targets calls for complex use of the radar information supplied by the remote and local radars.

The target should be tracked on the direction plotting boards or special plotting boards with delivery of the data from the remote units in the "azimuth - distance" coordinate system.

Due to the short detection distances, the low-altitude targets are attacked, as a rule, from the air alert zones. In this case, arrangement of the air alert zones, as well as the flight pattern therein should ensure a rapid leading of the fighter to an air target. In providing the navigation computation data one should envisage leading the fighters to the air alert zone 3 to 5 minutes prior to the target approach to the detection zone of the direction radar.

In case sufficient information about the target movement is available, the fighters are directed by conventional methods. In case information of the target movement is irregular, the fighters are directed to the target by the calculated trajectories.

By the moment of expected detection of the target, the fighters descend in the air alert zone to an altitude of 1000 - 1200 m that ensures better visual detection of the target in the process of direction and reduces the time for interception of the maneuvering altitude.

The fighter descent for entry to the maneuvering altitude should be performed at direction under the IFR conditions after a turn to the target. In case direction is performed under the

VFR conditions, the fighter may descent during the turn. To ensure flight safety during the fighter descent to the target attack altitude, the combat control officer should account for the ground relief and artificial obstacles, know the safe altitude in the flight area and inform the pilot about it. The combat control officer should also constantly check the fighter flight altitude.

If it is necessary to descend the fighter after its arrival to the target rear hemisphere, the fighter should be led prior to descending to a distance calculated by the formula:

$$D_{\text{lead}} = D_{\text{p. max}} + V_{\text{cl}} (t_{\text{atk}} + t_{\text{des}}),$$

where  $t_{\text{atk}}$  is the attack time;

$t_{\text{des}}$  is the time for descent to the attack altitude.

To ensure the necessary conditions for the pilot to perform the attack and preclude the aircraft from getting into the target wake, the fighter is led to the target with an interval of 1 - 2 km. In the process of the attack, the closing speed should be 150 - 200 km/h that is associated with short distances of detection, lock-on and missile launching. Information on the target position relative to the fighter should be as accurate as possible. After the pilot reports about the target lock-on, the fighter-to-target approach should be checked with due account for a possibility of a false lock-on. In the process of the fighter-to-target approach, the Sun or Moon position should be considered, the attack at an aspect angle from the light source should be ensured, whenever necessary. In the process of attack, do not allow a decrease in the target and fighter altitude difference less than 300 m. If the target is not detected at a distance of 4 km, failure of the lock-on at a distance of 3 km and when the target distance is 2 km, the combat control officer should issue a command to pilot to break away in a safe direction and perform the next direction, if the cause of failure of the first attack is clear.

If the fighter is directed to the targets flying at altitudes from 50 to 1000 m, use can be made of the LA mode of the airborne radar (direction on the terrain background).

In this case, the fighter is directed to the target at an aspect angles of 1/4 to 0/4 to a distance of 8 to 10 km from the target at a stepped-up vertical separation of 500 m.

When the target distance is 8 to 10 km, the combat control officer should order the pilot to switch on emission. After that, up to the missile launch, the combat control officer should inform the pilot about the target angular attitude relative to the fighter, stepped-up vertical separation of the fighter relative to the target, and fighter-to-target closing speed. In the process of the attack, do not allow a decrease of the altitude difference between the fighter and the target of less than 300 meters.

To ensure steady observation of the target and fighter in the process of direction, use should be made of the radar and radar altimeters in various ranges, modes of active response and identification, the moving target indicator cancellor system. In case of ground clutter on the plan position indicator and cloudiness, switch on the respective protective equipment of the radar. Make use of the communication-relay aircraft to ensure a steady communication.

After the pilot reports on execution of the attack, the combat control officer should issue a command for breakaway to a safe side. After the breakaway is over, the combat control officer should request the fuel remainder from the pilot and lead the aircraft to the landing airfield.

In case the training flights are performed according to the combat training plan, the target aircraft should be controlled in the direction channel. In the process of direction, the combat control officer should check the flight altitude and airspeed of the target aircraft, accuracy of its flight along the route and the fuel remainder. After the direction is executed, the combat control officer should lead the target aircraft to the landing airfield.



## *Chapter 5*

# **FLIGHT ANALYSIS WITH USE OF FLIGHT DATA RECORDING EQUIPMENT**

### **1. PURPOSE AND STANDARD SET OF AIRBORNE FLIGHT DATA RECORDING EQUIPMENT**

The TESTER-Y3-П small-size flight data recorder is used for recording the code/pulse information on the magnetic tape in flight and for storing the recorded information under normal and emergency conditions in case of mechanical shocks. The recorded information is processed on the ground to evaluate the results of the flying mission carried out by the pilot.

To ensure recording the flight parameters (altitude, air-speed, etc.) the aircraft systems are provided with transmitters supplying the respective signals via the electronic unit and playback/self-test amplifier unit to the storage.

Almost all the systems and units of the aircraft are used as recorder transmitters. Besides, the stabilizer position transmitter, throttle lever position transmitter, aileron and rudder position transmitters, three acceleration sensors on three axes, rate gyro, indicated airspeed transmitter and barometric altitude transmitter are installed specially for the TESTER-Y3-П recorder. The electronic units operate as a digital computer. They perform the following functions:

- generate the TESTER-Y3-П recorder switching on number;
- convert all the data transmitted from the sensors into binary-code signals;
- generate the time signals;

- provide self-test of the equipment;
- control the reversing mechanism of the magnetic storage.

The magnetic storage is actually a reversing tape transport mechanism. It records the code/pulse information, plays it back and transmits it to the LUCH-71M ground decoder for storing the recorded information in case of accident.

During recording, the tape transportation speed is 1.2 to 1.6 cm/s and during playback, the speed is 12 to 40 cm/s.

The container of the storage keeps the recorded information safe in case of impact deceleration up to 1000 g, in sea water for 5 days, in kerosene and fire-extinguishing fluids for 2 days, at a temperature of 1000 °C.

The TESTER-Y3-II recorder records both continuous (analog) parameters and discrete (binary) commands (see Tables 20 and 21).

Besides, the following parameters are recorded - time in minutes and seconds and number of switching-on the TESTER-Y3-II recorder.

## 2. PROCEDURE FOR DECODING OBJECTIVE CHECK RESULTS

Objective evaluation of flying mission results and current serviceability check of the systems of aircraft ММГ-25ИИ are accomplished referring to the signal records of the flight data recording system with the aid of the LUCH-71M decoder. The LUCH-71M decoder is used for reproduction the parameters transmitted from the airborne magnetic storage in order to ensure qualitative and quantitative analysis and storage of the objective check results.

The LUCH-71M decoder is actually a computer which reproduces information on the screen of the cathode-ray tube and on the paper tape.

The information recorded by the tape recorder may be reproduced on a paper tape in the shape of a signal record and displayed on the screen of the cathode-ray tube (16 flight parameters).

For the interflight analysis, the following data are recorded on the signal paper record:

- altitude;
- indicated airspeed;
- left engine RPM;
- right engine RPM;
- stabilizer deflection angle;

- longitudinal g-load;
- vertical g-load;
- bank angle.

If the more detailed analysis of the flight is required, a provision is made for recording any other additional parameter on the signal record (Tables 20 and 21).

The CRT screen is used for visual qualitative evaluation of flight parameters change.

Each flight parameter is presented on the CRT screen in the respective vertical column displayed for the given parameter.

The changes of continuous analog parameters are displayed in these columns in the shape of vertical strobos. If a transparent grid with the limit marks for the recorded parameters is applied to this screen, it makes possible to read the changes in the displayed parameter changes, e.g. changes in airspeed, g-load, altitude, engine RPM, etc. Such an evaluation is termed qualitative analysis of the performed flight parameters.

Simultaneously the parameters are plotted on the signal record.

The signal record is used for qualitative and quantitative analyses of the flight parameters.

The plotter of the LUCH-71M decoder plots the signal record of the flight information.

The plotter has a number of nibs arranged evenly over the entire width of the paper tape. A voltage corresponding to the change of the flight parameter to be recorded on the tape is applied to the nibs. It results in a number of small dots. The dots form a line of the recorded parameter.

Fig. 167 illustrates an example of the record represented by horizontal lines. Each fifth horizontal line is plotted thick for fast determination of number of "ones". The information is recorded between two adjacent lines by the aid of five nibs which corresponds to five "ones".

The field of the signal record is divided into 296 "ones". The space between two thick lines contains 25 "ones". The sixth horizontal line from the bottom of the signal record is used as a time-base line, from which time counting starts. The discrete commands aboard the MvT-25M aircraft are recorded over the entire field of the signal record.

In order to determine what line (trail) on the signal record corresponds to what parameter, the line is marked.

Table 20

Parameter code number	Parameter designation	Parameter	Unit of measurement	Measurement limits	Maximum measurement error at input of recorder TES-TER-V3-II	Parameter decoding
1 (1)	$V_{ind}$	Indicated airspeed	km/h	0 to 1200	$\pm 2.5\%$	Calibration chart
2 (29)	$H_I$	Barometric altitude	km	-0,25 to 9.3	$\pm 2.5\%$	Calibration chart
3 (2)	$n_z$	Lateral g-load	g	$\pm 1.5$	$\pm 25\%$	(K-128)·0.0118
4 (3)	$\varphi_{stab, port}$	Port side stabilizer position	deg	-30 to +13	$\pm 2\%$	(K-K <sub>0</sub> )·0.169
5 (4)	$\gamma$	Bank	deg	$\pm 90$	$\pm 2.1\%$	Calibration chart
6 (5)	THROTTLE LEVER <sub>st, bd</sub>	Starboard engine throttle lever position	deg	0 to 121	$\pm 2\%$	K·0.475
7 (6)	THROTTLE LEVER <sub>port</sub>	Port side engine throttle lever position	deg	0 to 121	$\pm 2\%$	K·0.475
8 (7)	G <sub>r. fuel</sub>	Remaining fuel		0 to 20	$\pm 4\%$	K·0.0823
9 (8)	$n_{stbd eng}$	Starboard engine RPM	%	10 to 110	$\pm 0.5\%$	K·0.833 - LUCH-71Y
11 (10)						
10 (9)	$n_{port eng}$	Port side engine RPM	%	10 to 110	$\pm 0.5\%$	K·1.66 - LUCH-71M
12 (11)						

Table 20, continued

Parameter code number	Parameter designation	Parameter	Unit of measurement	Measurement limits	Maximum measurement error at input of recorder TES-TER-V3-II	Parameter decoding
13 (12)	$H_2$	Barometric altitude	km	8.5 to 26	$\pm 2.5\%$	Calibration chart
14 (20)	$\varphi_{\text{stbd stab}}$	Starboard stabilizer position	deg	-30 to +13	$\pm 2\%$	$(K - K_0) \cdot 0.169$
15 (19)	$\delta_{\text{rudder}}$	Rudder position	deg	$\pm 25$	$\pm 2\%$	$(K - 128) \cdot 0.196$
16 (18)	$\delta_{\text{ail}}$	Aileron position	deg	$\pm 90$	$\pm 2\%$	$(K - 128) \cdot 0.196$
17 (17)	$\psi$	Pitch angle	deg	$\pm 90$	$\pm 2.1\%$	Calibration chart
18 (16)	$W_x$	Rate of roll	1/s	$\pm 60$	$\pm 2\%$	Calibration chart
19	$\Delta\psi$	Heading mismatching	deg	$\pm 70$	$\pm (6^\circ \pm 30\%)$	$(K - 128) \cdot 1.8$
20	$H_{\text{sel}}$	"Selected altitude levelling off" command	V	$0.7 \pm 0.1$		$(30 \pm 4)$ "ones"
21 (32)	$n_x$	Longitudinal g-load	g	$\pm 1.5$	$\pm 2.5\%$	$(K - 128) \cdot 0.0118$
22 (30)	$\psi$	Magnetic heading	deg	0 to 360	$\pm 1.4\%$	Calibration chart
23 (29)	$n_y$	Normal g-load	g	-3.5 to +10	$\pm 2.5\%$	$(K - 89) \cdot 0.0529$
24 (21)	$\Delta\gamma$	Bank mismatching	deg	$\pm 30$	$\pm (4^\circ \pm 20\%)$	$(K - 128) \cdot 0.449$

Table 20, continued

540

Parameter code number	Parameter designation	Parameter	Unit of measurement	Measurement limits	Maximum measurement error at input of recorder TES-TER-V3-II	Parameter decoding
25 (13) 26 (14)	$\Delta n_y$ $\delta_{long}$	G-load mismatching Deflection of longitudinal channel pointer:		$\pm 1.5$	$\pm(0.15 \pm 20\%)$	(K - 128)·0.0176
	(a) $\Delta M$	Mach number error during programmed climb and Mach number stabilization;		$\pm 0.65$	$\pm(0.05 \pm 20\%)$	(K - 128)·0.0065 (K - 128)·0.0039
	(b) $\Delta H_{alt}$	. Altitude error during altitude stabilization	m	$\pm 2000$ $\pm 120$	$\pm(100m \pm 20\%)$	(K - 128)·0.021 (K - 128)·0.0124
	(c) $\Delta VERT$	Sighting error in vw vertical plane within control portion of flight in RADAR LOCK ON mode	deg	$\pm 60$	$\pm(5^\circ \pm 20\%)$	(K - 128)·0.618 (K - 128)·1.07
	(d) $\Delta H_{ALT CTLR}$	Error in altitude 15 s after selection of LEVELLING mode	m	$\pm 400$ $\pm 250$	$\pm(40m \pm 20\%)$	(K - 128)·0.0041 (K - 128)·0.0025
27 (15)	$\delta_{lat ptr}$	Deflection of lateral channel pointer:				

Table 20, continued

Parameter code number	Parameter designation	Parameter	Unit of measurement	Measurement limits	Maximum measurement error at input of recorder TES-TER-V3-II	Parameter decoding
28 (22)	(a) $\Delta\Psi$	Heading mismatching within ground-based direction portion	deg	$\pm 60$ $\pm 35$	$\pm(5^\circ \pm 30\%)$	(K - 128)•0.583 (K - 128)•0.353
	(b) $\Delta$ HOR	Sighting error in horizontal plane within control portion of flight in RADAR LOCKON mode	deg	$\pm 60$	$\pm(5^\circ \pm 20\%)$	(K - 128)•1.07 (K - 128)•0.618
	(a) PK46-1P	First significance discrete commands of missile P-40PI on first launcher:	V	24 to 29.4	$\pm 5\%$	
	S	SUSPENDED				22 to 28 "ones"
	F-II	FILAMENT-II				47 to 56 "ones"
	PREP	PREPARATION				178 to 218 "ones"
	AF-UP	ANGLES FOLLOWED-UP				67 to 84 "ones"
FA	FREQUENCY ADJUSTED				120 to 142 "ones"	
PR	PYLON READY				10 to 12 "ones"	
LP	LAUNCH PERMITTED				29 to 36 "ones"	
LCH	LAUNCH				66 to 83 "ones"	

Table 20, continued

542

Parameter code number	Parameter designation	Parameter	Unit of measurement	Measurement limits	Maximum measurement error at input of recorder TESTER-Y3-II	Parameter decoding
PUR ZPCS	(b) $\Delta\phi_I$ (2)	<p>POWER UNIT READY ZERO POSITION OF CONTROL SURFACES</p> <p>Angular mismatching in control channel I of missile P-40TH on second launcher between axes of radar antenna and IRHH target seaker, which is equal to difference between <math>\phi_{rdr}</math> and <math>\phi_{IRHH}</math> (is to be recorded with no missile P-40PH suspended from first launcher)</p>	deg	$\pm 60$ (coarse scale) $\pm 7.3$ (fine scale)	$\pm 5\%$	<p>116 to 145 "ones" 194 to 241 "ones"</p> <p>(K - 121)·0.6 - on coarse scale, absence of command <math>\Delta\phi_{perm}</math>; (K - 121)·0.05 - on fine scale, command <math>\Delta\phi_{prn}</math> is supplied</p>
	(c) PK62-I (1)	<p>First significance discrete commands of missile P-60 (P-60M) on port-side outboard launcher</p>	V	24 to 29.4	$\pm 5\%$	



Table 20, continued

Parameter code number	Parameter designation	Parameter	Unit of measurement	Measurement limits	Maximum measurement error at input of recorder TESTER-y 3-II	Parameter decoding
29 (23)	62 ON	(is to be recorded with command "Selection 62" supplied): SWITCHING-ON MISSILES P-60 (P-60M)				10 to 13 "ones"
	PR	PYLON READY				38 to 47 "ones"
	LP	LAUNCH PERMITTED				155 to 194 "ones"
	LCH (a) PK46-IP (2)	LAUNCH Same, see parameter 28 (a), on second launcher				198 to 242 "ones"
	(b) PK46-IT (2)	First significance discrete commands of missile P-40TH on second launcher:	V	24 to 29.4	±5%	
S	SUSPENDED				22 to 28 "ones"	
F-II	FILAMENT-II				47 to 56 "ones"	

Table 20, continued

Parameter code number	Parameter designation	Parameter	Unit of measurement	Measurement limits	Maximum measurement error at input of recorder TESTER-V3-II	Parameter decoding
	PREP	PREPARATION				67 to 84 "ones"
	$\Delta \phi_{perm}$	$\Delta \phi$ permitted				178 to 218 "ones"
	PR	PYLON READY				10 to 12 "ones"
	LP	LAUNCH PERMITTED				29 to 36 "ones"
	LCH	LAUNCH				66 to 83 "ones"
	PUR	POWER UNIT READY				116 to 145 "ones"
	ZPCS	ZERO POSITION OF CONTROL SURFACES				194 to 241 "ones"
30 (22)	(c) PK62-I (2)	Same, see parameter 28 (c), on port-side inboard launcher				
	(a) PK46-IP (3)	Same, see parameter 28 (a), on third launcher				
	(b) PK46-IT (3)	Same, see parameter 29 (b), on third launcher				
	(c) PK62-I (3)	Same, see parameter 28 (c), on starboard inboard launcher				
31 (23)	(a) PK46-IP (4)	Same, see parameter 28 (a), on fourth launcher				

Table 20, continued

Parameter code number	Parameter designation	Parameter	Unit of measurement	Measurement limits	Maximum measurement error at input of recorder TESTER-Y3-J	Parameter decoding
32 (24)	(b) $\Delta\phi_I$ (3)	Same, see parameter (28 (b), on third launcher (is to be recorded with no missile P-40PI suspended from fourth launcher)				
	(c) PK62-I (4)	Same, see parameter 28 (c), on starboard outboard launcher				
	(a) AFC (1)	Output signal of frequency discriminator of radar homing head automatic frequency control system of missile P-40PI suspended from first launcher (frequency is trimmed to carrier frequency of airborne radar continuous illumination channel)	V	$\pm 2$	$\pm 20\%$	(K - 121) - 0.0164

Table 20, continued

Parameter code number	Parameter designation	Parameter	Unit of measurement	Measurement limits	Maximum measurement error at input of recorder TES-TER-Y3-J	Parameter decoding
	(b) AFC (2)	Same is applicable to missile suspended from second launcher (is to be recorded with no missile P-40PII suspended from first launcher)				
	(c) $\Delta\varphi_{II}$ (2)	Same, see parameter 28 (b) in second channel for second launcher				
	(d) $E_y$	Target designation in target elevation transmitted from airborne radar to infrared homing heads of missiles P-60 (P-60M) suspended from port-side outboard launcher (is to be recorded with command "Selection 62 supplied")	deg	$\pm 20$	$\pm 5\%$	(K - 121)·0.164

Table 20, continued

Parameter code number	Parameter designation	Parameter	Unit of measurement	Measurement limits	Maximum measurement error at input of recorder TESTER-Y3-II	Parameter decoding
33 (24)	(a) $mF_{msl}$ (4)	Signal proportional to Doppler frequency to which radar homing head of missile P-40PI suspended from fourth launcher is tuned	kHz	0 to 300	±5%	K • 1.244
	(b) $mF_{msl}$ (3)	Same is applicable to missile suspended from third launcher (is to be recorded with no missile P-40PI suspended from fourth launcher)	kHz	0 to 300		
	(c) $\Delta\phi_{II}$ (3)	Same, see parameter 28 (b) in channel II for third launcher (is to be recorded with no missile P-40PI suspended from fourth launcher)				

Table 20, continued

Parameter code number	Parameter designation	Parameter	Unit of measurement	Measurement limits	Maximum measurement error at input of recorder TES-TER-Y3-J	Parameter decoding
34 (34)	(d) E <sub>z</sub> <u>PK-I</u> L-ON P-I ALU-I ALU-III D <sub>p</sub> BIC	Same, see parameter 32 (d), in azimuth Airborne radar discrete commands: LOCKON PERMITTED button depressed Operation of automatic lockon unit A3-I Operation of automatic lockon unit A3-III Generation of "Distance permitted" command Enabling of BUILT-IN CHECK mode	V	27±2.7		(63±4) "ones" (78±4) "ones" (97±4) "ones" (105±4) "ones" (120±6) "ones"
35 (25)	(a) AFC (3)	Same, see parameter 32 (a), on third launcher				

Table 20, continued

Parameter code number	Parameter designation	Parameter	Unit of measurement	Measurement limits	Maximum measurement error at input of recorder TES-TER-Y3-II	Parameter decoding
	(b) AFC (4)	Same is applicable to missile suspended from fourth launcher (is to be recorded with no missile P-40II suspended from third launcher)				
	(c) CA (3)	Same, see parameter 36 (c), on third launcher				
	(d) PK46-III	Third significance discrete commands of missiles P-40II (is to be recorded during "Launch" command active time):	V	24 to 29.4	±5%	
	H > 8	Altitude higher than 8 km				60 to 74 "ones"
	H > 18	Altitude higher than 18 km				185 to 237 "ones"

Table 20, continued

550

Parameter code number	Parameter designation	Parameter	Unit of measurement	Measurement limits	Maximum measurement error at input of recorder TES-TER-V3-J1	Parameter decoding	
36 (25)	(e) PK62-II	Discrete commands of missiles P-60 (P-60M):	V	24 to 29.4	±5%	19 to 24 "ones"	
	FH	Attack in target front hemisphere					
	UTSE	Untolerable sighting error					75 to 94 "ones"
	H < 12	Altitude lower than 12 km					174 to 219 "ones"
	(a) $mF_{msl}$ (2)	Same, see parameter 33 (a), on second launcher					
	(b) $mF_{msl}$ (I)	Same, see parameter 33 (a), on first launcher (is to be recorded with no missile P-40I suspended from second launcher)					



Table 20, continued

Parameter code number	Parameter designation	Parameter	Unit of measurement	Measurement limits	Maximum measurement error at input of recorder TESTER-Y3-II	Parameter decoding
	(c) CA (2)	Output signal of infrared homing head carrier frequency amplifier of missile P-40TH suspended from second launcher	V	0 to 3.5	+5%	K • 0.0144
	(d) PK46-II:	Second significance discrete commands of missiles P-40H (is to be recorded during LAUNCH command active time):	V	24 to 29.4	+5%	
	Dest 1	Estimated closing rate 1 of missile				\ 37 to 47 "ones"
	Dest 2	Estimated closing rate 2 of missile				80 to 100 "ones"
	Dest 3	Estimated closing rate 3 of missile				116 to 145 "ones"

Table 20, continued

552

Parameter code number	Parameter designation	Parameter	Unit of measurement	Measurement limits	Maximum measurement error at input of recorder TES-TER-V3-II	Parameter decoding
37	D <sub>est</sub> 4	Estimated closing rate 4 of missile				153 to 192 "ones"
	D <sub>est</sub> 5	Estimated closing rate 5 of missile				195 to 242 "ones"
	(e) $\Omega$ polar	Angular rate of sighting line INFRARED HOMING HEAD OF MISSILE P-60 (P-60M)-TO-TARGET in polar coordinates (is to be recorded with "Selection 62" command supplied)	deg/s	0 to 20	$\pm 5\%$	K * 0.138
	(a) $\varphi_{hor}$ 1	Position of radar antenna axis in azimuth	deg	$\pm 60$	$\pm 2\%$	(K - 121) * 0.475
	(31) (b) $\varphi_{az}$ HDF	Position of heat direction finder coverage area in azimuth (is to be recorded with heat direction finder switched on)	deg	$\pm 30$	$\pm 2.5\%$	(K - 121) * 0.475

Table 20, continued

Parameter code number	Parameter designation	Parameter	Unit of measurement	Measurement limits	Maximum measurement error at input of recorder TES-TER-Y3-J	Parameter decoding
38 (26)	(a) $\varphi_{\text{VERT } 1}$	Position of radar antenna axis in elevation	deg	$\pm 60$	$\pm 2\%$	(K - 121)•0.475
	(b) $\varphi_{\text{elev HDF}}$	Position of heat direction finder coverage area in elevation (is to be recorded with heat direction finder switched on)	deg	-11 to +4	$\pm 2\%$	(K - 121)•0.119
39 (35)	(a) $U_{\text{man range}}$	Voltage proportional to range finder search area center range (or range itself) in case of strobe manual control by using knob of airborne radar unit 44	km	0 to 85	$\pm 4\%$	K • 0.343

Table 20, continued

554

Parameter code number	Parameter designation	Parameter	Unit of measurement	Measurement limits	Maximum measurement error at input of recorder TES-TER-Y3-II	Parameter decoding
	(b) $D_{xmtd}$	Target distance transmitted from ground control post through 5Y15K-11 system	km	0 to 100	$\pm 4.5\%$	$K \cdot 0.4$
	(c) D	Target distance in LOCKON mode of airborne radar operation	km	0 to 85	$\pm 4\%$	$K \cdot 0.343$
40 (33)	$\dot{D}$	Target closing rate	m/s	-1800 to +180	$\pm 3\%$	$(K_0 - K) \cdot 8.05$
41 (27)	$\Delta VERT$	Same, see parameter (26 (c))	deg	$\pm 60$	$\pm 2\%$	$K_{aver} = 24$ $(K - 121) \cdot 0.475$
42 (36)	$\Delta HOR$	Same, see parameter 27 (b)	deg	$\pm 60$	$\pm 2\%$	$(K - 121) \cdot 0.475$
43 (37)	$\omega_{hor}$	Angular rate of sighting "fighter-to-target" in horizontal plane	deg/s	$\pm 15$	$\pm 2\%$	$(K - 121) \cdot 0.119$

Table 20, continued

Parameter code number	Parameter designation	Parameter	Unit of measurement	Measurement limits	Maximum measurement error at input of recorder TES-TER-V3-II	Parameter decoding
44 (38)	$\omega$ vert	Same in vertical plane	deg/s	$\pm 15$	$\pm 2\%$	$(K - 121) \cdot 0.119$
45	MKR	Marker receiver signal	V	$0.7 \pm 0.1$		$(30 \pm 4)$ "ones"
46	L.G. RETR	Landing gear retracted	V	$1.45 \pm 0.1$		$(60 \pm 4)$ "ones"
47	FLAPS EXT	Flaps extended	V	$2.95 \pm 0.1$		$(120 \pm 4)$ "one"
48	CKB main	CKB-2HJ-2 failure (main)	V	$0.7 \pm 0.1$		$(30 \pm 4)$ "ones"
49	CKB stby	Same (stand-by)	V	$1.45 \pm 0.1$		$(60 \pm 4)$ "ones"
50						
51	$U_{27}$ stbd	Voltage of +27 V supplied by starboard engine DC generator	V	0 to 32	$\pm 0.2\%$	$K \cdot 0.13$
52	$U_{36}$ port	Voltage of 36 V 400 Hz supplied by port side engine AC generator	V	0 to 40	$\pm 1\%$	$(K + 3) \cdot 0.162$

Table 20, continued

556

Parameter code number	Parameter designation	Parameter	Unit of measurement	Measurement limits	Maximum measurement error at input of recorder TES-TER-V3-II	Parameter decoding
53	U <sub>115</sub> port	Voltage of 115 V 400 Hz supplied by port side engine AC generator	V	0 to 125	±1%	K · 0.494
54	U <sub>27</sub> port	Same, see parameter 51 of port side engine				
55	U <sub>115</sub> stbd	Same, see parameter 53 of starboard engine				
56	U <sub>36</sub> stbd	Same, see parameter 52 of starboard engine				
57	{PORT COWLING	Duplicating port-side cowling control	V	1.45±0.1		(60±4) "ones"
58	{STBD COWLING	Duplicating starboard cowling control	V	2.95±0.1		(170±4) "ones"

Note. Parameter in bracket ( { ) are transmitted over a single channel. Summed-up level of commands is equal to each command level sum.

Table 21

Parameter code No.	Parameter designation	Parameter	Parameter decoding ("one")
1	R/SET	Depression of R/SET button	-24
2		Ejection	-12
3	HYDRO	General hydraulic system failure	-21
4	BOOSTER	Booster system failure	-22
5	AUTOPILOT ON	Autopilot ON	-10
6	AFCS DIRECT	Depression of DIRECT light-button on control panel of automatic flight control system	-5
7	$n_{y \text{ ext}}$	Extreme manoeuver	-6
8	$v_{\text{ext}}$	Extreme pitching	-3
9	FLC	Operation of flying limitations computer	-4
10	STBD ENG HIGH T <sup>o</sup>	High temperature of starboard engine	0
11	PORT ENG HIGH T <sup>o</sup>	High temperature of port-side engine	+1
12	1046 STBD	Transfer to duplicating automatic controls of starboard engine	+257
13	1046 port	Same applicable to port engine	+258
14	STBD ENG FIRE	Starboard engine fire	-33
15	PORT ENG FIRE	Port engine fire	-15
16	GO	Setting of AIR - GROUND selector switch to GROUND position (generation of "Ground operation" command to missiles P-40I)	-28

Table 21, continued

Parameter code No.	Parameter designation	Parameter	Parameter decoding ("one")
17	$\varphi_o$	Setting of $\varphi_o$ - WITH RDR - $\varphi_b$ selector switch to $\varphi_o$ position (operation of armament control system with missiles P-40M in $\varphi_o$ mode)	-23
18	LT	Setting of ST - MT - LT selector switch to position LT (transmission of "Large target" command to armament system P-40M)	
19	FB	Depression of firing button	+2
20	IAV	Response signal to operation of shutter of gun camera IAV-473	-11
21	INTERROG	Depression of INTERROG button located on knob of airborne radar unit 44	-13
22	HDF	Enabling of heat direction finder TH-26M1	-30
23	MTI	Generation of "Moving target indication" (MTI) command in airborne radar	+3
24	$\Delta H_1$	Selection of HIGH/MEDIUM ALTITUDES (HMA- $\Delta H_1$ ) mode in airborne radar	-19
25	AUTO DIRECT	Setting of DIRECT selector switch to position AUTO on unit 24 of airborne radar	-9



Table 21, continued

Parameter code No.	Parameter designation	Parameter	Parameter decoding ("one")
26	MLA	Selection of MEDIUM/LOW ALTITUDES mode in airborne radar	-17
27	JRF	Generation of "Jamming to range finder" (Active jamming) command	-16
28	TI	Enabling of moving target indication circuit with respect to closing rate	-32
29	DESENSITIZE	Generation of "Desensitize" command in airborne radar	-25
30	PA	Enabling of parametric amplifier in airborne radar	-29
31	A3-II	Operation of lockon controller A3-II in airborne radar	+259
32	ILLUM	Switching-on of target illumination by airborne radar	+260

mark is actually a square, consisting of 16 dots (four dots represent width, four dots represent length), which is recorded on the line itself. The marks are shifted in time relative to each other and recorded from left to right. The group of the marks is recorded repeatedly after every 2 minutes.

An operator of the LUCH-71M decoder can mark 8 lines. For decoding of the signal record and analysis of the results, one should calibrate charts for every aircraft and a template to count a number of "ones".

### 3. USE OF OBJECTIVE CHECK MATERIALS FOR ANALYSIS AND EVALUATION OF FLYING TECHNIQUE

The qualitative analysis of the signal records made by the flight data recording system makes it possible to determine the following:

- (1) completeness of flight mission performed;
- (2) maintaining the assigned parameters at separate flight stages;
- (3) observance of flight safety;
- (4) serviceability of the main aircraft systems.

Analysis of performing takeoff. The beginning of the take-off run is determined by the existence of characteristic oscillation on the lines of the normal ( $n_y$ ) and longitudinal ( $n_x$ ) g-loads (Fig. 168). Straightening-out of the lines usually takes place at the moment of the aircraft separation. An intensive displacement of the stabilizer deflection angle record line off neutral indicates the moment of the nose wheel lift-off.

The moment of retraction of the landing gear is determined by a short-time alteration of the longitudinal g-load. The moment of disengagement of the engine afterburners is determined by the characteristic oscillation of the engine speed record lines and a rapid upward deflection of the longitudinal g-load record line. At this time, intensive deviation of the speed and altitude record lines from the datum line upward.

Analysis of performing a 360° turn. A correct 360° turn is characterized by constant flying altitude and speed throughout the entire maneuver. The record lines pertaining to these parameters must, therefore, be in parallel to the datum line. Apart from this, the vertical g-load is more than 1 g throughout the entire turn and must correspond to the amount of bank. The

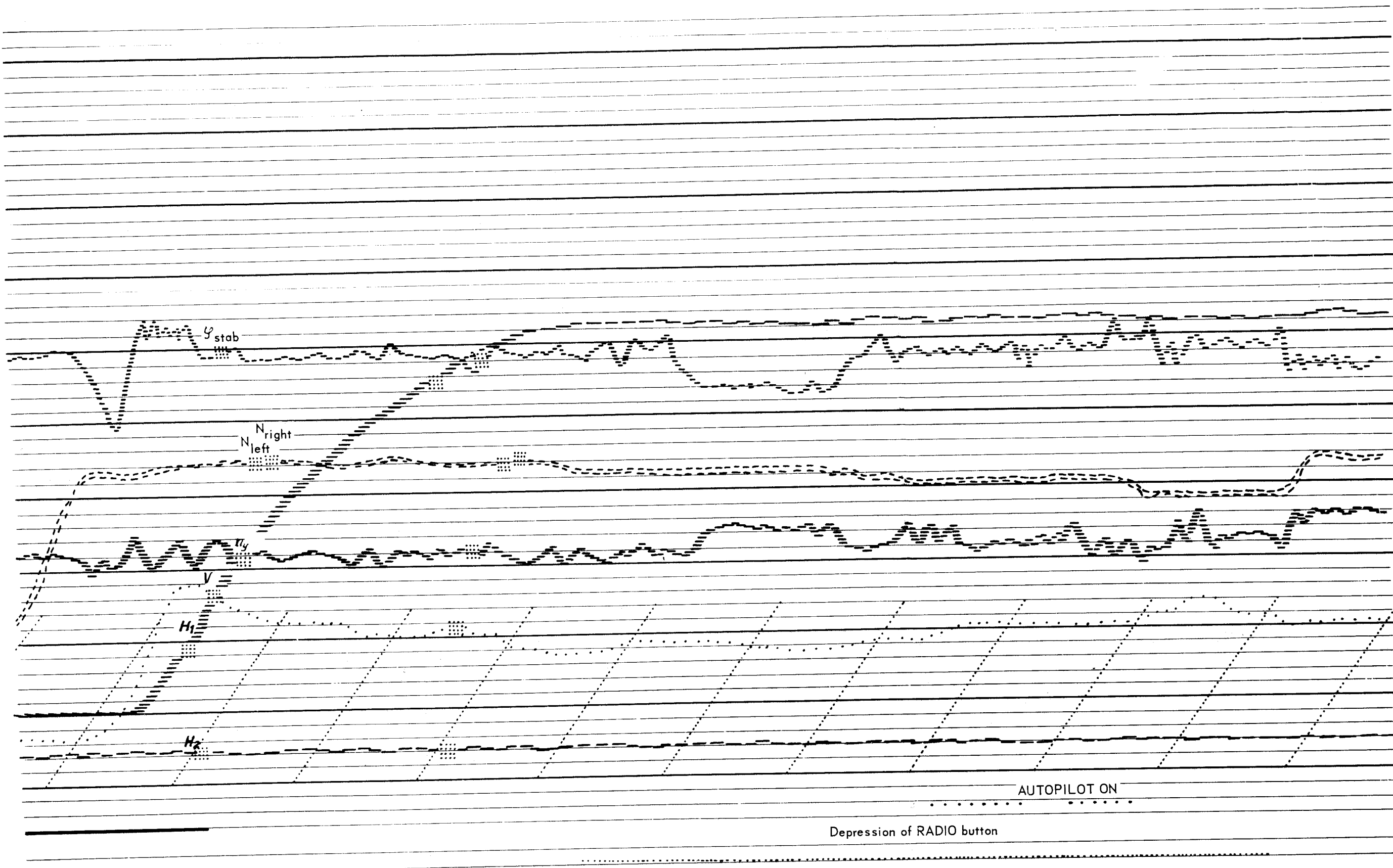

FIG. 168. EXAMPLE OF TAKEOFF SIGNAL RECORD

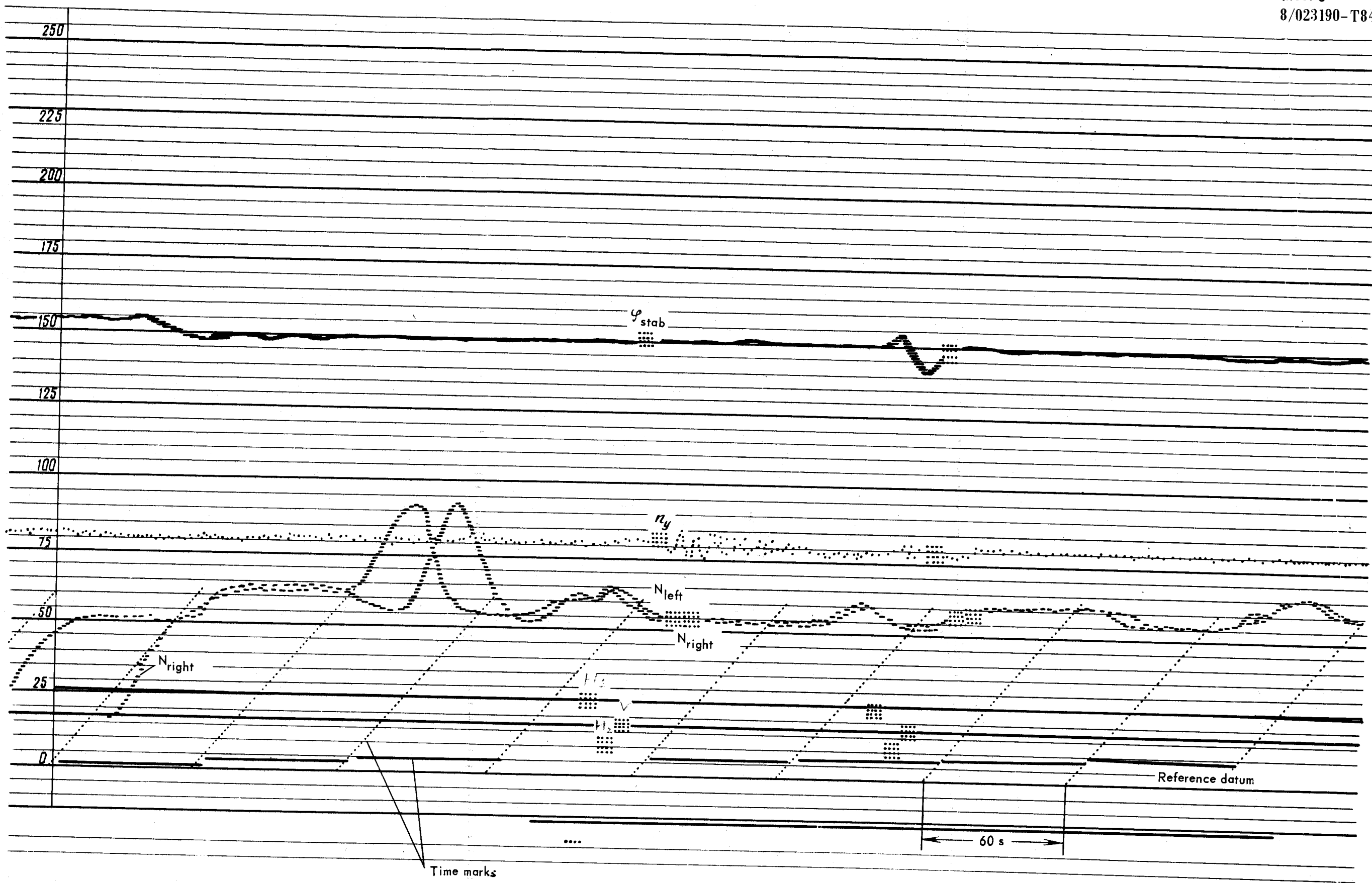

FIG. 167. EXAMPLE OF PARAMETER RECORDING ON SIGNAL RECORD

beginning of a 360° turn is determined by a drastic change in the normal g-load and deflection of the stabilizer for creating a pitch-up moment with the purpose of compensating for the altitude loss sustained in banking. On the signal records this moment can also be determined by deflection of the ailerons and their return to the initial positions after the required bank is obtained (Fig. 169). In this case, a characteristic impulse occurs on the aileron deflection angle record line. The 360° turn direction is determined by the sign of the aileron deflection.

The moment of bringing the aircraft into level flight is determined by deflection of the ailerons in the direction of smaller bank. The average normal g-load in the 360° turn corresponds to the average bank which is maintained throughout the entire maneuver. With the correctly performed 360° turn, a bank is determined from the following relationship:

$$n_y = \frac{1}{\cos \gamma},$$

where:  $n_y$  - normal g-load in a 360° turn;  
 $\gamma$  - bank angle.

When analysing the quality of performing a 360° turn, apart from the vertical g-load, an additional important information can be derived from such parameters as the engine speed, longitudinal g-load, flight altitude and speed.

By the nature of change in the engine speed one can judge the proficiency of the pilot in selecting the required engine power setting. Constant normal g-load and stabilizer deflection angles are characterizing the degree of skill of the pilot in performing a 360° turn.

Analysis of performing vertical flight maneuvers. The character of the normal g-load record and the nature of the mutual alteration of the flight altitude and speed records are the major symptoms for identification of vertical maneuvers. The beginning of performing ascending maneuvers is characterized by a vigorous growth of g-load and further increase of flying altitude and decrease of flight speed.

Z o o m is characterized by an intensive growth of g-load in zoom entry and decrease of g-load to below 1 g in the middle portion of the maneuver (Fig. 170). Further change in g-load depends on the method of recovery, namely:

- g-load may tend to diminish if the zoom recovery is performed without bank, i.e. by applying forward stick pressure;
- normal g-load may increase to 1 - 1.5 g in zoom recovery involving a turn at a bank of less than  $90^{\circ}$  and to 2 - 4 g in zoom recovery involving a half-wingover or wingover.

In zooming, the flying speed constantly diminishes, and the altitude increases. In zoom recovery the rate of decrease in flying speed and increase in flight altitude diminishes. Subsequently, these parameters remain nearly unchanged.

By the maximum and minimum values of the speed and normal g-load one can judge how the respective limitations are observed. The zoom angle may be determined by referring to the rate of flying speed decrease during a certain period of time.

*C h a n d e l l e* is characterized by an intensive increase in the normal g-load in the initial phase and the linear change in this g-load to 1 g throughout the entire chandelle, i.e. the normal g-load must not be less than 1 g throughout the entire period of performing chandelle (Fig. 171). The direction of chandelle as indicated on the signal records can be determined by the sign of aileron deflection.

When analysing the vertical ascending maneuvers (chandelle, zoom) for correct execution, one should consider the rate of change (gradient) of the normal g-load at the entry into the vertical maneuver. The g-load gradient must not exceed 1.5 g per second. An increase in the rate of g-load growth may give rise to an unintentional pitch-up in some flight regimes which is characterized by an inadvertent increase in the g-load at a constant stabilizer deflection angle. Practice flying calculations and data show that the optimum entry into vertical ascending maneuvers should be made at a rate of g-load growth of 1 to 1.5 g per second.

*D i v e* registered on the signal record is identified by an intensive increase in flying speed, with the engines running at a speed approximating flight idle power setting, and energetic altitude loss, with the normal g-load being equal or slightly below 1 g (Fig. 172).

In dive recovery the g-load rapidly increases. The respective recording has a form of a surge lasting for 5 to 10 s. When analysing this maneuver from the point of view of flight safety, one should consider the amount of altitude loss  $\Delta H$  taken from the moment of dive recovery to the moment of level-

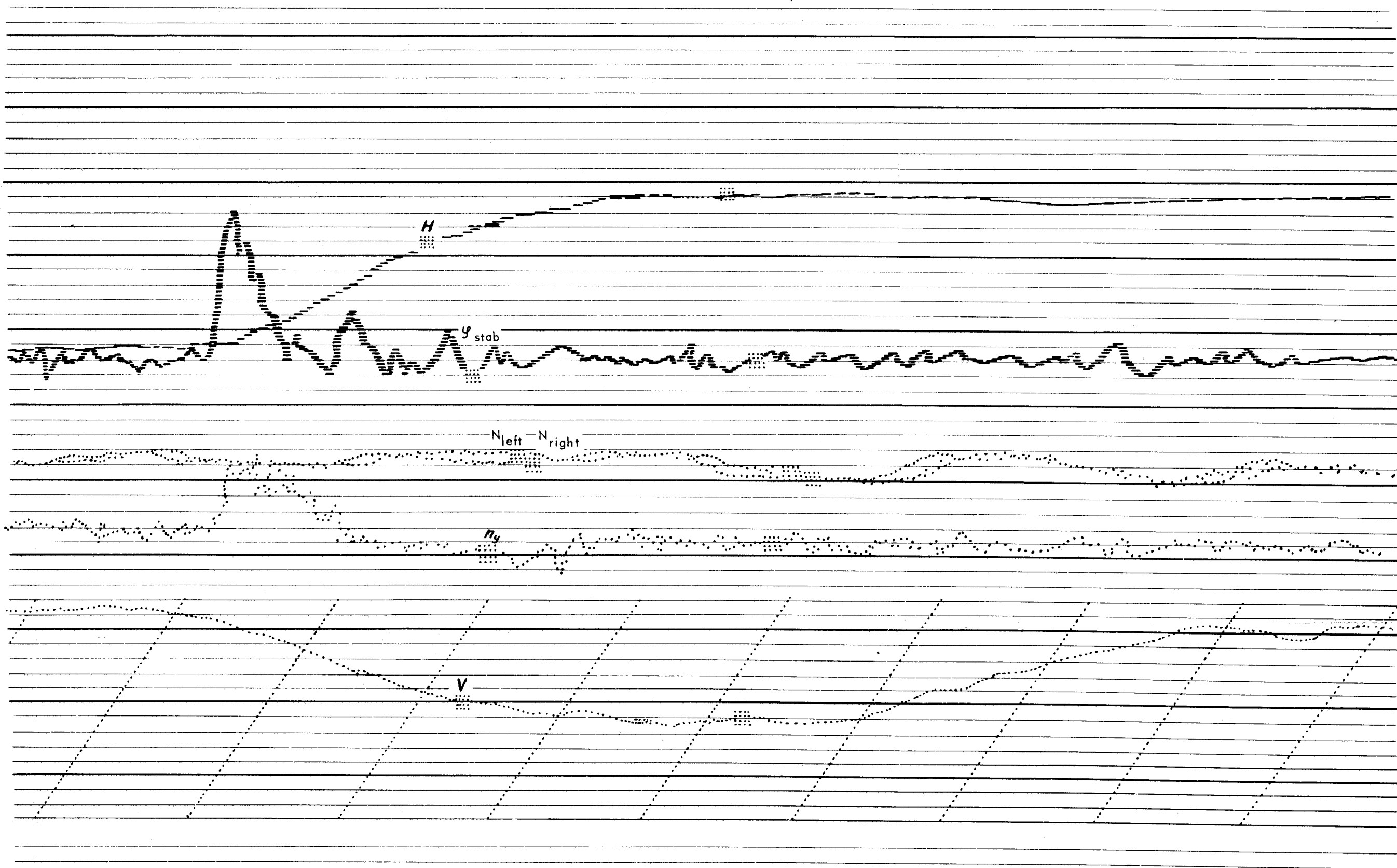

FIG. 170. EXAMPLE OF ZOOM SIGNAL RECORD

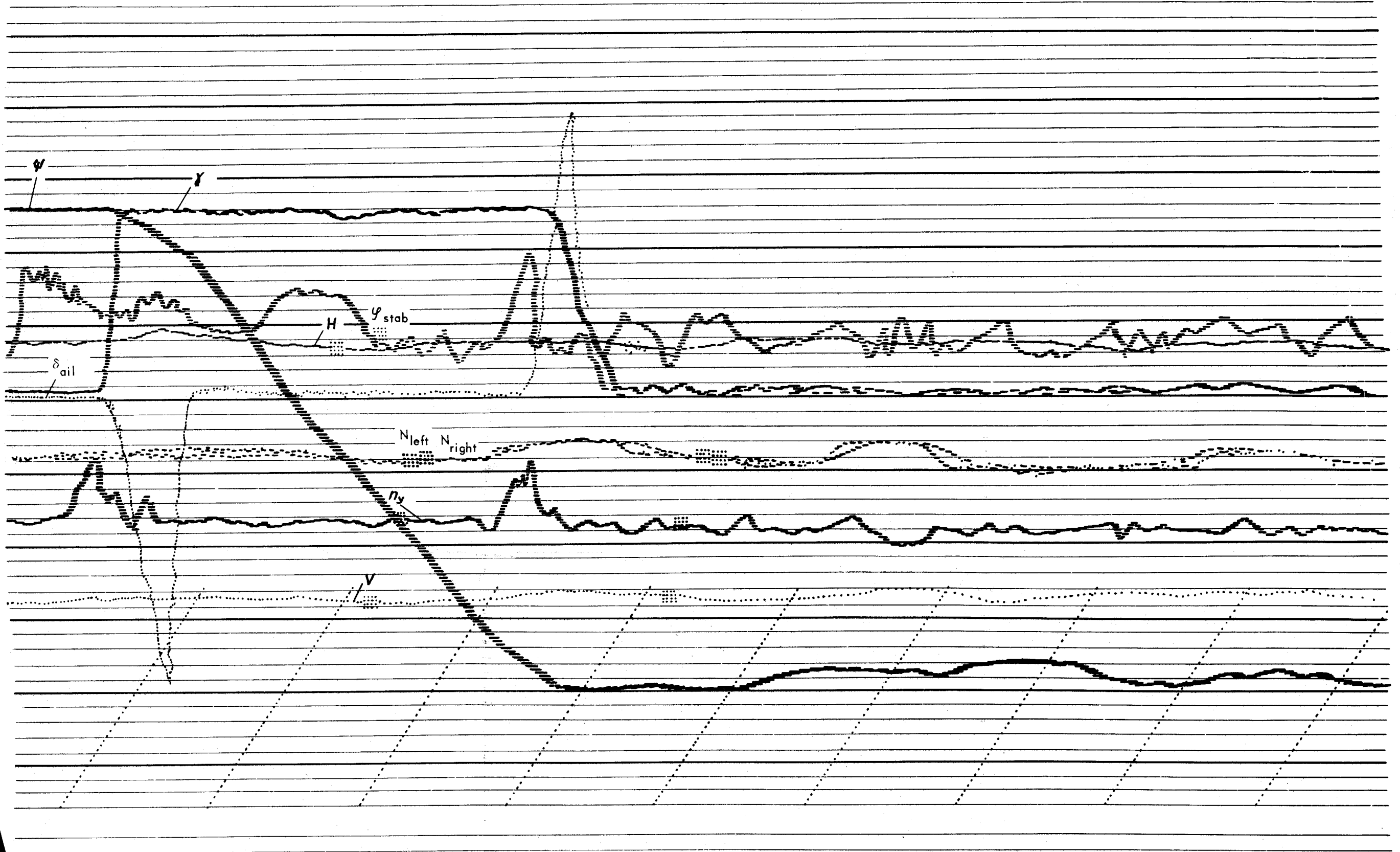

FIG. 169. EXAMPLE OF 360° TURN SIGNAL RECORD



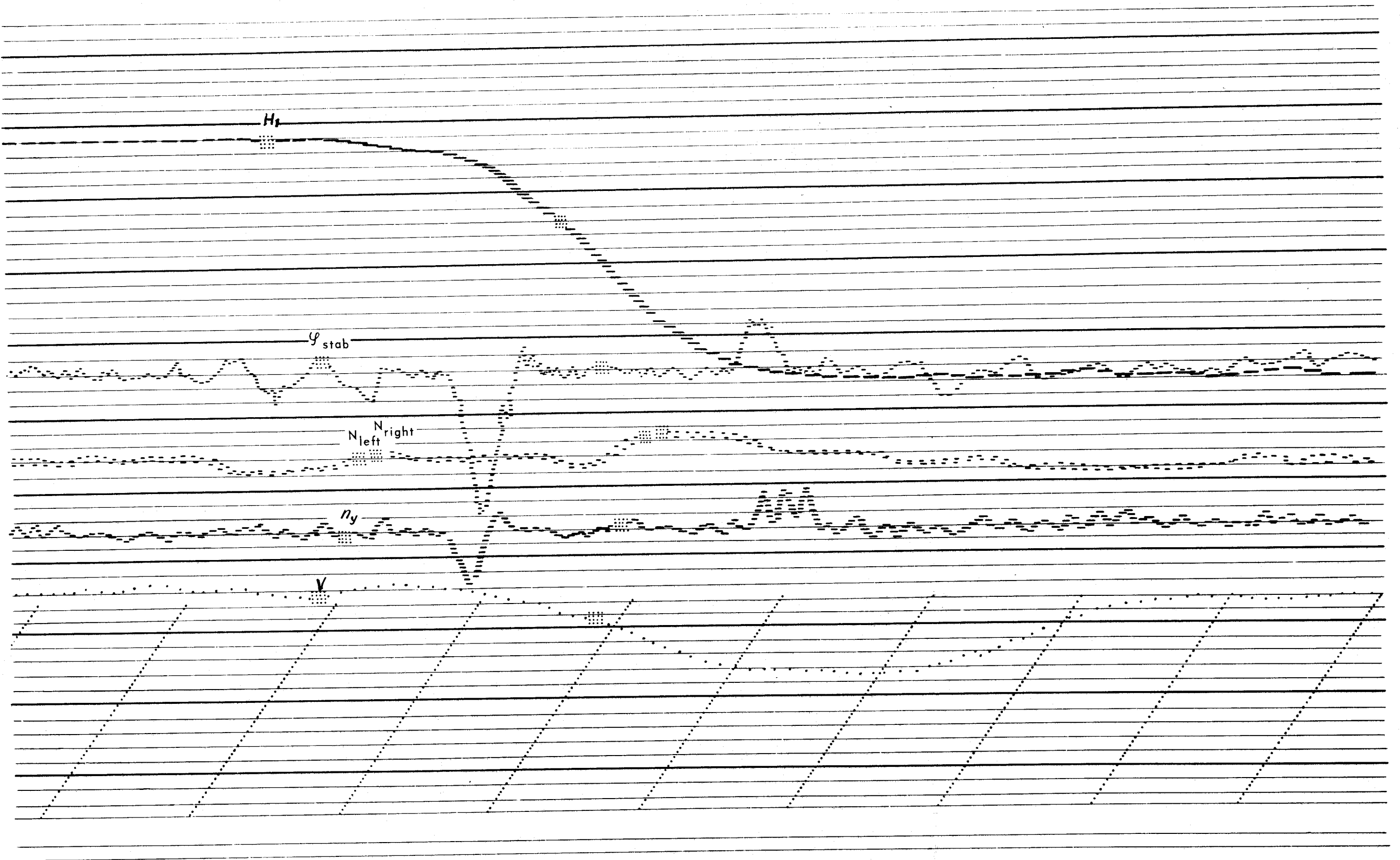

FIG. 172. EXAMPLE OF DIVE SIGNAL RECORD

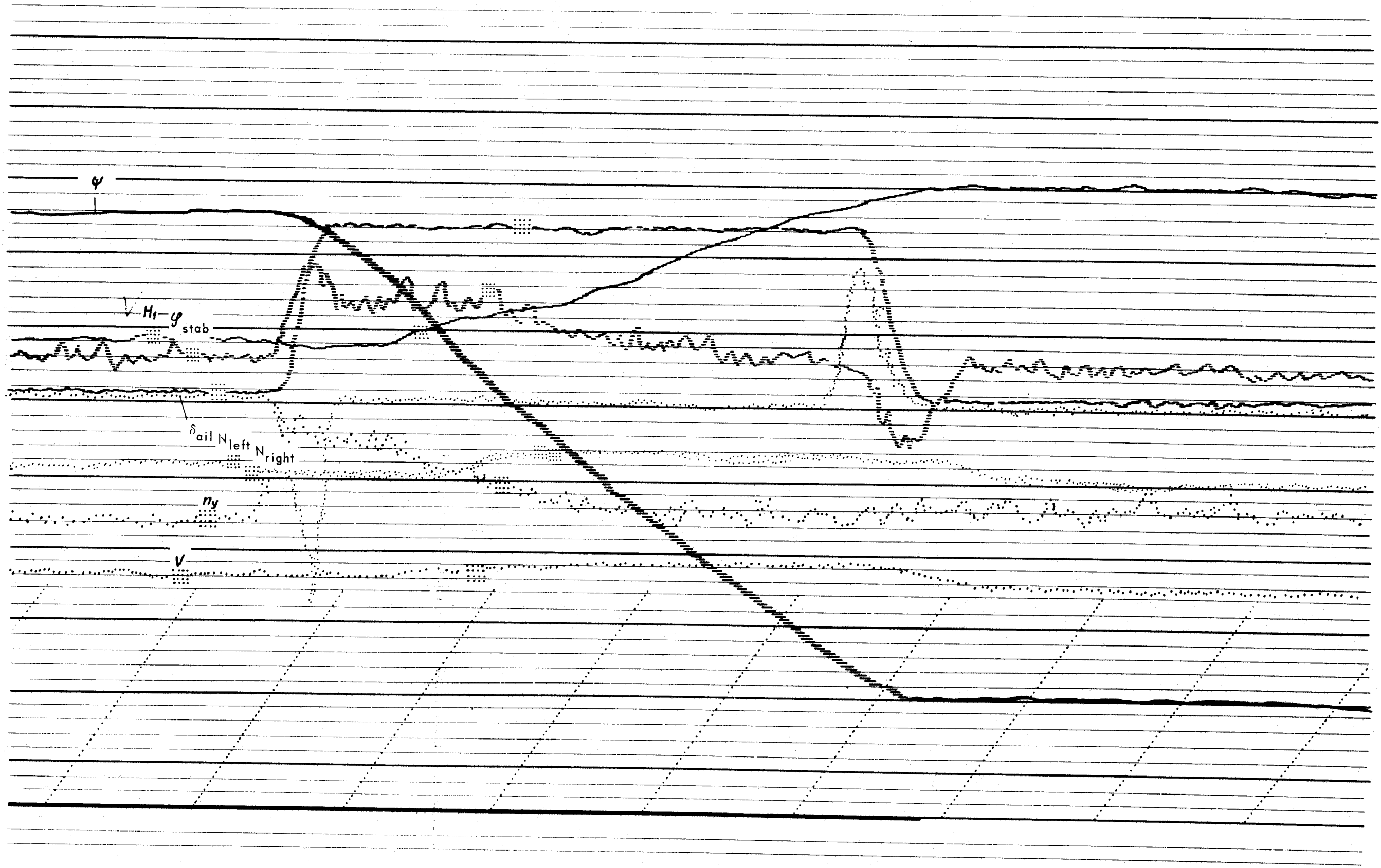

FIG. 171. EXAMPLE OF CHANDELLE SIGNAL RECORD

ling-off as the main criterion. The moment of starting dive recovery can be determined by a characteristic stabilizer deflection and increase in normal  $g$ -load.

Landing performing analysis. Landing is one of the most important stages of flight. Therefore, performing of landing should be analysed in detail with the use of the respective data recording (Fig. 173). The moments of extension of the landing gear and flaps are determined by the following symptoms:

- (1) change in longitudinal  $g$ -load;
- (2) increase in engine speed;
- (3) stabilizer deflection for compensation of aerodynamic moments.

In landing approach glide the flying speed and altitude change very smoothly and the normal  $g$ -load remains unchanged and approximates 1  $g$ . A considerable change in the engine speed is indicative of an incorrect maintaining of the glide speed caused due to an insufficient control, diverting an attention from the instruments or improper distribution of attention.

Decrease in speed usually corresponds to fluctuation of the stabilizer deflection angle.

A thorough analysis of the signal records makes it possible to reveal the main cause of mistakes committed by the pilot in landing approach gliding and enhance flight safety.

The moment of the runway touchdown is determined by oscillation of the normal  $g$ -load record line. The moment of deployment of the drag chute is determined by an intensive increase in the absolute value of the longitudinal  $g$ -load.

#### 4. EVALUATION OF COMBAT FLIGHT RESULTS BY USE OF FLIGHT DATA RECORDS

The results of the combat flight are evaluated referring to the signal records plotted by the TESTER-Y3-II recorder (see Figs 174 to 176) or referring to the film pictures made by the IAY-473 camera gun. The evaluation is accomplished in several stages.

Stage 1. Evaluation of the flight control technique quality at the direction stage starts with tracing the  $H_{\text{preset}}$  command (see parameter No. 20, Table 20). Generation of this command corresponds to a jump of parameter  $\xi_{\text{long}}$ . Record of

parameter  $\delta_{\text{long}}$  is used for evaluation of speed stabilization quality (Mach number) before generation of the  $H_{\text{preset}}$  command whereas the flight altitude stabilization quality is evaluated in the settled mode after generation of the  $H_{\text{preset}}$  command.

The flying technique is considered normal if  $\Delta M \leq \pm 0.06$  of  $M_{\text{preset}}$ ,  $\Delta H_{\text{alt}} \leq \pm 300$  m when  $1.5 \text{ km} < H_{\text{ftr}} < 10 \text{ km}$  and  $\Delta H_{\text{alt}} \leq \pm 500$  m when  $H_{\text{ftr}} > 10 \text{ km}$ . In this case, the normal g-load signal should be reduced to a near-zero value  $\Delta n_y \leq \pm 0.3$ . Transient process from the speed stabilization mode to the altitude stabilization one continues 30 s, maximum.

Evaluation of the flight control technique quality in lateral channel is accomplished referring to parameters  $\delta_{\text{lat}}$  and  $\Delta \gamma$ . The flying technique is considered normal if resulted misalignments  $\Delta \Psi$  (correspond to yaw commands) are reduced to near-zero values and in level flight ( $\gamma = 0^\circ$ ) with constant heading ( $\psi = \text{const}$ ) the yaw misalignment is maintained  $\Delta \Psi \leq 2^\circ$ . In this case, the bank signal should be reduced to near-zero values.

At the airborne direction stage (after the target is locked on by the airborne radar), the flying technique quality is evaluated referring to flying errors  $\delta_v$  and  $\delta_h$  in the longitudinal and lateral channels. The errors are determined by deflection of the small electronic ring from the center of the cross-hairs on the film picture made by the PAV-473 camera gun.

Stage 2. Evaluation of the parameters recorded on the signal record is performed to analyze the operating mode of the airborne radar referring to the following indications:

- if during scan the value of parameter  $\varphi_{\text{hor}}$  is maximum, the airborne radar is controlled manually whereas if the value of parameter  $\varphi_{\text{hor}}$  is minimum the airborne radar is controlled automatically;

- the values of parameters  $H_{\text{ftr}}$  and  $\varphi_{\text{vert } 1}$ . These parameter values are calculated from the formula:

$$\varphi_{\text{tilt}} = \varphi_{\text{vert } 1} + \nu - \mu,$$

where  $\nu$  is the fighter pitch and  $\mu$  is the antenna setting angle equal to  $4^\circ$ .

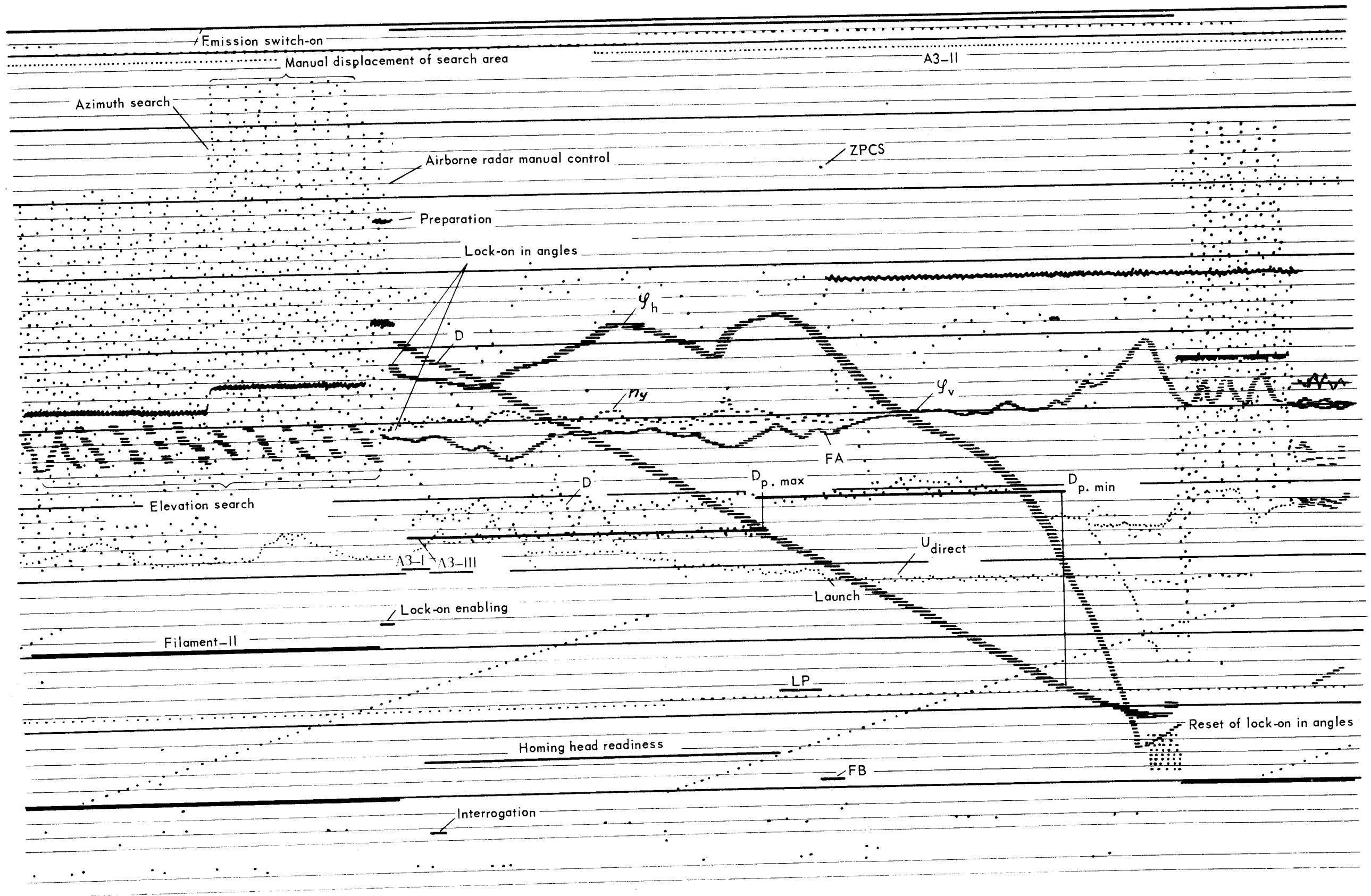

FIG. 174. EXAMPLE OF COMBAT EMPLOYMENT SIGNAL RECORD

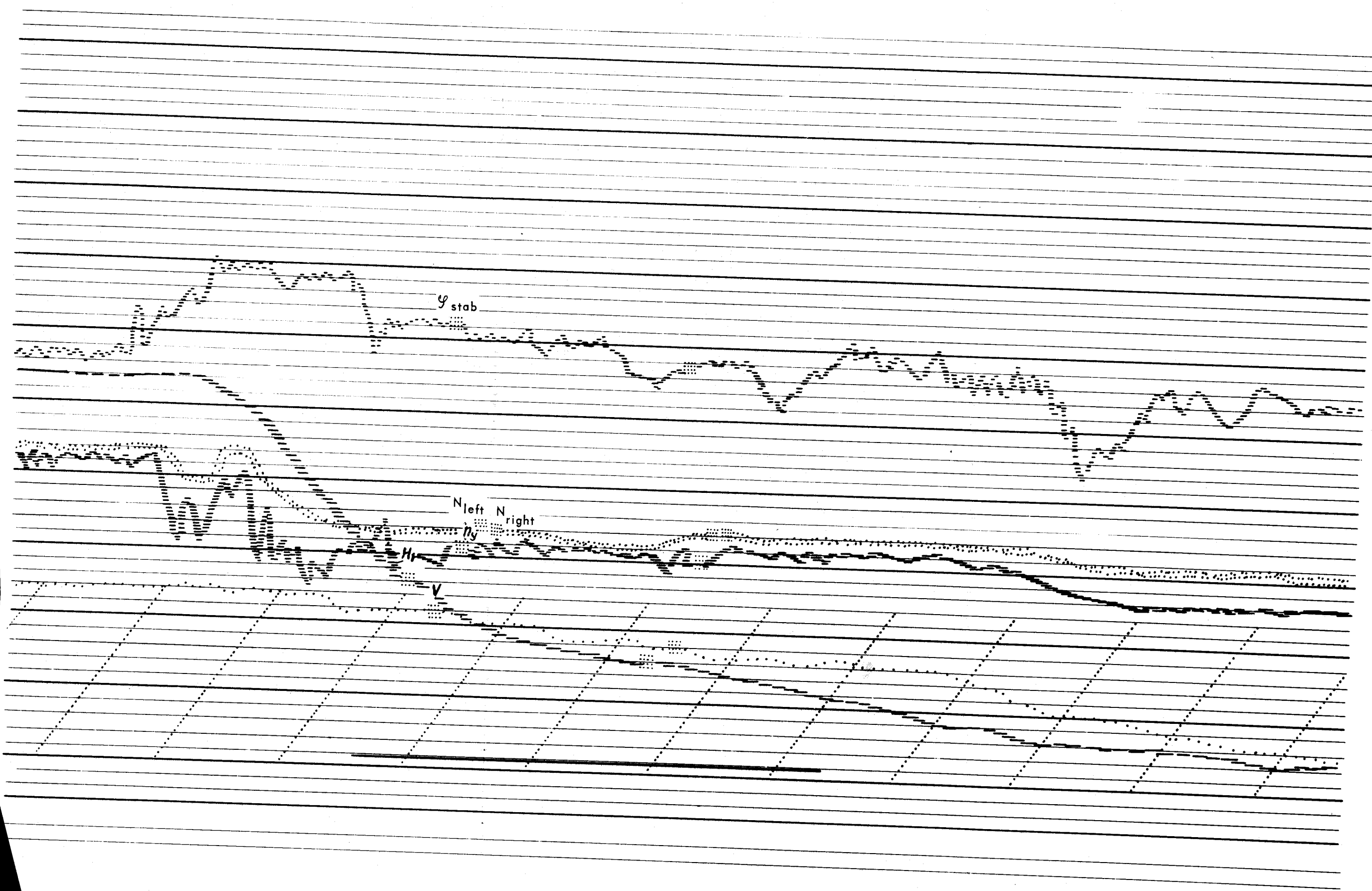

FIG. 173. EXAMPLE OF LANDING SIGNAL RECORD

ZPCS

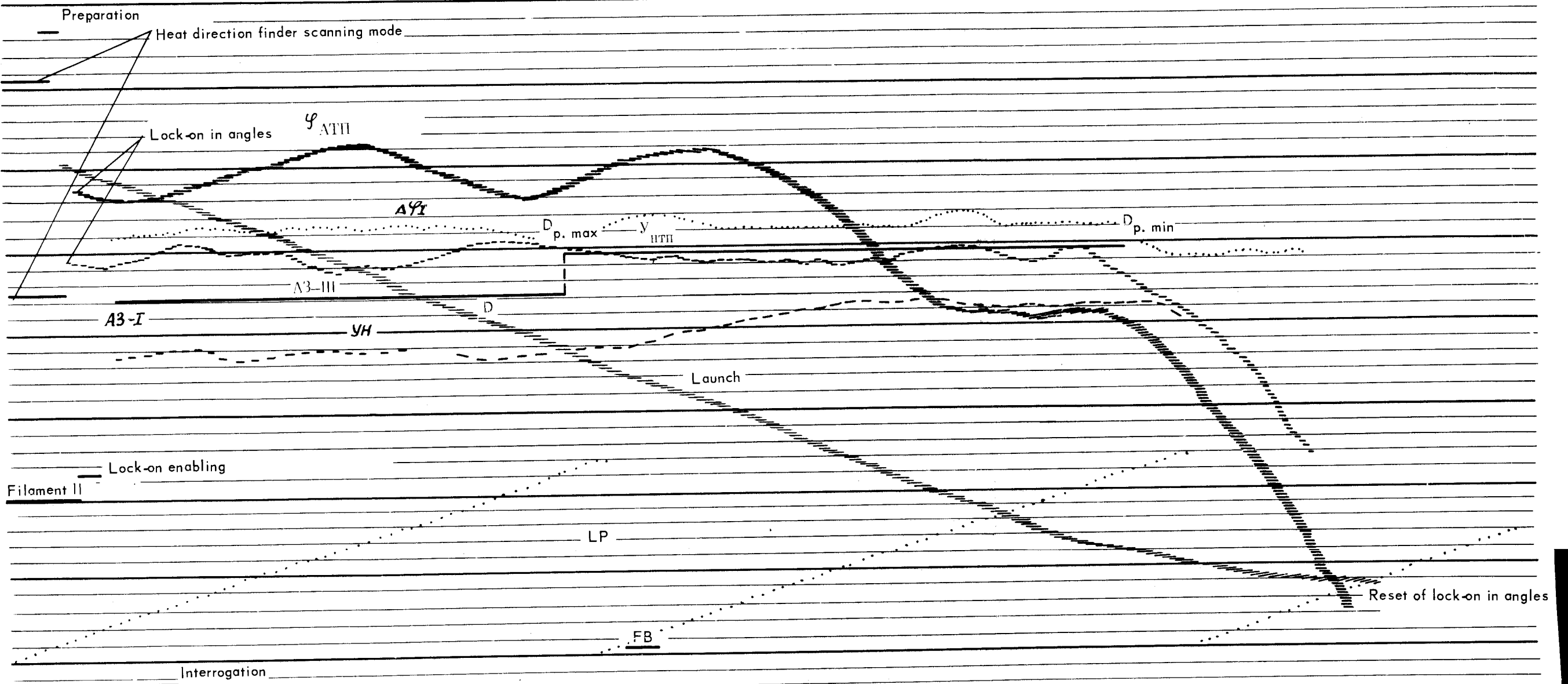

FIG. 176. EXAMPLE OF COMBAT EMPLOYMENT SIGNAL RECORD

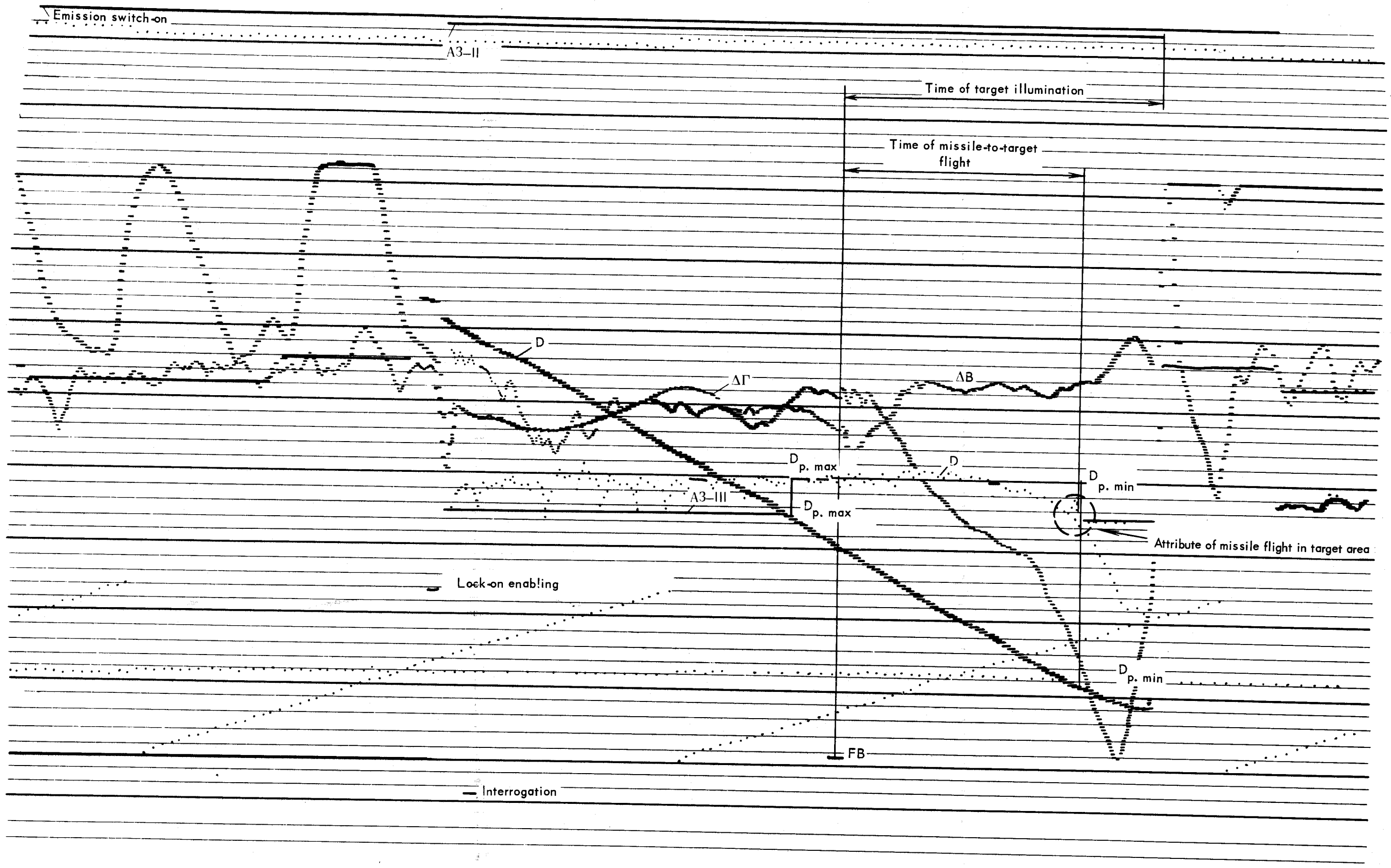

FIG. 175. EXAMPLE OF COMBAT EMPLOYMENT SIGNAL RECORD



The antenna beam tilt angle is measured from the horizon line for the respective operating mode of the airborne radar. For instance, the HMA mode is characterized by fighter flying altitude  $1.5 \text{ km} < H_{\text{ftr}} < 4.2 \text{ km}$  and antenna beam tilt angle relative to horizon line  $\delta_{\text{tilt}} > 2.3^\circ$ ; the HMA- $\Delta$ H mode is characterized by fighter flying altitude  $1.5 \text{ km} < H_{\text{ftr}} < 4.2 \text{ km}$  and antenna beam tilt angle relative to horizon  $\varphi_{\text{tilt}} < 2.3^\circ$ .

If  $H_{\text{ftr}} < 1.5 \text{ km}$ , enabling of the MLA and LA modes may be determined from the position of the scan area relative to the horizon line. If the lower line of the scan area is higher than the horizon line by  $1.5^\circ$  and more, the airborne radar operates in the MLA mode. In the LA mode, the upper line of the scan area is lower than the horizon line by  $0.5^\circ$ .

In the tracking mode, when  $H_{\text{ftr}} < 1.5 \text{ km}$ , the MLA mode is selected if  $\varphi_{\text{tilt}} > 0^\circ$ , and the LA mode is selected if  $\varphi_{\text{tilt}} < 0^\circ$  relative to the horizon line. As the LA mode is selected it is interlocked.

Evaluation of range finder autotracking quality is performed referring to parameter D. The rate of change of the parameter should be within the limits  $\pm 40 \text{ m/s}$ .

The value of parameter D should correspond to the actual fighter-to-target closing rate.

The indications of false target lock-on and autotracking are the following:

- sharp fluctuations and spikes of the signal, which do not correspond to the actual closing rate;
- equality of the closing rate and fighter airspeed (if such equality is impossible under the actual attack conditions);
- sharp overshoots of the parameter signal toward positive values (lag behind the target).

The following values may be determined referring to parameter D (distance) represented on a signal record:

- illumination cut-in distance;
- lock-on and reset distance;
- $D_p$  command generation/removal distance;
- "Zoom" command generation distance (spike of parameter  $\Delta_{\text{vert}}$ ).

Evaluation of target autotracking quality by angular coordinates is performed by reference to change of parameters

$\varphi_{\text{VERT}}$ ,  $\varphi_{\text{HOR}}$ ,  $W_{\text{elev}}$ ,  $W_{\text{az}}$ .

Tolerable oscillations of the airborne radar antenna are  $2^\circ$ , maximum.

Parameters  $\Delta \text{VERT}$  and  $\Delta \text{HOR}$  are used to determine the sighting errors. If the sighting errors are large the launching distance becomes shorter.

Stage 3. During the attack with employment of a heat direction finder the analysis of the signal record makes it possible to determine the phenomena of target lock-on and autotracking by the heat direction finder from the following indications:

- lock-on permitted" command supplied from discrete command set PK-1;
- parameter  $U_{\text{direct}}$  (the value of this parameter is arbitrary and does not reflect actual target distance);
- change of parameters  $\varphi_{\text{az HDF}}$  and  $\varphi_{\text{elev HDF}}$ .

Serviceability of the heat direction finder and its sighting quality are fully evaluated during integrated analysis of the information obtained from the  $\text{PAV-473}$  camera gun and  $\text{TESTER-V3-N}$  recorder.

Timing of the film pictures made by the  $\text{PAV-473}$  camera gun and signal record of the  $\text{TESTER-V3-N}$  recorder is performed referring to the photo attachment shutter operation marks recorded on the signal record (CG discrete command).

Note. The shutter operation signal repetition frequency is 2.5 s, missed marks (CG discrete commands) should be recorded manually on the signal record.

Stage 4. Evaluation of missile launch preparation procedure and results of the launch is based on information regarding store version and decoding of missile discrete commands PK46-I and PK62-I recorded on the signal record. Sequence and time intervals of the commands should be in compliance with the pre-launch missile preparation schedules. The heat direction finder sighting mode (position  $\varphi_b$  or  $\varphi_o$ ) is determined from the "Filament-II" and "Preparation" commands enabling sequence and from generation of the " $\varphi_o$ " and "HDF" discrete commands.

Correctness of scanning of the infrared homing head of missile P-40TH (before generation of the "HDF" command) is checked referring to parameters  $\Delta \varphi_I$  and  $\Delta \varphi_{II}$  in the following sequence:

- determine the field of lock-on in each channel (variations in parameters  $\Delta\varphi_I$  and  $\Delta\varphi_{II}$  within  $\pm 2.5$  to  $4^\circ$  are tolerable);
- calculate the rate of forced drift (the rate of 1.5 to  $2^\circ/s$  is tolerable);
- check accuracy of the armament system adjustment for missiles P-40TH referring to parameters  $\Delta\varphi_I$  and  $\Delta\varphi_{II}$  during the target autotracking (generation of the PR and LP commands). Maximum deviation of the values from the zero should not exceed 80 (when measuring, the values the RF oscillations should be averaged).

Lock-on of true or false target is determined on the signal record from the values of parameters CA,  $\Delta\varphi_I$  and  $\Delta\varphi_{II}$  during autotracking by the infrared homing head of missile P-40TH. Indications of true target autotracking are the following:

- rise of CA signal level due to decrease of the target distance (without the aspect angle changing considerably);
- presence of AC component of 7 to 10 Hz in signals  $\Delta\varphi_I$ ,  $\Delta\varphi_{II}$  and CA. The AC component rises as a function of target echo volume.

Indication of false target autotracking are the following:

- absence of the CA signal volume rise as the fighter approaches the target, irregular spikes of this signal;
- partial reaiming of the infrared homing head due to "droop" in azimuth and elevation, evaluated from increase of parameters  $\Delta\varphi_I$  and  $\Delta\varphi_{II}$ ;
- sharp spikes of signals  $\Delta\varphi_I$ ,  $\Delta\varphi_{II}$  which may occur due to IR jamming.

Sun/Moon lock-on within their  $\pm 30$ -deg bearing range is characterized by sharp rise of the CA signal up to the clipping level.

Sharp decrease of the CA signal and associating collapse of target autotracking by the infrared homing head may occur in the following cases:

- target cloud shielding;
- target shading by the fighter fuselage. The angles of shading are the following:

$$\varphi_{\text{hor I shade}} \geq \pm 18^\circ \text{ when } \varphi_{\text{VERT I}} = 0 \text{ to } 10^\circ;$$

$$\varphi_{\text{hor I shade}} \geq \pm 22^\circ \text{ when } \varphi_{\text{VERT I}} > 10^\circ.$$

Tuning accuracy of the radar homing head of the P-40PA missile to the carrier frequency is evaluated on the signal record referring to the AFC signal which should be 1 V, maximum, by the moment of the LP command generation.

After generation of discrete command A3-III, the change of parameter  $mF_{msl}$  is used for checking the radar homing head autoselector for proper frequency follow-up which corresponds to the design closing rate ( $\dot{D}$ ). The  $mF_{msl}$  signal record should exactly following the changes of the  $\dot{D}$  signal record. The value of the  $\dot{D}$  signal is calculated from the following formula:

$$\dot{D} \text{ (m/s)} = mF_{msl} \text{ (kHz)} \times 5.$$

Parameters  $E_y$  and  $E_z$  are used to check correctness of angular target designation signals transmitted from the airborne radar to the infrared homing heads of the P-60 or P-60M missiles as the "Selection 62" command is supplied. The infrared homing head of the P-60 missile receives the signals of target designation with the preset accuracy within a range of  $\pm 12^\circ$ , and that of the M-60M missile, within a range of  $\pm 20^\circ$ .

The record of parameter  $\dot{\Omega}_{polar}$  is analysed to determine the moment of true target lock-on for autotracking by the infrared homing head of the P-60 missile. The lock-on is characterized by smooth changing of parameter  $\dot{\Omega}_{polar}$  (without spikes).

Serviceability of the missiles is evaluated by reference to the records of the PR and LP discrete commands. The missile launching moment is determined by presence of the FB and "Launch" commands.

The target stepped-up or stepped-down vertical separation relative to the fighter ( $\Delta H$ ) at the moment of the missile lift-off is estimated from the distance ( $D$ ) at the moment of the missile launch and sighting angle ( $\varphi_{vert}$ ) using the following formula:

$$\Delta H = D \sin \varphi_{vert}$$

A fact of the missile guidance to the target after the missile lift-off (engagement of the target) may be determined from a specific spike of the  $\dot{D}$  signal and sharp bend of the  $D$  signal record at the moment of the missile fly-by (explosion) near the target.

## 5. PRESENTATION OF ANALYSIS RESULTS

The results of combat flight analysis and evaluation of the flying technique are entered in special log books. The results are tabulated. The recommended table forms are listed in the Appendix (Tables 22 and 23). The remarks on operation of the aircraft systems and pilot's activity and deviations from the flying mission conditions are to be entered in the "Remarks" column.

The signal records of the TESTER-V3-II recorder should have a legend containing the following information: flight date, aircraft number, flight number, calibration chart number, pilot's name, attack number (if two or more attacks are performed). Besides, the film of the MAV-473 camera gun should bear inscriptions START and END.

Signs of the parameters on the signal record and other service marks should be made with a lead pencil only.

*Appendix*

**RECOMMENDED FORMS  
OF TABLES CONTAINING  
RESULTS OF COMBAT FLIGHT**

Table 22

Date, aircraft No., flight departure, attack No., meteorological conditions, pilot's name	Target type, H <sub>tgt</sub> , V <sub>tgt</sub> , hemisphere	Direction mode Control	D <sub>lock-on</sub> D <sub>prm max</sub>	D <sub>lf</sub>	D <sub>lp</sub>	t <sub>fb</sub> t <sub>illum</sub>	Missile lift-off moment						Main results, Remarks	
							H <sub>ftr</sub>	$\frac{\dot{D}}{D}$	$\frac{n_y}{\gamma}$	$\frac{v}{\psi_{ftr}}$	$\frac{\Delta VERT}{\Delta HOR}$	PK-II PK-III		FA LE
							V <sub>ftr</sub>							





## C O N T E N T S

	Page
Introduction .....	3
Brief Information on Aircraft Interception Complex МиГ-25-40Д (МиГ-25-40ДС) .....	5

## P a r t O n e

## FLYING TECHNIQUE AND AIR NAVIGATION

Chapter 1. Aircraft Aerodynamics .....	9
1. Aerodynamic Characteristics .....	9
2. Aircraft Maneuvering Characteristics .....	33
3. Aircraft Stability and Controllability .....	47
Chapter 2. Aircraft Automatic Flight Control System .....	77
1. General .....	77
2. Use of Autonomous Modes of Automatic Flight Control System .....	80
3. Use of External Modes of Automatic Flight Control System .....	84
4. Automatic Flight Control System and Flight Safety ..	100
Chapter 3. Daylight Flying under VFR Conditions .....	105
1. General .....	105
2. Circling Flight .....	106
3. Maneuvering Flights .....	125
4. Flights at High Altitudes and in Stratosphere at Supersonic Airspeeds .....	151
5. Recommendations to Commander (Instructor) on Train- ing and Mastering of Flying Technique .....	168

	Page
Chapter 4. Air Navigation .....	174
1. General .....	174
2. Complex System POLJOT-1M and Its Employment .....	175
3. Performing En-Route Flight .....	191
4. Peculiarities Involved in Air Navigation under Various Conditions .....	214
5. Recommendations to Commander (Instructor) on Train- ing Pilots in Air Navigation .....	222
Chapter 5. Daylight Flying under IFR Conditions .....	225
1. Peculiarities Involved in Instrument Flights .....	225
2. Principles of Pilot's Attention Distribution during Instrument Flights .....	228
3. Flights in Maneuvering Area for Practising Instrument Flying Technique .....	232
4. Aircraft Recovery from Abnormal Attitude .....	242
5. Performing Flight on Duplicating Instruments .....	243
6. Landing Approach to Programmed Airfield with Use of POLJOT-1M System .....	248
7. Instrument Approach with Use of Automatic Direction Finder .....	259
8. Landing Approach with Use of Ground-Based Radio Direction Finder .....	280
9. Recommendations to Commander (Instructor) on Train- ing Pilots in Flying under IFR Conditions .....	281
Chapter 6. Formation Flights .....	288
1. General .....	288
2. Twin Flight .....	290
3. Section Flights .....	299
4. Formation Flights under IFR Conditions .....	304
5. Recommendations to Commander (Instructor) on Train- ing Pilots in Formation Flights .....	319
Chapter 7. Individual Night Flying under VFR and IFR Conditions .....	323
1. Physiological Peculiarities Involved in Night Flying .....	323
2. Peculiarities of Circling Flights .....	324
3. Peculiarities Involved in Landing on Non-Floodlight- ed Runway, with Land/Taxi Lights Switched on .....	326
4. Peculiarities Involved in Night Maneuvering, Low- Altitude and Stratosphere Flights .....	328

	Page
5. Peculiarities Involved in Night Flights under IFR Conditions .....	330
6. Recommendations to Commander (Instructor) on Training Pilots in Night Flying .....	332

P a r t   T w o  
COMBAT EMPLOYMENT

Chapter 1. Combat Capabilities and Main Information on Armament of Fighter МиГ-25ПЦ (МиГ-25ПДС) .....	337
1. Combat Capabilities of Fighter МиГ-25ПЦ (МиГ-25ПДС) .....	337
2. Brief Description and Characteristics of Armament Control System C-25 .....	344
3. Purpose and Arrangement of Controls of Armament Control System C-25 .....	377
Chapter 2. Combat Employment of Armament Control System C-25 .....	384
1. Flight for Aerial Combat with Employment of Armament Control System C-25 in RDR Mode .....	384
2. Peculiarities of Employment of Airborne Radar SAPFIR-25 in Attack of Active and Passive Jamming Aircraft .....	403
3. Aerial Combat Flight with Employment of C-25 Armament Control System in Modes T-I and T-φ <sub>0</sub> I .....	417
4. Operational Check of Armament Control System C-25 in Flight .....	425
Chapter 3. Aerial Combat Flight .....	429
1. General .....	429
2. Aerial Combat at Medium and High Altitudes.....	432
3. Peculiarities of Performance of Aerial Combat Flights at Supersonic Airspeeds and Maximum Reference Altitude .....	494
4. Peculiarities Involved in Low-Altitude Aerial Combat Flight .....	500
Chapter 4. Peculiarities of Direction of Fighters МиГ-25ПЦ to Air Targets under Various Situation Conditions .....	513
1. Fighter Direction for Performing Attacks at Medium and High Altitudes .....	513
2. Direction of Fighters for Performing Attacks at Supersonic Airspeeds and Maximum Reference Altitude .....	527

	Page
3. Direction of Fighters for Performing Low-Altitude Attacks .....	531
Chapter 5. Flight Analysis with Use of Flight Data Recording Equipment .....	535
1. Purpose and Standard Set of Airborne Flight Data Recording Equipment .....	535
2. Procedure for Decoding Objective Check Results ...	536
3. Use of Objective Check Materials for Analysis and Evaluation of Flying Technique .....	560
4. Evaluation of Combat Flight Results by Use of Flight Data Records .....	563
5. Presentation of Analysis Results .....	569
Appendix. Recommended Forms of Tables Containing Results of Combat Flight .....	571

---

Методическое пособие  
по технике пилотирования  
и боевому применению  
самолета МиГ-25ПД  
(на английском языке)  
8/023190-184