

Mikoyan-Gurevich MiG-15

arts: Greg Reynolds

UNION OF SOVIET SOCIALIST REPUBLICS

Russian Aerobatic Team

Red upper surfaces, natural metal undersurfaces Black numbers
Insignia, red star outlined in white and bordered with a thin red line

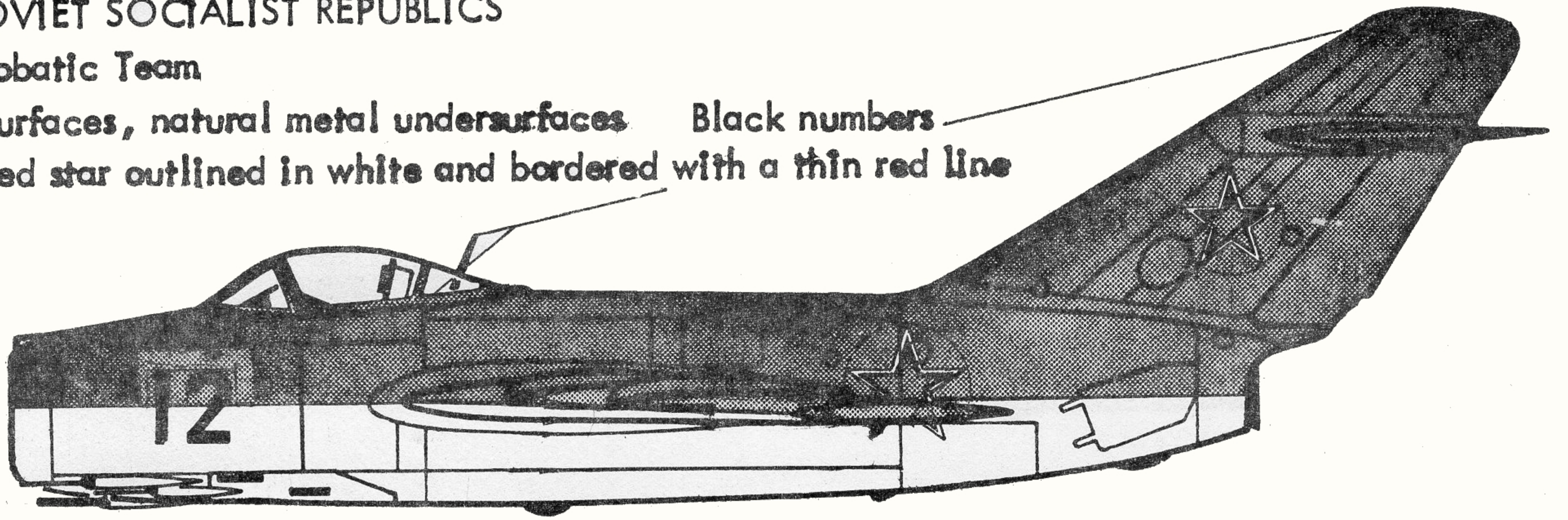

1/72 Scale

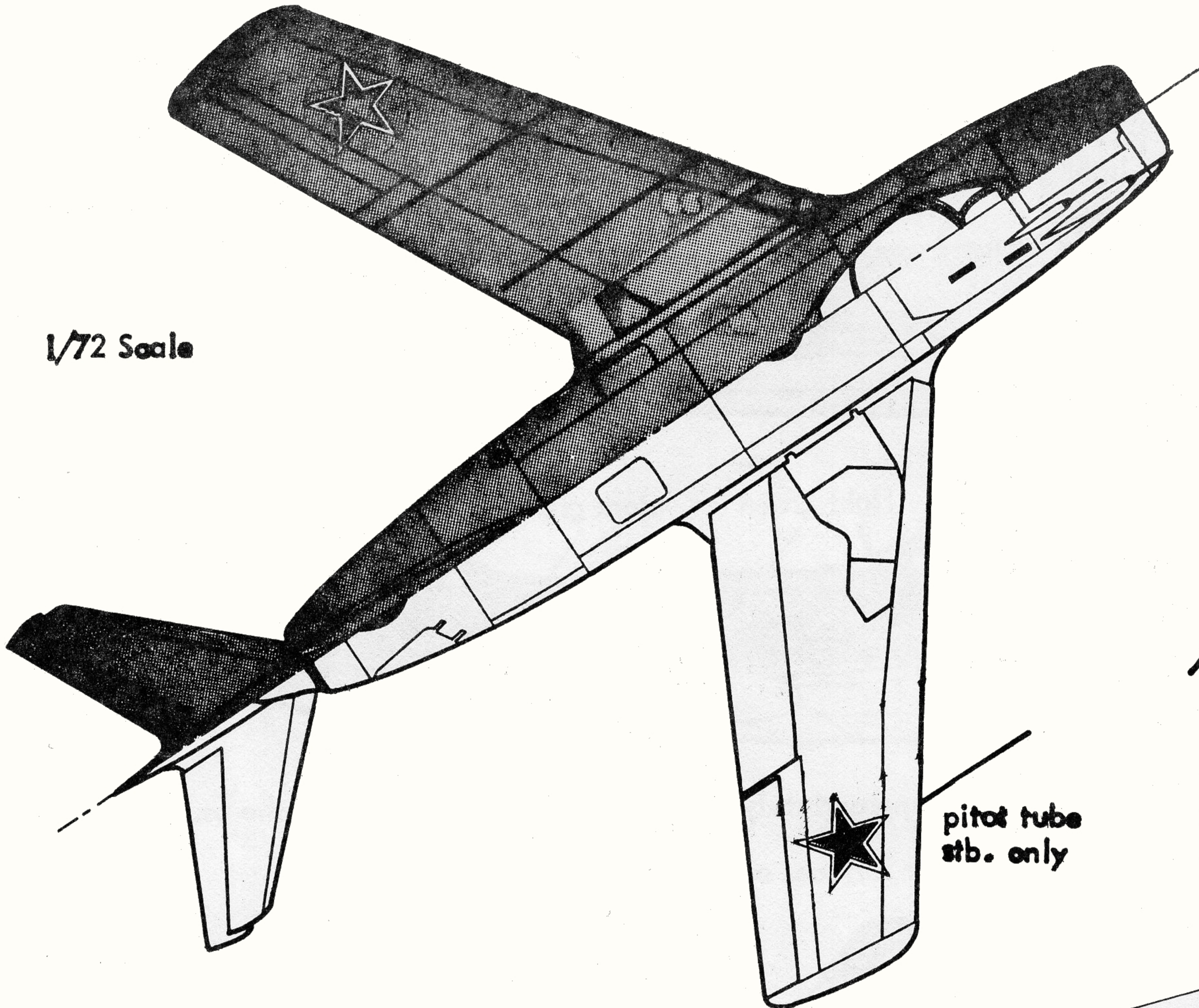

Top view of
UTI canopy

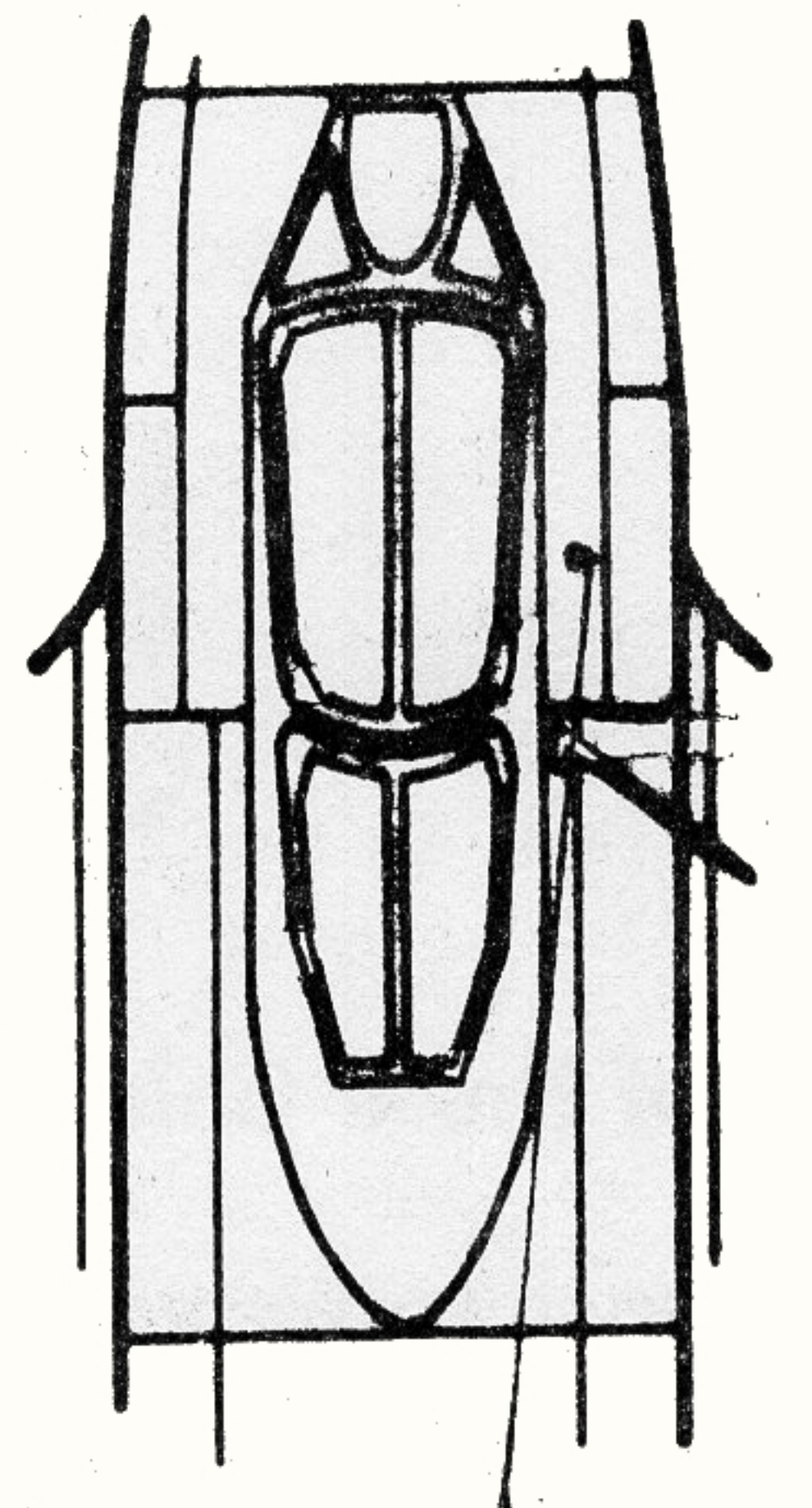

pitot tube
stb. only

GERMAN DEMOCRATIC REPUBLIC

East German MiG-15 UTI

Black numbers

All natural metal

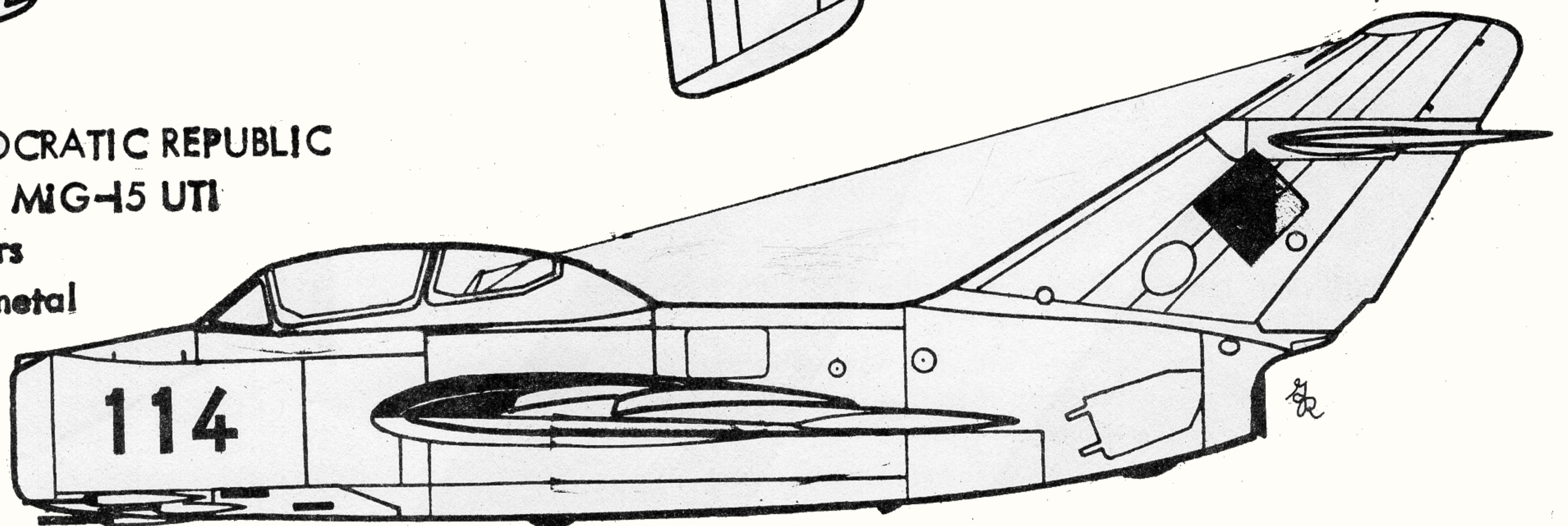

Lengthen Airfix body as given by Gerry Nilles and add an Airmodel conversion canopy

PEOPLE'S REPUBLIC OF CHINA
 Note positions of national insignia

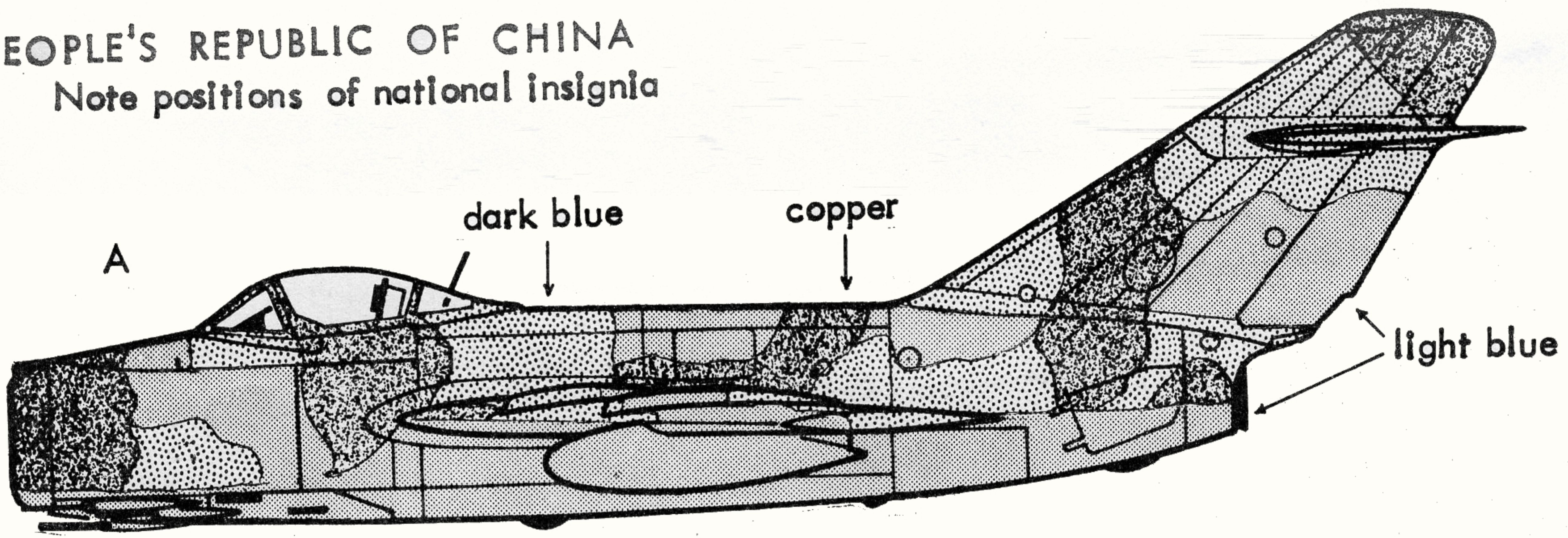

N.B. "Copper" is the word used in all our MiG-15 references, but a metallic color is unbelievable. We prefer to believe its really a warm dark brown

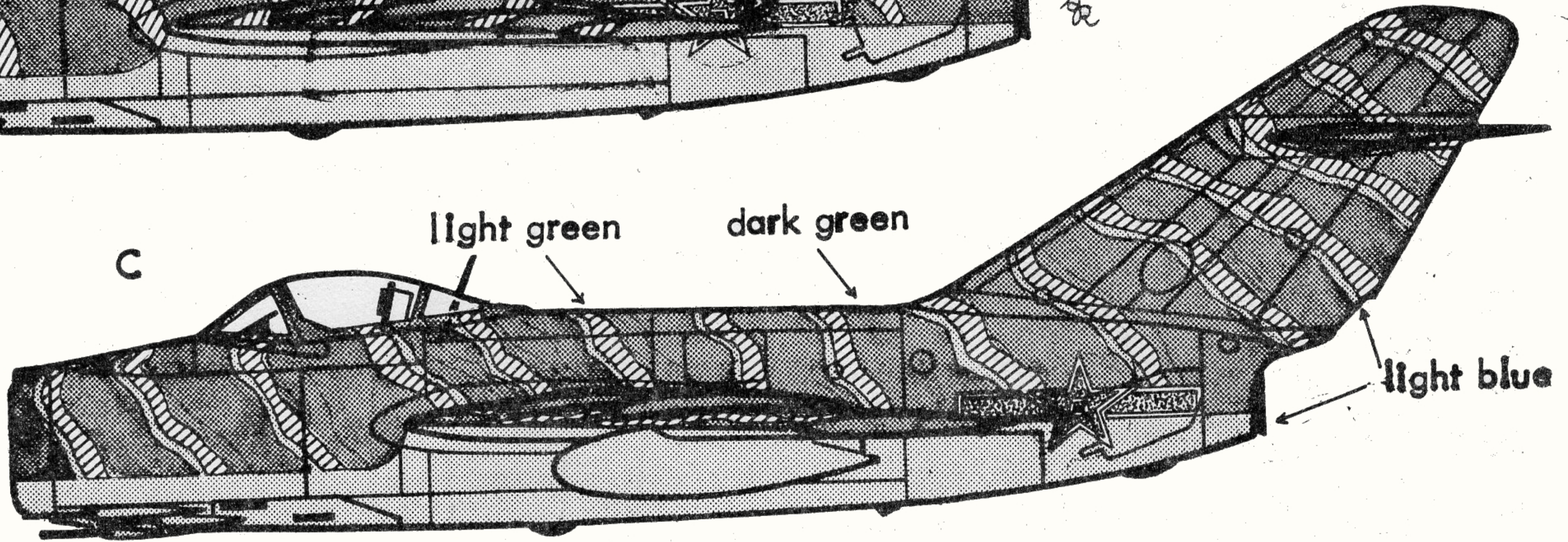
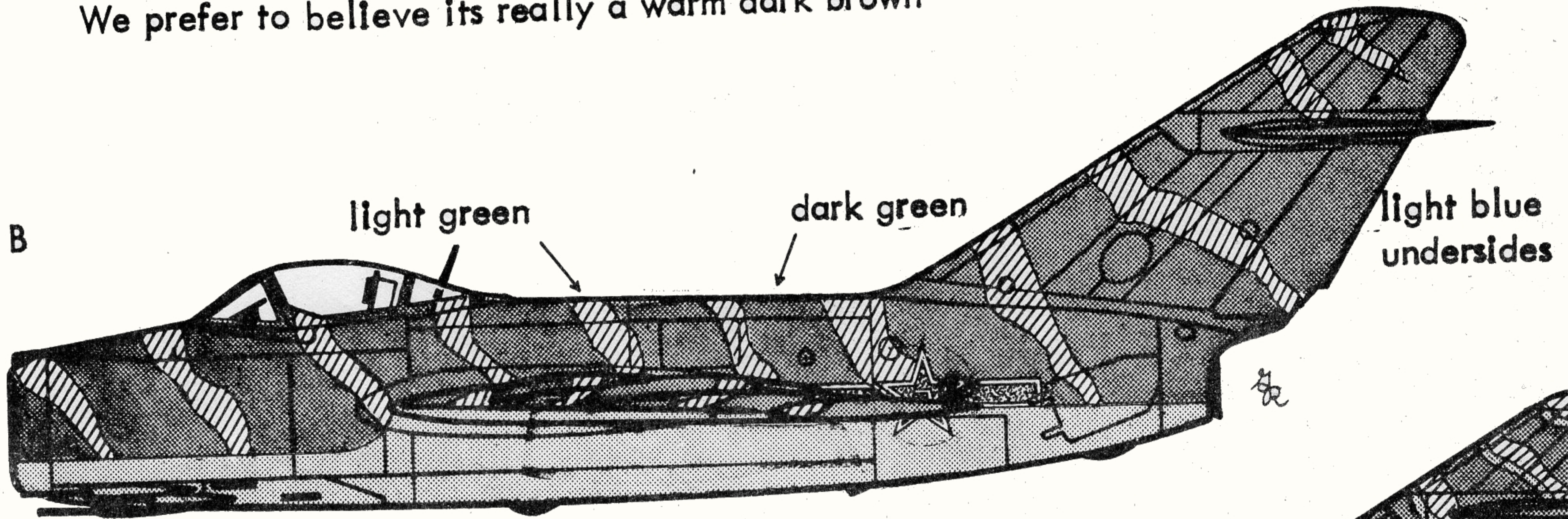

Any of these Chinese planes can also appropriately carry North Korean Insignia in the usual 6 places

Upper surfaces of B

Upper surfaces of C

Undersurface of A, B, and C

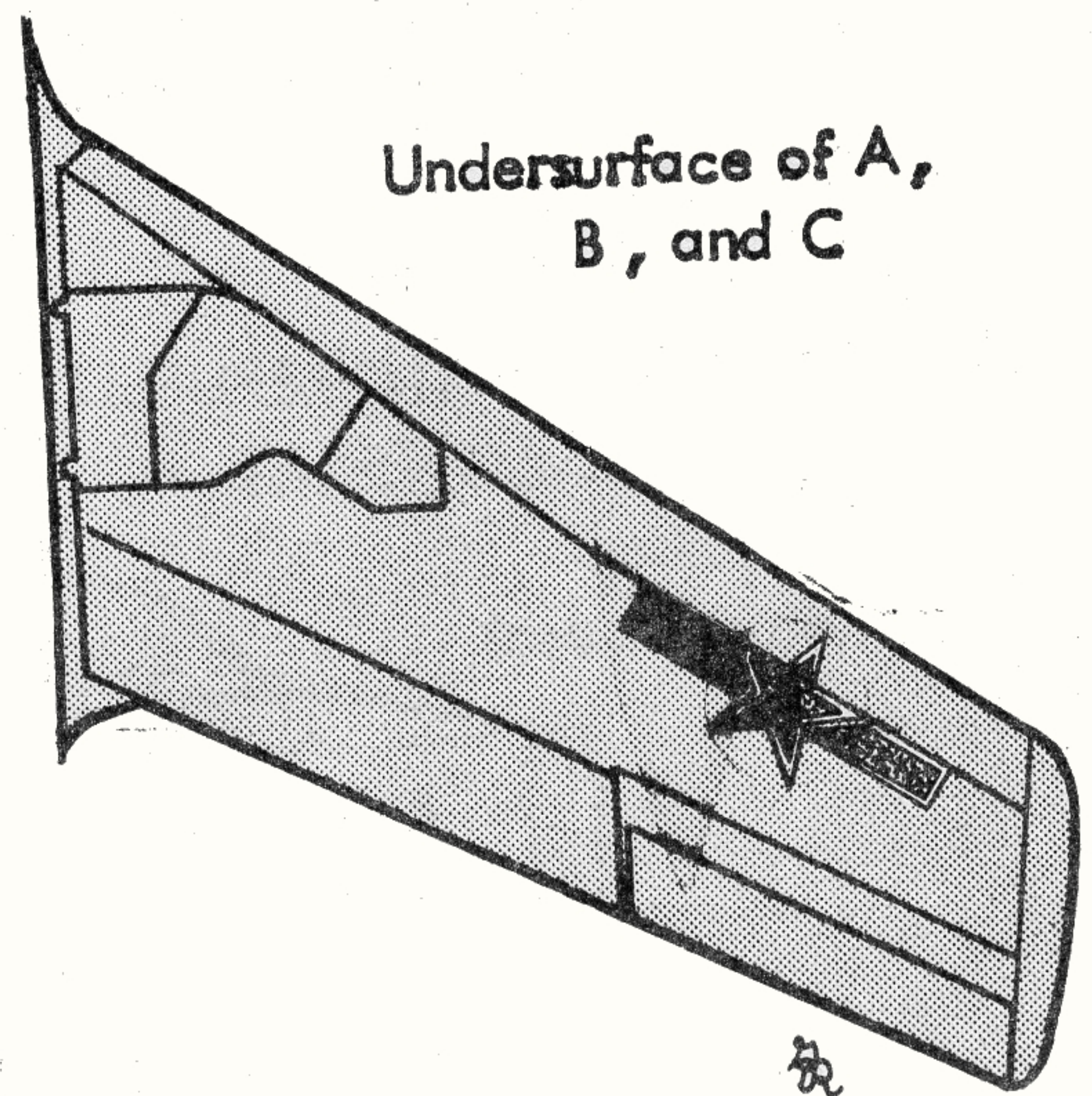
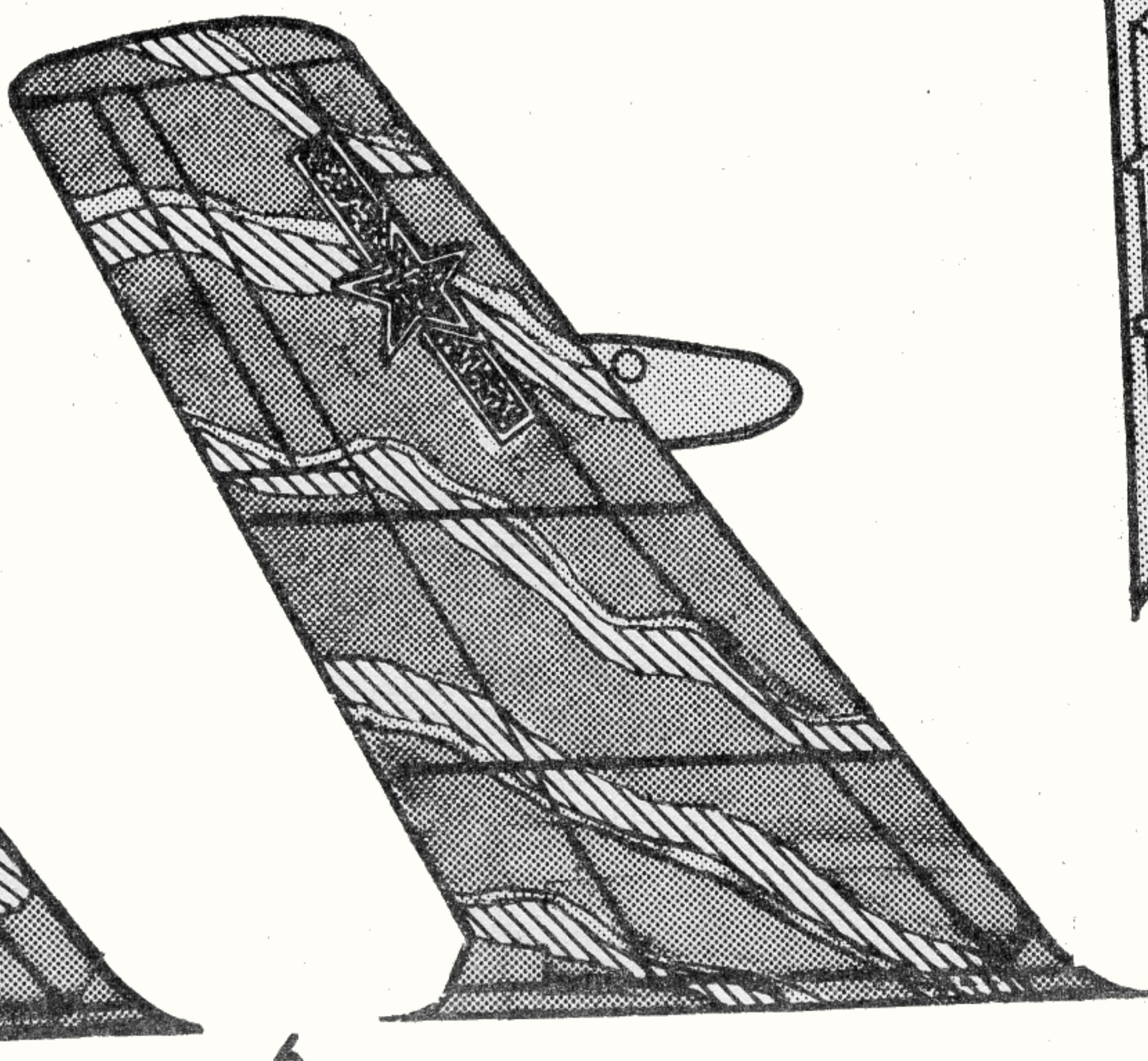
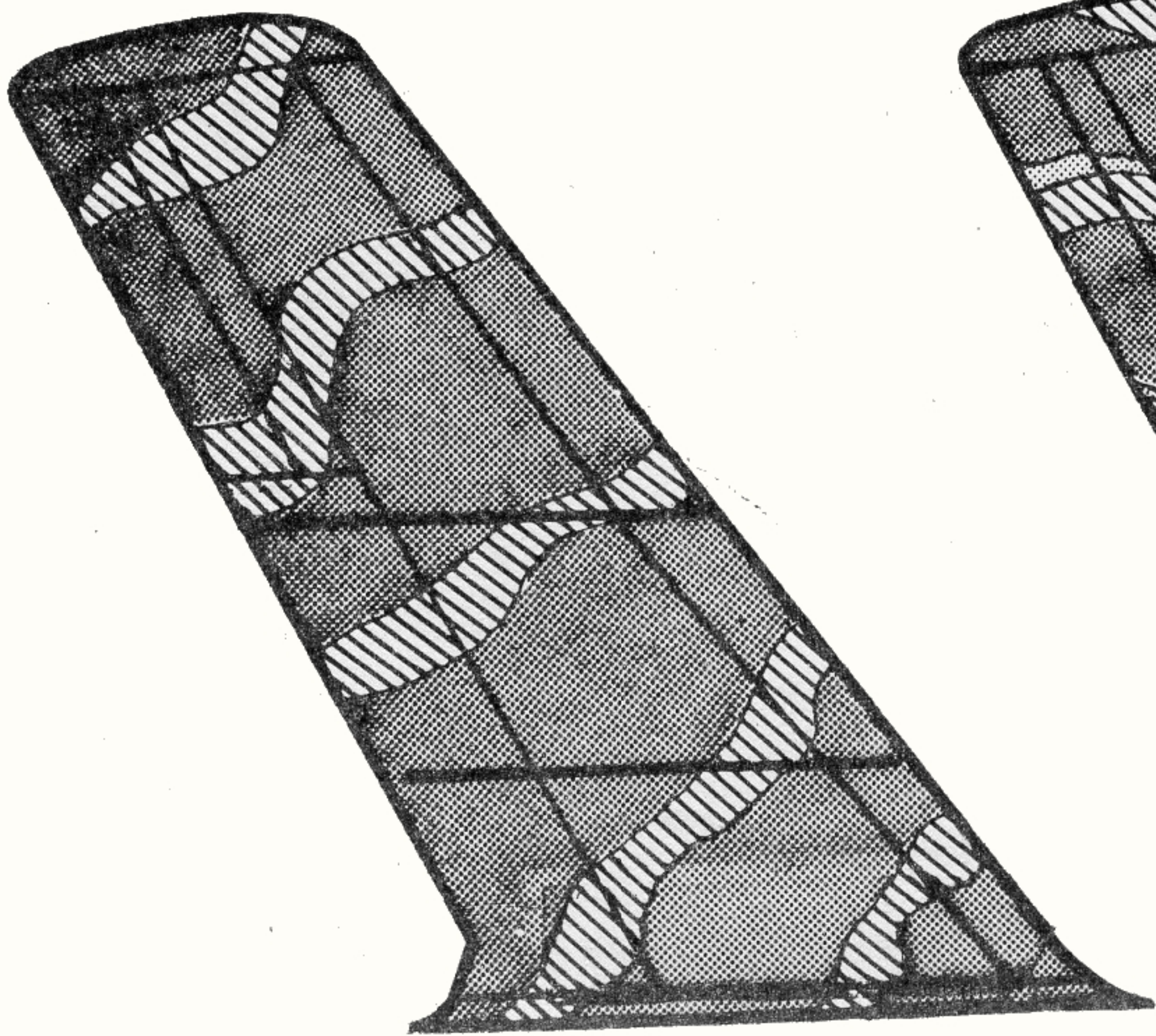

1/72 Scale

Chinese MiG-15s cont.

- Fuselage characters, badge and numbers both sides
- Small characters, both tanks, outside only
- All characters, the wings, horizontal tail, underside of nose, and tip of fin/rudder-red
- Black anti-glare panel and numbers
- National Insignia in six places
- Body and lower fin and rudder-natural metal

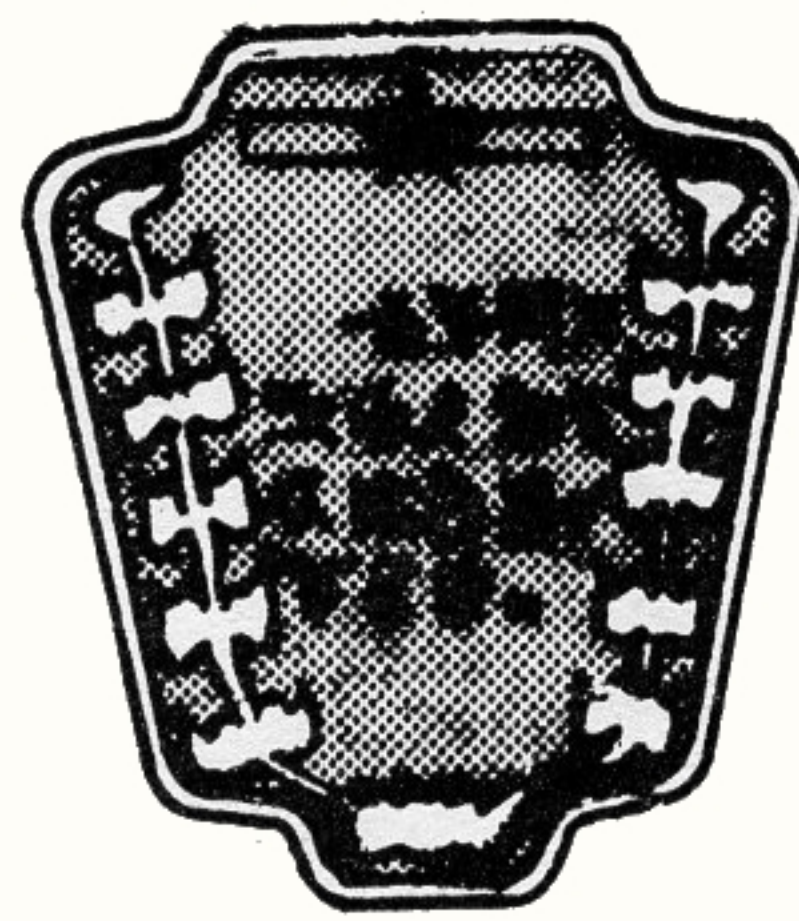

Badge Details: Small national insignia-red and yellow. Wreath, outline, and characters -yellow Background-red

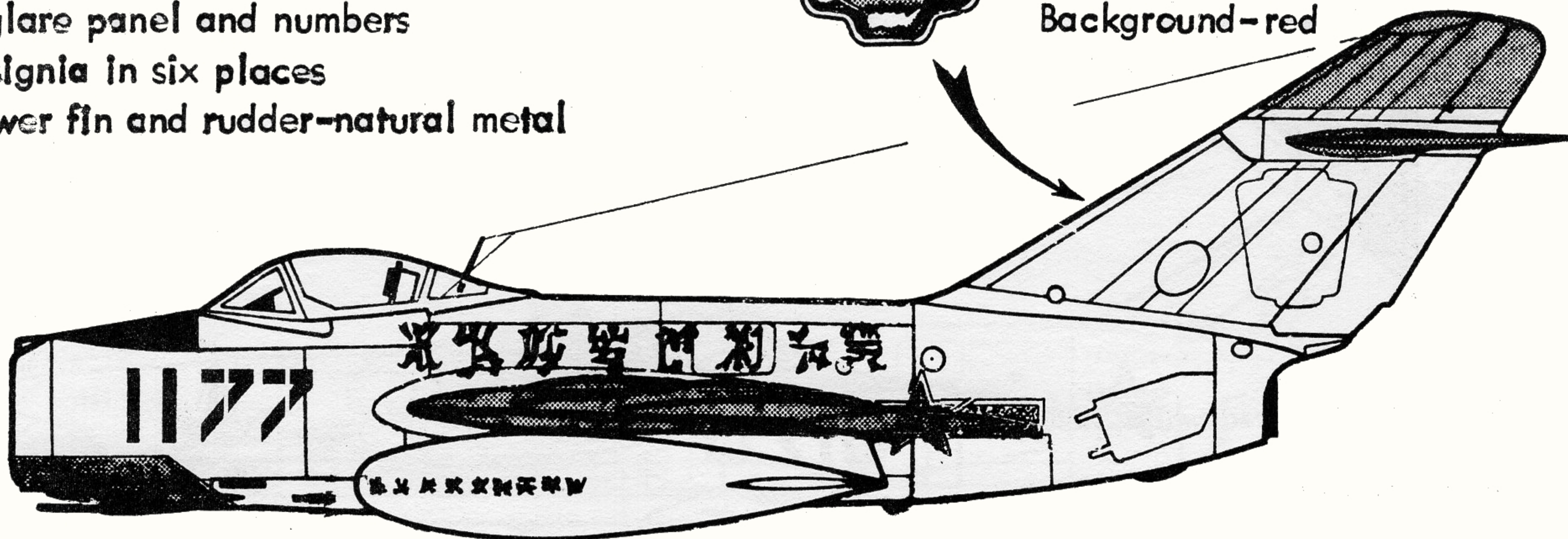

Use tanks from Monogram Albatross sans mounts and joint flanges; make pylons and fins from .020" sheet

There is good reason to believe these two planes have no wing Insignia at all

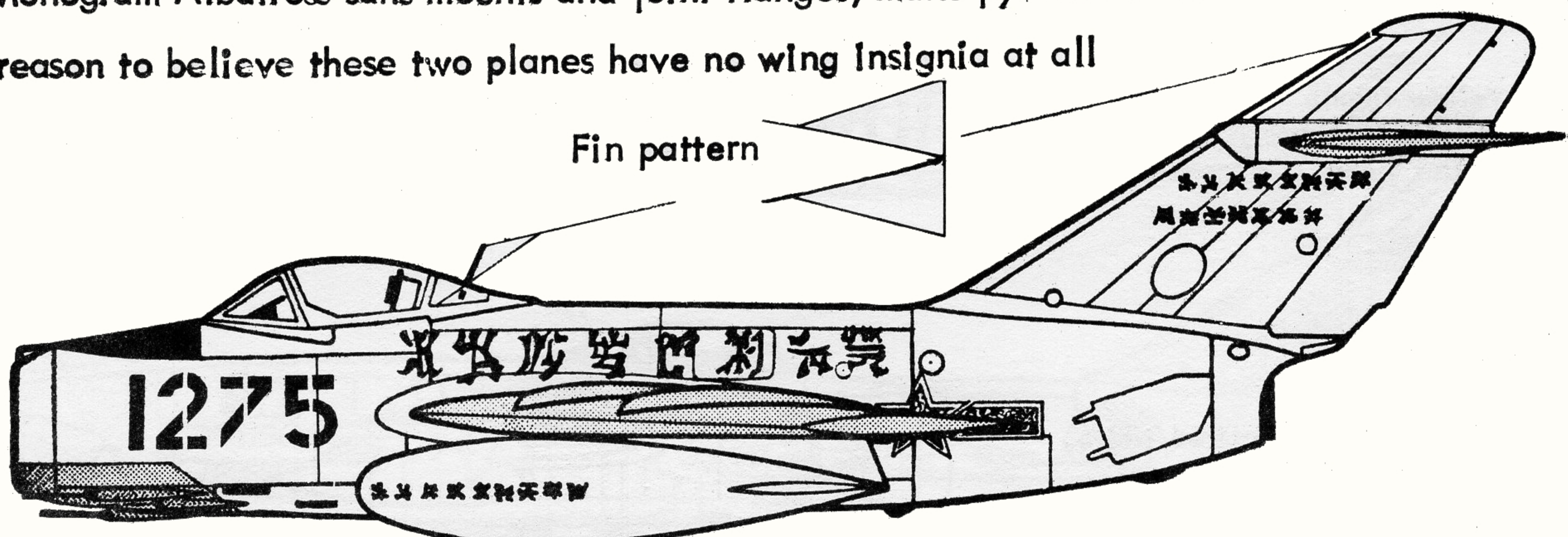

As above, except no red on vertical tail; badge replaced with script

On all Airfix MiG-15's, use Hasegawa MiG-17 gun blisters and landing gear for finer detail

CZECHOSLOVAKIA

- Radar Equipped MiG-15 UTI
- Black nose, numbers and wing walk
- All natural metal

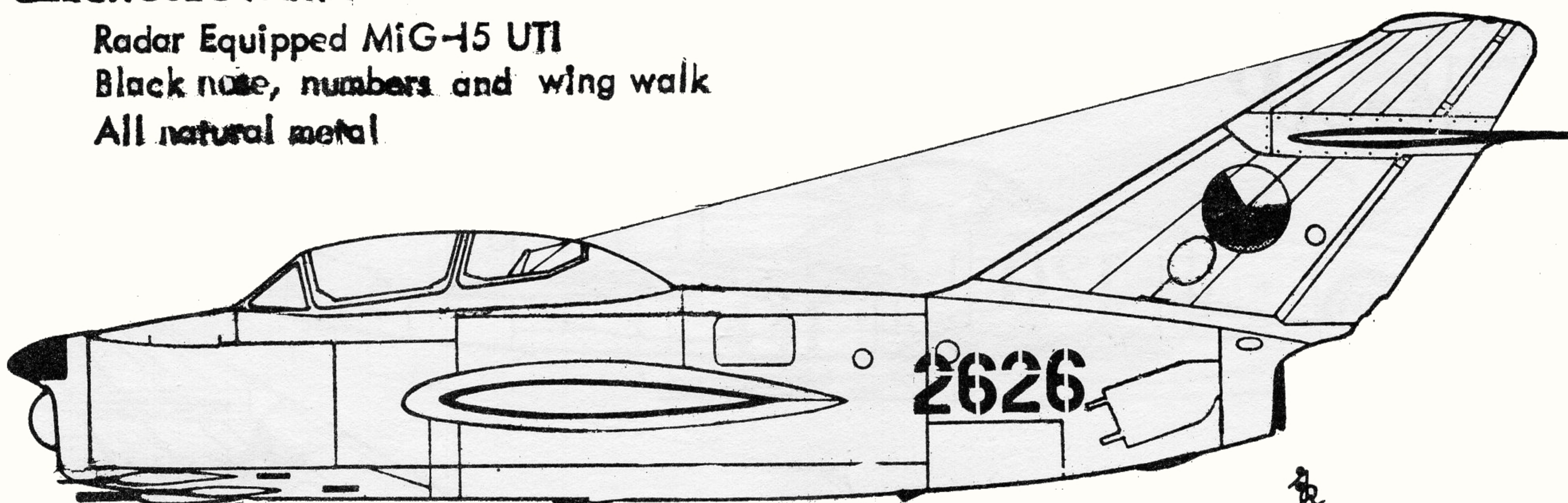

Lengthen Airfix body as given by Gerry Nilles; add an Almodel conversion canopy, and the radar nose from Hasegawa's MiG-17

MIG-15 UTI MIG-15 UTI's shown have wing insignia in usual 4 places

INDONESIA

Black numbers

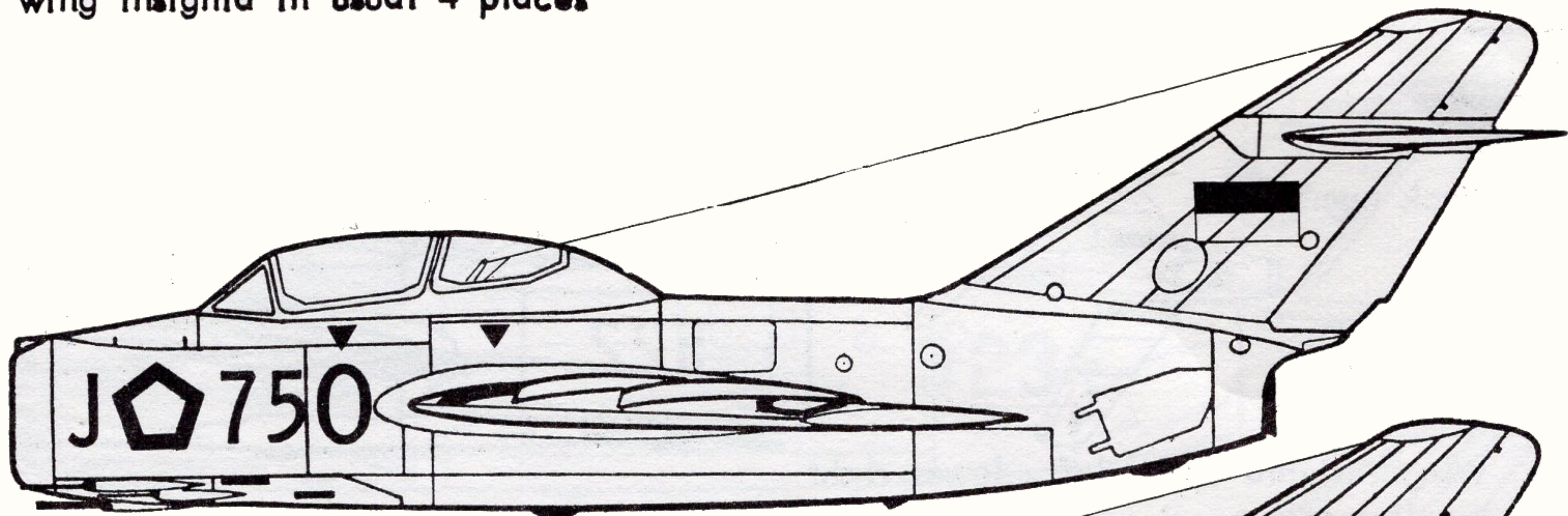
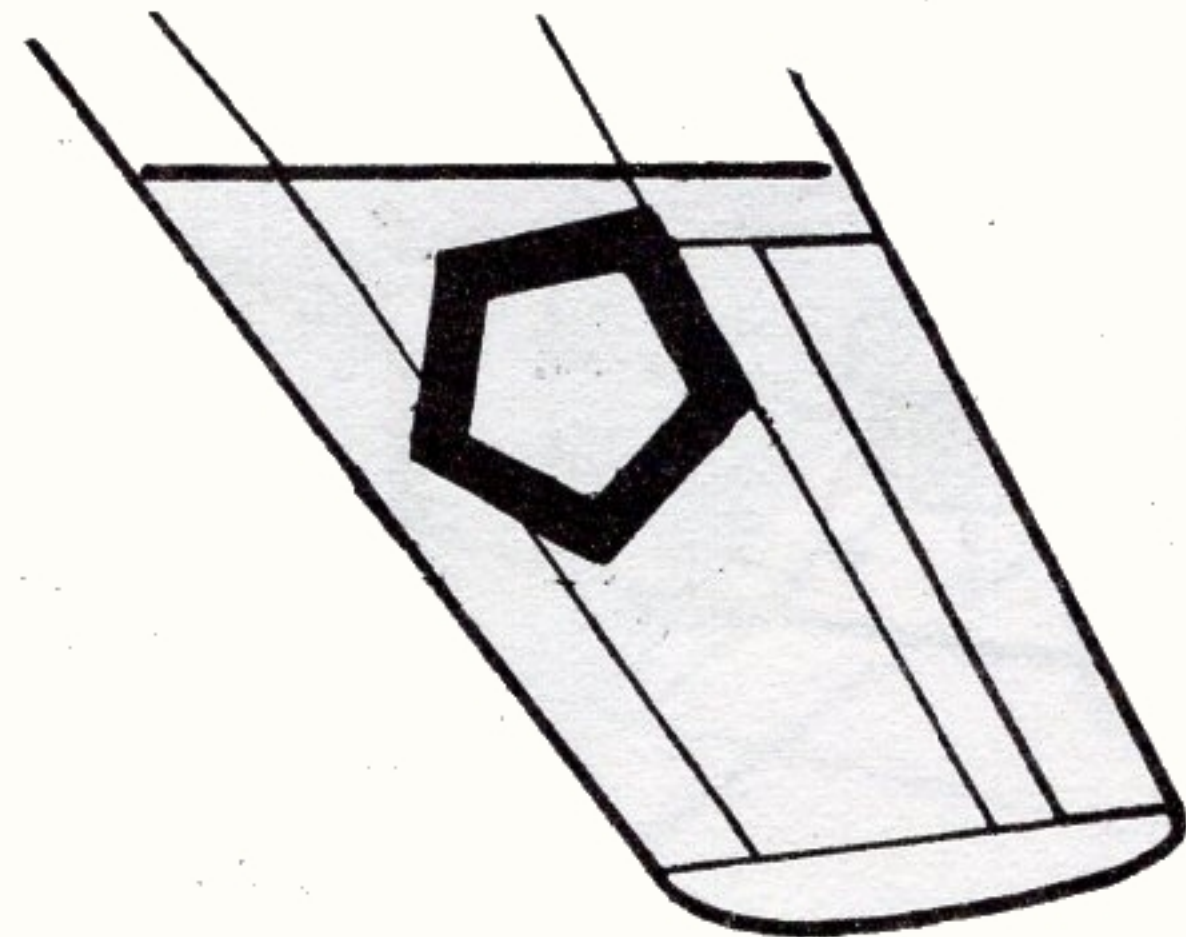

USSR

Red star, bordered yellow (or white), outlined red

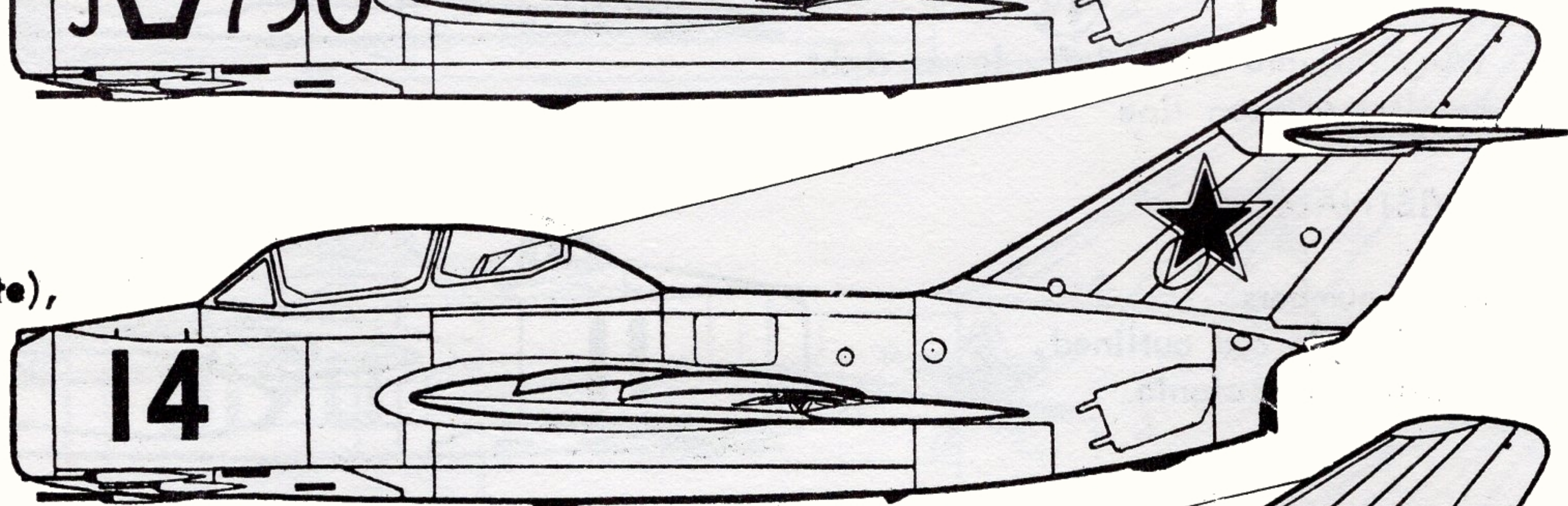

PAKISTAN

Black numbers

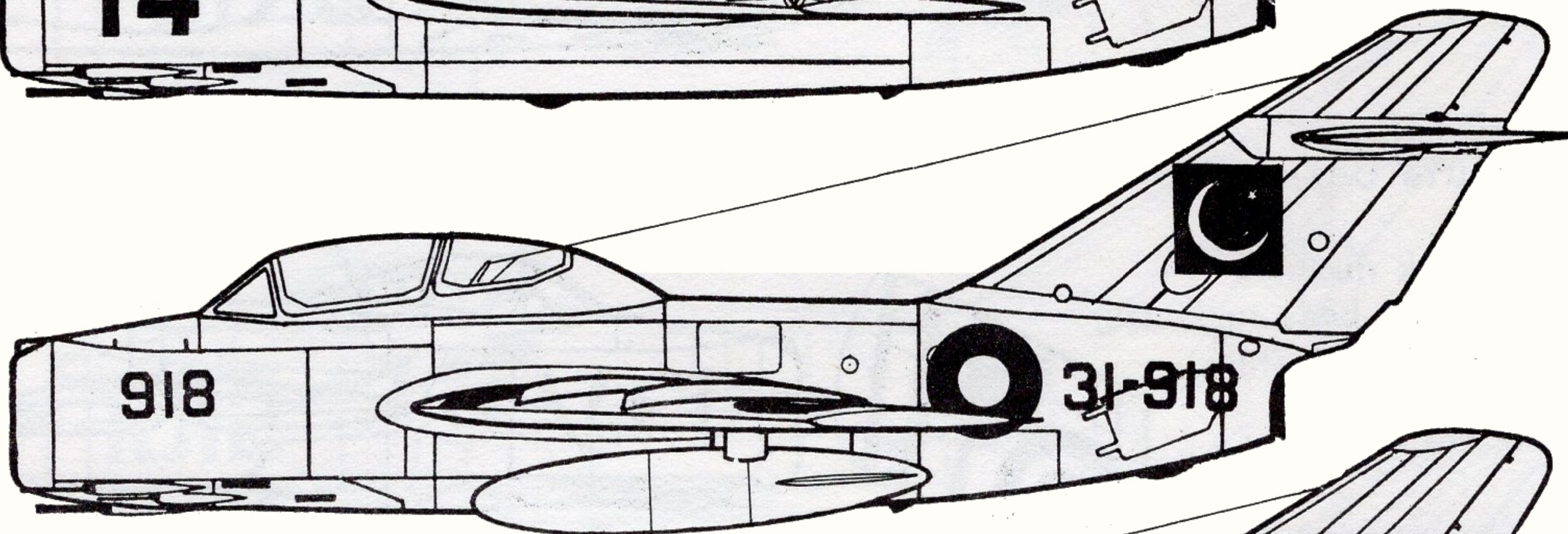

NIGERIA

"NAF" aft of roundel on right side

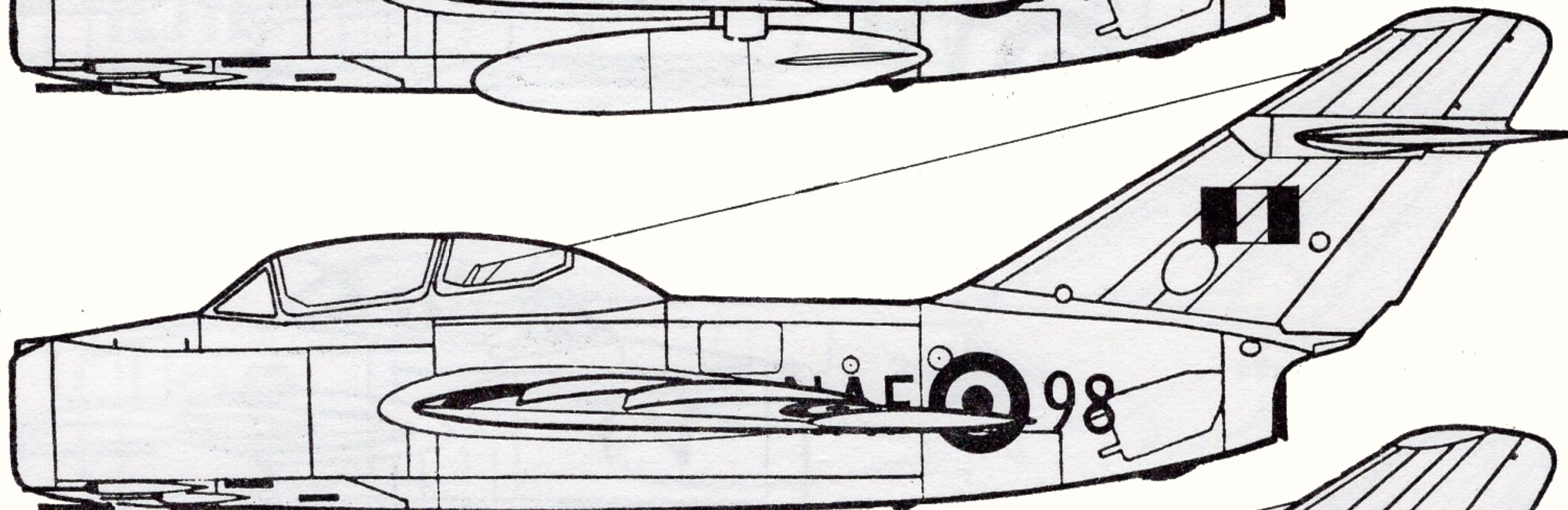

FINLAND

Black numbers and cat
"MU-4" fwd of roundel on right side

Shortened, wider wing walk-black

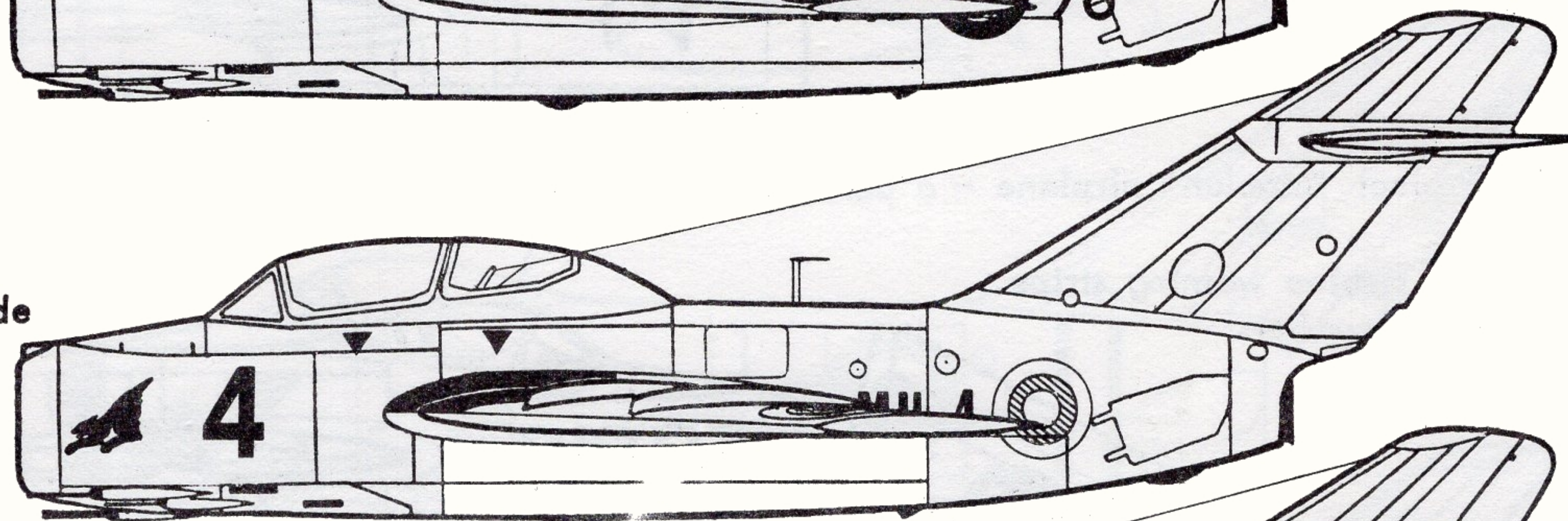
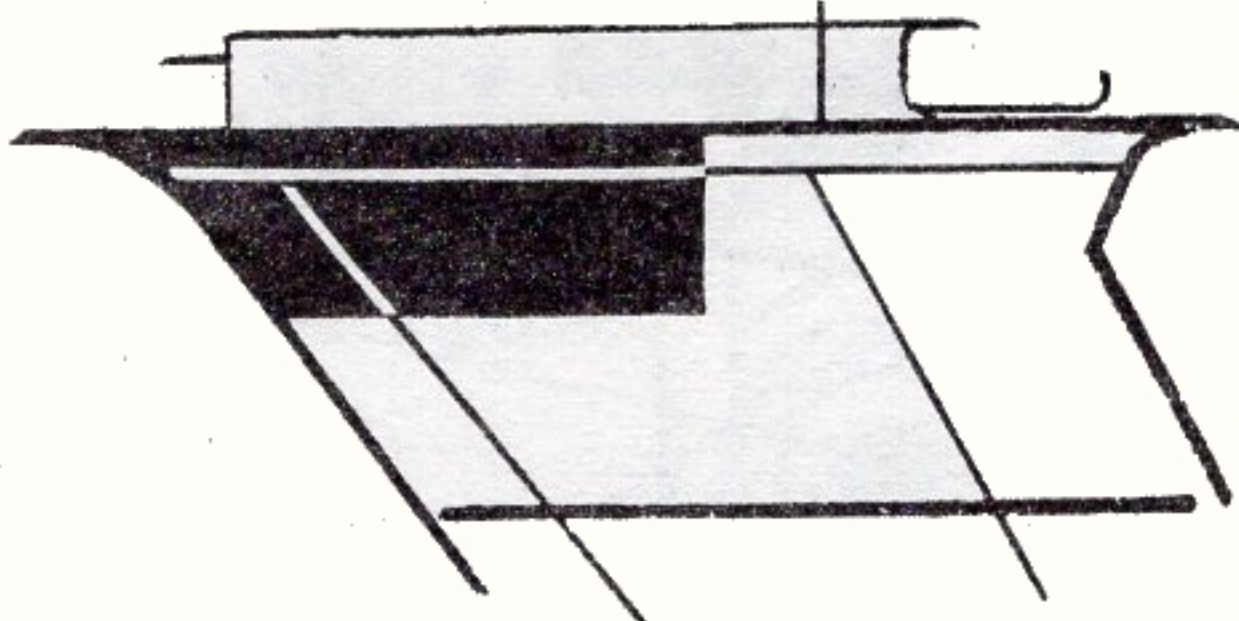

MOROCCO

Black numbers

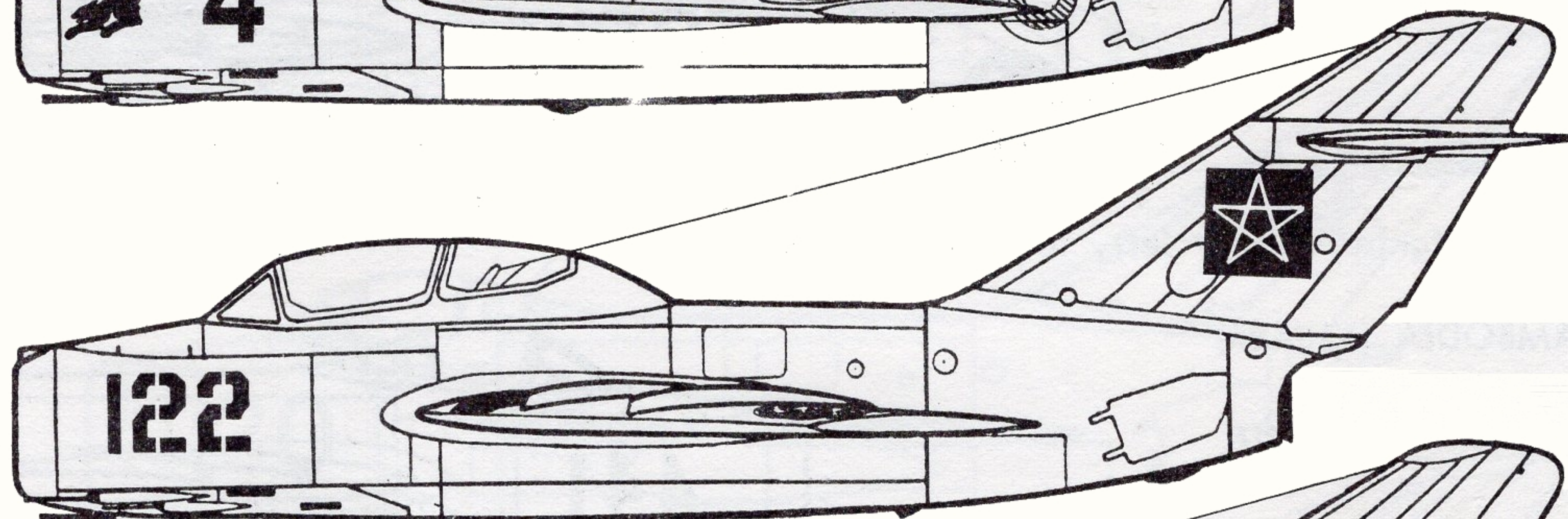
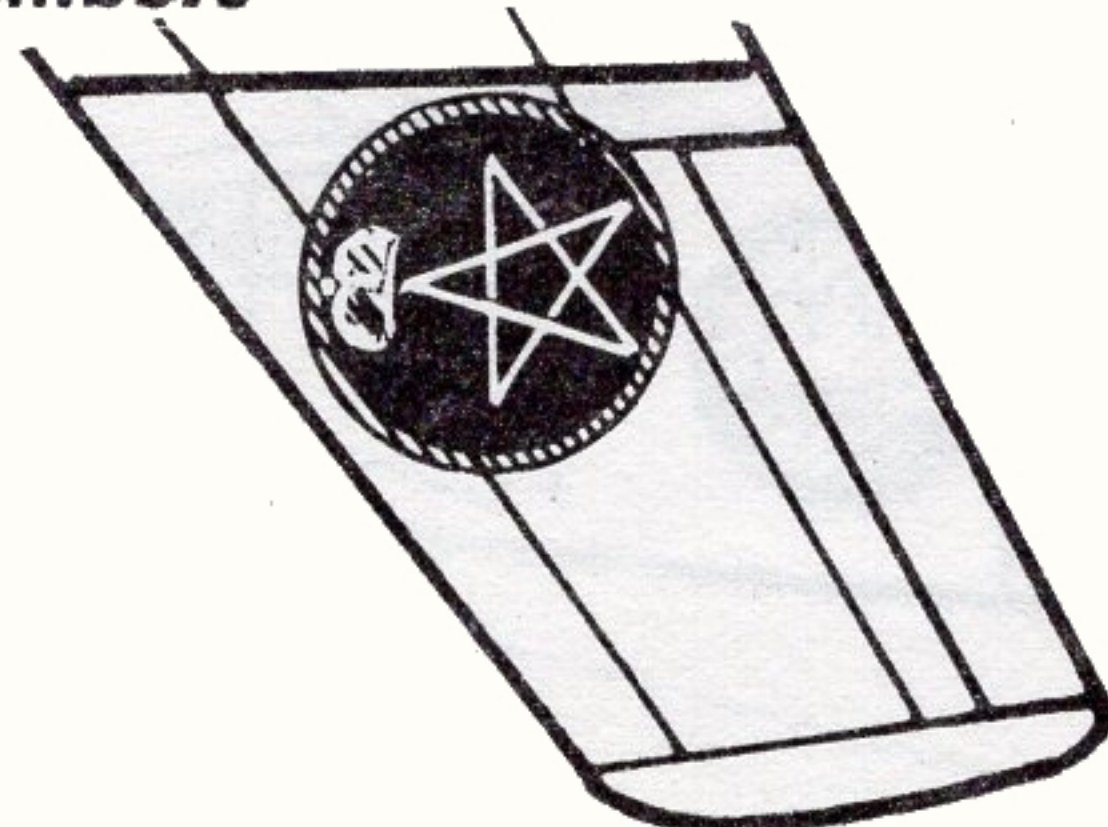

CUBA

Black numbers
Point of triangle fwd on wings

