

DI. 11 :  
510-213-10

**TM 55-1510-213-10**

---

**TECHNICAL MANUAL**

**Operator's Manual  
OV-1D/RV-1D AIRCRAFT**

UNIVERSITY OF VIRGINIA  
ALDERMAN LIBRARY  
JAN 15 1991  
GOVERNMENT DOCUMENTS

**This manual supersedes TM 55-1510-204-10/5, 29 August 1975, including all changes**

This copy is a reprint which includes current pages from Changes 1 through 18.

---

**HEADQUARTERS, DEPARTMENT OF THE ARMY**

**4 AUGUST 1978**

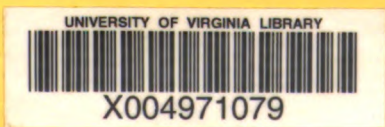

91 23-P

CHANGE }  
NO. 18 }

HEADQUARTERS  
DEPARTMENT OF THE ARMY  
WASHINGTON, D.C., 31 January 1990

Operator's Manual

OV-1D/RV-1D AIRCRAFT

TM 55-1510-213-10, 4 August 1978, is changed as follows:

1. Remove and insert pages as indicated below. New or changed text material is indicated by a vertical bar in the margin. An illustration change is indicated by a miniature pointing hand.

Remove pages

9-7 and 9-8

Insert pages

9-7 and 9-8

2. Retain this sheet in front of manual for reference purposes.

**By Order of the Secretary of the Army:**

**CARL E. VUONO**  
*General, United States Army*  
*Chief of Staff*

**Official:**

**WILLIAM J. MEEHAN II**  
*Brigadier General, United States Army*  
*The Adjutant General*

**DISTRIBUTION:**

To be distributed in accordance with DA Form 12-31, -10 and CL Maintenance requirements for OV-1D Airplane, Observation and RV-1D Airplane, Reconnaissance.

CHANGE }  
NO. 17 }

HEADQUARTERS  
DEPARTMENT OF THE ARMY  
WASHINGTON, D.C., 29 September 1989

Operator's Manual  
OV-1D/RV-1D AIRCRAFT

TM 55-1510-213-10, 4 August 1978, is changed as follows:

1. Remove and insert pages as indicated below. New or changed text material is indicated by a vertical bar in the margin. An illustration change is indicated by a miniature pointing hand.

Remove pages

9-5 and 9-6  
-----

Insert pages

9-5 and 9-6  
9-7 and 9-8

2. Retain this sheet in front of manual for reference purposes.

By Order of the Secretary of the Army:

**CARL E. VUONO**  
*General, United States Army*  
*Chief of Staff*

Official:

**WILLIAM J. MEEHAN II**  
*Brigadier General, United States Army*  
*The Adjutant General*

DISTRIBUTION:

To be distributed in accordance with DA Form 12-31, -10 & CL Maintenance requirement for OV-1D Airplane, Observation and RV-1D Airplane, Reconnaissance.

CHANGE }  
NO. 16 }

HEADQUARTERS  
DEPARTMENT OF THE ARMY  
WASHINGTON, D.C., 3 August 1989

Operator's Manual

OV-1D/RV-1D AIRCRAFT

TM 55-1510-213-10, 4 August 1978, is changed as follows:

1. Remove and insert pages as indicated below. New or changed text material is indicated by a vertical bar in the margin. An illustration change is indicated by a miniature pointing hand.

Remove pages

4-41 and 4-42

Insert pages

4-41 and 4-42

2. Retain this sheet in front of manual for reference purposes.

**By Order of the Secretary of the Army:**

**CARL E. VUONO**  
*General, United States Army*  
*Chief of Staff*

**Official:**

**WILLIAM J. MEEHAN II**  
*Brigadier General, United States Army*  
*The Adjutant General*

**DISTRIBUTION:**

To be distributed in accordance with DA Form 12-31, -10 & CL Maintenance requirements for OV-1D Airplane, Observation and RV-1D Airplane, Reconnaissance.

CHANGE }  
 NO. 15 }

HEADQUARTERS  
 DEPARTMENT OF THE ARMY  
 WASHINGTON, D.C., 26 June 1989

### Operator's Manual

#### OV-1D/RD-1D AIRCRAFT

TM 55-1510-213-10, 4 August 1978, is changed as follows:

1. Remove and insert pages as indicated below. New or changed text material is indicated by a vertical bar in the margin. An illustration change is indicated by miniature pointing hand.

#### Remove pages

2-63 and 2-64  
 - - -  
 2-77 and 2-78  
 2-99 and 2-100  
 2-105 and 2-106  
 3-3 through 3-8  
 3-25 through 3-34  
 4-2G and 4-2H  
 5-11 and 5-12  
 5-19 and 5-20  
 5-25 and 5-26  
 - - -  
 7-1 and 7-2  
 - - -  
 7-3 and 7-4  
 7-28A/7-28B  
 7-29/7-30  
 7-31 and 7-32  
 7-35 and 7-36  
 7-36A/7-36B  
 8-8A and 8-8B  
 8-9 and 8-10  
 8-19 and 8-20  
 8-39 and 8-40  
 9-5 through 9-8  
 9-11 and 9-12  
 9-19 through 9-22  
 - - -  
 Index-1 through Index-8

#### Insert pages

2-63 and 2-64  
 2-64A/2-64B  
 2-77 and 2-78  
 2-99 and 2-100  
 2-105 and 2-106  
 3-3 through 3-8  
 3-25 through 3-34  
 4-2G and 4-2H  
 5-11 and 5-12  
 5-19 and 5-20  
 5-25 and 5-26  
 5-26A/5-26B  
 7-1 and 7-2  
 7-2A/7-2B  
 7-3 and 7-4  
 -----  
 7-29 blank/7-30  
 7-31 and 7-32  
 7-35 and 7-36  
 7-36A and 7-36B  
 8-8A/8-8B  
 8-9 and 8-10  
 8-19 and 8-20  
 8-39 and 8-40  
 9-5 and 9-6  
 9-11 and 9-12  
 9-19 through 9-22  
 9-22A/9-22B  
 Index-1 through Index-8

2. Retain this sheet in front of manual for reference purposes.

**By Order of the Secretary of the Army:**

**CARL E. VUONO**  
*General, United States Army*  
*Chief of Staff*

**Official:**

**WILLIAM J. MEEHAN II**  
*Brigadier General, United States Army*  
*The Adjutant General*

**DISTRIBUTION:**

To be distributed in accordance with DA Form 12-31, -10 & CL Maintenance requirements for OV-1D Airplane, Observation and RV-1D Airplane, Reconnaissance.

# URGENT

NOTICE: THIS CHANGE HAS BEEN PRINTED AND DISTRIBUTED OUT OF SEQUENCE. IT SHOULD BE INSERTED IN THE MANUAL AND USED. UPON RECEIPT OF THE EARLIER SEQUENCED CHANGE INSURE A MORE CURRENT CHANGE PAGE IS NOT REPLACED WITH A LESS CURRENT PAGE.

TM 55-1510-213-10  
C 14

CHANGE }  
NO. 14 }

HEADQUARTERS  
DEPARTMENT OF THE ARMY  
WASHINGTON, D.C., 31 March 1988

Operator's Manual

OV-1D/RV-1D AIRCRAFT

TM 55-1510-213-10, 4 August 1978, is changed as follows:

1. Remove and insert pages as indicated below. New or changed text material is indicated by a vertical bar in the margin. An illustration change is indicated by a miniature pointing hand.

Remove pages

7-19 through 7-22  
- - -  
7-23 through 7-28  
- - -  
7-31 and 7-32  
8-19 and 8-20  
- - -  
8-21 and 8-22  
9-7 and 9-8  
- - -

Insert pages

7-19 through 7-22  
7-22A/7-22B  
7-23 through 7-28  
7-28A/7-28B  
7-31 and 7-32  
8-19 and 8-20  
8-20A/8-20B  
8-21 and 8-22  
9-7 and 9-8  
9-8A/9-8B

2. Retain this sheet in front of manual for reference purposes.

By Order of the Secretary of the Army:

CARL E. VUONO  
General, United States Army  
Chief of Staff

Official:

R. L. DILWORTH  
Brigadier General, United States Army  
The Adjutant General

DISTRIBUTION:

To be distributed in accordance with DA Form 12-31, -10 & CL Maintenance requirements for OV-1D Airplane, Observation and RV-1D Airplane, Reconnaissance.

# URGENT

CHANGE

NO. 13

HEADQUARTERS  
DEPARTMENT OF THE ARMY  
WASHINGTON, D.C., 28 March 1988

## Operator's Manual

## OV-1D/RV-1D AIRCRAFT

TM 55-1510-213-10, 4 August 1978, is changed as follows:

1. Remove and insert pages as indicated below. New or changed text material is indicated by a vertical bar in the margin. An illustration change is indicated by a miniature pointing hand.

## Remove pages

WRN-1 and WRN-2  
i and ii  
1-1 and 1-2  
2-44A/2-44B  
2-59 and 2-60  
4-44G/4-44H  
5-13 and 5-14  
8-5 through 8-8  
8-9 through 8-16  
8-16A/8-16B  
8-17 and 8-18  
8-23 and 8-24  
8-24A/8-24B  
8-25 and 8-26  
8-26A/8-26B  
8-39 and 8-40  
9-9 and 9-10  
9-11 and 9-12  
9-23 and 9-24  
A-1 through A-4

## Insert pages

WRN-1 and WRN-2  
i and ii  
1-1 and 1-2  
2-44A/2-44B  
2-59 and 2-60  
4-44G/4-44H  
5-13 and 5-14  
8-5 through 8-8  
8-9 through 8-16  
8-16A/8-16B  
8-17 and 8-18  
8-23 and 8-24  
8-24A/8-24B  
8-25 and 8-26  
8-26A/8-26B  
8-39 and 8-40  
9-9 and 9-10  
9-11 and 9-12  
9-23 and 9-24  
A-1 through A-4

2. Retain this sheet in front of manual for reference purposes.

By Order of the Secretary of the Army:

Official:

**CARL E. VUONO**  
*General, United States Army*  
*Chief of Staff*

**R. L. DILWORTH**  
*Brigadier General, United States Army*  
*The Adjutant General*

## DISTRIBUTION:

To be distributed in accordance with DA Form 12-31, -10 & CL Maintenance requirements for OV-1D Airplane, Observation and RV-1D Airplane, Reconnaissance.



# URGENT

TM 55-1510-213-10  
C 12

CHANGE }  
NO. 12 }

HEADQUARTERS  
DEPARTMENT OF THE ARMY  
WASHINGTON, D.C., 1 December 1986

## Operator's Manual

### OV-1D/RV-1D AIRCRAFT

TM 55-1510-213-10, 4 August 1978, is changed as follows:

1. Remove and insert pages as indicated below. New or changed text material is indicated by a vertical bar in the margin. An illustration change is indicated by a miniature pointing hand.

#### Remove pages

- - -  
- - -  
8-7 and 8-8  
- - -  
8-9 and 8-10  
8-25 and 8-26  
- - -  
Index 1 and Index 2

#### Insert pages

4-44E and 4-44F  
4-44G/4-44H  
8-7 and 8-8  
8-8A and 8-8B  
8-9 and 8-10  
8-25 and 8-26  
8-26A/8-26B  
Index 1 and Index 2

2. Retain this sheet in front of manual for reference purposes.

By Order of the Secretary of the Army:

**JOHN A. WICKHAM, JR.**  
*General, United States Army*  
*Chief of Staff*

Official:

**R. L. DILWORTH**  
*Brigadier General, United States Army*  
*The Adjutant General*

#### DISTRIBUTION:

To be distributed in accordance with DA Form 12-31, -10 & CL Maintenance requirements for OV-1D Airplane, Observation and RV-1D Airplane, Reconnaissance.

# URGENT

CHANGE }  
NO. 10 }

HEADQUARTERS  
DEPARTMENT OF THE ARMY  
WASHINGTON, D.C., 25 October 1985

Operator's Manual  
OV-1D/RV-1D AIRCRAFT

TM 55-1510-213-10, 4 August 1978, is changed as follows:

1. Remove and insert pages as indicated below. New or changed text material is indicated by a vertical bar in the margin. An illustration change is indicated by a miniature pointing hand.

Remove pages

i and ii  
2-5 through 2-8  
2-11 through 2-14  
2-23 and 2-24  
2-75 and 2-76  
2-83 and 2-84  
2-105 and 2-106  
2-107 and 2-108  
4-43 and 4-44  
---  
6-9 and 6-10  
---  
6-11 and 6-12  
---  
8-7 through 8-10  
8-19 through 8-24  
9-5 and 9-6  
Index 3 through Index 6

Insert pages

i and ii  
2-5 through 2-8  
2-11 through 2-14  
2-23 and 2-24  
2-75 and 2-76  
2-83 and 2-84  
2-105 and 2-106  
2-107 and 2-108  
4-43 and 4-44  
4-44A through 4-44F  
6-9 and 6-10  
6-10A through 6-10C/6-10D  
6-11 and 6-12  
6-12A/6-12B  
8-7 through 8-10  
8-19 through 8-24  
9-5 and 9-6  
Index 3 through Index 6

2. Retain this sheet in front of manual for reference purposes.

**By Order of the Secretary of the Army:**

**JOHN A. WICKHAM, JR.**  
*General, United States Army*  
*Chief of Staff*

**Official:**

**MILDRED E. HEDBERG**  
*Brigadier General, United States Army*  
*The Adjutant General*

**DISTRIBUTION:**

To be distributed in accordance with DA Form 12-31, Operator Maintenance requirements for OV-1D Airplane, Observation and RV-1D Airplane, Reconnaissance.

CHANGE }  
NO. 9 }HEADQUARTERS  
DEPARTMENT OF THE ARMY  
WASHINGTON, D.C., 28 MARCH 1985

## Operator's Manual

## OV-1D/RV-1D AIRCRAFT

TM 55-1510-213-10, 4 August 1978, is changed as follows:

1. Remove and insert pages as indicated below. New or changed text material is indicated by a vertical bar in the margin. An illustration change is indicated by a miniature pointing hand.

Remove pages

---

Insert pages

9-10A/9-10B

2. Retain this sheet in front of manual for reference purposes.

By Order of the Secretary of the Army:

**JOHN H. WICKHAM, JR.**  
*General, United States Army*  
*Chief of Staff*

Official:

**DONALD J. DELANDRO**  
*Brigadier General, United States Army*  
*The Adjutant General*

## DISTRIBUTION:

To be distributed in accordance with DA Form 12-31, Operator Maintenance Requirements for OV-1D/RV-1D Aircraft.

CHANGE }  
NO. 8 }

HEADQUARTERS  
DEPARTMENT OF THE ARMY  
WASHINGTON, D.C., 22 February 1984

## Operator's Manual

## OV-1D/RV-1D AIRCRAFT

TM 55-1510-213-10, 4 August 1978, is changed as follows:

1. Remove and insert pages as indicated below.

	Remove pages	Insert pages
Warning	WRN-1 and WRN-2	WRN-1 thru WRN-3/4
Table of Contents	i and ii	i and ii
Chapter 2	2-1 and 2-2	2-1 and 2-2
	2-9 thru 2-14	2-9 thru 2-14
	2-17 thru 2-20	2-17 thru 2-20
	2-23 and 2-24	2-23 and 2-24
	2-37 and 2-38	2-37 thru 2-38A/2-38B
	2-44A/2-44B	2-44A/2-44B
	2-45 thru 2-48	2-45 thru 2-48
	2-53 thru 2-58	2-53 thru 2-58
	2-61 and 2-62	2-61 and 2-62
	2-75 thru 2-78	2-75 thru 2-78
	2-83 thru 2-86	2-83 thru 2-86
	2-89 and 2-90	2-89 and 2-90
	2-97 thru 2-102	2-97 thru 2-102A/2-102B
	2-103 and 2-104	2-103 and 2-104
Chapter 3	3-11 and 3-12	3-11 and 3-12
	3-15 and 3-16	3-15 and 3-16
	3-19 thru 3-22	3-19 thru 3-22
	3-25 and 3-26	3-25 and 3-26
	3-31 thru 3-38	3-31 thru 3-38
	3-41 and 3-42	3-41 and 3-42
	3-45 thru 3-50	3-45 thru 3-50
Chapter 5	5-1 and 5-2	5-1 and 5-2
	5-5 and 5-6	5-5 and 5-6
	5-9 thru 5-14	5-9 thru 5-14
	5-17 thru 5-20	5-17 thru 5-20
		5-27/5-28
Chapter 6	6-3 and 6-4	6-3 and 6-4
	6-7 thru 6-10	6-7 thru 6-10
	6-10A and 6-10B	6-10A and 6-10B
	6-11 and 6-12	6-11 and 6-12
Chapter 7	7-1 and 7-2	7-1 and 7-2
	7-7 and 7-8	7-7 and 7-8
	7-17 thru 7-20	7-17 thru 7-20
	7-31 thru 7-34	7-31 thru 7-34
	7-34A and 7-34B	7-34A and 7-34B
	7-36A/7-36B	7-36A/7-36B
	7-37 and 7-38	7-37 and 7-38
	7-61 thru 7-64	7-61 thru 7-64

	Remove pages	Insert pages
Chapter 8	8-5 thru 8-16 8-16A/8-16B 8-17 thru 8-24 8-30A/8-30B 8-37 and 8-38	8-5 thru 8-16 8-16A/8-16B 8-17 thru 8-24A/8-24B 8-30A/8-30B 8-37 and 8-38
Chapter 9	9-5 and 9-6 9-9 thru 9-16 9-23 and 9-24	9-5 and 9-6 9-9 thru 9-16A/9-16B 9-23 and 9-24
Appendix A	A-1 and A-2	A-1 and A-2
Index	Index 5 thru Index 8	Index 5 thru Index 8

2. New or changed text material is indicated by a vertical bar in the margin. An illustration change is indicated by a miniature pointing hand.

3. Retain this sheet in front of manual for reference purposes.

**By Order of the Secretary of the Army:**

**JOHN A. WICKHAM, JR.**  
*General, United States Army*  
*Chief of Staff*

**Official:**

**ROBERT M. JOYCE**  
*Major General, United States Army*  
*The Adjutant General*

**DISTRIBUTION:**

To be distributed in accordance with DA Form 12-31, Operator Maintenance Requirements for OV-1D/RV-1D aircraft.

# URGENT

TM 55-1510-213-10  
C 7

CHANGE }  
NO. 7 }

HEADQUARTERS  
DEPARTMENT OF THE ARMY  
WASHINGTON, D.C., 28 May 1982

Operator's Manual  
OV-1D/RV-1D AIRCRAFT

TM 55-1510-213-10, 4 August 1978, is changed as follows:

1. Remove and insert pages as indicated below.

	Remove Pages	Insert Pages
Chapter 7	7-27 and 7-28	7-27 and 7-28

2. New or changed text material is indicated by a vertical bar in the margin. An illustration change is indicated by a miniature pointing hand.

3. Retain this sheet in front of manual for reference purposes.

By Order of the Secretary of the Army:

**E. C. MEYER**  
*General, United States Army*  
*Chief of Staff*

Official:

**ROBERT M. JOYCE**  
*Brigadier General, United States Army*  
*The Adjutant General*

**DISTRIBUTION:**

To be distributed in accordance with DA Form 12-31, Operator Maintenance Requirements for OV-1D/RV-1D aircraft.

# URGENT

CHANGE }  
 No. 6 }

HEADQUARTERS  
 DEPARTMENT OF THE ARMY  
 WASHINGTON, D.C., 24 February 1982

Operator's Manual

OV-1D/RV-1D AIRCRAFT

TM 55-1510-213-10, 4 August 1978, is changed as follows:

1. Remove and insert pages as indicated below.

	Remove pages	Insert pages
Table of Contents	i and ii	i and ii
Chapter 1	1-1 and 1-2	1-1 and 1-2
Chapter 2	2-3 thru 2-8 2-11 thru 2-14 2-17 and 2-18 2-23 and 2-24 2-57 and 2-58 2-73 thru 2-78 2-81 thru 2-86 2-91 thru 2-102 2-106A and 2-106B	2-3 thru 2-8 2-11 thru 2-14 2-17 and 2-18 2-23 and 2-24 2-57 and 2-58 2-73 thru 2-78 2-81 thru 2-86 2-91 thru 2-102 2-106A and 2-106B
Chapter 3	3-1 thru 3-4 3-5 thru 3-8 3-37 and 3-38 3-49 and 3-50	3-1 thru 3-4B 3-5 thru 3-8 3-37 and 3-38 3-49 and 3-50
Chapter 4	4-1 and 4-2 4-3 thru 4-8 4-31 thru 4-42 4-43 and 4-44	4-1 thru 4-2P 4-3 thru 4-8 4-31 thru 4-42G/4-42H 4-43 and 4-44
Chapter 5	5-1 and 5-2 5-11 thru 5-20 5-21 and 5-22 5-25 and 5-26	5-1 and 5-2 5-11 thru 5-20A/5-20B 5-21 and 5-22 5-25 and 5-26
Chapter 6	6-1 thru 6-4 6-7 thru 6-10 6-11 thru 6-18	6-1 thru 6-4 6-7 thru 6-10B 6-11 thru 6-18
Chapter 7	7-59 and 7-60	7-59 and 7-60
Chapter 8	8-1 thru 8-6 8-9 and 8-10	8-1 thru 8-6 8-9 and 8-10

	Remove pages	Insert pages
Chapter 8 ( cont )	8-13 thru 8-16 8-17 thru 8-20 8-23 and 8-24 8-27 and 8-28 8-39 and 8-40	8-13 thru 8-16 8-17 thru 8-20 8-23 and 8-24 8-27 and 8-28 8-39 and 8-40
Chapter 9	9-7 thru 9-10 9-21 thru 9-24	9-7 thru 9-10 9-21 thru 9-24
Appendix A	A-1 thru A-4	A-1 thru A-4
Appendix B	B-1/B-2	B-1/B-2
Index	Index 1 thru Index 8	Index 1 thru Index 8

2. New or changed text material is indicated by a vertical bar in the margin. An illustration change is indicated by a miniature pointing hand.

3. Retain these sheets in front of manual for reference purposes.

**By Order of the Secretary of the Army:**

**E. C. MEYER**  
*General, United States Army*  
*Chief of Staff*

**Official:**

**ROBERT M. JOYCE**  
*Brigadier General, United States Army*  
*The Adjutant General*

**DISTRIBUTION:**

To be distributed in accordance with DA Form 12-31, Operator Maintenance Requirements for OV-1D/Rv-1D aircraft.



**WARNING PAGE****WARNING**

Personnel performing operations, procedures, and practices which are included or implied in this technical manual shall observe the following warnings. Disregard of these warnings and precautionary information can cause serious injury or loss of life.

**NOISE LEVELS**

Sound pressure levels in this aircraft during some operating conditions exceed the Surgeon General's hearing conservation criteria, as defined in TB MED 251. Hearing protection devices, such as the aviator helmet or ear plugs, are required to be worn by all personnel in and around the aircraft during its operation.

**STARTING ENGINES**

Coordinate all cockpit actions with ground observer. Insure that brakes are set, that aircraft is properly chocked, prop and blast area is clear, all ground plugs and covers are removed, and fire guard is posted.

**GROUND OPERATION**

Engines shall be started and aircraft operated only by authorized personnel. Reference AR 95-1.

**FIRE EXTINGUISHER**

Exposure to high concentrations of Bromotrifluoromethane (CF<sub>3</sub>Br) extinguishing agent or decomposition products shall be avoided. The liquid shall not be allowed to come into contact with the skin, as it may cause frostbite or low temperature burns.

**EJECTION SEATS**

Before entering or leaving the aircraft, insure that ejection seats are not armed.

**VERTIGO**

The rotating beacon light shall be turned off during flight through clouds to prevent sensations of vertigo as a result of reflections of the light on the clouds.

**CARBON MONOXIDE**

When smoke or suspected carbon monoxide fumes exist, the crew shall immediately set the diluter control lever to 100% OXYGEN on their individual oxygen regulator panel, don masks, and activate the system. If symptoms of hypoxia exist, move the emergency pressure control lever to EMERGENCY.

## WARNING PAGE

### HANDLING FUEL AND OIL

Turbine fuels and lubricating oils contain additives that are poisonous and readily absorbed through the skin. Skin and clothing that come in contact with turbine fuels or lubricating oils should be washed thoroughly without delay.

### ACIDS/ELECTROLYTE

Corrosive Battery Electrolyte (Potassium Hydroxide). If potassium hydroxide is spilled on clothing or other material, wash immediately with clean water. If spilled on personnel, immediately start flushing the affected area with clean water. Continue washing until medical assistance arrives.

### OVERHEATED BATTERY

If battery overheats, do not open battery compartment or attempt to disconnect or remove battery. Battery fluid will cause burns, and overheated battery could cause thermal burns and may explode.

### HANDLING HYDRAULIC FLUID (MIL-H-83282)

When handling hydraulic fluid (MIL-H-83282), observe the following:

- Prolonged contact with liquid or mist can irritate eyes and skin.
- After any prolonged contact with skin, immediately wash contacted area with soap and water. If liquid contacts eyes, flush them immediately with clear water.
- If liquid is swallowed, do not induce vomiting; get immediate medical attention.
- Wear rubber gloves when handling equipment. If prolonged contact with mist is likely, wear an appropriate respirator.
- When fluid is decomposed by heating, toxic gases are released.

### HIGH VOLTAGE

High voltage exists in the electronic equipment compartments. Death on contact may result if personnel fail to observe safety precautions.

### SERVICING AIRCRAFT

When conditions permit, the aircraft shall be positioned so that the wind will carry fuel vapors away from all possible sources of ignition. The fueling unit shall maintain a distance of 20 feet between unit and filler point. A minimum of 10 feet shall be maintained between fueling unit and aircraft. Prior to refueling, the hose nozzle static ground wire shall be attached to the grounding lugs that are located adjacent to the filler openings.

### **JET BLAST**

Occasionally, during starting, excess fuel accumulation in the combustion chamber causes flames to blow from the exhausts. This area shall be clear of personnel and flammable materials.

### **RADIOACTIVE MATERIAL**

Instruments contained in this aircraft may contain radioactive material (TB 55-1500-314-25). These items present no radiation hazard to personnel unless seal has been broken. If seal is suspected to have been broken, notify the radioactive protective officer.

### **RF BURNS**

Do not stand near the antennas during transmission.

## TECHNICAL MANUAL

## REPORTING OF ERRORS AND RECOMMENDING IMPROVEMENTS

You can improve this manual. If you find any mistakes or if you know of a way to improve the procedures, please let us know. Mail your letter, DA Form 2028 (Recommended Changes to Publications and Blank Forms), or DA Form 2028-2, located in the back of this manual, direct to Commander, US Army Aviation Systems Command, ATTN: AMSAV-MMD 4300 Goodfellow Blvd., St. Louis, MO 63120-1798. A reply will be furnished to you.

## Operator's Manual

## OV-1D/RV-1D Aircraft

	<b>Page</b>
<b>CHAPTER 1. INTRODUCTION</b>	<b>1-1</b>
<b>CHAPTER 2. AIRCRAFT AND SYSTEMS DESCRIPTION AND OPERATION</b>	<b>2-1</b>
Section I. Aircraft	2-1
II. Emergency equipment	2-37
III. Engines and related systems	2-39
IV. Fuel system	2-46
V. Flight controls	2-49
VI. Hydraulic and pneumatic systems	2-53
VII. Propeller group	2-56
VIII. Utility systems	2-59
IX. Heating, ventilation, cooling, and environmental control unit	2-66
X. Electrical power supply and distribution system	2-72
XI. Lighting	2-86
XII. Flight instruments	2-89
XIII. Servicing, parking, and mooring	2-96
<b>CHAPTER 3. AVIONICS</b>	<b>3-1</b>
Section I. General	3-1
II. Communications	3-4
III. Navigation	3-12
IV. Transponder and radar	3-46
<b>CHAPTER 4. MISSION EQUIPMENT</b>	<b>4-1</b>
Section I. General	4-1
II. Mission avionics	4-2
III. External stores	4-44F
<b>CHAPTER 5. OPERATING LIMITS AND RESTRICTIONS</b>	<b>5-1</b>
Section I. General	5-1
II. System limits	5-1
III. Power limits	5-10
IV. Loading limits	5-13
V. Airspeed limits	5-15
VI. Maneuvering limits	5-17
VII. Environmental restrictions	5-27

<b>CHAPTER 6.</b>	<b>WEIGHT/BALANCE AND LOADING</b>	<b>6-1</b>
<i>Section I.</i>	General	6-1
<i>II.</i>	Weight and balance	6-1
<i>III.</i>	Mission equipment	6-7
<i>IV.</i>	Cargo loading	6-12
<i>V.</i>	Fuel/oil	6-14
<i>VI.</i>	Allowable loading	6-14
<b>CHAPTER 7.</b>	<b>PERFORMANCE DATA</b>	<b>7-1</b>
<i>Section I.</i>	Introduction	7-1
<i>II.</i>	Performance planning	7-5
<i>III.</i>	Crosswind - takeoff or landing	7-12
<i>IV.</i>	Idle fuel flow	7-14
<i>V.</i>	Torque available for takeoff (30 minutes)	7-18
<i>VI.</i>	Takeoff - normal	7-20
<i>VII.</i>	Normal rotation/takeoff airspeed	7-22
<i>VIII.</i>	Acceleration check distance	7-24
<i>IX.</i>	Accelerate stop distance	7-26
<i>X.</i>	Minimum single-engine control speed	7-28
<i>XI.</i>	Single-engine climb	7-32
<i>XII.</i>	Cruise climb	7-36
<i>XIII.</i>	Cruise	7-38
<i>XIV.</i>	Drag	7-60
<i>XV.</i>	Climb/descent	7-62
<i>XVI.</i>	Approach speed	7-64
<i>XVII.</i>	Landing	7-66
<b>CHAPTER 8.</b>	<b>NORMAL PROCEDURES</b>	<b>8-1</b>
<i>Section I.</i>	Mission planning	8-1
<i>II.</i>	Operating procedures and maneuvers	8-2
<i>III.</i>	Instrument flight	8-25
<i>IV.</i>	Flight characteristics	8-27
<i>V.</i>	Adverse environmental conditions	8-34
<i>VI.</i>	Crew duties	8-39
<i>VII.</i>	Passenger briefing	8-41
<b>CHAPTER 9.</b>	<b>EXTERNAL STORES</b>	<b>9-1</b>
<i>Section I.</i>	Aircraft systems	9-1
<i>II.</i>	Mission equipment	9-24
<b>APPENDIX A.</b>	<b>REFERENCES</b>	<b>A-1</b>
<b>APPENDIX B.</b>	<b>ABBREVIATIONS AND TERMS</b>	<b>B-1</b>
<b>INDEX</b>		<b>Index 1</b>

This manual supersedes TM 55-1510-204-10/5, 29 August 1975, including all changes.

# CHAPTER 1

## INTRODUCTION

### 1-1. General.

These instructions are for use by the operator. They apply to Army Models OV-1D, OV-1D(C), and RV-1D Aircraft.

#### NOTE

*This manual does not apply to pre-production OV-1D aircraft with T53-L-15 engines installed. Unless otherwise indicated, all information applicable to OV-1D aircraft also applies to OV-1D(C) aircraft.*

### 1-2. Warnings, Cautions, and Notes.

Warnings, cautions, and notes are used to emphasize important and critical instructions and are used for the following conditions:

#### WARNING

An operating procedure, practice, etc., which, if not correctly followed, could result in personal injury or loss of life.

#### CAUTION

An operating procedure, practice, etc., which, if not strictly observed, could result in damage to or destruction of equipment.

#### NOTE

*An operating procedure, condition, etc., which it is essential to highlight.*

### 1-3. Description.

The aircraft is a two-place, twin turboprop aircraft featuring a midwing, triple vertical stabilizers, and a tricycle landing gear. The aircraft is capable of performing missions of observation surveillance and air control. In addition, the RV-1D aircraft incorporates an Airborne Non-Communications Emitter Locator Identification (ELINT) system that supplies classification and location of electronic emitters. This manual contains the best operating instructions and procedures for the OV-1D and RV-1D aircraft under most circumstances. The observance of limitations, performance, and weight/balance data provided is mandatory; the observance of procedures is mandatory, except when modification is required because of multiple emergencies, adverse weather, terrain, etc. Your flying experience is recognized, and therefore, basic flight principles are not included. It is required that THIS MANUAL BE CARRIED IN THE AIRCRAFT AT ALL TIMES.

### 1-4. Appendix A, References.

Appendix A is a listing of official publications cited within the manual applicable to and available for flight crews.

### 1-5. Appendix B, Abbreviations and Terms.

Appendix B is a listing of abbreviations and terms used throughout this manual.

**1-6. Index.**

The index lists, in alphabetical order, every titled paragraph, figure, and table contained in this manual. Chapter 7, Performance Data has an additional index within the chapter.

**1-7. Army Aviation Safety Program.**

Reports necessary to comply with the safety program are prescribed in AR 385-40.

**1-8. Destruction of Army Materiel to Prevent Enemy Use.**

For information concerning destruction of Army materiel to prevent enemy use, refer to TM 750-244-1-5.

**1-9. Equipment Serviceability Criteria.**

Equipment serviceability criteria for the aircraft are provided in TM 55-1510-204-ESC.

**1-10. Forms and Records.**

Army aviator's flight records and aircraft maintenance records which are to be used by crewmembers are prescribed in DA PAM 738-751 and TM 55-1500-342-23.

**1-11. Explanation of Change Symbols.**

Changes, except as noted below, to the text and tables, including new material on added pages, are indicated by a vertical line in the outer margin extending close to the entire area of the material affected; exception: pages with emergency markings, which consist of black diagonal lines around three edges, may have the vertical line or change symbol placed along the inner margins. Symbols show current changes only. A miniature pointing hand symbol is used to denote a change to an illustration. However, a vertical line in the outer margin, rather than miniature pointing hands, is utilized when there have been extensive changes made to an illustration. Change symbols are not utilized to indicate changes in the following:

- a. Introductory material.
- b. Indexes and tabular data where the change cannot be identified.

c. Blank space resulting from the deletion of text, an illustration, or a table.

d. Correction of minor inaccuracies, such as spelling, punctuation, relocation of material, etc., unless such correction changes the meaning of instructive information and procedures.

**1-12. Aircraft Designation System.**

The designation system prescribed by AR 70-50 is used in aircraft designations as follows.

**EXAMPLE - OV-1D**

OV - Basic mission and type symbol (observation/surveillance)

1 - Design number

D - Series symbol

**1-13. Designator Symbols.**

Designator symbols such as **R** shall be used in conjunction with text contents, text headings, and illustration titles to show limited effectivity of the material. (Refer to table 1-1.) One or more designator symbols may follow a text heading or illustration title to indicate proper effectivity, unless the material applies to all series and configurations within the manual. If the material applies to all series and configurations, no designator symbols will be used. Where practical, descriptive information shall be condensed and combined for all series to avoid duplication.

**1-14. Use of Words Shall, Should, and May.**

Within this technical manual the word "shall" is used to indicate a mandatory requirement. The word "should" is used to indicate a non-mandatory but preferred method of accomplishment. The word "may" is used to indicate an acceptable method of accomplishment.

**Table 1-1. Designator Symbols**

Symbol	Aircraft Configuration
<b>O</b>	OV-1D and OV-1D(C)
<b>R</b>	RV-1D

## CHAPTER 2

# AIRCRAFT AND SYSTEMS DESCRIPTION AND OPERATION

### SECTION I. AIRCRAFT

#### 2-1. General.

The OV-1D and RV-1D aircraft are two-place, twin turboprop, Class 1B type aircraft (figure 2-1) featuring a midwing, triple vertical stabilizers, and a tricycle landing gear. The triple vertical stabilizers permit installation of manual instead of power controls, reduce radar reflectivity, and allow for low-ceiling hangar storage. The fuselage is of semimonocoque construction, seating a crew of two side-by-side. Design features include hydraulically operated landing gear, brakes, nosewheel steering, windshield wipers, speed brakes, wide span flaps and inboard ailerons, and mechanically controlled elevators, rudders, and outboard ailerons. For aircraft and cockpit arrangements, see figures 2-2 and 2-3.

*a. Dimensions.* Principal aircraft dimensions are illustrated in figure 2-4.

*b. Turning Diameter.* The turning diameter of the propellers is illustrated in figure 2-4. Ground clearances and turning radius of the wings and landing gear are illustrated in figure 2-5.

*c. Main Difference Table.* Table 2-1 lists the most significant differences between the OV-1D and RV-1D aircraft.

#### 2-2. Controls.

The control pedestal (figure 2-6), between the pilot and right seat occupant, contains controls that contribute to the operation of the aircraft. The function of the control and the end result produced when the control is moved to each of its possible positions, is covered in the applicable system.

#### 2-3. Indicators.

*a.* The aircraft indicators are on the pilot's instrument panel (figure 2-7) and the center instrument panel (figure 2-9) above the control pedestal.

*b.* A warning and caution light system provides the pilot with visual indication of an abnormal system operation. The system consists of a caution annunciator panel, a MASTER CAUTION light, a WHEELS warning light, and a MASTER CAUTION test switch (figure 2-10). Refer to table 2-2 for the relationship between caution annunciator panel lights and abnormal system operation. For a detailed description and operation of the warning and caution lights system, refer to paragraph 2-40.



# OV-1D

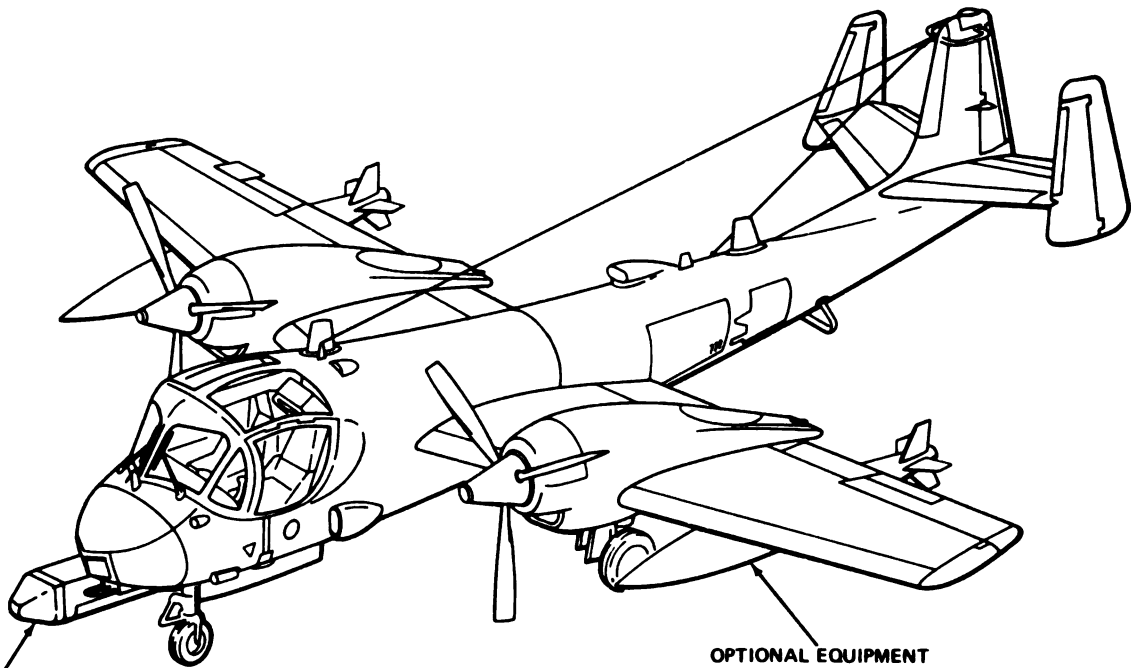
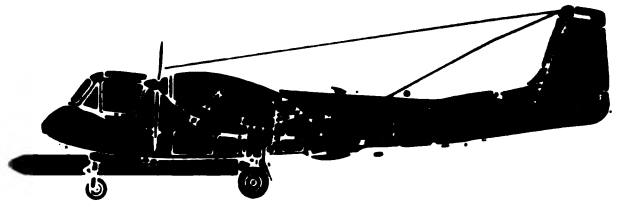
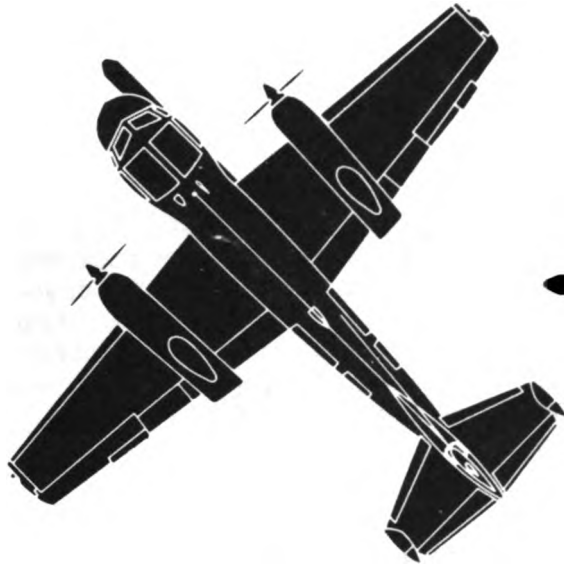
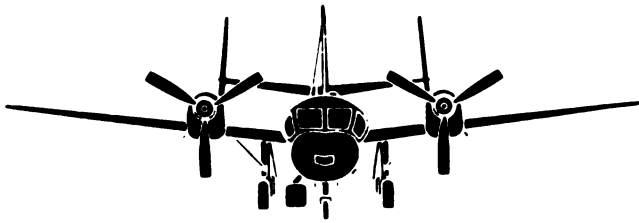

OPTIONAL EQUIPMENT

OPTIONAL EQUIPMENT

B-2-10-D-1-1

*Figure 2-1. The OV-1D and RV-1D Aircraft (Sheet 1 of 2)*

# RV-1D

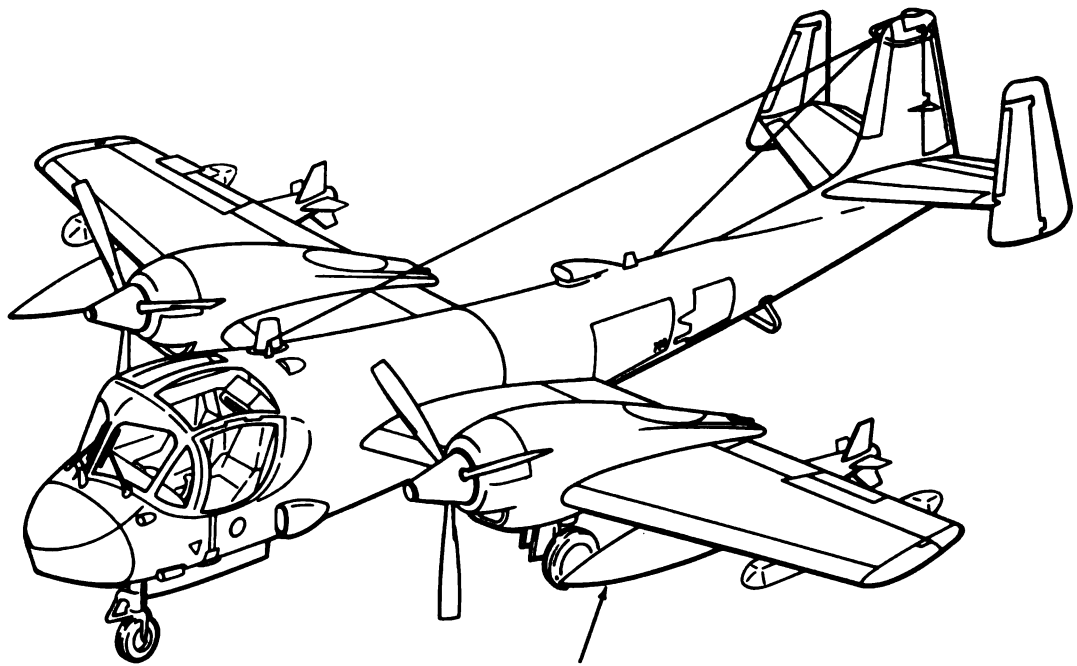
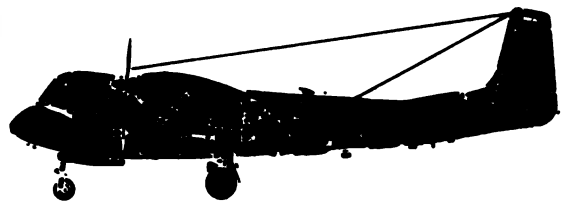
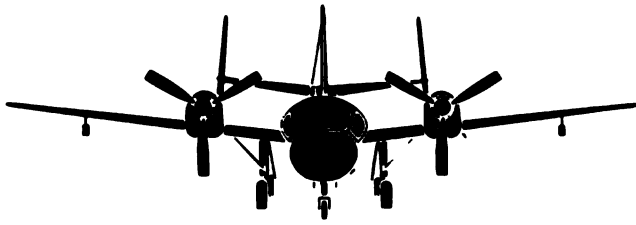

OPTIONAL EQUIPMENT

B-2-10-D-1-2

**Figure 2-1. The OV-1D and RV-1D Aircraft (Sheet 2 of 2)**

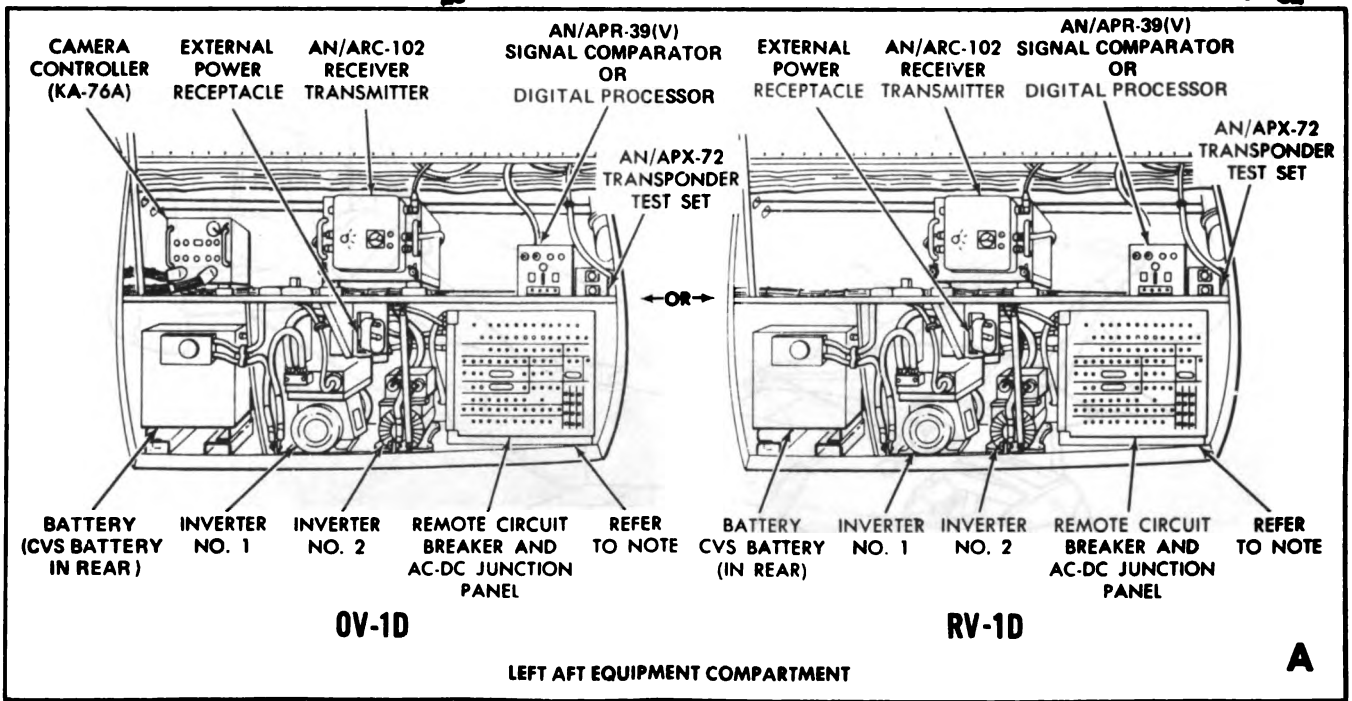
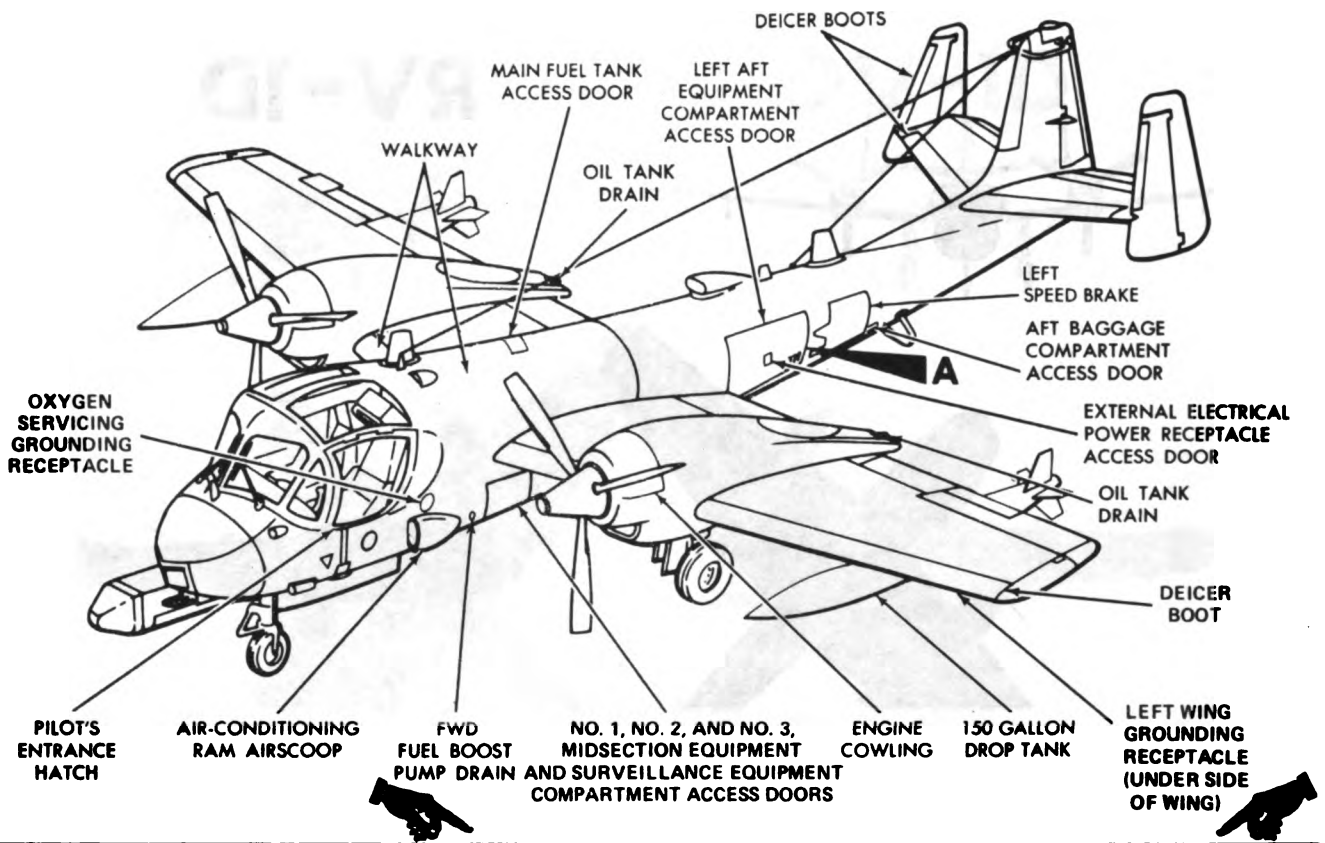

**NOTE**  
 WITH CIRCUIT BREAKER PANEL CLOSED, LOWER PORTION OF JUNCTION PANEL PAINTED WITH RED BAND WILL ALERT PERSONNEL THAT INTERNAL SHIELD HAS NOT BEEN INSTALLED.

D-2-10-D-2-1

**Figure 2-2. Aircraft General Arrangement (Sheet 1 of 2)**

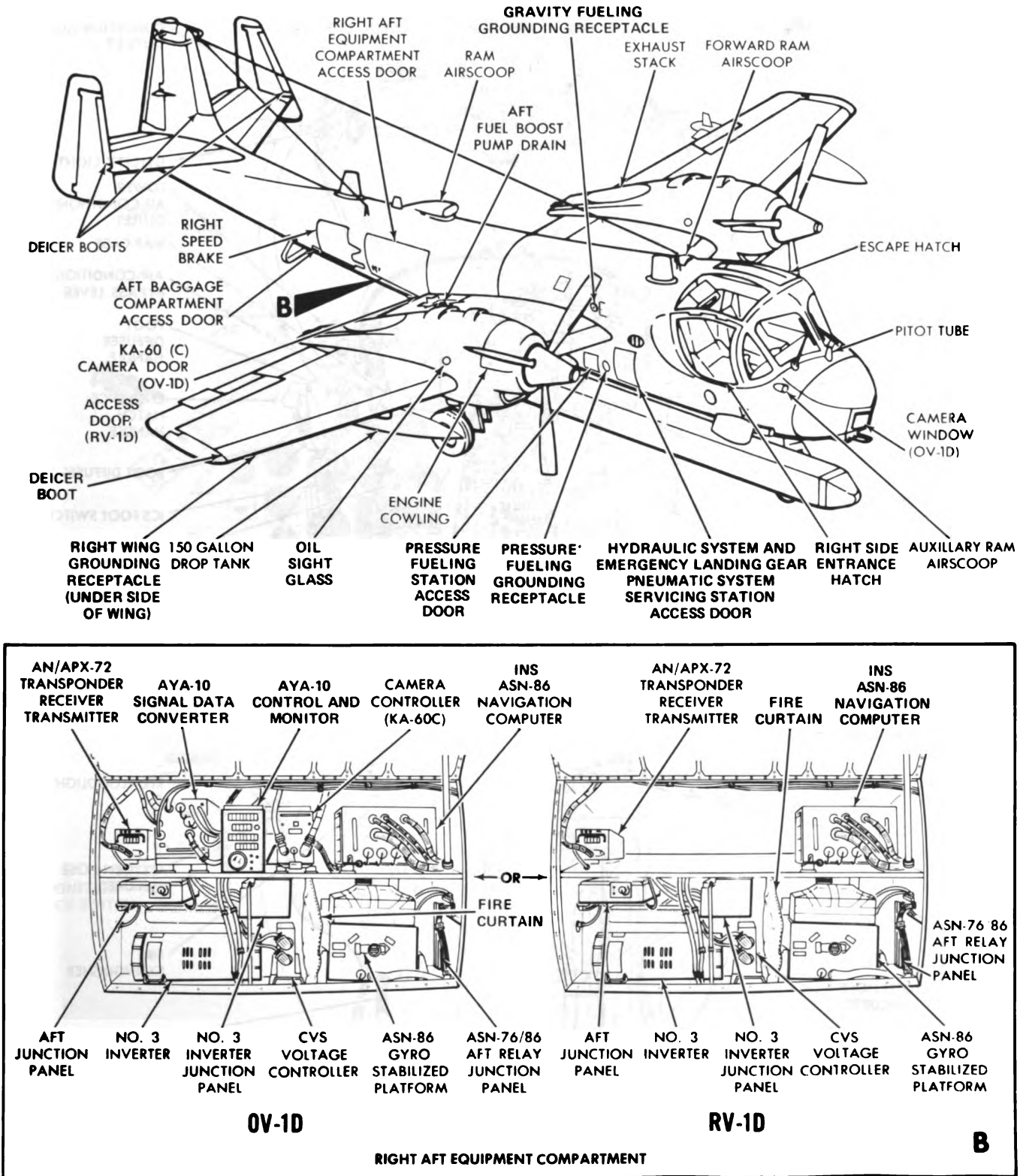

C 210 D 22

Figure 2-2. Aircraft General Arrangement (Sheet 2 of 2)

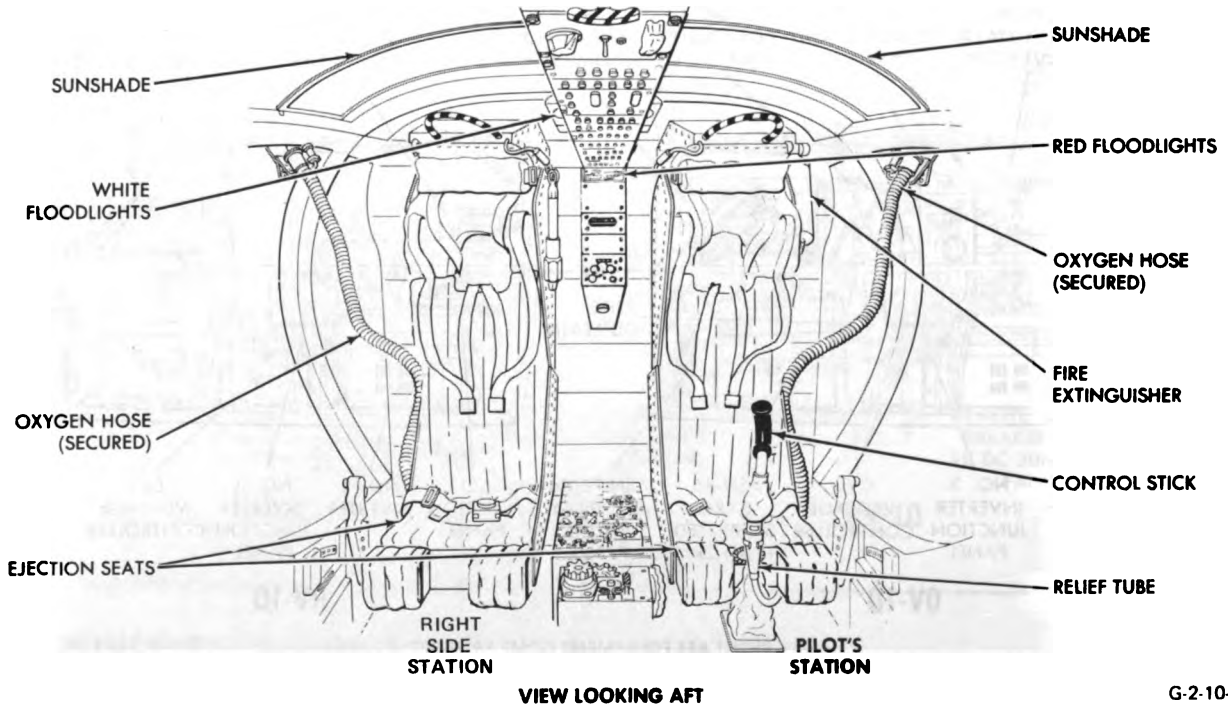
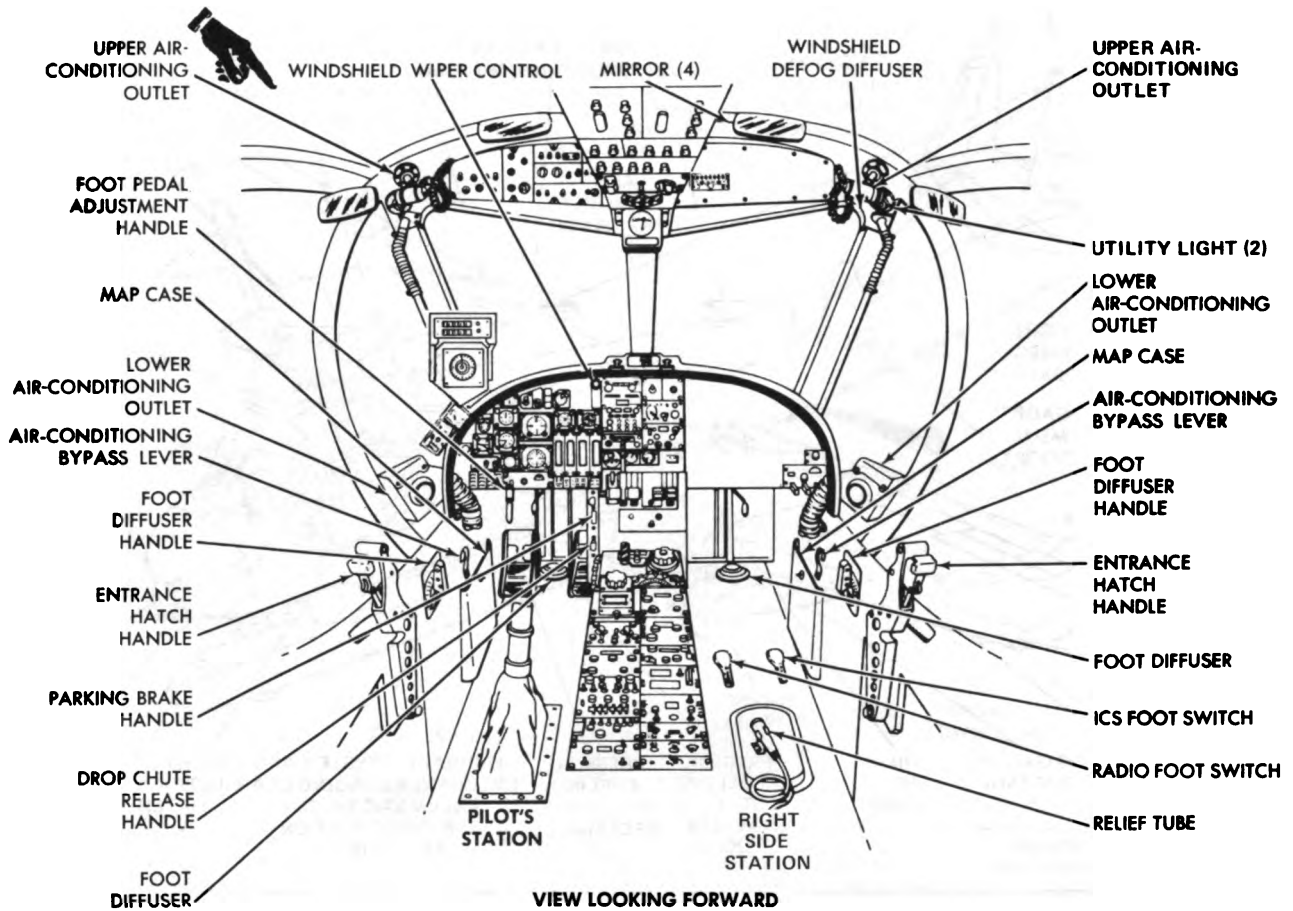
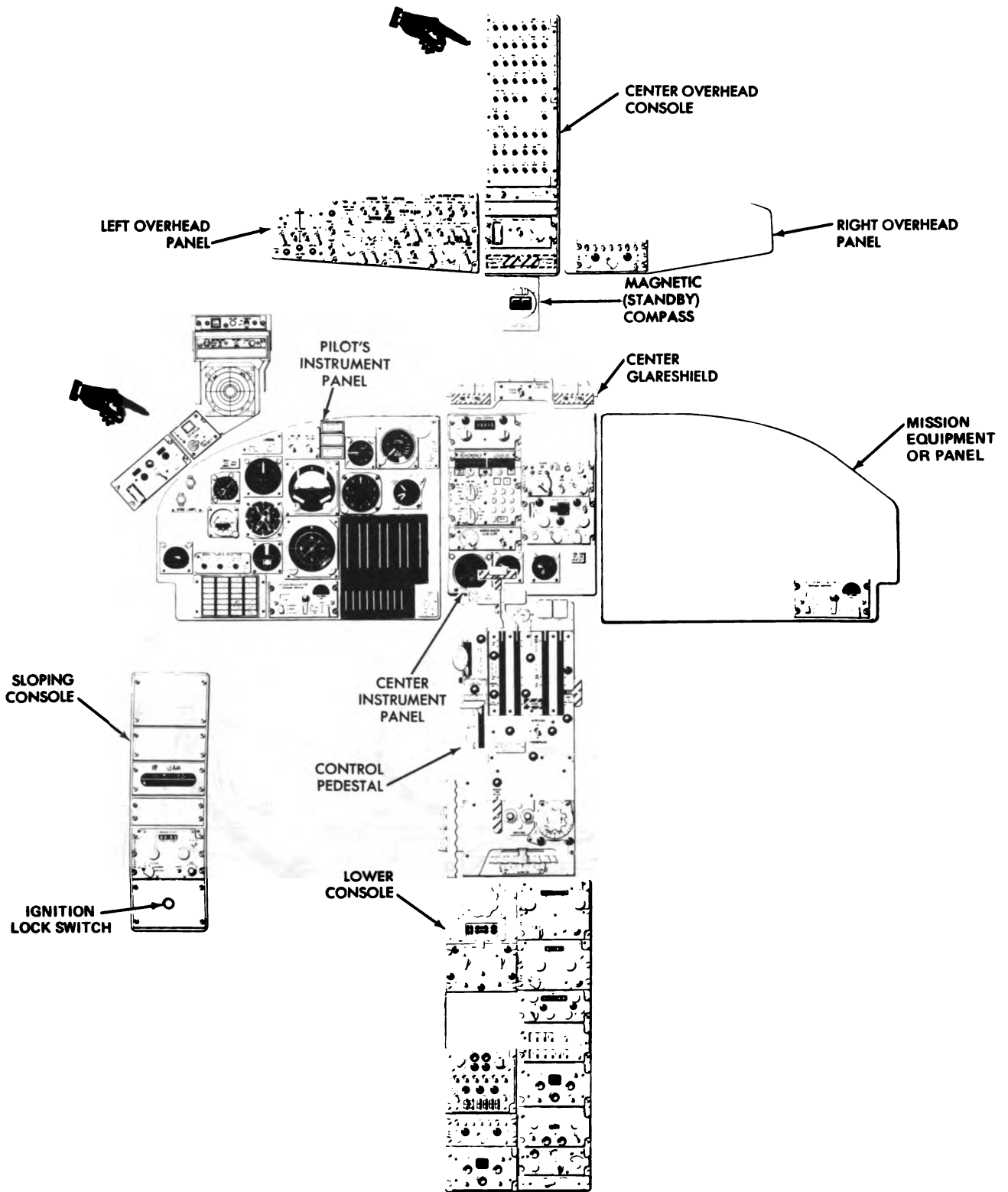

Figure 2-3. Cockpit General Arrangement (Typical) (Sheet 1 of 2)

G-2-10-D-3-1



E-2-10-D-3-2

Figure 2-3. Cockpit General Arrangement (Typical) (Sheet 2 of 2)

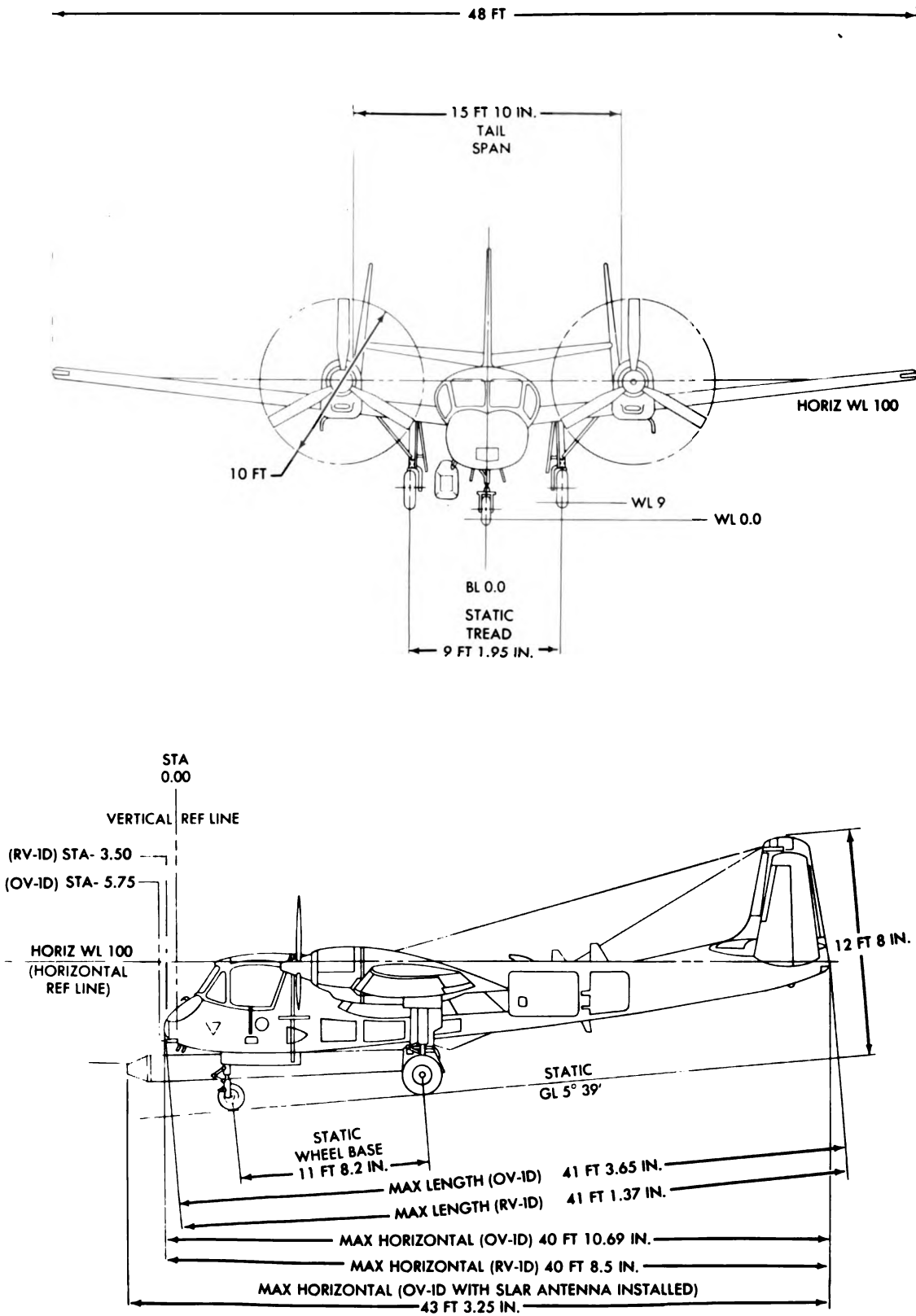

2-10-D-4

Figure 2-4. Principal Dimensions

**NOTE**  
 CLEARANCES SHOWN ARE FOR  
 TAXIING USING POWER STEERING  
 OR FOR TOWING. REFER TO SECTION  
 XIII FOR ADDITIONAL INFORMATION  
 ON GROUND HANDLING AND  
 CHAPTER 8 FOR TAXIING.

GROUND CLEARANCES (WINGS LEVEL)	
VERTICAL STABILIZER	12 FT 8 IN.
WINGTIP	7 FT 3 IN.
PROPELLER	
UPPER BLADE	13 FT 2 IN.
LOWER BLADE	3 FT 2 IN.

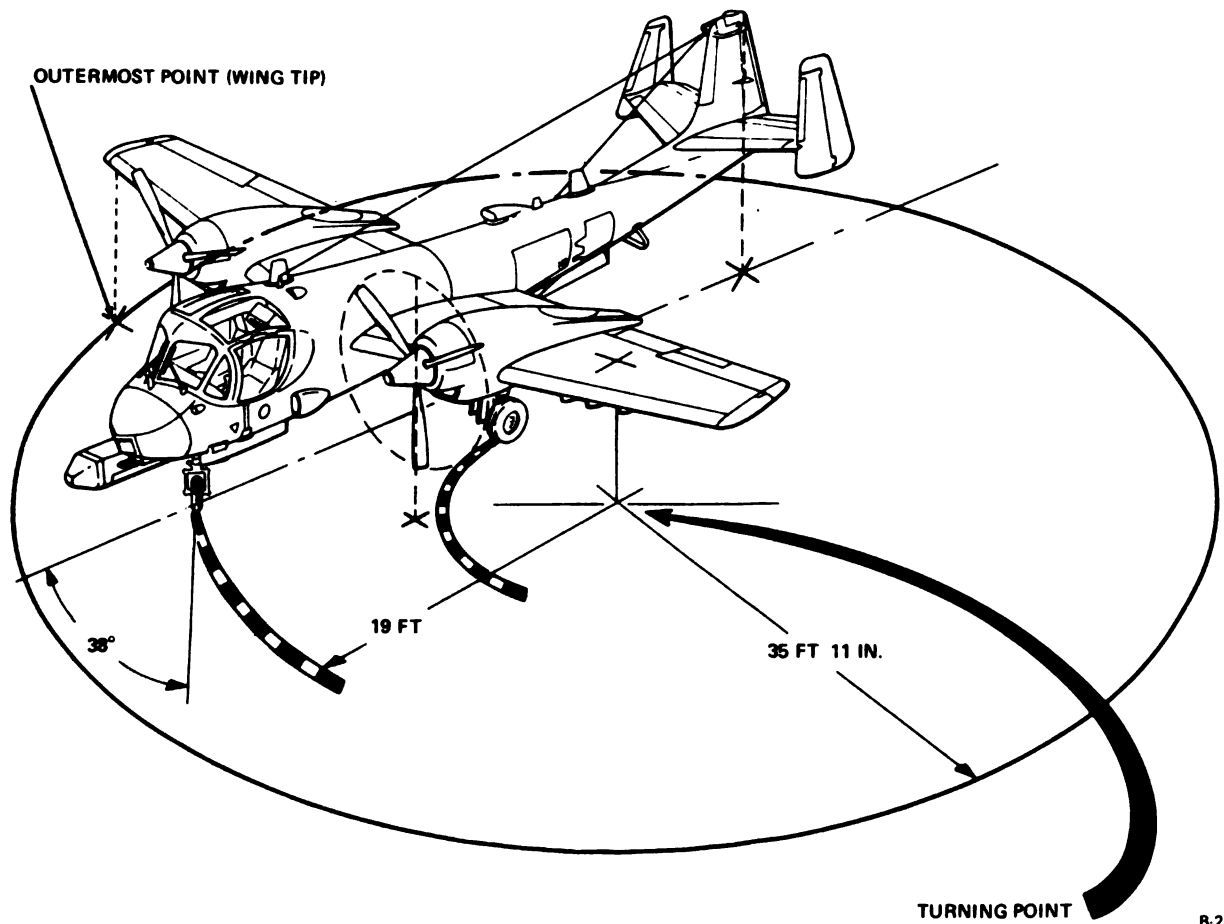

B-2-10-D-5

**Figure 2-5. Turning Radius and Ground Clearance**



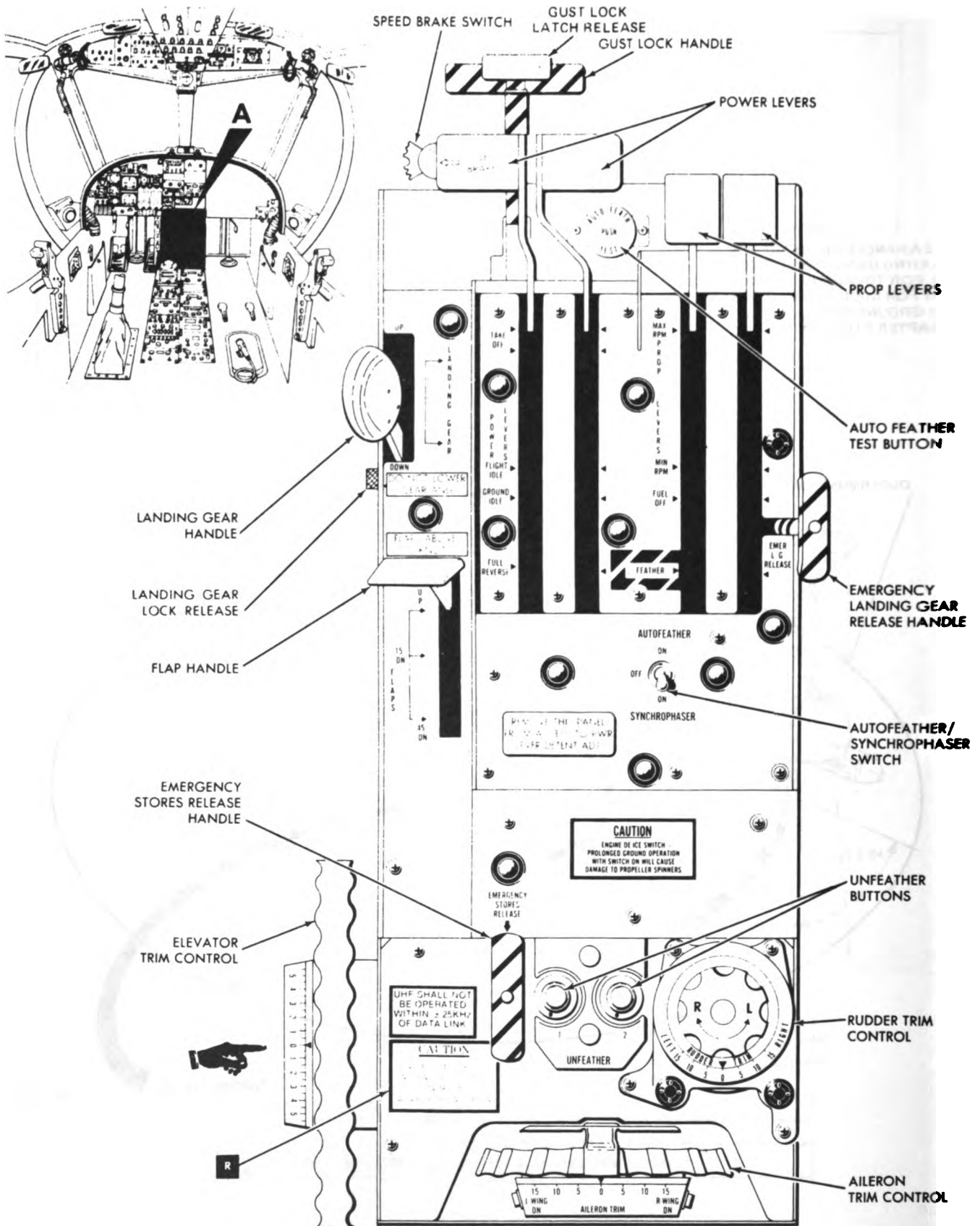

**A** CONTROL PEDESTAL (TOP VIEW)

8-2-10-D-6

**Figure 2-6. Control Pedestal**

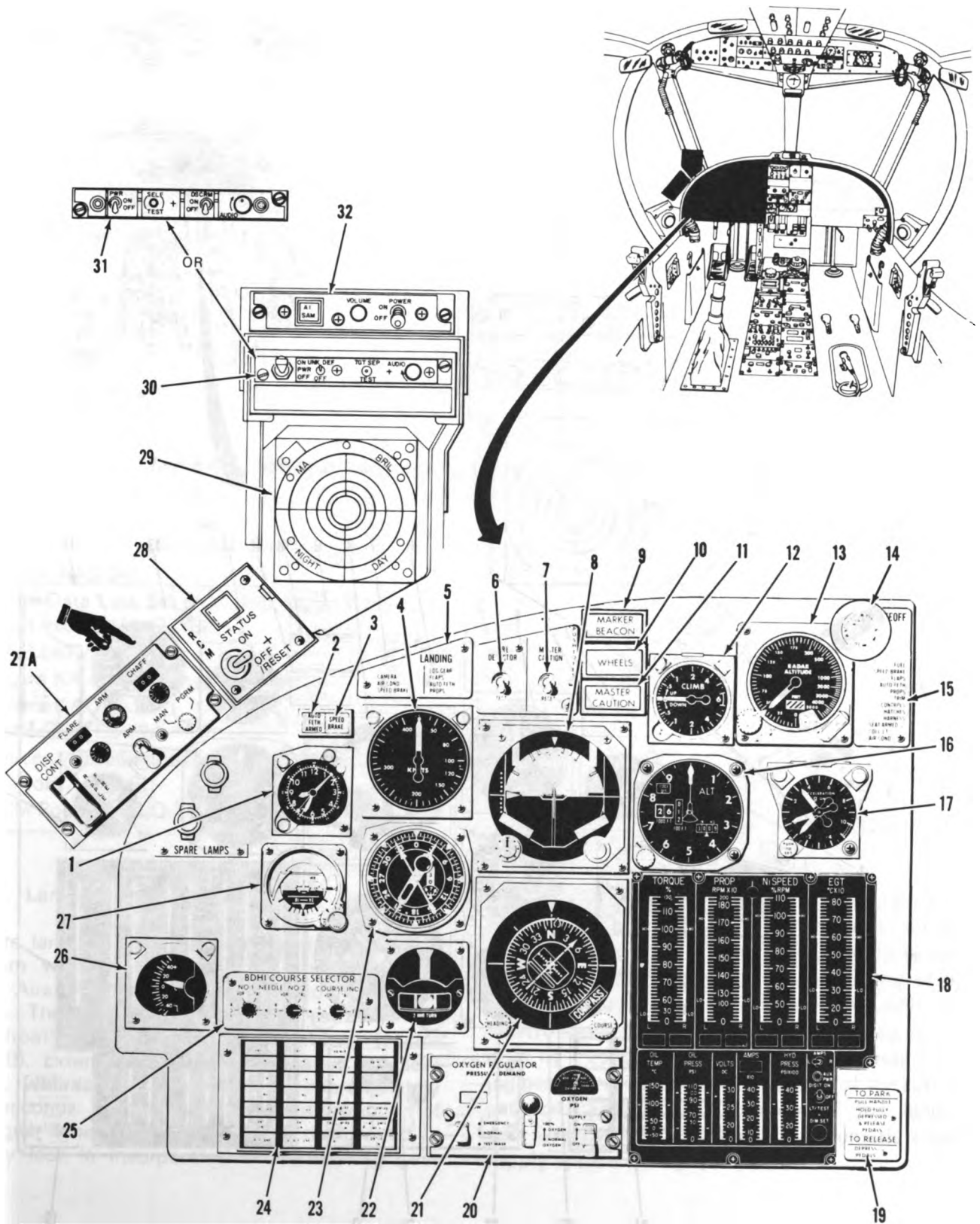
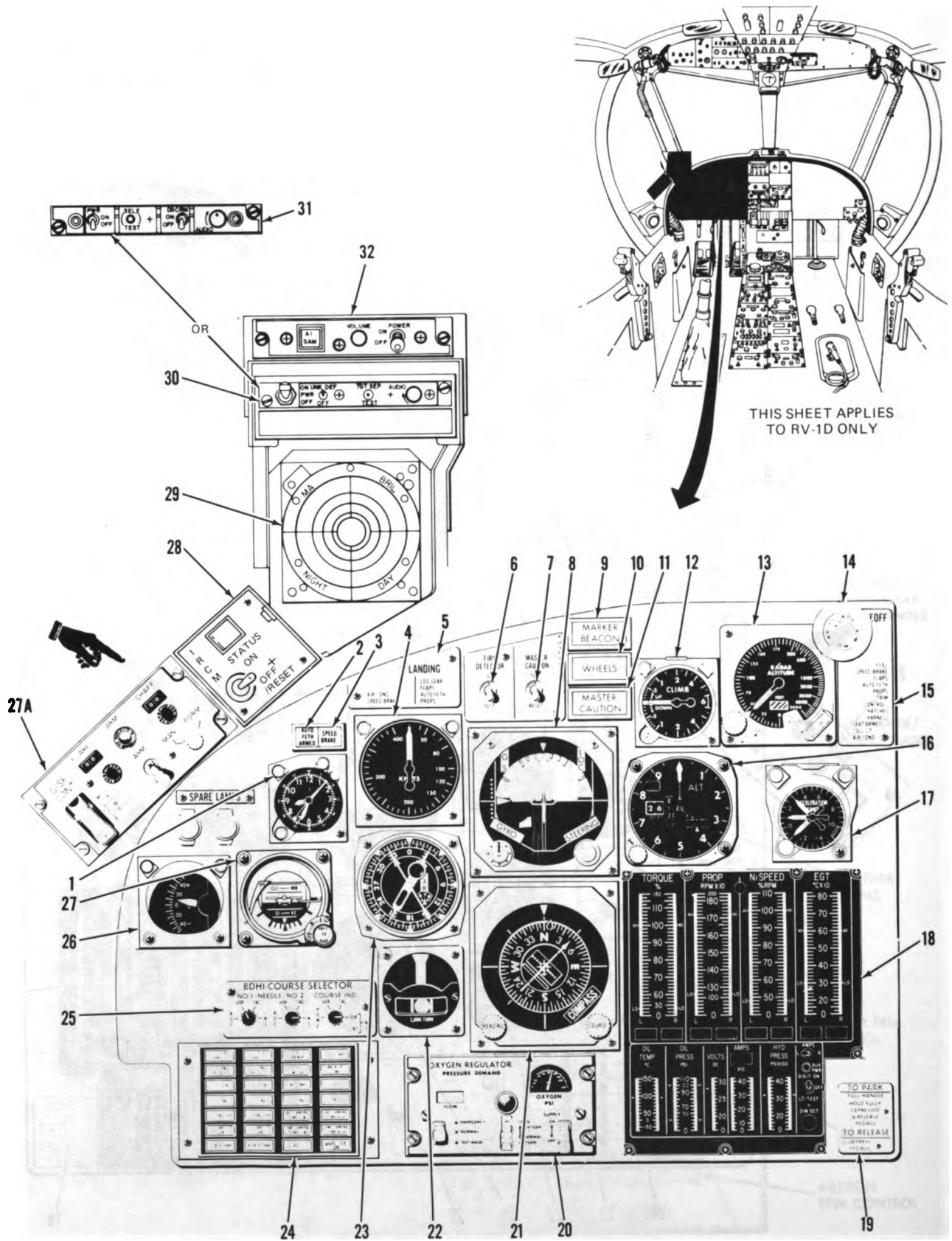

Figure 2-7. Pilot's Instrument Panel (Typical) (Sheet 1 of 3)

F-2-10-D-7-1



THIS SHEET APPLIES TO RV-10 ONLY

F-2-10-D-7-2



**R** Figure 2-7. Pilot's Instrument Panel (Typical) (Sheet 2 of 3)

Legend for fig. 2-7

- |  |  |
|--|--|
| <ol style="list-style-type: none"> <li>1. Mechanical clock A-13A</li> <li>2. Autofeather armed light</li> <li>3. Speed brake warning light</li> <li>4. Airspeed indicator</li> <li>5. Landing checklist</li> <li>6. Fire detector test switch</li> <li>7. Master caution test switch</li> <li>8. Attitude navigation indicator ID-882/ASN (approach horizon indicator)</li> <li>9. Marker beacon light</li> <li>10. Wheels warning light</li> <li>11. Master caution light</li> <li>12. Vertical velocity indicator</li> <li>13. Height indicator ID-1345A/APN-171(V)</li> <li>14. Windshield wiper control knob</li> <li>15. Takeoff checklist</li> <li>16. Altimeter-encoder AAU-32/A</li> </ol> | <ol style="list-style-type: none"> <li>17. Accelerometer indicator</li> <li>18. Vertical instrument display system (VIDS) display unit</li> <li>19. Parking checklist</li> <li>20. Oxygen regulator panel</li> <li>21. Course indicator ID-883/ASN</li> <li>22. Turn and slip indicator</li> <li>23. Bearing distance heading indicator ID-663B/U</li> <li>24. Caution annunciator panel</li> <li>25. BDHI/course selector panel</li> <li>26. Free air temperature indicator</li> <li>27. Standby attitude indicator ARU-42/A-2</li> <li>27A. Dispenser Control Panel M130</li> <li>28. Operator's control unit (OCU) C-10698/ALQ-147A(V)</li> <li>29. Indicator 1P-1150/APR-39(V)</li> <li>30. Control unit C-10412/APR-39(V)</li> <li>31. Control unit C-9326/APR-39(V)</li> <li>32. Control Panel C-10387/APR-44</li> </ol> |
|--|--|

Figure 2-7. Pilot's Instrument Panel (Typical) (Sheet 3 of 3)

Table 2-1. Main Difference Table OV-1D and RV-1D Aircraft

Item		
IR (AN/AAS-24)	Yes	No
Digital Data Link Set (AN/USQ-61A( ))	No	Yes
Data Link (AN/AKT-18B)	Yes	No
SLAR (AN/APS-94F)	Yes	No
Camera KA-60C (Forward and Aft)	Yes	No
Camera KA-76A	Yes	No
Flasher Pod LS-59A	Yes	No
Intercept Receiver Pods AN/ALQ-133 (Store Stations 1 and 6)	No	Yes
IRCM Pod AN/ALQ-147A(V)1	Yes	No

**2-4. Landing Gear System.**

The landing gear is a retractable tricycle-type system with pneudraulic struts and pneumatic tires. Aircraft operation should be from improved fields. The gear is extended and retracted hydraulically by the hydraulic system (figure 2-29). Extension takes approximately 5.0 seconds, whereas retraction time is approximately 3.0 seconds. To prevent inadvertent retraction of the gear when the aircraft is on the ground, a safety lock is incorporated in the landing gear

control system. It consists of a solenoid-actuated pin that locks the landing gear handle to DOWN position when weight is on the right main landing gear (figure 2-11). In the event of failure of the switch to actuate the solenoid, the LANDING GEAR handle may be manually unlocked by the pilot by means of a manual override release (landing gear lock release) on the left side of the control pedestal. Emergency extension of the landing gear is provided by a one-shot pneumatic power supply system (paragraph 2-29).

**WARNING**

If the LANDING GEAR handle is in any position other than DOWN and locked, the landing gear will retract – even during engine cranking.

**NOTE**

*During high-speed taxiing, just before takeoff, or when taxiing over undulating surfaces such as PSP, the safety lock may be unreliable.*

a. *Landing Gear Handle.* The LANDING GEAR handle (figure 2-6) is a two-position lever on the left side of the control pedestal. To move the handle out of either the UP or DOWN position, the handle shall first be moved to the left to release it from the detent. The gear is restrained in the up position by uplock hooks. To extend the gear, the LANDING GEAR handle is moved to the DOWN position, directing hydraulic pressure to the gear and door actuating cylinders. The door cylinders extend and the doors open. As the doors approach the full-open position, a cable actuated by the door movement pulls the uplock hooks to the unlocked position and permits the gear to extend. When the gear reaches the full-down position, the downlocks engage and lock the gear in the extended position. To retract the gear, the LANDING GEAR handle is placed in the UP position.

All data on pages 2-15 and 2-16, and figure 2-8 deleted.

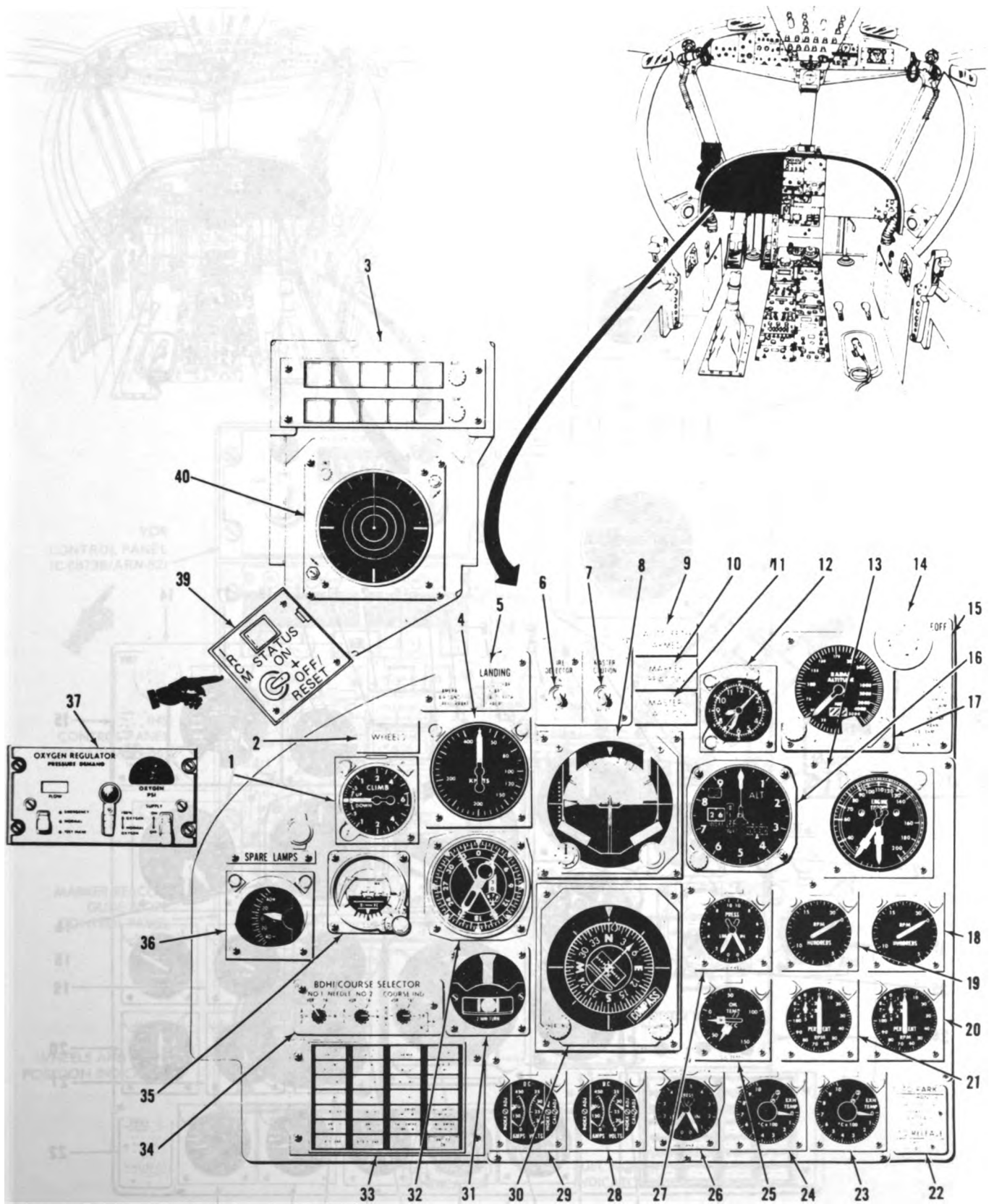

D-2 10 D 8-1



**Figure 2-8. Pilot's Instrument Panel-Round-Dial Engine Instrument Configuration (Typical) (Sheet 2 of 3)**

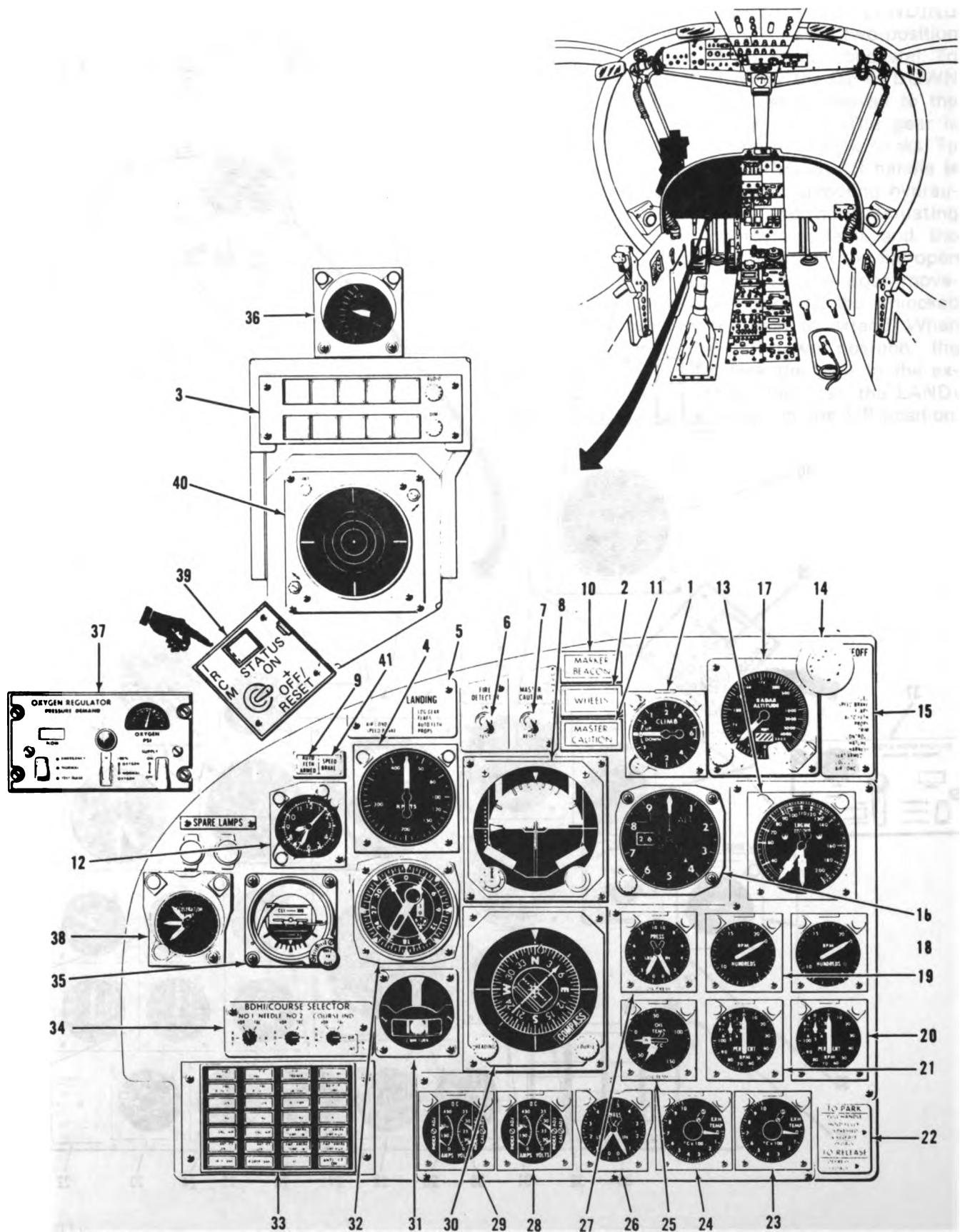

**Figure 2-8. Pilot's Instrument Panel-Round-Dial Engine Instrument Configuration (Typical) (Sheet 3 of 3)**

C-2-10-D-8-2

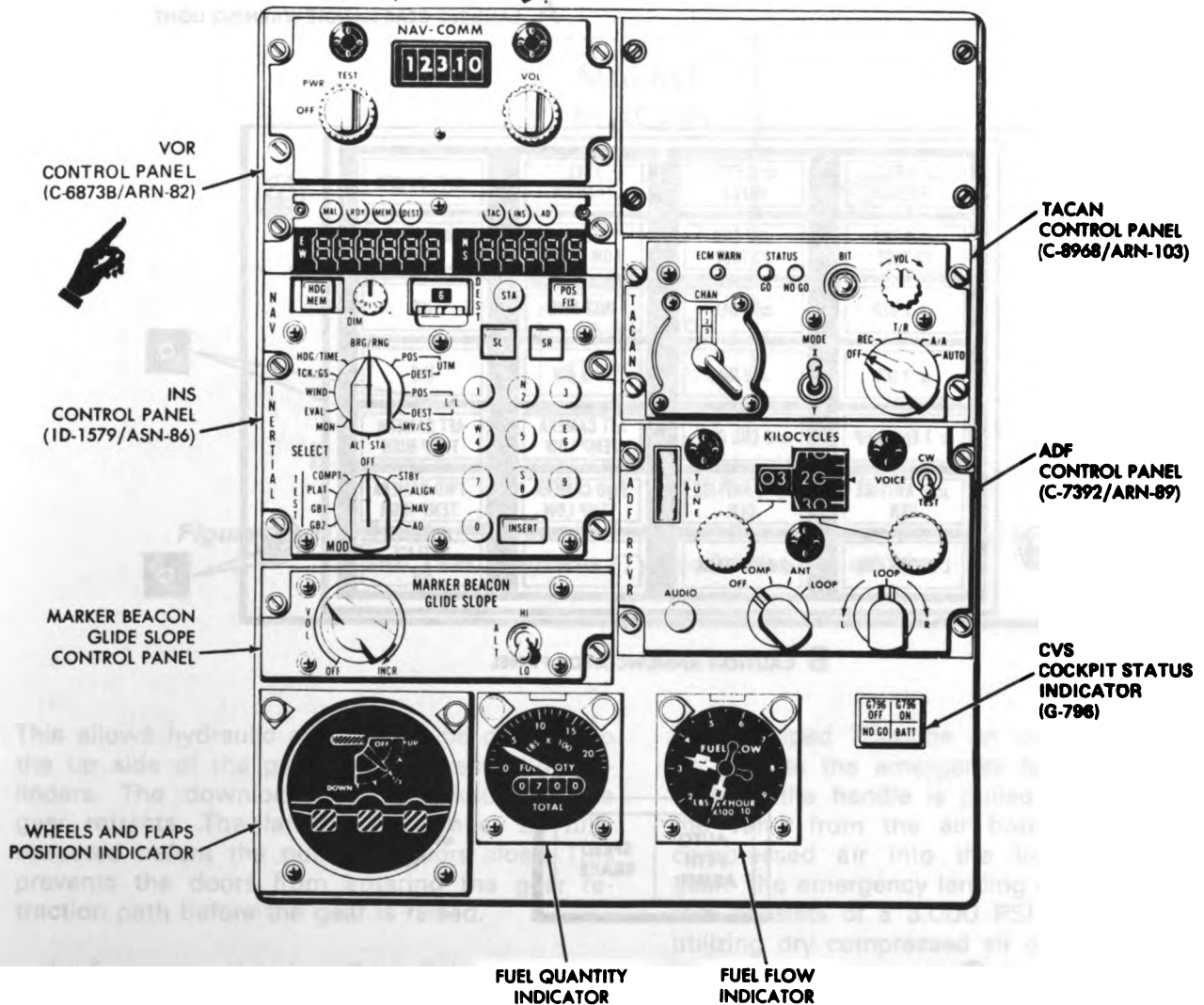
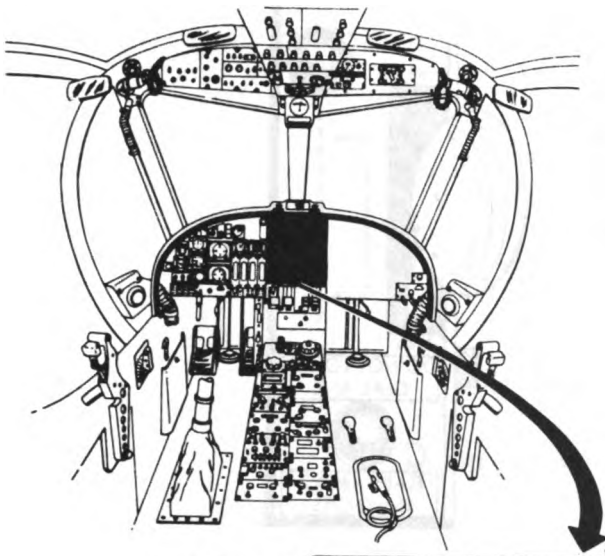
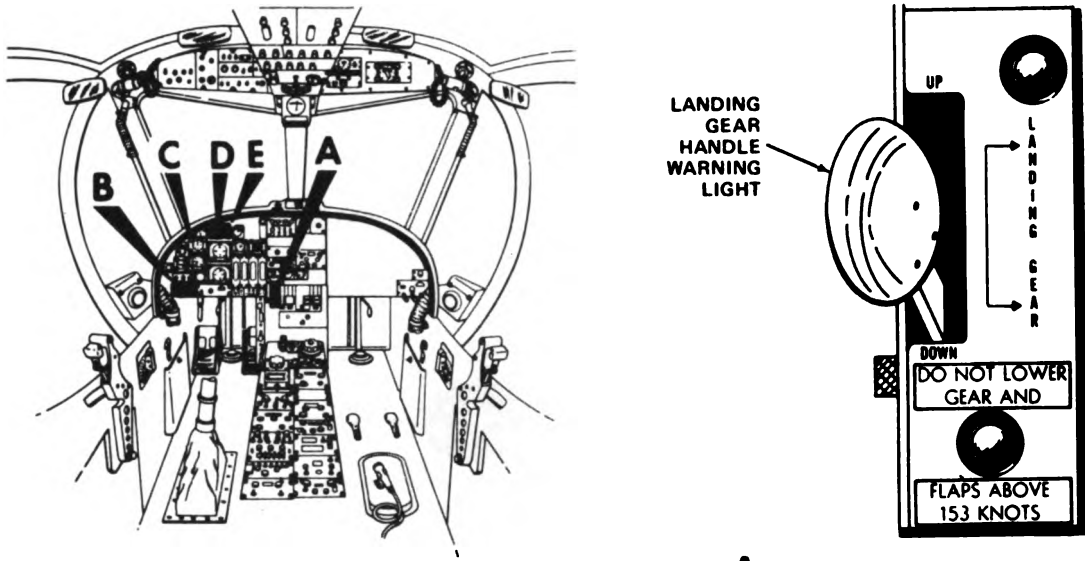
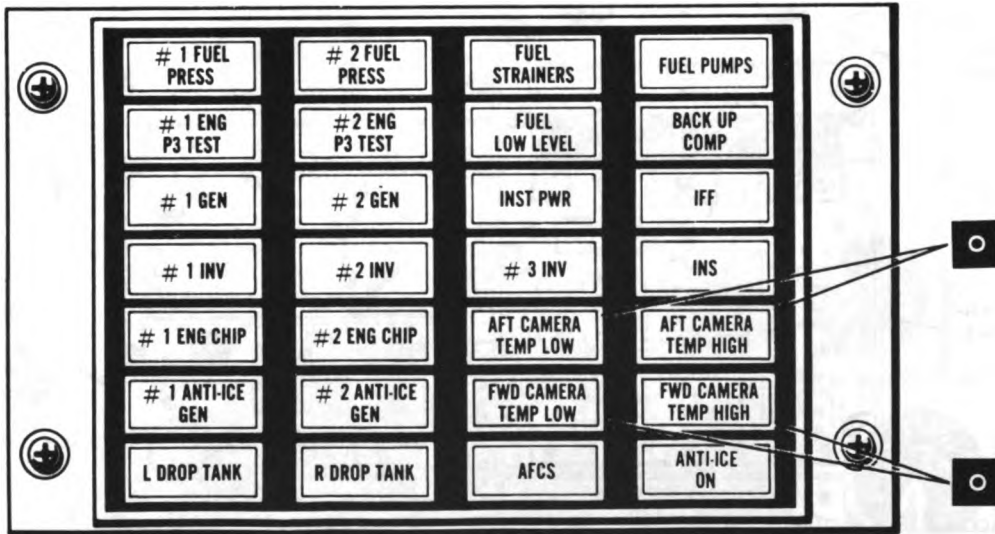

Figure 2-9. Center Instrument Panel (Typical)





**A** LANDING GEAR HANDLE WARNING LIGHT



**B** CAUTION ANNUNCIATOR PANEL

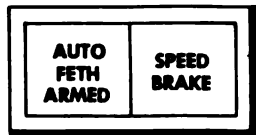

**C** AUTOFEATHER ARMED LIGHT AND SPEED BRAKE ADVISORY LIGHT

**Figure 2-10. Caution Annunciator Panel, Caution and Warning Lights, and Test Switches (Typical) (Sheet 1 of 2)**

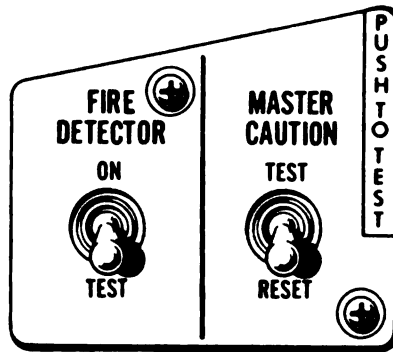

**D** FIRE DETECTOR AND MASTER CAUTION TEST SWITCHES

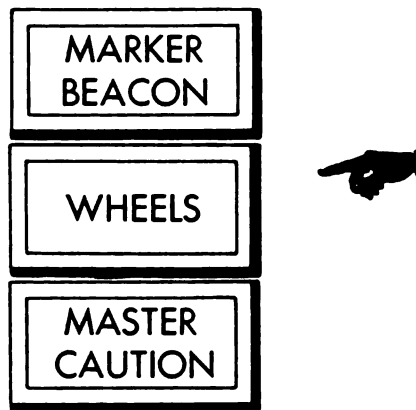

**E** MASTER CAUTION, MARKER BEACON, AND WHEELS WARNING LIGHTS

D2-10-D-10-2

**Figure 2-10. Caution Annunciator Panel, Caution and Warning Lights, and Test Switches (Typical) (Sheet 2 of 2)**

This allows hydraulic pressure to be directed to the up side of the gear and door actuating cylinders. The downlocks are unlocked and the gear retracts. The landing gear must be fully retracted before the outboard doors close. This prevents the doors from entering the gear retraction path before the gear is raised.

**b. Emergency Landing Gear Release Handle.** The emergency landing gear release (EMER L.G. RELEASE) handle (figure 2-6) is a yellow and

black striped T-handle on the control pedestal. To actuate the emergency landing gear release system, the handle is pulled out, thus opening the valve from the air bottle and forcing the compressed air into the lines, extending the gear. The emergency landing gear extension system consists of a 3,000 PSI pneumatic system utilizing dry compressed air or nitrogen. Since it is a one-shot system, it provides for lowering the gear only one time, and then must be serviced.

**Table 2-2. Caution Annunciator Panel Lights**

Light	Illuminates to Indicate
# 1 FUEL PRESS	One or both elements of No. 1 engine-driven fuel pump have failed.
# 2 FUEL PRESS	One or both elements of No. 2 engine-driven fuel pump have failed.
# 1 ENG P3 TEST	Operation of the engine P3 switch during autofeather system check. Will also glow upon actual autofeather.
# 2 ENG P3 TEST	Operation of the engine P3 switch during autofeather system check. Will also glow upon actual autofeather.
# 1 GEN	Disconnection of No. 1 generator from primary bus.
# 2 GEN	Disconnection of No. 2 generator from primary bus.
# 1 INV	Failure of No. 1 inverter.
# 2 INV	Failure of No. 2 inverter.
# 3 INV	Failure of No. 3 inverter.
# 1 ENG CHIP	Metallic contamination of No. 1 engine oil system.
# 2 ENG CHIP	Metallic contamination of No. 2 engine oil system.
# 1 ANTI-ICE GEN	Failure of No. 1 engine anti-ice generator.
# 2 ANTI-ICE GEN	Failure of No. 2 engine anti-ice generator.
L DROP TANK	Zero fuel pressure from left drop tank.
R DROP TANK	Zero fuel pressure from right drop tank.
FUEL STRAINERS	One or both main fuel filters may become bypassed.
FUEL PUMPS	Failure of both main tank fuel boost pumps.
FUEL LOW LEVEL	Fuel in main tank is less than 290 pounds.
IFF	When transponder fails to reply to mode 4 interrogation.
INST PWR	Loss of power to instrument AC bus.
INS	Failure of inertial navigation system.
BACK UP COMP	Failure of power source of backup compass system.
AFT CAMERA TEMP LOW	Low temperature in aft camera compartment.
AFT CAMERA TEMP HIGH	High temperature in aft camera compartment.
FWD CAMERA TEMP LOW	Low temperature in nose camera compartment.
FWD CAMERA TEMP HIGH	High temperature in nose camera compartment.
AFCS	Autopilot gyro is not erected or autopilot disengage button has been pressed.
ANTI-ICE ON	ENGINE DE-ICING switch is ON when aircraft is on the ground.

**NOTE**

*The LANDING GEAR handle can be in either the DOWN or the UP position before using the emergency gear extension system. However, the gear handle warning light will be on if the handle is not in the DOWN position.*

*c. Landing Gear Handle Warning Light.* The landing gear warning light (figure 2-10) is in the translucent portion of the LANDING GEAR handle. This red light will illuminate whenever the position of the nose and main gear does not agree with the position of the LANDING GEAR handle. The light will also illuminate if the master caution test switch is placed in the TEST position.

*d. Wheels Warning Light.* The WHEELS warning light (figure 2-10) is a rectangular warning light on the pilot's instrument panel. This light will flash when either or both POWER LEVERS are moved out of the TAKEOFF range if the landing gear handle is up and the flap handle is in any position other than up. The light will also illuminate if the master caution test switch is placed in the TEST position.

*e. Landing Gear Position Indicator.* The landing gear position indicator, part of the wheels and flaps position indicator, is on the center instrument panel (figure 2-9). The position of both nose and main gear is shown in the down and locked or the up and locked positions, and also in any unsafe position. In an unsafe position, the indicator will display white diagonal lines.

**2-5. Power Steering System.**

The power steering system is controlled from the cockpit by a mechanical linkage connecting the rudder pedals to the nosewheel steering damper. The system is powered by the 3,000 PSI aircraft hydraulic system (figure 2-29) and

is energized when the PWR STEER switch (figure 2-21) is in the ON position and the nose gear shock strut is compressed. The switch is a two-position toggle switch on the center of the glare shield. In the ON position and in conjunction with the compressed nose gear shock strut, the switch energizes a shutoff valve connecting one port of the steering damper to the hydraulic pressure. In the OFF position, the shutoff valve is deenergized, opening both ports of the steering damper to the hydraulic return line. See figure 2-5 for the minimum turning radius with nosewheel steering.

**2-6. Brake System.**

*a.* The brake system consists of two dual-disk type brakes, two power boost master brake cylinders, and a dual parking brake valve. Hydraulic system pressure (3,000 PSI) powers the master cylinders. The toe brake sections of the rudder pedals are connected by a series of pushrods to the master cylinders, which actuate the brakes. The PARK BRAKE handle (figure 2-3), beneath the pilot's instrument panel on the left side of the cockpit, is provided for setting the parking brake. To engage the parking brake, pull the PARK brake handle, press and release the brake pedals, and release the PARK brake handle. Pressing the brake pedals releases the parking brake. No emergency power boosted brake system is incorporated, however, hydraulic (unboosted) brakes are available in the event of failure of the power boost system.

*b.* To reduce maintenance difficulties and wheel and brake failure, it is important to use wheel brakes properly. Repeated excessive application of brakes without allowing sufficient time for cooling between applications will cause temperature increases to a dangerous degree, which may result in complete breakdown of the brake structure, failure of brake disk and wheel structure, and blowing of tires. This can also be caused by excessively short stops from high rates of speed and dragging brakes for an appreciable distance while taxiing at slow speeds. The following precautions should be observed when practicable:

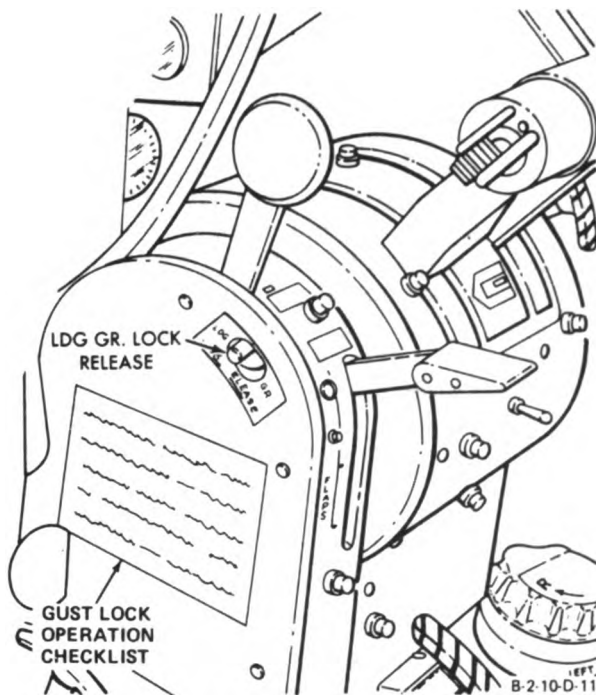

**Figure 2-11. Landing Gear Lock Release**

(1) Immediately after landing or at any time when there is considerable lift on the wings, extreme care should be used during any brake applications to prevent skidding the tires and causing flat spots. Proper traction cannot be expected until the tires are carrying heavy loads. In the event that maximum braking is required after touchdown, propellers should be reversed immediately and the brakes applied smoothly and evenly after the aircraft has decelerated.

(2) With the landing gear remaining extended, at least 10 minutes should be allowed to elapse between landings where maximum braking is applied to permit adequate time for brakes to cool.

(3) With the landing gear retracted, at least 30 minutes should be allowed to elapse between landings to permit adequate time for brakes to cool when maximum braking is applied.

(4) At the first indication of brake malfunction, the aircraft should be controlled through the use of both forward and reverse thrust and nosewheel steering.

(5) Advantage should be taken of the full length of the usable runway during the landing roll in order to minimize the use of brakes.

(6) The brakes should not be dragged when taxiing, either intentionally or inadvertently. Personnel should insure that toe brake pressure is not applied when operating the rudder pedals. Normally the brake linkage is adjusted to prevent inadvertent toe pressure when operating the rudder pedals.

(7) For short landing rolls, reversing the propellers and a single, smooth application of the brakes with constantly increasing pedal pressure is most desirable.

(8) To prevent damage during landing, brakes must not be set and locked during flight. It is advisable to apply and release the brakes a few times before landing to determine by feel whether the brake system is functioning properly. If the pedals feel spongy or soft, it may be possible to pump up the brakes before landing to insure the best possible operation.

(9) Unless new wheel brakes are properly broken in, adequate braking action may not be available for ground engine runup. Apply hard pedal pressure to new brakes four times during taxiing, allowing them to cool each time.

## 2-7. Escape Hatch.

The escape hatch (figure 2-2) is the section making up the cockpit roof directly over the occupant's heads. The escape hatch pneumatic jettison system is a self-contained system used to jettison the escape hatch. The system is actuated by the escape HATCH JETTISON handle (figure 2-12), that must be rotated 90° clockwise and pulled.

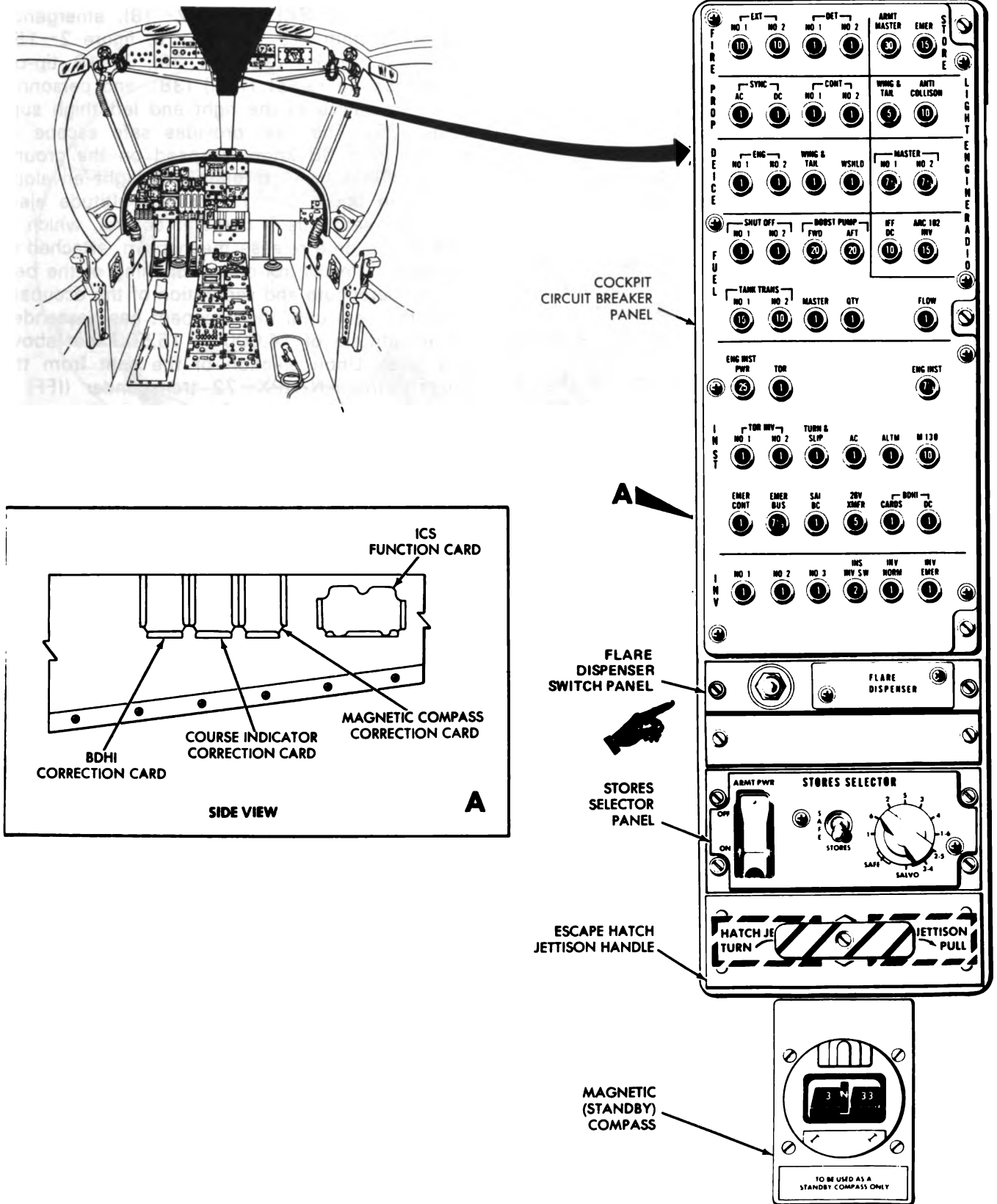

Figure 2-12. Center Overhead Console (Typical)

## 2-8. Entrance Hatches, Boarding and Access Ladders.

**CAUTION**

**Do not release boarding ladder on right side when SLAR antenna is installed. Upon release, the ladder may hit the antenna and damage it.**

The pilot and airborne systems specialist each have their own entrance hatch and boarding ladder (figure 2-13). The hatches contain bubble windows and are opened by two external hatch handles. From the cockpit, the hatches are opened with the internal hatch handles (figure 2-3). When open, the hatches are supported by a spring bungee assembly. A handgrip on the glareshield is used to aid the pilot in entering the cockpit. A wing access ladder (figure 2-14) is flush-stowed on the right side of the fuselage near the inboard flap. It is used to obtain access to the top of the aircraft. The ladder is released by pressing a flush latch in the ladder step. The latch is released from a bracket that secures the ladder in the retracted position. After releasing the latch, the ladder must be pulled down to extend. To stow, the ladder must be pushed up flush with the fuselage. The wing access ladder shall be secured prior to flight. The boarding ladder on the pilot's side is released by pressing in the kick-plate, located forward of the ladder. On the specialist's side, the SLAR antenna is used as the boarding ladder, when installed. When the SLAR antenna is not installed, the specialist uses a boarding ladder similar to the pilot's. To release the specialist's boarding ladder, push in slide-lock button, on the boarding ladder, and pull down slide to unlock the ladder. Then, press in kick-plate, forward of the ladder, to release ladder. Both boarding ladders cannot be stowed from the inside of the aircraft, and must be stowed by maintenance personnel, before flight.

## 2-9. Seats.

Two MK-J5D rocket assisted ejection seat systems (figure 2-15) are utilized. Each seat system consists of an ejection gun, main beam assembly, seat bucket (28), drogue parachute container (23), drogue gun (26), time release mechanism (20), personnel parachute container

and harness assembly (figure 2-16), rigid seat survival kit (RSSK) (figure 2-18), emergency oxygen system (15 through 18, figure 2-15), guillotine system (35 and 36), M119 tip-off compensating rocket (TCR) (38), and personnel lowering device in the right and left thigh supports (39). The seat provides safe escape at speeds from 60 knots airspeed on the ground (straight and level) through the flight envelope shown in figure 2-17. For high-altitude ejection, the seat has a barostat control, which is part of the time release mechanism, attached to the seat. The control delays opening of the personnel parachute and separation of the occupant from the seat until the occupant has descended to an altitude of 14,000 to 15,500 feet above sea level. Upon ejection of the seat from the aircraft, the AN/APX-72 transponder (IFF) is automatically triggered. A schematic diagram of the seat system is given in figure 2-19. The seat is secured in a safe condition on the ground by the installation of seven ejection seat ground lock safety pins (figure 2-54).

*a. Ejection Gun.* A medium velocity, long stroke cartridge actuated gun provides initial thrust for the ejection seat and occupant. The channel members mounted on opposite sides of the cylinder serve as guides to the seat. The ejection gun is attached to the bulkhead behind the seats in two places. Three explosive charges (one primary and two auxiliary) are used for ejection of the seat. The primary charge is placed in the top of the tube, under the firing mechanism. When the upper firing handle (4, figure 2-15) or the lower firing handle (34) is pulled, the primary cartridge is fired forcing the seat upward. With further movement of the seat, successive ports are opened, allowing the lower and upper auxiliary charges to be fired, propelling the seat and occupant from the aircraft.

*b. M119 Tip-off Compensating Rocket (TCR).* The TCR, (38, figure 2-15), attached to the bottom of the seat, is fired immediately after ejection. The TCR initiator is attached to a cable approximately 5 FT 4 IN. long. One end of the cable is attached to the stationary rails, causing the cable dispenser (37) to feed out the cable as the seat rises. When the cable has been completely fed out, the initiator ignites the TCR. The thrust of the TCR positions the seat in the correct attitude for deployment of the drogue chute and optimal seat position for subsequent withdrawal of the personnel parachute.

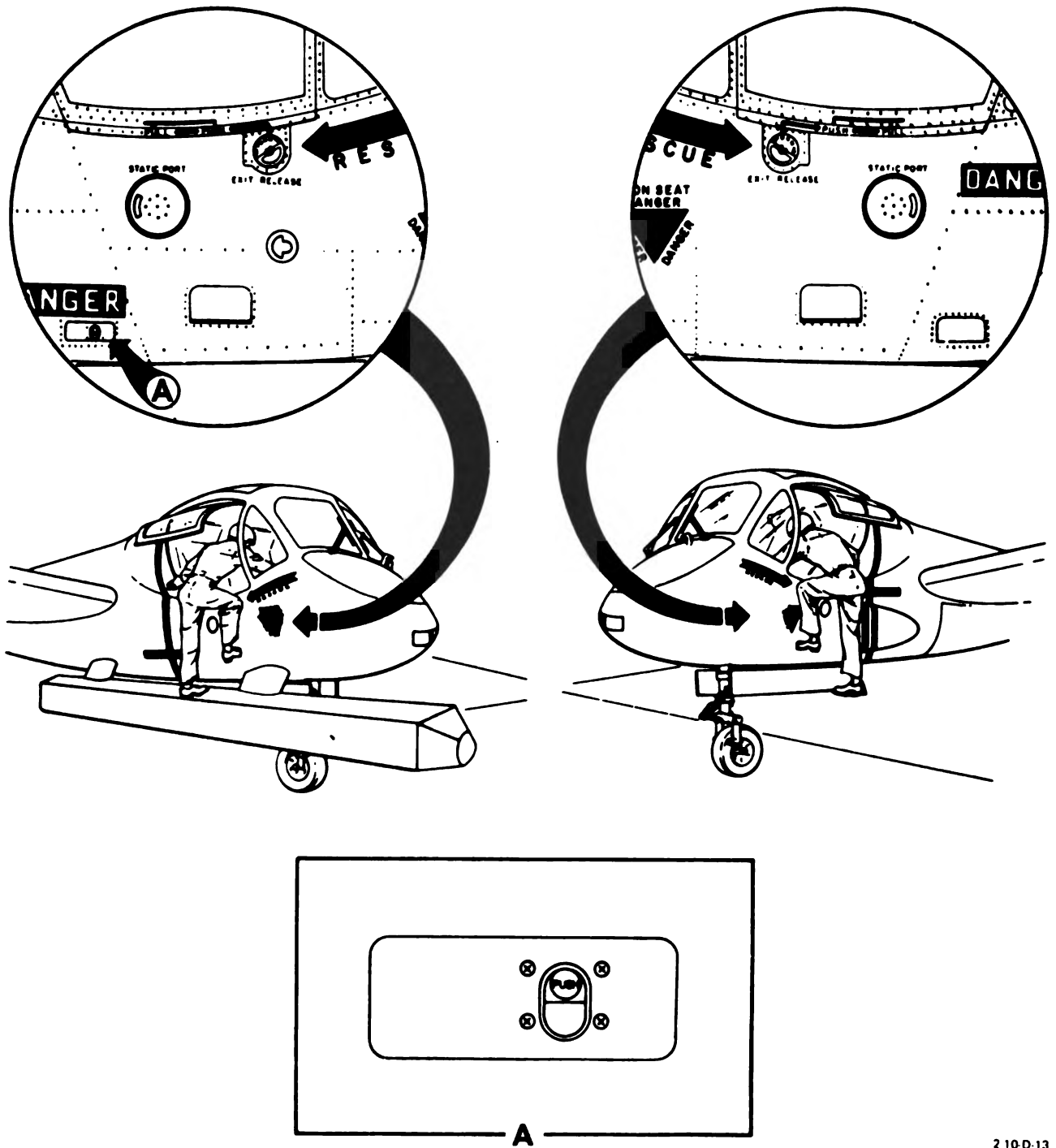

210-D-13

Figure 2-13. Entrance Hatches and Boarding Ladders



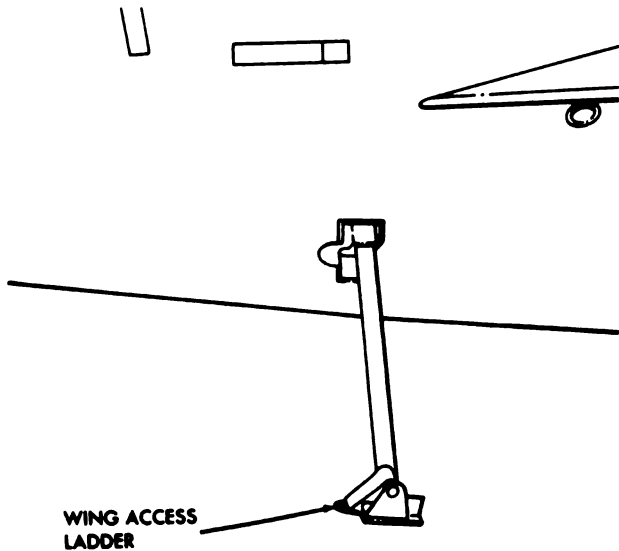

A 2-10-0-14

**Figure 2-14. Wing Access Ladder**

c. **Seat Assembly.** The seat assembly consists of two vertical side beams bridged by three horizontal crossmembers supporting the seat pan, drogue parachute container (23, figure

2-15), drogue gun (26), and time release mechanism (20). The middle crossmember is the top support of the seat raising jack, the lower end of which is attached to a beam at the rear of the seat bucket (28). The inertia reel mechanism is mounted above the top support of the seat raising jack and is capable of supporting the seated occupant in his harness and preventing him from being thrown forward in the event of a crash landing. The vertical beams support the drogue gun and the time release mechanism. The purpose of the drogue gun is to extract the drogue parachute withdrawal line (2) and drogue parachute. The drogue parachute container (23) is bolted to the upper portion of each vertical beam and houses the face blind and drogue parachute. The sides of the drogue parachute container extend upward to form overhead hatch breakers, permitting through-the-hatch ejections. Four guide tracks, bolted to the lower portion of the seat main beams (two per beam), guide the seat bucket assembly in height adjustment. The seat bucket assembly supports the occupant and is the only part of the seat that moves with height adjustment. A seat height adjustment switch (13), on the right side of the seat bucket, controls the height adjustment. Additional items fitted to the seat are

Legend for fig. 2-15.

- |   |  |
|---|--|
| 1. Link line                                  | 22. Parachute restraint strap (short)            |
| 2. Drogue parachute withdrawal line           | 23. Drogue parachute container                   |
| 3. Face blind locking mechanism               | 24. Link line                                    |
| 4. Upper firing handle                        | 25. Top latch plunger (with handwheel installed) |
| 5. Personnel parachute riser                  | 26. Drogue gun                                   |
| 6. Personnel parachute container              | 27. Drogue gun trip rod                          |
| 7. Backplate with lumbar support              | 28. Seat bucket                                  |
| 8. Seat belt                                  | 29. Leg restraint roller bracket                 |
| 9. Rigid seat survival kit cushion            | 30. Leg restraint quick-release pin              |
| 10. Leg restraint quick-release garters       | 31. Inertia reel manual control lever            |
| 11. Leg restraint cords                       | 32. Leg restraint cord lock-release lever        |
| 12. Manual override handle                    | 33. Leg line snubber release ring                |
| 13. Seat height adjustment switch             | 34. Lower firing handle                          |
| 14. Electrical disconnect                     | 35. Guillotine ignitor                           |
| 15. Emergency oxygen quick-release pin        | 36. Guillotine head assembly                     |
| 16. Emergency oxygen quick-disconnect fitting | 37. Tip-off compensating rocket cable dispenser  |
| 17. Emergency oxygen manual control           | 38. M119 Tip-off compensating rocket (TCR)       |
| 18. Emergency oxygen cylinder                 | 39. Thigh support and personnel lowering device  |
| 19. Time release mechanism trip rod           | 40. Emergency oxygen disconnect lanyard          |
| 20. Time release mechanism                    | 41. Emergency oxygen hose                        |
| 21. Parachute restraint strap (long)          |  |

**Figure 2-15. Ejection Seat (Sheet 1 of 2)**

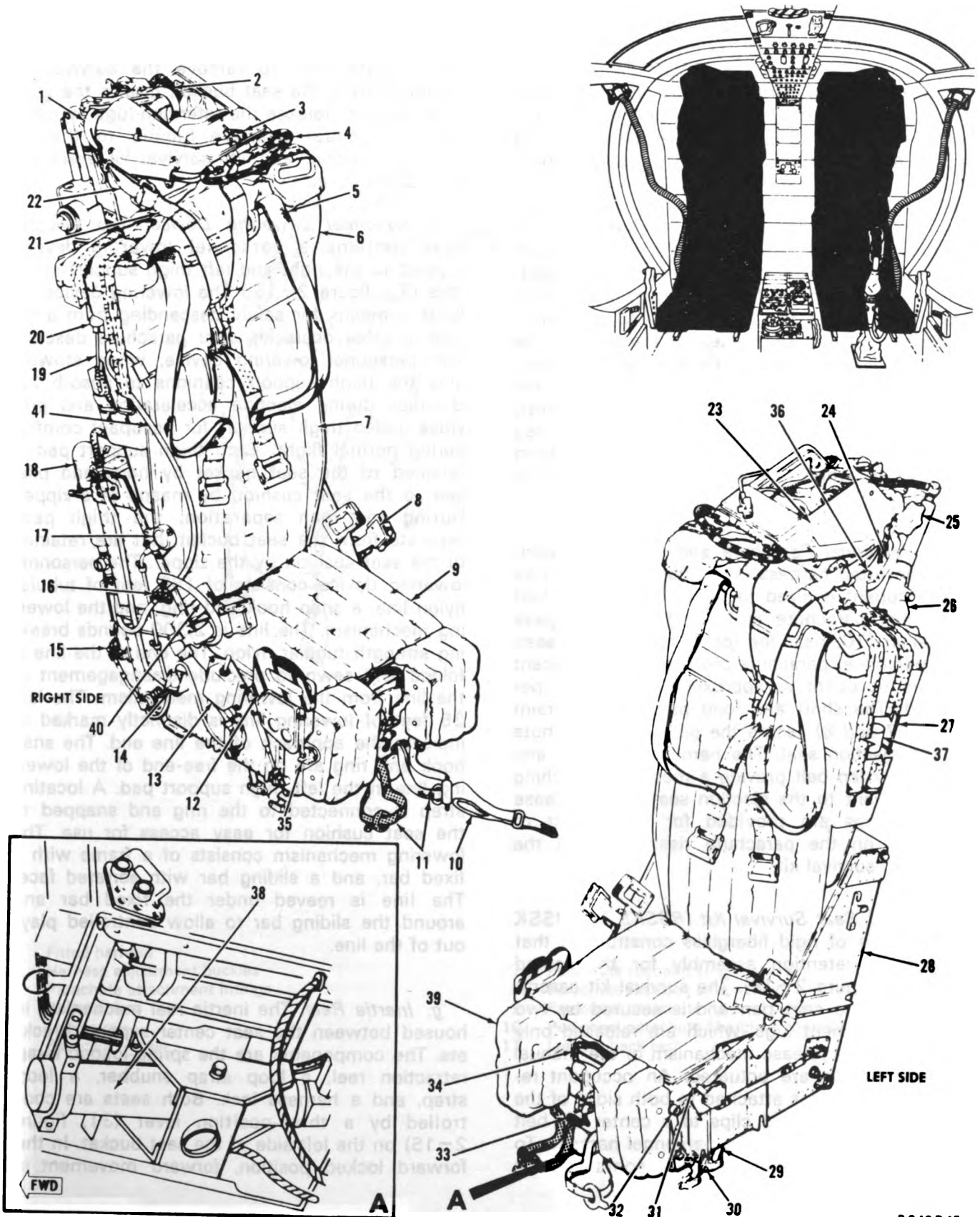

Figure 2-15. Ejection Seat (Sheet 2 of 2)

B-2-10-D-15

a lower firing handle (34), manual override lever (12), inertia reel manual control lever (31), M119 tip-off compensating rocket (TCR) (38), a lumbar contour support backplate (7) that provides for the occupant's comfort and protection, thigh support cushions that house the personnel lowering device (39), and a leg restraint cord lock-release lever (32) for the leg restraint cords (11). The dual leg restraint mechanism pulls and holds the occupant's legs together during ejection by means of the leg restraint cords attached to the two quick-release leg garters (10) that are attached securely just below the knees. Slack is provided for leg movement during normal flight. When the seat is ejected, the initial movement of the seat takes up the slack in the cords, pulling the occupant's legs tight together. Further movement of the seat tightens the cords, shearing the rivets on the roller brackets, separating the cords from the aircraft. The leg restraint cords are automatically released from their locks when the time release mechanism actuates.

*d. Personnel Parachute and Harness Assembly.* The fitted harness (1, figure 2-16) worn by the occupant is sized to fit his body. A 28-foot personnel parachute is housed in a fiberglass container (10) near the top of the ejection seat. The personnel parachute provides a safe descent for the occupant at approximately 18 feet per second. The short and long parachute restraint straps (7 and 8) secure the personnel parachute to the ejection seat. The harness assembly and the center lap belt provide a means of attaching the occupant to the ejection seat. Quick-release type fittings are provided for attachment to adapters on the parachute risers (6) and the rigid seat survival kit.

*e. Rigid Seat Survival Kit (RSSK).* The RSSK container is of rigid fiberglass construction that includes a retention assembly for the seated occupant (figure 2-18). The survival kit assembly fits in the seat pan and is secured by two lower attachment lugs, which are released only when the time release mechanism or the manual override handle are actuated. An occupant retention assembly is attached to both sides of the survival container and clips to a center lap belt that is integrated with the personnel harness. To gain access to an equipment bag containing the

survival gear, there are grip handles, which when squeezed and pulled, release a locking assembly separating the container bottom and the lid assembly. To remove the survival kit assembly from the seat bucket, disarm the guillotine system, release the retention lugs by moving the manual override handle to the up (unlock) position, and lift survival kit assembly from seat bucket.

*f. Personnel Lowering Device.* The ejection seat contains a personnel lowering device, stowed in the right and left thigh support cushions (39, figure 2-15.) The lowering device affords a means for safely descending from a tall tree or other obstacles after parachute descent. The personnel lowering device, when stowed, aids the thigh support cushions to absorb the G-forces during ejection acceleration and provides added thigh support for occupant comfort during normal flight. Each thigh support pad is retained to the seat bucket by hook and pile, and to the seat cushion by means of a zipper. During seat-man separation, the thigh pads separate from the seat bucket, but are retained to the seat cushion by the zipper. The personnel lowering device consists of 150 feet of tubular nylon line, a snap hook and ring, and the lowering mechanism. The line is 2,300 pounds breaking strength tubular nylon. The end of the line is folded and sewn to preclude disengagement of the line from the lowering mechanism. The last 25 feet of lowering line is distinctly marked to indicate the approach of the line end. The snap hook and ring are on the free-end of the lowering line in the left thigh support pad. A locating strap is connected to the ring and snapped to the seat cushion for easy access for use. The lowering mechanism consists of a frame with a fixed bar, and a sliding bar with serrated face. The line is reeved under the fixed bar and around the sliding bar to allow controlled play-out of the line.

*g. Inertia Reel.* The inertia reel mechanism is housed between the seat center support brackets. The components are the spring-loaded strap retraction reel, a loop strap snubber, a loop strap, and a harness lock. Both seats are controlled by a three-position lever (31, figure 2-15) on the left side of the seat bucket. In the forward locked position, forward movement is

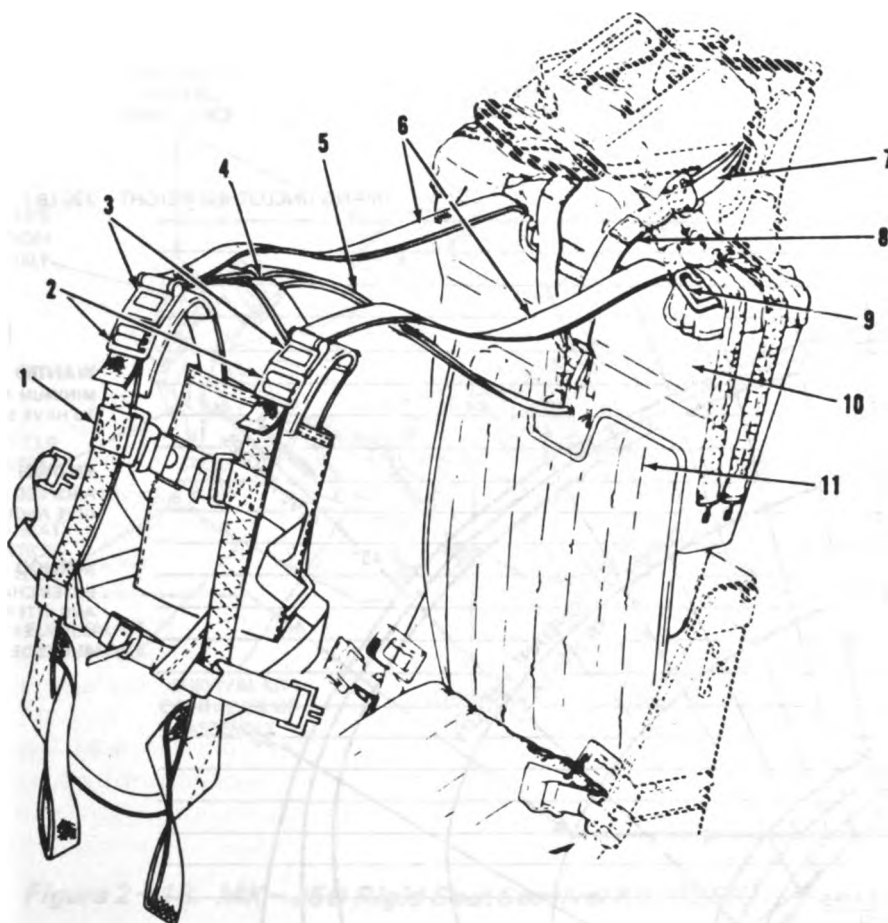

A 2-10-D-16

- |   |   |
|---|---|
| <ul style="list-style-type: none"> <li>1. Fitted harness</li> <li>2. Harness adjustment buckles</li> <li>3. Parachute attachment fittings</li> <li>4. Roller yokes</li> <li>5. Loop strap</li> <li>6. Parachute risers</li> </ul> | <ul style="list-style-type: none"> <li>7. Parachute restraint straps (short)</li> <li>8. Parachute restraint straps (long)</li> <li>9. Personnel parachute rip-cord D-ring</li> <li>10. Personnel parachute fiberglass container</li> <li>11. Lumbar back rest</li> </ul> |
|---|---|

**Figure 2 – 16. Personnel Parachute Container and Harness Assembly**

■ G

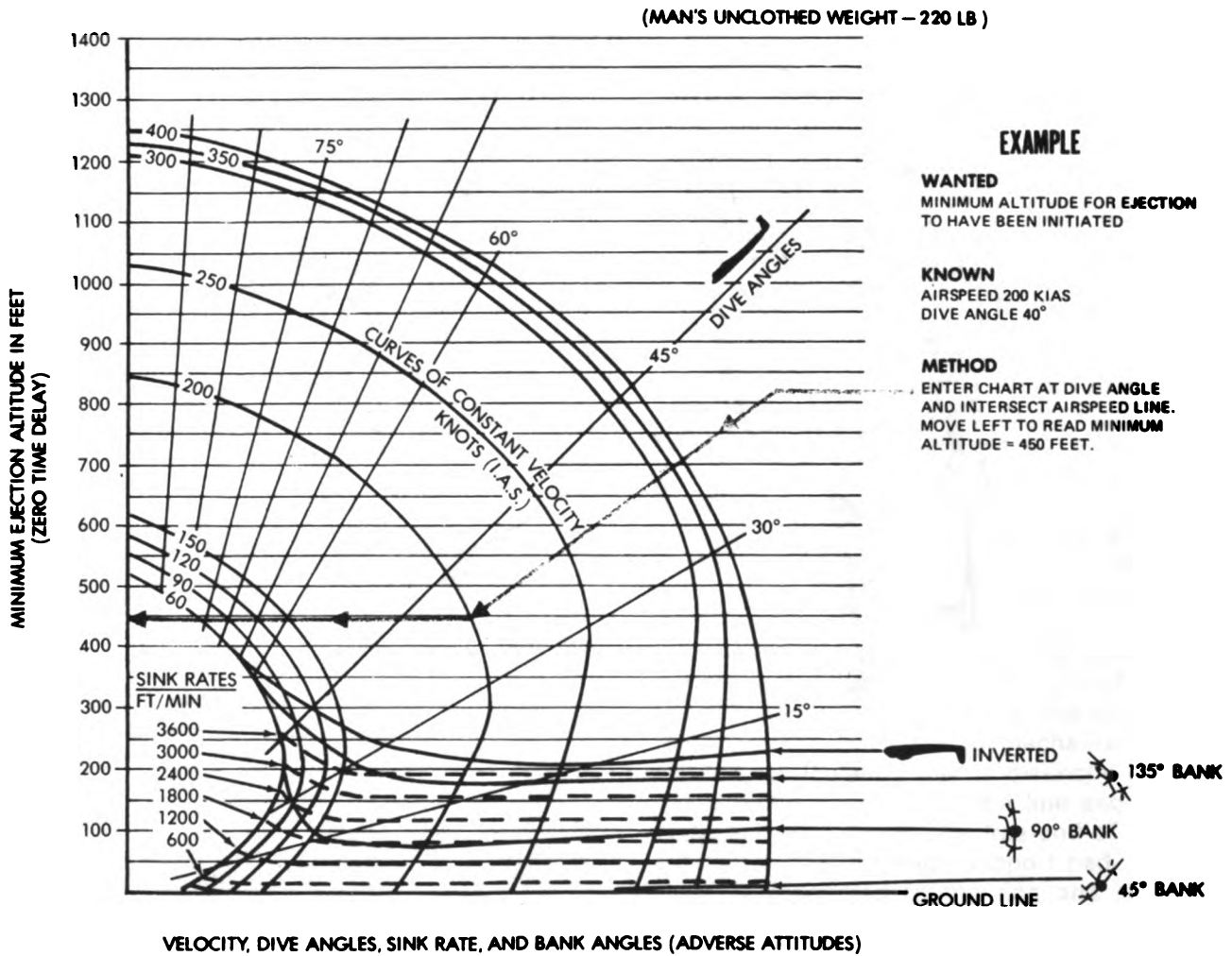

**NOTE**

THE CURVES ON THIS CHART REPRESENT THE EJECTION SEAT CAPABILITY AND ARE THE MINIMUM ALTITUDES AT WHICH EJECTION MUST HAVE BEEN INITIATED. THEY DO NOT INCLUDE ADDITIONAL ALTITUDES REQUIRED FOR HUMAN REACTION TIME (DECISION AND ACTION). MINIMUM EJECTION ALTITUDES FOR DIVE ANGLES, SINK RATES, AND BANK ANGLES ARE FOUND AT THEIR RESPECTIVE INTERSECTIONS WITH THE VELOCITY CURVES, AND ARE READ ON THE MINIMUM ALTITUDE ORDINATE SCALE.

**WARNING**

EFFORT TO RECOVER FROM SPINS OR UNCONTROLLED FLIGHT SHOULD NOT BE CONTINUED BELOW 5000 FEET (AGL).

■ □

8-2-10-D-17

**Figure 2-17. MK-J5D Ejection Seat Capabilities Chart**

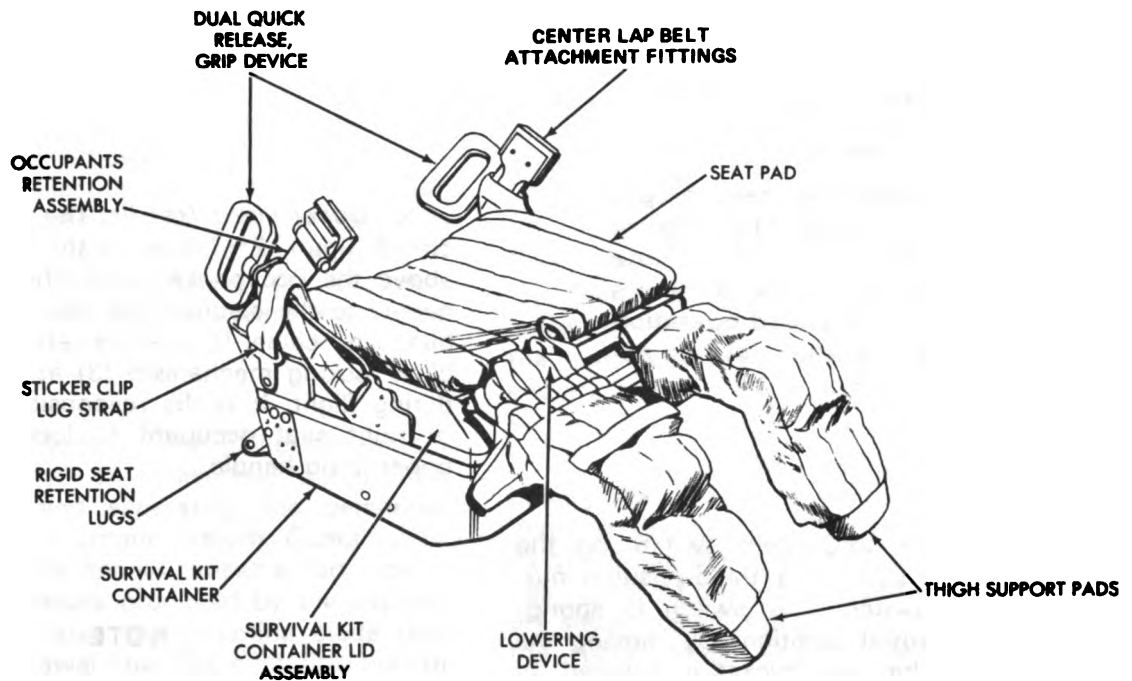

B-2-10-D-18

**Figure 2-18. MK-J5D Rigid Seat Survival Kit (RSSK)**

prevented by the snubber, and any slack is taken up by the reel, keeping the harness loop strap taut. When the lever is cycled through the aft position, the snubber unlocks and the lever is spring-loaded to the autolock position. In the autolock position, the loop strap may be extended, allowing the occupant to move forward, end will lock when subjected to approximately a 2 to 3 G force.

**h. Time Release Mechanism.** The time release mechanism, on the right side of the main beam, automatically delays extraction of the main parachute until the seat has been retarded and stabilized by the drogue parachute. The time delay does not exceed 1.65 to 1.85 seconds unless ejection takes place above 14,000 to

15,500 feet; then the barostat prohibits any further action until the seat has descended to the proper altitude. If conditions are met, the time release mechanism actuates, releases the drogue parachute from the scissor shackle, unlocks the harness, and releases the face blind and leg restraint cords. The pull of the drogue parachute is then transferred, through the parachute withdrawal line, to the canopy of the personnel parachute to effect its deployment. If the time release mechanism fails, the harness locks, and the face blind and leg restraint cords must be released by operating the manual override handle (12, figure 2-15) on the seat pan. The personnel parachute must then be deployed by manually pulling the parachute D-ring on the parachute pack (9, figure 2-16). The opening forces of the personnel parachute will separate the occupant from the seat.

*i. Seat Height Adjustment Switch.*

**CAUTION**

Do not operate the seat height adjustment switch (13, figure 2-15) for more than 1 minute (maximum) during any 8-minute period of time. Extended operation will shorten the seat raising actuator service life.

The seat height adjustment switch, on the right side of the seat, is a three-position momentary toggle switch. The switch is spring-loaded to the neutral position. By moving the switch forward, the seat bucket is lowered. In the aft position, the seat is raised.

*j. Inertia Reel Manual Control Lever.* The inertia reel manual control lever (31, figure 2-15) is a three-position lever on the left side of the seat bucket. The lever is spring-loaded to the autolock (center) position. In this position, the loop strap (5, figure 2-16) may extend. In the forward position, the loop strap is locked and may not be extended. When cycled to full aft position, the lever releases the loop strap lock and returns it to the autolock position.

*k. Leg Restraint Cord Lock-Release Lever.* The leg restraint cord lock-release lever (32, figure 2-15) is a two-position lever on the left side of the seat bucket. Placing the lever in the aft position releases the upper end of the leg restraint cords. The forward position is the normally locked position of the lever.

*l. Leg Line Snubber Release Rings.* The leg line snubber release rings (33, figure 2-15) are

at the forward lower edge of the seat bucket. When pulled, these rings allow the occupant to pull the leg restraint cord forward in order to provide sufficient slack for comfortable leg movement.

*m. Upper Firing Handle.* The upper firing handle (4, figure 2-15) is on the front of the seat above the occupant's head. The handle is connected to the ejection gun sear through the face blind and cable. It must be retained by the face blind locking mechanism (3) at all times except during flight. It is the responsibility of the pilot or right seat occupant to lock or unlock the upper firing handle.

**NOTE**

*There is no interlock between the upper firing handle or the lower firing handle and the overhead hatch when either firing handle is pulled. The hatch may be jettisoned by pulling the hatch jettison handle if time permits.*

*n. Lower Firing Handle.* The lower firing handle (34, figure 2-15), on the front of the seat bucket between the occupant's legs, is used to initiate ejection at low altitude and/or during uncontrolled flight. A safety guard is mounted in front of the lower firing handle to prevent it from being extracted inadvertently. Rotating the guard to the right and down unlocks the guard and permits access to the firing handle. The guard shall be up (locked) at all times except during flight. It is the responsibility of the occupant to lock or unlock the lower firing handle.

*o. Manual Override Handle.* The manual override handle (12, figure 2-15), on the forward right side of the seat bucket, is a two-position

lever with a locking clutch and is normally in the down (locked) position. To operate the manual override handle, the trigger and handgrip must be squeezed and the handle pulled up and aft. When the manual override handle is pulled, the following actions take place: the face blind handle (upper firing handle) and the lower firing handle are locked in position to prevent accidental firing of the ejection gun if it has not been fired; the leg restraint cords, the seat retention system, the personnel parachute and survival kit assembly are released, freeing the occupant from the seat; and the guillotine system is activated.

*p. Guillotine System.* The guillotine system provides a method of ballistically cutting the withdrawal line and separating the personnel parachute from the drogue system. Operation of the manual override handle causes a cartridge to be fired. Gas pressure produced by the exploding cartridge actuates the guillotine blade that severs the withdrawal line. The guillotine system consists of the following: interconnecting linkage and operating levers to the manual override system, breech assembly, flex lines and piping, and the guillotine blade assembly.

*q. Emergency Oxygen System.* The automatically activated oxygen system provides an emergency source of oxygen under pressure for approximately 10 minutes. The emergency oxygen bottle is attached to the aft right side of the seat bucket. During ejection, a lever attached to the bucket strikes a pin to activate the oxygen bottle automatically. A manual release handle (green apple), on the upper right side of the seat bucket, is provided for manual activation of the bottle.

*r. Ejection Sequence.* The following is a description of the sequence for a normal ejection and automatic separation from the seat (figures 2-19 and 2-20):

(1) When the occupant pulls either the face blind handle (upper firing handle) or the lower firing handle, the primary cartridge in the ejection gun is fired.

(2) As the seat and occupant start to rise, the following concurrent events take place:

(a) The heat and pressure from the primary cartridge ignites the lower and upper auxiliary cartridges, providing the necessary thrust to clear the aircraft.

(b) The drogue gun sear is extracted from the drogue gun, and the time release mechanism sear is extracted from the time release mechanism. A micro switch mounted on the seat gun activates the emergency control circuits in the transponder.

(c) Dual leg restraint cords tighten, pulling the occupant's legs together to prevent injury as the ejection seat leaves the flight compartment. As the seat and occupant continue to rise, rivets in the leg restraint cord roller brackets shear, freeing the lower end of the cord from the cockpit floor. The occupant's legs are still held securely together by the upper cord locks and the snubbers.

(d) The emergency oxygen system is activated whether needed or not.

(e) The tip-off compensating rocket (TCR) initiator cable, attached to the ejection gun crossbeam, is deployed from its storage drum as the seat rises from the aircraft. When the ejection gun is approximately nine inches from full extension, the TCR initiator cable is fully extended. As the ejection seat continues to rise, the firing pin sear of the rocket motor initiator is withdrawn activating the rocket motor. Thrust from the M119 TCR positions the ejection seat in the correct attitude for rapid unrestricted deployment of the drogue parachute, and increases the seat trajectory height.

(3) The seat is now clear of the aircraft with the occupant held securely in place by the loop strap and parachute harness assembly, lap belt, rigid seat survival kit assembly, and leg restraint cords. The drogue gun fires 0.5 seconds after the sear is withdrawn from the drogue gun.



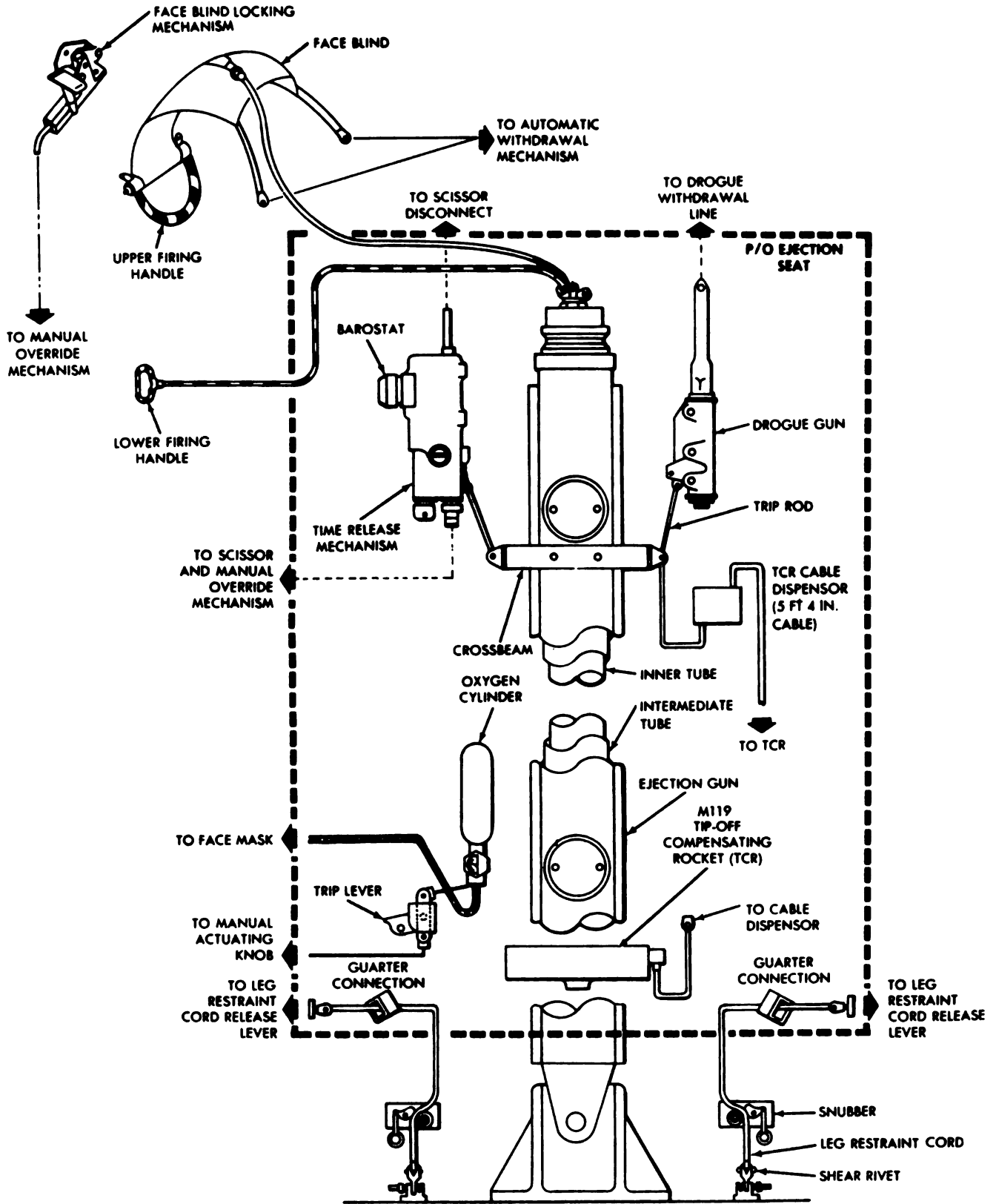

2-10-0-20-1

Figure 2-19. Ejection Seat Schematic (Sheet 1 of 2)

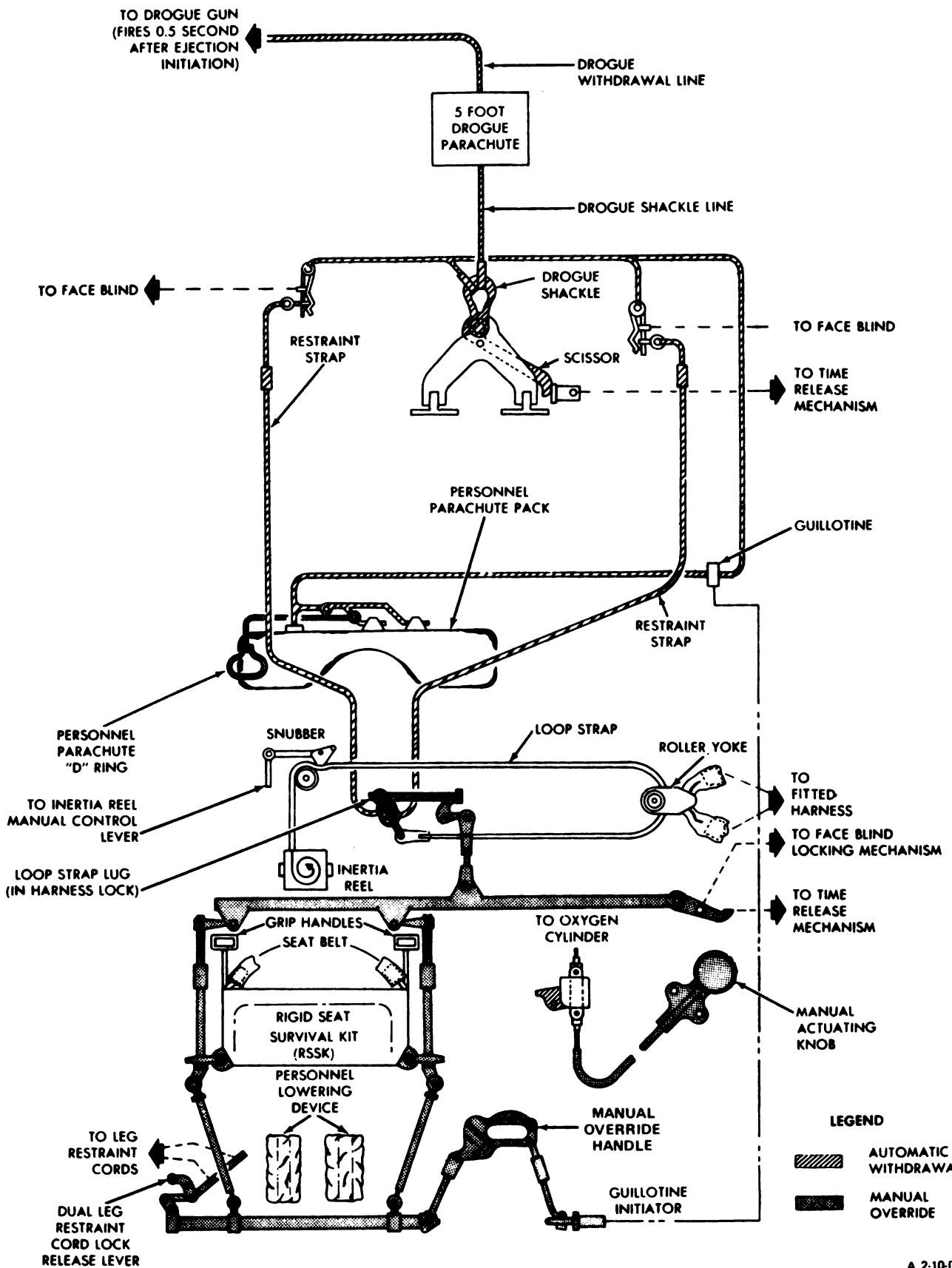

A 2-10-D-20-2

Figure 2-19. Ejection Seat Schematic (Sheet 2 of 2)

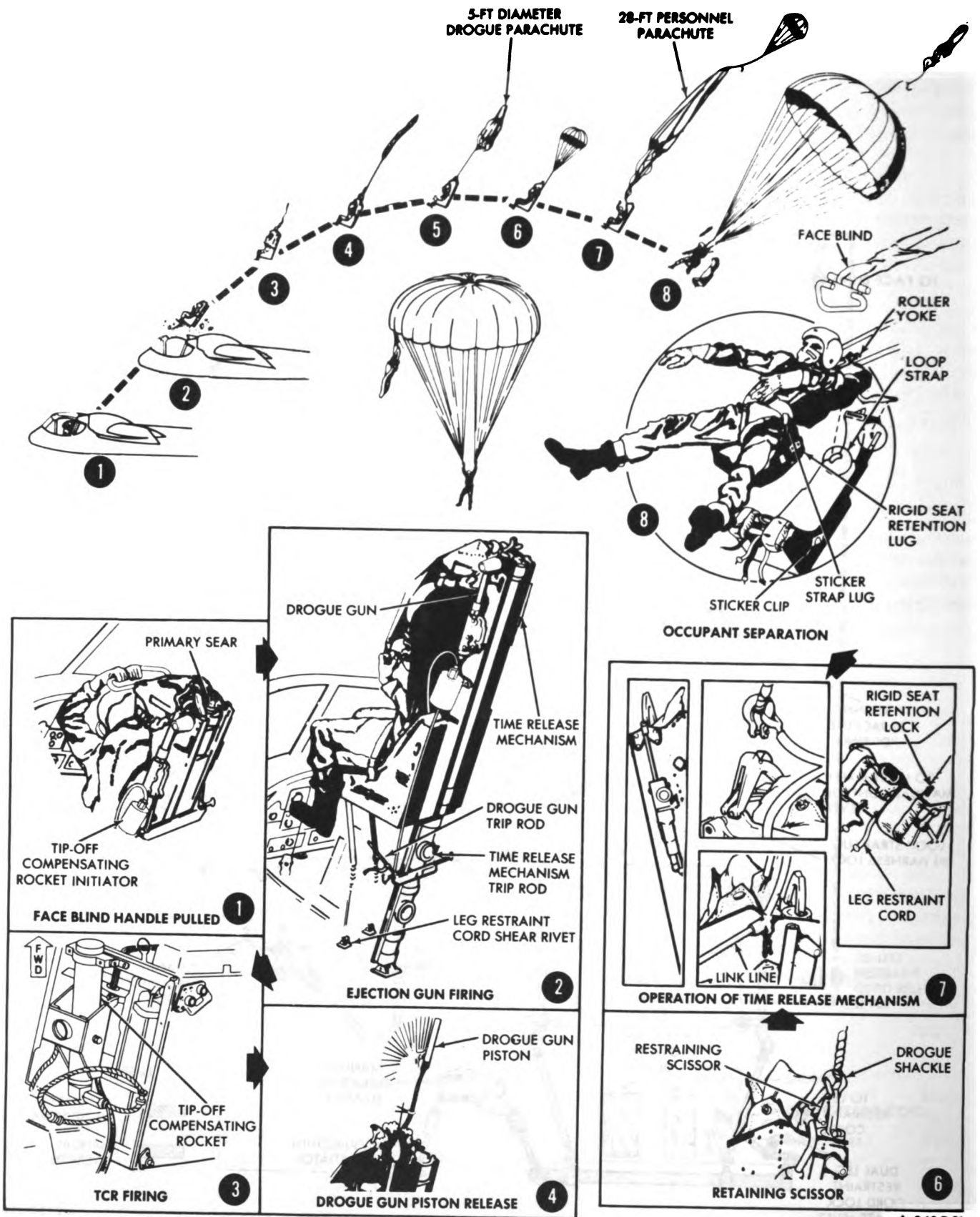

Figure 2-20. Ejection Sequence

(4) The TCR has positioned the ejection seat in the proper attitude for drogue parachute deployment. The drogue gun fires, forcibly extracting the drogue parachute. The drogue parachute then inflates, stabilizing and decelerating seat and occupant.

(5) If ejection takes place above 14,000 to 15,500 feet, the barostat, on the time release mechanism, inhibits any further action until the seat and occupant have fallen to an altitude of 15,500 to 14,000 feet.

(6) If the ejection occurred below the barostat setting, the time release mechanism actuates 1.65 to 1.85 seconds after the seat has been withdrawn. The following functions are performed simultaneously through mechanical linkage:

(a) The scissor holding the drogue shackle to the ejection seat opens, releasing the drogue parachute.

(b) The pull of the drogue parachute is then transmitted through the link line to the personnel parachute, extracting it from its pack for deployment.

(c) The attachment points holding the occupant and survival kit to the seat release.

(d) The upper lock fitting of the leg restraint cords releases, freeing the occupant's legs from the seat.

(e) The face blind attachment disconnects from the drogue container. This insures absolute separation if the occupant's hands are frozen to the face blind handle.

(f) Temporary restraint of the occupant in the ejection seat is maintained by two spring-loaded sticker clips. The sticker clips prevent collision of occupant with ejection seat during the separation process. This is done by providing enough restraint to effect a positive separation of occupant from ejection seat in response to the opening forces of the personnel parachute. The opening forces overcome the spring tension of the sticker clips, thus causing the seat and occupant to separate. The separation action automatically disconnects the emergency oxygen hose from the occupant at the oxygen quick-disconnect fitting.

(7) The occupant then descends on a 28-foot personnel parachute.

## SECTION II. EMERGENCY EQUIPMENT

### 2-10. Description.

The emergency equipment used in the aircraft is described in the following paragraphs. Refer to Chapter 9 for emergency procedures, operation of emergency exits, and location of all emergency equipment.

*a. First Aid Kit.* A first aid kit is behind the sloping console within reach of either occupant (figure 9-1).

*b. Hand Fire Extinguisher.* The fire extinguisher is on the left side of the pilot's seat within reach in the event of fire. It is filled with 1 quart of bromotrifluoromethane under pressure (figure 9-1).

*c. Escape Hatch Jettison System.* The escape hatch (figure 2-2) is the section making up the cockpit roof directly over the occupant's heads.

The self-contained system includes an air bottle, a cam mechanism, a pneumatic actuator, and a lanyard-operated firing pin. The escape HATCH JETTISON handle (figure 2-12) is a yellow and black striped T-handle that is used to actuate the escape hatch jettison system. The handle must be rotated 90° clockwise and pulled to jettison the hatch. Jettisoning of the hatch occurs in two successive operations. The actuator first drives the cam mechanism that disengages the hatch from the fuselage structure, and then it flings the hatch up into the airstream, which carries the hatch away from the aircraft. Hatch jettison pressures are shown in figure 2-51.

*d. Fire Detection System.* The fire detection system provides a warning to the pilot if a fire or an overheated condition occurs in either engine. Each engine's system is a continuous-type, automatic-resetting detection system consisting of a control unit, sensing elements in the engine

and nacelle area, warning lights, and connectors. A test switch is used to check the operation of both systems simultaneously. The system is powered from the primary bus and is protected by circuit breakers. The sensing elements are wired in series with the warning lights and in the normal condition present an open circuit. When excessive temperatures exist in areas in which the sensing elements are located, the electrical resistance of the ceramic material in which the element wires are encased decreases rapidly, allowing current to pass. This completes the circuit and causes the warning light to illuminate.

the agent takes place through the line ends in the nacelle, eliminating the need for nozzles. A pressure versus temperature chart is on the bulkhead adjacent to the two containers.

(1) *Engine Fluid Shutoff Switches.*

NOTE

*When the ENGINE MASTER NO. 1 or ENGINE MASTER NO. 2 circuit breakers are pulled, the associated engine fuel shutoff valve cannot be closed.*

The engine fluid shutoff switches operate in conjunction with the fire handles (figure 2-21) and are located, together with the handles, on the center glareshield. Power for fuel shutoff associated with the fire handle is provided by the primary bus, through the ENGINE MASTER NO. 1 and NO. 2 circuit breakers, whereas power for hydraulic shutoff comes from the secondary bus through the HYD SOV circuit breaker. Pulling the fire handles out, closes the hydraulic and engine fuel shutoff valves.

(1) *Fire Detector Switch.* The FIRE DETECTOR switch (figure 2-7) on the pilot's instrument panel, is a toggle switch with ON and momentary TEST positions. In the ON position, the fire detection circuit will provide an indication of an engine fire or an overheat condition, and the respective fire pull warning light will illuminate. In the TEST position, the fire detection circuit is completed, and the fire pull warning lights will illuminate.

(2) *Fire Pull Warning Lights.* The fire pull warning lights are in the two fire handles (figure 2-21) on the center glareshield. The corresponding handle, labeled FIRE #2 PULL, will illuminate if an engine should catch fire or overheat.

(2) *Fire Extinguisher Switches.* The fire extinguisher switches are three-position toggle switches covered by the fire handles (figure 2-21). Power for these switches is provided by the primary bus through the FIRE EXT NO. 1 and NO. 2 circuit breakers. After pulling the No. 1 engine fire handle, placing the switch for the No. 1 engine in the No. 1 position directs the extinguishing agent from the No. 1 bottle into the No. 1 nacelle. In the ALT position, the agent in the No. 2 bottle is directed to the No. 1 engine. The switch for the No. 2 engine operates in a similar manner.

e. *Fire Extinguishing System.* The fire extinguishing system consists of two containers (bottles) with extinguishing agent, bromotrifluoromethane, and the necessary lines running to each engine. Normally, the No. 1 bottle provides the extinguishing agent for the No. 1 engine and the No. 2 bottle for the No. 2 engine. However, both bottles can be, and are, discharged to either engine in the event of fire. Discharge of

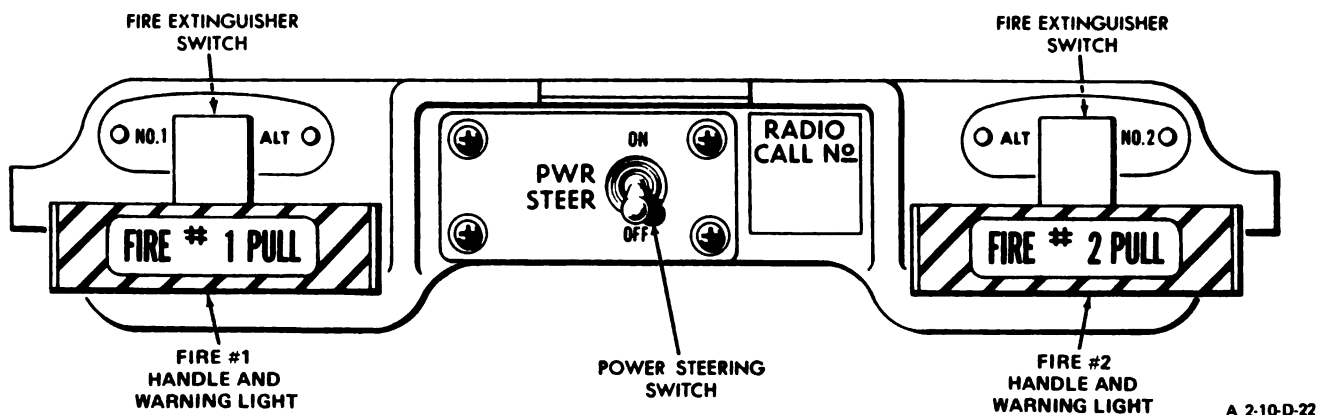

Figure 2-21. Center Glareshield

*(3) Overboard Thermal Discharge Indicator.*

The overboard thermal discharge indicator assembly, mounted on the right side of the fuselage at fuselage station 146.111, provides an immediate visual check on the condition of the fire extinguisher system and containers. The overboard thermal discharge indicator assembly will eject its red disc when one or more of the fire extinguisher containers has discharged due to an overtempera-

ture condition within the forward baggage compartment. When the temperature in the forward baggage compartment exceeds approximately 220° F, a fusible disc, located in the filler port of the fire extinguisher containers, will blow out and provide a path for the abnormally high pressures developing in the containers to escape through the overboard discharge line and overboard at the overboard thermal discharge indicator assembly.



## SECTION III. ENGINES AND RELATED SYSTEMS

### 2-11. Engines.

a. The aircraft is powered by two T53-L-701 or T53-L-701A gas turbine engines (figure 2-22), turning three-bladed hydromatic propellers. No distinction is made between left or right installations. Refer to Chapter 5 for a description of the operating limitations.

#### NOTE

*For the purpose of this manual, no distinction is made between the T53-L-701 and T53-L-701A engines.*

b. The major systems of the engine are: the engine cooling and pressurization system, induction system, engine inlet anti-icing/deicing system, engine fuel control system, oil supply system, ignition system, and starting system.

### 2-12. Engine Cooling and Pressurization System.

Engine cooling and pressurization is provided by compressed air developed by the compressor rotor. The engine cooling system provides cooling air for internal engine components.

### 2-13. Induction System.

The induction system consists of the variable inlet guide vane system, the interstage airbleed system, and the infrared louvered scarfed shroud suppressor (IRLSSS) system.

a. *Variable Inlet Guide Vane System.* Variable inlet guide vanes change angle of incidence between inlet air and first compressor rotor blades to maintain airflow requirements of the compressor rotor assembly. From 0 to 80 percent N1 speed, the vanes are in a closed position. The vanes start to open at 80 percent N1 speed, and are fully open at 95 percent N1 speed at standard day conditions. At any steady state N1 speed between 80 and 95 percent at standard day conditions, the inlet guide vanes assume a constant position.

b. *Interstage Airbleed System.* To facilitate compressor rotor acceleration, an interstage airbleed system is provided. After the last stage of axial compression, a series of vent holes in the compressor housing allows air to bleed from the compressor section, enabling the compressor rotor to attain selected RPM faster.

c. *Louvered Scarfed Shroud Suppressor (IR Suppressor) System.* The IR suppressor system is a passive device installed in the nacelle of each engine. Its purpose is to decrease aircraft vulnerability to heat-seeking airborne missiles by reducing turbine engine exhaust infrared radiation. The IR suppressor interfaces with the engine firewall plenum, nacelle, and wing-mounted brackets. During engine operation, exhaust gases are diluted with ambient air before discharge to the atmosphere, thus lowering emitted infrared radiation. The system is installed in the form of a kit that can be removed, thus allowing conversion of the aircraft back to an unsuppressed configuration. It consists of three major assemblies: a ram air inlet, a louvered plug assembly, and a louvered scarfed shroud. These items replace the conventional engine shroud assembly, nacelle frames, and exterior skins. The ram air inlet directs cooling air into the exhaust gas flow path. Inlet air is simultaneously routed to the inner suppressor plug where it is also directed into the gas flow path via aft facing louvers. The mixture of ambient air and cooled exhaust gases is then routed overboard at the shroud exit. The system consists of no moving parts and requires no operation by the pilot.

### 2-14. Engine Inlet Anti-icing/Deicing System.

The engine inlet anti-icing/deicing system prevents ice formation in the engine inlet area by routing pressurized hot air from the engine air diffuser housing to the inlet housing. The flow of air is controlled by the normally closed hot-air solenoid valve. When anti-icing air is required, the valve is deenergized to open position by manually activating the ENGINE DE-ICING switch on the WEATHER CONTROL panel (figure 2-23) in the cockpit. In event of electrical power failure, the fail-safe, spring-loaded valve returns to the open position to provide continuous anti-icing air.



MODEL T53-L-701

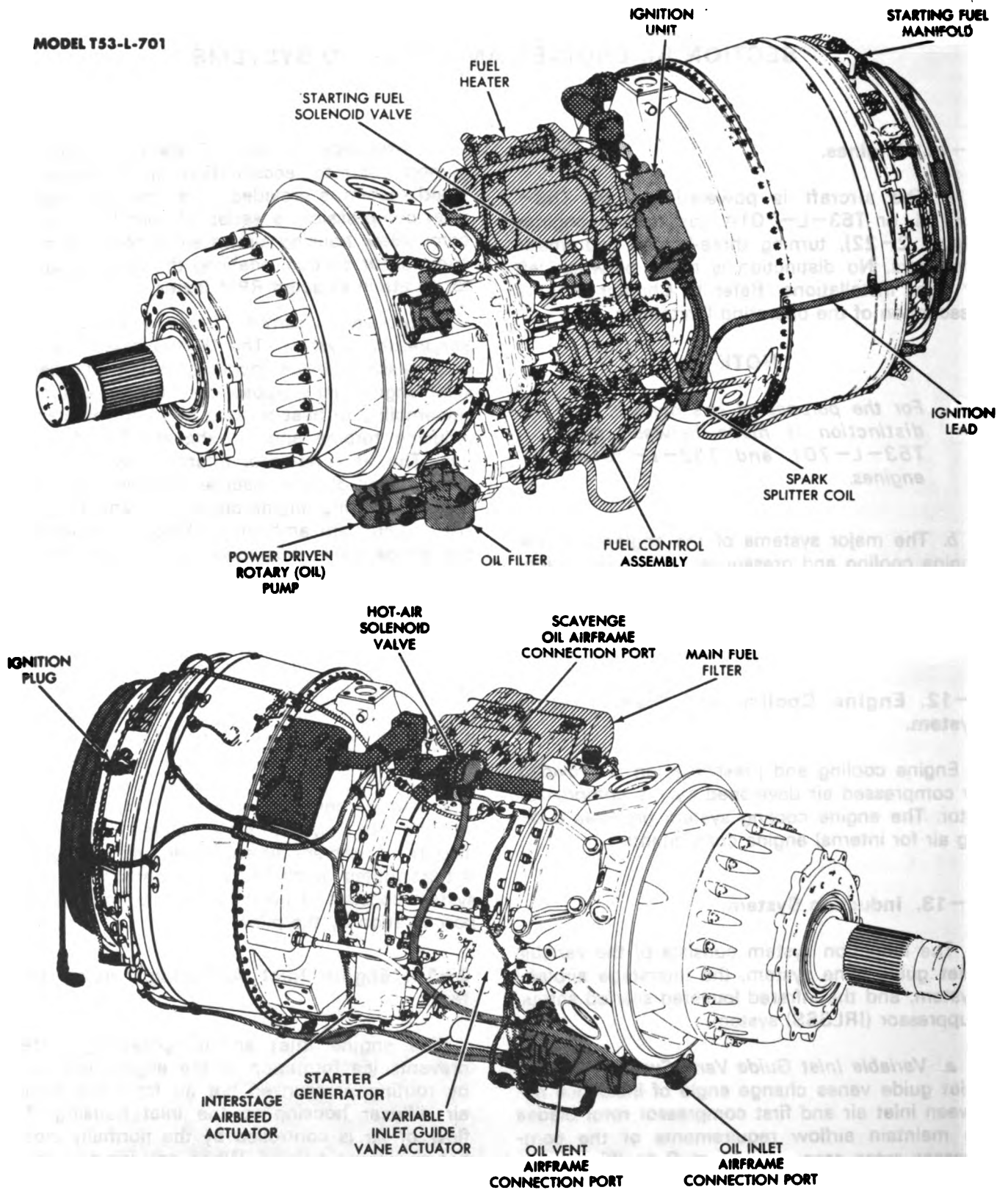

**LEGEND**

- |  |  |
|--|--|
|  ELECTRICAL SYSTEM |  ANTI-ICING SYSTEM  |
|  FUEL SYSTEM       |  LUBRICATION SYSTEM |

A 2-10-D-23

**Figure 2-22. Engine Components**

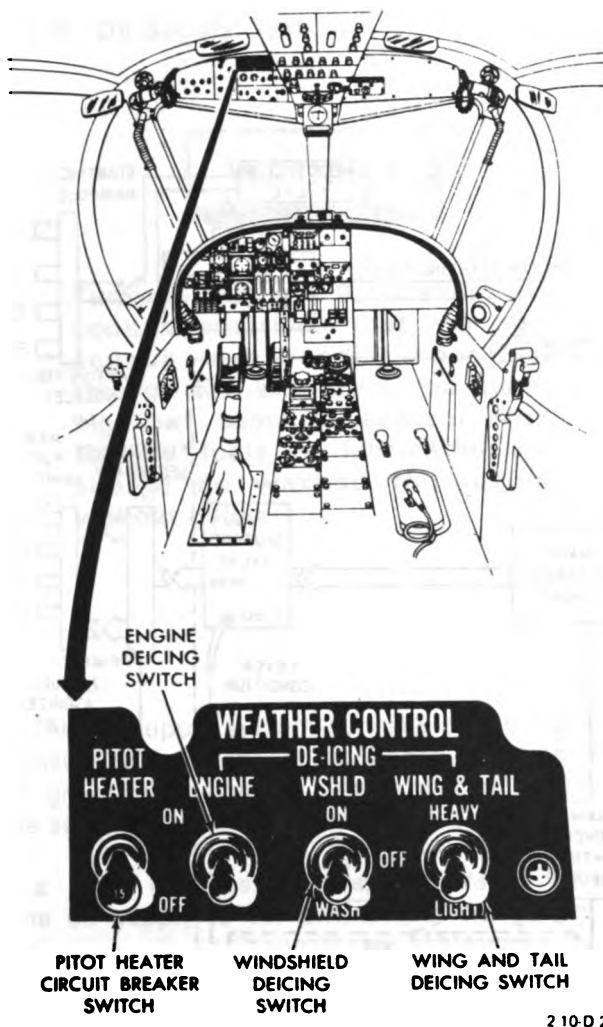

Figure 2-23. Weather Control Panel

## 2-15. Engine Fuel Control System.

The engine fuel control system consists of the starting fuel system and the main fuel system (figure 2-24). The starting fuel system consists of a starting fuel solenoid valve, starting fuel manifold, and starting fuel nozzle. The main fuel system consists of a fuel heater, main fuel filter, fuel control, flow divider assembly, main fuel manifold and lines, and fuel atomizers. A pressure-operated drain valve, at the bottom of the combustion chamber housing, automatically drains unburned fuel from the combustion chamber during start and engine shutdown. The engines are designed to use JP-4 or JP-5 fuel, Military Specification MIL-T-5624. For specified, alternate, and emergency fuels, their equivalents and usage, refer to paragraph 2-41. For information on the aircraft fuel supply system, refer to paragraph 2-20.

a. *Starting Fuel System.* During engine start, pressing the ignition button opens the starting fuel solenoid valve (figure 2-24), allowing un-metered starting fuel from the fuel regulator to flow through the starting fuel manifold, starting fuel nozzles, and into the combustion chamber where it is ignited by the igniter plugs. When N1 reaches sufficient speed (40% approximate), the ignition system is deenergized by releasing the ignition button, causing the fuel solenoid valve to close and stop the flow of starting fuel. After engine start, any residual fuel that may be left in the starting fuel lines and starting fuel nozzles is purged by air from the combustion chamber through a check filter valve.

b. *Main Fuel System.* Fuel entering the fuel control (figure 2-24) or regulator system flows through a fuel heater and main fuel filter and flows to a dual-element fuel pump. It is then pumped through check valves and an outlet screen to the main metering valve. The position of the main metering valve and the flow of fuel is automatically controlled by the computer section of the fuel control. The metered fuel flows through a shutoff valve and discharge port to the fuel flow divider, main fuel manifold, and atomizing fuel nozzles in the combustion chamber.

c. The power levers (figure 2-6) are on the upper left side of the control pedestal. The levers are operated individually and have four placard positions: TAKEOFF, FLIGHT IDLE, GROUND IDLE, and FULL REVERSE. Placing the power levers in the full forward position also completes the arming of the autofeather system with the autofeather/synchrophaser switch in the AUTOFEATHER ON position. A detent at FLIGHT IDLE minimizes the possibility of inadvertent use of GROUND IDLE while in flight. To prevent reversing the propeller by accident, either on the ground or in the air, a cam has been placed within the quadrant between GROUND IDLE and FULL REVERSE. The lever must be raised 1.5 inches along the cam before it can be moved into reverse. Upon initially passing over the cam, the propeller will go into reverse pitch and the engine will be in reverse idle. Further aft movement will increase the amount of reverse thrust until the FULL REVERSE position is attained.

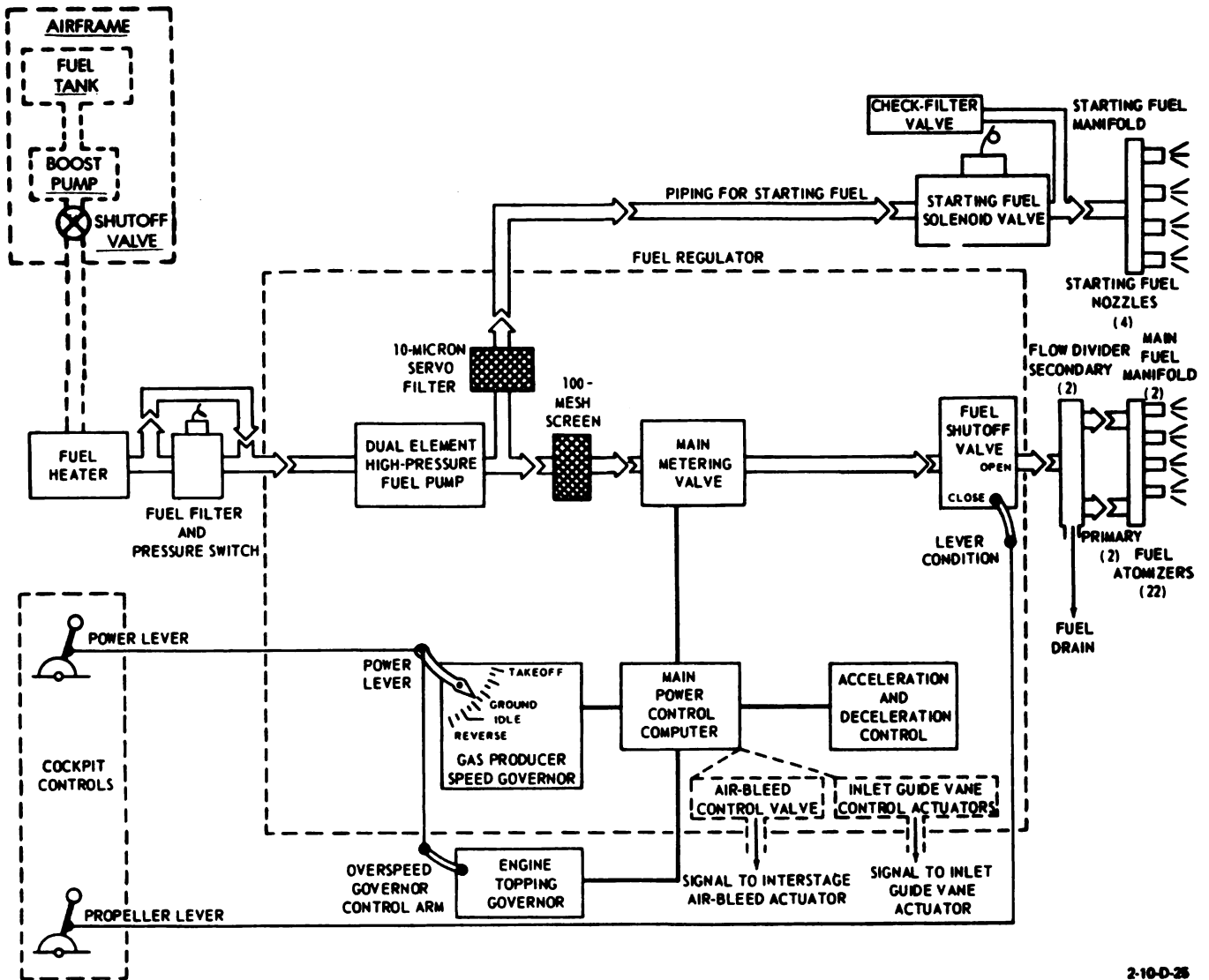

Figure 2-24. Engine Fuel System Schematic

d. The amber-colored FUEL STRAINERS light, on the caution annunciator panel (figure 2-10), illuminates when one or both of the main fuel filters are going to be bypassed due to blocked filter elements. A pressure switch, on the base of the main fuel filter, gives a warning of impending bypass that indicates contamination of the filters. The MASTER CAUTION light will illuminate simultaneously with this light.

e. The amber-colored #1 and #2 FUEL PRESS caution lights, on the caution annunciator panel (figure 2-10), illuminate when either or both elements of the engine-driven fuel pump

has failed. The MASTER CAUTION light will illuminate simultaneously with one or both of these lights.

NOTE

*If both elements of the engine-driven fuel pump fail, the engine will shut down due to fuel starvation.*

**2-16. Oil Supply System.****WARNING**

Turbine fuels and lubricating oils contain additives that are poisonous and readily absorbed through the skin. Skin and clothing that come in contact with turbine fuels or lubricating oil should be washed thoroughly without delay.

The oil supply system consists of the main oil pressure supply and oil scavenge systems. For oil grade, specification, and servicing stations, see servicing diagram, figure 2-51.

*a. Main Oil Pressure Supply System.* The engine oil supply is contained in a 4.2 gallon oil tank on each engine with a usable capacity of 2.5 gallons of oil with 1.7 gallons of space allowed for expansion. A sight glass is installed on the right side of each engine cowling to provide visual indication of the engine oil level. In addition, the oil tank is vented overboard of the aircraft. The oil is gravity-fed from the oil tank through a check valve to the oil pump, located on the accessory drive gearbox. It is then routed through internal passages in the gearbox to the oil filter. From the oil filter, the oil continues on to provide engine lubrication.

*b. Oil Scavenge System.* The scavenge section of the oil pump returns oil from the accessory drive gearbox through the aircraft oil cooler to the oil storage tank. The engine incorporates a fuel heater through which scavenge oil flows before reaching the aircraft oil cooler. Chip detectors, mounted on the accessory drive gearbox, are provided to detect metallic contamination of the oil. #1 and #2 ENG CHIP caution lights on the caution annunciator panel provide a cockpit indication of oil contamination (figure 2-10).

**2-17. Ignition System.**

The ignition system is used for engine starting and not for sustaining combustion. The ignition system consists of an ignition unit, spark splitter coil, four igniter plugs, and ignition leads. The ignition unit converts low voltage to high voltage and supplies current to the spark splitter coil. The spark splitter coil, in turn, distributes current equally to the igniter plugs that ignite the starting fuel-air mixture in the combustion chamber. Ignition is supplied to the combustion chamber whenever the IGNITION button (figure 2-25) is pressed during the starting cycle. Ignition is interrupted when the IGNITION button is released. A key-operated ignition system lock switch is installed on the sloping console (figure 2-49). With the switch in the OFF position, the engine ignition and starting systems are inoperative, thus preventing engine start.

**2-18. Starting System.**

*a.* The engine starting system consists of the starter-generator, mounted on the engine (figure 2-22), the ignition lock switch (figure 2-49), and the engine control panel switches on the left overhead panel (figure 2-25). Either battery power or external power can be used to power the starter-generator during engine starting procedures. When the engine has been brought up to speed and stabilizes, the engine will drive the starter. In this mode the starter-generator will operate as a generator.

*b.* The engine master switches are two-position ON-OFF switches. In the ON position, each switch supplies power to the engine crank switch and opens the appropriate main tank fuel shutoff valve. The switches are the pull-to-unlock type that require a definite pressure to place in OFF position.

*c.* The engine crank switches have two placarded positions: CRANK and INTERRUPT CRANK. The switches are spring-loaded to the center (off) position. Placing the switch momentarily in the CRANK position will supply power to the starter. During engine start, when the crank switch of the second engine is set to the CRANK position, the generator associated with the first operating engine is automatically disconnected from the primary DC bus. When the

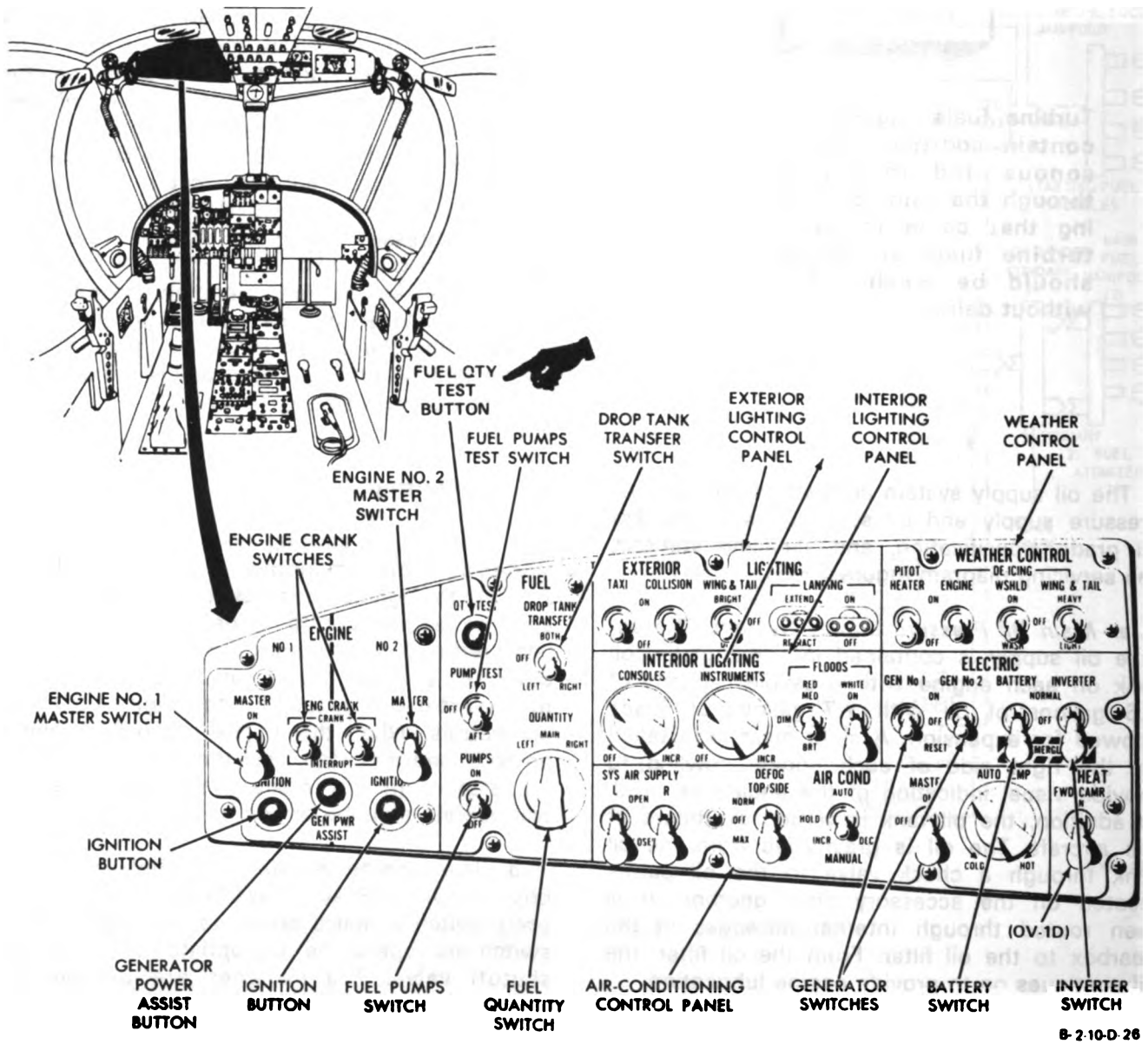

Figure 2-25. Left Overhead Panel

generator power assist button is pressed, the generator of the operating engine is again connected to the primary DC bus for the purpose of assisting the battery in starting the second engine. Placing the switch in INTERRUPT CRANK will stop the cranking cycle.

## 2-19. Engine Instrumentation Systems.

Engine instrumentation systems provide accurate and instantaneous visual displays on the pilot's instrument panel. Left and right engine parameters displayed are torque, gas producer N1 speed, propeller RPM, exhaust gas temperature, amps, oil temperature, and oil pressure. A VIDS (vertical instrument display system) display unit (figure 2-7) is installed. See figure 5-1 for instrument markings and table 5-1 for engine operation limitations.

*a. VIDS Display Unit.* The VIDS is powered from the 28-volt DC primary bus through the 25-ampere ENG INST PWR circuit breaker (figure 2-12) and the 7-1/2 ampere ENG INST circuit breaker. The VIDS is operational when the VOLTS vertical display is illuminated. On any vertical display, normal operating ranges are in green, prohibited operating ranges are in red, and marginal operating ranges are in amber. The VIDS display unit is equipped with a small control panel in the lower right corner (figure 5-1). The control panel includes a toggle switch marked L-AMPS-R, a lamp marked AUX PWR, a toggle switch marked DIGIT ON-OFF-LT/TEST, and a control knob marked DIM SET. The function of the L-AMPS-R toggle switch is explained in paragraph 2-36. Illumination of the AUX PWR lamp indicates failure of one of the two VIDS power supplies and the system is operating with reduced capability on the remaining power supply. When one power supply has failed, all digital displays for one engine and every other lamp in each vertical display will not illuminate. When operating on only one power supply, the accuracy of information on the remaining displays will not be degraded, but scale increment readability of vertical displays will be halved. When the DIGIT switch is in ON, three-digit digital displays will illuminate and provide redundant display for left and right TORQUE, PROP RPM, N1 SPEED, EGT, and AMPS; all digital displays are extinguished when the DIGIT switch is set to OFF. Holding the DIGIT switch in the LT/TEST position will illuminate all functional vertical display lamps and 8's on each digital

display. The DIM SET control knob adjusts the nominal light intensity of the vertical and digital signal displays. A light sensor, in the top center of the VIDS display unit, will automatically correct display light intensity when the ambient light level changes. Lighting intensity of the scales and nomenclature of the VIDS display unit may be adjusted using the INSTRUMENTS INTERIOR LIGHTING control knob on the left overhead panel (figure 2-25). Eight latch indicators are installed in the VIDS signal data converter in the nose cap compartment. When operating limits of each propeller or engine are exceeded, the appropriate latch indicator will trip to record the prohibited operation. The latch indicator normally appears as a white circle, but when tripped, three Day-glo red arcs alternately spaced with three white arcs appear in the circle. The latches shall retain their status when power is off to provide a record of abnormal engine operation for use by maintenance personnel. After each flight or engine run, the latch indicators may be inspected by maintenance to determine if special engine or propeller inspections are necessary. Only maintenance personnel are authorized to reset the latches. In addition to engine performance, the VIDS display unit monitors performance of the hydraulic, propeller, and electrical systems (paragraph 2-28, 2-30, and 2-36).

(1) *Torque Display.* Torque output from each engine is displayed on the VIDS display unit. The torque scale range is from 0 to 130% of military rated power (max rated torque). Each vertical display for torque output is augmented by a selectable three-digit digital display graduated to units of 1% of military rated power (max rated torque). Torque inverters must be operating to provide torque displays. Torque inverters are powered from the 28-VDC primary bus through the 5-ampere TOR INV NO. 1 and TOR INV NO. 2 circuit breakers (figure 2-12).

(2) *N1 Speed Display.* Gas producer speed (N1) speed from each engine is displayed on the VIDS display unit. The N1 speed scale range is from 0 to 110% RPM. Normal reading at military rated power is 100% RPM. Each vertical display for N1 speed is augmented by a selectable three-digit digital display graduated to units of 1% RPM. N1 speed greater than 101.5% will permanently trip a latch indicator on the VIDS signal data converter.



**(3) Exhaust Gas Temperature Display.** Exhaust gas temperature (EGT) from each engine is displayed on the VIDS display unit. The EGT scale range is from 0 to 820 degrees C. Each vertical display for EGT is augmented by a selectable three-digit digital display graduated to units of 1 degree C. EGT greater than 760 degrees C will trip a latch indicator on the signal data converter.

**(4) Engine Oil Temperature Display.** The engine oil temperature from each engine is displayed on the VIDS display unit. The oil temperature scale range is minus 75 to plus 150 degrees C.

**(5) Engine Oil Pressure Display.** The engine oil pressure from each engine is displayed on the VIDS display unit. The oil pressure scale range is 0 to 110 PSI.

**b. Deleted.**



## SECTION IV. FUEL SYSTEM

## 2-20. Fuel Supply System.

a. Fuel is contained in one 297-gallon self-sealing main tank in the fuselage and, if installed, in two externally mounted 150-gallon drop tanks (figure 2-2) attached to the pylons on the wings at store stations 3 and 4. An IRCM pod AN/ALQ-147A(V)2 may be installed in lieu of one of the 150-gallon drop tanks. The IRCM pod contains 135 gallons of fuel available only to the aircraft engines and 15 gallons of fuel available only to the countermeasures system. The capacity of all tanks is shown in table 2-5. All tanks may be fueled through a 3-inch gravity filler unit, one at each tank, or by single-point pressure fueling (paragraph 2-41).

b. Two tank-mounted centrifugal boost pumps (figure 2-26) are forward and aft in the main tank. The forward boost pump feeds a negative-G can in which the aft boost pump is mounted. The engines are fed from the aft boost pump. With the failure of the aft boost pump, the forward pump will supply sufficient fuel for proper engine operation. An ejector pump will supply the negative-G can in case of forward boost pump failure with the aircraft in a nose-down attitude. The aircraft will operate satisfactorily up to 6,000 feet pressure altitude with both boost pumps inoperative. Fuel is transferred from the drop tanks to the main tank by means of two electrically operated drop tank transfer pumps, one in each wing. A pilot valve in the main tank controls the flow of fuel from the drop tanks, thus the main tank remains full until the drop tanks are empty. Cockpit control of the fuel system is provided by left and right engine master switches and the fuel pumps switch on the left overhead panel (figure 2-25). A switch for drop tank transfer is also provided.

c. For fuel grade, specification, and servicing stations, see servicing diagram, figure 2-51. The use of alternate fuel grades is permissible (paragraph 2-41).

d. Normally, the drop tanks, mounted on wing stations 3 and 4, are released from the drop tank rack hooks when the stores release button on the pilot's stick grip is pressed

and the switches on the stores selector panel are properly positioned. External stores can also be released by pulling the emergency stores release handle.

## 2-21. Controls and Indicators.

a. *Fuel Pumps Switch.* The fuel PUMPS switch is a two-position ON-OFF toggle switch on the left overhead panel (figure 2-25). In the ON position, this switch energizes the low-pressure boost pumps. It also arms the fuel pump test switch, the drop tank transfer switches, and the L and R DROP TANK caution lights.

b. *Fuel Pumps Test Switch.*

**WARNING**

Activating the fuel pump test switch above 6,000 feet pressure altitude may cause dual engine failure.

The fuel PUMP TEST switch, with three positions (FWD, OFF, and AFT), is on the left overhead panel (figure 2-25). The switch is used to test the operation of the forward and aft boost pumps. Placing the switch in the AFT position deenergizes the aft boost pump, allowing the forward boost pump to be tested. The reverse is true in the FWD position. If the pump being tested is inoperative, the FUEL PUMPS low pressure caution light and the master caution light will illuminate. It is normal for the FUEL PUMPS caution light (figure 2-10) to illuminate when the switch is placed in the AFT position if the main tank fuel quantity is less than 140 gallons (910 pounds); therefore, a sufficient quantity of fuel should be on board during test.

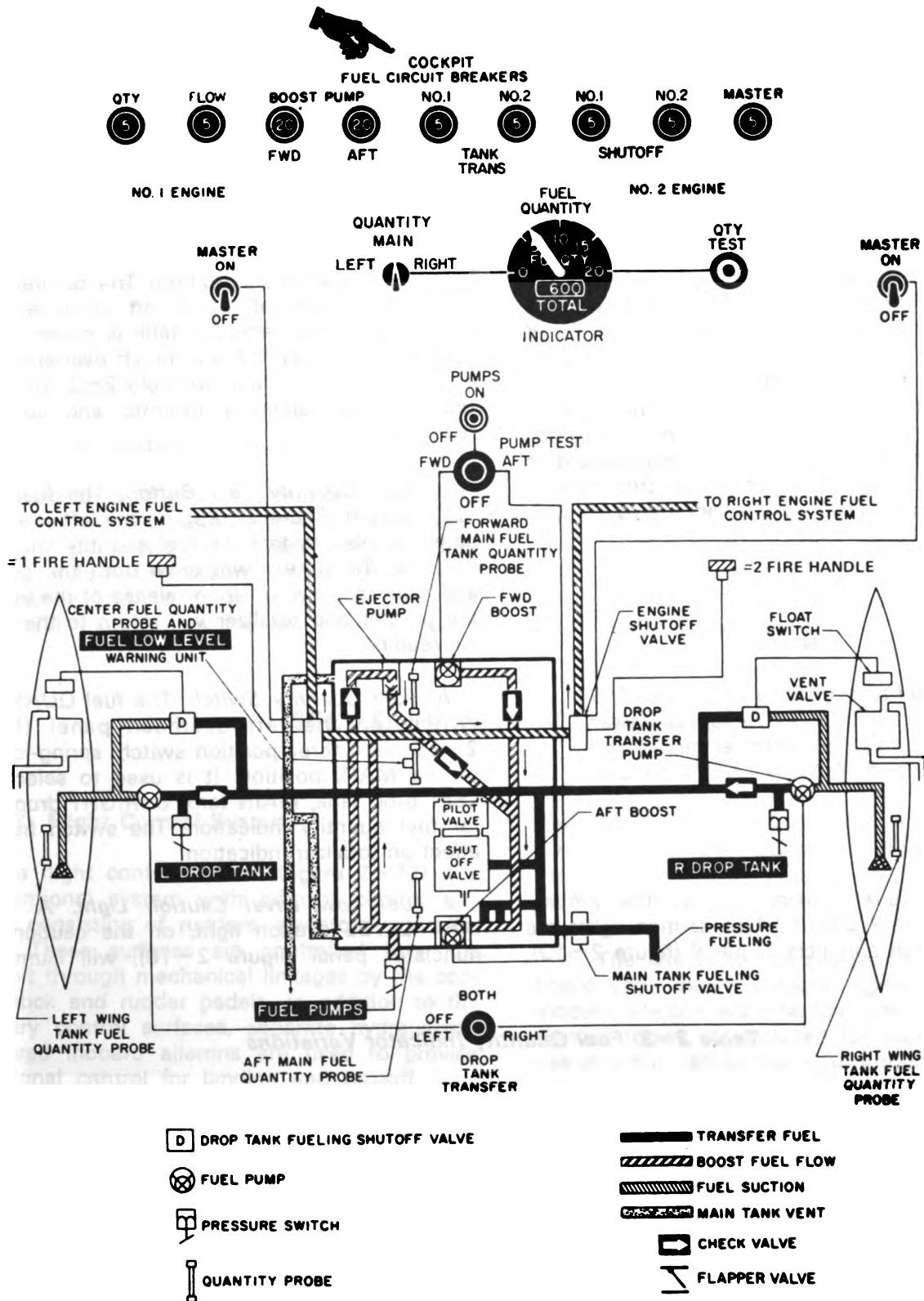

B-2-10-D-27

Figure 2-26. Fuel Supply System Schematic

*c. Fuel Pumps Caution Light.* The amber-colored FUEL PUMPS caution light (figure 2-10) indicates failure of both boost pumps when illuminated. The MASTER CAUTION light will illuminate simultaneously with this light.

*d. Drop Tank Transfer Switch.* The DROP TANK TRANSFER switch, on the left overhead panel (figure 2-25), is a four-position toggle switch used to transfer fuel from the left or right drop tank, or both, to the main tank. The fuel PUMPS switch must be ON, thus arming the drop tank transfer circuit and the L and R DROP TANK caution lights. When the DROP TANK TRANSFER switch is set to LEFT, RIGHT or BOTH, the corresponding transfer pump(s) is (are) energized and fuel flows from the selected drop tank(s) to the main tank. A pressure switch in each transfer line operates its corresponding caution light. Cross-flow from one drop tank to another is prevented by a check valve in each line.

**NOTE**

*For fuel to transfer, the fuel PUMPS switch shall be ON to supply power to the drop tank transfer circuit and the L and R DROP TANK caution lights.*

*e. Drop Tank Caution Lights.* The amber-colored L and R DROP TANK caution lights are on the caution annunciator panel (figure 2-10).

These lights, when illuminated, indicate zero fuel pressure from the drop tanks when the DROP TANK TRANSFER switch is on and the fuel PUMPS switch is ON. The MASTER CAUTION light will illuminate simultaneously with one or both of these lights.

*f. Fuel Quantity Indicator.* The fuel quantity indicator (figure 2-9) is on the center instrument panel. The total weight of fuel in all tanks is indicated in pounds by a four-digit totalizer below the instrument pointer. The pointer indicates the weight of fuel in an individual tank. Selection of the particular tank is made by the fuel QUANTITY switch on the left overhead panel (figure 2-25). Refer to table 2-3 for variations in fuel quantity (pointer and counter) readings.

*g. Fuel Quantity Test Button.* The fuel QTY TEST button (figure 2-25), on the left overhead panel, is used to test the fuel quantity indicator. Pressing the button will drive both the pointer and totalizer to zero. Upon release of the button, the pointer and totalizer will return to the original reading.

*h. Fuel Quantity Switch.* The fuel QUANTITY switch, on the left overhead panel (figure 2-25), is a three-position switch, spring-loaded to the MAIN position. It is used to select the LEFT drop tank, MAIN tank, or RIGHT drop tank for fuel quantity indication. The switch has no effect on totalizer indication.

*i. Fuel Low Level Caution Light.* A FUEL LOW LEVEL caution light, on the caution annunciator panel (figure 2-10), will illuminate

**Table 2-3. Fuel Quantity Indicator Variations**

Indicated Fuel Quantity (Pounds)	Pointer Tolerance (± Pounds)	Counter Tolerance (± Pounds)
0	44	90
500	64	110
1,000	84	130
1,500	104	150

**NOTE:** Tolerances are ± 2% of full scale plus 4% of indication.

automatically whenever the fuel in the main tank drops below 290 pounds ( $\pm 55$  pounds indicated on pointer or  $\pm 102$  pounds on counter totalizer of the fuel quantity indicator). The MASTER CAUTION light will illuminate simultaneously with this light.

*j. Fuel Flow Indicator.* A dual-pointer round indicator, on the center instrument panel (figure 2-9), displays fuel flow for each engine in pounds per hour. Transducers, in each engine fuel control system, measure and transmit instantaneous fuel flow rates to the fuel flow indicator. The fuel flow indicator system is powered from the 26-volt AC instrument transformer through the 2-ampere FUEL FLOW circuit breaker (figure 2-12).

## 2-22. Fuel System Management.

During cruise flight, drop tank fuel should be used first and the quantity of each tank should be checked periodically to detect irregular transferring of fuel from the drop tanks to the main fuel tank. This is done by placing the fuel QUANTITY switch, on the left overhead panel

(figure 2-25) to LEFT, then checking the amount of fuel shown on the fuel quantity indicator (figure 2-9). The procedure for checking the fuel quantity in the right drop tank is identical, except for the position of the fuel QUANTITY switch. If the drop tanks are not transferring evenly, place the DROP TANK TRANSFER switch (figure 2-25) to either LEFT or RIGHT depending upon which drop tank has a greater fuel quantity reading. When the fuel quantity of both drop tanks equalize, place the DROP TANK TRANSFER switch to BOTH. Repeat this procedure, as necessary, to maintain even wing loading.

### NOTE

*For fuel to transfer, the fuel PUMPS switch shall be ON to supply power to the drop tank transfer circuit and the L and R DROP TANK caution lights.*

## SECTION V. FLIGHT CONTROLS

### 2-23. Flight Control System.

The flight control system (figure 2-27) is a conventional system with primary control surfaces consisting of rudders, elevators, and ailerons. These surfaces are controlled from the cockpit through mechanical linkages by the control stick and rudder pedals. In addition to the primary control surfaces, separate hydraulically powered inboard ailerons are used to provide additional control for landing and takeoff. Trim control is accomplished by a manual cable and drum system controlling the position of the trim tabs. A gust lock system is installed to lock the surface controls in their neutral positions.

### 2-24. Description.

*a.* The longitudinal control system consists of conventional elevators (figure 2-27) operated mechanically by a pushrod and crank linkage connected to the cockpit control stick. Two par-

allel systems run the full length of the fuselage. Control forces are reduced for the pilot by the use of aerodynamic balance and a trim tab on each elevator.

*b.* The lateral control system consists of outboard and inboard ailerons (figure 2-27). The inboard ailerons are interconnected to the flaps. Control forces are reduced for the pilot by the use of a trim tab on the right outboard aileron.

*c.* The directional control system consists of three rudder surfaces (figure 2-27) on the vertical stabilizers. Control forces are reduced for the pilot by the use of a trim tab on the center rudder surface.

*d.* The gust lock control system consists of a manual GUST LOCK handle (figure 2-6), and cables and pulleys connected to the gust lock mechanisms near each control surface. The gust lock locks the surface controls in their neutral positions. The GUST LOCK handle (figure 2-6) is a T-handle located forward of the cockpit

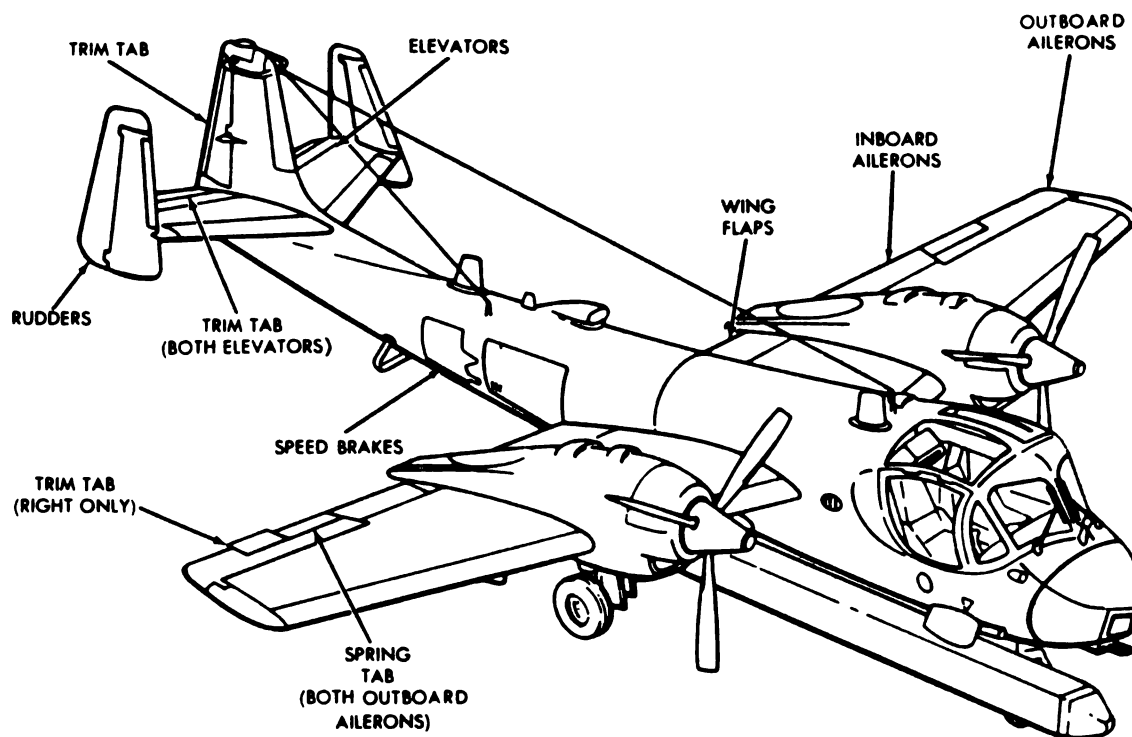

2 10-D-28

**Figure 2-27. Flight Control Surfaces**

control pedestal. The gust lock is positioned by pulling the handle up and aft to engage the locks. In the locked position, the handle automatically locks and is positioned so that it interferes with normal power lever operation and will not allow inadvertent takeoff with gust locks engaged. The gust lock latches are spring-loaded to the unlocked position so that the latches will unlock in the event of a gust lock cable failure. These springs also return the GUST LOCK handle from the locked to the unlocked position when the handle position lock is released. To stow the handle, push down. A placard, on both sides of the pedestal, outlines the gust lock operation in checklist form (figure 2-11).

## 2-25. Controls.

*a. Wing Flaps.* The wing flaps are operated by the hydraulic system (figure 2-29) and are controlled from the cockpit by the FLAPS handle (figure 2-6). Retraction time is approximately

3.0 seconds and extension time is approximately 3.0 seconds. The flaps are supported and guided in motion by linkages near each end. Each flap is actuated up and down by a hydraulic cylinder in the wing. A pushrod and idler linkage between the left and right flapdrive bellcranks interconnects the flaps to insure synchronization. The inboard aileron is connected to the flaps by a jack shaft and link arrangement. To protect the system, the flap actuating mechanism allows the flaps to partially retract from the extended position when the aerodynamic load on the flaps is greater than actuator power. When this occurs the flaps will retract, depending on the airspeed, until a new balance of flap hinge moment and actuator power is reached. With full flap extension this occurs at speeds in excess of 110 knots. With loss of hydraulic pressure, the flaps cannot be lowered since there is no emergency flap lowering system. If flaps are already extended when the loss of hydraulic pressure occurs, the flaps will retract erratically depending on flap airloads and hydraulic system internal leakage.

**NOTE**

*If a loss of hydraulic pressure occurs with the flaps extended, the FLAPS handle should be returned to the UP position releasing hydraulic pressure and allowing the slipstream to retract the flaps and inboard ailerons.*

**b. Flap Handle.****CAUTION**

The FLAPS handle should be placed in the detent positions only. Placing the flaps at an intermediate position or milking the flaps between the UP and the 15° DN position may result in physical interference between the outer ends of the flaps and the inboard ailerons.

The FLAPS handle (figure 2-6) is on the control pedestal in the cockpit. The handle may be placed in any one of three detented positions: UP, 15° DN, or 45° DN. In addition to flaps extension and retraction, the FLAPS handle also controls the extension and retraction of the inboard ailerons.

**c. Speed Brakes.** The speed brakes (figure 2-27), on the fuselage midway between the wing and stabilizer, are drag-increasing devices used for reducing speed in any flight attitude. They are powered by the hydraulic system and controlled by the SPEED BRAKE switch (figure 2-6) on the left power lever.

**d. Speed Brake Switch.** The SPEED BRAKE switch (figure 2-6) on the left power lever is a thumb-operated switch with two positions: OUT position to extend the speed brakes, and IN position for retraction of the speed brakes.

**e. Inboard Ailerons.** The inboard ailerons are hydraulically operated control surfaces interconnected to the flaps (figure 2-29). When the flaps are retracted, the inboard ailerons remain in the retracted or neutral position regardless of lateral control stick position. Lowering of the flaps to either the 15° DN or 45° DN position automatically extends the inboard ailerons to the 25° down position. In this position, the inboard ailerons act as lateral control surfaces between nominal 24° up and 25° down positions. These auxiliary surfaces provide greater control of the aircraft during takeoff and landing and for single-engine operation with flaps extended.

**f. Outboard Ailerons.** The outboard ailerons, spring tabs, and trim tab are on the wing outer panel (figure 2-27). The spring tabs are mechanically connected to the ailerons, and the trim tab, controlled from the cockpit, is connected to the right aileron. The ailerons are controlled from the cockpit by the control stick, through a series of pushrods connected to the spring tabs. Rapid full lateral stick displacement will bottom the spring tab. The aileron trim control (figure 2-6) on the control pedestal may be adjusted 15° to either side of neutral.

**g. Rudders.** The rudders and trim tab are on the vertical stabilizers (figure 2-27). The rudders are controlled from the cockpit by the rudder pedals through a mechanical system consisting of cables used as tension members between cranks. The rudder pedals may be adjusted by means of a foot pedal adjustment handle (figure 2-3) located between the pedals below the pilot's instrument panel. The trim tab is on the center rudder surface and is controlled by a rudder trim control (figure 2-6) on the control pedestal. Internal stops in the pedestal determine the maximum amount of trim travel available, which varies somewhat with rudder position. As the rudder moves away from the neutral position, the amount of trim available decreases. With neutral rudder, 18° right or 17° left trim is available.

**h. Elevators.** The elevators and trim tabs are on the horizontal stabilizer (figure 2-27). The elevators are mechanically operated by a pushrod and crank linkage connected to the cockpit control stick. Both elevators have trim tabs controlled by an elevator trim control (figure 2-6) on the control pedestal. Elevator trim is adjustable from 5° noseup to 7° nosedown.

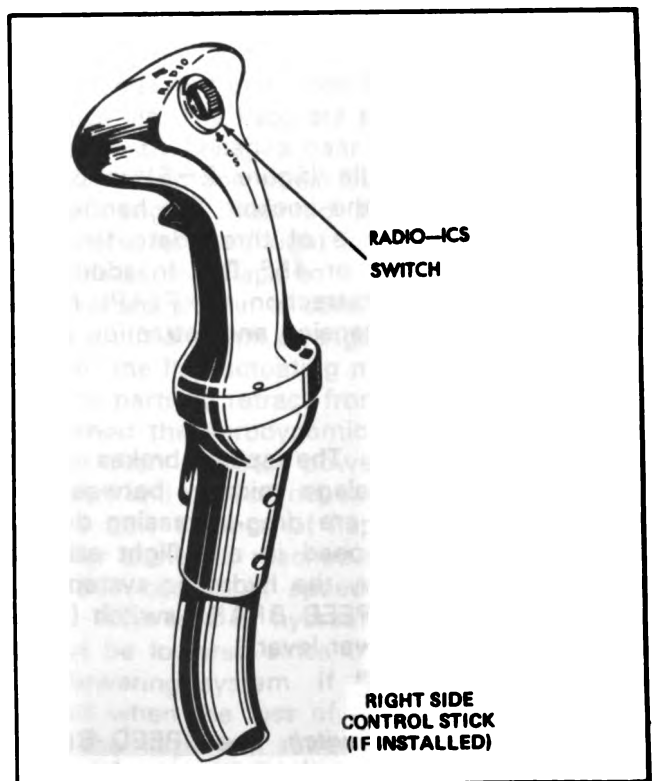
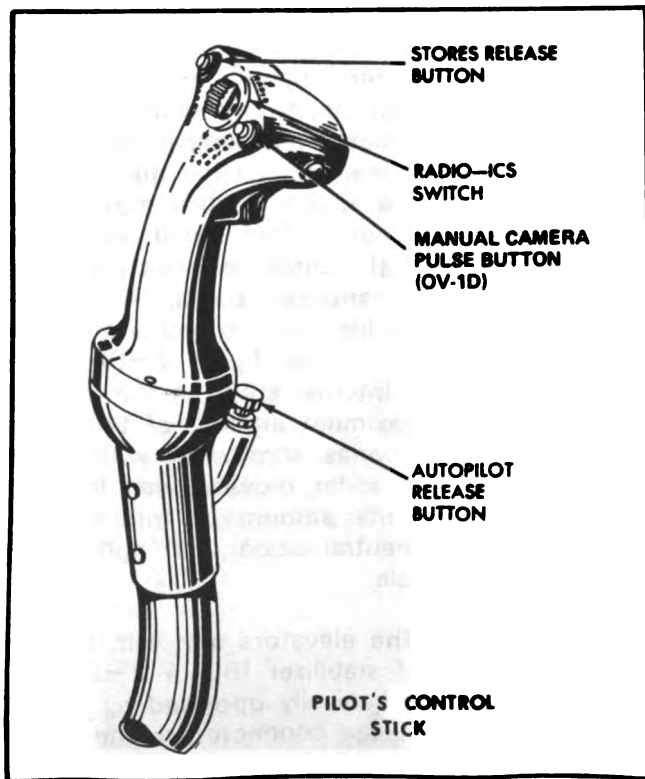
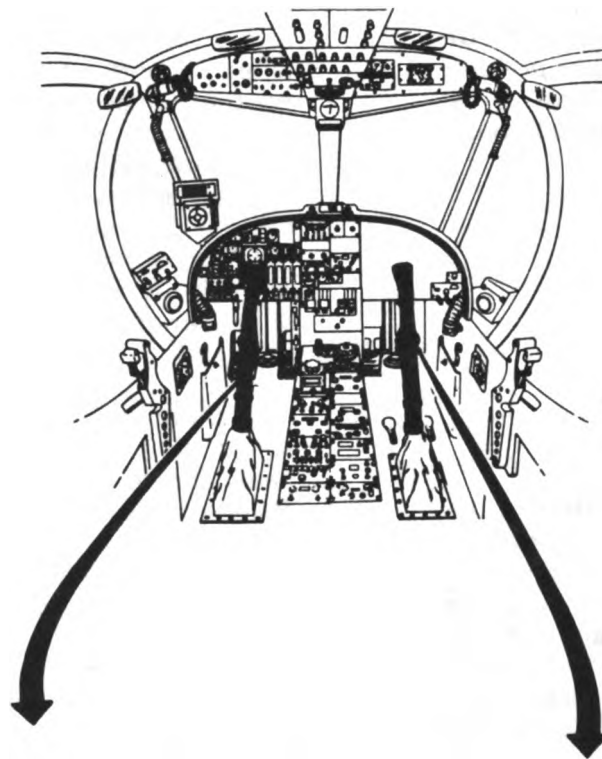

B-2-10-D-29

Figure 2-28. Control Sticks

*i. Pilot's and Instructor Pilot's Control Sticks.*

The pilot's control stick and instructor pilot's control stick (if installed) provide for control of the longitudinal and lateral control systems. Each control stick is constructed in two parts. The lower part provides only fore and aft movement. The upper portion is connected to the lower portion by a knuckle fitting to permit lateral movement of the control stick. Controls installed on each control stick are shown in figure 2-28.

**2-26. Indicators.**

*a. Wheels and Flaps Indicator.* A wheels and flaps position indicator is on the center instrument panel (figure 2-9). The face of the indicator contains a miniature flap profile that indicates the position of the flaps. Power is supplied to the indicator from the DC primary bus via the

WHEEL & FLAP 2 ampere circuit breaker on the remote circuit breaker panel.

*b. Speed Brake Light.* A SPEED BRAKE advisory light, of the press-to-test type, is on the pilot's instrument panel (figure 2-7). When illuminated, this light indicates that the speed brakes are extended.

**2-27. Automatic Stabilization Equipment.**

The autopilot is an automatic flight control system that can automatically control flight attitudes along the pitch, roll, and yaw axes. Automatic attitude control is accomplished through actuators connected to the longitudinal (pitch), lateral (roll), and directional (yaw) control system. Refer to Chapter 3 for detailed description and operation of the autopilot.

## SECTION VI. HYDRAULIC AND PNEUMATIC SYSTEMS

**2-28. Hydraulic System.**

The hydraulic system (figure 2-29) provides pressure for the landing gear, speed brakes, wing flaps, inboard ailerons, wheel brakes, power steering and windshield wipers. A 3,000 PSI hydraulic pressure is provided by two engine-driven pumps, one on each engine, that draw fluid from a common reservoir in the fuselage. The reservoir is pressurized by engine bleed air (from both engines) to maintain proper pump inlet pressure at altitude. Either pump can provide normal pressure for all systems during single engine operation. There is no hydraulic emergency system; however, there is a pneumatic system for emergency gear extension (paragraph 2-29). For hydraulic fluid grade, specification, and servicing stations, refer to paragraph 2-42.

*a. Hydraulic Shutoff Valves.* A hydraulic shutoff valve is in the suction line of each hydraulic pump. The valves are used to stop the flow of hydraulic fluid to the engines in the event of a fire. The valve is closed by pulling the tire handle for the applicable engine (figure 2-21).

*b. Hydraulic Pressure Instrumentation System.* A hydraulic pressure instrumentation system provides accurate and instantaneous visual display on the pilot's instrument panel. A VIDS (vertical instrument display system) display unit (figure 2-7) is installed to display left and right hydraulic pressure. Normal pressure for each hydraulic system is 3,000 PSI. See figure 5-1 for instrument markings.

*(1) VIDS Hydraulic Pressure Display.* Hydraulic pressure outputs from the left and right hydraulic pumps are displayed on the VIDS display unit. Refer to paragraph 2-19a for instructions to power, test, and illuminate the VIDS display unit. The hydraulic pressure scale range is from 0 to 4,200 PSI.

*(2) Deleted.*



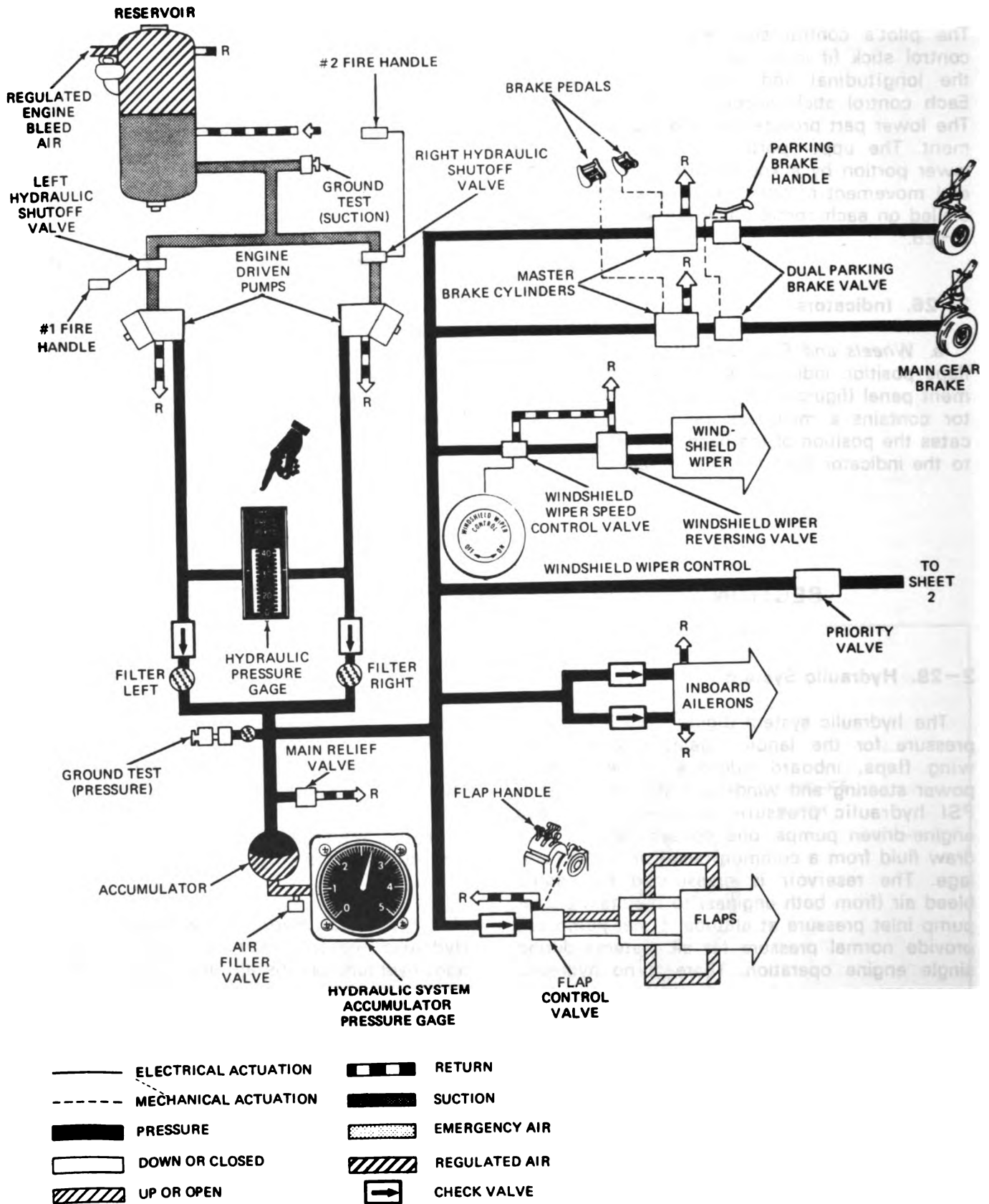

C-2-10-D-30-1

Figure 2-29. Hydraulic and Emergency Landing Gear Pneumatic Systems Schematic (Sheet 1 of 2)

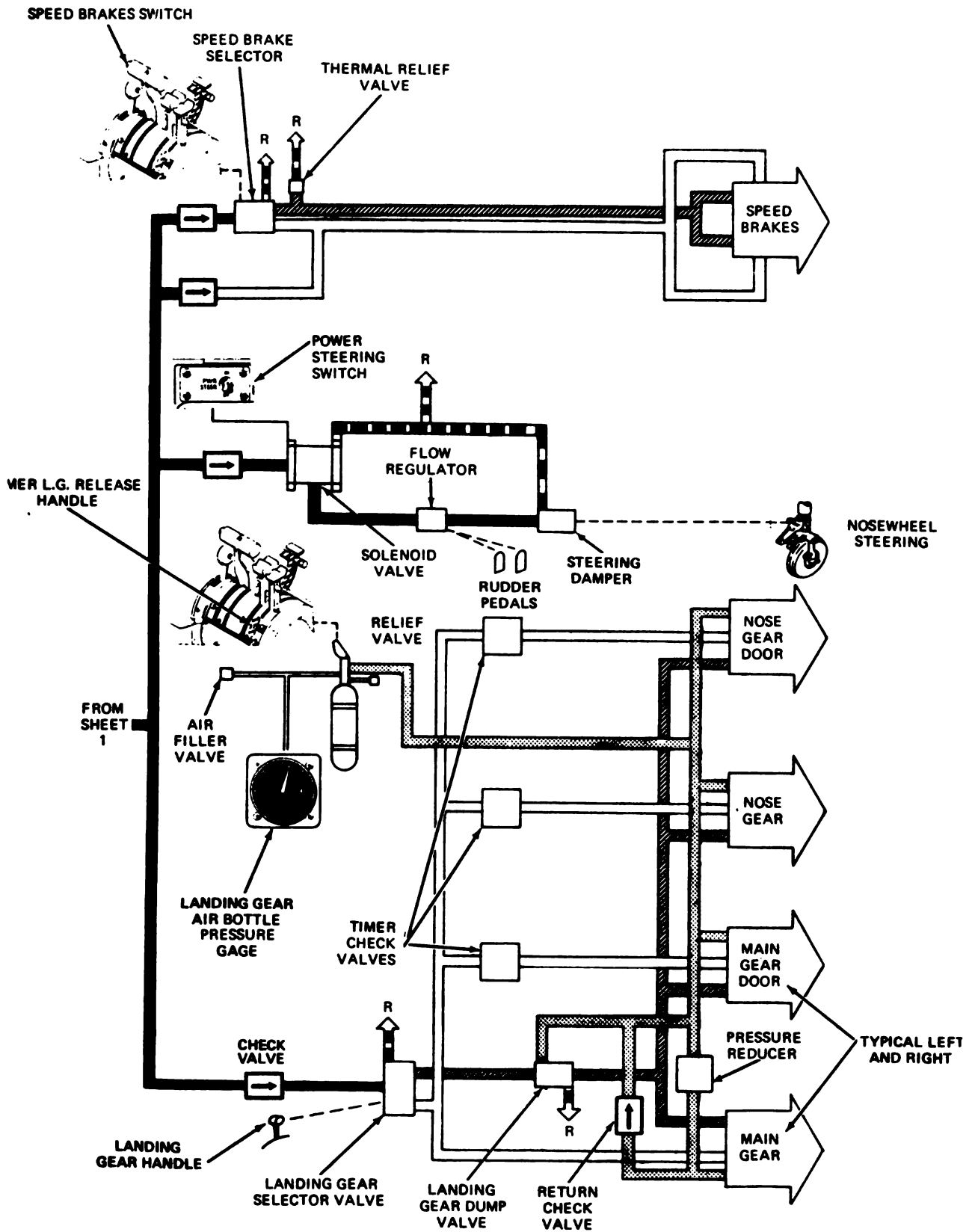

A 2-10-D-30-2

**Figure 2-29. Hydraulic and Emergency Landing Gear Pneumatic Systems Schematic (Sheet 2 of 2)**

**2-29. Pneumatic Systems.**

*a. Emergency Landing Gear Pneumatic System.* The emergency landing gear pneumatic system (figure 2-29) is a one-shot feature incorporated in the hydraulic system for lowering the landing gear in the event of a hydraulic system failure. Pneumatic pressure for the system is supplied by a charged air bottle behind the cockpit sloping console. The system is actuated by pulling the emergency landing gear release handle (figure 2-6) on the right side of

the pedestal. The system is charged through the hydraulic system servicing station on the right side of the fuselage, aft of the entrance hatch. System pressure will vary with ambient temperature as indicated in table 2-4.

*b. Escape Hatch Pneumatic System.* The escape hatch pneumatic system is a self-contained system used to jettison the escape hatch. The system is actuated by the escape HATCH JETTISON handle (figure 2-12), that must be rotated 90° clockwise and pulled.

**Table 2-4. Emergency Landing Gear Pneumatic System Pressure Indications with Variations in Ambient Temperature**

Ambient Temperature (°C)	Pressure (± 100 PSI)
43° and above	3,500
32.2°	3,200
21.1°	3,000
10.0°	2,800
- 1.1°	2,600
-17°	2,400
-30°	2,255

**SECTION VII. PROPELLER GROUP**

**2-30. Propellers.**

The engines are fitted with three-bladed, constant-speed, full-feathering, reversible-pitch propellers with synchronizing, synchrophasing, and autofeathering features. The oil supply for operating the propeller is independent of the engine oil system and is contained in an integral oil control assembly. For oil grade, specifications, and servicing stations, refer to paragraph 2-42.

*a. Pitch Change Mechanism.* The propeller pitch change mechanism consists of a double-acting piston whose movement rotates the blades about their longitudinal axis. All propeller operating conditions are derived from two actions, increasing blade angle (reducing RPM) and decreasing blade angle (increasing RPM). Changing propeller RPM is done mechanically by setting the prop lever. A propeller governor for each propeller automatically adjusts the blade pitch to maintain a constant speed under varying flight conditions. An auxiliary pump driven

by an electric motor is used for feathering, unfeathering, and reversing operations.

*b. Feathering.* Feathering of a propeller can be done either manually or automatically. Manual feathering of a propeller is initiated by placing the prop lever to the FEATHER position. The prop lever closes a switch in the pedestal that energizes the feather solenoid and the auxiliary pump motor. The auxiliary pump supplements the main pump. After the propeller stops in the feather position, pressure buildup activates a pressure cutoff switch, shutting off the auxiliary motor and deenergizing the feather solenoid. A blade switch in the circuit also turns off the air-conditioning system when a propeller is feathered.

*c. Unfeathering.* To unfeather a propeller, the prop lever is placed out of the feathered position before pressing the UNFEATHER button (figure 2-6), which energizes the auxiliary pump motor and the unfeather solenoid. As the propeller un-

feathers and a rise in RPM is noted, release of the UNFEATHER button terminates the unfeathering operation. Placing the power levers in reverse range will also unfeather the propellers.

#### NOTE

*While airborne, place the prop lever at MIN RPM to prevent surging. The auxiliary motor will continue to operate as long as the UNFEATHER button is pressed.*

**d. Reversing.** To prevent reversing the propeller by accident, either on the ground or in the air, a cam has been placed within the control quadrant between GROUND IDLE and FULL REVERSE. Propeller reversing is done by moving the power lever up 1.5 inches and aft along the cam before it can be moved into reverse. Upon initially passing over the cam, the propeller will go into reverse pitch. This action mechanically and electrically activates the reversing circuit. Propeller reversing time is decreased with increased propeller RPM. After the propeller reaches reverse, the auxiliary motor operation is terminated by blade switches and a pressure cutout switch. In addition, further aft movement of the power lever will increase the amount of reverse thrust until the FULL REVERSE position is attained.

**e. Unreversing.** Unreversing is done by moving the power lever forward of the cam, out of the reverse range.

**f. Prop Levers.** The prop levers (figure 2-6), on the right side of the control pedestal, are used to regulate the propeller speeds and initiate manual propeller feathering and engine shut-down. The lever positions are placarded: MAX RPM, MIN RPM, FUEL OFF, and FEATHER. With the levers full forward, maximum governed RPM can be obtained. Moving the levers aft reduces the RPM within governor limits. Moving the levers back past the MIN RPM detent to FUEL OFF shuts off fuel flow to the engine. When the levers are brought back to end of travel, the propellers will feather while fuel shut-off is maintained.

**g. Unfeather Buttons.** The #1 and #2 UNFEATHER buttons (figure 2-6), on the control pedestal, are used to unfeather the propellers. Pressing the UNFEATHER button, with the prop lever between MIN RPM and MAX RPM, ener-

gizes the unfeather relay which, in turn, energizes the auxiliary pump motor and the unfeather solenoid, unfeathering the propeller.

**h. Propeller RPM Instrumentation System.** A propeller RPM instrumentation system provides accurate and instantaneous visual displays on the pilot's instrument panel. A VIDS (vertical instrument display system) display unit (figure 2-7) is installed to display left and right propeller RPM. See figure 5-1 for instrument markings and table 5-1 for propeller RPM operating limitations.

**(1) VIDS Propeller RPM Display.** Propeller RPM outputs from the left and right propellers are displayed on the VIDS display unit. Refer to paragraph 2-19a for instructions to power, test, and illuminate the VIDS display unit. The propeller RPM scale range is from 0 to 2,000 RPM. Propeller speed greater than 1,720 RPM for three seconds or longer will permanently trip a latch indicator on the VIDS signal data converter (paragraph 2-19a). Propeller speed greater than 1,850 RPM will permanently trip an additional latch indicator.

**(2) Deleted.**

**i. Propeller Autofeather Circuit.**

#### WARNING

Due to engine acceleration characteristics, a sudden power lever advance to the TAKEOFF position, before torque can increase beyond the setting ( $13\pm 3\%$ ) of the autofeather torque switch, causes the autofeather circuit to feather one propeller with the autofeather system armed.

The propeller autofeather circuit provides automatic feathering of a propeller in the event of engine power loss during takeoff. The autofeather system is armed when the autofeather/synchrophaser switch (figure 2-6) is placed in the AUTOFEATHER ON position and the power levers are advanced to the TAKEOFF position. An indication of power loss from the engine torque indicator and the P3 pressure switch will energize the autofeather relay. When the autofeather relay closes, the feather solenoid and auxiliary pump motor are energized, autofeathering the propeller. The autofeather circuits for both engines are interlocked so that actuation of either circuit automatically disarms the remaining autofeather circuit. The autofeather circuit will also be disarmed when one propeller is feathered manually, when the autofeather/synchrophaser switch is OFF, when the P3 pressure switch is open, or when the power levers are moved aft of the TAKEOFF position. Neglecting to disarm the autofeather circuits will not affect operation of other electrical propeller systems, but autofeather should be armed only as specified in Chapter 8.

*(1) Pressure Switch.* The P3 pressure switch is a nonadjustable, pneumatically actuated switch that permits autofeather as a result of actual engine power loss. It is installed to eliminate erroneous actuation of the autofeather circuit due to torque indicator circuit failure.

*(2) Autofeather/Synchrophaser Switch.* The autofeather/synchrophaser switch (figure 2-6) has three positions: AUTOFEATHER ON, OFF, and SYNCHROPHASER ON. To place the switch in AUTOFEATHER ON position from the OFF position, it is necessary to pull the lever-lock toggle over a detent. No other movements of the toggle are impeded by a detent. When placed in the AUTOFEATHER ON position, the switch arms the autofeather circuits. The circuits will only work when the power levers are in the TAKEOFF position. When placed in the SYNCHROPHASER ON position, the propeller synchrophaser circuit is turned ON. Placing the switch in the OFF position turns off both autofeather and synchrophaser circuits.

*(3) Autofeather Test Button.* The autofeather test button (figure 2-6) is near the forward section of the control pedestal. The button is used during engine runup to determine if the P3 and autofeather switches are operating properly.

*(4) Autofeather Armed Light.* A green light marked AUTO FETH ARMED is on the pilot's instrument panel. When illuminated, this light indicates that the autofeather circuit is armed.

*j. Propeller Synchrophaser System.* Synchrophasing is the process by which the propellers are maintained at identical speeds with the angular relationship of the two sets of blades arranged to transmit the least amount of vibration and noise to the airframe. The proper propeller phase relationships are automatically established by the synchrophasing circuits. Operation and special problems relating to this system are covered in the following paragraphs:

*(1)* The synchrophaser is used during stabilized climb, cruise, and descent. During takeoff, the autofeather/synchrophaser switch is placed in the AUTOFEATHER ON position. The synchrophaser assembly, in the forward equipment compartment, receives operating power directly from the SYNC AC circuit breaker.

*(2)* The propeller synchrophaser is not used during takeoff because the switch is used at this time to arm the autofeather system.

*(3)* Use of the propeller synchrophaser for landing is not recommended because operation of the propeller at landing pattern airspeed and power setting usually results in blade angles at or near the mechanical low pitch setting. Interference of the low pitch stop with normal blade angle changes (when synchrophaser is on) would cause undesirable RPM hunting of the slave propeller. Also, during a go-around, loss of power on the No. 1 engine may cause a drop of almost 70 RPM in the No. 2 propeller.

*(4)* Slave propeller (No. 2) RPM will probably vary from the master propeller (No. 1) RPM in turbulent air, or during large or rapid change of power, RPM, or aircraft attitude; but synchronization will be restored automatically within 5 to 10 seconds. Because of the transient RPM disturbance, the pilot must use his own discretion as to whether he should turn off the autofeather/synchrophaser switch in preparation for acrobatics, or any other sustained period of transient power plant or flight condition. It is not recommended to turn off the autofeather/synchrophaser switch for isolated power changes, RPM changes, turns, etc. This merely increases

the time necessary for the synchrophaser to automatically restore synchronization. With the autofeather/synchrophaser switch in SYNCHROPHASER ON, smooth power lever and prop lever movements will often not result in loss of synchronization.

(5) For synchronization to be effective, slave propeller RPM must be mechanically set to within 2% (approximately 35 RPM) of the master propeller RPM. Slave RPM can follow master RPM within plus or minus 2% of slave RPM as set with the prop lever. Therefore, synchrophasing will be most effective when slave RPM has been mechanically matched with the master RPM. Otherwise, the synchrophaser may be holding slave RPM to master RPM at one extreme of the 2% range, and relatively slight

variations in flight conditions can cause the slave propeller to lose synchronization.

(6) Synchrophasing will not necessarily operate satisfactorily on a ground check because of the difference in wind conditions which the propellers experience on the ground. There may be evidence that the synchrophaser is operating, as indicated by automatic changes in slave propeller RPM to match the master propeller RPM, but operation may not be sufficiently stable to determine whether the entire system is satisfactory.

*k. Pitchlock Assembly.* The pitchlock assembly in the propeller, locks the blades at a fixed blade angle in case of an overspeed or loss of propeller oil pressure. After an overspeed, the propeller will return to constant speed operation.



## SECTION VIII. UTILITY SYSTEMS

### 2-31. Defrosting System.

The defrosting system, an integral portion of the heating and ventilation system, is contained in Section IX of this chapter.

### 2-32. Anti-icing/Deicing Systems.

#### a. Windshield Anti-icing System.

(1) *Description.* The windshield anti-icing system has the dual purpose of washing and anti-icing of the windshield. Engine bleed air from the air-conditioning system is applied to a control valve that regulates the airflow passing into a fluid tank. The tank is normally vented to the atmosphere and is pressurized to  $8 \pm 0.5$  PSI when the system is energized. When the system is in use, fluid flows on to the windshield. In the wash cycle, fluid flows through two restrictors, whereas one restrictor is used in the anti-ice cycle. Therefore, a greater flow of fluid is obtained when the WASH position is selected. The fluid used in this system is a mixture of alcohol and water.

(2) *Controls and Operation.* The control used to spray fluid onto the windshield is the three-position WSHLD DE-ICING switch on the weather control panel (figure 2-23). In the WASH position or the ON position, fluid will flow onto the windshield. The fluid flow during the anti-icing mode is less than the fluid flow during the wash mode.

#### NOTE

*The duration of the fluid during the wash cycle is approximately 6 to 8 minutes. The duration of the fluid during the anti-ice cycle is approximately 10 to 15 minutes.*

#### b. Pitot Static System Heater Anti-icing Circuit.

(1) *Description.* To prevent the formation of ice from occurring in the pitot tube, a heating element receiving power from the DC secondary bus is inside the pitot tube.

(2) *Controls and Operation.* Operation of the pitot heating element is done by setting the PITOT HEATER circuit breaker switch, on the weather control panel (figure 2-23), to ON.

#### c. Pneumatic Deicing System.

(1) *Description.* The pneumatic deicing system consists of the deicer control valve, the deicer timer, the pneumatic deicer boots, and the necessary lines to complete the system. The rubber boots are installed on the leading edges of the wings and empennage. They are pressurized by engine bleed air taken from a line in the air-conditioning system.

(2) *Controls and Operation.* The WING & TAIL DE-ICING toggle switch, on the weather control panel (figure 2-23), is used to select the timing sequence of the inflation of the pneumatic boots. Selection may be made for either LIGHT or HEAVY ice with this switch. In the LIGHT position, the tail boots are inflated for 5 seconds and then deflated. There is a 10-second pause, and then the wing boots are inflated for 5 seconds and deflated. There is then a pause of 3 minutes and 40 seconds before the cycle begins again. In the HEAVY position the cycle is the same, except that the pause between cycles is reduced to 40-seconds. To insure complete deicing of wing and empennage, the pneumatic deicing system should not be activated before ice has accumulated to approximately 0.5 inches in thickness. The L or R SYS AIR SUPPLY switches, on the AIR COND control panel located on the left overhead panel (figure 2-25), shall be in the OPEN position in order to have engine bleed air available to the pneumatic deicer boots.



*d. Engine Deicing System.*

(1) *Description.* The engine deicing system supplies hot air under pressure to prevent icing of the air inlet areas when operating under icing conditions. Pressurized hot air from the air diffuser is routed into an inline valve that is controlled by the engine deicing switch. From the inline valve, hot air is directed through hollow inlet housing struts to prevent ice formation in the air inlet. Hot scavenge oil, draining through the lower strut into the accessory drive gearbox, prevents ice formation in the bottom of the air inlet area. Hot air also flows through the inlet guide vanes to prevent icing in the compressor area.

(2) *Controls and Normal Operation.*



Prolonged ground operation of engine deice may cause damage to system.

The ENGINE DE-ICING switch is an ON-OFF toggle switch on the weather control panel (figure 2-23). It receives DC secondary bus power through the NO. 1 and NO. 2 ENG DEICE circuit breakers. Engine deicing is done by positioning this switch to ON. The engine deicing system shall be used when the ambient temperature is below +4°C and visible moisture exists.

(3) *Emergency Operation.* In the event that the electrical system fails, the inline valve automatically switches to the open position and hot air will flow continuously.

*e. Propeller and Cowl Deicing System.*

(1) *Description.* The propeller and cowl deicing system prevents the accumulation of ice on the critical surfaces of the propellers, propeller spinners, and the engine cowls. The system uses 115 VAC to energize the heating elements on these surfaces. Each section is sequentially heated in a predetermined timing se-

quence established by the timer. Each element is heated for 15 seconds every 105 seconds. The electrical heating elements heat these surfaces whenever the ENGINE DE-ICING switch on the weather control portion of the left overhead panel is set to ON (figure 2-23). This system is not automatic; therefore, it must be activated manually when icing conditions occur. The ENGINE DE-ICING switch also energizes a deicer relay when positioned to ON. This applies 115 VAC supplied by the deicer generator for each engine to the propeller and engine cowl heating elements. The #1 and #2 ANTI-ICE GEN caution lights on the caution annunciator panel will illuminate to indicate a failure of the deicer generators.

(2) *Controls and Operation.*



Prolonged ground operation of engine deicer may cause damage to system.

The only control of the propeller and cowl deicing system is the ENGINE DE-ICING switch, on the weather control panel (figure 2-23). It should be ON when the ambient temperature is below +4°C and visible moisture exists. On some aircraft, an ANTI-ICE ON advisory light is installed on the caution annunciator panel (figure 2-10) to indicate that the ENGINE DE-ICING switch is in the ON position when the aircraft is on the ground.

**2-33. Oxygen System.**

*a. Description.* A high-pressure oxygen system consisting of two 514-cubic inch oxygen cylinders, two automatic pressure-demand regulators, and two ejection disconnect assemblies, are installed in the aircraft. The cylinders are installed behind the seat support bulkhead, aft of the cockpit. The oxygen is stored in cylinders at a pressure of 1,850 PSI maximum. The system is filled through the oxygen filler valve on the left side of the fuselage below the entrance hatch. The pressure regulators (figure 2-30) are

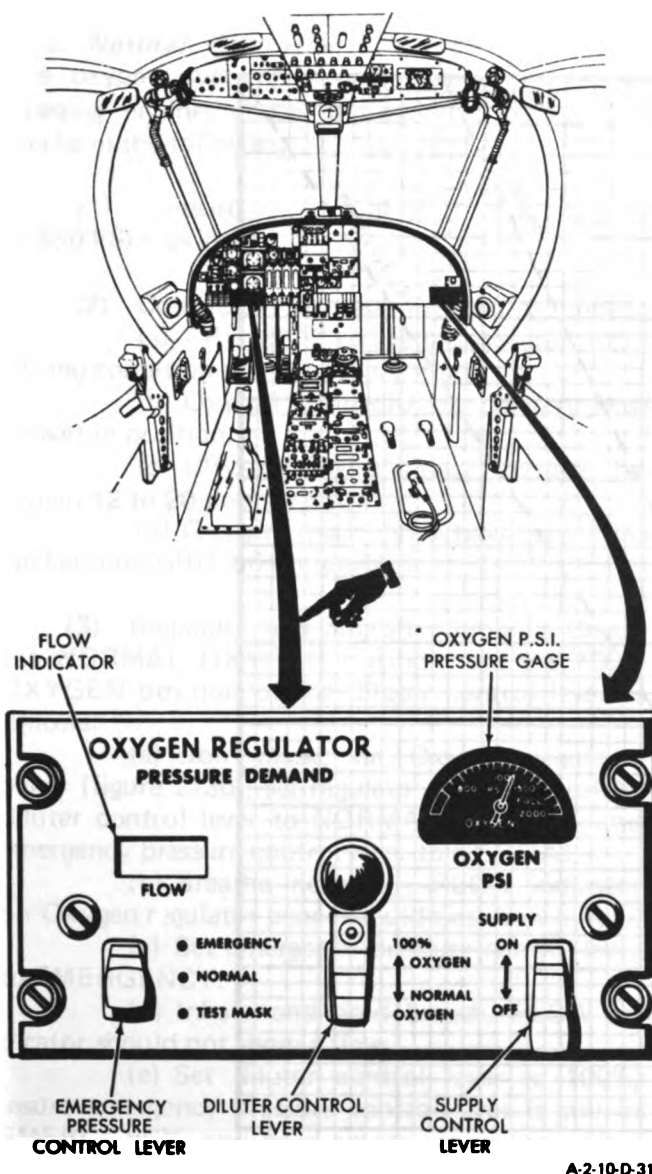

A-2-10-D-31

Figure 2-30. Oxygen Regulator Panels

installed on the pilot's and right side instrument panel in the cockpit. The regulators are installed in the oxygen system between the oxygen supply and the crewmember's mask. The supply control lever shall be turned OFF unless the system is in use. Oxygen pressure is admitted to the regulator through the inlet assembly. This oxygen passes through a reducer assembly that drops the pressure to between 37 and 45 PSI, making regulator operation substantially independent of inlet pressure. Air is admitted to the regulator through an air valve on the side of the case. The air/oxygen mixture is delivered to the

mask by a flexible hose attached to the regulator outlet. For oxygen duration, see figure 2-31.

*b. Controls and Indicators.*

(1) *Diluter Control Lever.* With the diluter control lever set at NORMAL OXYGEN, the regulator will deliver a mixture of air and oxygen in the quantity demanded by inhalation at the mask. The ratio of air to oxygen varies with the altitude and is automatically regulated by an aneroid assembly. As the altitude is increased, the quantity of air mixed with the oxygen is decreased. At any time that the diluter control lever is positioned at 100% OXYGEN, the regulator will deliver undiluted oxygen as demanded by inhalation.

**NOTE**

*When not in use, the diluter control lever should be left in the 100% OXYGEN position to prevent regulator contamination.*

(2) *Emergency Pressure Control Lever.* In the EMERGENCY position, the emergency pressure control lever, on the left side of the regulator, provides positive pressure at the regulator outlet at altitudes where positive pressure is not automatically provided. Movement of the lever to the TEST MASK position provides an outlet pressure for testing the mask.

(3) *Oxygen Pressure Gage.* The oxygen pressure gage is calibrated in PSI and is designed for use with a maximum inlet pressure of 2,000 PSI. When the oxygen cylinders are connected and the supply control lever is ON, oxygen at cylinder pressure is admitted to the regulator. The oxygen flows through the inlet valve and the pressure gage channel upstream of the pressure reducing chamber, thus indicating the actual pressure in the cylinders.

(4) *Flow Indicator.* The oxygen flow indicator incorporates a blinker plate that operates with each breath of the mask wearer, exposing a white segment in the window on the regulator panel.

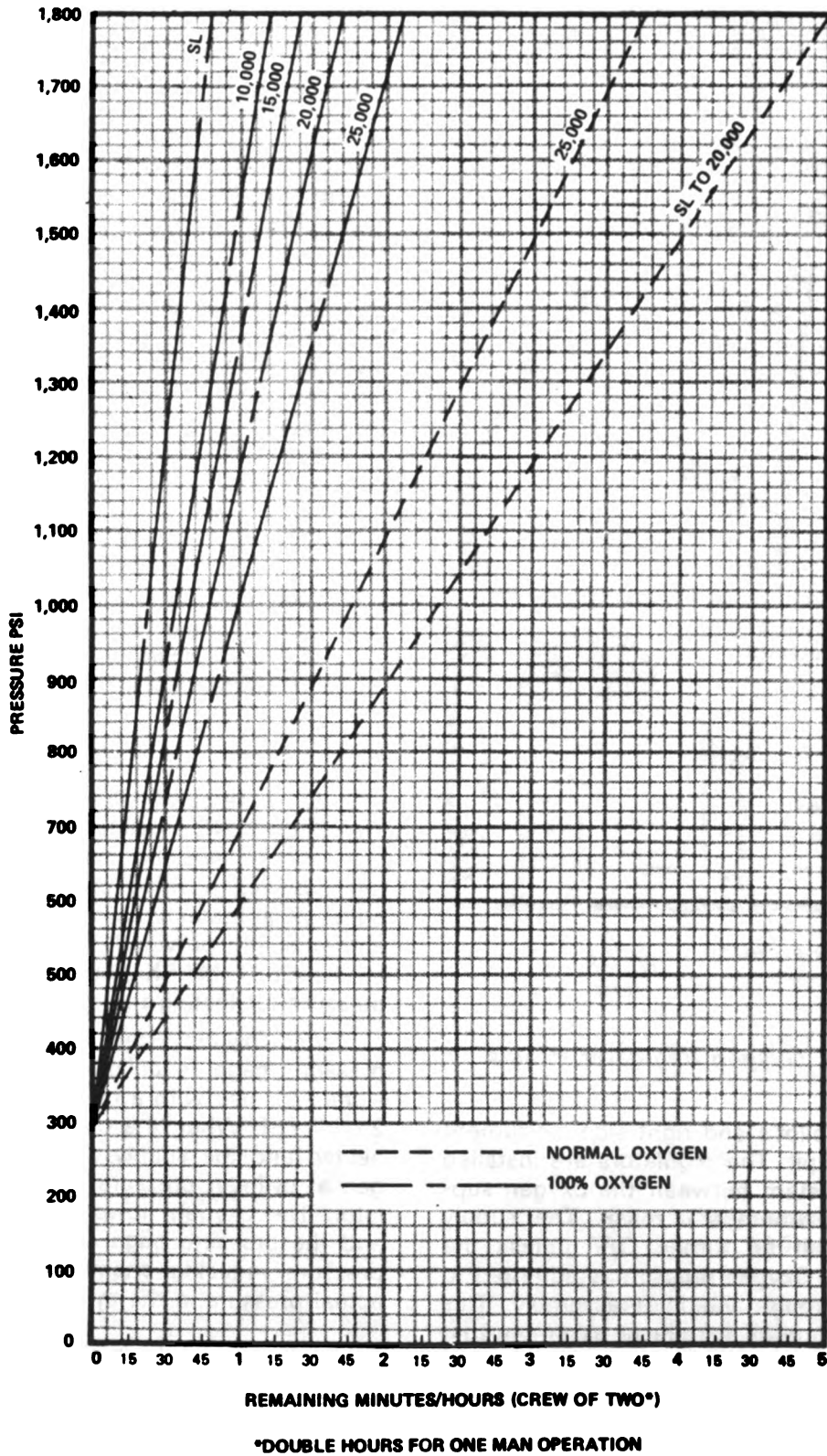

Figure 2-31. Oxygen Duration Chart

A-2-10-D-32

*c. Normal Operation.* Preflight check for the oxygen system is done during the before starting engines check in Chapter 8. Check and perform the following:

(1) Pressure — 800 PSI minimum to 1,850 PSI maximum.

(2) Connectors at mask. Proceed as follows:  
(a) CRU-60/P oxygen connector inner O-ring condition (no cuts, tears, etc).

(b) Oxygen connector to delivery hose gasket in position.

(c) CRU-60/P disconnect pressure between 12 to 20 pounds pull.

(d) Oxygen mask hose bayonet fitting locked into CRU-60/P connector.

(3) Regulator and aircraft plumbing. Check the NORMAL OXYGEN position and the 100% OXYGEN position of the diluter control lever as follows:

(a) Don mask; on Oxygen regulator panel (figure 2-30), set regulator SUPPLY to ON, diluter control lever to NORMAL OXYGEN, and emergency pressure control lever to NORMAL.

(b) Breathe normally; FLOW indicator on Oxygen regulator panel should not show a flow.

(c) Set emergency pressure control lever to EMERGENCY.

(d) Inhale and hold breath, FLOW indicator should not show a flow.

(e) Set diluter control lever to 100%, insure emergency pressure control lever is still in EMERGENCY, and hold breath; FLOW indicator should not show a flow.

(f) Set emergency pressure control lever to TEST MASK.

(g) Insure mask is overpressurized with diluter control lever set to NORMAL OXYGEN position and then to 100% OXYGEN position.

(4) If a flow is indicated in any step of paragraph (3) except TEST MASK, a leak exists in either the mask or the aircraft delivery plumbing; then proceed as follows:

(a) Remove the mask fitting from the aircraft hose and plug the aircraft hose.

(b) Repeat paragraph (3), steps (a) thru (e).

(c) If a flow is still indicated, there is a leak between the regulator and the hose mask fitting.

(d) Condition must be corrected before flight.

*d. Emergency Operation.* If any symptoms occur suggestive of the onset of anoxia, immediately set the emergency pressure control lever to the EMERGENCY position and descend below 10,000 feet. Whenever excessive carbon monoxide or other noxious gas is present or suspected, set the diluter control lever to 100% OXYGEN and continue breathing undiluted oxygen until the danger is past.

## 2-34. Miscellaneous Equipment.

### a. Windshield Wiper System.

(1) *Description.* The windshield wiper system is a hydraulic system that consists essentially of a speed control, a reversing valve, two window units, and an arm and blade assembly for each window. These units are interconnected by hydraulic tubing and supplied with hydraulic fluid from the aircraft hydraulic system. The speed control functions as a valve for starting and stopping the system and regulates the wiper blade speed by metering the rate of flow of hydraulic fluid to the reversing valve. The reversing valve alternately directs the flow of hydraulic fluid to opposite ends of the window units, directs the fluid discharged from the window units through the return line to the source, and locks the window units in the park position when the system is turned off. The window units convert the hydraulic energy, directed from the reversing valve, into rotary motion to drive the wiper blades. Each window unit contains a double-acting relief valve so that if the stroke of either wiper blade is limited for any reason, the impeded blade continues to operate within its limited scope while the other blade functions normally. The motion of both blades remains synchronized and continues in synchronization when the impeded blade is completely free. The arm and blade assemblies wipe an area conforming as closely as possible to the shape of the aircraft windshield. The blades are controlled from the cockpit by the windshield wiper speed control valve.

(2) *Control and Operation.* The windshield wiper control (figure 2-3) is on the upper portion of the pilot's instrument panel. This control turns the wipers on and off and also controls the speed of the wipers. When placing the control to the OFF position, it must be adjusted to position the blades to the inboard position. Do not use wipers on a dry windshield.

*b. Personnel Furnishings.* Personnel furnishings include relief tubes, map cases, and sunshades (figure 2-3). The sunshades can be moved forward or aft as desired. Personnel protection is afforded by removable thermal blankets (figure 2-32), in addition to a self-sealing main fuel tank and fuel lines, 1-inch bullet resistant laminated windshield, and provisions for installation of armor plating (figure 2-33). The cockpit floor is .25 and .50 inches aluminum armor plate.

*c. Drop Chute.* The drop chute is below the pilot's seat and is used for dropping messages. A hinged door, under the cockpit, opens when the drop chute control handle (figure 2-34) is pulled to its full travel (3.25 inches). When the control handle is released, the spring-loaded linkage to the door will close the door and retract the handle to its original position.

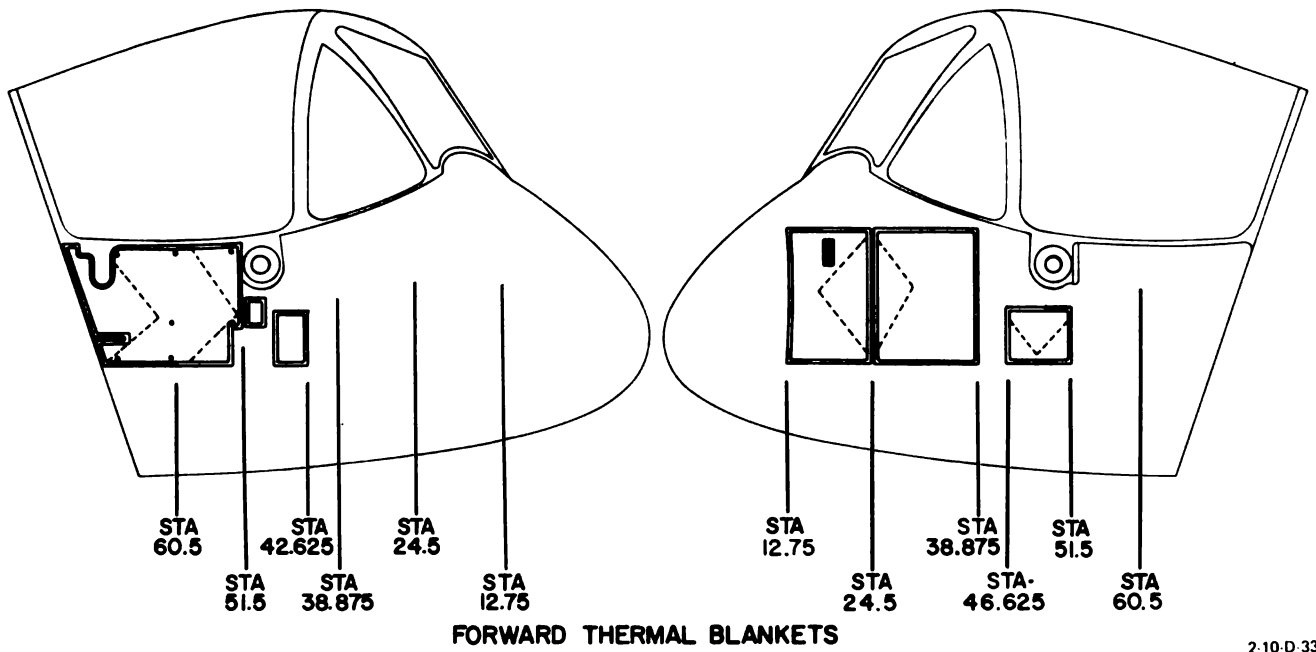

2-10-D-33

**Figure 2-32. Thermal Blankets**

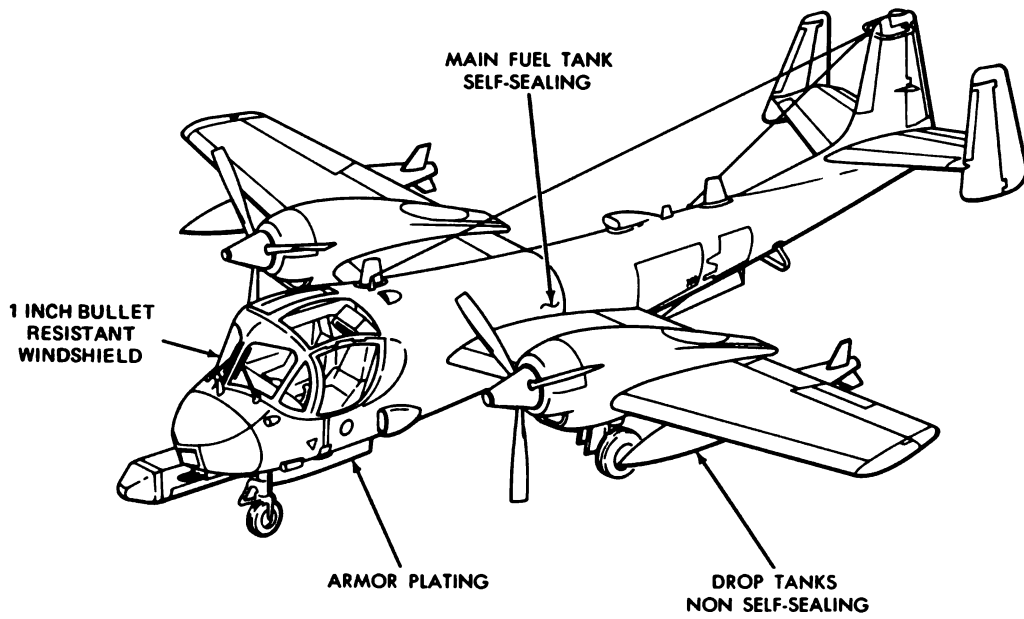

A 2-10-D-34

**Figure 2-33. Personnel Protection**



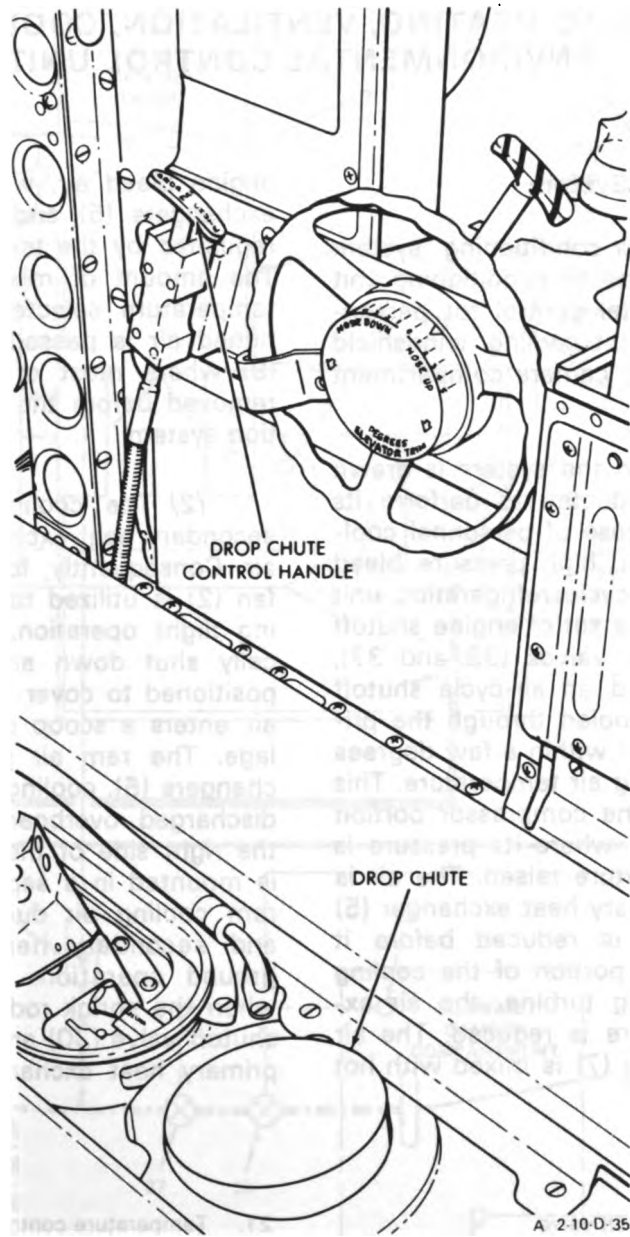

**Figure 2-34. Drop Chute**



## SECTION IX. HEATING, VENTILATION, COOLING, AND ENVIRONMENTAL CONTROL UNIT

### 2-35. Air-Conditioning System.

*a. Description.* The air-conditioning system consists of an air-cycle type air-conditioning unit that provides environmental control for personnel requirements, equipment cooling, windshield defogging, and if installed, camera compartment cooling and defogging.

(1) Bleed air used in the system is drawn from the engine and is ducted to perform its various functions. In the case of personnel cooling, the high temperature, high pressure bleed air is directed to the air-cycle refrigeration unit (4, figure 2-35) through a set of engine shutoff valves (1 and 31), check valves (33 and 37), venturis (32 and 38), and an air-cycle shutoff valve (34). It is initially cooled through the primary heat exchanger (5) to within a few degrees of the effective ram cooling air temperature. This air then passes through the compressor portion of the cooling turbine (7) where its pressure is increased and its temperature raised. The air is then ducted to the secondary heat exchanger (5) where the temperature is reduced before it passes on to the turbine portion of the cooling turbine (7). In the cooling turbine, the air expands and the temperature is reduced. The air leaving the cooling turbine (7) is mixed with hot

engine bleed air, which has bypassed the heat exchangers (5) and the cooling turbine, and is regulated by the temperature control valve (21). The amount of mixing is dependent upon the temperature selected by the pilot. This conditioned air is passed through a water separator (9) where most of the entrapped moisture is removed before the air passes into the distribution system.

(2) The cooling air for the primary and secondary heat exchanger (5) is obtained by ram air. Consequently, for ground operation, a turbo fan (2) is utilized to supply forced cooling. During flight operation, the turbo fan is automatically shut down and the ram air door (3) is positioned to cover the turbo fan outlet and ram air enters a scoop on the left side of the fuselage. The ram air passes across the heat exchangers (5), cooling the engine bleed air, and is discharged overboard through guide vanes on the right side of the fuselage. The turbo fan (2) is mounted in a separate duct and ties into the ram cooling air duct upstream of the primary and secondary heat exchangers (5). During ground operation, the turbo fan is actuated when the shrink rod switch opens the turbo fan shutoff valve (30) and permits bleed air from the primary heat exchanger to drive the turbo fan.

#### Legend for fig. 2-35

- |   |   |
|---|---|
| 1. Right engine bleed air shutoff valve         | 21. Temperature control valve                     |
| 2. Turbo Fan                                    | 22. High temperature limit switch                 |
| 3. Ram air door                                 | 23. Temperature sensor                            |
| 4. Air-cycle refrigeration unit                 | 24. Temperature sensor                            |
| 5. Primary and secondary heat exchangers        | 25. Modulating valve                              |
| 6. Compressor maximum temperature switch        | 26. Modulating valve                              |
| 7. Cooling turbine and compressor               | 27. Bleed air shutoff valve                       |
| 8. Anti-icing valve                             | 28. Camera bleed venturi                          |
| 9. Water separator                              | 29. Bleed air check valve                         |
| 10. Defog modulating valve                      | 30. Turbo fan shutoff valve                       |
| 11. Top and side defog outlet                   | 31. Left engine bleed air shutoff valve           |
| 12. Upper air-conditioning outlets              | 32. Left engine bleed air venturi                 |
| 13. Windshield and quarter panel defog outlets  | 33. Left engine high temperature air check valve  |
| 14. Lower air-conditioning outlets              | 34. Air-cycle main shutoff valve                  |
| 15. Temperature selector                        | 35. Camera bleed air duct shutoff valve           |
| 16. Temperature controller                      | 36. Bleed air maximum temperature switch          |
| 17. 300°F Duct temperature maximum limit switch | 37. Right engine high temperature air check valve |
| 18. 245°F Duct temperature limit switch         | 38. Right engine bleed air venturi                |
| 19. Duct temperature sensor                     | 39. Compartment defog outlets                     |
| 20. Camera compartment temperature controller   |   |

**Figure 2-35. Air-Conditioning System Schematic (Sheet 1 of 2)**

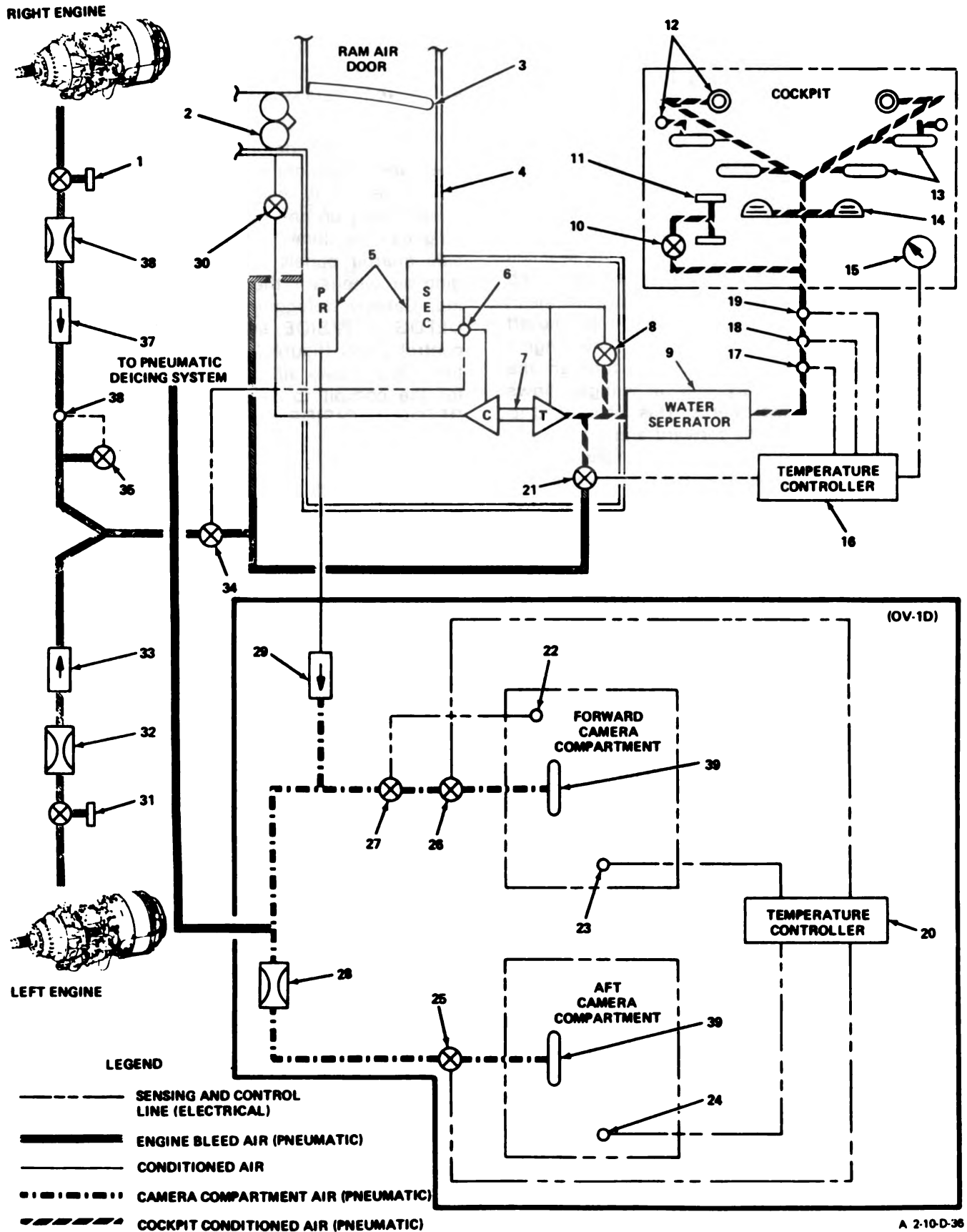

A 2-10-D-36

Ambient cooling air is forced across the heat exchangers (5) and then overboard through the guide vanes. The positive fan pressure opens the ram air door (3), permitting the cooling air to enter the ram air duct and closes off the ram air inlet preventing loss of turbo fan flow.

(3) On OV-1D aircraft, air used for camera compartment heating is engine bleed air that is taken from either the engine bleed line or from the primary heat exchanger (5). Whenever the engine bleed air is below 205°C, air is taken from the engine bleed air duct for heating of the camera compartments. When the engine bleed air reaches 205°C, the camera bleed air shutoff valve (35) is driven closed. At this time, engine bleed air, which has been cooled through the first pass of the primary heat exchanger, flows to the camera compartments. This air is used to heat and defog both the forward and aft camera compartments. Conditioning of the forward and aft camera compartment is fully automatic and requires no control by the pilot. There is, however, a FWD CAMR HEAT switch on the left overhead panel that the pilot can use to shut off the supply of hot air to the forward camera compartment. Hot air at temperatures up to 205°C is routed to the forward camera compartment through ducting that runs along the cockpit floor outboard of the pilot's position. In the event of a rupture in this ducting, the pilot can shut off the supply of hot air to the forward camera compartment by placing the FWD CAMR HEAT switch in the OFF position, and need not shut off the air-conditioning system.

(4) On OV-1D aircraft, air used to heat and defog the forward camera compartment is automatically controlled to approximately 32°C. When the ambient temperature is above this value, a modulating valve (26) closes and the compartment will assume approximately ambient temperature. If the temperature of the forward camera compartment goes above approximately 55°C, a shutoff valve (27) closes to protect the camera and equipment from overheat due to a system failure. During normal operation, any change in temperature in the compartment is sensed by a temperature sensor (23), which controls the modulating valve that opens or closes to correct the temperature.

(5) On OV-1D aircraft, air used to heat and defog the aft camera compartment is also automatically controlled to approximately 32°C. When the ambient temperature goes above this value, a modulating valve (25) closes and the

compartment will assume approximately ambient temperature. During normal operation, any change in temperature is sensed by a temperature sensor (24), that controls the modulating valve that opens or closes to correct the temperature.

(6) Air for defogging is the same air as used for conditioning the cockpit temperature. Therefore, it is necessary to have the air-conditioning on and operating before any defogging can be done. The forward windshield and side quarter panels continuously receive defogging air whenever the system is on and operating. Canopy defogging is done by placing the DEFOG TOP/SIDE switch on the AIR COND control panel (figure 2-36) to the NORM position. This allows air at the temperature selected for the cockpit to defog the canopy. When the DEFOG TOP/SIDE switch is placed in the MAX position, the temperature control valve (21, figure 2-35) is driven open to allow air at 121°C to defog the canopy. The upper, lower, and foot air-conditioning outlets should be closed before the selection of MAX defog to prevent the direction of 121°C air onto the crew.

*b. Air-Conditioning Controls.* The air-conditioning controls are on the AIR COND control panel (figure 2-36).

(1) *Left and Right System Air Supply Switches.* The L and R SYS AIR SUPPLY switches are two-position toggle switches with OPEN and CLOSED positions. In the OPEN position, the applicable engine bleed air shutoff valve is opened, permitting the flow of engine bleed air from that engine, to the air-conditioning system. The system can operate on one engine if it becomes necessary to close either the L or R SYS AIR SUPPLY switch.

#### NOTE

*The engine bleed air extracted for operation of the air-conditioning system is also used to supply pressurization to the hydraulic reservoir, windshield wash and anti-ice tank, and pneumatic deicer boots. Closing both SYS AIR SUPPLY switches will cause the loss of bleed air for these systems.*

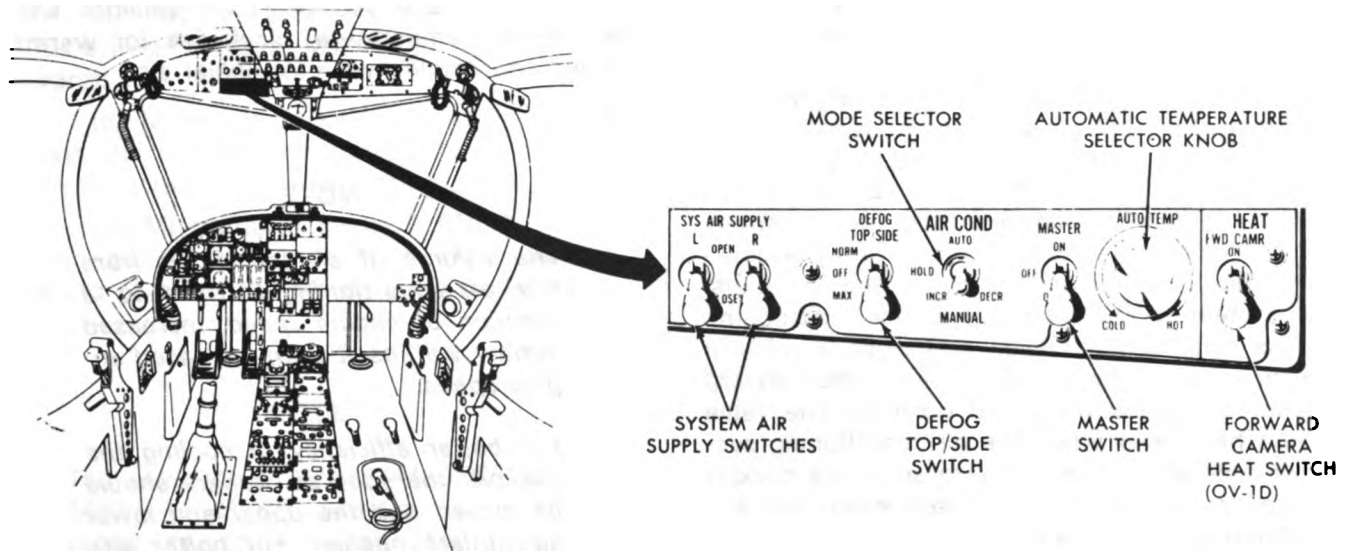

A 2 10 D 37

**Figure 2-36. Air-Conditioning Control Panel**

(2) *Defog Top/Side Switch.* The DEFOG TOP/SIDE switch is a three-position toggle switch with NORM, OFF, and MAX positions. With the air-conditioning system on and operating, placing the switch in the NORM position permits the flow of air to the defogging nozzles at the same temperature selected for the cockpit. In the OFF position, the flow of air to the defogging nozzles is stopped. With the air-conditioning system on and operating, placing the switch in the MAX position permits the flow of air to the defogging nozzles at a temperature of up to 121°C regardless of the temperature selected for the cockpit.

(3) *Air-Conditioning Mode Selector Switch.* The air-conditioning mode selector switch is a four-position switch with AUTO, HOLD, MANUAL INCR, and MANUAL DECR positions, which is used to select the mode of operation (automatic or manual) of the air-conditioning system. Placing the switch in the AUTO position permits automatic operation of the air-conditioning system, with the temperature selected by the AUTO TEMP control knob, being maintained. With the switch in the HOLD position, the temperature of the air entering the cockpit will not change from the value selected while in the automatic mode. The MANUAL INCR and MANUAL DECR positions may be selected for manual control of the temperature of the air entering the cockpit. Placing the switch in the MANUAL INCR position permits

manual selection of increased temperature, and placing it in the MANUAL DECR position permits manual selection of decreased temperature. When selecting either MANUAL INCR or MANUAL DECR, the switch is spring-loaded to the HOLD position.

(4) *Air-Conditioning Master Switch.* The air-conditioning MASTER switch is a three-position toggle switch with ON, OFF, and OVRD positions. The system will automatically shut down if either propeller feathers. Placing the MASTER switch in the OVRD position will override this feature and turn the system on again. Since the air-conditioning system shall be turned off before takeoff, the OVRD position of the master switch should never be used, except when operating on the ground with propellers feathered, or when airborne, and it has been determined that engine limitations will not be exceeded.

(5) *Automatic Temperature Selector Knob.* The AUTO TEMP selector knob is used to select the desired temperature when operating the system in the automatic mode. When operating in the manual mode, this knob has no function in system operation. When the system is operated in the automatic mode, rotating the AUTO TEMP selector knob clockwise will increase the temperature selected, and rotating the knob counterclockwise will decrease the temperature selected.

*c. Auxiliary Cooling Control.* The auxiliary cooling provisions consist of an auxiliary ram air system. The auxiliary ram air system is installed and intended to be used in the event of a malfunction of the air-conditioning system. Two auxiliary ram air scoops are installed, one on either side of the nose of the aircraft. When the auxiliary ram air system is in use, ram air enters the auxiliary ram air scoops and enters the cockpit through the lower air-conditioning outlets. The system is controlled by an air-conditioning bypass lever used to open and close a valve in the air-conditioning ducts outboard and forward of the pilot's and right seat position. The valve should be closed when the air-conditioning system is operating. Auxiliary ram air to the cockpit for cooling should only be used when the air-conditioning system is off.

*d. Normal Operation of Air-Conditioning System.*

*(1) Automatic Mode of Operation.* For normal operation of the air-conditioning system in the automatic mode, proceed as follows:

(a) Set the controls on the AIR COND control panel (figure 2-36) as follows:

- 1 L and R SYS AIR SUPPLY switches - OPEN.
- 2 DEFOG TOP/SIDE switch - OFF.
- 3 Air-conditioning mode selector switch - AUTO.
- 4 Air-conditioning MASTER switch - ON.

**NOTE**

*With either propeller feathered, the air-conditioning MASTER switch must be placed in the OVRD position.*

5 AUTO TEMP selector knob - Middle position.

(b) Position pilot's and right side air-conditioning bypass levers to AIR COND (forward).

(c) Rotate AUTO TEMP selector knob for desired temperature, clockwise for warmer air and counterclockwise for cooler air.

**NOTE**

*The volume of air that flows from the air-conditioning outlets is a function of engine speed. Increased airflow will result from increased engine speed.*

*For better efficiency in cooling the cockpit, the foot air outlets should be closed and the upper and lower air outlets opened. For better efficiency in heating the cockpit, the upper and lower air outlets should be closed and the foot air outlets opened.*

*With the air-conditioning operating, fog may accumulate in the cockpit. When descending, condensation may also form on the interior surfaces. This is a normal condition and should be no cause for alarm. If this situation should become excessive, the pilot can select a warmer temperature and close the upper, lower, and foot air outlets, forcing the air onto the windshield.*

(d) To shut off the air-conditioning system, place the air-conditioning MASTER switch to the OFF position.

*(2) Manual Mode of Operation.* For normal operation of the air-conditioning system in the manual mode, proceed as follows:

(a) Set the controls on the AIR COND control panel (figure 2-36) as follows:

- 1 L and R SYS AIR SUPPLY switches - OPEN.
- 2 DEFOG TOP/SIDE switch - OFF.
- 3 Air-conditioning mode selector switch - HOLD.
- 4 Air-conditioning MASTER switch - ON.

(b) Position pilot's and right side air-conditioning bypass levers to AIR COND (forward).

(c) Momentarily select MANUAL INCR position on the air-conditioning mode selector switch to increase the temperature of the air.

(d) Momentarily select MANUAL DECR position on the air-conditioning mode selector switch to decrease the temperature of the air.

#### NOTE

*The selection of MANUAL INCR or MANUAL DECR position on the mode selector switch should be short duration pulses of less than 1 second at a time. The period between these pulses should be sufficient to allow duct temperature stabilization.*

(e) To shut off the air-conditioning system, place the air-conditioning MASTER switch to the OFF position.

#### e. Normal Operation of Defogging System.

(1) *Normal Mode of Operation.* For operation of the defogging system, proceed as follows:

(a) Set the controls on the AIR COND control panel (figure 2-36) as follows:

1 L and R SYS AIR SUPPLY switches - OPEN.

2 DEFOG TOP/SIDE switch - OFF.

3 Air-conditioning mode selector switch - AUTO.

4 Air-conditioning MASTER switch - ON.

5 AUTO TEMP selector knob - Middle position.

(b) Position pilot's and right side air-conditioning bypass levers to AIR COND (forward).

(c) Place DEFOG TOP/SIDE switch to the NORM position. Air will start to flow from the defogging nozzles at the same temperature as selected by the AUTO TEMP selector knob.

(d) To increase or decrease the temperature of the air flowing from the defogging nozzles, rotate the AUTO TEMP selector knob or momentarily place the air-conditioning mode selector switch to the MANUAL INCR or MANUAL DECR position.

(e) To shut down the defogging system, place the DEFOG TOP/SIDE switch and air-conditioning MASTER switch to the OFF position. The air-conditioning MASTER switch may be left ON if desired to keep the air-conditioning system operating.

(2) *Maximum Mode of Operation.* For maximum operation of the defogging system, proceed as follows:

(a) Set the controls on the AIR COND control panel (figure 2-36) as follows:

1 L and R SYS AIR SUPPLY switches - OPEN.

2 DEFOG TOP/SIDE switch - OFF.

3 Air-conditioning mode selector switch - HOLD.

4 Air-conditioning MASTER switch - ON.

5 AUTO TEMP selector knob - Any position.

(b) Position pilot's and right side air-conditioning bypass levers to AIR COND (forward).

(c) Close upper, lower, and foot air-conditioning outlets.

(d) Place DEFOG TOP/SIDE switch to the MAX position. Hot air at up to 121°C will flow from the defogging nozzles, regardless of the temperature selected for the cockpit.

#### NOTE

*Failure to close the upper, lower, and foot air-conditioning outlets will permit this hot air to be directed to the crew positions.*

(e) To shut the system down, place the DEFOG TOP/SIDE switch and the air-conditioning MASTER switch to the OFF position. The air-conditioning MASTER switch may

be left ON if desired to keep the air-conditioning system operating. The temperature of the air will automatically change until it is equal to the temperature selected on the AUTO TEMP selector knob. This change in temperature will require approximately 3 minutes.

*f. Emergency Operation.* In the event of a failure while operating the air-conditioning sys-

tem in the automatic mode, proceed as follows:

(1) Place air-conditioning mode selector switch in the HOLD position.

(2) Momentarily position the air-conditioning mode selector switch to MANUAL INCR or MANUAL DECR to adjust the temperature.

## SECTION X. ELECTRICAL POWER SUPPLY AND DISTRIBUTION SYSTEM

### 2-36. Description.

The electrical power supply and distribution system is composed of a DC power supply system, an external DC power receptacle, a constant voltage supply (CVS) system, an AC power supply system, and circuit breaker panels.

(1) *Description.* The sources of DC power (figure 2-37) for the aircraft are two 400-ampere engine-driven starter-generators and a 24 VDC 34-ampere-hour nickel-cadmium aircraft battery. The starter-generators function as electric starters, and when the engines are up to speed, each starter-generator then acts as an electrical generator, providing 28 VDC power to the distribution buses on the aircraft; namely, primary, secondary, monitored, nonessential, instrument power panel, CVS, armament, and emergency bus groups. (Circuit breakers associated with each DC bus group are shown in figure 2-38). The emergency bus is normally powered from the primary bus, however, if all other aircraft DC power is lost, the emergency bus will continue to operate using the CVS battery as a source of power, with the BATTERY switch in the EMERGENCY position. If both generators should fail in flight (as indicated by the #1 and #2 GEN caution lights and the left and right ammeter), the secondary, monitored, armament, and nonessential buses are disconnected, and battery power is applied to the primary and emergency busses, and instrument power panel only (with the battery switch in the NORMAL position). When the landing gear handle is placed in the DOWN position, however, battery power is also applied to the secondary

bus. Battery power can be applied to the secondary bus with the landing gear handle in the UP position by placing the BATTERY switch to the EMERGENCY position. In the event of simultaneous failure of both generators and the battery, placing the BATTERY switch in the EMERGENCY position will connect the CVS battery directly to the emergency bus. All other buses are disconnected. If a single generator fails, the primary, secondary, armament, emergency, and monitored buses, and instrument power panel will remain powered by the operating generator. The nonessential bus is only powered when both generators are operating or when external power is connected to the aircraft. With external power connected to the aircraft, all buses except the armament bus are energized. The armament bus is energized from the secondary bus (with the ARMT PWR switch ON) when the landing gear handle is in the UP position.

### (2) Controls and Indicators.

(a) *Battery Switch.* The BATTERY switch is a three-position lever-lock switch (figure 2-25) on the left overhead panel. With the switch in the NORMAL position, the engines running, and both generator switches ON, generator power is used to supply all DC equipment through the respective DC distribution buses. With the primary bus powered and the BATTERY switch in the NORMAL position, a positive charge is maintained on the battery. Should both generators fail in flight (landing gear handle UP) with the BATTERY switch in the NORMAL

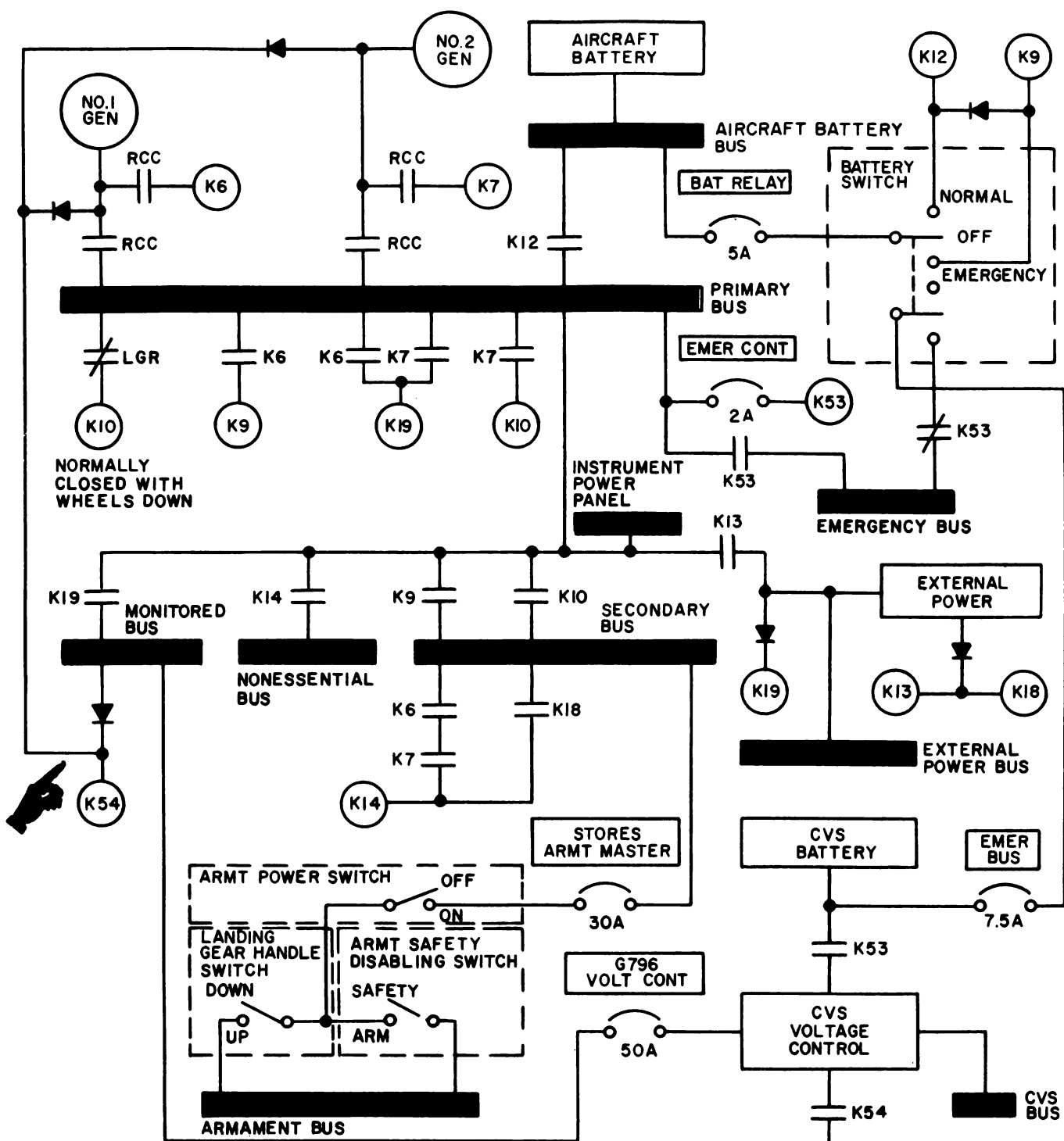

**LEGEND**

K6 BUS CONTROL RELAY NO.1	K18 EXTERNAL POWER RELAY NO.2
K7 BUS CONTROL RELAY NO.2	K19 MONITORED BUS RELAY
K9 SECONDARY BUS RELAY NO.1	K53 EMERGENCY CONTROL RELAY
K10 SECONDARY BUS RELAY NO.2	K54 CVS CONTROL RELAY
K12 BATTERY RELAY	RCC REVERSE CURRENT CUTOUT RELAY
K13 EXTERNAL POWER RELAY NO.1	LGRL LANDING GEAR HANDLE RELAY
K14 NONESSENTIAL BUS RELAY	

OPEN RELAY CONTACT  
 CLOSED RELAY CONTACT  
 RELAY COIL  
 BLOCKING DIODE

Figure 2-37. DC Electrical System Schematic (Typical)

B-2-10-D-38



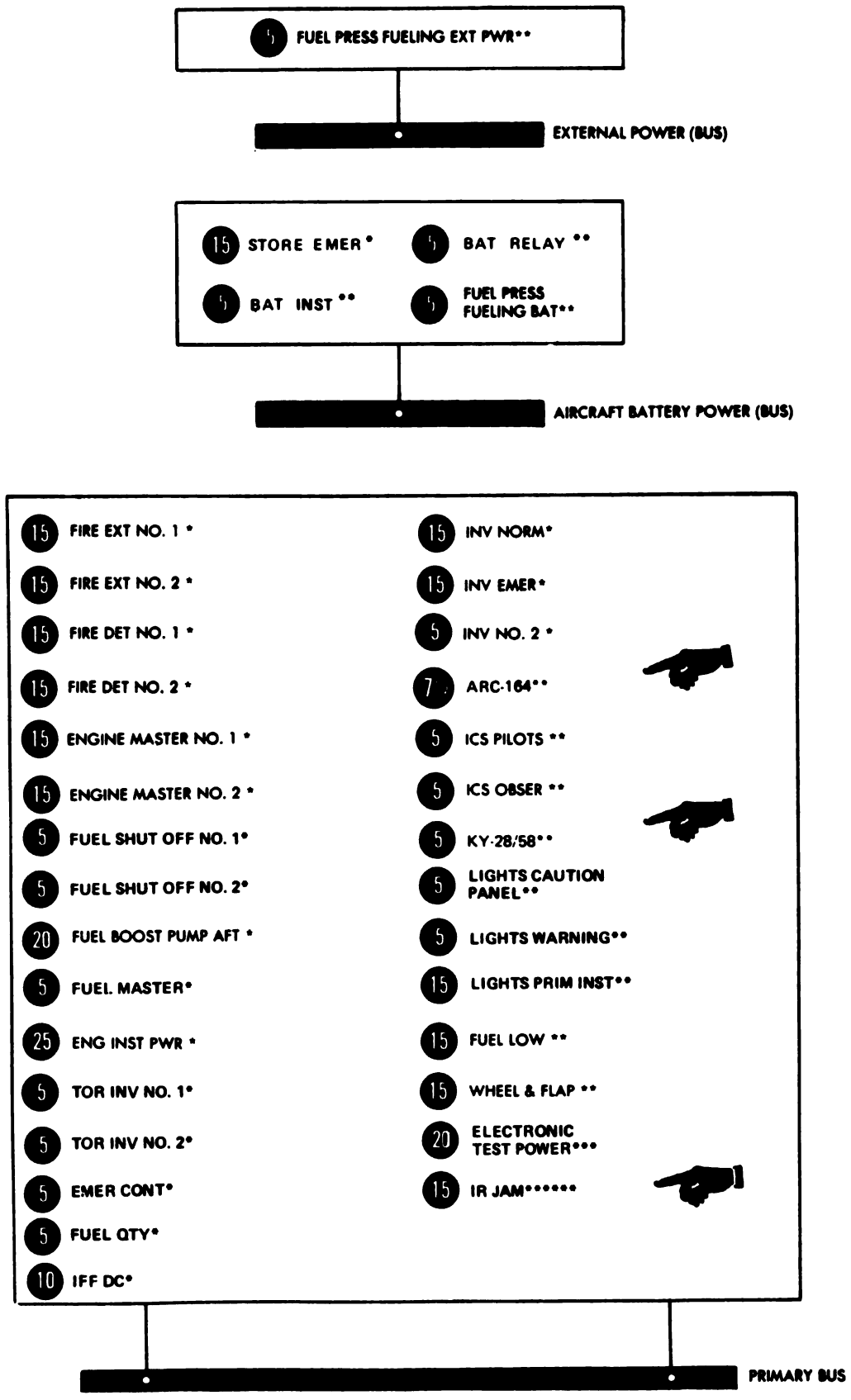

E-2-10-D-38-1

Figure 2-38. DC Electrical System Circuit Breaker Schematic (Typical) (Sheet 1 of 4)

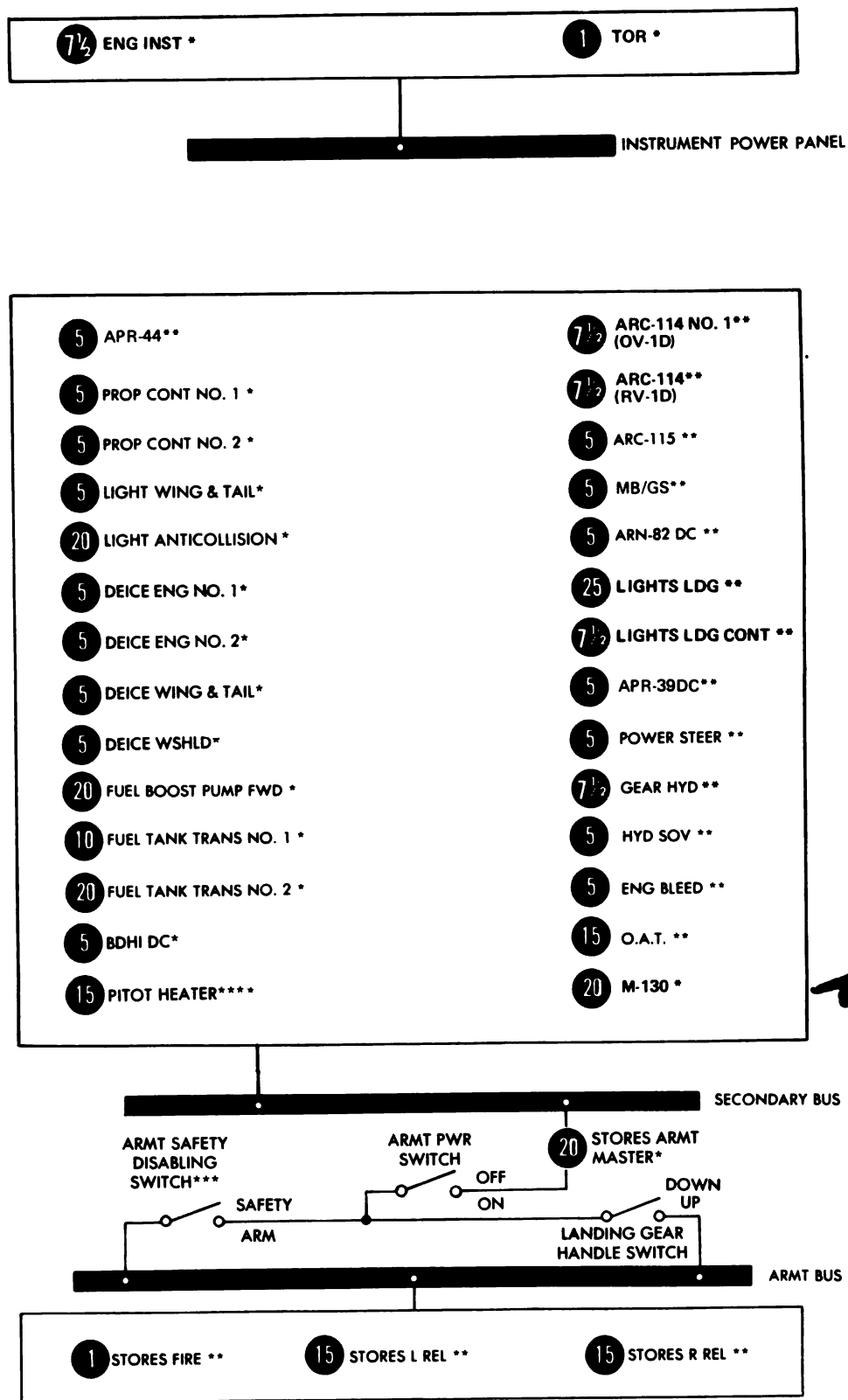

G-2-10-D-39-2

Figure 2-38. DC Electrical System Circuit Breaker Schematic (Typical) (Sheet 2 of 4)

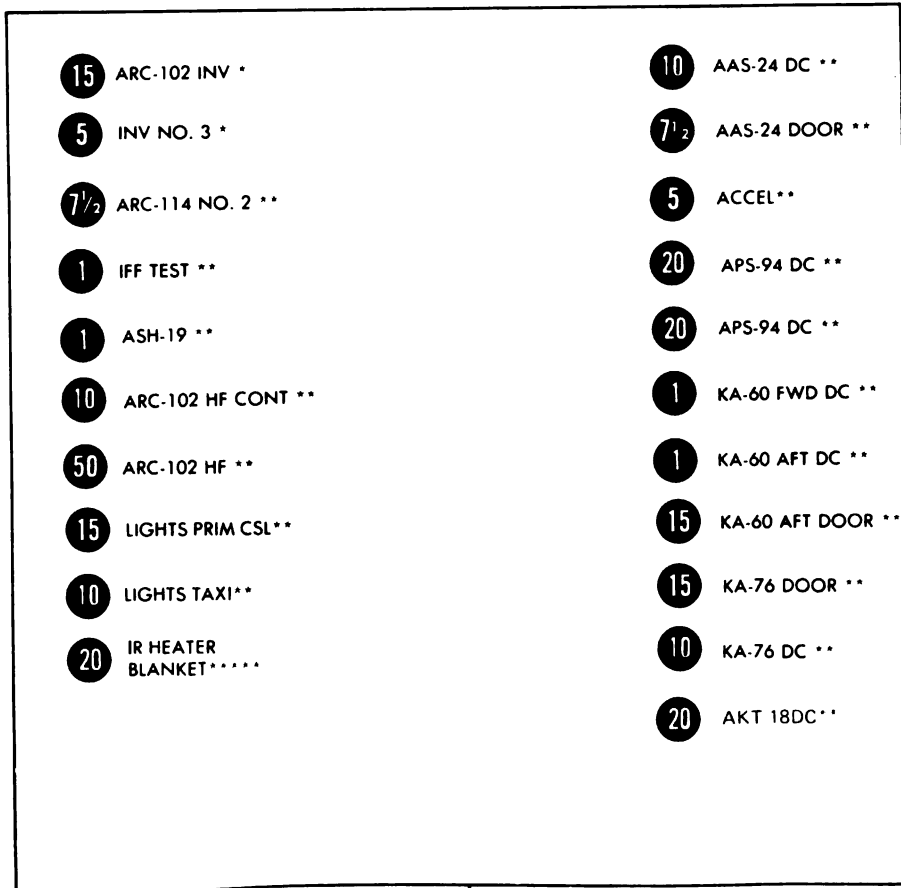
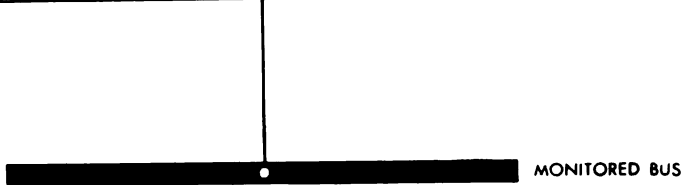
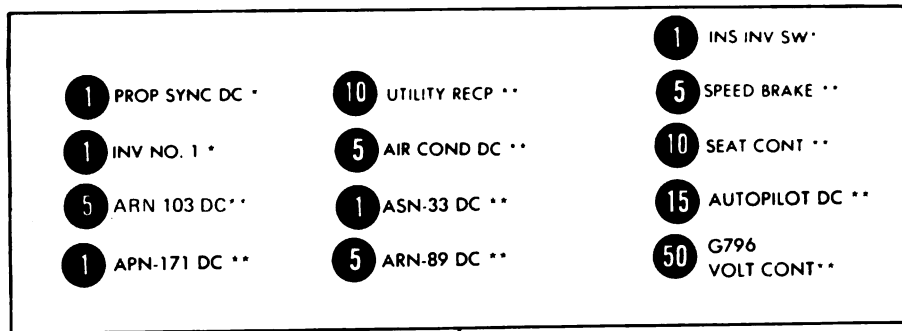

E 2 10 D-39 3

Figure 2-38. DC Electrical System Circuit Breaker Schematic (Typical) (Sheet 3 of 4)

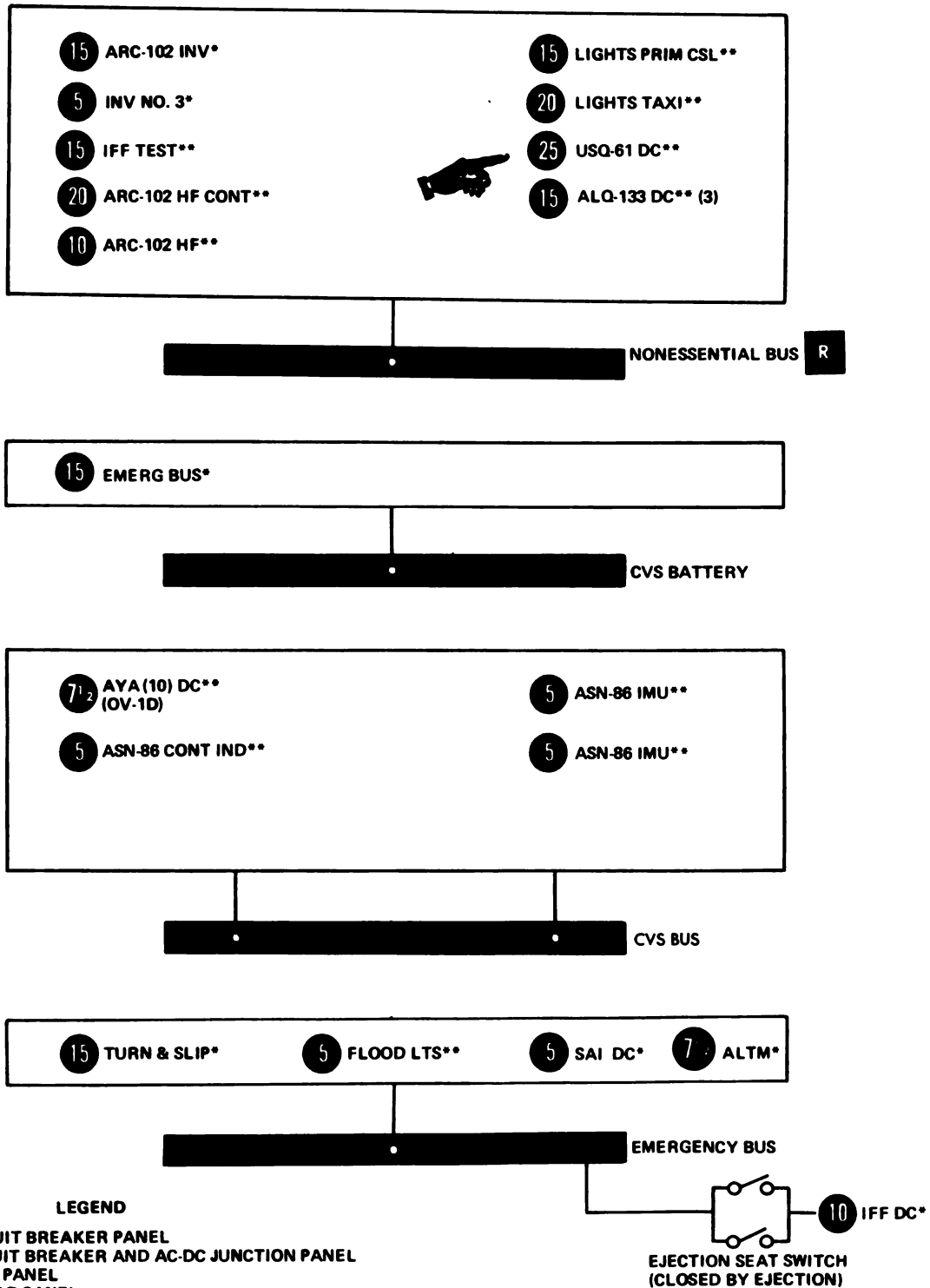

LEGEND

- \*COCKPIT CIRCUIT BREAKER PANEL
- \*\*REMOTE CIRCUIT BREAKER AND AC-DC JUNCTION PANEL
- \*\*\*AFT JUNCTION PANEL
- \*\*\*\*LEFT OVERHEAD PANEL
- \*\*\*\*\*IR HEATER PANEL (OV-1D)
- \*\*\*\*\*SLOPING CONSOLE CIRCUIT BREAKER PANEL

EJECTION SEAT SWITCH  
(CLOSED BY EJECTION)

Figure 2-38. DC Electrical System Circuit Breaker Schematic (Typical) (Sheet 4 of 4)

position, the battery assumes the load on the primary and emergency buses and instrument power panel only. If the landing gear handle is in the DOWN position, or the BATTERY switch is set to the EMERGENCY position, the battery will also assume the load on the secondary bus. If both generators and the battery should fail, setting the BATTERY switch to the EMERGENCY position connects the CVS battery directly to the emergency bus. This maintains operation of the DC powered standby attitude indicator (SAI), turn and slip indicator, IFF switches on the ejection seats (when ejected), essential cockpit lighting (flood and utility), and altimeter encoder vibrator for 2 to 4 hours. Regardless of battery switch position, battery power is applied to the battery bus which supplies power to the drop tank emergency jettison and pressure fueling circuits.

*(b) Generator Switches.* The left and right generator switches, GEN No. 1 and GEN No. 2 (figure 2-25), are three-position toggle switches with ON, OFF, and RESET positions. When placed in the ON position, the switch connects the generator to the primary bus. In the event of a malfunction indication, the applicable GEN switch shall be placed to the RESET position, then to the ON position in an attempt to correct the malfunction. If the generator continues to malfunction (as indicated by the #1 GEN or #2 GEN caution light), the switch shall be placed in the OFF position.

*(c) Volts DC Display.* The DC voltage on the primary bus is displayed on a single column of the VIDS display unit mounted on the pilot's instrument panel (figure 2-7). Refer to paragraph 2-19 for instructions to adjust and test VIDS lighting. See figure 5-1 for instrument markings.

*(d) Amperes (AMPS) Display.* DC current drain from the starter-generators is displayed on two columns of the VIDS display unit mounted on the pilot's instrument panel (figure 2-7). The VIDS for AMPS is augmented by a single selectable three-digit digital display graduated to units of 1 ampere. The AMPS toggle switch on the VIDS may be set to left (L), center (for sum of left and right), and right (R) to select the information to be presented in the AMPS digital display. Refer to paragraph 2-19 for instructions to adjust and test VIDS lighting. See figure 5-1 for instrument markings.

*(e) Generator Caution Lights.* The #1 and #2 GEN caution lights, on the caution annunciator panel (figure 2-10), illuminate to indicate the disconnection of a generator from the primary bus. The MASTER CAUTION light will illuminate simultaneously with one or both of these lights.

*(f) Deleted*

*b. External DC Power Receptacle.* The EXTERNAL POWER receptacle (figure 2-2) is installed on the left side of the aft equipment compartment. This receptacle is accessible through a spring-loaded access plate on the aft equipment compartment access door. It is used to connect a 28 VDC external power source to energize all DC buses in the aircraft.

*c. Constant Voltage Supply (CVS) System.*

*(1) Description.* The CVS system contains a 24 VDC 7-ampere-hour nickel-cadmium battery, voltage controller, cockpit status indicator, and associated circuit breakers. When primary bus power is lost, the CVS system provides a source of 24 VDC (nominal) power directly from the CVS battery, through the BATTERY switch (EMERGENCY position), to the emergency bus to operate the DC powered standby attitude indicator (SAI), turn and slip indicator, IFF switches on the ejection seats (when ejected), essential cockpit lighting, and altimeter encoder vibrator. During normal operation, the CVS system provides 24 VDC automatically for short durations to the CVS bus to operate the airborne data annotation system (ADAS) (if installed) and inertial navigation system (INS), when DC voltage fluctuations are experienced from the monitor bus (with CVS cockpit status indicator activated and green G796 ON light illuminated), allowing continued noninterrupted operation of these systems. When monitor bus voltage returns to normal, it will again supply the power to operate the ADAS (if installed) and INS.

**NOTE**

*The CVS system does not provide continuous constant power output for operation of the ADAS and INS.*

The input voltage to the CVS voltage controller is interlocked with the aircraft inverter switching circuit. The INVERTER switch on the left overhead panel must be in either the NORMAL or EMERGENCY position for proper operation of the CVS system. If the CVS voltage controller is activated and the INVERTER switch is in the OFF position, the CVS battery will continuously supply power to the CVS bus even though the monitor bus is within limits. To charge the CVS battery using the aircraft's DC system, the INVERTER switch must be in either the NORMAL or EMERGENCY position.

(2) *CVS Cockpit Status Indicator.* The CVS cockpit status indicator, on the center instrument panel (figure 2-9), is an on/off pushbutton switch that displays four modes of CVS system operation. Operating 28 VDC is supplied to the indicator from the monitored bus. The four modes of system operation displayed by the indicator are G796 ON, G796 OFF, BATT, and NO GO.

(a) The green G796 ON indicator window of the CVS cockpit status indicator illuminates when the pushbutton is pressed and aircraft 28 VDC is present to the CVS voltage controller. The G796 ON indicator window illuminates only when the voltage controller is energized by the presence of 28 VDC from the monitored bus.

(b) The amber G796 OFF indicator window illuminates when the pushbutton switch has been pressed following CVS system operation, indicating no input power is being supplied to the voltage controller.

#### NOTE

*Both the NO GO and BATT indicator windows will also illuminate when the voltage controller has been deactivated by pressing the switch.*

(c) The amber BATT indicator window illuminates when the voltage controller senses monitored DC bus voltages below 24 VDC or above 30 VDC, indicating that the CVS battery is now supplying power to the CVS bus and that the CVS battery is below 24 VDC and discharging.

(d) The amber NO GO indicator window illuminates and remains on when the voltage controller fails to pass its automatic initialization check, and when an initial overvoltage condition is experienced.

#### NOTE

*Ignore the NO GO indicator if the light is illuminated for less than 5 seconds.*

#### d. AC Power Supply System.

(1) *Description.* The AC power supply system (figure 2-39) incorporates three inverters to supply 115-volt, three-phase, 400 Hz, AC power. The No. 1 inverter has an output rating of 2,500 VA and normally supplies power to the No. 1 and No. 2 inverter load buses. The No. 2 inverter has an output rating of 750 VA and is used to power the No. 2 inverter load bus in the event of a failure of the No. 1 inverter. During normal operation, with the No. 1 inverter output supplying the No. 1 and No. 2 load buses, the No. 2 inverter is operating, but it is disconnected from its load bus. The No. 3 inverter has an output rating of 5,000 VA and normally supplies the AC power necessary for operation of the inertial navigation system, ELINT or camera systems, and SLAR or IR systems, whichever is installed. In the event of a failure of the No. 3 inverter, the No. 1 inverter will automatically assume the load to supply the power necessary for operation of the inertial navigation system, in addition to its own load. Power for operation of the ELINT or camera systems and SLAR/IR system will, however, be lost. (Circuit breakers associated with each AC bus group are shown in figure 2-40). The No. 1, No. 2, and No. 3 inverters receive their driving voltage from the primary bus. However, the on-off function for each inverter is controlled by an inverter control relay. The No. 1 inverter control relay is energized by power from the monitored bus and the No. 2 inverter control relay is energized by power from the primary bus. The No. 3 inverter control relay is energized from the nonessential bus. The No. 1 and No. 2 inverter can be operated with either or both generators operating, however the No. 3 inverter will not operate if either generator fails. Inverter operation is controlled by the INVERTER switch on the left overhead panel (figure 2-25).

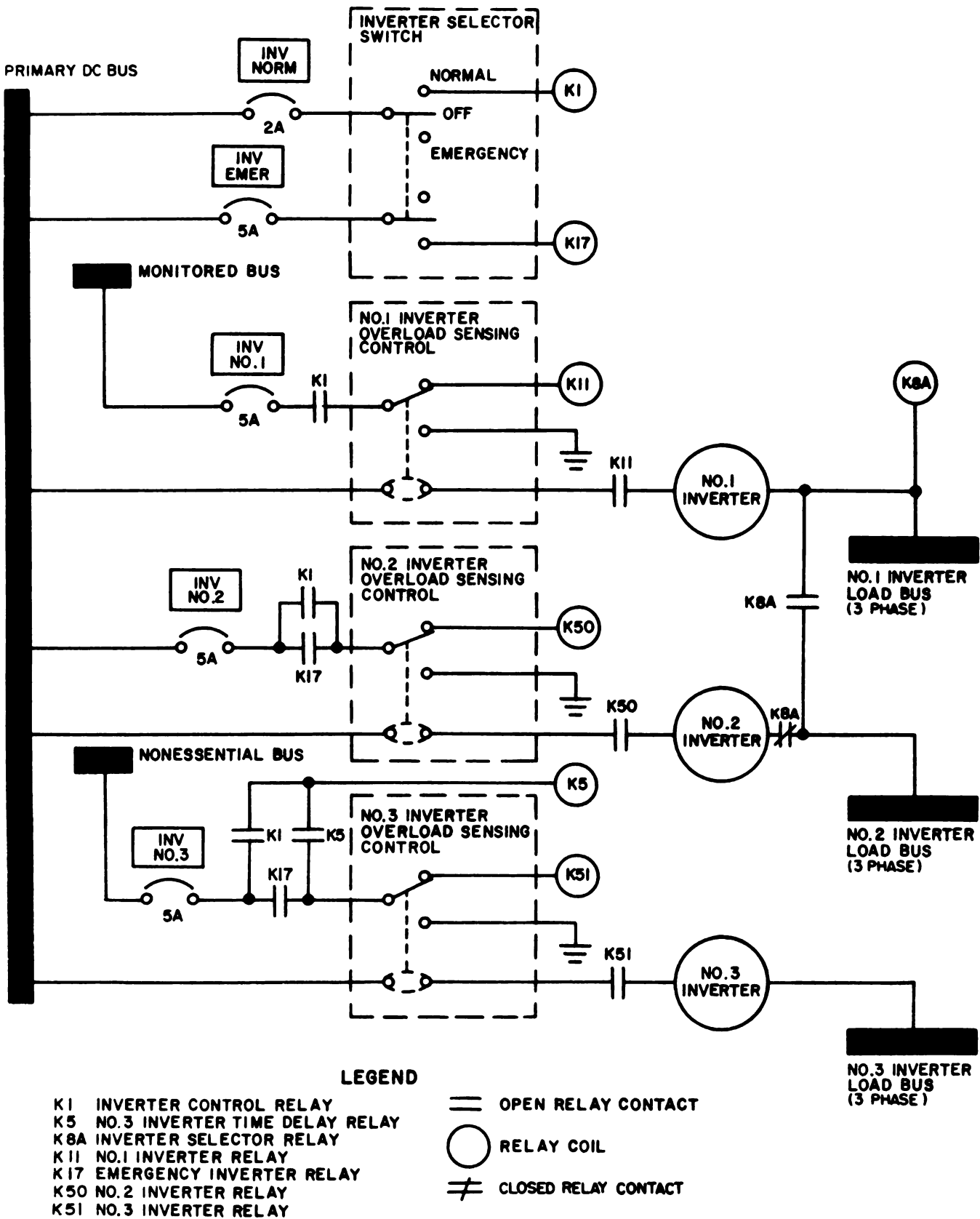
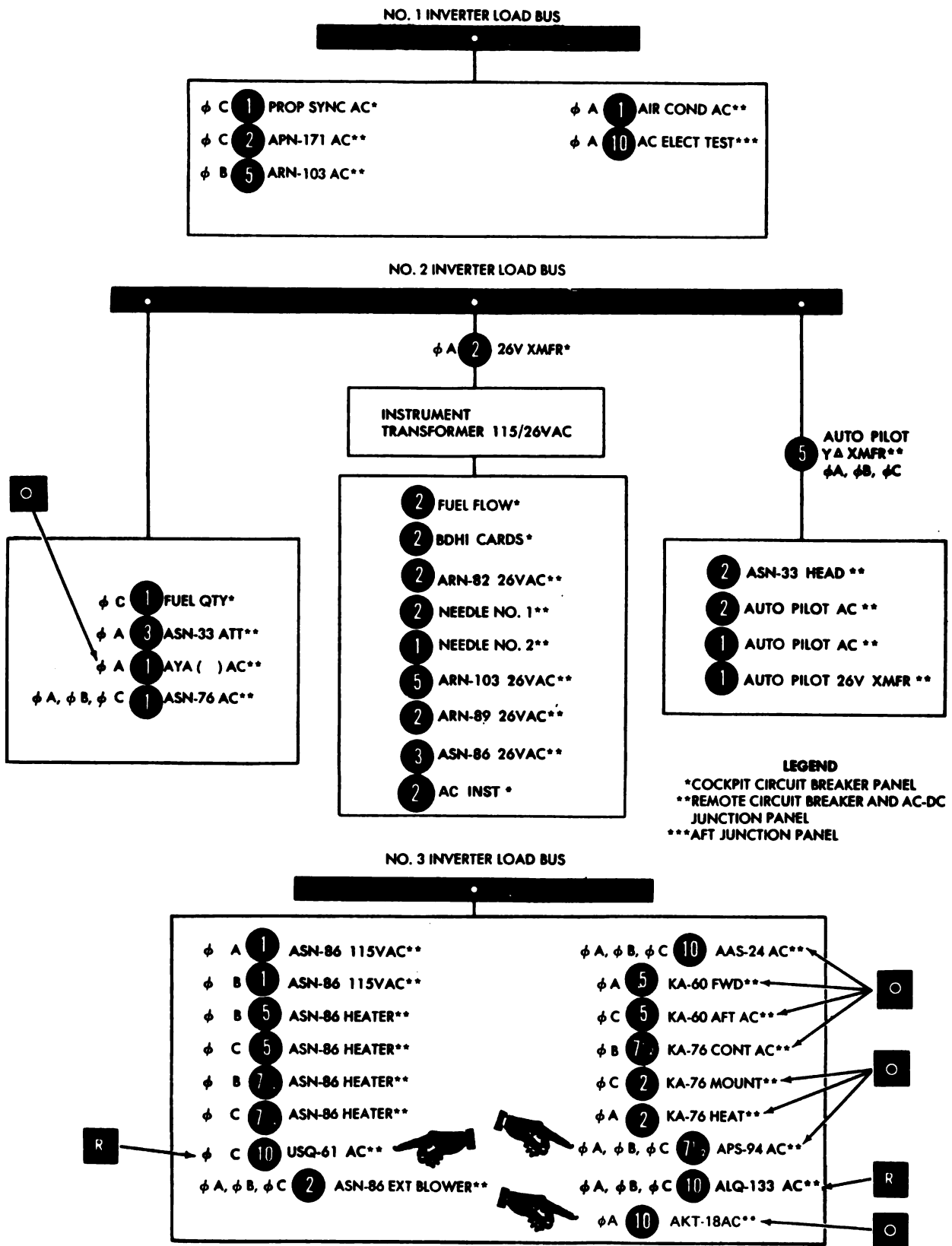

Figure 2-39. AC Electrical System Schematic



D-2-10-D-41

Figure 2-40. AC Electrical System Circuit Breaker Schematic (Typical)



## (2) Controls.

(a) *Inverter Switch.* The INVERTER switch, on the left overhead panel (figure 2-25), is a three-position lock-toggle switch. The switch receives 28 VDC through the INV NORM circuit breaker with the switch in the NORMAL position, and through the INV EMER circuit breaker with the switch in the EMERGENCY position. With the respective circuit breakers pulled, the inverters are inoperative. With the switch set to NORMAL, the No. 1 and No. 3 inverters supply the AC requirements of the aircraft. The No. 2 inverter is operating but is not connected to the No. 2 inverter load buses. A delay of 15 seconds, provided by a time delay relay, prevents the No. 3 inverter from energizing simultaneously with the No. 1 and No. 2 inverters to prevent an overload condition. With the switch set to EMERGENCY, the No. 2 inverter output is connected to the No. 2 inverter load buses, the No. 3 inverter functions without time delay, and the No. 1 inverter is shut down. The OFF position of the switch turns off the three inverters.

(b) *Failure Modes.* The inverters are protected by overload sensing controls in the 28 VDC input circuits. Excess input current through an overload sensing control results in shutdown of the inverter. In the event of failure of the No. 1 inverter with the INVERTER switch in the NORMAL position, the No. 2 inverter AC output automatically is connected to the No. 2 inverter load bus (figure 2-39), the No. 1 inverter load bus is not energized, the #1 INV caution light on the caution annunciator panel and the MASTER CAUTION light illuminate (figure 2-10), and the No. 3 inverter functions normally. Since the No. 2 inverter is operating without an AC load when the INVERTER switch is set to the NORMAL position, no power surge shall be experienced if the No. 1 inverter fails. In the event of a failure of the No. 2 inverter, the #2 INV caution light and MASTER CAUTION light will illuminate. Switching from the NORMAL to EMERGENCY position does not affect the operation of the No. 3 inverter; however, systems powered by the No. 3 inverter may be affected. If the No. 3 inverter should fail, the #3 INV caution light and the MASTER CAUTION light will illuminate. The

power: ... for operation of the inertial navigation system, which is normally supplied by the No. 3 inverter, will automatically be transferred to the output of the No. 1 inverter. At this time, the No. 1 inverter will supply power for operation of the inertial navigation system, in addition to its own load. Power for operation of the ELINT or camera systems and SLAR/IR systems (if installed) will, however, be lost. With the INVERTER switch in any position other than OFF, and both generators inoperative, the No. 2 inverter will continue to operate and deplete aircraft battery power.

## NOTE

*The navigation instrument flags may unmask and BACK UP COMP light may illuminate for up to 2 minutes during phase realignment.*

e. *Circuit Breaker Panels.*

## CAUTION

**Indiscriminate recycling of circuit breakers may cause damage to the circuit breaker actuating mechanism and/or associated circuitry.**

Circuit breakers protecting systems essential for flight are on the cockpit circuit breaker panel, on the center overhead console (figure 2-12). Other circuit breakers used by systems not essential for flight are on a remote circuit breaker and ac-dc junction panel, in the aft equipment compartment, left side. For identification of all circuit breakers, see figure 2-41.

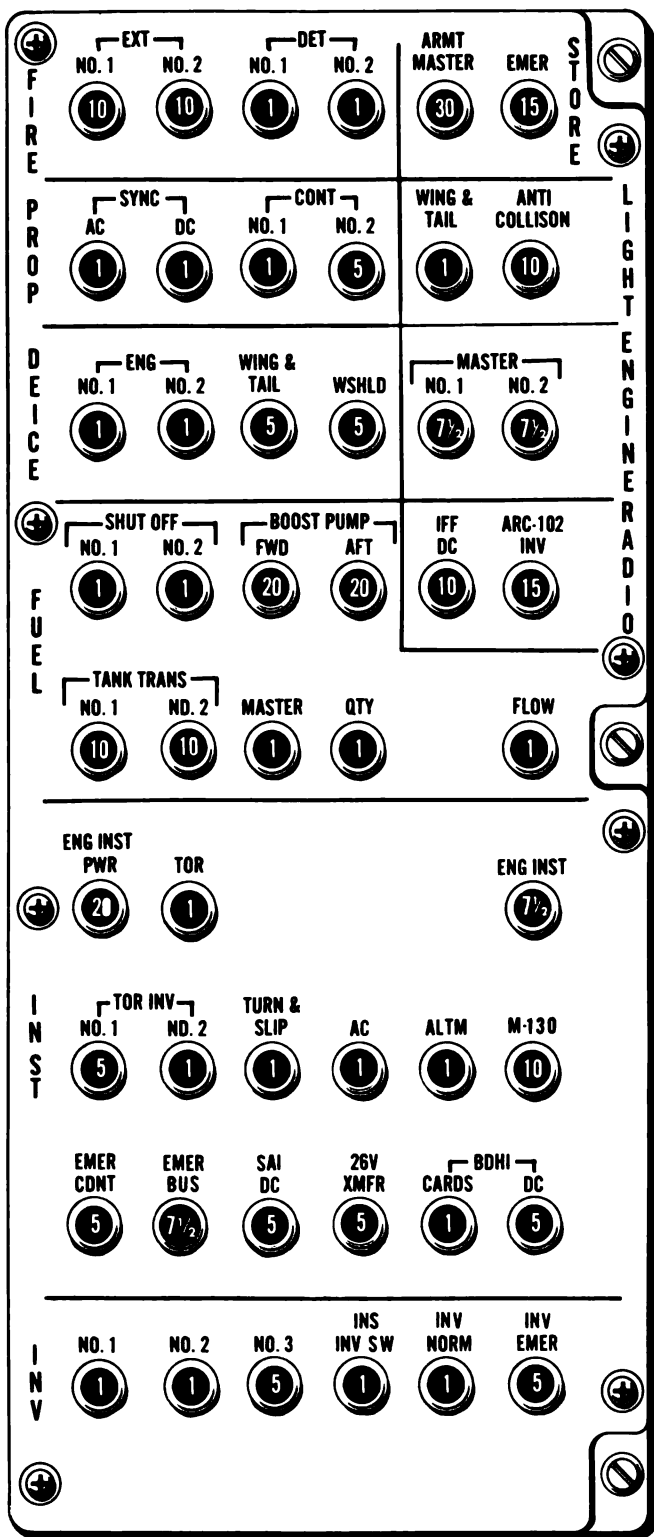

COCKPIT CIRCUIT BREAKER PANEL

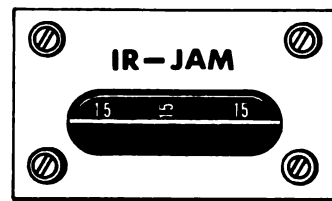
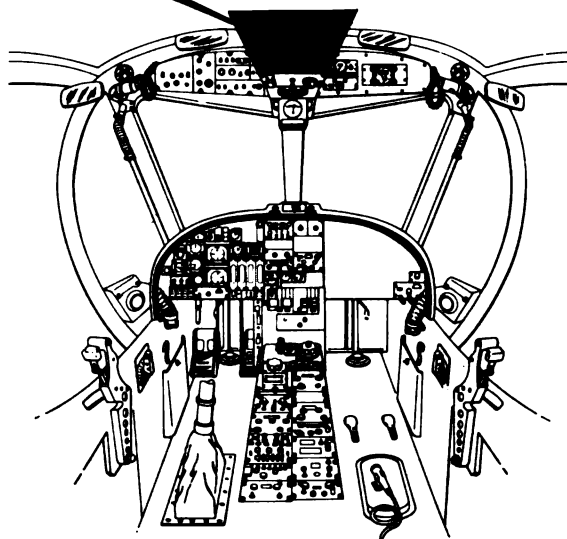

SLOPING CONSOLE CIRCUIT BREAKER PANEL

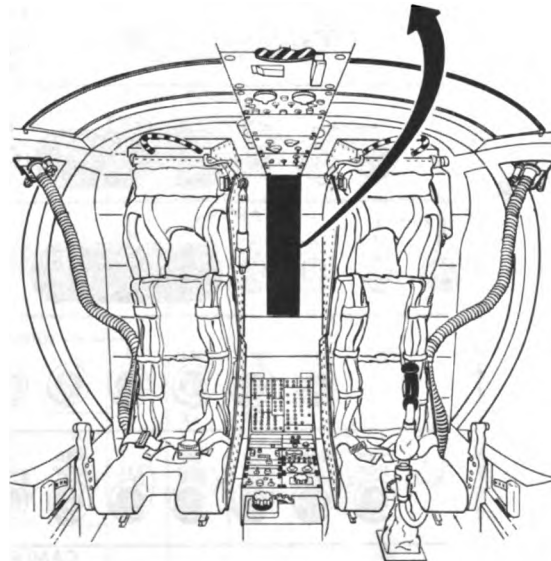
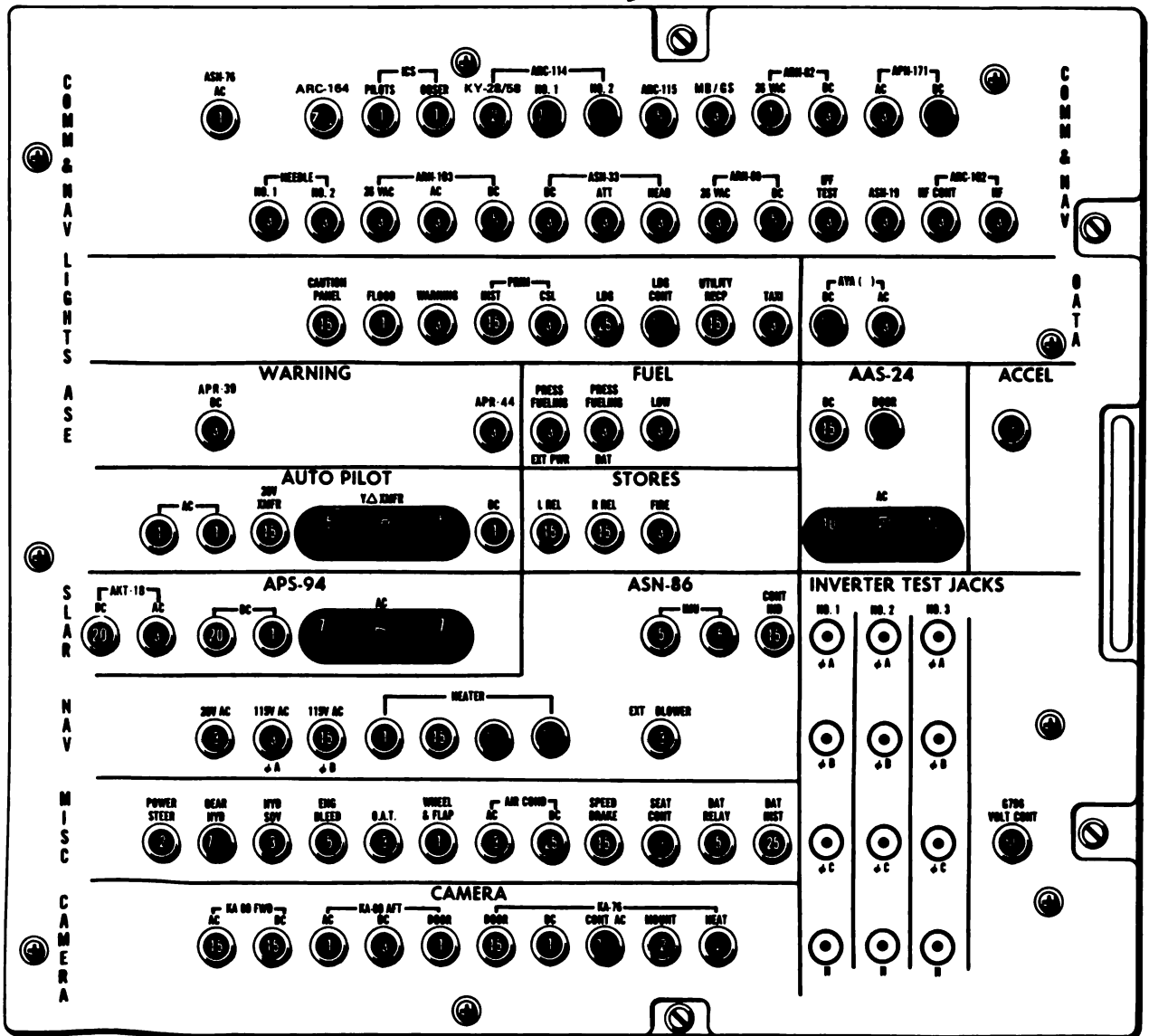
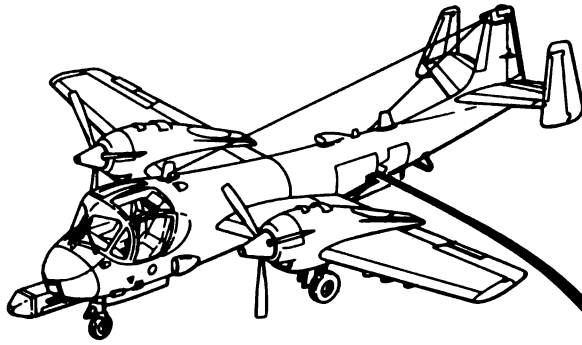

Figure 2-41. Circuit Breaker Panels (Typical) (Sheet 1 of 3)



REMOTE CIRCUIT BREAKER AND AC-DC JUNCTION PANEL

F2-10-D-42-2

Figure 2-41. Circuit Breaker Panels (Typical) (Sheet 2 of 3)

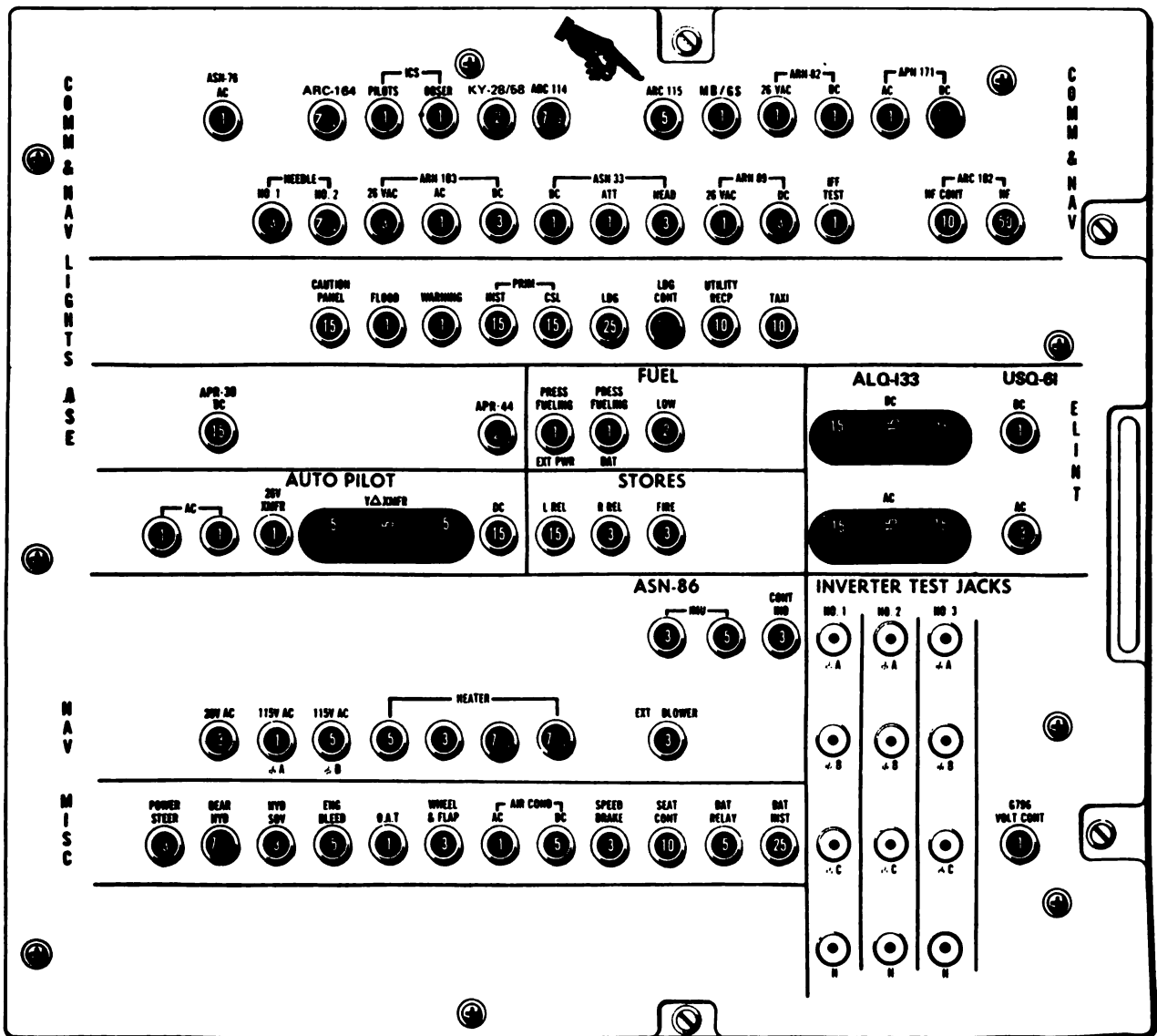
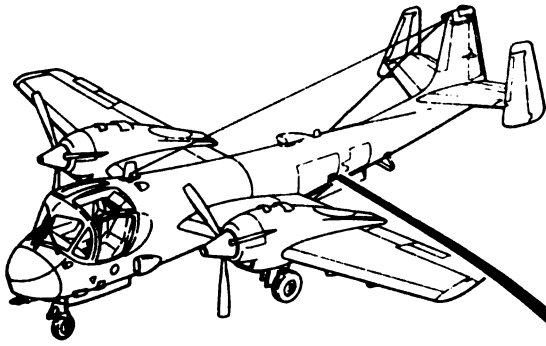

REMOTE CIRCUIT BREAKER AND AC-DC JUNCTION PANEL

E2-10-D-42-3

**R** Figure 2-41. Circuit Breaker Panels (Typical) (Sheet 3 of 3)

## SECTION XI. LIGHTING

### 2-37. Exterior Lights System.

*a. Description.* The exterior lights system consists of wingtip and tail position lights, anti-collision lights (rotating beacons), taxi light, and landing light (figure 2-42). The wing position lights are the bubble type in the wingtip of each wing. They are equipped with round covers, the left one red and the right one green. The tail position light is a white light on the rear of the fuselage tail cone. The anti-collision lights are rotating/oscillating red beacons installed on the top of the center rudder and the underside of the fuselage, to the rear of the wings. Each assembly is fitted with two reflector lamps. The landing light is installed flush in the left wing outer panel. The taxi light is on the nosewheel strut. The lights are powered from the DC secondary and nonessential buses and are protected by the associated circuit breakers. The exterior lights are controlled by switches on the exterior lighting portion of the left overhead panel (figure 2-25).

*b. Controls.* The exterior lighting control panel (figure 2-43) is on the left overhead panel, contains the controls for all exterior lighting.

*(1) Wing and Tail Position Light Switch.* The WING & TAIL position light switch is a three-position toggle switch. Switch positions are BRT, OFF, and DIM. Intensity of the lights is controlled by the BRT and DIM switch positions.

*(2) Anti-Collision Lights Switch.* The COLLISION lights switch is a two-position ON-OFF toggle switch.

*(3) Landing Light Switches.* The landing light is extended down and forward and energized by the LANDING light switches. One switch has EXTEND, RETRACT, and center (off) positions to lower and raise the landing light, while the second is used to turn the light ON or OFF.

*(4) Taxi Light Switch.* The TAXI light switch is a two-position, ON-OFF toggle switch.

*c. Operation.* Operation of the exterior lights system is dictated by the conditions under which the aircraft will be flown. Refer to the normal operating procedures contained in Chapter 8.

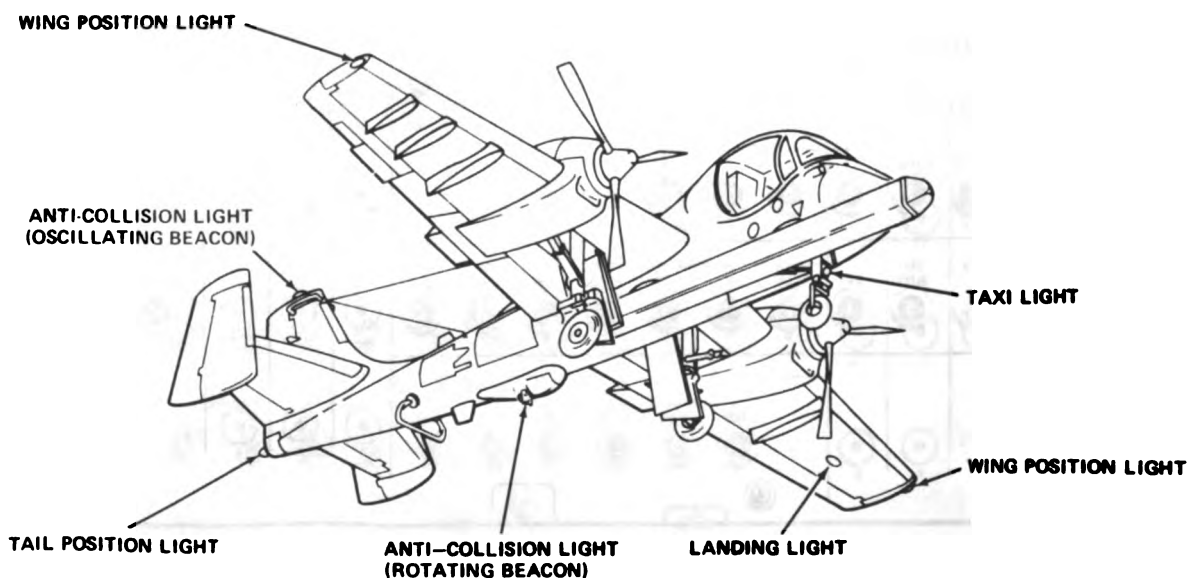
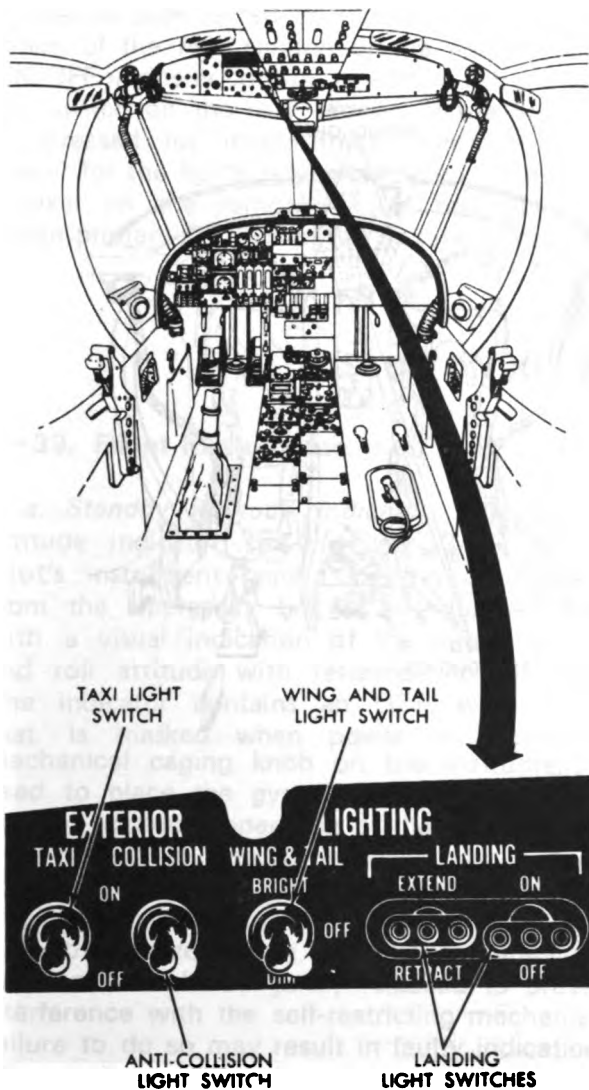

Figure 2-42. Exterior Lights

B-2-10-D-43



2-10-D-44

**Figure 2-43. Exterior Lighting Control Panel**

## 2-38. Interior Lights System.

**a. Description.** The interior lights system consists of primary instruments lights, console lights, red floodlights, white floodlights, and utility lights (figure 2-44). This system provides for direct red floodlighting of the instrument panels and also for individual red lighting for all instruments and consoles. In addition, the lower console may be floodlighted by the white floodlights located on the sloping bulkhead. The intensity of the instrument and console lights may be varied from dim to bright by means of the appropriate rheostats (figure 2-45). When the INSTRUMENTS rheostat is rotated from the OFF position, all warning lights except those of the fire detection system are automatically dimmed. Light intensity can be increased by turning the knob clockwise.

Controls for the interior lights system are on the interior lighting control portion of the left overhead panel (figure 2-25).

**b. Controls.** The interior lighting control panel (figure 2-45), on the left overhead panel, contains the controls for all the lights in the interior lights system except for the utility lights which have integral switches.

**(1) Consoles Rheostat.** The CONSOLES rheostat controls the intensity of all the console lights. Rotating the rheostat clockwise from the OFF position turns the console lights on and increases their intensity. The CONSOLES rheostat must be rotated clockwise from the OFF position before the red floodlights can be turned on, and their intensity is controlled by the RED FLOODS switch. Console lights will be lost with one generator inoperative.

**(2) Instruments Rheostat.** The INSTRUMENTS rheostat controls the intensity of the instruments illumination. Rotating the rheostat clockwise from the OFF position turns the instrument lights on, increases their intensity, and dims all warning lights except those of the fire detection system.

**(3) Red Floods Switch.** The RED FLOODS switch controls the intensity of the red floodlights. The red floodlights are turned on when the CONSOLES rheostat is rotated clockwise from the OFF position. When the red floodlights are illuminated, positioning the RED FLOODS switch to the MED, DIM, or BRT position, adjusts their intensity accordingly. When primary DC bus power is lost, power may be made available to these lights from the emergency bus by placing the BATTERY switch to the EMERGENCY position.

**(4) White Floods Switch.** The WHITE FLOODS switch controls the operation of the white floodlights on the sloping bulkhead. Placing the switch to the ON position illuminates the white floodlights. When primary DC bus power is lost, power may be made available to these lights from the emergency bus by placing the BATTERY switch in the EMERGENCY position.

**(5) Utility Lights.** Utility lights (figure 2-44) are provided in the cockpit for the pilot and observer and are detachable from clip-type mounts outboard of the left and right overhead panels. The lens section of each light can be

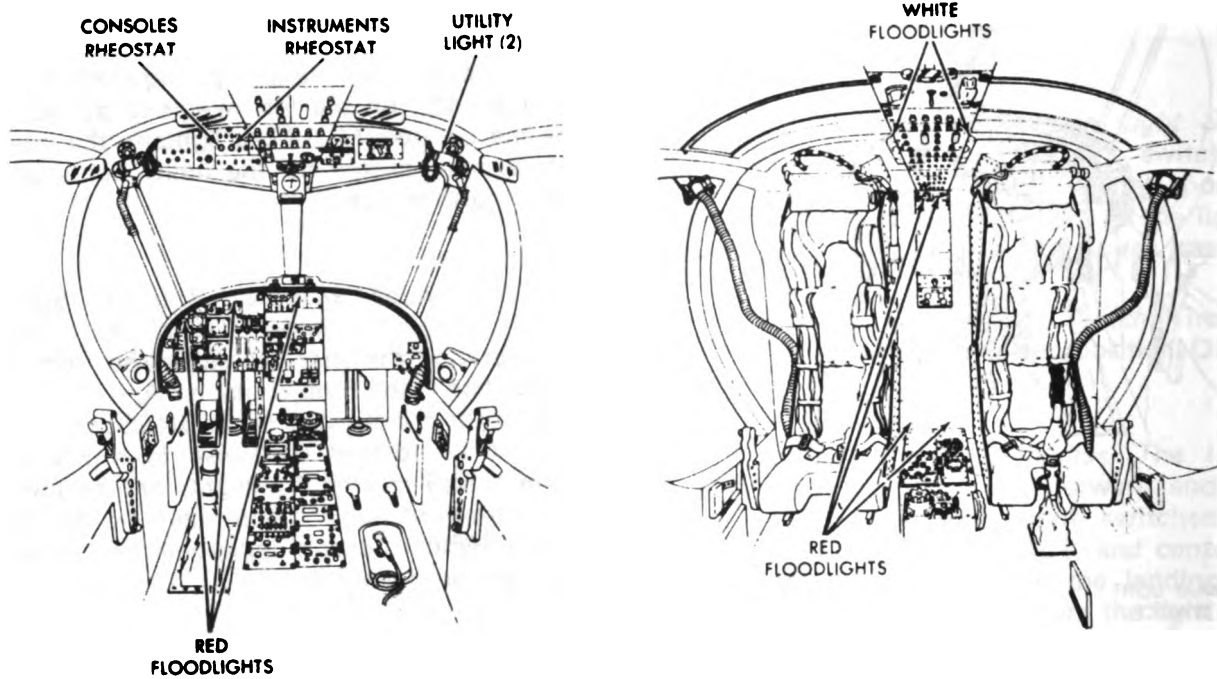

2 10 D 45

Figure 2-44. Interior Lights

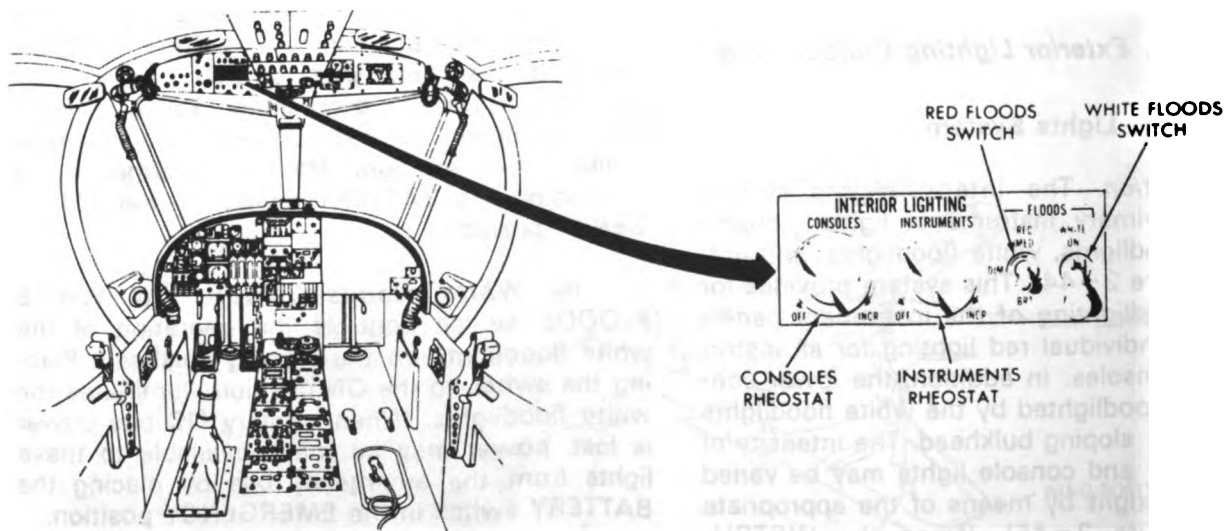

2 10 D 46

Figure 2-45. Interior Lighting Control Panel

rotated to provide red or white illumination. Rotation of the rear section of the light provides ON-OFF intensity control. In addition, a pushbutton switch on the rear section of the light can be pressed for intermittent illumination. DC power for the lights is provided through a circuit breaker on the remote circuit breaker panel. When primary DC bus power is lost, power may

be made available to these lights from the emergency bus by placing the BATTERY switch to the EMERGENCY position.

*c. Operation.* Operation of the interior lights system is dictated by the conditions under which the aircraft will be flown. Refer to the normal operating procedures contained in Chapter 8.

## SECTION XII. FLIGHT INSTRUMENTS

### 2-39. Flight Instruments.

*a. Standby Attitude Indicator.* The standby attitude indicator (SAI) (figure 2-7), on the pilot's instrument panel, operates on 28 VDC from the emergency bus. It provides the pilot with a visual indication of the aircraft's pitch and roll attitude with reference to the earth. The indicator contains an OFF warning flag that is masked when power is applied. A mechanical caging knob on the instrument is used to place the gyro in proper position. To prevent improper operation of the caging mechanism, the knob should be pulled with a steady positive pressure to the fully extended position and held there momentarily to allow the internal gyro to stabilize. When the gyro has stabilized, the knob should be gently released to prevent interference with the self-restricting mechanism. Failure to do so may result in faulty indications. When primary DC bus power is lost, the SAI may be powered by setting the BATTERY switch to the EMERGENCY position. The SAI will continue to operate for up to 9 minutes with a loss of all DC power.

#### CAUTION

Do not permanently cage the SAI gyro.

*b. Turn and Slip Indicator.* The turn and slip indicator (figure 2-7) on the pilot's instrument panel consists of a 2-minute turn indicator (needle) and slip indicator (ball). The turn needle is driven by a gyroscope through mechanical linkage. The slip indicator is an inclinometer, with a ball enclosed in a glass tube. DC

power for operation of the turn indicator is supplied from the emergency bus. This permits operation of the indicator if aircraft primary DC bus is lost and BATTERY switch is placed in EMERGENCY position.

*c. Radar Altimeter.* The radar altimeter (figure 2-7), on the pilot's instrument panel, provides altimeter readouts and remote control of the radar altimeter receiver-transmitter unit. For detailed description and operation, refer to Chapter 3.

*d. Pitot-Static System.* The pitot-static system operates airspeed indicator, the altimeter-encoder, and the vertical velocity indicator. The system incorporates a PITOT HEATER two-position toggle circuit breaker switch on the left overhead panel (figure 2-25). In the ON position, it applies power to a heating element in the pitot tube, that prevents icing of the tube.

*(1) Airspeed Indicator.* Either of two types of airspeed indicator may be installed: an airspeed indicator or a maximum allowable airspeed indicator, on the pilot's instrument panel (figure 2-7). Both indicators operate off the pitot-static system, requiring no electrical power for operation. The dial of the indicator is calibrated in knots from 0 to 400 KIAS. The maximum allowable airspeed indicator also has a maximum safe airspeed pointer (colored red) that varies as the maximum allowable airspeed changes with altitude. A window on the dial of the maximum allowable airspeed indicator shows the maximum allowable Mach number.

*(2) Altimeter-Encoder.* The altimeter-encoder on the pilot's instrument panel (figure 2-7) is a self-contained unit, which consists of an altitude encoder combined with a precision pressure altimeter. For detailed description and operation, refer to Chapter 3.



(3) *Vertical Velocity Indicator.* The vertical velocity indicator, on the pilot's instrument panel (figure 2-7), indicates the speed in feet per minute at which the aircraft ascends or descends based on the changes in atmospheric pressure. The indicator is a direct-reading pressure instrument requiring no electrical power for operation.

*e. Navigation Instruments.* The navigation instruments are the bearing distance heading indicator (BDHI), approach horizon indicator, and course indicator.

(1) *Bearing Distance Heading Indicator (BDHI).* The BDHI, on the pilot's instrument panel (figure 2-7), provides the pilot with a visual presentation of outputs from the INS (or backup compass system), VOR set, ADF set, and TACAN set. For detailed description and operation, refer to Chapter 3.

(2) *Approach Horizon Indicator.* The approach horizon indicator (attitude navigation indicator), on the pilot's instrument panel (figure 2-7), provides the pilot with a pictorial display of pitch and bank information, deviation from a glide slope, and lateral guidance information. For detailed description and operation, refer to Chapter 3.

(3) *Course Indicator.* The course indicator, on the pilot's instrument panel (figure 2-7), combines compass headings with radio position indications received from other electronic navigation equipment to present aircraft position and bearing information on the face of the indicator. For detailed description and operation, refer to Chapter 3.

## 2-40. Miscellaneous Instruments, Control Panels, and Consoles.

Avionic and mission equipment controls for various aircraft configurations are on the following control panels and consoles: pilot's instrument panel (figure 2-7), center instrument panel (figure 2-9), right side instrument panel (figure 2-46), right overhead panel (figure 2-47), lower console (figure 2-48), and sloping console (figure 2-49). The miscellaneous instruments installed in the aircraft are described in the following paragraphs.

*a. Magnetic Compass.* The magnetic compass (standby compass) is on the front of the center overhead console (figure 2-12). It may be used in the event of failure of the compass system, or for instrument crosscheck. Readings should be taken only during steady level flight since errors may be introduced by turning or acceleration. A compass correction card indicating deviation is on the left side of the center overhead console.

*b. Mechanical Clock.* The mechanical clock, on the pilot's instrument panel (figure 2-7), is equipped with a sweep second hand and totalizer that indicate elapsed time. The sweep hand and totalizer are controlled by a knob in the upper right corner of the instrument. Successive pressing of the knob starts, stops, and returns the hands to zero. The totalizer indicates 1 minute for each sweep of the second hand.

*c. Free Air Temperature Indicator.* The free air temperature indicator is an electrically powered instrument that indicates the outside air temperature in degrees C. The indicator is protected by the O.A.T. circuit breaker on the remote circuit breaker panel. The indicator is on the pilot's instrument panel (figure 2-7).

*d. Accelerometer Indicator.* The accelerometer indicator, on the pilot's instrument panel (figure 2-7), indicates the rate of change in the velocity of the aircraft along its vertical axis. The dial is graduated in units of gravity with a range of -5 to +10G. The instrument has three pointers: one is a continuous reading hand, which varies with changing acceleration; the other two pointers show maximum readings remaining at the greatest positive and negative readings reached during any maneuvers. These latter pointers record, for reference purposes, the highest positive and negative G-loads to which the aircraft is subjected. Pressing the knob on the instrument resets all readings.

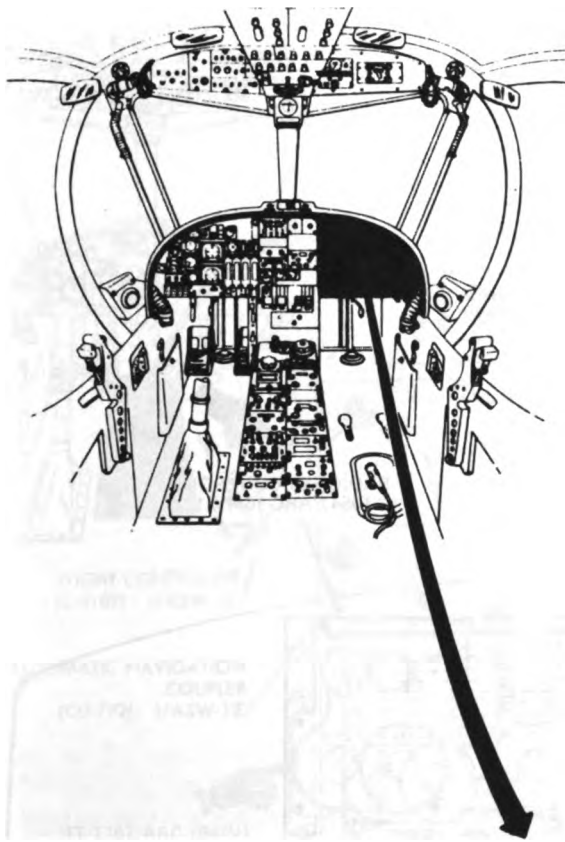

**NOTE**  
CONTROL INDICATOR GROUP OK-138/AAS-24 OR  
RADAR SURVEILLANCE SET AN/APS-94 F  
ELECTRICAL EQUIPMENT AND COMPONENTS  
FOR OV-1D SHOWN REMOVED.



REFER TO NOTE

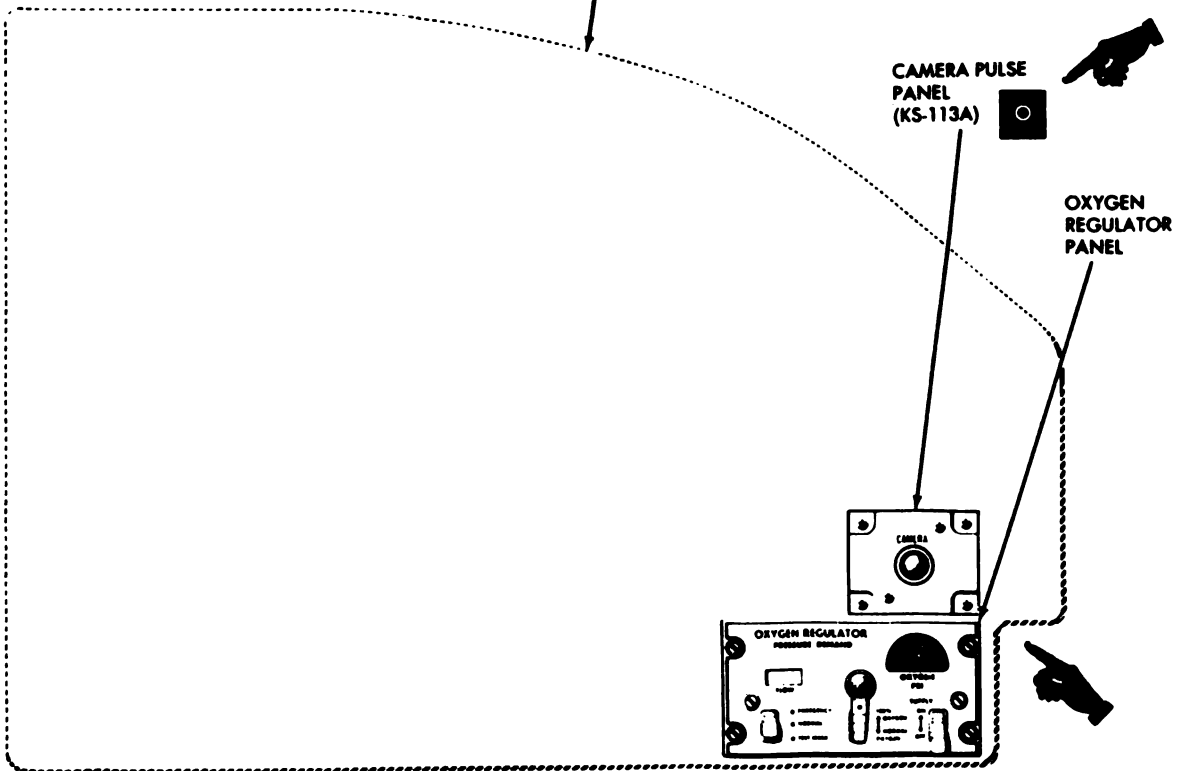

C-2-10-D-47

**Figure 2-46. Right Side Instrument Panel**

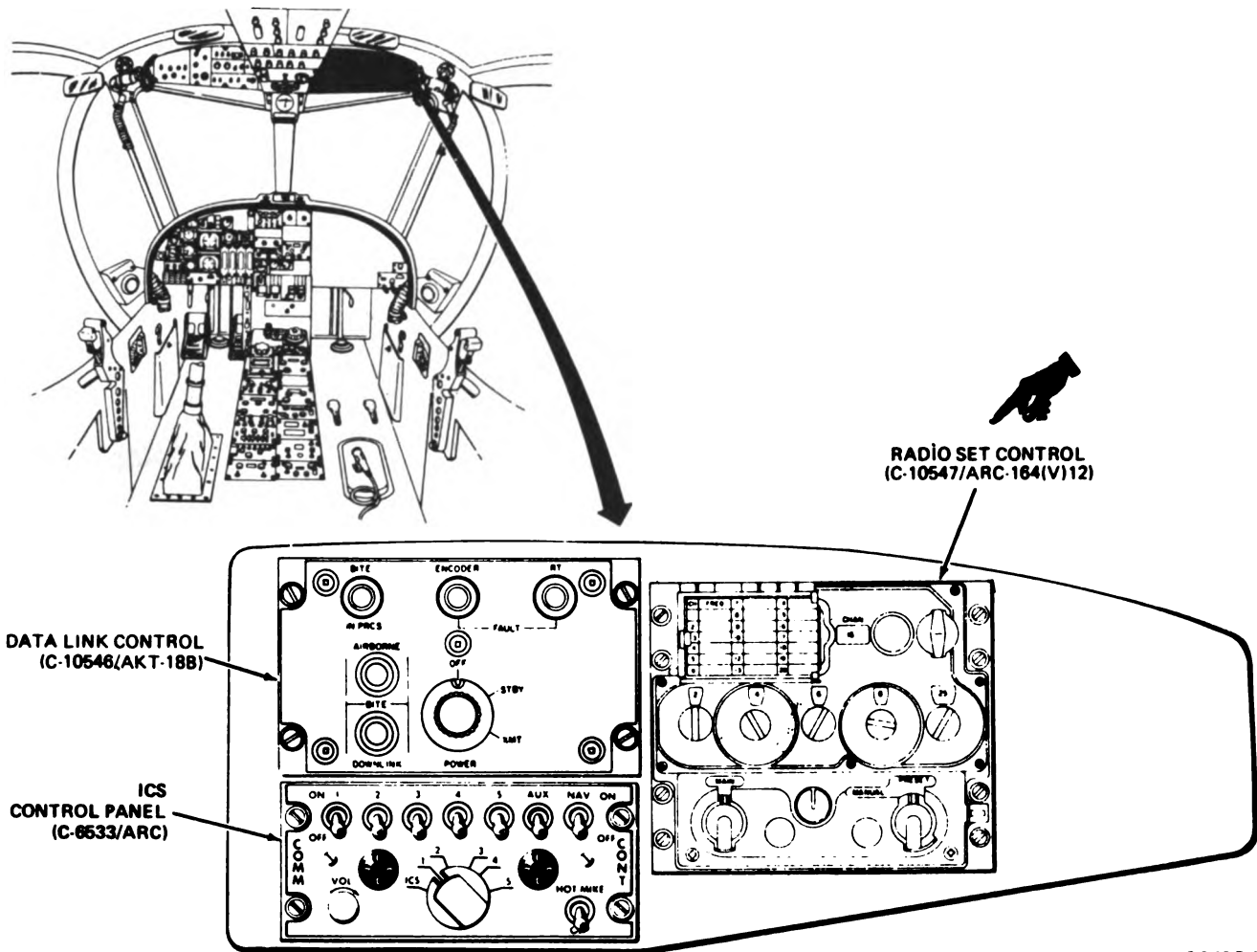

C-2-10-D 48-1

Figure 2-47. Right Overhead Panel (Sheet 1 of 2)

**NOTE**

*Accelerometer readings indicated during taxiing and landing are usually erroneous and read high. The instrument should be reset after takeoff, as only readings recorded in flight are reliable.*

prohibited since damage or shorting of the electrical contacts can occur.

**e. Warning and Caution Lights System.**

**CAUTION**

The use of any tools to open a panel section and replace lamps in the caution annunciator panel is

The warning and caution lights system provides the operator with visual indication of an abnormal system operation. When an abnormal condition occurs within a system(s), a MASTER CAUTION light (figure 2-10), directly in front of the pilot on the instrument panel, and related system caution light(s) on the caution annunciator panel, illuminate. A WHEELS warning light and landing gear handle warning light provide a visual indication of an unsafe landing gear condition to decrease the possibility of a gear-up landing. The MASTER CAUTION switch, immediately to the left of the MASTER CAUTION

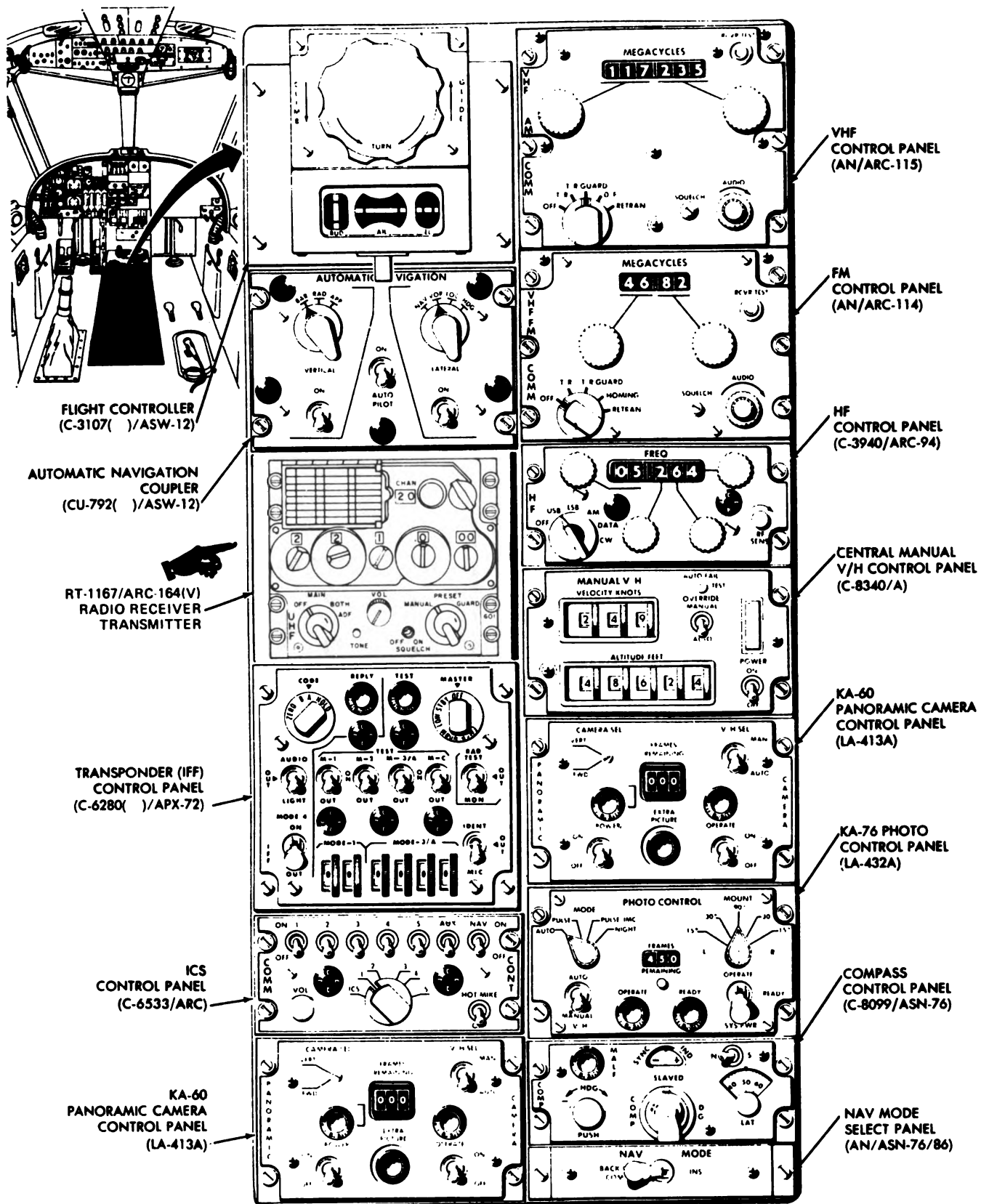
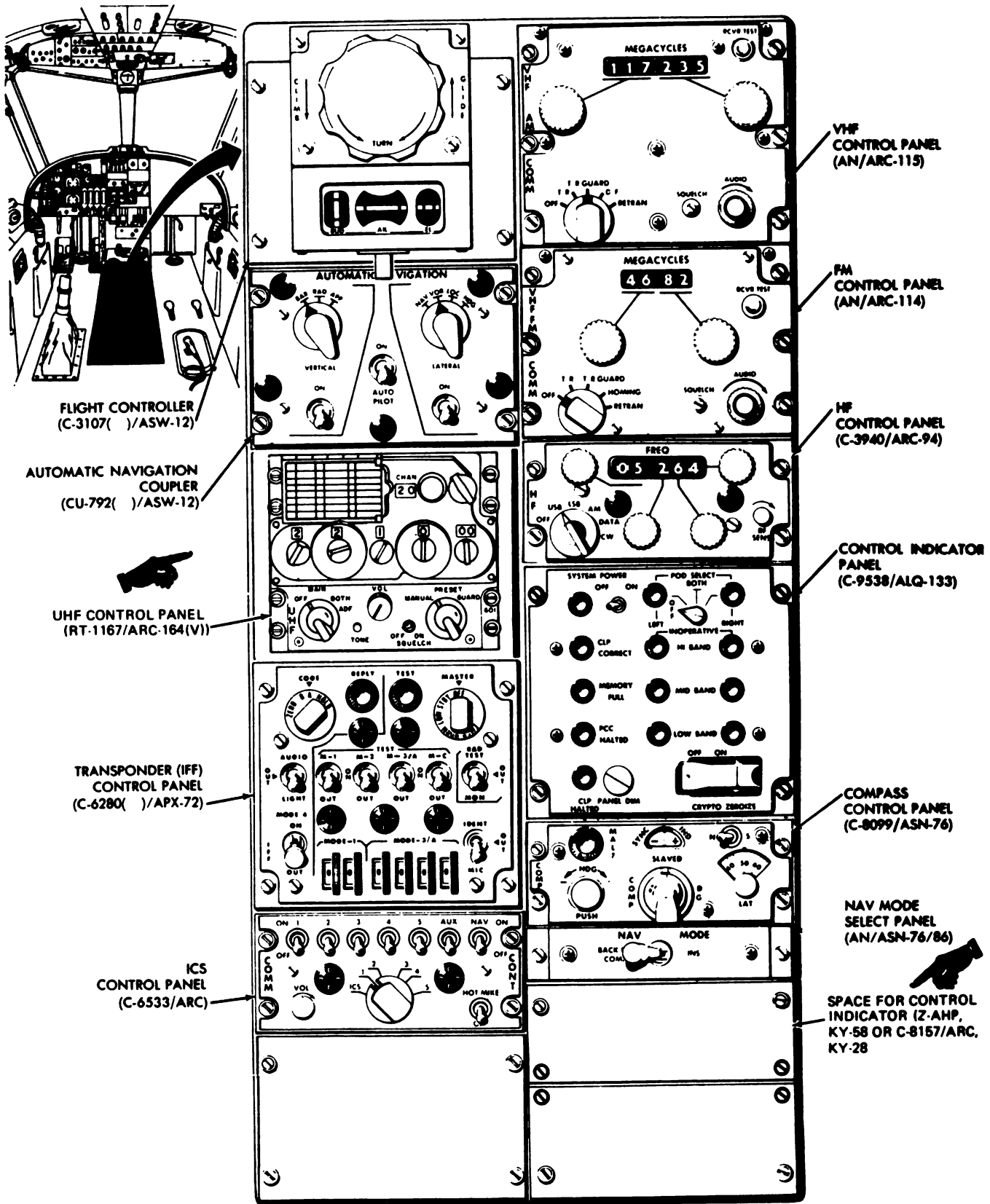

Figure 2-48. Lower Console (Typical) (Sheet 1 of 2)

D-2-10-D-49-1



**R**

Figure 2-48. Lower Console (Typical) (Sheet 2 of 2)

light, is used to check the WHEELS warning light, landing gear handle warning light, MASTER CAUTION light, and all indicator lights on the caution annunciator panel. When the switch is held in the TEST position, all warning and caution lights will illuminate. Releasing the

switch turns off the lights and readies the circuit for automatic operation. The switch shall be momentarily positioned to the RESET position to turn off the lights and ready the circuits for automatic operation after an abnormal indication.

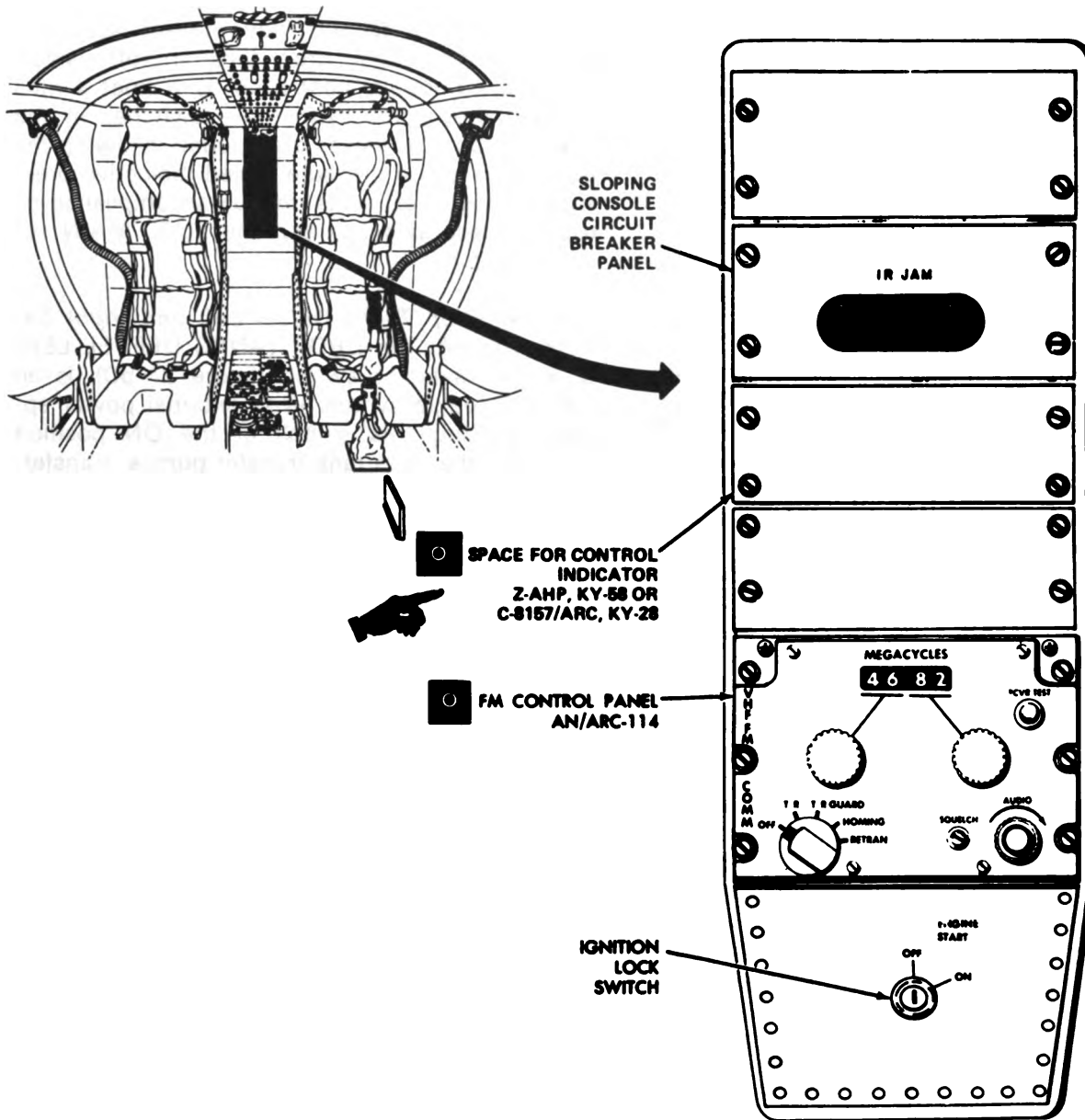

D-2-10-D-50

Figure 2-49. Sloping Console (Typical)

## SECTION XIII. SERVICING, PARKING, AND MOORING

## 2-41. Servicing.

**WARNING**

Turbine fuels and lubricating oils contain additives that are poisonous and readily absorbed through the skin. Skin and clothing that come in contact with turbine fuels or lubricating oil should be washed thoroughly without delay.

*a. Single-Point Pressure Fueling.* Complete operation of the single-point pressure fueling system, including selective filling and shutoff precheck on all tanks, can be accomplished at the pressure fueling station (figure 2-50). The pressure fueling station also provides for single-point pressure defueling if the fuel in both drop tanks has been transferred to the main tank. During pressure refueling, maintain pressure between 15 and 50 PSI. The following switches on the pressure fueling station control the entire operation of pressure fueling and defueling:

*(1) Pressure Fueling Door Interlock Switch.* The pressure fueling door interlock switch (figure 2-50), is a plunger-operated microswitch (spring-loaded to the closed position). When the pressure fueling station door is closed, the switch is held in the open position and the circuit to the pressure fueling switches is broken. Opening the door allows the switch to close, completing the circuit to the fueling switches and supplying power to the three post-type servicing lights which illuminate the panel.

*(2) Fuel Main Selector Switch.* The FUEL MAIN selector switch (figure 2-50), is a three-position toggle switch with PRI and SEC positions. The primary and secondary positions control two solenoids in the main tank pilot valve used to test the operation of the primary and secondary diaphragms in the main tank fuel

shutoff valve. The secondary system exists only as an alternate system for use in the event of failure in the primary system. The center position is the off position of the switch.

*(3) Drop Tanks Fuel Left and Right Selector Switches.* The DROP TANKS FUEL LEFT and RIGHT selector switches (figure 2-50), are ON-OFF toggle switches. They control solenoid-operated diaphragm drop tank shutoff valves, which are normally controlled by a float switch in each drop tank. With these switches in the ON position, the valves are opened, allowing the drop tanks to be pressure fueled. Selective pressure fueling of all tanks may be accomplished by use of these switches and the FUEL MAIN selector switch.

*(4) Drop Tanks Defuel Left and Right Selector Switch.* The DROP TANKS DEFUEL LEFT & RIGHT selector switch (figure 2-50), is an ON-OFF toggle switch. With external power applied, placing this switch in the ON position energizes the drop tank transfer pumps, transferring the fuel from the drop tanks to the main tank. Without external power applied, the fuel PUMPS switch on the left overhead panel must be placed in the ON position. Placing the switch in the OFF position shuts the pump off.

*(5) Fuel and Defuel Master Switch.* The FUEL & DEFUEL MASTER switch (figure 2-50), is a two-position ON-OFF toggle switch. Setting this switch in the ON position energizes the fuel-defuel relay, which opens the main tank fueling shutoff valve. The ON position also arms the DROP TANKS FUEL LEFT and RIGHT selector switches and FUEL MAIN selector switch through the OFF position of the DROP TANKS DEFUEL LEFT & RIGHT selector switch. This means that with the DROP TANKS DEFUEL LEFT & RIGHT selector switch in ON, the fueling circuit is deenergized.

*b. Fuel Requirements.* Fuel specifications and capacity for all tanks are listed in table 2-5. A general listing of approved fuels is provided in table 2-6. The fuels listed in table 2-6, have nearly identical characteristics. All of the fuels are compatible and may be mixed in aircraft fuel tanks. The use of fuels shall be in accordance with TB55-9150-200-24.

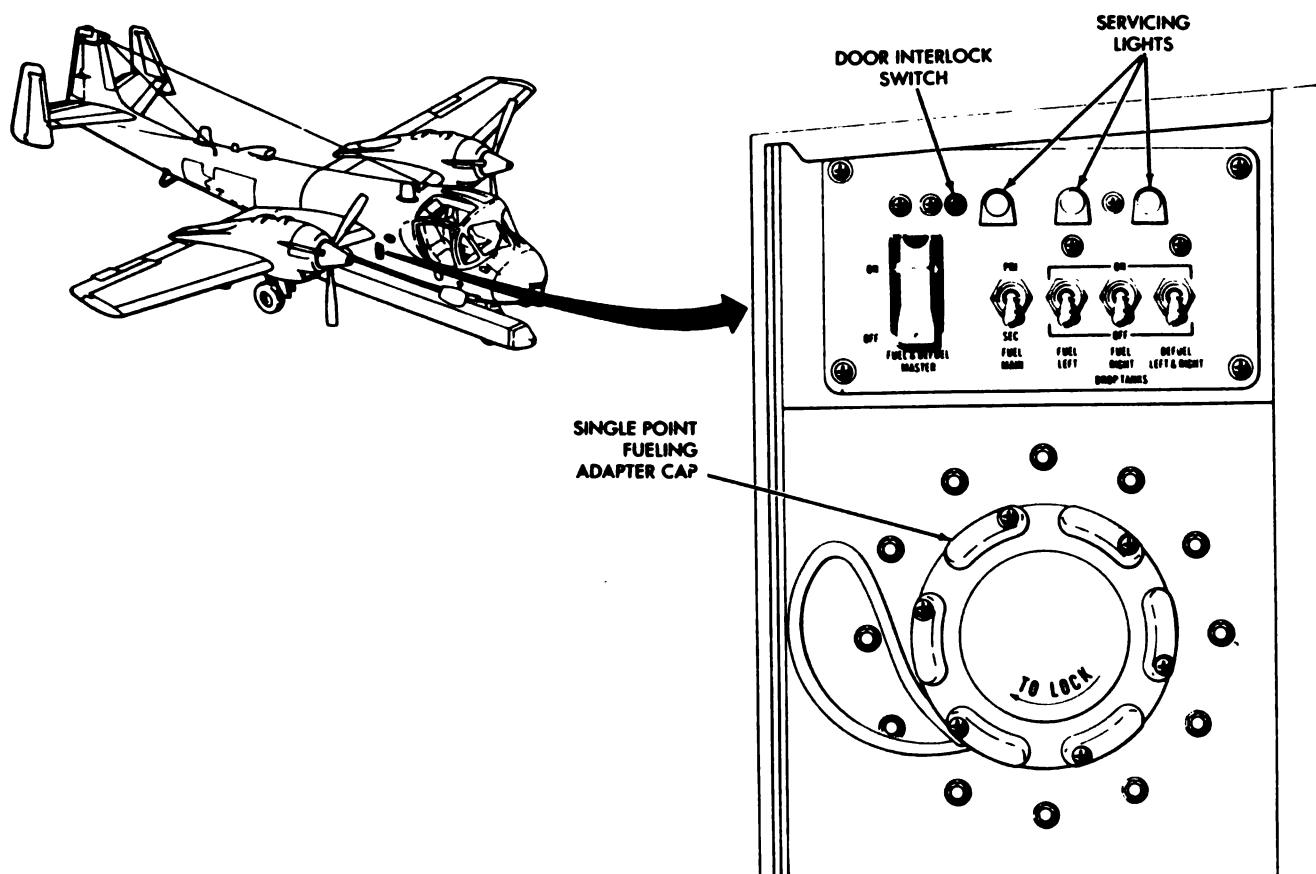

2-10-D-51

**Figure 2-50. Pressure Fueling Station**

(1) **Fuel Types.** Fuels are classified as Army Standard, Alternate, or Emergency (table 2-7).

(a) **Army Standard Fuels (JP-4, MIL-T-5624-NATO Code No. F-40).** These are the Army-designated primary fuels adapted for worldwide use. These will be the only fuels readily available in the Army supply system. Commercial jet B fuels (ASTM-D-1655) should be used when JP-4 fuel is not available.

(b) **Alternate Fuels (JP-5, MIL-T-5624-NATO Code No. F-44).** These are the fuels that can be used continuously when Army standard fuel is not available, without reduction in power output. Power setting adjustments and increased maintenance may be required when an alternate fuel is used. Commercial jet A and jet A-1 fuels should be used when JP-5 fuel is not available.

(c) **Emergency Fuels (Gasoline).** These are fuels which can be used if Army Standard and approved Alternate fuels are not available. Their use is subject to a specific time limit unless prior approval has been obtained from responsible authority.

(2) **Use of Fuels.** There is no special limitation of the use of Army Standard fuel, but certain limitations are imposed when Alternate or Emergency fuels are used. For the purpose of record, fuel mixtures shall be identified as to the major component of the mixture (except when the mixture contains leaded gasoline) and recorded on DA Form 2408-13 (Aircraft Inspection and Maintenance Record). A fuel mixture that contains over 10 percent leaded gasoline shall be recorded as all leaded gasoline. (Refer to TB55-9150-200-24.)

(a) The use of kerosene fuels (JP-5 type) in turbine engines requires observance of



**Table 2-5. Fuel, Lubricants, Fluids, Specifications, and Capacities**

System	Specification	Capacity
Fuel	MIL-T-5624 (JP-4)	Main Tank Usable: 297 U.S. Gal Total: 298.8 U.S. Gal Drop Tanks Usable: 150 U.S. Gal each Total: 151.2 U.S. Gal each IRCM Pod AN/ALQ-147A(V)2 Usable: 135 U.S. Gal IR Fuel: 15 U.S. Gal Total: 151.2 U.S. Gal IRCM Pod AN/ALQ-147A(V)1 (OV-1D) IR Fuel: 12 U.S. Gal
Engine Oil	MIL-L-7808 (See Notes 1 and 3) MIL-L-23699 (See Notes 2 and 3)	2.5 U.S. Gal
Hydraulic System Reservoir Propeller Strut	MIL-H-83282 (See Note 4) MIL-H-83282 (See Note 4) MIL-H-5606 MIL-H-5606	6.5 U.S. Gal 2.6 U.S. Gal 8.5 U.S. Qts 48 oz. (Nose) 114 oz. (Main)
Oxygen Cylinders Bottles	MIL-O-27210 MIL-O-27210	514 Cubic In. each 22.5 Cubic In. each
Fire Extinguishing Containers	MIL-B-12218	86 Cubic In. each

**NOTE 1:** MIL-L-7808 oil used in the engine oil system is specified for operation in ambient temperatures below -32° C. This oil may also be used when MIL-L-23699 oil is not available.

**CAUTION**

Under no circumstances shall MIL-L-23699 oil be used at ambient temperatures below -32° C.

**NOTE 2:** MIL-L-23699 oil used in the engine oil system is authorized and directed for use in ambient temperatures above -32° C.

**NOTE 3:** It is not advisable to mix MIL-L-23699 oil with MIL-L-7808 oil except in case of emergency. If it becomes necessary to mix the oils, record on DA Form 2408-13 to ensure the engine oil system shall be flushed within six flight hours and filled with the proper oil.

**NOTE 4:** MIL-H-5606 should be used in the hydraulic system at temperatures below -40° C.

Table 2-6. Approved Fuels

Source Or Vendor	Standard Fuel	Alternate Fuel	
<b>U.S. MILITARY</b>	<b>JP-4 (MIL-T-5624)</b>	<b>JP-5 (MIL-T-5624)</b>	
<b>NATO</b>	<b>F-40 (Wide Cut Type)</b>	<b>F-44 (High Flash Type)</b>	<b>F-34</b>
<b>Commercial (ASTM-D-1655)</b>	<b>JET B</b>	<b>JET A</b>	<b>JET A-1</b>
American Oil	American JP-4	American Type A	-
Atlantic Richfield	Arcojet B	Arcojet A	Arcojet A-1
B.P. Trading	B.P.A.T.G.	-	B.P.A.T.K.
Caltex Petroleum Corp.	Caltex Jet B	-	Caltex Jet A-1
Chevron	Chevron B	Chevron A-50	Chevron A-1
Cities Service Co.	-	Citgo A	-
Continental Oil Co.	Conoco JP-4	Conoco Jet-50	Conoco Jet-60
EXXON Co., USA	EXXON Turbo Fuel B	EXXON A	EXXON A-1
Gulf Oil	Gulf Jet B	Gulf Jet A	Gulf Jet A-1
JP-9			
Mobil Oil	Mobil Jet B	Mobil Jet A	Mobil Jet A-1
Phillips Petroleum	Philjet JP-4	Philjet A-50	-
Richfield Div.	-	Richfield A	Richfield A-1
Shell Oil	Aeroshell JP-4	Aeroshell 640	Aeroshell 650
Sinclair	-	Superjet A	Superjet A-1
Standard Oil Co.	-	Jet A Kerosene	Jet A-1 Kerosene
Texaco	Texaco Avjet B	Avjet A	Avjet A-1
Union Oil	Union JP-4	76 Turbine Fuel	-
<b>Foreign Source</b>	<b>NATO F-40</b>	<b>NATO F-44</b>	
Belgium	BA - PF - 2B	-	
Canada	3GP-22F	3-6P-24e	
Denmark	JP-4 MIL-T-5624	-	
France	Air 3407A	-	
Germany (West)	VTL-9130-006	UTL-9130-007 or UTL-9130-010	
Greece	JP-4 MIL-T-5624	-	
Italy	AA-M-C-1421	AMC-143	
Netherlands	JP-4 MIL-T-5624	D. Eng RD 2493	
Norway	JP-4 MIL-T-5624	-	
Portugal	JP-4 MIL-T-5624	-	
Turkey	JP-4 MIL-T-5624	-	
United Kingdom (Britain)	D. Eng RD 2454	D. Eng RD 2498	

special precautions. Both ground starts and air starts at low temperature may be more difficult due to low vapor pressure.

(b) Deleted.

(c) Leaded gasoline, either straight or mixed with other fuels in any proportion, will deposit a layer of lead oxide on combustor parts. The lead oxide attacks the underlying metal and also acts as an insulator that reduces combustion efficiency and causes the formation and deposition of carbon. Therefore, the operating time between scheduled internal (hot-end) inspections is limited (table 2-7). If the permissible accumulated operating time is exceeded, a special cleaning and inspection is mandatory.

**NOTE**

*Special cleaning and inspection may be delayed for 10 operating hours, provided only Army Standard fuel is used during the delay.*

*U.S. Military JP-4 and JP-5 fuels, NATO Code No. F-40 and F-44 respectively, contain icing inhibitors blended at the refinery; most commercial fuels do not.*

(d) Even though the aircraft has a fuel heater, when refueling with commercial fuel that does not contain an anti-icing additive, add icing inhibitor per MIL-I-27686 regardless of ambient temperature. Inhibitor per MIL-I-27686 functions as a biocide to kill microbial growths in fuel systems. Refueling operations shall be done in accordance with accepted commercial procedures.

(e) Deleted.

**2-42. Additional Servicing.**

a. *Engine Oil System.* Servicing the engine oil system consists of filling the two engine oil

**Table 2-7. Standard, Alternate, and Emergency Fuels**

Army Standard Fuel	Alternate Fuel	Emergency Fuel*
MIL-T-5624 (Grade JP-4)	MIL-T-5624 (Grade JP-5)	Any aviation gas and/or mixture thereof: Max limit – 50 hrs (with TCP – 25 hrs)

\* An entry shall be made on the DA Form 2408-13 of the aircraft log book if emergency fuel is used for any time length – list type of aviation gas. Refer to paragraph 2-41b(2) for further information.

tanks to the proper level with lubricating oil. Refer to table 2-5 for specifications and capacity. Access to the oil tank filler cap (figure 2-51) is at the inboard side of the left nacelle and outboard side of the right nacelle. The volume of each oil tank is 4.2 U.S. gallons, of which the maximum permissible oil capacity is 2.5 U.S. gallons. The remaining volume of the tank is expansion space.

**b. Propeller Oil System.** Propeller servicing consists of inspecting and maintaining the level of hydraulic oil in the propeller. Refer to table 2-5 for specification and capacity. See figure 2-51 for location of propeller oil filler cap.

**c. Hydraulic System.** Servicing the hydraulic system is accomplished through the hydraulic and pneumatic systems servicing station (figure 2-52). Refer to table 2-5 for specifications and capacities.

**d. Pneumatic Systems.** There are two pneumatic systems installed in the aircraft: escape hatch pneumatic system and landing gear emergency pneumatic system.

**(1) Escape Hatch Pneumatic System.** The cockpit contains an escape hatch bottle filler valve (on the center overhead console, left side) (figure 2-51) that is used to charge the escape hatch pneumatic system. A pressure gage, mounted above the filler valve, indicates bottle pressure.

**(2) Landing Gear Emergency Pneumatic System.** Servicing the landing gear emergency pneumatic system is accomplished through the hydraulic and landing gear emergency pneumatic servicing station (figure 2-52).

**e. Oxygen System.** Servicing the two oxygen cylinders is accomplished through the oxygen bottle filler valve (figure 2-51) on the left side of the fuselage near the lower rear corner of the pilot's entrance hatch. Refer to table 2-5 for specification and capacity.

**f. Windshield Wash and Anti-Ice Fluid Tank.** The windshield wash and anti-ice fluid tank has a capacity of 3 U.S. gallons. The tank is serviced through the filler cap (figure 2-51) on the right side of the fuselage, below the EXIT RELEASE handle.

**g. Tire Pressures.** Inflate main wheel tires to 100 PSI and nosewheel tire to 65 PSI.

**h. Pseudraulic Struts.** Servicing the nose and main landing gear pseudraulic struts with hydraulic fluid and air or nitrogen is accomplished through a filler valve on each strut. When servicing, observe instructions on placard located on the nose and main landing gear pseudraulic struts. Refer to table 2-5 for specification of hydraulic fluid. See figure 2-51 for location of filler valve.

## 2-43. Ground Handling.

Ground handling covers all the essential information concerning movement and handling of the aircraft while on the ground. The following paragraphs give, in detail, the instructions and precautions necessary to accomplish ground handling functions.

**a. Ground Handling Safety Precautions.** Accidents resulting in injury to personnel and damage to equipment can be avoided or minimized by close observance of existing safety standards and recognized ground handling procedures. Carelessness or insufficient knowledge of the aircraft or equipment being handled can be fatal. The applicable technical manuals and pertinent directives should be studied for familiarization with the aircraft, its components, and the ground handling procedures applicable to it, before attempting to accomplish ground handling. The following list of safety practices should be observed at all times to prevent possible injury to personnel and/or damaged or destroyed aircraft:

- (1) Keep air inlet ducts free of loose articles such as rags, tools, etc.
- (2) During ground runup, make sure the brakes are firmly set and wheels are chocked.
- (3) Keep area fore and aft of propellers clear of maintenance equipment.
- (4) When high winds are present, do not unlock the control surfaces until prepared to properly operate them.
- (5) Do not operate engines while towing equipment is attached to the aircraft.
- (6) Hold control surfaces in the neutral position when the engines are being operated at high power settings.

**b. Taxiing.** Taxiing shall be in accordance with Chapter 8.



MIL-L-23699 ABOVE -32°C;  
MIL-L-7808 BELOW -32°C.  
TANK CAPACITY 4.2 US GAL.;  
USEABLE 2.5 US GAL. OIL,  
EXPANSION SPACE 1.7 US GAL.  
**ENGINE OIL TANK FILLER CAP**

**A**



FILL WITH  
MIL-H-5606 ONLY

(HYDRAULIC FLUID) SPEC MIL-H-5606 CAPACITY 8.5 QUARTS  
**PROPELLER OIL FILLER CAP**

**B**



EMERGENCY OXYGEN SPEC MIL-O-27210  
PRESSURE 1800 TO 2000 PSI  
OXYGEN BOTTLE CAPACITY 22.5 CU IN. EA  
BOTH SEATS  
**EMERGENCY OXYGEN BOTTLE PRESSURE GAGE**

**C**

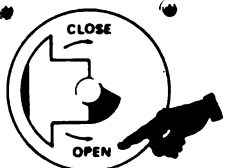

WINDSHIELD WASHER—FILL WITH  
WATER OR ALCOHOL MIL-F-5566  
(ISOPROPYL), MIL-A-6091 (ETHYL) CAP. 3.0 GAL

WINDSHIELD ANTI-ICING FLUID MIL-F-5566  
SUPERSEDED BY SPEC TT-1-735 (ISOPROPYL  
ALCOHOL); OR SPEC O-M-232, GRADE A  
(METHYL ALCOHOL) MIL-A-6091 (ETHYL ALCOHOL), OR  
WINDSHIELD WASH FLUID 100% WATER,  
TANK CAPACITY 3.0 US GAL

**WINDSHIELD WASH AND ANTI-ICE TANK FILLER CAP**

**D**

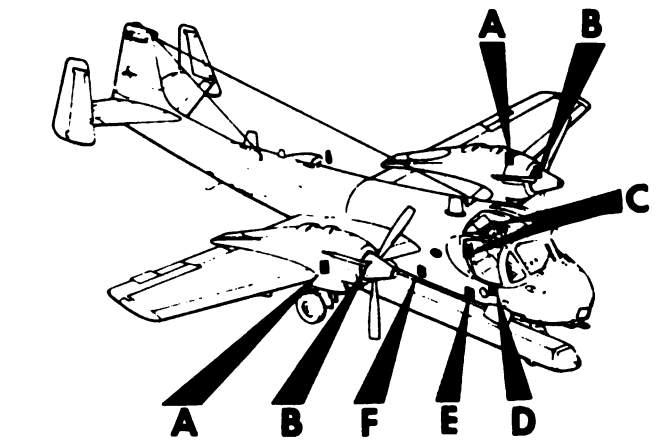
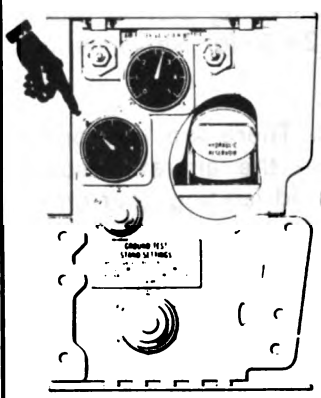
HYDRAULIC SYSTEM  
ACCUMULATOR AND  
LANDING GEAR EMERGENCY  
AIR BOTTLE. USE DRY AIR OR  
NITROGEN MIL-N-6011.

HYDRAULIC FLUID SPEC MIL-H-83282 SYSTEM CAPACITY 6.5  
US GAL RESERVOIR CAPACITY 2.6 US GAL.  
**HYDRAULIC SYSTEM AND EMERGENCY LANDING GEAR  
PNEUMATIC SYSTEM SERVICING STATION**

**E**

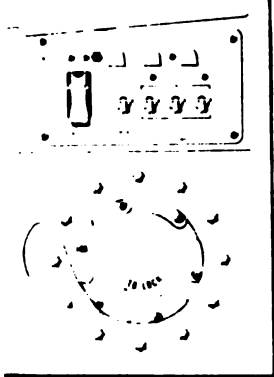

FUEL SPEC MIL-T-5624 MAIN TANK CAPACITY 297 US GAL,  
DROP TANK CAPACITY 150 US GAL EA.  
**PRESSURE FUELING STATION**

**F**

C-2-10-D-62-1

Figure 2-51. Servicing Diagram (Sheet 1 of 3)

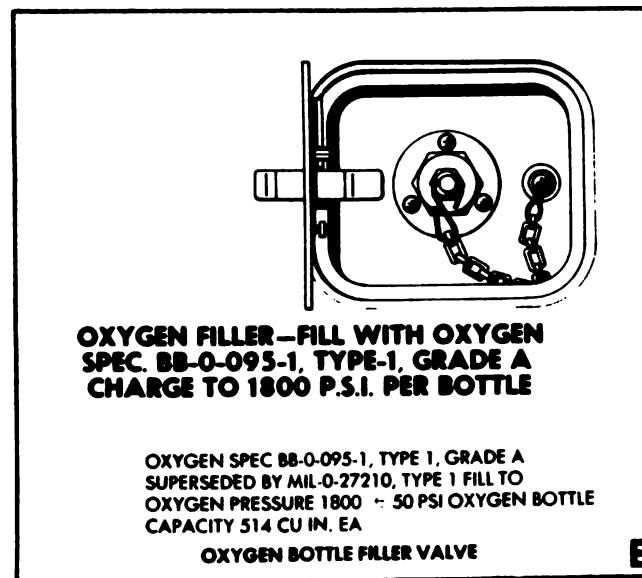
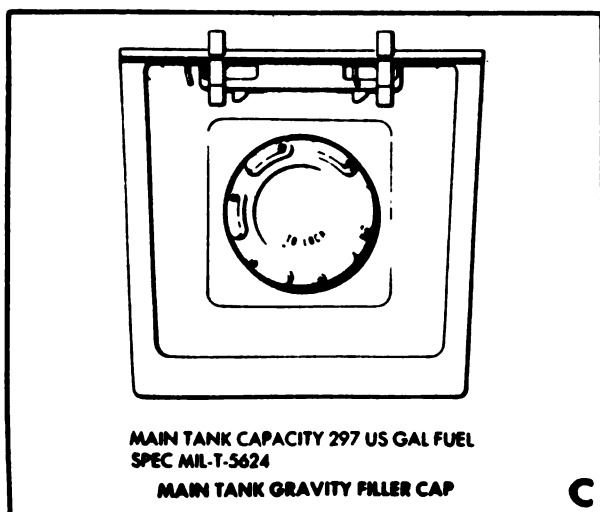
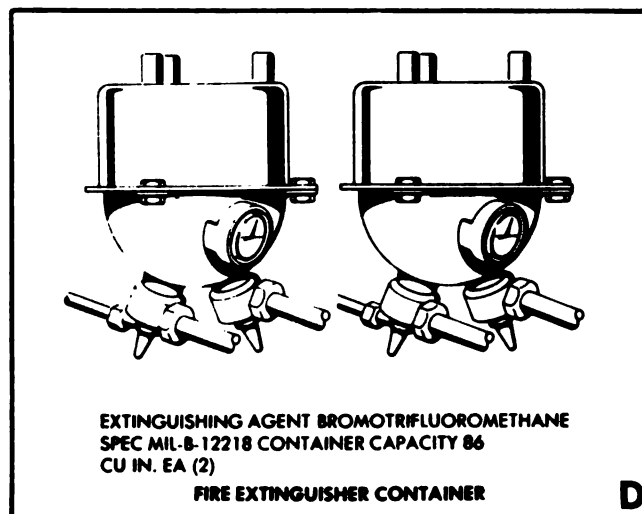
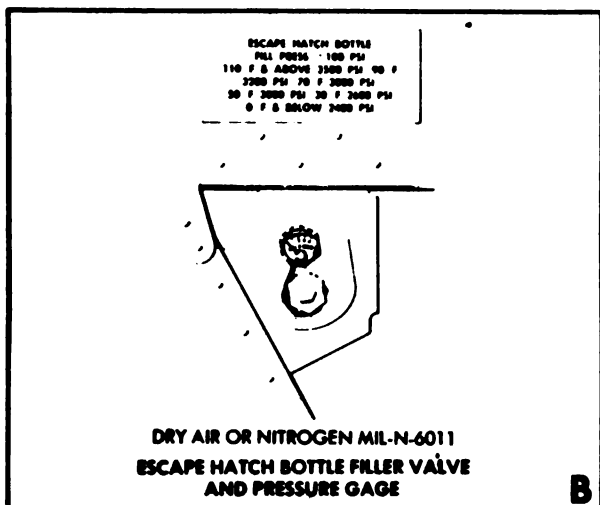
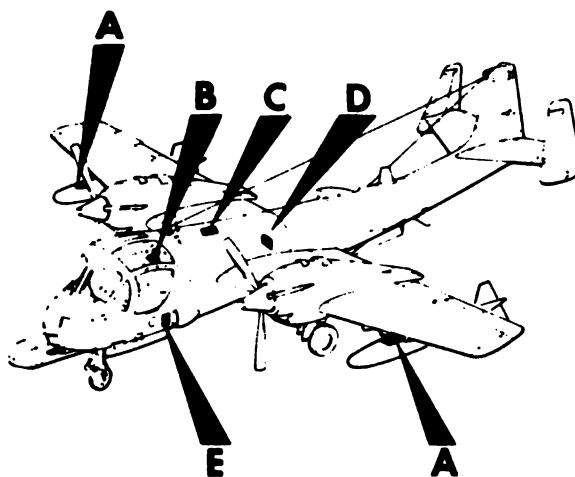
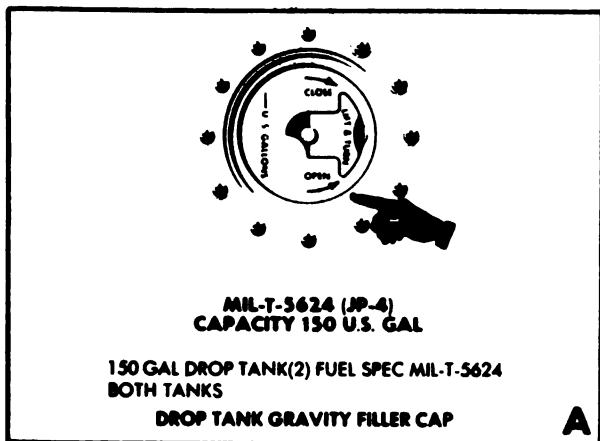

B-2-10-D-52-2

Figure 2-51. Servicing Diagram (Sheet 2 of 3)



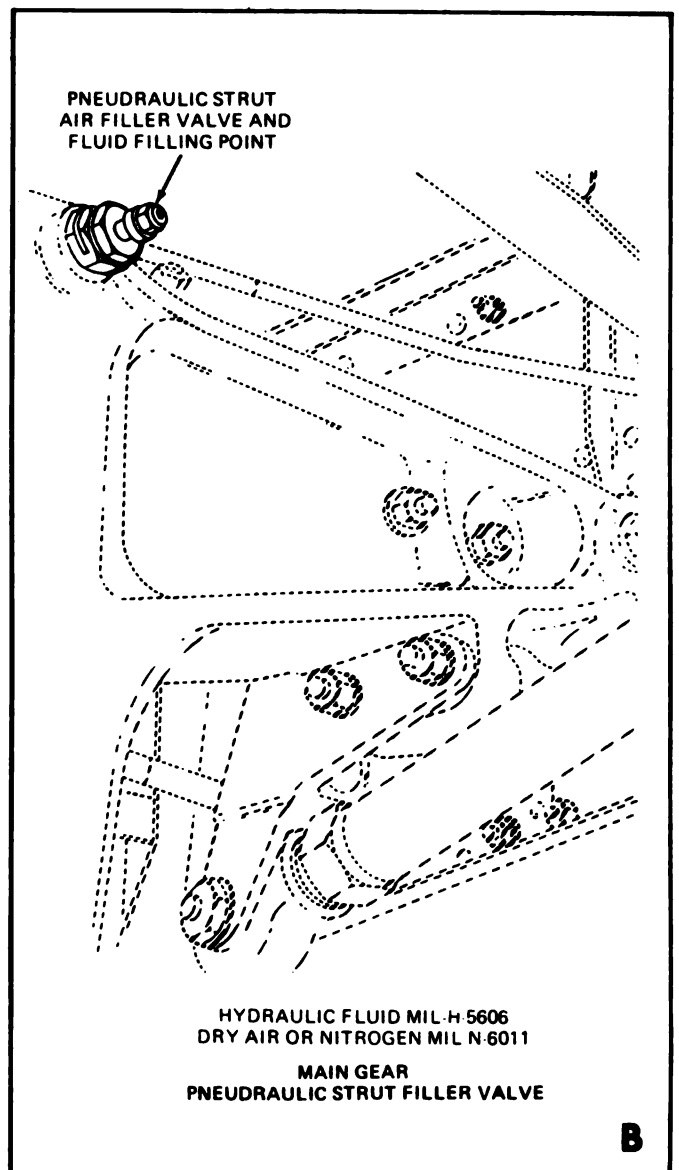
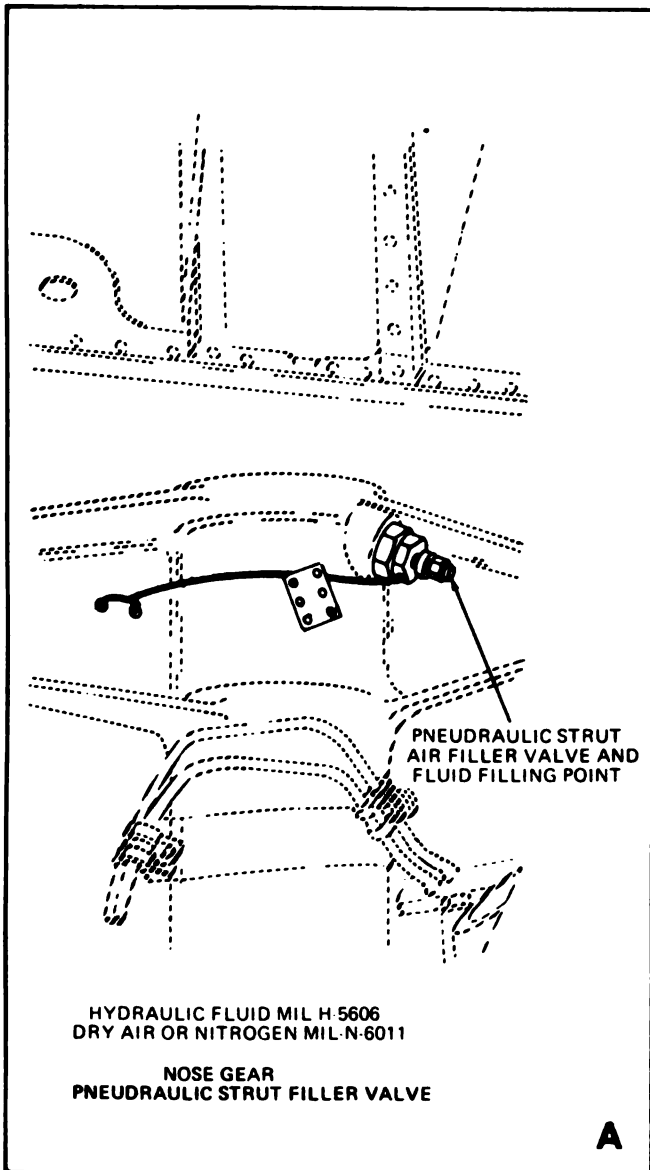
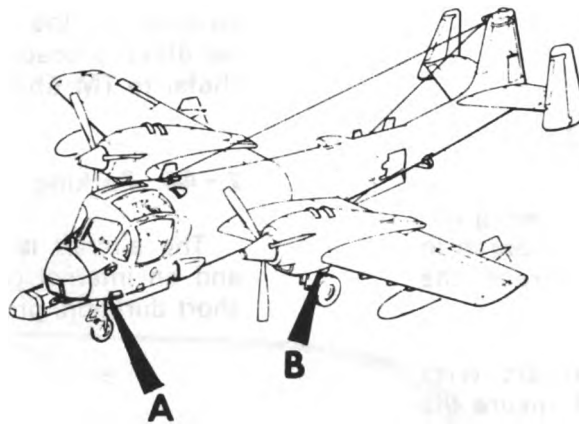

A 2 10 D-52 3

Figure 2-51. Servicing Diagram (Sheet 3 of 3)



*c. Towing.*

**CAUTION**

At all times during the towing operation, there shall be a person in the pilot's seat to operate the brakes.

Before towing an aircraft with SLAR antenna installed, insure the nose landing gear shock strut and nosewheel tire have been serviced properly. If strut and tire are not serviced properly, tow bar may strike SLAR antenna when aircraft is towed over a bump or up a slope while making a right turn.

Parking brakes shall be off before attempting to tow the aircraft.

When towing the aircraft, do not exceed the maximum tow limits as indicated on nosewheel doors or the maximum allowable nosewheel turning radius (figure 2-5). Exceeding turning radius will cause torque collar stops to fail.

Towing is done by attaching a standard aircraft towing bar to the fitting on the fork of the nosewheel landing gear (figure 2-55). The towing fittings receive the hooks on the end of the towing bar. No special pins or attaching hardware are required.

*d. Ground Handling Under Extreme Weather Conditions.* Extreme weather conditions necessitate particular care in ground handling of the aircraft. In hot, dry, sandy, desert conditions, special attention must be devoted to finding a firmly packed parking and towing area. If such areas are not available, steel mats or an equivalent solid base must be provided for these purposes. In wet, swampy areas, care must be taken to avoid bogging down the aircraft. Under cold, icy, arctic conditions, additional mooring is required, and added precautions must be taken to avoid skidding during towing operations. The particular problems to be encountered under adverse weather conditions and the special meth-

ods designed to avoid damage to the aircraft are covered by the various phases of the ground handling procedures included in this section. (Refer to TM 55-1500-204-25/1.)

**2-44. Parking.**

The aircraft is equipped with parking brakes and an internal gustlock system. For parking of short duration, proceed as follows:

**CAUTION**

Propellers shall be prevented from windmilling during high wind by installing engine covers (figure 2-53) or by securing one propeller blade with standard tie-down rope to landing gear mooring rings.

a. When practical, head the aircraft into the wind, especially if strong winds are forecast or if it will be necessary to leave the aircraft overnight.

b. Set the parking brakes. If chocks are available, chock all wheels fore and aft (figure 2-55). After wheels are chocked, release the parking brakes.

c. Set the gustlock system (figure 2-6).

d. Install protective covers and ground safety locks and pins (figures 2-53 and 2-54).

**2-45. Aircraft Covers and Ground Safety Locks.**

Protective covers (figure 2-53) should be in place to protect the various components of the aircraft when it is either parked or moored. In addition, to prevent possible injury to personnel and/or damage to the aircraft, ground safety locks and pins should be installed whenever the aircraft is either parked or moored (figures 2-53 and 2-54). The ground safety locks and pins are stored in a canvas bag on the no. 2 midsection equipment compartment access door.

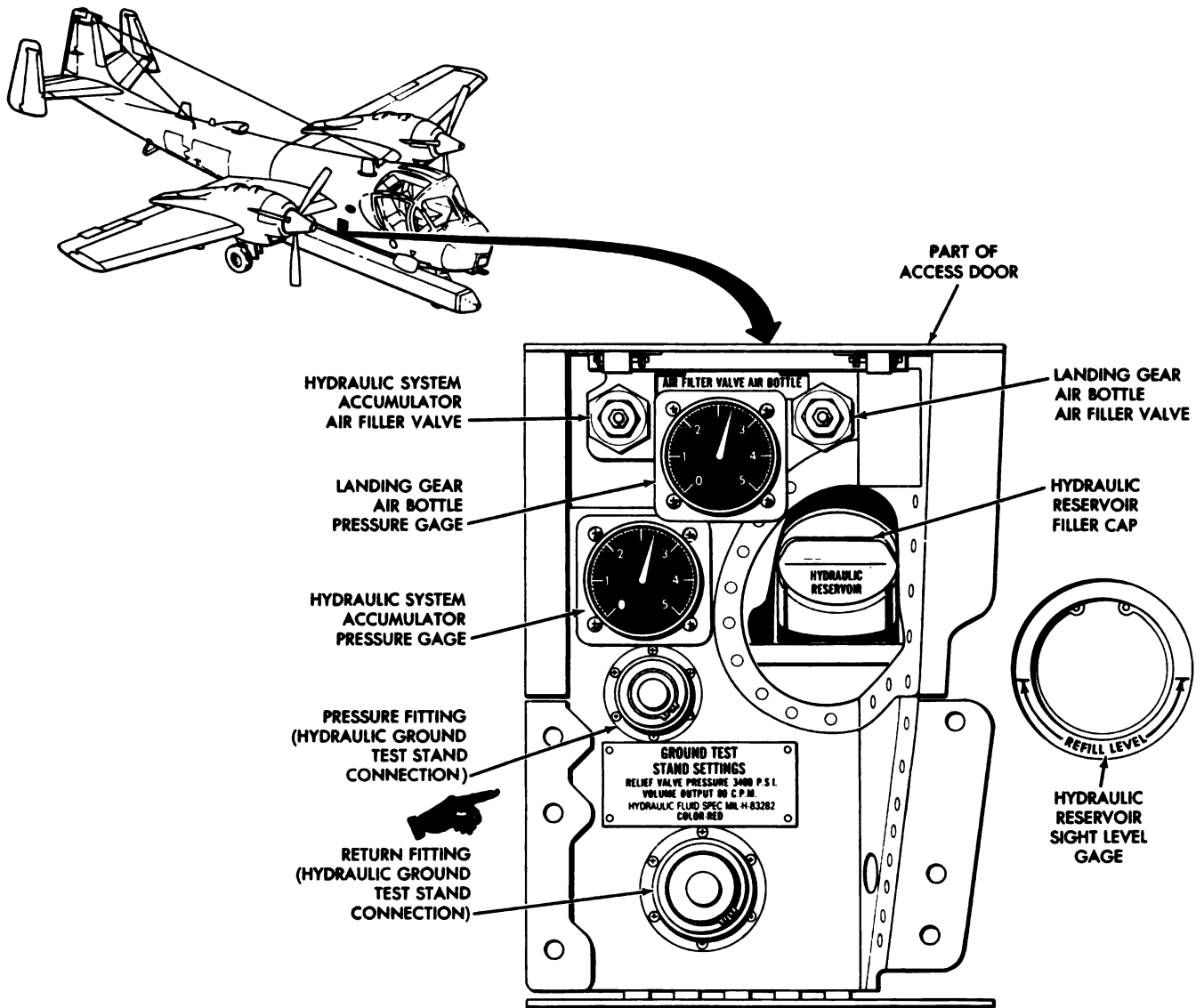

**EMERGENCY LANDING GEAR  
AIR BOTTLE CHARGING PRESSURES**

TEMPERATURE		PRESSURE ±100 PSIG
°C	°F	
43.0 and above	110 and above	3500
32.2	90	3200
21.1	70	3000
10.0	50	2800
-1.1	30	2600
-17.8 and below	0 and below	2400

**HYDRAULIC SYSTEM ACCUMULATOR  
CHARGING PRESSURES**

TEMPERATURE		PRESSURE ±100 PSIG
°C	°F	
43.0 and above	110 and above	2250
32.2	90	2100
21.1	70	2000
10.0	50	1850
-1.1	30	1750
-17.8 and below	0 and below	1600

A-2-10-D-53

**Figure 2-52. Hydraulic System and Emergency Landing Gear Pneumatic System Servicing Station**

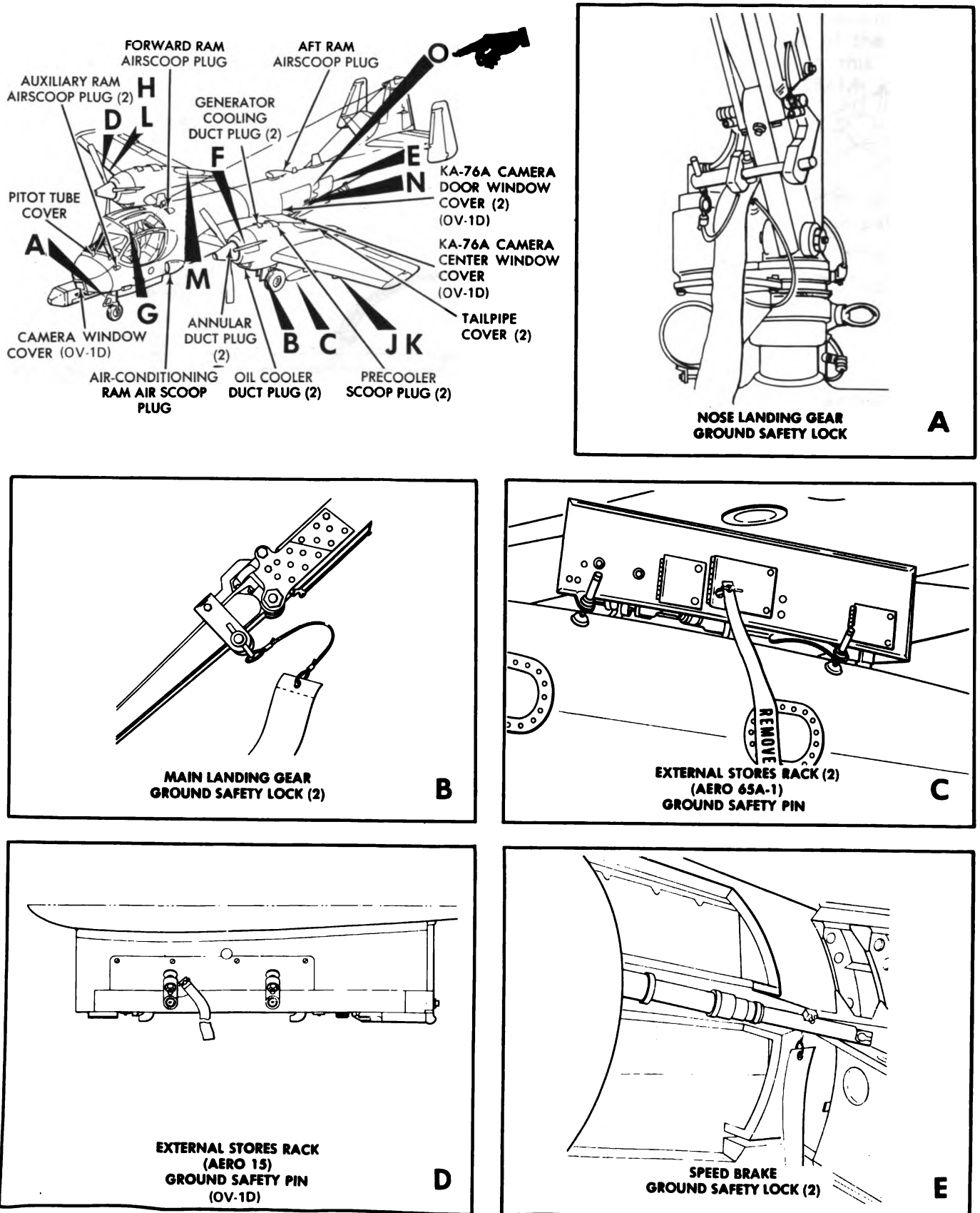

D-2-10-D-54-1

Figure 2-53. Ground Safety Locks and Pins; and Protective Covers and Plugs (Sheet 1 of 4)

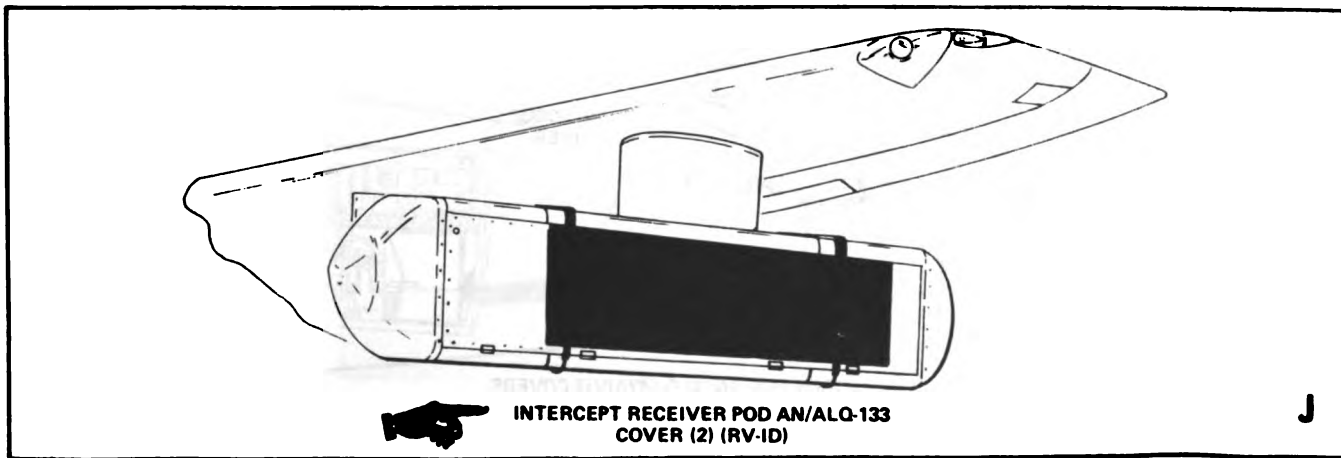
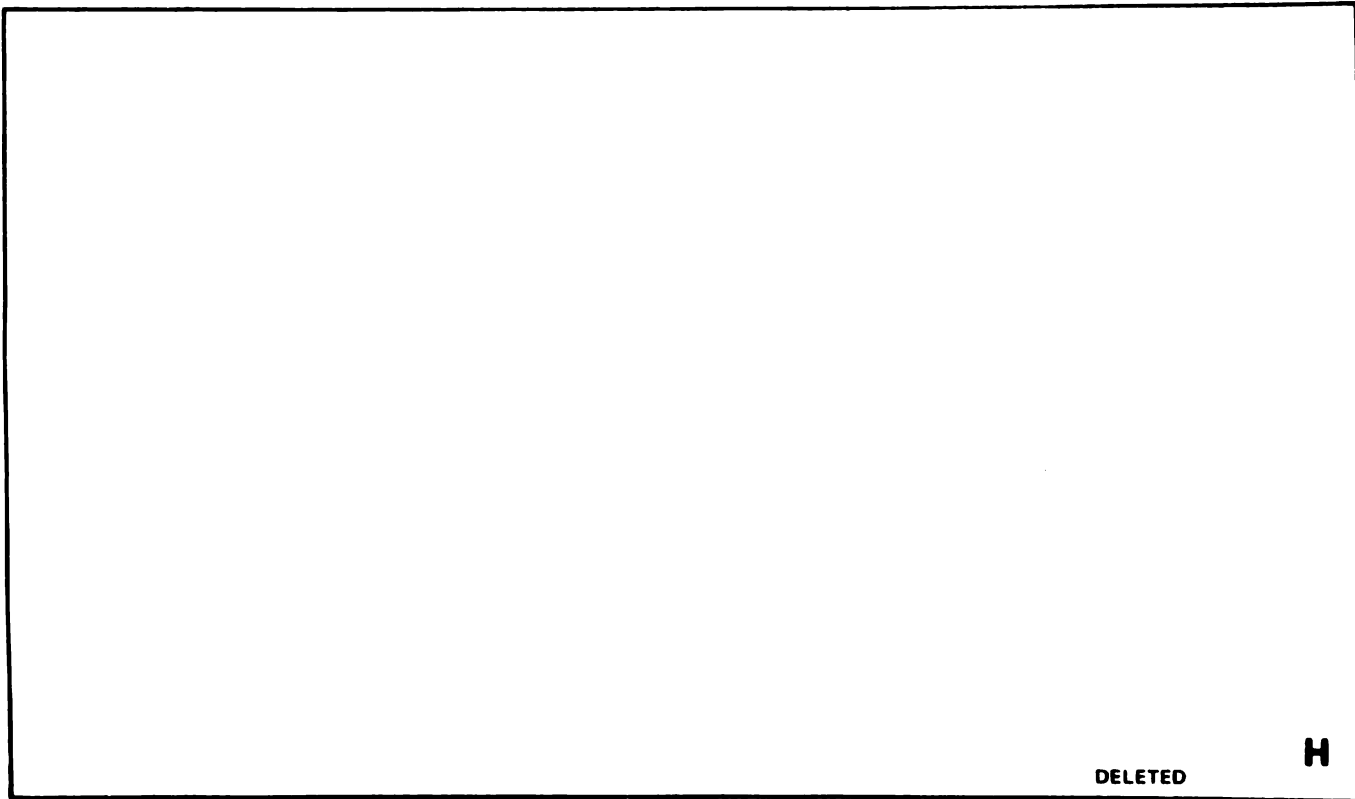
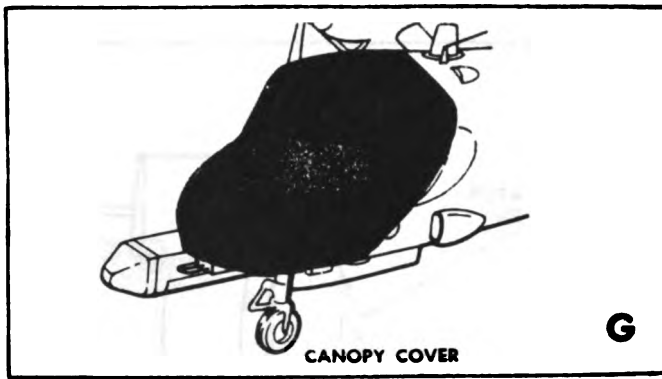
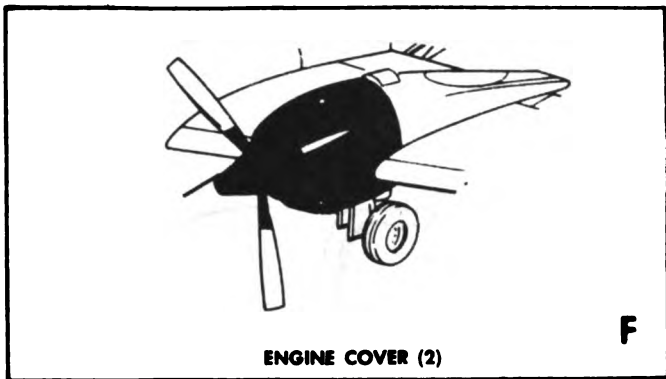

E-2-10-D-64-2

Figure 2-53. Ground Safety Locks and Pins; and Protective Covers and Plugs (Sheet 2 of 4)

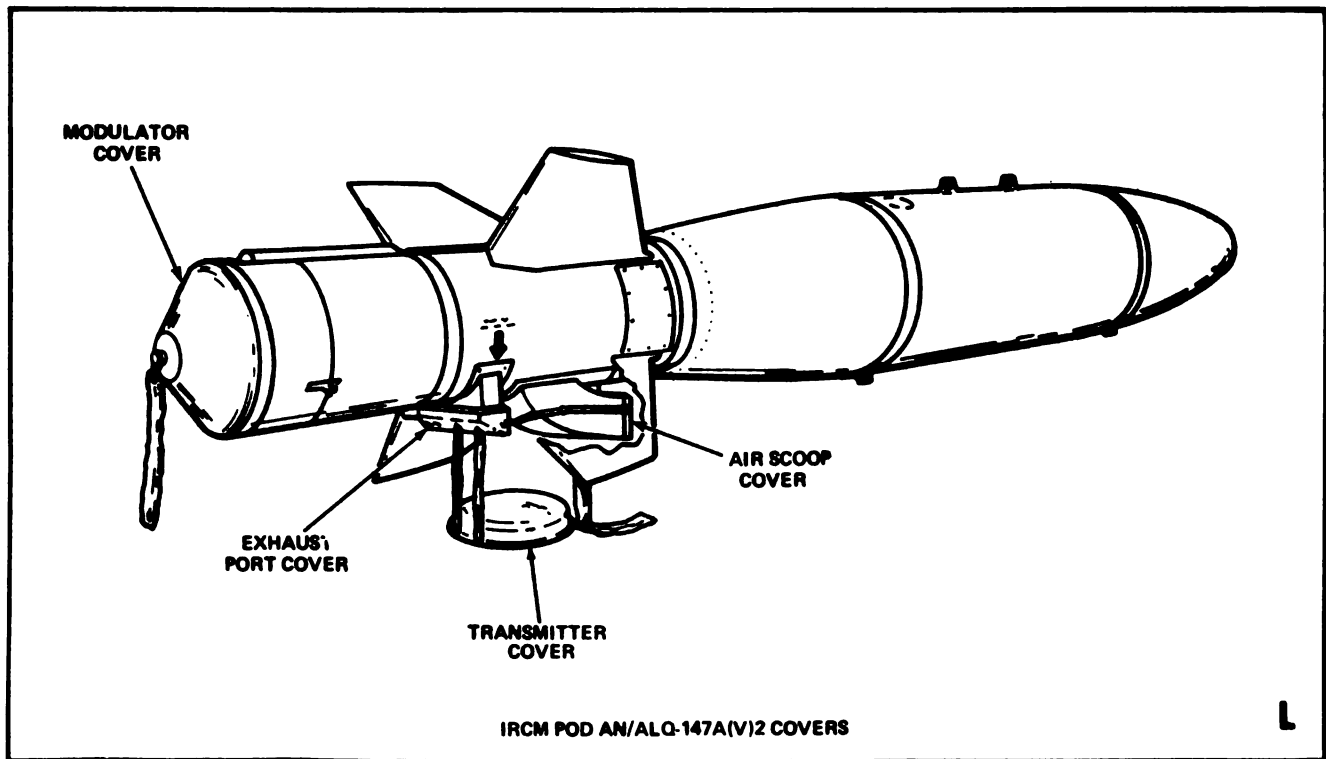
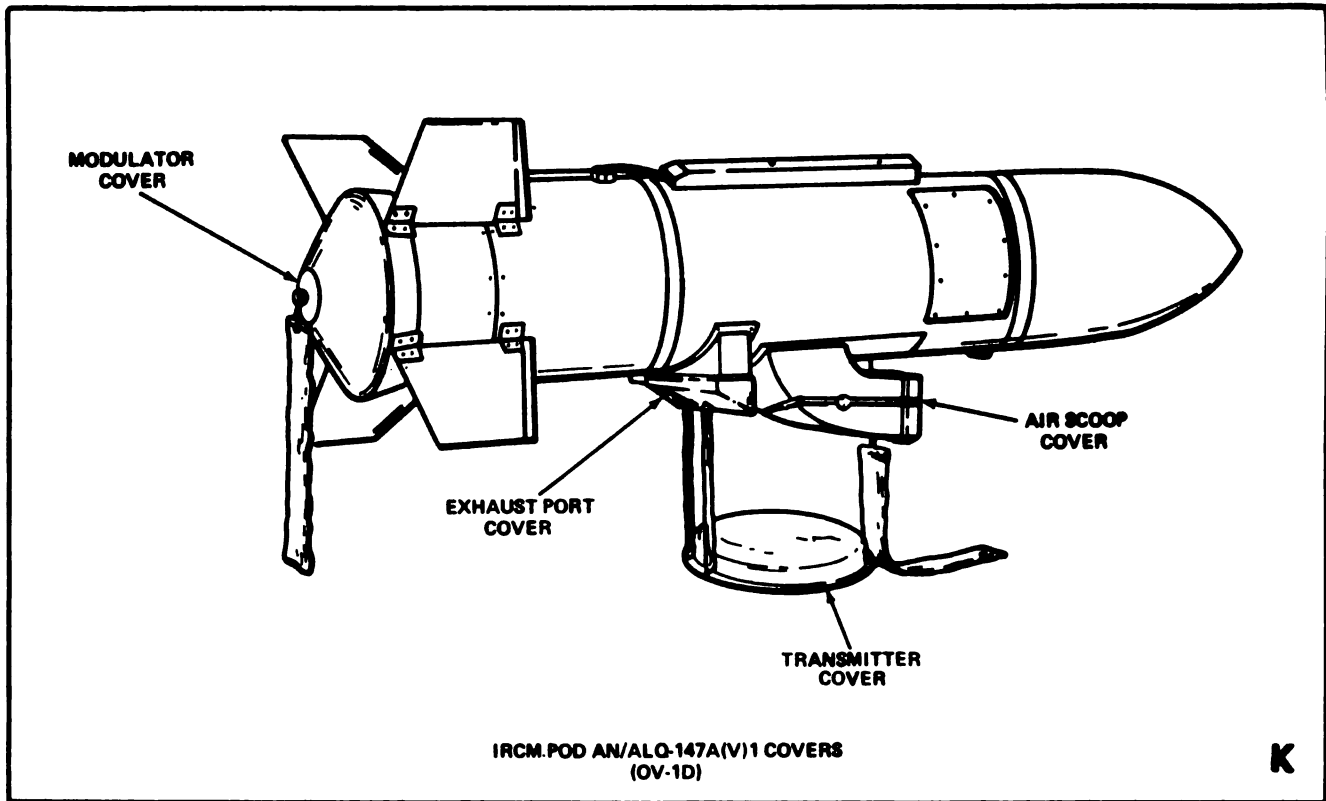

A-2-10-D-84-3

Figure 2-53. Ground Safety Locks and Pins; and Protective Covers and Plugs (Sheet 3 of 4)

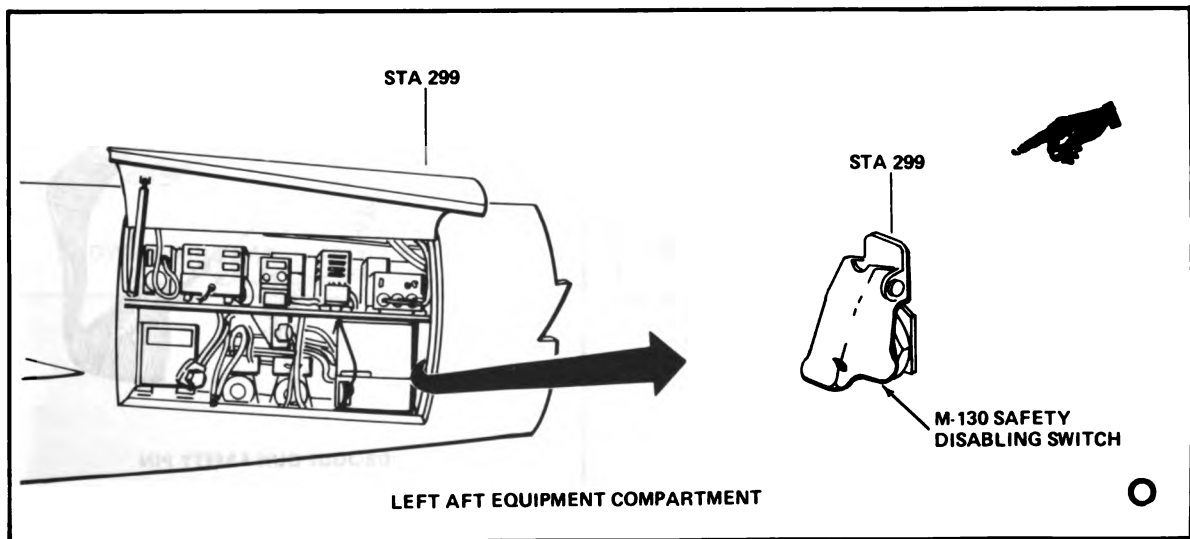
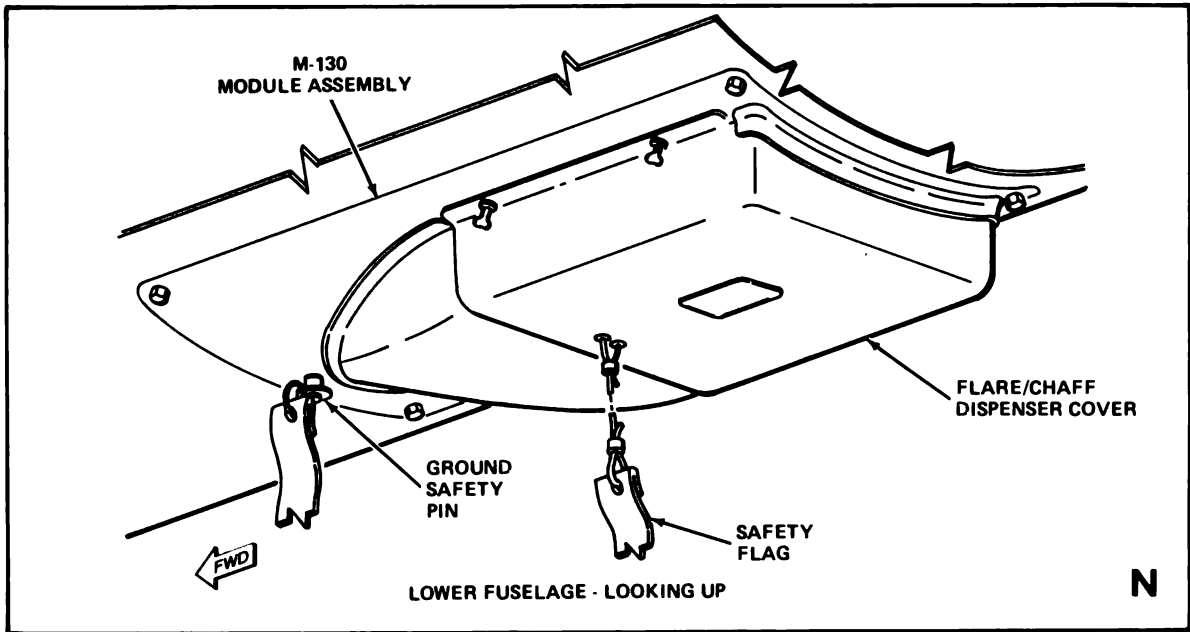
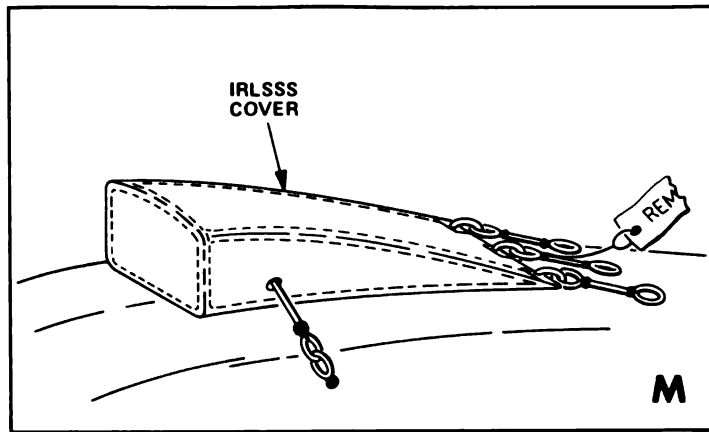

A-2-10-D-544

Figure 2-53. Ground Safety Locks and Pins; and Protective Covers and Plugs (Sheet 4 of 4)

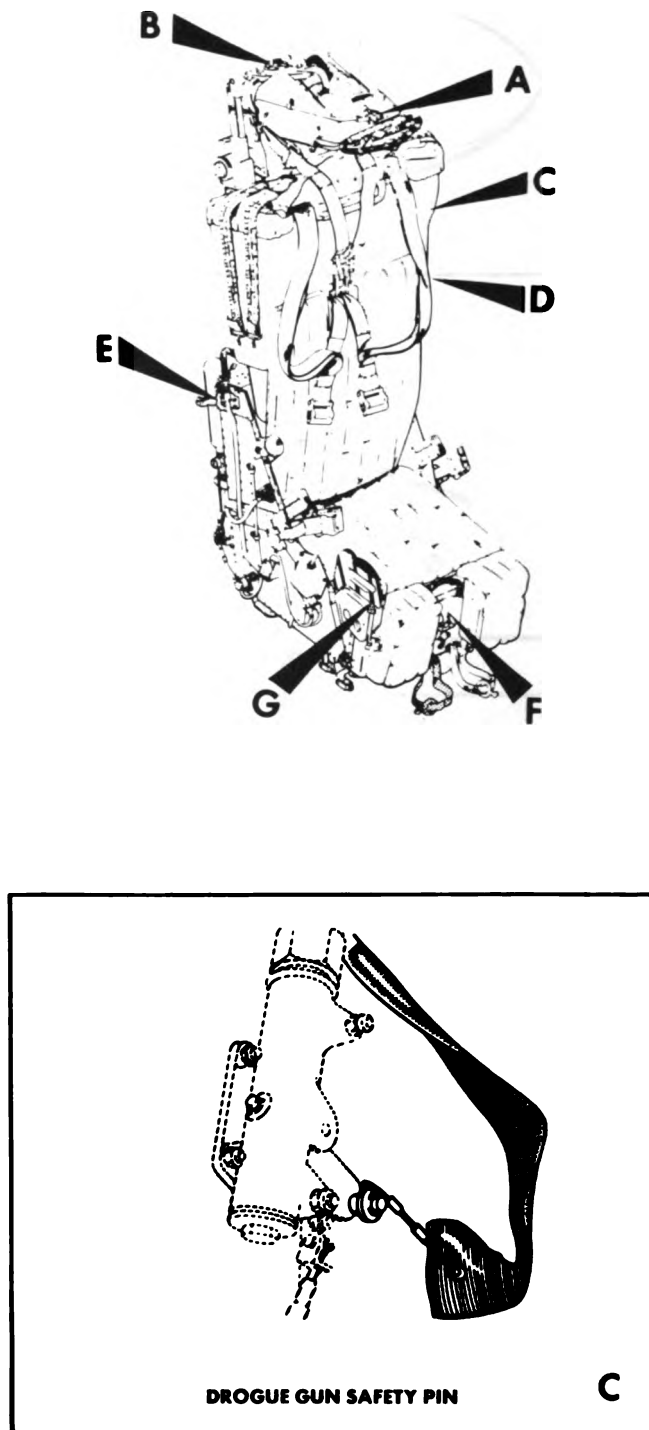
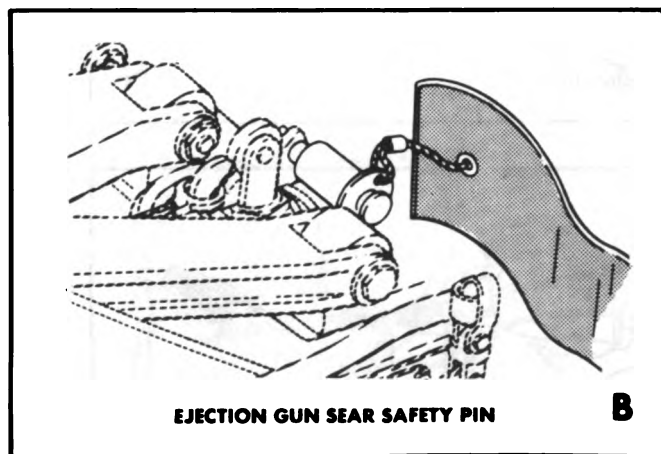
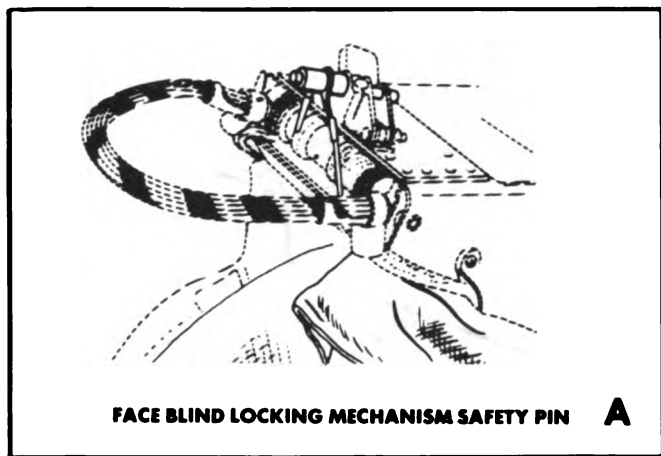

2-10-D-55-1

**Figure 2-54. Ejection Seat Ground Lock Safety Pins (Sheet 1 of 2)**

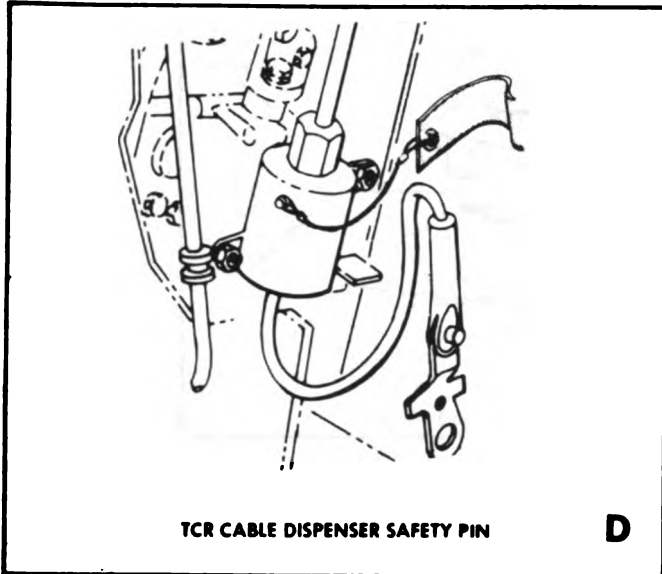

**NOTE**  
THE SAFETY PINS ARE PART OF THE FOLLOWING:  
MARTIN BAKER EJECTION SEAT GROUND SAFETY  
LOCK  
TCR CABLE DISPENSER SAFETY PIN

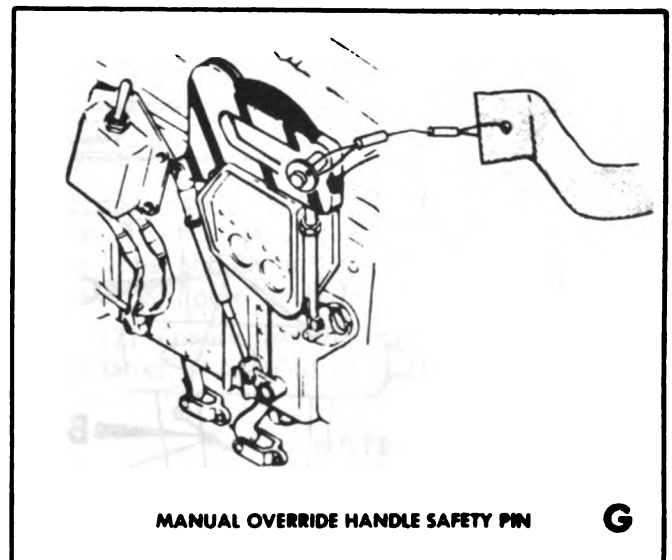
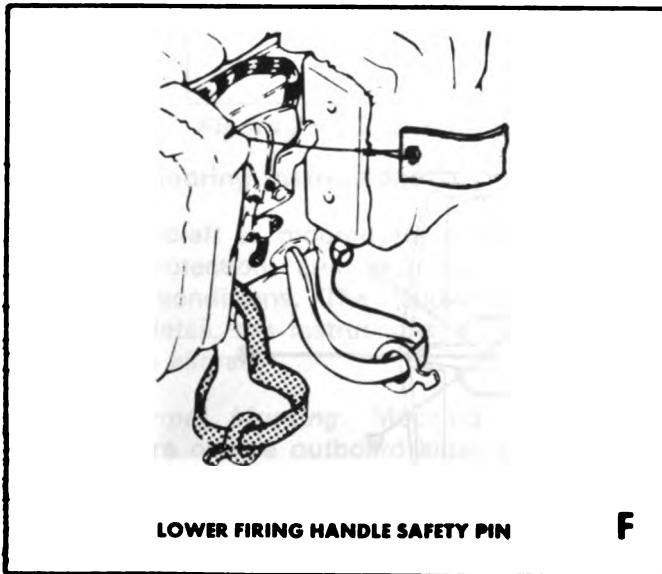
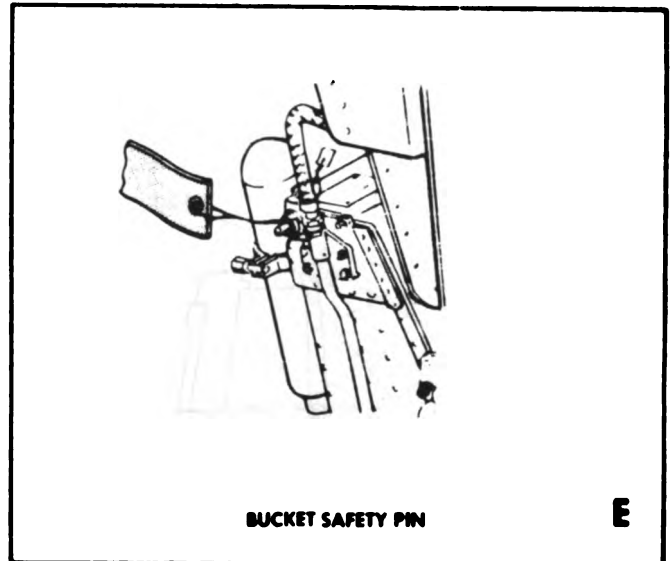

**Figure 2-54. Ejection Seat Ground Lock Safety Pins (Sheet 2 of 2)**

A 2-10-D-55-2



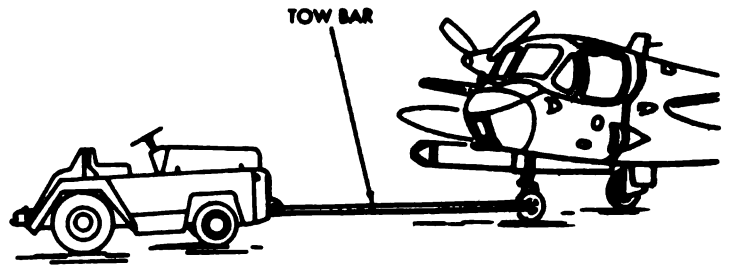
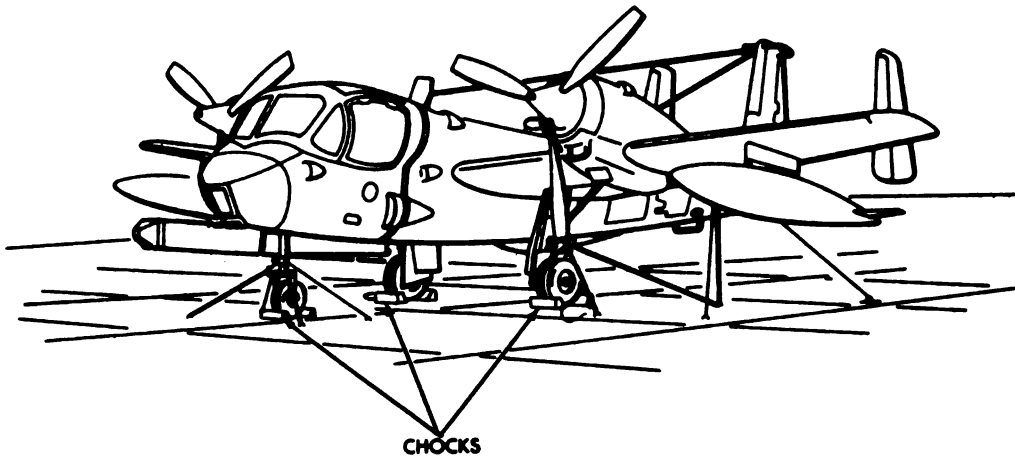

TOWING

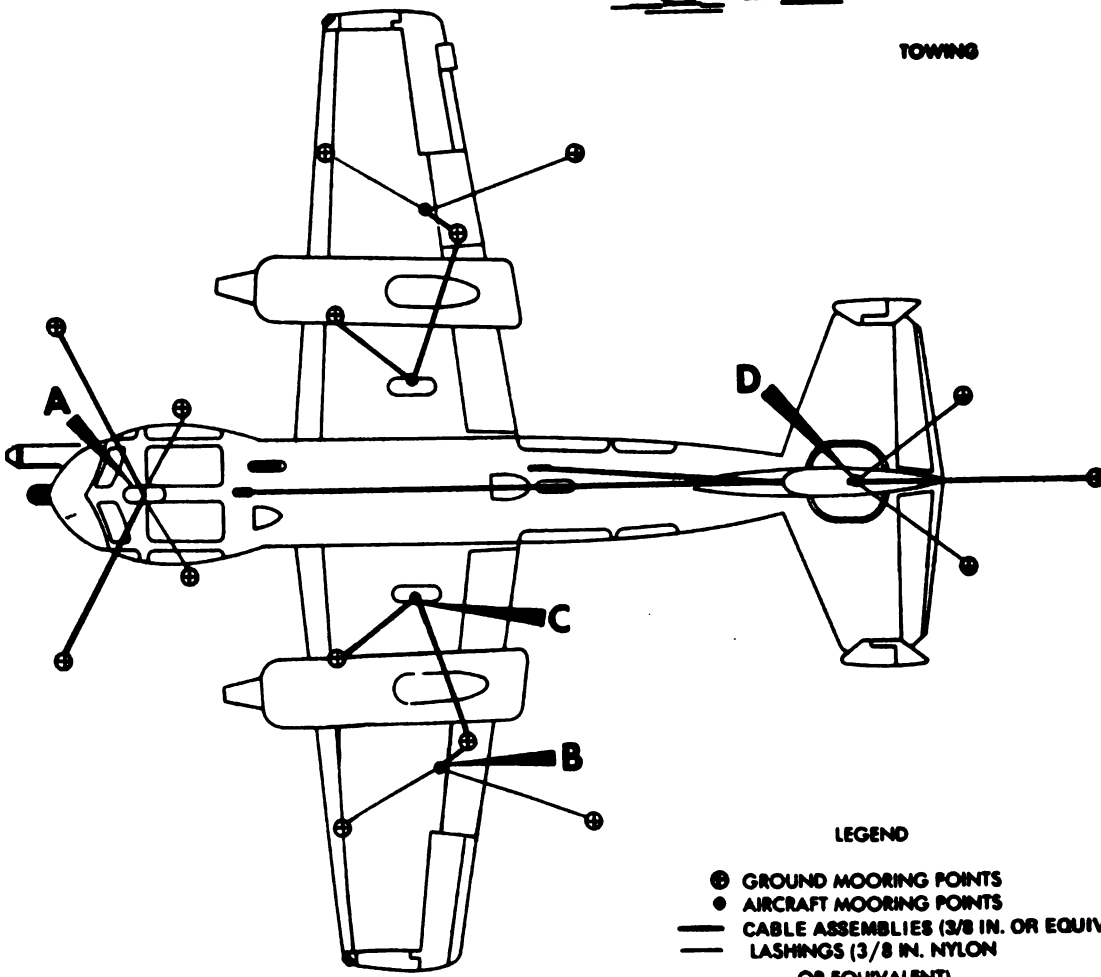

A 2-10-D-88-1

Figure 2-55. Ground Handling, Parking, and Mooring Diagram (Sheet 1 of 2)

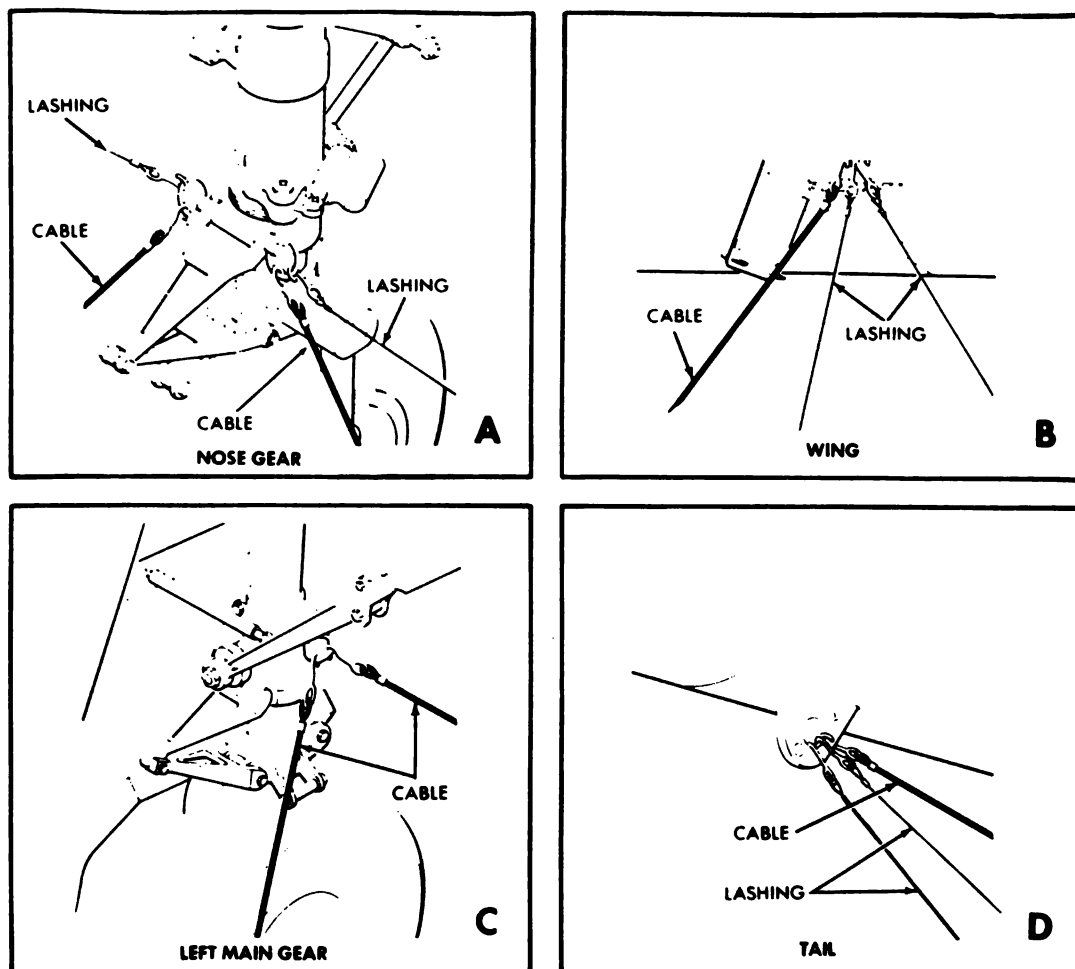

2-10-D-56-2

Figure 2-55. Ground Handling, Parking, and Mooring Diagram (Sheet 2 of 2)

## 2-46. Mooring Instructions.

The aircraft is moored to insure its immovability, protection, and security under various weather conditions. The following paragraphs give, in detail, the instructions for proper mooring of the aircraft.

*a. Normal Mooring.* Mooring rings (figure 2-55) are on the outboard sides of both main landing gear struts and the bottom side of each wing. In addition, a hole is provided in the tail skid for rear tiedown. For maximum protection and safety of the aircraft, the following details of aircraft security apply at all times:

- (1) Perform parking instructions as stated in paragraph 2-44.
- (2) Space and arrange mooring lines to afford maximum security in all directions.
- (3) Avoid excessive line slack to prevent fore-and-aft, horizontal, lateral, and vertical movement.

*b. High Wind Mooring.* When winds in excess of 50 MPH are anticipated, effort should be

made to evacuate the aircraft to another airfield, out of the path of the high winds, or to park the aircraft within a hangar or other suitable enclosure. If evacuation of the aircraft is impractical and hangar space is not available proceed as follows:

- (1) Moor the aircraft as described in paragraph 2-46a, using steel cable where shown by dark lines and nylon lashings where shown by light lines (figure 2-55).
- (2) Ensure that the main fuel cell and wing drop tanks, if installed, are full.

### NOTE

*If possible, trucks or other heavy duty vehicles should be parked around the aircraft to form a windbreak.*

- (3) After high winds, inspect aircraft for visible signs of structural damage and for evidence of damage from flying objects.



## CHAPTER 3

# AVIONICS

### SECTION I. GENERAL

#### 3-1. General.

a. This chapter covers the avionic equipment configuration installed in Army Model OV-1D and RV-1D aircraft. It includes a brief description of the equipment, their technical characteristics, capabilities, and location in the aircraft. The chapter also contains complete operating instructions for all avionic equipment installed in the aircraft.

b. Equipment descriptions and operating procedures contained in this chapter are oriented toward the normal operating procedures contained in Chapter 8. For more technical information, refer to the references listed in Appendix A.

c. The avionic equipment installed in the aircraft may vary among different serial numbered aircraft; moreover, equipment for which installation provisions are provided may not always be installed. No attempt is made to specify the exact combinations of equipment in a particular aircraft, since these combinations are dependent on aircraft mission and equipment availability. All unclassified avionic equipment for which complete provisions are made are described in this Chapter. Antenna locations for the avionic equipment are shown in figure 3-1.

d. Information pertaining to avionic systems installed in the aircraft that are classified are not covered in detail in this manual. Refer to the Operator's Manual Classified Supplement, TM 55-1510-213-10/1, for coverage of these systems. Mission avionics are covered in Chapter 4.

#### NOTE

*Transmission on emergency frequencies (guard channel) shall be restricted to emergencies only.*

#### 3-2. Electronic Equipment Configuration.

a. *Communication Equipment.* The communication equipment configuration consists of the ICS, UHF, VHF, FM, and HF systems used to provide CW and radio-telephone communication.

b. *Navigation Equipment.* The navigation equipment configuration consists of the ADF set, compass system, glide slope and marker beacon receiver, flight director system, VOR set, TACAN, INS, and autopilot. These systems provide the pilot with the instrumentation required to establish and maintain an accurate flight course and position, and to safely make an approach under IMC conditions.

c. *Transponder and Radar Equipment.* The transponder and radar equipment configuration consists of the transponder (IFF) set, altimeter-encoder, and radar altimeter.

#### 3-3. Power Supply.

Electrical power for operation of the avionic systems is provided by the aircraft DC and AC power supply systems through the respective aircraft distribution buses. All systems are protected by their associated circuit breakers located on the cockpit and remote circuit breaker panels. Refer to Chapter 2 for a complete description of the DC and AC power systems, and illustrations of the circuit breaker panels.

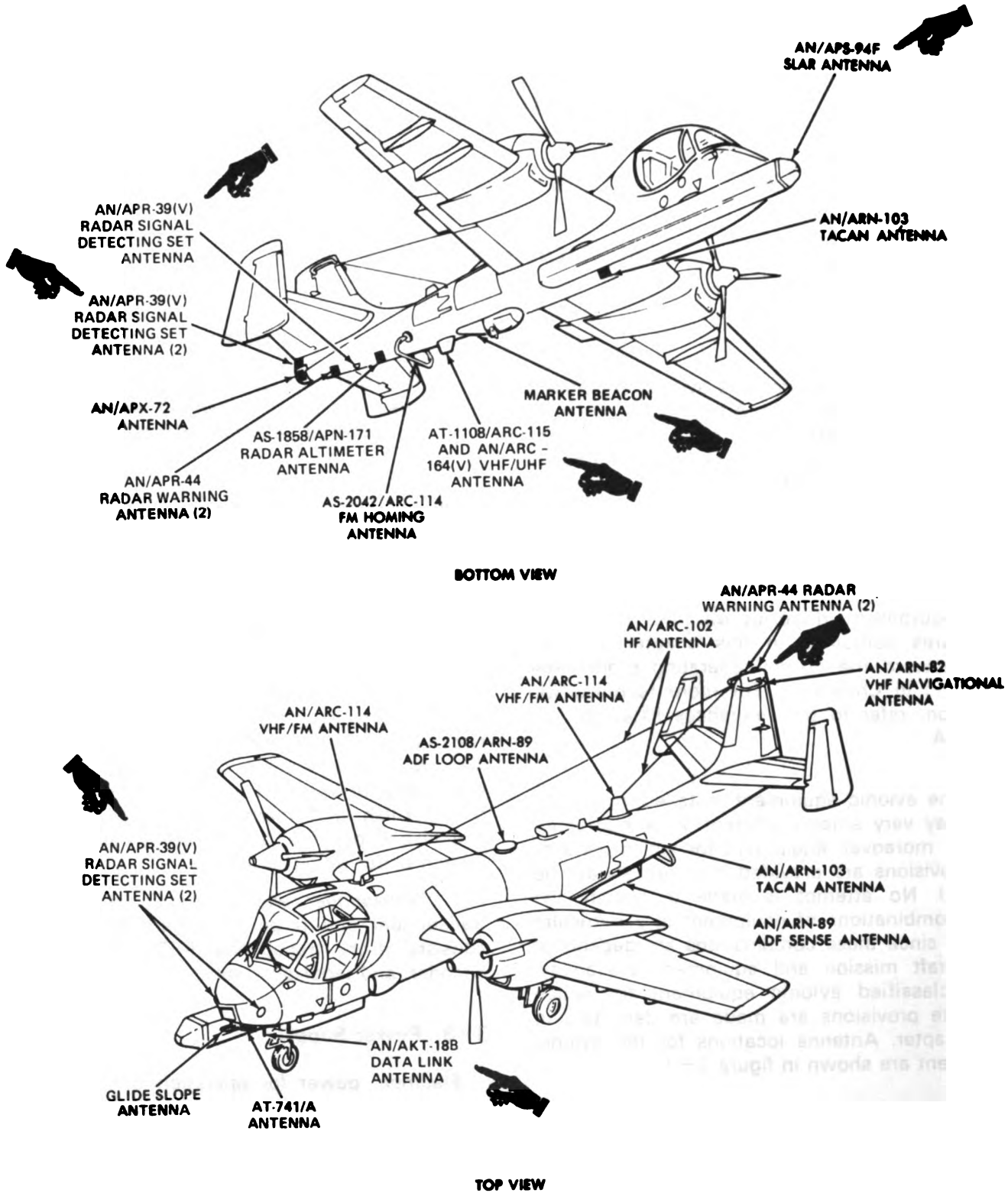

F-3-10D-1-1



Figure 3-1. Antenna Locations (Typical) (Sheet 1 of 2)

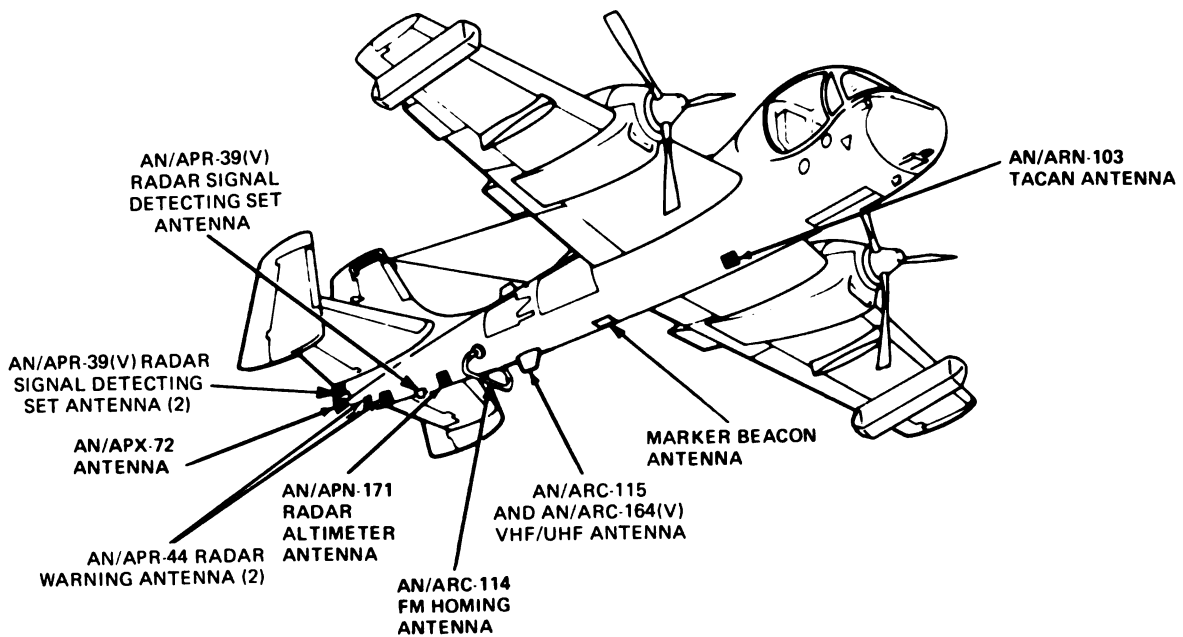
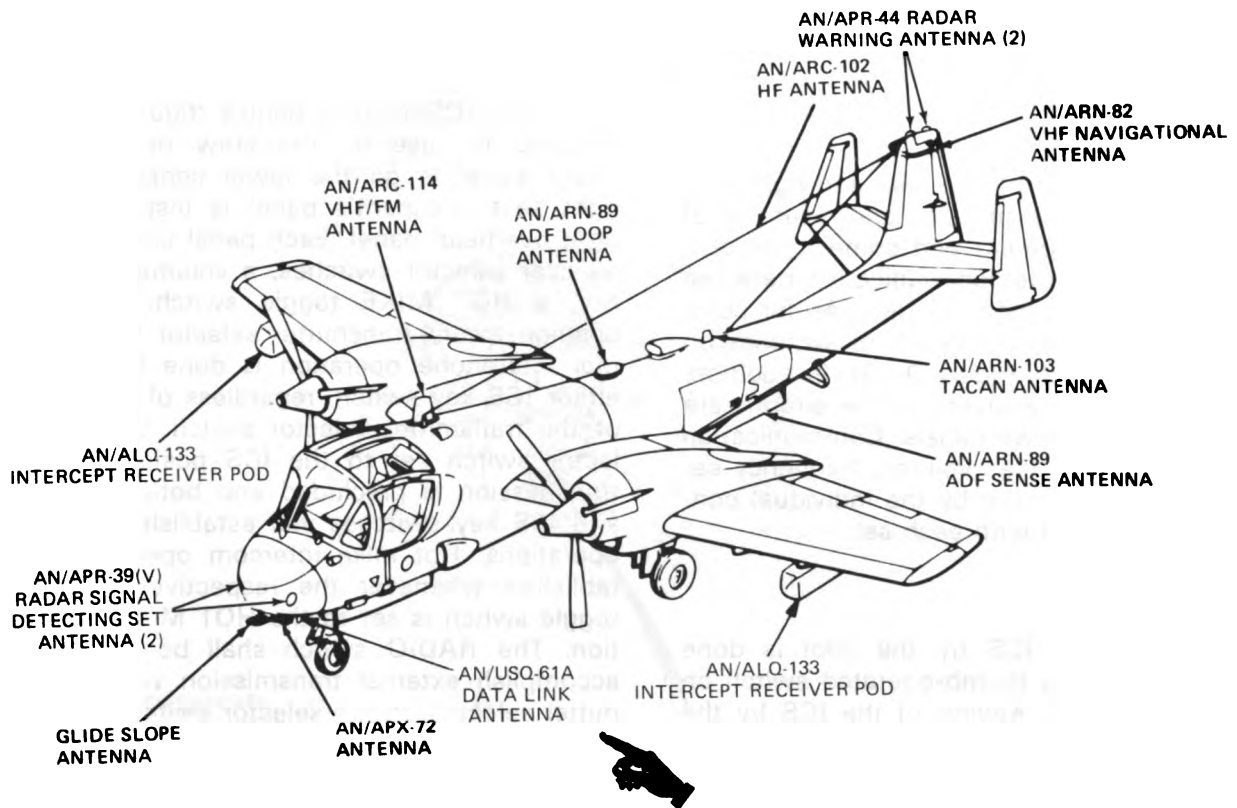

F-3-10-D-1-2

**R** Figure 3-1. Antenna Locations (Typical) (Sheet 2 of 2)

## SECTION II. COMMUNICATIONS

### 3-4. ICS.

a. The ICS is used by the pilot and right seat occupant to select transmission and reception of communication equipment and some navigation equipment, and for intercommunication between crew members. Equipment to be used for communication is selected by means of switches on the ICS control panels (figure 3-2). In addition, all navigation radio receivers in the aircraft are monitored through these panels. Communication equipment operation (i.e., volume, frequency selection, etc.), is controlled by the individual control panels associated with each set.

b. Keying of the ICS by the pilot is done through the use of a thumb-operated switch on the pilot's stick grip. Keying of the ICS by the right seat occupant is done through the use of a foot switch on the cockpit floor, forward of the right seat. Power for the ICS is provided through circuit breakers on the remote circuit breaker panel.

c. Two ICS control panels (figure 3-2) are installed for use by the crew members. The pilot's panel is on the lower console, and the right seat occupant's panel is installed on the right overhead panel. Each panel contains seven receiver selector switches, a volume (VOL) control, a HOT MIKE toggle switch, and a six-position rotary transmitter selector switch. Normal interphone operation is done by operating either ICS key switch, regardless of the position of the transmitter selector switch. With the selector switch set to the ICS position, external transmission is precluded and both the RADIO and ICS key switches will establish normal ICS operations. Hot mike intercom operation is established whenever the respective HOT MIKE toggle switch is set to the HOT MIKE (up) position. The RADIO switch shall be activated to accomplish external transmission via the transmitter selected on the selector switch, regardless of the position of the HOT MIKE toggle switch. ICS function cards, on both sides of the overhead console in the cockpit, indicate switch settings necessary for transmission and reception of particular sets.

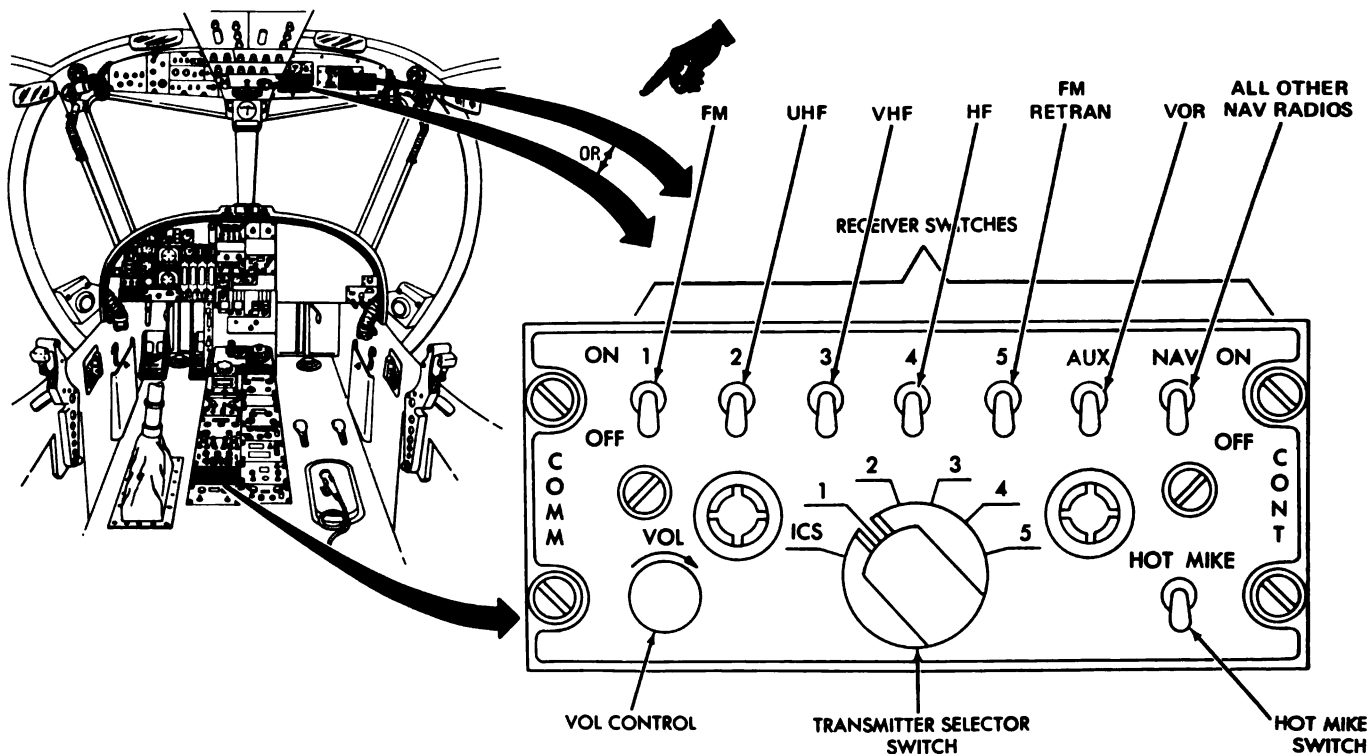

8-3-10-D-2

Figure 3-2. ICS Control Panel (C-6533/ARC)

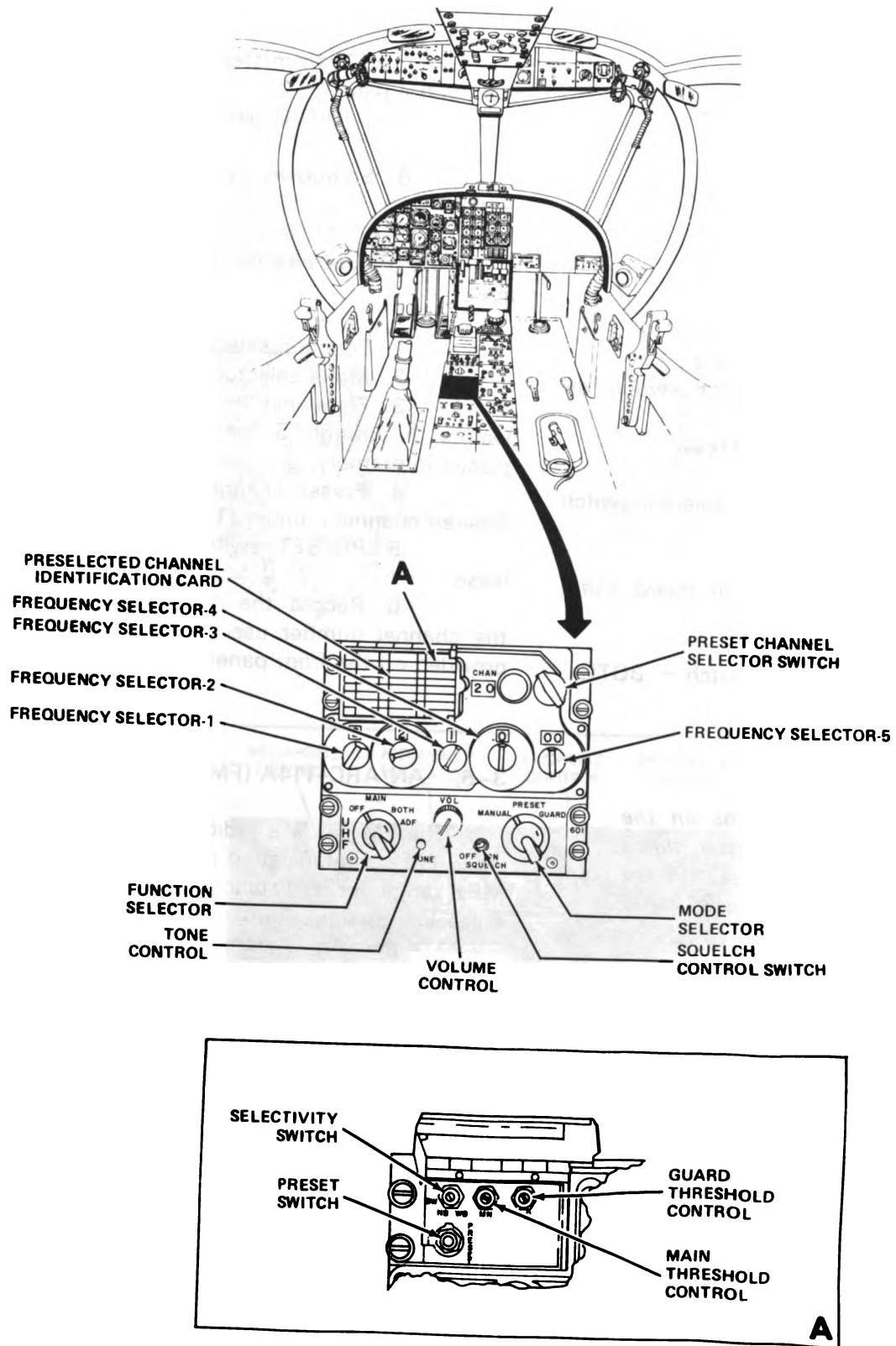

A 3 10 D 3

Figure 3-3. UHF Control Panel (RT-1167/ARC-164(V))



**NOTE**

*To adjust volume control when audio is not being received, set SQUELCH control switch to OFF, adjust volume for a comfortable level, then set OFF ON SQUELCH switch to ON.*

5. Transmit.

- a. TONE switch — Press.
- b. Transmitter selector switch on ICS control panel — 2.
- c. RADIO switch — Press.

6. Shutdown. Function selector switch — OFF.

*(c) Constant monitoring of guard channel.*

- 1. Function selector switch — BOTH.

**NOTE**

*This position (BOTH) turns on the main receiver and transmitter (tuned to the selected frequency) and the guard receiver (tuned to 243.000 MHz).*

- 2. Mode selector switch — MANUAL or PRESET, as desired.

- 3. Frequency — Adjust frequency selectors 1 through 5 for the required operating frequency.

**NOTE**

*This tuning has no effect on guard receiver frequency, the guard frequency is always 243.000 MHz.*

- 4. VOL control — Adjust as desired.

5. Transmit.

- a. Transmitter selector switch on ICS control panel — 2.
- b. RADIO switch — Press.

6. Shutdown. Function selector switch — OFF.

*(d) Preset channel selector memory storage.*

- 1. Function selector switch — MAIN.
- 2. Mode selector switch — PRESET.
- 3. Frequency — Adjust frequency selectors 1 through 5 for the frequency to be placed in memory.
- 4. Preset channel selector switch — Desired channel number (1 through 20).
- 5. PRESET switch — Press and release.
- 6. Record the frequency selected for the channel number used on the function card provided on the front panel (figure 3-3).

3-6. AN/ARC-114A (FM Set).

a. The FM set is a radio transceiver that provides FM communication in the 30.00 to 75.95 MHz range for a distance of approximately 50 miles line-of-sight. Two sets may be installed in OV-1D aircraft; a command FM set and an auxiliary FM set. The command set is used for voice communications and FM homing, and the auxiliary set (if installed) is used as a standby system.

b. The set incorporates a main receiver and a fixed-tuned guard receiver (40.0 to 42.0 MHz), and has an FM homing and retransmission capability. The audio output of the receiver is applied to the ICS where it is made available to the headsets. Power is applied to the set through circuit breakers on the remote circuit breaker panel. Figure 3-4 illustrates the control panels and shows their location in the cockpit. The associated antennas are shown in figure 3 1.

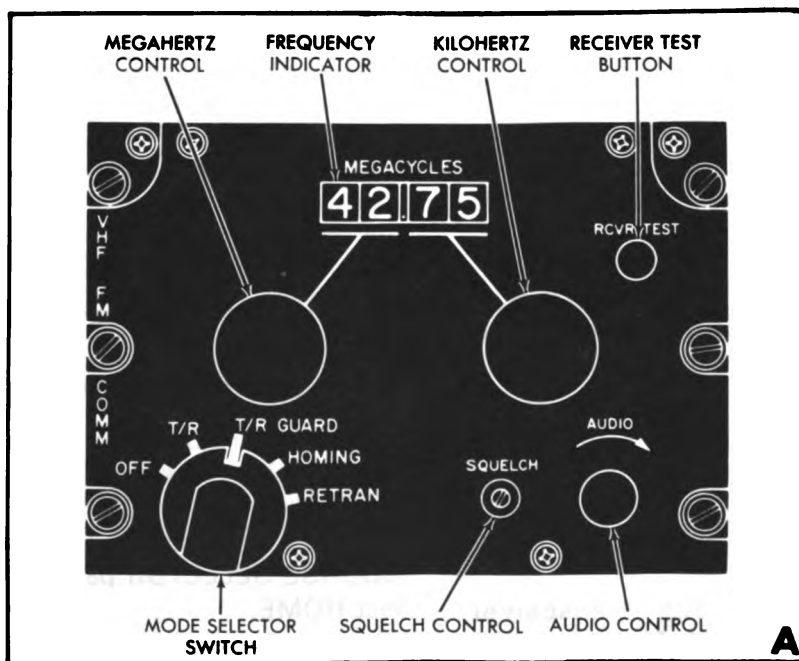
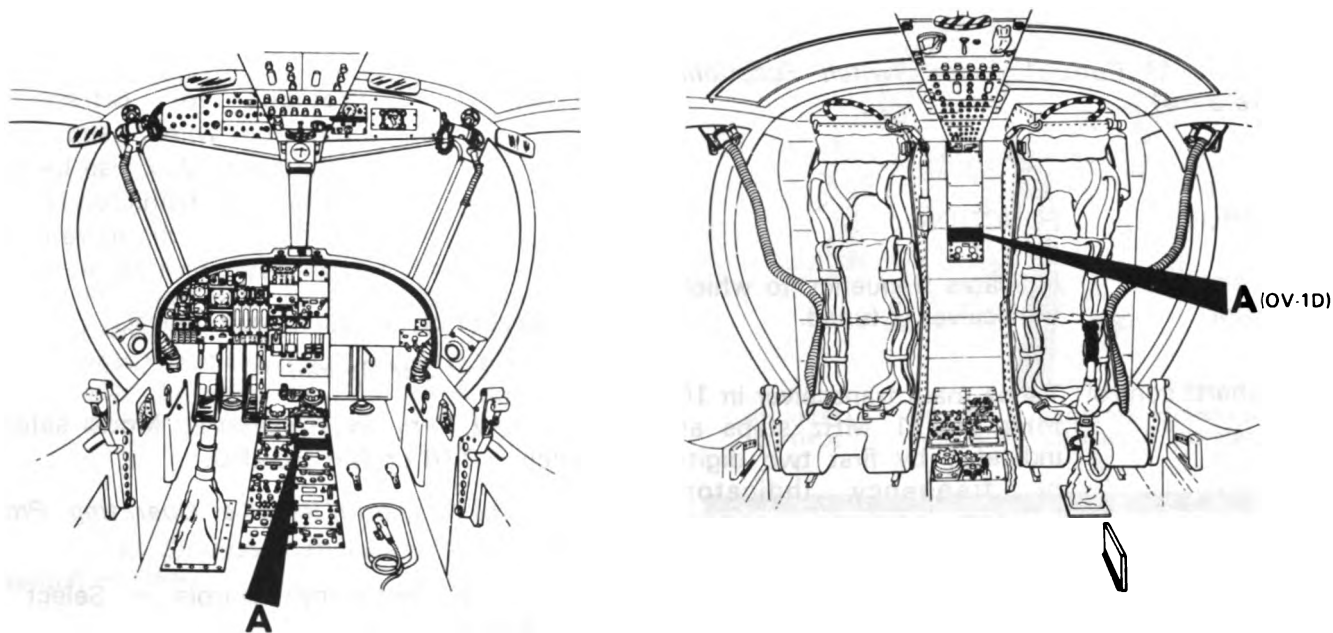

A 3-10-D-4

Figure 3-4. FM Control Panel (AN/ARC-114A)

c. The FM control panel provides remote control for operation of the transceiver. The panel provides power application and volume control, selection of operating mode and frequency, squelch adjustment, and receiver self-test.

*(1) FM Control Panel Switch Functions (figure 3-4).*

CONTROL	FUNCTION
Frequency indicator	Indicates frequency to which transceiver is tuned.
Megahertz control	Tunes main transceiver in 10 MHz and 1 MHz steps as indicated by first two digits of frequency indicator. (Guard receiver is fixed-tuned.)
Kilohertz control	Tunes main transceiver in 100 kHz and 50 kHz steps as indicated by last two digits of frequency indicator. (Guard receiver is fixed-tuned.)
RCVR TEST button	Used to inject noise signal to test receiver operation. Normally a maintenance function.
SQUELCH screwdriver adjustment	Adjust squelch level of receiver.
Mode selector switch	Determines operating mode:
OFF	Turns set off.
T/R	Provides for transceiver operation of frequency displayed on frequency indicator. (Guard receiver is inoperative.)
T/R GUARD	Same as T/R above plus reception of guard channel.

CONTROL	FUNCTION
HOMING	Provides for operation in homing mode.  May also be operated as transceiver on main channels indicated on frequency indicator.
RETRAN	Provides for retransmit operation when used with second set. May also be operated as transceiver on frequencies displayed on frequency indicator.
AUDIO control	Adjusts audio level.

*(2) FM Set Operation.*

*(a) Turn-On Procedure.* Mode selector switch — T/R or T/R GUARD.

*(b) Transmit/Receive Operating Procedure.*

1. Frequency controls — Select desired frequency.
2. Transmitter selector switch on ICS control panel (figure 3-2) — 1.
3. Pilot's or right seat occupant's RADIO switch — Press, listen for sidetone.
4. AUDIO control — Adjust.

**NOTE**

*No set shall be keyed concurrently with the FM set when KY-28 or KY-58 is in operation.*

*(c) Homing Operating Procedure.*

1. Mode selector switch — HOMING.
2. Frequency controls — Select homing frequency.
3. COURSE IND switch on BDHI/COURSE SELECTOR panel (figure 3-10) — Select HOME.
4. Observe homing indication on course indicator.

*(d) Retran Operating Procedure.*

1. Receivers 1 and 5 switches on ICS control panel (figure 3-2) — ON.

2. Establish communication with other stations in relay and determine two frequencies to be used. These two frequencies shall have minimum separation of 10 MHz.

3. Set one frequency on control panel for FM command set, and other frequency on control panel for FM auxiliary set.

4. Set mode selector switch on both FM control panels to RETRAN position.

**NOTE**

*If desired, the audio output of the FM sets may be monitored during retransmission to verify proper equipment operation. Both sets may also be operated as transceivers during retransmission.*

(e) *Shutdown Procedure.* Mode selector switch - OFF.

**3-7. VHF Set.**

a. The VHF set is a line-of-sight radio transceiver that provides transmission and reception AM signals in the very high frequency range of 116.000 to 149.975 MHz for a distance range of approximately 50 miles. The set incorporates two separate receivers; a main receiver and a fixed tuned guard frequency receiver. The guard receiver is for use during emergency conditions. The audio output from both receivers is applied to the ICS, where it is made available to the headsets.

b. Power is applied to the VHF set through a circuit breaker on the remote circuit breaker panel. Figure 3-5 illustrates the VHF control panel and shows its location in the cockpit. Figure 3-1 illustrates the associated blade-type antenna.

c. The VHF control panel provides remote control of the operation of the transceiver. The panel provides power application and volume control, selection of operating mode and frequency, squelch adjustment, and receiver self-test.

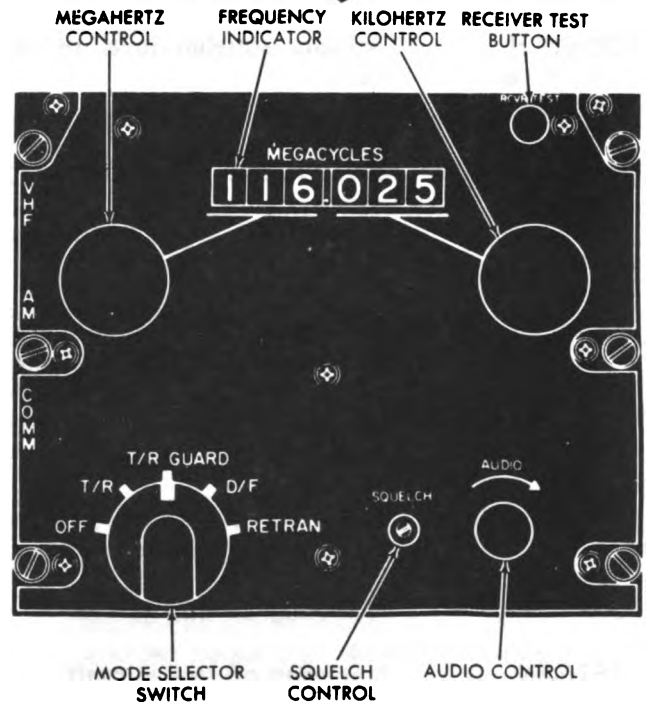
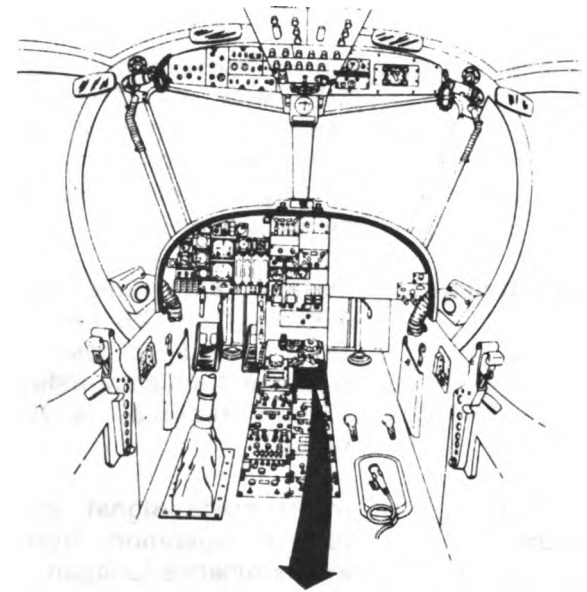

**Figure 3-5. VHF Control Panel (AN/ARC-115)**

(1) *VHF Control Panel Switch Functions (figure 3-5).*

CONTROL	FUNCTION
Frequency indicator	Indicates frequency to which transceiver is tuned.

CONTROL	FUNCTION
Megahertz control	Tunes main transceiver in 100 MHz, 10 MHz, and 1 MHz steps as indicated by first three digits of frequency indicator. (Guard receiver is fixed-tuned.)
Kilohertz control	Tunes main transceiver in 100 kHz and 25 kHz steps as indicated by last three digits of frequency indicator. (Guard receiver is fixed-tuned.)
RCVR TEST button	Inject noise signal to test receiver operation. Normally a maintenance function.
SQUELCH screwdriver adjustment	Adjusts squelch level of receiver.
Mode selector switch	Determines operating mode.
OFF	Turns set off.
T/R	Provides for transceiver operation on frequency displayed on frequency indicator. (Guard receiver is inoperative.)
T/R GUARD	Same as T/R above plus reception of guard channel.
D/F	Not used on this aircraft.
RETRAN	Not used on this aircraft.
AUDIO control	Adjusts audio level.

*(2) VHF Set Operation.*

*(a) Turn-On Procedure.* Mode selector switch - T/R or T/R GUARD.

*(b) Transmit/Receive Operating Procedure.*

1. Frequency control - Select desired frequency.

2. Transmitter selector switch on ICS control panel - 3.

3. Pilot's or right seat occupant's RADIO switch - Press, listen for sidetone.

4. AUDIO control - Adjust.

*(c) D/F Operating Procedure.* (Not used on this aircraft.)

*(d) RETRAN Operating Procedure.* (Not used on this aircraft.)

*(e) Shutdown Procedure.* Mode selector switch - OFF.

**3-8. HF Set.**

*a.* The HF set provides two-way AM voice and CW long range communication within the frequency range of 2.000 to 29.999 MHz. The audio output of the set is applied to the ICS where it is made available to the headsets. Power is applied to the set through the associated circuit breakers on the cockpit and remote circuit breaker panels. Figure 3-6 illustrates the HF control panel and its location in the cockpit. The associated wire antenna is shown in figure 3-1.

*b.* The HF control panel provides remote control operation of the transceiver. The panel provides power application, selection of operating mode and frequency, and RF sensitivity control.

*(1) HF Control Panel Switch Functions (figure 3-6).*

CONTROL	FUNCTION
Mode selector switch	When set to OFF, deenergizes HF set. When set to USB, upper sideband modulation is employed. When set to LSB, lower sideband modulation is employed. When set to AM, amplitude modulation is employed. DATA position not used. When set to CW, 1,000 Hz tone is modulated on upper sideband when transceiver is keyed.

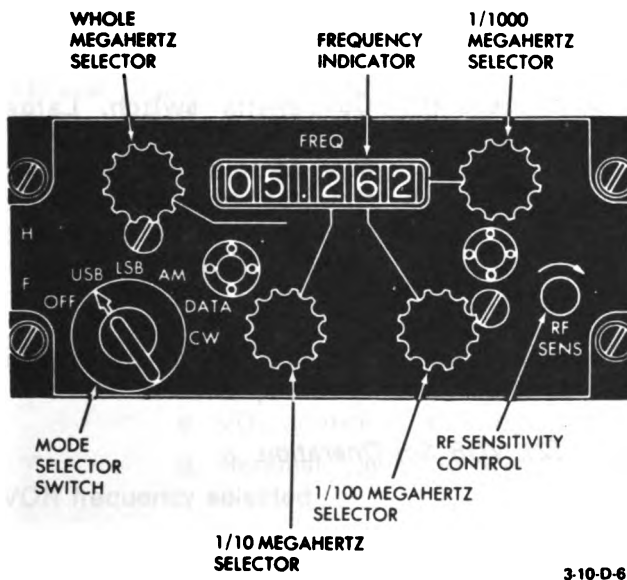
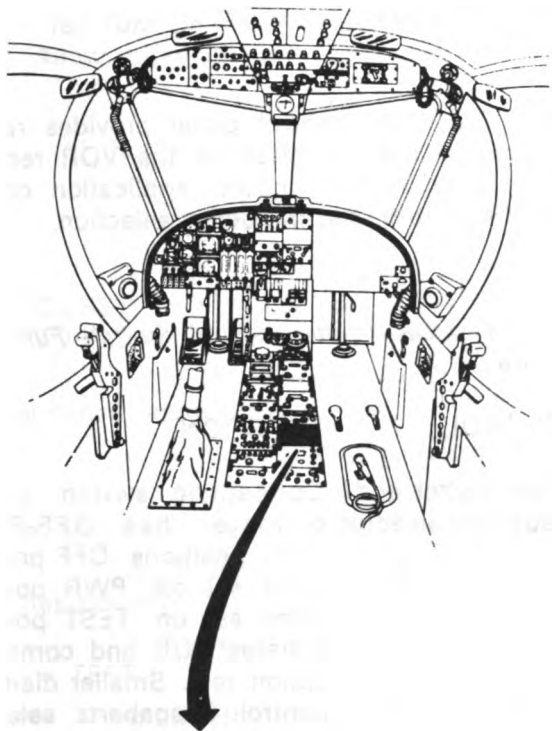

Figure 3-6. HF Control Panel (AN/ARC-102)

CONTROL	FUNCTION
Frequency selector controls	Whole megahertz selector, 1/10 megahertz selector, 1/100 megahertz selector, and 1/1000 megahertz selector are used to select operating frequency.
Frequency indicator	Indicates operating frequency.
RF SENS control	Adjusts sensitivity (RF gain) and consequently audio level and quality.

(2) HF Set Operation.

(a) Turn-On Procedure. Mode selector switch - As desired. Allow approximately 2-minute warmup.

(b) Transmit/Receive Operation Procedure.

1. Frequency controls - Select desired frequency.
2. Transmitter selector switch on ICS control panel - 4.
3. RF SENS control - Adjust for barely audible background noise.
4. Pilot's or right seat occupant's RADIO switch - Press.

NOTE

Keying tone will be heard for 10-15 seconds as transmitter is tuned to the selected frequency. After this is completed, two-way voice communication can be established.

(c) Shutdown Procedure. Mode selector switch - OFF.

SECTION III. NAVIGATION

3-9. VOR Set.

a. The VOR set is an airborne navigation-communication radio receiving set whose function is to receive and interpret VHF omnidirectional radio range (VOR) and localizer (LOC) signals in the frequency range of 108.00 to 117.95 MHz. Audio signals may also be received in the frequency range of 118.00 to 126.95 MHz. Visual indications of the VOR and localizer signals are displayed on the BDHI, the course indicator, and the approach horizon indicator of the flight director system. Reception distance depends on line-of-sight. Audio signals are applied to the ICS where they are made available to the headsets. Power is applied to the VOR set through associated circuit breakers on the remote circuit breaker panel. Figure 3-7 illustrates the control panel for the VOR set and its location in the cockpit. The associated antennas are shown in figure 3-1.

b. The VOR control panel provides remote control of the operation of the VOR receiver. The panel provides power application control, volume control, and frequency selection.

(1) VOR Control Panel Switch Functions (figure 3-7).

CONTROL	FUNCTION
Power switch and megahertz selector	Concentric switch. Larger diameter has OFF-PWR-TEST positions. OFF position turns set off. PWR position turns set on. TEST position initiates VOR and communication test. Smaller diameter control (megahertz selector) selects megahertz digits of operating frequency.
VOL control and kilohertz selector	Concentric switch. Larger diameter control (VOL) is used to adjust volume of set. Smaller diameter control (kilohertz selector) selects kilohertz digits of operating frequency.
Frequency indicator	Provides digital display of frequency selected.

(2) VOR Set Operation.

NOTE

*Inaccurate in-flight OMNI indicator readings can result if the power switch on the VOR control panel is left in the TEST position. Do not use TEST position of power switch while autopilot is in use; this may disrupt aircraft attitude. Power switch should be in TEST position for test purposes only. Do not leave power switch in TEST position except for testing.*

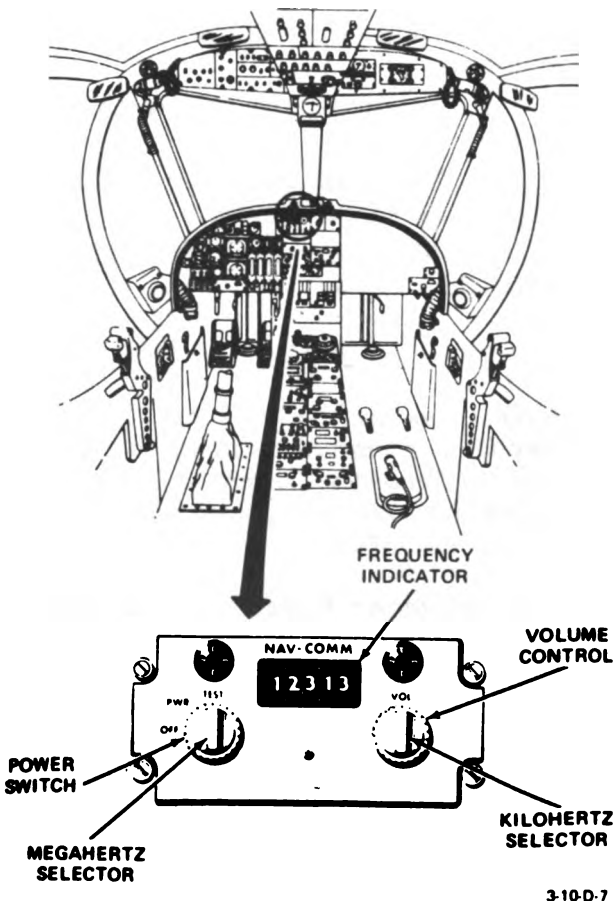

Figure 3-7. VOR Control Panel (AN/ARN-82)

(a) *Turn-On Procedure.* Power switch – PWR. Allow approximately 2 minutes for warm up.

(b) *Test Procedure.*

1. VOR Test. Proceed as follows:

a. NO. 1 or NO. 2 NEEDLE switch and COURSE IND switch on BDHI/COURSE SELECTOR panel (figure 3-10) – VOR.

b. AUX receiver switch on ICS control panel (figure 3-2) – ON.

c. VOR frequency – Select.

d. LOC flag (figure 3-11) – Masked (if within range of station).

e. To-from arrow (figure 3-12) – Indicates properly.

f. Power switch on VOR control panel – TEST.

g. BDHI (figure 3-9) – Indicates  $180^\circ \pm 4^\circ$ .

h. Course selector arrow on course indicator (figure 3-12) – Set to 0. Course bar should center  $\pm 2^\circ$  and to-from arrow should give a from indication.

2. Communication Test. Proceed as follows:

a. Power switch on VOR control panel – PWR.

b. VOR frequency – Select.

c. VOL control – Midrange.

d. Request tower to transmit on VOR frequency selected.

e. When communication is received, VOL control – Adjust for comfortable audio level.

f. Power switch on VOR control panel – TEST. Noise should be heard in headset.

g. Power switch on VOR control panel – PWR. Noise should cease.

(c) *Navigational Mode Operating Procedure.*

1. NO. 1 NEEDLE or NO. 2 NEEDLE, and COURSE IND switches on BDHI/COURSE SELECTOR panel (figure 3-10) – Select VOR

for display on either BDHI needle, or course indicator, or both.

2. AUX receiver switch on ICS panel (figure 3-2) – ON.

3. Frequency controls – Select desired frequency.

4. VOL control – Adjust audio level.

5. BDHI (or course indicator, or both) and headset audio – Read indication and monitor audio.

(d) *Communications Receiver Operating Procedure.*

1. AUX receiver switch on ICS panel (figure 3-2) – ON.

2. Frequency controls – Select desired frequency.

3. VOL control – Adjust audio level.

(e) *Shutdown Procedure.* Power switch – OFF.

### 3-10. ADF Set.

a. The ADF set is an airborne low-frequency radio direction finder that receives modulated and continuous-wave signals from transmitters in the 100 to 3,000 kHz frequency range, to provide a visual and audio indication of the aircraft's bearing in relation to the transmitter. The set can also be used for homing and position fixing. Reception distance of reliable signals depends on the power output of the transmitting station and atmospheric conditions. Bearing indications are displayed visually on the BDHI and audio signals are applied to the ICS where they are made available to the headsets. Power is applied to the ADF set through associated circuit breakers on the remote circuit breaker panel. Figure 3-8 illustrates the control panel for the ADF set and shows its location in the cockpit. The associated loop and sense antennas are shown in figure 3-1.

b. The ADF control panel (figure 3-8) provides remote control of the operation of the ADF set. The panel provides power application and volume control, selection of operating mode and frequency, loop antenna control, a test switch, and a tuning indicator.



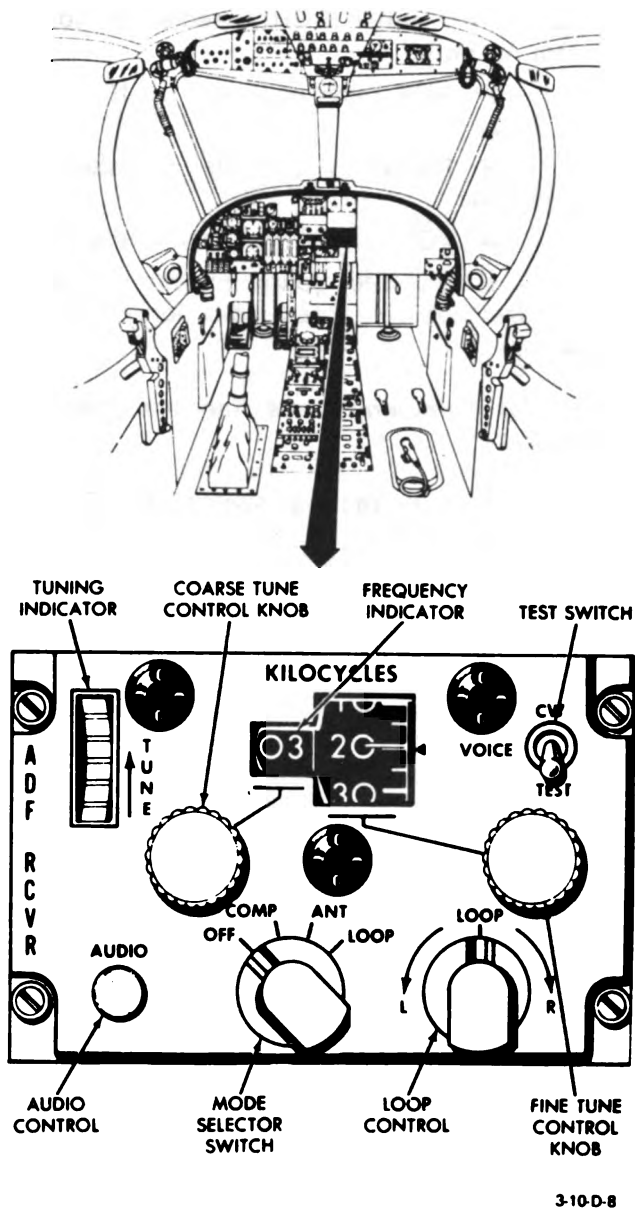

Figure 3-8. ADF Control Panel (AN/ARN-89)

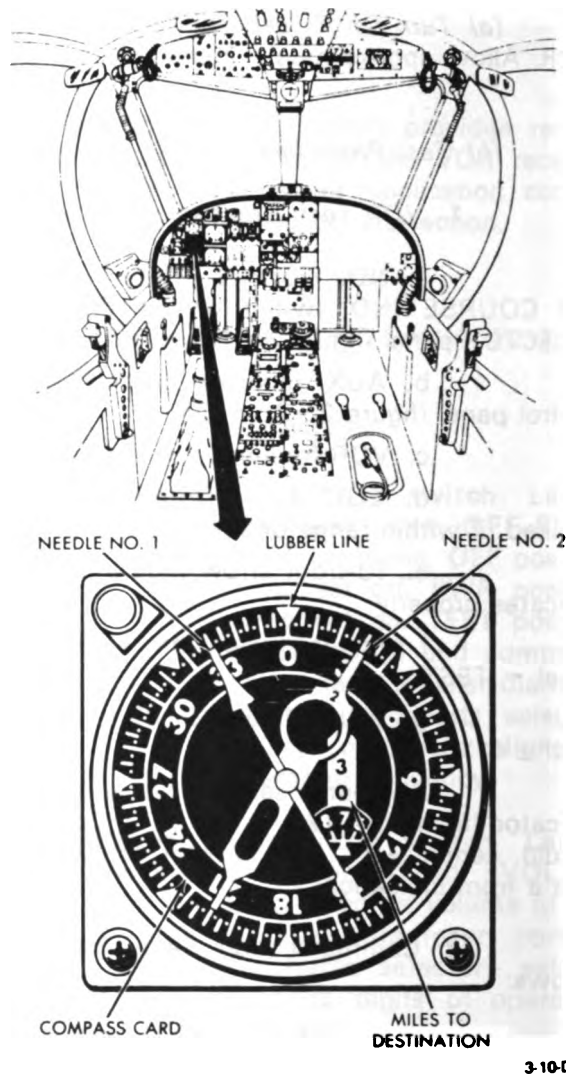
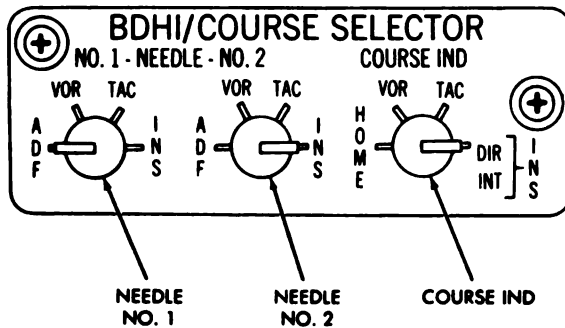
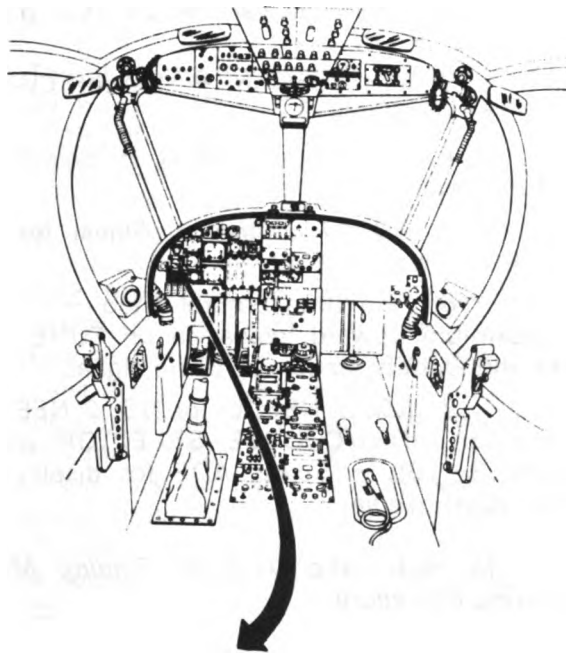

Figure 3-9. Bearing Distance Heading Indicator (BDHI)

point. Range information from the INS or TACAN is presented in nautical miles on the distance indicator.

c. The BDHI (figure 3-9), on the pilot's instrument panel, provides the pilot with a visual presentation of outputs from the INS (or backup compass system), VOR set, ADF set, and TACAN set. Needle No. 1 and needle No. 2 present bearing information from the VOR set, ADF set, TACAN set, or INS as selected by the pilot on the BDHI/COURSE SELECTOR panel. Magnetic heading information from the INS (or backup compass system) is presented on the compass card using the lubber line as an index

d. The BDHI/COURSE SELECTOR control panel (figure 3-10), on the pilot's instrument panel, provides the means of selecting the inputs to the BDHI needles and to the course indicator. The pilot may select BDHI needle inputs from the ADF, VOR, TACAN, or INS. In addition, the pilot may select course indicator inputs from the FM set, VOR set, TACAN set, and the INS (direct or intercept).



A 3-10-D-10

Figure 3-10. BDHI/COURSE SELECTOR Panel

(1) ADF Control Panel Switch Functions (figure 3-8).

CONTROL	FUNCTION
Mode selector switch	
OFF	Turns set off.
COMP	Provides operation as an automatic direction finder.
ANT	Provides operation as an AM receiver using sense antenna only.
LOOP	Provides operation as a manual direction finder using loop antenna only.

CONTROL	FUNCTION
LOOP control knob	Provides positioning of loop antenna reference when operating in manual direction finding mode.
AUDIO control knob	In COMP position, adjusts audio level. In ANT and LOOP position, adjusts sensitivity (RF gain) and consequently audio level.
Coarse tune control knob	Tunes receiver in 100 kHz steps as indicated by first two digits of frequency indicator.
Fine tune control knob	Provides selection of 10 and 1 kHz digits (continuous tuning); as indicated by last two digits of frequency indicator.
Test switch	
CW	Provides beat frequency oscillator for reception of CW transmissions and to aid in tuning weak stations.
VOICE	Permits operation as an AM receiver.
TEST	Spring-loaded switch. Provides slewing of goniometer through 180° to provide check on receiver in COMP mode; inoperative in LOOP and ANT modes.

TUNE indicator	Provides indication of relative signal strength while tuning receiver.
Frequency indicator	Indicates operating frequency to which receiver is tuned.

(2) BDHI Display Functions (figure 3-9).

CONTROL	FUNCTION
Compass card	Rotating card. Number under lubber line indicates magnetic heading of aircraft.

CONTROL	FUNCTION
Needle No. 1	Indicates selected VOR, ADF, TACAN, or INS course.
Needle No. 2	Indicates selected VOR, ADF, TACAN, or INS course.
Miles to destination indicator	Indicates nautical miles to or from destination.

**(3) BDHI/COURSE SELECTOR Panel Switch Functions (figure 3-10).**

CONTROL	FUNCTION
NEEDLE NO. 1 switch	Selects ADF, VOR, TACAN, or INS heading information to be fed to needle no. 1 on BDHI.
NEEDLE NO. 2 switch	Selects ADF, VOR, TACAN, or INS heading information to be fed to needle no. 2 on BDHI.
COURSE IND switch	Selects FM homing information, VOR course, TACAN course, or INS (direct or intercept) heading information for display on course indicator.

**NOTE**

*If needle switches on BDHI/COURSE SELECTOR panel are in INS position when compass (backup) system is selected, needles on BDHI (No. 1, No. 2, or both) will drive to zero, and OFF flag covers the miles to destination read-out. With INS mode inoperative, select VOR set, ADF set, or TACAN set for bearing information. With NEEDLE NO. 2 switch in VOR or ADF position, disregard miles to destination readout on BDHI.*

**(4) ADF Set Operation**

**(a) Turn-On Procedure.**

1. Mode selector switch - COMP.

2. NAV receiver switch (ICS panel, figure 3-2) - ON.
3. Test switch - Select CW or VOICE, as applicable.
4. Frequency controls - Select desired frequency.
5. AUDIO control - Adjust for desired audio level.
6. Fine tune control knob - Adjust for maximum upward indication on TUNE indicator and identify station by audio signal.
7. NO. 1 NEEDLE or NO. 2 NEEDLE switch on BDHI/COURSE SELECTOR panel (figure 3-10) - Select ADF for display on either BDHI needle.

**(b) Automatic Direction Finding Mode Operating Procedure.**

1. Mode selector switch - COMP.
2. Read magnetic bearing on BDHI; monitor audio.

**(c) Manual Direction Finding Mode Operating Procedure.**

1. Mode selector switch - LOOP.
2. Test switch - CW (unless station is transmitting MCW).
3. LOOP control knob - Turn left (L) or right (R) to obtain aural null. Read bearing on BDHI.

**NOTE**

*In manual mode, two null positions, separated by 180 degrees, will be obtained.*

**(d) Test Mode Operating Procedure (COMP Mode Only).**

1. Read bearing on BDHI.
2. Test switch - TEST. Note that bearing on BDHI changes by 180 degrees.

**(e) Shutdown Procedure. Mode selector switch - OFF.**

**3-11. Flight Director System.**

a. The flight director system uses information supplied by the INS (or backup compass system), VOR set, ADF set, TACAN set, and glide slope and marker beacon receiver to provide a visual indication of the aircraft's pitch and roll attitude, magnetic heading, deviation from selected course, selected VOR course, lateral displacement from selected course, vertical guidance during ILS approach, and direction of turn necessary to arrive at a selected course. These indications are presented on the approach horizon indicator (figure 3-11) and the course indicator (figure 3-12) on the pilot's instrument panel. Power is applied to the system through associated circuit breakers on the remote circuit breaker panel. Operation of the flight director system consists of two modes designated HDG and ILS.

b. The approach horizon indicator (figure 3-11), on the pilot's instrument panel, operates with the course indicator to display computed navigational data and aircraft attitude information supplied from the other installed electronic navigational equipment. The indicator furnishes the pilot with a pictorial display of pitch and bank information, deviation from a glide slope, and lateral guidance information. The bank pointer and the horizon bar operate jointly to produce bank indications. Bank indices are shown for 10°, 20°, 30°, and 60° of bank. The horizon bar also displays roll attitudes; 90° of roll in either direction can be shown by the horizon bar and bank pointer combination. The pitch bar moves either up or down from the center of the dial to show a maximum of 85° of pitch attitude. In the HDG mode of operation, adjustments of the pitch bar can be made by means of the pitch TRIM knob to meet varied loading and flight performance conditions. In the ILS mode, this adjustment is done automatically. The steering pointer is the pilot's turn command: to maintain a selected course, right deflection of the pointer is a command to turn the aircraft to the right; left deflection is a command to turn to the left. Four warning flags on the dial indicate malfunction of the corresponding flight system components and contributing systems.

c. The course indicator (figure 3-12), on the pilot's instrument panel, combines compass headings with radio position indications received

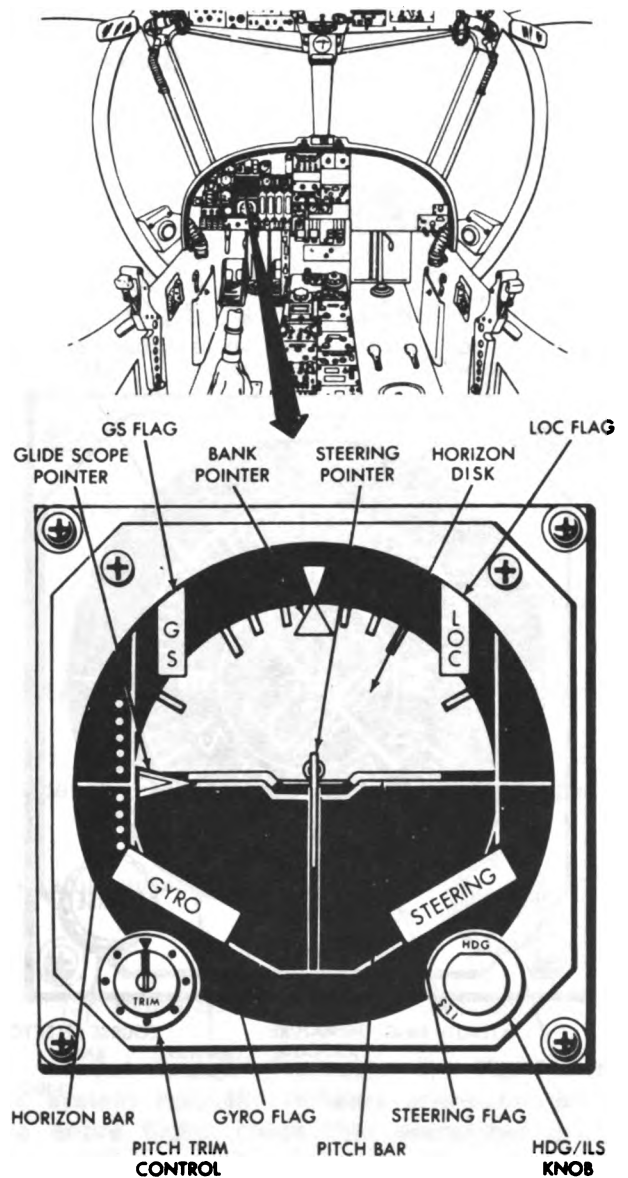

**Figure 3-11. Approach Horizon Indicator (AN/ASN-33)**

3-10-D-11

from other electronic navigation equipment to present aircraft position and bearing information on the face of the instrument. The azimuth ring rotates to reflect aircraft headings indexed on the lubber line. The COURSE selector knob at the lower right corner of the instrument is used to select the desired course (VOR, TACAN, or ILS) that is indicated by the course selector arrow. The course bar indicates course in relation to the miniature airplane. Deviation from selected course is shown on a five-dot scale. The to-from arrow displays aircraft direction from a VOR station on the selected radial when

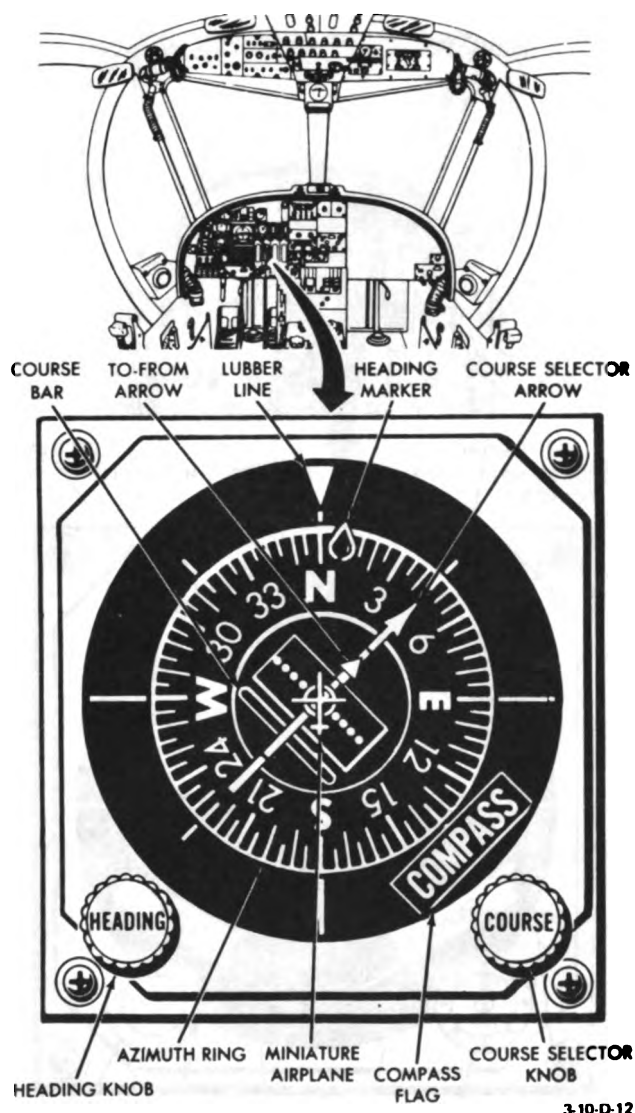

**Figure 3-12. Course Indicator (AN/ASN-33)**

referenced with the miniature airplane. It is not displayed in localizer operations. The heading marker is adjusted by the HEADING knob on the lower left corner of the instrument, and reflects bearing changes in reference to the lubber line. A COMPASS warning flag appears whenever the magnetic heading input is not reliable. Bearing information is fed from the VOR set, TACAN set, INS, or FM set as selected on the BDHI/COURSE SELECTOR panel (figure 3-10). If the COURSE IND switch on BDHI/COURSE SELECTOR panel is in INS position when compass (backup) system is selected, the course bar on the course indicator will center itself. With INS mode inoperative, select VOR

set, TACAN set, or FM set for bearing information. In FM homing operations, the mode selector switch on the FM control panel (figure 3-4) is set to the HOMING position and the COURSE IND switch on the BDHI/COURSE SELECTOR panel is set to the HOME position. The course selector arrow on the course indicator (figure 3-12) is next aligned under the lubber line. The homer deviation signals, in the FM homing mode, are applied to the course bar, that will deflect to the right or left of the course selector arrow, depending upon the location of the ground station with respect to the aircraft. Correct maneuvering of the aircraft, when homing, is to keep the course bar centered in line with the course selector arrow. When operating in FM homing mode, the to-from arrow may disappear.

*(1) Approach Horizon Indicator Display Functions (figure 3-11).*

CONTROL	FUNCTION
GS flag	Indicates lack of signal strength from glide slope receiver.
GYRO flag	Indicates malfunction in attitude system.
STEERING flag	Indicates signals from steering computer are not reliable.
LOC flag	Indicates signal from VOR set is not reliable.
Steering pointer	Indicates direction aircraft is to be turned to correct heading error. Deflects right or left to provide aircraft turn information relative to selected course or localizer beam. Right deflection is command to turn aircraft to right; left deflection is command to turn aircraft to left.
Pitch bar	Indicates relative aircraft longitudinal attitude. Pitch bar above horizon bar indicates nose up attitude; pitch bar below horizon bar indicates nose down attitude.

CONTROL	FUNCTION
Pitch TRIM control	Raises or lowers position of pitch bar in HDG mode. Adjustment range is +20° to -15° in 5° increments. In ILS mode, pitch bar position is preset to normal approach attitude.
HDG/ILS knob	Selects mode of operation of flight system for navigation (HDG) or Instrument Landing System (ILS). Switch should be placed in same relative function as corresponding set control setting (omnirange or localizer).
Horizon disk	Rotates against fixed bank pointer to indicate amount of bank.
Bank pointer	Operates with horizon disk to indicate amount of bank in increments of 10°, 20°, 30°, and 60°.
Glide slope pointer	Moves up or down to show displacement of aircraft above or below glide path on a 5-dot vertical scale. Aircraft is on glide path when glide slope pointer centers.
Horizon bar	Fixed reference to the horizon.

*(2) Course Indicator Display Functions (figure 3-12).*

CONTROL	FUNCTION
Azimuth ring	Indicates aircraft magnetic heading in relation to lubber line.
Course bar	Indicates deviation of aircraft from selected course, in relation to five-dot scale. Aircraft is on selected course when course bar aligns with head and tail of course selector arrow. Indicates direction to turn for selected navigation inputs (INS, VOR, TACAN, FM homing).

CONTROL	FUNCTION
Course selector arrow	Indicates selected aircraft course in relation to TACAN, VOR, or localizer course. Centered under lubber line for FM homing.
COURSE selector knob	Positions course selector arrow.
To-from arrow	Displays direction of selected TACAN or VOR station. To-from arrow will not be visible when operating in ILS mode.
HEADING knob	Adjusts heading marker to selected heading.
Heading marker	Indicates heading selected for use in HDG mode.
COMPASS flag	Appears if magnetic heading input is not reliable.
Lubber line	Indicates aircraft magnetic heading.
Miniature airplane	Indicates relative position of aircraft with respect to selected course.

*(3) Flight Director System Operation.*

*(a) Turn-On Procedure.* The flight director system normally remains energized during the entire flight; check that associated equipment (VOR set, TACAN set, FM set, marker beacon and glide slope receiver, ADF set, and INS (or backup system) is turned on and operating.

*(b) Heading Mode Operating Procedure.*

1. HDG/ILS knob (approach horizon indicator) – HDG.
2. Pitch TRIM control (approach horizon indicator) – Set to desired attitude as indicated by pitch bar.
3. HEADING knob (course indicator) – Set heading marker to desired magnetic heading.
4. Turn aircraft toward steering pointer using bank angle that will maintain steering pointer centered.

**NOTE**

*The aircraft heading is indicated by the position of the azimuth ring with respect to the lubber line. The heading marker rides with the azimuth ring as aircraft heading changes. Heading error is indicated by the displacement of the heading marker with respect to the lubber line. For heading corrections, the amount of bank called for by the steering pointer depends on the required heading change and is limited to a predetermined safe bank angle. If the aircraft makes a bank entry steeper than this limit, the steering pointer will move past center and thus advise an easing of bank. When the aircraft approaches the selected heading, the bank angle called for by the steering pointer will decrease gradually and the aircraft will roll out smoothly on the new heading.*

5. Selecting and maintaining a VOR course. Proceed as follows:

- a. VOR receiver - Select desired frequency.
- b. Nav switch on ICS control panel (figure 3-2) - ON.
- c. VOL control on VOR control panel - Adjust audio level.
- d. COURSE IND switch (figure 3-10) - VOR.
- e. LOC flag on approach horizon indicator - Masked.
- f. Course selector arrow on course indicator (figure 3-12) - Set to desired VOR course to be followed.
- g. Heading marker on course indicator - Set on heading giving desired interception angle.
- h. Steering pointer on approach horizon indicator (figure 3-11) - Center by turning aircraft in direction of pointer deflection.
- i. Maintain heading by keeping steering pointer centered.

j. When course bar centers - Set heading marker to desired course and turn aircraft to maintain steering pointer centered.

k. Maintain selected course by keeping course bar centered.

**NOTE**

*When tracking on course (course bar centered), wind correction will be indicated by difference in heading marker and course selector arrow.*

6. Selecting and maintaining a TACAN course. Proceed as follows:

- a. TACAN receiver - Select desired channel.
- b. Nav switch on ICS control panel (figure 3-2) - ON.
- c. Operation mode select control on TACAN control panel (figure 3-17) - T/R.

**NOTE**

*If only course information is desired, select REC position of operation mode select control.*

d. VOL control on TACAN control panel - Adjust identity tone level.

e. COURSE IND switch (figure 3-10) - TACAN.

f. LOC flag on approach horizon indicator - Masked.

g. Course selector arrow on course indicator (figure 3-12) - Set to desired TACAN course to be followed.

h. Heading marker on course indicator - Set to desired heading.

i. Steering pointer on approach horizon indicator (figure 3-11) - Center by turning aircraft in direction of pointer deflection.

**NOTE**

*When tracking on course (course bar centered), wind correction will be indicated by difference in heading marker and course selector arrow.*

j. Maintain heading by keeping steering pointer centered.

k. When course bar centers — Set heading marker to desired course and turn aircraft to maintain steering pointer centered.

l. Maintain selected course by keeping course bar centered.

*(c) ILS Mode Operation.* Proceed as follows:

1. Select and maintain desired localizer course as outlined in step (b)5, above.

2. After alignment with localizer outside outer marker, inbound, check that the LOC and GS flags on the approach horizon indicator (figure 3-11) are masked. Set the HDG/ILS knob to ILS. Set heading marker to missed approach heading.

3. Intercept glide slope, start descent and maintain glide slope pointer on approach horizon indicator aligned at center scale following glide slope to minimums.

4. Maintain localizer track by keeping steering pointer on approach horizon indicator centered.

**NOTE**

*During ILS approach, wind drift is compensated for automatically. The pitch bar represents the aircraft approach attitude. Displacement of the course selector arrow from the lubber line represents crab angle and is the aircraft's true relation to the runway before flareout. During the ILS approach, computed steering commands are provided on the approach horizon indicator. Maintaining the steering pointer centered*

*and the pitch bar (wing tip) opposite the glide slope, the pointer will intercept and maintain the ILS localizer and glide slope. True deviation from the glide slope is indicated by the displacement of the glide slope pointer from the horizon bar, and from the localizer by displacement of the course bar.*

5. If approach is missed, place HDG ILS knob, on approach horizon indicator, to HDG, and follow normal climbout and navigation procedures.

*(d). Shutdown.* The flight director system is not normally shut down; however, the associated equipment (VOR, ADF, TACAN, glide slope and marker beacon receiver) may be turned off, if required.

**3-12. Inertial Navigation System (INS).**

a. The INS is a self-contained navigation and attitude-reference system that is totally independent of aircraft maneuvers, weather conditions, and terrain. The INS, in conjunction with aircraft equipment interface, permits all weather operation under IMC. The system continuously determines the position of the aircraft from measurements made entirely within the aircraft, permitting navigation without reference to ground transmitters or other external operational aids. The INS provides a navigation capability completely independent of hostile operating environments that may include electronic countermeasures. A computer in the system uses aircraft velocity changes and attitude to compute present position, distance to destination, and bearing to destination. The INS also supplies information such as easting or westing, northing or southing, drift angle, groundspeed, heading and V/H signals to the AN/AYA-10 Airborne Data Annotation System (if installed) for distribution to the sensor systems on board the aircraft. The INS provides visual display of present position data in Universal Transverse Mercator (UTM) coordinates or conventional latitude-longitude coordinates during all phases of the flight. When a suspected target is approached or overflown, the INS will display, or freeze, or



both, the geographic coordinates of the aircraft's position and provide approach and overfly warning light indications to the pilot.

b. Power is applied to the INS through the associated circuit breakers on the remote circuit breaker panel, and through the NAV MODE select switch. A constant voltage is supplied through the CVS voltage controller to the CVS bus, which powers the associated circuit breakers. A cockpit status indicator (figure 2-9) provides an indication that a steady voltage is being supplied from the controller to the INS and AN/AYA-10 Airborne Data Annotation System (if installed).

c. Warning lights on the INS control indicator unit and on the annunciator panel indicate failure of the INS. Should a malfunction of the INS occur, the operator can select a backup compass system for heading and attitude reference. This can be done by positioning the NAV MODE select switch (figure 3-13) from the INS mode to the BACK-UP COMP mode, and pressing the HDG-PUSH knob on the compass control panel (figure 3-15) to align the compass system. The INS control panel (figure 3-14), provides remote control operation of the INS.

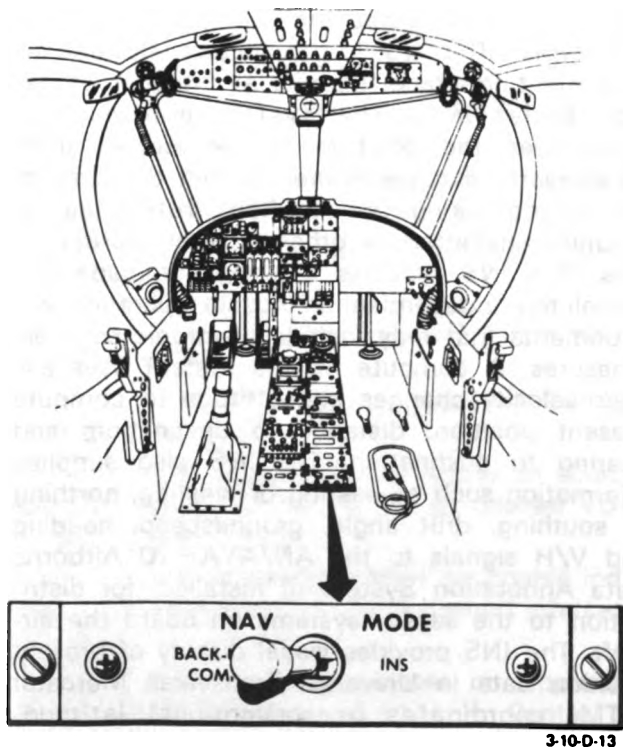

Figure 3-13. NAV MODE Panel (AN/ASN-76/86)

The panel provides controls for power application; mode selection; data memory insertion and display; destination selection, insertion, and display; position update; and display clearings. Indicators are provided for navigation mode status, destination approach and arrival malfunctions, data displays, and directional displays. The technical characteristics of the INS are shown below.

Modes of operation . . . . . Standby, align, navigate, and air data

Input signals from:

Compass Compensator . . . . . Magnetic heading  
 True airspeed transmitter . . . . . True airspeed error  
 Radar Altimeter . . . . . Radar Altitude  
 SLAR . . . . . Drift angle and ground speed feedback

Data annotation set . . . . . Data requests

Output signals to:

Data annotation set . . . . . Roll and pitch  
 SLAR . . . . . Drift angle and ground speed error  
 VOR . . . . . Magnetic heading  
 Autopilot . . . . . Lateral steering correction, true heading, navigation disengage, autopilot disengage, and course deviation

Flight director system . . . . .

Roll and pitch, compass flag control, gyro flag control, localizer flag control, magnetic heading, and course deviation

BDHI . . . . . Bearing-heading, range and magnetic heading

d. The NAV MODE panel (figure 3-13), on the lower console, contains the NAV MODE select switch. The switch provides a means of selecting either of two modes of operation.

e. The INS control panel (figure 3-14), on the center instrument panel, provides remote control operation of the INS and alignment capabilities.

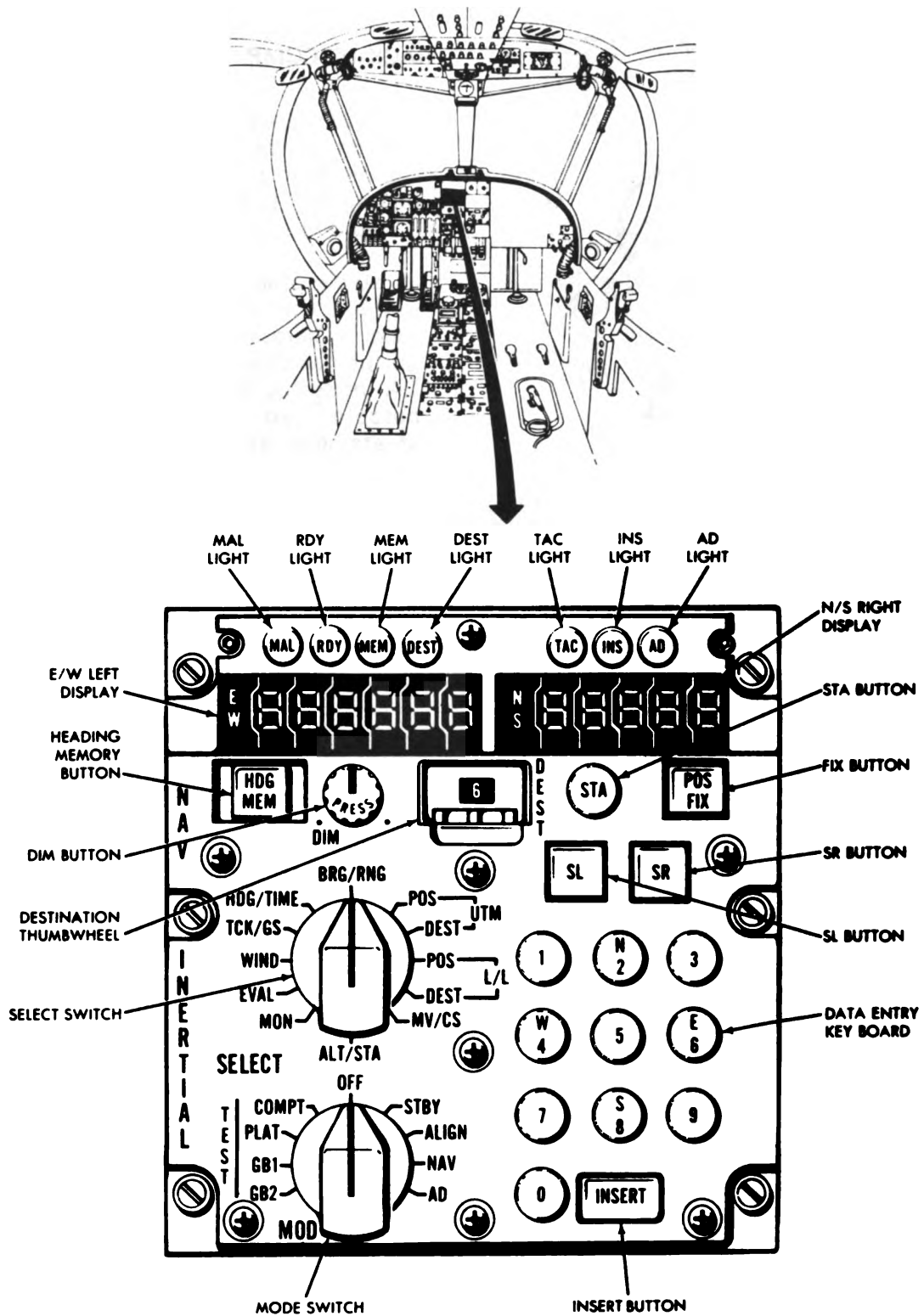

3-10-D-14

Figure 3-14. INS Control Panel (AN/ASN-86)

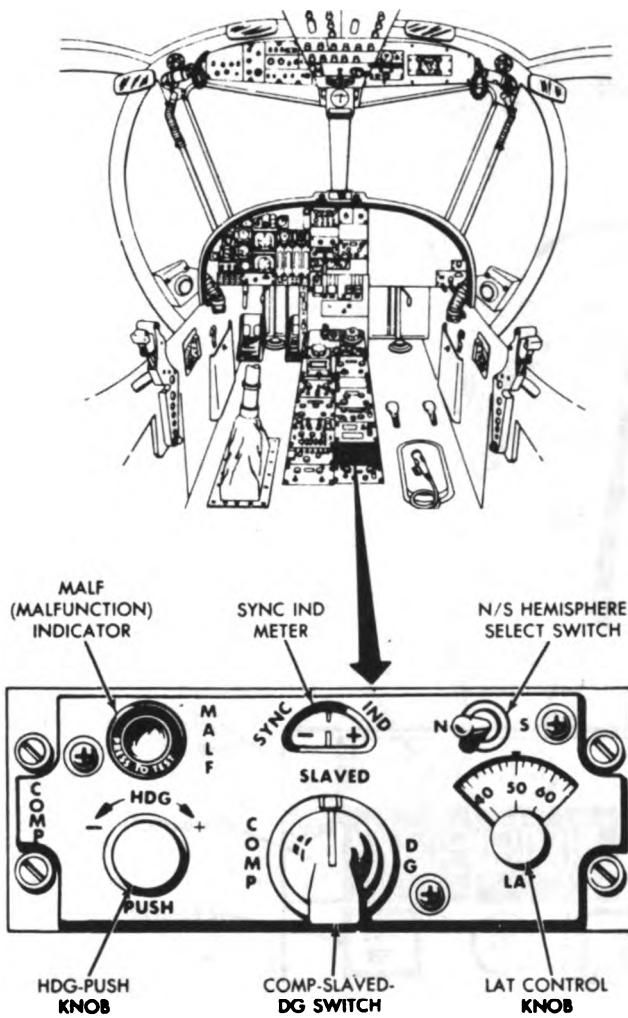

**Figure 3-15. Compass Control Panel (AN/ASN-76)**

3-10-D-15

**(1) NAV MODE Panel Switch Functions (figure 3-13).**

CONTROL	FUNCTION
NAV MODE select switch	Selects either INS or BACK-UP COMP mode of operation.
INS	Selects INS mode of operation.

**CONTROL FUNCTION**

**BACK-UP COMP** Selects BACK-UP COMPASS system mode of operation. With NAV MODE select switch in this position, the following occurs:

1. Course bar on course indicator centers if COURSE IND switch on BDHI/COURSE SELECTOR panel is in INS position.
2. Needles on BDHI (No. 1, or No. 2, or both) drive to zero, and OFF flag covers miles to destination readout if needle switches on BDHI/COURSE SELECTOR panel are in INS position.
3. NAV mode of autopilot operation is inoperative with NAV mode select switch in BACK-UP COMP position. In flight, autopilot should be disengaged before changing positions of NAV mode select switch. This insures that no sudden change in heading information is introduced into autopilot.

**(2) INS Control Panel Switch Functions (figure 3-14).**

CONTROL	FUNCTION
MODE switch	Selects navigation set mode of operation.
OFF	Turns navigation set off.
STBY	Initiates standby mode of operation that applies primary power to computer and control-indicator, and heater power to platform.
ALIGN	Initiates align mode of operation that allows platform stable element to be leveled with respect to local vertical and aligned to true north.

CONTROL	FUNCTION	CONTROL	FUNCTION
NAV	Initiates navigate mode of operation that is normal mode for flight or when aircraft is moved on ground when navigation set is on.	UTM POS	Allows insertion or display of present position zone number and easting distance in kilometers and tenths of a kilometer on left display and northing or southing distance in kilometers and tenths of a kilometer on right display.
AD	Initiates air date mode of operation. This mode is automatically selected if platform malfunctions during NAV mode of operation. AD mode may be selected manually as an alternate to NAV MODE.	UTM DEST	Allows insertion or display of destination zone number and easting distance in kilometers and tenths of a kilometer on left display and northing or southing distance in kilometers and tenths of a kilometer on right display for destination or TACAN station selected by DEST thumbwheel switch.
TEST		L/L POS	Allows insertion or display of present position longitude in degrees, minutes, and tenths of a minute on left display and latitude in degrees, minutes, and tenths of a minute on right display.
COMPT	Initiates built-in test of computer.	L/L DEST	Allows insertion or display of destination position longitude in degrees, minutes, and tenths of a minute on left display and latitude in degrees, minutes, and tenths of a minute on right display for destination or TACAN station selected by DEST thumbwheel switch.
PLAT	Initiates built-in test of platform.	EVAL	Allows updating and display of difference between present position and destination number selected on DEST thumbwheel. North-south difference in kilometers and tenths appears on right display; east-west difference in kilometers and tenths appears on left display.
GB1	Initiates gyro bias 1 test.		
GB2	Initiates gyro bias 2 test.		
SELECT switch	Selects data to be read into memory or displayed on control-indicator displays.		
BRG/RNG	Displays true bearing-to-destination or TACAN station true angle in degrees and tenths of a degree on left display and range-to-destination or TACAN station distance in kilometers and tenths of a kilometer on right display for destination selected on DEST thumbwheel switch. BDHI and course indicator will indicate bearing and range-to-destination of TACAN station by selecting desired destination or TACAN station or DEST thumbwheel and pressing INSERT button. Insert light will go out; but illuminate for all other positions of DEST thumbwheel.		

CONTROL	FUNCTION
MON	Allows display and selection of any computer core storage location.
ALT/STA	Allows insertion or readout of TACAN channel number on right display and TACAN altitude above sea level of selected TACAN station on left display when STA button is pressed. If STA button is not pressed, system altitude above sea level will appear on left display and right display will be blank.
WIND	Allows display of wind direction angle with respect to true north in degrees and tenths of a degree on left display, and wind speed in knots and tenths of a knot on right display during NAV mode. During AD mode, WIND allows insertion and readout of wind direction and wind speed.
MV/CS	With STA button not pressed, allows insertion or display of magnetic variation angle in degrees and tenths of a degree on left display, and course select angle in degrees and tenths of a degree on right display. With STA button pressed, allows insertion or display of magnetic variation and course angle of TACAN station selected on DEST thumbwheel.
TCK/GS	Allows display of ground track angle with respect to true north in degrees and tenths of a degree on left display, and ground speed in knots and tenths of a knot on right display.
HDG/TIME	Allows display of aircraft true heading with respect to true

CONTROL	FUNCTION
DIM button	When pressed, illuminates E, W, N, S, degrees, colon, and decimal points, and all other lights except keyboard lights and SL and SR buttons. Display readout will show all 8's. When rotated, controls intensity of control panel edge lights. Releasing button turns off lights.
STA button	Selects whether DEST thumbwheel is being used for destinations or TACAN channel number. In pressed position (button illuminated), DEST thumbwheel is selecting TACAN locations. When not pressed (button not illuminated), DEST thumbwheel is used for selecting destinations.
DEST thumbwheel	Allows insertion or display of any core storage location destination or TACAN station defined by position of SELECT switch. With SELECT switch set to MON, decimal quantities are displayed on right and left displays as follows:

STORE DEST	Left Display	Right Display
0	Numbers indicate test failure	Unused
1	X-gyro bias	Z-gyro bias
2	Y-gyro bias	Unused

CONTROL		FUNCTION		CONTROL		FUNCTION	
STORE DEST	Left Display		Right Display		TAC light	Illuminates when system is using TACAN data for automatic updating of present position, not Inertial present position.	
	3	East velocity error	North velocity error				INS light
4	All 1's indicate completion of self-test	Align status			Position fix button	With SELECT switch set to EVAL, UTM POS, or L/L POS, left and right displays will be frozen when POS FIX button is pressed. Used for position update. If no update, unfreezes display when pressed a second time.	
5	Percent of Specification	Elapsed time in mode of operation. (STBY, ALIGN, NAV, AD, etc.)			SL button	When pressed, clears left display and causes insert button to illuminate.	
6	Unused	UTM Grid			SR button	When pressed, clears right display and causes insert button to illuminate.	
7	Start	Running time GMT or local			Data entry keyboard pushbutton switches 1, N2, 3, W4, 5, E6, 7, S8, 9, and 0	Used in conjunction with SELECT switch, DEST thumbwheel, SL, SR, and INSERT buttons, to load left and right displays for display and storage in computer.	
8	Unused	Allows selection of any one of 4,096 core storage locations			Insert button	Used in conjunction with SELECT switch, DEST thumbwheel, data entry pushbuttons, SL, SR, and POS FIX buttons to store and update data in computer. Must be on BRIGHT to effect a change. Dimming indicates data entry.	
9	Displays octal value of contents in selected core storage location.	Displays octal value of contents in selected core storage location.			E/W (LEFT) display	Indicates direction, east or west, of data displayed on control indicator.	
RDY light	Flashes when align mode of operation is complete and INS is ready for navigation mode.				N/S (RIGHT) display	Indicates direction, north or south, of data displayed on control indicator.	
DEST light	Illuminates when aircraft is within 2-minutes flying time of destination. Flashes when destination is passed or range to selected destination begins to increase.						
MEM light	Illuminates when heading memory alignment is in progress or heading memory has been stored.						
A/D light	Illuminates when mode switch is set to AD.						
MAL light	Illuminates when any component in INS malfunctions.						

CONTROL	FUNCTION
HDG MEM button	Used to retain platform alignment after landing. Permits another flight to be made without performing another complete alignment. However, if inertial errors are encountered during the flight preceding the activation of the HDG MEM button, then these errors will be present when the INS is turned on from a HDG memory shutdown.

*IDLE, aircraft headed into the wind, and control surfaces locked by engaging gust lock handle.*

*Aircraft shall not be moved during alignment procedure or after HDG MEM is selected. Alignment will be lost and procedure must be repeated.*

**(3) INS Operation.**

**NOTE**

*If the INS malfunctions, the INS may become inoperative, and the pilot may experience a loss of aircraft heading and attitude reference, autopilot, and operation of the BDHI compass card. Heading and attitude reference, and operation of the BDHI compass card may then be obtained by disengaging the autopilot and switching the NAV MODE select switch on the NAV MODE panel (figure 3-13) to the BACK-UP COMP position. The autopilot NAV mode of automatic lateral control is inoperative with the NAV MODE select switch in the BACK-UP COMP position. Use of the autopilot may again be obtained by selecting some position other than NAV on the autopilot navigation coupler for automatic lateral control and re-engaging the autopilot.*

**(a) Alignment Procedure.** The INS may be aligned before starting the engines using the external power unit (GPU), or after starting both engines using the aircraft battery. Proceed as follows:

**NOTE**

*To insure most accurate alignment of INS, before starting alignment procedure, propellers shall be unfeathered and set at MAX RPM, power levers shall be set at FLIGHT*

1. CVS G796 ON pushbutton indicator— ON.

2. MODE switch — STBY.

**NOTE**

*If a heading memory alignment had been initiated before last system shutdown and the aircraft moved, a heading memory alignment cannot be performed, and a complete system alignment shall be made. If a heading memory alignment had been initiated previously, the HDG MEM indicator light on the INS control panel will illuminate when the MODE switch is set to the STBY position. If this occurs and heading memory alignment is not being initiated, press the HDG MEM button (which shuts off the HDG MEM light), place MODE switch to OFF position, then back to STBY position, verify that HDG MEM light is out, and proceed with alignment. If a heading memory alignment is to be initiated, place MODE switch to ALIGN position and proceed to step 11 below.*

3. DEST thumbwheel — 0. (Any number may be used.)

4. SELECT switch — POS UTM or POS L/L.

**NOTE**

*POS UTM is selected if Universal Transverse Mercator coordinates are to be inserted. POS L/L is selected if latitude and longitude coordinates are being inserted. If POS UTM is selected, proceed with step 5. If POS L/L is selected, proceed with step 6.*

5. Insert present position UTM coordinates as follows:

- a. SL button — Press. Check that left display clears and SL and INSERT buttons illuminate.
- b. Use data entry keyboard push-button switches to insert easting zone number, kilometers, and tenths of a kilometer on left display.

**NOTE**

*If an error is made while using data entry keyboard pushbutton switches, press the appropriate SL button (for left display) or SR button (for right display) twice, to clear; then repeat procedure for insertion of data.*

c. INSERT button — Press to store information on left display in computer. Check that SL and INSERT buttons go out and information on left display is correct.

d. SR button — Press. Check that right display clears and SR and INSERT buttons illuminate.

e. Use data entry keyboard push-button switches to insert northing or southing zone number, kilometers, and tenths of a kilometer on right display.

f. INSERT button — Press to store information on right display in computer. Check that SR and INSERT buttons go out and information on right display is correct.

g. Proceed with step 7.

6. Insert present position latitude and longitude coordinates as follows:

a. SL button — Press. Check that left display clears and SL and INSERT buttons illuminate.

b. Use data entry keyboard push-button switches to insert east or west longitude in degrees, minutes, and tenths of a minute on left display.

**NOTE**

*If an error is made while using data entry keyboard pushbutton switches, press the appropriate SL button (for left display) or SR button (for right display) twice, and repeat procedure for insertion of data.*

c. INSERT button — Press to store information on left display in computer. Check that SL and INSERT buttons go out and information on left display is correct.

d. SR button — Press. Check that right display clears and SR and INSERT buttons illuminate.

e. Use data entry keyboard push-button switches to insert north or south latitude in degrees, minutes, and tenths of a minute on right display.

f. INSERT button — Press to store information on right display in computer. Check that SR and INSERT buttons go out and information on right display is correct.

7. Select switch — MV/CS.

8. SL button — Press. Check that left display clears and SL and INSERT buttons illuminate.

9. Use data entry keyboard pushbutton switches to insert local magnetic variation in degrees and tenths of a degree on left display.

10. INSERT button — Press to store information on left display in computer. Check that SL and INSERT buttons go out and information on left display is correct.

11. Wait for platform temperature to come up before proceeding with alignment.



Temperature can be checked by placing SELECT switch to MON and DEST thumbwheel to 4. When last digit on right display changes from .] to 0, platform temperature is sufficient to proceed. Place MODE switch to ALIGN.

**NOTE**

*After placing MODE switch to ALIGN position, while awaiting completion of INS alignment, checkpoint and destination coordinates may be inserted as outlined in steps 12 through 19.*

12. DEST thumbwheel — Set to desired position. Previously stored coordinates may appear on left and right displays.

13. SELECT switch — DEST UTM or DEST L/L, depending on type coordinates being inserted.

14. SL button — Press. Check that left display clears and SL and INSERT buttons illuminate.

15. Use data entry keyboard pushbutton switches to insert coordinates on left display. (Use 6 digits to fill display.)

**NOTE**

*If UTM coordinates are used, insert easting zone number, kilometers, and tenths of a kilometer. If latitude and longitude coordinates are used, insert east or west longitude in degrees, minutes, and tenths of minutes.*

16. INSERT button — Press to store information on left display in computer. Check that SL and INSERT buttons go out and information on left display is correct.

17. SR button — Press. Check that right display clears and SR and INSERT buttons illuminate.

18. Use data entry keyboard pushbutton switches to insert coordinates on right display.

**NOTE**

*If UTM coordinates are used, insert north and south zone number, kilometers, and tenths of a kilometer. If latitude and longitude coordinates are used, insert north or south latitude in degrees, minutes, and tenths of minutes.*

19. INSERT button — Press to store information on right display in computer. Check that SR and INSERT buttons go out and information on right display is correct.

20. Repeat steps 12 through 19 for each destination or checkpoint to be stored in computer at different positions of DEST thumbwheel.

21. During alignment procedure, progress of alignment should be monitored. This is done by periodically placing SELECT switch to MON position. Set DEST thumbwheel to positions indicated in table 3-1, and observe for indications listed. If proper indications are not obtained, record indications received for maintenance personnel.

22. MODE switch (when RDY light flashes) — NAV. RDY light will flash upon completion of INS alignment.

**NOTE**

*During flight, INS will normally be in navigate mode. If navigation information is not valid, select air data mode by setting MODE switch from NAV to AD. If MODE switch is moved from NAV to any other position during flight, platform alignment is lost and cannot be regained until aircraft is landed and complete alignment performed.*

**Table 3-1. INS Alignment Progress**

DEST Thumbwheel Position	Notes	Left Display	Right Display
0		Malfunction light cause: 01 Computer failure 02 Control/Indicator interface 03 Data converters 04 Magnetic heading servo 05 Platform (in-flight) 06 Platform (on ground)	Thumbwheel number of fly-to destination or TACAN station selected for use in BRG/RNG
1	Values are displayed when mode switch is set to GB1 or GB2 (on ground only).	Y Gyro Bias	Z Gyro Bias
2		X Gyro Bias	
3	Values are displayed in ft/sec in NAV mode and ft/sec x 10 in ALIGN mode.	East Velocity	North Velocity
4	Left display operates in TEST mode. Right display operates in ALL mode.	Display of 111111 indicates success of built-in-test (BIT) in COMPT or PLAT TEST mode (on ground only).	Align Status 00 Stby Heat Off 01 Heat On 10 Cage 20 Level 30 GC1 40 GC2 50 GC3 60 Hdg Mem 70 Gyro Bias
5		Present of specification eval	Elapsed time in mode of operation. (STBY, ALIGN, NAV, A/D etc.)
6		Unused	Spheroid select
7		Set time	Running time
8	By entering 7777 in thumbwheel position 8, then selecting thumbwheel position 9, read identity of tape program in the computer.	Unused	Display of memory address inserted by operator for some desired data in computer.
9		Display of desired data held in memory address	

23. Insert TACAN data. TACAN data may be inserted as follows:

**NOTE**

*For TACAN automatic position update, the TACAN set shall be on with the mode select control in AUTO. It is necessary to know and insert the TACAN station location in L/L, channel number, altitude and magnetic variation. A minimum of three TACAN stations will be required and must be no less than 6.5 nautical miles ground range nor more than 100 nautical miles slant range from the present position of the aircraft. The INS inertial system L/L and the TACAN L/L eval must be within 5 nautical miles of each other. If not, the data received from the TACAN station will be rejected by the INS computer.*

- a. SELECT switch – MV/CS.
- b. STA button – Out.
- c. SL button – Press. Check that left display clears and SL and INSERT buttons illuminate.
- d. Use data entry keyboard push-button switches to insert local magnetic variation in degrees and tenths of a degree on left display.
- e. INSERT button – Press to store information on left display in computer. Check that SL and INSERT buttons go out and information on left display is correct.
- f. SELECT switch – ALT/STA.
- g. DEST thumbwheel – 0 position for entering data for the first TACAN station.
- h. STA button – Press. Check that STA button illuminates and right display indicates a 3-digit number.
- i. SR button – Press. Check that right display clears and SR and INSERT buttons illuminate.
- j. Use data entry keyboard push-button switches to insert TACAN channel number on right display.
- k. INSERT button – Press to store information on right display in computer. Check that SR and INSERT buttons go out and information on right display is correct.

- l. SL button – Press. Check that left display clears and SL and INSERT buttons illuminate.
- m. Use data entry keyboard push-button switches to insert TACAN station altitude in feet on left display.
- n. INSERT button – Press to store information on left display in computer. Check that SL and INSERT buttons go out and information on left display is correct.
- o. SELECT switch – DEST L/L.
- p. SL button – Press. Check that left display clears and SL and INSERT buttons illuminate.
- q. Use data entry keyboard push-button switches to enter TACAN station longitude in degrees, minutes, and tenths of a minute on left display.
- r. INSERT button – Press to store information on left display in computer. Check that SL and INSERT buttons go out and information on left display is correct.
- s. SR button – Press. Check that right display clears and SR and INSERT buttons illuminate.
- t. Use data entry keyboard push-button switches to enter TACAN station latitude in degrees, minutes, and tenths of a minute on right display.
- u. INSERT button – Press to store information on right display in computer. Check that SR and INSERT buttons go out and information on right display is correct.
- v. SELECT switch – MV/CS.
- w. SL button – Press. Check that left display clears and SL and INSERT buttons illuminate.
- x. Use data entry keyboard push-button switches to enter TACAN station magnetic variation in degrees and tenths of a degree on left display.
- y. INSERT button – Press to store information on left display in computer. Check that SL and INSERT buttons go out and data on left display is correct.
- z. Repeat steps f. through y. for all additional TACAN stations advancing DEST thumbwheel one number for each station selected.

- aa. SELECT switch - ALT/STA.
- ab. STA button - Out.
- ac. SL button - Press. Check that left display clears and SL and INSERT buttons illuminate.
- ad. Use data entry keyboard push-button switches to enter aircraft present altitude in feet on left display.
- ae. INSERT button - Press to store information on left display in computer. Check that SL and INSERT buttons go out and data on left display is correct.

- af. DEST thumbwheel - 8.
- ag. SELECT switch - MON.
- ah. SR button - Press. Check that right display clears and SR and INSERT buttons illuminate.
- ai. Use data entry keyboard push-button switches to enter N6777 on right display.

aj. INSERT button - Press to store information on right display in computer. Check that SR and INSERT buttons go out and information on right display is correct.

ak. DEST thumbwheel - 9 and observe right display. Observe a 4-digit number displays for approximately 3 to 5 seconds, then another 4-digit number displays for approximately 3 to 5 seconds, then another 4-digit number displays. Observe this sequence for three cycles.

- al. DEST thumbwheel - 8.
- am. SR button - Press. Check that right display clears and SR and INSERT buttons illuminate.
- an. Use data entry keyboard push-button switches to enter N6776 on right display.

ao. INSERT button - Press to store information on right display in computer. Check that SR and INSERT buttons go out and information on right display is correct.

ap. DEST thumbwheel - 9 and observe right display indicates same as in step ak., above.

*(b) Taxi Speed Readout Procedure.*

1. SELECT switch - TCK/GS.
2. Right display - Read taxi speed in knots. It will also indicate + or - inertial ground speed error, which can only be determined when the aircraft is not moving.

*(c) Bearing and Range Readout Procedure.*

1. DEST thumbwheel - Set to desired checkpoint or destination number.
2. SELECT switch - BRG/RNG.
3. Left display - Read bearing-to-destination or checkpoint angle in degrees and tenths of degree (true).
4. Right display - Read range-to-destination or checkpoint in kilometers and tenths of kilometer.
5. Press INSERT button to display BRG/RNG to selected destination on BDHI (magnetic/nautical miles).

*(d) Heading and Time Readout Procedure.*

1. DEST thumbwheel - Set to desired checkpoint or destination number.
2. SELECT Switch - HDG/TIME.
3. Left display - Read true heading angle of aircraft in degrees and tenths of degree.
4. Right display - Read flying time to checkpoint or destination in minutes and tenths of minute.

*(e) Track and Groundspeed Readout Procedure.*

1. SELECT switch - TCK/GS.
2. Left display - Read aircraft track angle with respect to true north in degrees and tenths of degree.
3. Right display - Read ground-speed in knots and tenths of knot.

*(f) Magnetic Variation and Course Select Readout Procedure.*

1. SELECT switch - MV/CS.
2. Left display - Read magnetic variation from true north in degrees and tenths of degree.
3. Right display - Read last selected course angle with respect to true north in degrees and tenths of degree for destination selected on DEST thumbwheel.

*(g) Wind Direction and Velocity Readout Procedure.*

1. SELECT switch - WIND.

2. Left display — Read wind direction angle with respect to true north in degrees and tenths of degree.

3. Right display — Read wind velocity in knots and tenths of knot.

*(h) Position Fix and Updating Present Position Operating Procedure.* Press POS FIX button when over point or area of interest to freeze digital readout. Record or relay INS position, as appropriate. If known position is to be overflown or accurate position fix is available, check and update aircraft present position as follows:

1. POS FIX button — Press when aircraft position is coincident with fix position; check that POS FIX button illuminates. Universal Transverse Mercator (UTM) and latitude and longitude information is now frozen at position fix point.

2. SELECT switch — UTM POS or L/L POS.

**NOTE**

*POS FIX button may be pressed in any position of SELECT switch. Only position fix information will be displayed, even though UTM and latitude-longitude information is being constantly updated. All other information is also updated and is available for display by setting SELECT switch to appropriate position.*

3. SELECT switch — EVAL. Check that INSERT button illuminates.

4. DEST thumbwheel — Set to number corresponding to position fix point.

5. Left and right displays — Read difference, in kilometers and tenths of kilometer, between known position and computed position at instant POS FIX button indicator was pressed.

**NOTE**

*SELECT switch shall be set to EVAL to accept present position update*

*information. Other positions will result in rejection of update information.*

6. INSERT button — If update of present position is required, press to accept update. Left and right displays and computer will be automatically updated and then restored to normal operation.

7. POS FIX button — If update of present position is not required, press to reject update.

*(i) Intercept Approach to Destination Operating Procedure.*

1. COURSE IND switch (BDHI/COURSE SELECTOR panel (figure 3-10)) — INT.

2. DES thumbwheel — Set to number corresponding to desired destination.

3. SELECT switch — MV/CS.

4. Right display — Read intercept course to destination with respect to true north.

5. If intercept course to destination is not correct, perform steps a through c below. If information is correct, proceed to step 6.

a. SR button — Press. Right display will clear; SR and INSERT buttons will illuminate.

b. Data entry keyboard — Use pushbuttons to insert new course to destination; read new course on right display.

**NOTE**

*If error is made while inserting information, press SR button twice and reinsert information.*

c. INSERT button — Press to store new information in computer. Check that SR and INSERT buttons go out and that information on right display is correct.

6. Engage autopilot. Aircraft will be directed to selected destination along new selected course. If desired, course bar on course indicator can be used to manually fly aircraft to destination.

*(j) Direct Approach to Destination Operating Procedure.*

1. COURSE IND switch (BDHI/COURSE SELECTOR panel (figure 3-10)) - DIR.

2. DEST thumbwheel - Set to number corresponding to desired destination.

3. Engage autopilot; aircraft will be automatically flown directly to selected destination. If desired, course bar on course indicator can be used to manually fly aircraft directly to destination.

*(k) Air Data Mode Operating Procedure.*

1. MAL and A/D lights - If illuminated during flight, air data mode is automatically initiated.

2. If navigation information is not valid; select air data mode by setting MODE switch to A/D.

*(l) Emergency Operating Conditions.*

1. Loss of compass input - Results in loss of magnetic heading indications.

2. Loss of radar altimeter input - Results in loss of altitude and groundspeed-to-altitude (V/H) ratio information to data annotation system - (if installed).

3. Loss of true airspeed input - Results in inoperative air data mode and loss of wind speed and direction information.

*(m) Shutdown Procedure.* INS is not normally deenergized during flight.

**3-13. Compass System.**

a. The compass system is installed as a backup system to insure IMC flight capability in event of failure of the inertial navigation system (INS). Should this condition exist, the operator can select the backup compass system by placing the NAV MODE select switch to the BACK-UP COMP position. The NAV MODE select switch is on the lower console (figure 3-13).

**NOTE**

*Anytime the NAV MODE switch position is changed during flight, the autopilot shall be disengaged first. This will insure that no sudden change in heading information is introduced into the autopilot.*

b. The compass system provides roll and pitch information for attitude indication, and magnetic heading or stabilized heading information for aircraft navigation at all latitudes of the earth. As a heading reference, three modes of system operation are used; Directional Gyro (DG), SLAVED, and COMP modes. In polar regions where magnetic heading references are not reliable, the system should be operated in the directional gyro (DG) mode. In this mode, the system furnishes an inertial heading reference, with latitude corrections introduced manually. In areas where magnetic heading references are reliable, the system should be operated in the SLAVED mode of operation. In this mode, the directional gyro is slaved to the compass transmitter, which supplies long-term magnetic reference for the correction of the apparent drift of the gyro. During emergencies when the DG or SLAVED modes are inoperative, the COMP mode of operation should be used. In this mode, an emergency heading reference is provided by the compass transmitter. The compass system does not supply pitch, roll, and heading information to the data annotation system (if installed). (This information is only obtained from the INS.) The INS information, if available, is then applied to the various sensor systems for presentation on the film. Power is applied to the compass system through a circuit breaker on the remote circuit breaker panel. Figure 3-15 illustrates the control panel and its location in the cockpit. A warning light on the annunciator panel will illuminate if a failure of the backup compass system is encountered in either the INS or BACK-UP mode of operation.

*(1) Compass Control Panel Switch and Display Functions (figure 3-15).*

CONTROL	FUNCTION
COMP-SLAVED-DG switch	Selects mode of system operation.

CONTROL	FUNCTION
N-S hemisphere select switch	Selects polarity of latitude correction.
LAT control knob	When set to local latitude, corrects heading gyro for apparent drift caused by earth's rotation.
HDG-PUSH knob	When compass system is in SLAVED mode, pressing knob provides automatic synchronization of heading output with compass transmitter heading. When system is in DG mode, rotating knob to - or + generates control signal that drives heading synchro to any desired heading. Pressing knob in DG mode increases normal pitch erection rate of gyro three times, and roll erection rate twelve times.
SYN IND meter	Indicates synchronization between gyro heading and compass transmitter in SLAVED mode.
MALF indicator	Indicates out-of-limit condition of the power supply voltage, loss of excitation for heading synchros, loss of heading, signal transmission, displacement of heading servo loop from null, or presence of fast erection voltage in gyro.

**(2) Compass System Operation.**

(a) N-S hemisphere select switch - As required for hemisphere of aircraft.

(b) LAT control knob - Set to latitude of aircraft. Allow 2-1/2 minutes for gyro erection.

(c) For SLAVED operation, proceed as follows:

1. COMP-SLAVED-DG switch - SLAVED position.

2. Compass card on BDHI (or course indicator) - Indicates aircraft heading.
3. SYNC IND - Full position.

**NOTE**

*Normal synchronization is at a rate of 1-1/2 degrees per minute. Fast synchronization can be done by pressing the HDG-PUSH KNOB.*

*SYNC IND on COMP control panel is operational in this mode; however, it will move rapidly. On-scale readings will indicate that the compass is within 4 degrees of the aircraft's heading.*

(d) For COMP operation, proceed as follows:

1. COMP-SLAVED-DG switch - COMP position.
2. Compass card on BDHI (or course indicator) - Indicates aircraft heading.

(e) For DG operation, proceed as follows:

1. COMP-SLAVED-DG switch - DG position. Allow 2-1/2 minutes for gyro to erect and stabilize.
2. Align aircraft with a known magnetic heading.
3. HDG-PUSH knob - Rotate until compass card on BDHI (or course indicator) agrees with heading established.

**NOTE**

*When the heading has thus been established, any rotation of the HDG-PUSH knob or COMP-SLAVED-DG switch will cause a temporary loss of heading reference.*

(f) Attitude operation of the system is automatic. Roll and pitch information will be

displayed on the approach horizon indicator (figure 3-11).

**NOTE**

*The normal erection rate for pitch is 5 degrees per minute and for roll is 1-1/2 degrees per minute. The erection rate can be increased by pressing the HDG-PUSH knob.*

(g) Shutdown. The system is not normally shut down.

b. The marker beacon/glide slope control panel (figure 3-16), on the center instrument panel, contains the volume and on-off controls for the marker beacon portion of the receiver.

**(1) Marker Beacon/Glide Slope Control Panel Switch Functions (Figure 3-16).**

CONTROL	FUNCTION
VOL-OFF control	Turns on marker beacon and glide slope receivers. Adjusts volume of marker beacon audio signal and provides power to the marker beacon light.

**3-14. Glide Slope and Marker Beacon Receiver.**

a. The glide slope and marker beacon receiver is used to provide the pilot with both glide slope and marker beacon information. The glide slope portion provides vertical guidance information to the glide slope pointer on the approach horizon indicator (figure 3-11) during Instrument Landing System (ILS) approaches, indicating the relative position of the aircraft with respect to the glide path. The VOR control panel (figure 3-7) is used to control application of power and frequency selection of the glide slope circuits within the receiver. The glide slope portion of the receiver operates over a frequency range of 329.15 to 335.00 MHz. The distance range is approximately 20 miles. The marker beacon portion is used to provide the pilot with visual and aural indication of the aircraft's position with respect to a 75 MHz marker beacon transmitter. The visual indication is presented in the form of a flashing light on the pilot's instrument panel. The light flashes at different intervals, depending on the type of marker beacon signal being received. The aural indication is provided in the form of an audio tone (400, 1,300, or 3,000 Hz, depending on the type of signal being received) in the headsets. Power is applied to the receiver through a circuit breaker on the remote circuit breaker panel. Figure 3-1 illustrates the location of the associated antennas.

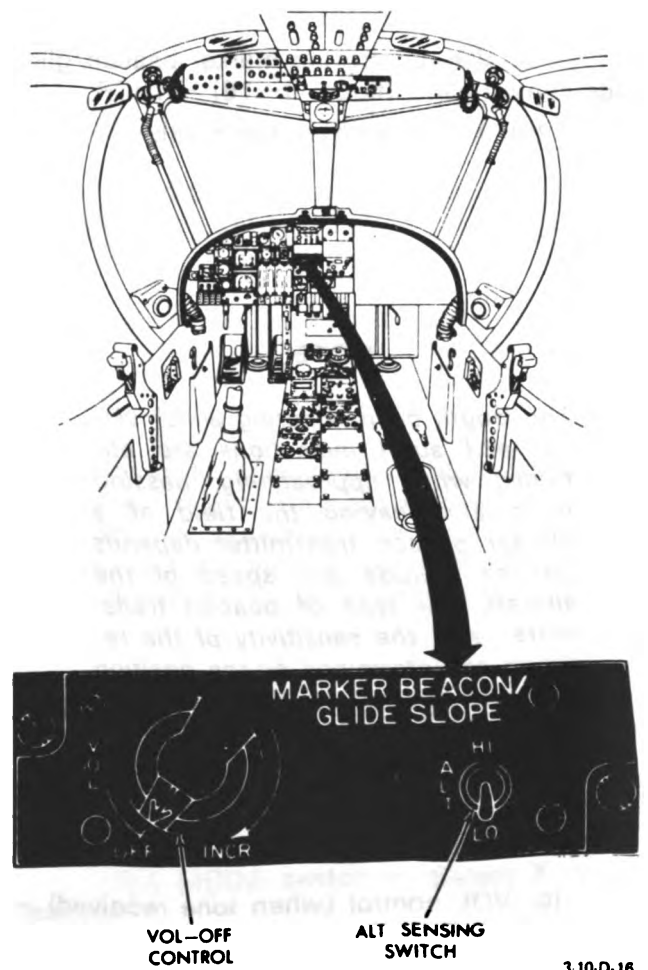

**Figure 3-16. Marker Beacon/Glide Slope Control Panel**



**CONTROL                      FUNCTION**

Alt sensing switch                      HI provides increased sensitivity of receiver. LO provides decreased sensitivity of receiver.

(2) *Glide Slope and Marker Beacon Receiver Operation.* The glide slope portion of the glide slope and marker beacon receiver is used in conjunction with the flight director system or autopilot, or both, during an Instrument Landing System (ILS) approach. Operation is, therefore, contained with the operation of the flight director system (paragraph 3-11) and the autopilot (paragraph 3-16). The following operating procedures apply to the marker beacon portion of the receiver.

- (a) VOL control on marker beacon/glide slope control panel (figure 3-16) - INCR.
- (b) ALT sensing switch - HI.

**NOTE**

*The length of time during which visual and aural indications are obtained while approaching, passing over, and leaving the field of a marker beacon transmitter depends on the altitude and speed of the aircraft, the type of beacon transmitter, and the sensitivity of the receiver as determined by the position of the alt sensing switch.*

- (c) VOL control (when tone received) - Adjust to desired level.
- (d) As audio signal increases in strength - Set ALT sensing switches to LO.
- (e) VOL control - Adjust, as necessary.

**NOTE**

*Switching the ALT sensing switch from HI to LO as the signal strength increases, provides for more accurate determination of the position of the marker beacon.*

- (f) Indicator light on pilot's instrument panel - Observe for proper indication.
- (g) Shutdown. VOL control - OFF.

**3-15. TACAN Set.**

a. The TACAN set is an airborne navigational set that operates in conjunction with selected TACAN ground stations or other TACAN equipped aircraft to provide bearing and distance to selected destination. Visual indication of bearing and distance to destination are displayed on the BDHI (figure 3-9), on the pilot's instrument panel. The TACAN set operates on any one of 126 preset channels with a distance range of approximately 300-miles. An audio tone is also applied through the ICS to the headsets to indicate TACAN signal reception. Power is applied to the set through circuit breakers on the remote circuit breaker panel. The associated antennas are shown in figure 3-1.

b. The TACAN control panel (figure 3-17), on the center instrument panel, provides power, channel, and mode selection. The panel also has Built-In-Test (BIT) capabilities, BIT indications, and an ECM indicator.

(1) *TACAN Control Panel Switch Functions (figure 3-17).*

**CONTROL                      FUNCTION**

ECM WARN lamp                      Indicates when counter-measures signal is attempting to jam system.

STATUS GO and NO GO indicators                      Indicates system GO or NC GO (fault) during self-test.

BIT pushbutton switch                      Initiates self-test sequence in system. Self-test result is displayed on status indicator.

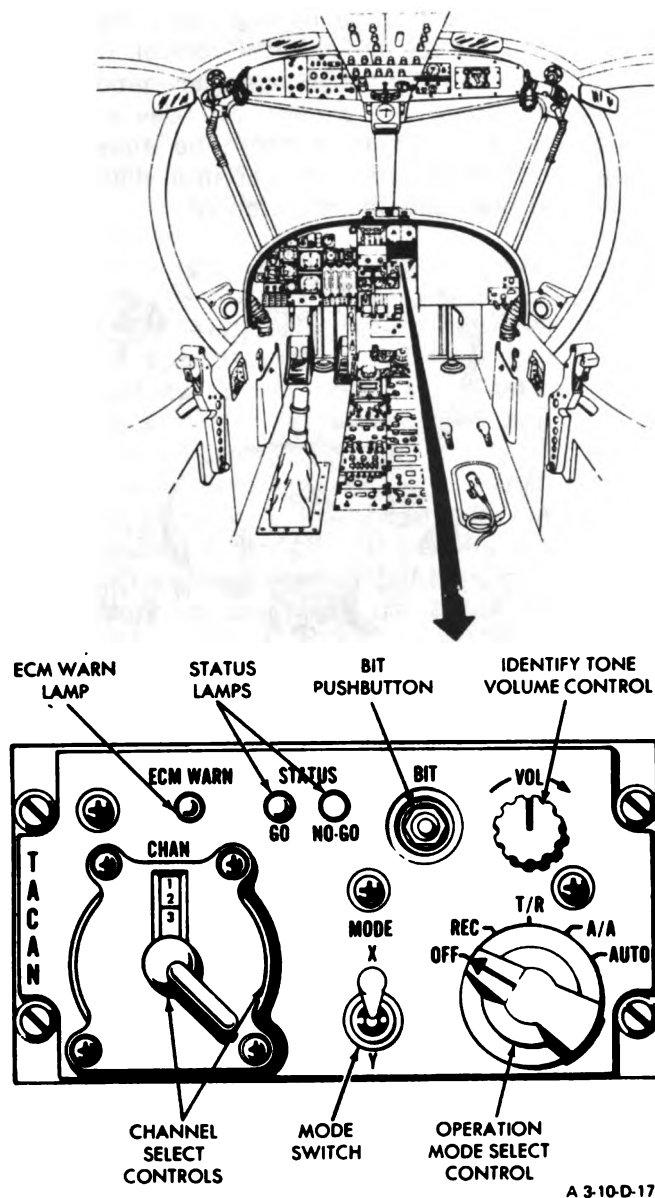

**Figure 3-17. TACAN Control Panel (AN/ARN-103)**

CONTROL	FUNCTION
T/R	Selects transmit and receive function of transceiver for course and distance information.
A/A	Selects air-to-air transmit and receive function for range information to cooperating aircraft.
AUTO	Inertial navigation system takes control of TACAN system.
MODE switch	Selects X or Y beacon channels.
CHAN (channel) selector switch	Provides selection of one of 126 TACAN channels for receiving and transmitting.

**(2) TACAN Set Operation.**

(a) Operation mode select control – As desired.

**NOTE**

*For air-to-air operation, both aircraft shall select channels within a 63 channel separation. (i.e., aircraft A selects channel 1, aircraft B selects channel 64 for range information)*

CONTROL	FUNCTION
VOL control	Adjust volume of beacon identity tone.
Operation mode select control	
OFF	Turns TACAN set OFF.
REC	Selects receive portion of transceiver for course information and station identity tone.

- (b) CHAN selector switch – Select TACAN channel, as desired.
- (c) MODE switch – Select X or Y, as desired.
- (d) VOL control – As desired.
- (e) NO. 2 NEEDLE switch (figure 3-10) – TACAN.
- (f) Shutdown. Operation mode select control – OFF.

3-16. Autopilot.

a. The autopilot is an automatic flight control system that can be used to maintain stabilized attitude and heading, automatic altitude control, and automatic steering using information supplied by the navigation equipment aboard the aircraft. The system is controlled by the automatic navigation coupler (figure 3-18) and the flight controller (figure 3-19), on the lower console in the cockpit. Three operating modes are provided; pilot operated command mode, automatic lateral control, and automatic vertical control. In the pilot operated command mode the pilot introduces commands by the use of switches and controls on the automatic navigation coupler and the flight controller, that cause

the aircraft to change its flight attitude. During automatic lateral and vertical control, the autopilot, in conjunction with other navigational systems on board the aircraft, provides automatic steering and attitude control. The autopilot release button on the pilot's control stick can be used for disengaging the autopilot.

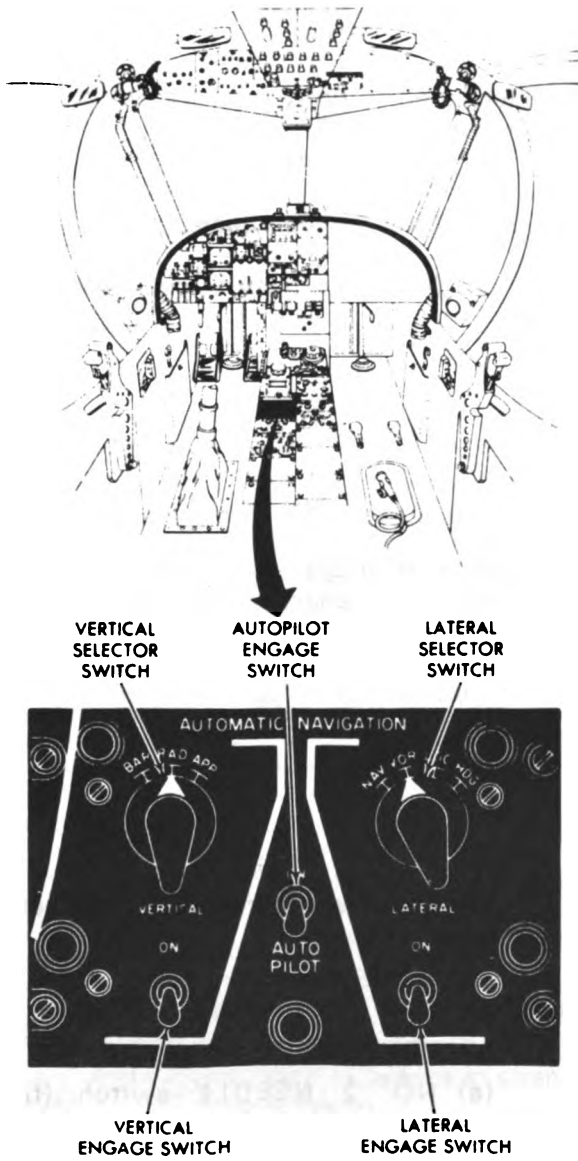

Figure 3-18. Automatic Navigation Coupler (AN/ASW-12)

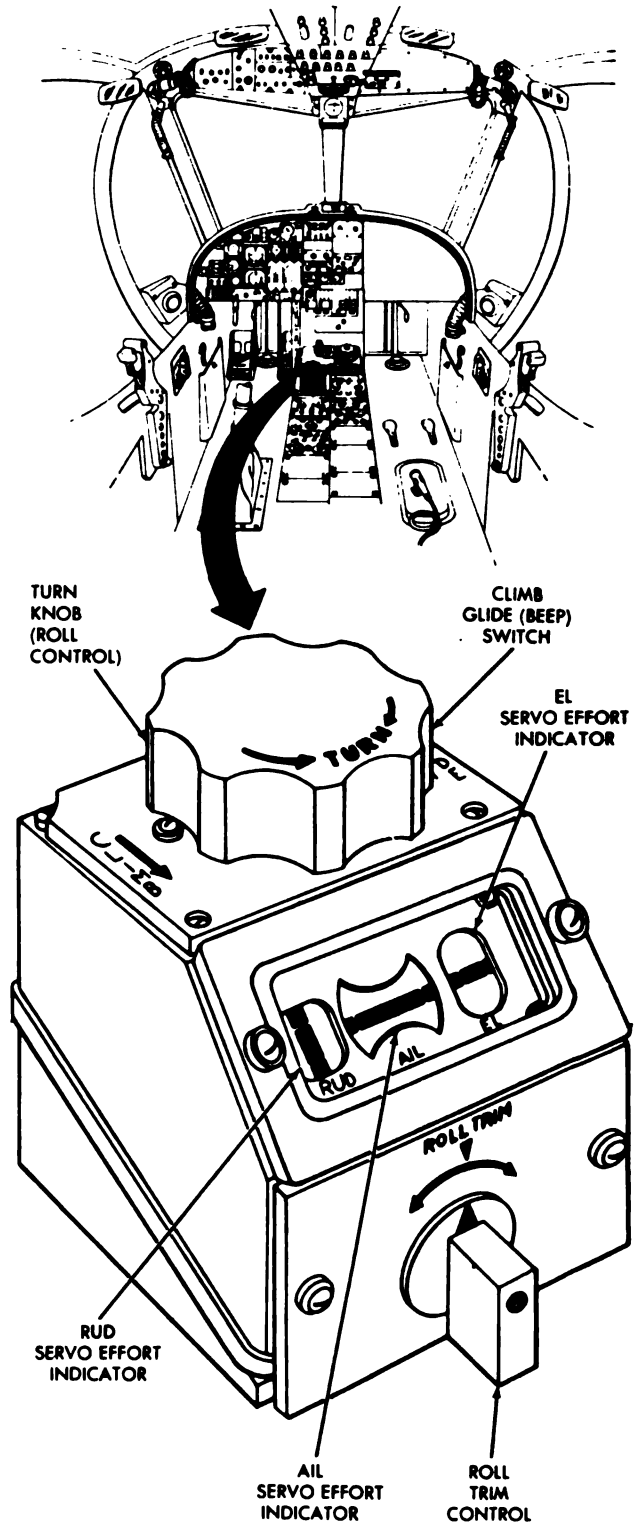

Figure 3-19. Flight Controller (AN/ASW-12)

**WARNING**

Do not engage autopilot during single engine operation with partial or full flaps down. Disengage autopilot for single engine flight below 130 knots IAS. The limited authority of the autopilot as single engine minimum control speeds are approached, results in decreasing lateral control. Should the autopilot be disengaged and an out of trim condition exist, an unusual flight attitude can occur. The unusual attitude can be avoided if the pilot trims the aircraft so that the servo effort indicators on the flight controller are centered before disengagement. Should available trim be insufficient to do this, the pilot must be ready to apply immediate corrective control upon autopilot disengagement.

During operation of the autopilot, the servo effort indicators shall be monitored closely to insure trim is being maintained. This is particularly true when changing speeds or power settings. Sustained out of trim flight conditions will result in overload and possible failure of the yaw and roll stabilization systems. Sustained out of trim conditions at high speeds (above normal cruise) may also produce lightly damped lateral oscillations.

**NOTE**

*The autopilot should not be engaged until the gyroscope has had 2-1/2 minutes to complete its fast erection cycle (AFCS caution light out). This time cycle is necessary to insure proper erection of the gyroscope.*

*The autopilot will align the aircraft with the existing pitch attitude and*

*heading attitude at the time of engagement. If the autopilot is engaged while the aircraft is executing a banked maneuver, the aircraft will roll out level and maintain the established heading at the time of engagement. The system can be engaged at pitch angles up to 25° and roll angles up to 45°.*

b. The automatic navigation coupler (figure 3-18) and the flight controller (figure 3-19), on the lower console, provide command selection to change the flight attitude of the aircraft.

(1) *Automatic Navigation Coupler Switch Functions (figure 3-18).*

CONTROL	FUNCTION
AUTOPILOT engage switch	Engages autopilot. When set to ON, maintains aircraft heading and pitch attitude at time of engagement.
VERTICAL selector switch	Selects method of vertical control.
BAR	Used to select barometric pressure as reference source for automatic altitude control.
RAD	Not used on this aircraft.
APP	Used with ILS for automatic approach (glide slope) control.
VERTICAL engage switch	In ON position, engages vertical control channel selected on the VERTICAL selector switch.
LATERAL selector switch	Selects method of lateral control.
NAV	Selects automatic lateral control of aircraft to destination selected by INS.
VOR	Selects automatic lateral control of aircraft to fly a VOR radial selected on VOR set or for FM homing.

CONTROL	FUNCTION
LOC	Selects automatic lateral control of aircraft to fly on ILS localizer.
HDG	Selects automatic lateral control of aircraft to fly magnetic heading selected by HEADING knob on course indicator.
LATERAL engage switch	In ON position, engages lateral control channel selected on LATERAL selector switch.

*(2) Flight Controller Switch and Display Functions (figure 3-19).*

CONTROL	FUNCTION
Combined CLIMB-GLIDE (beep) switch and roll control TURN knob	With AUTOPILOT engage switch on automatic navigation coupler set to ON (autopilot engaged), pushing beep switch forward causes aircraft dive that is maintained by autopilot; pulling beep switch back causes aircraft climb that is maintained by autopilot when beep switch is released and returned to center detent. VERTICAL engage switch shall be off (down) for beep switch operation. Turning TURN control left or right causes coordinated left or right turn of aircraft.
ROLL TRIM control	Adjusts aircraft roll attitude without affecting heading.
RUD servo effort indicator	Indirectly shows relative rudder position by indicating torque load on surface.
AIL servo effort indicator	Indirectly shows relative aileron position by indicating torque load on surface.
EL servo effort indicator	Indirectly shows relative elevator position by indicating torque load on surface.

*(3) Autopilot Operation.*

*(a) Mode of Operation.*

1. Pilot operated command mode. In the pilot operated command mode of operation, the pilot controls the roll, pitch, and yaw attitude of the aircraft through the use of the TURN knob, beep switch, and ROLL trim control on the flight controller on the lower console in the cockpit. The VERTICAL engage switch on the automatic navigation coupler control shall be in the off (down) position in order to obtain pilot operated command control over the pitch attitude of the aircraft.

2. Automatic lateral control (LATERAL). The modes of operation for automatic lateral control include the following:

a. Heading select (HDG). The HDG mode provides automatic lateral control for the aircraft to steer towards a selected magnetic heading.

b. Navigation (NAV). The NAV mode provides automatic lateral control of the aircraft to follow a ground path preset into the aircraft's INS.

**NOTE**

*The NAV mode of autopilot operation is inoperative with the NAV MODE select switch in the BACK-UP COMP position. In flight, the autopilot should be disengaged before changing position of the NAV MODE select switch. This will insure that no sudden change in heading information is introduced into the autopilot. Compass system is selected by positioning NAV MODE select switch from INS to BACK-UP COMP (figure 3-13). With NAV mode inoperative, select either HDG mode, LOC mode, or VOR mode of operation for automatic lateral control of aircraft.*

c. Localizer (LOC). The LOC mode provides automatic lateral control of the aircraft to fly an Instrument Landing System (ILS) localizer beam.

d. Very high frequency omnidirectional radio range (VOR). The VOR mode provides automatic lateral control of the aircraft to fly a preselected radial of a VOR ground station.

3. Automatic vertical control (VERTICAL). The modes of operation for automatic vertical control include the following:

a. Radar (RAD). The RAD mode of operation is not used on the aircraft.

b. Barometric altitude (BAR). The BAR mode provides automatic vertical control for the aircraft to maintain a constant barometric pressure altitude.

c. Approach (APP). The APP mode provides vertical control of the aircraft to automatically fly the glide slope path of an Instrument Landing System (ILS).

*(b) Turn-On Procedure.*

1. Autopilot engage switch - Off (down).

2. AFCS caution light (on caution annunciator panel) - Out. (Will go out after approximately 2-1/2 minutes warmup.)

3. TURN knob - Center detent.

4. ROLL TRIM control - Center mark aligned with index.

5. VERTICAL selector switch - Any position.

*(c) Autopilot Engaging Procedure.* AUTOPILOT engage switch - ON.

*(d) Command Mode Operating Procedure.*

**NOTE**

*VERTICAL engage switch shall be in off (down) position for beep switch operation. When beep switch is released, autopilot will maintain aircraft in pitch attitude selected.*

1. CLIMB-GLIDE (beep) switch - Set pitch attitude of aircraft; move rearward for noseup or forward for nosedown.

2. To command coordinated turn, rotate TURN knob right for right turn or left for left turn. To return aircraft to level attitude, rotate TURN knob back to center detent position.

3. To trim aircraft roll attitude without changing heading of aircraft, adjust ROLL TRIM control to right or left proportional to amount of roll trim required.

*(e) Automatic Lateral Control (LATERAL) Operating Procedures.*

1. Heading mode (HDG) operating procedure.

a. LATERAL selector switch - HDG.

**NOTE**

*When switching from one lateral selection to another (with LATERAL engage switch ON), LATERAL engage switch will automatically disengage.*

b. HDG/ILS knob (approach horizon indicator) - HDG.

c. HEADING knob (course indicator) - Set heading bug to lubber line.

d. LATERAL engage switch - ON. Aircraft will now automatically perform coordinated turns to arrive at and maintain heading selected on course indicator. Changes in selected heading can be made by positioning HEADING knob on course indicator to new desired heading.

e. HEADING knob (course indicator) - Set heading bug to desired heading.

2. VOR mode (VOR) operating procedure.

a. Tune VOR set to desired VOR station operating frequency.

b. LOC flag (approach horizon indicator) - Masked.

c. HDG/ILS knob (approach horizon indicator) - HDG.

d. COURSE selector knob (course indicator) – Set course selector arrow to desired course.

e. Operate roll control TURN knob to manually bracket VOR beam or place LATERAL select switch to HDG position, place LATERAL engage switch to ON, and rotate HEADING knob on course indicator to desired intercept heading. Bracket VOR beam in this manner to within less than half-scale of course bar and to within less than 20° of desired course to station.

**NOTE**

*As aircraft approaches zone of confusion over VOR station, autopilot will command aircraft to track erratic signal. Although commanded bank angles are small and smoothly executed, erratic tracking may be eliminated by turning the LATERAL engage switch off (down) until the VOR course indication has stabilized. The aircraft will fly through the zone of confusion at the heading prevailing upon disengagement of the LATERAL engage switch.*

f. Rotate LATERAL select switch to VOR and set LATERAL engage switch to ON. Aircraft will now capture and hold center of VOR radial.

**NOTE**

*Changing VOR frequencies with autopilot engaged may cause aircraft to pitch down 2° with each tenth Hz change in frequency.*

g. If change of VOR frequency is required, set LATERAL engage switch to OFF, select new VOR frequency, and set lateral engage switch to ON.

3. Localizer mode (LOC) operating procedure.

a. Tune VOR set to desired localizer frequency.

b. LOC flag (approach horizon indicator) – Masked.

c. Perform usual approach procedures, using either roll control TURN knob or heading mode (HDG). If flying an approach with procedure turn, fly outbound at least 1-minute beyond outer marker.

d. When turning inbound, set up 45-degree intercept of localizer course.

**NOTE**

*Banked turns commanded by autopilot during automatic approach are limited to 45-degrees with the TURN knob, 25-degrees in HDG mode, and 10-degrees in LOC mode. Automatic localizer bracket should not be attempted unless beam widths at point of intercept and turning rate of aircraft in 25-degree bank are compatible.*

*Do not attempt bracket capture of localizer beam with VERTICAL selector switch in APP position.*

e. When steering pointer on approach horizon indicator first reaches 80 percent of full-scale deflection, set LATERAL selector switch to LOC and LATERAL engage switch to ON. Aircraft will bracket and hold center of localizer beam.

**NOTE**

*If crab angle is required to fly localizer beam, magnitude and direction will be computed automatically and set in by flight director.*

f. HDG/ILS knob (approach horizon indicator) – ILS.

**NOTE**

*Glide slope indications may be erratic when propellers are set to 1,500 ± 50 RPM.*

g. GS flag (approach horizon indicator) – Masked.

h. Glide slope pointer (approach horizon indicator) – Adjust pitch attitude of aircraft by moving CLIMB-GLIDE (beep) switch forward or rearward until pointer is centered. At this point, set VERTICAL selector switch to APP; if glide slope capture and automatic vertical approach are desired, set VERTICAL engage switch to ON.

**WARNING**

Before disengagement of autopilot, check servo effort indicators on flight controller to insure that they are centered. If autopilot is disengaged when out of trim condition exists, unusual attitude can occur upon disengagement. This can be avoided if pilot trims aircraft until servo effort indicators are centered. Should available trim control be insufficient to do this, pilot shall be ready to apply immediate corrective control upon autopilot disengagement.

i. At predetermined altitude, or as conditions warrant in vertical approach, disengage autopilot either by pressing autopilot release button on pilot's control stick grip or by setting AUTOPILOT engage switch to off (down). Complete approach to touchdown manually.

4. Navigation mode (NAV) operating procedure.

a. LATERAL selector switch – NAV.

b. LATERAL engage switch – ON. Autopilot and INS will guide aircraft to destination selected on INS control panel. If it is desired to select new destination, select new destination on INS control panel.

(f) *Automatic Vertical Control (VERTICAL) Operating Procedures.*

1. Barometric altitude mode (BAR) operating procedure.

a. Stabilize aircraft rate of climb to less than 200 feet per minute.

b. VERTICAL selector switch – BAR.

c. VERTICAL engage switch – ON. Aircraft will be automatically stabilized to constant barometric altitude.

**CAUTION**

Do not overpower primary controls to change altitude.

d. To make change in altitude:

(1) VERTICAL engage switch – Off (down).

(2) CLIMB-GLIDE (beep) switch – Command change in altitude; stabilize rate of climb at less than 200 feet per minute.

(3) VERTICAL engage switch – ON.

2. Radar mode (RAD) operating procedure. RAD mode is inoperative on the aircraft.

3. Approach mode (APP) operating procedure. APP mode of automatic vertical control is used with LOC mode of automatic lateral control in an Instrument Landing System (ILS) approach.

(g) *Emergency Operating Procedures.*

1. Overpowering autopilot system.



a. Individual autopilot control channels in any operating mode may be overpowered if malfunction occurs, or to perform evasive maneuvers.

b. After overpowering controls, disengage autopilot by either AUTOPILOT engage switch to off (down) or pressing autopilot release button on pilot's stick grip.

2. Command mode malfunction. If action of flight controller is lost, autopilot can still be used for stabilization. Proceed as follows:

- a. TURN knob - Center.
- b. ROLL TRIM control - Center.
- c. Manually establish desired pitch, roll, and yaw reference of aircraft.

d. AUTOPILOT engage switch - ON.

- e. To make changes in attitude:
  - (1) AUTOPILOT engage switch - Off (down).
  - (2) Manually position aircraft to new attitude.

(3) AUTOPILOT engage switch - ON.

3. Other mode malfunctions. In any lateral mode or vertical mode malfunction, select another mode or set LATERAL and VERTICAL engage switches to off. Continue using autopilot in pilot-operated command mode; make changes in flight attitude with TURN knob and beep switch.

4. In the event the autopilot fails to disengage, proceed as follows:

a. Press autopilot release button on control stick several times.

b. Turn AUTOPILOT engage switch to off (down).

c. If autopilot is still engaged, shear autopilot pins by vigorously overpowering all three autopilot control axes.

*(h) Shutdown Procedure.*

1. Servo effort indicators - Trim aircraft until indicators are centered.

2. Prepare to take over manual control of aircraft; disengage autopilot by either setting AUTOPILOT engage switch to off (down) or pressing autopilot release button on pilot's stick grip.

## SECTION IV. TRANSPONDER AND RADAR

### 3-17. Transponder Set.

The transponder set is an airborne transceiver that receives, decodes and responds to interrogations in modes 1, 2, 3/A, C, and 4 from ground based or airborne interrogators. The transponder set transmits and receives (in the 1,090 ±0.5 MHz and 1,030 ±0.5 MHz range, respectively) a coded pulse-type L band signal. The set receives and decodes the signal and if it is correct, replies with a signal that carries the code corresponding to the mode of interrogation. The modes are set at the transponder (IFF) control panel (figure 3-20) for modes 1 and 3/A, and at the transceiver (preset before flight) for mode 2. The reply signals are used by the interrogator

to determine the aircraft's bearing, distance, and altitude. The distance range receiving and transmitting is line-of-sight. Circuits are provided to automatically reply in the emergency code to interrogations when either seat is ejected. The facility includes complete provisions for the Test Set TS1843(\*)/APX and KIT-1A/TSEC, which provide self-test and secure identification capabilities. An IFF caution light is installed on the caution annunciator panel in the cockpit, and illuminates when the transponder set fails to respond to a mode 4 interrogation. Power is applied to the set through circuit breakers on the remote circuit breaker panel. Figure 3-20 illustrates the transponder (IFF) control panel and its location in the cockpit. The associated antennas are shown in figure 3-1.

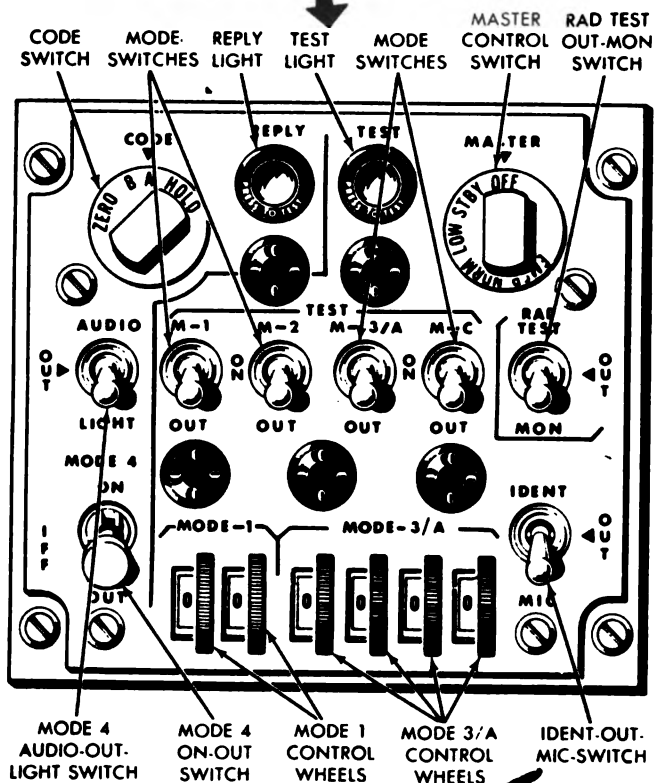
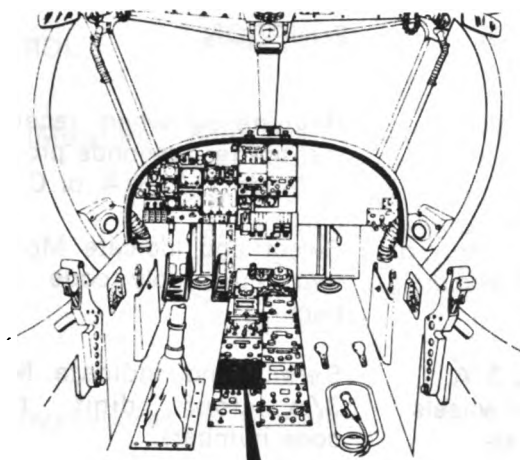

A 3-10-D-20

**Figure 3-20. Transponder(IFF) Control Panel (AN) APX-72**

**a. Transponder (IFF) Control Panel Switch Functions (figure 3-20).**

CONTROL	FUNCTION
MASTER control switch	
OFF	Turns transponder set OFF.

CONTROL	FUNCTION
STBY	Turns transponder set on. Used for initial warmup and maintains set ready for immediate use.
LOW	Provides low sensitivity operation of transponder set. (Used when aircraft is in close proximity of ground interrogator.)
NORM	Provides maximum sensitivity operation of transponder set. (Used under normal conditions.)
EMER	Transmits emergency coded signals in reply to interrogation. (Knob must be pulled out before it can be switched to EMER position.)
IDENT-OUT-MIC switch	
IDENT	Provides identity signal for approximately 30 seconds in reply to interrogation (spring loaded return to OUT position).
MIC	Provides identity signal as described above using microphone switch as keyer.
OUT	Off position of switch.
M-1 mode switch	
ON	Allows acceptance and reply to Mode 1 coded interrogation.
OUT	Off position of M-1 mode switch.
M-1 TEST	Turns on Test Set TS-1843(*)/APX (when installed) to locally interrogate receiver-transmitter. Test will measure characteristics of reply, and illuminate TEST light when reply is satisfactory.

CONTROL	FUNCTION	CONTROL	FUNCTION
<b>M-2 mode switch</b>		<b>TEST light</b>	Illuminates when receiver-transmitter responds properly to Mode 1, 2, 3/A, or C test.
ON	Allows acceptance and reply to Mode 2 coded interrogation.	<b>MODE 1 control wheels and dials</b>	Select and indicate Mode 1 two digit reply code numbers.
OUT	Off position of M-2 mode switch.	<b>MODE 3/A control wheels and dials</b>	Select and indicate Mode 3/A four digit reply code numbers.
<b>M-2 TEST</b>	Turns on Test Set TS-1843(*)/APX (when installed) to locally interrogate receiver-transmitter. Test will measure characteristics of reply, and illuminate TEST light when reply is satisfactory.	<b>MODE 4 - ON-OUT switch</b>	
<b>M-3/A mode switch</b>		ON	Allows receiver-transmitter to decode mode 4 interrogation, when mode 4 computer is installed in system.
ON	Allows acceptance and reply to Mode 3/A coded interrogation.	OUT	Off position of switch.
OUT	Off position of M-3/A mode switch.	<b>CODE switch</b>	Holds, zeroizes, or changes mode 4 code.
<b>M-3/A TEST</b>	Turns on Test Set TS-1843(*)/APX (when installed) to locally interrogate receiver-transmitter. Test will measure characteristics of reply, and illuminate TEST light when reply is satisfactory.	<b>MODE 4 AUDIO-OUT-LIGHT switch</b>	
<b>M-C mode switch</b>		AUDIO	Permits aural and REPLY light monitoring of valid Mode 4 interrogation and replies.
ON	Allows acceptance and reply to Mode C interrogation.	OUT	Off position of switch.
OUT	Off position of M-C mode switch.	LIGHT	Permits reply light monitoring only of valid Mode 4 interrogation and reply.
<b>M-C</b>	Turns on Test Set TS-1843(*)/APX (when installed) to locally interrogate receiver-transmitter. Test will measure characteristics of reply, and illuminate TEST light when reply is satisfactory.	<b>REPLY light</b>	Indicates presence of Mode 4 replies.
		<b>RAD TEST-OUT-MON switch</b>	
		RAD (Radiate)	Turns on Test Set TS-1843(*)/APX (when installed) to reply to mode interrogation.
		OUT	Off position of switch.

CONTROL	FUNCTION
MON (Monitor)	Energizes monitor circuit in Test Set TS-1843(*)/APX (when installed). TEST light will illuminate whenever replies are transmitted in response to interrogation in any SIF mode.

**b. Transponder Set Operation.**

**(1) Turn-On Procedure.**

(a) MASTER control switch - STBY. Allow 2-minute warmup before use. Normally turned on during before taxiing checks.

(b) All other switches - OUT.

**(2) Operating procedure.**

(a) MODE 1 and MODE 3/A control wheels - Set to preestablished codes. MODE 2 set before flight by maintenance personnel.

(b) MASTER control switch - NORM.

**(3) Test Procedure.**

(a) If Test Set TS-1843(\*)/APX is installed:

1. RAD TEST - OUT - MON switch - MON.

2. MODE switches - Sequentially set M-1, M-2, and M-3/A switches separately to TEST and check that TEST light illuminates for each, indicating proper self-interrogation.

(b) If Test Set TS-1843(\*)/APX is not installed:

1. Contact local interrogator station and request interrogation and monitoring.

2. On command of interrogation station, set M-1, M-2, and M-3/A to ON and OUT, and IDENT-OUT-MIC switch to IDENT and OUT.

3. Interrogation station should indicate satisfactory results.

(4) Shutdown. MASTER control switch - OFF.

**3-18. Altimeter-Encoder.**

The altimeter-encoder on the pilot's instrument panel, (figure 3-21), is a self-contained unit that consists of a precision pressure altimeter combined with an altitude encoder. The display indicates and the encoder simultaneously transmits (via IFF) the pressure altitude of the aircraft. Aircraft altitude is displayed on the altimeter by a 10,000 foot counter, a 1,000 foot counter, and a 100 foot drum. A single pointer indicates hundreds of feet on a circular scale with 50 foot center markings. Below 10,000 feet, a diagonal warning signal appears on the 10,000 foot counter. A barometric pressure setting knob is provided to insert the desired altimeter setting in inches of HG. A DC-powered vibrator operates inside the altimeter whenever the aircraft power is on. To obtain accurate readings, the altimeter should be allowed 1 minute warmup prior to use. If DC power to the encoder is lost, a warning flag placarded CODE OFF will appear on the upper left portion of the instrument face indicating that the encoder is inoperative and that the system is not reporting altitude to ground stations.

**NOTE**

*The CODE OFF flag monitors only the encoder function of the altimeter. It does not indicate transponder condition. The altitude reporting function may be inoperative without the flag showing, in case of transponder failure or improper control settings. It is also possible to get a good mode C test on the transponder control with the CODE OFF flag showing. Display of the flag only indicates an encoder power event. If the CODE OFF flag appears, check that the ALTM circuit breaker is in and that DC power is available. If the flag is still visible, radio contact should be made with a ground radar site to determine whether the altitude reporting function is operative, and the remainder of the flight should be conducted accordingly.*

**a. Normal Operation.** The M-C mode switch on the transponder control panel (figure 3-20) should be on for altitude reporting during flight.

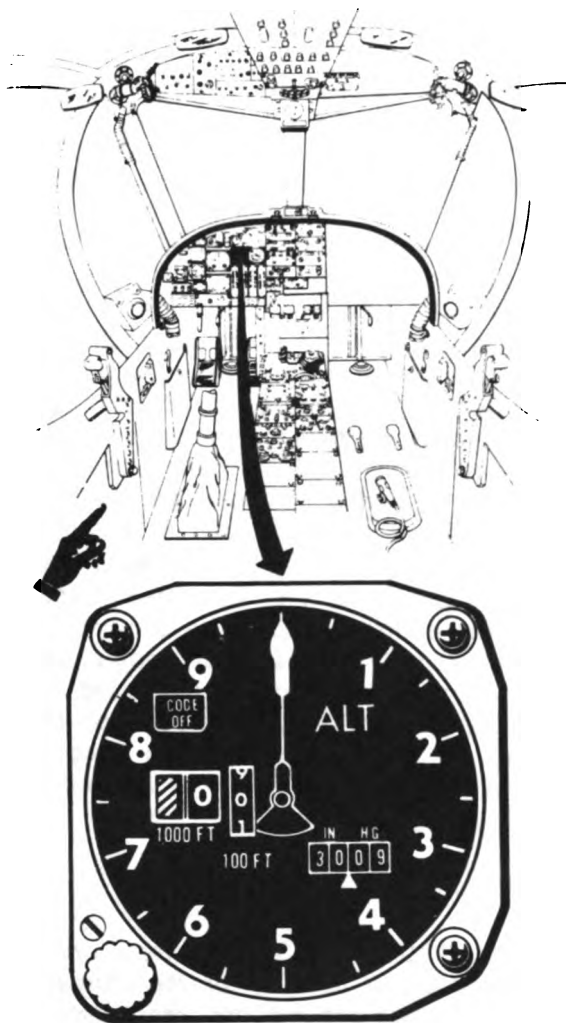

A-3-10-D-21

Figure 3-21. Altimeter-Encoder (AAU-32/A)

The altimeter indicates pneumatic altitude reference to the barometric pressure level as selected by the pilot. At ambient pressure, the altimeter should agree within  $\pm 70$  feet of the field elevation when the proper barometric pressure setting is set in the altimeter. If there is an error of greater than  $\pm 70$  feet, do not use the altimeter. In order to supply mode C information to the transponder for transmission, the CODE OFF flag must not be visible.

**b. Emergency Operation.**

(1) If the internal vibrator becomes inoperative, the pointer and drum may momentarily hang up when passing from 9 through 0 (climbing) or from 0 through 9 (descending). This hang up will cause lag, the magnitude of which will depend on the vertical velocity of the aircraft

and the friction in the altimeter. Pilots should be especially watchful of this type of failure when the minimum approach altitude lies between the 8 and 1 part of the scale (800-1100, 1800-2100, etc.).

(2) If the CODE OFF flag is visible, DC power is not available, the circuit breaker is not in, or there is an internal altimeter encoder failure.

(3) If the altimeter indication does not correspond within 75 feet of the field elevation (with correct local barometric setting), the altimeter needs rezeroing or there has been an internal failure.

(4) If the baroset knob binds or sticks, abnormal force should not be used to make the setting as this may cause internal failure resulting in altitude errors. Settings can sometimes be made by backing off and turning the knob at a slower rate.

**3-19. Radar Altimeter.**

a. The radar altimeter measures terrain clearance to a maximum of 5,000 feet, which is displayed on the radar altitude indicator (figure 3-22), on the pilot's instrument panel. It also provides an input to the INS system. Operating controls for the radar altimeter are contained on the radar altitude indicator. Power is applied to the radar altimeter through circuit breakers on the remote circuit breaker panel. Figure 3-22 illustrates the radar altitude indicator and shows its location in the cockpit.

b. The radar altimeter indicator, on the pilot's instrument panel, provides altimeter readouts and remote control of the radar altimeter receiver-transmitter unit. The indicator incorporates an altitude pointer, a combination power application, altitude limit setting, and self-test control, a low-altitude warning lamp, and a power-off flag.

**(1) Radar Altimeter Indicator Display Functions (figure 3-22).**

CONTROL	FUNCTION
PUSH TO TEST-SET-OFF switch	Turns ON, selects minimum altitude limit bug, and provides altimeter self-test. When pressed, altimeter will read $100 \pm 15$ feet.

CONTROL	FUNCTION
LOW limit indicator	Illuminates at or below pre-set altitude.
Limit bug	Preset to any desired altitude by rotating of push to test-set-off switch; used as reference for flying at fixed altitude.
Altitude pointer	Used (in conjunction with limit bug) to indicate altitude of aircraft above terrain.
NO TRACK flag	Used to indicate altitude at which altitude pointer indication is invalid due to no track condition or absence of system power.

**(2) Radar Altimeter Operation.**

**(a) Turn-On Procedure.**

1. PUSH TO TEST-SET-OFF switch – SET. Allow at least 3-minutes warm-up time. Normally turned on before taxiing check.
2. NO TRACK flag – Not visible.

**(b) Operating Procedure.**

1. Altitude pointer – Read terrain-to-aircraft altitude.
2. Limit bug – Turn PUSH TO TEST-SET-OFF switch until limit bug is opposite desired flight altitude limit. If aircraft is at or below selected altitude limit, LOW limit indicator lamp will illuminate.
3. No-track flag. – If flag is displayed and altitude pointer is in no track area of dial, altitude readings are not valid. Flag will disappear when aircraft altitude returns to 5,000 feet or below, or aircraft levels from excessive bank angles.

**(c) Self-Test Procedure.** PUSH TO TEST-SET-OFF switch – Push; pointer should indicate 100 ±15 feet.

**(d) Shutdown Procedure.** PUSH TO TEST-SET-OFF switch – OFF.

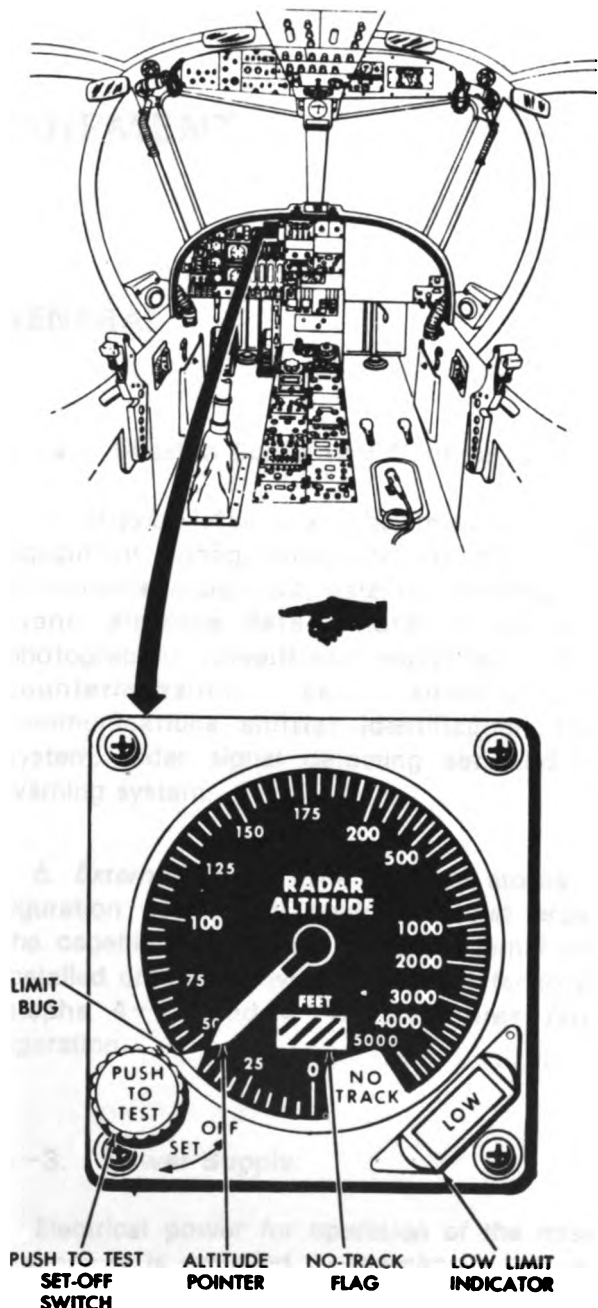

A-3-10-D-23

**Figure 3-22. Radar Altitude Indicator (AN/APN-171)**



## CHAPTER 4

# MISSION EQUIPMENT

### SECTION I. GENERAL

#### 4-1. General.

*a.* This chapter covers the mission equipment configuration installed in Army Model OV-1D and RV-1D aircraft. It includes a brief description of the equipment, their technical characteristics, capabilities, and location in the aircraft. The chapter also contains complete operating instructions for all mission equipment installed in the aircraft.

*b.* Equipment descriptions and operating procedures contained in this chapter are oriented toward the normal operating procedures contained in Chapter 8. For more technical information, refer to the references listed in Appendix A.

*c.* The mission equipment installed in the aircraft may vary among different serial numbered aircraft; moreover, equipment for which installation provisions are provided may not always be installed. No attempt is made to specify the exact combinations of equipment in a particular aircraft, since these combinations are dependent on aircraft mission and equipment availability. All unclassified mission equipment for which complete provisions are made are described.

*d.* Information pertaining to mission equipment installed in the aircraft that are classified are not covered in this manual. Refer to the Operator's Manual Classified Supplement, TM 55-1510-213-10/1, for coverage of these systems.

#### 4-2. Mission Equipment Configuration.

*a. Mission Avionics.* The mission avionics equipment configuration consists of the radar surveillance equipment, data transmitting equipment, airborne data annotation equipment, photographic surveillance equipment, infrared countermeasures set, airborne non-communications emitter identification locator system, radar signal detecting set, and radar warning system.

*b. External Stores.* The external stores configuration consists of equipment that provides the capability to jettison certain external stores installed on various wing stations. Refer to paragraphs 4-15 and 4-16 for stores normal operation.

#### 4-3. Power Supply.

Electrical power for operation of the mission equipment is provided by the aircraft DC power supply system and AC power supply system through the respective aircraft distribution buses. All systems are protected by their associated circuit breakers on the cockpit and remote circuit breaker panels. Refer to Chapter 2 for a complete description of the DC and AC power systems, and illustrations of the circuit breaker panels.



**SECTION II. MISSION AVIONICS**

**4-4. Radar Surveillance Set AN/APS-94F (OV-1D).**

a. Radar Surveillance Set AN/APS-94F is a side-looking airborne radar (SLAR) used to detect and display both fixed and moving ground targets on either or both sides of the aircraft flightpath, and record permanent imagery on dry-silver film strips (radar maps) in the cockpit during flight. These maps are interpreted by military intelligence personnel for the purpose of discovering moving targets, and maintaining surveillance on other objects and features of military importance. These maps may also be used to provide battlefield commanders with information of troop movements, road and airfield construction, etc. The SLAR can be used in conjunction with a digital data link (Radar Data Transmitting Set AN/AKT-18B) allowing duplicate maps to be produced simultaneously at a ground-based Radar Data Set AN/TKQ-2B. (Refer to paragraph 4-4A.) Additionally, the AN/AYA-10 Airborne Data Annotation System (paragraph 4-5) provides present position, drift angle, groundspeed, barometric and radar altitude, pitch and roll, and heading information to be recorded on the SLAR film.

**NOTE**

*ALT or BCD mode must be selected for SLAR. No annotation will appear on SLAR if NUM is selected.*

This information, supplied by the INS and radar altimeter, along with fixed data (date, time, sortie number, taking unit, and aircraft number) preset prior to flight, is printed on the SLAR film.

b. Operating controls, displays, and the film processor for the SLAR are installed in the cockpit (figure 4-1) forward of the right seat occupant's position, while the major radar components and signal processors are mounted on removable pallets in the No. 1, No. 2, and No. 3 midsection equipment compartments. A SLAR antenna (figure 3-1) is mounted outboard along the lower edge of the right side of the fuselage.

c. Power is applied to the radar surveillance set through circuit breakers on the remote cir-

cuit breaker panel. Figures 4-2 and 4-2A illustrate the Radar Set Control C-7645/APS 94D (radar control) and the Radar Mapping Recorder-Processor-Viewer RO-495/U (recorder), respectively, and show their locations in the cockpit. These units contain the controls used by the right seat occupant to operate the equipment during a mission. Additional information on the radar surveillance set is contained in TM 11-5895-1078-10.

*(1) Radar Set Control Switch Functions and Indications (figure 4-2).*

CONTROL	FUNCTION
KNOTS GRD SPEED dial and control knob	Dial indicates groundspeed of aircraft in knots. When NAV switch is at AUTO or GS, dial indicates current aircraft groundspeed from INS. When NAV switch is in MAN, groundspeed must be manually selected using KNOTS GRD SPEED control knob because the INS is not providing this information.
DEG DRIFT dial and control knob	Dial indicates aircraft drift angle in degrees. When NAV switch is at AUTO, drift angle information comes from the INS. When NAV switch is at MAN or GS, operator sets drift angle with DEG DRIFT knob.
XMTR FREQ dial and control knob	Selects and indicates radar transmitting frequency. Dial is marked in arbitrary units from 0 through 12. Numbers are for reference and do not represent actual frequencies.
ANTENNA switch	Selects area to be mapped. L position - Maps area left of flightpath. R position - Maps area right of flightpath. BOTH position - Maps area both left and right of flightpath.

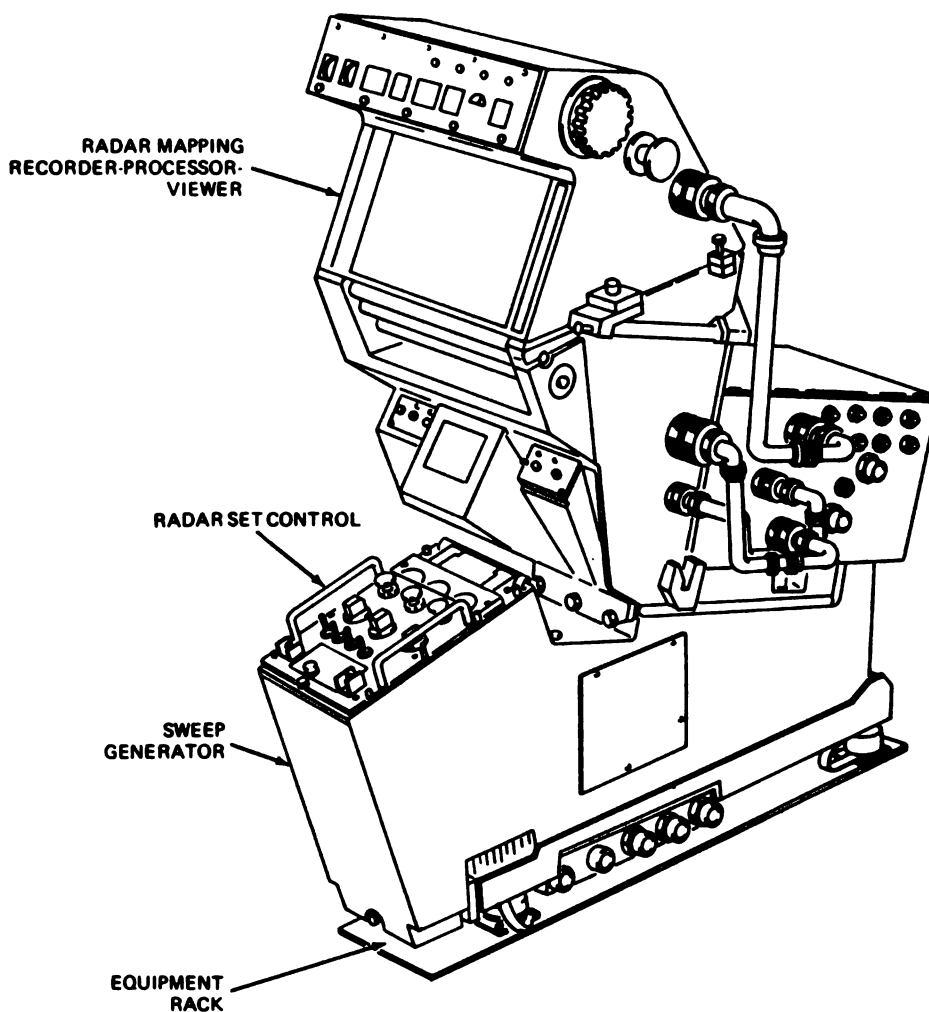
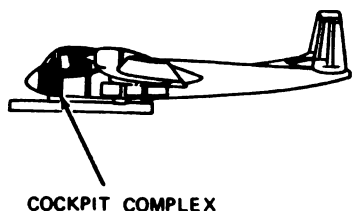

A4-10-D-36

Figure 4-1. SLAR Cockpit Components

Change 6 4-2A

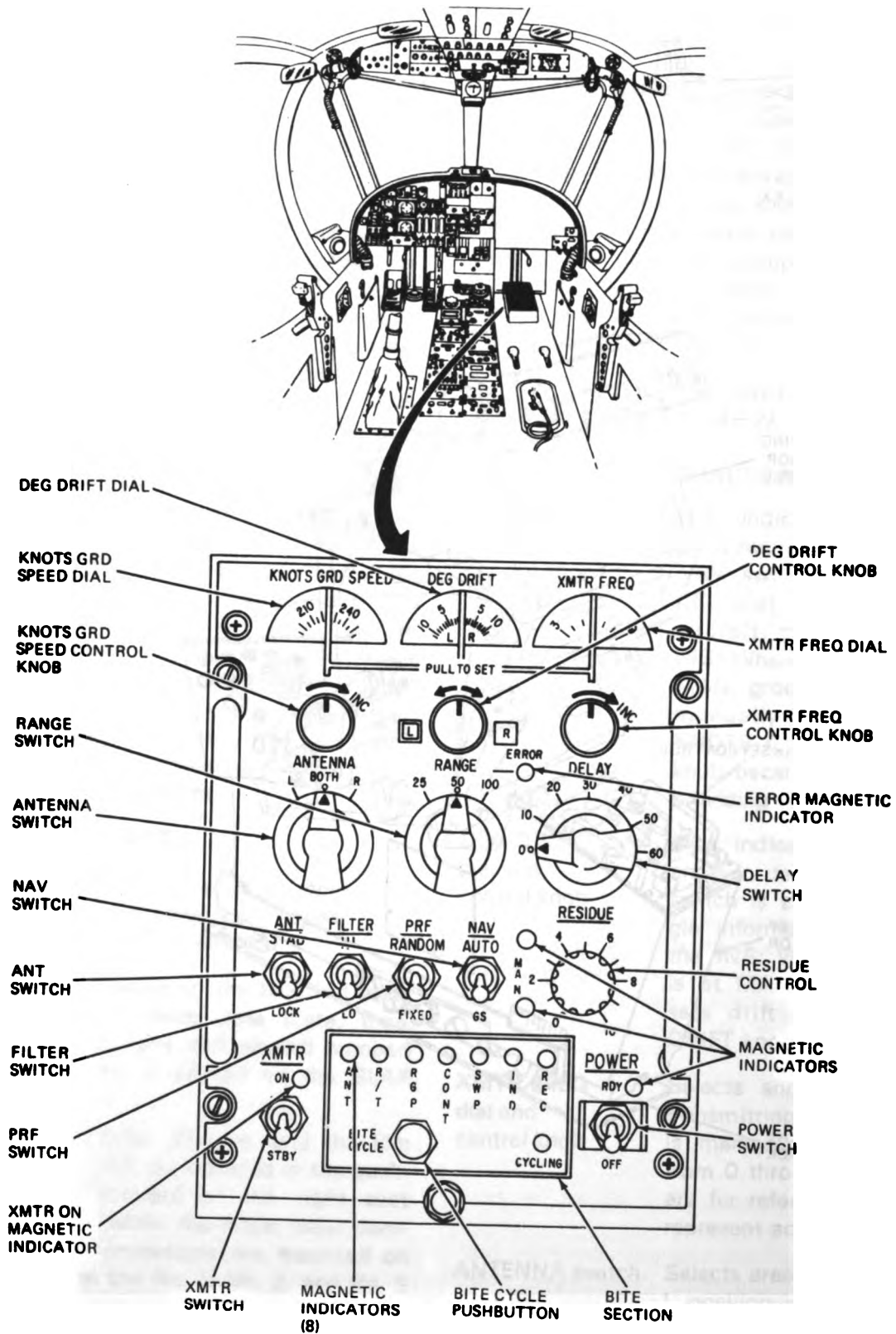

Figure 4-2. Radar Set Control (C-7645/APS-94D)

4-10-36

CONTROL	FUNCTION	CONTROL	FUNCTION
RANGE switch	Selects width (in kilometers) of area presented on radar map.	NAV switch	Three-position switch. Selects manual or automatic navigational data. AUTO position — Uses both groundspeed and drift angle data for inertial navigational system (INS). AUTO indicator turns white. GS position — Selects groundspeed data from INS. Drift correction must be set in manually. GS indicator turns white. MAN position — Both drift angle and groundspeed are set in manually.
DELAY switch	Determines distance (in kilometers) from aircraft to where radar mapping imagery begins.		
ERROR indicator	Normally black. Blinks white when combination of selected RANGE and DELAY exceeds maximum range of SLAR.		
ANT switch	STAB position — Antenna gyro stabilization system turned on. LOCK position — Antenna locked into position. Stabilization system off.	RESIDUE control	Controls amount of FT (fixed target) video appearing as background imagery on MT map. Clockwise rotation increases background imagery. RESIDUE control is properly set when moving targets are plainly visible and just enough background is present to enable the target location to be pinpointed.
FILTER switch	Selects filters for MT (moving target) map imagery. HI position — Improves signal contrast, but reduces ability to detect slow moving targets. Used to reduce effects of jamming (ECM). LO position — Normally provides adequate contrast and has greatest sensitivity to slow moving targets (most missions are flown with the switch set to LO).	XMTR switch	Controls transmitter power. STBY position — Applies standby power to the receiver-transmitter (if POWER switch is set to RDY). ON position — If POWER switch has been set to RDY more than 3 minutes, and pressurization is complete, ON position applies full power to the receiver-transmitter. XMTR ON indicator turns white and SLAR begins transmitting rf energy.
PRF switch	Selects pulse repetition frequency (PRF) of transmitted signal. FIXED position — PRF is fixed at 600 pulses per second. RANDOM position — Normal operation. PRF rate constantly varies between 550 and 650 pulses per second.		

CONTROL	FUNCTION
POWER switch	RDY position — Applies primary power to SLAR. OFF position — Removes primary power from SLAR.
POWER RDY indicator	Blinks when POWER switch is set to RDY. Continues to blink until waveguide pressurization is complete, normally less than 5 minutes. If pressurization is completed in less than 3 minutes, indicator stops on black. After 3 minutes, it turns white (if XMTR switch is in STBY). Indicator turns black when XMTR switch is set to ON.
BITE section	Contains BITE CYCLE pushbutton and indicators for built-in-test equipment (BITE) system.
ANT indicator	Blinks white after BITE CYCLE pushbutton has been pressed. Indicates a fault in the antenna system if it continues to blink after approximately 2 minutes.
R/T indicator	When blinking white, indicates a fault in the receiver-transmitter or power supply mount.
RGP indicator	When blinking white, indicates a fault in the signal processor.
CONT indicator	When blinking white, indicates a fault in the radar control or INS. When NAV switch is set to AUTO or GS, any change in data from the INS will cause the indicator to blink.
SWP indicator	When blinking white, indicates a fault in the sweep generator.

CONTROL	FUNCTION
IND indicator	When blinking white, indicates a fault in the recorder.
REC indicator	Not used.
CYCLING indicator	When white (for approximately 2 minutes after BITE CYCLE pushbutton is pressed), indicates BITE cycle self-test is in progress.
BITE CYCLE pushbutton	When pressed, initiates self-test of antenna system, signal processor, and receiver-transmitter.

(2) Radar Mapping Recorder-Processor-Viewer Switch Functions and Indications (figure 4-2A).

CONTROL	FUNCTION
ILLUM controls	PANEL position — Sets brightness level of recorder control panel edgelights. FILM position — Sets brightness level of film viewing panel lamps.
FT DISPLAY controls	BIAS position — Sets film background gray level. Larger numbers cause darker film background level. VIDEO position — Sets video contrast. Larger numbers cause higher contrast; strong returns are very dark and weak returns are very light. FT video is set properly when only the strongest returns are black.
MT DISPLAY controls	BIAS position — Sets film background gray level. Larger numbers cause darker film background level. VIDEO position — Sets video contrast. Larger numbers cause higher contrast; strong returns are very dark and weak returns are very light.

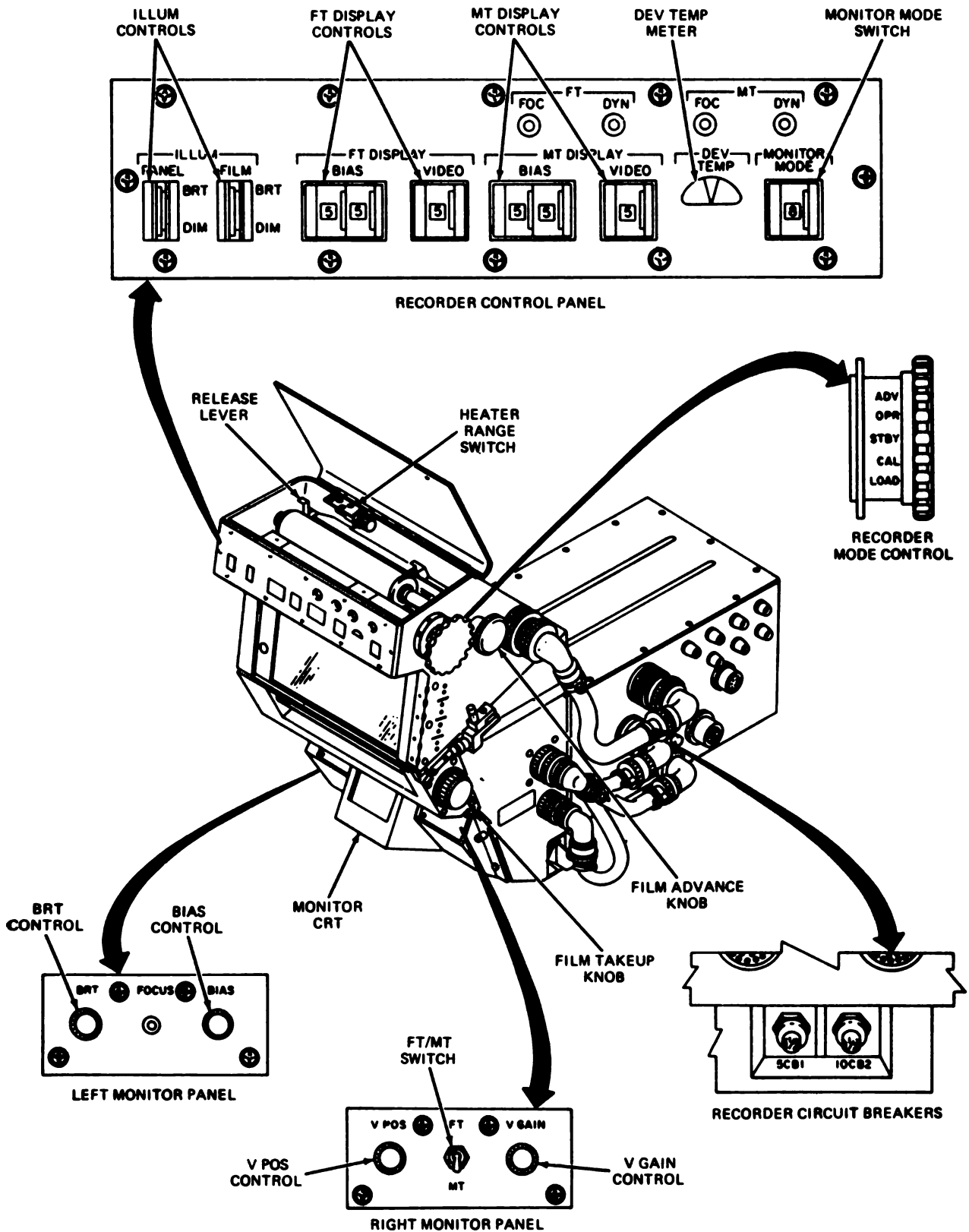

A4-10-D-37

Figure 4-2A. Radar Mapping Recorder-Processor-Viewer (RO-495/U)

CONTROL	FUNCTION	CONTROL	FUNCTION
DEV TEMP meter	Indicates relative temperature of film developing heat bar. Heat bar is at proper temperature when pointer is in green. Changes to RANGE, ANTENNA selection, and KNOTS GRD SPEED will cause DEV TEMP meter to show an increase or decrease in temperature.	Recorder mode control (Cont.)	circuits are disabled. Power is applied to all other recorder circuits. CAL position — Used by maintenance personnel for recorder calibration. LOAD position — Disables film drive and film developing heater circuits. It also lifts heater bar to allow loading of film.
MONITOR MODE switch	Ten-position thumbwheel switch used to select mode of monitor CRT as follows: Position Mode 0 Normal radar mode. 1 SLAR frequency band. 2 Horizontal and vertical centering and vertical test mode. 3 Horizontal gain and balance test mode. 4 Vertical offset test mode. 5 Not functional. 6 Bias test mode. 7 Video gain test mode. 8 Filmspeed monitor mode. 9 Not used.	Release lever	Used to disengage upper pinch roller when loading film.
Recorder mode control	ADV position — Rapidly advances film through recorder without recording or processing.	Heater range switch	Selects proper temperature range (1, 2, 3, or 4) for film being used (marked on each film cassette).
	OPR position — Power is applied to all recorder circuits for normal operation. STBY position — Film drive and film developing heater	Film advance knob	Allows operator to turn film drive rollers by hand during film loading.
		Film takeup knob	Allows operator to turn film takeup rollers by hand during film loading.
		BRT control	Sets brightness of monitor video.
		BIAS control	Sets threshold level of monitor CRT video.
		V POS control	Adjusts vertical position of monitor CRT display.
		FT/MT switch	Selects which mapping CRT (FT or MT) information will be displayed on monitor CRT.
		V GAIN control	Adjust vertical size of monitor CRT display.

## d. Operation.

**WARNING**

When XMTR switch is turned ON, RF radiation through the antenna is present. RF radiation clearance must be given before operational checks are made. Do not turn on XMTR switch until all personnel and equipment have been removed from the RF radiation danger area.

**NOTE**

*Detailed preflight check, film loading, system operational check, exposed film and cassette removal, and film handling and shipping procedures are contained in TM 11-5895-1078-10.*

**(1) Starting Procedure.**

(a) Set switches on radar set control (figure 4-2) as follows:

1. POWER switch — OFF.
2. XMTR switch — STBY.
3. ANT switch — LOCK.
4. FILTER switch — LO.
5. PRF switch — RANDOM.
6. NAV switch — MAN.
7. RESIDUE control — 5.
8. ANTENNA switch — BOTH.
9. RANGE switch — 50.
10. DELAY switch — 0.
11. KNOTS GRD SPEED control knob

— 225.

1.7°R.

12. DEG DRIFT control knob —
13. XMIT FREQ control knob — 6.

(b) Set switches on radar mapping recorder-processor-viewer (figure 4-2A) as follows:

1. Recorder mode control — STBY.
  2. FT and MT DISPLAY BIAS controls
- 55.
3. FT and MT DISPLAY VIDEO controls — 5.
  4. MONITOR MODE switch — 0.
  5. FT/MT switch — FT.

**NOTE**

*DC power must be available to the SLAR circuit breakers (engaged) and the No. 1, No. 2, and No. 3 inverters must be on for complete SLAR operation.*

(c) POWER switch — RDY. POWER RDY indicator will blink until waveguide pressurization is complete. RDY indicator remains white after 3-minute warmup.

**NOTE**

*Disregard BITE fail indications at this time.*

(d) Recorder mode control — OPR, then back to STBY. Verify that air is blowing out at recorder exhaust, and being drawn in at sweep generator air intakes.

(e) Start INS (paragraph 3-12) and ADAS (paragraph 4-5).

(f) If film is not in recorder, load it now. (Refer to TM 11-5895-1078-10 for film loading procedures, if needed.)

(g) Recorder mode control — OPR.

(h) XMTR switch — ON. Verify that XMTR ON indicator turns white and power RDY indicator turns black.

(i) Check that all BITE indicators are dark and verify that film is moving through recorder and is being taken up properly at the takeup spool.

(j) Set all SLAR controls to settings determined by mission requirements.

**(2) Final Mapping Preparation.**

(a) Watch monitor CRT for a normal radar return signal display on FT. Set FT/MT switch to MT and again observe radar signal return.

**NOTE**

*The monitor CRT signal constantly changes because the SLAR looks at a slightly different segment of terrain with each pulse.*



(b) Adjust ILLUM FILM control to get desired illumination of film in viewing panel. Re-adjust as required throughout the mission.

(c) Verify that film is moving through the recorder and is taken up at the takeup spool.

(d) Check DEV TEMP meter. If pointer is not in green, wait until it is before proceeding.

(e) FT and MT DISPLAY BIAS control settings of 55 should produce the proper film background density level (0.35 0.05).

(f) In general, video is properly set when strongest returns appear black, yet do not cause blooming (blurring) of images. Weak returns will be light gray.

**NOTE**

*FT and MT DISPLAY VIDEO controls set to 5 normally produce good SLAR imagery. It may be necessary to set them higher or lower, however, depending on terrain, or specific mission requirements.*

(g) Adjust moving target presentations as follows:

1. Set MT DISPLAY VIDEO control so that moving targets show up clearly and distinctly. Moving targets should be dark, but should not bloom (appear fuzzy).

2. Adjust RESIDUE control to get just enough background (FT video) to allow the location of moving targets to be pinpointed easily.

3. To make moving targets stand out more, set FILTER switch to HI. Keep in mind, however, that the ability to detect slow moving targets is reduced with the FILTER switch set to HI.

(h) Activate data link (paragraph 4-4A) if mission requirements dictate.

**(3) Things To Remember During Mapping.**

(a) *Film Developing Time Lag.* Changes to aircraft ground speed and RANGE and ANTENNA switch settings change film developing temperature. Allow up to 4 minutes for heater bar to stabilize. Be sure DEV TEMP needle is in green before starting each mapping run.

(b) *Aircraft Course Changes.* When radar control NAV switch is in AUTO position, abrupt course changes cause temporary errors in DEG DRIFT and KNOTS GRD SPEED indications. It may take up to 5 minutes for these functions to be updated automatically. To eliminate this delay, proceed as follows:

1. Set NAV switch to MAN position and XMTR switch to OFF track (mapping run) is completed.

2. When all imagery from last track is visible in the viewing panel, manually set in new DEG DRIFT and KNOTS GRD SPEED.

3. Set XMTR switch to ON and resume mapping.

4. When BITE CONT indicator stops blinking (stays black), return NAV switch to AUTO position.

(4) *Standby Procedure.* If mapping is stopped but it is intended to resume later in the same flight, place the SLAR in standby mode as follows:

(a) Radar control XMTR switch — STBY.

(b) When end of imagery appears in the viewing panel, set the recorder mode control to STBY.

(c) When ready to resume mapping, set recorder mode control to ADV momentarily, then to OPR and set radar control XMTR switch to ON.

**(5) Shutdown Procedure.**

(a) Radar control XMTR switch — STBY.

(b) When end of imagery appears in the viewing panel, set the recorder mode control to

ADV. Leave in ADV until all film with radar imagery is wound onto film takeup spool. Set mode control to STBY.

(c) Radar control POWER switch — OFF.

(d) Shut down data link (paragraph 4 4A), if applicable.

(e) Remove film in accordance with TM 11-5895-1078-10.

**(6) Operation Under Unusual Operating Conditions.**

**(a) SLAR Will Not Start or Starts and Immediately Shuts Down.**

1. Check VIDS on pilot's instrument panel for normal DC indications.
2. Check NO. 3 INV circuit breaker is engaged.
3. Check #3 INV caution light on caution annunciator panel is extinguished.

**(b) SLAR Shuts Down While Operating.**

1. Set radar control XMTR switch to STBY and POWER switch to OFF. Wait 30 seconds, then perform normal starting procedure.
2. If SLAR operates for several minutes then shuts off again, there may be an overheat problem. Set XMTR switch to STBY and POWER switch to OFF. Do not operate equipment until problem has been corrected.

(c) **XMTR ON Fault.** If XMTR ON indicator goes black and monitor scope shows no video at monitor mode 0, proceed as follows:

1. If indications occur more than 5 minutes after startup or at some time during SLAR operation, set radar control XMTR switch to STBY and POWER switch to OFF.
2. Do not operate SLAR until cause of problem has been corrected.

**(d) Signal Processor (RGP) or Receiver-Transmitter (R/T) Fault.**

1. During preflight check, report fault to maintenance personnel.

2. During mission, continue mapping until film imagery no longer meets mission requirements.

**(e) Radar Control (CONT) Fault.**

1. During preflight check, report fault to maintenance personnel.
2. During or immediately after aircraft course change, this is normal. Refer to step d(3)(b), above.
3. During mission (other than aircraft course change), it may be due to missing drift angle or groundspeed inputs from the INS. Set radar control NAV switch to MAN position and set in DEG DRIFT and KNOTS GRD SPEED information manually.
4. If CONT fault is not due to missing INS inputs, continue mapping. Stop mapping when SLAR fails to operate properly, or imagery obtained no longer meets mission requirements.

**(f) Antenna (ANT) Fault.**

1. If ANT fault is detected during preflight check or mission and if mission requirements permit, operate SLAR without antenna stabilization. To do so, set radar control ANT switch to LOCK position.
2. If ANT fault occurs during turbulent weather, this is a normal indication. Leave ANT switch in STAB position.

**(7) Operation Through Electronic Countermeasures (ECM).** If effects of ECM are seen on radar map, perform one or more of the following:

- (a) Set radar control XMTR FREQ control knob one or more index marks away from current setting.
- (b) Change aircraft course and repeat run.
- (c) Change aircraft altitude (last resort).
- (d) Continue radar mapping as long as imagery meets mission requirements.

**(8) Video Level Selection.** This procedure is performed in flight. It will help in determining the best video level setting for a particular mission. For best results, video selection sample should be

of the area to be mapped. A sample of the SLAR imagery should be taken at four different video level settings. The start of each video level should be marked by momentarily increasing the tens' digits of the BIAS controls. After examining each sample, select the video level that best suits the mission requirements. Select video level as follows:

**NOTE**

*Ensure all SLAR controls are set per mission requirements before starting video level selection.*

(a) Set left (tens) digits of FT and MT DISPLAY BIAS controls to 6, then back to 5. Set FT and MT DISPLAY VIDEO controls to 2. Wait 1 minute.

(b) Set left digits of BIAS switches to 6, then back to 5. Set VIDEO switches to 4. Wait 1 minute.

(c) Set left digits of BIAS switches to 6, then back to 5. Set VIDEO switches to 6. Wait 1 minute.

(d) Set left digits of BIAS switches to 6, then back to 5. Set VIDEO switches to 8. Wait 1 minute.

(e) Set left digits of BIAS switches to 6, then back to 5. Set VIDEO switches to 5. When all of the sample imagery becomes visible in the viewing panel, set recorder mode control to STBY.

(f) Examine each video level to determine the one that best fits the needs of the mission. If one level is too low and the next is too high, set it to the level in between.

(g) *Video and Bias Settings for Specific Requirements.*

(a) *Low Contrast Targets.* Examples of low contrast targets are roads or trails through jungles, woods, or grassy areas.

1. Set VIDEO to highest level. Strong and moderate returns will be black. Differences in poor and weak (low contrast) returns will show up best.

2. Reduce VIDEO to the lowest level that will bring out the low contrast targets of interest.

(b) *High Contrast Targets.* Examples of high contrast targets are industrial and other heavily populated areas. If only high, strong, and moderate returns are important and it is necessary to be able to tell them apart, proceed as follows:

1. Set FT DISPLAY BIAS control to 52.

2. Set FT DISPLAY VIDEO control to a level that will cause only the highest returns to be black. If the highest returns are not black at the highest VIDEO level, increase FT DISPLAY BIAS control settings until they are.

**NOTE**

*Under these conditions, strong and moderate returns will be dark and gray, respectively. Low returns will not appear. The map will contain a lot of clear area, but it will show the reconnaissance information required.*

**4-4A. Radar Data Transmitting Set AN/AKT-18B (OV-1D).**

a. Radar Data Transmitting Set AN/AKT AN/AKT-18B (data transmitting set) is an airborne system that accumulates radar video data and navigational data, encodes the data into a serial digital bit stream; and transmits it to a ground-based Radar Data Receiving Set AN TKQ-2B (data receiving set). Video and navigational information to be transmitted is derived from Radar Surveillance Set AN/APS-94F (radar set). Refer to paragraph 4-4. The radar set and data transmitting and receiving sets are components of Radar Surveillance System AN UPD-7 (system). The system permits fixed and moving target radar imagery from the airborne

radar set to be recorded in real time by ground receiving sets for immediate use of field commanders.

b. All signal inputs to the data transmitting set are supplied by the radar set. These signals include fixed target (FT) and moving target (MT) radar video, radar set mode information, and aircraft navigational data. A video encoder accumulates and formats the data for transmission. The message format is established automatically, depending on radar set operating conditions (mapping range, antenna selection, etc.). The radar data to be transmitted is not affected by the control settings of the radar mapping recorder-processor-viewer. The encoded data is applied to a UHF receiver-transmitter, where it is converted to frequency shift keying (FSK) signals for transmission to ground units.

c. Operating controls for the data transmitting set are contained on the data link control (figure 4-2B) and the radio set control (figure 4-2C) installed on the right overhead panel in the cockpit, while the receiver-transmitter and video encoder are mounted on removable pallets in the No. 1, No. 2, and No. 3 midsection equipment compartments. A blade-type antenna (figure 3-1) is mounted on the underside of the nose of the aircraft.

d. Power is applied to the data transmitting set through circuit breakers on the remote circuit breaker panel. Figures 4-2B and 4-2C illustrate the Data Link Control C-10546/AKT-18B and Radio Set Control C-10547/ARC 164(V), respectively, and show their locations in the cockpit. These units contain the controls used by the right seat occupant to operate the equipment during a mission. Additional information on the data transmission set is contained in TM 11-5841-287-12.

*(1) Data Link Control Switch Functions and Indications (figure 4-2B).*

CONTROL	FUNCTION
POWER switch	OFF position deenergizes data transmitting set. STBY position energizes UHF radio set and video encoder. XMT position energizes transmitter in UHF radio set.

CONTROL	FUNCTION
AIRBORNE BITE switch	When pressed, initiates data link control lamp test and AIRBORNE BITE test.
DOWNLINK BITE switch	When pressed, initiates data link control link test and DOWNLINK BITE test.
BITE IN PRCS indicator (green)	When illuminated, indicates AIRBORNE BITE or DOWNLINK BITE test is in process.
ENCODER FAULT indicator (yellow)	When illuminated, indicates video encoder or power supply malfunction.
RT FAULT indicator (yellow)	When illuminated, indicates either a date synchronization or a low rf power malfunction in the UHF receiver-transmitter.

*(2) Radio Set Control Switch Functions and Indications (figure 4-2C).*

CONTROL	FUNCTION
Function selector switch	Selects operating mode of UHF radio set. Limited to MAIN position by covering bezel. Other positions not functional.
Mode selector switch	MANUAL position enables frequency selection by means of 5 frequency selector switches. PRESET position enables channel frequency selection by means of preset channel selector switch.
Preset channel selector switch	Selects preselected channel frequency. Can be set to any one of 20 preselected frequencies. Selected channel number is displayed in window.

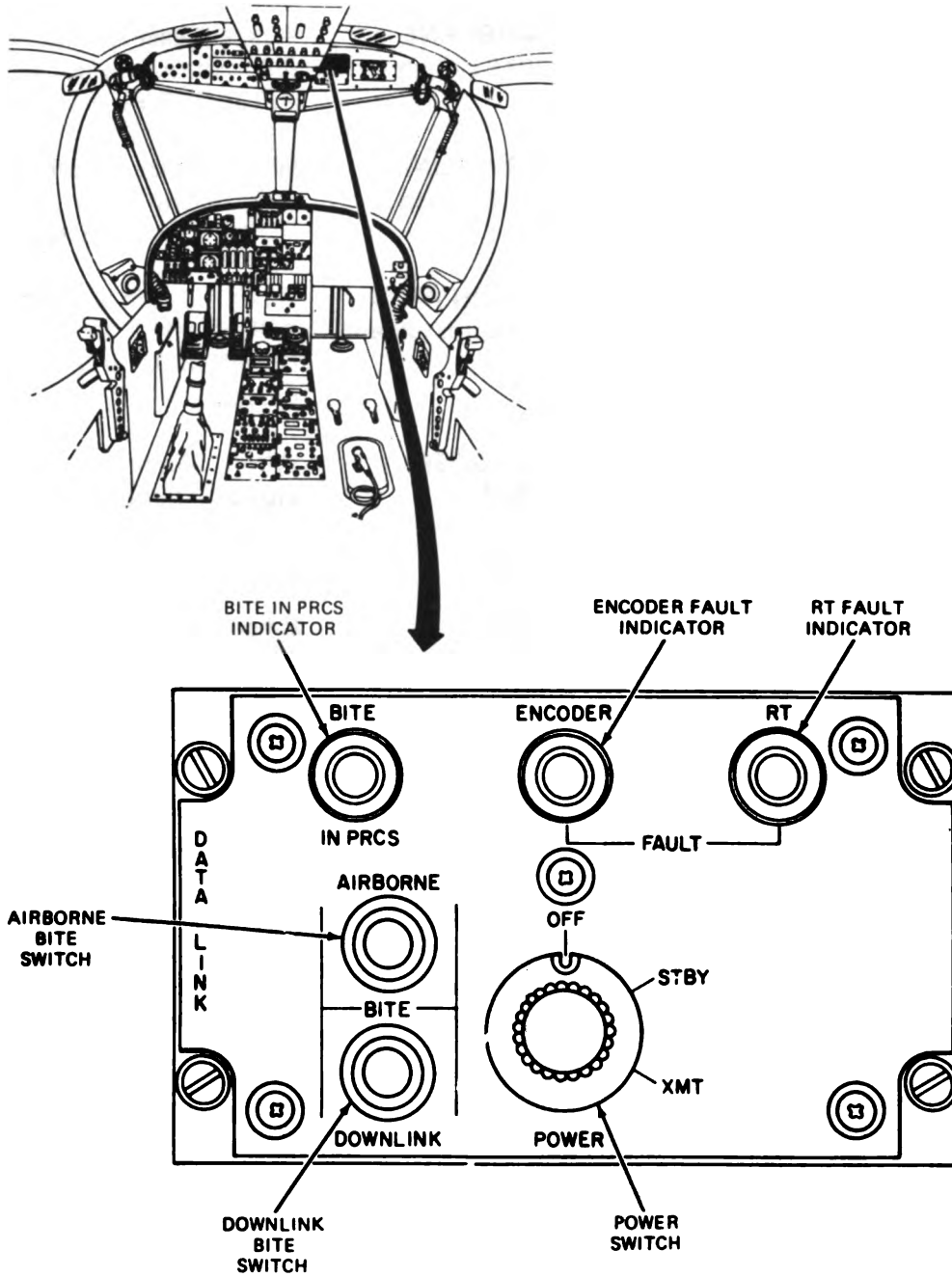

A-4-10-D-38

Figure 4-2B. Data Link Control (C-10546/AKT-18B)

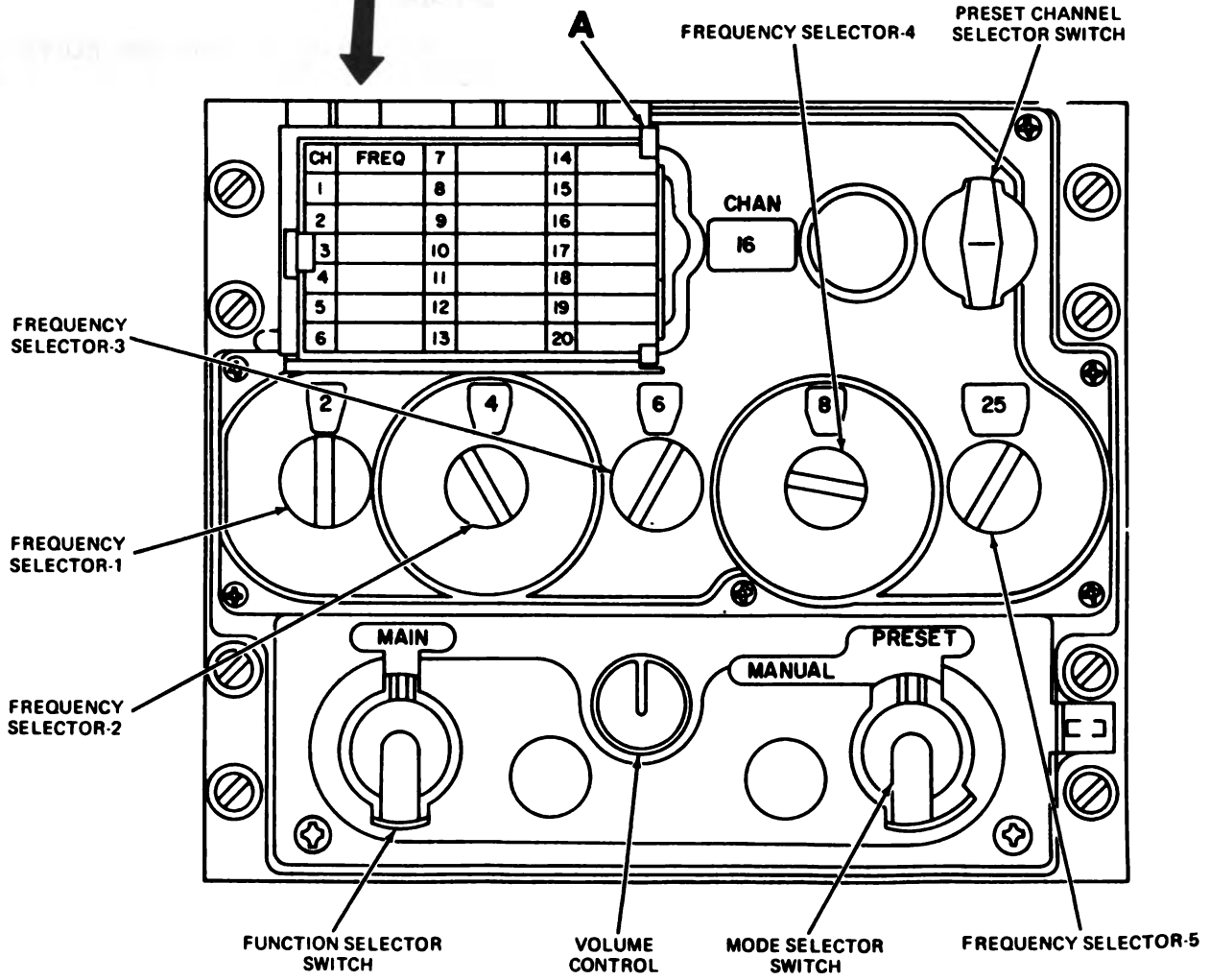
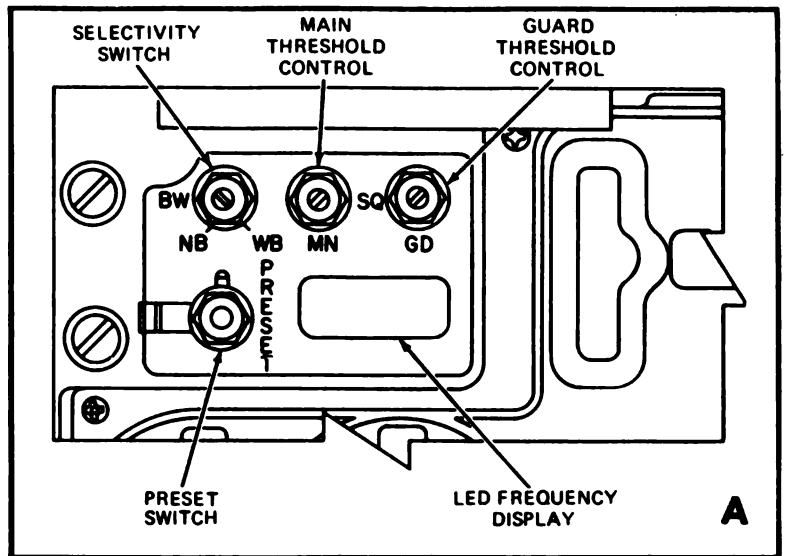
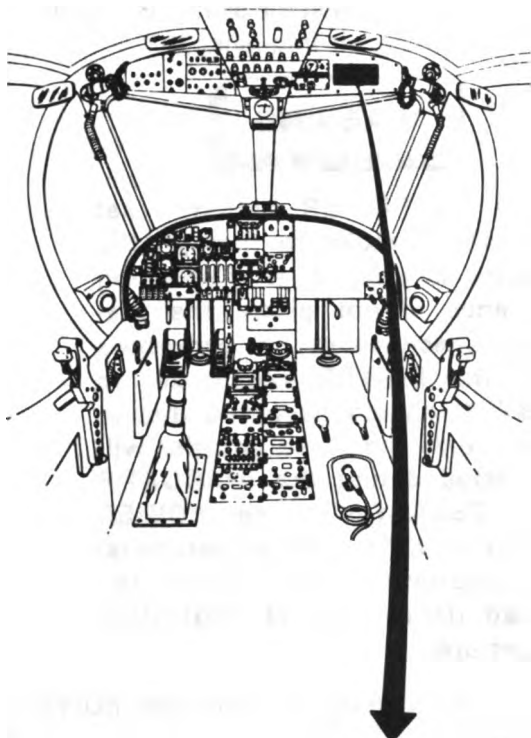

A4-10-D-39

Figure 4-2C. Radio Set Control (C-10547/ARC-164(V))

CONTROL	FUNCTION
Frequency selector switch-1	Selects operating frequency in 100 MHz steps.
Frequency selector switch-2	Selects operating frequency in 10 MHz steps.
Frequency selector switch-3	Selects operating frequency in 1 MHz steps.
Frequency selector switch-4	Selects operating frequency in 0.1 MHz steps.
Frequency selector switch-5	Selects operating frequency in 0.025 MHz steps.
Selectivity switch	Used to select wideband or narrowband selectivity of main receiver. Set to WB at all times.
Main threshold control	Not operable. Squelch adjustment is performed on the receiver-transmitter by maintenance personnel.
Guard threshold control	Not functional.
PRESET switch	Stores selected frequency in selected preset channel.
LED frequency display (red)	LED display of preset channel frequency.
Volume control	Not functional.

**e. Operation.**

(1) *Preflight Check.* Perform preflight check of data transmitting set as follows:

(a) POWER switch (figure 4-2B) - STBY.

(b) Frequency selector switches (figure 4-2C) - Set to assigned frequency.

**WARNING**

When the POWER switch is set to XMT, rf radiation through the antenna is present. If rf radiation clearance is not given, the preflight check must be performed with the POWER switch set to STBY. It should be noted that in STBY, only the video encoder will be tested during the AIRBORNE BITE TEST. Do not set POWER switch to XMT until all personnel and equipment have been removed from the rf radiation danger area.

(c) After warmup of 3 minutes, POWER switch - XMT.

(d) On data link control, press AIRBORNE BITE switch. Observe that BITE IN PRCS, ENCODER FUALT, and RT FAULT indicators illuminate for 3 seconds. This indicates successful lamp test.

(e) After the indicator lamp test sequence is completed, observe that the ENCODER FAULT and RT FAULT indicators extinguish and the BITE IN PRCS indicator remains illuminated for an additional 3 seconds, after which it extinguishes. This indicates that the AIRBORNE BITE test was successful. If the ENCODER FAULT and/or RT FAULT indicators illuminate again, the AIRBORNE BITE test was not successful.

**NOTE**

*Following initial observation of an ENCODER FAULT or RT FAULT indication, recycle the POWER switch several times between XMT and OFF in an attempt to clear the fault indication. Wait approximately 30 seconds between switch transitions.*

*Disregard steps (f) and (g) when performing the AIRBORNE BITE test with the POWER switch set to STBY.*

(f) Radio set control mode selector switch — PRESET.

(g) Repeat steps (d) and (e) for each preset UHF receiver-transmitter channel, using the preset channel selector switch for channel selection.

#### NOTE

*If the preset channel frequencies have not been selected or if it is desired to change any one or all of the frequencies, follow the procedures given in steps (h) through (l), below. Otherwise, proceed to step (m).*

(h) Frequency selector switches — Set to desired frequency.

(i) Preset channel selector switch — Set to desired channel number.

(j) PRESET switch (located under channel frequency chart) — Press and release. This action stores selected channel frequency in memory at that switch position.

(k) Record selected channel frequency on channel frequency chart.

(l) Repeat steps (h) through (k) for each channel frequency to be preset.

(m) If data transmission does not begin immediately, POWER switch — OFF.

(2) *Inflight Check.* The inflight check of the data transmitting set consists of performing the DOWNLINK BITE test. During the DOWNLINK BITE test, a fixed test pattern is continuously transmitted to the ground station to enable evaluation of system performance. Proceed as follows:

#### WARNING

Rf radiation permission must be granted before performance of the

**DOWNLINK BITE test** since rf radiation through the antenna will be present.

(a) Instruct ground station to place equipment into the receive mode with full mapping capability.

(b) Data link control POWER switch — STBY.

(c) Set frequency selector switches to assigned frequency or select assigned channel using preset channel selector switch.

(d) POWER switch (after 3-minute warmup) — XMT.

(e) Data link control DOWNLINK BITE switch — Press. Observe that the BITE IN PRCS, ENCODER FAULT, and RF FAULT indicators illuminate for 3 seconds. This indicates successful lamp test.

(f) After the indicator lamp test sequence is complete, observe that the ENCODER FAULT and RF FAULT indicators extinguish and the BITE IN PRCS indicator remains illuminated. This indicates transmission of the DOWNLINK BITE test pattern is in progress. After approximately 5 minutes, verify with the ground station that the recorded proper test pattern is reproduced. This indicates successful completion of the DOWNLINK BITE test. To return to normal operation, press the DOWNLINK BITE switch. At this time, the BITE IN PRCS indicator should extinguish. This indicates termination of the DOWNLINK BITE test.

#### NOTE

*Following initial observation of an ENCODER FAULT or RT FAULT indication, recycle the POWER switch several times between XMT and OFF in an attempt to clear the fault indication. Wait approximately 30 seconds between switch transitions.*



**(3) Normal Operation.** Proceed as follows:

(a) Insure radar set is on and operating (paragraph 4-4).

(b) Data link control POWER switch - STBY. Allow 3 minutes for warmup.

(c) Set frequency selector switches or preset channel selector switch to desired transmitting frequency. The mode selector switch must be set to MANUAL if the frequency selector switches are used to set the frequency, or to PRESET if the preset channel selector switch is used to set the frequency.

(d) POWER switch - XMT.

**(4) Standby Operation.** To place the data transmitting set in standby mode, set the POWER switch to STBY.

**(5) Shutdown Procedure.** To shut down the data transmitting set, place the data link control POWER switch to OFF.

**4-5. Airborne Data Annotation System.**

The airborne data annotation system (ADAS) is applicable to OV-1D aircraft. It provides a means of recording accurate aircraft position and identification data on the film of the various sensor systems installed in the aircraft. The ADAS converts DC analog, synchro analog, and binary input data into either a numeric or a binary coded decimal (BDC) format for display on various recording head assemblies (RHA). These formats represent data such as present aircraft position, drift angle, groundspeed, radar and barometric altitude, and pitch, roll, and heading information to be recorded on the film of the various aircraft sensor systems. This includes the SLAR/IR and forward and two aft camera systems. This data, supplied by the INS and radar altimeter, along with fixed data (date, time, sortie number, taking unit, aircraft tail number, and camera lens focal length) preset into the system before flight, is recorded on the sensor film. The preset data is programmed into the system at the control panel (figure 4-3), in the right aft equipment compartment, before flight. Once programmed, the system is automatic and requires no operating procedures to

be performed in flight. Operation consists of the preflight check, programming of fixed data before flight, and post flight shutdown procedures.

**a. Control Display Monitor (CDM) Switch Functions and Indications (figure 4-3).**

CONTROL	FUNCTION						
Day indicator switches	Program day of month.						
Month indicator switches	Program month of year.						
Year indicator switches	Program year.						
Focal length indicator switches	Select focal length of KA-76 camera.						
KA-60-2 exp indicator switch	Selects KA-60-2 RHA exposure intensity.						
Sortie No. indicator switches	Program sortie number.						
Taking unit indicator switches	Program number of taking unit.						
KA-60-1 exp indicator switch	Selects KA-60-1 RHA exposure intensity.						
KA-76 exp indicator switch	Selects KA-76 RHA exposure intensity.						
Hrs indicator switches	Program hour of day.						
Mins indicator switches	Program minutes of hour.						
Secs indicator switches	Program seconds of minute.						
Mode switch	Selects CRT display format as follows:						
	<table border="1"> <thead> <tr> <th>Switch Position</th> <th>Function</th> </tr> </thead> <tbody> <tr> <td>BCD</td> <td>Selects +3 BCD format.</td> </tr> <tr> <td>NUM</td> <td>Selects numerical format.</td> </tr> </tbody> </table>	Switch Position	Function	BCD	Selects +3 BCD format.	NUM	Selects numerical format.
Switch Position	Function						
BCD	Selects +3 BCD format.						
NUM	Selects numerical format.						

**NOTE**

*NUM mode cannot be selected for SLAR operation.*

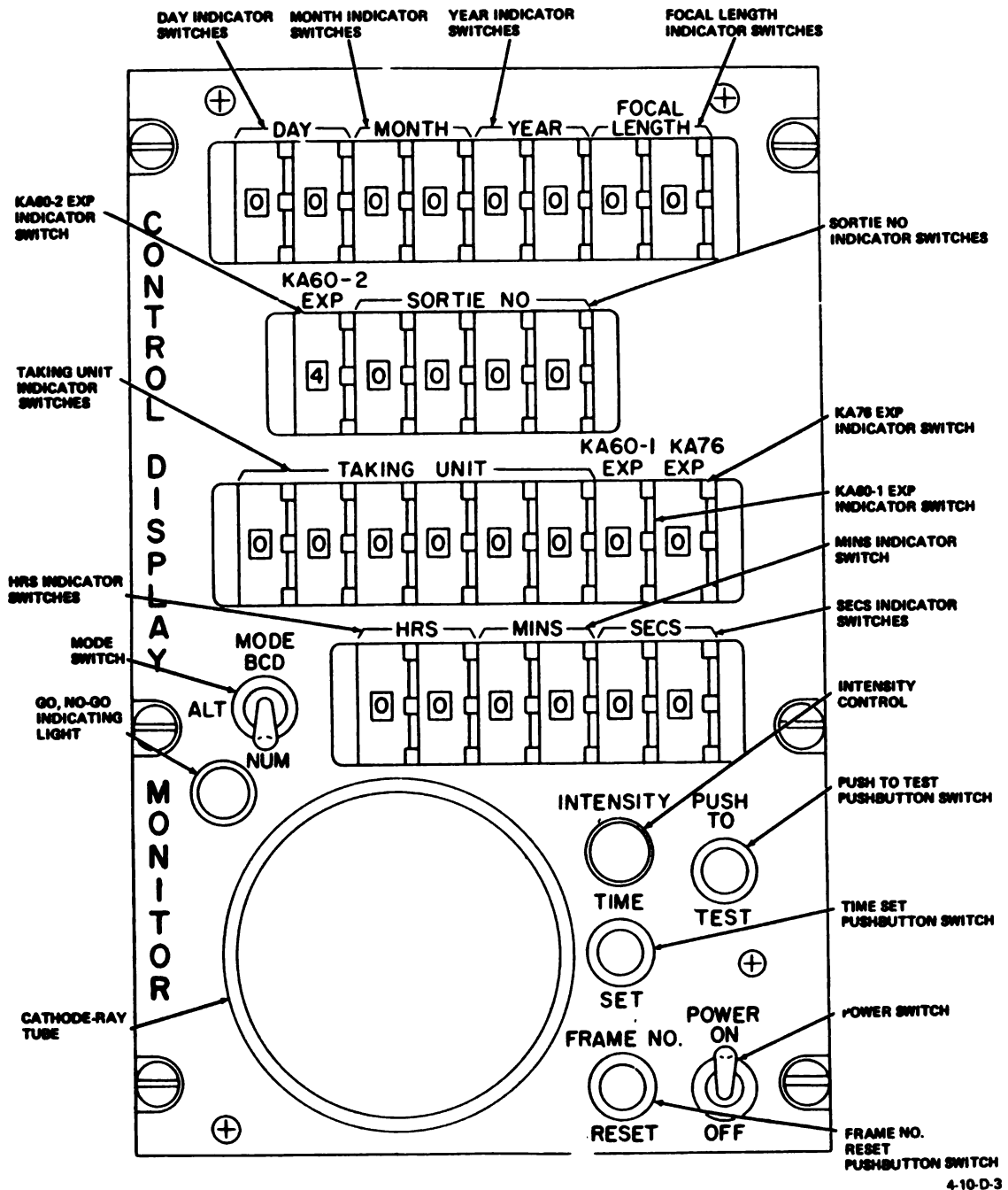

Figure 4-3. Control Display Monitor (AN/AYA-10)

CONTROL	FUNCTION	CONTROL	FUNCTION
Mode switch (cont)	ALT Selects alternating +3 BCD and numeric format. Intermittent display if data demand is present from any surveillance system.	Intensity control	Adjusts dot display brightness of cathode-ray tube.
		Push to test pushbutton switch	Allows review of preset data on CDM.

CONTROL	FUNCTION
Time set pushbutton switch	Sets in time inserted by time indicator switches when pressed. Initiates time count.
Frame No. reset pushbutton switch	Resets frame counters and checks go, no-go indicating light when pressed.
Power switch	Applies power to the system.
Cathode-ray tube	Displays +3 BCD and/or numeric output data when push to test pushbutton is pressed.
Go, no-go indicating light	Indicates go, no-go status of self-test. Light illuminates for go status when frame No. reset pushbutton is pressed.

**b. ADAS Operation.** The ADAS functions automatically and does not require monitoring or adjustment during normal operation. Operation, therefore, is limited to performing a preflight check, programming fixed data into the system, and performing a post flight shutdown procedure.

**c. Preflight Check.** Perform the following preflight check procedure before each mission and before programming fixed data into the system. If any results stated are not obtained, refer to maintenance personnel. Unless otherwise specified, all controls are on the control display monitor front panel (figure 4-3).

(1) Set following indicating switches at settings indicated:

- (a) Day switches - 05.
- (b) Month switches - 08.
- (c) Year switches - 80.
- (d) Focal length switches - 00.
- (e) KA60-2 exp switch - 1.
- (f) Sortie No. switches - 6789.
- (g) Taking unit switches - 012345.
- (h) KA60-1 exp switch - 1.
- (i) KA76 exp switch - 1.

- (j) HRS switches - 01.
- (k) Mins switches - 23.
- (l) Secs switches - 40.

- (2) Mode switch - BCD.
- (3) Power switch - ON.

(4) On signal data converter (adjacent to control display monitor in right aft equipment compartment), check that elapsed time meter is operating by observing rotation of wheel or gear in opening next to window.

(5) Push-to-test pushbutton switch - Press and hold while observing CRT display. Adjust intensity control until dots of display can be observed.

(6) Push-to-test pushbutton switch - Hold pressed and check that CRT display is as shown in figure 4-4. Disregard data displayed on CRT shown enclosed within a box in figure 4-4. Release pushbutton switch after comparison.

(7) Time set pushbutton switch - Press momentarily and release.

(8) Frame No. reset pushbutton switch - Press and release.

- (9) Mode switch - NUM.

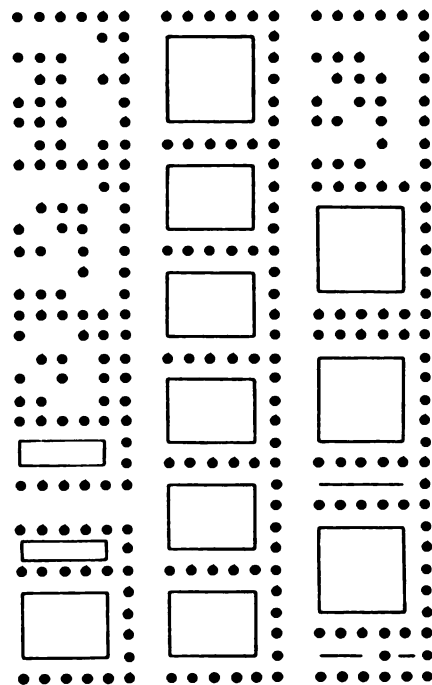

4-10D-4

Figure 4-4. +3 BCD Control Display Monitor Self-Test Display (AN/AYA-10)

(10) Push-to-test pushbutton switch - Press and hold. Check that CRT display is as shown in figure 4-5. Disregard data displayed on CRT shown enclosed within a box in figure 4-5. Release pushbutton switch after comparison.

(11) Mode switch - ALT.

(12) Push-to-test pushbutton switch - Press and hold. Check that CRT display alternates between numeric and bit-coded data. Release switch after observation.

*d. Fixed Data Programming.* Before each mission, program ADAS to preset the time, date, photographic equipment characteristics, applicable military information, and type of display in accordance with the following procedure. Record all data on a programming chart similar to that shown in figure 4-6.

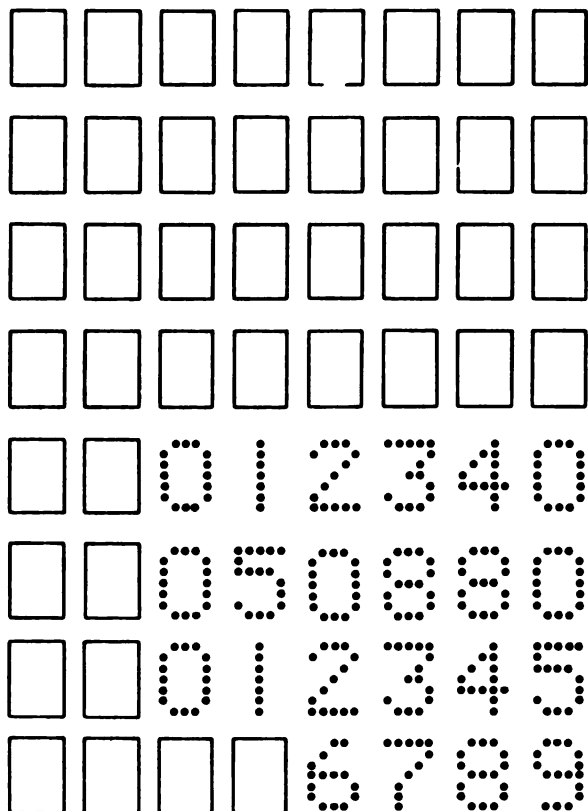

4-10-D-5

Figure 4-5. Numeric Control Display Monitor Self-Test Display (AN/AYA-10)

DATA	NUMERICAL VALUES
DAY	X <sub>1</sub> — X <sub>2</sub> —
MONTH	X <sub>3</sub> — X <sub>4</sub> —
YEAR	X <sub>5</sub> — X <sub>6</sub> —
FOCAL LENGTH	X <sub>7</sub> — X <sub>8</sub> —
SORTIE NUMBER	X <sub>9</sub> — X <sub>10</sub> — X <sub>11</sub> — X <sub>12</sub> —
TAKING UNIT (DETACHMENT)	X <sub>13</sub> — X <sub>14</sub> — X <sub>15</sub> — X <sub>16</sub> — X <sub>17</sub> —
TAKING UNIT (SQUADRON)	X <sub>18</sub> — X <sub>19</sub> — X <sub>20</sub> —
KASO-1 EXPOSURE	X <sub>21</sub> —
KASO-2 EXPOSURE	X <sub>21</sub> —
KATS EXPOSURE	X <sub>22</sub> —

NOTE

THIS CHART SHOULD BE DUPLICATED TO RECORD PROGRAMMING DATA.

4-10-D-6

Figure 4-6. Sample Programming Chart (AN/AYA-10)

**WARNING**

After starting No. 1 engine, insure the CVS and No. 2 inverter are on. At this time, either the right seat occupant or the groundcrew can turn on the ADAS and reset the time and frame count without the dangers present with No. 2 engine running. After turnon and checkout are completed, and personnel are clear, the No. 2 engine can be started.

**CAUTION**

The CVS will insure that unstable voltages will not damage the ADAS.

- (1) Verify date: day, month, and year.
- (2) Record first and second digits of numbers representing day as X1 and X2.

NOTE

If the day is represented by a single digit number, record a zero as X1 and the number as X2.

(3) Record first and second digits of numbers representing month as X3 and X4.

**NOTE**

*If the month is represented by a single digit number, record a zero as X3 and the number as X4.*

(4) Record last two digits of numbers representing year as X5 and X6.

(5) If KA-76 camera is to be used on mission, determine lens being used, and note focal length of that lens.

(6) Record lens focal length as X7 and X8.

(7) Determine film speed index (ASA or AEI) for camera system being used.

(8) Using film speed index, select exposure setting shown in table 4-1.

**Table 4-1. Exposure Settings**

Exposure Setting	Film Speed Index (ASA)	Film Speed Index (AEI)
7	≤ 32	≤ 20
6	32-65	20-45
5	65-125	45-65
4	125-250	65-80
3	250-400	80-100
2	400-800	100-200
1	≥ 800	≥ 200

(9) Record exposure setting for KA-76 camera as X22, if applicable. If not, record a zero as X22.

(10) Record exposure setting for KA-60 camera as X21, if applicable. If not, record a zero as X21.

(11) Determine sortie number, detachment number, and squadron number to be entered.

(12) Record sortie number as X9, X10, X11, and X12.

(13) Record detachment number as X15, X16, and X17.

(14) Record squadron number as X18, X19, and X20.

(15) Set day switch to numerical values for X1 and X2 recorded in figure 4-6.

(16) Set month switch to numerical values for X3 and X4.

(17) Set year switch to numerical values for X5 and X6.

(18) Set focal length switch to numerical values for X7 and X8.

(19) Set sortie number switch to numerical values for X9 through X12.

(20) Set taking unit switch to numerical values for X15 through X20.

(21) Set KA-60-1 (or KA-60-2) exp and KA-76 exp switches to numerical values for X21 and X22, respectively.

(22) Set power switch to ON. Allow 30 seconds for CRT cathode to warm up.

(23) Momentarily press and release frame number reset switch.

(24) Set mode switch to NUM.

(25) Obtain and synchronize stopwatch with actual time.

(26) Set hrs switches to numerical value for last actual hour indicated on stopwatch.

**NOTE**

*If the hour is indicated by a single digit number, set the first switch to zero and the second switch to the actual hour.*

(27) Set mins switches to numerical value for next minute to be indicated on stopwatch.

**NOTE**

*The next two steps must be performed rapidly.*

(28) Set secs switches to 00.

(29) When second hand on stopwatch indicates 12, press and release time reset push-button switch.

(30) Push-to-test pushbutton switch - Press and hold. Observe hours, minutes, and seconds displayed on CRT.

**NOTE**

*If the time displayed on the CRT differs from that shown on the stopwatch by more than two seconds, repeat steps (27) through (29) until a tolerance of two seconds or less is achieved.*

(31) Mode switch - set as desired.

(32) Record time indicated on elapsed time meter.

*e. Post Flight Shutdown.* After a mission is completed, set the power switch to OFF, record the time indicated on the elapsed time meter, and check that the indicator switch settings on the control display monitor agree with the settings on the programming chart (figure 4-6).

**4-6. Photographic Equipment.**

Three photographic equipment facilities are installed in OV-1D aircraft, and provide full aerial photographic coverage of the terrain. These facilities are the forward KA-60 Panoramic Camera Surveillance System, the aft KA 60 Panoramic Camera Surveillance System, and the KS-113A Airborne Photographic Surveillance System. Each is an independent system with separate control. V/H information for each system is provided through the central manual V/H control panel. The following paragraphs provide a functional description, controls and indicators, and operating instructions for the central manual V/H control panel and each of the photographic facilities.

**4-7. Central Manual V/H Control Panel.**

*a.* The central manual V/H control panel (figure 4-7), on the lower console, provides a V/H source control interface with the forward KA

-60 Panoramic Camera Surveillance System, the aft KA-60 Panoramic Camera Surveillance System, and the KS-113A Photographic Surveillance System. V/H ratio signals are received from the airborne data annotation system (ADAS) and distributed by the central manual V/H control panel to the aircraft photographic facilities when the V/H switch is in the AUTO position. This information is utilized by the cameras for image motion compensation (IMC). IMC components in the cameras are driven by V/H voltage inputs to speed up or slow down the film movement so that aircraft speed and altitude are compensated and the target image, in effect, remains stationary on the film.

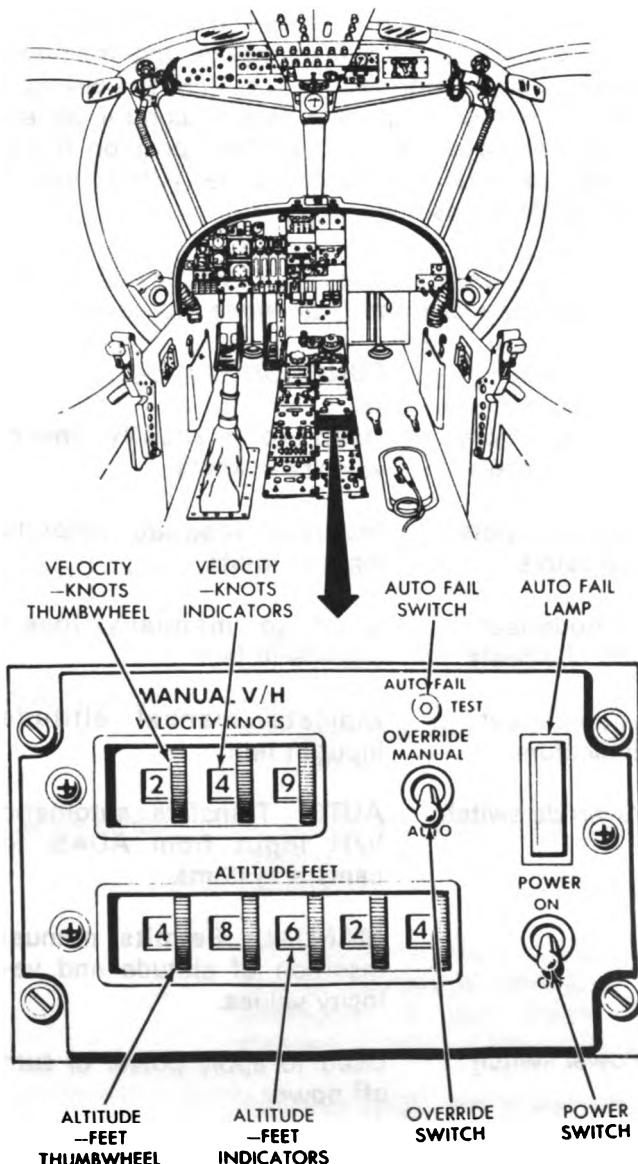

4-10-D-7

**Figure 4-7. Central Manual V/H Control Panel**

b. The central manual V/H control panel also makes provision for manual insertion of V/H parameters in case a failure occurs in the airborne data annotation system or the radar altimeter.

c. The auto fail lamp on the central manual V/H control panel will flash to indicate a failure in either of the associated V/H input sources. When the reset button is pressed, the auto fail lamp will cease flashing and remain steadily illuminated. The speed and altitude of the aircraft may be manually inserted using the velocity and altitude thumbwheels on the panel. When the velocity and altitude indicators on the panel show correct aircraft speed and altitude and the V/H switch is placed in the MAN position, the camera facilities receive the manually inserted V/H information. The V/H switches on the aircraft photographic facility control panels need not be placed to the MAN position if the central manual V/H control panel V/H switch is in the MAN position.

*(1) Control Manual V/H Control Panel Switch Functions and Indications (figure 4-7).*

CONTROL	FUNCTION
Velocity-knots thumbwheels	Used to manually insert velocity in knots
Velocity-knots indicators	Indicate manual velocity input in knots
Altitude-foot thumbwheels	Used to manually insert altitude in feet
Altitude-foot indicators	Indicate manual altitude input in feet
Override switch	AUTO: Transfers automatic V/H input from ADAS to camera systems.  MANUAL: Permits manual insertion of altitude and velocity values.
Power switch	Used to apply power or turn off power
Auto fail switch	Pressed to reset auto fail alarm
Auto fail lamp	Indicates failure of automatic V/H source

*(2) Central Manual V/H Control Panel Operation.* Operation of the functions of the central manual V/H control panel is contained within the operating procedures for the three camera facilities with which it interfaces.

**4-8. Panoramic Camera Surveillance System KA-60.**

a. *Description.* Two KA-60 panoramic camera systems are installed in the OV-1D aircraft; a forward system and an aft system. The forward system uses a forward-looking camera mounted in the nose cap. The aft system uses a camera mounted in the fuselage midsection with the camera lens trained vertically toward the terrain. Each system consists of a camera body, magazine, camera control, and camera control panel. The following paragraphs are common to both of these photographic facilities.

*(1) KA-60 Camera.* The KA-60 camera is a moving film panoramic type, using a 3-inch f/2.8 lens, and includes automatic exposure control (AEC). A 10.25-inch long by 2.25-inch wide frame is provided, which produces 9.4 inches of image area. This image area corresponds to a scan angle of 180 degrees. Relative shutter speeds of 1/100 through 1/10,000 of a second are obtainable, and are a function of the amount of reflected light of the target area, aircraft groundspeed (V), and aircraft altitude (H). Camera system components include the camera body, magazine, camera controls, and control panel (figure 4-8). The camera body achieves the photographic coverage of the camera system. The magazine supplies fresh film to the film keeper where the film is exposed, and collects the exposed film. A photocell, on the lower portion of the camera body, monitors the terrain brightness. The photocell operates in conjunction with the KA-60 control panel and the camera controls to automatically control film exposure.

*(2) Camera Body.* The camera body includes the prism, lens, aperture and slit mechanism, photocell, and drive mechanism. The upper portion of the camera body supports the magazine and provides a mechanical linkage to the magazine to accomplish film transport. Two latch hooks lock the magazine to the camera body and three trunnions allow the camera body to be secured to a mount. Control voltages are received from the camera controls through an

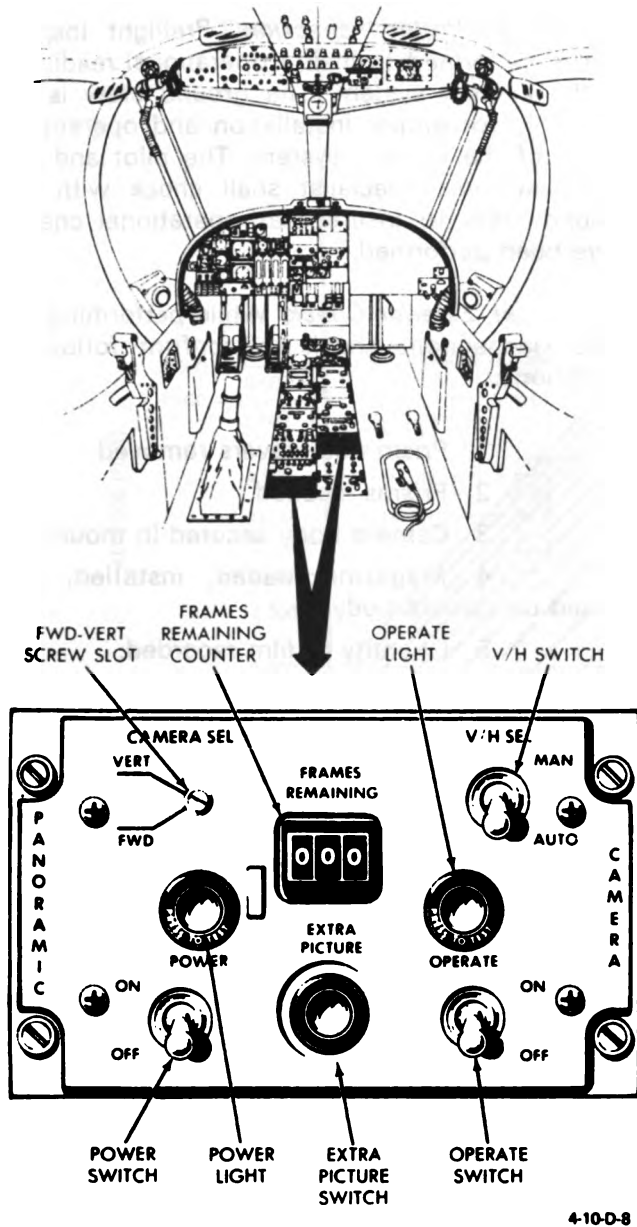

Figure 4-8. KA-60 Panoramic Camera Control Panel

electrical connector. Aperture and slit mechanisms control the camera system exposure. The lift cam is used to sequence film transport.

(3) *Magazine.* The magazine provides space for the supply spool, takeup spool, film keeper, and the pressure roller. The supply spool stores 250 feet of film and mounts on two keyed shafts. The supply knob and two keyed shafts facilitate the supply spool mounting. The

takeup knob and two keyed shafts allow the takeup spool to be mounted in the magazine. Two fasteners latch the magazine to the camera body, and eight cover fasteners latch the covers to the magazine. The input gear mates with the camera body linkage gear. The cam follower rests on the lift cam for film transport.

(4) *Control Panel.* The KA-60 panoramic control panel contains the controls and indicators of the camera system. Each control panel contains a screw slot switch placarded FWD-VERT. This control permits interchangeability of the control panels, however, this switch shall be turned to the position, FWD or VERT, of the camera installation that it will control.

(5) *Camera Controls.* When power is applied to the control panel and the power and operate switches are set to ON, the control panel applies an operate command signal through the camera body interlock circuit to the camera controls. This condition initiates camera system operation and allows the camera controls to generate and regulate voltages that control camera operation. The V/H switch is used to select the source of V/H voltage used in the automatic exposure control subsystem. All control voltages for operating the camera are controlled by, or routed through, the camera controls.

*b. KA-60 Panoramic Camera Control Panel Switch Functions and Indications (figure 4-8).*

CONTROL	FUNCTION
Power switch	Applies power to camera equipment so that it is ready to operate.
Operate switch	Applies 28 VDC operate voltage to internal circuitry of camera.
	Adjusted manually to sequence camera to take photographs 1 per second through 1 every 60-seconds.
	Indicate cycle rate of camera when in pulse mode.
	Sets one of three camera operating modes.



CONTROL	FUNCTION
Extra picture switch	When pressed, camera takes photographs between time interval preset on intervalometer.
Frames remaining counter	Indicates total remaining exposures in camera.
Power light	Illuminates to indicate that 28 VDC power is applied to internal camera circuitry.
Operate light	Flashes each time KA-60 control panel indicates normal camera operation and remains illuminated when either film breaks or end of film is reached.
V/H switch	Select manual or automatic V/H input.
Fwd-vert (screwslot)	Selects either Forward (FWD) or aft (VERT) installation.

*c. Normal Operation.*

*(1) Modes of Operation.* Mode selection in the KA-60 Camera System is automatic and is a function of aircraft speed and altitude. This relationship is illustrated in figure 4-9. This illustration should be used as a reference only, since the operating modes (PULSE and AUTOCYCLE) cannot be selected by the operator. When power is applied to the camera system and the power and operate switches on the KA-60 control panel are placed to ON, the camera begins to cycle automatically. During normal operation, the V/H switches on the KA-60 control panel and the central manual V/H control panel are placed in AUTO position. This provides an automatic continuous input of V/H signals for image motion compensation (IMC). The source of the automatic V/H information is the airborne data annotation system. The central manual V/H control panel provides a means for selecting the V/H input source.

*(2) Preflight Inspection.* Preflight inspection is performed to insure operational readiness of the camera system. The ground crew is responsible for proper installation and operational check of the camera system. The pilot and airborne systems specialist shall check with the ground crew to insure that operational checks have been performed.

*(a) Exterior Check.* While performing exterior inspection, check to confirm following conditions:

1. Prism dust covers removed.
2. Prisms cleaned.
3. Camera body secured in mount.
4. Magazine loaded, installed, and locked on camera body.
5. Quantity of film recorded.
6. Camera controls secured in mount.
7. Windows cleaned.
8. Camera systems tested (operational checks).

*(b) Interior Check.* Check for completeness of equipment during normal interior check.

*(3) Operation.* The operation of the system consists of pretarget and on-target starting procedures.

*(a) Pretarget Starting Procedure.*

1. On KA-60 control panel and on central manual V/H control panel, set V/H switch to AUTO.
2. On KA-60 control panel, set power switch to ON at least 30-seconds before intended camera use.

*(b) On-Target Starting Procedure.*

1. For continuous photographing, set operate switch on KA-60 control panel to ON.
2. Check operate lamp. Operate lamp shall flash for each exposure.
3. Check frames remaining counter for subtraction of one digit for each exposure.

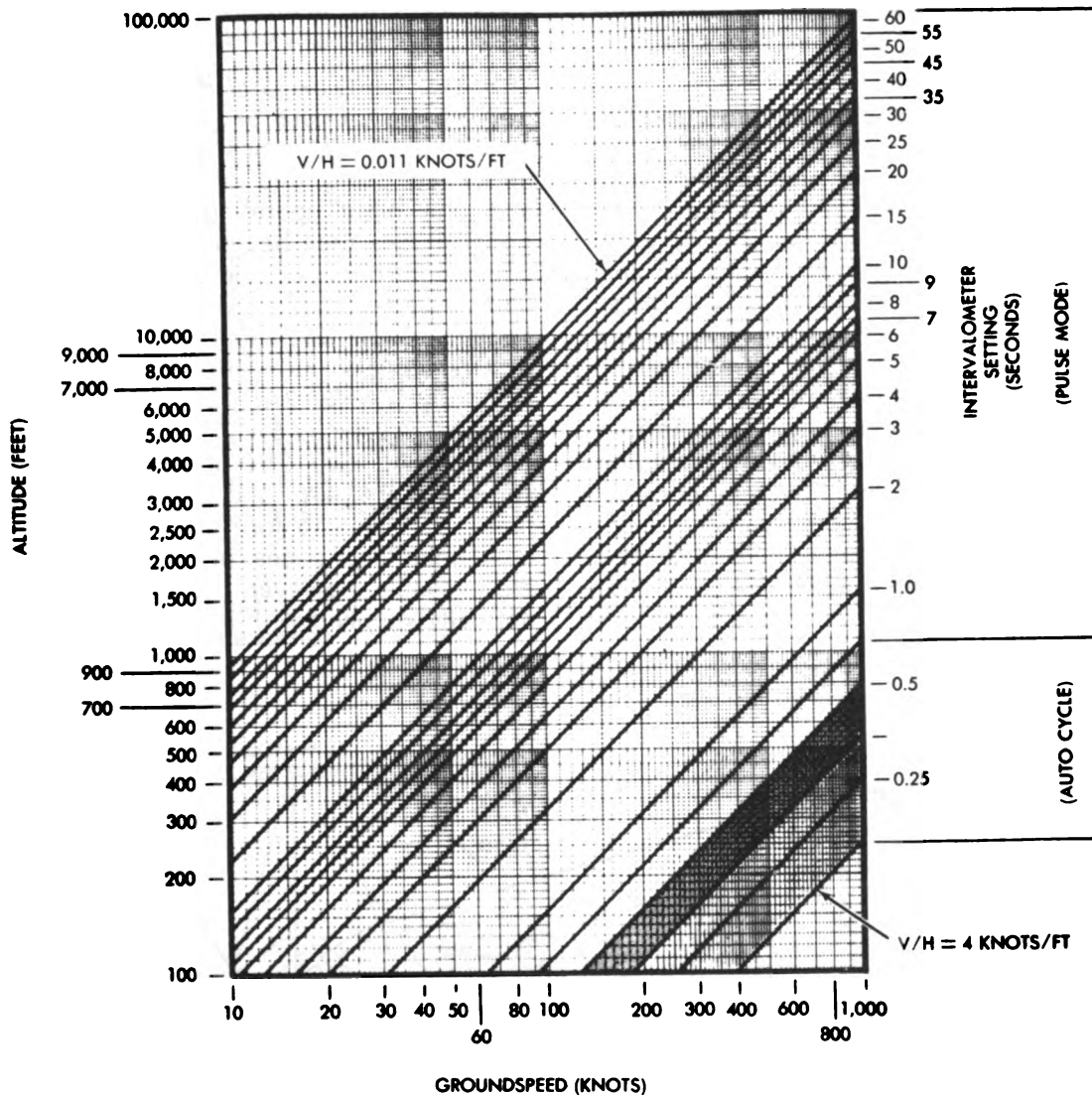

Figure 4-9. KA-60 Mode Operating Chart

**NOTE**

*Operate lamp remains illuminated to indicate camera system failure, broken film, or end of film.*

**(c) Stopping Procedure.**

1. Place operate switch on KA-60 control panel to OFF.
2. Place power switch on KA-60 control panel to OFF.

**d. Emergency Operation.**

- (1) Auto fail lamp on central manual V/H control panel will flash to indicate failure of

automatic V/H source. Press reset button on central manual V/H control panel to stop lamp flashing. Auto fail lamp will remain steadily illuminated.

- (2) Place operate switch on KA-60 control panel to OFF.

- (3) Place V/H switch on central manual V/H control to MAN.

- (4) Using altitude and velocity thumbwheels on central manual V/H panel, insert speed and altitude figures so that altitude and velocity indicators show aircraft altitude and speed.

- (5) Place operate switch on KA-60 control panel to ON. Camera will begin to cycle using values manually set into central manual V/H control panel as its V/H source.

4 10 D 9

**4-9. Airborne Photographic Surveillance System KS-113A.**

*a. Description.* The Airborne Photographic Surveillance System KS-113A provides automatic, continuous, and single picture photography during day or night operations. The photo system is capable of still pictures over a wide range of the aircraft's terrain clearance and groundspeed envelope. Still pictures are made possible by an image motion compensation (IMC) feature that automatically speeds up or slows down the film movement, according to the aircraft's groundspeed to height over terrain ratio (V/H). This function, in effect, places a stationary image on the film. System controls are provided to select any of the available operating modes and camera depression angles. The photo system consists of a KA-76A Still Picture Camera Set mounted in the aft camera

compartment, and associated camera control system and components.

(1) *KA-76A Still Picture Camera Set.* The Still Picture Camera Set KA-76A (figure 4-10) can be used for vertical or oblique angle reconnaissance using one of three distinct daylight and one night operating modes. These operational modes may be selected remotely from the photo control panel. The camera set mounts two film cassettes that provide support and housing for film spools and spool drive coupling. The still picture camera (KA-76A) consists of the Camera Body (LA-373A), camera drive, Shutter Assembly (LA-375A), 6-inch Lens Cone (LA-374A), two 250 foot capacity Film Cassettes (LA-414A), and a data annotation input tube assembled to form an operating unit. Three additional lens cones of different focal lengths are available, however, the still picture camera is normally supplied with a 6-inch lens cone.

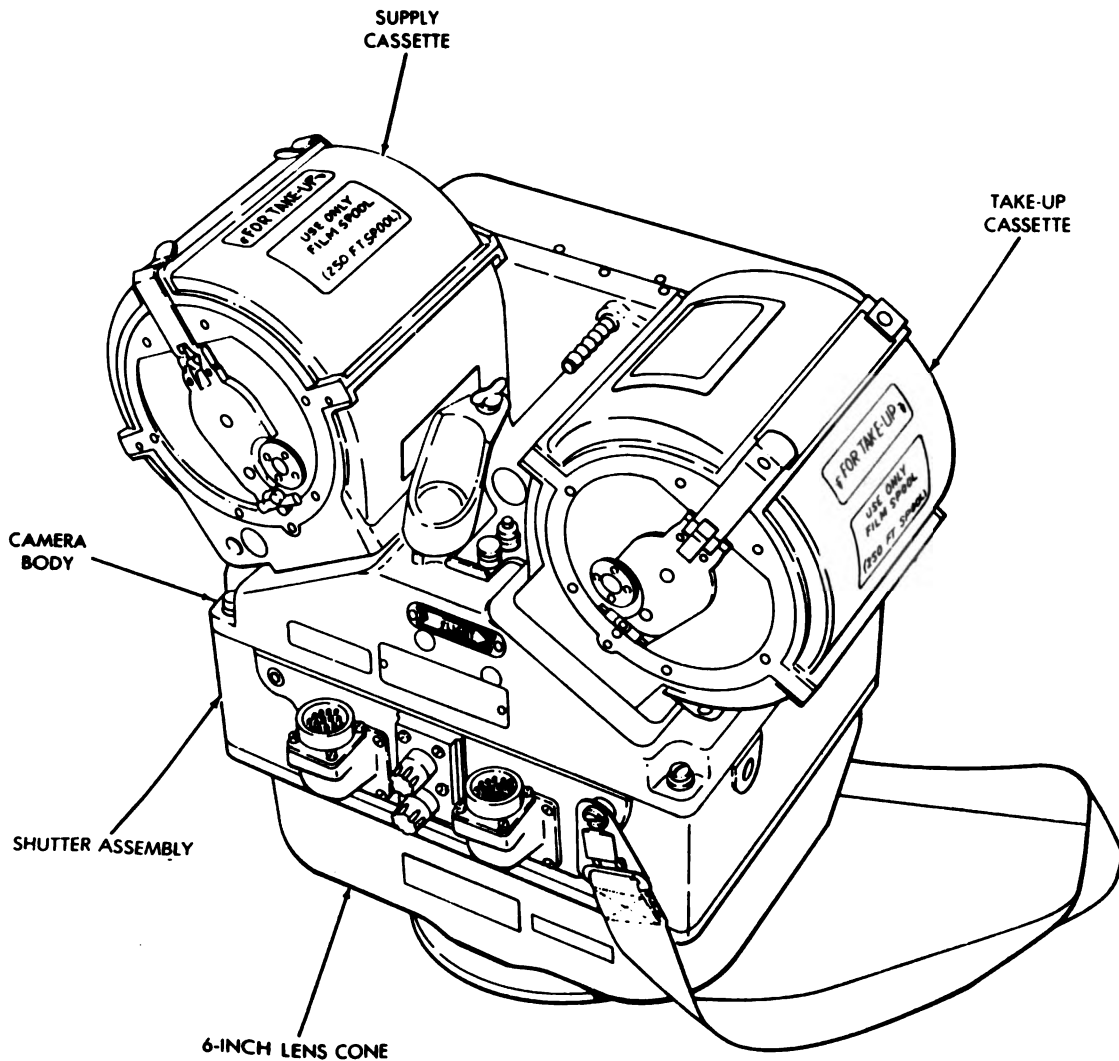

**Figure 4-10. KA-76A Camera**

4-10-D-10

(a) *Aircraft Camera Body LA-373A.* The aircraft camera body LA-373A (camera body) is a modular assembly (figure 4-11 and 4-12) that contains the mechanism for film transport, image motion compensation, and mode selection. A means is also provided for attaching the shutter assembly and film cassettes. A cassette interlock switch is provided to prevent camera operation if the cassettes are not properly installed. Two cassette retainers, a cassette latch, and a cassette latch bolt are on top of the still picture camera body to secure the film cassettes. A motor-generator, between the cassettes, provides power for advancing the film and for image motion compensation (IMC). On the left side of the camera body (figure 4-11) are a fuse access panel, a camera cycle counter, and two coupling drive knobs. The coupling drive knobs are attached to spool couplings (figure 4-12) that engage pivot drive assemblies on the film cassettes. The film drive

motor fuse and a spare fuse are behind the fuse access panel. A mode selector switch is beneath the mechanism cover. Two guide pins, the platen, a threading curtain, an electrical connector, and the film format shield are on the bottom of the camera body. The format shield frames the picture area and is formed into guides at the ends to direct film in and out of the still picture camera body during film loading. Four fiducial marks are machined into the format shield. These marks are recorded on each frame of exposed film to enable the photo interpreter to determine the direction of flight. The electrical connector on the bottom mates with a connector on top of the shutter assembly.

(b) *Shutter Assembly LA-375A.* The shutter assembly LA-375A (shutter assembly) (figure 4-13) is a cast aluminum housing containing the shutter mechanism, a mechanism cover, and a light shield. The housing is ma-

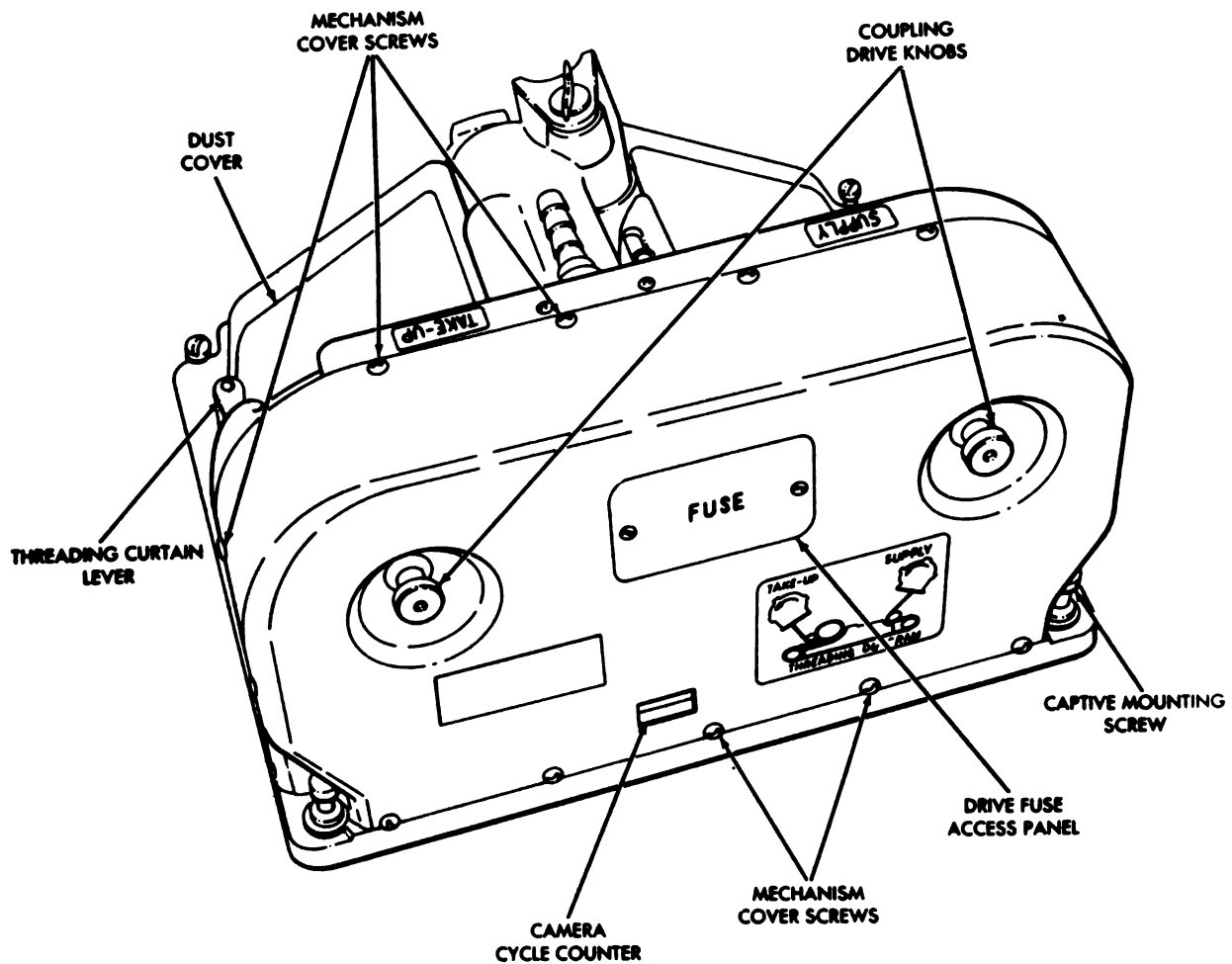
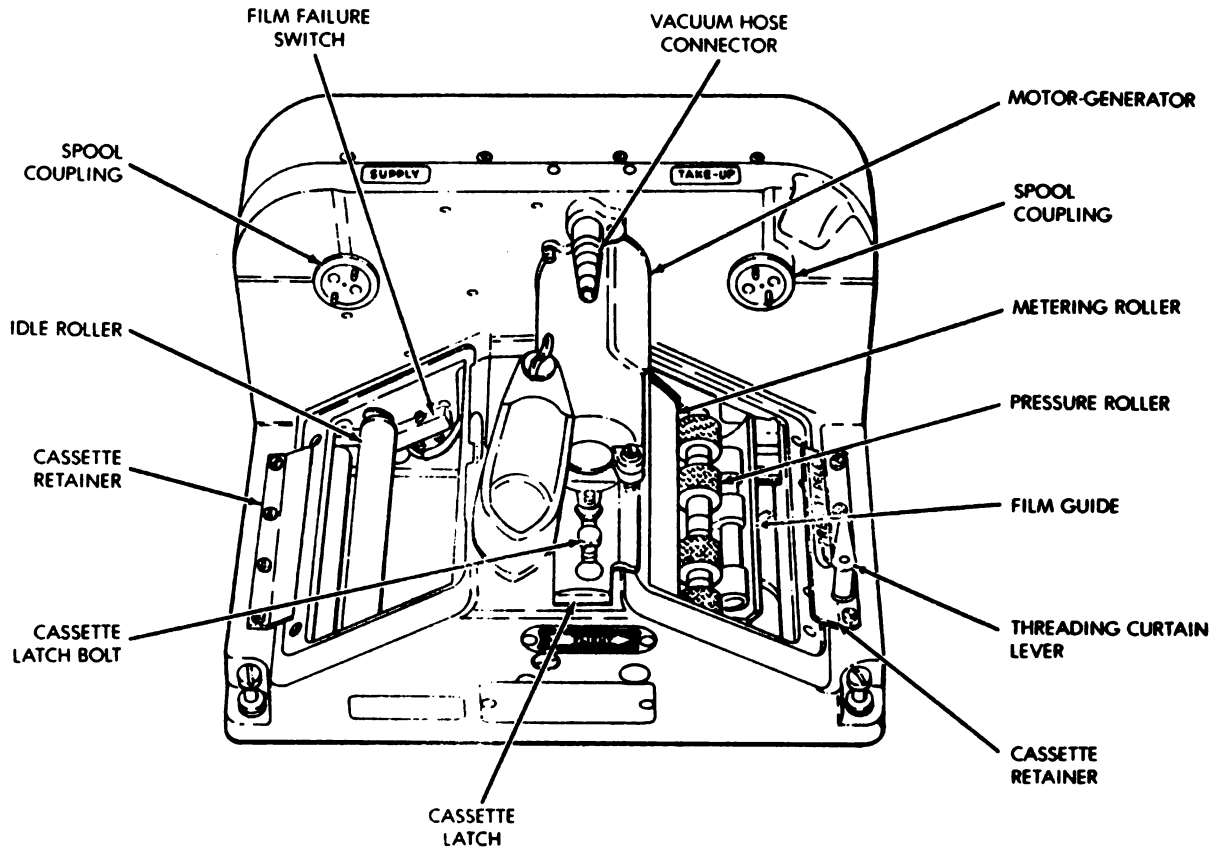

Figure 4-11. Camera Body, Rear View

4-10-D-11



4-10D-12

Figure 4-12. Camera Body, Front View

chined on top and bottom surfaces to insure a light-tight assembly with the camera and the lens cone. Guide pin holes on top and guide pins on the bottom of the shutter assembly insure proper alignment of the camera components in the optical axis. On the left side of the shutter housing are a curtain latch access panel, a shutter cycle counter access panel, and a manual shutter speed indicator. A screwdriver slot curtain latch control, behind the curtain latch access panel, is set to DAY for all modes in which the camera will be operated. A five-digit cumulative shutter cycle counter is mounted behind the shutter cycle counter access panel. The shutter mechanism consists of a leading and trailing shutter curtain, a slit control motor, two drive motor and clutch assemblies, and associated gear trains and switches. The shutter curtains are covered by a mechanism cover with a format opening. The edge of the format opening is marked to indicate whether the shutter is cocked or uncocked. Red dots on

the shutter curtains line up with the appropriate mark to indicate the shutter condition. A light shield on the bottom of the shutter housing prevents the entrance of stray light.

(c) *Lens Cones.* The lens cones consist of a metal housing, the lens assembly, an S/C control and indicator, an aperture indicator, and a manual aperture control. The 3-inch lens cone, 6-inch lens cone (figure 4-14), and the 12-inch lens cone contain electrical and mechanical components that vary the aperture opening automatically. The 1-3/4-inch lens cone does not incorporate the automatic feature. The 1-3/4-inch lens cone also lacks the aperture control and indicator, since the aperture has a fixed opening. All lens cones, except the 1-3/4-inch lens cone, contain a diaphragm servo drive assembly and an associated circuit board mounted in the housing provided with electrical connectors for easy removal and replacement.

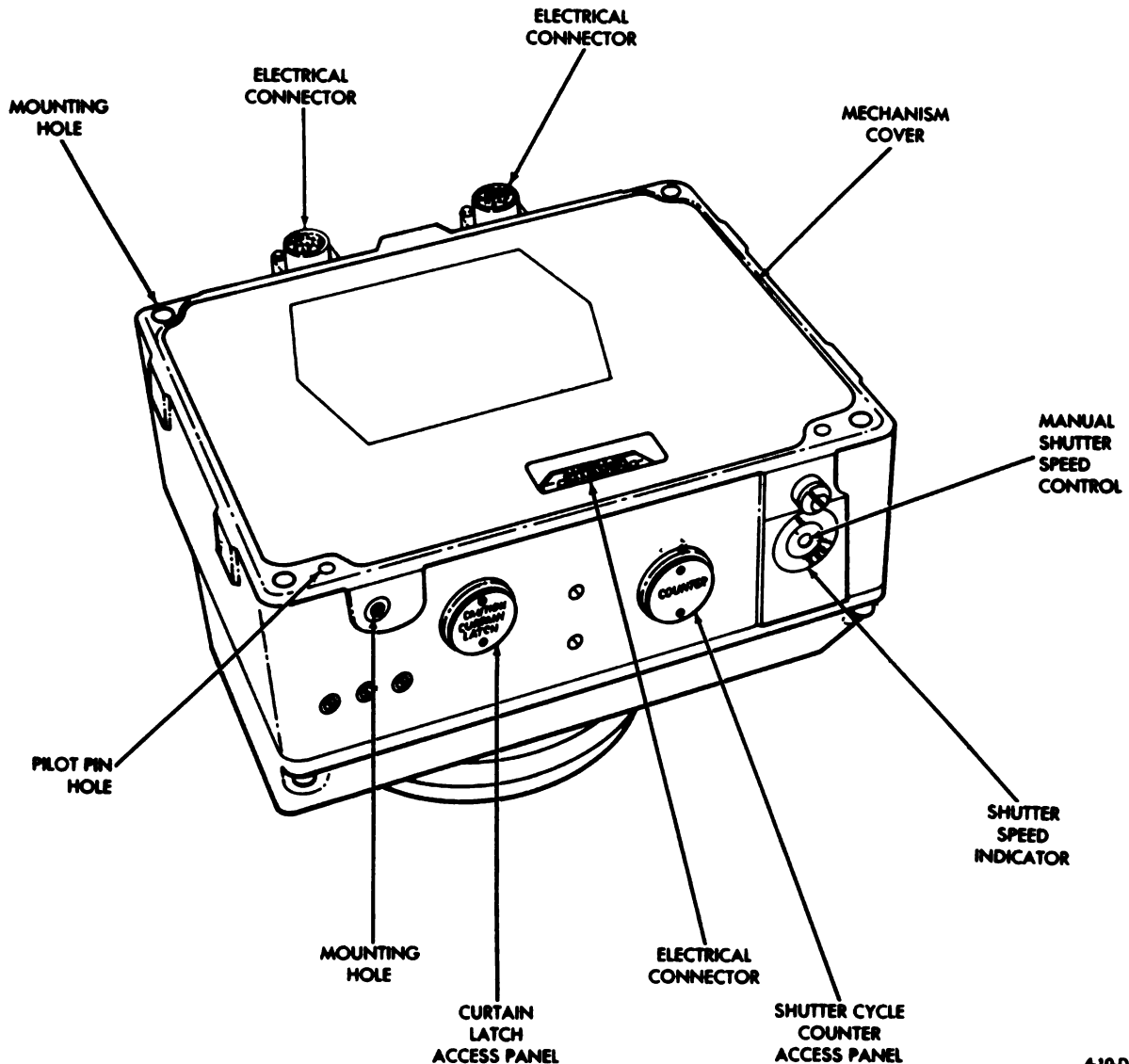

4-10-D-13

**Figure 4-13. Shutter Assembly, Top View**

(d) *Film Cassettes LA-414A.* Two Film Cassettes LA-414A provide support and housing for the film spools and spool drive coupling. The film cassettes have a capacity for 250 feet of film and perform the film takeup and supply functions (figure 4-15).

(e) *Light Sensors LA-407A.* Three Light Sensors LA-407A are used to monitor terrain brightness and provide signal voltages for the exposure control circuits.

(f) *Filters.* A yellow and red filter are provided with each lens cone except the 1-3/4-inch lens cone. The filters are constructed

of optical glass. The filter is positioned over the lens for operation when atmospheric conditions create haze.

(g) *Modes of Operation.* The camera set has four separate modes of operation. Selection of the proper mode depends on conditions of the mission.

1 *Autocycle.* In the Autocycle mode of operation, the camera control equipment scans the terrain for reflected light and forward motion, and automatically sets the camera for correct exposure, IMC, and exposure interval to produce 60 percent overlap between frames.

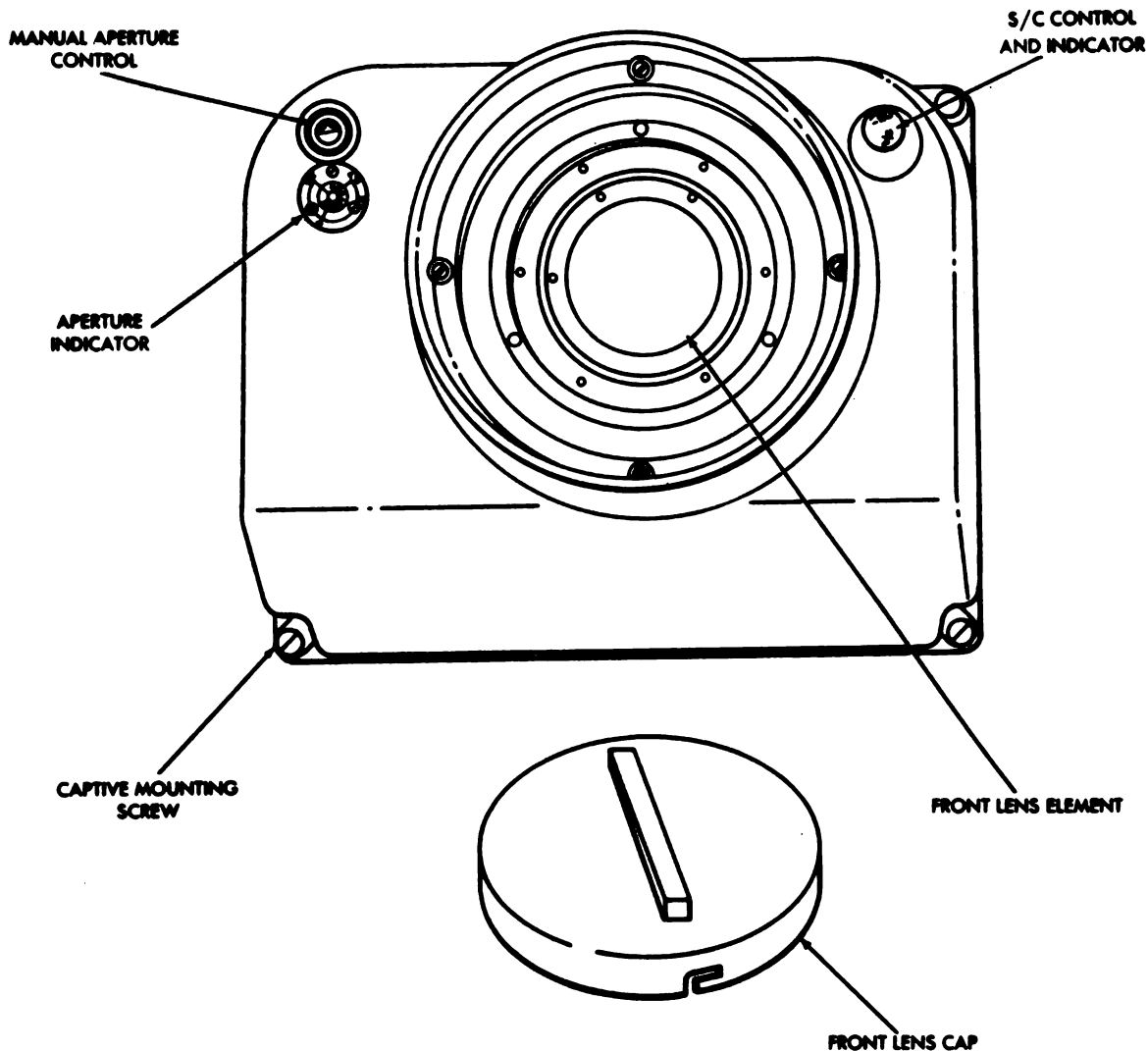

4-10-D-14

Figure 4-14. Lens Cone (6-Inch)

Film movement is continuous in the Autocycle mode.

**2 Pulse.** In the Pulse mode of operation, an exposure is made each time a cycle pulse is received from the photo control system. The control equipment scans the terrain for reflected light and automatically sets the camera for the proper exposure. No IMC is used in this mode of operation.

**3 Pulse IMC.** In the Pulse IMC mode, operation of the camera is the same as in the Pulse mode, except that IMC is utilized.

**4 Night Electronic Flash.** In the night electronic flash mode, operation is the same as

in the autocycle mode except that a cam-operated switch in the shutter triggers electronic circuits in the flasher system to produce illumination. Exposures are made at the slowest shutter speed and the largest lens aperture opening.

**(2) Camera Control System.** The camera control system provides the man-machine interface and all electrical signals required for camera operation. The camera control system consists of the photo control subsystem, exposure control subsystem, camera mount and mount positioning subsystem, camera window doors subsystem, oblique optical sights and photo flight-line sight. The control system provides timed pulses for stereo coverage (60% frame overlap), vertical photography and a servo drive

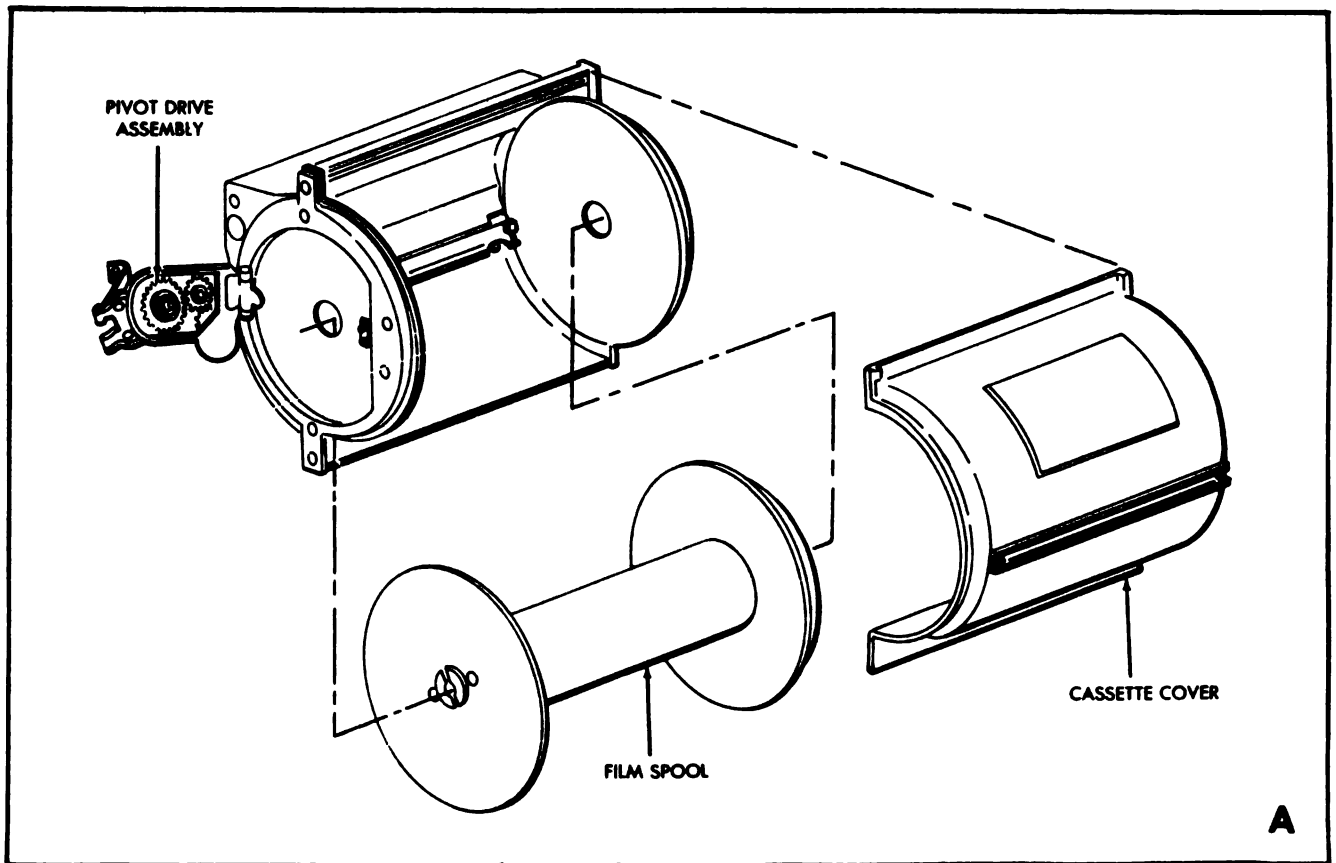
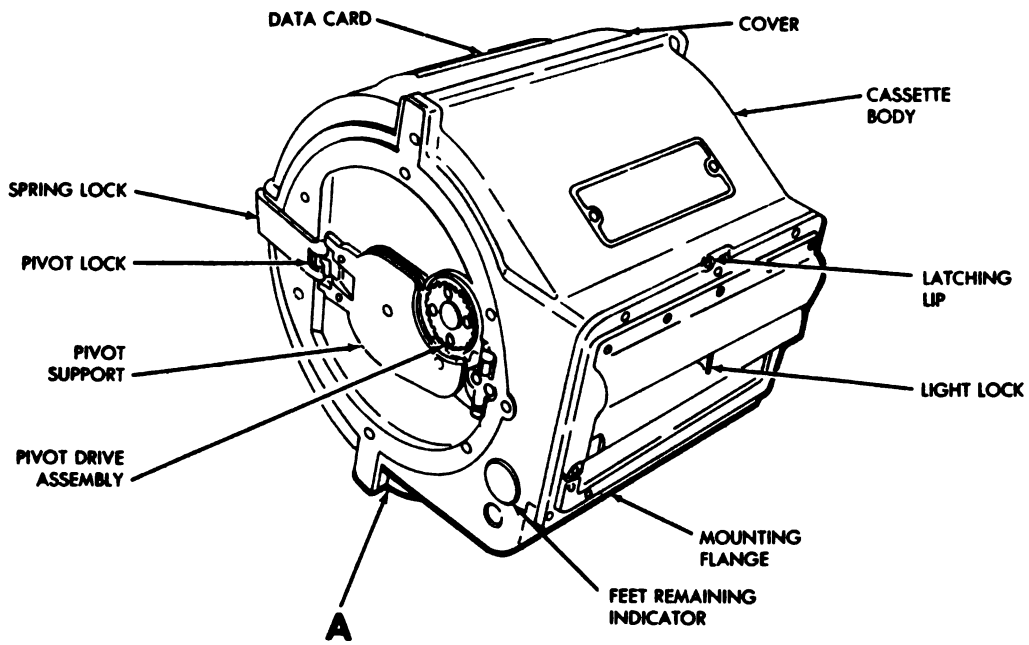

4-10D-15

Figure 4-15. Film Cassette



voltage to move the film in the camera at the same speed as the ground image. The pulse interval rate or the IMC drive rate with the camera depression angle is manually controlled by values of velocity and terrain clearance set on the central manual V/H control panel or automatically controlled by the V/H input signals from the airborne data annotation system. In-flight selection shall be made for either manual or automatic V/H input.

(a) *Photo Control Subsystem.* The photo control subsystem provides a means of selecting the mode of system operation, camera depression angle, and auto or manual V/H operation. The aircraft groundspeed and altitude are set into the control system by the operator by means of analog-type potentiometers. These potentiometers are controlled by the velocity-knots thumbwheels and the altitude-feet thumbwheels on the central manual V/H control panel. The photo control subsystem consists of the photo control panel and the photo system assembly.

1 *Photo Control Panel.* The photo control panel (figure 4-16) is a rack-mounted panel on the lower console in the cockpit. The switches, indicators, and lamps provide the operator with a means of remotely controlling the photo system.

2 *Photo System Assembly.* The photo system assembly (figure 4-17) is on the left side of the equipment compartment. This assembly contains the control circuitry for switching the modes of operation established by the operator, regulating camera cycling rate, and producing a film drive voltage adapted to the signals from the V/H source and compensated for camera depression angle, lens focal length, and regulation of the flasher system.

(b) *Exposure Control Subsystem.* Three light sensors monitor terrain brightness and provide signal voltages that drive the exposure control circuits in the lens cone and adjust the slit width of the focal plane shutter, thus setting the lens opening automatically according to the prevailing light conditions. There is a light sensor on each side of the aircraft below the landing flaps junction, and one on the bottom vertical axis. The light sensors are flush-mounted in the fuselage behind a protective glass lens.

(c) *Camera Mount and Mount Positioning Subsystem.* The camera mount and mount

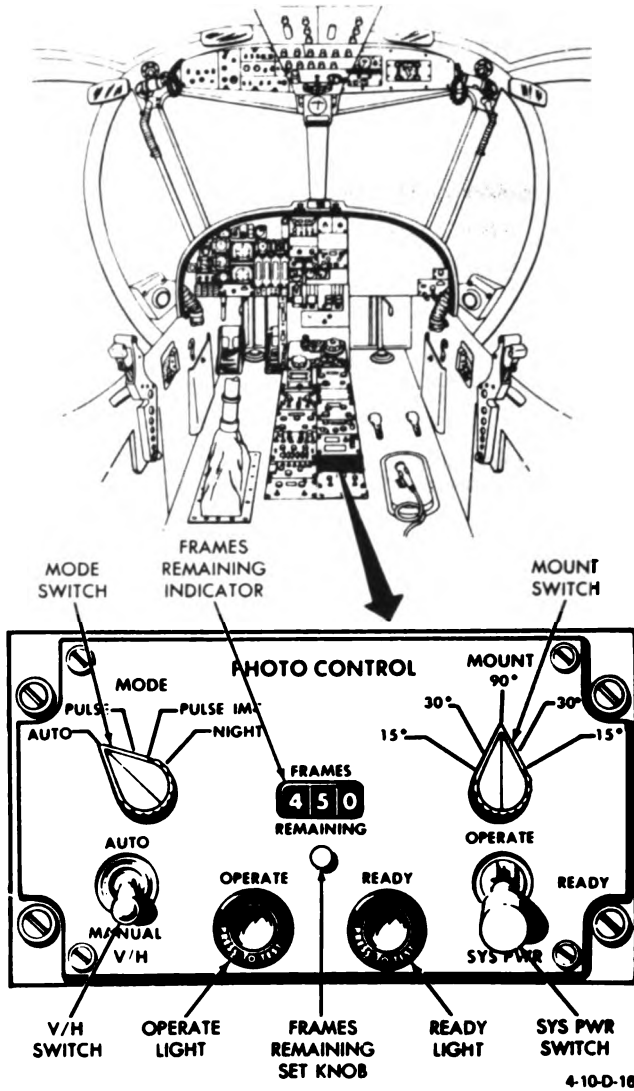

Figure 4-16. Photo Control Panel

positioning subsystem provides support for the still picture camera set and a means of positioning the camera for certain depression angles. The mount may be positioned at one of five different depression angles (15°L, 30°L, 90°, 30°R, and 15°R), thus increasing the overall oblique range of a single camera. Depression angles are measured using the horizon as a reference. The desired angle of operation is determined by selecting one of five MOUNT switch positions on the PHOTO CONTROL panel. When the 1-3/4-inch lens cone is installed, a camera mount interlock is activated that prevents the mount from taking any position but the 90° (vertical) position.

(d) *Camera Window Doors Subsystem.* The camera window doors subsystem provides

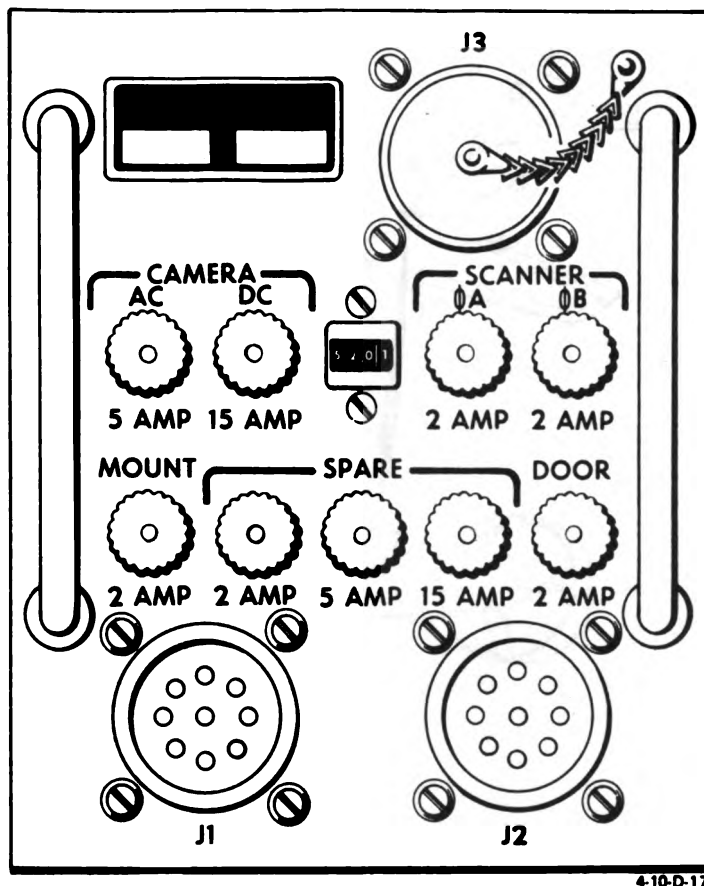
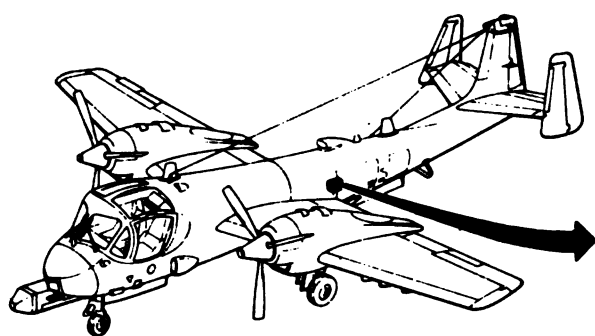

Figure 4-17. Photo System Assembly

remote control of the camera window doors (figure 4-18) in order to give coverage for the five depression angles available to the still picture camera. The camera window doors are located to the left and right of the camera and one, the vertical camera window door, directly below the door. The proper camera window door is opened and closed automatically when the camera angle is selected by the mount switch on the photo control panel. An open camera window door will automatically close when the power switch on the photo control panel is turned to OFF or the landing gear handle is down. A camera window doors interlock switch is provided that deenergizes the door drive power when the camera compartment door is open for ground servicing. The left, vertical, and right camera door actuator is composed of two limit switches and a drive motor.

(e) *Flasher Subsystem.* The flasher subsystem provides short duration flashes of high

intensity light to illuminate the terrain for night aerial photography. The flasher is contained in a pod (figure 4-19) mounted under the right wing at station 5. Operation of the flasher subsystem is controlled by the photo control panel and is automatically energized when the night mode is selected. The flasher is instantaneously triggered by the camera frame pulse generated in the still picture camera. Synchronization of the flasher with the still picture camera provides maximum illumination at the instant the camera shutter is fully open. An alternator enclosed in the nose section of the flasher pod generates the AC power required by the three illumination modules of the flasher subsystem. A propeller mounted on the nose of the pod drives the alternator.

(f) *Oblique Optical Sights.* One oblique optical sight (figure 4-20) is outboard of the pilot's position and one outboard of the observer's position. These sights provide the op-

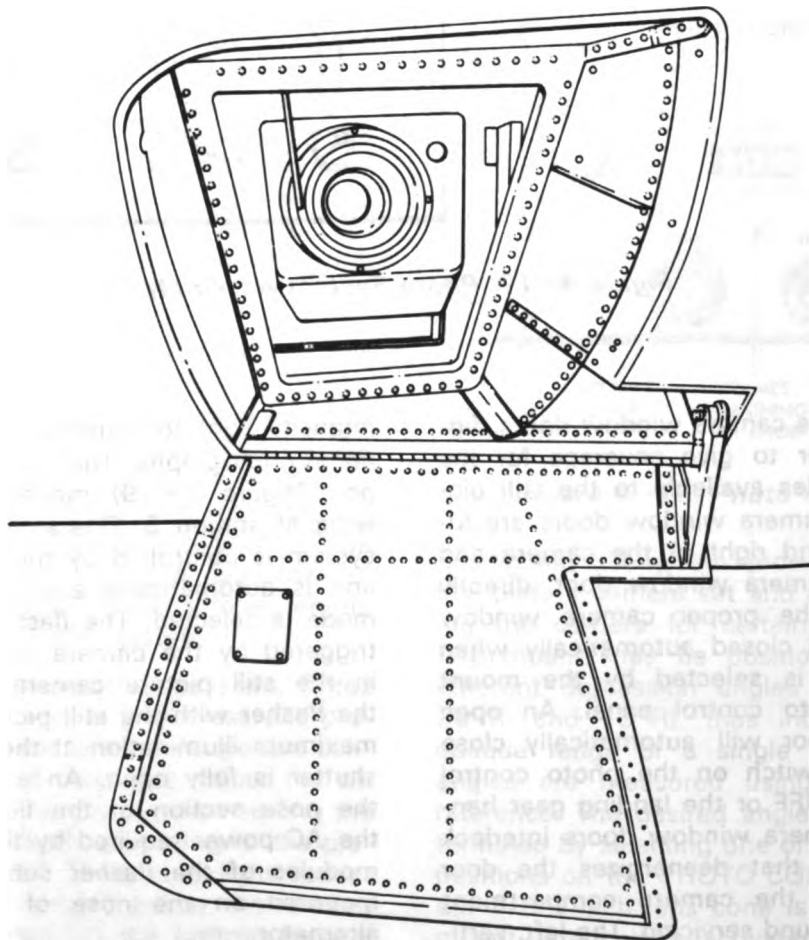
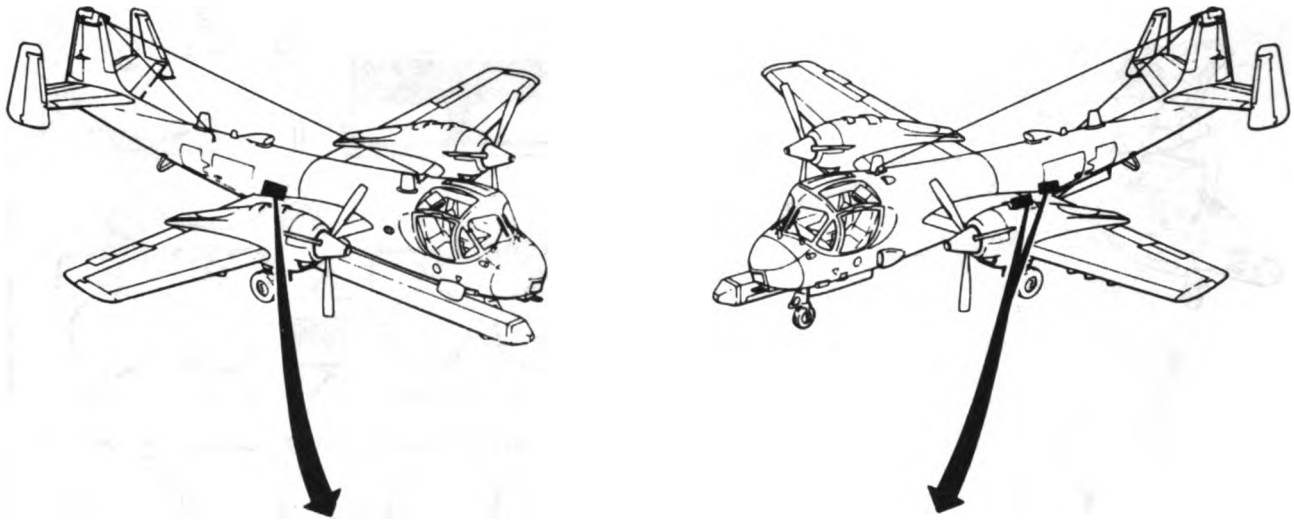

4-100-18

**Figure 4-18. Camera Window Door**

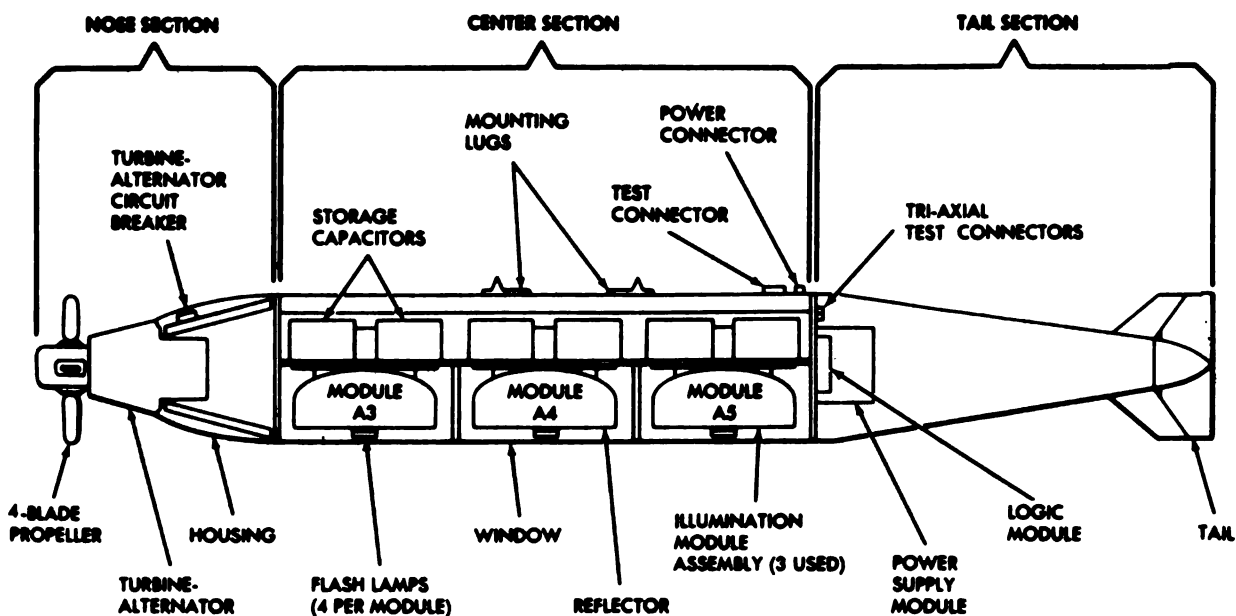
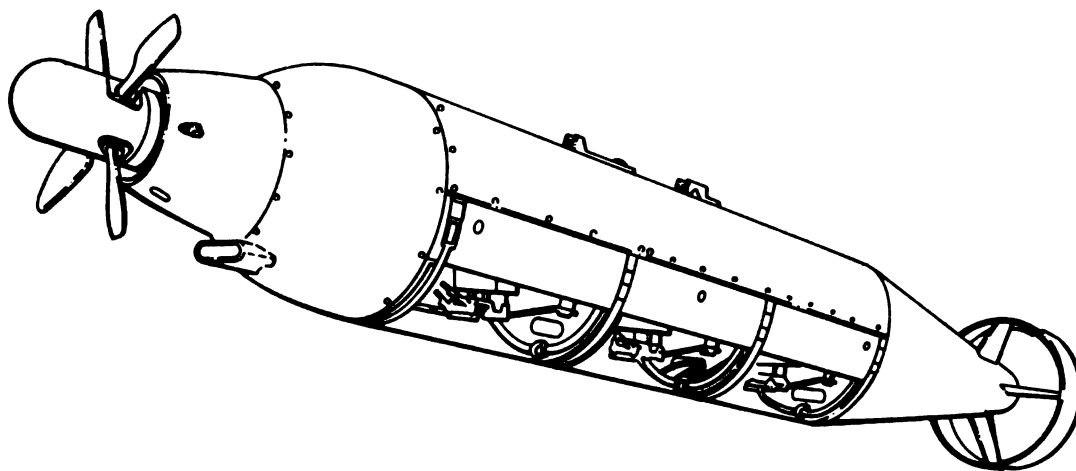

4-10-D-19

Figure 4-19. LS-59A Flasher Pod

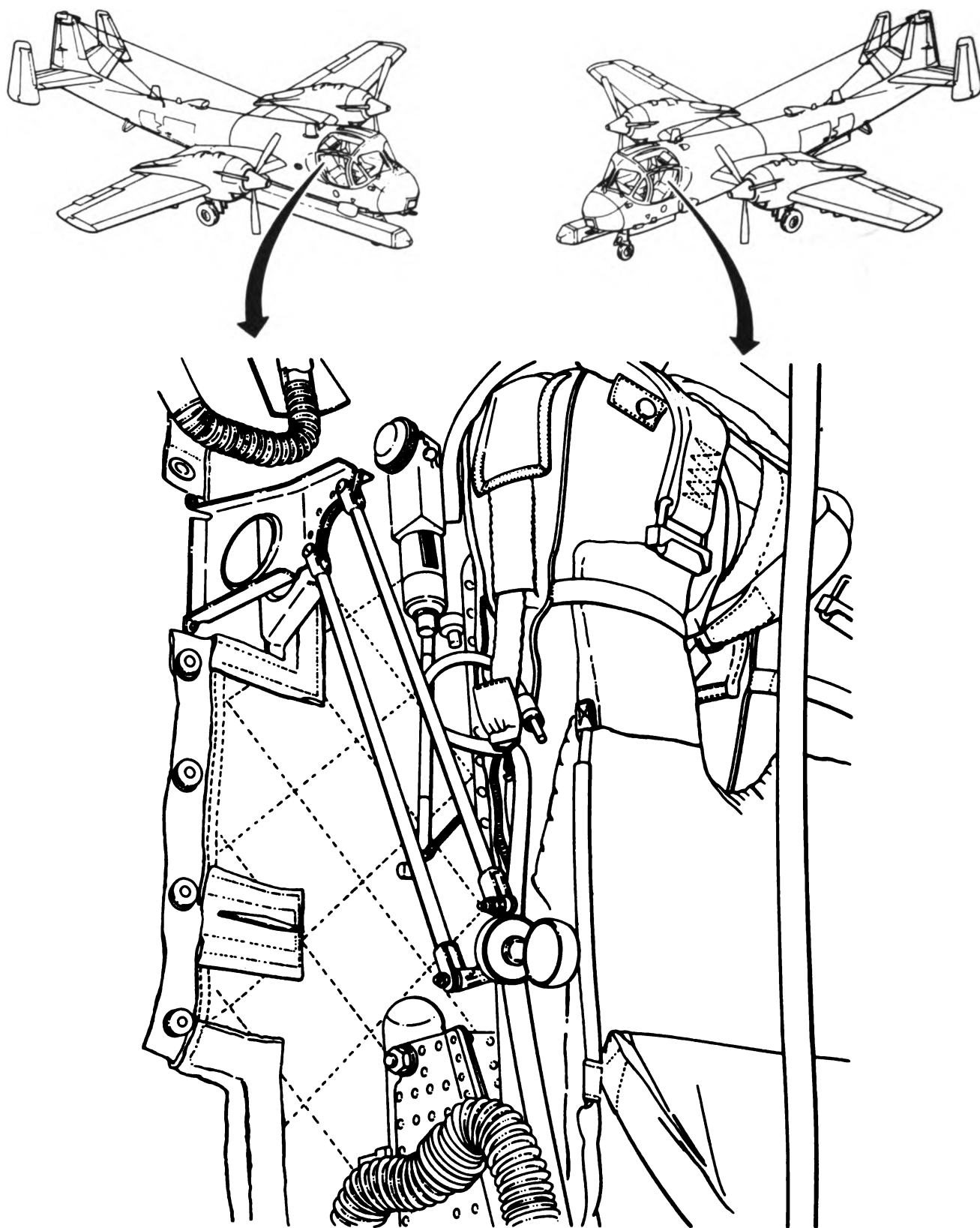

4-10-D-20

Figure 4-20. Oblique Optical Sight

erator with a means of viewing the field of view of the camera when positioned to any of the oblique positions.

(g) *Flight Line Sight.* The flight line sight (figure 4-21) is a non-optic collapsible viewfinder for sighting during vertical photography. The flight line sight is on the glareshield forward of the pilot's position. Sighting is done by aligning the pointer and vertical wire reference with an imaginary straight line between the target and a reference point (or other target) in the line of flight. When the imaginary straight line between the target and the reference point moves in line with the wire reference and pointer, the target will pass under the aircraft within the camera field of view. Rotation of the sight about the vertical axis allows the pilot to sight when crabbing to compensate for crosswinds.

*b. Photo Control Panel Switch Functions and Indications (figure 4-16).*

CONTROL	FUNCTION
Sys pwr switch	OFF AC and DC power removed from photo system.
	READY AC and DC power applied to photo system.
	OPERATE Places photo system in operation.
Ready light	When on, indicates power applied to photo system and all interlocks required for operation are made.
Operate light	Flashes on each time frame is made in camera. Illuminates continuously when film failure has occurred.
V/H switch	MANUAL Permits insertion of V/H ratio information from manual settings on central manual V/H control panel.
	AUTO Permits insertion of V/H ratio signals from ADAS through central manual V/H control panel.

CONTROL	FUNCTION
Frames remaining indicator	Indicates number of unexposed frames remaining in film supply cassette. Each exposure made reduces indicated number by one.
Frames remaining set knob	Used to set frames remaining indicator to number of frames in film cassette.
Mode switch	AUTO Places photo system in autocycle mode.
	PULSE Places photo system in pulse mode.
	PULSE IMC Places photo system in pulse mode with IMC.
Mount switch	NIGHT Places photo system in autocycle mode with flasher system energized.
	(L)15° Camera mount drives to depression angle 15 degrees below aircraft horizontal plane on left side of aircraft.
	(L)30° Camera mount drives to depression angle 30 degrees below aircraft horizontal plane on left side of aircraft.
	90° Camera mount drives to vertical position (lens downward).
	(R)30° Camera mount drives to depression angle 30 degrees below aircraft horizontal plane on right side of aircraft.
	(R)15° Camera mount drives to depression angle 15 degrees below aircraft horizontal plane on right side of aircraft.

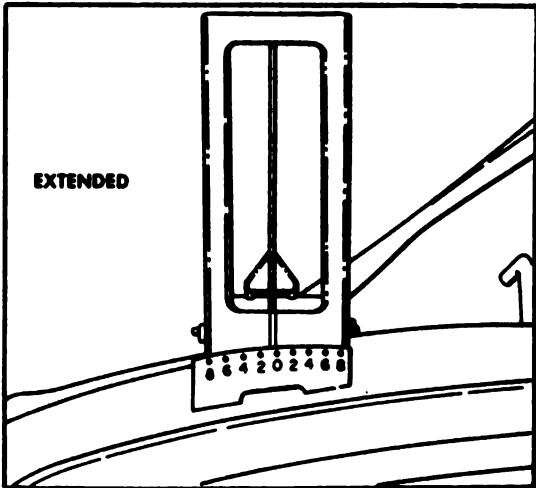
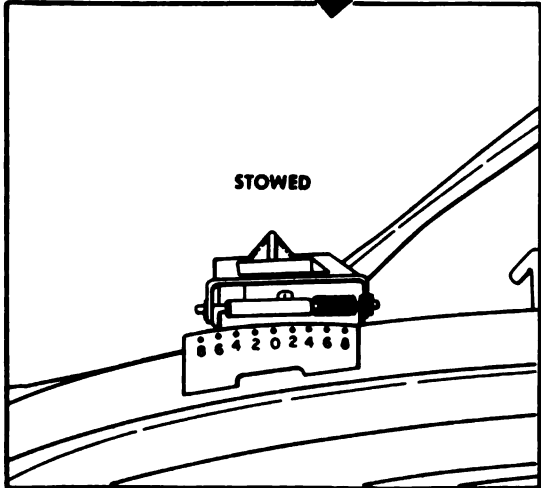
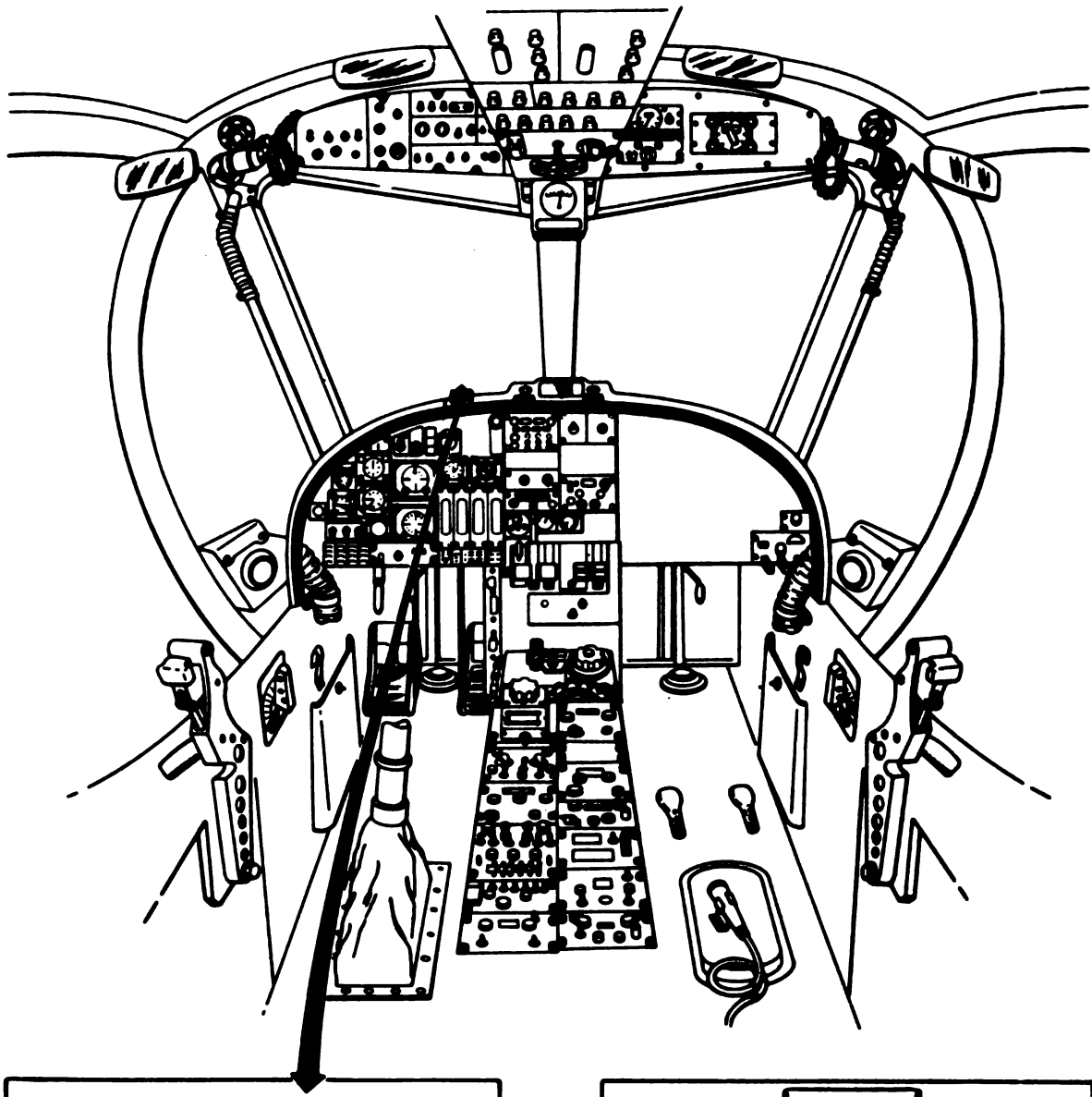

4-10-D-21

Figure 4-21. Flight Line Sight

*c. Normal Operation.*

(1) *Modes of Operation.* Refer to TM 11-6720-250-12 for procedures to be followed in planning a photographic mission. These procedures include methods of determining altitude and coverage, V/H ratio (velocity/altitude), IMC speed, interval between exposures, camera mode and limitations, filter selection, S/C index numbers and exposure. The following are the four separate modes of operation. (Refer to Chapter 5 for photo system operational limits.)

(a) *AUTO Mode.* The autocycle mode is used for high-speed, low-altitude precision operation. Selection of this mode is made by placing mode switch on photo control panel to AUTO. Mode selector switch on camera body shall be set to AUTO-REMOTE. The source of V/H ratio input may be selected at the photo control panel and the central manual V/H control panel with the V/H switch. The V/H ratio signal is sent to the photo system assembly. The photo system assembly produces a DC-voltage output, the amplitude of which depends upon the V/H input. The DC-voltage output of the photo system assembly drives a servo motor in the camera body that moves the film at the IMC rate at the instant an exposure is made. The total effect of this operation is that for a given aircraft speed and altitude, the image is motionless on the film. The film exposure interval is computed within the camera to produce a 60 percent overlap between frames for a stereo effect. The light sensor scans the terrain for reflected light and generates a signal that automatically sets the camera for correct exposure. Film motion is continuous in this mode.

(b) *PULSE Mode.* The pulse mode is used primarily for high-altitude photography. This mode is selected by placing the mode switch on the photo control panel to PULSE. The mode selector switch on the camera body is set to AUTO-REMOTE. V/H values may be manually inserted using the altitude and velocity set controls on the photo control panels. In the pulse mode, a V/H ratio signal is sent to the intervalometer that sends out a train of self-generated pulses. These pulses are transmitted to the camera to trigger the shutter and are timed to produce the necessary 60 percent frame overlap. To make a single exposure, the pilot may press the camera pulse switch on the stick. The light sensor scans the terrain for re-

flected light and generates a signal that automatically sets the camera for correct exposure.

(c) *PULSE IMC Mode.* In the PULSE IMC mode, operation of the camera is the same as in the PULSE mode except that IMC is used as stated in TM 11-6720-236-12. Image motion compensation is the only advantage gained in using this mode of operation.

(d) *NIGHT Mode.* In the NIGHT electronic flash mode, operation is the same as in the AUTO cycle mode except that a cam-operated switch in the shutter triggers electronic circuits in the APCS to produce synchroflash illumination. Place mode switch to NIGHT. The source of the V/H ratio input may be selected at the photo control panel using either the central manual V/H control panel with its velocity and height dial or from the AUTO V/H system.

(2) *Preflight Inspection.* The following preflight checks shall be done to insure photo system readiness. Refer TM 11-6720-250-12 for planning a photographic mission. The ground crew is responsible for lens cone installation, camera settings, and all operational checks. The pilot and airborne systems specialist shall check with the ground crew to insure the proper photo system settings for the planned mission.

(a) *Exterior Check Day Mission.*

1. Camera lens cone correct for mission.
2. Camera lens cover removed.
3. Lens clean.
4. Camera mode selector switch set to AUTO-REMOTE.
5. Lens filter installed (if required).
6. S/C control properly set.
7. Film cassettes loaded, installed, and locked on camera.
8. Aerial index rating recorded.
9. Quantity of film recorded.
10. Camera secure in rotary mount.
11. Rotary mount with camera installed and lockpins inserted in mount hooks.
12. Proper electrical connections made.
13. Vacuum hose connected.



14. Window covers removed and inside window surfaces cleaned.
15. Mount positioning system tested.
16. Camera compartment access door secured.
17. Camera exterior window surfaces cleaned.
18. Light sensor lenses cleaned.
19. Photo control system tested.
20. V/H scanner subsystem tested.
21. Camera window doors subsystem tested.

*(b) Exterior Check Night Mission.*

1. Camera lens cone shall be 6-inch lens cone.
2. Camera lens cover removed.
3. Lens clean.
4. Camera body mode selector switch to AUTO-REMOTE (when photo control panel is used for system control).
5. Film cassettes loaded with proper film, installed and locked on camera.
6. Quantity of film recorded.
7. Camera secure in rotary mount.
8. Rotary mount with camera installed, and lockpins inserted in mount hooks.
9. Proper electrical connections made.
10. Vacuum hose connected.
11. Window covers removed and window interior surfaces cleaned.
12. Mount positioning system tested.
13. Camera compartment access door secure.
14. Camera exterior window surfaces cleaned.
15. Proper electrical connections made for flasher pod.
16. Photo system tested.
17. Camera window doors subsystem tested.
18. Flasher subsystem tested.

*(c) Interior.* The interior inspection of the photo system is performed before starting

engines. Both pilot and airborne systems specialist check the following:

1. Completeness of equipment.
2. Photo control panel, camera body, and photo system assembly for loose or binding control knobs, switches, and faulty indicator lamps.
3. On photo control panel, set frames remaining counter according to film load. (Check number of feet of film loaded in cassette with ground crew.) Counter setting may be calculated by the equation:

$$\text{No. of frames} = \frac{\text{No. of feet} \times 12}{4\text{-}3/4\text{-inches per exposure}}$$

4. Check oblique optical sights for cleanliness and damage.

*(3) Day Operation.* The photo system operating modes available for daytime missions are auticycle, pulse (without IMC), and pulse IMC.

*(a) Starting Procedures.*

1. Place MOUNT switch on photo control panel to desired depression angle.

**NOTE**

*With 1-3/4-inch lens cone, camera cannot depress to any angle except 90°.*

2. Place mode switch on photo control panel to desired day mode position (AUTO, PULSE, or PULSE IMC).

3. If automatic insertion of V/H ratio is desired, place V/H switch on photo control panel to AUTO. If manual insertion of V/H ratio is desired, set V/H switch to MANUAL.

**NOTE**

*Steps 4 and 5 need not be performed if V/H switch on photo control panel is set to AUTO.*

4. Check altitude indicator for correct terrain clearance setting.

5. Check velocity indicator for correct groundspeed setting.

8. Place sys pwr switch on photo control panel to READY. Green ready lamp shall illuminate within approximately 20 seconds.

*(b) Normal Operation.*

1. To take pictures continuously, set sys pwr switch on photo control panel to OPERATE.

**NOTE**

*This provides time interval pulses to actuate the camera shutters.*

2. Observe that operate lamp on photo control panel flashes for each exposure.

**NOTE**

*If operate lamp remains illuminated and ready lamp goes out, the film has failed, the camera has failed, or the film has reached the end.*

3. Check that frames remaining counter decrements by one each time an exposure is made.

*(c) Stopping Procedure.*

1. Set mount switch on photo control panel to 90°.

2. After ready lamp illuminates, set sys pwr switch to OFF position.

*(4) Night Operation (Flasher Pod).* The night operating mode of the photo system is used for night missions or very low-light level missions where artificial illumination of the terrain is necessary. For optimum results, the altitude of the aircraft should be between 1,500 and 2,000 feet.

**WARNING**

Do not operate flasher pod above 12,500 feet pressure altitude.

**CAUTION**

Cycling rate depends on the V/H setting, therefore, until equipment modifications are done, operators are cautioned to limit V/H settings (in both manual and automatic modes) to the limits prescribed in Chapter 5. Cycling at a rate greater than three flashes per second will cause the LS-59A power supply circuitry to burn out.

*(a) Starting Procedures.*

1. Place mount switch on photo control panel to 90°.

2. Place mode switch on photo control panel to NIGHT.

3. Place V/H switch on photo control panel to MANUAL, and set dial on control height to GRND SPEED RATIO C-8340/A or set V/H switch to AUTO for automatic V/H voltages from automatic system.

4. Place sys pwr switch on photo control panel to READY. Green ready lamp shall illuminate within approximately 20 seconds.

5. Check altitude indicator on photo control panel for correct terrain clearance setting.

6. Check velocity indicator on photo control panel for correct groundspeed setting.

*(b) Normal Operation.*

1. To take pictures continuously, set sys pwr switch on photo control panel to OPERATE.

**NOTE**

*This provides time interval pulse to actuate the camera shutters and the photo flasher subsystem.*

2. Check that frames remaining counter on photo control panel decrements by one for each exposure made.

3. Observe operate lamp on photo control panel. Operate lamp shall flash each time an exposure is made. If operate lamp remains illuminated and ready lamp goes off, camera has failed, and film has reached its end.

*(c) Stopping Procedure.* Place sys pwr switch on photo control panel to OFF position.

*d. Emergency Operation.* Emergency procedure for the photo system consists of quick shutdown. In case of system malfunction, the sys pwr switch on the photo control panel shall be placed to the OFF position. This removes power from the photo system and allows the camera window doors to close. If the landing gear is lowered with the camera system in operation, the camera system will automatically deenergize itself, the windows will close, and the mount will rotate to 90°.

**4-10. Infrared Countermeasures Set AN/ALQ-147A(V)1 and 2.**

*a.* Infrared countermeasures (IRCM) pod AN/ALQ-147A(V)1 may be installed on wing station 1 or 6 on OV-1D aircraft. IRCM pod AN/ALQ-147A(V)2 may be installed on wing station 3 or 4 on OV-1D aircraft and on wing station 4 only on RV-1D aircraft. The aircraft will be configured with only one IRCM pod at a time. Refer to paragraph 5-15 for external stores loading limitations. During normal operation, the system can be manually started or shut down using the switch on the operator's control unit (OCU) mounted on the glareshield above the pilot's instrument panel (figure 4-23). The system is wired through the left landing gear uplock switch for automatic shutoff when the landing gear is lowered (in the event the pilot neglects to turn the system off before landing). The system operates on 28 VDC from the primary bus through a separate IR JAM circuit breaker panel mounted on the sloping console in the cockpit. For additional information, refer to TM 11-5895-1051-12.

*b.* IRCM pod AN/ALQ-147A(V)1 is a self-contained jettisonable external store incorporating its own 12-gallon fuel supply. The IR transmitter assembly is coupled with a modulator assembly and is mounted on the rear of a

bullet-shaped fairing containing a 12-gallon internal fuel tank (figure 4-22). The pod may be installed on either wing station 1 or 6, and can be jettisoned in flight using the normal aircraft external stores jettison system.

*c.* IRCM pod AN/ALQ-147A(V)2 is a 150-gallon drop tank modified to house a separate internal 15-gallon fuel supply tank or reservoir. The inner tank contains the fuel to be supplied to the transmitter assembly during operation. A sight glass is installed in the inner tank at the 12-gallon level for determining fuel quantity. Two gravity filler ports are incorporated in the modified drop tank: one for filling the main tank and the other for filling the inner tank. When fueling the inner tank through the drop tank, the inner tank inlet is at the 100-gallon level, but the inner filler valve is spring-loaded and requires 130 to 140 gallons to open and fill the inner tank. Ten minutes should be allowed for the inner tank to fill. The IR transmitter assembly is coupled with a modulator assembly and is mounted on the rear of the modified 150-gallon drop tank (figure 4-22). In an emergency situation, the entire pod can be jettisoned in flight using the normal aircraft external stores jettison system.

*d.* The IR source consists of a ceramic radiating element heated by the combustion of JP-4 fuel mixed with ambient air. Both combustion and cooling air are drawn from a common inlet mounted on the underside of the pod. A flow control valve in the pod maintains an approximately constant mass flow through the combustor regardless of airspeed or altitude. During system operation, fuel enters the transmitter assembly where combustion takes place and the resulting modulating infrared frequency is exited through the rear of the transmitter. An air scoop (forward) and an exhaust vent (rear) protrude from the transmitter housing. Ram air is required to support combustion and, therefore, the system shall not be operated on the ground other than by maintenance personnel using special ground support equipment. Two hatches (ECU and maintenance) are installed to provide access to the electronic control unit and for maintenance. When the system is turned on and combustion is initiated, internal circuitry automatically determines that the system is functioning properly and permits continued operation. If the system is not functioning properly, the internal circuitry automatically shuts the system down.

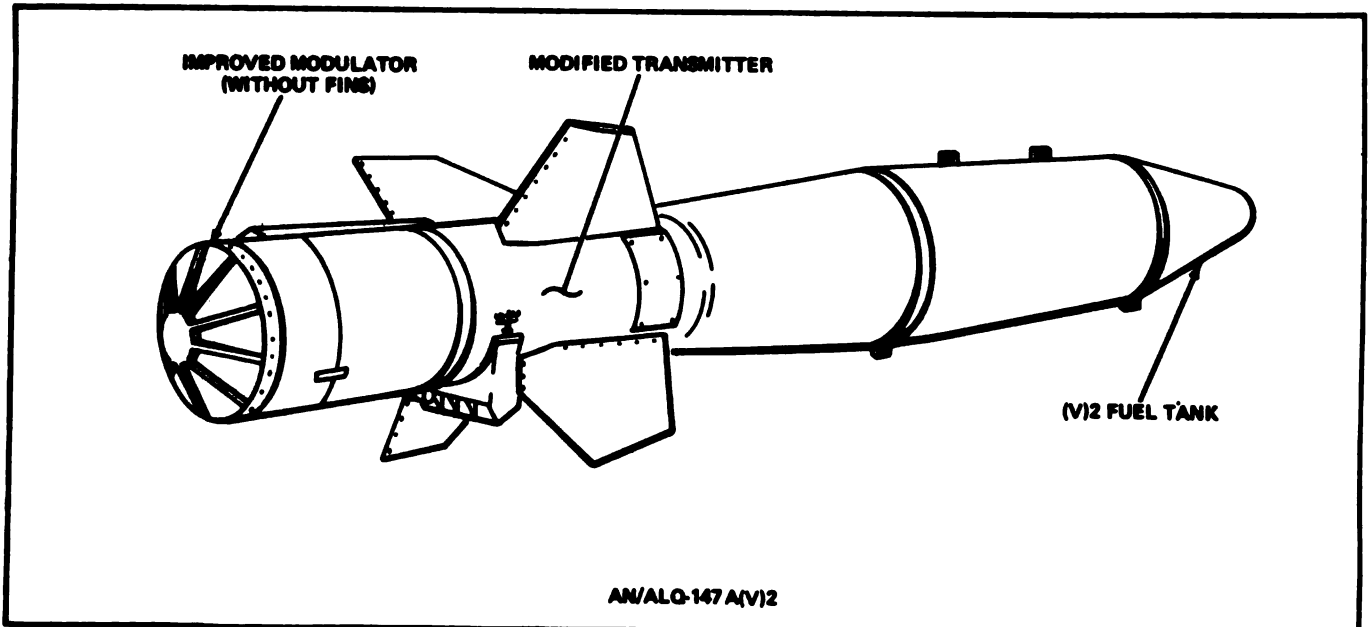
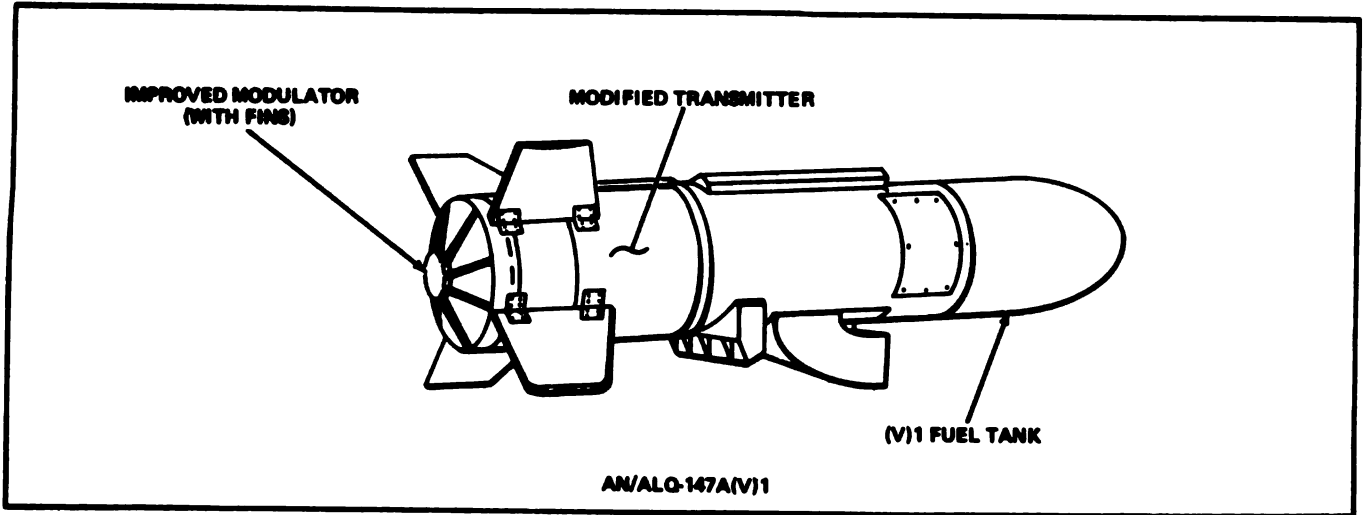

A4-10-0-26

**Figure 4-22. Infrared Countermeasures (IRCM) Pod (AN/ALQ-147A(V1) and AN/ALQ-147A(V2))**

e. The OCU (figure 4-23) provides for remote control of the IRCM set. It contains a momentary ON-OFF/RESET toggle switch and a two-section press-to-test status indicator light that displays an indication of system operation. When the toggle switch is pulled out and momentarily set to ON, the upper half of the status indicator will illuminate OPR (green). The light extinguishes after the set has completed its start cycle and combustion is attained. The bottom half of the status indicator will illuminate INOP (yellow) if a system malfunction occurs and remains illuminated until a restart is attempted. When the toggle switch is momentarily set to OFF/RESET, the system will shut down and the INOP light will illuminate for 60 seconds. System status can be verified in flight by momentarily depressing the STATUS indicator and observing a 3- to 6-second OPR (green) or INOP (yellow) indication.

*(1) Operator's Control Unit (OCU) Switch Functions and Indications (figure 4-23).*

CONTROL	FUNCTION
ON-OFF/RESET toggle switch	Momentary switch spring-loaded to center position.
ON	Turns on infrared countermeasures set.
OFF/RESET	Turns off infrared countermeasures set. Resets system.
Status indicator light	Two-section display indicator.
OPR (green)	Upper half indicates system start cycle initiated and combustion has been attained. Verifies system is functioning.
INOP (yellow)	Lower half indicates automatic shutdown or normal shutdown of system. Verifies system is not in operation.

*(2) Infrared Countermeasures Set Operation.* As mission requirements dictate, set OCU ON-OFF/RESET switch to ON immediately before brakes are released for takeoff. The OPR indicator will illuminate green and extinguishes after the start cycle is completed and combustion is attained. Further operation is automatic and requires no control by the pilot. System status can be verified in flight by momentarily depressing the STATUS indicator and observing a 3- to 6-second OPR (green) or INOP (yellow) indication. The system will continue to operate until the ON-OFF/RESET switch is set to the OFF/RESET position, the airspeed drops below 120 KIAS, the fuel supply is exhausted, or the landing gear is lowered. The system shall be turned off manually before landing.

**CAUTION**

**During flight, if airspeed is below 120 knots, the system should be turned off at the OCU and only turned on again when the airspeed exceeds 120 knots.**

**Failure to turn the switch off before landing may cause damage to the IRCM system.**

**In the event of a system shutdown, allow a 3-minute cool-down before attempting a restart. If operational requirements dictate restart in less than 3 minutes, the system shall be subjected to a hot start inspection at the next inspection/maintenance period. Hot starts can damage the combustor/gasket assembly.**

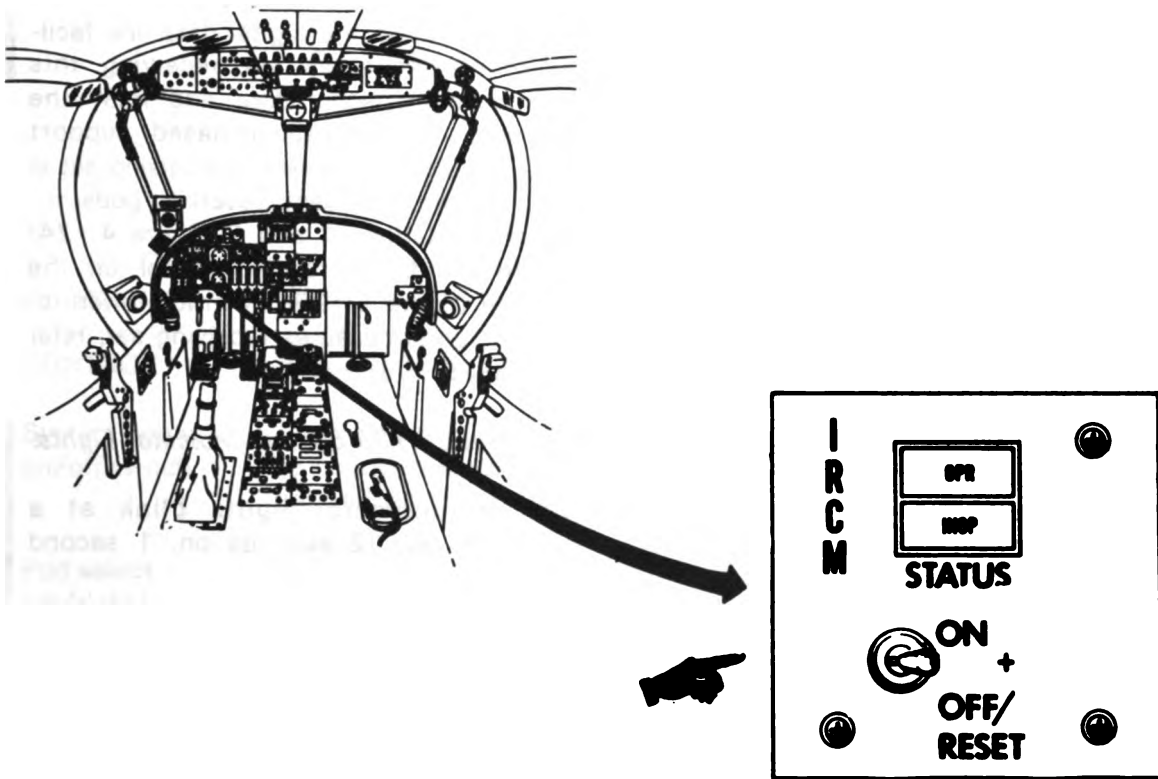

4-10-0-27

**Figure 4-23. Operator's Control Unit (OCU) (C-10698/ALQ-147)**

**NOTE**

*If the display indicator illuminates INOP (yellow), the system will shut down automatically. During initial start, an INOP light may not be indicative of a true malfunction, and a restart may be attempted. Set on-off/reset toggle switch to OFF/RESET position and wait 10 seconds before setting switch to ON. If system does not start after three attempts, malfunction should be assumed and reported to maintenance personnel.*

**(3) Infrared Countermeasures Set Emergency Operation.** If a fuel leak in the pod is detected by sensing circuits within the system, an automatic shutdown occurs. An overtemperature sensor, installed to detect fire outside of the combustion area, automatically shuts the system down if activated. Automatic shutdown stops fuel transfer from the fuel tank to the transmitter assembly and closes the air intake door to assist in extinguishing an IRCM pod fire. If a pod fire is experienced and automatic shutdown and subsequent extinguishing of the fire does not occur, the IRCM pod should be jettisoned using the aircraft external stores jettison system.

#### **4-11. Airborne Non-Communications Emitter Locator Identification System AN/ALQ 133 (RV-1D).**

The airborne non-communications emitter locator identification system supplies classification and location of electronic emitters to ground-based data collection and emitter location detachments. The airborne system consists of the countermeasures receiving set AN/ALQ-133 and the digital data link set AN/USQ-61A.

**a. Countermeasures Receiving Set AN/ALQ-133.** The countermeasures receiving set is a tactical airborne non-communications emitter locator set that provides real time location of

electro-magnetic emitters and electronic-order-of-battle (EOB) information over a specified frequency range. This set collects and processes data it receives from non-communications radio frequency emitters that are detected along the flight path of the aircraft. Upon return of the aircraft to its ground station, the collected information is removed from the receiving set data files for interpretation and printout. The countermeasures receiving set can also respond to control signals transmitted from the ground-based support equipment via the digital data link facility. The countermeasures set receiving this signal will collect specific data and relay the collected data to the ground-based support equipment. The countermeasures receiving set is composed of two intercept receiver pods installed at store stations 1 and 6 (figure 4-24) and a control indicator control panel on the lower console (figure 4-25). For more information on the countermeasures receiving set, refer to TM 11-5895-955-10-1.

#### **(1) AN/ALQ-133 System Indicator Lights.**

**(a)** The indicator lights blink at a 3-second cycle rate (2 seconds on, 1 second off).

**(b)** The SYSTEM POWER light will never blink. It is hard-wired to the power supply.

**(c)** During normal operation, only the CLP CORRECT and the POD SELECT light will blink. No other lights will be on.

**(d)** A BITE test is performed every 3 minutes. If an error is detected, the associated error light will start blinking at the 3-second rate. It will continue to blink for at least 3 minutes until the next BITE test is performed. If the error is not detected again, the light will stop blinking.

**(e)** An INS failure will cause all lights to blink at the 3-second cycle rate. However, to verify this, the INS should be checked as there are several other AN/ALQ-133 malfunctions that can cause all lights to blink at the 3-second rate.

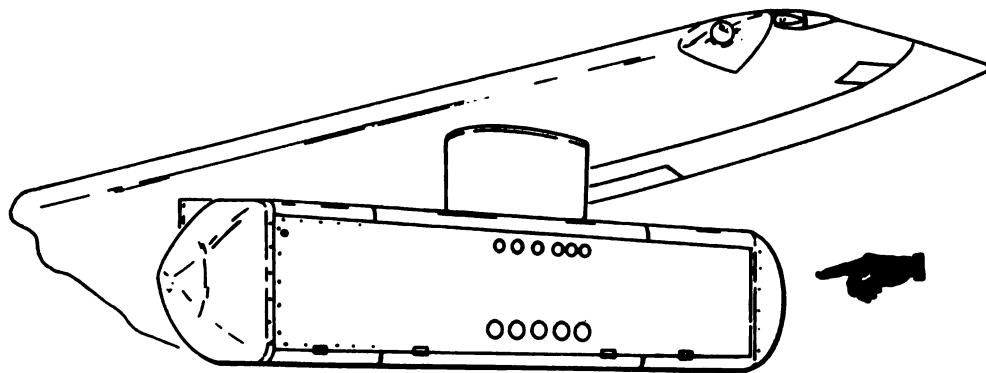

A4-10-D-28

**Figure 4-24. Intercept Receiver Pod (CY-7410/ALQ-133)**

**(2) Control Indicator Control Panel Switch Functions and Indications (figure 4-25).**

CONTROL	FUNCTION	CONTROL	FUNCTION
System power on/off switch	Controls application of power to countermeasures receiving set and digital data set.	Inoperative hi band, mid band, and low band indicators (amber)	Indicates low, mid, or high band BITE test failure in left or right intercept receiver pod.
Pod select left/right/both/off selector switch	Selects data from left, right, or both intercept receiver pods. No data is filed, when set to OFF.	CLP correct indicator (green)	Illuminates in a 3-second cycle (2 seconds on, 1 second off) when CLP is functioning properly.
Crypto zeroize switch	Spring-loaded switch that zeros computer files and crypto unit. Never hold longer than 15 seconds.	Memory full indicator (amber)	Illuminates when PCC or CLP memories are at maximum capacity and the PURGE routine is in progress.
Panel dim potentiometer	Controls illumination intensity of panel indicators.	PCC halted indicator (amber)	Illuminates to indicate failure condition in PCC.
System power indicator (green)	Illuminates steady when system power switch is ON and power is applied.	CLP halted indicator (amber)	Illuminates to indicate failure condition in CLP.
Pod select left/right indicators (green)	Left or right indicator illuminates when computer acknowledges intercept receiver pod selection. Both indicators illuminate when pod select switch is set to BOTH.	All indicators are illuminated (steady)	Monitor-controlled has malfunctioned.



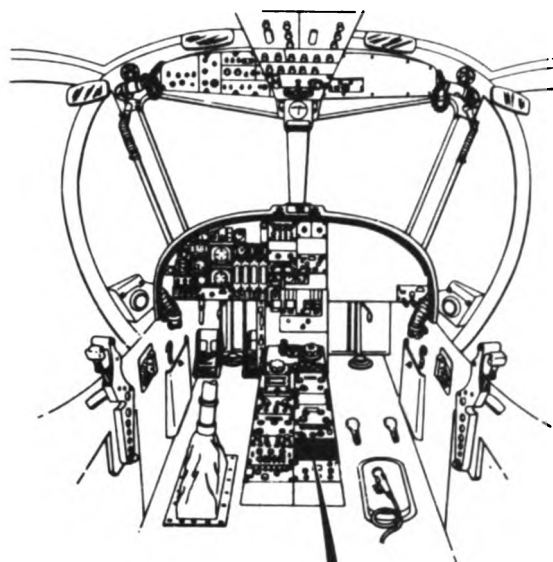

**(3) Operation of Countermeasures Receiving Set.**

**(a) Preflight Check.**

1. System power on/off switch – OFF.
2. Pod select switch – OFF.
3. Panel dim control – Mid range.

**NOTE**

*The data link is normally tested prior to takeoff after the INS is in the NAV mode. To initiate this test, perform steps 4 thru 7.*

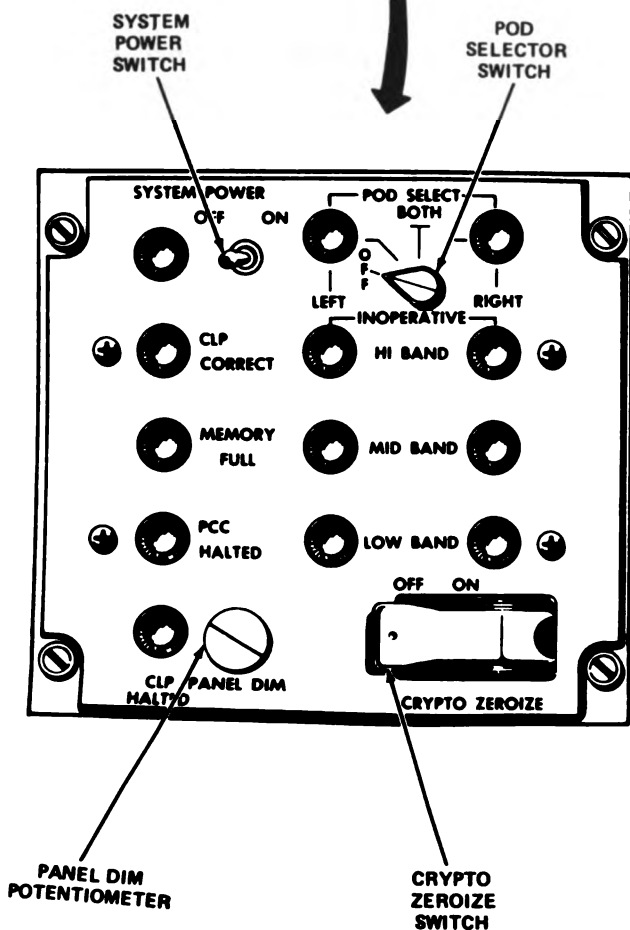

4. Pod select switch – OFF.
5. System power switch – ON. This switch applies power to and turns on the countermeasures receiving set and the digital data set. All of the indicators on the control indicator panel should illuminate for approximately 3 seconds. Then, all of the indicators should go out and only system power and CLP correct should remain illuminated. The power light will be steady while the CLP correct light will blink at the 3-second cycle rate (2 seconds on, 1 second off).
6. Panel dim control – As desired.
7. Establish voice communications with ground station.
8. On completion of data link test, set system power switch to OFF.

**(b) In-flight Operating Procedure.**

1. System power switch – ON. Allow the countermeasures receiving set 15-minute warm-up while enroute to mission flight track.
2. Panel dim control – As desired.
3. Establish voice communications with ground station.
4. With aircraft on mission flight track, set pod select switch to position dictated by flight track and/or other mission requirements (BOTH, LEFT, or RIGHT).

4-10-D-29

**Figure 4-25. Control Indicator Control Panel (C-9538/ALQ-133)**

5. Set pod select switch to OFF any time aircraft is not on designated flight track, or it is not desired to take data. However, leave system power switch set to ON to maintain countermeasures receiving set in power on standby condition.

6. On completion of mission and prior to descent for landing, set system power switch to OFF.

*(c) Mission Failure Indications.* Failure indications that can occur on the control indicator control panel and the appropriate actions to be taken are listed below.

1. Memory full indicator illuminated:

a. Continue mission flight for 10-minutes. If program purge criteria makes limited amount of memory space available, memory full indicator will go out.

b. Communicate with ground station for determination of whether to continue or abort mission.

2. All indicators are illuminated:

a. System power switch — OFF. Wait approximately 10 seconds, then set system power switch to ON (recycles power).

b. If indicators are still illuminated, verify that navigational system is operational, and contact ground station for instructions.

3. All pod inoperative indicators illuminated:

a. System power switch — OFF. Wait approximately 10 seconds, then set system power switch to ON.

b. If indicators are still illuminated, contact ground station for instructions.

4. One or more band inoperative indicator(s) is illuminated.

a. Continue mission.

b. Notify ground station of equipment status.

5. PCC halted and/or CLP halted indicators are illuminated:

a. System power switch — OFF. Wait approximately 10 seconds, the set system power switch to ON.

b. If indicators are still illuminated, contact ground station for instructions.

*b. Digital Data Link Set AN/USQ-61A.* The digital data link set provides secure data link communications between the airborne countermeasures receiving set and ground facilities. The digital data link set is powered through the SYSTEM POWER OFF ON switch on the control indicator control panel (figure 4-25), and is automatically controlled by the operating programs of the airborne non-communications emitter locator identification system (AN/ALQ-133). The only operator/crew procedures required to operate the digital data link set are those necessary for the selection of the desired system operating frequency. The digital data link set consists of a receiver-transmitter (RT-1288/ARC-164(V)12) with mounting base (MT-6017/ARC-164(V)), a radio set control (C-10547/ARC-164(V)12), a modified power supply (PP-7036A/USQ-61A), and a data link power panel. For additional information on the data link set, refer to TM 11-7035-200-14.

*(1) Radio Set Control Switch Functions and Indications (figure 4-25A).*

CONTROL	FUNCTION
Function selector switch	Selects operating mode of system. Limited to MAIN position by covering bezel. Other positions not functional.
Mode selector switch	MANUAL position enables frequency selection by means of 5 frequency selector switches. PRESET position enables channel frequency selection by means of preset channel selector switch.
Preset channel selector switch	Selects preselected channel frequency. Can be set to any one of 20 preselected frequencies. Selected channel number is displayed in window.
Frequency selector switch-1	Selects operating frequency in 100 MHz steps.
Frequency selector switch-2	Selects operating frequency in 10 MHz steps.
Frequency selector switch-3	Selects operating frequency in 1 MHz steps.
Frequency selector switch-4	Selects operating frequency in 0.1 MHz steps.
Frequency selector switch-5	Selects operating frequency in 0.025 MHz steps.
Selectivity switch	Used to select wideband or narrowband selectivity of main receiver. Set to WB at all times.
Main threshold control	Not operable. Squelch adjustment is performed on the receiver-transmitter by maintenance personnel.

CONTROL	FUNCTION
Guard threshold control	Not functional.
PRESET switch	Stores selected frequency in selected preset channel.
LED frequency display (red)	LED display of preset channel frequency.
Volume control	Not functional.

*(2) Frequency Selection Procedures (figure 4-25A).*

*(a) Manual Frequency Selection.*

1. Mode selector switch - MANUAL.
2. Select desired operating frequency using the five manual frequency selector switches.

*(b) Preset Frequency Selection.*

1. Mode selector switch - PRESET.
2. Select desired operating frequency using preset channel selector switch.

*(c) Preset Channel Selector Memory Storage.*

1. Preset channel selector switch - Set to desired number.
2. Mode selector switch - PRESET.
3. Select frequency to be stored in memory using five manual frequency selector switches.
4. Lift access cover.
5. PRESET switch - Press and release.
6. Record the frequency stored for that channel on the card located on the front of the access cover.

*(3) Data Link Power Panel (figure 4-25B).*

The data link power panel provides, through a guarded toggle switch, a means of interfacing the receiver-transmitter with either a 30-watt or 100-watt data link antenna. Only a 30-watt antenna is installed in this aircraft; therefore, the power panel toggle switch is safety-wired in the 30-watt position. The panel is edge-lighted, and illumination control is provided through the CONSOLES rheostat on the left overhead panel.

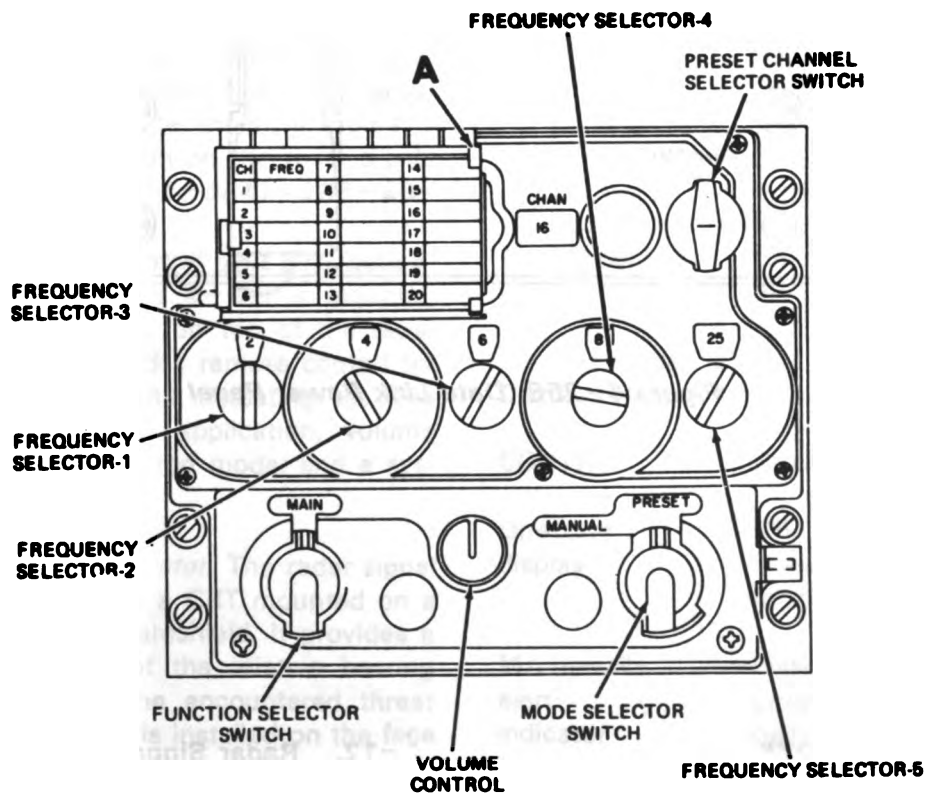
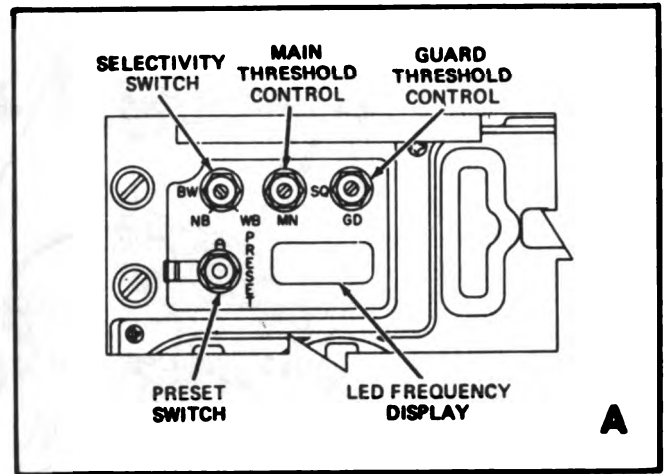
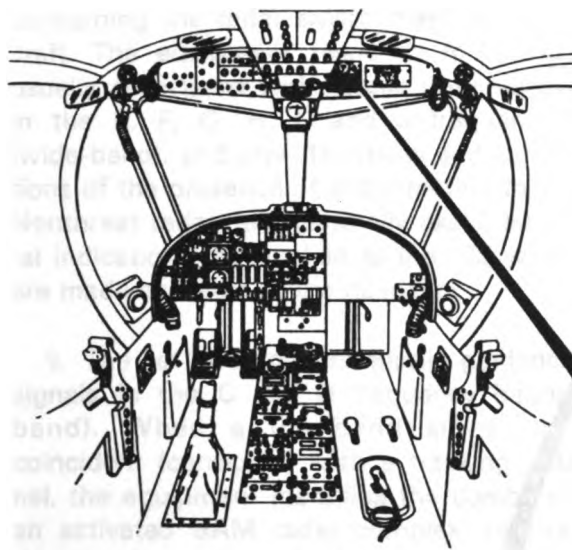

A-4-10-D-33

Figure 4-25A. Radio Set Control Panel (C-10547/ARC-164(V)12)

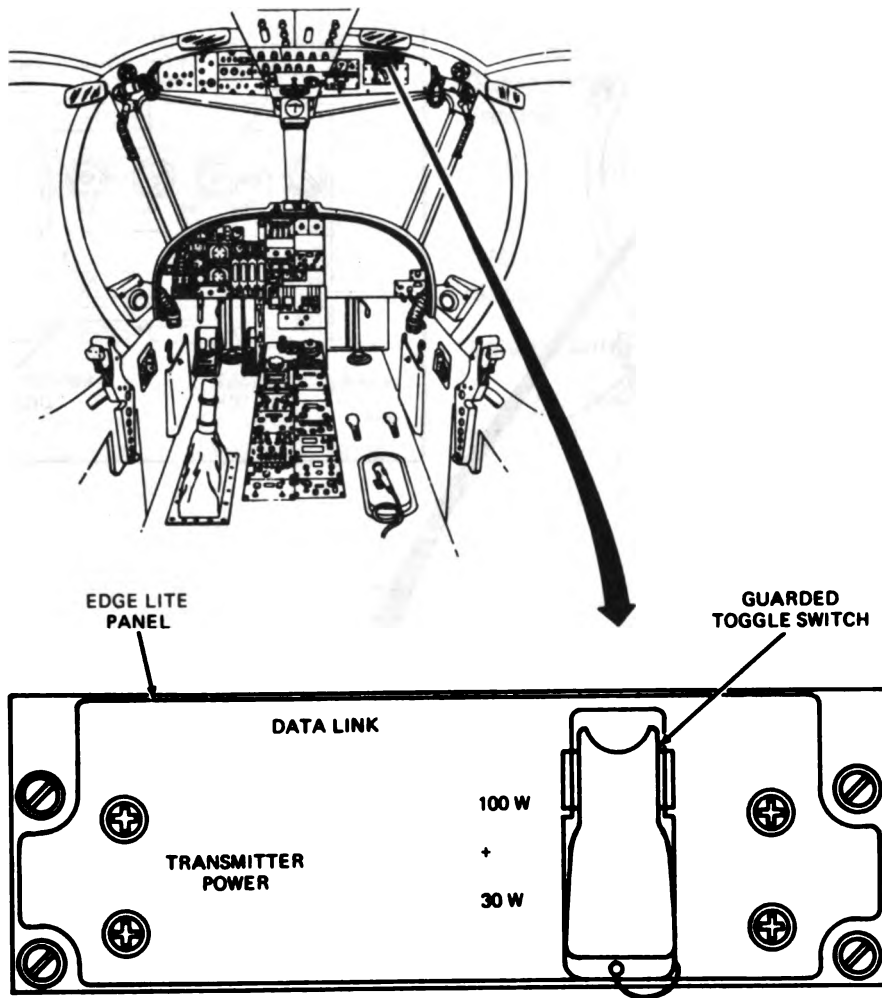

4-10-D-34

**Figure 4-25B. Data Link Power Panel**

**NOTE**

*Either of two Radar Signal Detecting Sets may be installed in the aircraft, an AN/APR-39(V)1 or an AN/APR-39(V)2. Each system is covered in the following paragraphs.*

**4-12. Radar Signal Detecting Set AN/APR-39(V)1.**

- a. Radar Signal Detecting Set AN/APR-39(V)1 is a passive, omnidirectional radar warning set that receives and displays information

concerning the radar environment about the aircraft. The equipment responds to those radars usually associated with hostile fire-control radars in the E, F, G, H, I, and J frequency bands (wide-band), and provides visual and aural indications of the presence of and direction to emitters. Nonthreat radars are generally excluded. The aural indications are applied to the ICS where they are made available to the headsets.

5. The set also accepts missile guidance radar signals in the C and D frequency bands (low-band). When a low-band signal is time-coincident (corrected) with a tracking radar signal, the equipment identifies the combination as an activated SAM radar complex. In this case, the visual and aural displays are uniquely identified to warn the operator that the emitter has become a potential threat. Power is applied to the set through a circuit breaker on the remote circuit breaker panel. Figures 4-26 and 4-27 illustrate the detecting set control unit and radar signal indicator associated with the radar signal detecting set and their location in the cockpit. The associated antennas are shown in figure 3 1. For additional information on the radar signal detecting set, refer to TM 11-5841-283-20.

(1) *Detecting Set Control Unit.* The detecting set control unit (figure 4-26) is mounted over the pilot's glareshield on top of the radar signal indicator, and provides remote control for operation of the radar signal detecting set. The panel provides for power application, volume control, selection of operation mode, and a system self-test control.

(2) *Radar Signal Indicator.* The radar signal indicator (figure 4-27) is a CRT mounted on a bracket over the pilot's glareshield. It provides a visual strobe indication of the relative bearing and signal strength of the encountered threat emitters. A potentiometer is installed on the face of the indicator to control the CRT brightness level. An indicator lamp is also installed and flashes to indicate time correlation between missile guidance and associated tracking radars (SAM radar complex). A red faceplate is also included for day or night operation.

(3) *Detecting Set Control Unit Switch Functions (figure 4-26).*

CONTROL	FUNCTION
PWR switch	Two-position toggle switch that controls application of 28 VDC aircraft power to the detecting set. ON position applies operating power. Set is fully operational 1 minute after switch is turned on. OFF position removes operating power from the set.
SELF TEST button	Spring-loaded pushbutton switch. When pressed, initiates self-test function.
DSCRM switch	Two-position toggle switch that selects mode of operation. ON position activates the discriminator circuit. OFF position deactivates the discriminator circuit.
AUDIO control	Controls the level of the audio output to the ICS.

(4) *Radar Signal Indicator Controls and Displays (figure 4-27).*

CONTROL	FUNCTION
Direction display	CRT display showing a line-of-bearing radial strobe for each processed emitter.
MA (missile alert) indicator	Flashes on and off to indicate time correlation between missile guidance and associated tracking radars (SAM radar complex).
BRIL control	Potentiometer that varies the brilliance of the CRT display. Used in conjunction

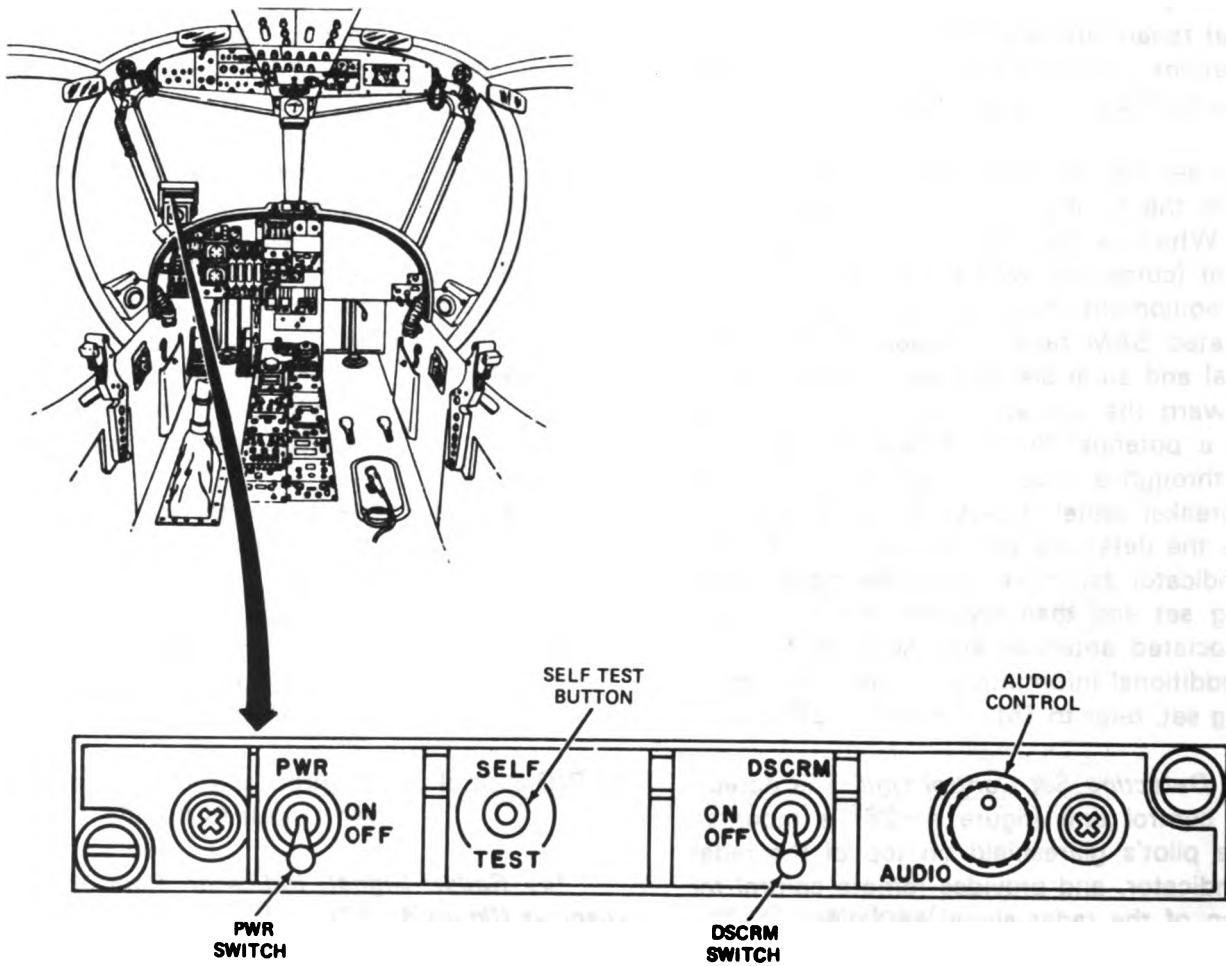

4-10-D-40

**Figure 4-26. Detecting Set Control Unit (C-9326/APR-39(V))**

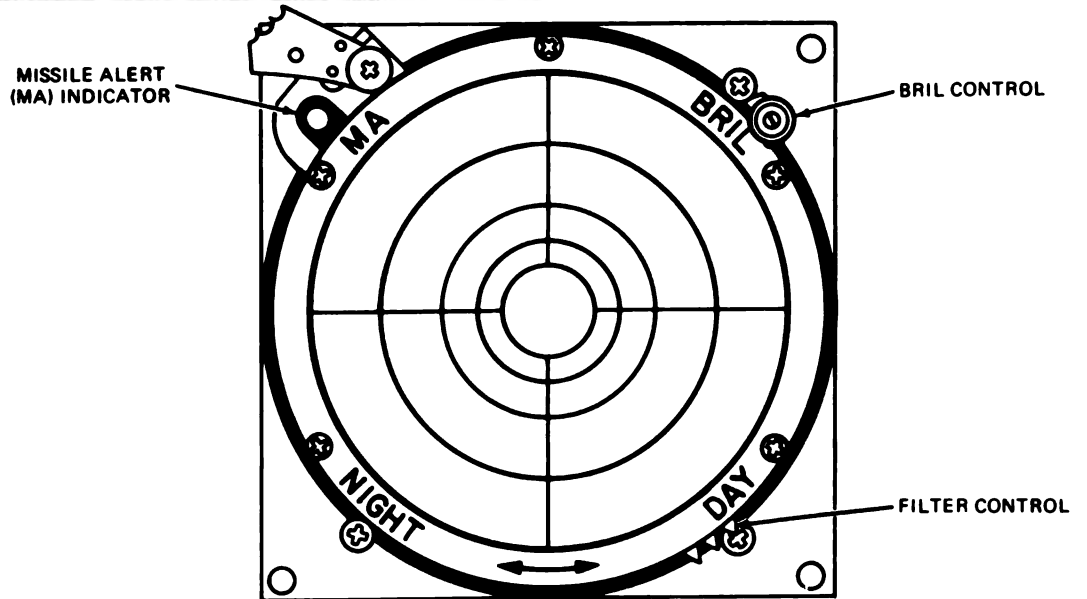
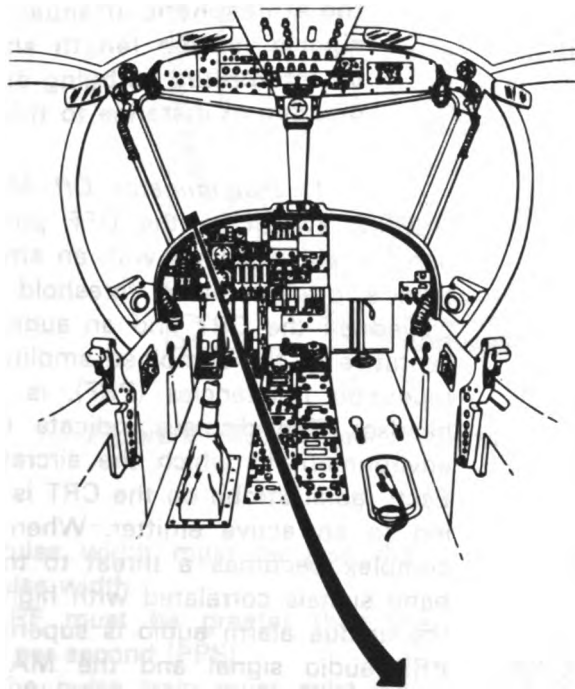

A-4-10-D-41

Figure 4-27. Radar Signal Indicator (IP-1150/APR-39(V))



CONTROL	FUNCTION
BRIL control (Cont.)	with the filter control to produce a highly visible display under most lighting conditions.
Filter control	Varies the density of the red polarizing faceplate filter (primarily for DAY or NIGHT operation).



Display strobe lengths indicate only received signal amplitude. Since many variables can affect the atmospheric attenuation of the signals, strobe length should not be interpreted as being directly indicative of distance to the emitter.

(5) *Operating Procedure.*

(a) *Turn-On Procedure.* The procedure for turning on the equipment is as follows:



To prevent damage to the receiver detector crystals, assure that the AN/APR-39(V)-1 antennas are at least 60 meters from active ground radar antennas or 6 meters from active airborne radar antennas. Allow an extra margin for new, unusual, or high power emitters.

1. PWR switch - ON, allow 1-minute for warmup.
2. BRIL and filter controls - Adjust as desired.
3. AUDIO control - Adjust volume as desired.
4. DSCRM switch - Set for mission requirement.
5. Stopping Procedure - PWR switch - OFF

(b) *Operation Modes.* The radar signal detecting set may be operated in either the discriminator off mode or the discriminator on mode.

**1. Discriminator Off Mode.** With the DSCRM switch in the OFF position, all high band received signals with an amplitude greater than a predetermined threshold level are displayed on the CRT and an audio signal, representative of the combined amplitudes and pulse repetition frequencies (PRF), is present in the headset. The displays indicate the total radar environment in which the aircraft is operating. Each radial strobe on the CRT is a line of bearing to an active emitter. When a SAM radar complex becomes a threat to the aircraft (low band signals correlated with high band signals), the unique alarm audio is superimposed on the PRF audio signal and the MA indicator and associated strobe start flashing. Lengths of strobes and audio levels depend on the relative strength of the intercepted signal. A typical display when operating in the discriminator off mode is shown in figure 4-28.

**NOTE**

*In this mode, received low band signals that are not correlated with a wide band intercept will cause the MA indicator to flash and an alarm audio will be present.*

**2. Discriminator On Mode.** With the DSCRM switch in the ON position, signals are processed to determine their conformance to certain threat-associated criteria:

- a. The signal level must be greater than the minimum threshold level.

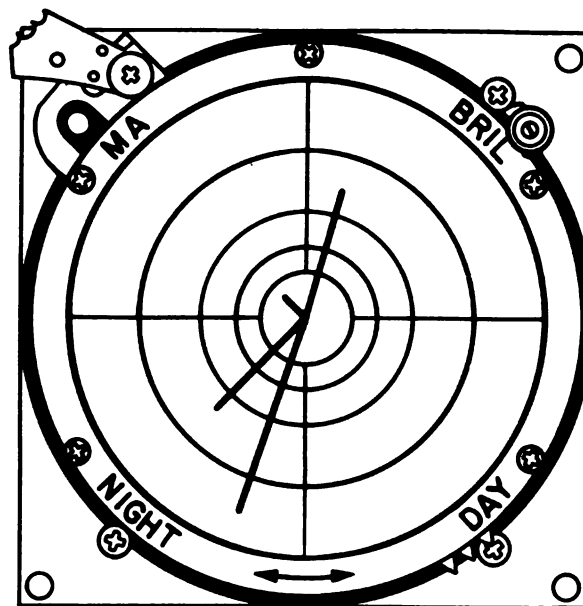

4-10-D-42

**Figure 4-28. Typical Discriminator Off Mode Display**

b. Pulse width must be less than the maximum pulse width.

c. PRF must be greater than the minimum pulses per second (PPS).

d. The pulse train must exist with not less than the minimum pulse train persistence.

e. The CRT display is divided into eight sectors. Strokes are displayed only in sectors that receive signals meeting threat criteria. This reduces display clutter by eliminating low-level and wide-pulse-width signals and by selective sector display. Intercepts that meet these requirements are displayed as described in paragraph 1, above.

#### NOTE

*In this mode, only correlated low band signals will give an indication.*

f. A typical display when operating in the discriminator on mode is shown in figure 4-28A. Conditions are the same as for figure 4-28, but it is assumed that one or more threats have been identified in the 225° to 270° sector only.

#### (c) Self-Test.

1. Set PWR switch on control unit (figure 4-26) to ON and DSCRM switch to OFF. Allow 1 minute for set to warm up.

2. Monitor the radar signal indicator and audio, and press and hold the SELF TEST button. Forward and aft strokes will appear on the CRT, extending to approximately the third circle on the indicator (figure 4-28B), and a 2.5 kHz (approximate) PRF audio will be present. Within approximately 6 seconds, alarm audio will be present and the MA indicator will start flashing.

3. Rotate the indicator BRIL control clockwise and counterclockwise. Indicator strokes will brighten and dim as the control is rotated. Set control for desired brightness level.

4. Rotate the AUDIO control clockwise and counterclockwise. Audio level will raise and lower as the control is rotated.

5. Release SELF TEST button.

6. Set DSCRM switch to ON position, and press and hold SELF TEST button. Within approximately 4 seconds, a forward or aft stroke (either may appear first) will appear and 1.2 kHz (approximate) PRF audio will be present. Within about 6 seconds, the other stroke will appear

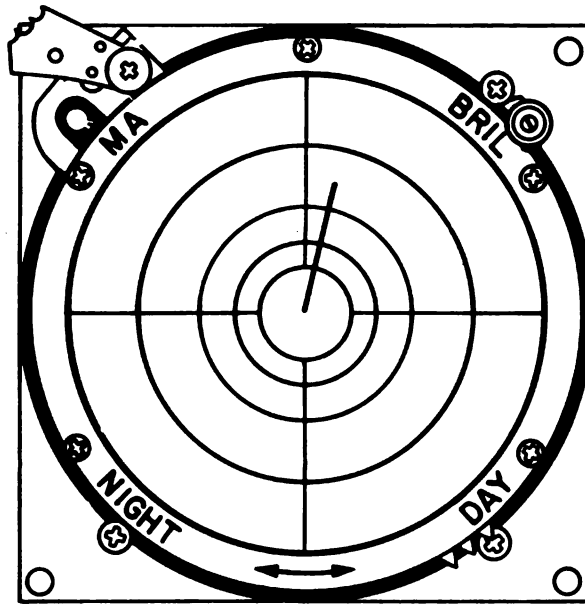

4-10-D-43

**Figure 4-28A. Typical Discriminator On Mode Display**

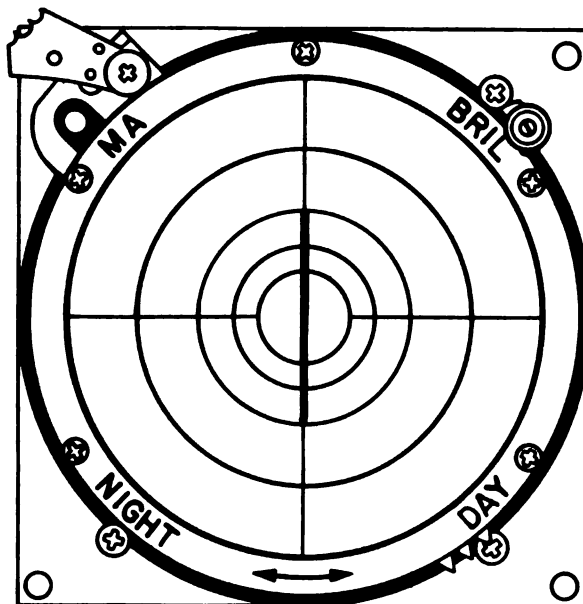

4-10-D-44

**Figure 4-28B. Typical Self-Test Mode Display**

and the PRF audio frequency will double. Several seconds later, the alarm audio will start and the MA indicator will be flashing.

**NOTE**

*Occasionally, during the period between pressing the SELF TEST button and the appearance of the first strobe, a distorted dot on the indicator and an intermittent audio will be present. This is not a fault indication.*

7. Release SELF TEST button. All indications shall cease.

8. Set PWR switch to OFF position.

*(d) Shutdown Procedure.* The detecting set is shut down by placing the PWR switch to the OFF position.

**4-12A. Radar Signal Detecting Set AN/APR-39(V)2.**

a. Radar Signal Detecting Set AN/APR-39(V)2 is a passive, omnidirectional radar warning set that receives and displays symbolic information concerning the radar environment about the aircraft. The equipment responds to those radars usually associated with hostile fire-control radars, and provides visual and aural indications of the presence of and direction to these emitters. The specific radar types and frequency bands to which the set responds are classified and are not included in this manual. Refer to TM 11-5841-288-34(C) for a description of these radar types and frequency bands. The visual indications are displayed on the radar signal indicator (figure 4-27) while the aural indications are applied to the ICS where they are made available to the headsets.

b. Power is applied to the set through a circuit breaker on the remote circuit breaker panel. Figures 4-27 and 4-28C illustrate the radar signal indicator and detecting set control unit associated with the radar signal detecting set and their location in the cockpit. The associated

antennas are shown in figure 3-1. For additional information on the radar signal detecting set, refer to TM 11-5841-283-20.

*(1) Radar Signal Indicator.* The radar signal indicator (figure 4-27) is a CRT mounted on a bracket over the pilot's glareshield. It provides a visual indication of the relative bearing and signal strength of the encountered threat emitters. A potentiometer is installed on the face of the indicator to control the CRT brightness level. A warning light on the upper left corner of the indicator alerts the operator to detection of a missile-alert condition. A red faceplate filter is also included for day or night operation.

*(2) Detecting Set Control Unit.* The detecting set control unit (figure 4-28C) is mounted over the pilot's glareshield on top of the radar signal indicator. It provides remote control for operation of the radar signal detecting set. The panel provides for power application, volume control, selection of operating mode, and system self-test.

*(3) Radar Signal Indicator Controls and Displays (figure 4-27).*

CONTROL	FUNCTION
Threat and direction display	CRT display showing alphanumeric symbols representing processed emitter signals (figure 4-28D). Characters represent threat types as described in TM 11-5841-288-34(C). Position of symbol on display represents bearing of threat. Bearing is given by the angular position of the symbol, distance away from the aircraft by spacing from display center.
MA (missile alert) indicator	Flashes on and off to indicate correlation between missile guidance and associated tracking radars (SAM radar complex).

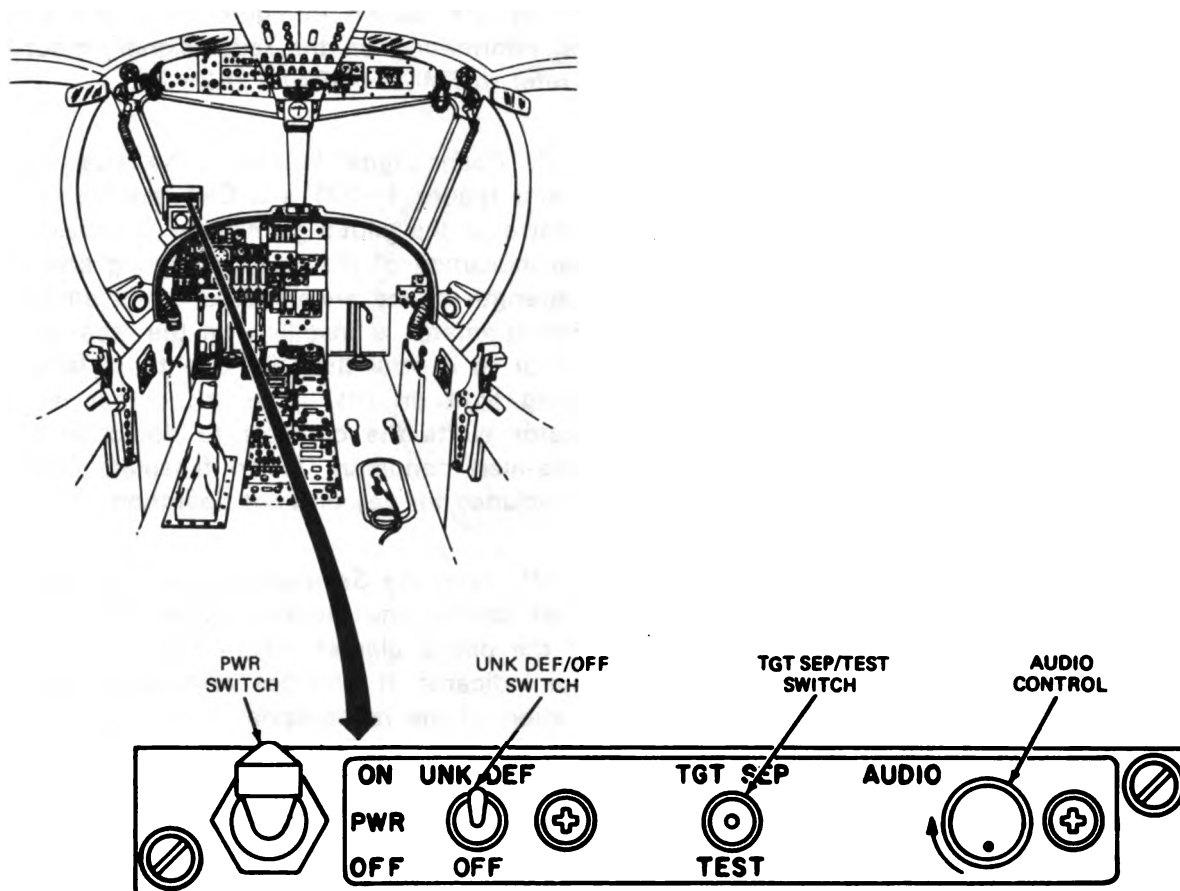

4-10-D-45

Figure 4-28C. Detecting Set Control Unit (C-10412/APR-39(V))

CONTROL	FUNCTION
BRIL control	Potentiometer that varies the brilliance of the CRT display. Used in conjunction with the filter control to provide a highly visible display under most lighting conditions.
Filter control	Varies the density of the red polarizing filter (primarily for DAY or NIGHT operation).

(4) Detecting Set Control Unit Switch Functions (figure 4-28C).

CONTROL	FUNCTION
PWR switch	Two-position toggle switch that controls application of 28 VDC aircraft power to the detecting set. ON position applies operating power. Set is fully operational 2 minutes after switch is turned ON. OFF position removes operating power from the set.

CONTROL	FUNCTION
UNK DEF (unknown defeat)/ OFF switch	Two-position toggle switch. UNK DEF position suppresses display of unknown targets (shown by symbol U). If unknown targets are detected, the U is displayed at the center of the CRT. OFF position permits normal display to occur.
TGT SEP (target separate)/ TEST switch	Three-position toggle switch spring-loaded to the center position. TGT SEP position separates overlapping symbols on the indicator display. TEST position, system operates to show fixed target displays (figure 4-28D) and to activate warning tone and MA indicator. Self-test responses are on for 5 seconds only, then system returns to normal operation.
AUDIO control	Controls the level of the audio output to the ICS.

(5) Operation.

**CAUTION**

To prevent damage to the detector crystals in the receiver, the aircraft shall be positioned at least 80 yards from active ground-based radar antennas, or 6 yards from active airborne radar antennas. Allow an extra margin for new, unusual, or high powered emitters.

(a) Turn-On Procedures. Proceed as follows:

1. Set PWR switch (figure 4-28C) to ON and allow 2 minutes for equipment to become fully operational.
2. UNK DEF/OFF switch is normally set to OFF position unless it is desired to suppress display of unknown targets.

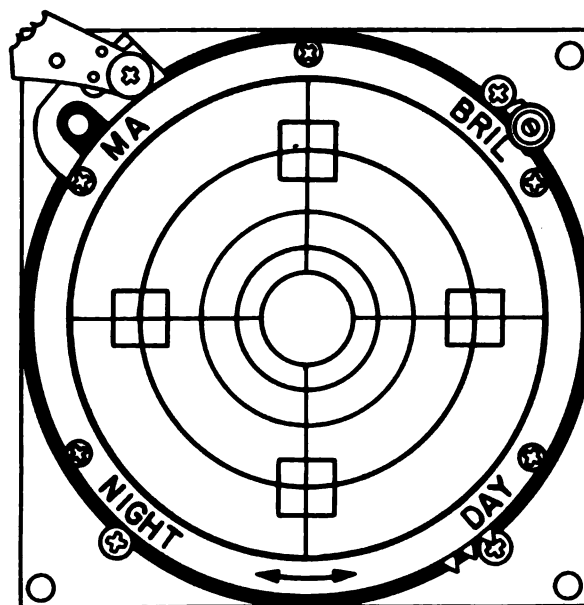

4-10-D-46

Figure 4-28D. Radar Signal Indicator Display with No Signal Inputs

3. If desired to separate overlapping threat displays, set TGT SEP/TEST switch to TGT SEP position. This is a momentary setting with the switch spring-loaded to the center position.

4. Perform self-test of detecting set as outlined in paragraph (b).

*(b) Self-Test. Proceed as follows:*

**NOTE**

*When the secondary bus is first powered (with the APR-39 DC circuit breaker pressed and the PWR switch in the OFF position), an audio tone may be heard in the headset after equipment warmup (approximately 2 minutes), a test sequence display may appear on the indicator, the MA indicator may flash on and off, and a no-signal display (figure 4-28D) may appear.*

1. Set PWR switch on control unit (figure 4-28C) to ON and allow 2-minute warmup.

2. Set TGT SEP/TEST switch to TEST position and monitor radar signal indicator and headset audio. Test display as shown in figure 4-28E appears with frame 1 first and lasting for approximately 4 seconds, then frames 2 and 3 for approximately 1/2 second each, after which the no-signal display of figure 4-28D appears.

**NOTE**

*Self-test responses last for approximately 5 seconds. To initiate self-test again, release TGT SEP/TEST switch and activate again after 1 second.*

3. Rotate the indicator BRIL control clockwise and counterclockwise. Indicator symbols will brighten and dim as control is rotated. Set control for desired brightness level.

4. Rotate the AUDIO control clockwise and counterclockwise. Audio level will raise and lower as control is rotated.

5. Release TGT SEP/TEST switch. After the above sequence is complete, indicator symbols revert to no-signal display (figure 4-28D), audio ceases, and MA indicator extinguishes.

*(c) Shutdown Procedure. The detecting set is shut down by placing the PWR switch to the OFF position.*

**4-12B. Radar Warning System AN/APR-44(V)1.**

a. Radar Warning System AN/APR-44(V)1 is an airborne radar detection system used to detect a cw radar signal aimed at the aircraft and provide visual and aural indications to the operator. The visual indication is in the form of a light (AI/SAM) that illuminates upon detection of a cw radar signal; the aural indication is in the form of an audio alert signal in the headsets.

b. Four antennas (two high-band and two low-band) intercept cw signals from SAM threats. The output of each antenna passes through a dual low pass filter to the front of the radar receivers. An rf switch in each receiver switches from one antenna to another in 680 millisecond intervals. The receivers respond to a cw signal in the 680 millisecond interval and detect and convert it to an audio alert, lamp alert, and logic signals. All three signals are available at the same time when a cw signal is detected. The audio signal goes to the VOLUME control on the control unit (figure 4-28F) and, from there, to the ICS where it is made available to the headsets. In the presence of a SAM threat, the lamp alert signal illuminates the AI/SAM indicator on the control unit.

c. Power is applied to the radar warning system through a circuit breaker on the remote circuit breaker panel. Figure 4-28F illustrates the control unit for the radar warning system and its location in the cockpit. The associated antennas are shown in figure 3-1.

*(1) Control Unit. The control unit (figure 4-28F) is mounted on a bracket over the pilot's glareshield. It provides remote control for operation of the radar warning system. The panel provides for power application, volume control, and threat identification.*

FRAME 1  
(NOTE 1)

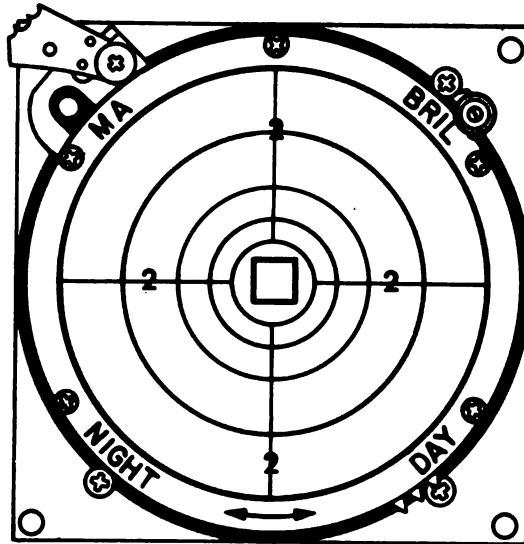

FRAME 2

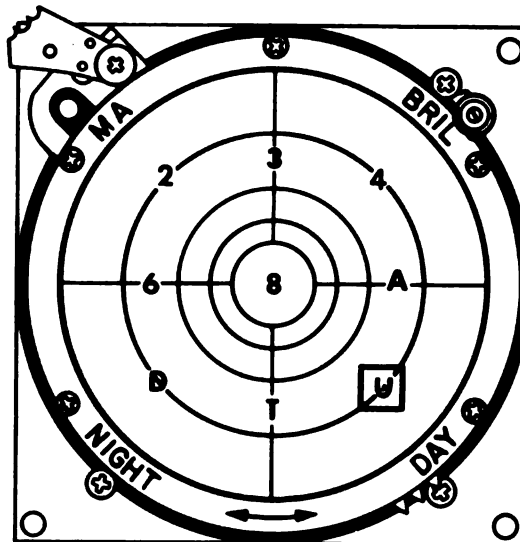

FRAME 3

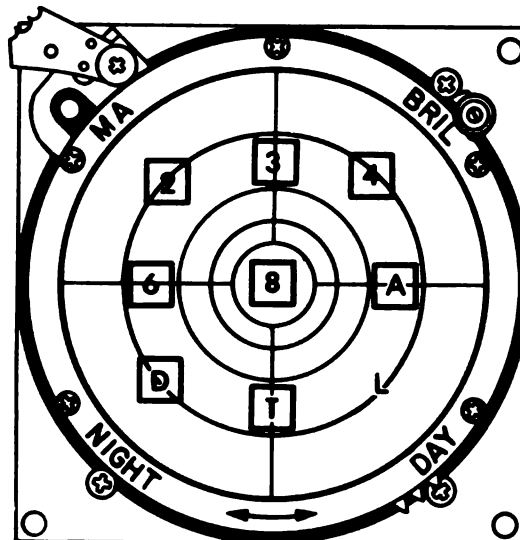

NOTE:

1. 2's MAY APPEAR IN OPPOSITE PAIRS VERTICALLY, HORIZONTALLY, OR BOTH AS SHOWN.

A-4-10-D-47

Figure 4-28E. Radar Signal Indicator Self-Test Mode Display





**(2) Control Unit Switch Functions and Indications (figure 4-28F).**

CONTROL	FUNCTION
AI/SAM switch/indicator	Illuminates to indicate that a radar signal is being received. When pressed, indicator illuminates to test lamps.
VOLUME control	Adjusts level of audio alert tone.
POWER switch	Two-position switch used to turn system power on and off. Must be pulled out and up to set to ON position.

**d. Operation.** Power is available to the radar warning system whenever the secondary bus is

powered and the APR-44 circuit breaker is pressed. To operate the system, proceed as follows:

**(1) Turn-On.**

**(a) AI/SAM switch/indicator (figure 4 28F)** — Press for lamp test. Both sections of switch/indicator shall illuminate.

**(b) POWER switch** — Pull out and up to ON position. Panel edge lights shall illuminate. Audio tone and AI/ASM switch/indicator should come on momentarily, then go off.

**(c) VOLUME control** — Adjust for comfortable audio level.

**(2) Shutdown Procedure.** The radar warning system is shut down by placing the POWER switch to the OFF position.

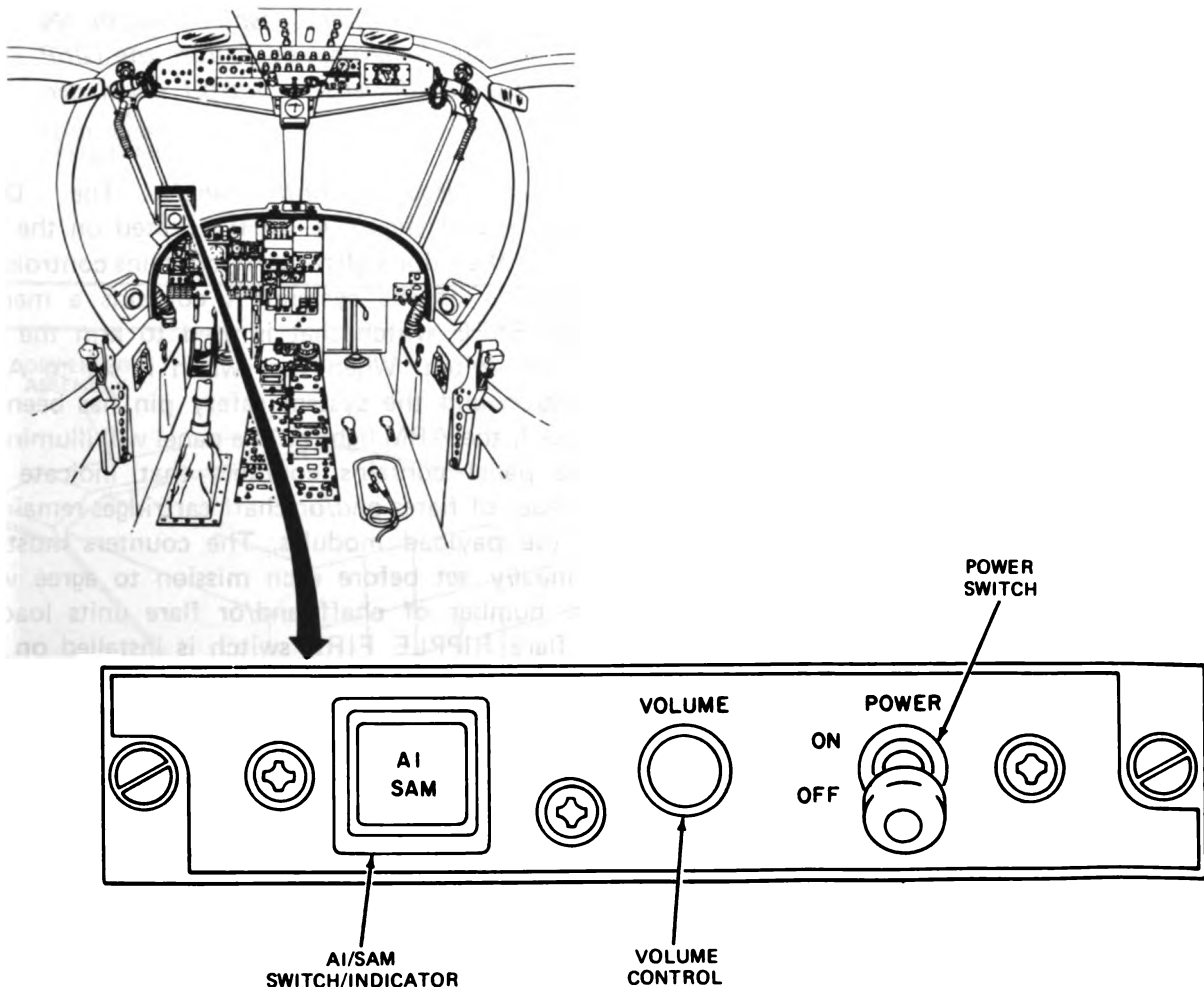

**Figure 4-28F. Control Unit (C-10387/APR-44(V))**

4-10-D-48

**4-12C. M130 General Purpose Dispenser System.**

a. The M130 general purpose dispenser system is designed to dispense decoy flares (M206) and/or chaff (M1) from two flare/chaff dispensers located in the underside of aft fuselage. The system provides survival countermeasures against infrared seeking missile threats (flares) and/or radar guided weapon systems (chaff). Each dispenser has the capacity of dispensing 30 flares or 30 chaff cartridges. Flares may be dispensed singly or in ripple fire (salvo). Chaff may be dispensed singly or programmed (as preset on the electronics module programmer).

b. The dispenser system (figure 4-28G) consists of a dispenser control panel, a flare dispenser switch panel, and the trigger switch on pilot's stick grip, all located in the cockpit. Fuselage-mounted components consist of an electronic module, two flare/chaff dispensers with payload module assemblies, a ground test receptacle, and a remote safety switch, all located on a hinged mounting module with forward fairing located on the underside of aft fuselage. The mounting module is hinged at the forward end allowing it to swing downward to set program mode for chaff dispensing on the electronic module, setting of FC (flare/chaff) selector switch position on the dispenser assembly, and for maintenance. A safety pin and flag are mounted at the forward (hinged) end of module. A ground cover with flag assembly is provided for installation at the aft end of the module when the aircraft is on the ground. The system is wired through the shrink rod switch on the right main landing gear to prevent inadvertent operation while the aircraft is on the ground (weight-on-wheels). A safety disabling switch is mounted on the aft bulkhead in the left aft equipment compartment for use by maintenance personnel during ground testing of the system. The system is protected by a 10-amp circuit breaker on the cockpit circuit breaker panel. Installation of the dispenser system necessitated relocation of the fuselage fuel vent aft to fuselage station 472. A flame arrester is installed to prevent flare flame ingestion.

c. The dispenser system functions in the following manner: When the pilot sights a missile launch or receives a radar warning, presses the FLARE DISPENSER switch to fire a flare, or presses the trigger switch on the stick grip (first detent) to dispense chaff. The aircraft's power supply (28 VDC from the secondary bus) will immediately pulse (via the dispenser control panel) the programmer section of the electronic module, and signal the dispenser assembly. This activates a sequencer assembly, completing a circuit to the contact pin in the breech assembly. The current in this completed circuit initiates the impulse cartridge, forcing the flare out of the dispenser and igniting it as it is ejected or, in the case of chaff, the chaff is ejected.

**NOTE**

*The guarded ARMT PWR switch on STORES SELECTOR panel (cockpit overhead center console) must be set to ON (guard raised) before the DISP CONT (dispenser control) panel can function.*

(1) *Dispenser Control Panel.* The DISP CONT panel (figure 4-28H), located on the left side of the pilot's glareshield, contains controls for operation of the system. It contains a manual ARM-SAFE switch that is used to arm the dispenser switch. When the switch is set to ARM position and the system safety pin has been removed, the ARM light on the panel will illuminate. The panel contains counters that indicate the number of flares and/or chaff cartridges remaining in the payload modules. The counters must be manually set before each mission to agree with the number of chaff and/or flare units loaded. A flare RIPPLE FIRE switch is installed on the panel that, when activated, will salvo fire all remaining flares in the event of an inflight emergency. A two-way MAN-PGRM switch controls the firing of chaff only. When the switch is set to PGRM position, the number of bursts (series of shots) per salvo (any number of bursts) fired is

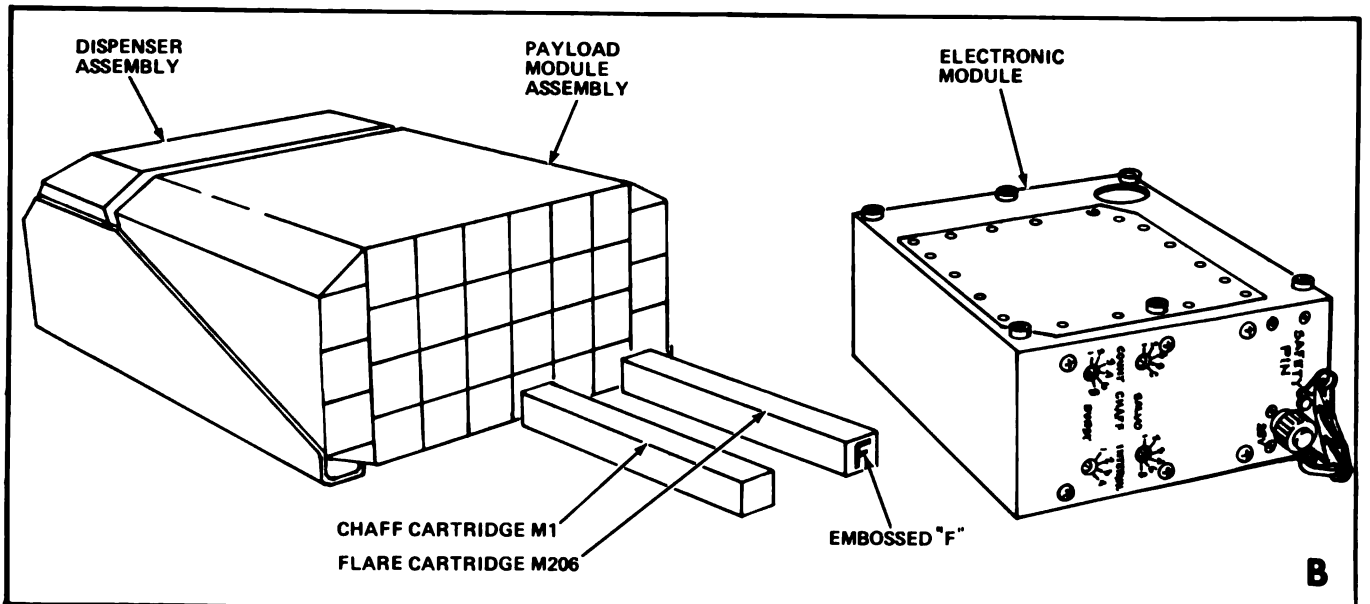
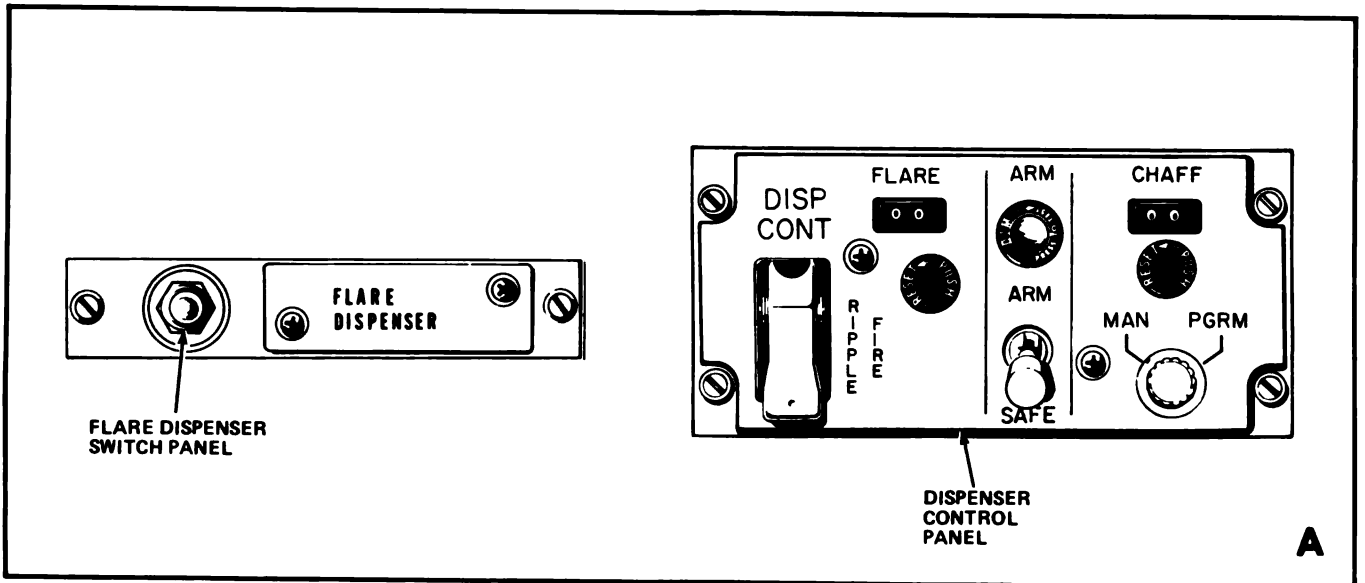
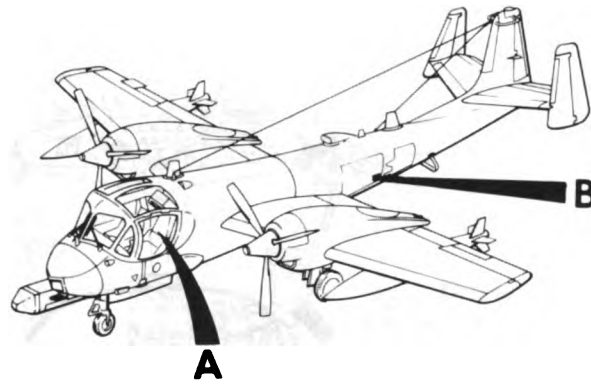

A-4-10-D-49

Figure 4-28G. M130 General Purpose Dispenser System

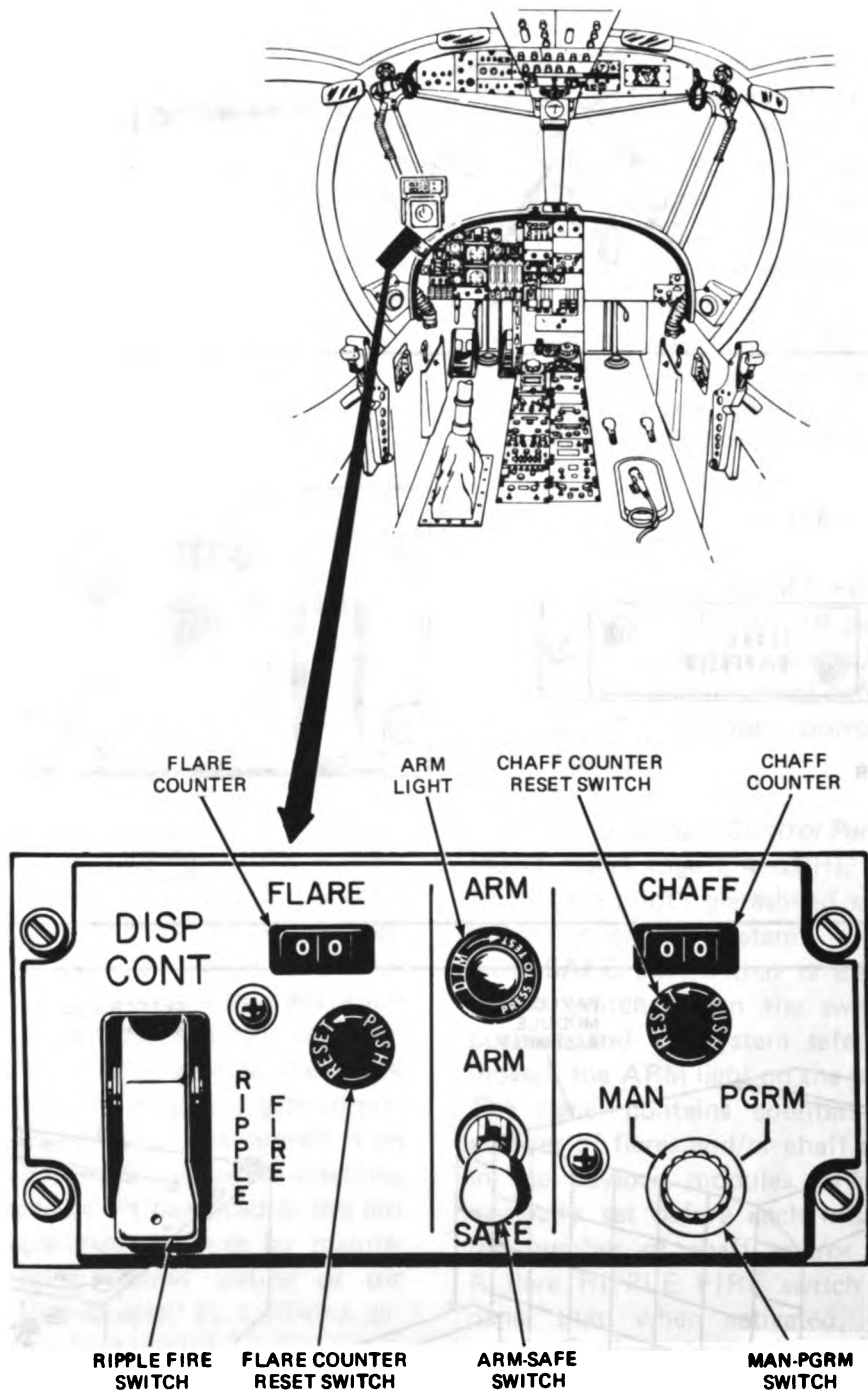

Figure 4-28H. Dispenser Control Panel

automatically controlled by a preset programmer. The MAN position of the switch bypasses the programmer and fires one chaff cartridge each time the trigger switch on the pilot's stick grip is pressed (first detent).

*(2) Dispenser Control Panel Switch Functions and Indications (figure 4-28H).*

CONTROL	FUNCTION
RIPPLE FIRE switch	Two-position guarded switch when set to up position will salvo fire all remaining flares regardless of the position of the ARM-SAFE switch.
ARM-SAFE switch	Two-position switch used to turn system power on and off. Must be pulled out and up to set to ARM position.
MAN-PGRM switch	Rotary switch used to select mode of chaff firing. When set to PGRM position, number of bursts per salvo fired is automatically controlled as preset into the system. In MAN position, one chaff cartridge is fired each time the trigger switch is pressed.
FLARE and CHAFF counters	Indicate number of flare and chaff cartridges remaining.
Flare and chaff counter reset switches	Used to reset FLARE and CHAFF counters to agree with the number of chaff and/or flare units loaded.
ARM light	Illuminates when ARM-SAFE switch is set to ARM position with system safety pin removed.

**NOTE**

*The guarded ARMT PWR switch on STORES SELECTOR panel (cockpit overhead center console) must be set to ON (guard raised) and aircraft weight must be off gear before the DISP CONT panel will function.*

*(3) Flare Dispenser Switch Panel.* The flare dispenser switch panel (figure 4-28G) is located on the forward end of the center overhead console aft of the stores selector panel. It contains a push-button switch labeled FLARE DISPENSER. With the system on and operating, a flare will be fired each time the switch is pressed.

*(4) Dispenser Assembly.* Two dispenser assemblies (figure 4-28G) are mounted on a hinged module on the underside of the aft fuselage at approximately fuselage station 312. The aft dispenser is designated as the primary, and the forward dispenser is designated as the secondary dispenser. Each dispenser assembly contains a breech assembly, flare sensor, selector switch for flare or chaff (marked C or F), reset switch, and a housing containing a sequencer assembly. The sequencer assembly receives power through the firing switches circuit and furnishes pulses to each of the 30 contacts of the breech assembly, in sequential order 1 through 30, thus firing each of the impulse cartridges.

*(5) Dispenser Assembly Switch Functions and Indications (figure 4-28G).*

CONTROL	FUNCTION
CF selector switch	Must be set prior to flight to agree with payload module's load - either flare or chaff.

*(6) Payload Module Assembly.* A payload module assembly (figure 4-28G) is assembled to each of the dispenser assemblies. Each consists of a payload module and retaining plate assembly. The payload module has 30 chambers that will accept either chaff or flares. Chaff and flares cannot be loaded in the same payload module at the same time. Flares or chaff are loaded through the studded end of the payload module, one per chamber, and secured in place by the retaining plate assembly.

*(7) Electronic Module Assembly.* The electronic module assembly (figure 4-28G) is installed on the hinged mounting module forward of the dispenser assemblies. It consists of a programmer

with a programming circuit that allows for the setting of chaff burst number, chaff salvo number, chaff burst interval, chaff salvo interval, and flare detector circuitry. The flare detector circuit is provided to assure that a burning flare is ejected to protect the aircraft from a missile threat. The electronic module also has a receptacle for insertion of a ground safety pin, which is not used on this aircraft. Instead, a remote safety switch is installed forward of the electronic module for insertion of the ground safety pin with flag assembly which must be removed before flight.

(8) *Ammunition.* The ammunition for the system consists of both chaff and flare units. Each requires an impulse cartridge which is inserted into the base of the flare or chaff casing. Impulse cartridge (M796) fits flush into the base of the casing and is electronically initiated to eject flares or chaff from the payload module. Countermeasures flare (M206) consists of an aluminum case that houses the flare pellet piston, and end cap. The flanged base of the case is equipped with a preformed packing and a cavity that receives the M796 impulse cartridge. The impulse cartridge is fired by an electrical impulse. The hot gases developed by the impulse cartridge ignite the flare pellet, causing the piston to expell the flare pellet from the case. The payload composition of the flare consists of magnesium and teflon. Countermeasures chaff (M1) consists of a plastic case, chaff payload, piston, and end cap. The flanged base of the case has a cavity to receive the M796 impulse cartridge which, upon initiation, provides hot gases to expell the payload. The chaff payload consists of inert bundles of fiberglass dipoles coated with aluminum. The outer dimensions of the M1 chaff cartridge is equivalent in size to the M206 flare cartridge. Both flare and chaff cartridges use the M796 impulse cartridge for payload expulsion.

d. *Operation.* Power is available to the dispenser system whenever the 28 VDC secondary bus is powered, the STORES SELECTOR panel ARMT PWR switch is ON, the M130 circuit breaker is closed, the ground safety pin flag assembly is removed, the aircraft weight is off the wheels, and the ARM-SAFE switch is set to ARM.

## NOTE

*Before flight, ensure the following: the number of chaff and/or flares in the payload module are the same as shown on the dispenser control panel counters. The chaff flare (CF) switch on each dispenser assembly is set to the proper position. The preplanned chaff program is properly set on the electronic module. The M130 SAFETY DISABLING SWITCH (station 299) is closed (guard down). The system safety pin is removed.*

(1) *Infrared (IR) Threat.* Visual coverage around the aircraft must be maintained when in a hostile area for IR missiles that have been launched against the aircraft. The crewmember who observes a missile launch will initiate the dispensing of flares in accordance with prescribed tactics for the aircraft.

(2) *Radar-Guided Weapons Threat.* The radar warning system provides an alert when the aircraft is being tracked by a radar-guided anti-aircraft weapon system. To be effective as a decoy, the dispensing of chaff must be accompanied with an appropriate aircraft maneuver in accordance with prescribed tactics for the aircraft.

(3) *Air-to-Air Threats.* The radar warning system provides an alert when the aircraft is being engaged by an air-to-air threat. The pilot shall dispense countermeasures chaff or flares in accordance with prescribed tactics for the aircraft.

(4) *Flare Firing Procedures.* Upon observing an IR missile launch, flares shall be dispensed by pressing the FLARE DISPENSER switch. If more than one missile launch is observed, the firing sequence shall be continued until the aircraft cleared the area.

**NOTE**

*The flare dispenser will dispense one flare each time the FLARE DISPENSER switch is pressed. If the flare detector does not detect burning of the first flare, another flare is automatically fired within 75 milliseconds; if burning is still not detected, a third and final flare is fired. If all three flares fired result in failures, ejection of flares will cease until the system is activated again by pressing the FLARE DISPENSER switch.*

(5) *Chaff Firing Procedures.* Upon receiving an alert from the radar warning system, the pilot shall dispense chaff by pressing the trigger switch on the stick grip to the first detent and initiate an evasive maneuver. The number of bursts salvo and number of salvos/program and their intervals will be set into the system prior to takeoff. If desired, the pilot can override the programmed operational mode and fire chaff manually. Manual operation is achieved by setting the MAN-PGRM switch on the dispenser control panel to MAN position and pressing the trigger switch. Each operation of trigger switch will release one chaff cartridge in manual operation.

(6) *Emergency Operation.* In the event of an inflight emergency where it would be advisable to dispense the remaining flares, the pilot can ripple fire (salvo) the flares by setting the RIPPLE FIRE switch on the dispenser control panel to the up position. Flares can be ripple fired (salvoed) regardless of the position of the ARM-SAFE switch; the STORES SELECTOR panel ARMT PWR switch must be ON.

(7) *Shutdown.* The system is shut down prior to landing by setting the ARM-SAFE switch on the dispenser control panel to SAFE position, and setting STORES SELECTOR panel ARMT PWR switch to OFF. Ensure that safety pin is installed after landing.

**e. Counting Accelerometer System.**

(1) The counting accelerometer system is used to measure and record the G forces encountered by the aircraft during flight. The system consists of a transducer, indicator and the ACCEL circuit breaker. The transducer measures the level of the G load forces encountered by the aircraft during flight and converts these measurements into electrical impulses. The indicator records the amount and strength of G Load information received from the transducer. The ACCEL circuit breaker, in the remote circuit breaker and ac-dc junction panel, protects the wiring and components of the counting accelerometer system from electrical overload. To ensure that landing loads are not recorded, the system is wired to the right landing gear up-lock switch which de-energizes the system when the landing gear is down and locked.

(2) The counting accelerometer transducer (figure 4-28J) is located at station 171 in the No. 2 mid-section equipment compartment. The transducer measures the level of the G load forces encountered by the aircraft during flight and converts these measurements into electrical impulses which are recorded by the indicator.

(3) The counting accelerometer indicator (figure 4-28J) is located at station 204 in the left No. 1 camera compartment. The indicator records G-load information in excess of 2.5G, 3.5G, 4.5G and 5.5G. The number of exceedances at the four levels are shown on windows 1 through 4 respectively of the counting accelerometer. A high level count will also be recorded on all of the lower level windows.

(4) The 3 ampere ACCEL circuit breaker is a push-pull type breaker located on the remote circuit breaker and ac-dc junction panel. It protects the wiring and components of the counting accelerometer system from electrical overload.



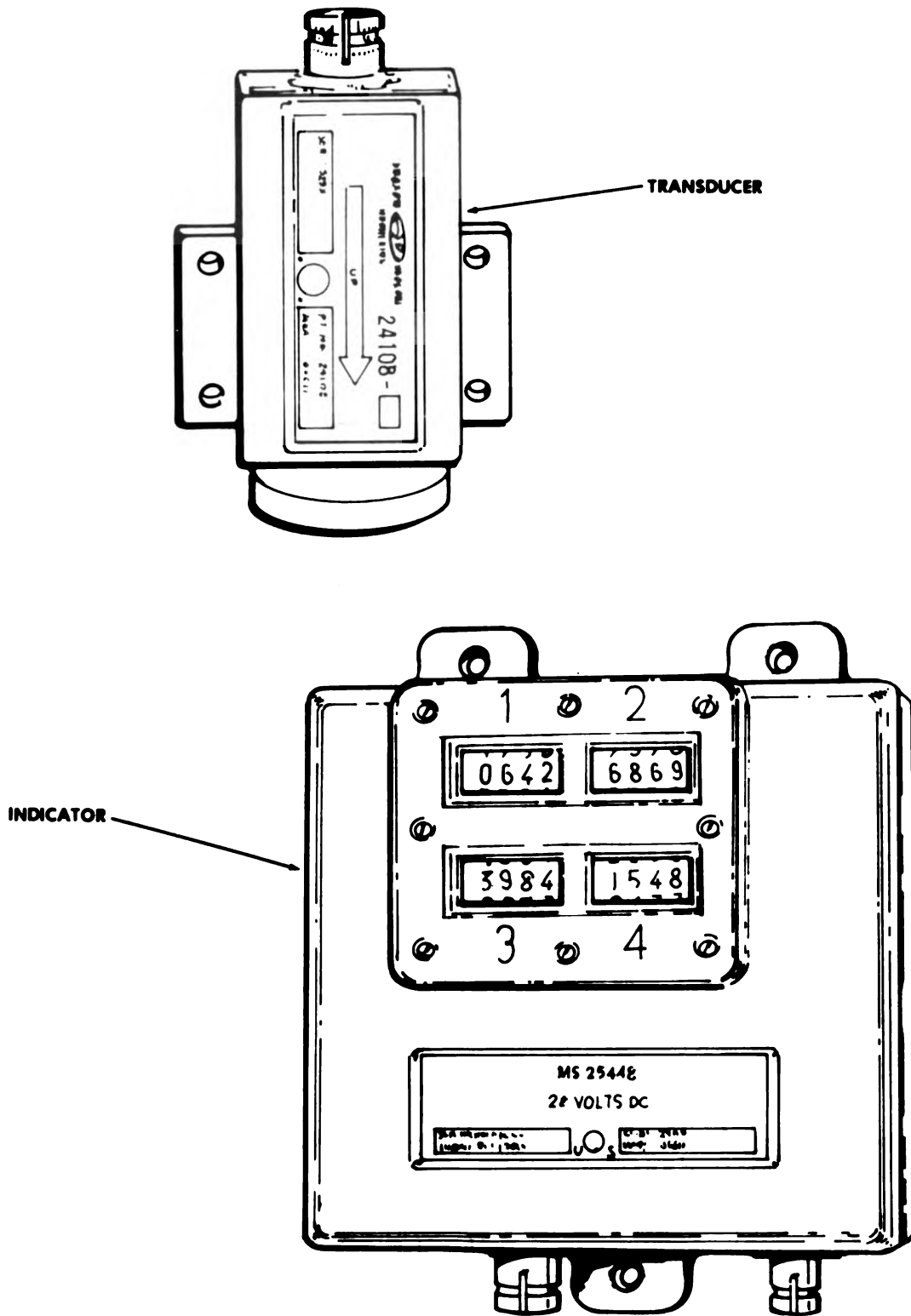

Figure 4-28J. Counting Accelerometer Group

### SECTION III. EXTERNAL STORES

#### 4-13. External Stores System Description.

a. The external stores system on OV-1D aircraft provides for the installation of the following external stores: two jettisonable drop tanks (figure 4-29) on wing stations 3 and 4, and a jettisonable LS-59 flasher pod on wing station 5. After modification, a combination drop tank/infrared countermeasures pod AN/ALQ-147A(V)2 may be installed on either wing station 3 or 4 (with a drop tank on the other wing station), or a self-contained infrared countermeasures pod AN/ALQ-147A(V)1 may be installed on either wing station 1 or 6. Refer to paragraph 5-15 for external stores loading limitations.

b. The external stores system on RV-1D aircraft provides for the installation of the following external stores: two jettisonable drop tanks (figure 4-29) on wing stations 3 and 4, and two non-jettisonable intercept receiver pods AN/ALQ-133 on wing stations 1 and 6. On modified RV-1D aircraft, a combination drop tank/infrared countermeasures pod AN/ALQ-147A(V)2 may be installed on wing station 4 with a drop tank installed on wing station 3. Refer to paragraph 5-15 for external stores loading limitations.

c. A safety feature is included in the system to prevent accidental electrical release of external stores when the aircraft landing gear is

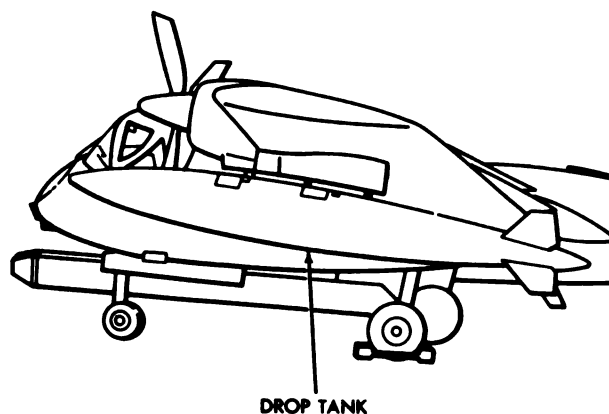

4-10-D-22

Figure 4-29. Drop Tank

down. With the landing gear handle in the down position, the normal release circuit cannot be energized. To facilitate ground release of external stores, the ARMT PWR switch on the stores selector panel (figure 4-30) is set to ON and the ARMAMENT SAFETY DISABLING switch (figure 4-31), on the right side of aft equipment compartment on aft junction panel, is momentarily set to ARM. This energizes the armament bus, thus supplying normal release power through the stores selector panel. Selecting the

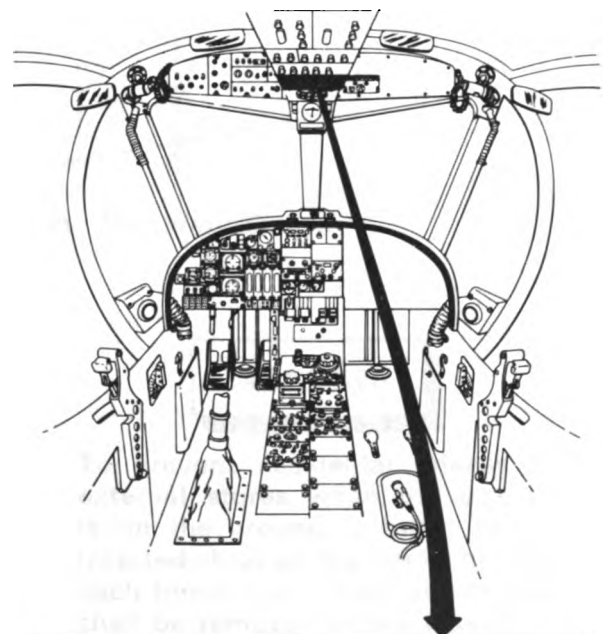

ARMT PWR SWITCH

STORES SELECTOR SWITCH

STATION SELECTOR SWITCH

4-10-D-23

Figure 4-30. Stores Selector Panel



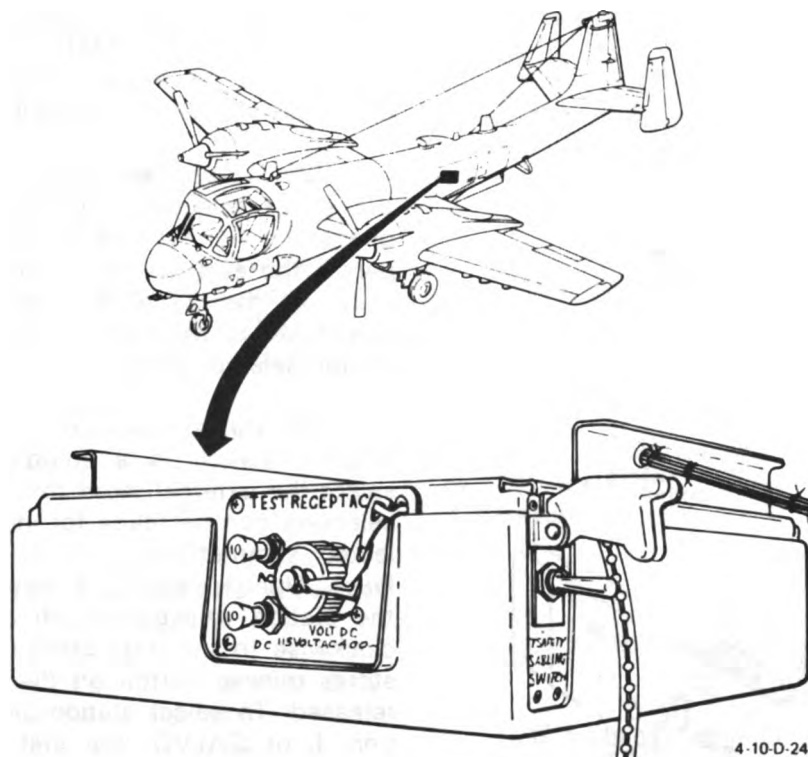

Figure 4-31. Armament Safety Disabling Switch

OFF position of the ARMT PWR switch or opening the ARMT MASTER circuit breaker reestablishes ground safe. Emergency release is accomplished through the emergency stores release handle which, when pulled, mechanically releases the stores on stations 3 and 4, and electrically releases stores on stations 1, 5, and 6 when aircraft weight is off the landing gear.

d. Aero 65A-1 bomb racks are used to carry the droppable stores carried on wing stations 3 and 4. The rack (figure 4-32) provides adequate suspension and positive release for external stores in the 1,000-pound class. Each rack includes an electrical release assembly, a linkage assembly, and appropriate wiring. All components are contained in or mounted on the rack frame. The action of the release plunger, controlled by switches on the stores selector panel, causes the rack hooks to open, releasing the external stores. The rack hooks can also be opened mechanically by pulling the emergency stores release handle. The Aero 15 type rack may be installed on stations 1, 5 and 6 and OV-1D aircraft only.

## WARNING

To prevent accidental release of external stores when the aircraft is on the ground, a safety pin is inserted through the SAFE hole of each bomb rack. These safety pins shall be removed before takeoff. If the release plunger is extended, do not remove the ground safety pin until the plunger has been recocked. Ground safety pins must be removed by hand pressure only. Before withdrawing ground safety pin, turn it so that flat side is horizontal facing up, and check rack sear and hook latch position.

### 4-14. External Stores System Controls.

a. *Stores Selector Panel.* Controls for the release of external stores are on the stores selector panel (figure 4-30) and the pilot's stick grip.

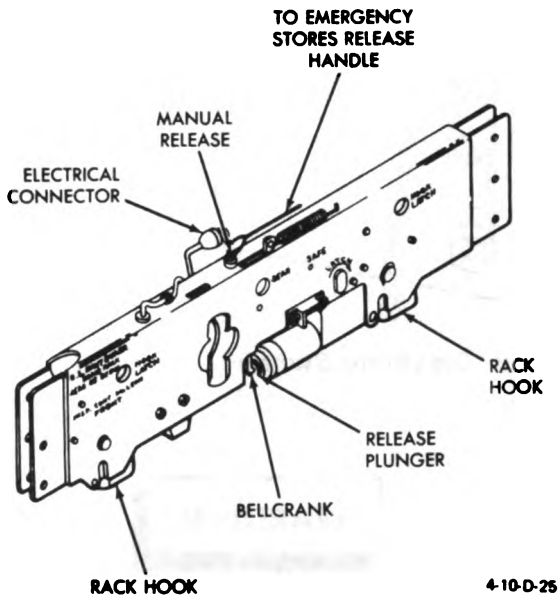
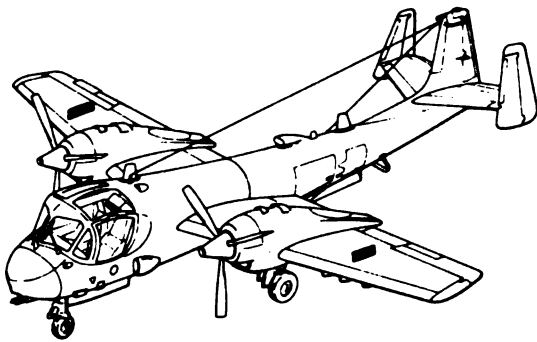

Figure 4-32. Aero 65A-1 Rack

4-10-D-25

that, in turn, supplies power to the normal release system. The ARMT PWR switch also supplies power to flasher pod subsystem of the photo system (when installed).

(2) *Stores Switch.* The STORES switch on the stores selector panel, in the SAFE position, opens the normal release circuit that does not permit the external stores to be released electrically. In the STORES position, the circuit is completed to the external store selected by the station selector switch.

(3) *Station Selector Switch.* The station selector switch is a stepping switch used to select the external store to be released. Release selection can be made for individual station, selected symmetrical (pair) release, or salvo release. Upon releasing a selected store station, the station selector switch automatically steps clockwise to the next station position when the stores release button on the pilot's stick grip is released. To select station selector switch position 1 or SALVO, the station selector switch shall be manually rotated into the desired position. The release sequence of the station selector switch is 1, 6, 2, 5, 3, 4, 1-6, 2-5, 3-4, SALVO, and SAFE (clockwise rotation). Manual reset of the switch shall be only in clockwise direction.

*b. Armament Safety Disabling Switch.* The ARMAMENT SAFETY DISABLING switch (figure 4-31), on the aft junction panel provides the ground crew with a means of energizing the armament electrical power, bypassing the landing gear interlock. With landing gear handle in the down position, raise the switch guard and momentarily position the switch to ARM. The armament safety disabling relay will energize a power relay that, in turn, supplies power to the normal release system.

*c. Emergency Stores Release Handle.* The emergency stores release handle is on the control pedestal in the cockpit. It provides an in-flight emergency release capability to mechanically release the stores installed on stations 3 and 4, and electrically release the stores installed on stations 1, 5, and 6 (OV-1D). The Aero 15 racks when installed on stations 1, 5, and 6 must have detonator squibs installed in order to have a release capability using the emergency stores release handle.

The following controls are on the stores selector panel:

(1) *Armt Pwr Switch.* The ARMT PWR switch shall be placed in the ON position for the normal release system to be energized. Power is applied to the normal release system through the landing gear handle switch. In flight, the landing gear handle shall be in the UP position to close this switch and energize a power relay

**4-15. External Stores System Normal Operation.****CAUTION**

Release empty external drop tanks only when the aircraft is in zero side slip and level flight. See Chapter 5 for 150-gallon drop tank jettison envelope.

d. Press stores release button on pilot's stick grip.

e. If the next external store is to be released, press the stores release button again and proceed with steps f and g. If it is not desirable to release the next external store, proceed with steps f and g, but do not press stores release button.

f. Place STORES switch to SAFE and place station selector switch to SAFE.

g. Set ARMT PWR switch to OFF (guard down).

**4-16. External Stores System Emergency Operation.**

To release external stores with station selector switch (figure 4-30), proceed as follows:

- a. Set station selector switch to 1, 6, 2, 5, 3, 4, 1-6, 2-5, 3-4, or SALVO as desired.
- b. Set STORES selector switch to STORES.
- c. Set ARMT PWR switch to ON.

**CAUTION**

If possible, release external stores when aircraft flight attitude approximates zero side slip and level flight.

**NOTE**

*When the stores release button on the pilot's stick grip is pressed, the external store, as set in step a. above, will release. The station selector switch will then step clockwise to the next selection and the next external store will release when the stores release button is again pressed. To select station selector switch position 1 or SALVO, the station selector switch must be manually rotated into the desired position.*

To release all droppable external stores, pull the emergency stores release handle to its limit. The Aero 65A-1 racks (installed on stations 3 and 4) will mechanically release when the emergency stores release handle is pulled. The Aero 15 racks (if installed on stations 1, 5, and 6) will electrically release when the emergency stores release handle is pulled if the aircraft weight is off the landing gear and the detonator squibs are installed in the racks. Pulling the emergency stores release handle provides 28 VDC to fire the primer cartridge in the rack. The detonator squibs must be installed in order to give the rack a jettison capability using the emergency stores release handle.



## CHAPTER 5

# OPERATING LIMITS AND RESTRICTIONS

### SECTION I. GENERAL

#### 5-1. Purpose.

This chapter includes all important operating limits and restrictions that shall be observed during ground and flight operations.

#### 5-2. General.

The operating limitations set forth in this chapter are the direct results of design analysis, tests, and operating experiences. Compliance with these limits will allow the pilot to safely perform the assigned missions and to derive maximum utility from the aircraft. Limits concerning maneuvers, weight, and center of gravity limitations are also covered in this chapter.

#### 5-3. Exceeding Operational Limits.

Anytime an operational limit is exceeded, an appropriate entry shall be made on DA Form 2408-13. Entry shall state what limit or limits were exceeded, range, time above limits, and any additional data that would aid maintenance personnel in the inspection that may be required.

#### 5-4. Minimum Crew Requirements.

The minimum crew required for aircraft operation is one pilot. Additional crewmembers, as required, will be added at the discretion of the commander, in accordance with pertinent Department of the Army regulations.

### SECTION II. SYSTEM LIMITS

#### 5-5. Instrument Markings.

Instruments that display operating limitations are illustrated in figure 5-1. The operating limitations are color coded on the face of the instruments. Color coding of each instrument is explained on the illustration. The illustration also denotes the fuel grade upon which the limits are based.

#### 5-6. Instrument Marking Color Codes.

Operating limitations and ranges are illustrated by the colored markings that appear on the dial faces of engine, flight, and utility system

instruments. RED markings on the dial faces of these instruments indicate the limit above or below which continued operation is likely to cause damage or shorten life. The GREEN markings on the instruments indicate the safe or normal range of operation. The YELLOW markings on instruments indicate the range when special attention should be given to the operation covered by the instrument. Operation is permissible in the yellow range, but should be avoided.

#### 5-7. Instrument Glass Alignment Marks.

Limitation markings consist of strips of semi-transparent color tape, which adhere to the



- R
- G
- Y

FUEL GRADE JP-5 OR JP-4



**FUEL FLOW INDICATOR**

MAXIMUM: 880 PHR

NORMAL: 110 - 880 PHR

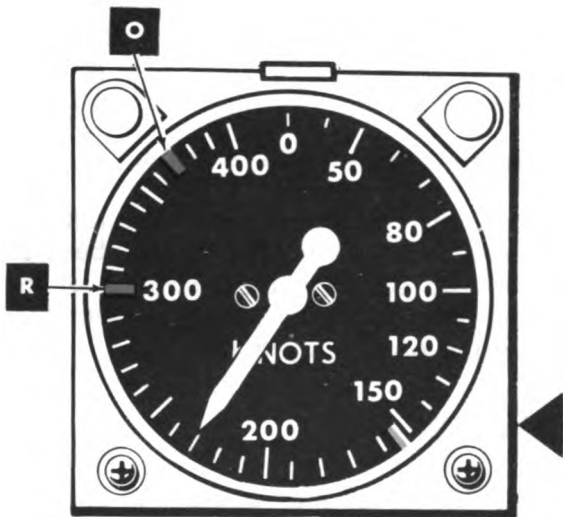

OR

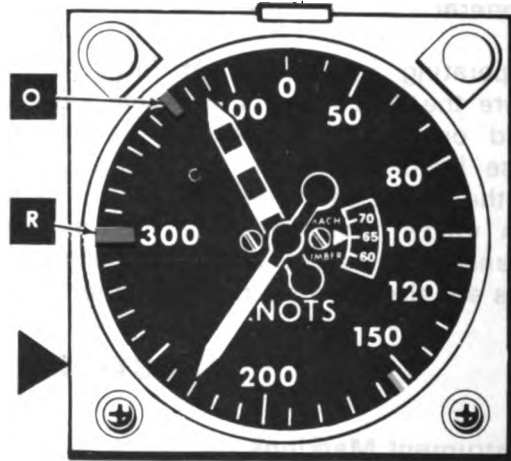

**AIRSPD INDICATOR**

AIRSPD

MAXIMUM: 370 KNOTS O

300 KNOTS R

MAXIMUM: WITH GEAR AND FLAPS EXTENDED: 153 KNOTS

**AIRSPD INDICATOR**

AIRSPD

MAXIMUM 370 KNOTS O OR 300 KNOTS R  
 POINTER MOVES TO INDICATE THE AIRSPD CORRESPONDING TO THE MAXIMUM ALLOWABLE MACH NO.  
 (M = 0.65 OV-1D)  
 (M = 0.51 RV-1D)

MAXIMUM WITH GEAR AND FLAPS EXTENDED: 153 KNOTS

- Y
- G
- R

D-5-10-D-1-1

Figure 5-1. Instrument Markings (Sheet 1 of 5)

5-2 Change 8

All data on pages 5-3 and 5-4, and figure 5-1 sheets 2 and 3 deleted.

R  
G  
Y

FUEL GRADE JP-5 OR JP-4

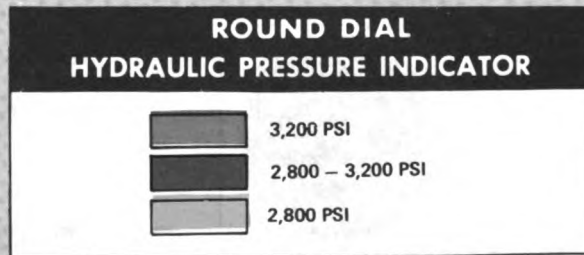
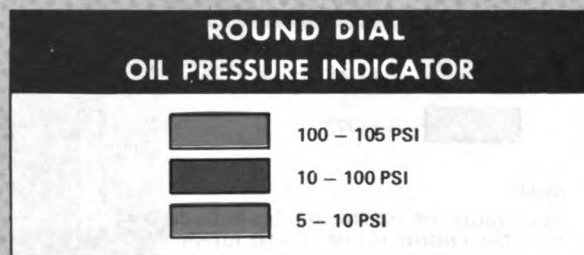
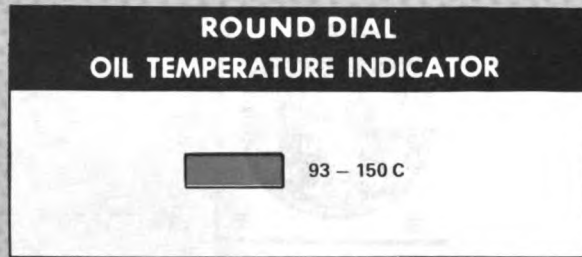

Y  
G  
R

C-5-10-D-1-2

Figure 5-1. Instrument Markings (Sheet 2 of 5)

■ R  
■ G

FUEL GRADE JP-5 OR JP-4



**ROUND DIAL  
ENGINE TACHOMETER  
INDICATOR**

- MAXIMUM: 100-110%
- 40-100%

NOTE:  
ALTHOUGH THE INSTRUMENT IS REDLINED AT 100% THE ENGINE IS LIMITED TO 101.5%



**ROUND DIAL  
PROPELLER TACHOMETER  
INDICATOR**

- 1,720-2,000 RPM
- 1,070-1,720 RPM



**ROUND DIAL  
EXHAUST GAS  
TEMPERATURE INDICATOR**

- 625-760°C
- 300-625°C

NOTE:  
ALTHOUGH THE INSTRUMENT IS REDLINED AT 625°, THE ENGINE IS LIMITED TO 630°.



**ROUND DIAL  
TORQUE INDICATOR**

- 130-210 PSI
- 20-130 PSI

■ G  
■ R

D6-10D-1.3

Figure 5-1. Instrument Markings (Sheet 3 of 5)

FUEL GRADE JP-5 OR JP-4

■ R  
 ■ G  
 ■ Y

VIDS DISPLAY UNIT

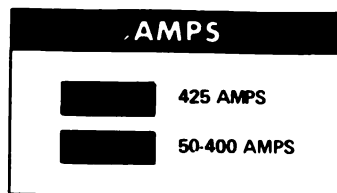
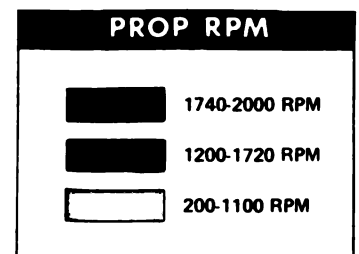
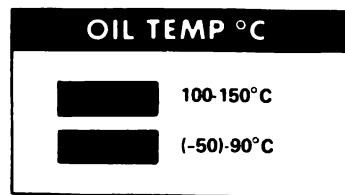
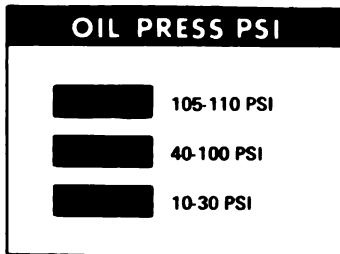
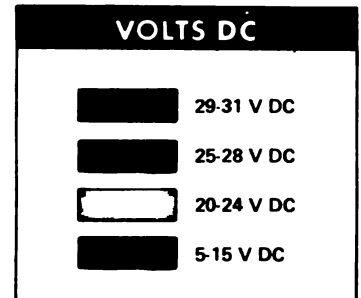
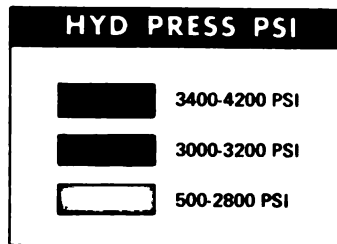
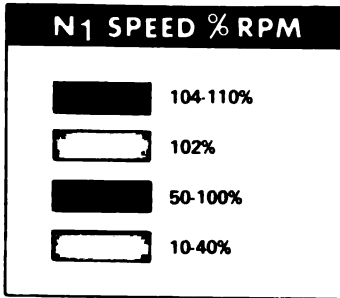
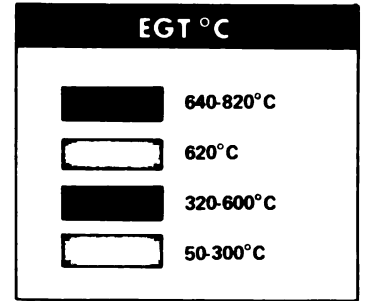
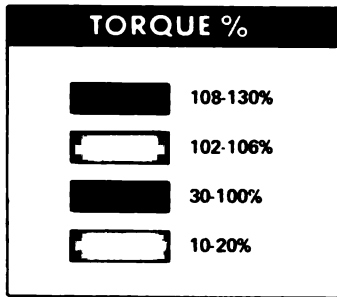
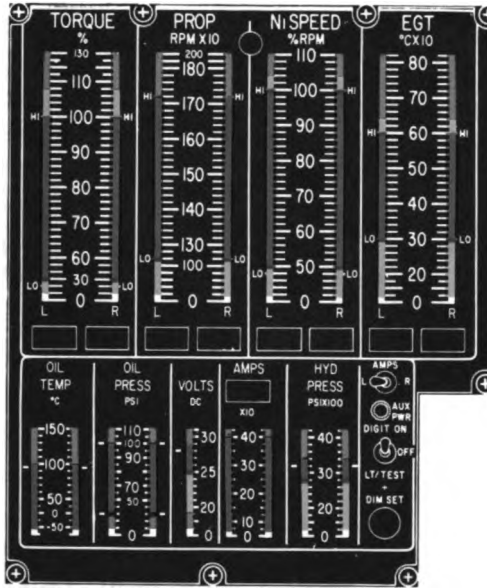

Y  
 G  
 R

5-10-D-1-5

Figure 5-1. Instrument Markings (Sheet 4 of 5)



FUEL GRADE JP-5 OR JP-4

■ R  
 ■ G  
 ■ Y

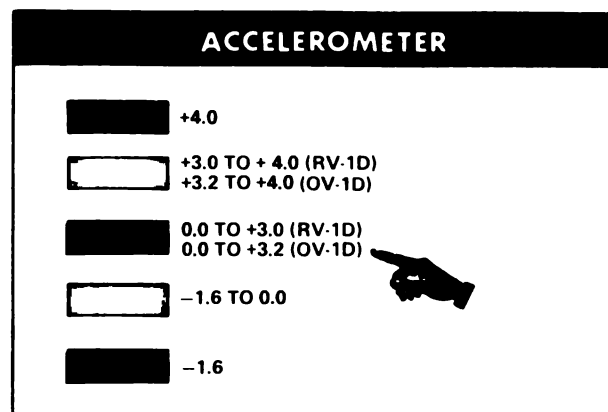

Y ■  
 G ■  
 R ■

D-5-10-D-1-4

Figure 5-1. Instrument Markings (Sheet 5 of 5)

glass outside of an indicator dial. Each tape strip aligns to increment marks on the dial face so correct operating limits are portrayed. The pilot should occasionally verify alignment of the glass to the dial face. For this purpose, all round-dial engine instruments (except fuel flow meters) have short, vertical white alignment marks extending from the bottom part of the dial glass onto the fixed base of the indicator. These slippage marks appear as a single vertical line when limitation markings on the glass properly align with reading increments on the dial face. However, the slippage marks appear as separate radial lines when a dial glass has rotated.

d. Other propeller limitations are listed in table 5-1.

**NOTE**

*Transient propeller RPM peaks will occasionally approach 1,800 RPM under normal conditions, but operation beyond this limit is evidence of deteriorating performance and requires investigation as to the cause (i.e., improper servicing, rigging, etc.).*

**5-8. Propeller Limitations.**

The following additional apply:

- a. Do not unfeather the propeller above 145 KIAS.
- b. When unfeathering, do not hold unfeather buttons pressed longer than 30 seconds. Unfeathering normally takes approximately 4 seconds. Allow 15-minute cooling period before using again if the normal 4-second time period is exceeded.
- c. Set prop levers at MIN RPM when unfeathering during flight.

**5-8A. Starter Engagement Limitations.**

Do not exceed starter engagement limitation of 45 seconds on, 2 minutes off for 3 starts, and 45 seconds on, 5 minutes off for all additional starts.

**5-9. Photographic Surveillance System (KS-113A) Limitations (OV-1D).**

Limits for use of the different modes of the photographic surveillance system are presented in figure 5-2. These limits will vary depending

SYSTEM LIMITS WITH 1 3/4-INCH LENS CONE

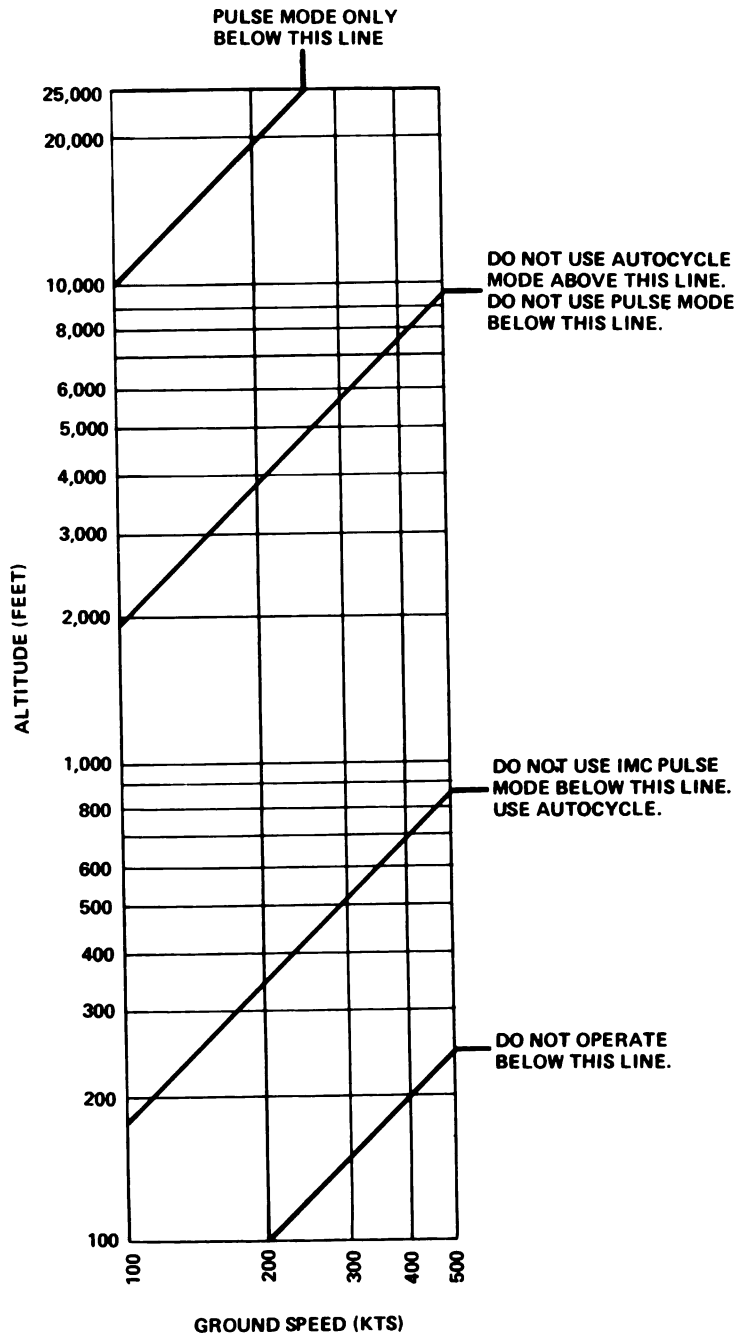

A-5-10-D-2-1

Figure 5-2. Photographic Surveillance System (KS-113A) Operational Limits (Sheet 1 of 4)

SYSTEM LIMITS WITH 3-INCH LENS CONE

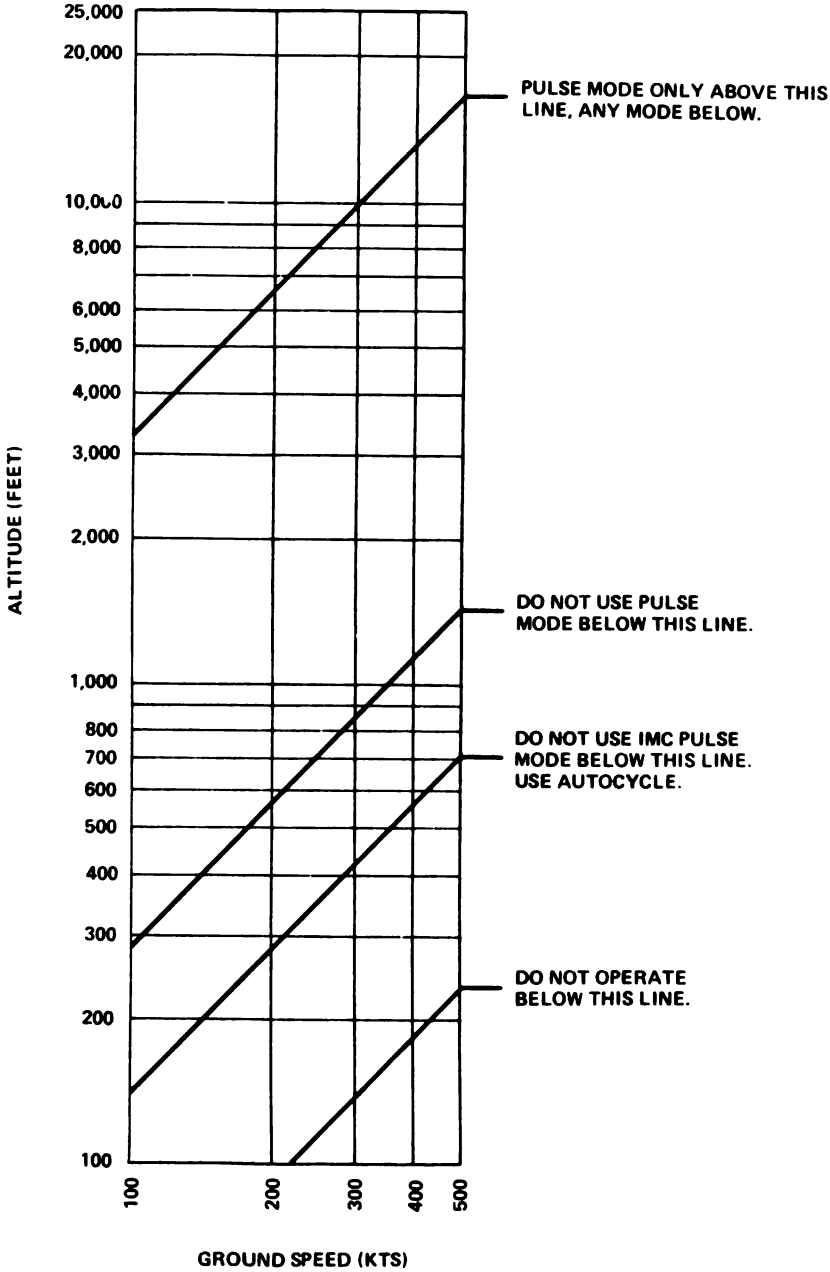

A5 10 D-2-2

Figure 5-2. Photographic Surveillance System (KS-113A) Operational Limits (Sheet 2 of 4)



SYSTEM LIMITS WITH 6-INCH LENS CONE

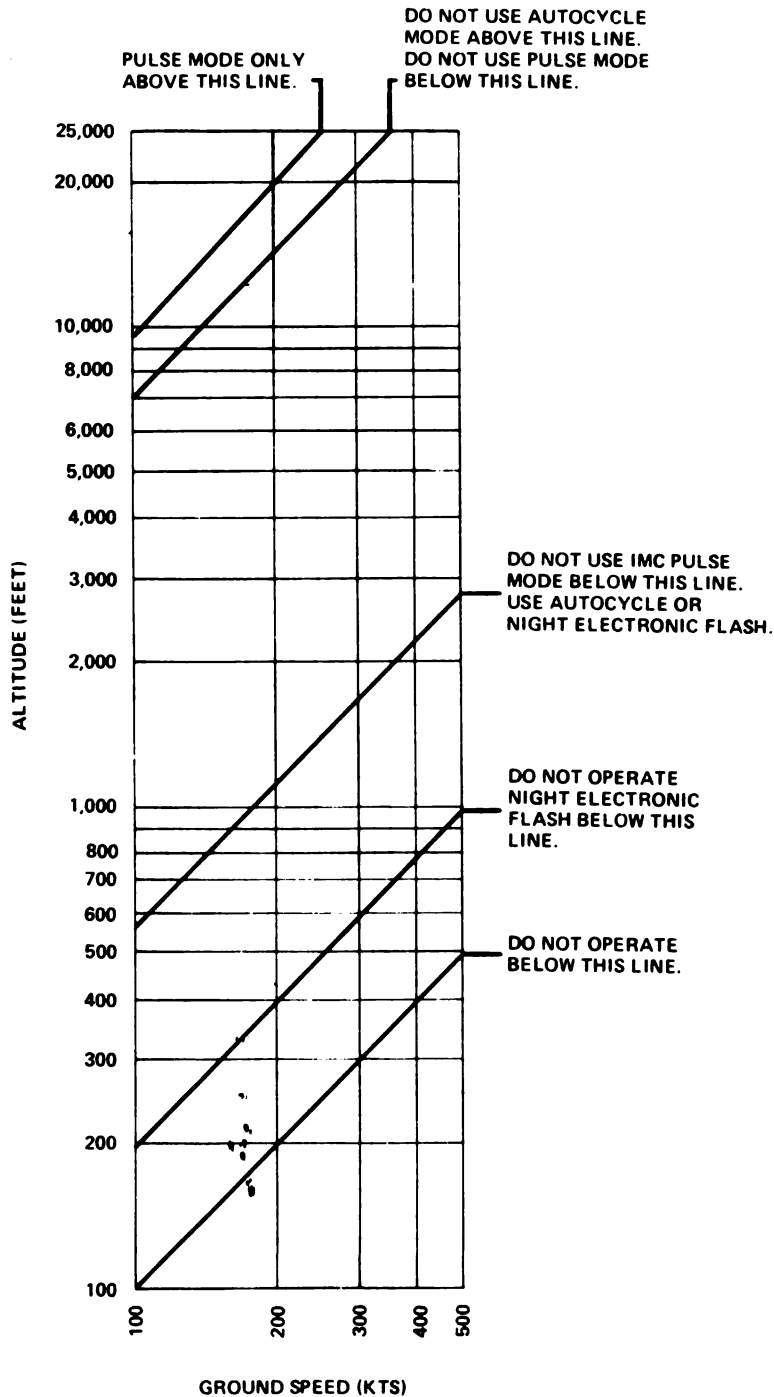

A 5-10-D-23

Figure 5-2. Photographic Surveillance System (KS-113A) Operational Limits (Sheet 3 of 4)

SYSTEM LIMITS WITH 12-INCH LENS CONE

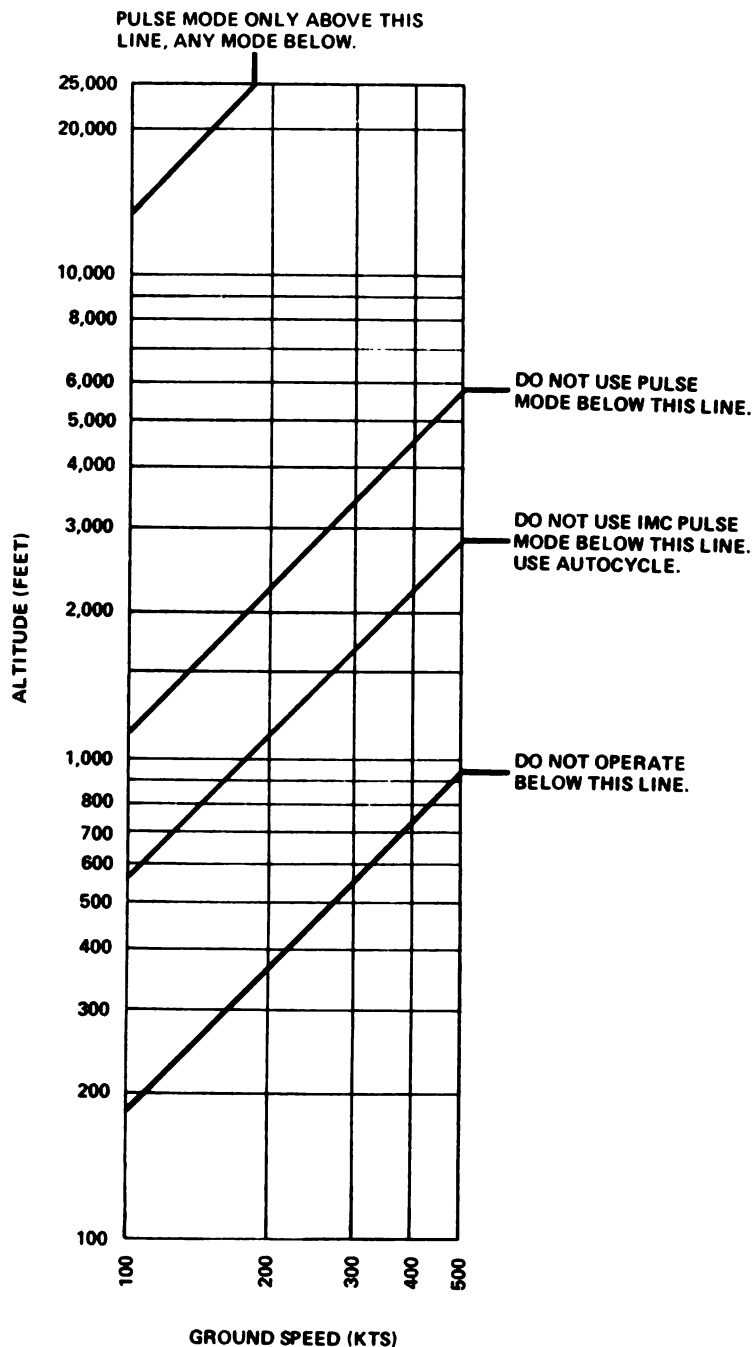

A-5-10-D-24

Figure 5-2. Photographic Surveillance System (KS-113A) Operational Limits (Sheet 4 of 4)

on the lens cone installed on the camera for any given mission.

### 5-10. Air-Conditioning System Limitations.

The following limits apply to the use of the air-conditioning system on this aircraft:

- a. Air-conditioning system shall be turned off before takeoff.
- b. Air-conditioning system cooling mode shall be turned off above 95% N1 speed (gas producer RPM).
- c. Air-conditioning system shall be turned off before landing.

## SECTION III. POWER LIMITS

### 5-11. Engine Rating.

In addition to the engine operating limitations shown on the instruments (figure 5-1) and listed in the engine operating limits table (table 5-1), the following engine limits shall be observed:

#### a. Torque Limits.



Never exceed an indicated torque of 100% for a maximum period of 30 minutes or as limited in figure 5-3.

Propeller shaft torque shall not exceed the limits indicated in table 5-1. Pilot monitoring is necessary to prevent the engines from exceeding these limits at all power settings. An overtorque inspection is required if an engine is subjected to an overtorque for a period of time longer than indicated in figure 5-3.

**b. Altitude Limitation.** Operation above 25,000 feet pressure altitude will have a deteriorating effect on engine performance to the extent that a flameout may be experienced.

**c. Exhaust Gas Temperature (EGT) Limitation.** An overtemperature condition exists and a hot-end inspection is required when any of the following occurs:

(1) *During Starts.* When EGT is greater than 760°C at any time, or exceeds 675°C for more than 5 seconds total elapsed time.

(2) *During Accelerations.* When EGT is greater than 760°C at any time, or exceeds 675°C for more than 5 seconds.

(3) *At Takeoff/Military Power Setting.* When EGT exceeds 630°C for more than 10 seconds, 675°C for more than 5 seconds, or 760°C, an overtemperature condition exists.

(4) *At Normal Power Settings.* When EGT exceeds 613°C for more than 10 seconds, 675°C for more than 5 seconds, or 760°C, an overtemperature condition exists.

**d. Engine Overspeed Limit.** An engine overspeed condition exists and an overspeed inspection is required when any of the following occurs:

(1) When compressor rotor speed (gas producer speed N1) exceeds 101.5% at any time.

(2) When propeller speed (N2) exceeds 1,850 RPM at any time, or exceeds 1,720 RPM for 3 seconds maximum.

### 5-12. Engine Power Definitions.

Definitions of engine power referenced throughout this manual are as follows:

**a. Takeoff/Military Power.** The maximum horsepower specified for the engines as allowable under specified operating conditions for periods of 30 minutes duration with the power levers in the TAKEOFF position.

**b. Normal Rated Power.** The maximum horsepower specified for the engines as allowable, for continuous operation, under specified conditions obtained when operating at normal rated speed and normal exhaust gas temperature.

**Table 5-1. T53-L-701 Engine Limitations**

Power Operating Condition	Time	Note (2) Propeller N2 Speed (RPM)	Notes (2) & (5) Compressor N1 Speed (% RPM)	Note (3)	Note (4)	Oil Temp (°C)	Oil Pressure (PSI)
				Torque (%)	Exhaust Gas Temp (°C)		
	MAX	MAX	MAX	MAX	MAX	MAX	MIN
Takeoff/Military	30 Minutes	1,720	101.5	100	630	93	80
Normal	Continuous	1,720	101.5	94	613	93	80
Starting	Note (1)	1,720	101.5	100	—	93	10
Transient (Forward or Reverse)	2 Seconds	1,720	101.5	109	—	93	80
Full Reverse Note (6)	30 Seconds	1,720	101.5	100	630	93	80

- NOTES:**
- (1) Do not exceed starter engagement limitation of 45 seconds on, 2 minutes off for three starts; and 45 seconds on, 5 minutes off for all additional starts.
  - (2) Special inspections are required for propellers operating outside the governing speed range, and for engines subjected to overspeed. The propeller governing speed range should be 1,150 to 1,200 RPM to 1,660 to 1,700 RPM. An engine overspeed condition exists when:
    - (a) Compressor N1 speed exceeds 101.5%; or
    - (b) Propeller N2 speed exceeds 1,850 RPM; or
    - (c) Propeller N2 speed exceeds 1,720 RPM for more than 3 seconds.
  - (3) Special inspections are required for engines subjected to overtorque conditions as shown in figure 5-3.
  - (4) Special inspections are required for engines subjected to excessive temperatures. An engine overtemperature condition exists when exhaust gas temperature (EGT) exceeds:
    - (a) 630°C for more than 10 seconds
    - (b) 675°C for more than 5 seconds
    - (c) 760°C.
  - (5) The air-conditioning system cooling mode shall be turned off above 95% compressor N1 speed to avoid excessive engine temperatures.
  - (6) Full reverse is adjusted to 1600 to 1640 RPM.

# MAXIMUM ALLOWABLE TORQUE T53-L-701 ENGINE

**EXAMPLE**  
**WANTED**  
MAXIMUM  
TORQUE ALLOWABLE

**KNOWN**  
TIME = 5 MINUTES

**METHOD**  
ENTER TIME HERE →  
MOVE RIGHT TO  
INTERCEPT LIMIT LINE  
MOVE DOWN AND READ  
MAXIMUM ALLOWABLE  
INDICATED TORQUE = 100%

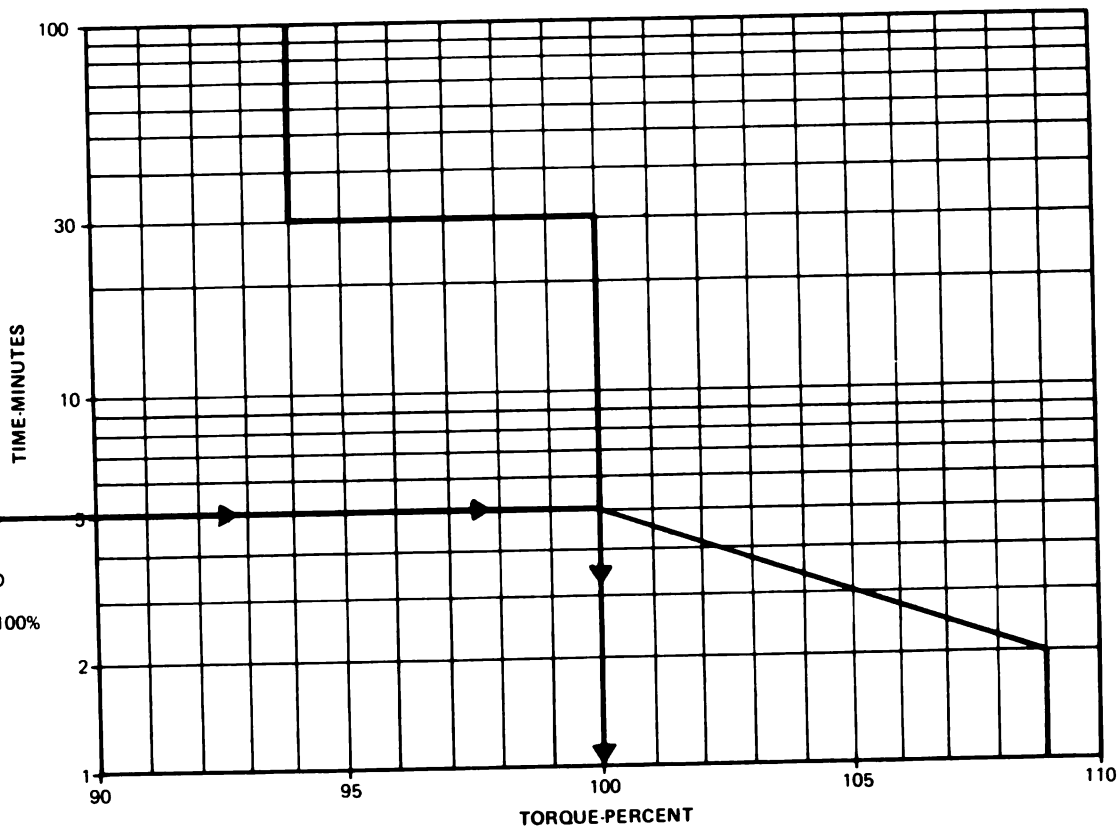

Figure 5-3. Maximum Torque Limits

## SECTION IV. LOADING LIMITS

## 5-13. Center of Gravity Limitations.

The aircraft center of gravity will remain within the center of gravity limits provided the aircraft is loaded in accordance with Chapter 6. The center of gravity limits are as follows:

- a. Forward CG limit is 156.4 inches for all configurations.
- b. Aft CG limit for RV-1D aircraft and OV-1D aircraft without SLAR is 165.2 inches.
- c. Aft CG limit for OV-1D aircraft with SLAR is 163.5 inches.

## NOTE

*The above limits apply for flight with landing gear extended or retracted; however, aircraft weight and balance records are based on weighings with landing gear extended. If aircraft CG is near the aft limit (within 0.3 inches), the CG with the landing gear retracted should be checked to assure it is within limits. To determine aircraft CG with landing gear retracted, add the gear retraction moment (2500 inch-pounds, moment/1000 = 2.5) to the aircraft moment and divide by the gross weight.*

## 5-14. Weight Limitations.

The maximum gross takeoff weight for various aircraft configurations is shown in figure 6-6. When operating in the yellow gross weight (caution) zone of figure 6-6, see single-engine rate of climb charts in Chapter 7 for a determination of operating restrictions. Refer to Chapter 2 for information and techniques to be used for fuel management.

**WARNING**

**Adequate power to continue take-off climb following an engine failure will not be available under certain conditions of high gross weight, high altitude, and high temperature. Except when the nature of the mission justifies the additional risk, takeoff gross**

**weight shall be limited to that which will provide a single-engine, gear and flaps up, rate of climb of 200 feet per minute following jettison of wing stores. Refer to Chapter 7 for single-engine climb performance data.**

## 5-15. External Stores Jettison Limitations.

External stores may be carried singly, or in combination, as illustrated in figure 5-4. Limits under which external stores may be jettisoned are defined as follows:

## 5-16. External Stores Loading.

Figure 5-4 illustrates the type and location of external stores that may be installed on the aircraft. Both jettisonable and fixed-mounted (nonjettisonable) stores are included. Aircraft configuration based on stores installation is defined and limits are included for inflight jettison.

## NOTE

*These limits represent speeds at which external stores will clear the aircraft cleanly when jettisoned. However, in an emergency situation where jettison of external stores becomes necessary, they may be jettisoned outside these limits at the discretion of the pilot.*

a. *Drop Tanks/IRCM Pod (AN/ALQ-147A(V)2).* Aero 1C or Sargent-Fletcher tanks/IRCM Pod (AN/ALQ-147A(V)2) may be jettisoned in +1.0G level flight at speeds up to 225 KIAS. Up to 125 KIAS, Aero 1C or Sargent-Fletcher tanks/IRCM Pod (AN/ALQ-147A(V)2) may be jettisoned at up to 6° sideslip with either engine shut down.

b. Deleted.

c. *Flasher Pod (LS-59A).* Flasher pod (LS-59A) may be jettisoned in balanced level flight at airspeeds up to 225 KIAS. Up to 125 KIAS, flasher pod (LS-59A) may be jettisoned at up to 6° sideslip with either engine shut down.

d. *IRCM Pod (AN/ALQ-147A(V)1).* IRCM pod AN/ALQ-147A(V)1 may be jettisoned in level flight at airspeeds up to 225 KIAS. Up to 125 KIAS, the pod may be jettisoned at up to 6° sideslip with either engine shut down.

EXTERNAL STORES LOADING

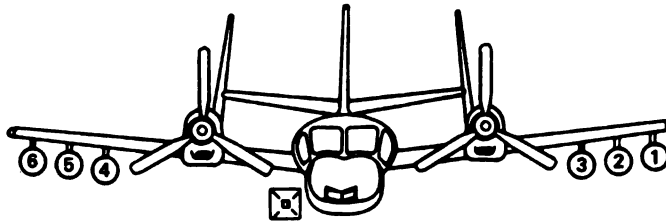

STORES CONFIGURATION		STORE STATION							REMARKS
		6	5	4	FUSLG	3	2	1	
A	SEE NOTE 2							SEE NOTE 2	REFER TO SECTION V FOR AIRSPEED LIMITS. (SEE NOTE 3)
B			◇			◇			
C									
D		○	◇			◇			
E		○	◇	☒		◇			
F				☒					
G		○		☒					
H			◇	☒		◇			
I									

KEY TO SYMBOLS

- ☒ SLAR (AN/APS-94F) — SIDE LOOKING AIRBORNE RADAR
- FLASHER POD (LS-59A) — AIRBORNE PHOTOGRAPHIC SURVEILLANCE WITH AERO 15C BOMB RACK
- ◇ 150 GALLON DROP TANK OR IRCM POD (AN/ALQ-147A(V)2) WITH AERO 65A-1 BOMB RACK (SEE NOTE 1)



NOTES

1. AN/ALQ-147A(V) 2 IRCM POD:
  - a. ONLY ONE IRCM POD, OF ANY TYPE, MAY BE INSTALLED ON THE AIRCRAFT AT ONE TIME.
  - b. IRCM POD (AN/ALQ-147A(V)2) MAY BE INSTALLED ON WING STATION 3 OR 4; HOWEVER, A 150 GALLON DROP TANK MUST BE INSTALLED ON THE OPPOSITE WING.
  - c. IF FLASHER POD (LS-59A) IS INSTALLED, THE IRCM POD, IF USED, MUST BE INSTALLED ON WING STATION 3.
  - d. IF FLASHER POD (LS-59A) IS NOT INSTALLED, THE IRCM POD, IF USED, MUST BE INSTALLED ON WING STATION 4.
2. AN/ALQ-147A(V)1 IRCM POD:
  - a. ONLY ONE IRCM POD, OF ANY TYPE, MAY BE INSTALLED ON THE AIRCRAFT AT ONE TIME.
  - b. IF FLASHER POD (LS-59A) IS INSTALLED, THE IRCM POD, IF USED, MUST BE INSTALLED ON WING STATION 1.
  - c. IF FLASHER POD (LS-59A) IS NOT INSTALLED, THE IRCM POD, IF USED, MUST BE INSTALLED ON WING STATION 6.
3. REFER TO PARAGRAPH 5-16 FOR EXTERNAL STORES JETTISON LIMITATIONS.

F-5-10-D-4-1

Figure 5-4. External Stores Loading and Limitations (Sheet 1 of 2)

EXTERNAL STORES LOADING

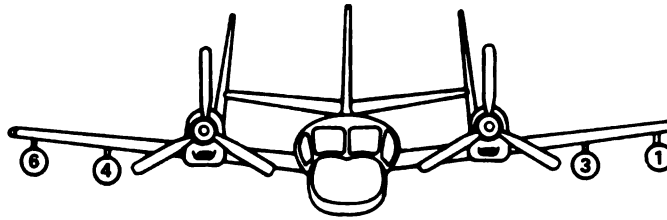

STORES CONFIGURATION		STORE STATION							REMARKS
		6	5	4	FUSL	3	2	1	
RA									REFER TO SECTION V FOR AIRSPEED LIMITS (SEE NOTE 3)
RB			◇		◇				
RC	○		◇		◇			○	
RD			☆		◇				
RE	○		☆		◇			○	
RF	○							○	
<p>KEY TO SYMBOLS</p> <p>◇ 150 GALLON DROP TANK WITH AERO 65A-1 BOMB RACK.</p> <p>☆ IRCM POD (AN/ALQ-147A(V)2) WITH AERO 65A-1 BOMB RACK (SEE NOTE 2).</p> <p>○ INTERCEPT RECEIVER POD (AN/ALQ-133) (SEE NOTE 1).</p>									

NOTES:

1. WHEN INSTALLED, INTERCEPT RECEIVER POD (AN/ALQ-133) IS FIXED-MOUNTED AND IS NOT JETTISONABLE.
2. IRCM POD (AN/ALQ-147A(V)2) MAY BE INSTALLED ON WING STATION 4 WITH A DROP TANK INSTALLED ON WING STATION 3.
3. REFER TO PARAGRAPH 5-16 FOR EXTERNAL STORES JETTISON LIMITATIONS.

E-5-10-D-4-2

**R** Figure 5-4. External Stores Loading and Limitations (Sheet 2 of 2)

SECTION V. AIRSPEED LIMITS

5-17. Airspeed Limitations.

The following paragraphs contain the airspeed limitations placed on this aircraft under the conditions specified.

*a. Gear and Flaps Retracted.* With gear and flaps retracted, for all configurations except RV-1D aircraft with ECM pods (AN/ALQ-133) installed, the airspeed limitation is 370/0.65M /KIAS. When ECM pods (AN/ALQ-133) are installed on RV-1D aircraft, the airspeed limit is 300/0.51M KIAS. See figure 5-5.

*b. Gear or Flaps Extended.* With gear and flaps extended, the airspeed limitation on this aircraft is 153 KIAS.

**CAUTION**

Do not extend gear or flaps above 153 KIAS.

*c. Landing Light Extended.* With the landing light extended, the airspeed limitation on this aircraft is 180 KIAS.

*d. Severe Turbulence.* In severe turbulence, the maximum airspeed shall be limited to 197 KIAS.



# AIRSPEED LIMITATIONS

STANDARD DAY ALL CONFIGURATIONS

AIRSPEED  
LIMITATION  
OV-1D/RV-1D  
T53-L-701

■ G

### EXAMPLE

**WANTED**

AIRSPEED LIMITATION  
FOR A GIVEN ALTITUDE

**KNOWN**

ALTITUDE = 15,000 FEET  
MODEL = OV-1D

**METHOD**

ENTER INDICATED  
ALTITUDE HERE →  
MOVE RIGHT TO  
INTERSECT LIMIT LINE  
MOVE DOWN AND READ  
AIRSPEED LIMITATION = 330 KIAS

**NOTE**

ON RV-1D AIRCRAFT  
WITH INTERCEPT RECEIVER PODS  
AN/ALQ-133 INSTALLED. ON RV-1D  
AIRCRAFT WITHOUT INTERCEPT  
RECEIVER PODS AN/ALQ-133  
INSTALLED, AIRSPEED LIMITS  
ARE THE SAME AS OV-1D.

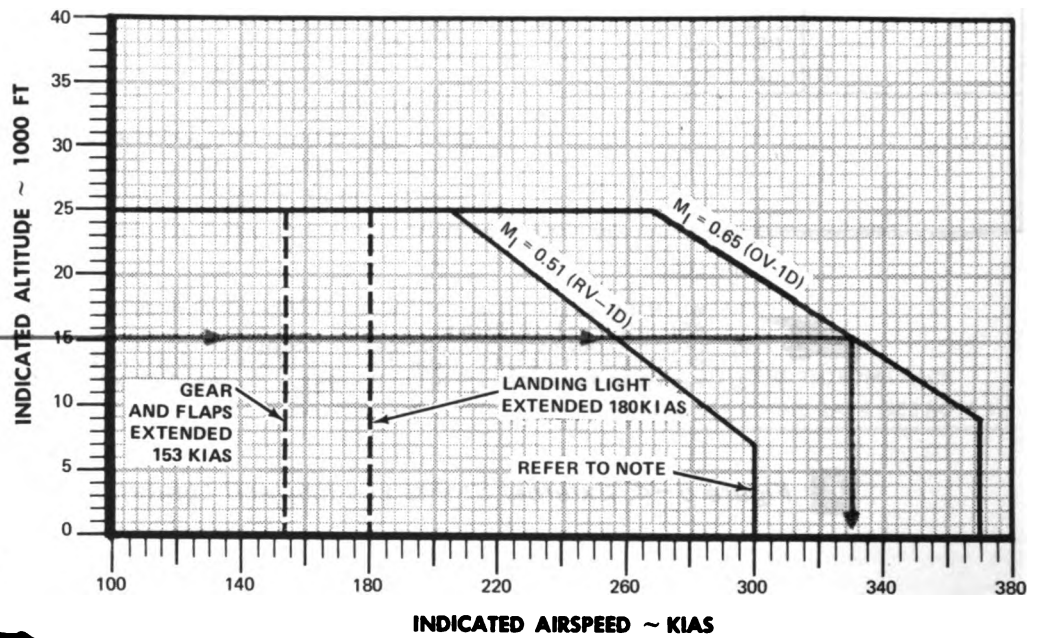

■ G

E-5-10-D-5

Figure 5-5. Airspeed Limitations

## SECTION VI. MANEUVERING LIMITS

## 5-18. Rolling Limits.

The following paragraphs contain the rolling limitations on this aircraft under various external stores configurations defined in figure 5-4. These limitations are further defined on figure 5-6.

## NOTE

*Longitudinal forces for left rolling pullouts are noticeably less than for right rolling pullouts.*

*a. Gear and Flaps Up (Figure 5-4 Sheet 1, Configurations A and F, and Configurations B and H with Empty Drop Tanks, and Figure 5-4 Sheet 2, Configuration RA and Configuration RB with Empty Drop Tanks).*

(1) Full abrupt stick 360° of roll is permitted up to 250 KIAS.

(2) Full abrupt stick left or right 60° of bank is permitted up to 370 KIAS.

*b. Gear and Flaps Up (All Configurations Except Those Listed in Paragraph 5-18a).*

(1) Full abrupt stick left or right 180° of bank is permitted to 250 KIAS. (Refer to Chapter 8 for control characteristics during roll maneuvers.)

(2) Only gradual control inputs left or right to 60° of bank are permitted in excess of 250 KIAS. See figure 5-6 for maximum airspeed limitations.

*c. Gear and/or Flaps Extended.* Left or right 60° of bank to 153 KIAS is permitted in all store configurations.

## 5-19. Sideslip Limits.

The following paragraphs contain the sideslip limits on this aircraft with the gear and flaps up and down.

*a. Gear and Flaps Up, All Configurations.* Full pedal 300-pound pedal force sideslips are permitted at airspeeds between 180 and 370 KIAS. Below 180 KIAS, sideslips are limited to a maximum sideslip angle of 15° due to pedal force lightening. Refer to Chapter 8 for flight characteristics in this configuration.

*b. Gear and/or Flaps Extended.* Below 153 KIAS, sideslips are only permitted to a maximum sideslip angle of 15° due to pedal force lightening.

## 5-20. Crosswind Takeoff or Landing Limits.

Limitations for takeoff or landing in crosswind under various external store configurations are described in the following paragraphs.

*a.* For aircraft without stores installed on wing stations 1, 2, 5, and 6 and without SLAR installed, normal operating procedures are applicable.

*b. For All Other Store Configurations.* For aircraft in this configuration, takeoff or landing is permitted for all wind conditions up to 15 knots 90° crosswind component. Takeoff or landing in higher crosswinds are not permitted because of adverse directional handling qualities with asymmetric loadings, especially in the case where the wind is from the left side.

## 5-21. Stall Limits.

Unaccelerated level stalls (1 G stalls) are permitted for all aircraft configurations at power settings up to and including torque indicator reading of 67% torque at 1,650 propeller RPM. Intentional stalls at higher power settings are prohibited to prevent entering extreme nose-high attitudes at stall. Intentional stalls at pitch attitudes in excess of 20° shall be avoided to preclude abnormal aircraft attitude at recovery.

# ROLLING RESTRICTIONS

ROLLING RESTRICTIONS  
OV-10  
T53-L-701

## EXAMPLE

### WANTED

MAXIMUM ALLOWABLE BANK ANGLE  
AT A GIVEN AIRSPEED AND CONFIGURATION

### KNOWN

CONFIGURATION SLAR PLUS  
(2) 150 GALLON DROP TANKS (H, FIGURE 5-4)  
AIRSPEED 270 KIAS

### METHOD

ENTER INDICATED AIRSPEED HERE →  
MOVE RIGHT TO CONFIGURATION  
LIMIT LINE  
MOVE DOWN AND READ MAXIMUM  
ALLOWABLE BANK ANGLE = 60°

### NOTE

1. CONFIGURATIONS REFERENCED ARE DEFINED IN FIGURE 5-4.
2. 380° ROLLS ARE PERMITTED TO 250 KIAS IN CONFIGURATIONS A AND F AND CONFIGURATIONS B AND H WITH EMPTY DROP TANKS.

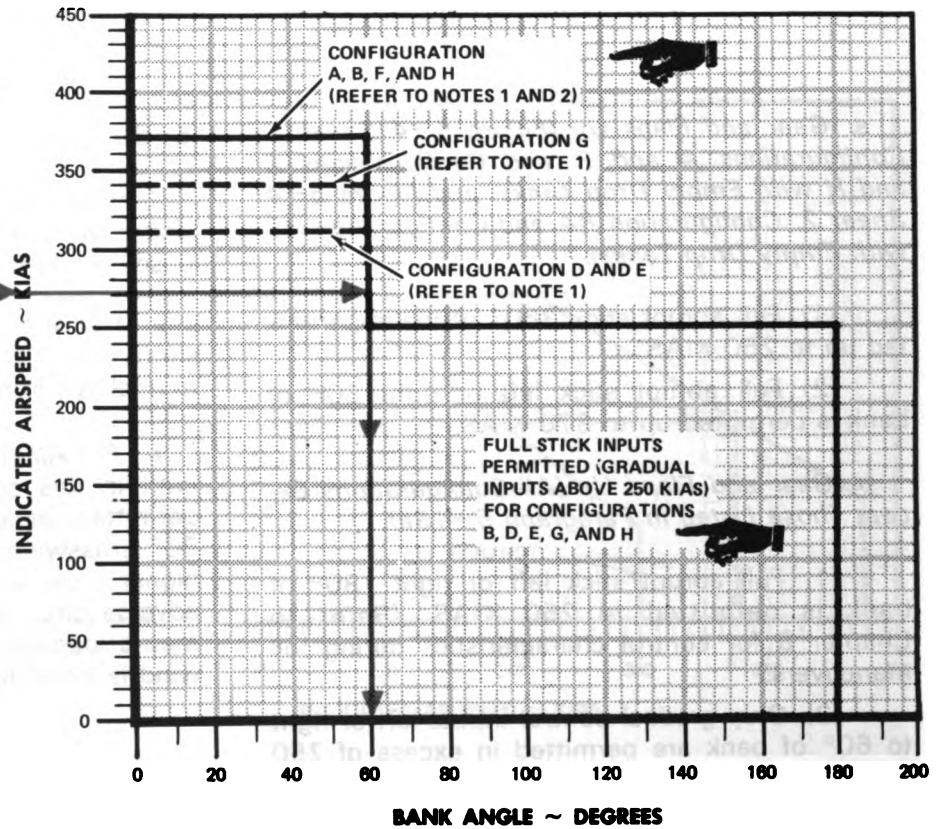

G

B-5-10-D-6-1

Figure 5-6. Rolling Restrictions (Sheet 1 of 2)

# ROLLING RESTRICTIONS

ROLLING RESTRICTIONS  
RV-1D  
T63-L-701

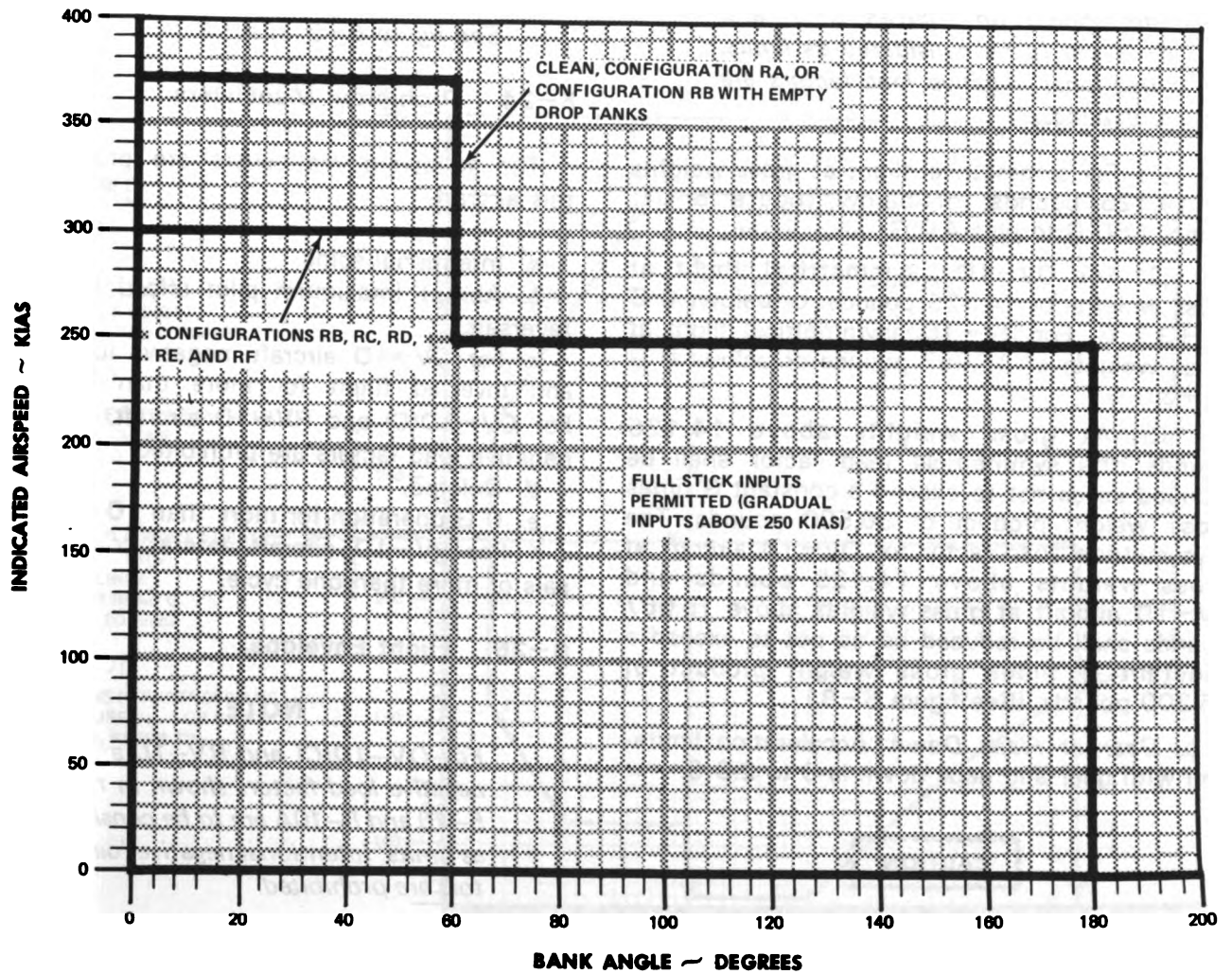

**NOTE**

360° ROLLS ARE PERMITTED TO 250 KIAS IN CONFIGURATION RA AND RB WITH EMPTY DROP TANKS.

B-5-10-D-6-2

Figure 5-6. Rolling Restrictions (Sheet 2 of 2)

**5-22. Acceleration Limits.**

The following paragraphs describe the acceleration limits for gear and flaps up and down, and for symmetrical and asymmetrical flight.

*a. Gear and Flaps Up.*

**NOTE**

*For OV-1D(C) and RV-1D aircraft, negative load factors stated below and shown on figures 5-7 and 5-8 are to be considered as limits. Intentional negative load factors are prohibited.*

(1) For symmetrical flight at gross weights of 14,125 pounds, or below (figure 5-7): Minus 1.60 G to plus 4.0 G.

(2) For OV-1D asymmetrical flight at gross weights of 14,125 pounds, or below: 0 G to +3.2 G. For RV-1D asymmetrical flight at gross weights of 15,067 pounds or below: 0 G to +3.0 G.

(3) At gross weights above 14,125 pounds, the symmetrical load factor shall be reduced so as not to exceed a constant G times gross weight product of 56,500 pounds. The asymmetrical load factor for OV-1D aircraft at gross weights above 14,125 pounds and RV-1D aircraft at gross weights above 15,067 pounds shall be reduced so as not to exceed a constant G times gross weight product of 45,200 pounds. (See figure 5-8.)

*b. Gear or Flaps Down.* Acceleration limitation with gear and flaps down is 0 to 2.0 G.

**CAUTION**

**When flying in turbulence, accelerations due to deliberate maneuvers shall be limited to plus 0.5 to plus 1.5 G to avoid overstressing the aircraft, as a result of the combined effect of maneuvering and gusts.**

**5-23. Landing Sink Speed Limitations.**

The landing sink speed limitations are shown in figure 5-9.

**NOTE**

*Specific attention is directed to the reduced landing sink speed limitation for OV-1D(C) and RV-1D with usable fuel in external tanks. See figure 5-9, sheet 2.*

**5-24. Prohibited Maneuvers.**

The following maneuvers are prohibited in this aircraft.

- a. Intentional spins.*
- b. Abrupt (maximum pilot effort) full control reversals.*
- c. For OV-1D aircraft, negative load factors and inverted flight for more than 5 seconds. For OV-1D(C) and RV-1D aircraft, intentional negative load factors are prohibited.*
- d. Deleted.*
- e. 0 G operation for more than 10 seconds.*
- f. For RV-1D aircraft, lateral control reversals of more than one cycle.*

**5-25. Flight Envelope.**

**NOTE**

*For OV-1D(C) and RV-1D aircraft, negative load factors shown in figures 5-10 and 5-10A are to be considered as limits. Intentional negative load factors are prohibited.*

The OV-1D aircraft operational flight envelope is shown in figure 5-10 and the RV-1D aircraft operational flight envelope is shown in figure 5-10A. The maximum permissible airspeed and load factor at various altitudes are shown based on aircraft gross weight.

All data on page 5-20A/(5-20B Blank) deleted.

# AIRSPEED-LOAD FACTOR

ALTITUDE 5,000 FT  
GROSS WEIGHT 14,125 LBS

AIRSPEED-LOAD FACTOR  
OV-1D  
T53-L-701

G

## EXAMPLE

### WANTED

ASYMMETRICAL G LIMITS  
AT A GIVEN GROSS WEIGHT,  
CONFIGURATION, AND AIRSPEED

### KNOWN

GROSS WEIGHT LESS THAN 14,125 LB  
CONFIGURATION CLEAN  
AIRSPEED 225 KIAS

### METHOD

ENTER INDICATED AIRSPEED HERE  
MOVE RIGHT TO WITHIN  
ROLLING LIMIT LINES  
MOVE DOWN AND READ G  
LIMITS TO BE 0G TO +3.2G

### NOTE

CONFIGURATIONS REFERENCED ARE  
DEFINED IN FIGURE 5-4. FOR GRWT  
ABOVE 14,125 LB, REFER TO  
PARAGRAPH 5-22.

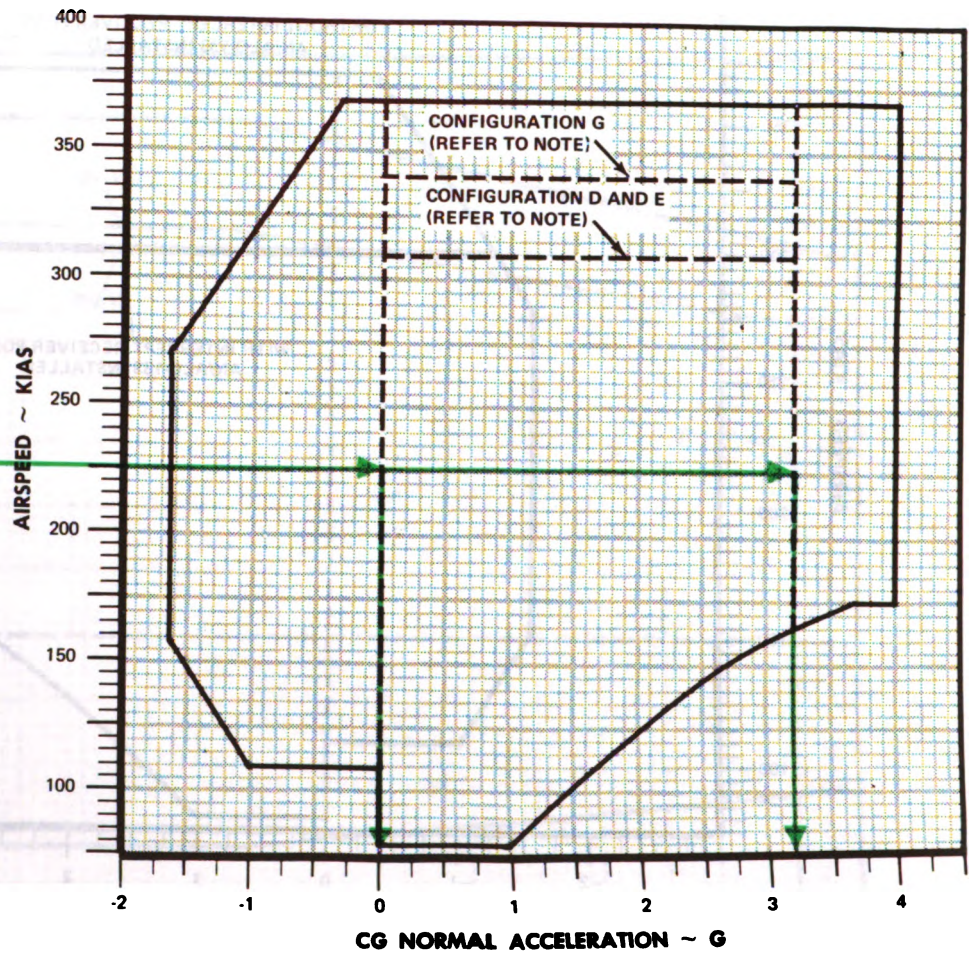

--- ROLLING  
— SYMMETRICAL

G

A-5-10-D-7-1

Figure 5-7. Airspeed-Load Factor Limitations (Sheet 1 of 2)

# AIRSPEED-LOAD FACTOR

ALTITUDE 5,000 FT  
GROSS WEIGHT 14,125 LBS

AIRSPEED -  
LOAD FACTOR  
RV-1D  
T53-L-701

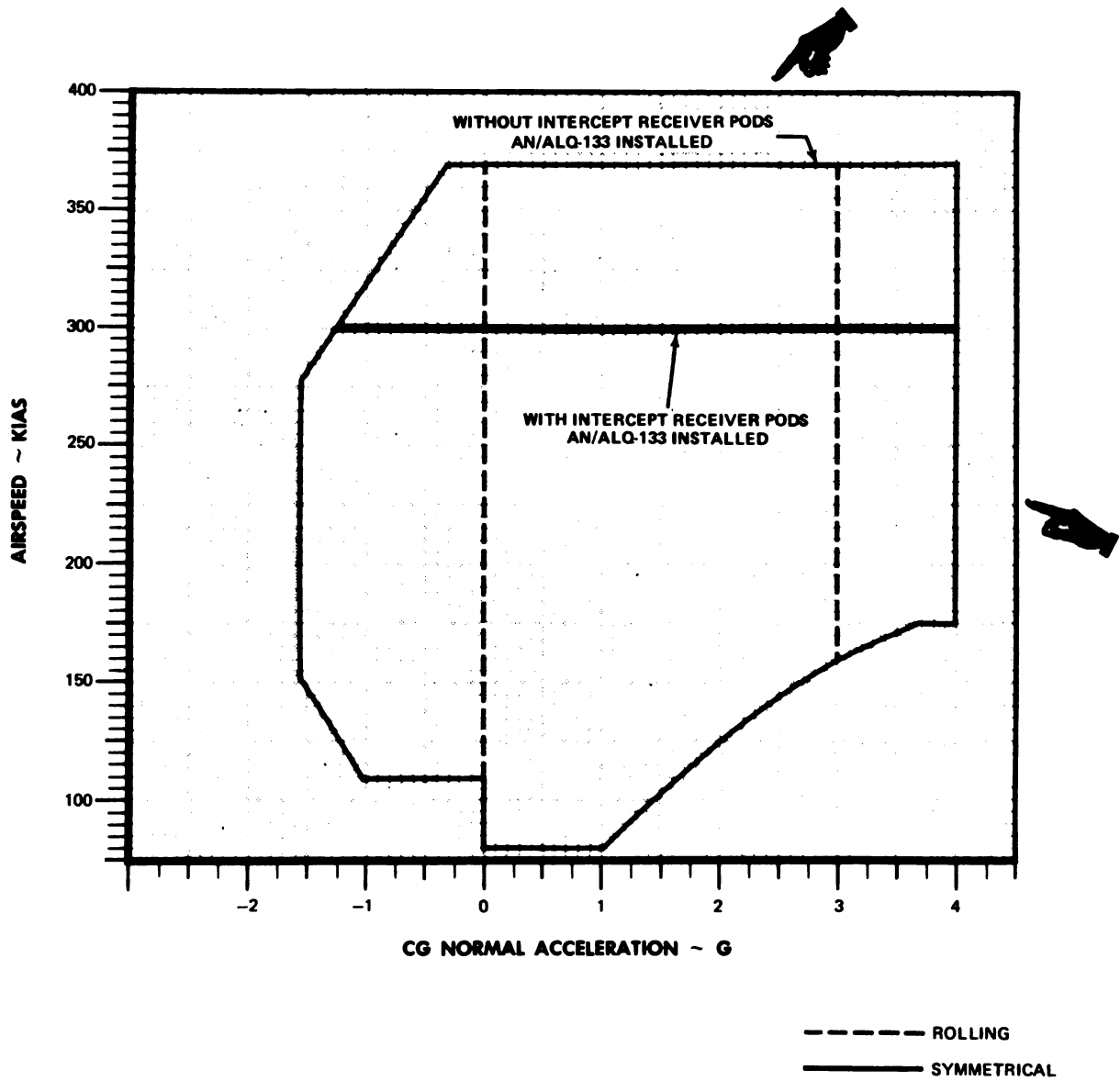

B-5-10-D-7-2

Figure 5-7. Airspeed-Load Factor Limitations (Sheet 2 of 2)

# ACCELERATION-GROSS WEIGHT LIMIT

ACCELERATION-GROSS WEIGHT LIMIT  
OV-1D/RV-1D  
T53-L-701

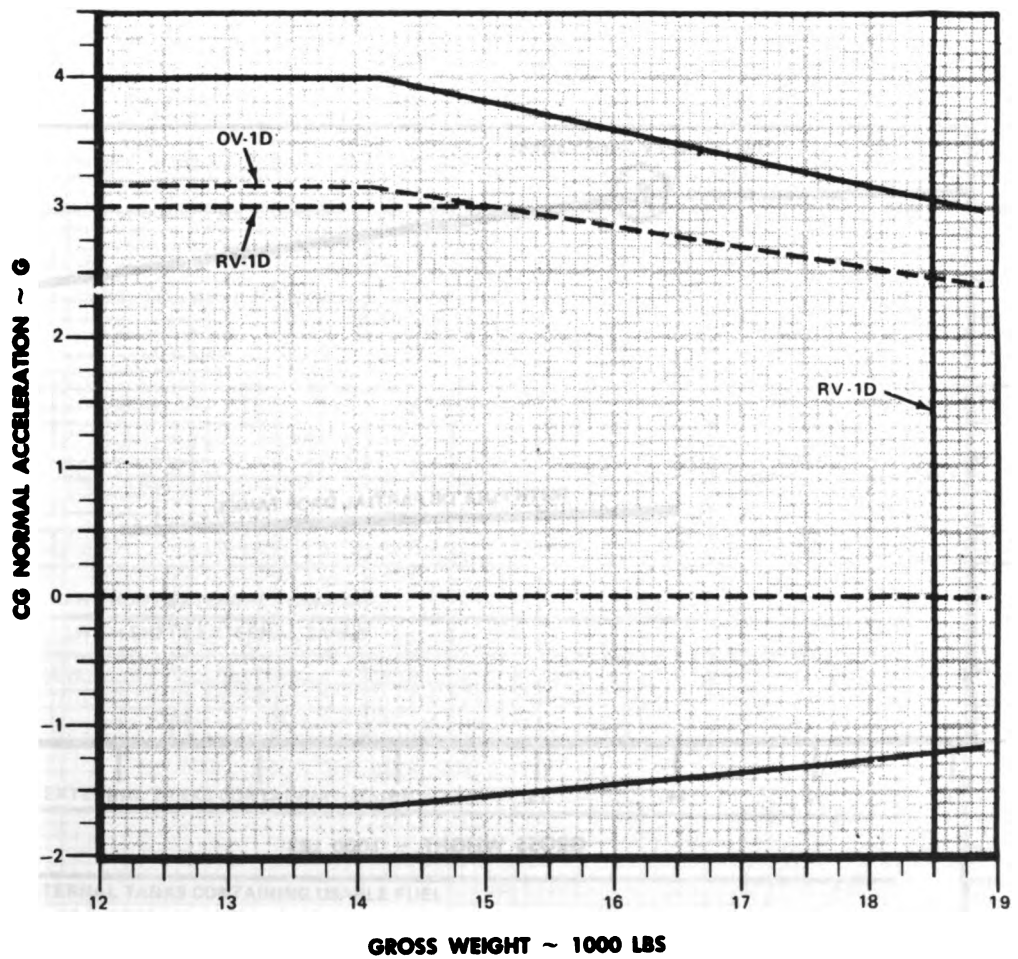

--- ROLLING  
— SYMMETRICAL

A-5-18-D-8

Figure 5-8. Acceleration - Gross Weight Limitations



# LIMIT LANDING SINK SPEED VS GROSS WEIGHT

LIMIT LANDING SINK  
SPEED VS GROSS WEIGHT  
OV-10  
T53-L-701

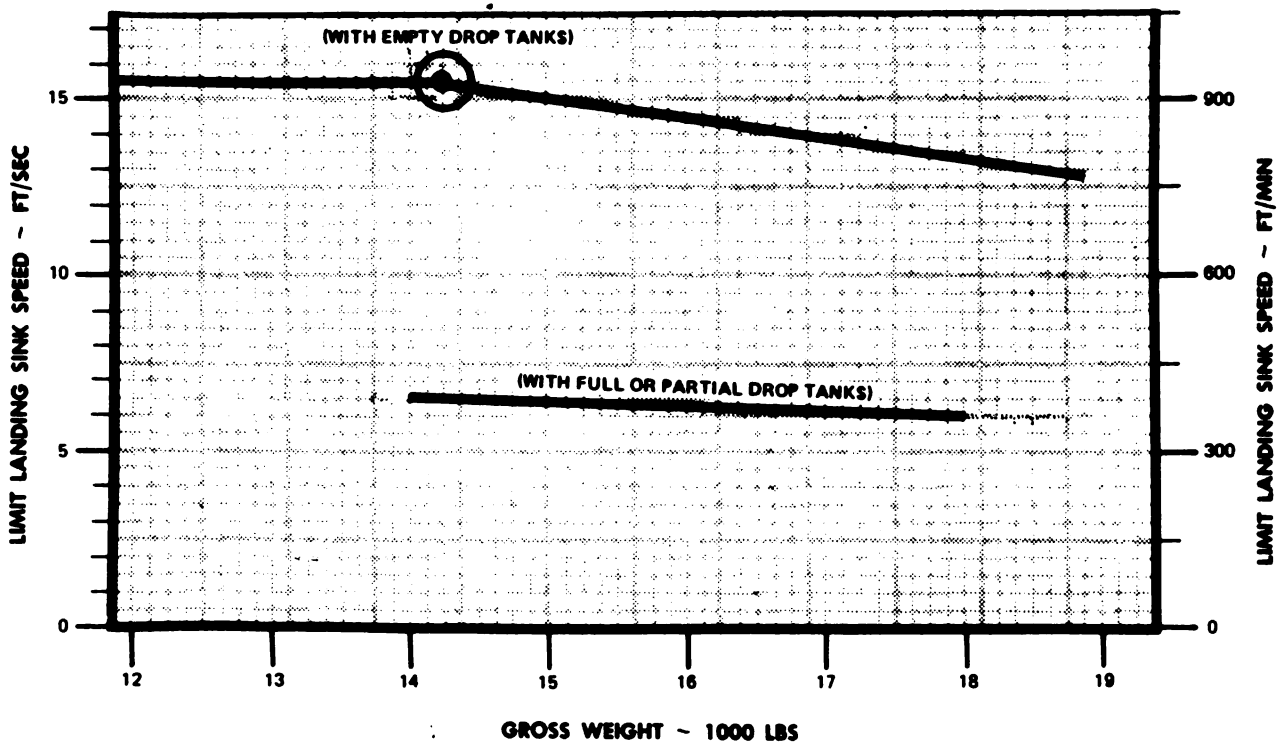

A-5-10-D-9-1

Figure 5-9. Limit Landing Sink Speed vs Gross Weight (Sheet 1 of 2)

# LIMIT LANDING SINK SPEED VS GROSS WEIGHT

LIMIT LANDING SINK SPEED VS GROSS WEIGHT  
OV-1D(C)/ RV-1D  
T53-L-701

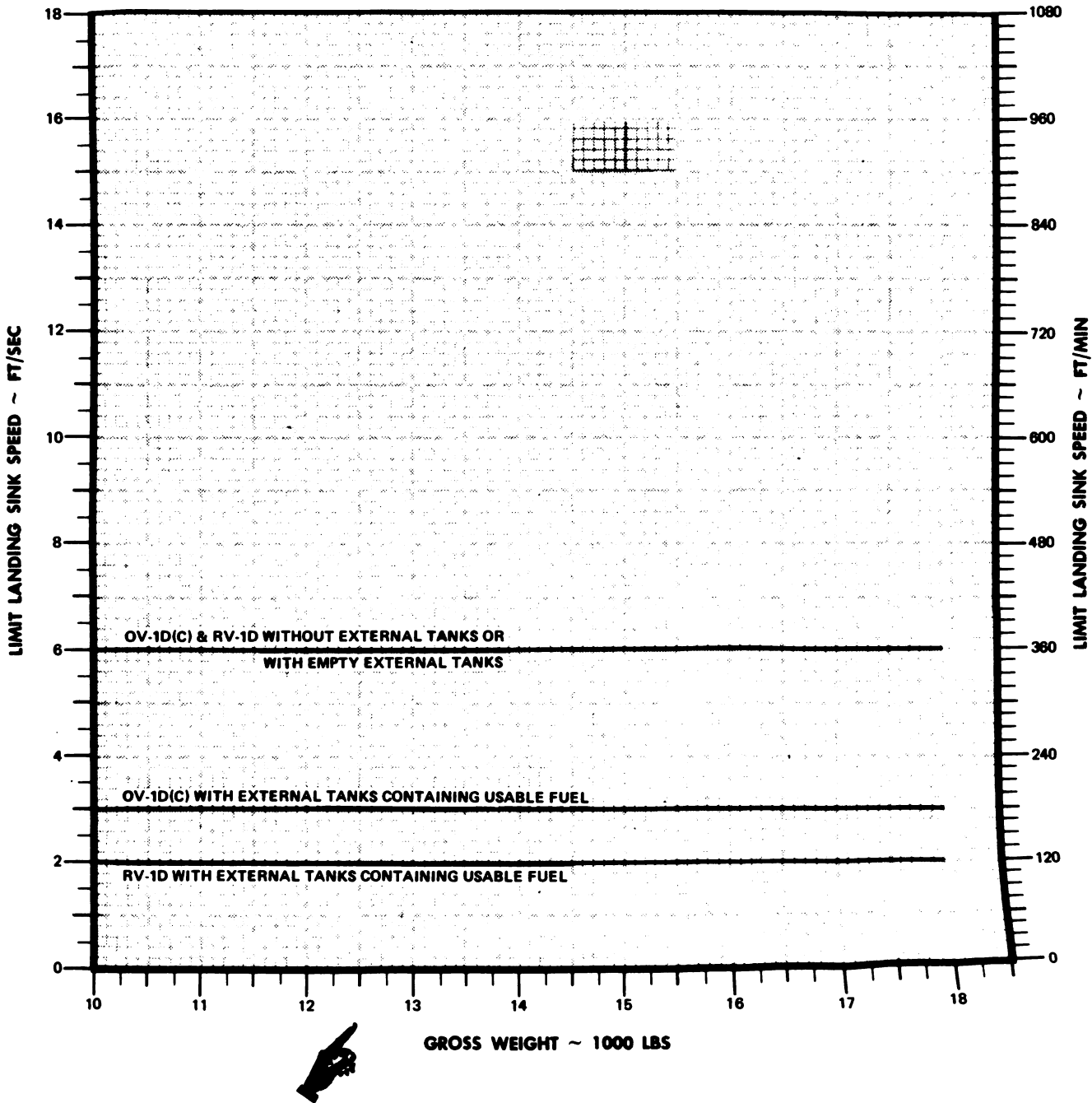

C-5-10-D-9-2

Figure 5-9. Limit Landing Sink Speed vs Gross Weight (Sheet 2 of 2)

# OPERATIONAL FLIGHT ENVELOPE

SYMMETRICAL FLIGHT  
GROSS WEIGHT 14,125 LBS

FLIGHT ENVELOPE  
OV-10  
T53-L-701

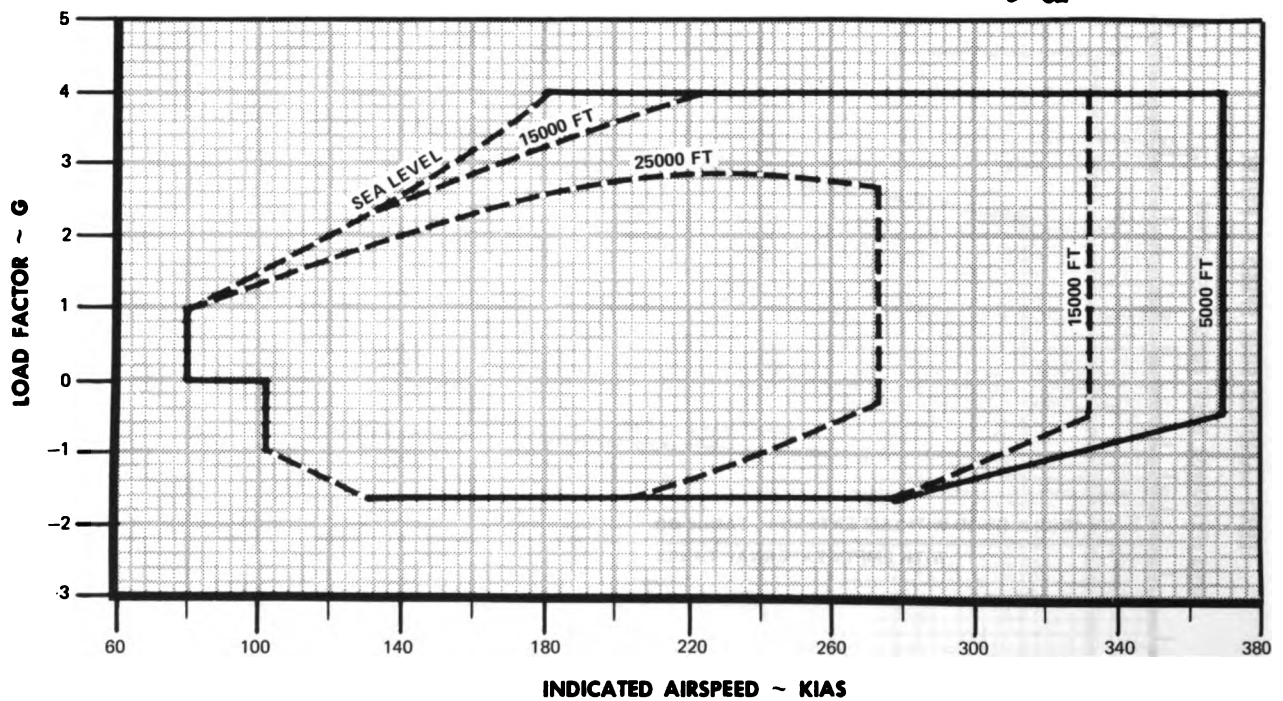

———— STRENGTH BOUNDARY  
- - - - STALL AND BUFFET BOUNDARY

C-5-10-D-10

Figure 5-10. Operational Flight Envelope

# OPERATIONAL FLIGHT ENVELOPE

## SYMMETRICAL FLIGHT

GROSS WEIGHT 14,125 LBS

FLIGHT ENVELOPE  
RV-1D ONLY  
T53-L-701

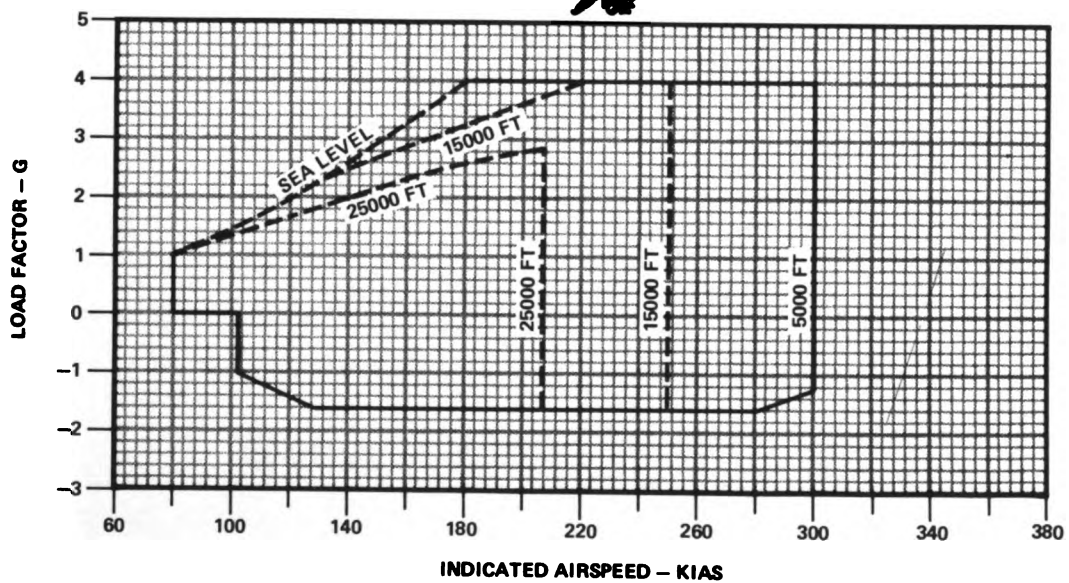

**NOTE:**

USE FOR RV-1D AIRCRAFT WITH INTERCEPT RECEIVER PODS AN/ALQ-133 INSTALLED. WHEN INTERCEPT RECEIVER PODS AN/ALQ-133 ARE NOT INSTALLED USE FIGURE 5-10.

**LEGEND:**

- STRENGTH BOUNDARY
- - - - - STALL AND BUFFET BOUNDARY

A-5-10-D-101

**R** Figure 5-10A. Operational Flight Envelope



## SECTION VII. ENVIRONMENTAL RESTRICTIONS

### **5-26. Flight Under IMC (Instrument Meteorological Conditions).**

This aircraft is qualified for flight under instrument conditions. Refer to Chapter 8 for techniques and procedures to be followed under IMC.

### **5-27. Wind Limitations.**

Refer to Chapter 7 for crosswind limitations to be observed during takeoff and landing.



## CHAPTER 6

# WEIGHT/BALANCE AND LOADING

### SECTION I. GENERAL

#### 6-1. Extent of Coverage.

This chapter contains sufficient instructions and data so that an aviator, knowing the basic weight and moment of the aircraft, can compute any combination of weight and balance.

#### 6-2. Class.

Army Models OV/RV/1D are in Class 1. Additional directives governing weight and balance of Class 1 aircraft forms and records are contained in

AR 95-16, TM 55-1500-342-23, and DA PAM 738-751.

#### 6-3. Aircraft Compartments and Stations.

The aircraft compartments and stations diagram (figure 6-1) identifies the aircraft compartments and defines the station of each. The reference datum and butt line are also indicated. The purpose of this diagram is to aid personnel in the computation of aircraft weight/balance and loading.

### SECTION II. WEIGHT AND BALANCE

#### 6-4. Purpose.

The purpose of this section is to provide appropriate information for the computation of weight and balance for loading an individual aircraft. The data to be inserted on charts and forms are applicable only to the individual aircraft, the serial number of which appears on the title page of the various forms and charts that remain with the aircraft. The charts and forms may change from time to time, but the principle on which they are based will not change.

#### 6-5. Charts and Forms.

The standard system of weight and balance control requires the use of different charts and forms. They are identified as follows:

a. Chart C-Basic Weight and Balance Record, DD Form 365C.

b. Form F-Weight and Balance Clearance Form, DD Form 365F.

#### 6-6. Responsibility.

The aircraft manufacturer inserts all aircraft identifying data on the title page of the various charts and forms. He completes one sample Weight and Balance Clearance Form F, if applicable, at the time of delivery. This record is the basic weight and balance data of the aircraft at delivery. All subsequent changes in weight and balance are compiled by the weight and balance technician.



All data on page 6-2 and figure 6-1 sheet 1 of 2 deleted.

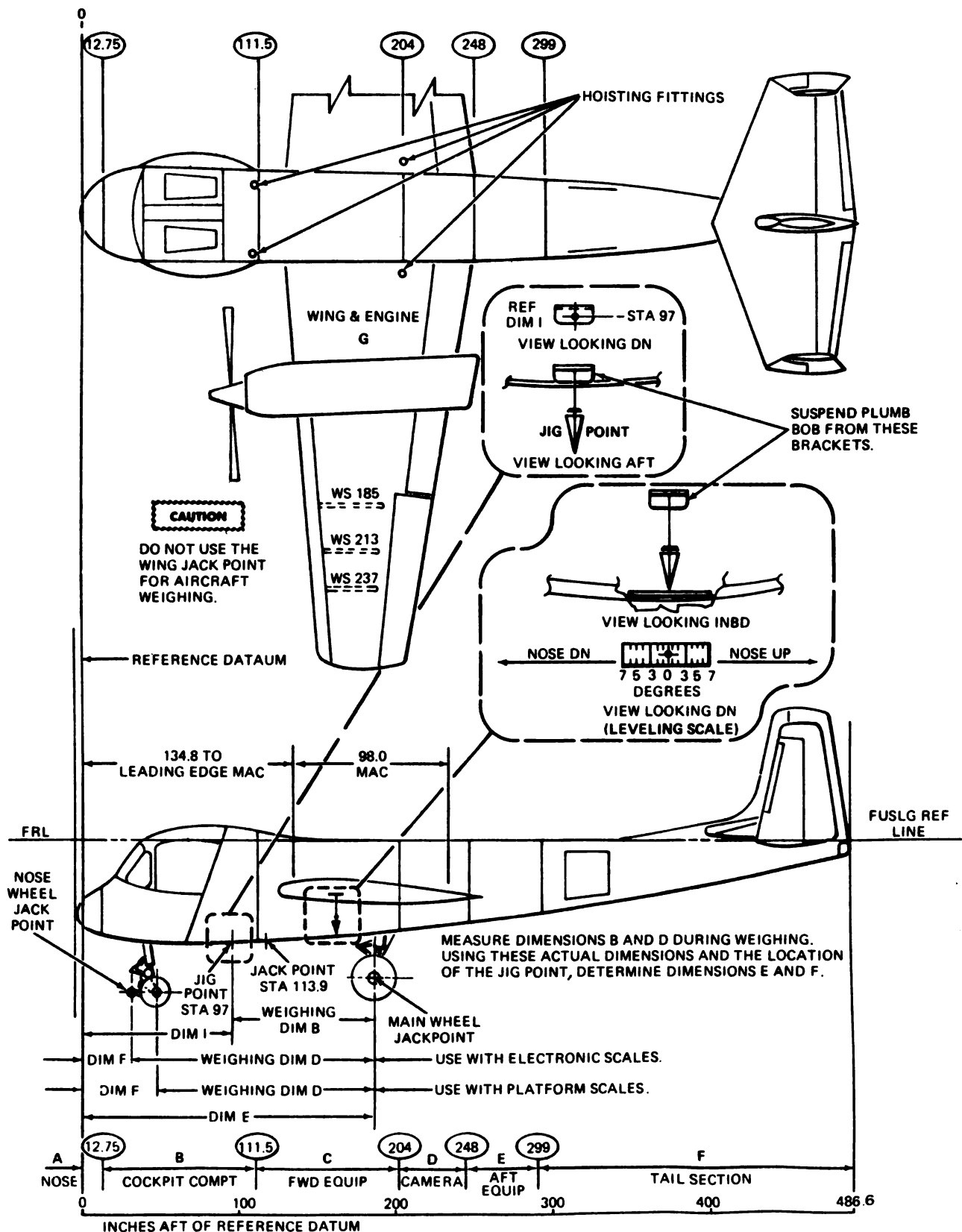

Figure 6-1. Aircraft Compartments and Station Diagram

C 6-10-D-12

### 6-7. Aircraft Weighings.

The aircraft must be weighed periodically, as required by TM 55-405-9, or when:

- a. The pilot reports unsatisfactory flight characteristics (nose or tail heaviness).
- b. Major modifications or repairs are made.
- c. The basic weight data contained in the records are suspected to be in error.

### 6-8. Weight Definitions.

a. *Basic Weight.* The basic weight of an aircraft varies with the standard modifications and changes in the fixed operating equipment. The term basic weight, when qualified with a word indicating the type of mission such as Basic Weight for Combat, Basic Weight for Ferry, etc., may be used in conjunction with directives stating what the equipment shall be for these missions. For example, extra fuel tanks and various items of equipment installed for long range ferry flights, which are not normally carried on combat missions, will be included in Basic Weight for Ferry but not in Basic Weight for Combat.

b. *Operating Weight.* The operating weight of an aircraft is the basic weight plus those variable items that remain substantially constant for the type mission. These items include oil, crew, crew's baggage, and emergency and extra equipment that may be required.

c. *Gross Weight.* The gross weight is the total weight of an aircraft and its contents.

(1) *Takeoff Gross Weight.* The takeoff gross weight is the operating weight plus the variable and expendable load items that vary with the mission.

(2) *Landing Gross Weight.* The landing gross weight is the takeoff gross weight minus the expended load items.

### 6-9. Balance Definitions.

a. *Reference Datum.* The reference datum is an imaginary vertical plane from which all horizontal distances are measured for balance purposes. Diagrams of each aircraft show this reference datum as balance station zero.

b. *Arm.* Arm, for balance purposes, is the horizontal distance in inches from the reference datum to the center of gravity of the item. Arms may be determined from the aircraft compartment and station diagram (figure 6-1).

c. *Moment.* Moment is the weight of an item multiplied by its arm. Moment divided by a constant is generally used to simplify balance calculations by reducing the number of digits. For this aircraft, inches and moment/1,000 have been used.

d. *Average Arm.* Average arm is the arm obtained by adding the weights and adding the moments of a number of items and dividing the total moment by the total weight.

e. *Basic Moment.* Basic moment is the sum of the moments of all items making up the basic weight. When using data from an actual weighing of an aircraft, the basic moment is the total moment of the basic aircraft with respect to the reference datum.

f. *Center of Gravity (CG).* The center of gravity is the point about which an aircraft would balance if suspended. Its distance from the reference datum is found by dividing the total moment by the gross weight of the aircraft.

g. *CG Limits.* CG limits are the extreme forward and aft points that the CG can have without making the aircraft unsafe to fly. The CG of the loaded aircraft must be within these limits at takeoff, in the air, and on landing. In some cases, separate takeoff and landing limits may be specified.

### 6-10. Chart C-Basic Weight and Balance Record.

Chart C (DD Form 365C) is a continuous history of the basic weight and moment resulting from structural and equipment changes in service. At all times, the last weight and moment/1,000 entry is considered the current weight and balance status of the basic aircraft. A sample Chart C, Basic Weight and Balance DD Form 365C, is shown in figure 6-2.

CHART C—BASIC WEIGHT AND BALANCE RECORD						FOR USE IN T.O. 11B 40 & AN 611B 40					
CONTINUOUS HISTORY OF CHANGES IN STRUCTURE OR EQUIPMENT AFFECTING WEIGHT AND BALANCE						FR-1					
AIRCRAFT NO.		SERIAL NO.		FR-1		1					
OV-10		68-16990									
DATE	ITEM NO.	DESCRIPTION OF ARTICLE OR MODIFICATION	WEIGHT CHANGE						RUNNING TOTAL BASIC AIRPLANE		
			ADDED		REMOVED		WEIGHT	MOMENT	WEIGHT	MOMENT	Safe (lb.)
IN	OUT		WEIGHT	ARM (in.)	WEIGHT	ARM (in.)	WEIGHT	MOMENT	WEIGHT	MOMENT	Safe (lb.)
1 1 69		DELIVERY BASIC WEIGHT - ASSUMED						9950	1634.8	154.3	
2 20 69	F-5	AERO 1A SWAY BRACES (2 SETS)-INBOARD				44.62	7.1				
	F-6	AERO 65A BOMB RACK (2)-INBOARD				30.163	4.9				
	F-8	PYLON (2)-INBOARD				60.170	10.2				
		TOTALS				134.166	22.2	9816	1612.6	164.3	
2 21 69	E-32	AEM-68 RECEIVER-FILTER ADAPTER & MOUNT	3	284	0.8			9819	1613.4	164.3	
5 1 69		CALCULATED BASIC WEIGHT						9819	1613.4	164.3	
5 1 69		AS WEIGHED						9812	1605.1	163.6	

SAMPLE

DD FORM 1089 SEP 64 365C

6 10-D-2

Figure 6-2. Sample Form DD 365C, Chart C-Basic Weight and Balance Record

**6-11. Weight and Balance Clearance Form F, DD 365F.**

Form F is a summary of the actual disposition of load in the aircraft. It records the balance status of the aircraft step by step. It serves as a work sheet on which to record weight and balance calculations and any corrections that must be made to insure that the aircraft will be within weight and CG limits. Form F is furnished in expendable pads, or as separate sheets, which can be replaced when exhausted. An original and carbon are prepared for each loading. The original sheets, carrying the signature of responsibility, can be removed to serve as certificates of proper weight and balance as required by existing clearance directives. The duplicate copy must remain in the aircraft for the duration of

the flight. On a cross-country flight, this aids the weight and balance technician at refueling bases and stopover stations. There are two versions of this form: TRANSPORT and TACTICAL. They were designed to provide for the respective loading arrangement of these two type aircraft. The general use and fulfillment of either version is the same. A sample Form F is shown in figure 6-3. Specific instructions for filling out the version for TACTICAL type aircraft are as follows:

a. Insert the necessary identifying information at the top of the form. In the blank spaces of the LIMITATIONS table, enter the gross weight and CG restrictions.

b. Ref 1: Enter the aircraft basic weight and moment/1,000. Obtain these figures from the

WEIGHT AND BALANCE CLEARANCE FORM F TACTICAL (USE REVERSE FOR TRANSPORT MISSIONS)						FOR USE IN T.O. 1-18-60 AN 01-10-60 & TM 55-60-9		
DATE 18 NOVEMBER 76	AIRCRAFT TYPE OV 1D	PILOT FT. RUCKER		HOME STATION FT. RUCKER				
MISSION/TRIP/FLIGHT/NO TRAINING	SERIAL NO 69-16997	TC FT. RUCKER		PILOT J.V. MURRAY, CPT				
REMARKS FULL MAIN TANKS DROP TANKS REMOVED	REF	ITEM		WEIGHT		INDEX OR MOM/1000		
	1	BASIC AIRCRAFT (From Chart C)		11287	1843.3			
	2	OIL 5.0 (Ref 2)		38	5.3			
	3	LESS DROP TANKS		274	48.0			
	DISTRIBUTION OF LOAD							
	COMPT	CRW NO	WEIGHT	BAGGAGE	CARGO AND MISC			
	B	2	400			400	24.4	
	COMPUTER PLATE NO. (If used)							
	Pertinent instructions to the pilot for shifting load and crew during takeoff and landing should be noted above.				4	OP	11451	1825.0
	CORRECTIONS (Ref 11)				5	ROUNDS		
					CALIBER			
COMPT	ITEM	WEIGHT	INDEX MOM					
CHANGES (+ or -)								
6 FORWARD								
7 BULB IN (Gal.)				1930	310.7			
8 BOMB BAY (Gal.)								
9 EXTERNAL (Gal.)								
10 WATER IN FLUID (Gal.)								
11 JATO OR PATO								
TOTAL WEIGHT REMOVED								
TOTAL WEIGHT ADDED								
NET DIFFERENCE (Ref 11)								
LIMITATIONS								
1 GROSS WT. TAKEOFF (B.)		1 GROSS WT. LANDING (B.)						
18,900		18,900						
2 PERMISSIBLE C. G. TAKEOFF		2 PERMISSIBLE C. G. LANDING						
FROM 156.4"		FROM 156.4"						
TO 165.2"		TO 165.2"						
15 ESTIMATED LANDING CONDITION				11934	1902.5			
16 ESTIMATED LANDING C. G. IN % M. A. C. OR IN.				159.4"				
COMPUTED BY (Signature)								
WEIGHT AND BALANCE AUTHORITY (Signature)								
PILOT (Signature)								

DD FORM 1 SEPT 54 365F

D 6-10-D-3

Figure 6-3. Sample Form DD 365F, Weight and Balance Clearance Form F

last entry on the Chart C, Basic Weight and Balance Record.

c. Ref 2: Enter the amount, weight, and moment/1,000 for oil. Section V of this chapter contains engine oil weight and balance data.

d. Ref 3: Using the compartment letter designations as shown on the aircraft compartment

and station diagram (figure -1), enter the number, weight, and moment/1,000 of the crew at their takeoff positions, baggage, cargo, and miscellaneous items. Use actual crew weights, if available. Section III of this chapter contains mission equipment weight and balance data. Enter the total weight and moment/1,000 of each compartment in the proper column.

e. Ref 4: Enter the sum of the weights and moment/1,000 for Ref 1 through Ref 3 to obtain OPERATING WEIGHT.

f. Ref 5: Not applicable.

g. Ref 6: Enter the size, distribution, and weight of all external stores, if applicable. Section III of this chapter contains external stores weight and balance data.

h. Ref 7: Enter the number of gallons, weight, and moment/1,000 for takeoff fuel. The weight of fuel used for warmup and taxiing should not be included. When external fuel is carried, make the appropriate entries in the space provided. See figure 6-5 for fuel weights and moments.

i. Ref 8: Not applicable.

j. Ref 9: Not applicable.

k. Ref 10: Enter the sum of the weights for Ref 4 through Ref 9 opposite TAKEOFF CONDITION (uncorrected). At this point, if not already done, calculate and enter the moment/1,000 values for Ref 1 through Ref 10 inclusive.

l. Check the weight figure opposite Ref 10 against the GROSS WT. TAKEOFF in the LIMITATIONS table. Check the moment/1,000 figure opposite Ref 10 against the figure 6-6 to ascertain that the indicated CG is within allowable limits.

m. If changes in the amount or distribution of load are required, indicate necessary adjustments by proper entries in the CORRECTIONS table at the left hand side of the form. Enter a brief description of the adjustments made in the column marked ITEM. Add all the weight and moment decreases and insert the totals in the space opposite TOTAL WEIGHT REMOVED. Add all the weight and moment increases and insert

the totals in the space opposite TOTAL WEIGHT ADDED. Subtract the smaller from the larger of the two totals and enter the difference (with applicable + sign or - sign) opposite NET DIFFERENCE. Transfer the NET DIFFERENCE figures to the space opposite Ref 11.

n. Ref 12: Enter the sum of, or the difference between, Ref 10 and Ref 11. Recheck to assure that these figures do not exceed allowable limits.

o. By reference to figure 6-6 determine the takeoff CG position. Enter the CG value in the space provided opposite TAKEOFF CG.

p. Ref 14: Estimate the weight of fuel (including external fuel tanks) to be expended before landing. Enter figures together with moment/1,000 (determined from figure 6-5) in the space provided.

#### NOTE

*Do not consider reserve fuel as expended when determining ESTIMATED LANDING CONDITION.*

q. Ref 15: Enter the difference in weights and moment/1,000 between Ref 12 and the total of Ref 14.

r. Ref 16: By again referring to figure 6-6, determine the estimated landing CG position. Enter this figure opposite ESTIMATED LANDING CG.

s. The necessary signatures shall be entered at the bottom of the form.

### SECTION III. MISSION EQUIPMENT

#### 6-12. Purpose.

This section contains tabular listings (tables 6-1 through 6-6) of the type, weight, and moment/1,000 for the various items of mission equipment that can be installed in the aircraft. These tables shall be used to determine weights

and moments/1,000 necessary for entry on the weight and balance clearance form. Mission equipment configuration shall be determined, the weight and moment/1,000 of the items installed shall be calculated, and the totals entered on the weight and balance clearance form, as applicable.

Table 6-1. External Stores Loading

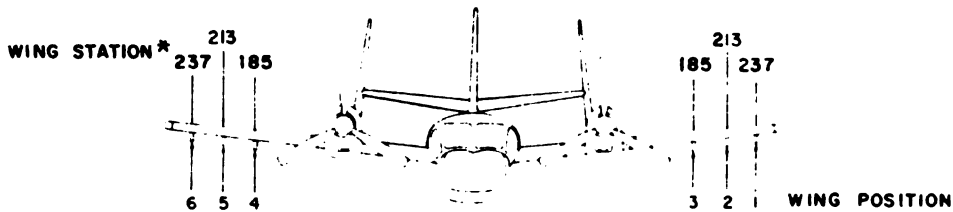

6-10-D-7

Item	Weight Per Aircraft	Horizontal Arm	Moment 1,000	Wing Position					
				6	5	4	3	2	1
OV-1D:									
Drop Tanks (150 GAL)									
Sargent Fletcher (2)	284	175	49.70	0	0	1	1	0	0
Aero IC (2)	274	175	47.95	0	0	1	1	0	0
or									
Sargent Fletcher (1)	142	175	24.85	0	0	0	1	0	0
Aero IC (1)	137	175	23.98	0	0	0	1	0	0
Drop Tank/IRCM									
Pod (AN/ALQ-147A(V)2)**	425	174.4	74.12	0	0	1	0	0	0
or									
Drop Tank/IRCM									
Pod (AN/ALQ-147A(V)2)**	425	174.4	74.12	0	0	0	1	0	0
Sargent Fletcher (1)	142	175	24.85	0	0	1	0	0	0
or									
Aero IC (1)	137	175	23.98	0	0	1	0	0	0
Aero 65A-1 Racks (2)	135	166	22	0	0	1	1	0	0
IRCM Pod (AN/ALQ-147A(V)1)*	236.7	157.7	37.3	0	0	0	0	0	1
Aero 15C Rack	29	167	4.84	0	0	0	0	0	1
IRCM Pod (AN/ALQ-147A(V)1)*	236.7	157.7	37.3	1	0	0	0	0	0
Aero 15C Rack	29	167	4.84	1	0	0	0	0	0
Flasher Pod (LS-59A)	241	165	39.77	0	1	0	0	0	0
Aero 15C Rack	29	167	4.84	0	1	0	0	0	0

Table 6-1. External Stores Loading (cont)

Item	Weight Per Aircraft	Horizontal Arm	Moment 1,000	Wing Position						
				6	5	4	3	2	1	
RV-1D: Drop Tanks – Empty (150 GAL)										
Sargent Fletcher (1)	142	175	24.85	0	0	0	1	0	0	
Drop Tank/IRCM										
Pod (AN/ALQ-147A(V)2)**	425	174.4	74.12	0	0	1	0	0	0	
Aero 65A-1 Racks (2)	135	166	22.41	0	0	1	1	0	0	
Intercept Receiver Pod (AN/ALQ-133) (2)	694	165.7	115.0	1	0	0	0	0	1	

NOTE: \*Pod weight shown with 12 gallons (78 LB) of JP-4 (at 6.5 LB/GAL).  
 Empty pod weight is 156.7 LB, moment/1000 = 26.70.  
 \*\*Weight shown is empty weight (less fuel).

Table 6-2. Camera Systems Loading

Item	Weight	Arm	Moment 1,000
Camera - nose compartment - forward: KA-60 with magazine and 250 feet of film	33	3.2	0.11
Cameras - camera compartment - midsection:			
KA-76-1 3/4 inch lens with cassettes and 250 feet of film	50	220	11.00
KA-76-3 inch lens with cassettes and 250 feet of film	57	220	12.54
KA-76-6 inch lens with cassettes and 250 feet of film	51	220	11.22
KA-76-12 inch lens with cassettes and 250 feet of film	68	220	14.96
Camera - camera compartment - aft section: KA-60 with magazine and 250 feet of film	33	240	7.92
Miscellaneous: LS-59 flasher pod	241	165	39.77



Table 6-3. Typical Service Loading Conditions OV-1D Aircraft

Item	Arm	Observation Surveillance		Night Photo		Maximum Gross Weight	
		Weight	Moment 1,000	Weight	Moment 1,000	Weight	Moment 1,000
Equipment already installed: (See table 6-6A)							
Pilot (less chute)	61.0	200	12.20	200	12.20	200	12.20
Airborne systems specialist (less chute)	61.0	200	12.20	200	12.20	200	12.20
Personal effects of 2 crew	346.0					40	13.84
Oil (at 7.5 LB/GAL)(Note 1)	140.0	38	5.32	38	5.32	38	5.32
Fuel (JP-4 AT 6.5 LB/GAL) Main tank (297 GAL)	161.0	1,930	310.73	1,930	310.73	1,930	310.73
External fuel (300 GAL) 150 GAL drop tanks (2)	162.5 175.0					1,950 284	316.88 49.70
LS-59 flasher pod	165.2			241	39.81	241	39.81
KA-60 camera, magazine, and 250 FT film (fwd)	3.2	33	0.11			33	0.11
KA-76-3 inch lens camera, cassettes, and 250 FT film (mid)	220.0	57	12.54				
KA-76-12 inch lens camera, cassettes, and 250 FT film (aft)	220.0					68	14.96
KA-60 camera, magazine, and 250 FT film (aft)	240.0	33	7.92			33	7.92
IR suppressor Delta	185.6	112.0	20.78	112.0	20.78	112.0	20.78
IRCM pod (AN/ALQ-147A(V) 1) (Note 2)	157.7	236.7	37.3	236.7	37.3	236.7	37.3
M-130 general purpose dispenser module	296.6	25.31	7.1	25.31	7.1	25.31	7.1
Full flare load (See table 6-6A)		25.80	8.22	25.80	8.22	25.80	8.22
<b>TOTAL (See table 6-6A)</b>		<b>2,890.8</b>	<b>434.4</b>	<b>3,008.8</b>	<b>453.7</b>	<b>5,416.8</b>	<b>857.07</b>

- NOTES: 1. Weight and moment/1000 shown are for use of oil MIL-L-7808 at 7.5 lb/gal. When oil MIL-L-23699 is used, weight and moment/1000 should be based on 8.4 lb/gal. See table 6-7.
2. If IRCM pod (AN/ALQ-147A(V)2) is installed in lieu of a drop tank, use a weight of 425 lbs and moment/1000 of 74.12. See table 6-1.

Table 6-3. Typical Service Loading Conditions OV-1D Aircraft (Cont.)

Item	Arm	Observation Surveillance		Night Photo		Maximum Gross Weight	
		Weight	<u>Moment</u> 1,000	Weight	<u>Moment</u> 1,000	Weight	<u>Moment</u> 1,000
SLAR (AN/APS-94E) equipment (See table 6-5)	92.1	809.6	74.6	809.6	74.6	809.6	74.6
<b>TOTAL PLUS SLAR (AN/APS-94E)</b>		<b>3,700.4</b>	<b>509.0</b>	<b>3,818.4</b>	<b>528.3</b>	<b>6,226.4</b>	<b>931.67</b>
SLAR (AN/APS-94F) equipment (See table 6-5)	104.4	995.4	103.88	995.4	103.88	995.4	103.88
<b>TOTAL PLUS SLAR (AN/APS-94F)</b>		<b>3,886.2</b>	<b>528.28</b>	<b>4,004.2</b>	<b>557.58</b>	<b>6,412.2</b>	<b>960.95</b>
IR equipment (See table 6-6)	134.0	602.6	80.67	602.6	80.67	602.6	80.67
<b>TOTAL PLUS IR</b>		<b>3,493.4</b>	<b>515.1</b>	<b>3,611.4</b>	<b>534.37</b>	<b>6,019.4</b>	<b>937.74</b>

- NOTES: 1. Weight and moment/1000 shown are for use of oil MIL-L-7808 at 7.5 lb/gal. When oil MIL-L-23699 is used, weight and moment/1000 should be based on 8.4 lb/gal. See table 6-7.
2. If IRCM pod (AN/ALQ-147A(V)2) is installed in lieu of a drop tank, use a weight of 425 lbs and moment/1000 of 74.12. See table 6-1.

**Table 6-4. Typical Service Loading Conditions RV-1D Aircraft**

Item	Arm	Observation Surveillance		Maximum Gross Weight	
		Weight	Moment 1,000	Weight	Moment 1,000
Pilot (less chute)	61.0	200	12.20	200	12.20
Airborne systems specialist (less chute)	61.0	200	12.20	200	12.20
Personal effects of 2 crew	346.0			40	13.84
Oil (at 7.5 LB/GAL) (Note 1)	140.0	38	5.32	38	5.32
Fuel (JP-4 at 6.5 LB/GAL)					
Fuel in main tank (297 GAL)	161.0	1,930	310.73	1,930	310.73
Drop tank (1 each)	175.0			142	24.85
IRCM pod (AN/ALQ-147A(V)2) (1 each)	174.4			425	74.12
Fuel in 1 each drop tank and 1 each IRCM pod (AN/ALQ-147A(V)2) (300 GAL)	162.5			1,950	316.88
IR suppressor	185.6	112	20.78	112	20.78
M-130 general purpose dispenser module. (See table 6-6A)	296.6	25.31	7.1	25.31	7.1
Full flare load	318.7	25.80	8.22	25.80	8.22
<b>TOTAL</b>		<b>2531.11</b>	<b>376.55</b>	<b>5088.11</b>	<b>806.24</b>

**NOTE 1.** *Weight and moment/1000 shown are for use of oil MIL-L-7808 at 7.5 lb/gal. When oil MIL-L-23699 is used, weight and moment/1000 should be based on 8.4 lb/gal. See table 6-7.*

Table 6-5. Typical Service Loading SLAR Equipment Installation

Item	Arm	Weight	<u>Moment</u> 1,000
AN/APS-94E:			
Recorder-processor viewer RO-495/U	28.2	108.0	3.046
Equipment rack MT-4015/APS-94D	33.0	16.8	0.554
Sweep generator SG-1127/APS-94E	35.0	44.0	1.540
Radar set control C-7645/APS-94D	41.0	10.0	0.410
Antenna AS-2199/APS-94D	86.0	377.0	32.422
Radar signal processor CM-374/APS-94D	130.0	97.4	12.662
Receiver Transmitter RT-899/APS-94D	157.0	92.9	14.585
Interconnecting Box J-2794/APS-94D	188.0	12.0	2.256
Waveguides (6)	146.0	3.8	0.555
Pallet	187.0	5.9	1.103
Pallet	126.0	6.98	0.880
Pallet	158.8	6.4	1.106
Fitting	40.0	2.7	0.108
Fitting	144.0	2.1	0.302
Fairing	40.0	3.8	0.152
Fairing	144.0	3.8	0.547
Jumper cables	151.6	16.04	2.426
<b>TOTAL</b>	<b>92.1</b>	<b>809.6</b>	<b>74.564</b>



Table 6-5. Typical Service Loading SLAR Equipment Installation (Cont.)

Item	Arm	Weight	Moment/1000
<b>AN/APS-94F:</b>			
Recorder-processor viewer RO-495/U	28.2	108.0	3.046
Equipment rack MT-4015/APS-94D	33.0	16.8	0.554
Sweep generator SG-1127/APS-94E	35.0	44.0	1.540
Radar set control C-7645/APS-94D	41.0	10.0	0.410
Antenna AS-3322/APS-94F	85.7	421.0	36.080
Radar signal processor CM-481/APS-94F	187.0	96.8	18.102
Receiver transmitter RT-1283/APS-94F	157.0	148.0	23.236
Interconnecting box J-2794A/APS-94D	188.0	15.0	2.820
Power supply/mount PP-7508/APS-94F	157.0	38.3	6.013
Waveguide pressurization system HD-1067/APS-94F	121.0	5.9	0.714
Waveguides (5)	146.0	3.8	0.555
Pallets	155.5	10.9	1.695
Fairing (fwd)	40.0	3.8	0.152
Fairing (aft)	144.0	3.8	0.547
Fitting (fwd)	40.0	2.7	0.108
Fitting (aft)	144.0	2.1	0.302
<b>AN/AKT-18B:</b>			
Video encoder KY-865/AKT-18B	136.0	37.0	5.032
Encoder mount MT-6016	136.0	1.0	0.136
Radio receiver RT-1288/ARC-164(V)	121.0	16.0	1.936
DDL mount MT-6017	121.0	5.0	0.605
Data link control C-10546/AKT-18B	54.0	1.5	0.081
Radio set control C-10547/ARC-164(V)	55.0	4.0	0.220
<b>TOTAL</b>	<b>104.4</b>	<b>995.4</b>	<b>103.884</b>

**Table 6-6. Typical Service Loading IR (AN/AAS-24) Equipment Installation**

Item	Arm	Weight	Moment 1,000
Receiver infrared R-1615( )	160	112.0	17,920
Detect set subassembly MX-8357( )	180	20.4	3,672
Recorder group infrared OA-8511( )	125	123.6	15,450
Power supply PP-6270( )	191	59.0	11,269
Rotary compressor HD-841( )	118	28.0	3,304
Converter subassembly MX-8358( )	128	33.4	4,275
Video converter CV-2666( )	186	62.8	11,680
Indicator control group OK-138( )	38	101.4	3,838
Shock mount base MT-4157( )	180	12.4	2,232
Shock mount base MT-4158( )	128	3.3	422
Shock mount base MT-4159( )	186	6.0	1,116
Electrically heated recorder blanket MX-8539( )	125	13.0	1,625
Optical filters (5) IP-970( )	32	3.0	96
Forward equipment pallets and tracks	164	20.9	3,428
Fuselage forward hole cover	40	1.4	56
Fuselage aft hole cover	144	2.0	288
<b>TOTAL</b>	<b>134</b>	<b>602.6</b>	<b>80,671</b>

## SECTION IV. CARGO LOADING

### 6-13. Cargo Compartments and Storage Features.

The aircraft is designed for observation-surveillance and, thus, cargo features are not extensive. The small amount of baggage space provided serves mainly for luggage stowage, and is used by the crewmembers for this purpose. In addition, provisions are provided for storage of maps, a first aid kit, and certain items of equipment not being used for specific missions. Figure 6-4 illustrates the storage and baggage provisions as installed in the aircraft.

### 6-14. Description of Baggage Compartment and Storage Areas.

*a. Aft Baggage Compartment.* The aircraft has space provided for baggage in the aft baggage compartment, at the aft end of the fuselage. An access door, installed on the underside of the fuselage aft of the speed brake area, provides access to a canvas baggage bag. The maximum allowable baggage to be stowed in this compartment is limited to 40 pounds, when the aircraft is operated with two crewmembers, or 20 pounds when only the pilot is aboard.

Table 6-6A. Typical Service Loading M-130 General Purpose Dispenser System

Item	Arm	Weight	Moment 1000
Dispenser control panel	34.0	1.44	49.0
Electronics module	306.8	4.54	1392.8
#1 Dispenser and payload module	314.2	9.54	2997.5
#2 Dispenser and payload module	320.6	9.54	3058.5
Safety pin/flag (removable)	303.4	0.14	42.5
Flare dispenser panel	34.0	0.15	5.1
Chaff trigger switch	42.0	0.10	4.2
*Structural additions	314.2	11.46	3600.7
*Restraint additions	317.1	1.35	428.1
*Cables/plugs	169.0	9.75	1647.8
*Fuel vent line modification	377.1	14.39	5426.5
<b>TOTAL ADDED</b>	<b>298.9</b>	<b>+62.40</b>	<b>18652.7</b>
*Fuel vent line removal	259.0	- 3.06	-792.5
*Cover assembly	313.5	- 2.86	-896.6
<b>TOTAL REMOVED</b>	<b>285.3</b>	<b>- 5.92</b>	<b>-1689.1</b>
Installation (Note 1)	303.4	31.03	9414.0
Removable module/components	296.64	25.45	7549.6
<b>TOTAL CHANGE TO AIRCRAFT</b>	<b>300.3</b>	<b>+56.48</b>	<b>+16963.6</b>
<b>Payload for M-130 General Purpose Dispenser System (Note 2)</b>			
60 Chaff cartridges (30 fwd/30 aft) or 30 Chaff fwd/30 flare aft or 60 Flare cartridges (30 fwd/30 aft)	318.7	19.80	6310
	319.1	22.80	7275
	318.7	25.80	8222

- NOTES:**
1. Add the net weight(\*) items of installation (fixed equipment) to the C chart as part of basic and/or empty weight.
  2. Service/mission loading is the weight of the module/components plus the weight of flare/chaff cartridges as loaded into the dispenser for a specific mission.





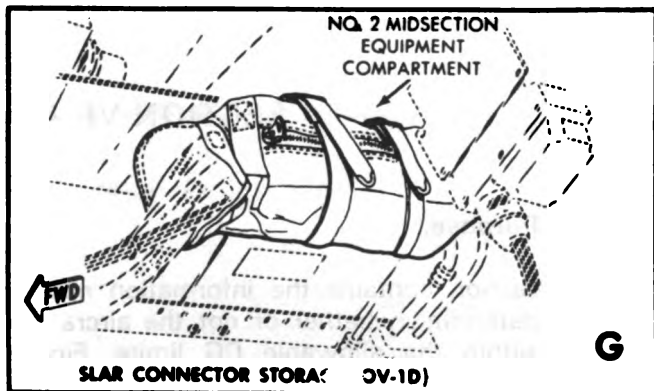
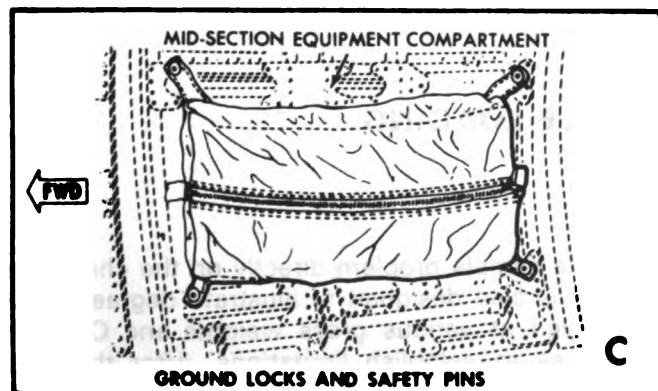
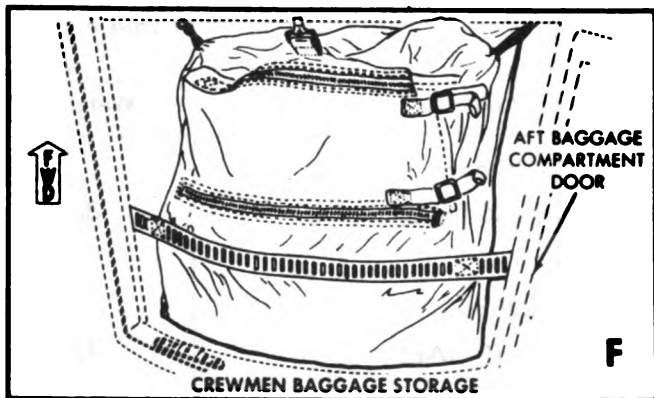
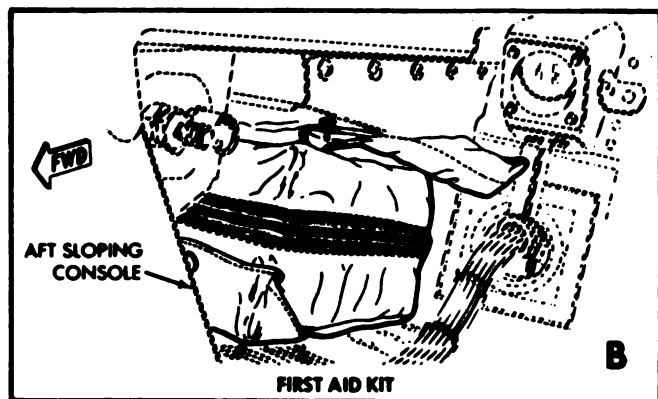
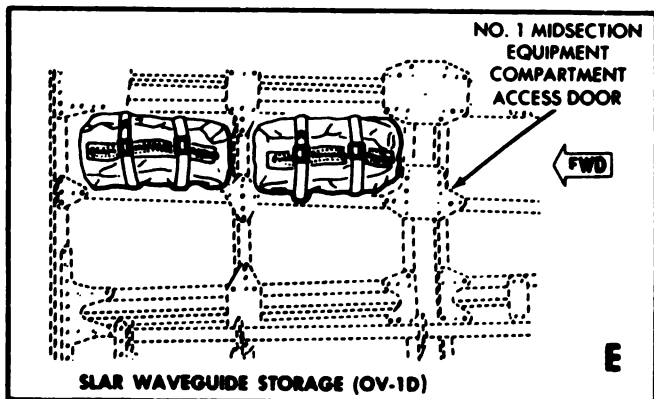
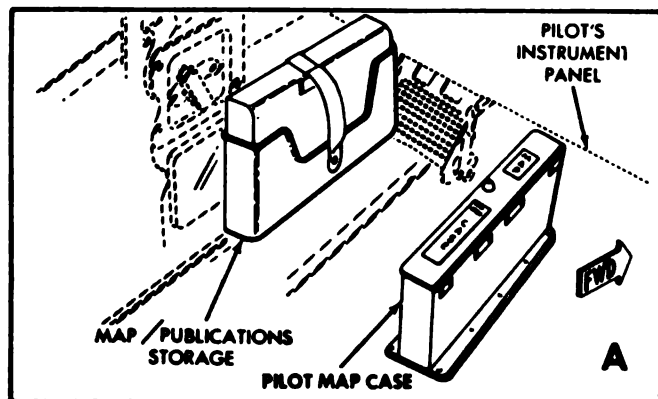
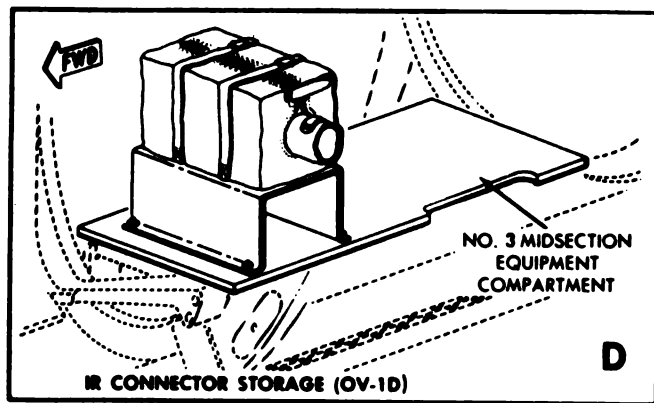
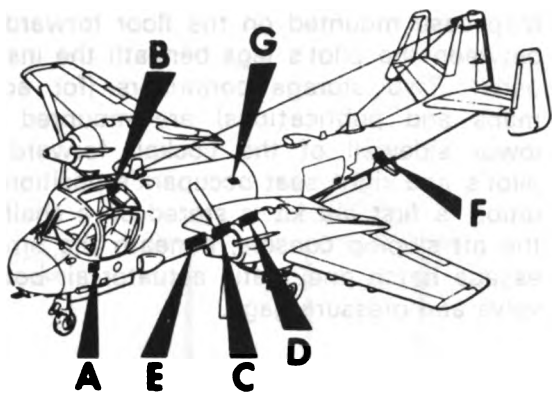

A-6-10-D-4

Figure 6-4. Storage and Baggage Provisions

*b. Midsection Equipment Compartments.* On OV-1D aircraft, the midsection equipment compartments contain provisions for storage of SLAR connectors and waveguides, and IR connectors, depending on mission configuration. On all aircraft, a canvas bag is installed on the No. 2 midsection equipment compartment access door for storage of ground locks and safety pins.

*c. Cockpit.* The cockpit contains provisions for storage of maps and publications. There is a

map case mounted on the floor forward of and between the pilot's legs beneath the instrument panel. Two storage containers (for additional maps and publications) are mounted on the lower sidewall of the cockpit forward of the pilot's and right seat occupant's position. In addition, a first aid kit is stored on a shelf behind the aft sloping console, beneath the emergency escape hatch pneumatic actuator air bottle filler valve and pressure gage.

## SECTION V. FUEL/OIL

### 6-15. Purpose.

This section contains the necessary fuel and oil data to be entered on the weight and balance clearance form. All weights stated or illustrated in this section are based on standard day

conditions. Fuel data is shown on figure 6-5 in gallons followed by a conversion to pounds. Oil data is shown in table 6-7 as the total capacity for both engines relative to weight, arm and moment/1,000.

*Table 6-7. Oil Loading Data*

Oil Quantity	Weight	Arm	Moment/1,000
MIL-L-7808: Usable (5 GAL)	38	140	5.32
MIL-L-23699: Usable (5 GAL)	42	140	5.88

## SECTION VI. ALLOWABLE LOADING

### 6-16. Purpose.

This section contains the information necessary to determine whether or not the aircraft is loaded within the allowable CG limits. Figure 6-6 shows the forward and aft center of gravity limits for the aircraft. Aircraft gross weight limit is also shown. Use of the chart is explained

with a sample problem directly on the chart. The chart is also designed to illustrate degree of risk involved at various gross weights and CG's, as well as to establish limitations. After the total gross weight and moment/1,000 are determined, figure 6-6 can also be used to determine the present CG of the aircraft.

# FUEL MOMENT MAIN TANK

FUEL MOMENT  
OV-1D/RV-1D  
T63-L-701

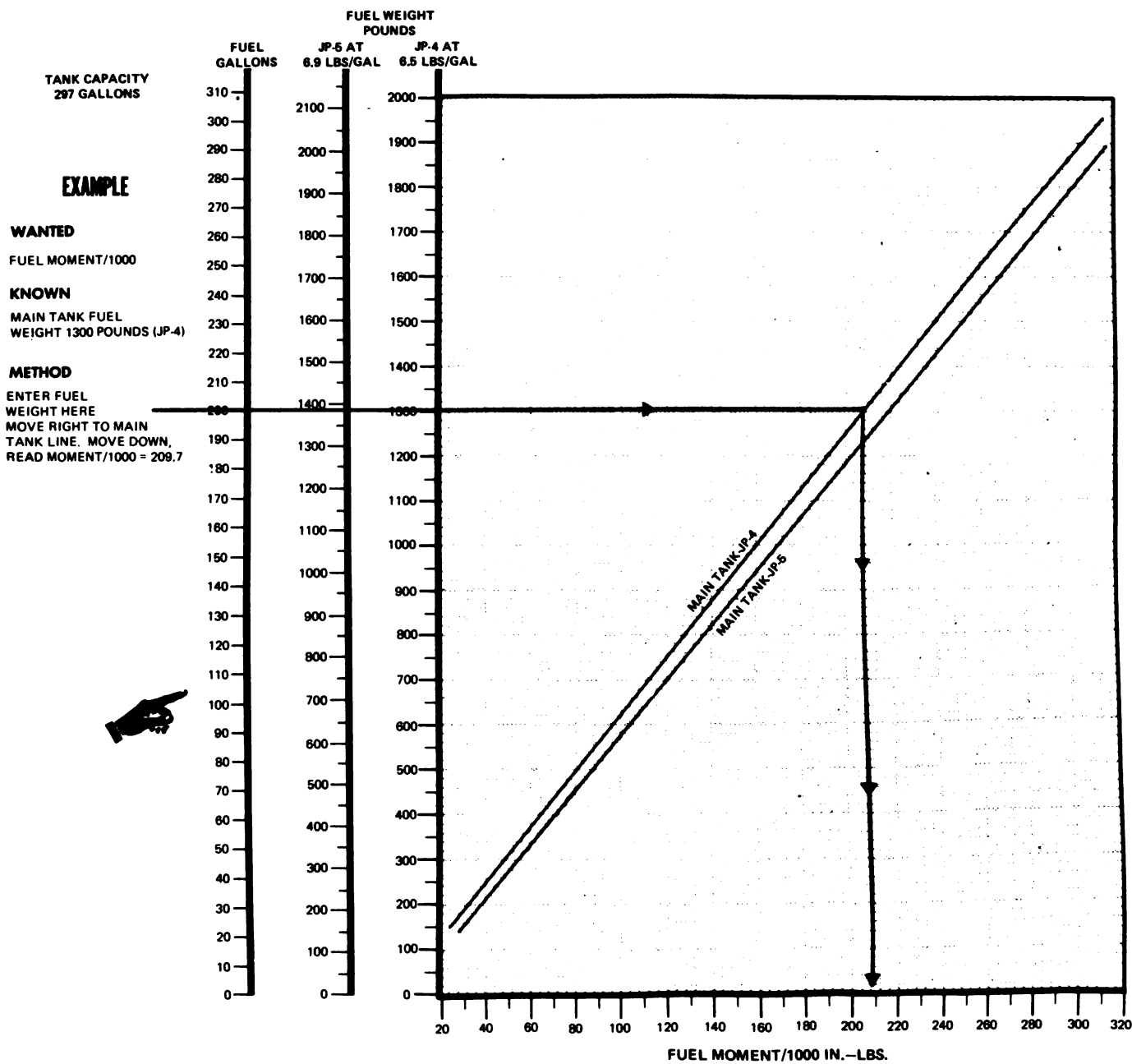
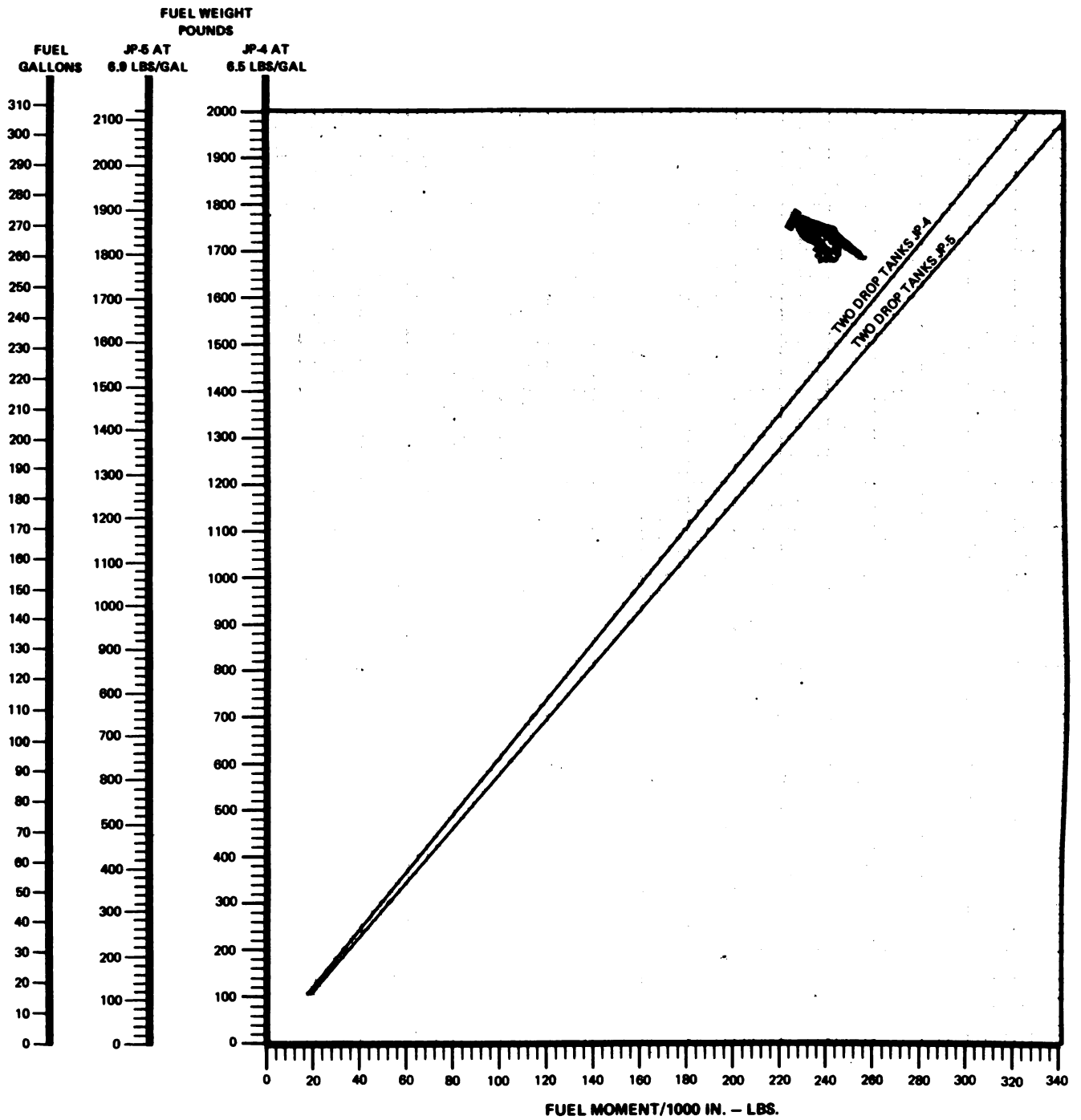

Figure 6-5. Fuel Moments (Sheet 1 of 2)



# FUEL MOMENT TWO DROP TANKS

FUEL MOMENT  
OV-1D/RV-1D  
T63-L-701



C-6-10-D-6-2

Figure 6-5. Fuel Moments (Sheet 2 of 2)

# CENTER OF GRAVITY LIMITS

C.G. LIMITS  
OV-1D  
T53-L-701

- G
- Y
- R

## EXAMPLE

### WANTED

DETERMINE IF LOADING LIMITS ARE EXCEEDED AND DETERMINE C.G. POSITION

### KNOWN

GROSS WEIGHT = 17,600 LBS  
MOMENT/1000 = 2830

### METHOD

ENTER GROSS WEIGHT HERE →  
MOVE RIGHT TO TOTAL MOMENT = 2830. READ LOAD WITHIN LIMITS. MOVE DOWN AND READ ARM = 161.0.

### NOTE

IF THE APPROXIMATE C.G. IS NEAR A LIMIT, ACCURATE DETERMINATION OF C.G. BY DIVIDING THE TOTAL AIRCRAFT MOMENT BY GROSS WEIGHT IS RECOMMENDED. THE LIMITS SHOWN APPLY FOR FLIGHT WITH LANDING GEAR EXTENDED OR RETRACTED, HOWEVER, AIRCRAFT WEIGHT AND BALANCE RECORDS ARE BASED ON WEIGHINGS WITH LANDING GEAR EXTENDED. IF THE AIRCRAFT C.G. IS NEAR THE AFT LIMIT (WITHIN 0.3 INCHES), CHECK TO ASSURE THE C.G. WITH THE LANDING GEAR RETRACTED IS WITHIN LIMITS. TO DETERMINE AIRCRAFT C.G. WITH LANDING GEAR RETRACTED, ADD THE GEAR RETRACTION MOMENT (2500 INCH POUNDS, MOMENT/1000 = 2.5) TO THE AIRCRAFT MOMENT BEFORE DIVIDING BY THE AIRCRAFT GROSS WEIGHT.

### CAUTION

FLIGHT WITH C.G. BETWEEN 163.5 - 165.2 INCHES SHALL BE AVOIDED IF PRACTICABLE. WHEN NECESSARY TO OPERATE AT HIGH SPEEDS IN THIS REGION, ABRUPT LONGITUDINAL CONTROL INPUTS SHALL BE AVOIDED TO PREVENT THE POSSIBILITY OF EXCEEDING NORMAL ACCELERATION LIMITS.

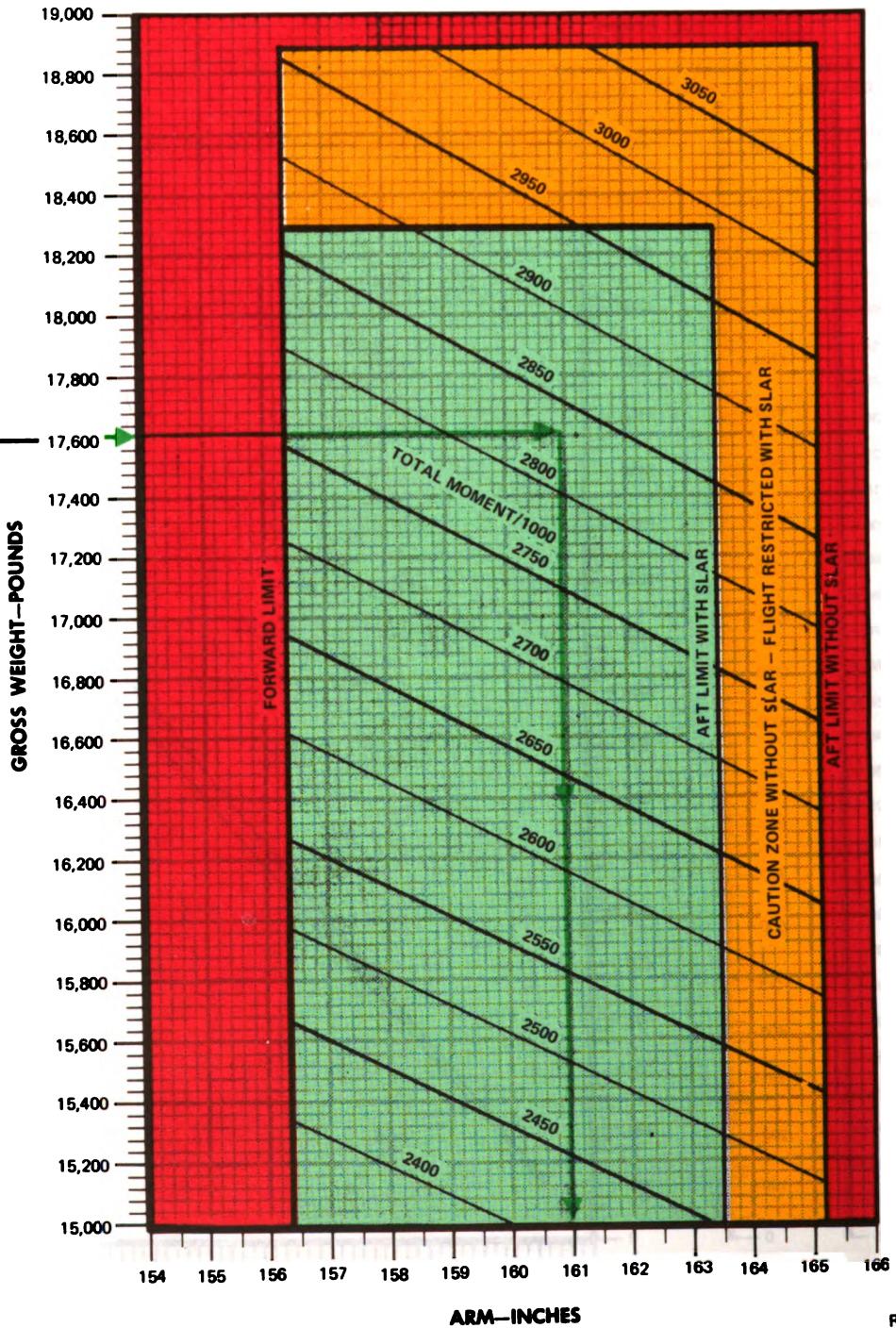

- R
- Y
- G

C-8-10-D-8-1

Figure 6-6. Center of Gravity Limits (Sheet 1 of 4)

# CENTER OF GRAVITY LIMITS

C.G. LIMITS  
OV-10  
T53-L-701

- R
- Y
- G

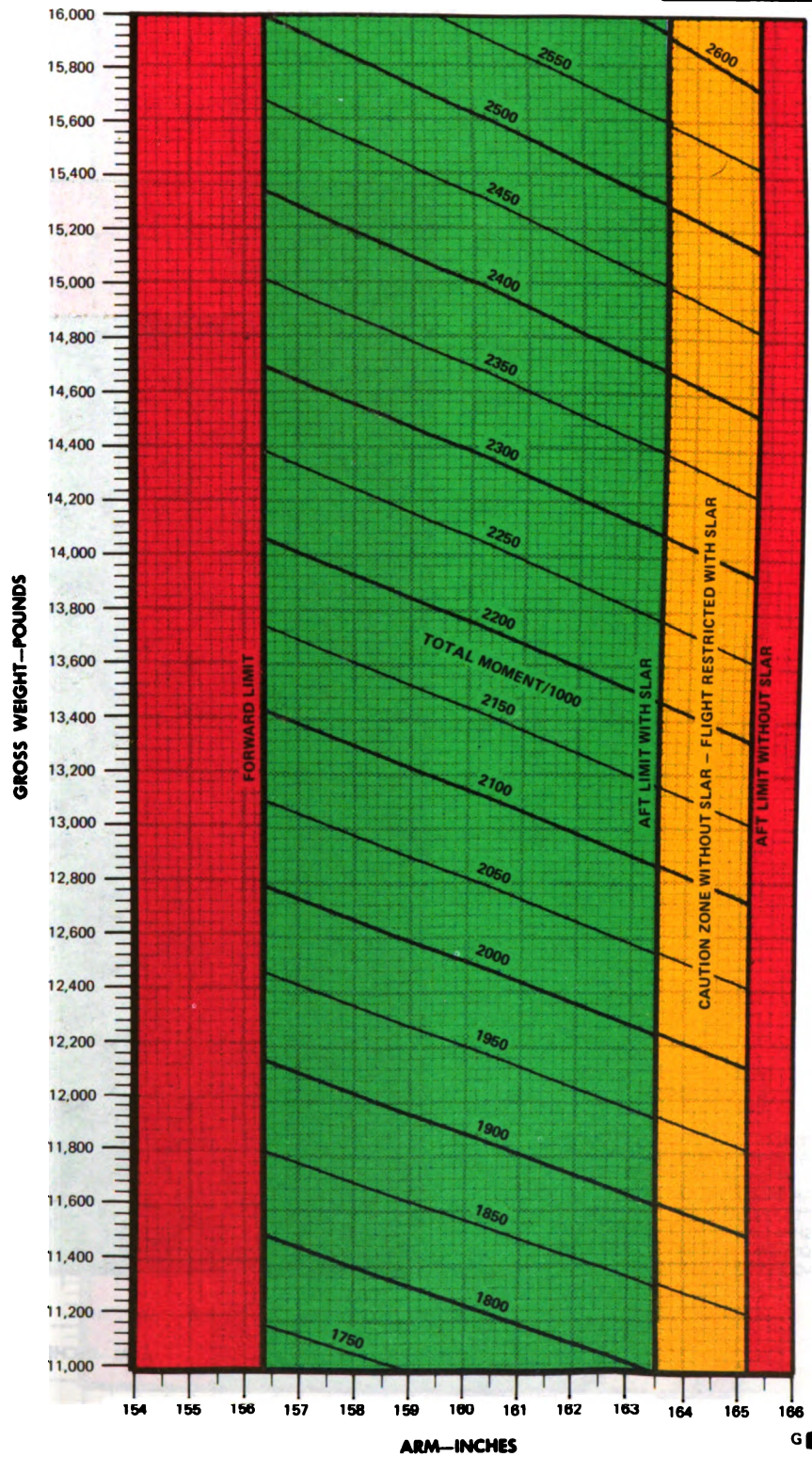

**CAUTION**

FLIGHT WITH C.G. BETWEEN 163.5 - 165.2 INCHES SHALL BE AVOIDED IF PRACTICABLE. WHEN NECESSARY TO OPERATE AT HIGH SPEEDS IN THIS REGION, ABRUPT LONGITUDINAL CONTROL INPUTS SHALL BE AVOIDED TO PREVENT THE POSSIBILITY OF EXCEEDING NORMAL ACCELERATION LIMITS.

- G
- Y
- R

86-10-D-6-2

Figure 6-6. Center of Gravity Limits (Sheet 2 of 4)



R  
G  
Y

# CENTER OF GRAVITY LIMITS

C.G. LIMITS  
RV-1D  
T53-L-701

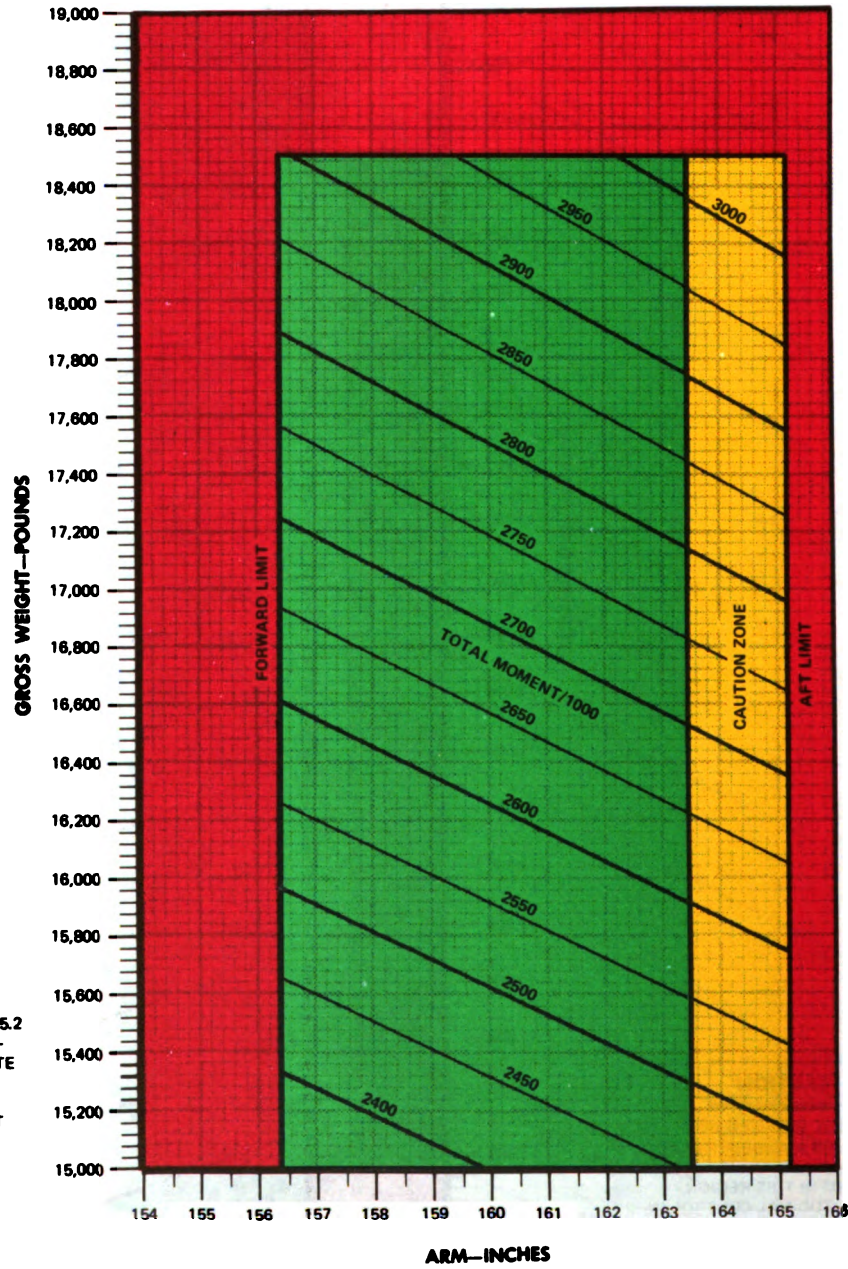

**CAUTION**

FLIGHT WITH C.G. BETWEEN 163.5 - 165.2 INCHES SHALL BE AVOIDED IF PRACTICABLE. WHEN NECESSARY TO OPERATE AT HIGH SPEEDS IN THIS REGION, ABRUPT LONGITUDINAL CONTROL INPUTS SHALL BE AVOIDED TO PREVENT THE POSSIBILITY OF EXCEEDING NORMAL ACCELERATION LIMITS.

Y  
G  
R

86-10-D-6-3

Figure 6-6. Center of Gravity Limits (Sheet 3 of 4)

R  
Y  
G

# CENTER OF GRAVITY LIMITS

C.G. LIMITS  
RV-1D  
T53-L-701

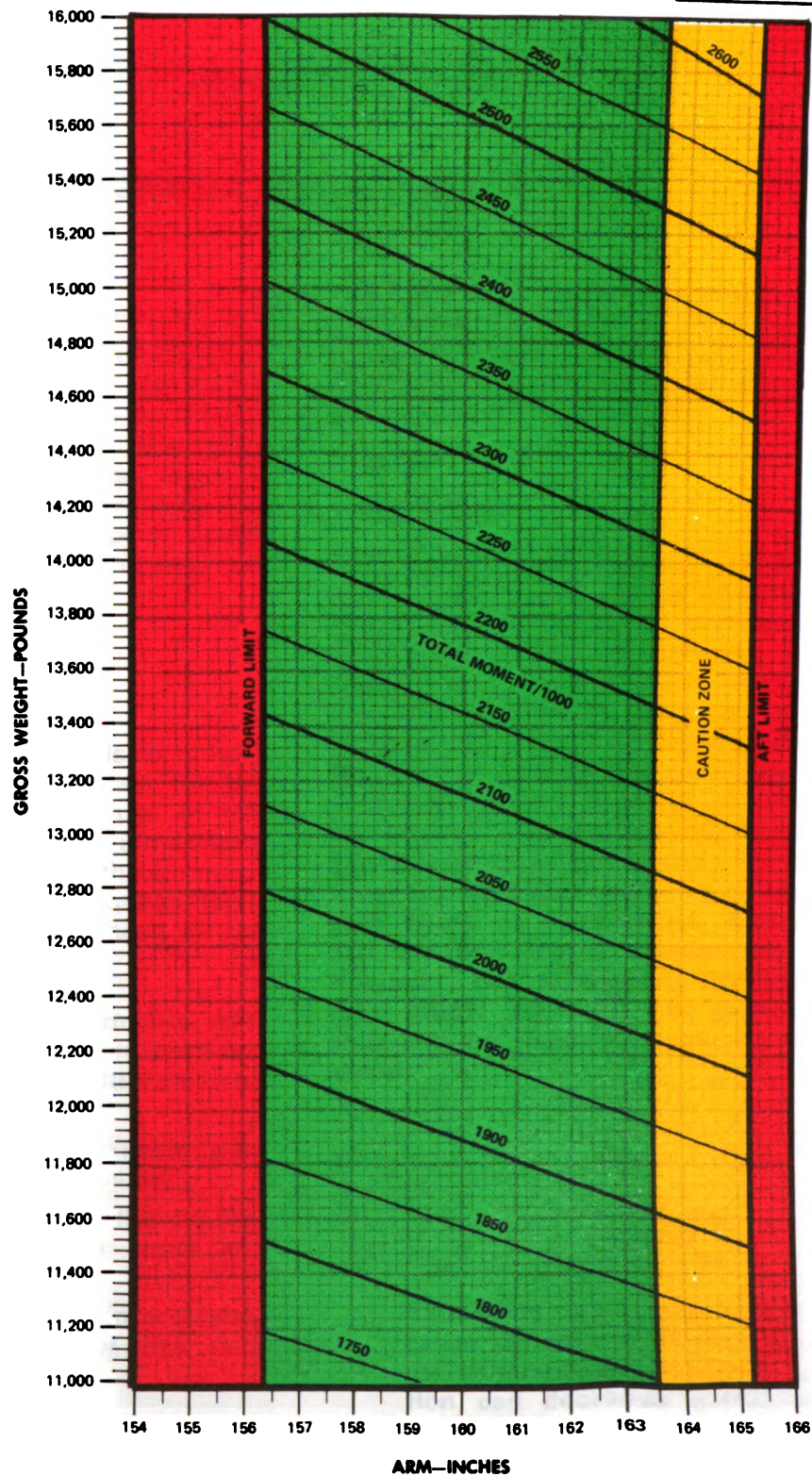

**CAUTION**

FLIGHT WITH C.G. BETWEEN 163.5 - 165.2 INCHES SHALL BE AVOIDED IF PRACTICABLE. WHEN NECESSARY TO OPERATE AT HIGH SPEEDS IN THIS REGION, ABRUPT LONGITUDINAL CONTROL INPUTS SHALL BE AVOIDED TO PREVENT THE POSSIBILITY OF EXCEEDING NORMAL ACCELERATION LIMITS.

G  
Y  
R

B-6-10-D-64

Figure 6-6. Center of Gravity Limits (Sheet 4 of 4)



## CHAPTER 7

### PERFORMANCE DATA

#### SECTION I. INTRODUCTION

##### 7-1. Description.

The charts presented in this chapter are based on, and are consistent with, the recommended operating procedures and techniques set forth in other chapters of this manual. The charts contain the performance data necessary for preflight and inflight mission planning. Explanatory text applicable to each type of chart is included to illustrate the use of the data presented.

##### 7-2. Purpose.

a. The purpose of this chapter is to provide the best available performance data for the OV-1D/RV-1D aircraft. Regular use of this information will enable you to receive maximum safe utilization from the aircraft. Although maximum performance is not always required, regular use of this chapter is recommended for the following reasons:

(1) Knowledge of your performance margin will allow you to make better decisions when unexpected conditions or alternate missions are encountered.

(2) Situations requiring maximum performance will be more readily recognized.

(3) Familiarity with the data will allow performance to be computed more easily and quickly.

(4) Experience will be gained in accurately estimating the effects of variables for which data are not presented.

b. The information is primarily intended for mission planning and is most useful when plan-

ning operations in unfamiliar areas or at extreme conditions. The data may also be used inflight, to establish unit or area standing operating procedures, and to inform ground commanders of performance/risk tradeoffs.

##### 7-3. General.

The data presented shall cover the maximum range of conditions and performance that can reasonably be expected. In each area of performance, the effects of altitude, temperature, gross weight, and other parameters relating to that phase of flight are presented. In addition to the presented data, your judgement and experience will be necessary to accurately obtain performance under a given set of circumstances. The conditions for the data are listed under the title of each chart. The effects of different conditions are discussed in the text accompanying each phase of performance. Where practical, data are presented at conservative conditions. However, **NO GENERAL CONSERVATISM HAS BEEN APPLIED.** All performance data presented are within the applicable limits of the aircraft.

**CAUTION**

Exceeding operating limits can cause permanent damage to critical components. Overlimit operation can decrease performance, cause immediate failure, or failure on a subsequent flight.

7-4. Limits.

Applicable limits are shown on the charts as red lines. Performance generally deteriorates rapidly beyond limits. If limits are exceeded, minimize the amount and time. Enter the maximum value and the time above limits on DA Form 2408-13 so proper maintenance action can be taken.

7-5. Chart Explanation.

A complete series of performance charts for the aircraft are provided in this manual. These

charts provide the pilot with sufficient data to make an intelligent and safe flight plan. The charts include data on takeoff, climb, landing, and operating instructions for cruising flight from maximum endurance to normal rated power. No allowance has been made for navigational error, formation flight, or other contingencies. Appropriate allowances for these items should be dictated by local regulations and should be accounted for when the fuel available for cruise is determined. The charts are arranged to give maximum facility of use in preflight and in-flight planning. All charts are based on ambient temperature conditions and pressure altitude.

7-6. Chapter 7 Index.

SECTION	TITLE	FIGURE NO.	CHART SUBJECT	PAGE NO.
I	Introduction	N/A	N/A	7-1
II	Performance planning	7-1	Performance planning card	7-6
		7-2	Temperature conversion correction	7-7
		7-3	Airspeed installation correction	7-9
		7-4	Altimeter installation correction	7-11
		7-5	Crosswind - takeoff or landing	7-13
III	Crosswind - takeoff or landing	7-5	Crosswind - takeoff or landing	7-13
IV	Idle fuel flow	7-6 (SHT 1)	Idle fuel flow (N1 = 48 to 52%)	7-15
		7-6 (SHT 2)	Idle fuel flow (N1 = 63 to 68%)	
V	Torque available for takeoff (30 minutes)	7-7	Torque available for takeoff (30 minutes)	7-19
VI	Takeoff - normal	7-8 (SHT 1)	Takeoff - normal (flaps 0°)	7-20A
		7-8 (SHT 2)	Takeoff - normal (flaps 15°)	7-20B
		7-8A	Critical field length	7-21
VII	Normal rotational takeoff airspeed	7-9 (SHT 1)	Normal rotation/takeoff airspeed (flaps 0°)	7-23
		7-9 (SHT 2)	Normal rotation/takeoff airspeed (flaps 15°)	7-24
		7-9A	Critical Engine Failure	7-24A
VIII	Acceleration check distance	7-10	Acceleration check distance	7-25
IX	Accelerate stop distance	7-11 (SHT 1)	Accelerate stop distance (0° flaps)	7-27
		7-11 (SHT 2)	Accelerate stop distance (15° flaps)	7-28
		7-11A	Refusal speed	7-29
X	Minimum single-engine control speed (Vmc)	7-12	Minimum single-engine control speed (Vmc)	7-31

SECTION	TITLE	FIGURE NO.	CHART SUBJECT	PAGE NO.	
XI	Single-engine climb (W/O LSSS IR suppressor)	7-13 (SHT 1)	Single-engine climb flaps 0°/gear up)	7-33	
	Single-engine climb (with LSSS IR suppressor)	7-13 (SHT 2)	Single-engine climb (flaps 0°/gear up)	7-34	
	Single-engine climb (W/O LSSS IR suppressor)	7-14 (SHT 1)	Single-engine climb (flaps 15°/gear up)	7-34A	
	Single-engine climb (with LSSS IR suppressor)	7-14 (SHT 2)	Single-engine climb (flaps 15°/gear up)	7-34B	
	Single-engine climb (W/O LSSS IR suppressor)	7-15 (SHT 1)	Single-engine climb (flaps 15°/gear down)	7-34C/ (7-34D blank)	
	Single-engine climb (with LSSS IR suppressor)	7-15 (SHT 2)	Single-engine climb (flaps 15°/gear down)	7-35	
	Single-engine climb gradient	7-15A	Single-engine climb gradient	7-36	
	XII	Cruise climb (W/O LSSS IR suppressor)	7-16 (SHT 1)	Cruise climb	7-36B
		Cruise climb (with LSSS IR suppressor)	7-16 (SHT 2)	Cruise climb	7-37
		XIII	Cruise	7-17	Cruise, FAT -45°C, sea level
7-18	Cruise, FAT -25°C, sea level			7-40	
7-19	Cruise, FAT -5°C, sea level			7-41	
7-20	Cruise, FAT +15°C, sea level			7-42	



SECTION	TITLE	FIGURE NO.	CHART SUBJECT	PAGE NO.
		7-21	Cruise, FAT +35°C, sea level	7-43
		7-22	Cruise, FAT -25°C, 5,000 feet	7-44
		7-23	Cruise, FAT -5°C, 5,000 feet	7-45
		7-24	Cruise, FAT +15°C, 5,000 feet	7-46
		7-25	Cruise, FAT +35°C, 5,000 feet	7-47
		7-26	Cruise, FAT -25°C, 10,000 feet	7-48
		7-27	Cruise, FAT -5°C, 10,000 feet	7-49
		7-28	Cruise, FAT +15°C, 10,000 feet	7-50
		7-29	Cruise, FAT -45°C, 15,000 feet	7-51
		7-30	Cruise, FAT -25°C, 15,000 feet	7-52
		7-31	Cruise, FAT -5°C, 15,000 feet	7-53
		7-32	Cruise, FAT +15°C, 15,000 feet	7-54
		7-33	Cruise, FAT -45°C, 20,000 feet	7-55
		7-34	Cruise, FAT -25°C, 20,000 feet	7-56
		7-35	Cruise, FAT -5°C, 20,000 feet	7-57
		7-36	Cruise, FAT -45°C, 25,000 feet	7-58
		7-37	Cruise, FAT -25°C, 25,000 feet	7-59
XIV	Drag	7-38	Drag	7-61
XV	Climb/descent	7-39	Climb/descent	7-63
XVI	Approach speed (Vref)	7-40	Approach speed	7-65
XVII	Landing	7-41	Landing Vref = 1.1 VSO	7-67
		(SHT 1)		
		7-41	Landing Vref = 1.3 VSO	7-68
		(SHT 2)		

**7-7. Color Coding.**

The performance charts are color coded as follows:

- a. Green: Example guidelines.
- b. Red: Limit lines.
- c. Yellow: Precautionary or time-limited operation.

**7-8. Reading The Charts.**

The primary use of each chart is given in an example and a green guideline is provided to help you follow the route through the chart. The use of a straight edge (ruler or page edge) and a hard ~~fine~~ point pencil is recommended to avoid cumulative errors. The majority of the charts provide a standard pattern for use as follows: enter first variable on top left scale, move right



to second variable, reflect down at right angles to third variable, reflect left at right angles to fourth variable, reflect down, etc., until the final variable is read out at the final scale. In addition to the primary use, other uses of each chart are explained in the text accompanying each set of performance charts. Colored registration blocks, on the bottom and top of each chart, are used to determine if slippage has occurred during printing. If slippage has occurred, refer to Chapter 5 for correct operating limits.

**7-9. Deleted.**

**7-10. Data Basis.**

The type of data used is indicated at the bottom of each performance chart under DATA BASIS. The data provided generally is based on one of four categories:

*a. Flight Test Data.* Data obtained by flight test of the aircraft by experienced flight test personnel at precise conditions using sensitive calibrated instruments.

*b. Derived From Flight Test.* Flight test data obtained on a similar rather than the same aircraft and series. Generally small corrections have been made.

*c. Calculated Data.* Data based on tests, but not on flight test of the complete aircraft.

*d. Estimated Data.* Data based on estimates using aerodynamic theory or other means, but not verified by flight test.

**7-11. Specific Conditions.**

The data presented is accurate only for the specific conditions listed under the title of each

chart. Variables for which data is not presented, but which may affect that phase of performance, are discussed in the text. Where data is available or reasonable estimates can be made, the amount that each variable affects performance will be given. Different configurations discussed throughout this chapter are defined as follows:

*a. Configuration Clean.* The basic aircraft with no external stores on wing stations and no SLAR antenna installed on the fuselage.

*b. Configuration All Stores.* The basic aircraft with all approved external stores installed on wing stations and SLAR antenna installed on the fuselage.

**7-12. General Conditions.**

The following general conditions might have deteriorating effects on the aircraft performance: atmospheric humidity, fuel pressure, rigging, pilot technique, aircraft variation, engine variation, and instrument variation.

**7-13. Performance Discrepancies.**

Regular use of this chapter will allow you to monitor instrument and other aircraft systems for malfunction, by comparing actual performance with planned performance. Knowledge will also be gained concerning the effects of variables for which data is not provided, thereby increasing the accuracy of performance predictions.

**7-14. Definitions of Abbreviations.**

Abbreviations and terms used throughout this chapter are defined in Appendix B.

## SECTION II. PERFORMANCE PLANNING

### 7-15. Performance Planning Card (PPC).

The performance planning card (figure 7-1) is provided to assist the pilot in recording data applicable to the mission and may be reproduced at the local level. The PPC provides readily available information for departure, climb, cruise, arrival, and prevailing conditions. Pertinent data required to fill in the blanks on the PPC shall be computed from the performance charts and tables contained in this chapter, and from existing conditions at time of takeoff or landing. The takeoff and landing data shall be computed prior to takeoff, as a precaution against emergency conditions which could develop after takeoff. The following blocks are provided on the front of the PPC for entry of data as applicable:

#### a. Weather Data.

- (1) PA (pressure altitude).
- (2) FAT (free air temperature).
- (3) WIND (speed and direction).
- (4) RWY (runway heading, length, and slope).

#### b. Aircraft Data.

- (1) T/O WT (takeoff weight).
- (2) LDG WT (landing weight).

#### c. Performance Data.

- (1) T/O PWR (torque).
- (2) T/O RUN (no obstacle or obstacle clearance (if required)).
- (3) ACC-STOP (accelerate stop distance).
- (4) V<sub>mc</sub> (minimum single engine control speed).
- (5) V<sub>r</sub>-V<sub>lof</sub> (rotation airspeed and liftoff airspeed).
- (6) V<sub>x</sub>-V<sub>y</sub> (best angle of climb and best rate of climb).
- (7) V<sub>yse</sub> (single engine best rate of climb).
- (8) V<sub>ref</sub> (landing speed).
- (9) LDG RUN.
- (10) Additional data as required.

### 7-16. General Information.

Pressure altitude may be determined by setting the altimeter to 29.92 and reading the pressure altitude, or by adding 100 feet to the field elevation for each .1 in. Hg. below 29.92, or by subtracting 100 feet from the field elevation for each .1 in. Hg. above 29.92. An estimate of temperature at cruise altitude and destination may be made at point of departure by subtracting 2°C per each 1,000-foot increase in altitude and adding 2°C per each 1,000-foot decrease in altitude. See figure 7-2 for temperature conversion/correction.

### 7-17. Performance Planning Sequence.

The following information may be extracted from the charts in this chapter.

#### a. Preflight Planning.

(1) Determine the following conditions for each phase of the flight, as appropriate, before entering the performance charts and enter the information on the PPC.

- (a) Pressure altitude.
- (b) Free air temperature.
- (c) Wind.
- (d) Aircraft weight (both takeoff and landing).

### NOTE

*Weight and balance blocks are provided on the rear of the PPC and should be utilized to determine exact weight and loading conditions prior to computing takeoff and landing data. Weight information may be obtained from either Chart C or the current Form 365F.*

- (e) Obstacles (if applicable).
- (f) Ceiling and visibility.
- (g) Instrument departure and approach.
- (h) Hazards.

<b>FW PERFORMANCE PLANNING (PPC)</b>	
TC-1-144/1-145 (draft)	
<b>PA</b>	<b>FAT</b>
<b>RWY</b>	<b>WIND</b>
<b>T/O WT</b>	<b>LDG WT</b>
<b>T/O PWR</b>	
<b>T/O RUN</b>	
<b>ACC-STOP</b>	
<b>V<sub>mc</sub></b>	
<b>V<sub>r</sub>-V<sub>lof</sub></b>	/
<b>V<sub>x</sub>-V<sub>y</sub></b>	/
<b>V<sub>yse</sub></b>	
<b>V<sub>ref</sub></b>	
<b>LDG RUN</b>	

C7-10D-1-1

Figure 7-1. Performance Planning Card (Sheet 1 of 2)

# THIS SIDE OPTIONAL DATA

WT COMPUTATION			
BASIC WT (OIL INCL)			
CREW & FLT EQUIP			
EMER OR OTHER EQUIP			
OPERATING WT			
FUEL WT			
PAX BAGGAGE-CARGO			
TAKEOFF WT		(MINUS R/U FUEL)	
CRUISE DATA			
PA	FAT	WIND	
WT	PWR		
CIAS	KTAS		
FUEL RATE		SE CEILING	
BLOCK SPEED & FUEL REQUIRED			
ITEM	TIME	FUEL	DIST
R/U-T/O			
CLIMB			
CRUISE			
DESCENT			
APPROACH			
TOTAL			
LANDING DATA			
INST APP	RWY	WIND	
CEIL	VIS	ALT	TEMP
WT	V <sub>ref</sub>	LDG RUN	

A7-10-0-1-2

*Figure 7-1. Performance Planning Card (Sheet 2 of 2)*



# TEMPERATURE CONVERSION / CORRECTION

TEMPERATURE  
CONVERSION/  
CORRECTION  
OV-10/RV-10  
T53-L-701

## EXAMPLE II-1

**WANTED**  
TRUE FAT

**KNOWN**  
INDICATED FAT = -11°C  
TRUE AIRSPEED = 200 KT

**METHOD**  
ENTER INDICATED FAT HERE  
MOVE RIGHT TO TRUE AIRSPEED  
MOVE DOWN READ  
TRUE FAT = -15°C

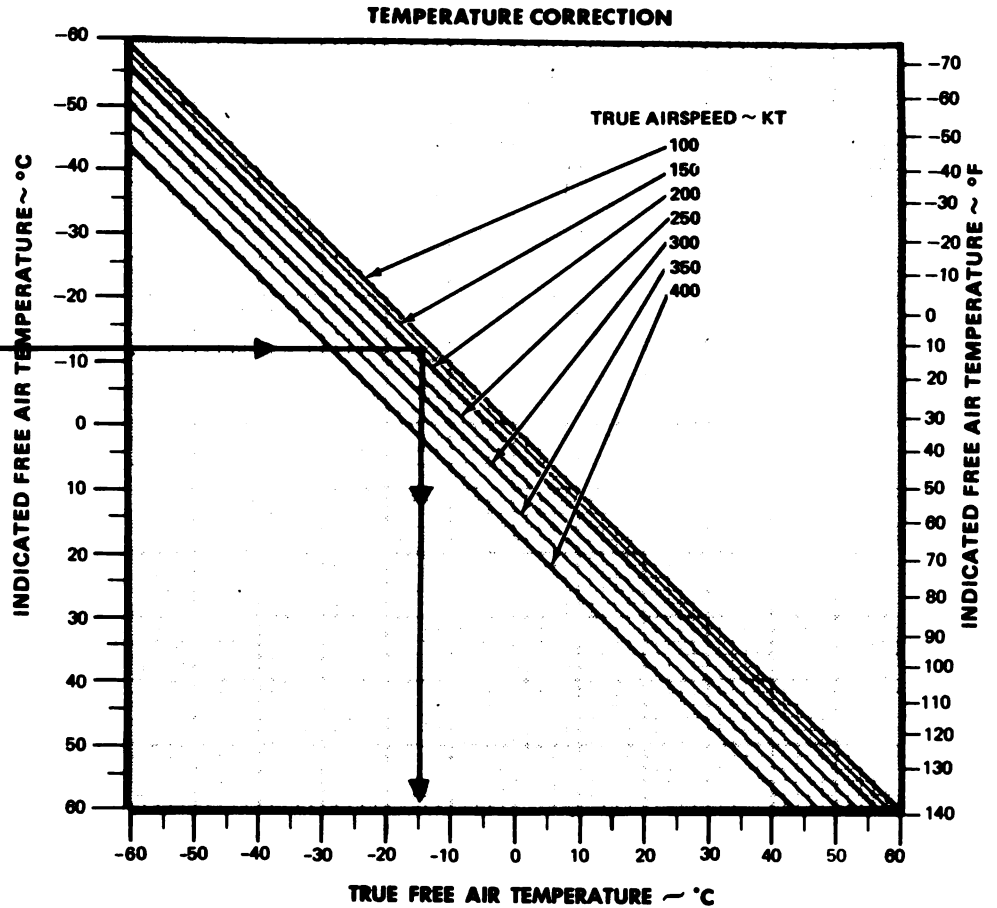

DATA BASIS: DERIVED FROM FLIGHT TEST

B-7-10-D-2

Figure 7-2. Temperature Conversion Correction

(2) Determine the following conditions from the performance charts and enter the information on the PPC blocks provided.

(a) T/O PWR – Takeoff power. Obtain from MAXIMUM TORQUE AVAILABLE (30 MINUTES) chart.

(b) T/O RUN – Takeoff distance. Obtain trim TAKEOFF-NORMAL chart.

(c) ACC-STOP – Accelerate-stop distance. Obtain from ACCELERATE-STOP chart. An ACCELERATE-STOP chart is provided for optional use during critical length takeoffs.

(d) V<sub>mc</sub> – Minimum single engine control airspeed. Obtain from MINIMUM SINGLE ENGINE CONTROL AIRSPEED (V<sub>mc</sub>) chart.

(e) V<sub>r</sub>-V<sub>lof</sub> – Rotation airspeed and lift-off airspeed. Obtain from NORMAL ROTATION /TAKEOFF AIRSPEED chart.

(f) V<sub>x</sub>-V<sub>y</sub> – Best angle of climb airspeed and best rate of climb airspeed. Obtain V<sub>x</sub> from NORMAL ROTATION/TAKEOFF airspeed chart. Obtain V<sub>y</sub> from the MAX R/C line (two engine) using the appropriate CRUISE chart.

(g) V<sub>yse</sub> – Best single engine rate of climb. Obtain from appropriate single engine climb chart.

(h) V<sub>ref</sub> – Landing approach airspeed. Obtain from APPROACH SPEED chart. This airspeed shall be computed for landing immediately after takeoff in the event of an emergency.

(i) LDG RUN – Landing distance. Obtain from LANDING chart. This distance shall be computed for landing immediately after takeoff in the event of an emergency.

(3) After the takeoff and landing data has been logged, insure the following conditions are satisfied:

(a) Crosswind conditions are within the recommended area on the CROSSWIND-TAKEOFF OR LANDING chart.

(b) Takeoff, accelerate-stop, and landing distances required are less than the distances available.

(c) Obstacles can be cleared in the event of engine failure.

*b. Rear of PPC.*

(1) *Cruise Data.* Space is provided on the rear of the PPC for such information as pressure altitude (PA), free air temperature (FAT), wind

speed and direction (WIND), aircraft weight (WT), power required (PWR), airspeed (KIAS and KTAS), fuel flow (FUEL RATE), and single engine ceiling (SE CEILING). Power, airspeed, and fuel rate may be obtained from the CRUISE charts.

**NOTE**

*BLOCK SPEED AND FUEL REQUIRED space is provided on the rear of the PPC for use as required. Performance charts are available for climb and cruise information. Descent information may be obtained by interpolating between CRUISE charts and the CLIMB/DESCENT chart. The approach spaces may be utilized to compute total time/fuel/ and distance to actual landing.*

(2) *Landing Data.* Space is provided on the rear of the PPC for entry of landing data. This information should be computed prior to landing and reflect actual landing weight so the landing approach speed (V<sub>ref</sub>) and landing distance will be correct. The instrument approach in use and current weather conditions may also be entered.

**7-18. Airspeed Installation Correction.**

The relationship between indicated airspeed and calibrated airspeed for various flap settings is shown for the normal static air source (figure 7-3).

**NOTE**

*Indicated airspeed assumes a zero instrument error, also, no significant change in airspeed position correction is apparent due to power settings, altitude, or landing gear position. All airspeed calibrations are for level flight and may not be appropriate for stall.*

**7-19. Altimeter Installation Correction.**

The altitude corrections to be made to the altimeter reading are shown for various altitudes and flap positions for the normal static air source (figure 7-4).

# AIRSPEED INSTALLATION CORRECTION

## ALL STORES

AIRSPEED  
OV-1D/RV-1D  
T53-L-701

### EXAMPLE N-2

**WANTED**

CALIBRATED AIRSPEED

**KNOWN**

INDICATED AIRSPEED = 240 KT  
FLAPS UP

**METHOD**

ENTER INDICATED AIRSPEED HERE →  
MOVE RIGHT TO CURVE →  
MOVE DOWN, READ CALIBRATED  
AIRSPEED = 239 KT

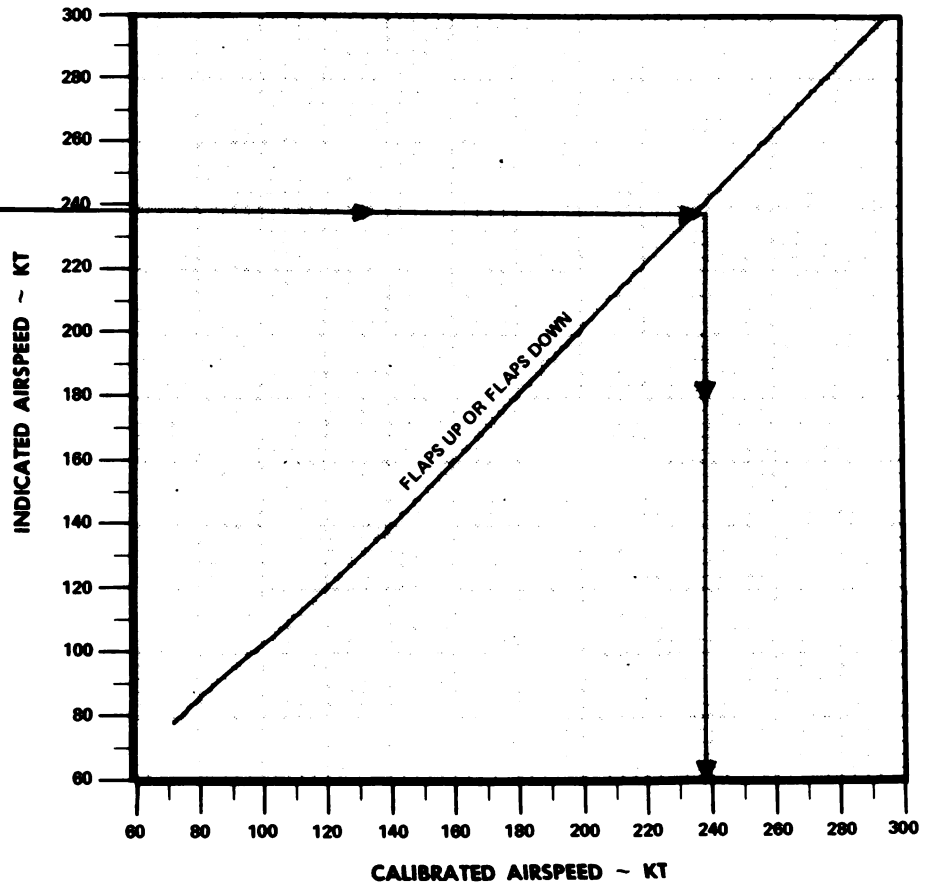

DATA BASIS: FLIGHT TEST

A-7-10-D-3

Figure 7-3. Airspeed Installation Correction





# ALTIMETER INSTALLATION CORRECTION ALL STORES

ALTIMETER  
OV-10/RV-10  
T53-L-701

## EXAMPLE 11-3

**WANTED**  
CORRECTED ALTITUDE

**KNOWN**  
INDICATED ALTITUDE = 15000 FT  
INDICATED AIRSPEED = 240 KT  
PRESSURE ALTITUDE = 15000 FT  
FLAP SETTING UP

**METHOD**  
ENTER INDICATED AIRSPEED HERE →  
→ MOVE RIGHT TO PRESSURE ALTITUDE  
→ MOVE DOWN, READ ALTITUDE  
CORRECTION = -95 FT.  
CORRECTED ALTITUDE = (INDICATED  
ALTITUDE + CORRECTION) = 14905 FT

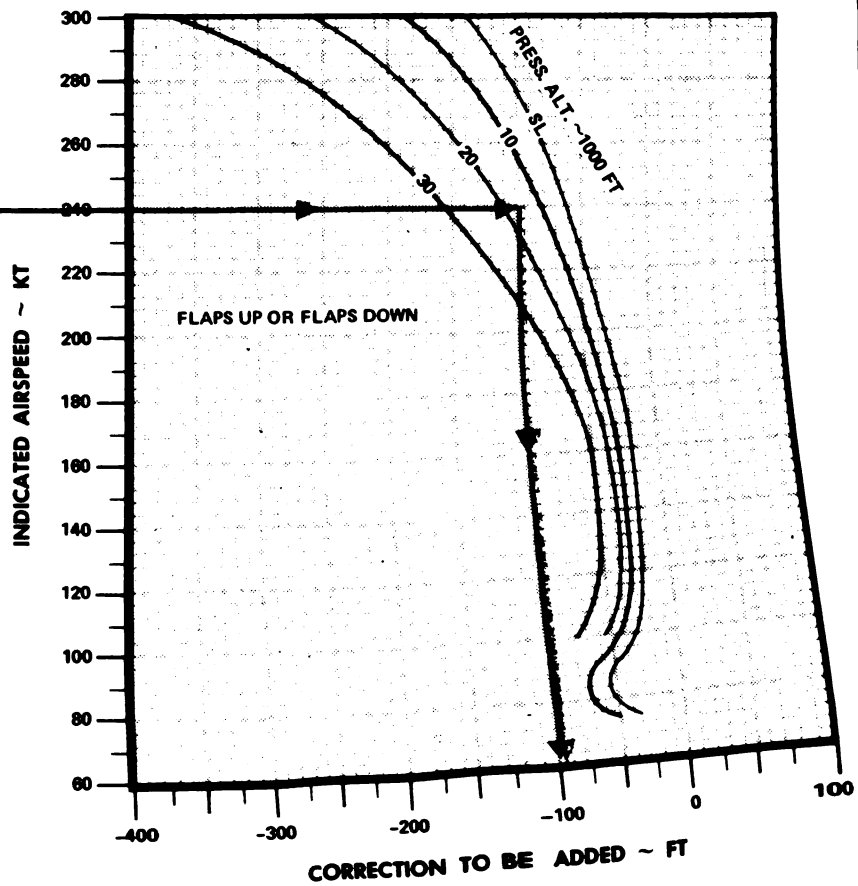

DATA BASIS: FLIGHT TEST

A-7-10-D-4

Figure 7-4. Altimeter Installation Correction

### SECTION III. CROSSWIND – TAKEOFF OR LANDING

#### 7-20. Description.

The crosswind – takeoff or landing chart (figure 7-5) shows the crosswind conditions under which a takeoff or landing is not recommended.

#### 7-21. Use of Chart.

The primary use of the crosswind – takeoff or landing chart is shown in Example III-1. Recommended rotation airspeed may be obtained from figure 7-9. Recommended touchdown airspeed (approach speed) may be obtained from figure 7-40. If the intersection point falls to the right of the configuration all

stores line, takeoff or landing shall not be attempted with other than a clean or two 150-gallon drop tanks configuration. If the intersection point falls to the right of the configuration clean or drop tanks line, takeoff or landing should not be attempted in any configuration.

#### 7-22. Conditions.

This chart is valid for any stores configuration.

#### 7-23. Data Basis.

Data for the crosswind – takeoff or landing chart were derived from flight test.

# CROSSWIND-TAKEOFF OR LANOING

CROSSWIND-TAKEOFF OR LANDING  
OV-1D/RV-1D  
T53-L-701

- G
- Y
- R

## EXAMPLE III-1

### WANTED

DETERMINE IF THE CROSSWIND EXCEEDS RECOMMENDED CONDITIONS FOR TAKEOFF

### KNOWN

CLEAN CONFIGURATION  
RUNWAY 27  
WIND VELOCITY = 20 KT  
WIND DIRECTION = 210°  
NORMAL ROTATION  
AIRSPEED = 95 KT (FROM FIGURE 7-9)

### METHOD

DETERMINE RUNWAY WIND ANGLE  
 $270^\circ - 210^\circ = 60^\circ$   
ENTER WIND VELOCITY HERE →  
MOVE RIGHT TO RUNWAY WIND ANGLE = 60°  
MOVE DOWN TO NORMAL ROTATION  
AIRSPEED LINE = 95 KT  
THE INTERSECTION POINT FALLS WITHIN THE RECOMMENDED AREA FOR A CLEAN CONFIGURATION TAKEOFF OR LANDING

### NOTE

IF THE INTERSECTION POINT FALLS TO THE RIGHT OF THE CONFIGURATION ALL STORES LINE, TAKEOFF OR LANDING SHALL NOT BE ATTEMPTED WITH OTHER THAN A CLEAN OR TWO 150-GALLON DROP TANKS CONFIGURATION. IF THE INTERSECTION POINT FALLS TO THE RIGHT OF THE CONFIGURATION CLEAN OR DROP TANKS LINE, TAKEOFF OR LANDING SHALL NOT BE ATTEMPTED. WHEN LANDING OR TAKING OFF IN A CROSSWIND WITH ASYMMETRIC WING STORES, IT IS RECOMMENDED THAT, WHEN FEASIBLE, THE AIR CRAFT BE POSITIONED SUCH THAT THE HEAVY WING IS UPWIND.

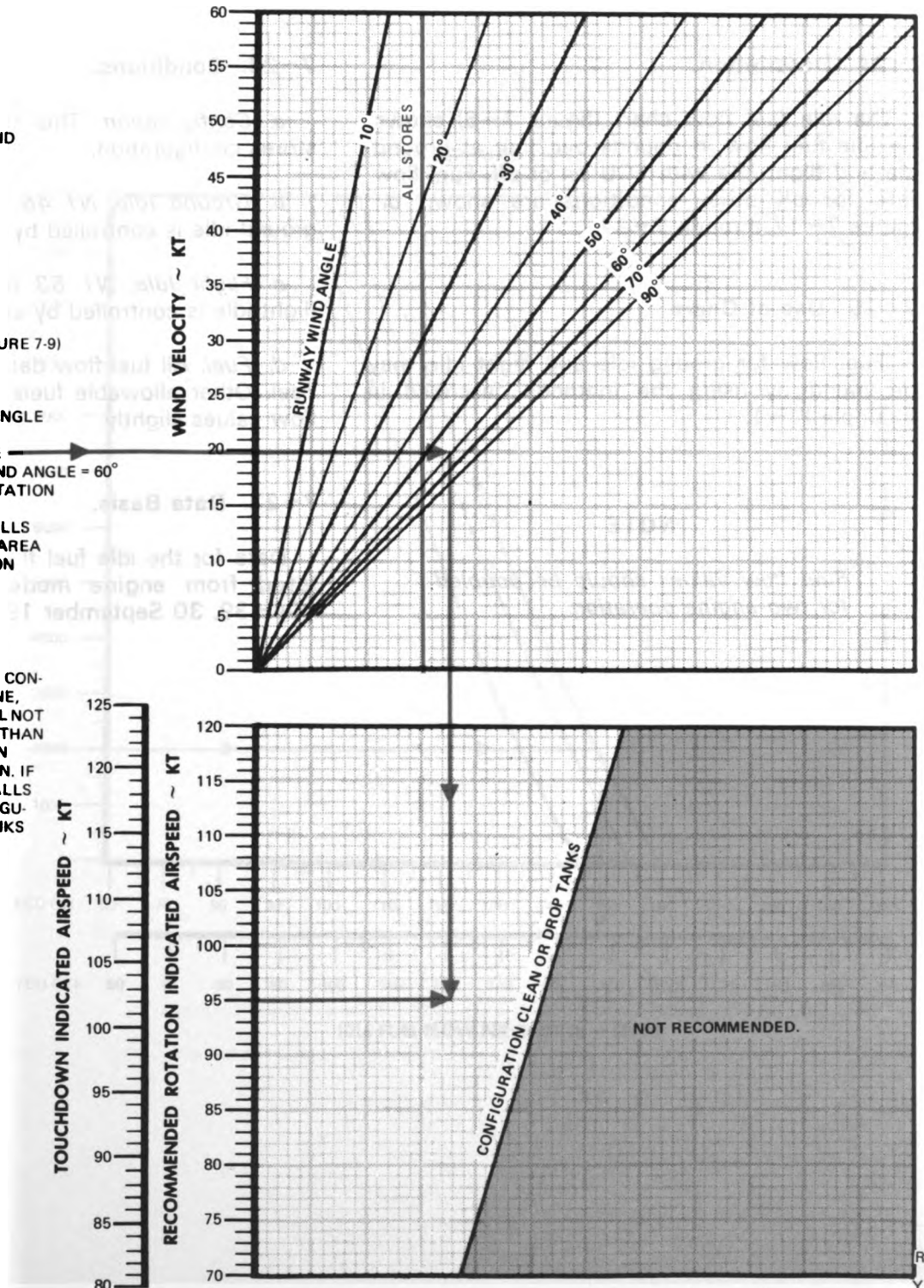

DATA BASIS: DERIVED FROM FLIGHT TEST

B-7-10-D-5

Figure 7-5. Crosswind - Takeoff or Landing

## SECTION IV. IDLE FUEL FLOW

### 7-24. Description.

The idle fuel flow chart (figure 7-6) shows the idle fuel flow in pounds per hour at ground idle and flight idle with ECU on or off. Fuel flow data for all other conditions are shown on figures 7-17 through 7-37.

### 7-25. Use of Chart.

Fuel flow for ground idle and flight idle may be found by using the methods described in Example IV-1.

### NOTE

*Fuel flow values should be doubled for two-engine operation.*

### 7-26. Conditions.

*a. Configuration.* This chart is valid for any stores configuration.

*b. Ground Idle, N1 48 to 52%.* Fuel flow at ground idle is controlled by engine rigging.

*c. Flight Idle, N1 63 to 68%.* Fuel flow at flight idle is controlled by engine rigging.

*d. Fuel.* All fuel flow data are based on JP-4 Fuel. Other allowable fuels may change the fuel flow values slightly.

### 7-27. Data Basis.

Data for the idle fuel flow charts were calculated from engine model Specification No. 104-39, 30 September 1968.

# IDLE FUEL FLOW

JP-4 FUEL

IDLE FUEL FLOW  
OV-ID/RV-ID  
T53-L-701

## EXAMPLE IV-1

**WANTED**  
GROUND IDLE FUEL FLOW

**KNOWN**  
PRESSURE ALTITUDE = 2000 FT  
FAT = 20°C  
ECU OFF

**METHOD**  
ENTER PRESSURE ALTITUDE HERE  
MOVE RIGHT TO FAT = 20°C  
MOVE DOWN, READ  
IDLE FUEL FLOW  
PER ENGINE ECU OFF = 147 LB/HR

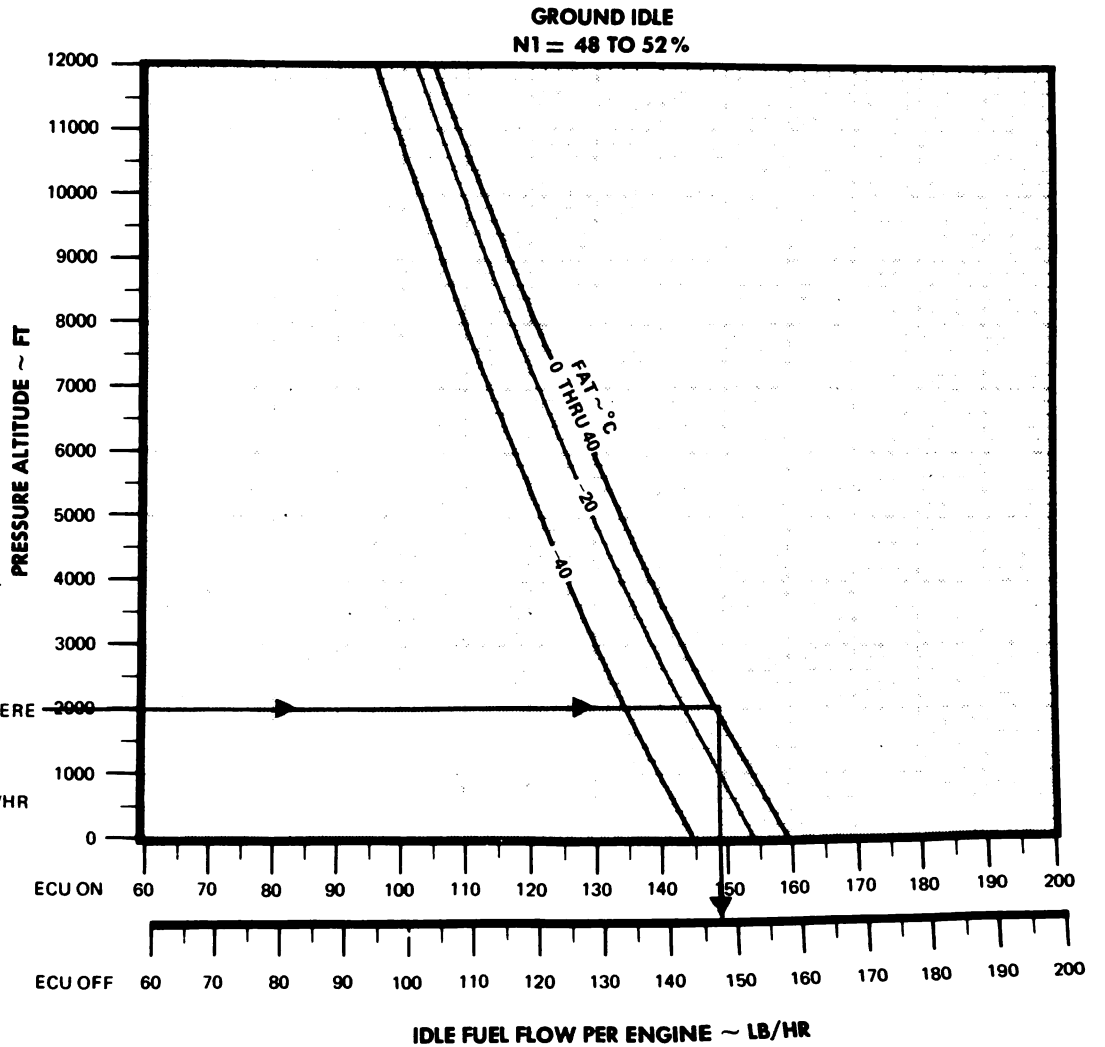

DATA BASIS: CALCULATED FROM ENGINE MODEL SPEC. NO. 104-39, 30 SEPTEMBER 1968

A-7-10-D-6-1

Figure 7-6. Idle Fuel Flow (Sheet 1 of 2)

7-15/(7-16 Blank)



**IDLE FUEL FLOW**  
JP-4 FUEL

IDLE FUEL FLOW  
OV-ID/RV-D  
T53-L-701

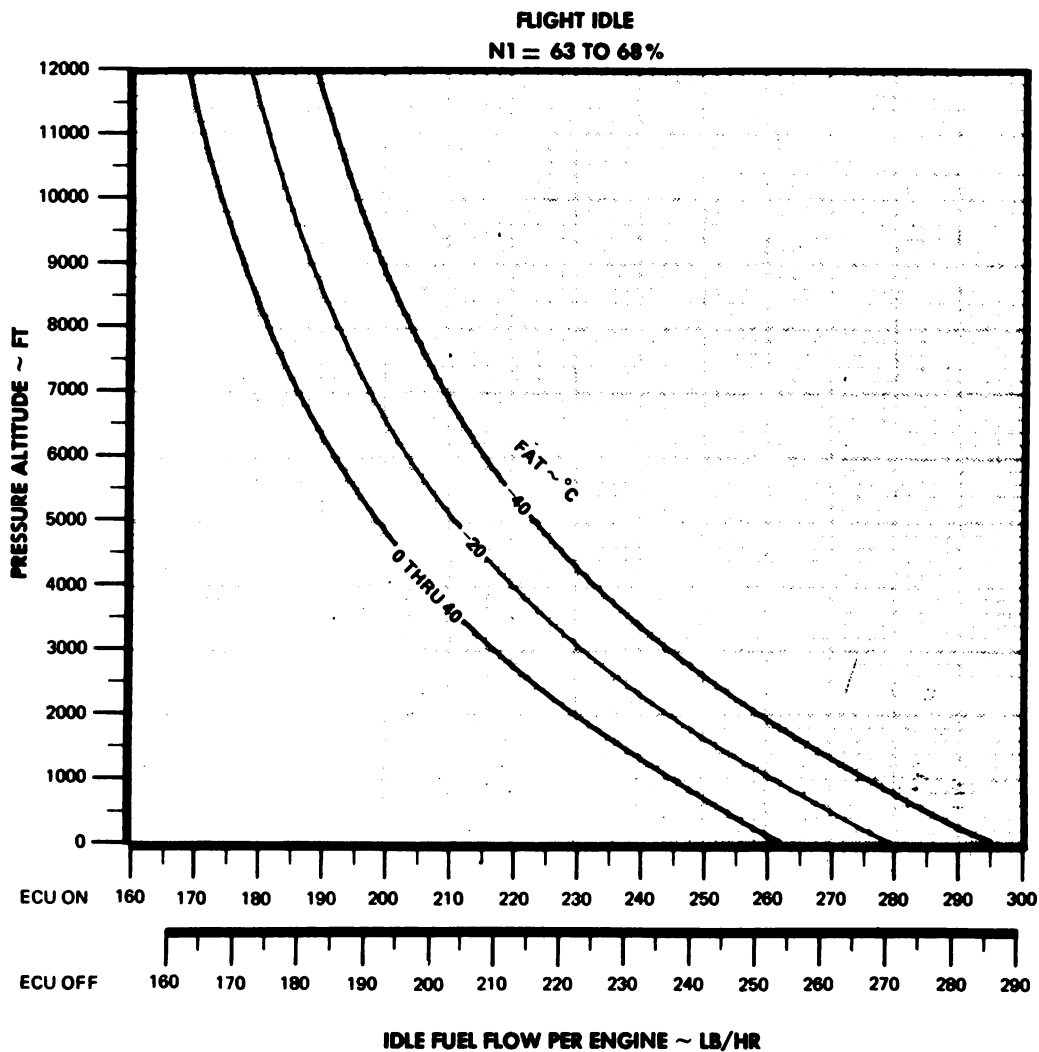

DATA BASIS: CALCULATED FROM ENGINE MODEL SPEC. NO. 104-39, 30 SEPTEMBER 1968

A-7-10-D-6-2

Figure 7-6. Idle Fuel Flow (Sheet 2 of 2)



## SECTION V. TORQUE AVAILABLE FOR TAKEOFF (30 MINUTES)

### 7-28. Description.

The torque available for takeoff chart (figure 7-7) shows the torque available per engine at various free air temperatures and pressure altitudes. The maximum torque for a 30-minute limit is also shown. Torque available per engine is shown in %.

### 7-29. Use of Chart.

The primary use of the chart is shown in Example V-1. The chart is based on a propeller speed of 1,678 RPM. Therefore, other propeller speeds will cause inaccuracies in chart interpretation if used. Due to engine deterioration, minor instrument inaccuracy, and individual interpreta-

tion of instrument readings, torque available readings may vary; therefore, a tolerance of 4% is allowable. If torque available per engine is not obtained during initial takeoff roll, the distance derived from figure 7-8 will not be obtained. Any excess power that may be developed without exceeding engine limitations can be utilized.

### 7-30. Conditions.

*a. Configuration.* This chart is valid for any stores configuration.

*b. ECU - OFF.*

### 7-31. Data Basis.

Data basis for the torque available for takeoff chart is flight test.

■ R  
■ G

# TORQUE AVAILABLE FOR TAKEOFF (30 MINUTES)

PROP SPEED = 1678 JP-4 FUEL ECU OFF V = 0 KNOTS

TORQUE AVAILABLE FOR TAKEOFF (30 MINUTES) OV-1D/RV-1D T53-L-701

## EXAMPLE V-1

**WANTED**

MAXIMUM TORQUE AVAILABLE FOR 30 MINUTES

**KNOWN**

FAT = 20°C  
PRESSURE ALTITUDE = 2000 FT

**METHOD**

ENTER FAT HERE →  
MOVE RIGHT TO PRESSURE ALTITUDE = 2000 FT  
MOVE DOWN, READ TORQUE AVAILABLE PER ENGINE = 80%

**NOTE**  
A TOLERANCE OF 4% IS ALLOWABLE

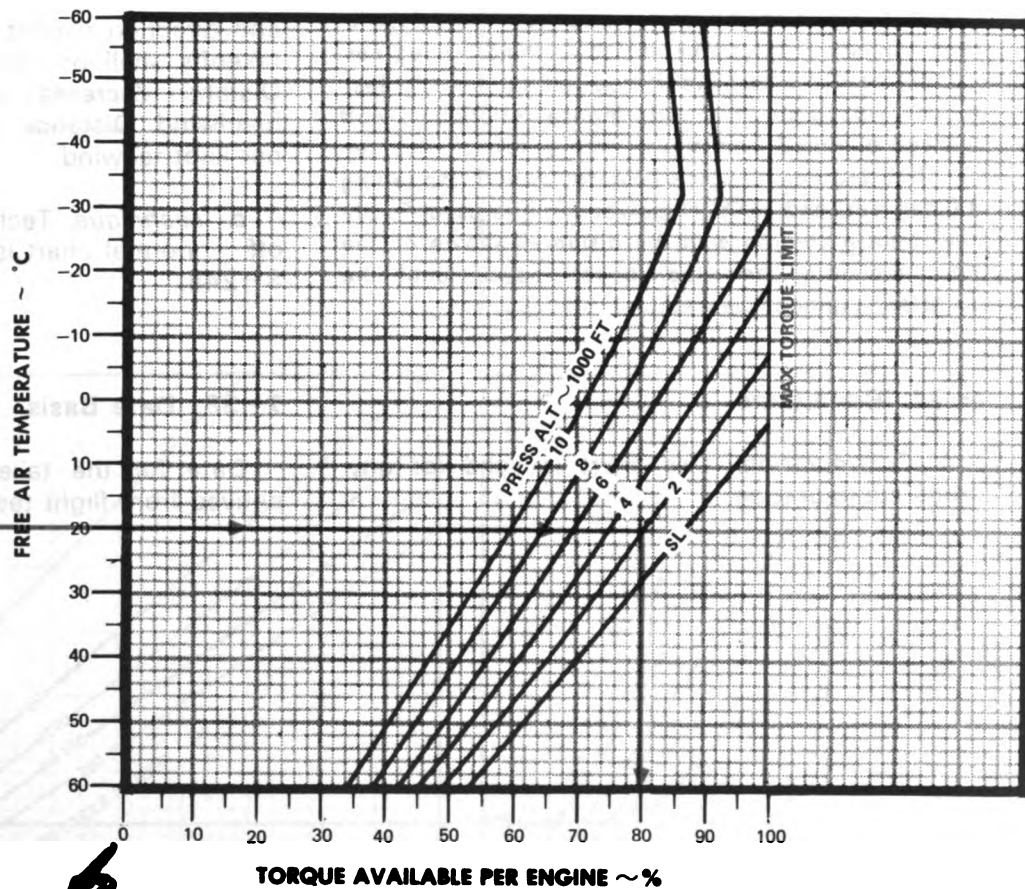

DATA BASIS: FLIGHT TEST

E-7-10-D-7

Figure 7-7. Torque Available for Takeoff (30 Minutes)

## SECTION VI. TAKEOFF – NORMAL

### 7-32. Description.

The takeoff – normal chart (figure 7-8 for takeoff flap setting of 15 degrees or figure 7-8A for takeoff flap setting of 0 degrees).

### 7-33. Use of Chart.

Takeoff ground roll distance and total distance to clear an obstacle can be found using the method described in Example VI-1 (for takeoff flap setting of 15 degrees) or Example VI-1A (for takeoff flap setting of 0 degrees). In order to obtain this performance, rotation/takeoff airspeed obtained from figure 7-9 (for takeoff flap setting of 15 degrees) or figure 7-9A (for takeoff flap setting of 0 degrees) and TAKEOFF power shall be used. To obtain obstacle clearance at the distances shown on the chart, maintain computed takeoff speed until the obstacles have been cleared.

### 7-34. Conditions.

*a. Configuration.* This chart is valid for any stores configuration.

*b. Runway.* Runway conditions for this chart are based on a dry, hard-surface, level runway. Conditions other than these will vary aircraft takeoff. Ground roll distance decreases approximately 5% per 1% downhill gradient. Ground roll distance increases approximately 7% per 1% uphill gradient.

*c. Wind.* All data presented are based on calm wind conditions. Since surface wind speed and direction cannot be accurately predicted, all takeoffs shall be planned based on calm wind. Distance decreases approximately 1% per knot headwind. Distance increases approximately 3% per knot tailwind.

*d. Technique.* Technique for use of the takeoff – normal chart is as described in paragraph 8-24a.

### 7-35. Data Basis.

Data for the takeoff – normal chart were derived from flight test.

**TAKEOFF-NORMAL**  
**FLAPS 15 DEGREES ALL STORES POWER-MAX AVAILABLE**  
**DRY, LEVEL, HARD SURFACE**

TAKEOFF-NORMAL  
 OV-1D/RV-1D  
 T53-L-701

**EXAMPLE VI-1**

**WANTED**

REQUIRED GROUND ROLL AND OBSTACLE CLEARANCE DISTANCES

**KNOWN**

FAT = 22°C  
 PRESSURE ALTITUDE = 2000 FT  
 TAKEOFF WEIGHT = 17000 LB  
 OBSTACLE HEIGHT = 100 FT

**METHOD**

ENTER FAT HERE →  
 MOVE RIGHT TO PRESSURE ALTITUDE  
 MOVE DOWN TO TAKEOFF WEIGHT  
 MOVE LEFT TO OBSTACLE HEIGHT  
 MOVE DOWN, READ TOTAL DISTANCE  
 REQUIRED TO CLEAR OBSTACLE = 3040 FT  
 MOVE DOWN FROM 0 OBSTACLE HEIGHT,  
 READ GROUND ROLL DISTANCE = 2000 FT

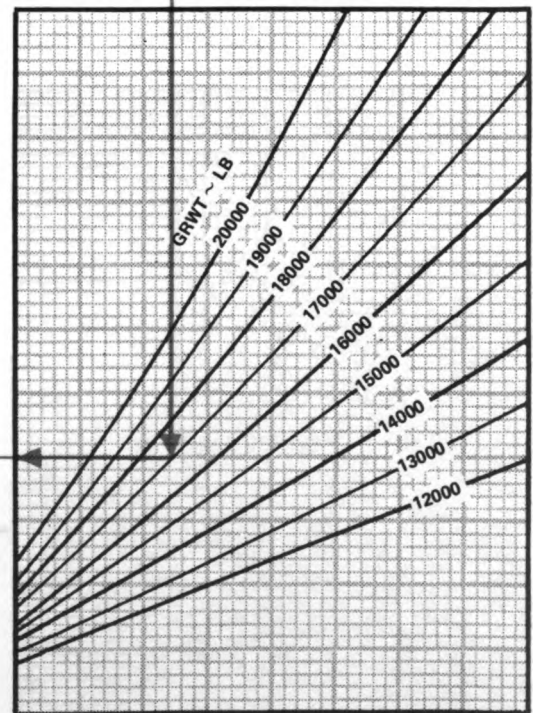
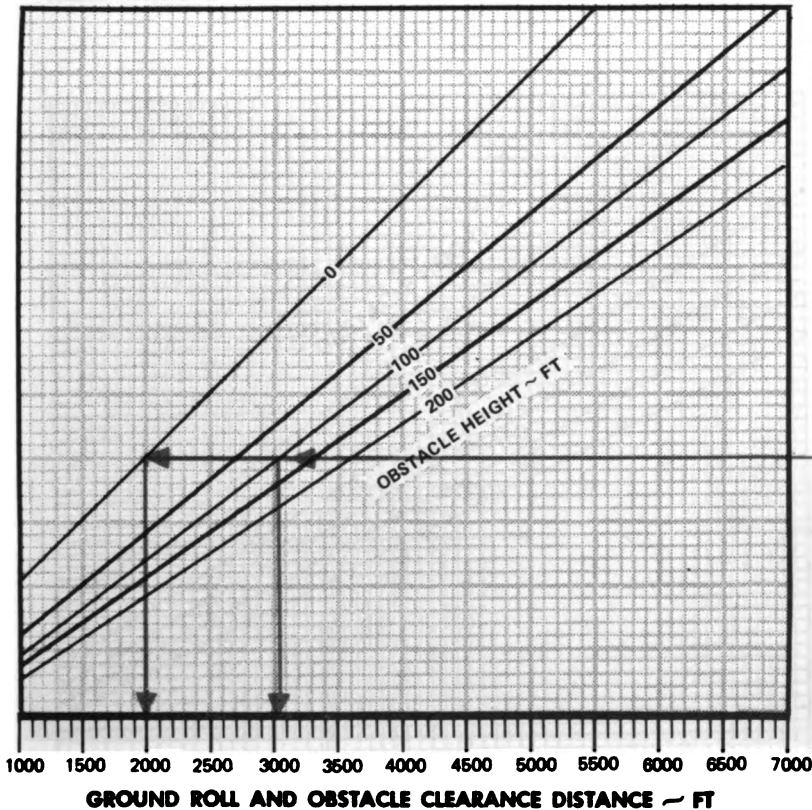
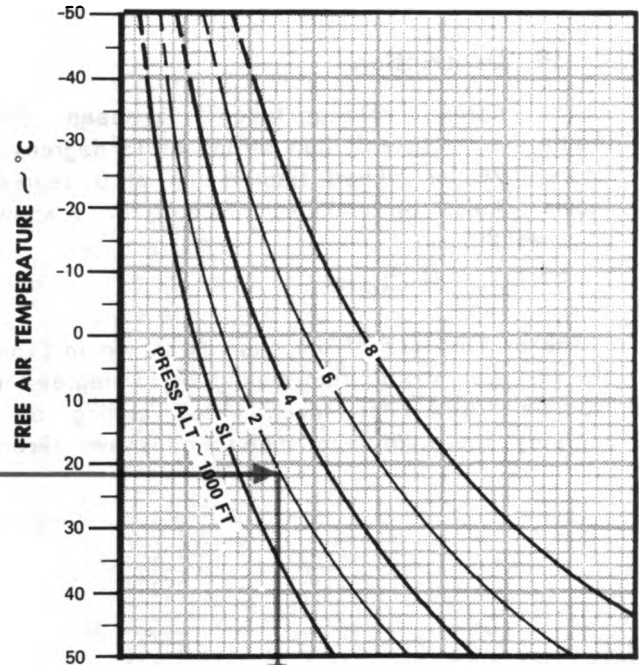

DATA BASIS: DERIVED FROM FLIGHT TEST

A-7-10-D-8

Figure 7-8. Takeoff - Normal

## SECTION VII. NORMAL ROTATION/TAKEOFF AIRSPEED

### 7-36. Description.

The normal rotation/takeoff airspeed chart (figure 7-9 for takeoff flap setting of 15 degrees or figure 7-9A for takeoff flap setting of 0 degrees) shows rotation and takeoff airspeed for a known gross weight.

### 7-37. Use of Chart.

The primary use of the chart is shown in Example VII-1 (for takeoff flap setting of 15 degrees) or Example VII-1A (for takeoff flap setting of 0 degrees). The rotation airspeed line shows recom-

mended rotation indicated airspeed for a given gross weight. The takeoff airspeed line shows recommended takeoff indicated airspeed for a given gross weight.

### 7-38. Conditions.

This chart is valid for any stores configuration.

### 7-39. Data Basis.

Data for the normal rotation/takeoff airspeed chart were derived from flight test.

# TAKEOFF - NORMAL

FLAPS 0 DEGREES ALL STORES POWER - MAX AVAILABLE  
 DRY, LEVEL, HARD SURFACE

TAKEOFF NORMAL  
 OV-1D/RV-1D  
 T53-L-701

**EXAMPLE VI-1**

**WANTED**

REQUIRED GROUND ROLL AND OBSTACLE  
 CLEARANCE DISTANCES

**KNOWN**

FAT 22°C  
 PRESSURE ALTITUDE = 2000 FT  
 TAKEOFF WEIGHT = 17000 LB  
 OBSTACLE HEIGHT = 100 FT

**METHOD**

ENTER FAT HERE →  
 MOVE RIGHT TO PRESSURE ALTITUDE  
 MOVE DOWN TO TAKEOFF WEIGHT  
 MOVE LEFT TO OBSTACLE HEIGHT  
 MOVE DOWN, READ TOTAL DISTANCE  
 REQUIRED TO CLEAR OBSTACLE = 4050 FT  
 READ GROUND ROLL DISTANCE 2800 FT

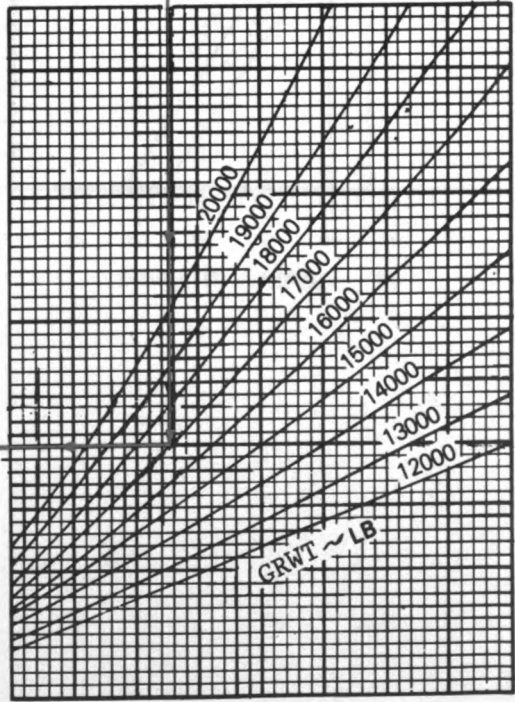
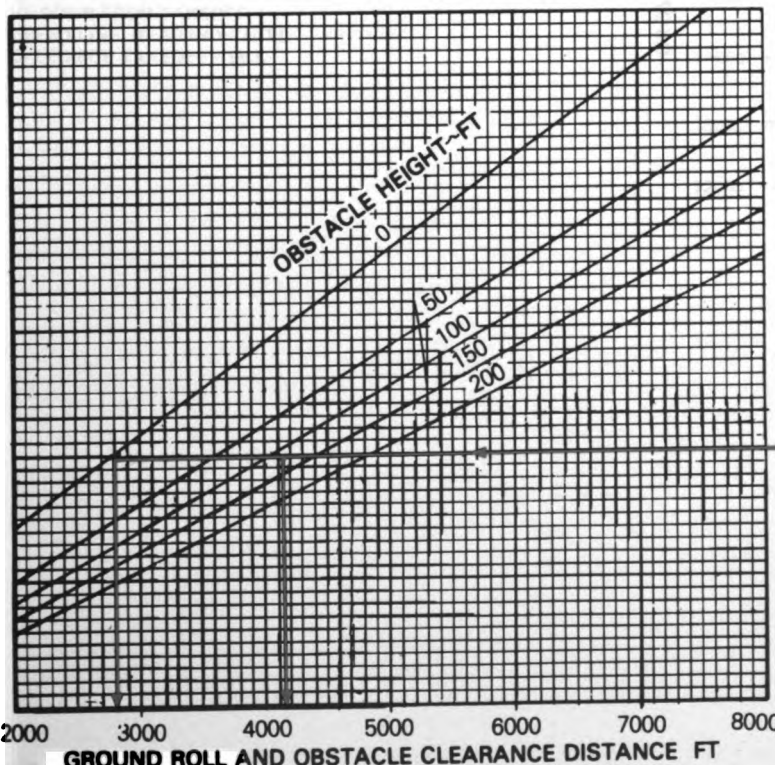
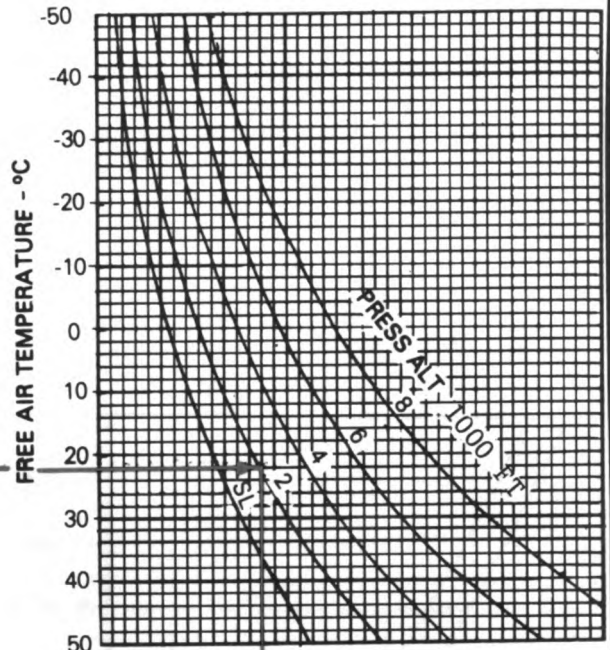

DATA BASIS: DERIVED FROM FLIGHT TEST

**Figure 7-8A. Takeoff - Normal (Flaps 0 Degrees)**



**NORMAL ROTATION/TAKEOFF AIRSPEED**  
**FLAPS 15 DEGREES**  
**ALL STORES**

NORMAL ROTATION/TAKEOFF  
 AIRSPEED  
 OV-1D/RV-1D  
 T53-L-701

**EXAMPLE VII-1**

**WANTED**

NORMAL ROTATION AND TAKEOFF  
 AIRSPEED FOR KNOWN GROSS WEIGHTS

**KNOWN**

GROSS WEIGHT = 17000 LB

**METHOD**

ENTER GROSS WEIGHT HERE →  
 MOVE RIGHT TO ROTATION  
 AIRSPEED AND TAKEOFF  
 AIRSPEED LINES  
 MOVE DOWN FROM ROTATION  
 AIRSPEED LINE, READ INDICATED  
 AIRSPEED FOR ROTATION = 95 KT  
 MOVE DOWN FROM TAKEOFF  
 AIRSPEED LINE, READ INDICATED  
 AIRSPEED FOR TAKEOFF = 98 KT

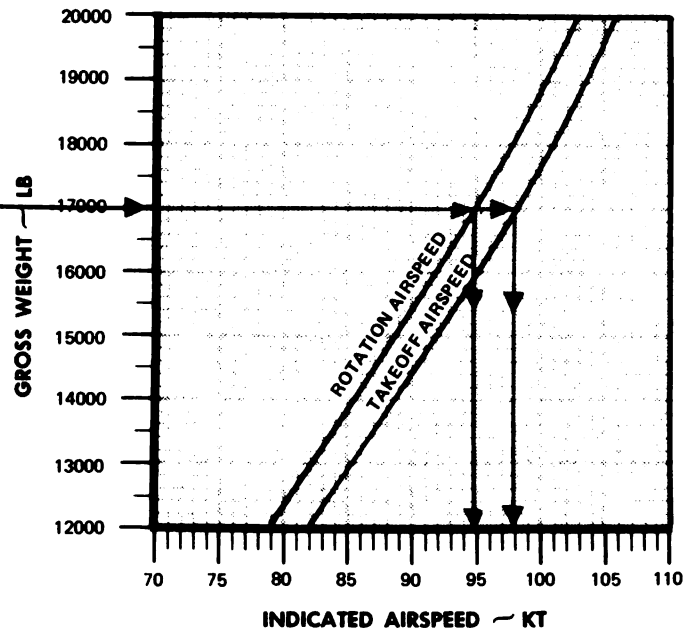

DATA BASIS: DERIVED FROM FLIGHT TEST

G ■  
 A-7-10-D-9

**Figure 7-9. Normal Rotation/Takeoff Airspeed**



## SECTION VIII. ACCELERATION CHECK DISTANCE

### 7-40. Description.

The acceleration check distance chart (figure 7-10) shows the relationship between indicated airspeed and ground roll distance during the takeoff run. Required airspeeds at designated points along the runway may be computed from this chart as shown in Example VIII-1. This chart is used in conjunction with the takeoff - normal chart (figure 7-8) and the normal rotation/takeoff airspeed chart (figure 7-9). Figures 7-8 and 7-9 shall be used to determine the actual indicated airspeed and ground roll distance required to compute the acceleration check distance.

### 7-41. Use of Chart.

The primary use of the acceleration check distance chart is shown in Example VIII-1. The first task in using the data is to determine the takeoff airspeed and ground roll distance required, as shown on figures 7-8 and 7-9. Normally, sufficient accuracy can be obtained by projecting a paralleling line down the guideline nearest the intersection point, but, for conservatism, guidelines to the left of the ground roll

distance and indicated airspeed intersection point may be used. If indicated airspeed is not obtained at a selected distance, and the runway distance is critical, the takeoff should be aborted.

### 7-42. Conditions.

*a. Conditions.* Runway conditions for this chart are based on a dry, level, hard-surface runway. Conditions other than these may vary aircraft acceleration.

*b. Wind.* All data presented are based on calm wind conditions. Since surface wind speed and direction cannot be accurately predicted, all takeoffs shall be planned based on calm wind.

*c. Configuration.* All acceleration check distance data are valid for any stores configuration.

### 7-43. Data Basis.

Data for the acceleration check distance chart were derived from flight test.

# NORMAL ROTATION/TAKEOFF AIRSPEED FLAPS 0 DEGREES ALL STORES

NORMAL ROTATION/TAKEOFF  
AIRSPEED  
OV-1D/RV-1D  
T53-L-701

### EXAMPLE VII-1A

**WANTED**

NORMAL ROTATION  
AIRSPEED FOR KNOWN  
GROSS WEIGHTS

**KNOWN**

GROSS WEIGHT = 17000 LB

**METHOD**

ENTER GROSS WEIGHT HERE →  
MOVE RIGHT TO ROTATION  
AIRSPEED AND TAKEOFF  
AIRSPEED LINES  
MOVE DOWN FROM ROTATION  
AIRSPEED LINE, READ INDICATED  
AIRSPEED FOR ROTATION = 108KT  
MOVE DOWN FROM TAKEOFF  
AIRSPEED LINE, READ INDICATED  
AIRSPEED FOR TAKEOFF = 111.5KT

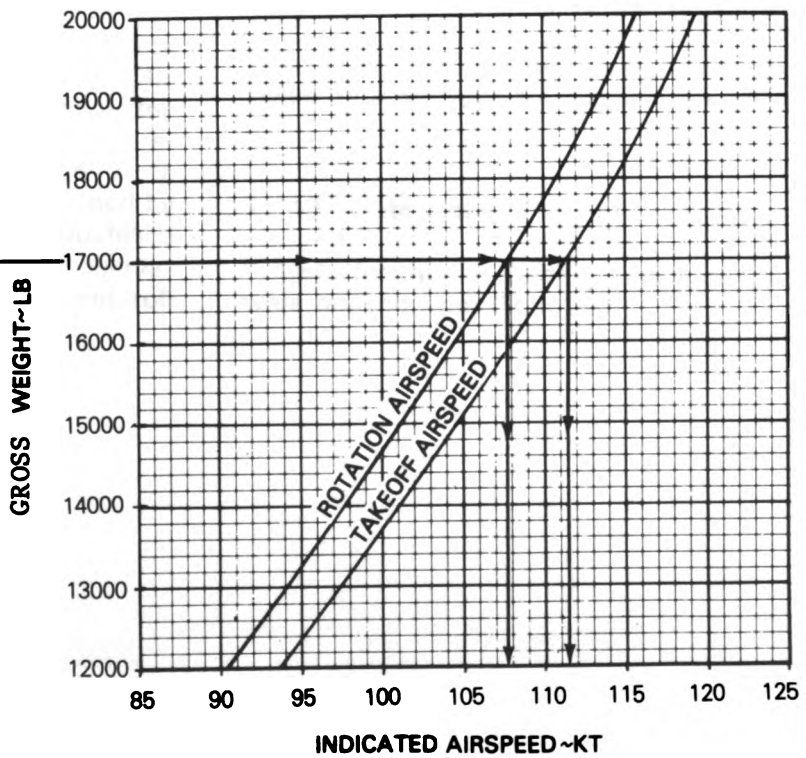

DATA BASIS: DERIVED FROM FLIGHT TEST

**Figure 7-9A. Normal Rotation/Takeoff Airspeed (Flaps 0 Degrees)**



## SECTION VIII. ACCELERATION CHECK DISTANCE

### 7-40. Description.

The acceleration check distance chart (figure 7-10) shows the relationship between indicated airspeed and ground roll distance during the takeoff run. Required airspeeds at designated points along the runway may be computed from this chart as shown in Example VIII-1. This chart is used in conjunction with the takeoff - normal chart (figure 7-8) and the normal rotation/takeoff airspeed chart (figure 7-9). Figures 7-8 and 7-9 shall be used to determine the actual indicated airspeed and ground roll distance required to compute the acceleration check distance.

### 7-41. Use of Chart.

The primary use of the acceleration check distance chart is shown in Example VIII-1. The first task in using the data is to determine the takeoff airspeed and ground roll distance required, as shown on figures 7-8 and 7-9. Normally, sufficient accuracy can be obtained by projecting a paralleling line down the guideline nearest the intersection point, but, for conservatism, guidelines to the left of the ground roll

distance and indicated airspeed intersection point may be used. If indicated airspeed is not obtained at a selected distance, and the runway distance is critical, the takeoff should be aborted.

### 7-42. Conditions.

*a. Conditions.* Runway conditions for this chart are based on a dry, level, hard-surface runway. Conditions other than these may vary aircraft acceleration.

*b. Wind.* All data presented are based on calm wind conditions. Since surface wind speed and direction cannot be accurately predicted, all takeoffs shall be planned based on calm wind.

*c. Configuration.* All acceleration check distance data are valid for any stores configuration.

### 7-43. Data Basis.

Data for the acceleration check distance chart were derived from flight test.



**ACCELERATION CHECK DISTANCE**

**POWER-MAX ALLOWABLE**

**CALM WINDS**

**FLAPS 15 DEGREES**

**LEVEL HARD SURFACE**

**ALL STORES**

ACCELERATION  
CHECK DISTANCE  
OV-1D/RV-1D  
T53-L-701

**EXAMPLE VIII-1**

**WANTED**

AIRSPED REQUIRED AT VARIOUS  
ACCELERATION CHECK POINTS

**KNOWN**

TAKEOFF AIRSPED FOR KNOWN GROSS  
WEIGHT OF 17000 LB = 97 KT  
GROUND ROLL DISTANCE = 1950 FT

**METHOD**

ENTER INDICATED AIRSPED HERE →  
MOVE RIGHT TO GROUND ROLL DISTANCE  
LINE = 1950 FT  
MOVE DOWN PARALLELING THE GUIDE  
LINE TO THE 1000 FT GROUND ROLL  
DISTANCE LINE  
MOVE LEFT READ INDICATED AIRSPED  
REQUIRED AT 1000 FT MARKER = 73 KT

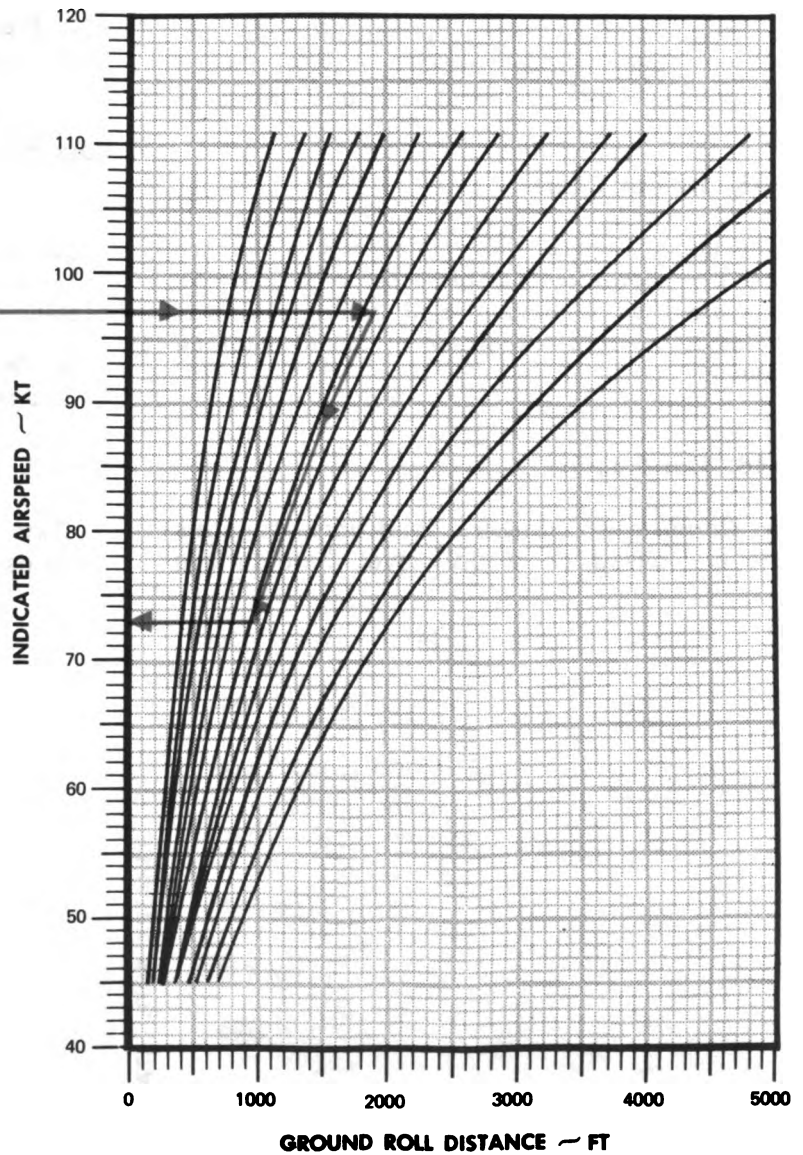

**DATA BASIS:** DERIVED FROM FLIGHT TEST

A-7-10-D-10

**Figure 7-10. Acceleration Check Distance**

## SECTION IX. ACCELERATE STOP DISTANCE

### 7-44. Description.

The accelerate stop distance chart (figure 7-11 for takeoff flap setting of 15 degrees and figure 7-11A for takeoff flap setting of 0 degrees) shows the distance required to accelerate to rotation speed, abort the takeoff and bring the aircraft to a stop. The chart covers various aircraft gross weights at various free air temperatures and pressure altitudes.

### 7-45. Use of Chart.

The primary use of the accelerate stop distance charts are shown in Examples IX-1 and IX-2. The charts are used to determine if sufficient runway remains to abort a takeoff or if takeoff must be completed.

### 7-46. Conditions.

*a. Conditions.* Runway conditions for this chart are based on a dry, level, hard-surface

runway. Conditions other than these may vary aircraft acceleration.

*b. Wind.* All data presented are based on calm wind conditions. Since surface wind speed and direction cannot be accurately predicted, all takeoffs shall be planned based on calm wind.

*c. Configuration.* All accelerate stop distance data are valid for any stores configuration.

*d. Runway Conditions.* While operating on snow or frost-covered runways, the accelerate stop distance may be increased by approximately 75 percent.

*e. Technique.* Technique for use of accelerate — stop charts is as described in paragraph 9-5c (1).

### 7-47. Data Basis.

Data for the accelerate stop distance chart were estimated.

# ACCELERATE - STOP DISTANCE

POWER - MAX ALLOWABLE CALM WINDS FLAPS 15 DEGREES  
 LEVEL HARD SURFACE ALL STORES

ACCELERATE - STOP  
 DISTANCE  
 OV-1D/RV-1D  
 T63-L-701

## EXAMPLE IX-1

### WANTED

DISTANCE REQUIRED TO ACCELERATE TO  
 ROTATIONAL SPEED, ABORT THE TAKEOFF  
 AND BRING THE AIRCRAFT TO A STOP

### KNOWN

FAT = 22°C  
 PRESSURE ALTITUDE = 2000 FT  
 GROSS WEIGHT = 17000 LB  
 TAKE-OFF FLAPS = 15 DEGREES

### METHOD

ENTER FAT HERE →  
 MOVE RIGHT TO PRESSURE ALTITUDE 2000 FT  
 MOVE DOWN TO GROSS WEIGHT = 17000 LB  
 MOVE LEFT AND READ  
 DISTANCE REQUIRED = 5400 FT

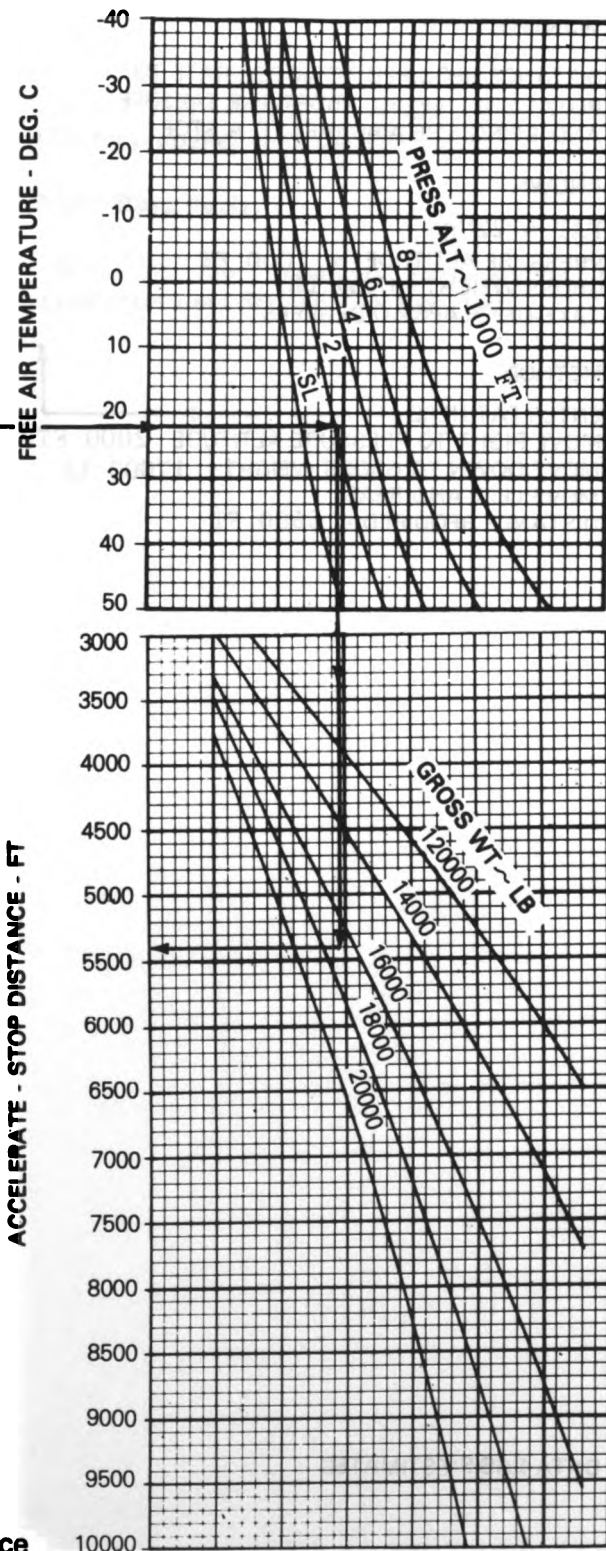

DATA BASIS: ESTIMATED

Figure 7-11. Accelerate Stop Distance



# ACCELERATE - STOP DISTANCE

POWER - MAX ALLOWABLE CALM WINDS FLAPS 0 DEGREES  
 LEVEL HARD SURFACE ALL STORES

ACCELERATE - STOP  
 DISTANCE  
 OV-1D/RV-1D  
 T53-L-701

## EXAMPLE IX-2

### WANTED

DISTANCE REQUIRED TO ACCELERATE TO  
 ROTATIONAL SPEED, ABORT THE TAKEOFF  
 AND BRING THE AIRCRAFT TO A STOP

### KNOWN

FAT = 22°C  
 PRESSURE ALTITUDE = 2000 FT  
 GROSS WEIGHT = 17000 LB  
 TAKE-OFF FLAPS = 0 DEGREES

### METHOD

ENTER FAT HERE →  
 MOVE RIGHT TO PRESSURE ALTITUDE 2000 FT  
 MOVE DOWN TO GROSS WEIGHT = 17000 LB  
 MOVE LEFT AND READ  
 DISTANCE REQUIRED = 6600 FT

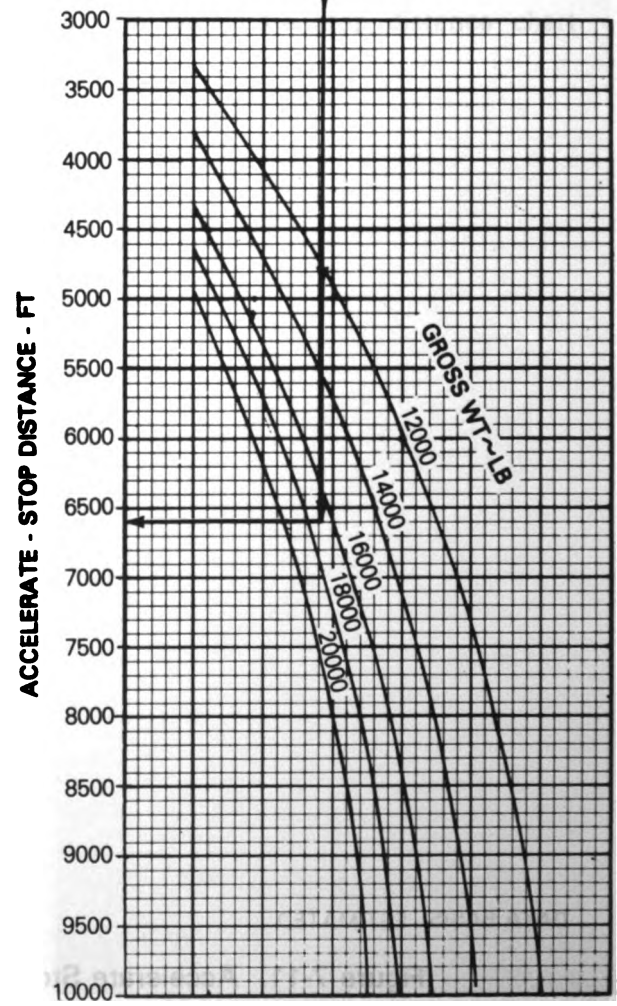
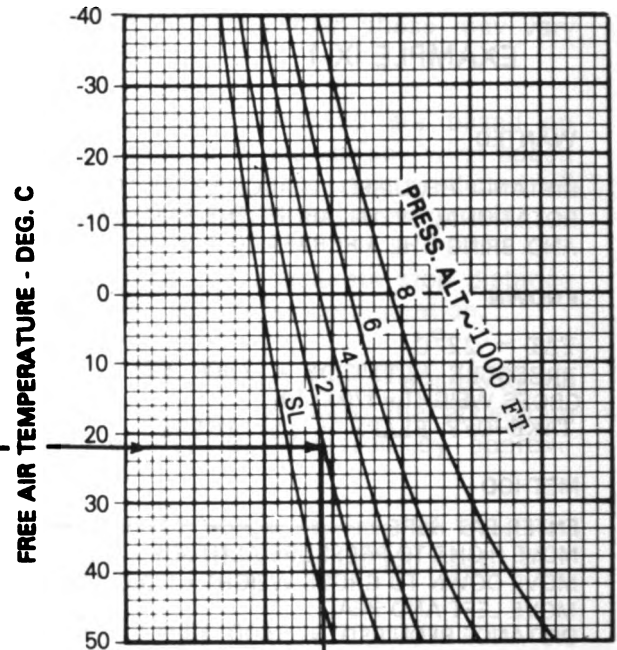

DATA BASIS: ESTIMATED

Figure 7-11A. Accelerate Stop Distance

**SECTION X. MINIMUM SINGLE-ENGINE CONTROL SPEED****7-48. Description.**

The minimum single-engine control speed chart (figure 7-12) shows the minimum airspeed ( $V_{mc}$ ) that will allow aircraft control during single-engine operation with flaps at 15° or up.

**7-49. Use of Chart.**

The primary use of this chart is to provide the minimum single-engine control airspeed ( $V_{mc}$ ) as shown in Examples X-1, -2, and -3. Flight at  $V_{mc}$  implies aircraft control only and does not provide the pilot with single-engine rate-of-climb information. At airspeeds above the rudder limited line,

sufficient directional control is available with takeoff power applied to the operative engine.

**7-50. Conditions.**

a. This chart is valid for any stores configuration.

b. The  $V_{mc}$  speed can increase by as much as 10 KIAS for propeller unfeathered condition.

**7-51. Data Basis.**

Data for the minimum single-engine control speed chart were derived from flight test.



# MINIMUM SINGLE-ENGINE CONTROL SPEED (V<sub>mc</sub>)

POWER-MAX ALLOWABLE GEAR DOWN FLAPS 15 DEGREES PROP FEATHERED  
ALL STORES

MINIMUM SINGLE ENGINE CONTROL AIRSPEED (V<sub>mc</sub>)  
OV-1D/RV-1D  
T53-L-701

■ G  
■ R

## EXAMPLE X-1

**WANTED**

MINIMUM SINGLE ENGINE CONTROL AIRSPEED AT A GIVEN FAT, PRESSURE ALTITUDE, AND GROSS WEIGHT

**KNOWN**

FAT = 18°C  
PRESSURE ALTITUDE = 3000 FT  
GROSS WEIGHT = 16000 LB

**METHOD**

ENTER FAT HERE →  
MOVE RIGHT TO PRESSURE ALTITUDE = 3000 FT  
MOVE DOWN TO GROSS WEIGHT = 16000 LB  
MOVE LEFT, READ INDICATED AIRSPEED = 92 KT

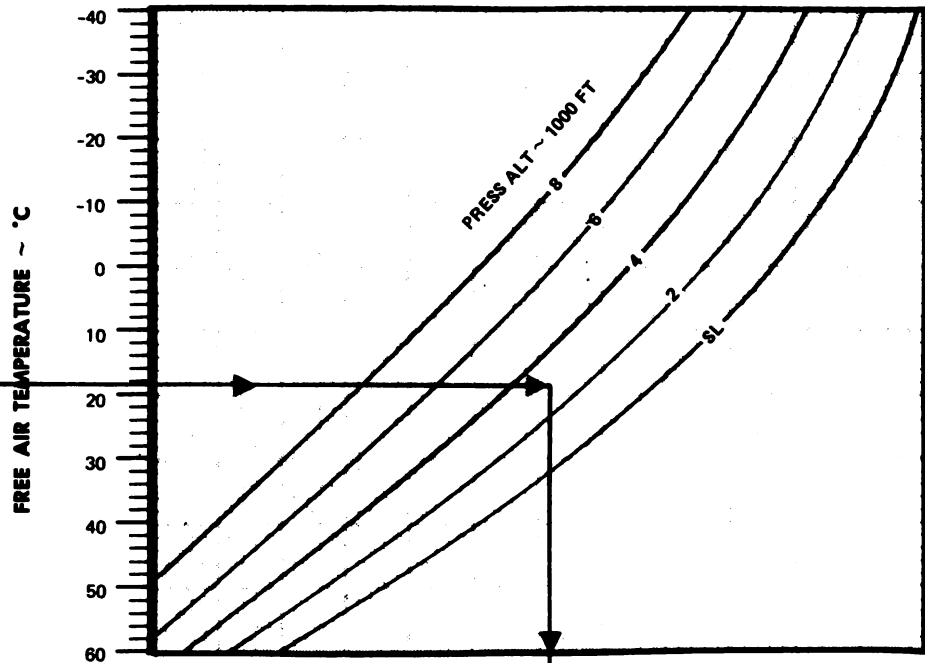

## EXAMPLE X-2

**WANTED**

MINIMUM SINGLE ENGINE CONTROL AIRSPEED AT A GIVEN FAT, PRESSURE ALTITUDE, AND GROSS WEIGHT

**KNOWN**

FAT = 18°C  
PRESSURE ALTITUDE = 3000 FT  
GROSS WEIGHT = 14000 LB

**METHOD**

ENTER FAT AT 18°C  
MOVE RIGHT TO PRESSURE ALTITUDE = 3000 FT  
MOVE DOWN TO GROSS WEIGHT OR RUDDER LIMIT LINE, WHICHEVER IS INTERSECTED FIRST  
MOVE LEFT, READ INDICATED AIRSPEED = 87 KT

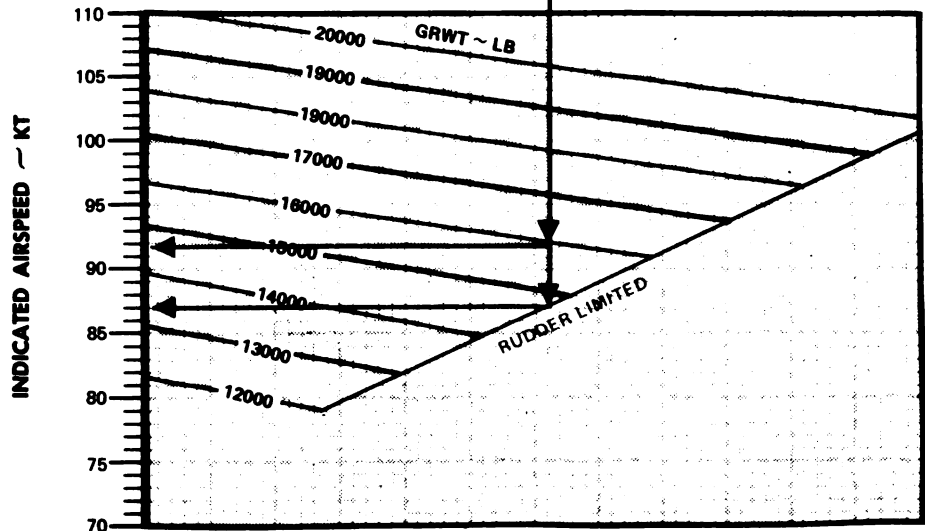

DATA BASIS: DERIVED FROM FLIGHT TEST

■ R  
■ G

B-7-10-D-11-1

Figure 7-12. Minimum Single-Engine Control Speed (V<sub>mc</sub>) (Sheet 1 of 2)

**SECTION X. MINIMUM SINGLE-ENGINE CONTROL SPEED****7-48. Description.**

The minimum single-engine control speed chart (figure 7-12) shows the minimum airspeed (V<sub>mc</sub>) that will allow aircraft control during single-engine operation with flaps at 15° or up.

**7-49. Use of Chart.**

The primary use of this chart is to provide the minimum single-engine control airspeed (V<sub>mc</sub>) as shown in Examples X-1 and X-2. Flight at V<sub>mc</sub> implies aircraft control only and does not provide the pilot with single-engine rate-of-climb information. At airspeeds above the rudder limit line, sufficient directional control is available with take-off power applied to the operative engine.

**NOTE**

*Minimum single-engine control airspeed with gear up and flaps up should be determined by adding 9 KIAS as derived from figure 7-12.*

**7-50. Conditions.**

- a. This chart is valid for any stores configuration.
- b. The V<sub>mc</sub> speed can increase by as much as 10 KIAS for propeller unfeathered condition.

**7-51. Data Basis.**

Data for the minimum single-engine control speed chart were derived from flight test.

# MINIMUM SINGLE-ENGINE CONTROL SPEED ( $V_{mc}$ )

POWER-MAX ALLOWABLE    GEAR DOWN    FLAPS 15 DEGREES    PROP FEATHERED  
ALL STORES

MINIMUM SINGLE  
ENGINE CONTROL  
AIRSPEED ( $V_{MC}$ )  
OV-1D/RV-1D  
T53-L-701

### EXAMPLE X-1

**WANTED**  
MINIMUM SINGLE ENGINE  
CONTROL AIRSPEED AT  
A GIVEN FAT, PRESSURE  
ALTITUDE, AND GROSS  
WEIGHT

**KNOWN**  
FAT = 18°C  
PRESSURE ALTITUDE = 3000 FT  
GROSS WEIGHT = 16000 LB

**METHOD**  
ENTER FAT HERE →  
MOVE RIGHT TO PRESSURE  
ALTITUDE = 3000 FT  
MOVE DOWN TO GROSS WEIGHT  
= 16000 LB  
MOVE LEFT, READ INDICATED  
AIRSPEED = 92 KT

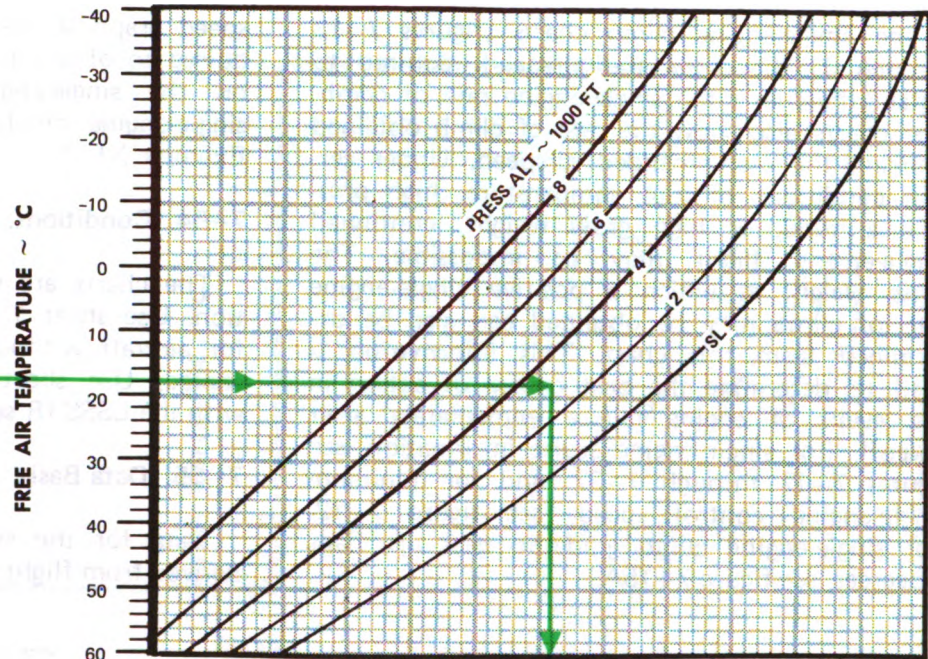

### EXAMPLE X-2

**WANTED**  
MINIMUM SINGLE ENGINE  
CONTROL AIRSPEED AT  
A GIVEN FAT, PRESSURE  
ALTITUDE, AND GROSS  
WEIGHT

**KNOWN**  
FAT = 18°C  
PRESSURE ALTITUDE = 3000 FT  
GROSS WEIGHT = 14000 LB

**METHOD**  
ENTER FAT AT 18°C  
MOVE RIGHT TO PRESSURE  
ALTITUDE = 3000 FT  
MOVE DOWN TO GROSS WEIGHT  
OR RUDDER LIMIT LINE,  
WHICHEVER IS INTERSECTED FIRST  
MOVE LEFT, READ INDICATED  
AIRSPEED = 87 KT

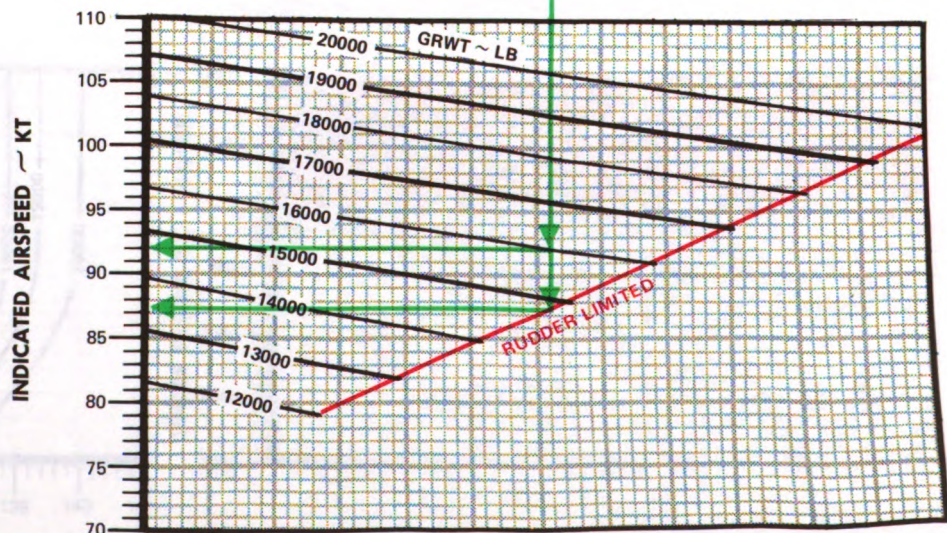

DATA BASIS: DERIVED FROM FLIGHT TEST

B-7-10-D-11-1

Figure 7-12. Minimum Single-Engine Control Speed ( $V_{mc}$ )

## SECTION XI. SINGLE-ENGINE CLIMB

### 7-52. Description.

The single-engine climb charts (figures 7-13 through 7-15) show the airspeed required to obtain the maximum single-engine rate of climb. The charts also show the rate of climb obtained utilizing the recommended airspeed. Under certain conditions of high temperature, high pressure altitude, or high gross weight, continued single-engine flight may be impossible. The gross weight at which a positive single-engine rate of climb may be obtained can also be determined from this chart. This information is used to determine the best course of action in the event of engine failure immediately after takeoff. For single-engine cruise information, see figures 7-17 through 7-37, and for minimum single-engine control speed, see figure 7-12. For single-engine climb gradient, gear up, flaps 0 degrees, see figure 7-15A.

### 7-53. Use of Charts.

The primary use of the charts is shown in figure 7-15, Example XI-1. The indicated airspeed graph shows the single-engine airspeed required to obtain the plotted rate of climb found on the single-engine rate-of-climb graph. For single-engine climb gradient use figure 7-15A, Example XI-2.

### 7-54. Conditions.

The charts are valid for any stores configuration. Use sheet 1 of figure 7-13 through 7-15 for aircraft without the LSSS IR suppressor installed. Use sheet 2 of the figure for aircraft with the LSSS IR suppressor installed.

### 7-55. Data Basis.

Data for the single-engine climb charts were derived from flight test.

# SINGLE ENGINE CLIMB CLIMB CONFIGURATION

SINGLE ENGINE CLIMB  
OV-1D/RV-1D  
T53-L-701

GEAR UP FLAPS 0 DEGREES ALL STORES  
PROP FEATHERED POWER-MAX ALLOWABLE  
WITHOUT LSSS IR SUPPRESSOR

### EXAMPLE XI-1

**WANTED**

SINGLE ENGINE RATE OF CLIMB IN CLIMB CONFIGURATION AND REQUIRED AIRSPEED FOR MAXIMUM SINGLE ENGINE RATE OF CLIMB

**KNOWN**

FAT = 22°C  
PRESSURE ALTITUDE = 2000 FT  
GROSS WEIGHT = 17000 LBS

**METHOD**

ENTER FAT HERE →  
MOVE RIGHT TO PRESSURE ALTITUDE  
MOVE DOWN TO GROSS WEIGHT  
MOVE LEFT, READ SINGLE ENGINE R/C = 200 FT/MIN  
ENTER FAT AGAIN AT 22°C (SEE BELOW)  
MOVE RIGHT TO GROSS WEIGHT  
MOVE DOWN, READ INDICATED CLIMB AIRSPEED = 130 KT

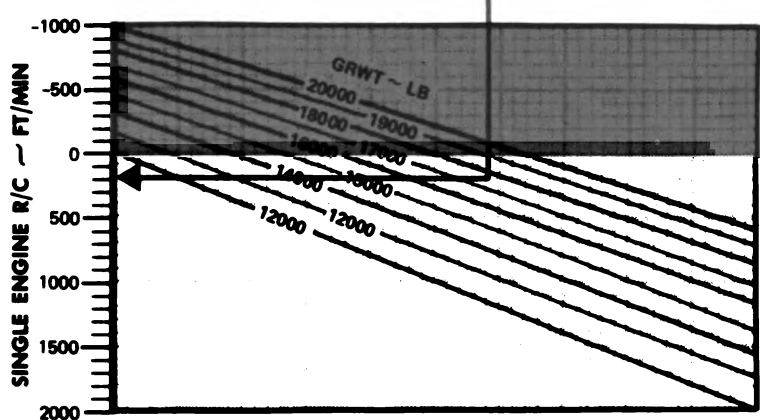
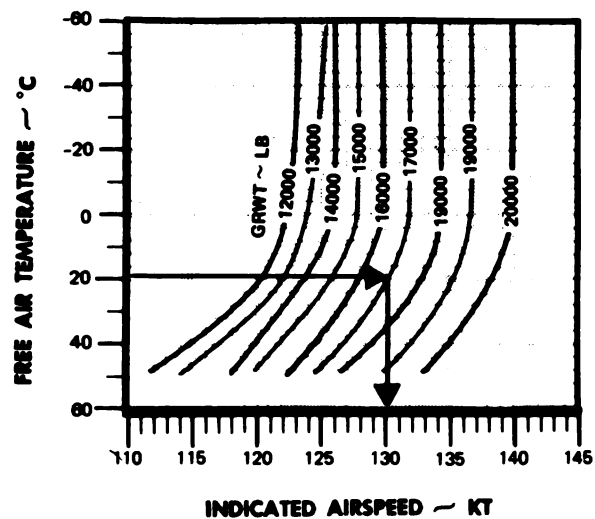
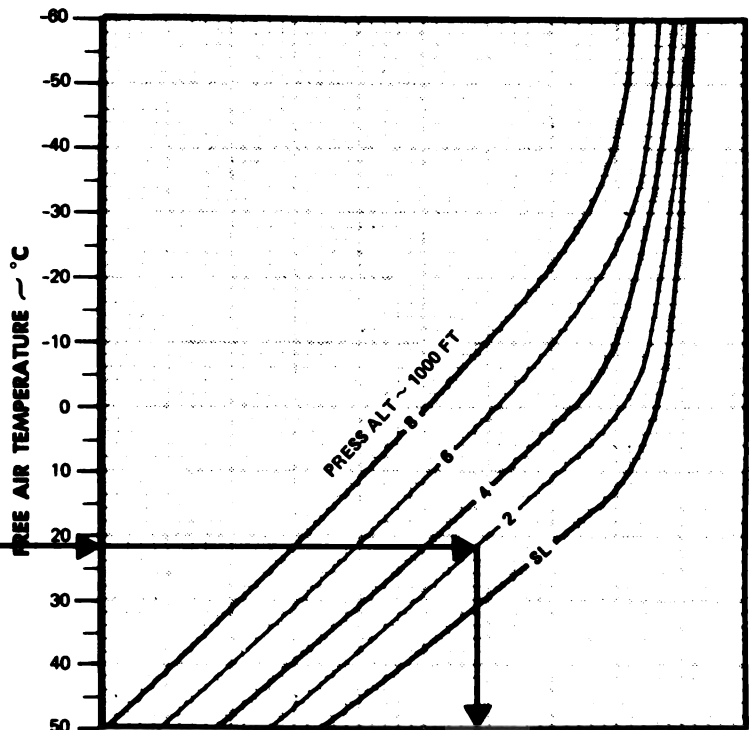

DATA BASIS: DERIVED FROM FLIGHT TEST

C-7-10-D-12-1

Figure 7-13. Single-Engine Climb (Flaps 0°/Gear Up) (Sheet 1 of 2)



# SINGLE ENGINE CLIMB

## CLIMB CONFIGURATION

SINGLE ENGINE  
CLIMB  
OV-10/RV-10  
T53-L-701

GEAR UP    FLAPS 0 DEGREES    ALL STORES    PROP FEATHERED    POWER-MAX ALLOWABLE  
WITH LSSS IN SUPPRESSOR

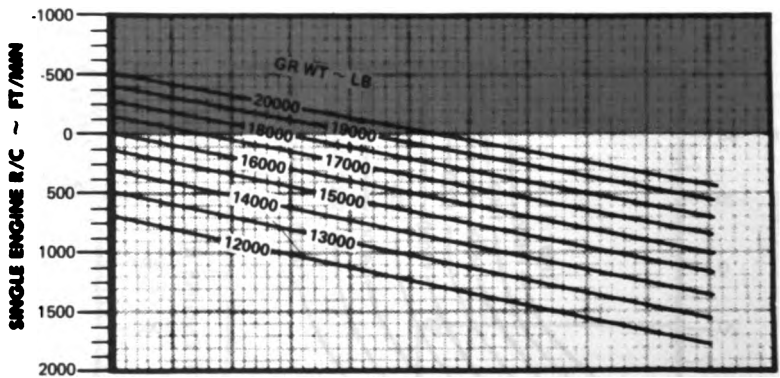
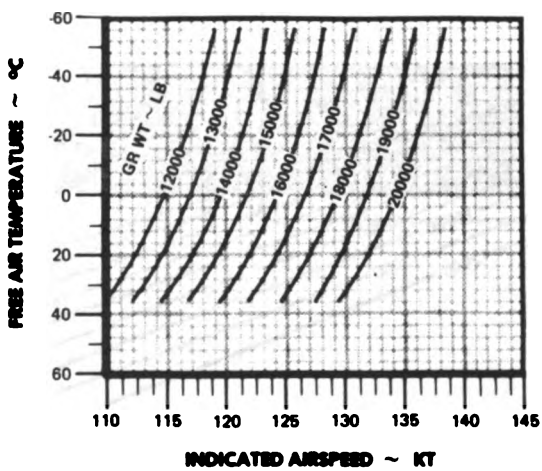
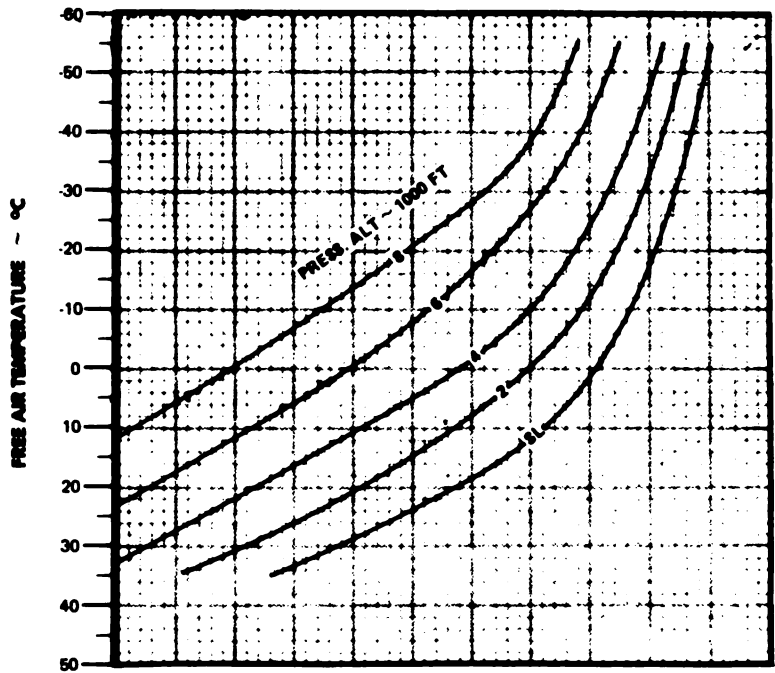

DATA BASIS: DERIVED FROM FLIGHT TEST

7-10-D-12-2

Figure 7-13. Single-Engine Climb (Flaps 0°/Gear Up) (Sheet 2 of 2)

7-34 Change 3

■ R

**SINGLE ENGINE CLIMB  
TAKEOFF CONFIGURATION**

SINGLE ENGINE  
CLIMB  
OV-1D/RV-1D  
T53-L-701

**GEAR UP    FLAPS 15 DEGREES    ALL STORES    PROP FEATHERED    POWER-MAX ALLOWABLE  
WITHOUT LSSS IR SUPPRESSOR**

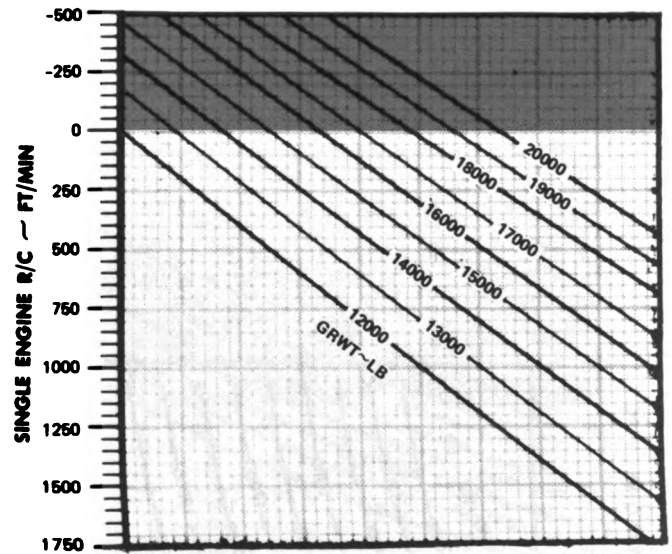
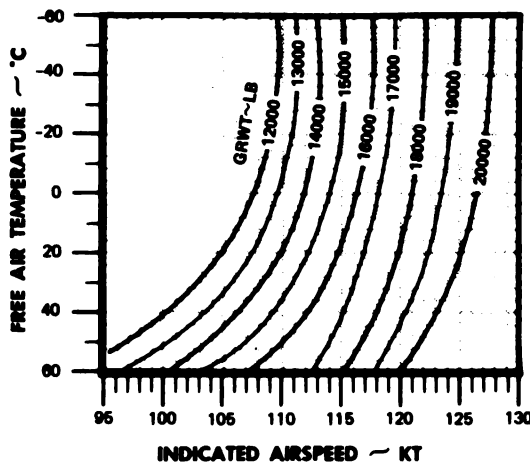
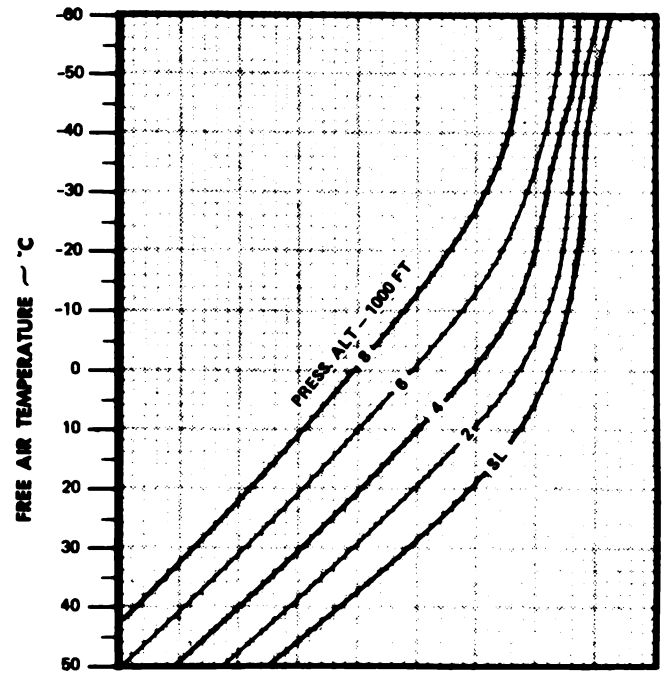

DATA BASIS: DERIVED FROM FLIGHT TEST

B-7-10-D-13-1

Figure 7-14. Single-Engine Climb (Flaps 15°/Gear Up) (Sheet 1 of 2)

Change 3 7-3AA

■ R

# SINGLE ENGINE CLIMB TAKEOFF CONFIGURATION

SINGLE ENGINE CLIMB  
OV-1D/RV-1D  
T53-L-701

GEAR UP FLAPS 15 DEGREES ALL STORES PROP FEATHERED POWER-MAX ALLOWABLE

WITH LSSS IR SUPPRESSOR

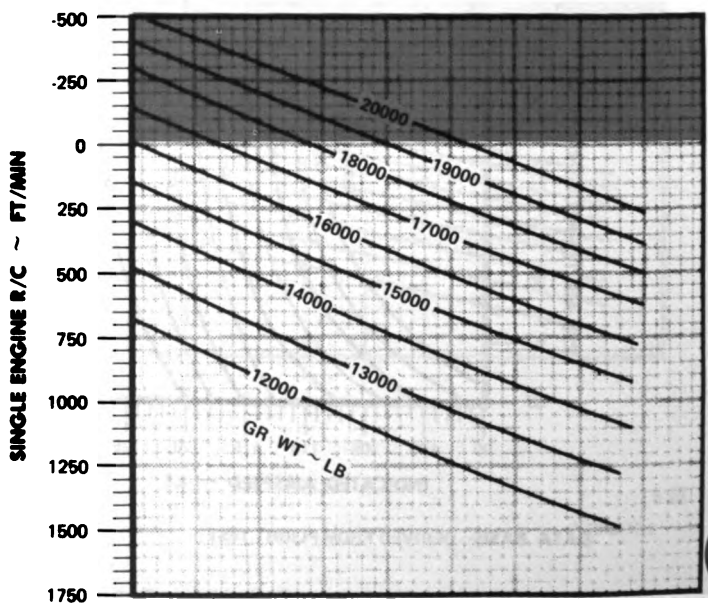
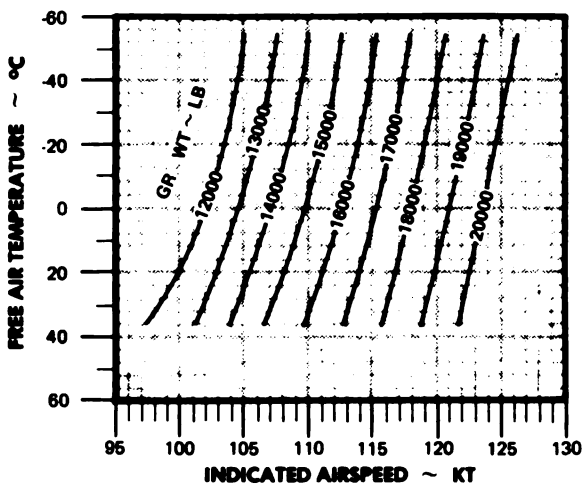
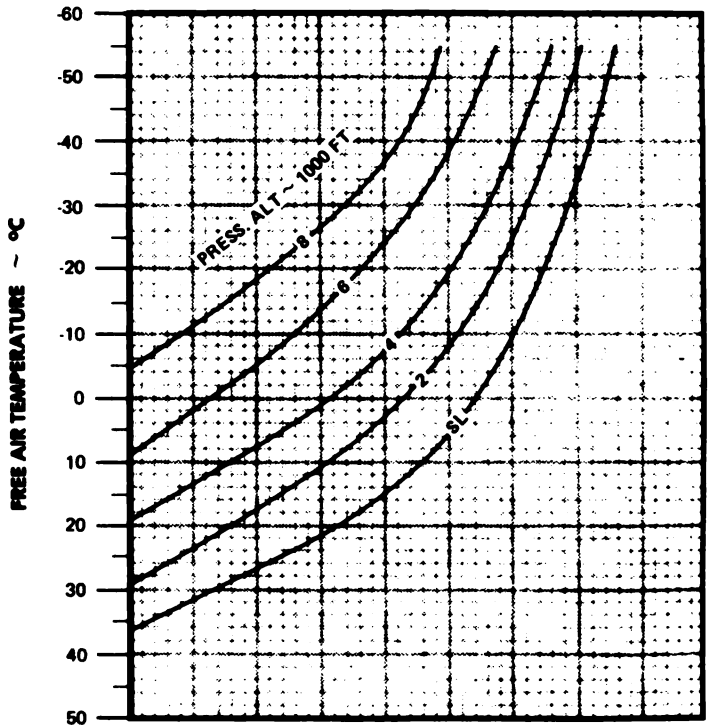

DATA BASIS: DERIVED FROM FLIGHT TEST

A-7-10-D-13-2

Figure 7-14. Single-Engine Climb (Flaps 15°/Gear Up) (Sheet 2 of 2)

# SINGLE ENGINE CLIMB

## TAKEOFF CONFIGURATION AT TAKEOFF AIRSPEED

GEAR DOWN    FLAPS 15 DEGREES    ALL STORES    PROP FEATHERED    POWER-MAX ALLOWABLE  
WITHOUT LSSS IR SUPPRESSOR

SINGLE ENGINE CLIMB  
OV-10/RV-1D  
T53-L-701

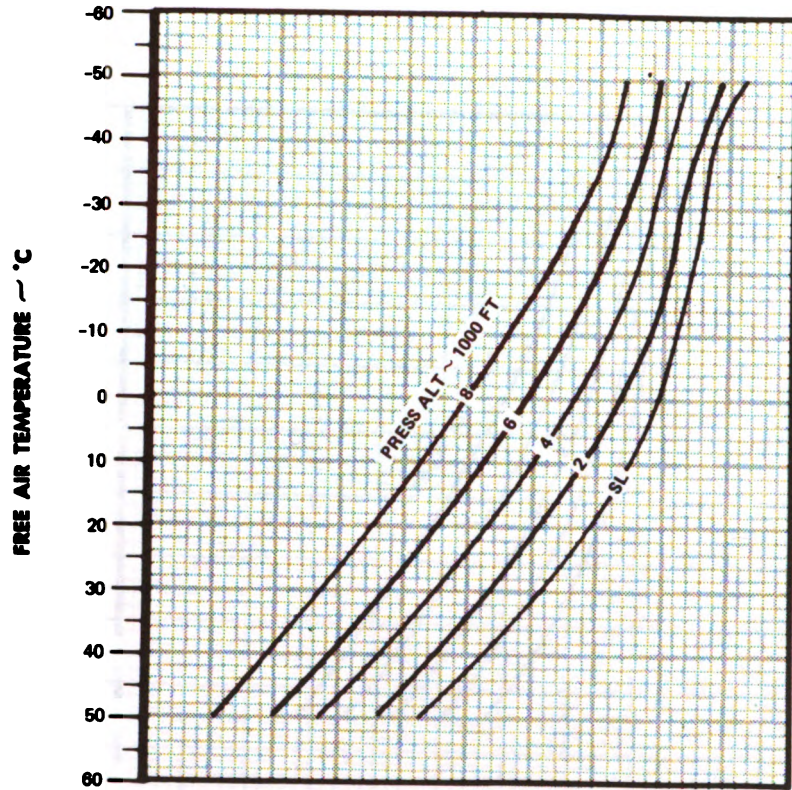

WEIGHT ~ LB	IAS ~ KT OUT OF GROUND EFFECT
11000	83
12000	87
13000	91
14000	94
15000	97
16000	101
17000	104
18000	107
19000	110

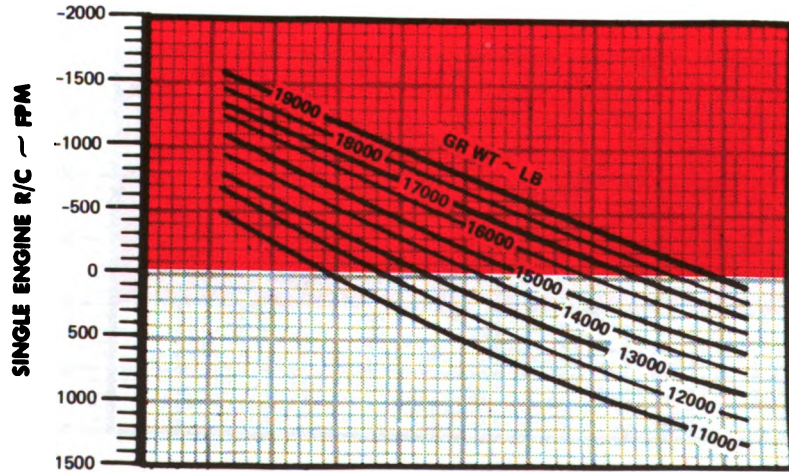

TA BASIS: DERIVED FROM FLIGHT TEST

R

C-7-10-D-14-1

Figure 7-15. Single-Engine Climb (Flaps 15°/Gear Down) (Sheet 1 of 2)



SINGLE ENGINE  
CLIMB  
OV-1D/RV-1D  
T53-L-701

**SINGLE ENGINE CLIMB**  
**TAKEOFF CONFIGURATION AT TAKEOFF AIRSPEED**  
GEAR DOWN FLAPS 15 DEGREES ALL STORES PROP FEATHERED POWER-MAX ALLOWABLE  
WITH LSSS IR SUPPRESSOR

EXAMPLE XI - 1

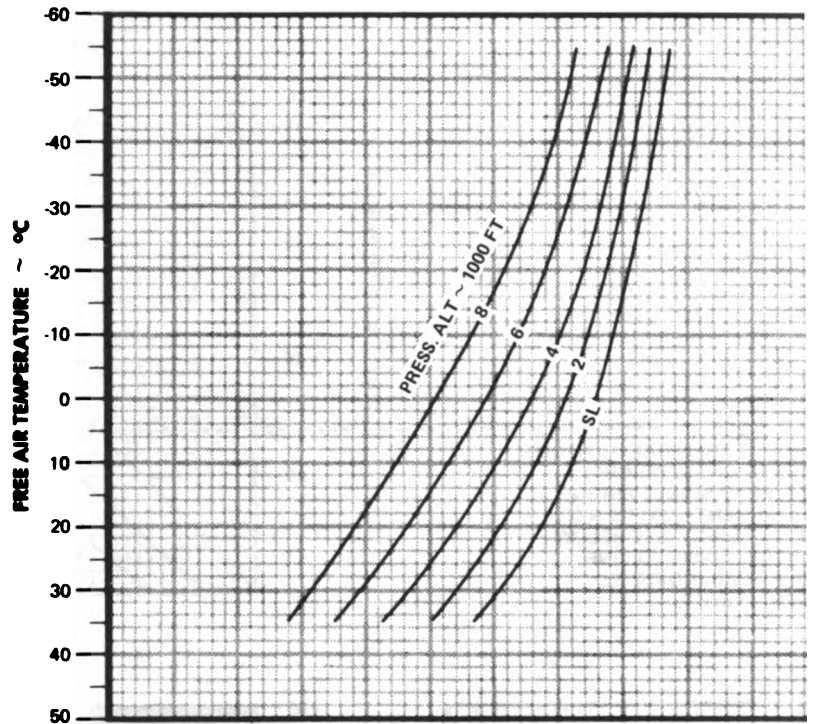

WEIGHT ~ LB	IAS ~ KT OUT OF GROUND EFFECT
12000	87
13000	91
14000	94
15000	97
16000	101
17000	104
18000	107
19000	110
20000	112

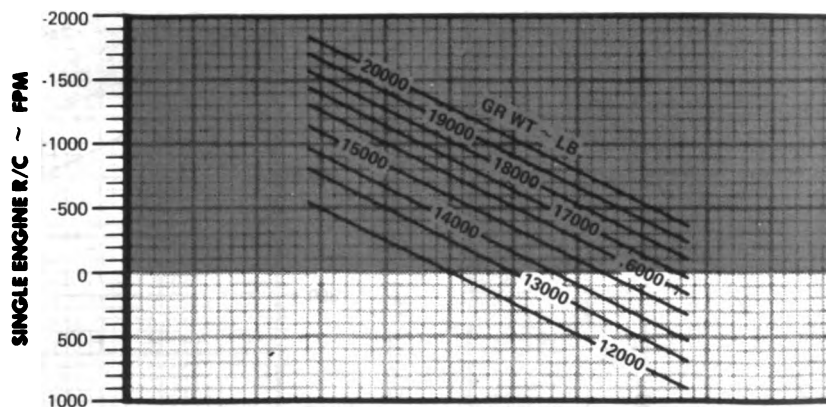

DATA BASIS: DERIVED FROM FLIGHT TEST

7-10-D-1

Figure 7-15. Single-Engine Climb (Flaps 15°/Gear Down) (Sheet 2 of 2)

# SINGLE ENGINE CLIMB GRADIENT

## CLIMB CONFIGURATION

GEAR UP FLAPS 0 DEGREES ALL STORES  
PROP FEATHERED POWER - MAX ALLOWABLE

SINGLE ENGINE  
CLIMB  
OV-1D/RV-1D  
T53-L-701

### EXAMPLE XI-2

#### WANTED

SINGLE ENGINE CLIMB GRADIENT  
AT THE CLIMBOUT SPEED ( $V_2$ )  
WITH TAKE-OFF FLAPS ( $0^\circ$ )  
AND GEAR UP.

#### KNOWN

F.A.T. =  $22^\circ\text{C}$   
PRESSURE ALTITUDE = 2000 FT  
GROSS WEIGHT = 16,000 LB

#### METHOD

ENTER F.A.T. HERE  
MOVE RIGHT TO PRESSURE ALTITUDE.  
MOVE DOWN TO GROSS WEIGHT.  
MOVE LEFT, READ SINGLE ENGINE  
CLIMB GRADIENT = 200 FT/N MI.  
ENTER GROSS WEIGHT (SEE BELOW).  
MOVE RIGHT TO AIRSPEED LINE.  
MOVE DOWN, READ INDICATED  
AIRSPEED = 110 KT.

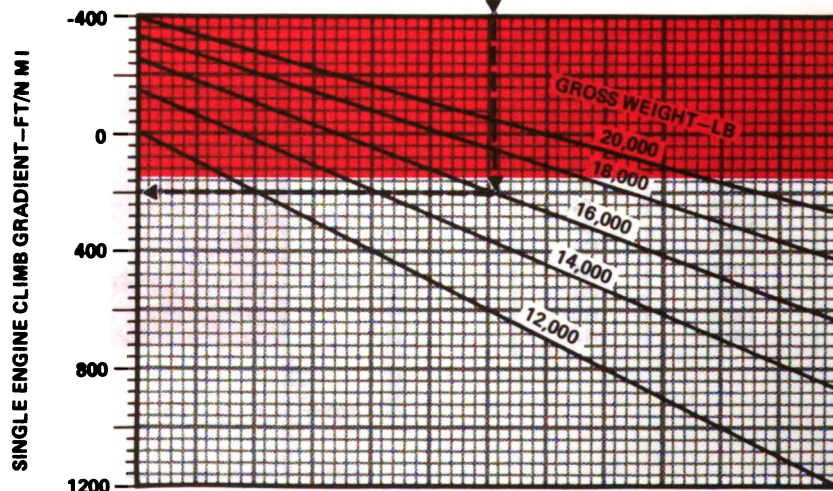
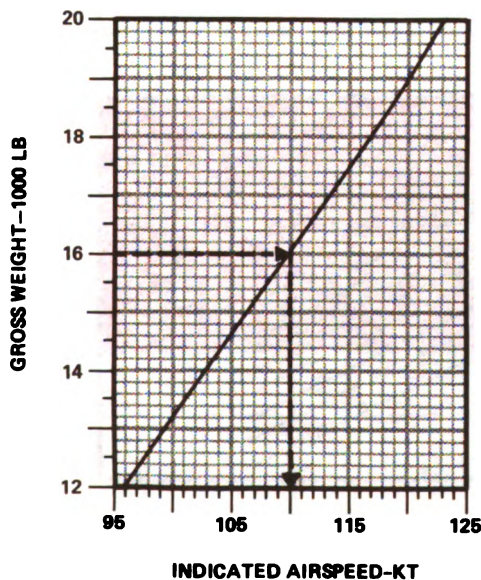
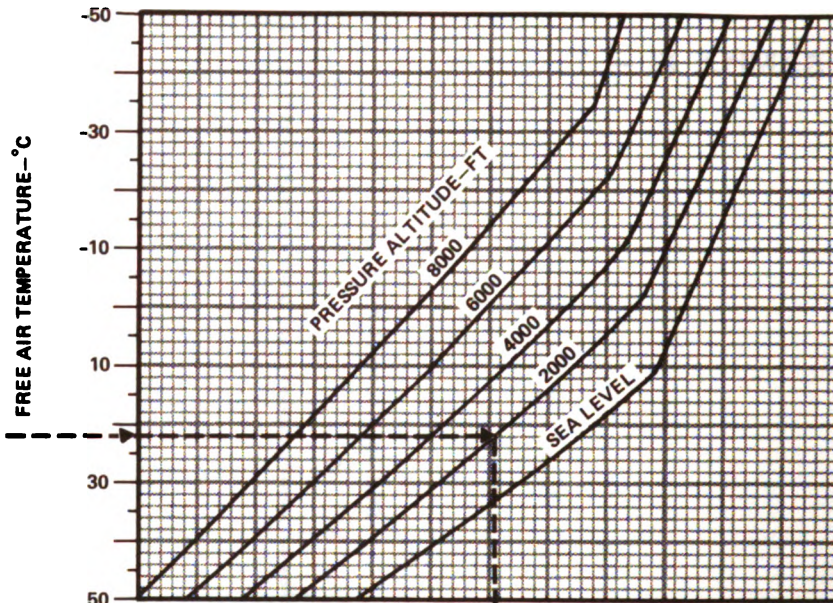

7-10-D-14-201

Figure 7-15A. Single-Engine Climb Gradient

## SECTION XII. CRUISE CLIMB

### 7-56. Description.

The cruise climb chart (figure 7-16) shows the time, fuel, and distance required to climb from sea level. For climb at conditions other than from sea level, see the cruise charts (figures 7-17 through 7-37) and the climb/descent chart (figure 7-39).

### 7-57. Use of Chart.

Use of the cruise climb chart is shown in Example XII-1. To determine the time, fuel, and distance required to climb from one altitude to another, subtract the time, fuel, and distance

from sea level to the initial altitude as shown in the example.

### 7-58. Conditions.

The cruise climb chart is valid for any stores configuration. Use sheet 1 of figure 7-16 for aircraft without the LSSS IR suppressor installed. Use sheet 2 of the figure for aircraft with the LSSS IR suppressor installed.

### 7-59. Data Basis.

Data for the cruise climb chart were derived from flight test.



# CRUISE CLIMB

**CLIMB SPEED 125 KIAS**  
**FLAPS UP GEAR UP CALM WIND**  
**MAXIMUM CONTINUOUS POWER 1678 PROP RPM ALL STORES**  
**WITHOUT LSSS IR SUPPRESSOR**

CRUISE CLIMB  
 OV-ID/RV-ID  
 T63-L-701

## EXAMPLE XII-1

**WANTED**

TIME, FUEL AND DISTANCE REQUIRED TO CLIMB

**KNOWN**

INITIAL FAT = 6°C  
 INITIAL PRESSURE ALTITUDE = 4500 FT  
 INITIAL WEIGHT = 17000 LB  
 FINAL FAT = -10°C  
 FINAL PRESSURE ALTITUDE = 12500 FT

**METHOD**

ENTER FAT HERE →  
 MOVE RIGHT TO PRESSURE ALTITUDE  
 MOVE DOWN TO INITIAL WEIGHT  
 MOVE LEFT, READ TIME, FUEL AND DISTANCE

**NOTE**

FIRST READ GRAPH FOR INITIAL CONDITIONS AND SECOND READ FOR FINAL CONDITIONS WITH INITIAL WEIGHT. DIFFERENCE BETWEEN READINGS IS TIME, FUEL AND DISTANCE TO CLIMB

TIME TO CLIMB (8.5 - 2.5) = 6 MIN  
 FUEL TO CLIMB (170 - 60) = 110 LB  
 DISTANCE TO CLIMB (20 - 5) = 15 NM

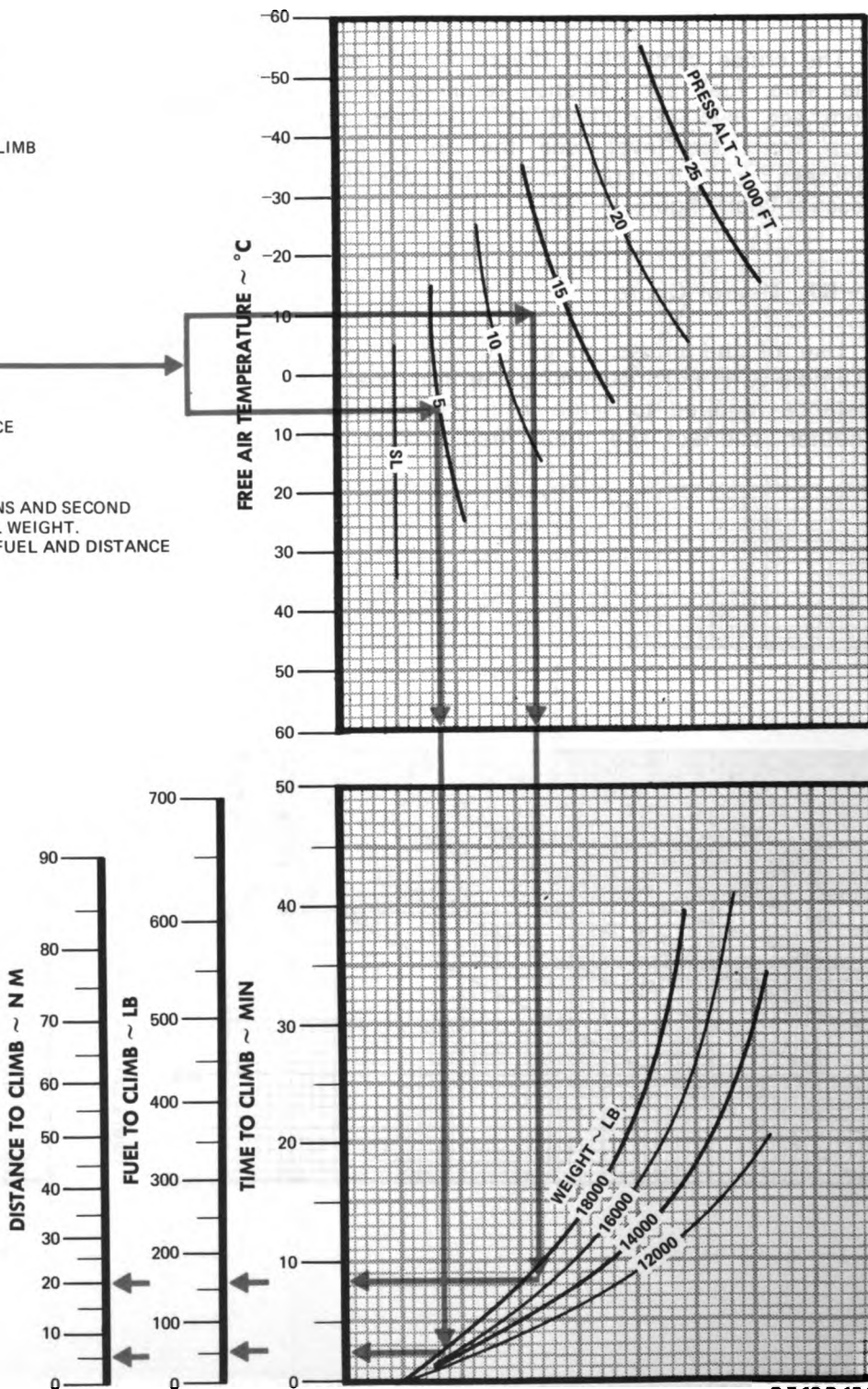

DATA BASIS: DERIVED FROM FLIGHT TEST

C-7-10-D-15-1

Figure 7-16. Cruise Climb (Sheet 1 of 2)

# CRUISE CLIMB CLIMB SPEED 125 KIAS



CRUISE CLIMB  
OV-1D/RV-1D  
T53-L-701

FLAPS UP GEAR UP CALM WIND  
MAXIMUM CONTINUOUS POWER 1678 PROP RPM  
WITH LSSS IR SUPPRESSOR

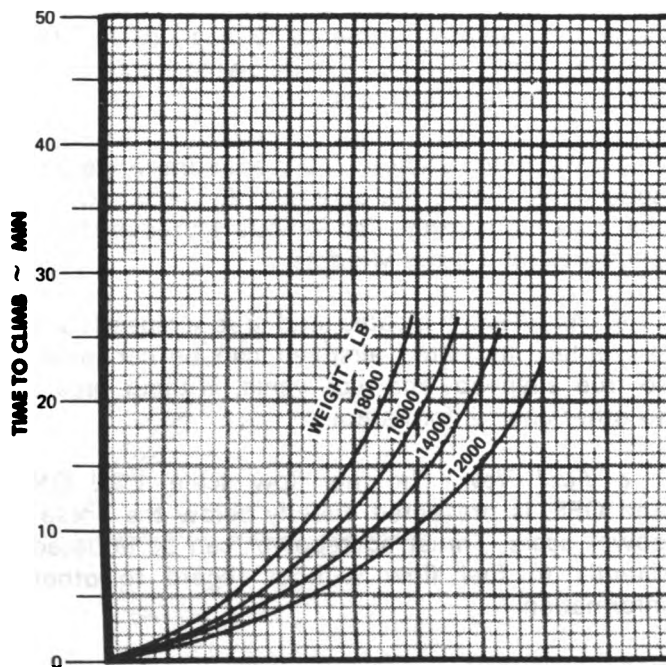
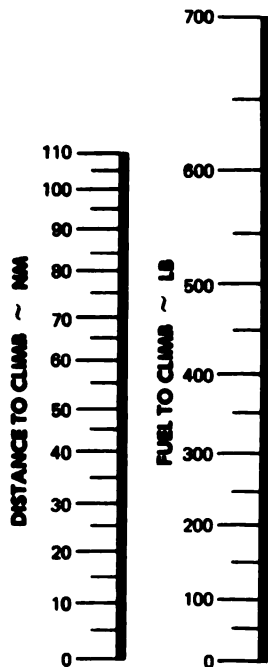
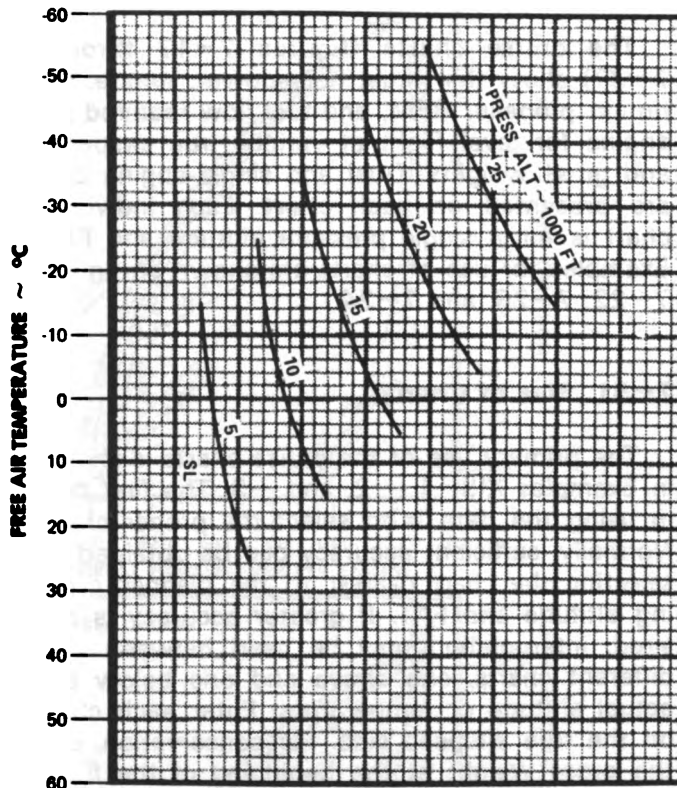

DATA BASIS: DERIVED FROM FLIGHT TEST

A7 10-D-15-2

Figure 7-16. Cruise Climb (Sheet 2 of 2)

## SECTION XIII. CRUISE

## 7-60. Description.

The cruise charts (figures 7-17 through 7-37) show the thrust horsepower, torque, optimum propeller RPM, and fuel flow required per engine for level flight at various true airspeeds and gross weights. Dual and single-engine data are presented on each chart. Each individual chart is for a single pressure altitude and FAT. Examples for use of charts are shown on figures 7-22, 7-23, and 7-24.

## 7-61. Use of Charts.

The primary use of the cruise charts is shown in Examples XIII-1, -2, and -3. The first task in using the data is to select the proper chart. Normally, sufficient accuracy can be obtained by selecting the chart nearest to the planned cruising altitude and FAT. If greater accuracy is desired, interpolation may be used between two different charts, one above and one below the actual altitude or temperature. Enter each chart on the true airspeed side. For conservation, use the gross weight at the beginning of the flight for one computation. For better accuracy on long flights, it may be desirable to break the flight into several segments to account for decreasing gross weight. The following parameters are included in the charts:

*a. Maximum Range.* The maximum range airspeed line shows the airspeed that will provide the maximum range for various altitudes, temperatures, and gross weights.

*b. Airspeed.* Indicated and true airspeeds are presented. Indicated airspeed can be converted to true airspeed, and vice versa, without regard to other chart information.

*c. Fuel Flow.* The fuel flow scale, ECU ON and OFF, is presented directly below the horsepower scale. Thrust horsepower can be equated directly to fuel flow without regard to other information.

## NOTE

*Fuel flow values should be doubled for two-engine operation.*

*d. Thrust Horsepower.* Thrust horsepower, although not readable in the cockpit, is utilized on the chart because of the requirement to vary propeller RPM to obtain optimum performance. Continuous and 30-minute limits are also depicted.

*e. Torque Required Per Engine.* The torque required per engine is shown as continuous torque required to maintain the desired cruise airspeed. The maximum torque limit is also shown. Torque per engine is shown in percent.

*f. Optimum RPM Line.* The optimum RPM line is used to select the best combination of propeller RPM and torque for the most efficient performance under varying conditions of altitudes, temperatures, airspeeds, and gross weights.

*g. Maximum Endurance Airspeed.* The maximum endurance airspeed line shows the airspeed that will provide maximum endurance for various altitudes, temperatures, and gross weights.

*h. Maximum Rate-of-Climb Speed.* The maximum rate-of-climb line shows the maximum rate-of-climb airspeed for various altitudes, temperatures, and gross weights.

## 7-62. Conditions.

*a. Configuration.* All cruise data are based on the aircraft being in a two 150-gallon drop tank configuration without SLAR or other stores. For changes in thrust horsepower required due to drag caused by external configuration changes (i.e., SLAR, flasher pod, etc), refer to Section XIV.

*b. Fuel.* Both fuel flow and torque available data are based on JP-4 fuel. Other allowable fuels may change the fuel flow values slightly.

## 7-63. Data Basis.

Data for cruise performance were derived from flight test.

R  
Y

CRUISE  
OV-10/RV-1D  
T53-L-701

**CRUISE**  
**PRESSURE ALTITUDE SEA LEVEL**  
FLAPS 0 DEGREES JP-4 FUEL GEAR UP 2-150 GALLON DROP TANKS\*

FAT -45°C

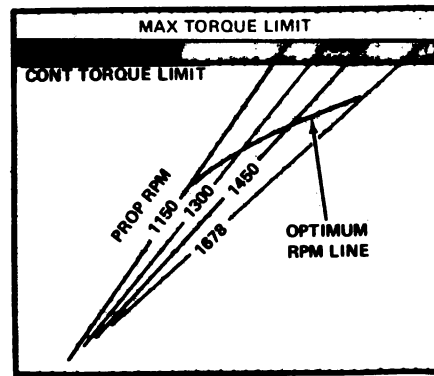
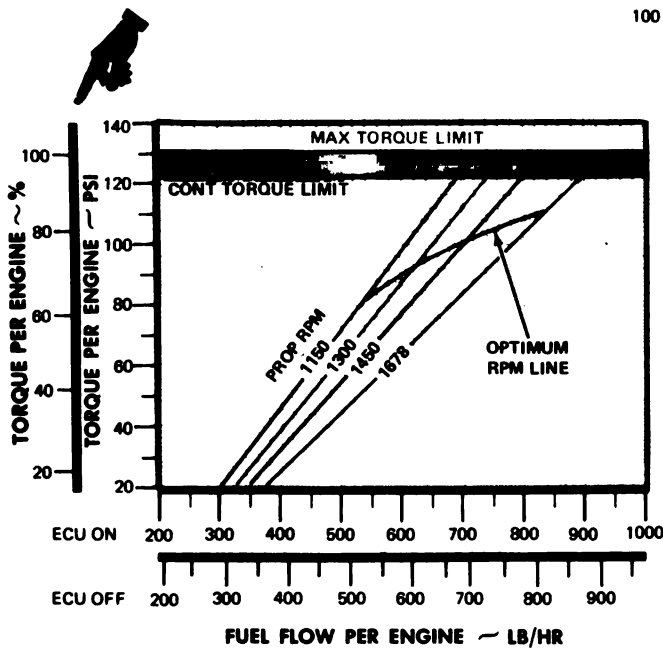
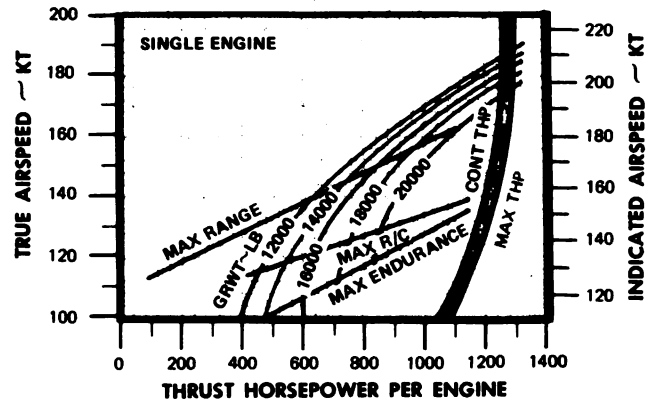
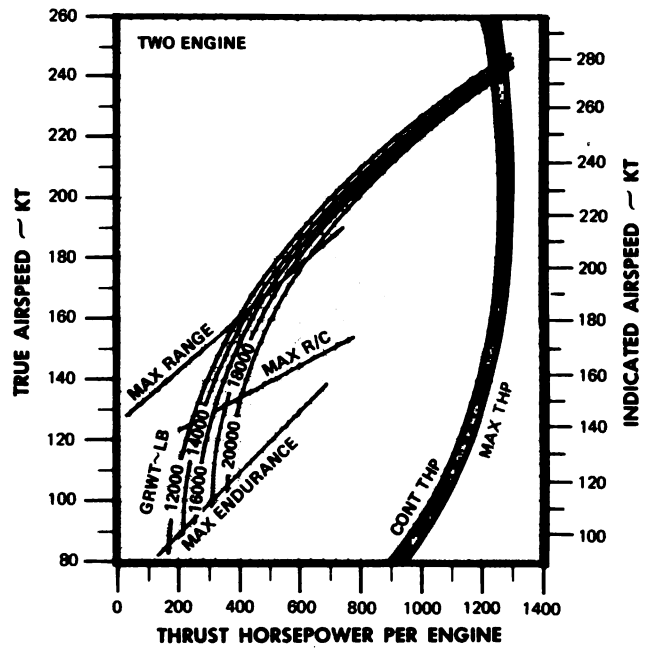

\*NO SLAR OR STORES OTHER THAN DROP TANKS.

DATA BASIS: DERIVED FROM FLIGHT TEST

Y  
R

B-7-10-D-16

Figure 7-17. Cruise, FAT -45°C, Sea Level

R  
Y

**CRUISE**

CRUISE  
OV-10D/RV-1D  
T53-L-701

PRESSURE ALTITUDE SEA LEVEL  
FLAPS 0 DEGREES IP-4 FUEL GEAR UP 2-150 GALLON DROP TANKS\*

FAT -25°C

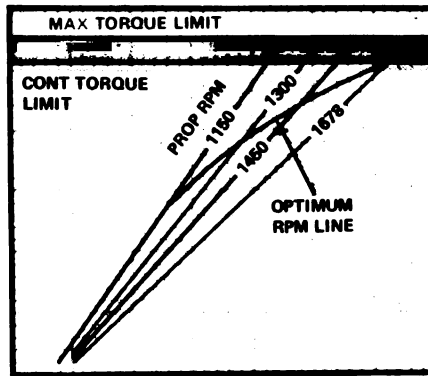
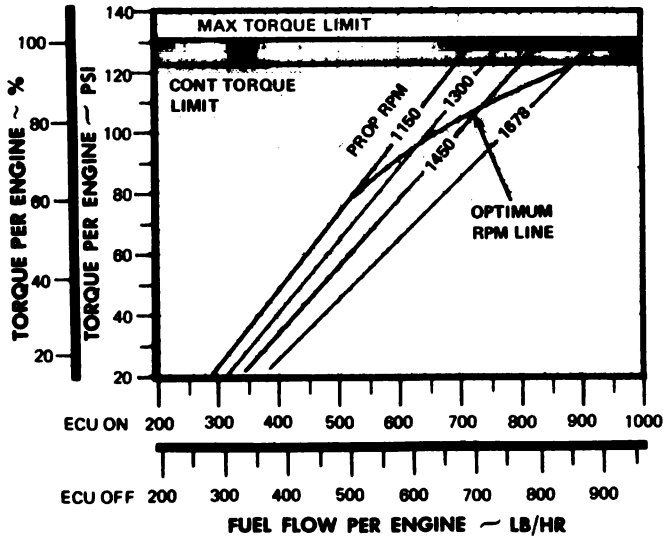
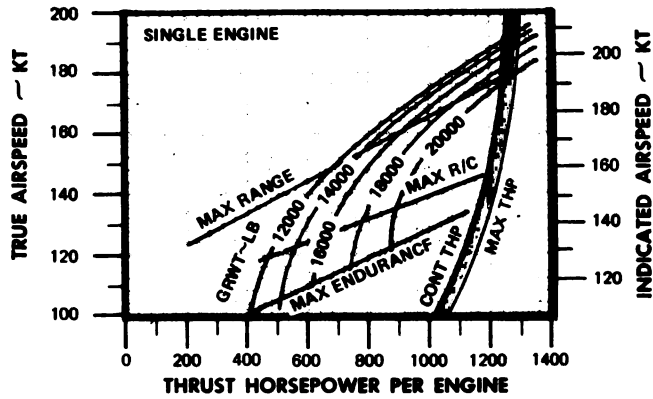
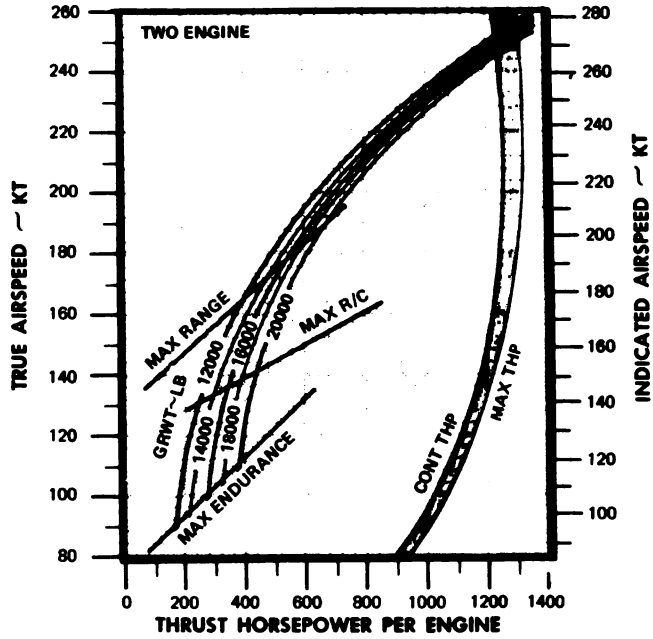

\* NO SLAR OR STORES OTHER THAN DROP TANKS.

DATA BASIS: DERIVED FROM FLIGHT TEST

B-7-10-D-17

Figure 7-18. Cruise, FAT -25°C, Sea Level

R  
Y

CRUISE  
OV-1D/RV-1D  
T53-L-701

**CRUISE**

**PRESSURE ALTITUDE SEA LEVEL**

**FLAPS 0 DEGREES JP-4 FUEL GEAR UP 2-150 GALLON DROP TANKS \***

FAT = -5°C

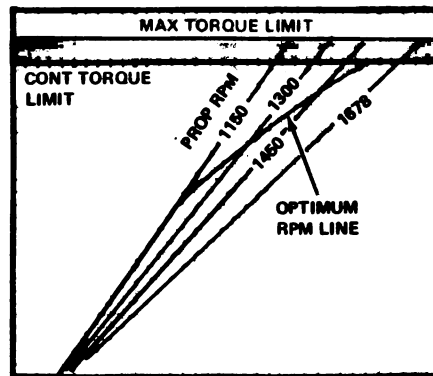
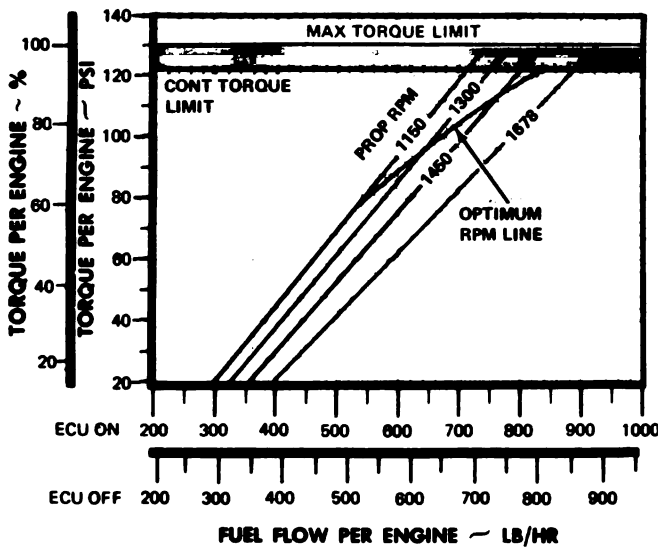
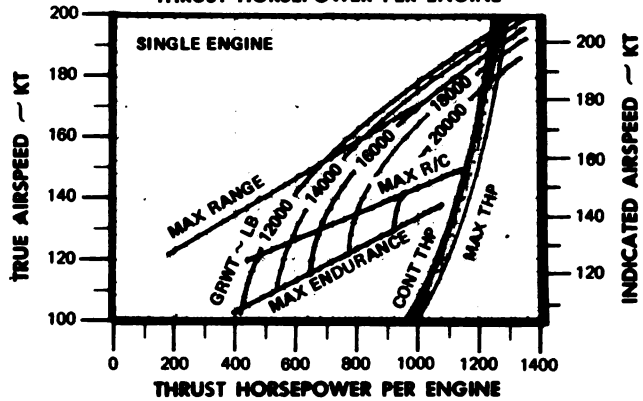
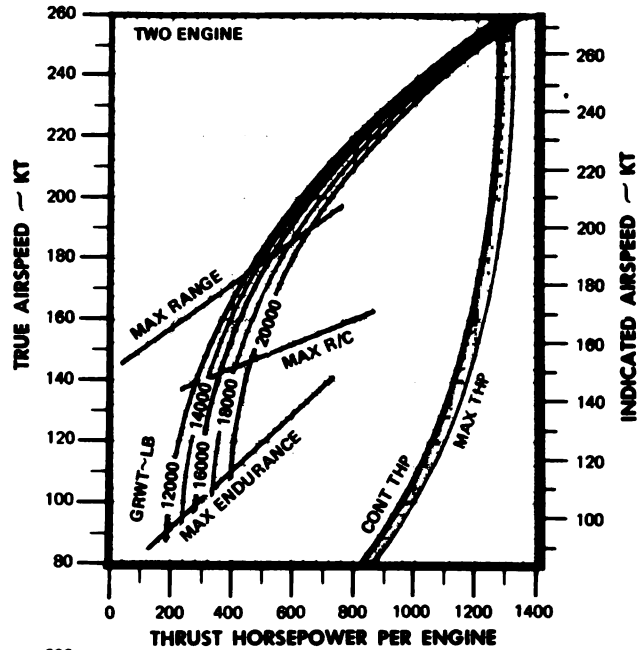

\* NO SLAR OR STORES OTHER THAN DROP TANKS.

DATA BASIS: DERIVED FROM FLIGHT TEST

**Figure 7-19. Cruise, FAT -5°C, Sea Level**

Y  
R

8-7-10-D-18

■ R  
■ Y

CRUISE  
OV-1D/RV-1D  
T53-L-701

**CRUISE**  
PRESSURE ALTITUDE SEA LEVEL  
FLAPS 0 DEGREES JP-4 FUEL GEAR UP 2-150 GALLON DROP TANKS \*

FAT = +15°C

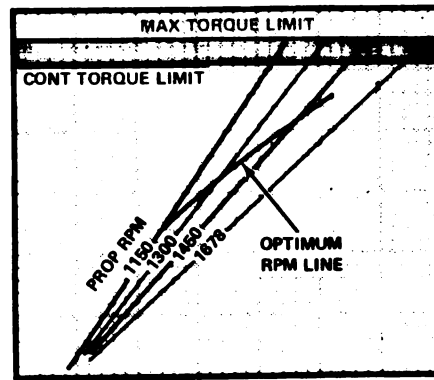
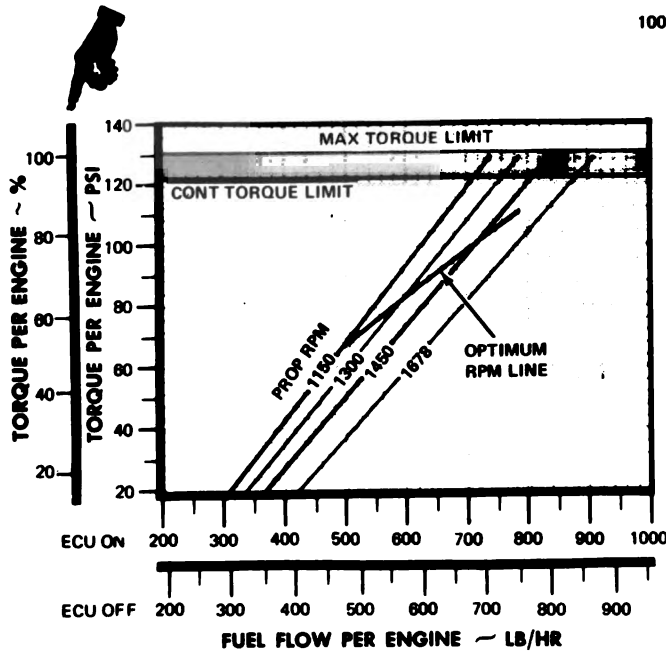
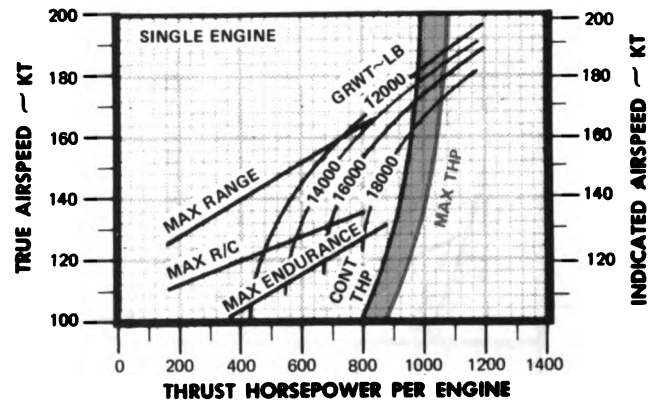
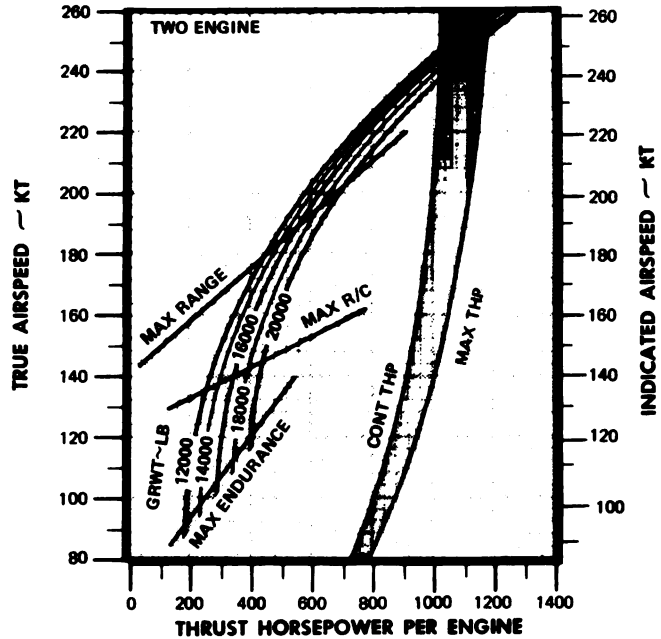

\* NO SLAR OR STORES OTHER THAN DROP TANKS.

DATA BASIS: DERIVED FROM FLIGHT TEST

Y  
R

B-7-10-D-19

Figure 7-20. Cruise, FAT +15°C, Sea Level

R  
Y

CRUISE  
OV-10/RV-1D  
T53-L-701

**CRUISE**  
**PRESSURE ALTITUDE SEA LEVEL**  
FLAPS 0 DEGREES JP-4 FUEL GEAR UP 2-150 GALLON DROP TANKS \*

FAT = +35°C

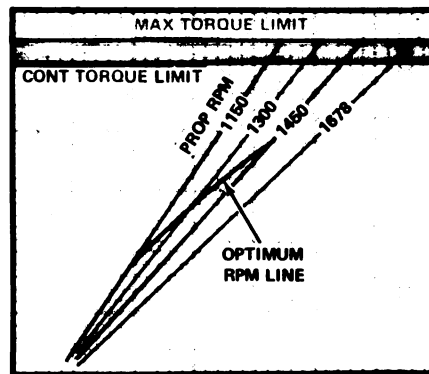
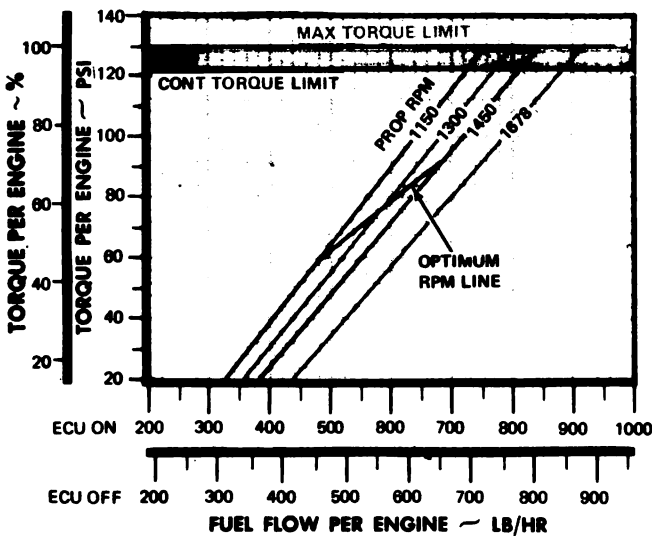
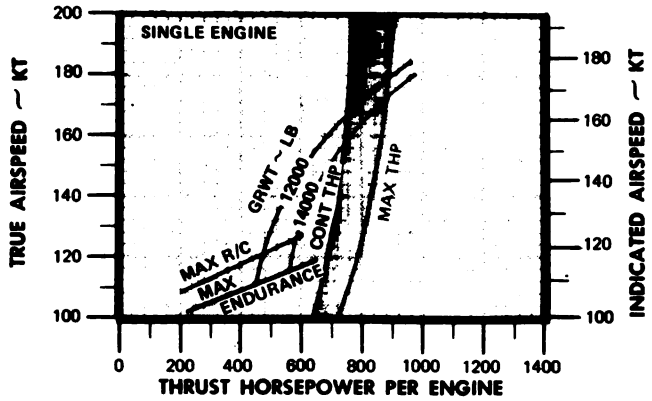
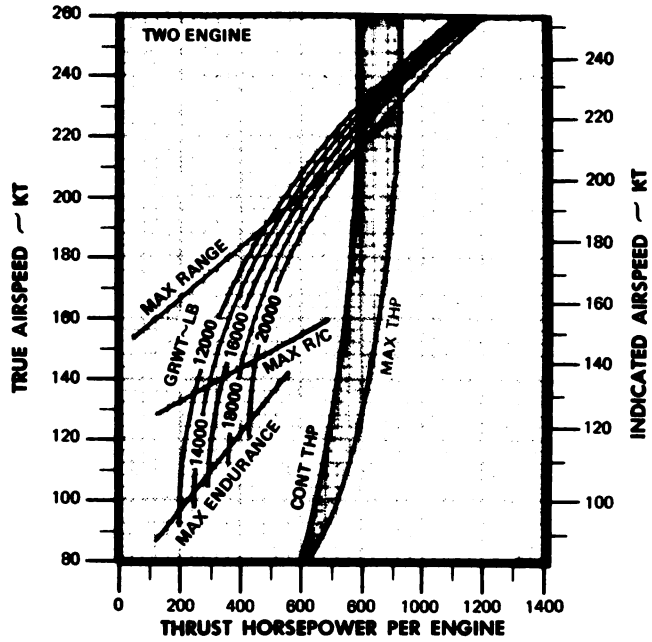

\* NO SLAR OR STORES OTHER THAN DROP TANKS.

DATA BASIS: DERIVED FROM FLIGHT TEST

B-7-10-D-20

Figure 7-21. Cruise, FAT +35°C, Sea Level



**CRUISE**

**PRESSURE ALTITUDE 5000 FT**

**FLAPS 0 DEGREES JP-4 FUEL GEAR UP 2-150 GALLON DROP TANKS \***

CRUISE  
OV-ID/RV-ID  
T63-L-701

G  
R  
Y

FAT --25°C

**EXAMPLE XIII-1**

**WANTED**

CRUISE AIRSPEED, THRUST HORSEPOWER PER ENGINE, PROP RPM, FUEL FLOW, AND TORQUE REQUIRED FOR MAXIMUM RANGE

**KNOWN**

PRESSURE ALTITUDE = 5000 FT, FAT = -25°C  
GROSS WEIGHT = 17000 LB  
ADDITIONAL THRUST HORSEPOWER DUE TO DRAG = 200 THP PER ENGINE (SEE FIGURE 7-38)

**METHOD**

ENTER MAX RANGE HERE  
MOVE RIGHT AND UP TO GROSS WEIGHT = 17000 LB  
MOVE LEFT, READ TRUE AIRSPEED = 188 KT  
MOVE DOWN TO THRUST HORSEPOWER PER ENGINE = 550 THP  
ADD ADDITIONAL THRUST HORSEPOWER REQUIRED PER ENGINE DUE TO DRAG 200 : 550 = 750 THP  
MOVE RIGHT TO 750 THP  
MOVE DOWN TO OPTIMUM RPM LINE,  
READ OPTIMUM RPM = 1340 RPM,  
MOVE LEFT TO OPTIMUM RPM LINE  
MOVE DOWN READ FUEL FLOW = 580 LB/HR  
ECU ON  
MOVE LEFT READ TORQUE = 90 PSI OR 66%

**NOTE**

SINGLE ENGINE PARAMETERS ARE OBTAINED IN THE SAME MANNER USING MAXIMUM RANGE LINE ON THE SINGLE ENGINE GRAPH

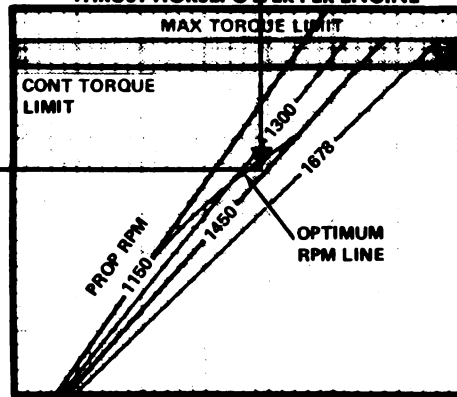
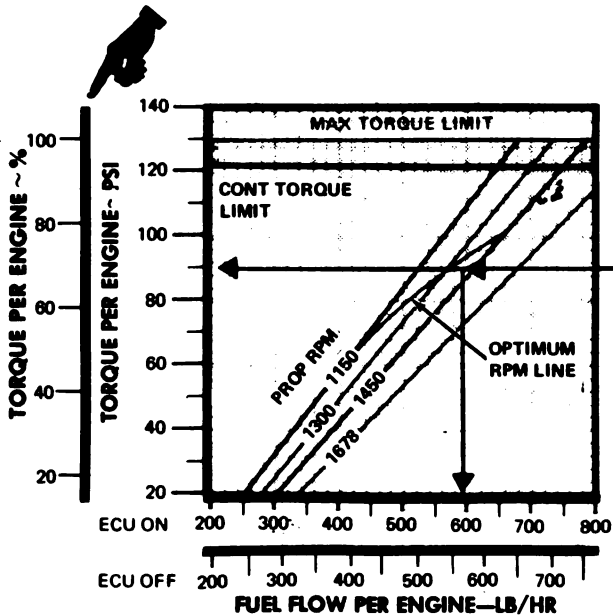
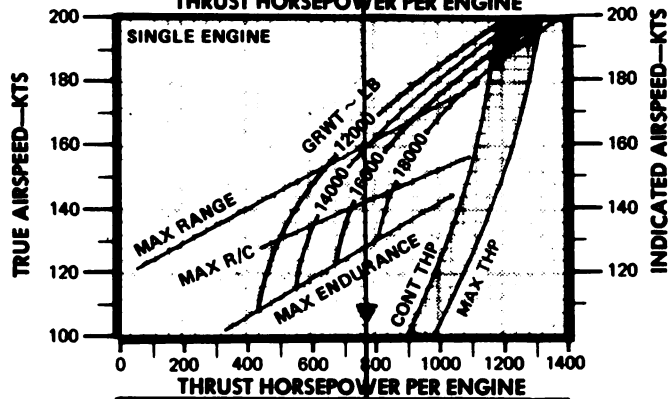
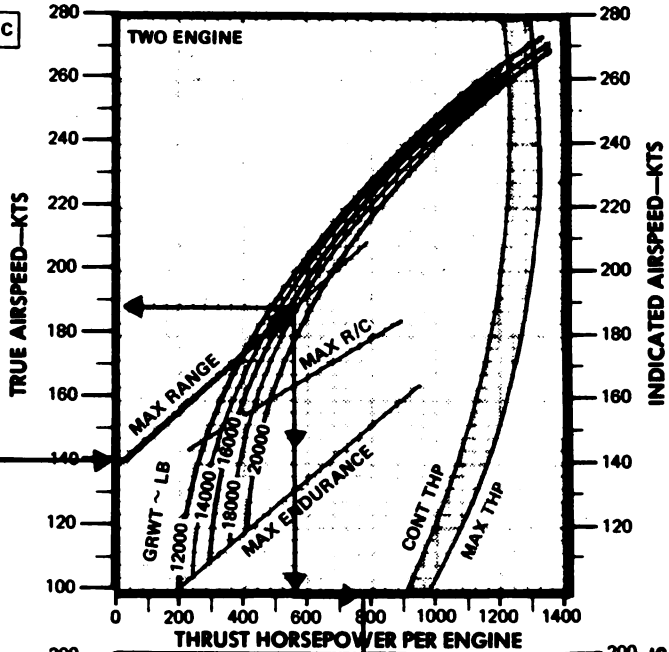

\* NO SLAR OR STORES OTHER THAN DROP TANKS.

DATA BASIS: DERIVED FROM FLIGHT TEST

Y  
R  
G

B-7-10-D-21

Figure 7-22. Cruise, FAT -25°C, 5,000 Feet

- G
- R
- Y

# CRUISE

PRESSURE ALTITUDE 5000 FT

FLAPS DEGREES JP-4 FUEL GEAR UP 2-150 GALLON DROP TANKS\*

CRUISE  
OV-1D/RV-1D  
T53-L-701

## EXAMPLE XII-2

FAT = -5°C

### WANTED

INDICATED AIRSPEED, THRUST HORSEPOWER PER ENGINE, PROP RPM, FUEL FLOW AND TORQUE REQUIRED FOR A SELECTED TRUE AIRSPEED

### KNOWN

PRESSURE ALTITUDE = 5000 FT, FAT = -5°C  
TAS = 240 KT, GROSS WEIGHT = 13000 LB, ECU OFF

### METHOD

ENTER CHART AT 240 KT  
MOVE RIGHT, READ INDICATED AIRSPEED = 229 KT  
MOVE DOWN FROM GROSS WEIGHT LINE TO OPTIMUM RPM LINE, READ THRUST HORSEPOWER PER ENGINE = 860 THP  
READ OPTIMUM RPM = 1500 RPM  
MOVE LEFT TO OPTIMUM RPM LINE  
MOVE DOWN READ FUEL FLOW = 610 LB/HR  
ECU OFF  
MOVE LEFT, READ TORQUE = 93 PSI OR 72%

### NOTE

SINGLE ENGINE PARAMETERS ARE OBTAINED IN THE SAME MANNER USING THE SINGLE ENGINE GRAPH

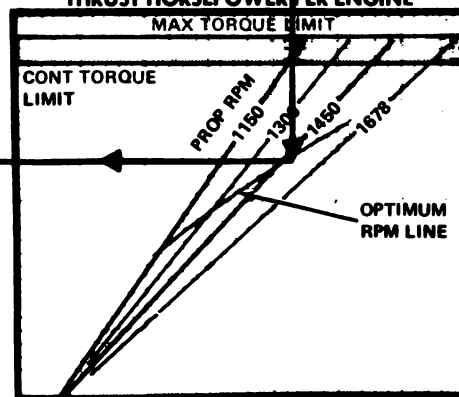
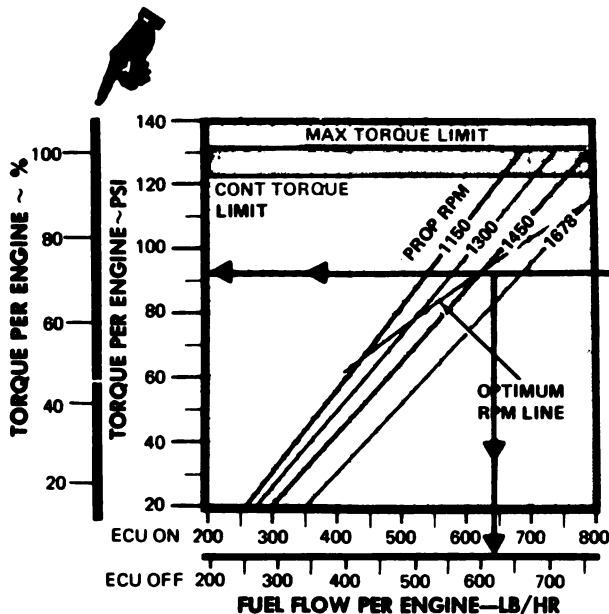
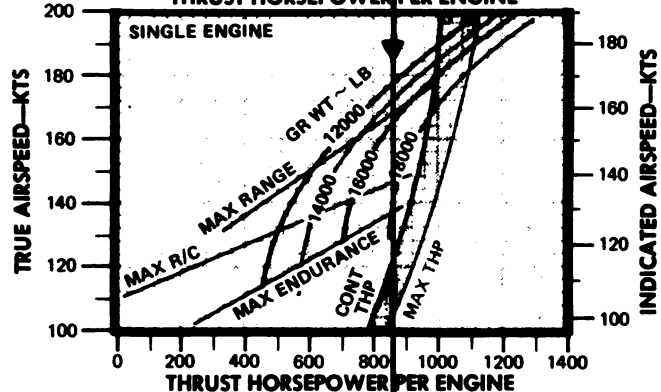
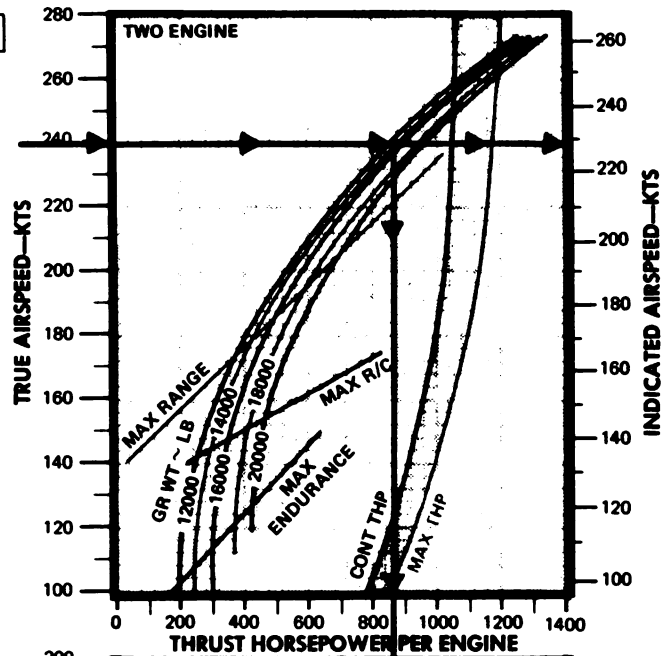

\* NO SLAR OR STORES OTHER THAN DROP TANKS.

- Y
- R
- G

DATA BASIS: DERIVED FROM FLIGHT TEST

B-7-10-D-22

Figure 7-23. Cruise, FAT -5°C, 5,000 Feet

# CRUISE

PRESSURE ALTITUDE 5000 FT

FLAPS 0 DEGREES JP-4 FUEL GEAR UP 2-150 GALLON DROP TANKS\*

CRUISE  
OV-ID/RV-ID  
T63-L-701

- G
- R
- Y

## EXAMPLE XIII-3

FAT = +15°C

### WANTED

MAXIMUM RATE OF CLIMB AIRSPEED, THRUST HORSEPOWER REQUIRED FOR LEVEL FLIGHT AT MAX R/C AIRSPEED, MAX THRUST HORSEPOWER AVAILABLE, PROP RPM, FUEL FLOW, AND TORQUE FOR MAXIMUM RATE OF CLIMB AND EXCESS THRUST HORSEPOWER AVAILABLE FOR CLIMB

### KNOWN

PRESSURE ALTITUDE = 5000 FT, FAT = 15°C,  
GROSS WEIGHT = 17000 LB  
ADDITIONAL THRUST HORSEPOWER REQUIRED DUE TO DRAG = 75 THP PER ENGINE (SEE FIGURE 7-38)

### METHOD

MOVE RIGHT ALONG TWO ENGINE MAX R/C LINE TO GROSS WEIGHT = 17000 LB  
MOVE LEFT, READ MAX R/C AIRSPEED = 142 KT  
MOVE DOWN FROM GROSS WEIGHT LINE  
READ THRUST HORSEPOWER PER ENGINE = 370 THP  
ADD ADDITIONAL THRUST HORSEPOWER REQUIRED PER ENGINE DUE TO DRAG 75 + 370 = 445 THP  
445 THP = THRUST HORSEPOWER REQUIRED FOR LEVEL FLIGHT AT MAX R/C AIRSPEED  
MOVE RIGHT FROM GROSS WEIGHT LINE TO MAX THP LINE  
MOVE DOWN, READ MAX THP = 860 THP, MOVE DOWN, READ OPTIMUM RPM = 1610 RPM  
MOVE LEFT TO OPTIMUM RPM  
MOVE DOWN, READ FUEL FLOW = 620 LB/HR ECU OFF  
MOVE LEFT FROM OPTIMUM RPM LINE, READ TORQUE = 86 PSI OR 66% DETERMIN EXCESS THRUS HORSEPOWER AVAILABLE FOR CLIMB = 860 - 445 = 415 THP PER ENGINE (SEE FIGURE 7-39 TO DETERMINE RATE OF CLIMB)

### NOTE

SINGLE ENGINE PARAMETERS ARE OBTAINED IN THE SAME MANNER USING THE SINGLE ENGINE GRAPH

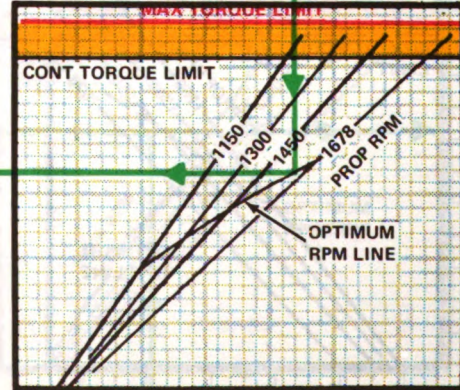
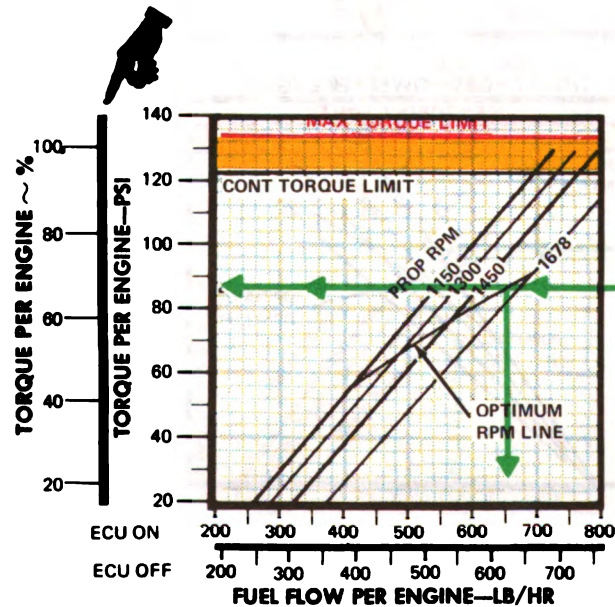
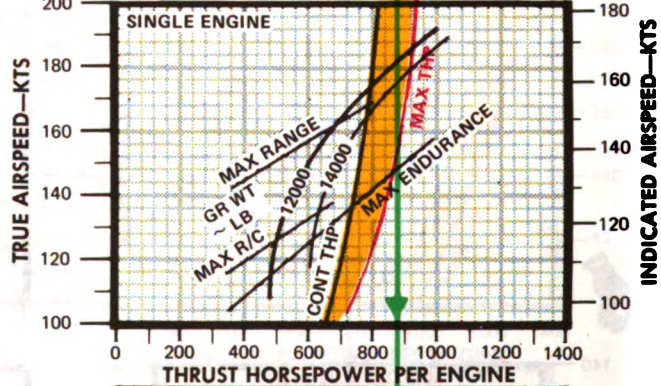
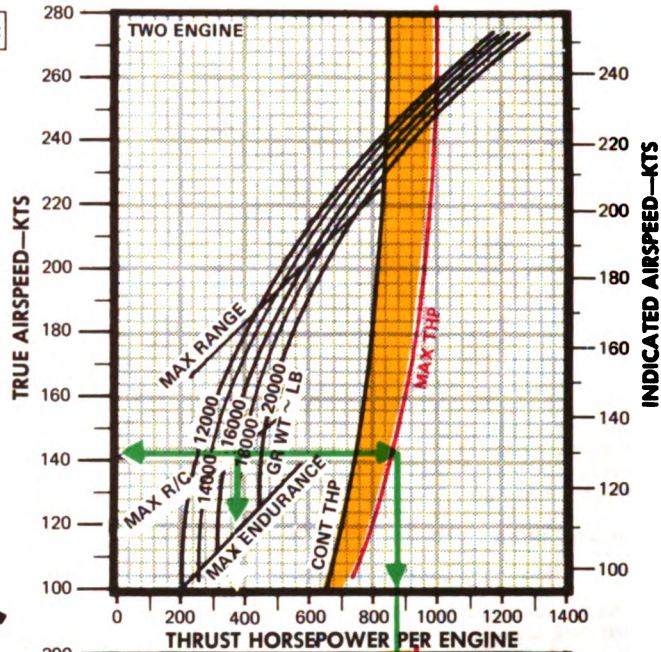

\* NO SLAR OR STORES OTHER THAN DROP TANKS.

DATA BASIS: DERIVED FROM FLIGHT TEST

8-7-10-D-23

Figure 7-24. Cruise, FAT +15°C, 5,000 Feet

# CRUISE

PRESSURE ALTITUDE 5000 FT

FLAPS 0 DEGREES JP-4 FUEL GEAR UP 2-150 GALLON DROP TANKS\*

CRUISE  
OV-ID/RV-ID  
T53-L-701

R  
Y

FAT - +35°C

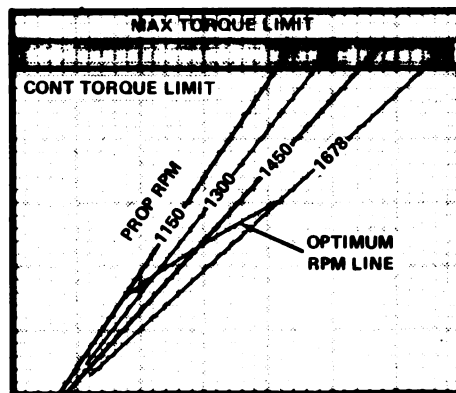
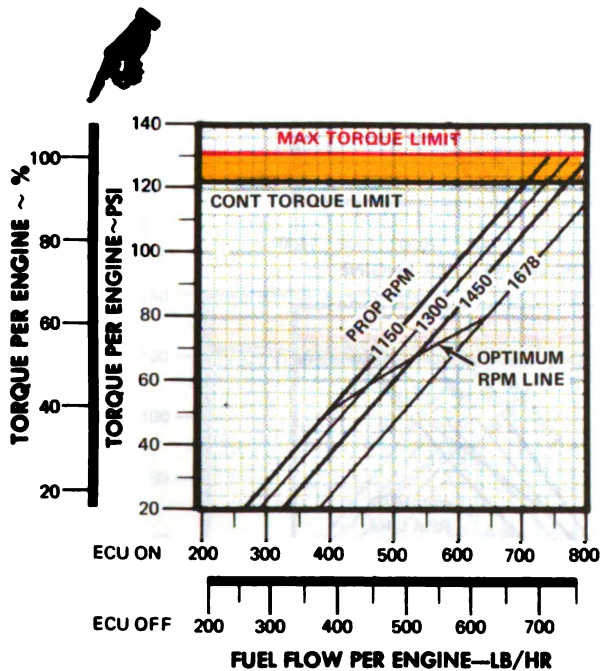
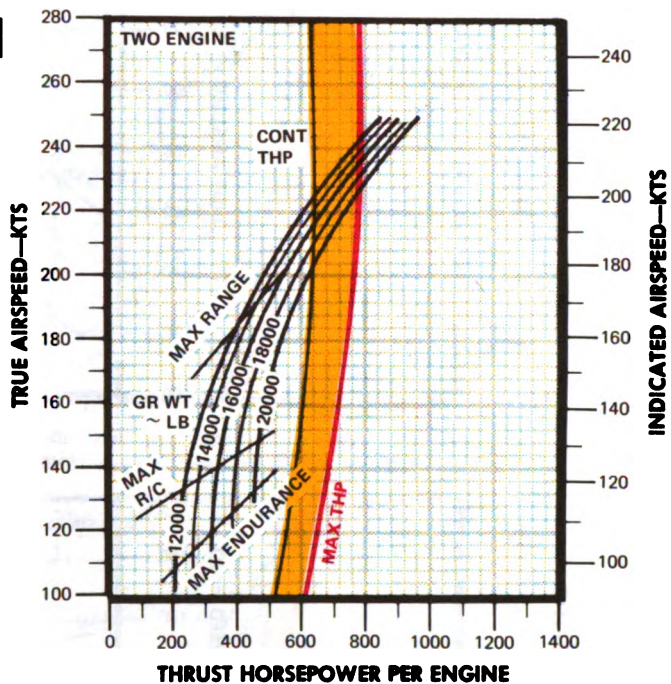

\* NO SLAR OR STORES OTHER THAN DROP TANKS.

DATA BASIS: DERIVED FROM FLIGHT TEST

Y  
R

B-7-10-D-24

Figure 7-25. Cruise, FAT +35°C, 5,000 Feet

R  
Y

CRUISE  
OV-1D/RV-1D  
T53-L-701

**CRUISE**  
**PRESSURE ALTITUDE 10,000 FT**

FLAPS 0 DEGREES JP-4 FUEL GEAR UP 2-150 GALLON DROP TANKS\*

FAT -25°C

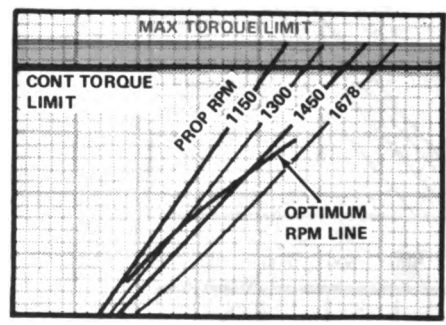
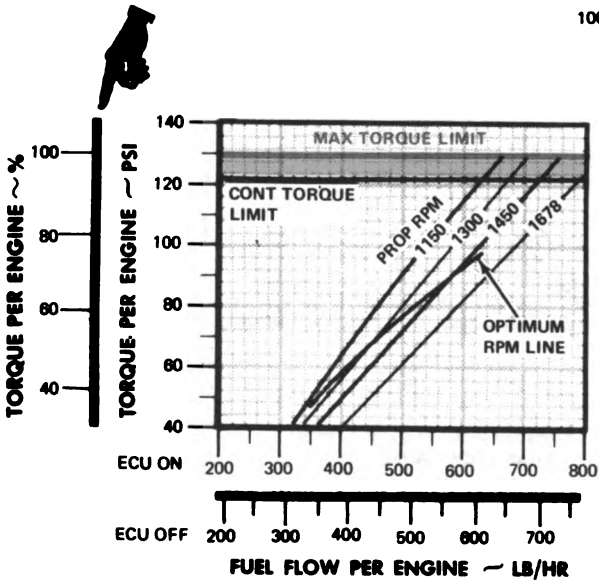
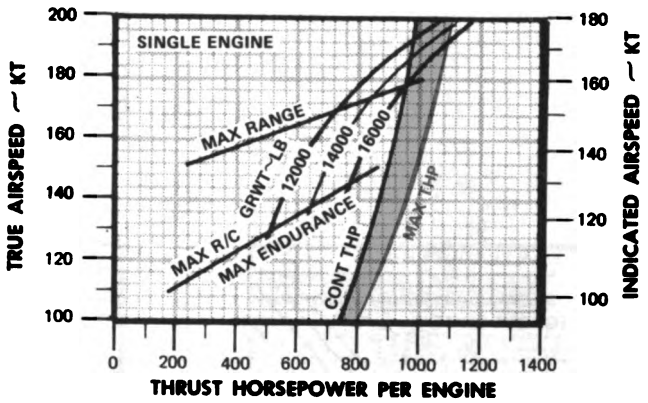
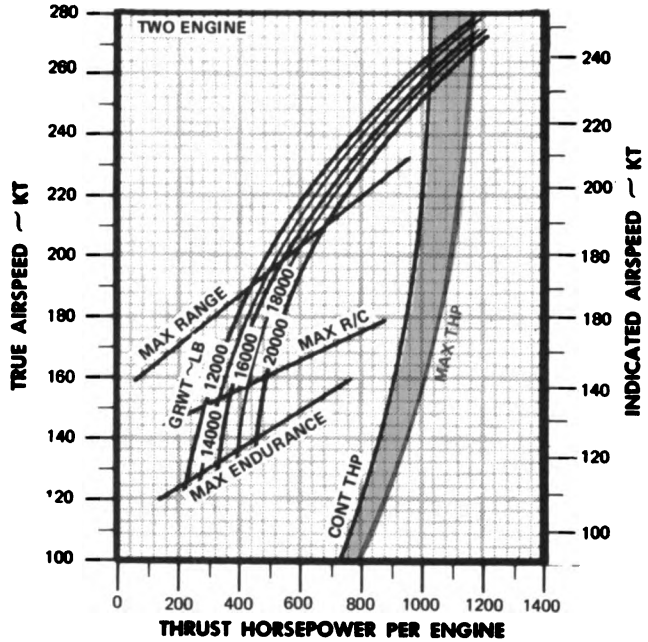

\* NO SLAR OR STORES OTHER THAN DROP TANKS.

DATA BASIS: DERIVED FROM FLIGHT TEST

Y  
R  
8-7-10-D-25

Figure 7-26. Cruise, FAT -25°C, 10,000 Feet

CRUISE  
OV-1D/RV-1D  
T53-L-701

**CRUISE**

**PRESSURE ALTITUDE 10,000 FT**

**FLAPS 0 DEGREES JP-4 FUEL GEAR UP 2-150 GALLON DROP TANKS \***

**FAT -5°C**

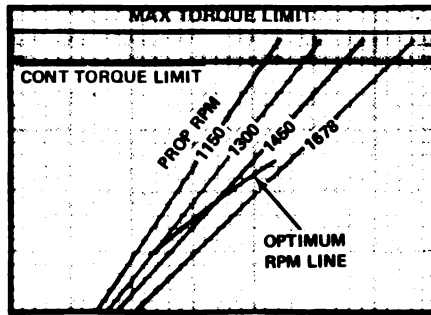
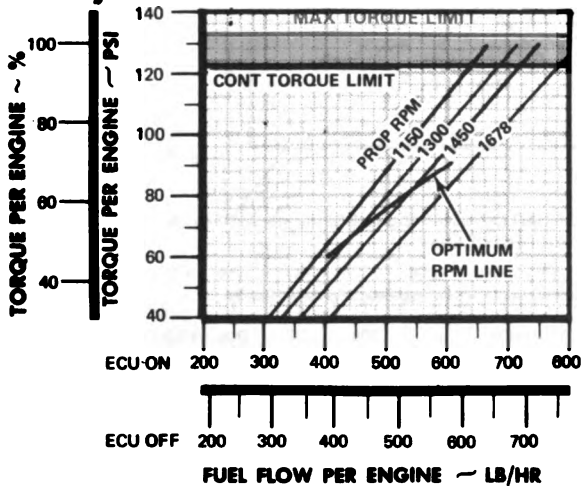
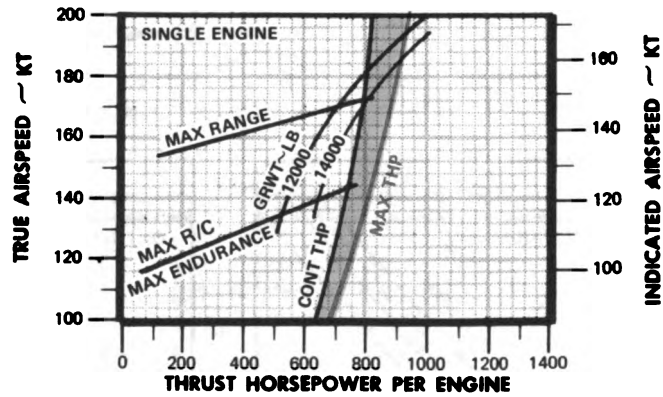
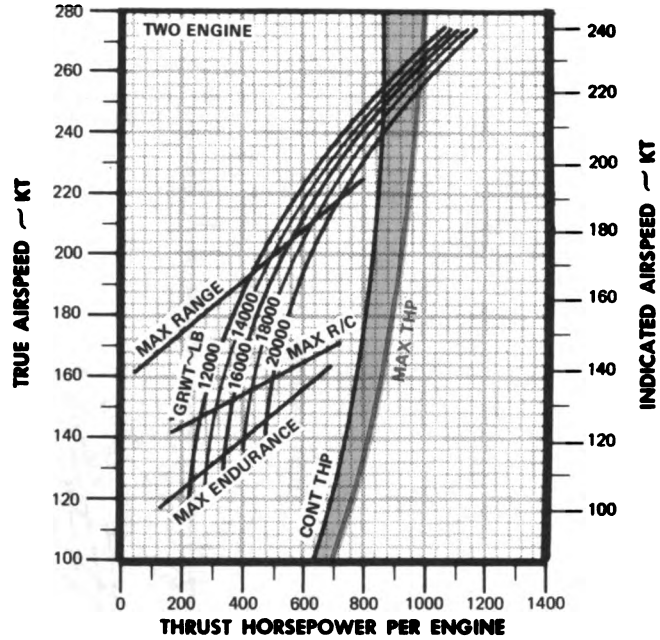

\* NO SLAR OR STORES OTHER THAN DROP TANKS.

DATA BASIS: DERIVED FROM FLIGHT TEST

**Figure 7-27. Cruise, FAT -5°C, 10,000 Feet**

Y  
R

8-7-10-D-28

R  
Y

# CRUISE

PRESSURE ALTITUDE 10,000 FT

FLAPS 0 DEGREES JP-4 FUEL GEAR UP 2-150 GALLON DROP TANKS \*

CRUISE  
OV-1D/RV-1D  
T53-L-701

FAT = +15°C

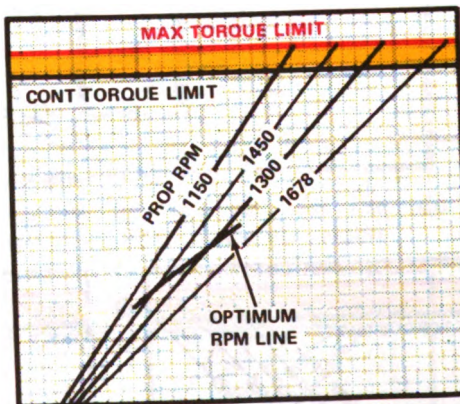
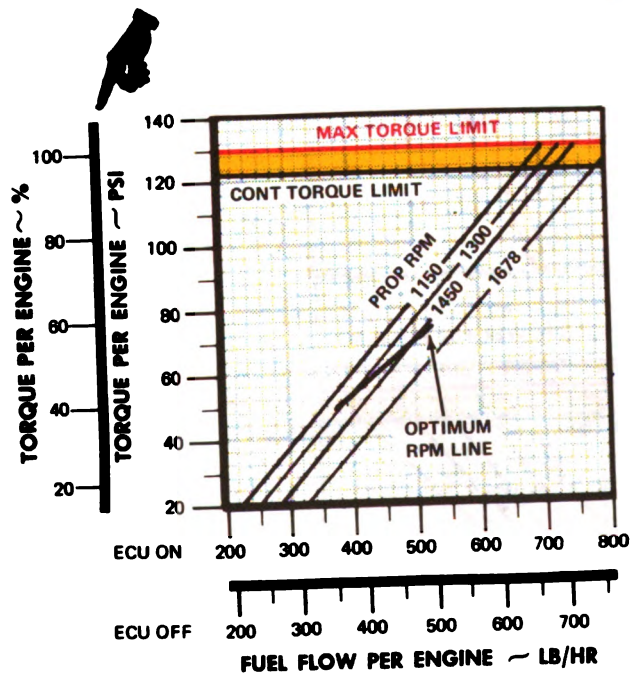
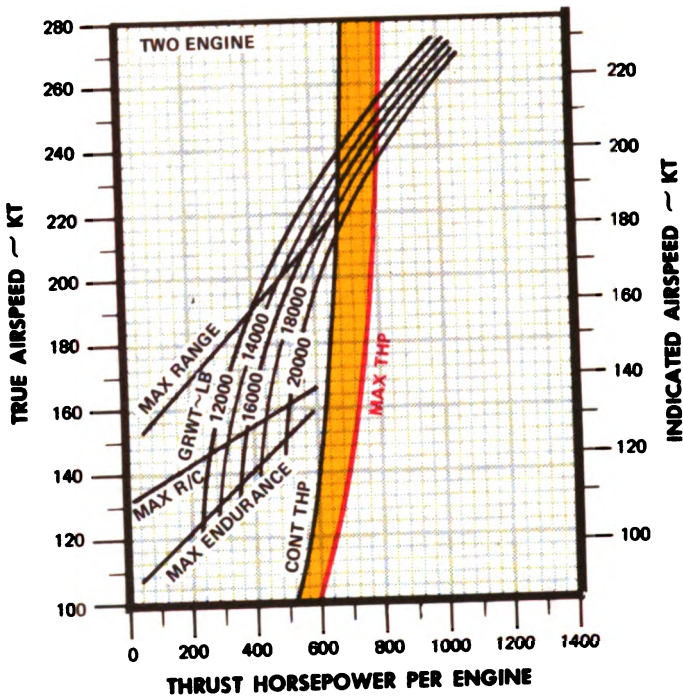

\* NO SLAR OR STORES OTHER THAN DROP TANKS.

DATA BASIS: DERIVED FROM FLIGHT TEST

Figure 7-28. Cruise, FAT +15°C, 10,000 Feet

Y  
R

**CRUISE**

**PRESSURE ALTITUDE 15,000 FT**

**FLAPS 0 DEGREES JP-4 FUEL GEAR UP 2-150 GALLON DROP TANKS\***

CRUISE  
OV-1D/RV-1D  
T63-L-701

R  
Y

FAT = -45°C

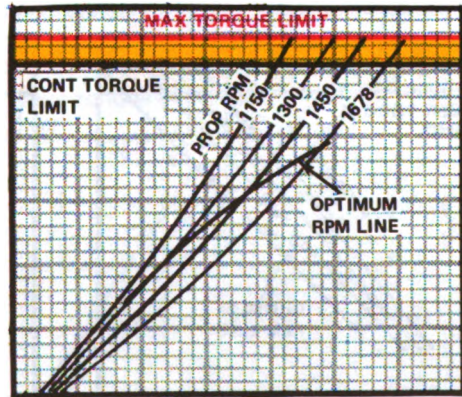
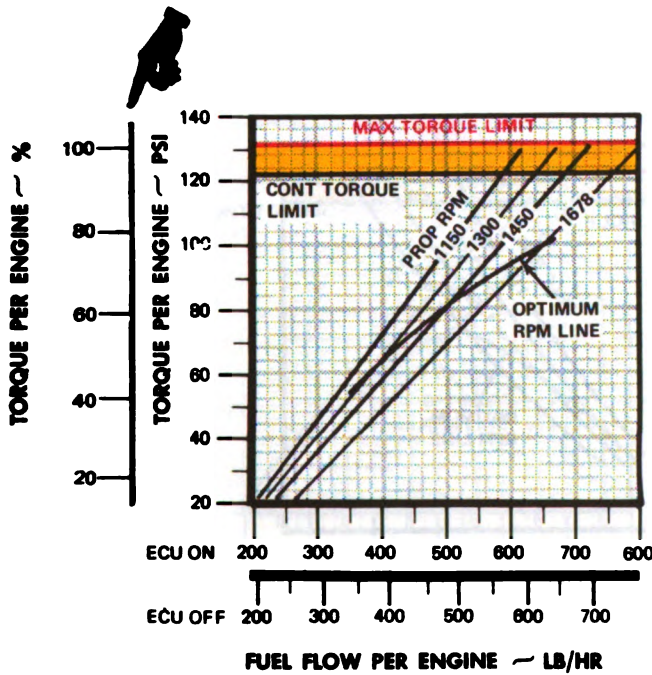
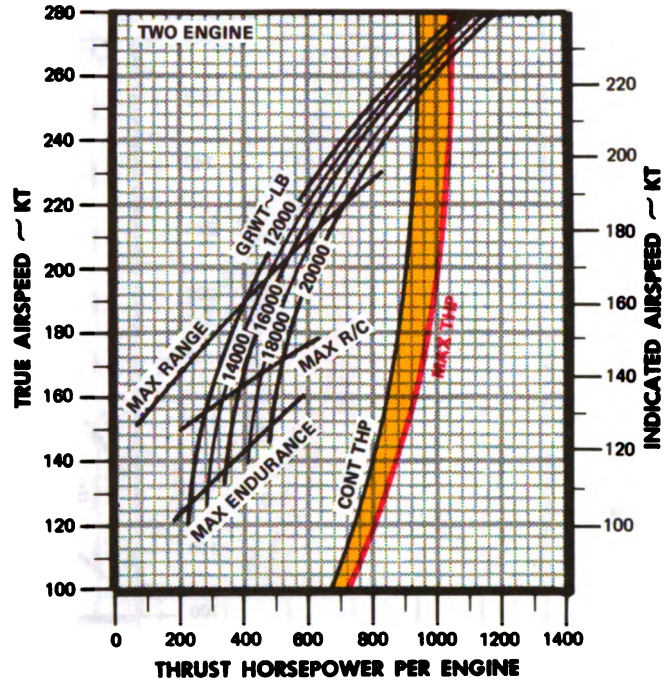

\* NO SLAR OR STORES OTHER THAN DROP TANKS.

DATA BASIS: DERIVED FROM FLIGHT TEST

Y  
R

B-7-10-D-28

Figure 7-29. Cruise, FAT -45°C, 15,000 Feet



# CRUISE PRESSURE ALTITUDE 15,000 FT

CRUISE  
OV-1D/RV-1D  
T53-L-701

FLAPS 0 DEGREES    JP-4 FUEL    GEAR UP    2-150 GALLON DROP TANKS\*

■ R  
□ Y

FAT = -25°C

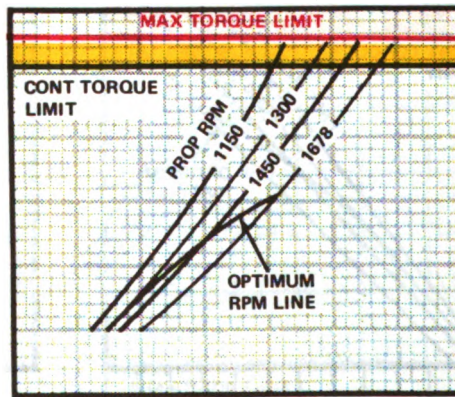
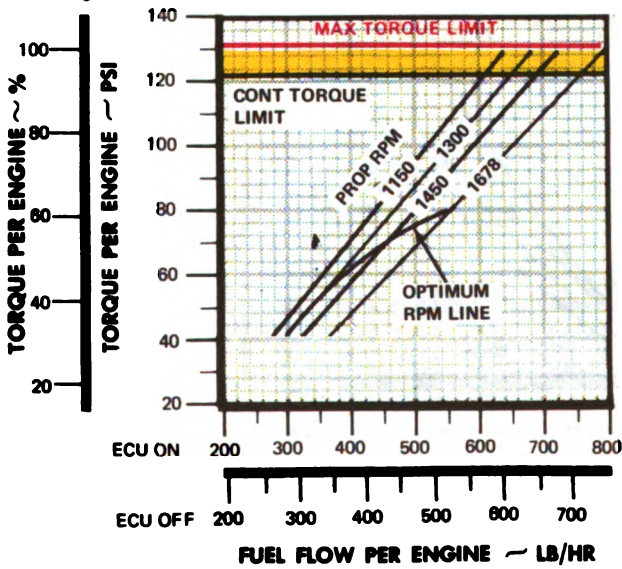
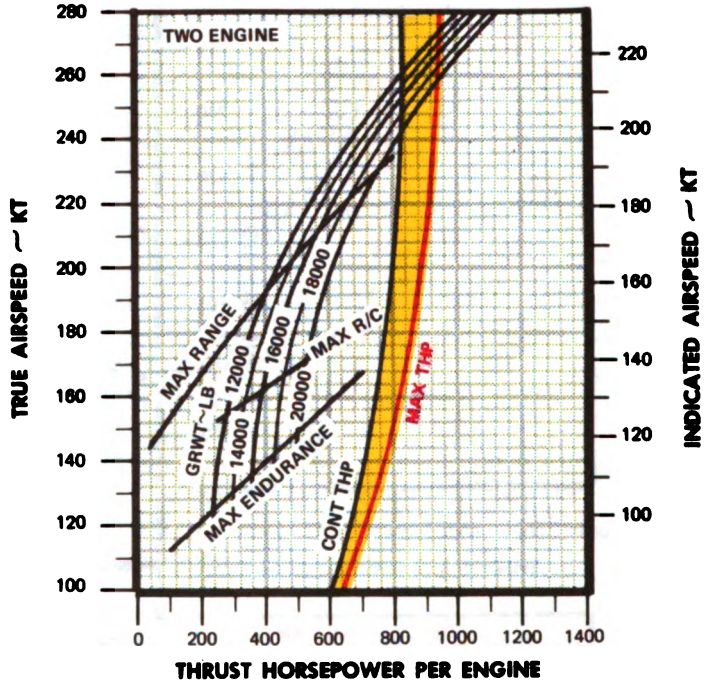

\* NO SLAR OR STORES OTHER THAN DROP TANKS.

DATA BASIS: DERIVED FROM FLIGHT TEST

B-7-10-D-29

**Figure 7-30. Cruise, FAT -25°C, 15,000 Feet**

# CRUISE

PRESSURE ALTITUDE 15,000 FT

CRUISE  
OV-1D/RV-1D  
T63-L-701

FLAPS 0 DEGREES JP-4 FUEL GEAR UP 2-150 GALLON DROP TANKS\*

■ R  
□ Y

FAT -5°C

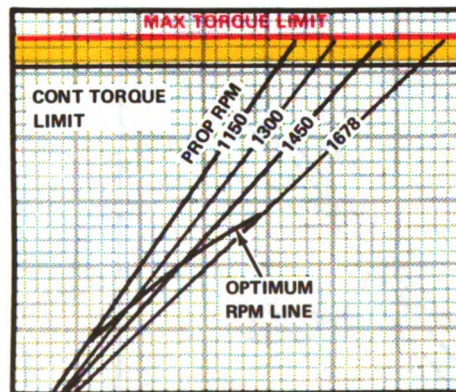
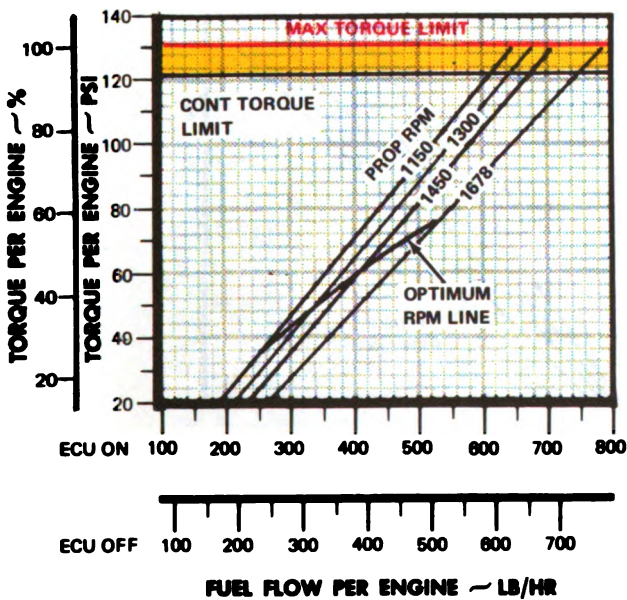
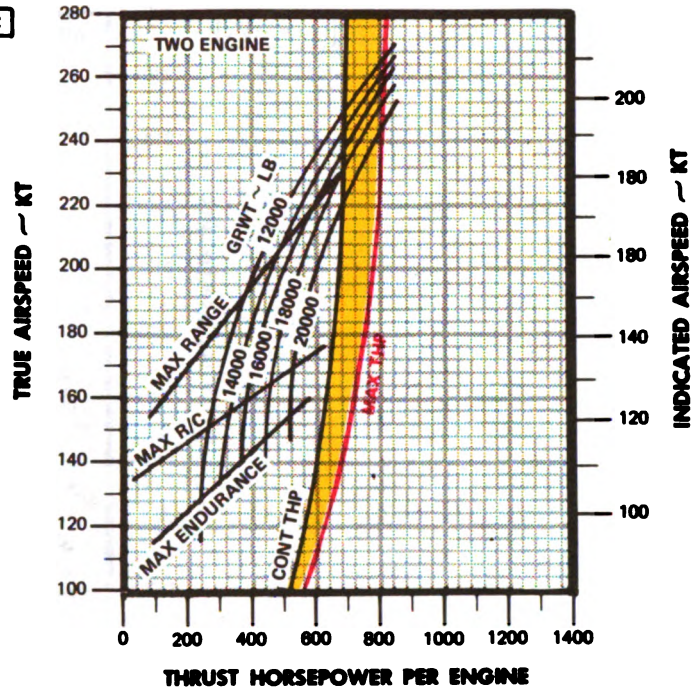

\* NO SLAR OR STORES OTHER THAN DROP TANKS.

DATA BASIS: DERIVED FROM FLIGHT TEST

B-7-10-D-3J

Figure 7-31. Cruise, FAT -5°C, 15,000 Feet

# CRUISE

PRESSURE ALTITUDE 15 000 FT

FLAPS 0 DEGREES JP-4 FUEL GEAR UP 2-150 GALLON DROP TANKS\*

CRUISE  
OV-ID/RV-ID  
T53-L-701

R  
Y

FAT = +15°C

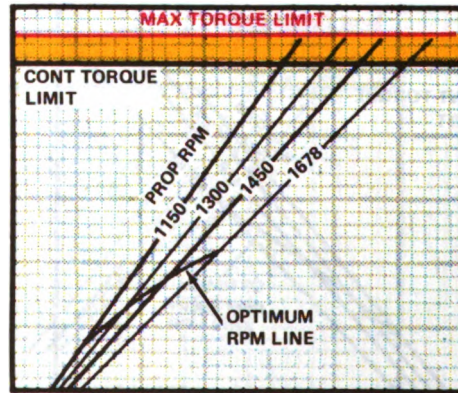
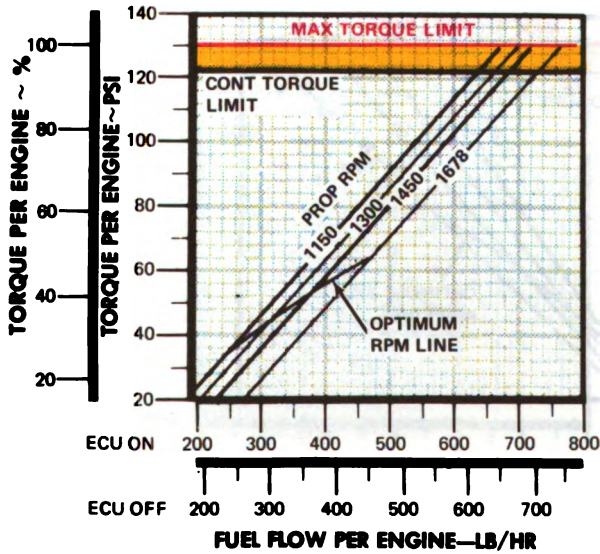
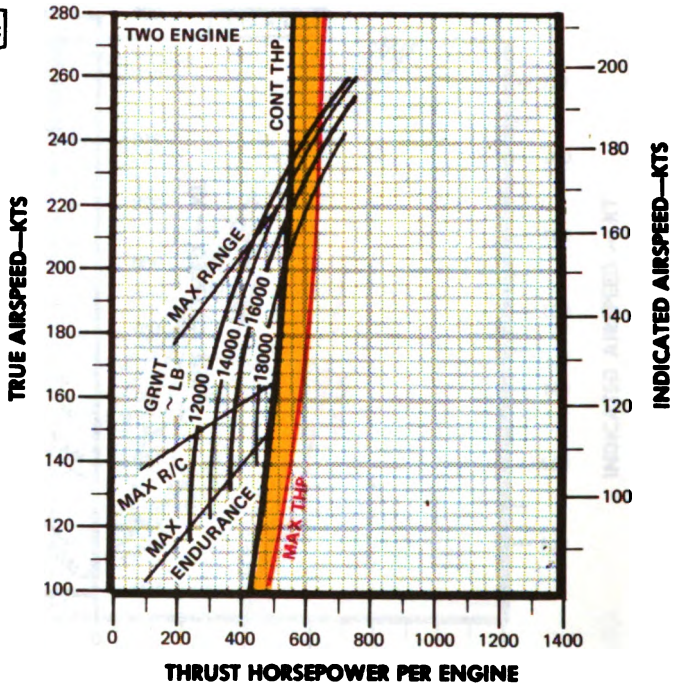

\* NO SLAR OR STORES OTHER THAN DROP TANKS.

DATA BASIS: DERIVED FROM FLIGHT TEST

Figure 7-32. Cruise, FAT +15°C, 15,000 Feet

B-7-10-D-31

Y  
R

# CRUISE

PRESSURE ALTITUDE 20,000 FT

FLAPS 0 DEGREES JP-4 FUEL GEAR UP 2-150 GALLON DROP TANKS\*

CRUISE  
OV-1D/RV-1D  
T63-L-701

R  
Y

FAT --45°C

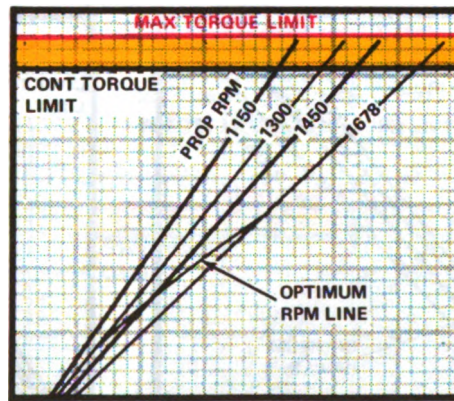
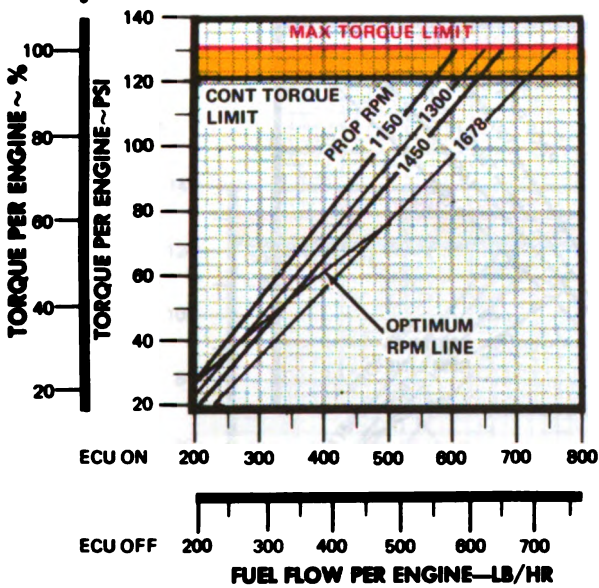
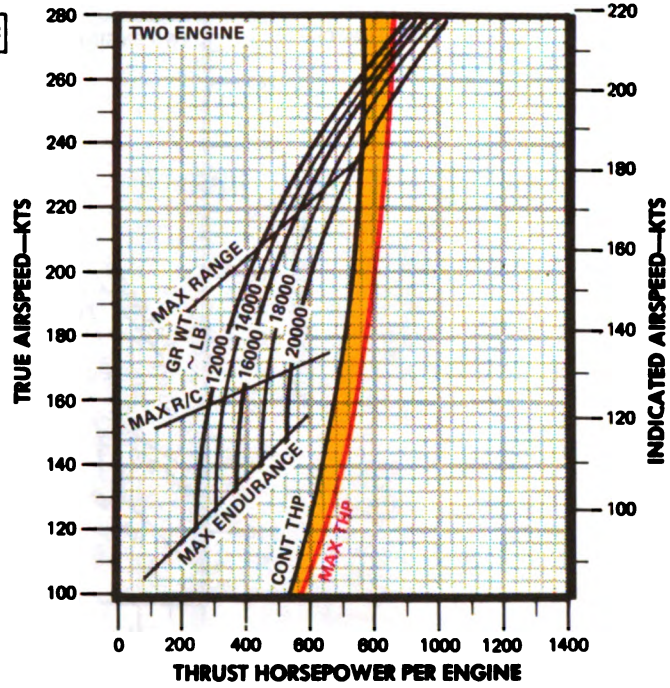

\* NO SLAR OR STORES OTHER THAN DROP TANKS.

DATA BASIS: DERIVED FROM FLIGHT TEST

B-7-10-D-32

Figure 7-33. Cruise, FAT -45°C, 20,000 Feet

Y  
R

■ R  
□ Y

# CRUISE

## PRESSURE ALTITUDE 20000 FT

CRUISE  
OV-ID/RV-ID  
T53-L-701

FLAPS 0 DEGREES JP-4 FUEL GEAR UP 2-150 GALLON DROP TANKS\*

FAT -- 25°C

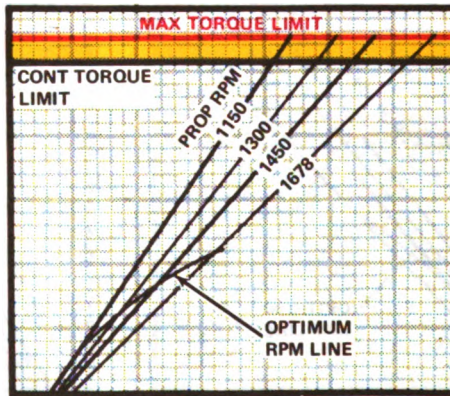
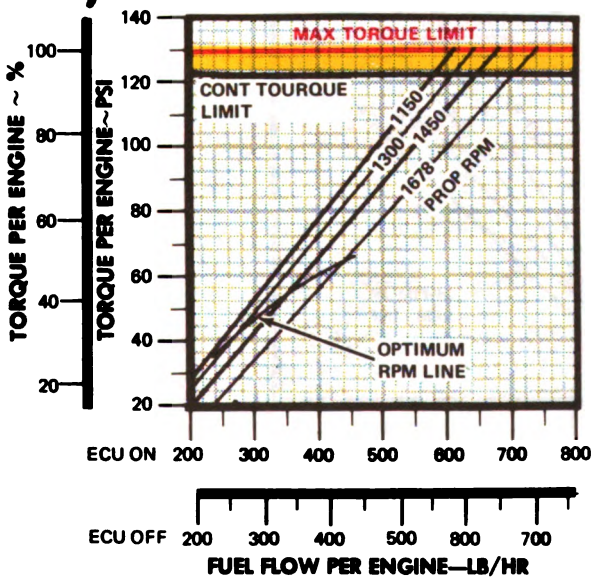
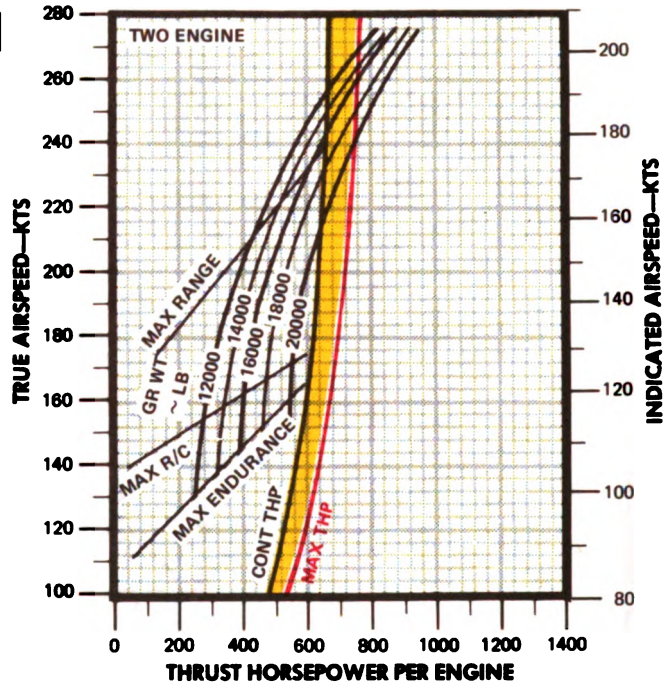

\* NO SLAR OR STORES OTHER THAN DROP TANKS.

DATA BASIS: DERIVED FROM FLIGHT TEST

C-7-10-D-33

Figure 7-34. Cruise, FAT -25°C, 20,000 Feet

# CRUISE

PRESSURE ALTITUDE 20000 FT

FLAPS 0 DEGREES JP-4 FUEL GEAR UP 2-150 GALLON DROP TANKS\*

CRUISE  
OV-ID/RV-ID  
TS3-L-701

FAT = -5°C

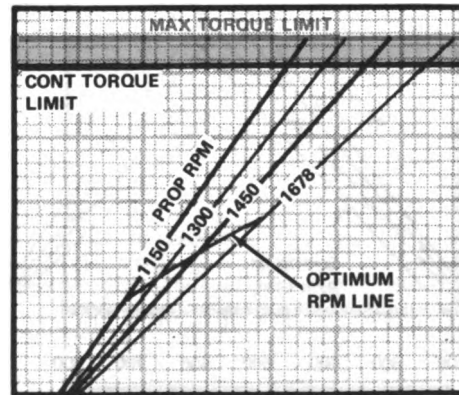
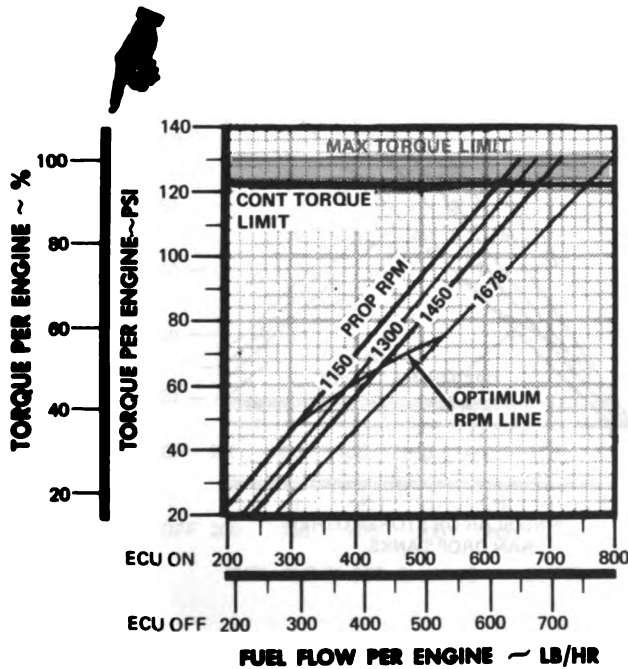
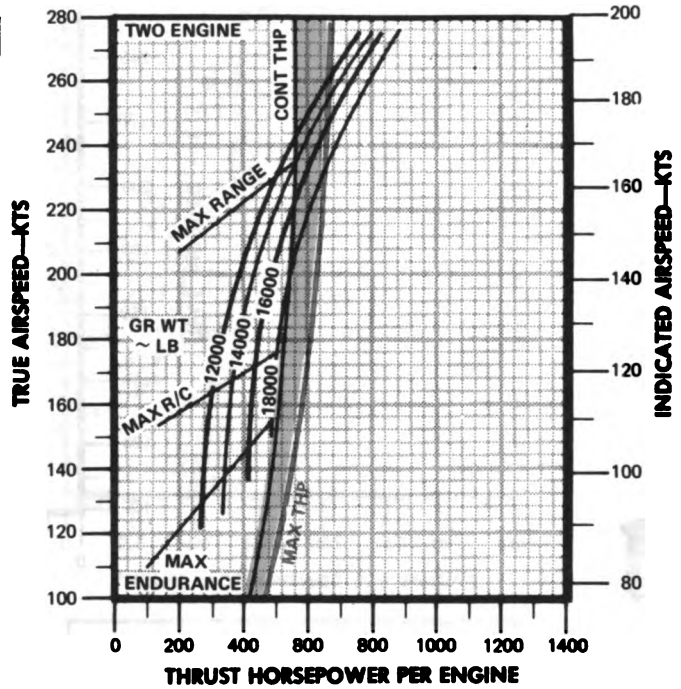

\* NO SLAR OR STORES OTHER THAN DROP TANKS.

DATA BASIS: DERIVED FROM FLIGHT TEST

Y   
R

8-7-10-D-34

Figure 7-35. Cruise, FAT -5°C, 20,000 Feet

R  
Y

# CRUISE

PRESSURE ALTITUDE 25,000 FT

CRUISE  
OV-1D/RV-1D  
T63-L-701

FLAPS 0 DEGREES JP-4 FUEL GEAR UP 2-150 GALLON DROP TANKS\*

FAT = -45°C

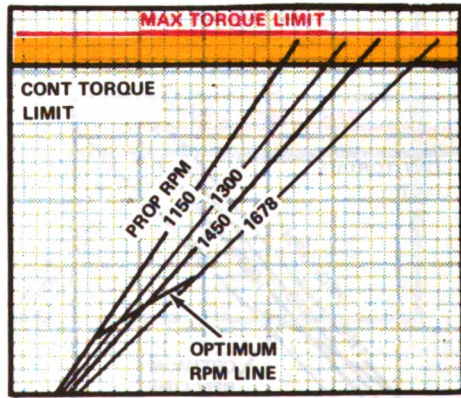
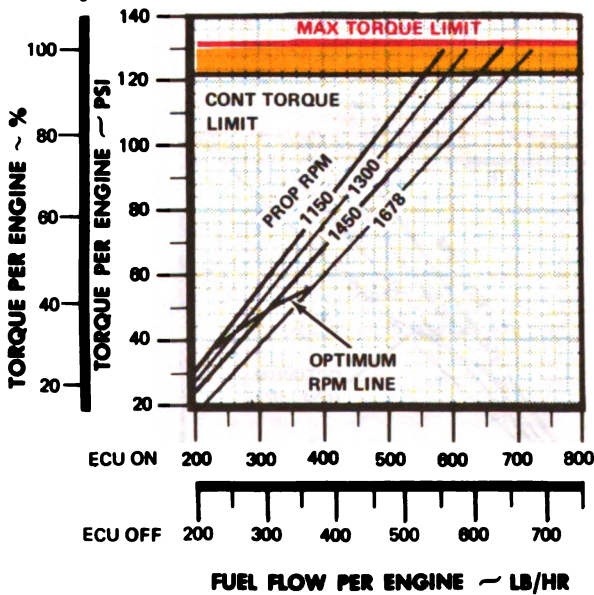
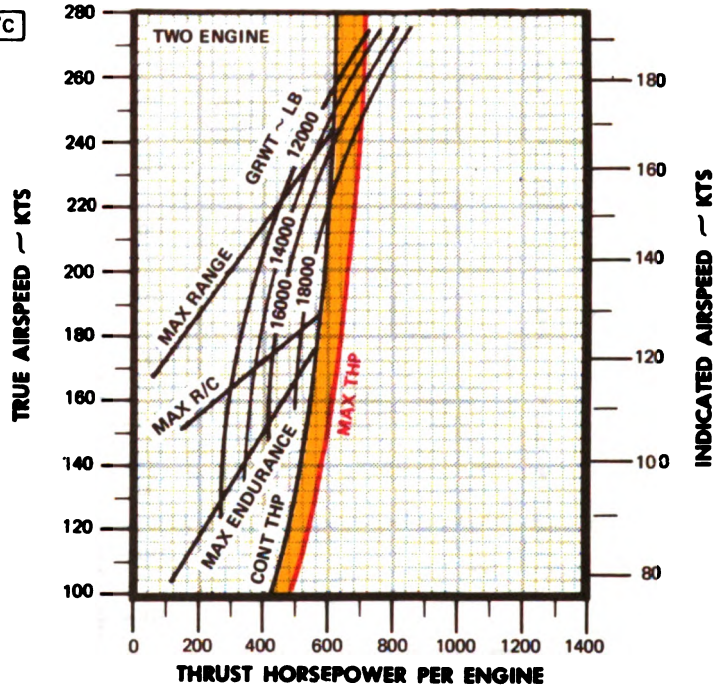

\* NO SLAR OR STORES OTHER THAN DROP TANKS.

DATA BASIS: DERIVED FROM FLIGHT TEST

Y  
R  
8-7-10-D-36

Figure 7-36. Cruise, FAT -45°C, 25,000 Feet

**CRUISE**

**PRESSURE ALTITUDE 25,000 FT**

**FLAPS 0 DEGREES JP-4 FUEL GEAR UP 2-150 GALLON DROP TANKS\***

CRUISE  
OV-1D/RV-1D  
T63-L-701

R  
Y

FAT = -26°C

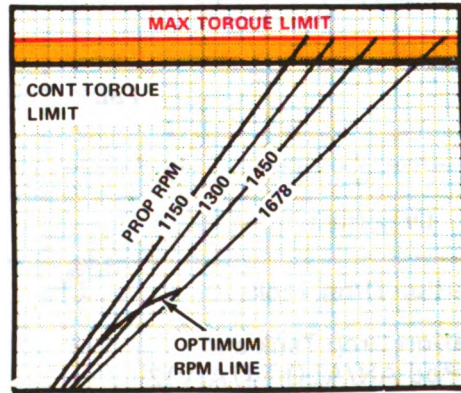
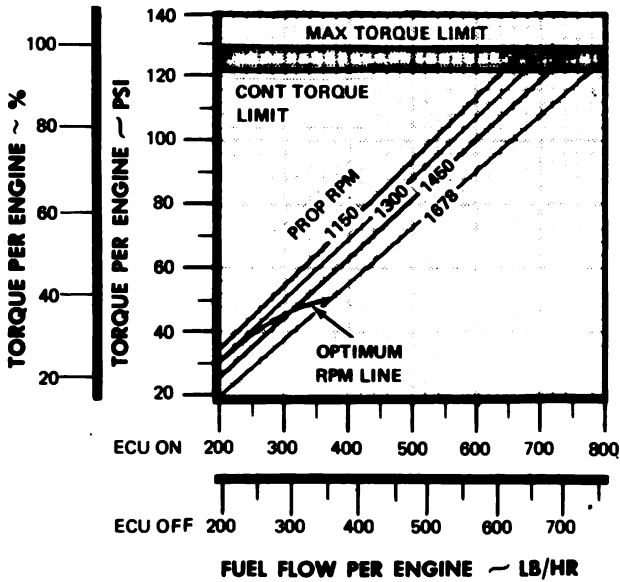
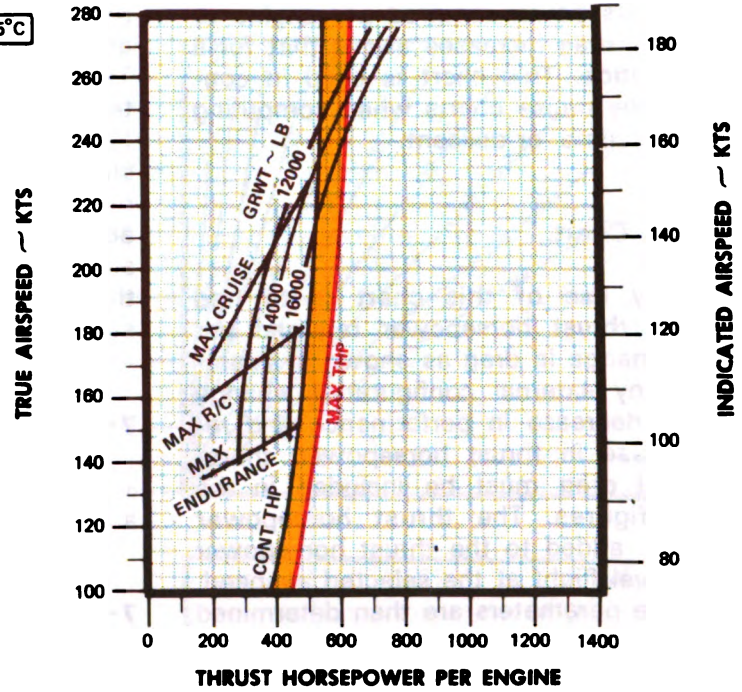

\* NO SLAR OR STORES OTHER THAN DROP TANKS.

DATA BASIS: DERIVED FROM FLIGHT TEST

B-7-10-D-37

Y  
R

Figure 7-37. Cruise, FAT -25°C, 25,000 Feet



## SECTION XIV. DRAG

### 7-64. Description.

The drag chart (figure 7-38) shows additional thrust horsepower required per engine to compensate for drag increases above that for a clean configuration. This chart is used in conjunction with the cruise charts when computing data for cruise, climb, or descent.

### 7-65. Use of Chart.

The primary use of this chart is to find the additional thrust horsepower required per engine for a change in drag as shown in Example XIV-1. Any external configuration change may cause a decrease in performance and require an increase in thrust horsepower; therefore, additional drag must be included in the performance figures. The thrust horsepower change is then added to the thrust horsepower required for level flight at the selected airspeed. All other cruise parameters are then determined at this higher thrust horsepower value. Cruise performance is then computed in the normal manner described in Section XIII. This additional

horsepower must also be added when computing climb or descent performance if the configuration is other than that for which the chart is prepared. The drag parameter used is the frontal area of the external store or other drag item. Test data or estimates of drag are given in terms of equivalent frontal area in square feet. Equivalent frontal areas of external stores are shown in table 7-1. It should be noted that drag for some of the items is greater than their actual area, due to the disturbance of normal airflow. This chart can also be used to determine the change in climb performance when external stores are jettisoned.

### 7-66. Conditions.

Varied conditions will apply, depending upon aircraft mission.

### 7-67. Data Basis.

Data for the drag chart and table are from flight test.

**Table 7-1. Drag**

Drag Item	Drag Area Change (Square Feet)
Two 150-Gallon Drop Tanks	1.3
One 150-Gallon Drop Tank and One IRCM Pod AN/ALQ-147A(V)2	1.3
One IRCM Pod AN/ALQ-147A(V)1	1.6
LS-59A Flasher Pod	0.7
SLAR Antenna	1.3
Two ECM Pods AN/ALQ-133	2.1
Aero 65A-1 Rack	0.06
Aero 15C Rack	0.04
LSSS (IR Suppressor)	1.6

**DRAG**

DRAG  
OV-ID/RV-ID  
T53-L-701

**EXAMPLE XIV-1**

**WANTED**  
CHANGE IN THRUST HORSEPOWER REQUIRED  
DUE TO DRAG AREA CHANGE

**KNOWN**  
DRAG AREA CHANGE = 3.0 SQ FT. TRUE AIRSPEED = 210 KT.  
PRESSURE ALTITUDE = 5000 FT. FAT = 20°C

**METHOD**  
ENTER DRAG AREA CHANGE HERE  
MOVE RIGHT TO TRUE AIRSPEED = 210 KT  
MOVE DOWN TO PRESSURE ALTITUDE = 5000 FT  
MOVE LEFT TO FAT = 20°C  
MOVE DOWN, READ CHANGE IN THRUST HORSEPOWER  
FOR TWO ENGINE OPERATION = 120 THP

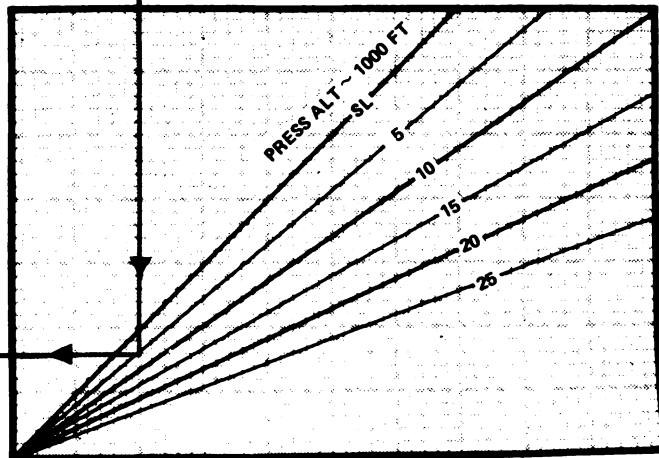
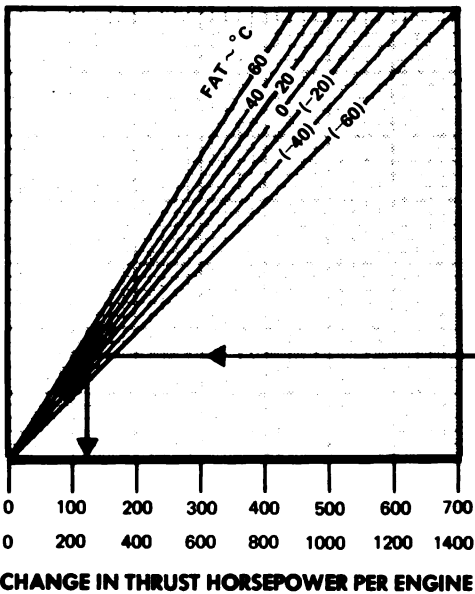
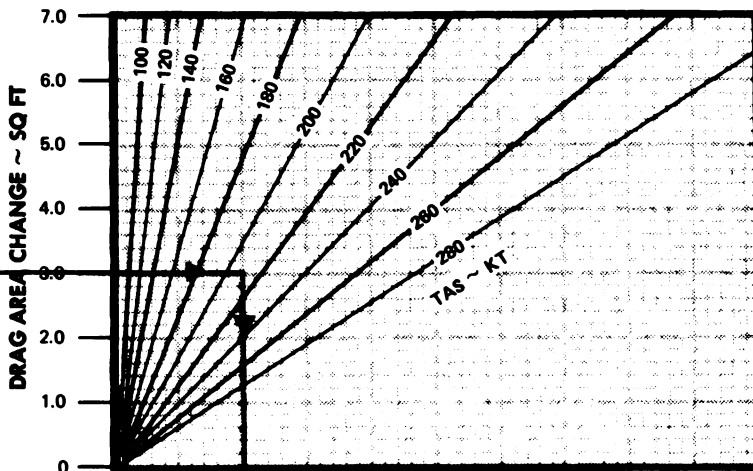

TWO ENGINE OPERATION  
SINGLE ENGINE OPERATION

CHANGE IN THRUST HORSEPOWER PER ENGINE

DATA BASIS: FLIGHT TEST

A-7-10-D-39

Figure 7-38. Drag

## SECTION XV. CLIMB/DESCENT

### 7-68. Description.

The climb/descent chart (figure 7-39) shows the change in torque (%) and thrust horsepower required to obtain a desired rate of climb or descent at a known gross weight and propeller RPM.

### 7-69. Use of Chart.

*a. Climb.* The primary use of the chart for climb information is shown in Example XV-1. The thrust horsepower change per engine is that additional power needed to obtain the desired rate of climb at a known gross weight. For maximum rate-of-climb information, see the cruise charts (figures 7-17 through 7-37). If the aircraft configuration is other than that for which the chart is prepared, a change in horsepower due to drag must be computed from figure 7-38 and added to that thrust horsepower required per engine.

*b. Descent.* The primary use of the chart for descent information is shown in Example XV-2. The thrust horsepower change per engine is that decrease in power needed to obtain a desired rate of descent at a known gross weight. If the aircraft configuration is other than that for which the chart is prepared, a change in horsepower will be required to obtain the desired rate of descent. Refer to Section XIII for change in thrust horsepower required for changes in aircraft configuration.

### 7-70. Conditions.

This chart is valid for any stores configuration.

### 7-71. Data Basis.

Data for climb/descent chart are calculated and from flight test.

# CLIMB/DESCENT

CLIMB/DESCENT  
OV-ID/RV-ID  
T53-L-701

## EXAMPLE XV-1

**WANTED**

RATE OF CLIMB OR DESCENT AS A RESULT OF CHANGE IN THRUST HORSEPOWER

**KNOWN**

THRUST HORSEPOWER CHANGE = 410 THP  
GROSS WEIGHT = 17000 LB

**METHOD**

ENTER THRUST HORSEPOWER CHANGE HERE  
MOVE RIGHT TO GROSS WEIGHT - 17000 LB MOVE DOWN,  
READ RATE OF CLIMB OR DESCENT = 1600 FT/MIN

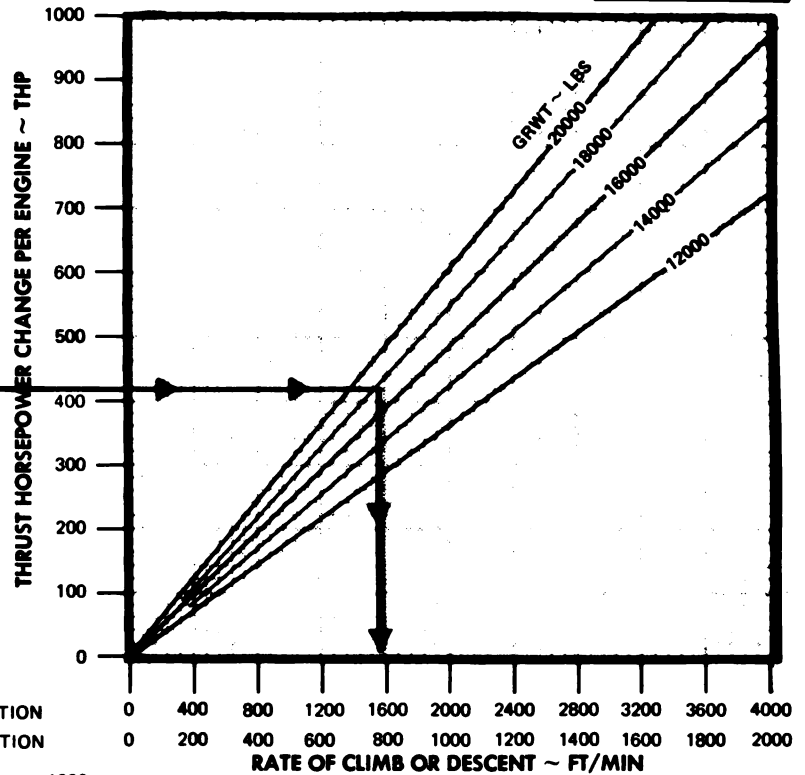

DATA BASIS: CALCULATED

TWO ENGINE OPERATION  
SINGLE ENGINE OPERATION

## EXAMPLE XV-2

**WANTED**

TORQUE CHANGE FOR CLIMB OR DESCENT AS A RESULT OF CHANGE IN THRUST HORSEPOWER OR RPM

**KNOWN**

THRUST HORSEPOWER CHANGE = 410 THP  
PROP RPM = 1450 RPM

**METHOD**

ENTER THRUST HORSEPOWER CHANGE HERE  
MOVE RIGHT TO RPM = 1450 RPM MOVE DOWN, READ  
TORQUE CHANGE PER ENGINE = 35%

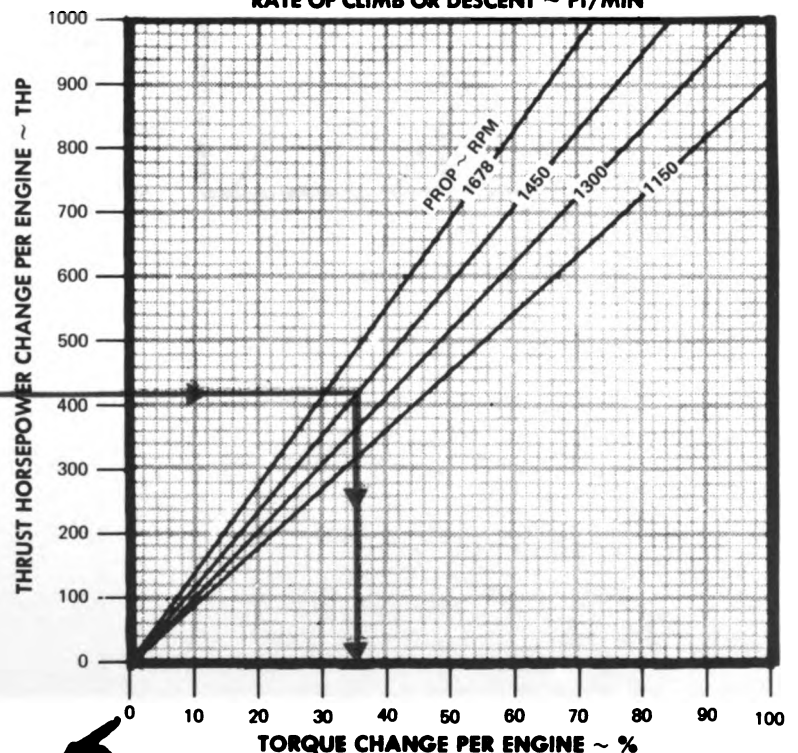

DATA BASIS: FLIGHT TEST

Figure 7-39. Climb/Descent

D-7-10-D-40

## SECTION XVI. APPROACH SPEED

### 7-72. Description.

The approach speed chart (figure 7-40) shows the approach speed for a known gross weight, with 0°, 15°, or 45° flaps.

### 7-73. Use of Chart.

The primary use of the chart is shown in Example XVI-1. The approach speed line shows

the approach indicated airspeed for given gross weights.

### 7-74. Conditions.

This chart is valid for any stores configuration.

### 7-75. Data Basis.

Data for the approach speed chart are from flight test.

**APPROACH SPEED  
GEAR DOWN  
ALL STORES**

APPROACH SPEED  
OV-1D/RV-1D  
T53-L-701

**EXAMPLE XVI-1**

**WANTED**

RECOMMENDED APPROACH SPEED  
FOR KNOWN GROSS WEIGHTS

**KNOWN**

GROSS WEIGHT = 17000 LB  
FLAPS = 45°

**METHOD**

ENTER GROSS WEIGHT HERE →  
MOVE RIGHT TO APPROACH  
SPEED LINE 45° FLAPS  
MOVE DOWN, READ INDICATED  
AIRSPEED = 97.9 KT

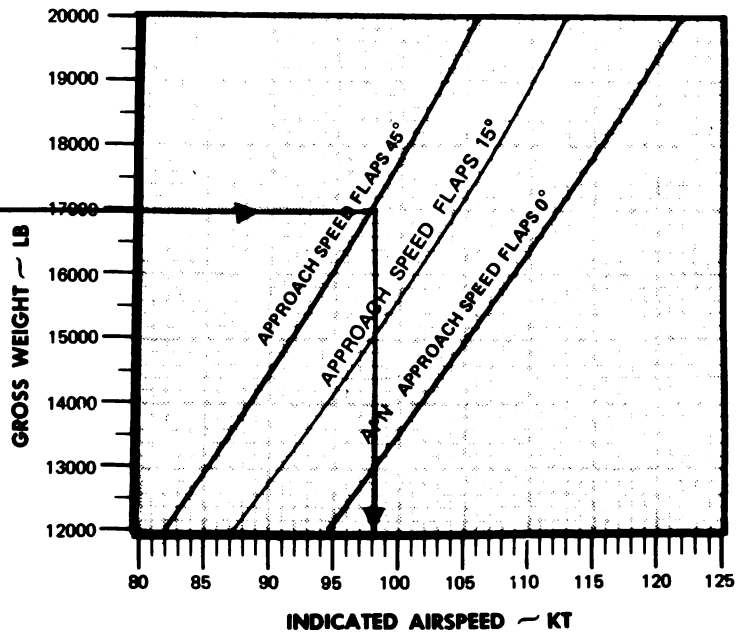

**DATA BASIS:** FLIGHT TEST

G ■  
A-7-10-D-41

**Figure 7-40. Approach Speed**

## SECTION XVII. LANDING

### 7-76. Description.

The landing chart (figure 7-41) shows the total ground roll distance for landing with no reverse thrust at a known gross weight, pressure altitude, and free air temperature. Full braking with 0°, 15°, and 45° flaps are presented.

### 7-77. Use of Chart.

The primary use of the landing chart is to provide total ground roll distance as shown in Example XVII-1. This performance is based on using the approach speed obtained from figure 7-40.

### 7-78. Conditions.

*a. Runway.* Runway conditions for this chart are based on a dry, level, hard-surface runway.

Conditions other than these may vary aircraft landing distance. Distance decreases approximately 4% per 1% uphill gradient. Distance increases approximately 4% per 1% downhill gradient.

*b. Wind.* All data presented are based on calm wind conditions. Since surface wind speed and direction cannot be accurately predicted, all landings shall be planned based on calm wind. Distance decreases approximately 1% per knot headwind. Distance increases approximately 4% per knot tailwind.

*c. Configuration.* This chart is valid for any stores configuration.

### 7-79. Data Basis.

Data for the landing chart are estimated.

# LANDING

CALM WINDS LEVEL DRY, HARD SURFACE  
ALL STORES

LANDING  
OV-1D/RV-1D  
T53-L-701

## EXAMPLE XVII-1

**WANTED**

LANDING DISTANCE

**KNOWN**

GROSS WEIGHT = 18000 LB  
PRESSURE ALTITUDE = 2000 FT  
FAT = 19°C  
FLAPS = 45°

**METHOD**

ENTER FAT HERE →  
MOVE RIGHT TO PRESSURE ALTITUDE = 2000 FT  
MOVE DOWN TO WEIGHT = 18000 LB  
MOVE LEFT TO FULL BRAKING 45° FLAPS  
MOVE DOWN, READ LANDING DISTANCE = 2750 FT

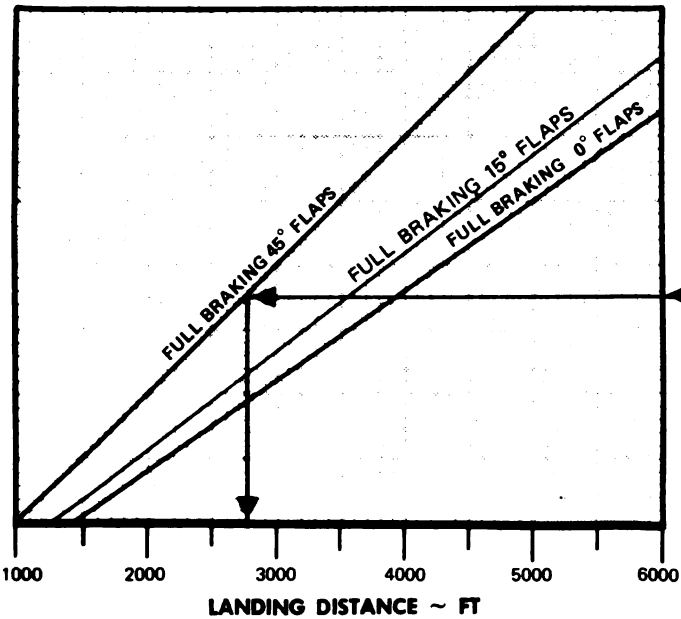
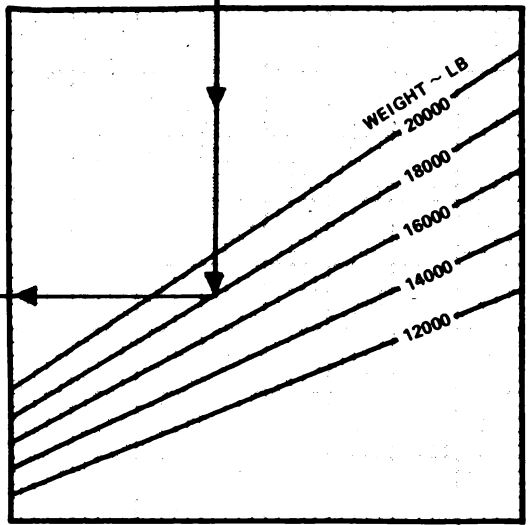
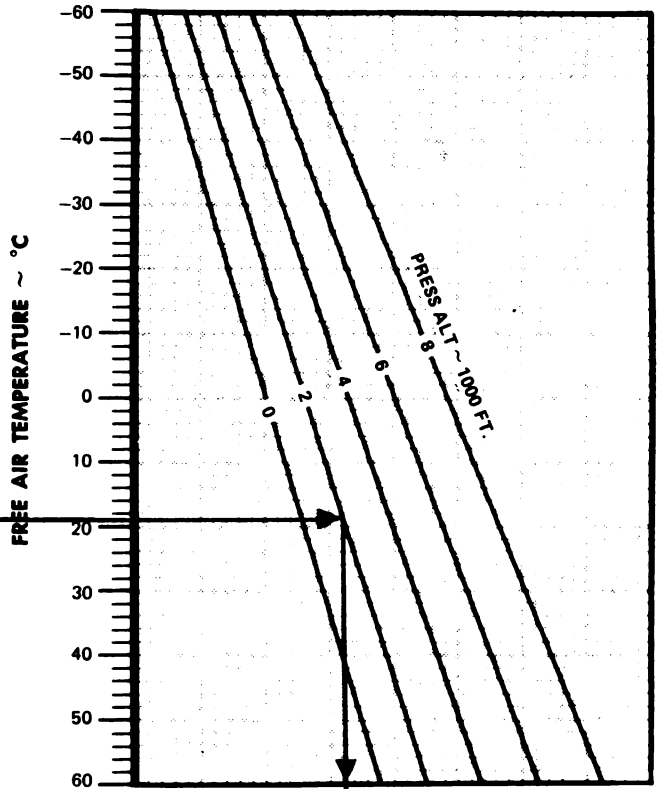

DATA BASIS: ESTIMATED

A-7-10-D-42

Figure 7-41. Landing





## CHAPTER 8

### NORMAL PROCEDURES

#### SECTION I. MISSION PLANNING

##### 8-1. Mission Planning.

Mission planning begins when the mission is assigned and extends to the preflight check of the aircraft. It includes, but is not limited to, checks of operating limits and restrictions; weight, balance, and loading; performance; publications; flight plan; and crew/passenger briefings. The pilot shall insure compliance with the contents of this manual that are applicable to the mission.

##### 8-2. Operating Limits and Restrictions.

The minimum, maximum, normal, and cautionary operational ranges represent careful aerodynamic and structural calculations, substantiated by flight test data. These limitations must be adhered to during all phases of the mission. Refer to Chapter 5, Operating Limits and Restrictions, for detailed information.

##### 8-3. Weight, Balance, and Loading.

The aircraft must be loaded, cargo and passenger secured, and weight and balance verified in accordance with Chapter 6, Weight, Balance, and loading. This aircraft is in weight and balance class 1B and requires a weight and balance clearance only when loaded in other than a normal manner specified in AR 95-16. The aircraft weight and center of gravity conditions

must be within the limits prescribed in Chapter 5, Operating Limits and Restrictions.

##### 8-4. Performance.

Refer to Chapter 7, Performance Data, to determine the capability of the aircraft for the entire mission. Consideration must be given to changes in performance resulting from variations in loads, temperatures, and pressure altitudes. Record the data on the Performance Planning Card for use in completing the flight plan and for reference throughout the mission.

##### 8-5. Flight Plan.

A flight plan must be completed and filed in accordance with AR 95-1, DOD FLIP, and local regulations.

##### 8-6. Crew/Passenger Briefing.

A crew/passenger briefing must be conducted to insure a thorough understanding of individual and team responsibilities. The briefing should include the copilot/passenger/airborne systems specialist and ground crew responsibilities, and the coordination necessary to complete the mission efficiently. A review of visual signals is desirable when ground guides do not have direct voice communication with the crew.

## SECTION II. OPERATING PROCEDURES AND MANEUVERS

### 8-7. Operating Procedures and Maneuvers.

a. This section deals with normal procedures and includes all steps necessary to insure safe and efficient operation of the aircraft from the time a preflight begins until the flight is completed and the aircraft is parked and secured. Unique feel, characteristics, and reaction of the aircraft during various phases of operation and the techniques and procedures used for taxiing, takeoff, climb, etc., are described including precautions to be observed. Your flying experience is recognized; therefore basic flight principles are avoided. Only duties of the minimum crew necessary for actual operation of the aircraft are included.

b. Procedures for instrument flight that differ from normal procedures are covered in Section III. Descriptions of functions, operations, and effects of controls are covered in Section IV, Flight Characteristics, and are repeated in this section only when required for emphasis. Checks that must be performed under adverse environmental conditions, such as desert and cold weather operations, supplement normal procedures checks in this section and are covered in Section V, Adverse Environmental Conditions.

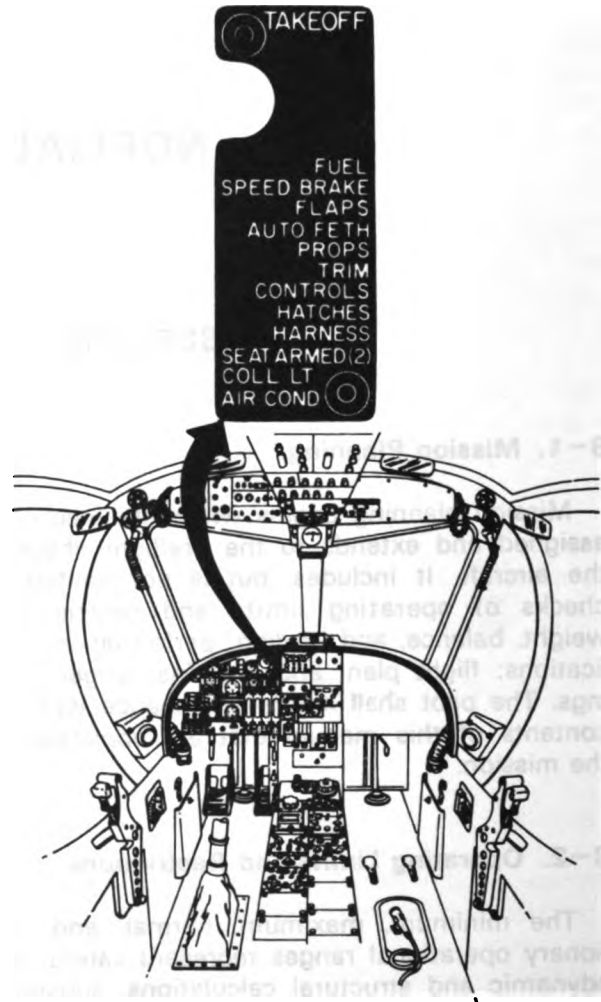

8-10-D-1

### 8-8. Checks.

The checklist includes items for day, night, and instrument flights with annotative indicators immediately preceding the checks to which they apply; (N) for night operations only; (I) for instrument operations only; and (O) to indicate a requirement if the equipment is installed. The symbol ★ preceding steps of the checklist indicates that detailed procedures for those checks are included in the performance checks section at the back of the condensed checklist (TM 55-1510-213-CL). Takeoff and landing checklist placards are mounted on the pilot's instrument panel. (See figures 8-1 and 8-2.)

**Figure 8-1. Takeoff Checklist**

#### NOTE

*These placards are not complete, they do not follow the sequence outlined in this Chapter, and they shall not be used.*

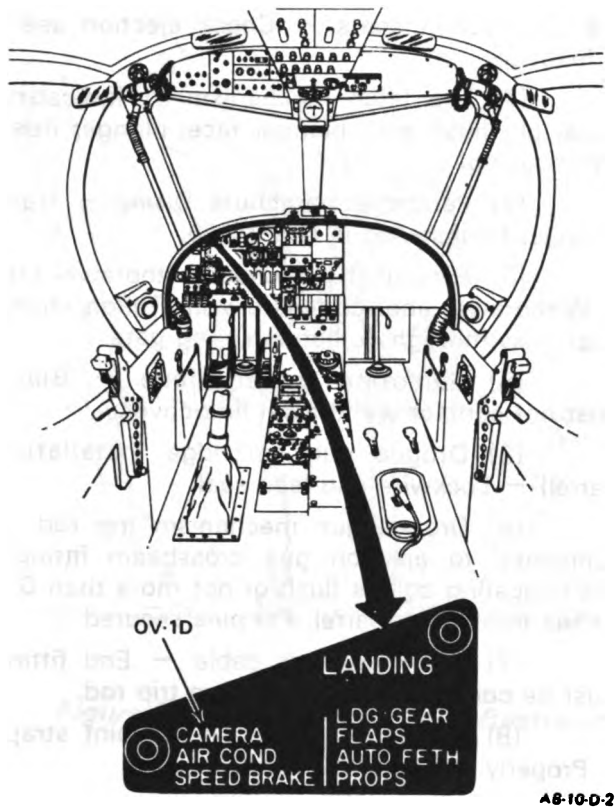

Figure 8-2. Landing Checklist

**8-9. Thru-Flight Check.**

When an aircraft is flown by the same crew on a mission requiring intermediate stops, it is not necessary to perform all the normal checks. The checks essential for safe aircraft operation on intermediate stops are designated as thru-flight checks. An asterisk (\*) indicates that performance of steps is mandatory for all thru-flights when there has been no change in crew. The asterisk applies only to checks performed before takeoff.

**8-10. Checklist.**

Normal procedures are given primarily in checklist form and amplified only if a detailed description of a procedure or maneuver is required. A condensed version of the amplified checklist, omitting all explanatory text, is contained in the Operator's and Crewmember's Checklist, TM 55-1510-213-CL. To provide for easier cross referencing, the procedural steps

in this chapter are numbered to coincide with the corresponding numbered steps in the Operator's and Crewmember's Checklist.

**8-11. Checklist Callout.**

Pilots and crewmembers shall not rely on memory to verify prescribed operational checks, except for those immediate action emergency procedures that must be memorized for safe aircraft operation. These memory items will be underlined. Oral callouts and confirmation of checklist items shall be accomplished by the pilot and crewmember.

**8-12. Entrance To Aircraft (figure 8-3).**

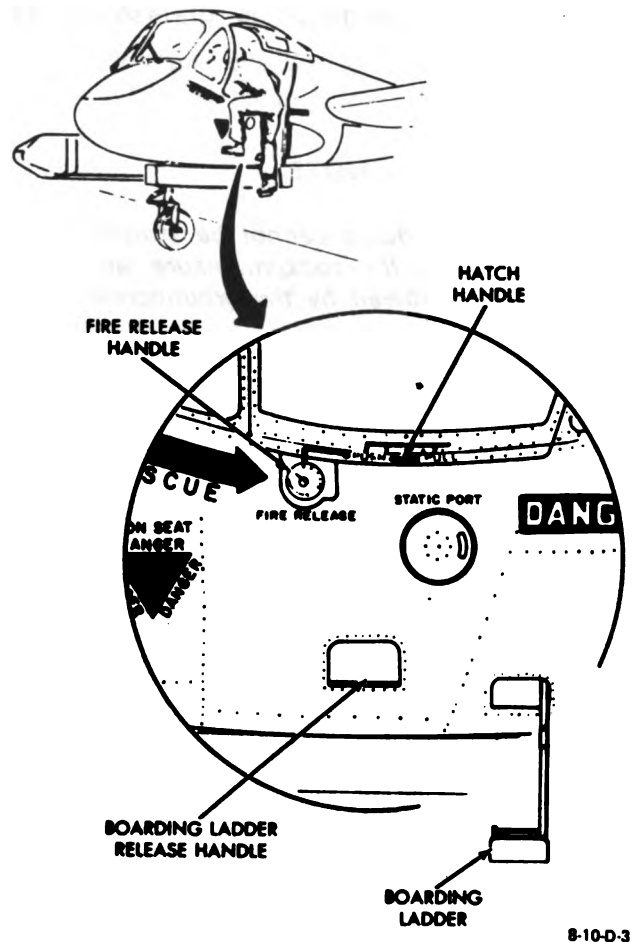

Figure 8-3. Entrance to Aircraft

**CAUTION**

Do not lower ladder on right side with SLAR antenna installed. Contact with and subsequent damage to antenna can occur.

1. Push in ladder release to release boarding ladder.
2. Lift external exit release handle and turn to UNLOCK position.
3. Push forward portion of hatch handle and pull handle out.
4. Place entrance hatch in open position.
5. Climb into cockpit using ladder (or antenna) and boarding step as footholds, and canopy ledge and handgrip on glareshield as handholds.

**NOTE**

*Boarding ladders cannot be stowed from inside the cockpit. Insure ladders are stowed by the groundcrew before flight.*

**8-13. Preflight Check.**

*a. Before Exterior Check.*

- \*1. Ejection seats - Safe. Check that face blind handle is locked (red tab up) and lower firing handle is locked (guard up).
- \*2. Publications - Check DA Form 2408-12, -13, -14, -18, DD Form 365F, DD Form 1896, and availability of Operator's Manual (-10), Checklist (-CL), and locally required forms and publications.
- \*3. Ignition lock switch - ON.
- 4. First aid kit - Check.
- 5. Canopy jettison air pressure - Check within placarded limits.
- \*6. Seat pins - Remove seven pins (figure 2-54).

★ 7. Ejection seats - Check ejection seats as follows:

- (1) Top latch mechanism - Indicating dowel pin flush with plunger face, plunger flush with housing.
  - (2) Personnel parachute D-ring - Handle must be installed in spring clip.
  - (3) Personnel parachute withdrawal line - Withdrawal line, complete with Teflon cover, must pass through guillotine spring gate.
  - (4) Guillotine cutter blade - Blade must not contact withdrawal line cover.
  - (5) Drogue gun cartridge installation (barrel) - Lockwire and lead seal.
  - (6) Drogue gun mechanism trip rod - Connected to ejection gun crossbeam fittings, and indicating collars flush or not more than 0.5 inches from outer barrel. Pip pins secured.
  - (7) TCR dispenser cable - End fitting must be connected to drogue gun trip rod.
  - (8) Personnel parachute restraint straps - Properly routed and secure.
  - (9) Personnel parachute risers - Risers must not be twisted. The roller yokes should not be separated.
  - (10) Seat survival kit container - Secure. Pull up on lap belt halves vigorously, to insure security. Visual check of sticker clips.
  - (11) Leg restraint cords - Secure and check garters for condition (figure 8-4).
  - (12) Manual override handle - Handle must be full down and connecting rod attached to guillotine sear.
  - (13) Guillotine cartridge installation (breach) - Lockwire and lead seal.
  - (14) Emergency oxygen bottle - Disconnect lanyard connected to lap belt half. Check for pressure (1,800 PSI).
  - (15) Time release mechanism trip rod - Connected to ejection gun crossbeam fitting, and indicating collars flush or not more than 0.5 inches from outer barrel. Pip pin secure.
  - (16) Time release mechanism barostat - Lockwire and lead seal.
8. Fire extinguisher - Check.
  - \*9. Landing gear handle - DOWN.
  10. Battery switch - NORMAL.

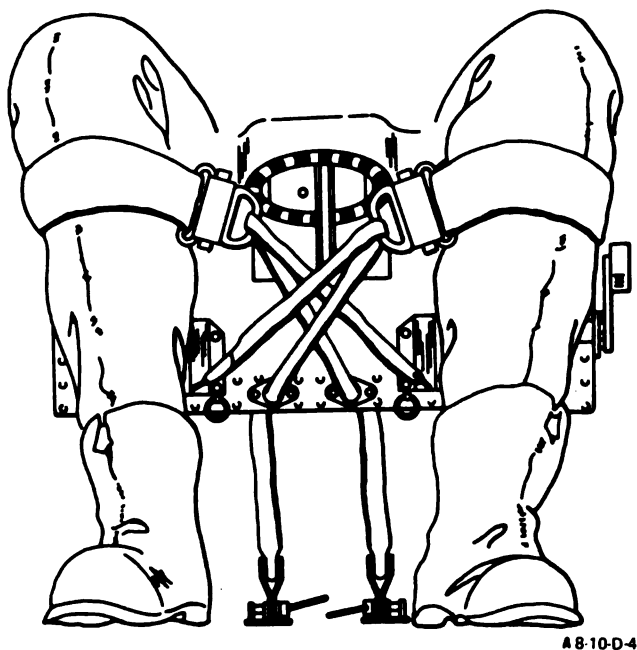

**Figure 8-4. Ejection Seat Leg Restraint Cord Routing**

11. Lighting systems – Check operation as required. Turn off after check.
12. Battery voltage – Check (24 VDC minimum).
13. Battery switch – As required.
- \*14. Gust lock – Disengage.
15. Trim tabs – ZERO.
16. Parachute harness – Check DA Form 3912 to verify inspection by authorized personnel in the past 30 days and by a parachute rigger in the past 120 days.
17. Oxygen pressure – Check (800 PSI minimum, 1850 PSI maximum).

**b. Exterior Check (figure 8-5).**

\*Fuel sample – Check collective sample for contamination prior to initial flight and after refueling on thru flights.

**NOTE**

**Preflight checks for mission equipment are contained in Chapter 4.**

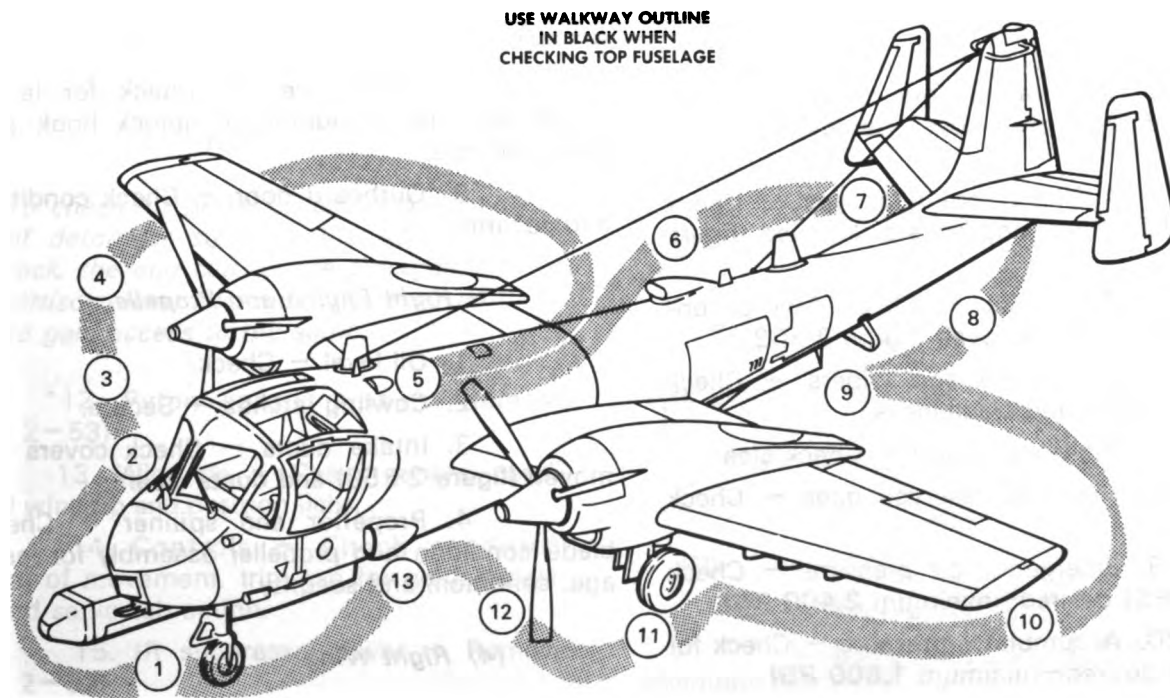

USE WALKWAY OUTLINE  
IN BLACK WHEN  
CHECKING TOP FUSELAGE

- Area 1. Nose section
- Area 2. Right main landing gear
- Area 3. Right engine and propeller
- Area 4. Right wing
- Area 5. Fuselage – top
- Area 6. Fuselage – right side
- Area 7. Empennage

- Area 8. Fuselage – left side
- Area 9. Fuselage – underside
- Area 10. Left wing
- Area 11. Left engine and propeller
- Area 12. Left main landing gear
- Area 13. Equipment compartments

**Figure 8-5. Exterior Check**

*(1) Nose Section.*

1. Skin condition - Check for wrinkles, cracks, defective rivets, and evidence of hydraulic leaks.

2. Air-conditioning scoop - Check free of obstructions and protective cover removed (figure 2-53).

3. Left static port - Check clear.

4. Wheel well - Check for condition, leaks, and cleanliness.

5. Doors and linkage - Check condition and security.

\*6. Safety lock - Remove (figure 2-53).

7. Strut - Check for proper extension (approximately 4 inches), cleanliness, and leakage.

\*8. Tiedown - Release.

9. Torque arm - Check secure.

\*10. Tire - Check for wear, cuts, cracks, inflation, and slippage mark.

\*11. Chocks - As required.

12. Compartment access door - Secure.

(O) 13. Camera window - Check condition, cleanliness, and cover removed (figure 2-53).

14. Auxiliary ram air scoops - Check clean, unobstructed, and covers removed (figure 2-53).

15. Pitot tube - Check free of obstruction and cover removed (figure 2-53).

16. Windshield and wipers - Check general condition and cleanliness.

17. Right static port - Check clear.

18. Hydraulic reservoir gage - Check fluid level.

19. Emergency air pressure - Check for 3,000 PSI desired - minimum 2,400 PSI.

20. Accumulator pressure - Check for 2,000 PSI desired - minimum 1,800 PSI.

**NOTE**

*Pressure placards on hydraulic service station are for maintenance use.*

21. Hydraulic filler cap and door - Secure.

22. Fire extinguisher thermal discharge indicator disc - Check for presence of disc.

\*23. Fuel cap and door - Secure.

(O) 24. SLAR antenna - Check general condition and security.

\*25. Fuel tank drain condition - Check for evidence of fuel leaks.

*(2) Right Main Landing Gear.*

\*1. Tire - Check for wear, cuts, cracks, and inflation.

\*2. Chocks - As required.

3. Brake assembly - Check for leaks and puck condition.

4. Inboard doors and linkage - Check condition and security.

5. Torque arm - Check secure.

6. Strut and shrink rod - Check for proper strut extension (approximately 4 inches), cleanliness, and leakage.

\*7. Safety lock - Remove (figure 2-53).

8. Wheel well - Check for leaks, cleanliness, and condition of uplock hook and gear switches.

9. Outboard door - Check condition and security.

*\* (3) Right Engine and Propeller.*

1. Oil level - Check.

2. Cowling latches - Secure.

3. Intake ducts - Check covers removed (figure 2-53) and ducts clear.

4. Propeller and spinner - Check blade condition and propeller assembly for leakage, condition, and security.

*(4) Right Wing.*

\*1. Tiedown door - Secure.

2. Skin condition - Check for wrinkles, cracks, or defective rivets, and evidence of fuel, oil, or hydraulic leaks.

(O) \*3. Drop tank/IRCM pod connections - Check secure.

**CAUTION**

To remove safety pin, rotate it until flat side is horizontal, facing up. Then pull pin out. If pin cannot be easily removed, do not remove pin. Advise maintenance personnel.

- (O) \*4. Pylon safety pin - Remove (figure 2-53).
- (O) \*5. Drop tank/IRCM pod - Check fuel quantity and cap secure.
- (O) 6. IRCM pod transmitter cover - Remove (figure 2-53). Check slippage marks aligned.
- (O) 7. IRCM pod air inlet - Check unobstructed.
- (O) 8. IRCM pod exhaust - Check unobstructed.
- 9. Deicer boot - Check general condition.
- (O) 10. External stores connections - Check secure.
- (O) 11. Detonator squib - Check condition.

**NOTE**

*To check for presence and condition of detonator squib in the Aero 15 rack, the end cap on the emergency jettison assembly must be removed to gain access to the squib.*

- (O) \*12. Pylon safety pins - Remove (figure 2-53).
- 13. Wing tip - Check general condition of wing tip and position light.
- 14. Controls - Check condition, freedom of movement, trim tab for neutral position, and servo tab action.
- (O) 15. IR suppressor cover - Remove (figure 2-53).
- \*16. Exhaust stack - Check for oil leakage and general condition.

*(5) Fuselage - Top.*

- \*1. Main fuel tank and cap - Check quantity and cap secure.

- \*2. Fuel tank cover - Secure.
- ★ 3. Ejection seats (top) - Check as follows:

**WARNING**

The upper firing handle cable (thick) must be on top of lower (thin) firing cable when installed on seat.

- (1) Firing cables - Installed and attached to seat.
- (2) Scissor shackle - Bolthead down.
- (3) Upper firing mechanism - Lockwire and lead seal.
- (4) Drogue withdrawal line - Connected to drogue gun projectile and routed over all other lines at top of seat. Withdrawal line connection pointed forward.
- (5) Drogue flap securing pin - Safetied.
- (6) Drogue flap sunshade - Check for deterioration.
- 4. Escape hatch - Check condition and security.
- 5. Airscoops - Check unobstructed (figure 2-53).
- 6. Skin condition - Check for wrinkles, cracks, or defective rivets.

*(6) Fuselage - Right Side.*

- \*1. Wing ladder - Secure.
- (O) 2. Camera access door - Secure.
- 3. INS air inlet - Check clear.
- 4. Equipment compartment - Check condition and ADAS (if installed) as required.
- 5. Equipment access door - As required.
- 6. Skin condition - Check for wrinkles, cracks, or defective rivets, and evidence of hydraulic leaks.
- \*7. Tiedown - Release.



*(7) Empennage.*

1. Skin condition — Check for wrinkles, cracks, or defective rivets.
2. Deicer boots, right side — Check general condition.
3. Controls and trim tabs — Check condition, freedom of movement, and trim tab for neutral position.
4. Beacon, position light, and antennas — Check general condition.
5. Deicer boots, left side — Check general condition.

*(8) Fuselage — Left Side.*

1. Skin condition — Check for wrinkles, cracks, or defective rivets, and evidence of hydraulic leaks.
2. Equipment compartment — Check condition.
3. Circuit breaker panel and separator — Check all circuit breakers in and separator installed.
- \*4. Batteries — Check condition, connections and vent tubing for no crimping.
5. M130 SAFETY DISABLING SWITCH — Check at station 299 for closed guard.
6. Equipment access door — As required.

(O) 7. KA-76 Camera access door — Open door and verify counting and accelerometer window readings are same as entries in DA Form 2408-13, Block 17 (figure 8-5.1). Secure door.

*(9) Fuselage — Under Side.*

1. Skin condition — Check for wrinkles, cracks, or defective rivets, evidence of hydraulic leaks, condition of beacon and antennas.
2. Baggage door — Secure.

(O) 3. Flare/chaff dispenser — Check. Check that M130 ground safety pin and flag are removed (figure 2-53), ground cover removed, and correct amount of flares/chaff loaded.

4. Fuel vent fitting — Check. Check fuel vent fitting is open and secured.

*(10) Left Wing.*

- (O) 1. IR suppressor cover — Remove (figure 2-53).
- \*2. Exhaust stack — Check for oil leakage and general condition.

3. Controls — Check condition, freedom of movement, and servo tab action.
4. Wing tip — Check general condition of wing tip, position light, and landing light.
5. Deicer boot — Check general condition.

(O) 6. IRCM pod — Check. Check fuel quantity and that cap is secure, covers removed, inlet and exhaust unobstructed, connections secure, and presence and condition of detonator squib in the rack.

**NOTE**

*To check for presence and condition of the detonator squib in the Aero 15 rack, the end cap on the emergency jettison assembly must be removed to gain access to the squib.*

- (O) \*7. Pylon safety pin — Remove (figure 2-53).
8. Skin condition — Check for wrinkles, cracks, or defective rivets, and evidence of fuel, oil, or hydraulic leaks.
- (O) \*9. Drop tank connections — Check secure.
- (O) \*10. Pylon safety pin — Remove (figure 2-53).
- (O) \*11. Drop tank — Check fuel quantity and cap secure.

\*12. Tiedown door — Secure.

*\*(11) Left Engine and Propeller.*

1. Cowling latches — Secure.
2. Intake ducts — Check covers are removed (figure 2-53) and ducts clear.
3. Propeller and spinner — Check blade condition and propeller assembly for leakage, condition, and security.
4. Oil level — Check.

*(12) Left Main Landing Gear.*

1. Outboard door — Check condition and security.
2. Wheel well — Check for leaks, cleanliness, and condition of uplock hook and gear switches.
- \*3. Safety lock — Remove (figure 2-53).
4. Strut and shrink rod — Check for proper strut extension (approximately 4 inches), cleanliness, and leakage.

1. DATE 3 MAR 86		2. MODEL OV-10		3. SERIAL NO. 68-15934		4. NAME OF CREW CHIEF/MECHANIC JOHN FIXIT		5. STATION FT. ANYWHERE		6. PAGE NO. 1		6a. NO. OF PAGES 1																	
7. STATUS TODAY				8. AIRCRAFT TIME			9. NEXT INSPECTION DUE		10.		HOT STARTS		LANDINGS		OTHER														
AIRCRAFT		ELEC-TRONIC		ARMA-MENT		OTHER		TIME TO DATE		3141.0		INTIMED NO. 100 NR		3190:5		NO. 1 ENGINE		NO. 2 ENGINE		PREVIOUS		1		0		2855			
1		4						TIME TO DAY		2.1		P.E. NO. PH# 2		3390:5		TODAY		0		0		1							
2		5						TOTAL TIME		3143.1		OTHER OIL SAMPLE		3150:5		TOTAL		1		0		2856							
11. FUEL (Grade or Lbs)				12. OIL (Quarts)						13. OXYGEN (PSI)		14. ANTI-ICING FLUID (Gals)		15. SERVICED															
SERV. ICE NO.	GRADE	ADDED	TOTAL IN TANKS	GRADE	ADDED NO. 1 ENG	TOTAL IN TANKS	ADDED NO. 2 ENG	TOTAL IN TANKS	APU	1800 PSI	3 GAL	BY		STATION															
1	JP4	300	497	236M	-	10	-	10				JOHN FIXIT		FT. ANYWHERE															
2																													
3																													
4																													
5																													
6																													
7																													
TOTAL																													
16. STATUS	17. FAULTS AND/OR REMARKS								18. ACTION TAKEN				19. SIGNATURE																
F	PMD DUE								PMD COMPLETED - 3 MAR 86				J. Fixit																
F	ACCEL. #1:1870, #2:1504, #3:1369, #4:124B FLT #1: OK								READINGS FROM 1 MAR 86 VERIFIED				J. Fixit																
	ACCEL. #1:1872, #2:1506, #3:1369, #4:124B																												
	FLEW 2 SPLIT "S" MANEUVERS J.P. Pilot																												

SAMPLE

DA FORM 2408-13, 1 DEC 86

REPLACES EDITION OF 1 JAN 84, WHICH WILL BE USED

AIRCRAFT INSPECTION AND MAINTENANCE RECORD  
For use of this form, see TM 38-750; the proponent agency is  
Office of The Deputy Chief of Staff for Logistics.

8-10-D-501

Figure 8-5.1. Sample Form DD2408-13, Counting Accelerometer Reading Entries



5. Torque arm — Check secure.

\*6. Tire — Check for wear, cuts, cracks, and inflation.

\*7. Chocks — As required.

8. Brake assembly — Check for leaks and puck condition.

9. Inboard doors and linkage — Check condition and security.

*(13) Equipment Compartments.*

\*1. Fire extinguisher pressure — Check (approximately 600 PSI).

2. Electrical cable assemblies — Check all unused cable assemblies secure.

3. Ground locks and safety pins — Check and secure.

4. Access doors — Secure.

\*5. Fuel tank drain condition — Check for evidence of fuel leaks.

(O) 6. External ground and bond cables — Disconnect and clear from aircraft.

*\*c. Interior Check.*

1. Boarding ladders — Stowed.

2. Loose equipment — Secure.

**CAUTION**

If rain is encountered in flight, water may enter the cockpit through an open air-conditioning outlet and cause damage to parachute and equipment.

3. Lower right air-conditioning outlet (solo flight) — Close.

**8-14. Before Starting Engines.**

\*1. Brakes and chocks — As required.

\*2. Pedals, leglines, seat belts, harnesses, straps — Adjust.

**NOTE**

*With rudder pedals installed on the right side of the aircraft, the outboard pedal may bind on the air-conditioner bypass lever if the pedals are adjusted fully aft.*

3. Magnetic compass — Check.

4. Hatch jettison handle — Check handle is in a horizontal position and locked.

5. Stores selector switches — OFF and SAFE.

6. Deleted.

7. All circuit breakers (except TOR INV NO. 1 and NO. 2) — Check in.

(O) 8. Sloping console switches — OFF.

9. Lower console equipment — As required.

(O) (1) KY-28/58 — OFF.

(2) Nav mode switch — BACK-UP COMP.

(3) Compass system — Set.

(O) (4) Camera power — OFF.

(O) (5) ALQ-133 switches — OFF.

(6) Pilot's ICS — Set.

(7) Transponder — OFF.

(8) Lower console radios — OFF.

(9) Autopilot — OFF.

10. Emergency stores release handle — Check in.

11. Autofeather/synchrophaser switch — OFF.

12. Emergency landing gear release handle — Check in.

\*13. Prop levers — MIN RPM.

14. Power levers — GROUND IDLE.

15. Speed brake switch — IN.

16. Flap handle — UP.

17. Center instrument panel equipment — As required.

(1) ADF — OFF.

(2) TACAN — OFF.

(3) Marker beacon/glide slope — OFF.

(4) INS — As required.

(5) VOR — As required.

18. Fire handles — IN.

19. Power steer switch — OFF.

20. Windshield wiper control — OFF.

21. Radar altimeter — OFF.

22. Engine instruments and flight instruments — Check. Reset accelerometer.

23. Pilot's air cond bypass lever — As required.

24. Oxygen equipment - Check mask, connections, and regulator (paragraph 2-33).

NOTE

When not in use, the diluter control lever should be left in 100% OXYGEN position to prevent regulator contamination.

- (O)25. Dispenser control panel - Check/set.
- (O)26. IRCM-OCU - OFF.
- (O)27. Radar warning equipment - OFF.
- \*28. Engine master switches - ON.
- \*29. Fuel panel switches - set as follows:
  - (1) Fuel pumps switch - As required.
  - (2) Drop tank transfer switch - OFF.
- 30. Exterior light switches - As required (Collision light ON.)
- 31. Weather control switches - OFF.
- 32. Interior lights switches - As required.
- 33. Electrical control switches - set as follows:
  - (1) Generator switches - ON.
  - (2) Battery switch - OFF.
  - (3) Inverter switch - OFF.
- 34. Air-conditioning control switches - Set as follows:
  - (1) L and R sys air supply switches - OPEN.
  - (2) Defog top/side switch - OFF.
  - (3) Air-conditioning mode selector switch - AUTO.
  - (4) Air-conditioning master switch - OFF.
  - (5) Auto temp control knob - As required.
- (O)35. Fwd camr heat switch - OFF.
- (O)36. Data link - OFF.
- 37. Right seat ICS - Set.
- 38. Right air cond bypass lever - As required.
- (O)39. Surveillance equipment - OFF.

8-15. \* Starting Engines with GPU (Preferred method).



In order to prevent excessive heat accumulation, the left and right aft equipment compartment access doors shall be open during extended ground operations.

- 1. Aft equipment compartment access doors - As required.
- 2. Entrance hatches - As required.
- 3. Fireguard - Posted.
- 4. GPU - Connect.

NOTE

*GPU shall be power-rated at 28 VDC, 600 amperes, or above. The INS should be aligned and the ADAS fixed data/time-of-day should be programmed (if installed) before starting engines, using external power (GPU).*

*If the engines are to be started following an INS alignment, accomplish heading memory operation and shut down the INS. After the engines have been started (generators and inverters on the line), initiate a heading memory alignment.*

- 5. Battery switch - NORMAL (check 28VDC).
- 6. Inverter switch - EMERGENCY, check No. 2 inv and inst pwr lights - OUT.
- 7. Inverter switch - NORMAL, check No. 1 and No. 2 inv and inst pwr lights - OUT.

8. G796 – ON, check G796 ON indicator is illuminated.

9. Fire detection system – TEST.

10. Caution, warning and advisory lights – TEST. Test the caution and warning lights using the master caution test switch. Push to test the speed brake light.

11. Auto feather armed light – Test by setting autofeather/synchrophaser switch to AUTO-FEATHER ON position. Turn switch OFF after test.

12. VIDS – Check operation as follows:

(1) Auto-dim control – Check by covering sensor.

(2) VIDS AUX PWR lamp – OUT.

**CAUTION**

Holding the VIDS DIGIT switch in the LT/TEST position for more than 5 seconds may cause the ENG INST circuit breaker to open.

(3) VIDS DIGIT switch – Press to LT/TEST. Check vertical displays illuminate and digital displays read 888.

13. VIDS DIGIT switch – OFF.

(O)14. ADAS – As required.

15. Right aft equipment compartment access door – secure.

16. Propeller and exhaust blast area – personnel and ground equipment cleared (figure 8-6).

**WARNING**

To protect ground personnel when making GPU starts, No. 2 engine shall be started first.

17. No. 2 engine crank switch – CRANK position and release.

18. No. 2 engine ignition button – Press and hold. Release when N1 reaches 40%.

**CAUTION**

If acceleration is uneven or intermittent, and EGT rises rapidly, abort start, clear engine, and advise maintenance personnel.

19. Engine RPM and EGT – Check for smooth engine acceleration and EGT is within limits – (48 to 52% N1).

**EMERGENCY PROCEDURES – Paragraph 9-7.**

20. Oil pressure – Check within limits.

21. Hydraulic pressure – Check within limits.

22. #2 fuel press light – Out.

23. #2 gen light – Out.

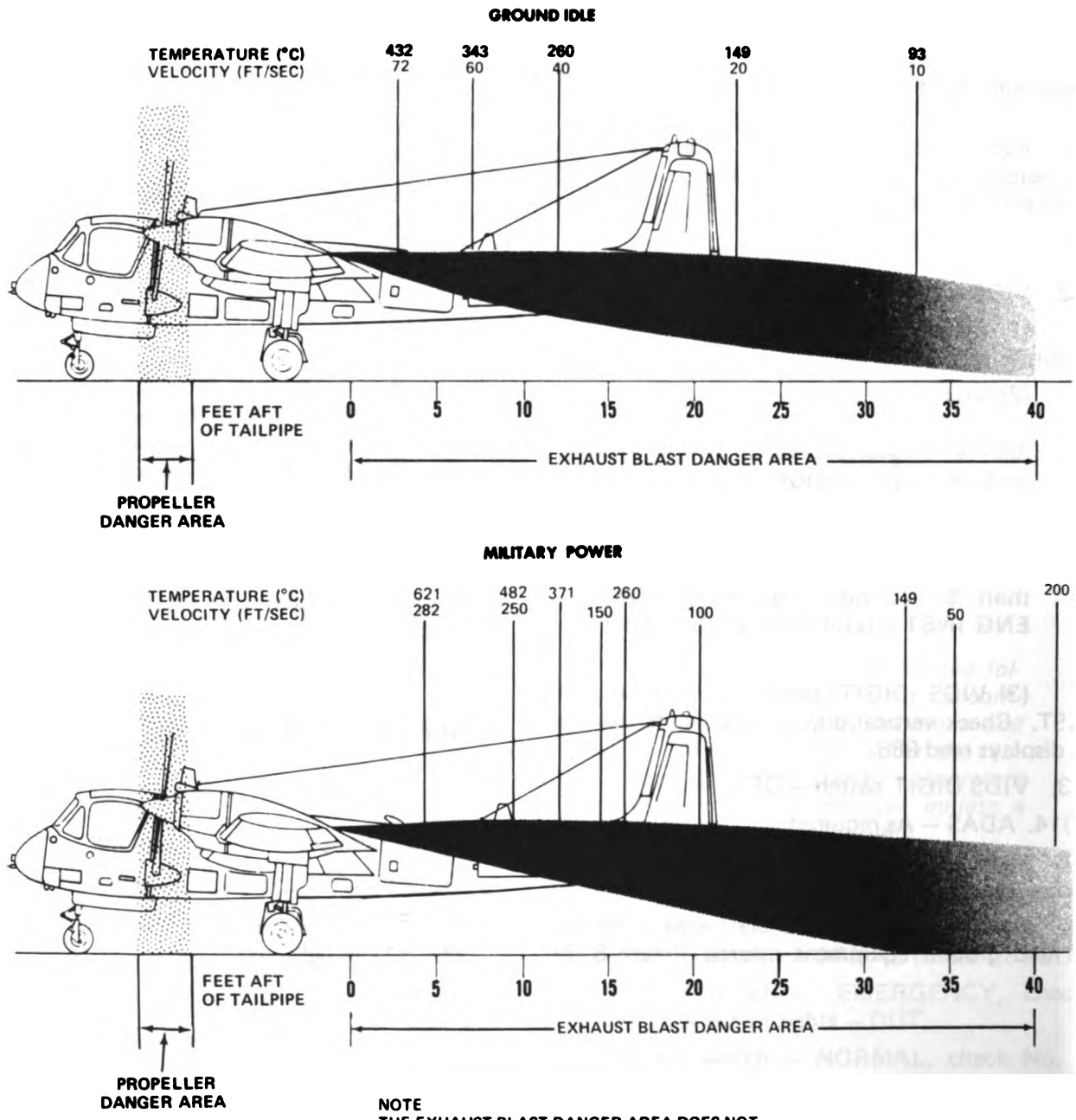

Figure 8-6. Exhaust Blast Danger Area

**EMERGENCY PROCEDURES – Paragraph 9-9.****CAUTION**

If there is no oil pressure within 10 seconds, abort start, clear engine, and advise maintenance personnel.

- 24. No. 2 prop lever – MAX RPM.
- 25. No. 2 power lever – FLIGHT IDLE (63 to 68% N1).
- 26. Fuel pumps switch – ON

**NOTE**

*VIDS DIGIT switch may be turned on to verify readings, but will be turned off prior to next engine start.*

- 27. GPU – Deactivate and disconnect.
- 28. Left aft equipment compartment access door – Secure.
- 29. No. 2 engine ammeter – Check. Pause until reading is 150 amperes or below.
- 30. No. 1 engine crank switch – CRANK position and release.

**NOTE**

*If the crank switch of the operating engine is inadvertently positioned to CRANK, an overvoltage condition may occur. This can be recognized by illumination of the applicable generator caution light. To correct this condition, set the crank switch of the operating engine to INTERRUPT CRANK and reset the generator of the operating engine.*

- 31. Gen pwr assist button – Press and release.

**NOTE**

*When starting the second engine, placing the engine crank switch to the CRANK position automatically disconnects the generator of the operating engine from the bus. Power for starting the second engine is provided by the aircraft battery. The generator of the operating engine is used to assist the second engine by pressing the gen pwr assist button after setting the engine crank switch to the CRANK position.*

- 32. No. 1 engine ignition button – Press and hold. Release when N1 reaches 40%.

- 33. Engine RPM and EGT – Check for smooth engine acceleration and EGT is within limits (48 to 52% N1).

**EMERGENCY PROCEDURES – Paragraph 9-7.**

- 34. Oil pressure – Check within limits.
- 35. Hydraulic pressure – Check within limits.
- 36. #1 fuel press light – Out.
- 37. #1 gen light – Out.
- 38. No. 1 prop lever – MAX RPM.
- 39. No. 1 power lever – FLIGHT IDLE (63 to 68% N1).
- 40. #3 inv light – Out.
- 41. TOR INV circuit breakers – In.
- 42. VIDS DIGIT switch – ON.

**EMERGENCY PROCEDURES – Paragraph 9-9.****NOTE**

*Operating engines at 72% N1 speed will provide adequate cockpit cooling.*



8-16. \* Starting Engines Without GPU.

**CAUTION**

Holding the VIDS DIGIT switch in the LT/TEST position for more than 5 seconds may cause the ENG INST circuit breaker to open.

**NOTE**

*One engine must be operating and providing power to the monitored bus for the CVS to supply DC power to the INS and ADAS (if installed), and for the No. 1 inverter to provide AC power to the INS gyro heaters. No. 1 engine shall be started first so ground personnel will not be subjected to exhaust blast and noise of the operating engine if inserting ADAS fixed data and time-of-day.*

**CAUTION**

In order to prevent excessive heat accumulation, the left and right aft equipment compartment access doors shall be open during extended ground operations.

**CAUTION**

If acceleration is uneven or intermittent, and EGT rises rapidly, abort start, clear engine, and advise maintenance personnel.

1. Aft equipment compartment access doors - As required.
2. Entrance hatches - As required.
3. Fireguard - Posted.
4. Battery switch - NORMAL. (Check 24 VDC.)
5. Fire detection system - Test.
6. Caution, warning, and advisory lights - Test. Test the caution and warning lights using the master caution test switch.
7. Autofeather armed light - Test by setting autofeather/synchrophaser switch to AUTO-FEATHER ON position. Turn switch OFF after test.
- ★ 8. VIDS - Check operation as follows:

- (1) Auto-dim control - Check by covering sensor.
- (2) VIDS AUX PWR lamp - Out.

(3) VIDS DIGIT switch - Press to LT/TEST. Check vertical displays illuminate and digital displays read 888.

9. VIDS DIGIT switch - OFF.

10. Propeller and exhaust blast area - Personnel and ground equipment cleared (figure 8-6).

11. No. 1 engine crank switch - CRANK position and release.

12. No. 1 engine ignition button - Press and hold. Release when N1 reaches 40%.

13. Engine RPM and EGT - Check for smooth engine acceleration and EGT is within limits (48 to 52% N1).

**EMERGENCY PROCEDURES - Paragraph 9-7.**

14. Oil pressure - Check within limits.
15. Hydraulic pressure - Check within limits.

**EMERGENCY PROCEDURES - Paragraph 9-9.**

16. #1 fuel press light - Out.
17. #1 gen light - Out.

**EMERGENCY PROCEDURES - Paragraph 9-9.**

**CAUTION**

If there is no oil pressure within 10 seconds, abort start, clear engine, and advise maintenance personnel.

- 18. Inverter switch — EMERGENCY, check #2 inv and inst pwr lights — Out.
- 19. Inverter switch — NORMAL, check #1 inv, #2 inv, and inst pwr lights — Out.
- 20. Fuel pumps — On.

**EMERGENCY PROCEDURES — Paragraph 9-9.**

- 21. No. 1 prop lever — MAX RPM.
- 22. No. 1 power lever — FLIGHT IDLE (63 to 68% N1).

**NOTE**

*VIDS DIGIT switch may be turned on to verify readings, but will be turned off prior to next engine start.*

- 23. G796 — ON. Check G796 ON indicator is illuminated.

**WARNING**

After starting No. 1 engine, insure the CVS and No. 2 inverter are on. At this time, either the right seat occupant or the groundcrew can turn on the ADAS and reset the time and frame count without the dangers present with No. 2 engine running. After turnon and checkout are completed, and personnel are clear, the No. 2 engine can be started.

**CAUTION**

The CVS will insure that unstable voltages will not damage the ADAS.

- 24. ADAS — As required.
- 25. Right aft equipment compartment access door — Secure.
- 26. No. 1 engine ammeter — Check. Pause until reading is 150 amperes or below.
- 27. No. 2 engine crank switch — CRANK position and release.

**NOTE**

*If the engine crank switch of the operating engine is inadvertently po-*

*sitioned to CRANK, an overvoltage condition will occur. This can be recognized by illumination of the applicable generator caution light. To correct this condition, set the crank switch of the operating engine to INTERRUPT CRANK and reset the generator of the operating engine.*

- 28. Gen pwr assist button — Press and release.

**NOTE**

*When starting the second engine, placing the engine crank switch to the CRANK position automatically disconnects the generator of the operating engine from the bus. Power for starting the second engine is provided by the aircraft battery. The generator of the operating engine is used to assist the second engine by pressing the gen pwr assist button after setting the engine crank switch to the CRANK position.*

- 29. No. 2 engine ignition button — Press and hold. Release when N1 reaches 40%.
- 30. Engine RPM and EGT — Check for smooth engine acceleration and EGT is within limits (48 to 52% N1).

**EMERGENCY PROCEDURES — Paragraph 9-7.**

- 31. #2 fuel press light — Out.
- 32. Hydraulic pressure — Check within limits.
- 33. Oil pressure — Check within limits.
- 34. #2 gen light — Out.
- 35. No. 2 prop lever — MAX RPM.
- 36. No. 2 power lever — FLIGHT IDLE (63 to 68% N1).
- 37. #3 inv light — Out.

**NOTE**

*A 15-second delay in the #3 inv light is normal.*

- 38. TOR INV circuit breakers — In.
- 39. VIDS DIGIT switch — On.

**EMERGENCY PROCEDURES — Paragraph 9-9.**

40. Air-conditioning — As required.

**NOTE**

*Operating engines at 72% N1 speed will provide adequate cockpit cooling.*

**8-17. Abort Start.**

1. Prop lever — FUEL OFF.
2. Ignition button — Release.
3. Engine crank switch — INTERRUPT CRANK after EGT returns to normal.

**8-18. Engine Clearing.**

1. Prop lever — FUEL OFF.
2. Engine crank switch — CRANK.
3. Engine crank switch — INTERRUPT CRANK after 20 seconds.

**8-19. \* Before Taxiing.**

**NOTE**

*The engine may be operated satisfactorily for extended periods at GROUND IDLE. Refer to Chapter 5 for engine operating limitations to be observed during ground operations.*

1. Radios and radar altimeter — ON.
2. Marker beacon light — Press to test.

**NOTE**

*Marker beacon VOL-OFF control must be out of the OFF position to enable operation or test of the marker beacon light.*

- (O)3. Surveillance equipment — Standby.
4. INS stby — As required.
5. Controls — Check the following with ground personnel:
  - (1) Speed brake switch — OUT.
  - (2) Speed brake light — Illuminated.
  - (3) Speed brake switch — IN.
  - (4) Speed brake light — Out.
  - (5) Flaps — 45° DN.
  - (6) Ailerons — Check operation of inboard and outboard ailerons.
  - (7) Flaps — 15:
  - (8) Flaps — UP.

- (9) Elevators — Check travel.
- (10) Rudders — Check travel.

6. Chocks — Check removed.
7. Backup COMP and AN/ASN-76 malf lights — Out.
8. Compass system — Set, verify. Set COMP-SLAVED-DG switch to SLAVED and press HDG-PUSH knob to synchronize heading. Observe null on SYNC IND meter. Verify slaved heading with magnetic compass reading.

★9. INS alignment — As required. Proceed as follows:

- (1) #3 inv light — Out.

**NOTE**

*A 15-second delay in the #3 INV light can be expected after the inverter switch is set to NORMAL.*

- (2) Gust lock — Engage.
- (3) NAV MODE switch — INS.
- (4) INS mode switch — STBY.
- (5) Dim button — Press. Check INS lights and digital readout for 8's.
- (6) Select switch — POS. Insert present position coordinates.
- (7) Select switch — MV/CS. Insert local magnetic variation.
- (8) Select switch — MON. DEST 4. When last two digits in right display are 0.0, set MODE switch to ALIGN.
- (9) Select switch — DEST. Insert destinations.
- (10) Select switch — ALT/STA. Insert TACAN channel numbers and altitude.
- (11) Select switch — DEST L/L. Insert positions for the above TACAN stations.
- (12) Select switch — MV/CS. Insert magnetic variations for the above TACAN stations.
- (13) Gust lock — As required.

★10. Radios — Check operation as follows:

ADF Check:

Check antenna, compass, and loop positions, tuning meter, BDHI indication, and operation of loop switch.

Flight Director System Check (VOR and ILS):

- (1) HDG/ILS knob - HDG.
- (2) Heading marker left and right from nose - Check for proper deflection.
- (3) Nav receiver - Tune to localizer frequency.
- (4) GS and LOC flags (if within range of station) - Masked.
- (5) Glide slope pointer - Deflected.
- (6) To-from arrow - Masked.
- (7) Course selector on localizer heading - Set.
- (8) Course bar - Indicating properly.
- (9) HDG/ILS knob - ILS.
- (10) Steering pointer and horizon bar - Checked.
- (11) HDG/ILS knob - HDG.
- (12) Nav receiver - Tune to VOR Frequency.
- (13) Loc flag (if within range of station) - Masked.
- (14) To-from arrow (if within range of station) - Indicating properly.

- (15) Course selector on test radial - Set.
- (16) Course bar - Indicating properly.
- (17) BDHI - Indicating properly.

11. Attitude indicator - Set.

★12. Autopilot - Check operation of autopilot as follows:

- (1) Aircraft controls - Neutral position.
- (2) Autopilot turn knob - Centered in detent.
- (3) Servo effort indicators - Check that they are aligned.
- (4) Autopilot engage switch - ON. Check for no movement of controls.
- (5) Turn knob - Move fore and aft, left and right. Check aircraft controls follow movement.
- (6) Steering pointer - Center.
- (7) Lateral selector switch - HDG.
- (8) Lateral engage switch - ON.
- (9) Heading marker left and right - Check aircraft controls follow movement.



- (10) Vertical selector switch - BAR.
- (11) Vertical engage switch - ON. Check that elevators remain neutral.
- (12) Autopilot release button - Press to disengage autopilot.
- (1)13. Weather control systems - Check as follows:

(1) Pitot heat - Check. Turn on momentarily and note increase in ammeter reading.

**CAUTION**

**Prolonged ground operation of engine deicer can cause damage to system.**

(2) Engine deicing switch - ON, note slight rise in EGT. Turn switch off after test.

**NOTE**

*The anti-ice on light on the caution annunciator panel will illuminate with the engine de-icing switch in the ON position and the aircraft on the ground. Light will go off when switch is turned OFF.*

(3) Windshield de-icing switch - ON. Check fluid flow on windshield. Turn switch OFF after test.

(4) Wing and tail de-icing switch - HEAVY. Check boot inflation and deflation. Turn switch OFF after test.

- 14. Taxi clearance - Check.
- 15. Clock - Set.
- 16. Altimeter - Set.
- 17. Power Steering - ON.

**CAUTION**

**Do not press unfeather buttons longer than 30 seconds. Unfeathering normally takes approximately 4 seconds. Allow**

**15-minute cooling period before using again if normal 4-second time period is exceeded.**

18. Propellers - UNFEATHER. Release at 500 RPM.

**8-20. \* Taxiing.**

**NOTE**

*The aircraft has considerable residual thrust at GROUND IDLE. To maintain slow taxi speeds and avoid excessive brake usage, residual thrust can be reduced by feathering one propeller. It may be desirable to feather both propellers when taxiing downwind with a strong wind velocity. When taxiing in a crosswind, add power to the upwind side for better control.*

- 1. Brakes - Check while taxiing.
- 2. Flight Instruments - Check the following:
  - (1) BDHI - Slaving and synchronization.
  - (2) Steering pointer - Proper deflection.
  - (3) Turn and slip indicator - Proper operation.
  - (4) Attitude indicators - check for precession in turns.
  - (5) Compass systems - check against known heading.

**CAUTION**

**During backup or turnaround operation, care should be taken to keep the propellers in reverse as long as necessary, but not continually in and out of reverse. Continual reversing of the propellers during taxiing tends to overheat the auxiliary motor, which has a limited cycle of usage.**

3. Reverse thrust - Check while taxiing.

**8-21. \* Engine Runup.**

**NOTE**

*Face aircraft into wind for runup.*

- \* 1. Nosewheel — Centered.
- \* 2. Parking brake — Set.
- 3. Power levers — FLIGHT IDLE.
- 4. Generators — Check voltage output of 27.0 to 28.0 volts and amperage output approximately equal.

**EMERGENCY PROCEDURES — Paragraph 9-9.**

- \*★5. Fuel pumps — Check operation as follows:
  - (1) Pump test switch — OFF.
  - (2) Fuel pumps switch off — Check fuel pumps caution light illuminated.
  - (3) Fuel pumps switch — ON.

**NOTE**

*If the fuel pumps caution light illuminates when the switch is placed in the FWD position, the aft fuel boost pump is inoperative. If the fuel pumps caution light illuminates when the switch is placed in the AFT position, the forward fuel boost pump is inoperative.*

- (4) Pump test switch — FWD position. Check fuel pumps caution light out.
- (5) Pump test switch — AFT position. Check fuel pumps caution light out.
- 6. Fuel gage — Check. Press fuel quantity test button and check that indicator moves.
- ★ 7. Fuel quantity — Check as follows:
  - (1) Fuel quantity switch main — Check quantity.
  - (2) Fuel quantity switch left — Check quantity.
  - (3) Fuel quantity switch right — Check quantity.
  - (4) Totalizer — Check with computed fuel.

- \*8. Transfer pumps — Check. Set drop tank transfer switch to BOTH position and check that drop tank caution lights remain out.

**NOTE**

*If the tank trans circuit breaker is out, fuel will not transfer and the drop tank caution lights will not illuminate.*



Parking brake may not hold at power above flight idle.

- ★ 9. Propeller governors — Check as follows:
  - (1) Prop levers — MAX RPM.
  - (2) Power levers — 1,400 RPM.
  - (3) Prop levers — MIN RPM. Check for 1,150–1,200 RPM.
  - (4) Prop levers — MAX RPM. Check for 1,400 RPM.
  - (5) Power levers — FLIGHT IDLE.
- 10. Air-conditioning master switch — OFF.
- ★11. Autofeather system — Check as follows:

**NOTE**

*Under certain circumstances (i.e., cold weather, and/or various engine trim settings), the GROUND IDLE power setting may produce torque in excess of the autofeather torque activation range (10–16% torque). If this occurs, steps (7), (8), and (10) below may be performed with both the NO. 1 and NO. 2 TOR INV circuit breakers pulled to assure proper operation of the autofeather system test. Press the circuit breakers at the completion of the test, if pulled. This modified procedure is solely to permit testing and in no way affects the inflight function of the autofeather system, since an inflight engine failure will drive the torque indicator to zero, thus activating the autofeather system.*

- (1) Power levers — 19% torque.
- (2) Autofeather/synchrophaser switch — AUTOFEATHER ON. Check autofeather armed light illuminated; #1 and #2 ENG P3 TEST lights out.

(3) Autofeather test button — Press. Check #1 and #2 ENG P3 TEST lights illuminated and neither propeller feathers.

**NOTE**

*The ENG P3 TEST lights may not illuminate and go out simultaneously. If either propeller feathers, it indicates a malfunction in the autofeather system and the aircraft should not be flown.*

(4) Power levers — Advance while pressing the autofeather test button until both ENG P3 TEST lights go out.

**NOTE**

*The ENG P3 TEST lights must go out before reaching takeoff power. Actual engine torque and N1 speed when the lights go out will vary between engines and with ambient temperature/pressure; however, the lights should normally go out before reaching 50% torque.*

(5) Autofeather test button — Release.

(6) Power levers — GROUND IDLE. Check #1 and #2 ENG P3 TEST lights out.

**NOTE**

*The above steps complete the test of the engine P3 switches. During the remaining steps, the #1 and #2 ENG P3 TEST lights may be ignored.*

(7) Advance No. 1 power lever rapidly to TAKEOFF and return to GROUND IDLE — Check that No. 1 propeller feathers.

(8) Advance No. 2 power lever rapidly to TAKEOFF and return to GROUND IDLE — Check that No. 2 propeller does not feather.

**NOTE**

*If the No. 2 propeller feathers, this constitutes an unsafe condition due to a failure in the autofeather system and the aircraft should not be flown.*

(9) Autofeather/synchrophaser switch — Recycle. Check autofeather armed light illuminated.

(10) Advance No. 2 power lever rapidly to TAKEOFF and return to GROUND IDLE — Check that No. 2 propeller feathers.

(11) Autofeather/synchrophaser switch — OFF.

(12) Power levers — FLIGHT IDLE.

★12. Air-conditioning — Check as follows:

(1) Air-conditioning master switch — OVRD. Check air-conditioning system comes on.

(2) Air-conditioning master switch — ON. Check air-conditioning system shuts off.

(3) Propellers — UNFEATHER. Check air-conditioning system comes on.

**CAUTION**

The air-conditioning system cooling mode shall be turned off above 95% compressor N1 speed to avoid excessive engine temperatures.

(4) Air-conditioning master switch — As required.

**8-22. \* Before Takeoff.**

1. Speed brake switch — IN.
2. Flap handle — As required.
3. Trim — Set as required. Approximately 0° elevators, 5° R WING DN, and 5° right rudder.
4. Autofeather ON — Check light.
5. Prop levers — MAX RPM.
6. Fuel quantity — Check.

**NOTE**

*On OV-1D aircraft with IRCM pod AN/ALQ-147A(V)1 installed on wing station 1, set aileron trim to approximately 10° R WING DN. With IRCM pod AN/ALQ-147A(V)1 installed on wing station 6, set aileron trim to approximately 3° L WING DN.*

7. Navigation equipment — Set.



8. Engine and flight instruments—Check.
9. Flight controls—Check for freedom of movement.
10. Entrance hatches—LOCKED.
11. Ejection seats—ARMED.
12. Stores selector switches—As required.
13. Ejection briefing—complete.

8-23. \*Lineup.

1. Transponder—As required.
2. Air-conditioning—OFF.
- (I) 3. Weather control switches—As required.
4. Gyro heading—Check.
5. Power—Stabilize as required (23% torque if runway conditions permit).
6. Engine instruments—Check within limits.

8-24. Takeoff.

Plan the takeoff, flaps up or flaps 15 degrees, according to the following variables affecting takeoff technique: field evaluation, gross weight, wind, free-air temperature, type of runway, and height and distance of nearest obstacles. With flaps-up, the ground-roll distance, lift-off speed and accelerate-stop distance are increased, and accordingly, takeoff conditions may dictate takeoff with flaps at 15 degrees. To aid in planning and to gain maximum performance, make full use of the information affecting takeoff contained in Chapter 7, Performance Data. Adhering to the following procedures will obtain the results set forth in Chapter 7.

**WARNING**

Adequate power to continue the takeoff climb following an engine failure will not be available under certain conditions of high gross weight, high altitude, and high temperature. Except when the nature of the mission justifies the additional risk, takeoff gross weight shall be limited to that which will provide a single engine, gear and flaps up rate of climb of 200 feet per minute following jettison of external stores.

a. Normal Takeoff.

1. Power levers—Stabilize at 46% torque.

**NOTE**

*Where maximum performance is not critical and/or other conditions indicate brakes may be released below 46 percent torque.*

**CAUTION**

With a right crosswind near the limit (15 knots), the download strut may become fully compressed as power is applied to 46 percent torque while the brakes are being held.

2. Brakes—Release.
3. Power levers—Advance to takeoff power.

**CAUTION**

For takeoff on cold days, it may be necessary to place the power levers aft of the TAKEOFF position to avoid exceeding maximum allowable torque. Failure of either engine will not result in automatic feathering of that propeller since the power lever must be in the TAKEOFF position to complete the autofeather circuit. Refer to Section V for cold weather takeoffs.

4. Engine instruments—Check that torque and propeller indications are within limits. Refer to table 5-1 and figure 7-7.

**EMERGENCY PROCEDURES — Paragraph 9-5.**

5. Maintain directional control through the use of nosewheel steering and rudders.

**NOTE**

*The aircraft may be steered during the initial portion of the takeoff run, regardless of the engine matching, without difficulty.*

6. At Vr airspeed specified in figure 7-9 (flaps 15°) or figure 7-9A (flaps up), apply back pressure to the stick to ease the aircraft off the runway at Vlof.

**EMERGENCY PROCEDURES — Paragraph 9-5.**

**CAUTION**

**With high gross weight, high altitude, and high temperature takeoff conditions, the aircraft rate of climb may decrease when the flaps are retracted. Caution must be exercised to ensure sufficient altitude and airspeed are available to compensate for the change in flight characteristics when the flaps are retracted.**

7. Obtain maximum rate-of-climb airspeed specified in Chapter 7 as soon as possible.



**EMERGENCY PROCEDURES - Paragraph 9-5.**

**b. Minimum Run Takeoff.** Set flaps at 15 degrees, apply brakes, and advance power toward maximum allowable. As the torque indication passes through approximately 46%, release brakes. Allow the aircraft to accelerate, maintaining directional control with rudders and power steering. Apply back pressure and rotate the aircraft to an altitude that will result in a liftoff at minimum airspeed. After airborne, lower the nose and accelerate to a speed above  $V_{mc}$  as soon as practical.

**NOTE**

*The minimum run takeoff is a contingency procedure and should not be used except for contingency operation or flight training for contingency operation.*

**c. Obstacle Clearance Takeoff.** If runway length and the height and distance of the obstacle permit, follow the normal takeoff procedures (flaps 15 degrees) to the point of liftoff. After liftoff, maintain takeoff airspeed to clear the obstacle. When clear, lower the nose and accelerate to normal climb airspeed.

**NOTE**

*The obstacle clearance takeoff is a contingency procedure and should not be used except for contingency operation or flight training for contingency operation.*

**d. Crosswind Takeoff.** Crosswind takeoffs are not critical due to the inherent stability of the tricycle landing gear. Nosewheel steering or differential use of the power levers may be used to facilitate directional control. In strong crosswinds, it is recommended that a higher than computed rotation speed be used to provide

more positive aircraft control after lift-off. Counteract drift when the aircraft becomes airborne by crabbing into the wind. (Refer to Chapter 7 for crosswind takeoff data.)

**e. High Gross Weight Takeoff at High Altitudes.**

**WARNING**

Adequate power to continue takeoff climb following an engine failure will not be available under certain conditions of high gross weight, high altitude, and high temperature. Except when the nature of the mission justifies the additional risk, takeoff gross weight shall be limited to that which will provide a single engine, gear and flaps up, rate of climb of 200 feet per minute following jettison of external stores.

When takeoffs in this configuration are made, using normal takeoff attitude, the aircraft may begin decelerating after lift-off. To prevent this, use a lower than normal pitch attitude at lift-off, allow airspeed to increase, and retract the landing gear to increase acceleration. Refer to Chapter 5 for takeoff gross weight limits.

**f. Night Takeoff.** Use normal takeoff procedures. Familiarity with the location of all controls and switches in the cockpit is essential. The landing and/or taxi lights should be used for takeoff as required.

**8-25. After Takeoff.**

1. Landing gear - UP.
2. Flaps - UP above flaps up  $V_{mc}$ .
3. Climb power - Set as required.

4. Wheel and flap indicator — Check for gear up indication. Check hydraulic pressure.
5. Autofeather — OFF.

**CAUTION**

Failure to turn taxi light off after gear retraction may damage components in the nosewheel well and is a potential fire hazard.

6. Taxi light — OFF.
7. Landing light — As required.
8. Stores selector switches — As required.

**CAUTION**

During flight, if airspeed is below 120 knots, the system should be turned off at the OCU and only turned on again when airspeed exceeds 120 knots.

(O)9. IRCM-OCU — As required.

10. Wings and nacelles — Check for fuel and oil leaks.

**8-26. Climb.**

Accelerate to normal climb speed. To obtain the best climb performance, the correct airspeed must be flown. Refer to Chapter 7 for climb performance data.

**8-27. Cruise.**

Refer to Chapter 7 for cruise charts indicating recommended airspeed, engine torque, and propeller RPM settings. Refer to Chapter 5 for engine limitations not to be exceeded during cruise.

1. Power — Set.
2. Fuel check — Initiate.

3. Wings and nacelles — Check for fuel and oil leaks.

**8-28. Descent.**

There are no required checks before initiating a normal descent. The following paragraphs describe the procedures to be followed for maximum descent in a clean or landing configuration.

**NOTE**

*Rapid descents may cause severe windshield fogging. Therefore, when a rapid descent is anticipated, set the defog top/side switch to the MAX position and close the upper, lower, and foot air outlets before descending.*

**a. Maximum Descent — Clean configuration.**

1. Heat and defog — As required.
2. Prop levers — MAX RPM.
3. Power levers — FLIGHT IDLE.
4. Airspeed — Vmo.

**EMERGENCY PROCEDURES — Paragraph 9-11.**

**b. Maximum Descent — Landing Configuration.**

1. Heat and defog — As required.
2. Prop levers — MAX RPM.
3. Power levers — FLIGHT IDLE.
4. Landing gear — DOWN (below 153 KIAS).
5. Flaps — 45°.
6. Airspeed — 153 KIAS maximum.

**EMERGENCY PROCEDURES — Paragraph 9-11.**

**8-29. Descent—Arrival Check.**

Perform the following checks before entering the traffic pattern:

1. Stores selector switches — As required.

(O)2. Surveillance equipment — As required.

**8-30. Before Landing.**

1. Landing gear - DOWN (below 153 KIAS).
2. Flaps - 15°.
3. Autofeather/synchrophaser - OFF.
4. Props - Set 1,600 RPM.
5. Gear down indications - Check gear handle light - out, hydraulic pressure - up, visual check of main gear.

**EMERGENCY PROCEDURES - Paragraph 9-11.**

6. Landing and taxi lights - As required.

**CAUTION**

Failure to turn switch off may cause damage to IRCM system.

(O)7. IRCM-OCU - OFF.

(O)8. Flare/chaff dispenser - SAFE.

**8-31. Landing Check.**

1. Landing gear - Rechecked DOWN.
2. Prop levers - MAX RPM.
3. Air-conditioning master switch - OFF.

**NOTE**

*Before disengagement of autopilot, check servo effort indicators on flight controller to insure they are centered. If autopilot is disengaged when out of trim condition exists, unusual attitude can occur upon disengagement. This can be avoided if the pilot trims the aircraft until servo effort indicators are centered. Should available trim control be insufficient to do this, pilot must be ready to apply immediate corrective control upon autopilot disengagement.*

4. Autopilot - Disengage.

**8-32. Landing.**

Refer to Chapter 7 for landing distances for various aircraft gross weights and configurations. Observe the comments and instructions in the following paragraphs for various types of landings.

**NOTE**

*At high gross weights, high rates of descent may not be stopped with elevators alone without a large increase in power.*

*a. Normal Landing.* For normal landings, maintain a nose-high attitude, and touch down on the main gear. Hold the nose gear off the runway, easing it down as speed decreases. Power steering will become energized when the nosewheel strut is compressed with the power steering switch in the ON position. If any rudder pedal deflection is present due to crosswind conditions or asymmetric power, the aircraft will swerve slightly. The swerve is minor in nature and can be corrected before the aircraft moves laterally to any appreciable degree. If runway length permits, normal braking can be applied; otherwise, the propellers should be reversed to stop the aircraft. During reverse thrust landing, reverse airflow will tend to cause rapid fluttering of the control surfaces. Maintain positive stick and rudder control pressure during reverse thrust landings to prevent excessive fluttering of controls.

*b. Heavy Weight Landing.* Perform normal landing procedure and establish approach speed corresponding to the gross weight of the aircraft.

*c. Crosswind Landing.* In strong crosswinds, the crab method should be used during approach to correct for drift. Touchdown should be made with one wing low (slip) to correct for drift followed with normal landing techniques. Refer to Chapter 7 for crosswind landing performance data.

*d. Wet Surface Landing.* Perform normal landing procedure, using aerodynamic braking as much as possible. On short fields, use reverse thrust rather than wheel brakes to slow aircraft down.

**CAUTION**

Do not extend landing light above 180 KIAS.

*e. (N) Night Landing.* Use normal landing procedure.

*f. Minimum Run Landing.* For a minimum run landing, full flaps and speed brakes are recommended. Upon touchdown, place the

power levers in FULL REVERSE. Reduce reverse power as the aircraft slows down and then apply brakes. Refer to Chapter 7 for landing distances.

*g. Obstacle Clearance Landing.* Use normal landing procedure and establish a near level flight attitude with a rate of descent required to clear the obstacle. Refer to Chapter 7 for landing air distances required to clear obstacles.

**8-33. Go-Around.**

The decision to go-around should be made as early as possible, to provide a safe margin of airspeed and altitude. Accuracy, judgement, and early recognition of the need to go-around are important. In a go-around situation, proceed as follows:

**WARNING**

Due to engine acceleration characteristics, a sudden power lever advance to the TAKEOFF position, before torque can increase beyond the setting (10-16%) of the autofeather torque switch, causes the autofeather circuit to feather one propeller with the autofeather system armed.

1. Power levers – As required.
2. Speed brake – IN.
3. AUTOFEATHER – Armed.
4. Landing gear – UP.
5. Flaps – 15° until flaps up Vmc, then UP.
6. Climb power – Set.
7. Wheel and flap indicator – Check.
8. AUTOFEATHER – Off.

**CAUTION**

Failure to turn taxi light off after gear retraction may damage components in the nosewheel well and is a potential fire hazard.

9. Taxi light – Off.
10. Landing light – As required.

**8-33A. Touch/Stop and Go.**

If a touch-and-go landing is necessary, perform the following:

**WARNING**

Rapid advancement of the power levers may cause inadvertent propeller feathering with the autofeather system armed.

1. Power – Stabilize (23% torque).
2. Speed brake – IN.
3. Flap handle – As required.
4. Trim – Set as required.
5. AUTOFEATHER ON – Check light.
6. Prop levers – MAX RPM.

**8-34. After Landing.**

After turning off the active runway, proceed as follows:

**CAUTION**

Prolonged ground operation of the engine deice system may cause damage to system.

1. Weather control panel switches – OFF.
2. Landing and taxi lights – As required.
3. Speed brake – IN.
4. Flap handle – UP.
5. Transponder – OFF/STBY.
6. Ejection seats – SAFE. Face blind handle locked (red tab up) and lower firing handle locked (guard up).
7. Stores selector switches – OFF and SAFE.
8. Flare/chaff dispenser – SAFE switch on control panel to SAFE position.

**8-35. Engine Shutdown.**

**CAUTION**

Run engines at ground idle until temperatures stabilize.

1. Power levers – GROUND IDLE.
2. Parking brake – As required.
3. Landing light – OFF/RETRACT.
4. INS heading memory – As required.
5. INS – OFF.

6. G796 – OFF.

7. Radios – OFF.

★8. Fuel pumps (post flight) – Check as follows:

(1) Pump test switch – FWD position.

Check fuel pumps caution light out.

(2) Pump test switch – AFT position.

Check fuel pumps caution light out.

#### NOTE

*If the fuel pumps caution light illuminates when the switch is placed in the FWD position, the aft fuel boost pump is inoperative. If the fuel pumps caution light illuminates when the switch is placed in the AFT position, the forward fuel boost pump is inoperative.*

(3) Pump test switch – OFF.

9. Fuel pumps switch – OFF. Check fuel pumps caution light illuminated.

10. Air-conditioning – OFF.

11. Inverter switch – OFF.

12. Prop levers (individually) – FUEL OFF.

13. Prop levers (individually) – FEATHER when engine tachometer indicates 10% RPM.

14. Prop levers (feathered props) – FUEL OFF after feather cycle is complete.

#### NOTE

*To conserve battery, shut down one engine at a time.*

*Following shutdown, coastdown should be accomplished with no rubbing or abnormal noises. Observe EGT; should EGT rise, motor engine to allow temperature to stabilize within limits.*





- 15. Engine master switches - OFF.
- 16. Lighting systems - OFF.
- 17. Ejection seats - Recheck SAFE.
- 18. Wheels - Chocked.
- 19. Brakes (no heading memory) - As required.

**NOTE**

*If heading memory is being used for INS, brakes should not be released.*

*Errors accumulated in system during flight will be reflected in new alignment if heading memory (HDG MEM) is used.*

- 20. Oxygen regulators - OFF.

**NOTE**

*When not in use, the diluter control lever should be left in the 100% OXYGEN position to prevent regulator contamination.*

- 21. Gust lock - Engage.
- 22. All switches (except generators) - OFF.
- 23. Ignition lock switch - OFF.
- 24. Battery switch - OFF.

**8-36. Before Leaving the Aircraft.****CAUTION**

Ground lock safety pins for wing stations shall be inserted from the outboard side, by hand pressure only. Insert pin with flat side horizontal facing up, and then rotate pin so flat side is vertical facing aft.

1. Ground lock safety pins - Insert (figure 2-53).
2. Walkaround inspection - Complete.
3. Form 2408-12 - Complete.
4. Form 2408-13 - Complete all entries and record four window readings of counting accelerometer in Block 17. Define specific maneuvers for all counts of 2.5 G and above within Block 17.

**NOTE**

*See paragraph 4-12e for definition of readings. Subtract pre-flight window readings from post-flight readings to ascertain number of exceedances at defined G levels.*

5. Aircraft - Secure.

## SECTION III. INSTRUMENT FLIGHT

### 8-37. General.

This aircraft is qualified for operation in instrument meteorological conditions. The aircraft has the same stability and flight handling characteristics during instrument flight conditions as when flown under visual flight conditions. The aircraft is equipped with adequate navigation and communication equipment to cover practically all conditions of instrument flight. In pre-flight planning, allowance should be made for any delay and also for additional fuel required for departure, descent, and approach.

#### NOTE

*In the event of an INS malfunction, the INS may become inoperative, and the pilot may experience a loss of aircraft heading and attitude reference, autopilot, and operation of the BDHI compass card. Heading and attitude reference, and operation of the BDHI compass card may then be obtained by switching the NAV MODE switch to the BACK-UP COMP position. With the switch in the BACK-UP COMP position, autopilot in the NAV mode of automatic lateral control is inoperative. Use of the autopilot may again be obtained by selecting some position other than NAV on the autopilot automatic navigation coupler for automatic lateral control.*

### 8-38. Instrument Flight Procedures.

Refer to FM 1-240, FM 1-230, POD, FLIP, AR 95-1, FAR, Part 91, and host nation regulations and procedures described in this manual.

*a. Instrument Takeoff.* The normal takeoff procedures apply with special emphasis on the following:

1. Maintain directional control by the use of rudders which, due to nosewheel steering, are effective at all speeds.

2. Apply back pressure to the stick so as to lift off the runway at the recommended takeoff speed for the gross weight involved. Maintain takeoff attitude by reference to the horizon indicator.

3. When the vertical velocity indicator and altimeter indicate a positive rate of climb, retract the landing gear.

*b. Instrument Climb.* Use normal climbing speeds and attitudes. Refer to Chapter 7 for information regarding fuel consumption and rate of climb. When safe altitude and airspeed are attained, reduce to climb power and complete after takeoff checks.

*c. Instrument Cruise.* There are no unusual flight characteristics during cruise operation under instrument meteorological conditions. No unusual discomfort should be experienced. Refer to Chapter 7 for cruise performance charts.

### 8-39. Speed Range.

This aircraft handles well at all altitudes and airspeeds from the maximum allowable airspeed down to approximately 10 knots above stall speed. When using autopilot, a steep-bank, low-speed turn at heavy gross weights will decelerate the aircraft, cause loss of lateral trim, and bottom the roll actuator. Therefore, power must be increased in order to prevent excessive bank angles (normal, approximately 40°).

### 8-40. Communication and Navigation Equipment.

The ADF set is very susceptible to static. Reception can usually be improved by switching to LOOP position and rotating the azimuth pointer 90° to the station or area of maximum reception.

### 8-41. Descent.

The same techniques outlined for descents under visual flight conditions apply to flight under instrument conditions.

**8-42. Holding.**

For holding patterns under instrument flight condition, keep the gear and flaps up and maintain power as required to maintain approximately **140 KIAS**.

**8-43. Instrument Approaches.**

The aircraft is equipped for any type of instrument approach now in common use.

**NOTE**

*During an ILS approach, propeller speeds of 1450 to 1500 RPM may cause the glide slope pointer to oscillate.*

**8-44. Automatic Approaches.**

In reducing speed from cruise to approach, retrim the lateral and directional controls since this is not an automatic function of the auto-

pilot. For automatic approaches, extend the approach pattern outbound to allow sufficient time to establish the normal ILS final approach configuration, power setting, and airspeed prior to interception of the glide slope. The autopilot requires the use of inboard ailerons under low-speed flight in order to operate satisfactorily; therefore, the flaps must be extended. Before reaching the outer marker, intercept the glide slope and establish the proper approach attitude to keep the aircraft on course and on the glide slope.

**NOTE**

*If autopilot approach mode is engaged at too great a deviation from the glide path, the autopilot will give a hard-over signal that could be dangerous at low altitudes.*

*To prevent excessive searching during ILS operation, the autopilot should not be engaged until the correct heading and descent have been established.*



## SECTION IV. FLIGHT CHARACTERISTICS

### 8-45. Normal Flight Characteristics.

At all allowable gross weights, the aircraft is stable at all speeds within the flight envelope. In two-engine flying, there is a noticeable torque effect in the lateral sense and the aircraft is easily controlled in single-engine flight above  $V_{mc}$ .

*abrupt wing drop, without warning, may be experienced at stall.*

#### CAUTION

**When practicing stall maneuvers, the air-conditioning system must be off to prevent exceeding engine turbine inlet temperature limits during recovery.**

### 8-46. Stalls.

a. The handling characteristics of this aircraft at low speeds are acceptable with adequate control response at all recommended minimum speeds of the aircraft. The aircraft with two 150 gallon drop tanks exhibits a mild nose down pitch at stall accompanied occasionally by controllable wing drop. It maintains stall attitude and will fly out of the stalled condition when back pressure is released. Although wing heaviness may be encountered in cruise configuration stalls, no abrupt wing drop tendencies are exhibited. At the stall, in the power approach configuration, a slight increase in roll-off will be noticed. During all stalls, there is essentially no buffet warning prior to stall. Installation of IRCM pod AN/ALQ-147A(V)1 results in a slight reduction in lateral control at high angles of attack near the stall.

c. Single-engine minimum control speed ( $V_{mc}$ ) and stall speed may occur simultaneously. At  $V_{mc}$ , the lateral and/or directional control limits have been reached (abnormally high control forces may be encountered) and a heading deviation is noticeable. Slight relaxation of elevator control force and reduction in power of the operating engine will prevent unusual attitude change and the aircraft is easily controlled. If the above recovery procedure is not initiated at the instant heading is lost, the aircraft will roll toward the inoperative engine.

b. When the aircraft is configured without any external stores, an abrupt wing drop, without warning, may be experienced at stall. Attention should be given to maintaining speed control when at or below 1.2 of the published stall speeds. The severity of the wing-down roll-off, which frequently occurs without warning, is a function of airspeed, power, and flap setting, and stall penetration (delay in initiation of stall recovery actions). The bank angle change can be minimized by reducing angle of attack with forward stick and then opposing the roll with lateral stick. Lateral stick without reducing angle of attack is ineffective. See figure 8-7 for stall speeds.

#### WARNING

**If the aircraft reaches a 90° bank, an altitude loss of approximately 500 feet can be expected while the wings are being leveled. If the aircraft rolls through a 90° bank angle toward 180° (inverted) before power on the operating engine is reduced, the aircraft must be recovered either by executing a split-S maneuver or a rolling pull-out, with a resulting altitude loss of approximately 4,000 feet.**

#### NOTE

*When the aircraft is configured without any external stores, an*

# STALL SPEED FLIGHT IDLE POWER ALL STORES

STALL SPEED  
OV-1D/RV-1D  
T53-L-701

## EXAMPLE

**WANTED**  
STALL SPEED

**KNOWN**  
GROSS WEIGHT = 17200 LB  
FLAP SETTING = 15°  
BANK ANGLE = 45°

**METHOD**  
ENTER GROSS WEIGHT HERE  
MOVE RIGHT TO FLAP SETTING  
MOVE DOWN TO BANK ANGLE  
MOVE LEFT, READ STALL SPEED = 109.5 KIAS

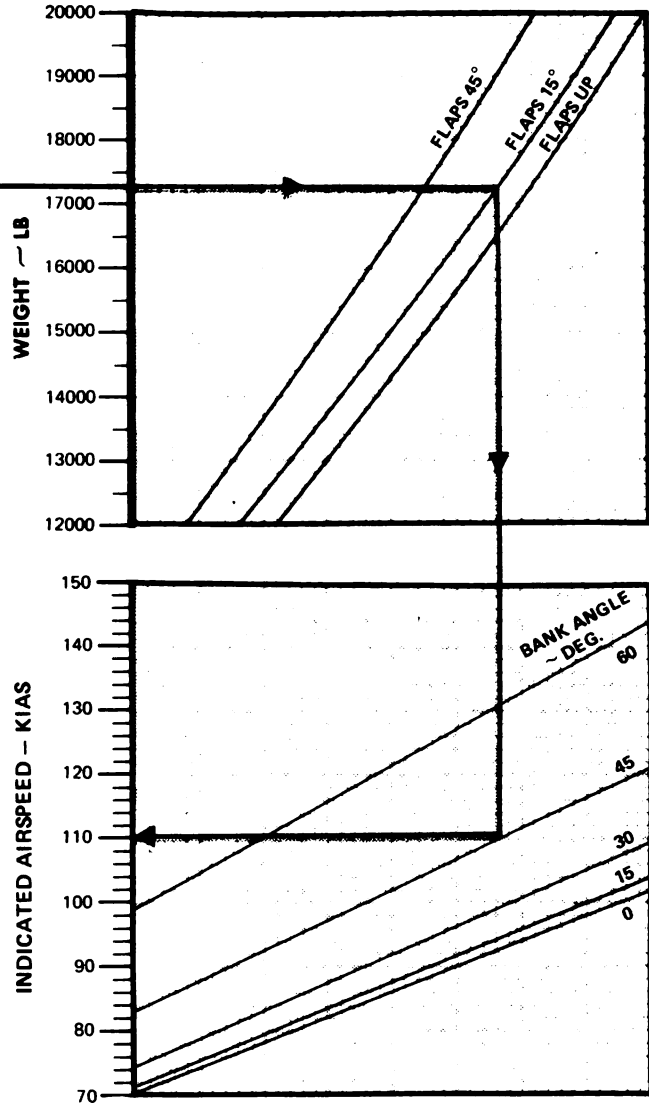

DATA BASIS: DERIVED FROM FLIGHT TEST

A-8-10-D-7-1

Figure 8-7. Stall Speed (Sheet 1 of 2)

**STALL SPEED  
POWER ON  
ALL STORES**

STALL SPEED  
OV-1D/RV-1D  
T53-L-701

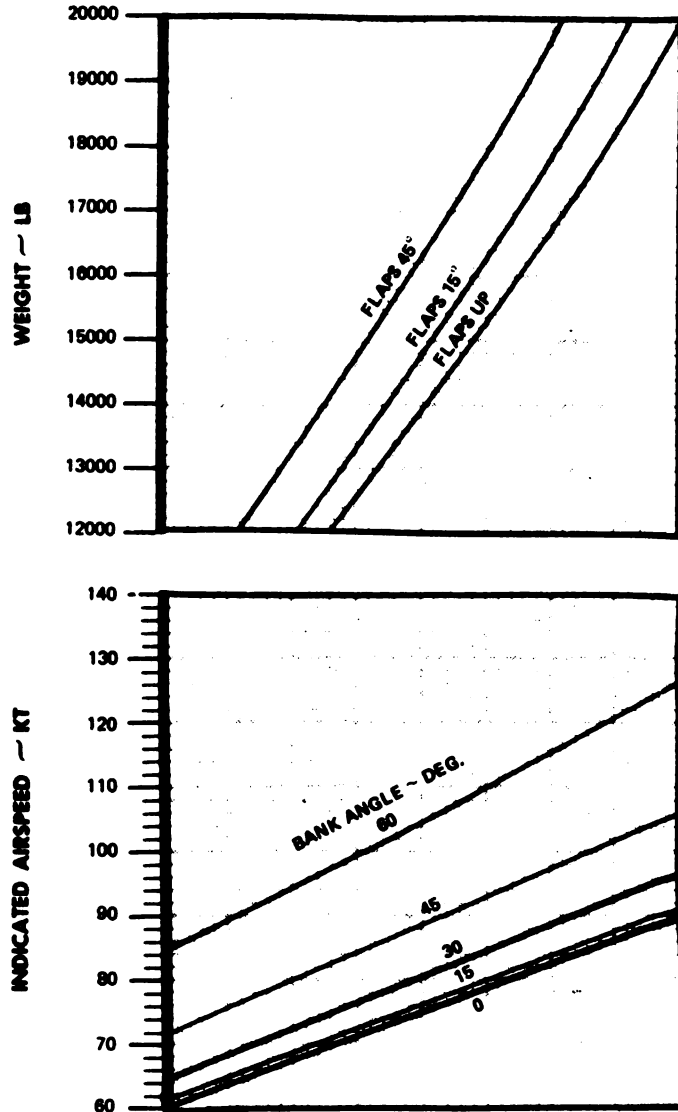

**NOTE**

BASED ON POWER REQUIRED  
TO MAINTAIN 120% FLIGHT  
IDLE STALL SPEED.

DATA BASIS: DERIVED FROM FLIGHT TEST

A-8-10-D-7-2

**Figure 8-7. Stall Speed (Sheet 2 of 2)**



**NOTE**

*During single-engine stalls with the landing gear and flaps down and the left engine inoperative, a pedal force reversal can be encountered.*

*d.* Slightly higher minimum control speeds were experienced during flight test with the AN/ALQ-147A(V)1 IRCM pod installed on stations 1 or 6 and flaps up. The pod, due to its proximity to the outboard aileron, has deteriorated to some extent the aircraft's low speed lateral control effectiveness, resulting in larger control surface deflections required to maintain balanced flight. This results in an earlier loss of lateral control and subsequently, higher minimum control speeds. With the flaps extended, there is less of a difference in  $V_{mc}$  with or without the pod installed. This is due to the inboard ailerons being functional when the flaps are extended, thus providing increased lateral control. Flight tests have demonstrated that  $V_{mc}$  in the takeoff configuration with the pod installed remain unchanged.

*e.* Changes in flight characteristics due to the installation of the IR suppressor are notable primarily in the lower speed portion of the flight envelope. In the flaps up, gear up configuration, a light-to-moderate airframe buffet may be encountered, primarily with the power levers at or close to FLIGHT IDLE during maneuvering flight up to approximately 160 KIAS. This buffet, which is a function of airflow separation on the trailing edge of the wing adjacent to and outboard of the engine nacelles, can be eliminated by either reducing the normal load factor (G's) or by adding power to increase the propeller generated airflow over the wing. Thus buffet will continue down to the stall in this configuration with no marked change in intensity if no power application is made.

*f.* The IR suppressor installation modifies the stall characteristics of the aircraft in that it intensifies the random wing heaviness prior to stalls in the cruise configuration and introduces the same characteristic of random lateral control feedback in the takeoff and power approach configuration stalls as well as the cruise stalls.

Additionally, if the wing heaviness persists to the point of stall, rolloff (usually right wing down) will mark the stall. This rolloff can be controlled by lowering the nose to reduce the angle of attack, followed by lateral control to regain a wings level attitude.

**8-47. Spins.****WARNING**

Spin testing has not been conducted in stores-configured aircraft other than with empty drop tanks installed on store stations 3 and 4. Additionally, jettison envelopes have not been established for jettison of stores during uncontrolled flight. In the event a spin is encountered in a stores-configured aircraft, the pilot should evaluate his altitude, aircraft response, and location in determining whether spin recovery or ejection is the best course of action.

*a.* If departure from controlled flight should occur, the power on both engines should be reduced immediately to idle. This procedure is essential since a flat spin is realized when asymmetric power is held during the incipient spin (i.e., spin entry) phase and turn rates and recovery times are increased. Also, if full asymmetric thrust is maintained during the spin, recovery through the use of the flight controls would be doubtful.

*b.* It is possible to experience two spin modes; a normal spin and a flat spin. The recovery technique in both cases is the same. First, the spin direction should be determined (preferably by reference to the turn needle, or visually). Then, apply full rudder in the direction to oppose the spin, followed immediately by forward stick while maintaining neutral ailerons. The rudder is the primary spin recovery control and is effective

in the flat spin mode (approximately 80° angle of attack) which is truly unique. Therefore, very slight forward stick is required, however, high longitudinal stick forces may be encountered during recovery. With this simple procedure, recovery should be affected in 1 to 1.5 turns. Since the aircraft spins at 3 to 3.5 seconds/turn with a sink rate of approximately 250 feet/second, 700 feet of altitude will be lost per turn.

c. As soon as rotation ceases, the rudder should be neutralized immediately to prevent re-entering a spin in the opposite direction. If the landing gear and flaps are down, they should be retracted immediately to prevent exceeding air-speed limitations. The aircraft will recover in a steep nosedown attitude, therefore, be sure to check airspeed and make recovery pullout carefully to avoid secondary stall. Approximately 3,500 feet will be lost between the time the rotation ceases and level flight is regained. Consequently, if spin rotation has not ceased by an altitude of 5,000 feet above ground level, EJECT.

d. In the unlikely event spin rotation does not cease after two turns upon application of full opposite rudder, the stick should be pushed full forward and moved laterally in the direction of the spin while maintaining opposite rudder (crossed controls). In this instance, all controls should be neutralized immediately to prevent overcontrolling as soon as rotation ceases. The following procedure is recommended.

1. Power levers – FLIGHT IDLE immediately at departure from controlled flight.

1A. Autopilot – Disengage by pressing autopilot release button on pilot's control stick.

2. Rudder – Apply full opposite rudder to spin direction until rotation has stopped.

#### NOTE

*During single engine stall with the landing gear and flaps down and the left engine inoperative, a pedal force reversal can be encountered.*

3. Control stick – Forward stick (but not beyond neutral) immediately following rudder application, maintaining neutral ailerons.

#### NOTE

*If rotation does not cease after two turns upon applying this procedure, the control stick should be moved laterally in the direction of the spin and full forward while maintaining opposite rudder to the spin. As the control stick is moved full forward, high stick forces may be encountered.*



4. As soon as rotation ceases — Neutralize all controls.

5. If gear and flaps are down — Retract immediately.

6. Allow buildup to safe flying speed, then, smoothly raise the nose to the horizon.

#### 8-48. Diving.

The diving characteristics of the aircraft are satisfactory up to 0.65 Mach. All control forces can be satisfactorily trimmed out in the dive. However, without retrimming, the longitudinal stick forces build up rapidly. A very lightly damped yaw oscillation begins at approximately 300 KIAS and increases in intensity with increasing airspeed, but is not considered objectionable. Care should be taken in recovering from high Mach number dives due to the low longitudinal stick forces per G required.

#### CAUTION

If speed brakes are used in a high Mach number dive recovery, a nose-up trim change and corresponding increase of 1.0 G results. Anticipation of this trim change is required in order to avoid exceeding G limitations.

#### 8-49. Flight Controls.

The flight controls have proved to be effective at all airspeeds and no unusual reactions will be encountered during normal flight operation. However, care should be exercised in regard to necessary intentional sideslips, i.e., during cross-wind landings at lower velocities and while retrimming during abrupt dive maneuvers at the higher velocities. In each case, especially in a stores-configured aircraft, rudder inputs should be smooth rather than abrupt kicks and rudder releases should be gradual rather than an abrupt withdrawal. In doing so, loads introduced to the stores and racks will be less dynamic. The rolling performance of the aircraft is considerably reduced compared with an unloaded aircraft (clean, SLAR, or empty drop tanks). Rolls to

180° in all store configurations are permitted to enable the pilot to perform other evasive maneuvers. Roll recovery will be slower (aircraft tends to continue rolling) than with an unloaded aircraft. Refer to Chapter 5 for rolling limits.

#### 8-50. Level Flight Characteristics Under Various Speed Conditions.

a. The aircraft trim systems are adequate to reduce control forces to zero about all three axis throughout the operational flight envelope. Lateral trim change is required with small changes in speed and power.

b. When sideslip angles in excess of 10° are performed, abrupt lightening of rudder pedal forces will be encountered at all airspeeds in a flaps down configuration, and at airspeeds less than 180 KIAS in a flaps up configuration. Therefore, when executing intentional sideslips, care should be exercised to make it a smooth push-type maneuver rather than an abrupt kick.

c. Roll rate in this aircraft, although generally low, is sufficient to satisfy mission requirements. The low roll rates of stores-equipped aircraft prohibit 360° rolls. In figure 5-4, Sheet 1, Configurations A and F and Sheet 2, Configuration RA, the nose has a tendency to drop through by the time the aircraft has rolled 180°, resulting in some altitude loss during completion of the roll. This condition is aggravated when external stores are installed on the wing. Without refined pilot technique, serious scoop-out occurs in which G limits can easily be exceeded.

d. Elevator control force gradients, although stable throughout the normal operational envelope, tend to decrease with increasing speed. When flying above 275 KIAS at aft CG, a noticeable reduction in control force gradient occurs at high load factors. Care should be taken when executing high-speed turns not to exceed maximum allowable G limits.

#### 8-51. Flight With External Loads.

The drop tanks have little effect on the flying characteristics of the aircraft. Uneven transfer of fuel from the drop tanks causes wing heaviness, but this can be trimmed out with the aileron trim tab control. The rolling performance of the

aircraft with all store stations loaded is considerably reduced compared to an unloaded aircraft. In addition, the increased inertia about the longitudinal axis has reduced the lateral control response. Upon starting roll recovery, the aircraft will respond slowly, exhibiting a tendency to continue rolling.

#### NOTE

*When the IRCM pod (AN/ALQ-147A(V)2) is installed on OV-1D aircraft in an all stores configuration, installation on wing station 3 rather than wing station 4 will provide greater left/right roll response harmony. When installed on OV-1D aircraft in a symmetrical stores configuration, installation on wing station 4 will help to oppose left yaw/roll moments induced by propeller torque and slipstream side-wash effects.*

#### 8-52. Flight With Asymmetrical Loads.

a. The present lateral trim system is sufficient to maintain trimmed balance flight down to an airspeed of **160 KIAS** with maximum attainable asymmetrical loading in the cruise configuration.

#### NOTE

*It is possible to run out of lateral control at speeds below the minimum trim speed with asymmetrical loads; therefore, caution must be exercised when landing with extreme asymmetry. If extreme asymmetry exists (i.e., figure 5-4, Sheet 1, Configuration E with left drop tank empty and right drop tank full), depending on runway length available and crosswind, consideration must be given to jettisoning necessary stores to equalize the store loading condition.*

b. This aircraft, when in the extreme asymmetric configuration (figure 5-4, Sheet 1, Configuration E), requires increased caution in general due to asymmetrical weight, increased inertia, and reduced right wing ground clearance. Major items to be considered when comparing the aircraft in this configuration as opposed to the lighter weight symmetrically loaded configuration are discussed in the following paragraphs.

#### 8-53. Ground Handling and Taxiing (Asymmetrical Stores Loading).

With the reduced right wing clearance and right wing heaviness due to asymmetric store loading, caution should be exercised in reference to objects protruding from the ground that will be cleared with the left wing and not the right. In doing so, left turns using nosewheel steering should be gradual to prevent increased right wing down inertia. In addition, crosswinds from the left tend to facilitate a greater right wing down condition. Military power runup should always be made into the wind, and never with a crosswind from the left. Additionally, due to increased ground roll inertia, slower taxi speeds are recommended to reduce tire wear.

#### NOTE

*When the IRCM pod (AN/ALQ-147A(V)2) is installed on OV-1D aircraft in an all stores configuration, installation on wing station 3 rather than wing station 4 will reduce right wing heaviness, increase right wing ground clearance and improve ground handling characteristics when taxiing in a crosswind.*

*Current loading conditions and gross weights would require an extremely hard surface due to the bearing weight ratio. This aircraft has not been tested on unimproved surfaces.*

**8-54. Takeoff and Landing Rollout (Asymmetric Stores Loading).**

a. Single-engine control speed and rate of climb capability should be planned for the aircraft gross weight, runway elevation, and free air temperature, before flight. In the event of an engine failure on takeoff, the reduction in gross weight due to dropping external stores greatly enhances single-engine climb capability. Therefore, selection of stores for emergency jettison should be made before rollout.

b. Takeoff rollouts with asymmetric loading are generally less significant as compared to landing. Directional control is not difficult and is aided greatly by use of the ailerons. More aileron is needed, however, to maintain wings level due to asymmetric loading. More aft elevator is also required to maintain a level attitude when the SLAR antenna is installed.

c. With IRCM pod AN/ALQ-147A(V)1 installed, and with an otherwise symmetrically loaded aircraft, the recommended takeoff trim settings should be changed. Ten degrees right aileron trim and 5° right rudder trim should be used with the pod installed on wing station 1. Three degrees left aileron trim and 5° right rudder trim should be used with the pod installed on wing station 6.

d. Landing in crosswind conditions is handled easily in approach, but after touchdown, becomes more critical. On touchdown, use ailerons as long as possible to maintain wings level. Due to asymmetric loading, greater aileron control input is required. It is also recommended that landing with extreme asymmetric fuel loading be avoided and that landings performed with asymmetric fuel be accomplished with the crosswind component coming from the direction of the heavy wing.

**NOTE**

*Caution should be exercised when using reverse thrust after touchdown with crosswinds from the left. The use of left aileron will help counteract right wing down inertia during rollout. Uneven power inputs are more critical due to stores inertia. Avoid abrupt nosewheel steering inputs. Use of brakes is also more critical due to heavier weight.*

**8-55. Inflight Characteristics (Asymmetric Stores Loading).**

a. *Roll Performance.* Roll performance is more critical with the aircraft in a heavy weight configuration (figure 5-4, Sheet 1, Configurations D and E) due to the asymmetric loading and increased inertia about the longitudinal axis. Right roll response (into the loaded wing) is good, but once initiated, is hard to stop due to high roll inertia. Roll response to the left, however, is low and the aircraft characteristics are sluggish. Turns, therefore, should be entered with caution and abrupt lateral stick movements avoided. Recovery control is much larger than required with lighter symmetrically configured aircraft.

**NOTE**

*360° roll maneuvers are prohibited with the aircraft in any configuration other than figure 5-4, Sheet 1, Configurations A and F, Configurations B and H with empty drop tanks, and Sheet 2, Configuration RA and Configuration RB with empty drop tanks.*

*When the IRCM pod (AN/ALQ-147A(V)2) is installed on OV-D aircraft in an all stores configuration, installation on wing station 3 rather than on wing station 4 will provide greater left/right roll response harmony. When installed on OV-1D aircraft in a symmetrical stores configuration, installation on wing station 4 will help to oppose left yaw/roll moments induced by propeller torque and slipstream sidewash effects.*

b. *Trimmability.* Trim requirements are greater with asymmetric loading, particularly at low speeds. The trim capability of this aircraft in a heavy weight configuration (with drop tank fuel maintained equal), is satisfactory about all three axis. However, if extreme asymmetry results from uneven fuel transfer and/or other causes, consideration must be given to the jettison of drop tanks before landing. Landings with full asymmetric stores loading can be accomplished using an approach speed of 120 KIAS if the wind is down the runway.

## SECTION V. ADVERSE ENVIRONMENTAL CONDITIONS

## 8-56. Introduction.

The purpose of this section is to inform the pilot of the special precautions and procedures to be followed during the various weather conditions that may be encountered. This section is primarily narrative; only those checks that cover specific procedures characteristic of weather operations are included. The checklist in Section II provides for adverse environmental operation.

## 8-57. Cold Weather Operation.

The general problems involved in maintaining satisfactory operation in extreme cold relate to preparation for flight, conditions of ice and snow, cold weather engine starts, taxiing, and landing. The problems presented by the occurrence of ice, snow, or rain are such that provisions must be incorporated in the aircraft to reduce and eliminate the adverse effects produced by each. Engine power output and response of flight control surfaces are particularly vulnerable. Since these two factors and the associated systems are ultimately responsible for flight, it is imperative that operation of each for maximum effectiveness be maintained. Although the presence of ice, snow, or rain constitutes an undesirable environment for operation, the countermeasures and procedures provided as described in paragraph 8-60 are adequate to permit the continuance of approximately normal flight. During cold weather and high humidity conditions, anti-frost fluid will prevent the buildup of an excessive amount of windshield frost and will reduce engine start-to-takeoff time. If the autopilot is to be used in flight, the ambient temperature should be above  $-55^{\circ}\text{C}$ . For engine operation at ambient temperatures of  $-32^{\circ}\text{C}$  or below, MIL-T-7808 oil must be used in lieu of MIL-L-23699.

## a. Preparation for Flight.

CAUTION

Ground operations at temperatures below  $-34.4^{\circ}\text{C}$  ( $-30^{\circ}\text{F}$ ) should be avoided for routine

training flights. Operating aircraft at these ground temperatures will result in the increased probability of hydraulic system leaks, collapsed landing gear struts, and inoperative anti-ice systems. Flightcrews operating at these low temperatures should maintain increased awareness of the increased possibility of failures, particularly during taxi, takeoff, and landing. Use of heated hangar facilities to avoid cold soaking before and during preflight, use of a Herman Nelson heater with one heat duct directed at each landing gear strut/actuator area once outside and prior to startup, and all possible shortening of time between removal of heat and takeoff will reduce hazards associated with maintenance and improve equipment effectiveness during extreme cold weather operations.

During cold weather operations, the following precautions should be observed. Before flight, all ice, snow, and frost should be removed from the aircraft with special attention being devoted to the control surfaces and the leading edges of the wings and empennage. To remove ice, have maintenance personnel apply sufficient heat to loosen ice particles and remove them with a stiff brush. When removing ice with heat, do not melt the ice completely, as water may get into control surfaces and freeze. Cold weather operation of the engines presents no unusual problems if the pilot is aware of changing conditions that result from low ambient temperatures and freezing moisture. Use of the deicing system will provide protection at power levels of flight idle and above.

b. Before Entering the Aircraft. When performing the exterior inspection under icing conditions, the pilot should insure that all ice is removed from the aircraft. In particular, the

flight controls should be carefully checked for freedom of movement and operation. Check landing gear struts and tires for proper extension and inflation, since cold weather causes a decrease in air volume. Hydraulic packings tend to harden and crack, and hydraulic leaks may occur in pressure lines (most prevalent in the landing gear down lines, speed brake lines, baggage compartment, and in the leading edge of the wing roots at the hydraulic check valves). Mois-

ture may have accumulated in the compressor housing, especially if the engines have been shut down during a snowfall. When starting on ice or snow, aircraft tiedowns should not be released and chocks removed until ready to taxi.

*c. Entering the Aircraft.* Arctic clothing presents some difficulty to cockpit entry and utilization of the ejection seat restraining devices. Operation of the aircraft while using the Arctic





Mitten set is not possible. The mittens should be secured under the Arctic Flight Jacket so that they will not be lost in the event of ejection. Anti-contact gloves must be worn by crewmembers. Exposed hands and fingers will be frostbitten by contact with metal controls and surfaces within the cockpit. Leather flight gloves worn over nomex gloves will normally provide sufficient protection in the cockpit. Mukluks should be laced tight so that they will not come off in the event of ejection. Foam rubber earphones within flying helmets must be warmed by hand or other methods before wearing. These tend to lose heat rapidly when exposed to low temperatures and can cause serious frostbite to facial contact areas.

*d. Interior Check.* Follow normal procedures provided in Section II.

*e. Engine Starting.* During cold weather operation, when the ambient temperature is  $-29^{\circ}\text{C}$  or below, follow normal engine starting procedure contained in Section II with the following additions:

1. Have accumulations of snow and ice removed from the engine air inlet area.

**CAUTION**

Do not use starter to free a frozen engine rotor.

2. Use ground heater units to preheat engines when they are frozen.

3. Inspect all drains to ensure normal drainage.

*f. Warmup and Ground Tests.* When operating on snow or ice surfaces, the engine runup usually conducted just before takeoff should be done before the aircraft tiedowns are released and the chocks removed. While still tied down, conduct all ground checks as outlined in Section II. Follow normal procedures given in Section II before taxiing.

**NOTE**

*When operating on iced taxiways or on snow-covered fields where tie-downs are not available, the runup procedures must be modified as high power settings for propeller and engine power checks cannot be obtained without sliding wheels. Under these conditions, check propeller at highest RPM that will not slide wheels and check engine power during takeoff run.*

*g. Taxiing.*

**CAUTION**

On bare ice or hard packed snow surfaces, slower taxi speeds sometimes cannot be achieved by feathering one engine. Regardless of nose gear position, the aircraft may turn into the feathered engine. Although static propeller clearance is 3 feet 2 inches, as a result of some operations, propeller clearance can be as little as 2 feet. Propeller and engine damage resulting from snow impact is as severe as ground impact.

**NOTE**

*When checking reverse thrust on ice, taxi speed should be kept to a minimum, so that in the event one propeller fails to reverse, directional control can be maintained.*

Extreme care should be exercised when taxiing on ice. A combination of brakes and forward and reverse power setting or nosewheel steering is required to maintain proper control. The use

of high power should be avoided during taxiing as this will produce a blinding propeller wash of ice or light snow. Damage may also occur from particles of ice picked up by the propeller blast. Do not stop in deep snow or slush, as moisture may collect and freeze on the brake discs. Follow normal procedures given in Section II for taxiing and before takeoff with the exceptions provided herein.

**NOTE**

*During parking operations, minimum forward or reverse power may slide the aircraft wheels. All power should be removed and the aircraft allowed to coast to a stop. Precise positioning must be completed with a prime mover by maintenance personnel.*

*h. Takeoff.* If the power levers are aft of the TAKEOFF position during takeoff, failure of either engine will not result in automatic feathering of that propeller since the power levers must be in the TAKEOFF position to complete the autofeather circuit. Should engine failure occur during takeoff, propeller feathering can be done by momentarily placing the power levers to the TAKEOFF position to activate the autofeather system, then retarding them to within limits. If the takeoff run must be done on an icy runway, the nosewheel should be centered before beginning the takeoff roll. Use the appropriate takeoff procedures outlined in Section II and the following:

**CAUTION**

When operating on surfaces covered with powdered snow, the width of the takeoff area selected should be double that normally used. Directional control is difficult, but not hazardous. Adequate control can be maintained by power steering. Use of asymmetrical power accentuates directional control difficulties on this surface condition. However, takeoff on packed snow over 4 inches deep, and containing ruts, should

not be attempted, as damage to the lower landing gear doors could occur.

1. Pitot heat switch – ON.
2. Windshield de-icing switch – ON.
3. Engine de-icing switch – ON.

**NOTE**

*Ice formation may be expected during takeoff in visible moisture at temperatures near freezing.*

*i. Cruise.* Cold ambient temperatures have no effect on the inflight aircraft operations, nor do these temperatures necessitate any special procedures.

**NOTE**

*When operated at any minus density altitude, fuel consumption of the aircraft will increase as much as 40%.*

*j. Descent.* Check that windshield defog system is fully on several minutes before making any rapid descents from altitude. Windshields not treated with antifrost solution will build up frost at any power setting less than 70% engine RPM.

*k. Landing.*

**NOTE**

*Stall speeds under icing conditions are higher due to the disfiguration of lifting surfaces and increased weight of ice on the aircraft. A stall should be expected at higher airspeeds than for normal conditions. Therefore, approach and landing speeds must be increased accordingly.*

**NOTE**

*As the possibility of unequal reverse thrust always exists, reverse thrust should be used only when necessary if landing on ice or packed snow.*

Normal traffic pattern and landing procedures should be used. Holding operation in heavy icing conditions should be kept to a minimum. Before the final approach, the windshield anti-icing and engine de-icing should be turned on and the windshield defog turned to maximum in order to keep the windshield free of ice. Extreme care should be exercised when landing on ice. A combination of brakes, reverse power setting and nosewheel steering is required. When landing and applying reverse thrust on ice surfaces, power should be applied equally to both engines to prevent unbalanced thrust, forcing the aircraft to slide sideways. When landing on a runway covered with snow or standing water, the pilot should be prepared for a blinding propeller wash when reversing the propellers and approaching a ground roll speed of **40 knots**. The aircraft cockpit can be kept in front of the wash by reducing the amount of reverse thrust being used. This procedure will increase the landing ground roll distance by 15 to 25%.

**NOTE**

*Normally the aircraft can be landed on frozen lakes and rivers with an ice thickness of **2 feet** or more. Before using frozen lakes and rivers, a thorough reconnaissance should be conducted and an ice load bearing capacity study completed by U.S. Army Engineers.*

*l. After Landing.* Perform normal after landing and engine shutdown procedures contained in Section II.

*m. Before Leaving the Aircraft.* Follow normal securing procedures contained in Section II. In addition, have maintenance personnel remove

the aircraft and constant voltage supply batteries, install all aircraft protective covers, and apply an ample coating of antifrost solution to the interior and exterior of the cockpit windshield surfaces.

**8-58. Desert and Hot Weather Operation.**

Hot weather and desert procedures differ from normal procedures mainly in that added precautions must be taken to protect the aircraft from damage due to high temperature and dust. Particular care should be taken to prevent the entrance of sand into the various aircraft parts and systems (engine, fuel system, pitot-static system, etc.) Tires should be checked frequently for blistering, cracking, and proper inflation.

*a. Preparation for Flight.* Check exposed portions of shock strut pistons for dust and sand, and have them cleaned if necessary. Check ducts for accumulations of dust and sand. Make sure all filters have been cleaned and that the aircraft has been thoroughly inspected for fuel or hydraulic leaks caused by the swelling of seals or expansion of fittings. Inspect the area directly behind the aircraft to make sure sand and dust will not be blown onto personnel or equipment during operation. Check the inflation of shock struts and tires, which may have become overinflated from heat. On entering the aircraft, check the cockpit for excessive accumulations of dust and/or sand. Check instruments and controls for moisture due to high humidity.

*b. Engine Starting.* To prevent false indications of hot starts, face the aircraft into the wind when wind velocities are **10 knots** or more. A necessity may arise for unfeathering at ground idle. When operating the engines in ambient temperatures above standard day conditions, the fuel control automatically biases fuel flow, preventing temperature limits at the inlet of the first stage turbine nozzle from being exceeded. Use normal starting procedures as described in Section II.

*c. Taxiing.* Avoid rolling over the same area repeatedly. The weight of the aircraft will tend to break the crust of the desert surface and drop the landing gear into a hole. Improved air-conditioning performance can be obtained by taxiing with one engine at **72% NI** with its propeller

feathered and the other engine with its propeller unfeathered at whatever power setting that results in the desired taxi speed. The air-conditioning master switch must be in the OVRD position in order to operate the system with one propeller feathered. Set air-conditioning master switch to OFF before takeoff.

**CAUTION**

During ground operation at ambient temperatures above 35°C (95°F), operating an engine at high power settings with the propeller feathered may cause oil temperature limits to be exceeded. Oil temperature should be monitored closely when operating under these conditions.

*d. Takeoff.* Do not attempt to takeoff in a sandstorm or duststorm. When the free air temperature or density altitude is high, more than usual takeoff distance will be required to obtain takeoff speed.

*e. Cruise.* If the autopilot is to be used during the flight, be sure that the ambient temperature is 55°C or below.

*f. Descent.* Check that the windshield defog system is on several minutes before making any rapid descent from altitude to prevent fogging of the windshield. Maintain the recommended indicated airspeeds for approach and touchdown. Due to high free air temperatures, the airspeed will be higher than normal, and a longer landing roll will result.

*g. Landing.* Avoid heavy braking during the landing roll. Small increments of braking will stop the aircraft in a reasonably short distance without excessive tire wear. Heavy braking may cause brake grabbing and tire failure.

*h. After Landing.* Perform normal after landing and engine shutdown procedures contained in Section II.

*i. Before Leaving the Aircraft.* Leave the entrance hatches open slightly to permit air circulation in the cockpit unless blowing sand or dust is expected. Make sure all airscoops are covered and the engine intake and exhaust covers are installed after the engine has cooled. Park the aircraft facing into the wind or in a sheltered area, if possible.

**8-59. Turbulence and Thunderstorm Operation.**

Power setting and pitch attitude are the keys to proper flight technique in turbulent air. If the proper power setting and pitch attitude required for the desired penetration airspeed is established before entering the storm and maintained throughout the storm, this will result in constant airspeed, regardless of the airspeed indicator. The pilot should not attempt to change power settings every time the airspeed indicator fluctuates. Rapid changes in horizontal gust velocity or heavy rain clogging the pitot tube may cause the airspeed indicator to fluctuate.

*a. Approaching the Storm.* It is imperative that the pilot prepare the aircraft before entering a zone of turbulent air. If the storm cannot be seen, its proximity may sometimes be detected by radio static and erratic ADF performance. The following procedures apply:

**NOTE**

*Do not lower gear or flaps as this will result in a loss of aerodynamic efficiency.*

1. Adjust power setting to establish the desired penetration speed. Approximately 150 KNOTS is recommended, but never exceed the severe turbulence limitation of 197 KIAS (paragraph 5-17d).
2. Check gyro instruments for proper settings.
3. Tighten lap belt.
4. At night, turn up cockpit lights to full bright to minimize the blinding effect of lightning.

*b. In the Storm.* Once inside the storm, the following procedures apply:

1. Maintain power setting and pitch attitude throughout the storm. By holding these constant, the airspeed will remain approximately constant.

2. Although turbulence, heavy precipitation, and lightning will be experienced, it should not cause undue alarm to the pilot.

3. Avoid using the elevators and rudder as much as possible to minimize the stresses imposed on the aircraft. Sudden maneuvers should be avoided.

4. Operate deicing and anti-icing equipment, as necessary, to prevent the accumulation of ice.

#### 8-60. Ice and Rain.

### WARNING

Continuous, sustained flight into moderate icing conditions is not recommended.

The general problems in maintaining satisfactory operation under ice and rain conditions occur primarily during takeoff and flight.

*a. Takeoff.* The techniques and precautions to be observed during takeoff are essentially the same as those described in paragraph 8-57h.

*b. During Flight.* Emergencies encountered during flight in ice, snow, or rain are almost solely confined to failure or malfunctioning of the anti-icing and deicing equipment, or modifications of operating procedures required under extremely hazardous atmospheric conditions. To meet as many of these problems as possible, the aircraft incorporates appropriate design features and auxiliary equipment. The aircraft is

equipped with the necessary wing and empennage deicer boots, pitot heater, engine strut anti-icing, engine cowl anti-icing, propeller deicing, and windshield anti-icing systems to enable it to fly with safety under icing conditions. These systems are described in Chapter 2. Planning and preparation for operation in ice, snow, or rain conditions should be accomplished in advance, whenever possible. In general, windshield wipers, heating system, radio equipment, and navigation equipment should be thoroughly tested before takeoff.

### NOTE

*The engine, propeller, and cowl deicing system should be used when ambient temperature is below 4°C, during conditions of visible moisture, or during any condition where icing could exist.*

Do not actuate the pneumatic deicing system until ice has had a chance to accumulate to an approximate thickness of 1/2 inch. This will insure complete deicing of the wings and empennage. In the event that severe icing conditions occur and the deicers prove inadequate, the pilot should effect an immediate change of altitude in an attempt to bring the aircraft clear of the icing zone.

### WARNING

When flying in icing conditions, if the indicated airspeed decreases as much as 15 knots within a 5 minute period or decreases to 145 knots with a power setting for maximum range airspeed, the airframe ice protection system may become ineffective and the icing conditions should be exited immediately.

## SECTION VI. CREW DUTIES

#### 8-61. Introduction.

This section covers the responsibilities of the airborne systems specialist and copilot or instructor pilot (when dual controls are installed). It includes a discussion of their primary and

alternate functions. The purpose of this section is to provide a compact collection of material wherein the specialist, copilot, or instructor pilot can readily determine their complete responsibilities. Preflight, mission, and after landing duties are included.

**8-62. Airborne Systems Specialist Responsibilities.**

The responsibilities of the specialist during preflight, mission, and after landing are given in the following paragraphs.

*a. Preflight Responsibility.* The specialist aids the pilot as directed in performing preflight checks of the aircraft. In addition, it is his responsibility to perform all preflight checks for the photographic surveillance system when preparing for photographic missions. The specialist must perform a preflight check of the SLAR system, IR system, or Airborne Emitter Locator Identification System, if installed. The IR system is classified and is not covered in this manual. Refer to TM 55-1510-213-10/1. The specialist also has the responsibility of performing the preflight checks on his ejection seat and for making certain that the upper and lower firing handles are unlocked before takeoff.

*b. Mission Responsibility.* The specialist operates the applicable equipment to accomplish the various surveillance missions. These missions include visual, photographic, radar, infrared surveillance, etc. The specialist can also assist the pilot, as directed.

*c. After Landing.* Check that the upper and lower firing handles on the ejection seat are locked. Remove the film from the cameras, SLAR, or IR systems and check that all surveillance equipment is properly shut down and secured. The specialist shall fill out the applicable forms if any equipment discrepancies are noted during the mission.

**8-63. Copilot or Instructor Pilot (IP) Responsibilities.**

The responsibilities of the copilot or instructor pilot during preflight, mission, and after landing are given in the following paragraphs.

*a. Preflight Responsibility - Copilot.* The copilot assumes the same responsibilities as does the airborne systems specialist unless the pilot and copilot share these responsibilities based on a preflight agreement.

*b. Preflight Responsibility - IP.* The IP observes and/or instructs the pilot being checked-out performing the preflight checks of the aircraft. He is also responsible for performing the preflight checks on his ejection seat and for making certain that the upper and lower firing handles are unlocked before takeoff.

*c. Mission Responsibility - Copilot.* The copilot assumes the same responsibilities as does the airborne systems specialist unless the pilot and copilot share these responsibilities based on a preflight agreement.

*d. Mission Responsibility - IP.* The IP observes and/or instructs the pilot being checked-out performing the mission activities during flight.

*e. After Landing Responsibility - Copilot.* The copilot assumes the same responsibilities as does the airborne systems specialist unless the pilot and copilot share these responsibilities based on a preflight agreement.

*f. After Landing Responsibility - IP.* The IP observes and/or instructs the pilot being checked-out performing the after landing checks on the aircraft. He is also responsible to lock the upper and lower firing handles on his ejection seat.

## SECTION VII. PASSENGER BRIEFING

### ★ 8-64. Passenger Briefing.

The following is a guide that should be used in accomplishing required passenger briefings, when a unit passenger briefing is not available. Items that do not pertain to a specific mission may be omitted. Items may be added or deleted, as necessary, depending on the type of mission.

#### *a. Crew Introduction.*

#### *b. Equipment.*

- (1) Personnel to include ID tags.
- (2) Professional.
- (3) Survival.

#### *c. Flight Data.*

- (1) Route.
- (2) Altitude.
- (3) Time enroute.
- (4) Weather.

#### *d. Normal Procedures.*

- (1) Entry and exit of aircraft.
- (2) Seating.
- (3) Seat belts.
- (4) Movement in aircraft.
- (5) Internal communications.
- (6) Security of equipment.
- (7) Smoking.
- (8) Oxygen.
- (9) Refueling.
- (10) Weapons.
- (11) Protective masks.
- (12) Parachutes.

#### *e. Emergency Procedures.*

- (1) Emergency exits.
- (2) Emergency equipment.
- (3) Emergency landing/ditching procedures.
- (4) Bailout.





## CHAPTER 9

# EMERGENCY PROCEDURES

### SECTION I. AIRCRAFT SYSTEMS

#### 9-1. Aircraft Systems.

This section describes aircraft system emergencies that could occur and the necessary procedures to be followed. Emergency operation of auxiliary equipment is contained in this chapter only where its use affects safety of flight. Emergency procedures are given in checklist form, when applicable. A condensed version of these procedures is contained in the condensed checklist TM 55-1510-213-CL. Emergency operation of avionic equipment is contained in Chapter 3, Avionics.

sloping console, and a hand fire extinguisher, on the left side of the pilot's ejection seat (figure 9-1).

#### 9-4. Emergency Entrance.

To rescue the occupants of a crash-damaged aircraft, proceed as described in the following paragraphs.

#### NOTE

*The urgency of certain emergencies requires immediate and instinctive action by the pilot. The most important single consideration is aircraft control. All procedures are subordinate to this requirement.*

#### NOTE

*If there is little chance of fire, leave the injured in their seats until qualified medical personnel have arrived.*

#### 9-2. Immediate Action Emergency Checks.

Those checks that must be performed immediately in an emergency procedure are underlined. These immediate action emergency checks must be committed to memory.

*a. Approaching the Aircraft.* Approach the aircraft from either side to gain access to the entrance hatches (figure 9-2). If the propellers are rotating, use extreme caution. If the landing gear has collapsed or is retracted, keep clear of engine intake and exhaust.

*b. Cockpit Access.* To gain access to the cockpit, proceed as follows:

#### 9-3. Emergency Exits and Equipment.

The cockpit entrance hatches or the jettisonable overhead escape hatch are used for emergency exit. Emergency equipment installed in the aircraft include a first aid kit, behind the

1. Lift exit release lock ring and turn to UNLOCK (figure 9-2).

2. Open entrance hatch with release lever. Lift entrance hatch to the full open position.

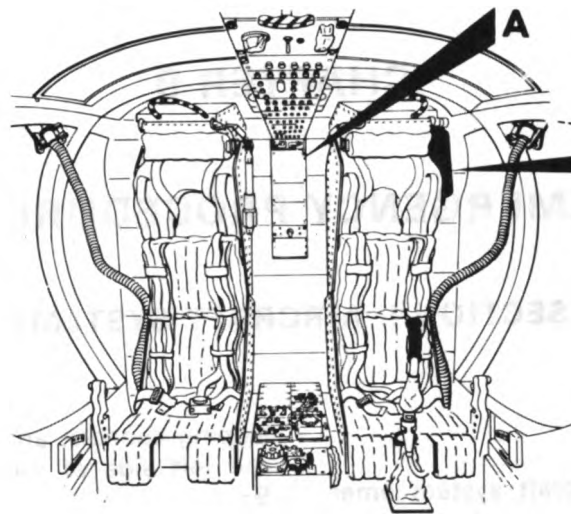

NOTE  
HAND FIRE EXTINGUISHER MAY  
NOT BE ACCESSIBLE TO OCCU-  
PANTS WHEN THEY ARE SECURED  
IN SEATS.

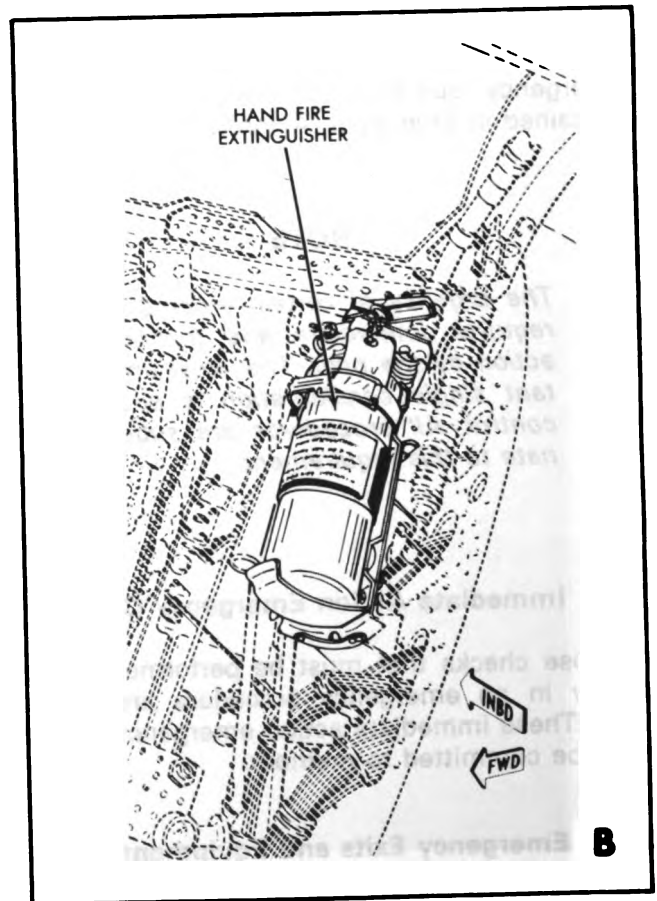
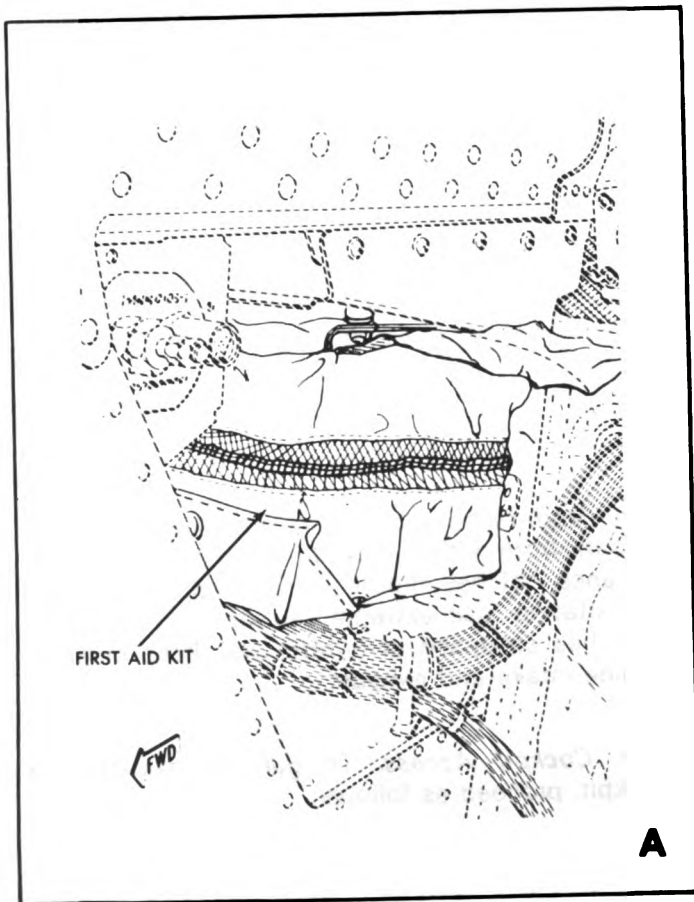
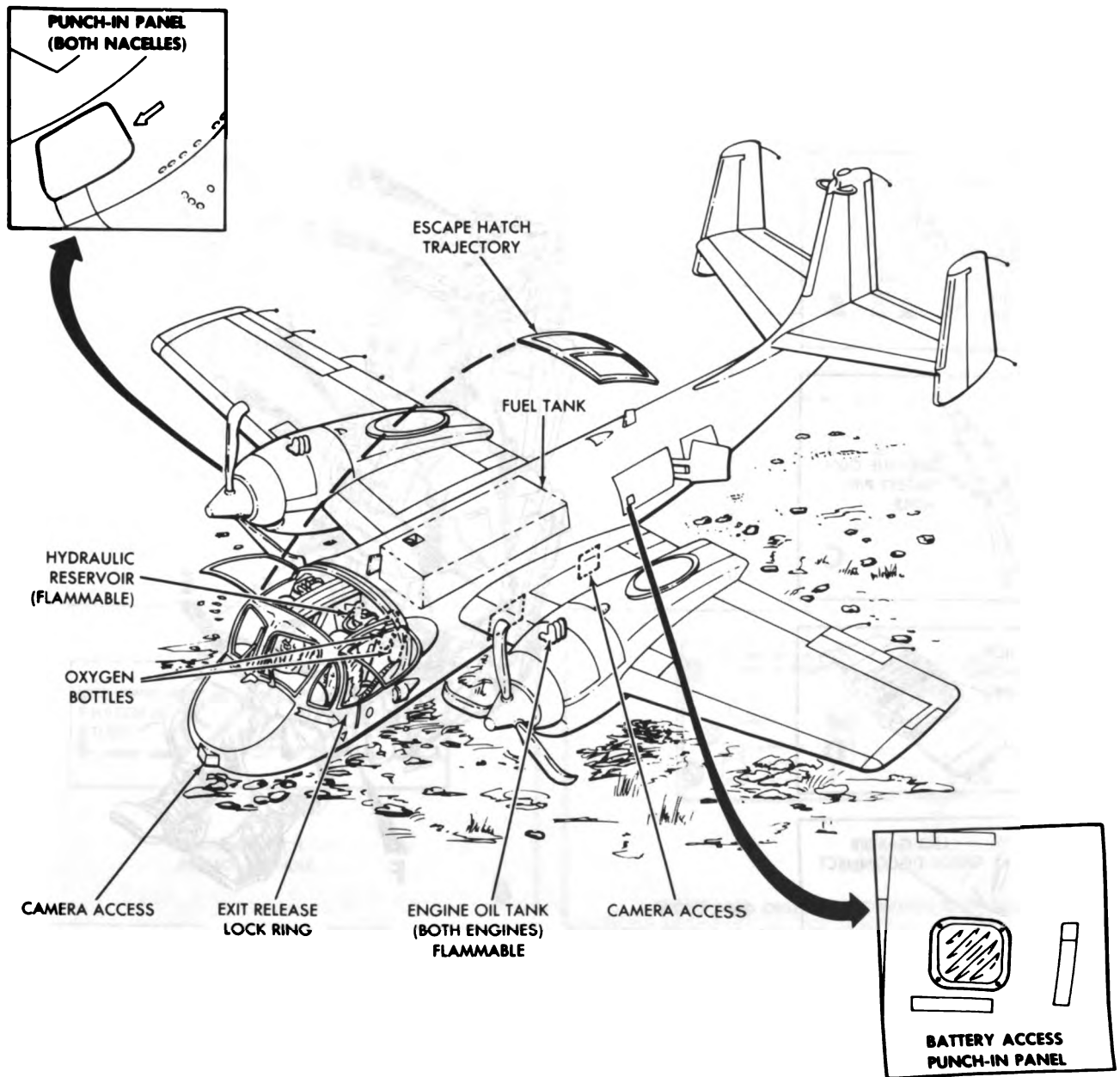
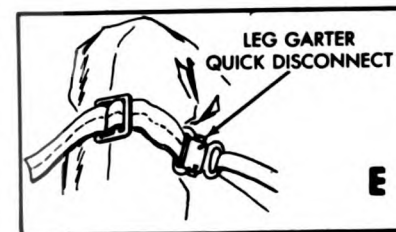
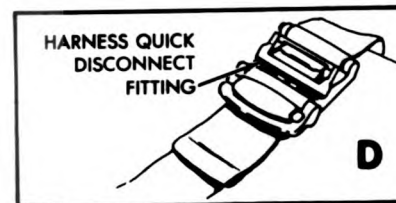
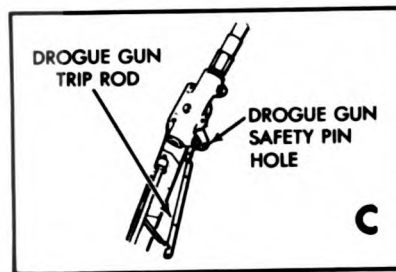
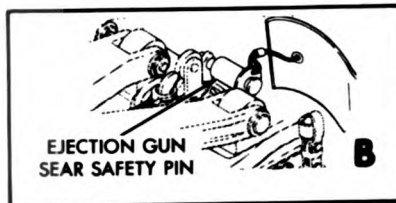
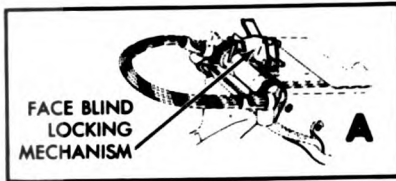

Figure 9-1. Emergency Equipment



A 9-10-D 2-1

Figure 9-2. Emergency Entrance (Sheet 1 of 3)



A 9-10-D-22

Figure 9-2. Emergency Entrance (Sheet 2 of 3)

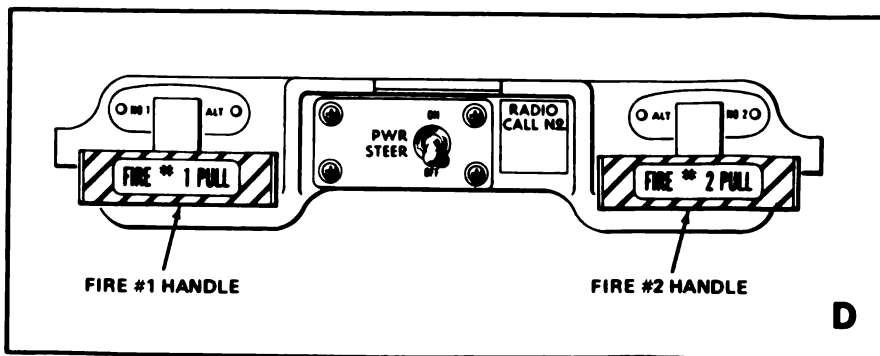
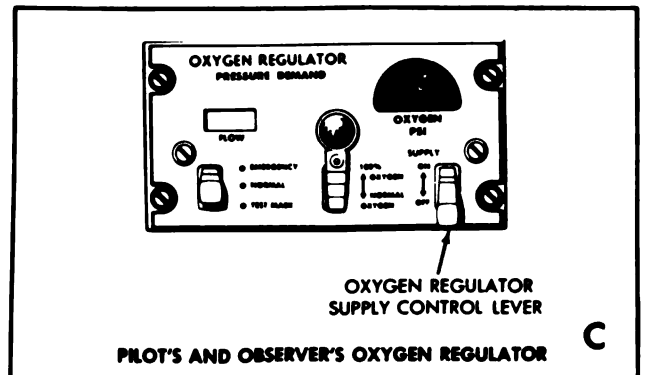
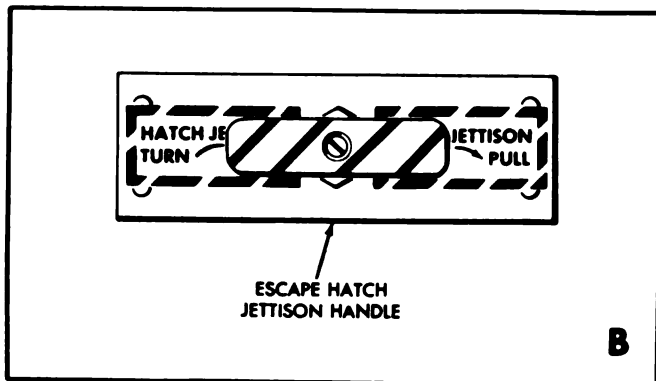
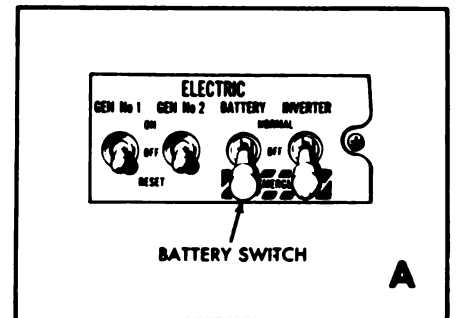
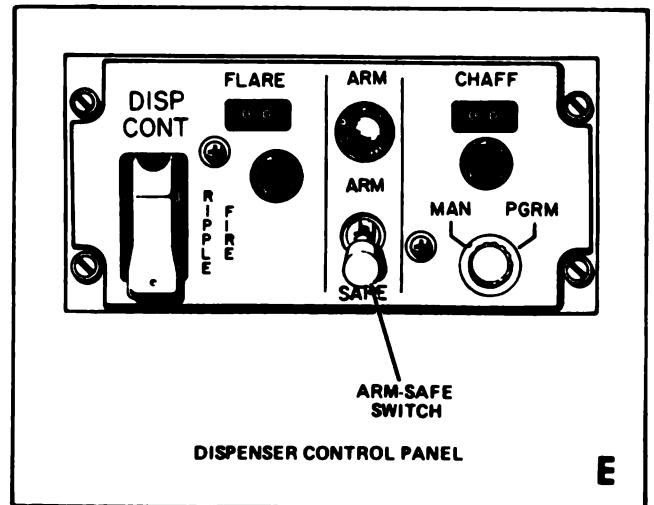
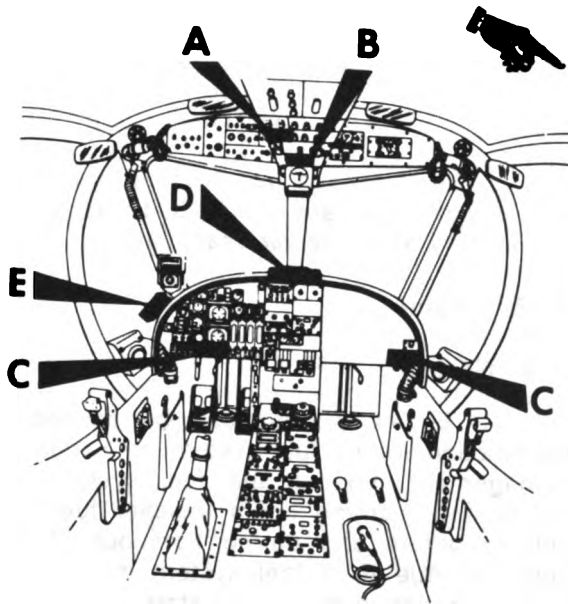

D-8-10-D-2-3

Figure 9-2. Emergency Entrance (Sheet 3 of 3)

**WARNING**

Ensure that all personnel are clear of the escape hatch area and trajectory path before activating the jettison.

3. Jettison escape hatch by rotating escape hatch jettison handle 90° clockwise and pulling.

4. If the aircraft is in an inverted position and the entrance hatch cannot be opened, cut the glass around the edge of the hatch. As a last resort, smash the glass with a heavy object, using care to minimize the amount of glass falling on the occupants.

*c. Ejection Seat Safety.* To prevent accidental ejection of the seats, proceed as follows:

1. Lift the red tab of the face blind locking mechanism (figure 9-2).

2. Insert safety pin in ejection gun sear. If safety pin is not available, a metal pin, the diameter of a ten-penny nail can be used.

3. Remove drogue gun trip rod safety pin and insert it in drogue gun safety pin hole.

4. Lift the lower firing handle safety guard.

*d. Cockpit Deactivation (Time Permitting).* To deactivate the cockpit, proceed as follows:

**NOTE**

*If fire should break out and fire fighting equipment is not available, a hand fire extinguisher is on the left side of the pilot's ejection seat (figure 9-1). Apply extinguishing agent to fire through any of the access panels and doors shown in figure 9-2. Battery power must be available for fire extinguishers to operate.*

1. Fire handles – PULL. If an engine fire exists, discharge both fire extinguishers into the affected engine (figure 9-2).

2. Battery switch – OFF.

3. Both oxygen regulator supply control levers – OFF.

(O) 4. Flare/chaff dispenser – SAFE. Check that ARM-SAFE switch on dispenser control panel is set to SAFE position.

5. ARMT PWR switch guard down.

**NOTE**

*Gain access to battery through punch-in panel and disconnect battery after cockpit deactivation.*

**9-5. Engine.***a. General.*

(1) Engine failures can be caused by a malfunction in the fuel system or incorrect fuel management. Engine and fuel system instruments and warning lights indicate fuel system failures before and during flameout. If engine failure is due to a fuel system malfunction or fuel mismanagement, an air start can usually be accomplished. If an obvious material or mechanical failure occurs, an air start should not be attempted.

(2) Effective engine operation depends on temperatures, pressures, and turbine speeds being normal. Marginal operating conditions normally indicate engine malfunction and shall be considered adequate cause to abort flight.

(3) Engine compressor surge can be recognized by intermittent engine roughness. Surge can occur with power levers full forward above 16,000 feet altitude. To eliminate surge, reduce engine speed slightly (approximately 1%).

(4) When an engine power loss occurs, an immediate check of the fuel system operation shall be made in accordance with established procedures. When a partial power loss occurs, but sufficient power is available for flight, a precautionary landing shall be made when practical, and the difficulty investigated.

**CAUTION**

If a loss of oil pressure occurs, the engine should be secured as soon as practical, contingent on flight requirements.

(5) If a loss of oil pressure is indicated, oil temperature shall be checked. An increase in oil temperature confirms an engine oil system failure.

*b. Flight Characteristics Under Partial Power Conditions.* If one engine fails, satisfactory flight characteristics permit continuing to a suitable airfield and making a single-engine landing. Landing characteristics are normal except for asymmetric power being applied. Refer to Chapter 7 for performance data pertaining to single-engine operation during the various phases of flight (i.e., climb, cruise, descent, etc.).

*c. Engine Failure Under Specific Conditions.* The following paragraphs describe the procedures to be accomplished if an engine failure should occur under specific conditions.

(1) *During Takeoff Run (Abort).* If an engine fails during the takeoff run and sufficient runway remains for a normal stop, proceed as follows.

**CAUTION**

If the aircraft becomes airborne when the flaps are lowered or during aerodynamic braking, execute a normal landing. After the main gear is on the ground, hold the nose wheel off until effective elevator control is lost.

1. Power levers — GROUND IDLE.
2. Speedbrakes — OUT.
3. Flaps — 45 degrees.
4. Aerodynamic braking — MAXIMUM CONTROLLABLE.

**WARNING**

Do not apply wheel brakes until the nose wheel is on the ground.

**NOTE**

Aft stick application for aerodynamic braking should be applied at the maximum rate possible consistent with airspeed but should not cause the aircraft to become airborne.

**NOTE**

When the nose wheel cannot be kept off the ground (approximately 60 — 65 KIAS), position the stick slightly forward of neutral.

5. Engine — REVERSE IDLE — as required.
6. Braking — As required.

**NOTE**

Brakes should be applied with increasing pressure to avoid skidding and/or blowing the fires.

**WARNING**

When the aircraft comes to a stop, secure both engines (if possible) and release brake pressure as brakes will be very hot. Do not approach wheels from sides until wheels have had approximately 10-15 minutes to cool.

(2) *After Takeoff Below Single-Engine Positive Rate of Climb (Sufficient Runway).* If an engine fails after airborne and sufficient runway remains for a landing, proceed as follows:

1. Power levers — AS REQUIRED.
2. Landing gear — DOWN.
3. Complete normal landing.
4. Perform procedures as prescribed in takeoff run (abort) above.

**WARNING**

If at any time aircraft control is in doubt or unable to clear obstacles, EJECT.

(3) *After Takeoff (Insufficient Runway).* If an engine fails after airborne and insufficient runway remains for a normal landing, proceed as follows:

1. Power levers - TAKEOFF.



**NOTE**

If the autofeather system fails, identify failed engine, retard power lever of suspected engine to confirm identification, and feather the inoperative engine by placing the respective prop lever to the FEATHER position.

If an engine fails during cold weather operation and the power levers are aft of the TAKEOFF position, both power levers shall be advanced to the TAKEOFF position. This insures contact with the microswitches in the control pedestal for autofeathering the propeller on the failed engine.

**WARNING**

If an engine fails during takeoff, before landing gear and flaps are retracted, all external stores shall be jettisoned immediately. Landing gear must be retracted as soon as possible to attain minimum single-engine climb speed. Flap retraction shall be delayed until the flaps-up, single engine minimum control speed is attained. Refer to Chapter 7 for single-engine Vmc and climb speeds.

2. External stores — JETTISON.

**NOTE**

If the landing gear handle is down, external stores can only be jettisoned using the emergency stores release handle.

After the landing gear and flaps have been retracted, the decision whether to jettison external stores must be based upon single-engine climb performance with or without stores, refer to Section II, Chapter 7.

3. Landing gear handle - UP.
4. Flaps — 15° until flaps up Vmc. then UP.
5. If unable to control aircraft or clear obstacles — EJECT.
6. Climbout — Best single-engine rate of climb.

(4) *During Flight.* Engine failure during flight should not cause alarm as the situation is not immediately critical. If one engine fails during flight, proceed as follows:

**NOTE**

In the event of engine failure during flight, banking the aircraft, not in excess of 5° toward the operating engine, will improve aircraft control.

1. Autopilot — Disengage.
2. Power — As required.
3. Speedbrake — IN.
4. Synchrophaser — OFF.
5. Power lever (dead engine) — FLIGHT IDLE.
6. Prop lever (dead engine) — FEATHER.
7. Prop lever (dead engine) — FULL OFF (after feather).
8. Landing gear — As required.
9. Flaps — As required.
10. Power — As required.
11. Air conditioner — OFF/OVRD (as required).
12. External stores — JETTISON (as required).

(5) *Use of Autopilot During Single-Engine Operation.* After single-engine cruise flight is attained, the autopilot may be reengaged. The autopilot will stabilize the aircraft adequately as long as the aircraft is maintained in reasonably good trim. If a substantial speed change develops, or the aircraft is allowed to go out of lateral or directional trim, the aircraft will not maintain control and the aircraft will bank and turn into the dead engine. If this occurs, disengage the autopilot and retrim the aircraft.

of 25,000 feet using JP-4 fuel, or 20,000 feet using JP-5. To restart an engine in flight, proceed as follows:

1. Power lever – FLIGHT IDLE.
2. Prop lever – MIN RPM.
3. Fuel pumps switch – Check ON.
4. Engine crank switch – CRANK and release.
5. Gen pwr assist button – Press and release.
6. Ignition button – Press and hold. Release when engine RPM reaches 40%.

#### NOTE

*If the engine fails to function, place the engine crank switch to INTERRUPT crank and descend to an altitude below 10,000 feet. Repeat restart procedure.*

7. Engine RPM and EGT – Check within limits.
8. Engine RPM – Stabilize.
9. Oil pressure – Check within limits.
10. Hydraulic pressure – Check within limits.

#### CAUTION

Do not unfeather propeller above 145 KIAS.

11. Propeller – UNFEATHER. Release unfeather button at 1,000 RPM.
12. Power – As required. Synchronize power lever and prop lever to operating engine.

*e. Maximum Glide.* In the event of failure of both engines, maximum glide distance can be obtained with landing gear up, flaps up, and propellers feathered. See figure 9-3 to determine maximum glide distance relative to altitude, airspeed, and aircraft gross weight.

*f. Single-Engine Descent Arrival.* During single-engine operation, perform the following checks before entering the traffic pattern:

1. Stores selector switches – OFF and SAFE.
- (O)2. Surveillance equipment – OFF.

*g. Single-Engine Before Landing.* During single-engine operation, perform the following checks before landing:

#### WARNING

During a single-engine approach, if the emergency landing gear extension system is used to lower the gear, the aircraft is committed to land as altitude cannot be maintained with one engine inoperative and the landing gear down. The landing gear cannot be raised hydraulically after the emergency landing gear extension system is used.

Do not engage autopilot during single-engine approach or landing maneuvers.

1. Landing gear – DOWN (below 153 KIAS).
2. Flaps – 15°.
3. Propeller – Set (1,600 RPM).
4. Gear down indications – Check gear handle light-out, hydraulic pressure-up, visual check of main gear.
5. Landing and taxi lights – As required.
- (O)6. IRCM-OCU – OFF.

# GLIDE DISTANCE

FLAPS UP    GEAR UP    PROPS FEATHERED    ALL STORES  
 WITHOUT LSSS IR SUPPRESSOR

GLIDE DISTANCE  
 OV-1D/RV-1D  
 T53-L-701



WEIGHT ~ LB	IAS ~ KT
12000	114
14000	122
16000	130
18000	138

## EXAMPLE

### WANTED

GLIDE DISTANCE AVAILABLE  
 AND GLIDE SPEED TO USE

### KNOWN

CRUISE ALTITUDE = 17000 FT  
 GROUND ELEVATION = 2800 FT  
 WEIGHT = 16000 LB.

### METHOD

HEIGHT ABOVE TERRAIN = 17000-2800 = 14200 FT  
 ENTER HEIGHT ABOVE TERRAIN HERE →  
 MOVE RIGHT TO LINE  
 MOVE DOWN, READ GLIDE DISTANCE = 20.5NM  
 ENTER TABLE FOR 16000 LB  
 READ GLIDE IAS = 130

### NOTE

EXTEND LANDING GEAR ONLY WHEN  
 ASSURED OF REACHING LANDING SITE.

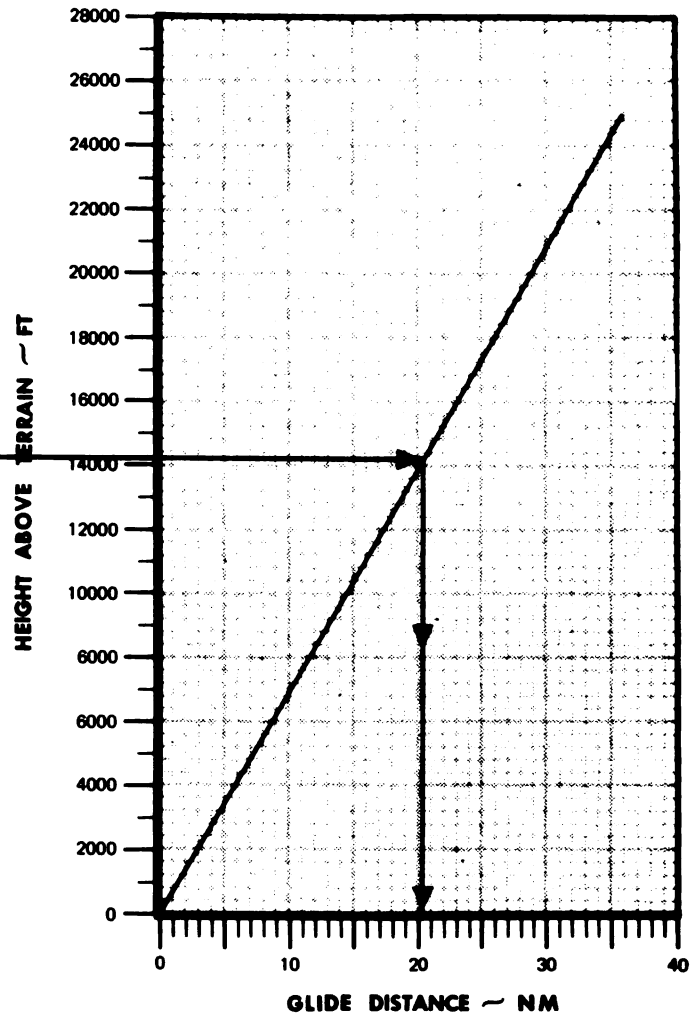

DATA BASIS: ESTIMATED

B-9-10-D-3-1

Figure 9-3. Maximum Glide Distance (Sheet 1 of 2)

# GLIDE DISTANCE

**FLAPS UP    GEAR UP    PROPS FEATHERED    ALL STORES**  
**WITH LSSS IR SUPPRESSOR**

GLIDE DISTANCE OV-1D/RV-1D T53-L-701
--

WEIGHT ~ LB	IAS ~ KT
12000	110
14000	119
16000	127
16000	135

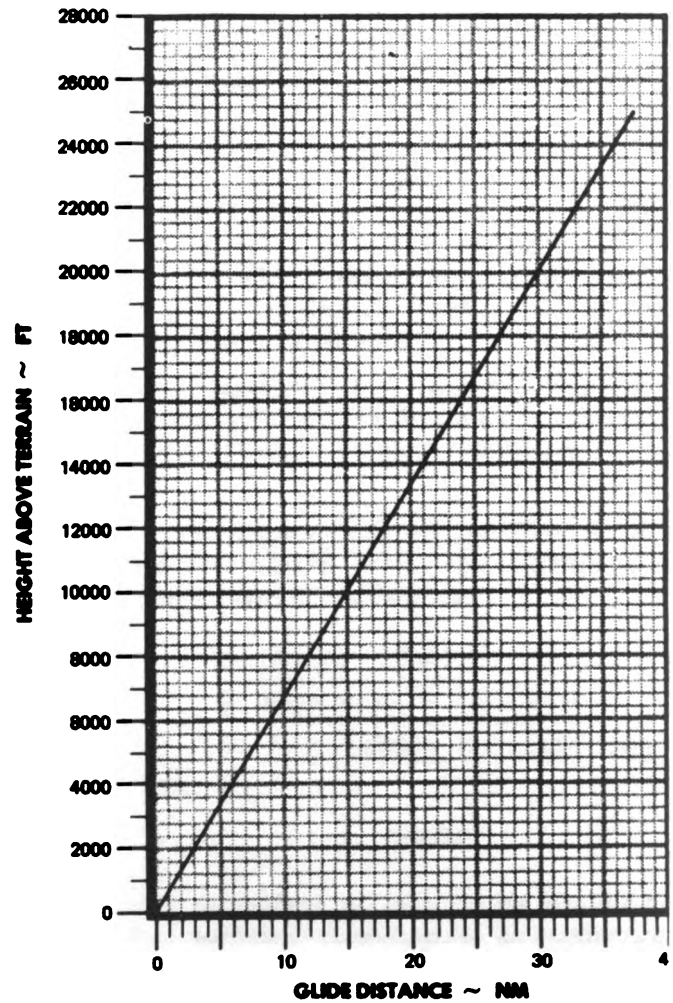

DATA BASIS: ESTIMATED

9-10-D-3-2

Figure 9-3. Maximum Glide Distance (Sheet 2 of 2)



*h. Single-Engine Landing.* Perform the following procedure for single-engine landing:

1. Landing gear — Recheck DOWN.
2. Prop lever — MAX RPM.
3. Air-conditioning master switch — OFF.

*i. Single-Engine Go-Around.* The decision to go-around shall be made as early as possible since the conditions governing any single-engine go-around are critical. If sufficient altitude is not available to allow acceleration to minimum single-engine climb speed, a straight ahead touchdown will be required. If there is any doubt that this can be safely done, EJECT. The procedures for single-engine go-around are as follows:

1. Power — Maximum controllable power.
2. Speed brake — IN.
3. Landing gear — UP.
4. Flaps — 15° until flaps up Vmc, then

UP.

5. External stores — JETTISON — As required.
6. Climb power — Set.
7. Wheel and flap indicator — Check.
8. Landing light — As required.

*j. Both Engines Inoperative — EJECT.*

*k. Chip Detector Warning Light.* If the chip detector warning light should go on, proceed as follows:

1. Engine instruments — Monitor.
2. Land as soon as practicable.

#### 9-6. Propeller.

*a. Failure of Propeller Governor.* If the propeller governor fails to control propeller speed, raise the nose of the aircraft to put a load on the propeller and proceed as follows:

1. Airspeed — Reduce.
2. Power lever — FLIGHT IDLE.
3. Prop lever — FEATHER if propeller is still uncontrollable.
4. Prop lever — Fuel OFF.

5. Synchrophaser — OFF.

*b. Uneven Reverse Thrust.* The worse yaw condition occurs when an upwind propeller reverses and a downwind propeller does not. If loss of directional control occurs due to uneven reverse thrust when propellers are reversed after touchdown, proceed as follows:

1. Power levers (immediately on loss of control) — Minimum reverse power setting.
2. Power levers (if yaw persists and runway length and conditions permit) — GROUND IDLE (forward thrust).

#### 9-7. Fire.

##### NOTE

*An open ENGINE MASTER NO. 1 or NO. 2 circuit breaker will render the applicable engine fuel shutoff valve inoperative.*

*a. Engine Fire.* The following paragraphs outline procedures to be followed in the event of an engine fire under various conditions.

*(1) Engine Fire on the Ground.* If an engine fire occurs while the aircraft is on the ground, proceed as follows:

1. Brakes — Set.
2. Prop levers — FEATHER.
3. Fire handle (affected engine) — PULL.

##### NOTE

*Activation of one bottle should be sufficient to extinguish an engine fire. In the event one bottle does not extinguish the fire, activate second bottle into effected engine.*

4. Discharge switch — Activate (both bottles into affected engine as required).
5. Battery switch — OFF.

6. Abandon aircraft.

(2) *Engine Fire in Flight (Fire Handle Light Illuminated)*. If an engine fire is suspected in flight, proceed as follows:

1. Power lever – FLIGHT IDLE. Attempt visual identification of fire.
2. Fire handle light out – Advance power lever slowly and avoid overheating condition.
3. Monitor engine instruments and land as soon as practical.
4. Fire handle light illuminated – Perform engine fire in flight (identified) procedure.

(3) *Engine Fire in Flight (Identified)*. If an engine fire is confirmed in flight, proceed as follows:

1. Power lever – FLIGHT IDLE.
2. Prop lever – FEATHER.
3. Fire handle – PULL.

**NOTE**

*Activation of one bottle should be sufficient to extinguish an engine fire. In the event one bottle does not extinguish the fire, activate second bottle into effected engine.*

4. Discharge switch – Activate (both bottles into affected engine as required).
5. If smoke or fumes are in the cockpit – Perform fire or smoke, source unknown.
6. If fire continues or aircraft control remains in doubt – EJECT.

*b. IRCM Pod Fire*. In the event of a fire in the infrared countermeasures pod, the system is designed to automatically shut down and cut off the fuel supply within the tank. In the event the system does not automatically shut down, or if shutting down does not extinguish the fire, proceed as follows:

1. IRCM-OCU – OFF.
2. If fire continues, applicable stores station(s) – JETTISON.

*c. Fuselage Fire*. In the event of a fuselage fire, proceed as follows:

1. Attempt to identify cause of fire.
2. If fire continues – EJECT.

*d. Wing Fire*. In the event of a wing fire, proceed as follows:

1. Power lever (applicable wing) – IDLE.
2. Prop lever (applicable wing) – FEATHER.
3. Fire handle (applicable wing) – PULL.

**NOTE**

*Activation of one bottle should be sufficient to extinguish an engine fire. In the event one bottle does not extinguish the fire, activate second bottle into effected engine.*

4. Discharge switch – Activate (both bottles into affected engine as required).
5. Transfer pump (applicable wing) – OFF.
6. External lights – OFF.
7. Landing light (left wing) – OFF.
8. If fire continues or aircraft control remains in doubt – EJECT.

*e. Electrical Fire*. In the event of an electrical fire, proceed as follows:

1. Defective circuit – isolate.
2. Defective circuit – OFF.
3. If unable to isolate – Descend to below 6,000 feet (if practicable).
4. Generators – OFF.
5. Battery – OFF.
6. Land as soon as practicable.
7. If fire continues – EJECT.

*f. Smoke or fumes in cockpit:*

1. Oxygen masks – Don. Activate 100% oxygen.
2. Systems air supply switches – CLOSED.
3. Generator switches – OFF.
4. Air cond bypass levers – OPEN.
5. Inverter switch – OFF.
6. Vmc and below 6000 ft – BATTERY switch – OFF.
7. If IMC or smoke continues or aircraft control is in doubt – EJECT.

**9-8. Fuel System.**

*a. Fuel Press Light Illuminated.* A fuel press caution light will illuminate if one or both elements of an engine-driven fuel pump fails. If both elements have failed, the engine will shut down due to fuel starvation. If the fuel press light illuminates, proceed as follows:

1. Engine instruments – Monitor.
2. Land as soon as practicable.

*b. Fuel Pumps Light Illuminated.* An inoperative aircraft fuel boost pump or an indicated or suspected low fuel pressure condition is not an immediate danger to flight. The engine-driven pump can provide sufficient fuel pressure to permit the aircraft to operate up to 6,000 feet pressure altitude. If the fuel pumps light illuminates, indicating a loss of fuel boost pump pressure, proceed as follows:

1. Circuit breakers – Check.
2. Fuel pumps switch – Check ON.
3. Light still illuminated – Descend to 6,000 feet pressure altitude or below (if practicable).
4. Avoid negative G's.
5. Land as soon as practicable.

**9-9. Electrical System Failure.****WARNING**

If battery overheats, do not open battery compartment or attempt to disconnect or remove battery. Battery fluid will cause burns, and overheated battery could cause thermal burns and may explode.

*a. Generator Light Illuminated.* If a generator light illuminates, proceed as follows:

**NOTE**

*Following the failure of a DC generator, check the amperage load on the operating generator to determine that the full-load rating of 400 amperes is not exceeded. If required, the pilot shall manually monitor the connected loads to limit the generator output to its 400-ampere rating.*

1. Gen switch – RESET, then ON.
2. Gen switch (light still illuminated) – OFF.
3. Land as soon as practicable.

*b. Both Generators Inoperative.* If both generators fail and will not reset, proceed as follows:

1. Battery switch – EMERGENCY.
2. Inverter switch – As required.
3. Emer cont circuit breaker – Pull.

**NOTE**

*If the SAI OFF warning flag becomes unmasked during remaining flight, reset EMER CONT circuit breaker.*

4. All unnecessary electrical equipment – OFF.
5. Land as soon as practicable.



**NOTE**

*The CVS battery will provide power to operate the SAI, turn and slip indicator, transponder, altimeter-encoder vibrator, and essential cockpit lighting for 2 to 4 hours, depending on cockpit lighting requirements.*

*External stores on store stations 3 and 4 are mechanically released. Other jettisonable stores are electrically jettisoned with battery power by pulling the emergency stores release handle, and, therefore, if jettison is to be accomplished under these circumstances, it must be done before the loss of the aircraft battery.*

*c. Inst Pwr Light Illuminated.* If the inst pwr light illuminates, proceed as follows:

1. Inverter switch — EMERGENCY.
2. Circuit breakers — Check and reset if required.
3. Inverter switch (light still illuminated) — OFF.
4. Land as soon as practicable.

*d. Overload Indications.* If both ammeters show an overload indication, proceed as follows:

1. Defective circuit — Isolate.
  2. Defective circuit — OFF.
- If Unable to Isolate:
3. All unnecessary electrical equipment — OFF.
  4. Land as soon as practicable.

*e. G796 BATT Light Illuminated or INS Failure.* If the G796 BATT light remains illuminated or the INS fails, proceed as follows:

**NOTE**

*Failure of the INS will cause the BDHI, flight director system, and autopilot (nav mode) to become inoperative. If the INS malfunction light illuminates in flight, indicating a malfunction in the system, the backup compass system (AN/ASN-76) should be selected to obtain normal flight and navigation information.*

1. Autopilot — Disengage.

**NOTE**

*Anytime the position of the nav mode switch is changed during flight, the autopilot shall be disengaged first. This will insure that no sudden change in heading information is introduced into the autopilot.*

2. Nav mode switch — BACK-UP COMP.
3. Compass heading and flux valve — Synchronize, if required.
4. G796 — OFF.
5. BDHI/course selector panel — Set to ADF/VOR/TAC, as required.
6. Flight director system and BDHI — Check indications.
7. Autopilot — As required.

**NOTE**

*The autopilot nav mode of automatic lateral control is inoperative with the nav mode switch in the BACK-UP COMP position; therefore, some position other than NAV must be selected.*

8. Electrical load indications — Check.

**9-10. Hydraulic Failure.**

If a hydraulic failure occurs when the flaps are extended, unusual lateral stick forces can be expected. Raising the flap handle to the UP position will allow the flaps and inboard ailerons to blow up (but not necessarily lock up), alleviating the stick forces. If a loss of hydraulic pressure occurs with the flaps extended, proceed as follows:

**NOTE**

*The flaps shall not be extended if a malfunction of the hydraulic system is suspected.*

1. Airspeed - Above 120 knots.
2. Banking attitude - Level as possible.
3. Flap handle - UP. Allow flaps to blow up (8 to 15 seconds).
4. Perform no-flap approach and landing.

**9-11. Landing and Ditching.**

The following paragraphs provide procedures to be accomplished when landing and ditching emergencies arise.

*a. Landing with Engines Inoperative.* Refer to engine failure paragraph 9-5h.

*b. Emergency Descent.* Perform the following procedure for emergency descent:

1. Air-conditioning master switch - ON.
2. Upper, lower, and foot air outlets - Close.
3. Defog top/side switch - MAX position.

**NOTE**

*When the defog top/side switch is in the MAX position, the temperature of the air from the defogging*

*nozzles may reach 121°C, regardless of the position of the auto temp control knob. Failure to close the upper, lower, and foot air outlets will allow this hot air to be directed to the pilot's and observer's position.*

4. Prop levers - MAX RPM.
5. Power levers - FLIGHT IDLE.
6. Speed brake - OUT.
7. Airspeed - Vmo.

**NOTE**

*With the air-conditioning system operating, fog may accumulate in the cockpit. When descending, condensation may also form on the interior surfaces. This is a normal condition and should not cause alarm.*

*c. Landing Gear System Failure.* In the event of a landing gear system failure, proceed as follows:

1. Hydraulic pressure - Check.
2. Landing gear handle - Recycle.
3. Landing gear - Check. Check gear handle light-out, hydraulic pressure-up, visual check of main gear.

**NOTE**

*When any of the gear cannot be extended using the normal hydraulic system and/or an unsafe gear indication is noted, the emergency gear extension system shall be used to lower the remaining gear.*

*d. Emergency Gear Extension.* If the landing gear cannot be extended hydraulically, proceed as follows:

**WARNING**

During a single-engine approach, when the emergency landing gear extension system is used, the aircraft is committed to land as altitude cannot be maintained with one engine inoperative and the landing gear down. The landing gear cannot be raised hydraulically after the emergency landing gear extension system is used.

1. Airspeed – Reduce (below 153 KIAS).
2. Landing gear handle – DOWN.
3. Emergency landing gear release handle – PULL.
4. Gear indications – Check for gear down condition.

*e. Landing with One Main Gear Up or Unlocked.*

(1) If a landing gear indicator shows an unsafe indication, every possible means should be used to determine the position of the landing gear. If it can definitely be determined that one main gear is not down and locked, then the decision rests with the pilot as to whether to retract the landing gear, if possible, and land gear up, or land with one main gear extended.

(2) If a landing is to be made with one main gear up or unlocked and the remaining gear down, then it is recommended that the landing be made on a prepared runway. If at all possible, the runway should be foamed for at least 1,500 feet. Make a normal landing with the planned touchdown at the beginning of, or very slightly short of the foamed area, so as to allow the aircraft to slide in the foamed area to reduce the fire hazard. After touchdown, hold the unsafe wheel off as long as possible, allowing the wheel or wing to smoothly touch down with minimum speed. Do not allow the wing to fall through and hit hard as this could cause more extensive damage.

(3) To assist in holding the unsafe wheel off until the airspeed has decreased to the absolute minimum, it is recommended that a 15-degree down flap setting (detent position) be used for landing. Proceed as follows:

1. Before landing checks – Complete.
- (O) 2. External stores stations 1, 5, and 6 – JETTISON.

**NOTE**

*A satisfactory landing can be made using an empty drop tank as a skid, or on the SLAR antenna, if installed.*

3. Drop tanks – If drop tanks contain fuel, the fuel should be burned off. If this is not possible, the tanks shall be jettisoned.

**NOTE**

*When the escape hatch is jettisoned in flight, a blast of air with accompanying dust and dirt particles may be created. Lowering the helmet visor prior to jettisoning the hatch may provide protection for the eyes.*

4. Escape hatch – JETTISON.
5. Ejection seats – SAFE.
6. Power levers – As required.
7. Prop lever (gear up side) – FEATHER (after touchdown).
8. Reverse thrust – As required on opposite side of retracted gear to maintain directional control.
9. Prop lever – FEATHER.
10. Battery switch – OFF.
11. Abandon aircraft.

*f. Landing with Main Gear Down, Nose Gear Up or Unlocked.*

(1) If a landing gear indicator shows an unsafe indication, every possible means should be used to determine the position of the landing gear. If it can definitely be determined that the nose gear is not down and locked, then the decision rests with the pilot as to whether to retract the main gear, if possible, and land gear up, or to land with the main gear extended.

(2) If a landing is to be made with the nose gear up or unlocked and the main gear down, then it is recommended that the landing be made on a prepared runway. If at all possible, the runway should be foamed for at least 1,500 feet. Make a normal landing with the planned touchdown at the beginning of, or very slightly short of the foamed area, so as to allow the aircraft to slide in the foamed area to reduce the fire hazard. After touchdown, hold the nose wheel off as long as possible, allowing the nose to smoothly

touch down with minimum speed. Do not allow the nose to fall through and hit hard as this could cause more extensive damage.

(3) To assist in holding the nose wheel off until the airspeed has decreased to the absolute minimum, it is recommended that a no-flap landing, or at least minimum flap setting be used. After touchdown, flaps, if extended should be retracted. Adjusting to full nose down elevator trim at this point will aerodynamically increase up elevator control effectiveness, thus, allowing a much lower nose wheel touchdown speed. Proceed as follows:

1. Before landing checks — Complete.
- (O) 2. External stores stations 1, 5, and 6 — JETTISON.

3. Drop tanks — If drop tanks contain fuel, the fuel should be burned off. If this is not possible, the tanks shall be jettisoned.

4. Flap handle — UP.

#### NOTE

*When the escape hatch is jettisoned in flight, a blast of air with accompanying dust and dirt particles may be created. Lowering the helmet visor prior to jettisoning the hatch may provide protection for the eyes.*



5. Escape hatch — JETTISON.
6. Ejection seats — SAFE.
7. Power levers — As required.
8. Landing attitude — Nose high. Make landing on main gear and keep nose up as long as possible.
9. Prop levers (after touchdown) — FEATHER.
10. Brakes — Minimum. Use minimum braking throughout landing roll.
11. Battery switch — OFF.
12. Abandon aircraft.

*g. Landing with Flat Tire.* Landing with a flat tire should be made in the normal manner using the following procedures:

1. Land on side of runway favoring good tire.
2. Brake — On good wheel only.
3. Flat nose tire — Use light braking.

*h. Ditching* (figure 9-4). In an emergency condition over water when airspeed can be maintained, ejection may not be advantageous. When ditching, maintain normal approach speed. Flareout should be executed in time to halt the rapid sink rate, and contact with the water should be made in a nose-high attitude. The following procedures should be followed:

1. Radio — Distress procedure performed.
2. Transponder — Emergency mode.
3. Right seat occupant — Alerted of decision to ditch.
4. Landing gear handle — UP.

#### NOTE

*If the landing gear handle is down, external stores can only be jettisoned using the emergency stores release handle.*

- (O) 5. External stores stations 1, 5, and 6 — JETTISON.

#### NOTE

*Do not jettison empty drop tanks as they will aid in keeping the aircraft afloat.*

6. Drop tanks — JETTISON (if full).
  7. Flaps — 45°.
  8. Ejection seats — SAFE.
  9. Inertia reel — LOCKED.
- Before Impact:

#### NOTE

*When the escape hatch is jettisoned in flight, a blast of air with accompanying dust and dirt particles may be created. Lowering the helmet visor prior to jettisoning the hatch may provide protection for the eyes.*

10. Escape hatch — JETTISON.
  11. Power levers — FLIGHT IDLE.
  12. Prop levers — FEATHER.
- After Impact:
13. Parachute release fittings — Disconnect.

#### WARNING

**Do not activate manual override until aircraft has come to a complete stop.**

14. Manual override — Activate.
15. Leg garters — Squeeze manual release.

PLANNED DITCHING		IMMEDIATE DITCHING	
PILOT		PILOT	
A. TRANSMIT DISTRESS MESSAGE		A. ALERT RIGHT SEAT OCCUPANT	
B. SELECT TRANSPONDER EMERGENCY MODE		B. TRANSMIT DISTRESS MESSAGE	
C. ALERT RIGHT SEAT OCCUPANT		C. SELECT TRANSPONDER EMERGENCY MODE	
D. GEAR UP		D. SAFETY EJECTION SEAT	
E. JETTISON EXTERNAL STORES EXCEPT EMPTY DROP TANKS		E. LOCK INERTIA REEL	
F. JETTISON FULL DROP TANKS		F. JETTISON ESCAPE HATCH	
G. SET FLAPS TO 45°		G. PROP LEVERS TO FEATHER	
H. SAFETY EJECTION SEAT		H. LAND AND DITCH AIRCRAFT	
I. LOCK INERTIA REEL		I. DISCONNECT PARACHUTE RELEASE FITTINGS	
J. JETTISON ESCAPE HATCH		J. ACTIVATE MANUAL OVERRIDE	
K. POWER LEVERS TO FLIGHT IDLE		K. DISCONNECT LEG GARTERS	
L. PROP LEVERS TO FEATHER		L. EXIT AIRCRAFT THROUGH ESCAPE HATCH	
M. LAND AND DITCH AIRCRAFT			
N. DISCONNECT PARACHUTE RELEASE FITTINGS			
O. ACTIVATE MANUAL OVERRIDE			
P. DISCONNECT LEG GARTERS			
Q. EXIT AIRCRAFT THROUGH ESCAPE HATCH			
RIGHT SEAT OCCUPANT		RIGHT SEAT OCCUPANT	
A. ACKNOWLEDGE ALERT		A. SAFETY EJECTION SEAT	
B. SAFETY EJECTION SEAT		B. LOCK INERTIA REEL	
C. LOCK INERTIA REEL		C. BRACE FOR IMPACT	
D. BRACE FOR IMPACT		D. DISCONNECT PARACHUTE RELEASE FITTINGS	
E. DISCONNECT PARACHUTE RELEASE FITTINGS		E. ACTIVATE MANUAL OVERRIDE	
F. ACTIVATE MANUAL OVERRIDE		F. DISCONNECT LEG GARTERS	
G. DISCONNECT LEG GARTERS		G. EXIT AIRCRAFT THROUGH ESCAPE HATCH	
H. EXIT AIRCRAFT THROUGH ESCAPE HATCH			

B-9-10-D-4

**Figure 9-4. Ditching Chart**

**NOTE**

*Exiting aircraft with parachute attached will impede egress.*

*Egress cannot be accomplished through the entrance hatches with the seat survival kit attached.*

*The most expedient method of egress is with head down across the windshield. Grasp the pitot tube mount and swing feet downward to regain standing position.*

**16. Exit aircraft - Escape hatch.**

*i. Emergency Egress.* If an emergency develops while the aircraft is on the ground (gear up or down) and the cockpit must be evacuated as quickly as possible, proceed as follows:

1. Manual override - Activate.
2. Leg garters - Squeeze manual release.
3. Lap belt fittings - Release.
4. Parachute release fittings - Disconnect.
5. Oxygen hose - Disconnect.
6. Escape hatch - JETTISON.

**NOTE**

*Emergency exit with the parachute attached impedes egress.*

*Egress cannot be accomplished through the entrance hatches with the seat survival kit attached.*

*The most expedient method of egress is with head down across the windshield. Grasp the pitot tube mount and swing feet downward to regain standing position.*

**7. Exit aircraft – Escape hatch.**

**9–12. Flight Controls Emergency.**

The following paragraphs provide procedures to be accomplished in the event a flight control emergency arises.

*a. Flaps Emergency Operation.* No provisions are made for emergency extension of the flaps. In the event of failure, the normal landing procedures are followed except that the approach for landing is made at the flaps up speed.

*b. Inboard Aileron Emergency Operation.* No provisions are made for emergency operation of the powered inboard ailerons. If one inboard aileron jams, the aircraft is controllable with the other powered inboard aileron plus the outboard ailerons. Anticipate a reduced roll rate in the landing configuration.

**9–13. Bailout.**

If ejection is necessary, it is an established procedure that the observer eject first. At low altitudes, the aircraft should be placed in a shallow climb attitude, if possible. This attitude increases the time available for separation from

the seat and deployment of the parachute. When circumstances permit, slow the aircraft down before ejection to reduce forces exerted on the body. When the aircraft is uncontrollable, ejection should not be delayed.

**WARNING**

The manual override handle shall never be actuated before ejection since both firing handles will be locked and the occupant restraint points will be released.

**NOTE**

*To further ensure safe ejection and survival, refer to TM 10-1670-213-10 and TM 55-1680-316-10.*

*a. Ejection Procedure.* Inform the observer of the decision to eject and, time permitting, proceed as follows (figure 9–5):

1. Radio – Distress procedure performed.
2. Transponder – Other than OFF.

**NOTE**

*When the escape hatch is jettisoned in flight, a blast of air with accompanying dust and dirt particles may be created. Lowering the helmet visor prior to jettisoning the hatch may provide protection for the eyes.*

3. Escape hatch – JETTISON.
4. Sit erect with head pressed back.



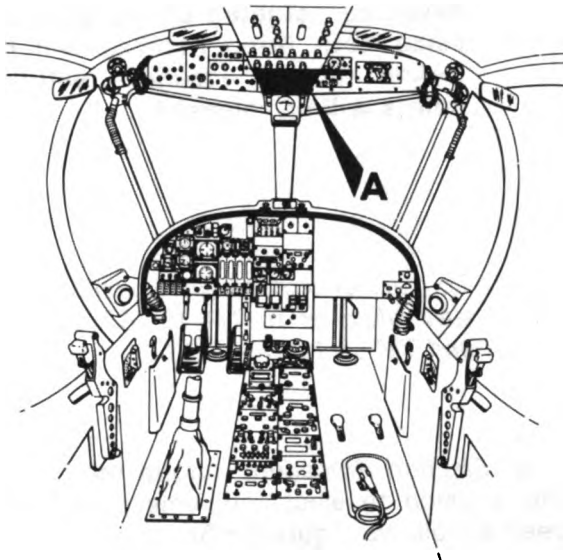

AIRCRAFT COMMANDER WILL MAKE SURE THAT THE OTHER OCCUPANT IS AWARE OF IMMINENT EJECTION, AND RECEIVES AND UNDERSTANDS THE COMMAND TO EJECT.

**WARNING**

MINIMUM OF 60 KNOTS IS REQUIRED FOR GROUND LEVEL EJECTION

TIME PERMITTING, THE FOLLOWING MAY BE ACCOMPLISHED:

- RADIO — DISTRESS PROCEDURE.
- TRANSPONDER — OTHER THAN OFF.
- ESCAPE HATCH — JETTISON.
- SIT ERECT WITH HEAD PRESSED BACK.
- FIRING HANDLE — PULL.

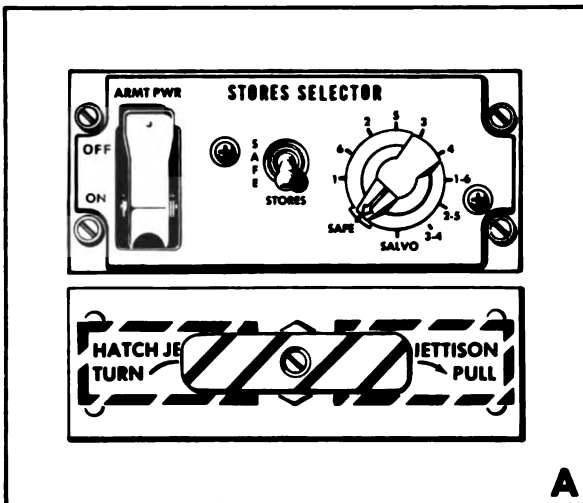

A 9-10-D-5-1

Figure 9-5. Ejection Procedure (Sheet 1 of 2)

**EJECTION PROCEDURE—**

**PRIMARY MEANS OF ESCAPE IS TO  
EJECT THROUGH THE ESCAPE HATCH**

- 1 LOWER FIRING HANDLE—PULL UP**
  - GRASP LOWER FIRING HANDLE WITH ONE HAND AND GRASP WRIST WITH THE OTHER HAND.
  - PULL UP LOWER FIRING HANDLE.

- 2 UPPER FIRING HANDLE—PULL**
  - GRASP UPPER FIRING HANDLE WITH BOTH HANDS (PALMS DOWN) ELBOWS TOGETHER AND PULL OUT AND DOWN SO THAT FACE BLIND COVERS FACE.

**IF SEAT FAILS TO EJECT**

**WARNING**

DO NOT RELEASE HAND HOLD ON FACE BLIND ONCE IT HAS BEEN PULLED. WIND BLAST WILL FLAIL FACE BLIND CAUSING FACIAL INJURY.

- 2 LOWER FIRING HANDLE—PULL UP**
  - HOLD UPPER FIRING HANDLE WITH THE LEFT HAND AND GRASP LOWER FIRING HANDLE WITH THE RIGHT HAND.
  - WHILE HOLDING THE UPPER FIRING HANDLE, PULL UP LOWER FIRING HANDLE.

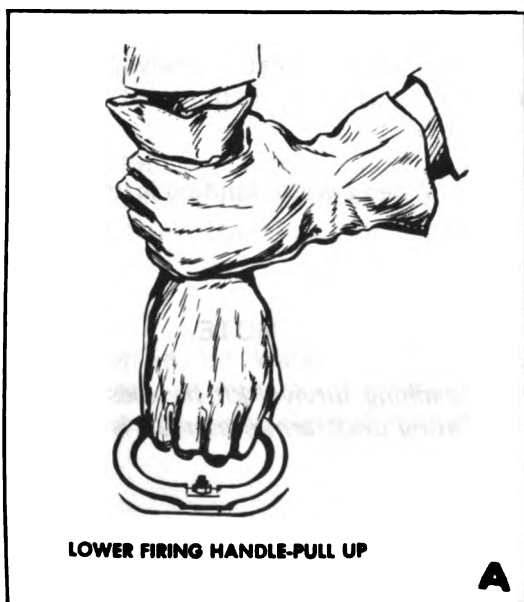

B-9-10-D-5-2

**Figure 9-5. Ejection Procedure (Sheet 2 of 2)**

**WARNING**

While the upper or lower firing handle is being pulled, the occupant shall make a conscious effort to hold his head back against the parachute pack. The natural consequence of pulling the arms down or reaching down between the legs to pull upwards is for the head to move forward, thus placing the spine in a curved position at the time of ejection gun firing. This must be avoided if possible.

During ejection, it is desirable that the occupant use both hands in pulling whichever firing handle is used. The reason for this is to keep both arms close to the occupant while exiting the aircraft. Failure to do this could result in serious injury to the occupant from a limb striking the aircraft while exiting the cockpit.

The additional time required to activate the upper firing handle may preclude successful ejection at low altitudes and/or during uncontrolled flight conditions.

5. Firing handle — PULL.

**NOTE**

*If the seat fails to eject after pulling either handle, pull the other handle.*

*b. Manual Separation from the Seat.* If the time release mechanism malfunctions and the occupant fails to automatically separate from the seat, or if the drogue parachute fails to deploy or extract the personnel parachute, manual deployment of the personnel parachute and separation from the seat is necessary. Proceed as follows:

1. Parachute riser assembly — Grasp left parachute riser assembly up near the parachute pack with the left hand.

2. Manual override handle — Squeeze hand grip; lift and rotate handle to the aft position.

3. Parachute D-ring — With left hand holding the left riser assembly, grasp the parachute D-ring with the right hand.

**NOTE**

*The drag forces exerted by deployment of the personnel parachute automatically causes seat-man separation.*

4. Thrust left shoulder forward with a twisting motion about the waist and with the right hand, pull the D-ring on the parachute pack while still seated.

*c. Parachute Landing.* Perform the following during parachute landings:

1. When a tree landing is imminent:

(a) Helmet Visor — Down to protect eyes from branches.

(b) Oxygen Mask — Loosen to improve natural breathing, but leave attached for added facial protection.

(c) Rigid Seat Survival Kit (RSSK) Container — Do not deploy kit contents until on ground.

2. When a water landing is imminent:

**NOTE**

*Reaching survival kit handles after inflating underarm preservers is difficult.*

(a) Life Preservers — Inflate underarm preservers after deploying survival kit contents, and secure preservers with velcro tabs.

(b) Helmet Visor — Up to prevent neck injury during water entry.

**WARNING**

Failure to remove oxygen mask and subsequent loss of consciousness can result in drowning or suffocation after a successful ejection egress.

(c) Oxygen Mask — Remove from helmet, disconnect from CRU-60/P adapter, and discard.

**CAUTION**

Either RSSK deployment handle may be used. However, inner grip surface must be squeezed before handle is pulled. Failure to squeeze handle inner grip surface will prevent kit contents from being deployed.

**NOTE**

*To provide time for raft to inflate automatically during overwater deployment, deploy kit contents as soon as possible.*

(d) RSSK — Squeeze and pull either survival kit handgrip to deploy survival kit contents and lower section of container in preparation for landing.

(e) Prepare for Water Landing — Eyes on horizon, feet and legs together, toes pointed down, and hands on risers close to KOCH release fittings.

**WARNING**

Do not operate KOCH releases until water entry has been experienced. Distance above water cannot be accurately judged.

(f) Water Landing — Immediately upon entering water, operate KOCH releases to prevent being dragged by wind and/or pulled underwater by waves.

(g) Swim away from parachute canopy and then prepare for water survival by locating and pulling raft and contents within reach.

(h) Secure raft and contents to your parachute harness to prevent loss during subsequent survival efforts.

**WARNING**

To avoid catastrophic damage to raft from sharp objects, the lid of the RSSK container must be removed prior to attempting entry into raft.

(i) Remove RSSK container lid assembly by operating both right and left KOCH releases on lap belt.

(j) Position raft so entry is initiated from either end. Do not attempt entry from either side of raft.

(k) Enter raft by pulling yourself over end and belly-sliding into raft.

*d. Use of Personnel Lowering Device.* The personnel lowering device (figure 9-6) is in the left thigh support of the ejection seat, and is used as follows:



1. Lift cover flap at the top of the left high support and pull the locating strap secured to the left side of the seat cushion with a snap fastener. Pull out an arm's length of lowering line.
2. Pass the line between the forward and rear risers above the canopy release fitting on both the right and left side of the harness.

**WARNING**

Pass the line across in front; do not pass the line behind the helmet.

**CAUTION**

The hook must face outward to prevent disconnecting caused by the canopy release fitting coming into contact with the spring gate on the hook.

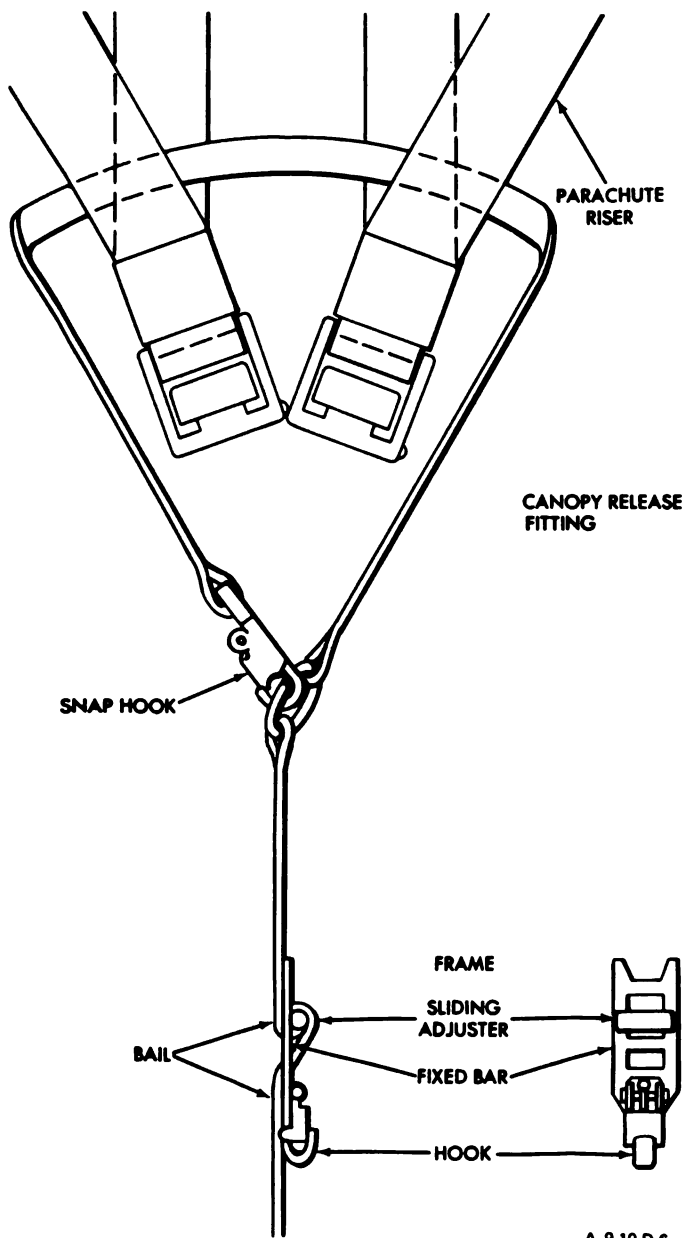

3. Connect the snap hook into the ring with the hook facing out.
4. Connect the lowering mechanism to the V-ring location on the right side of the harness immediately below the right parachute canopy release fitting by passing the V-ring through the hook spring gate on the lowering mechanism.
5. Grasp the lowering line and pull in an outward fashion away from the lowering mechanism so that the line run is slightly above the mechanism.

**NOTE**

*The lowering mechanism is a friction device and, therefore, restrictive (opposite) action to line motion or direction of feed will reduce the descent rate.*

6. With one hand holding outward on the lowering line, release each canopy release fitting separately.

**NOTE**

*Release the right canopy release fitting first to determine that the lowering device is securely attached and does not slip. Then release the left canopy release fitting. When the last canopy release fitting is operated, the right and left risers will come together and the lowering line and securing loop will come taut, causing a slight falling drop.*

**Figure 9-6. Personnel Lowering Device**

7. Pull an arm's length of line out of the left thigh support pad with the free hand.

8. Lower the hand holding the line above the lowering mechanism and slowly feed excess line into the mechanism as the descent begins. The descent is readily controlled by raising the line above the lowering mechanism and restricting line feed with hand pressure.

**WARNING**

Control descent to prevent overheating of the nylon line. A descent rate of 2 to 3 feet per second is recommended, but in no instance exceed 10 feet per second.

9. Attempt to prevent twists in the line from entering the device. Although simple twists will pass through the device in most cases knots will not. If a twist becomes jammed in the device and stops the descent, it is possible in most cases to grasp the line above the device, lift your weight slightly, and let go. This will permit the twist to pass and allow a normal descent to continue.

10. Lowering line stowed in the right thigh support pad is available for use by separating the crossover cover and lifting on the right thigh support pad.

11. Continue pulling the lowering line out of the pads, as necessary.

**SECTION II. EXTERNAL STORES**

**9-14. External Stores Emergency Jettison.**

The emergency jettison of external stores may be accomplished by releasing individually selected stores (or groups of stores), or by releasing all stores in salvo (except fixed-mounted intercept receiver Pods AN/ALQ-133, if installed). The conditions under which the jettison of external stores is recommended will vary, depending on the type of emergency, aircraft position at the time of the emergency (i.e., during takeoff, during landing, at altitude, during single-engine operation, etc.), the condition of the stores at the time of the emergency (i.e., drop tanks full or empty, quantity and type of stores installed), and the weight of the aircraft at the time of the emergency (ability to maintain a positive single-engine rate of climb, ability to maintain altitude, etc.). The requirement to jettison external stores, as well as which stores to jettison and when, is contained throughout this Chapter under the following emergency conditions:

Engine Failure After Takeoff (Insufficient Runway) (paragraph 9-5c(3)).

Engine Failure During Flight (paragraph 9-5c(4)).

Single-Engine Go-Around (paragraph 9-5i).  
IRCM Pod Fire (paragraph 9-7b).

Landing With One Main Gear Up or Unlocked (paragraph 9-11e).

Landing with Main Gear Down, Nose Gear Up or Unlocked (paragraph 9-11f).

Ditching. (paragraph 9-11h).

Either of two methods may be used in the release of external stores; selected jettison using the switches on the stores selector panel in conjunction with the stores release button on the pilot's stick grip, or nonselected jettison of external stores using the emergency stores release handle on the control pedestal.

**NOTE**

*Jettison of full drop tanks will reduce aircraft weight by 2,230 pounds and may preclude the need to jettison other stores.*

*a. Selected Jettison.* To jettison selected external stores, using the switches on the stores

selector panel and the stores release button on the pilot's stick grip, the landing gear handle must be in the up position. This is the method normally used in flight, when time and conditions permit the selected jettison of external stores. To jettison selected external stores, proceed as follows:

#### NOTE

*Unless otherwise noted, all switches and controls are on the stores selector panel.*

1. Station selector switch - As required. Select station(s) of external stores to be released.
2. Stores selector switch - STORES.
3. Armt pwr switch - ON.
4. Stores release button on pilot's stick grip - Press.

#### NOTE

*When the stores release button on the pilot's stick grip is pressed, the external store(s) selected in step 1 will release. The station selector switch will then step clockwise to the next position and that store will be released if the stores release button is again pressed.*

*b. Nonselected Jettison.* The emergency release of external stores provides for a non-selected jettison of all jettisonable stores using the emergency stores release handle on the control pedestal. Use of the emergency stores release handle will mechanically release the stores installed on wing stations 3 and 4, and electrically release the jettisonable stores installed on the other wing stations. The Aero 15 racks installed on the other wing stations must have detonator squibs installed and the aircraft weight must be off the landing gear in order to have a release capability using the emergency stores release handle. Release of external stores using the emergency stores release handle should be done when time and conditions do not permit the selected jettison of external stores, or on takeoff ground roll when the landing gear handle is in the down position and time and conditions do not permit raising the handle. To release external stores using the emergency stores release handle, proceed as follows:

#### NOTE

*Use of the emergency stores release handle while the aircraft weight is on the gear will release stores on wing stations 3 and 4 only.*

1. Emergency Stores release handle - Pull to its limit.





## APPENDIX A

### REFERENCES

Reference information for the subject material contained in this manual can be found in the following documents:

AR70-50	Aircraft Designation System
AR 95-1	Army Aviation - General Provisions
AR 95-9	Navigational Facilities and Instrument Approach Procedures
AR 95-16	Weight and Balance - Army Aircraft
AR 95-51	Aerial Observer Training
AR 310-3	Preparation, Coordination, and Approval of Department of the Army Publications
AR 385-40	Accident Reporting and Records
R 750-1	Maintenance Concepts
AR 750-5	Organization, Policies, and Responsibilities for Maintenance Operations
AR 750-7	Installation Support Maintenance Activities
DA Pam No. 310-1	Index of Administrative Publications
DA Pam No. 310-2	Index of Blank Forms
DA Pam No. 310-4	Index of Technical Manuals
DA PAM 738-751	Functional Users Manual for the Army Maintenance Department System, Aviation (TAMMS-A)
FAR Part 91	General Operating and Flight Rules
FM 1-5	Instrument Flying and Navigation for Army Aviators
FM 1-30	Meteorology for Army Aviators
FM 10-69	Petroleum Handling Equipment and Operations
AVAIR 16-30APN171-1	Radar Set AN/APN-171
TBAVN 23-13	Anti-icing, Deicing, and Defrosting of Parked Aircraft
TB 43-0108	Handling, Storage, and Disposal of Army Aircraft Components Containing Radioactive Material
TB 55-1500-307-24	Aircraft Components Requiring Maintenance Management and Historical Data

**TM 55-1510-213-10**

<b>TB 55-1500-314-24</b>	<b>Handling, Storage, and Disposal of Self-Luminous Aircraft Instrument and Markers, and Aircraft Engine Ignition Exciter Units Containin Radioactive Material</b>
<b>TB 55-9150-200-24</b>	<b>Engine and Transmission Oils, Fuels, and Additives for Army Aircraft</b>
<b>TB 746-93-2</b>	<b>Painting and Marking of Army Aircraft</b>
<b>TM 3-261</b>	<b>Handling and Disposal of Unwanted Radioactive Material</b>
<b>TM 9-1095-206-13 and P</b>	<b>Operator's Aviation Unit Maintenance and Aviation Intermediate Maintenance Manual including Repair Parts and Special Tools List for Dispenser, General Purpose, M130</b>
<b>TM 9-1300-206</b>	<b>Care, Handling, Preservation, and Destruction of Ammunition</b>
<b>TM 11-5821-248-12</b>	<b>Operator and Organizational Maintenance Manual, Radio Set AN/ARC-102</b>
<b>TM 11-5821-259-20</b>	<b>Organizational Maintenance Manual, Radio Set AN/ARC-114</b>
<b>TM 11-5821-260-20</b>	<b>Organizational Maintenance Manual, Radio Set AN/ARC-115</b>
<b>TM 11-5821-262-20</b>	<b>Organizational Maintenance Manual, Communication System Control C-6533/ARC</b>
<b>TM 11-5821-311-12</b>	<b>Operator's and Organizational Maintenance Manual Receiver-Transmitter Radio RT-1167/ARC-164(V)</b>
<b>TM 11-5826-218-12</b>	<b>Operator and Organizational Maintenance Manual, Navigation, Computer Set AN/ASN-33</b>
<b>TM 11-5826-226-20</b>	<b>Organizational Maintenance Manual, Radio Receiving Set AN/ARN-82</b>
<b>TM 11-5826-227-20</b>	<b>Organizational Maintenance Manual, Direction Finder Set AN/ARN-89</b>
<b>TM 11-5826-257-24</b>	<b>Organizational, Direct Support, and General Support Maintenance Manual, Radio Receiver R-1963/ARN</b>
<b>TM 11-5841-283-20</b>	<b>Organizational Maintenance Manual, Detecting Set, Radar Signal AN/APR-39(V)1</b>
<b>TM 11-5841-287-12</b>	<b>Operator's and Organizational Maintenance Manual, Transmitting Set, Radar Data AN/AKT-18B</b>
<b>TM 11-5841-288-20</b>	<b>Organizational Maintenance Manual, Detecting Set, Radar Signal AN/APR-39(V)2</b>
<b>TM 11-5841-288-34(C)</b>	<b>Direct Support and General Support Maintenance Manual, Detecting Set, Radar Signal AN/APR-39(V)2</b>
<b>TM 11-5841-291-12</b>	<b>Operator's and Organizational Maintenance Manual, Radar Warnin System AN/APR-44(V)1</b>
<b>TM 11-5850-242-12</b>	<b>Operator and Organizational Maintenance Manual, Airborne Data Annotation System AN/AYA-10</b>

TM 11-5895-490-20	Organizational Maintenance Manual, Transponder Set AN/APX-72
11-5895-847-14	Operator, Organizational, DS, and GS Maintenance Manual, Countermeasures Set AN/ALQ-147
TM 11-5895-955-10-1	Operator's Manual, Countermeasures Receiving Set AN/ALQ-133, Simulator Set AN/USM-393, and Flight Line Test Set AN/ALM-154
TM 11-5895-1051-12	Operator's and Organizational Maintenance Manual, Countermeasures Sets AN/ALQ-147A(V)1 and (V)2
TM 11-5895-1078-10	Operator's Manual, Radar Surveillance Set AN/APS-94F
TM 11-6140-203-14-2	Organizational Maintenance Manual, Aircraft Nickel-Cadmium Batteries
TM 11-6140-203-15-1	Aircraft and Non-Aircraft Nickel-Cadmium Batteries
TM 11-6615-204-12	Operator and Organizational Maintenance Manual, Automatic Flight Control System AN/ASW-12
TM 11-6615-245-20	Organizational Maintenance Manual, Attitude Heading Reference Set AN/ASN-76
TM 11-6720-228-12	Operator and Organizational Maintenance Manual, LS-59A Photographic Flasher Pod
TM 11-6720-236-12	Operator and Organizational Maintenance Manual, Camera, Still Picture KA-76A and Lens Cones, Camera, Aerial Reconnaissance LA-370A, LA-371A, and LA-372A
TM 11-6720-250-12	Operator and Organizational Maintenance Manual, Photographic Surveillance System KS-113A
TM 11-7035-200-14	Operator, Organizational, DS, and GS Maintenance Manual, Digital Data Set AN/USQ-61
TM 38-250	Packaging and Handling of Dangerous Materials for Transportation by Military Aircraft
TM 55-1500-204-25/1	General Aircraft Maintenance Manual
TM 55-1500-323-25	Organization, DS, GS, and Depot Maintenance Manual, Installation Practices for Aircraft Electric and Electronic Wiring
TM 55-1500-326-25	Standards of Serviceability for Transfer of Army Aircraft
TM 55-1500-328-25	Test Flights and Maintenance Operational Checks for Army Aircraft
TM 55-1500-342-23	Army Aviation Maintenance Engineering Manual: Weight and Balance
M 55-1510-204-ESC	Equipment Serviceability Criteria for Observation Aircraft OV-1

**TM 55-1510-213-10**

<b>TM 55-1510-213-CL</b>	<b>Operator and Crewmembers Manual, Army Model OV-1D and RV-1D Airplane, Observation STOL, Pilot's Checklist</b>
<b>TM 55-1510-213-PMS</b>	<b>Preventive Maintenance Services OV-1D and RV-1D Aircraft</b>
<b>TM 55-1510-213-10/1</b>	<b>Operator's Manual Classified Supplement OV-1D and RV-1D Aircraft</b>
<b>TM 55-1510-217-S</b>	<b>Preparation for Shipment of OV-1/RV-1 Aircraft</b>
<b>TM 55-1680-246-40</b>	<b>GS Maintenance Manual Including Repair Parts and Special Tool Lists, Extinguisher, Fire, Aircraft</b>
<b>TM 55-1680-308-24</b>	<b>Organizational, DS, and GS Maintenance Manual, Ejection Seat, Model MK-J5D (Martin Baker)</b>
<b>TM 55-2840-233-24</b>	<b>Organizational, DS and GS Maintenance Manual, Engine, Turboprop</b>
<b>TM 55-4920-201-14</b>	<b>Operator's, Organizational, DS and GS Maintenance Manual Including Repair Parts and Special Tool Lists, Balancing and Adapter Kits (Marvel), Balancing Kits</b>
<b>TM 55-4920-334-14</b>	<b>Operator's, Organizational, DS and GS Maintenance Manual, Environmental Control System Test Set, (A/E 24T-102) 134SEAV10000</b>
<b>TM 55-6115-499-14</b>	<b>Operator, Organizational, DS, and GS Maintenance Manual Including Repair Parts and Special Tools List, Generator Set, Engine Driven, Model C-26C</b>
<b>TM 750-143</b>	<b>Procedures for Rapid Deployment, Redeployment, and Retrograde, U.S. Army Fixed Wing Aircraft</b>
<b>TM 750-199</b>	<b>Procedures for Rapid Deployment, Redeployment, and Retrograde, U.S. Army Aircraft Component Spare Parts, and Support Equipment Class II(A) and Class IV(A) Supplies</b>
<b>TM 750-244-1-5</b>	<b>Procedures for the Destruction of Aircraft and Associated Equipment to Prevent Enemy Use</b>

## APPENDIX B

## ABBREVIATIONS AND TERMS

For the purposes of this manual, the following abbreviations and terminologies apply. See appropriate technical manuals for additional terms.

ADAS	Airborne Data Annotation System	MAX	Maximum
AEC	Automatic Exposure Control	MHz	Megahertz
AEI	Aerial Exposure Index	MIN	Minimum
AGL	Above Ground Level	MPH	Miles Per Hour
AIDATS	Army Inflight Data Transmission System	MT	Moving Target
ASA	American Standards Association	NMI	Nautical Miles
AMP	Ampere(s)	N1	Engine Speed (% RPM)
BCD	Binary Coded Decimal	PCC	Parameter and Control Computer
°C	Degrees Celsius	PRESS	Pressure
CAS	Calibrated Airspeed	PRESS ALT	Pressure Altitude
CG	Center of Gravity	PROP	Propeller
CLP	Correlation and Location Processor	PSI	Pounds Per Square Inch
CRT	Cathode-Ray Tube	PSP	Pierced Steel Plank
DEG	Degrees	R/C	Rate of Climb
DN	Down	RHA	Recording Head Assembly
ECU	Environmental Control Unit	RPM	Revolutions Per Minute
EGT	Exhaust Gas Temperature	SEC	Second
ELINT	Emitter Location Identification System	SL	Sea Level
°F	Fahrenheit	SLAR	Side Looking Airborne Radar
FAT	Free Air Temperature	SQ	FT Square Feet
FSK	Frequency Shift Keying	TAS	True Airspeed
FT	Foot or Feet	TCR	Tip-Off Compensating Rocket
FT/MIN	Feet Per Minute	TEMP	Temperature
FT/SEC	Feet Per Second	T/O	Takeoff
FUSLG	Fuselage	VA	Volt-Ampere
G	Acceleration of Gravity	VAC	Volts Alternating Current
GAL	Gallon(s)	VDC	Volts Direct Current
GRWT	Gross Weight	VIDS	Vertical Instrument Display System
HP	Horsepower	Vlof	Liftoff Speed (Normally Vr +3 Knots)
HR	Hour	V <sub>mc</sub>	Velocity Minimum Controllable
HYD	Hydraulic	V <sub>mo</sub>	Velocity Maximum Operational
Hz	Hertz	Vr	Rotation Speed
IAS	Indicated Airspeed	Vref	Approach Speed (optimum indicated airspeed at 50 feet above runway elevation with aircraft in landing configuration)
IMC	Image Motion Compensation	Vs	Stall Speed
IN.	Inch	Vso	Stall Speed-Landing Configuration
inHg	Inches of Mercury	Vy	Climb Speed
IP	Instructor Pilot	Vyse	Single-Engine Climb Speed
IR	Infrared	%	Percent
kHz	Kilohertz		
KIAS	Knots Indicated Airspeed		
KT	Knots		
LB	Pound		
LB/HR	Pounds Per Hour		



## ALPHABETICAL INDEX

<i>Subject</i>	<i>Paragraph, Figure, Table, Number</i>	<i>Subject</i>	<i>Paragraph, Figure, Table, Number</i>
<b>A</b>		<b>A (continued)</b>	
Abort Start .....	8-17	Aircraft - Controls .....	2-2
Accelerate Stop Distance		Aircraft Covers and Ground	
Conditions .....	7-46	Safety Locks .....	2-45
Data Basis .....	7-47	Aircraft Designation System .....	1-12
Description .....	7-44	Aircraft - Entrance Hatches,	
Use of Chart .....	7-45	Boarding and Access Ladders ..	2-8
Acceleration Check Distance:		Aircraft Escape Hatch .....	2-7
Conditions .....	7-42	Aircraft - General .....	2-1
Data Basis .....	7-43	Aircraft General Arrangement .....	F 2-2
Description .....	7-40	Aircraft - Indicators .....	2-3
Use of Chart .....	7-41	Aircraft - Landing Gear System ..	2-4
Acceleration - Gross Weight		Aircraft - Power Steering	
Limitations .....	F 5-8	Systems .....	2-5
Acceleration Limits .....	5-22	Aircraft - Seats .....	2-9
AC Electrical System Circuit		Aircraft Systems .....	9-1
Breaker Schematic .....	F 2-40	Aircraft Weighings .....	6-7
AC Electrical System		Airspeed Installation Correction ..	7-18, F 7-3
Schematic .....	F 2-39	Airspeed Limitations .....	5-17, F 5-5
Additional Servicing .....	2-42	Airspeed - Load Factor	
ADF Control Panel		Limitations .....	F 5-7
(AN/ARN-89) .....	F 3-8	Altimeter - Encoder .....	3-18
ADF Set .....	3-10	Altimeter - Encoder	
Aero 65A-1 Rack .....	F 4-32	(AAU-32/A) .....	F 3-21
After Landing .....	8-34	Altimeter Installation Correction ..	7-19, F 7-4
After Takeoff .....	8-25	Antenna Locations .....	F 3-1
Airborne Data Annotation		Anti-icing/Deicing Systems .....	2-32
System .....	4-5	Appendix A, References .....	1-4, A-1
Airborne Emitter Locator		Appendix B, Abbreviations and	
Identification System		Terms .....	1-5, B-1
(AN/ALQ-133) .....	4-11	Approval Fuels .....	T 2-6
Airborne Photographic		Approach Horizon Indicator	
Surveillance System		(AN/ASN-33) .....	F 3-11
KS-113A .....	4-9	Approach Speed:	
Airborne Systems Specialist		Conditions .....	7-74
Responsibilities .....	8-62	Data Basis .....	7-75
Air-Conditioning Control Panel ..	F 2-36	Description .....	7-72
Air-Conditioning System .....	2-35	Use of Charts .....	7-73
Air-Conditioning System		Armament Safety Disabling	
Limitations .....	5-10	Switch .....	F 4-31
Air-Conditioning System		Army Aviation Safety Program ..	1-7
Schematic .....	F 2-35	Automatic Approaches .....	8-44
Aircraft - Brake System .....	2-8	Automatic Navigation Coupler	
Aircraft Compartments and		(AN/ASW-12) .....	F 3-18
Station Diagram .....	F 6-1	Automatic Stabilization	
Aircraft Compartments and		Equipment .....	2-27
Stations .....	6-3	Autopilot .....	3-16



ALPHABETICAL INDEX (continued)

<i>Subject</i>	<i>Paragraph, Figure, Table, Number</i>	<i>Subject</i>	<i>Paragraph, Figure, Table, Number</i>
<b>B</b>			
Bailout .....	9-13		
Balance Definitions .....	6-9		
<b>BDHI/COURSE SELECTOR</b>			
Panel .....	F 3-10		
Bearing Distance Heading			
Indicator (BDHI) .....	F 3-9		
Before Landing .....	8-30		
Before Leaving the Aircraft .....	8-36		
Before Starting Engines .....	8-14		
Before Takeoff .....	8-22		
Before Taxiing .....	8-19		
Brake System .....	2-6		
<b>C</b>			
Camera Body, Front View .....	F 4-12		
Camera Body, Rear View .....	F 4-11		
Camera Systems Loading .....	T 6-2		
Camera Window Door .....	F 4-18		
Cargo Compartments and			
Storage Features .....	6-13		
Caution Annunciator Panel,			
Caution and Warning Lights,			
and Test Switches .....	F 2-10		
Caution Annunciator Panel			
Lights .....	T 2-2		
Center Glareshield .....	F 2-21		
Center Instrument Panel .....	F 2-9		
Center of Gravity Limitations .....	5-13		
Center of Gravity Limits .....	F 6-6		
Center Overhead Console .....	F 2-12		
Central Manual V/H Control			
Panel .....	4-7, F 4-7		
Chapter 7 Index .....	7-6		
Chart C - Basic Weight and			
Balance Record .....	6-10		
Chart Explanation .....	7-5		
Charts and Forms .....	6-5		
Checklist .....	8-10		
Checklist Callout .....	8-11		
Checks .....	8-8		
		<b>C (continued)</b>	
		Circuit Breaker Panels .....	F 2-41
		Climb .....	8-26
		Climb/Descent:	
		Conditions .....	7-70
		Data Basis .....	7-71
		Description .....	7-68
		Use of Chart .....	7-69
		Cockpit General Arrangement .....	F 2-3
		Cold Weather Operation .....	8-57
		Color Coding .....	7-7
		Communication and Navigation	
		Equipment .....	8-40
		Compass Control Panel	
		(AN/ASN-76) .....	F 3-15
		Compass System .....	3-13
		Control Display Monitor	
		(AN/AYA-10) .....	F 4-3
		Control Indicator Control Panel	
		(C-9538/ALQ-133) .....	F 4-25
		Control Pedestal .....	F 2-6
		Controls .....	2-2, 2-25
		Controls and Indicators - Fuel	
		System .....	2-21
		Control Sticks .....	F 2-28
		Control Unit	
		(C-10387/APR-44(V)) .....	F 4-28F
		Copilot or Instructor Pilot (IP)	
		Responsibilities .....	8-63
		Counting Accelerometer .....	4-12, F8-5.1
		Course Indicator (AN/ASN-33) .....	F 3-12
		Crew/Passenger Briefing .....	8-6
		Crosswind - Takeoff or Landing:	
		Conditions .....	7-22
		Data Basis .....	7-23
		Description .....	7-20
		Use of Chart .....	7-21
		Cruise:	
		Conditions .....	7-62
		Data Basis .....	7-63
		Description .....	7-60
		Use of Charts .....	7-61
		Cruise Checks .....	8-27
		Cruise Climb:	
		Conditions .....	7-58
		Data Basis .....	7-59

## ALPHABETICAL INDEX (continued)

<i>Subject</i>	<i>Paragraph, Figure, Table, Number</i>	<i>Subject</i>	<i>Paragraph, Figure, Table, Number</i>
<b>C (continued)</b>		<b>E (continued)</b>	
Description .....	7-56	Ejection Sequence .....	F 2-20
Use of Chart .....	7-57	Electrical Power Supply and Distribution System .....	2-36
<b>D</b>		Electrical System Failure .....	9-9
Dashed Line Data .....	7-9	Electronic Equipment Configuration .....	3-2
Data Basis .....	7-10	Electronic Module Assembly .....	F4-28L
Data Link Power Panel .....	F 4-25B	Emergency Entrance .....	9-4, F 9-2
DC Electrical System Circuit Breaker Schematic .....	F 2-38	Emergency Equipment .....	F 9-1
DC Electrical System Schematic ..	F 2-37	Emergency Equipment - Description .....	2-10
Definitions of Abbreviations .....	7-14	Emergency Exits and Equipment ..	9-3
Defrosting System .....	2-31	Emergency Landing Gear Pneumatic System Pressure Indications with Variations in Ambient Temperature .....	T 2-4 8-18
Descent .....	8-28	Engine Clearing .....	F 2-22
Descent - Arrival Check .....	8-29	Engine Components .....	2-12
Descent - Instrument Flight .....	8-41	Engine Cooling and Pressurization System .....	9-5
Description of Baggage Compartment and Storage Areas .....	6-14	Engine - Emergency Procedures .....	2-15
Desert and Hot Weather Operation .....	8-58	Engine Fuel Control System .....	F 2-24
Designator Symbols .....	1-13	Engine Fuel System Schematic ..	2-14
Destruction of Army Material to Prevent Enemy Use .....	1-8	Engine Instrumentation System .....	2-19
Detecting Set Control Unit (C-9326/APR-39(V)) .....	F 4-26	Engine Instruments and Indicators .....	5-12
Detecting Set Control Unit (C-10412/APR-39(V)) .....	F 4-28C	Engine Power Definitions .....	5-11
Dispenser Control Panel .....	F4-28H	Engine Rating .....	8-21
Ditching Chart .....	F 9-4	Engine Runup .....	2-11
Diving .....	8-48	Engine Shutdown .....	8-35
Drag: Conditions .....	7-66	Entrance Hatches and Boarding Ladders .....	F 2-13
Data Basis .....	7-67	Entrance Hatches, Boarding and Access Ladders .....	2-8
Description .....	7-64	Entrance To Aircraft .....	8-12, F8-3
Use of Chart .....	7-65	Equipment Serviceability Criteria ..	1-9
Drop Chute .....	F 2-34	Escape Hatch .....	2-7
Drop Tank .....	F 4-29	Exceeding Operational Limits .....	5-3
<b>E</b>		Exhaust Blast Danger Area .....	F 8-6
Ejection Procedure .....	F 9-5	Explanation of Change Symbols ..	1-11
Ejection Seat .....	F 2-16	Exposure Settings .....	T 4-1
Ejection Seat Ground Lock Safety Pins .....	F 2-54	Exterior Check .....	F 8-5
Ejection Seat Leg Restraint Cord Routing .....	F 8-4	Exterior Lighting Control Panel ..	F 2-43
Ejection Seat Schematic .....	F 2-19	Exterior Lights .....	F 2-42
		Exterior Lights System .....	2-37



**ALPHABETICAL INDEX (continued)**

<i>Subject</i>	<i>Paragraph, Figure, Table, Number</i>	<i>Subject</i>	<i>Paragraph, Figure, Table, Number</i>
<b>I (continued)</b>		<b>L (continued)</b>	
Inertial Navigation System (INS) ..	3-12	Level Flight Characteristics Under Various Speed Conditions .....	8-50
Inflight Characteristics (Asymmetric Stores Loading) ...	8-55	Limit Landing Sink Speed vs Gross Weight .....	F 5-9 7-4
Infrared Countermeasures (IRCM) Pod (AN/ALQ-147A(V)1 and AN/ALQ-147A(V)2) .....	F 4-22	Limits - Performance Data .....	8-23
Infrared Countermeasures Set AN/ALQ-147A(V)1 and 2 .....	4-10	Lineup .....	F 2-48
INS Alignment Progress .....	T 3-1	Lower Console .....	F 4-19
INS Control Panel (AN/ASN-86) .....	F 3-14	<b>M</b>	
Instrument Approaches .....	8-43	Main Difference Table OV-1D and RV-1D Aircraft .....	T 2-1
Instrument Flight Procedures .....	8-38	Marker Beacon/Glide Slope Control Panel .....	F 3-16
Instrument Glass Alignment Marks .....	5-7	Maximum Torque Limits .....	F 5-3
Instrument Marking Color Codes ..	5-6	Minimum Crew Requirements ...	5-4
Instrument Markings .....	5-5, F 5-1	Minimum Single-Engine Control Speed:	
Interior Lighting Control Panel .....	F 2-45	Conditions .....	7-50
Interior Lights .....	F 2-44	Data Basis .....	7-51
Interior Lights System .....	2-38	Description .....	7-48
Intercept Receiver Pod (CY-7410/ALQ-133) .....	F 4-24	Use of Chart .....	7-49
<b>J</b>		Miscellaneous Equipment .....	2-34
Jettison .....	4-15, 4-16	Miscellaneous Instruments, Control Panels, and Consoles ...	2-40
<b>K</b>		Mission Equipment Configuration .....	4-2
KA-60 Mode Operating Chart ..	F 4-9	Mission Planning .....	8-1
KA-60 Panoramic Camera Control Panel .....	F 4-8	MK-J5D Ejection Seat Capabilities Chart .....	F 2-17
KA-76A Camera .....	F 4-10	MK-J5D Rigid Seat Survival Kit (RSSK) .....	F 2-18
<b>L</b>		Mooring Instructions .....	2-46
Landing .....	8-32	M130 General Purpose Dispenser System .....	4-12C, F4-28G
Landing:		<b>N</b>	
Conditions .....	7-78	NAV MODE Panel (AN/ASN-76/86) .....	F 3-13
Data Basis .....	7-79	Normal Flight Characteristics ....	8-45
Description .....	7-76	Normal Rotation/Takeoff Airspeed:	
Use of Chart .....	7-77	Conditions .....	7-38
Landing and Ditching - Emergency Procedures .....	9-11	Data Basis .....	7-39
Landing Check .....	8-31	Description .....	7-36
Landing Checklist .....	F 8-2	Use of Chart .....	7-37
Landing Gear Lock Release .....	F 2-11		
Landing Gear System .....	2-4		
Landing Sink Speed Limitations ..	5-23		
Left Overhead Panel .....	F 2-25		
Lens Cone (6-Inch) .....	F 4-14		

**ALPHABETICAL INDEX (continued)**

<i>Subject</i>	<i>Paragraph, Figure, Table, Number</i>	<i>Subject</i>	<i>Paragraph, Figure, Table, Number</i>
<b>N (continued)</b>		<b>P (continued)</b>	
Numeric Control Display Monitor Self-Test Display (AN/AYA-10).....	F 4-5	+3 BCD Control Display Monitor Self-Test Display (AN/AYA-10).....	F 4-4
<b>O</b>		Pneumatic Systems.....	2-29
Oblique Optical Sight.....	F 4-20	Power Steering System.....	2-5
Oil Loading Data.....	T 6-7	Power Supply - Avionics.....	3-3
Oil Supply System.....	2-16	Power Supply - Mission Equipment.....	4-3
Operating Limits and Restrictions.....	8-2	Preflight Check.....	8-13
Operating Procedures and Maneuvers.....	8-7	Pressure Fueling Station.....	F 2-50
Operational Flight Envelope.....	F 5-10	Principle Dimensions.....	F 2-4
Operator's Control Unit (OCU) (C-10698/ALQ-147A(V)).....	F 4-23	Prohibited Maneuvers.....	5-24
OV-1D and RV-1D Aircraft....	F 2-1	Propeller - Emergency Procedures.....	9-6
Oxygen Duration Chart.....	F 2-31	Propeller Limitations.....	5-8
Oxygen Regulator Panels.....	F 2-30	Propellers.....	2-30
Oxygen System.....	2-33	<b>Q</b>	
<b>P</b>		<b>R</b>	
Panoramic Camera Surveillance System KA-60.....	4-8	Radar Altimeter.....	3-19
Parking.....	2-44	Radar Altitude Indicator (AN/APN-171).....	F 3-22
Passenger Briefing.....	8-64	Radar Signal Indicator Display with No Signal Inputs.....	F 4-28D
Performance.....	8-4	Radar Signal Indicator (IP-1150/APR-39(V)).....	F 4-27
Performance Discrepancies.....	7-13	Radar Signal Indicator Self-Test Mode Display.....	F 4-28E
Performance Planning Card.....	7-15, F 7-1	Radio Set Control Panel (C-10547/ARC-164(V)).....	F 4-25A
Performance Planning Sequence.....	7-17	Reading The Charts.....	7-8
Personnel Lowering Device.....	F 9-6	Responsibility.....	6-6
Personnel Parachute Container and Harness Assembly.....	F 2-16	Right Overhead Panel.....	F 2-47
Personnel Protection.....	F 2-33	Right Side Instrument Panel.....	F 2-46
Photo Control Panel.....	F 4-16	Rolling Limits.....	5-18
Photographic Equipment.....	4-6	Rolling Restrictions.....	F 5-6
Photographic Surveillance System (KS-113A) Limitations.....	5-9	<b>S</b>	
Photographic Surveillance System (KS-113A) Operational Limits..	F 5-2	Sample Form DD 365C, Chart C - Basic Weight and Balance Record.....	F 6-2
Photo Supply Assembly.....	F 4-17	Sample Form DD 365F, Weight and Balance Clearance Form F..	F 6-3
Pilot's Instrument Panel.....	F 2-7	Sample Programming Chart (AN/AYA-10).....	F 4-6
		Seats.....	2-9

ALPHABETICAL INDEX (continued)

<i>Subject</i>	<i>Paragraph, Figure, Table, Number</i>	<i>Subject</i>	<i>Paragraph, Figure, Table, Number</i>
<b>S (continued)</b>		<b>T (continued)</b>	
Servicing .....	2-41	Torque Available For Takeoff:	
Servicing Diagram .....	F 2-51	Conditions .....	7-30
Shutter Assembly, Top View .....	F 4-13	Data Basis .....	7-31
Sideslip Limits .....	5-19	Description .....	7-28
Single-Engine Climb:		Use of Chart .....	7-29
Conditions .....	7-54	Touch-and-Go .....	8-33A
Data Basis .....	7-55	Transponder (IFF) Control Panel	
Description .....	7-52	(AN/APX-72) .....	F 3-20
Use of Charts .....	7-53	Transponder Set .....	3-17
Sloping Console .....	F 2-49	Turbulence and Thunderstorm	
Specific Conditions -		Operation .....	8-59
Performance Data .....	7-11	Turning Radius and Ground	
Speed Range .....	8-39	Clearance .....	F 2-5
Spins .....	8-47	Typical Discriminator Off	
Stall Limits .....	5-21	Mode Display .....	F 4-28
Stalls .....	8-46	Typical Discriminator On	
Stall Speed .....	F 8-7	Mode Display .....	F 4-28A
Standard, Alternate, and		Typical Self-Test Mode	
Emergency Fuels .....	T 2-7	Display .....	F 4-28B
Starter Engagement Limitations .....	5-8A	Typical Service Loading Conditions	
Starting Engines with GPU .....	8-15	OV-1D Aircraft .....	T 6-3
Starting Engines Without GPU .....	8-16	Typical Service Loading Conditions	
Starting System .....	2-18	RV-1D Aircraft .....	T 6-4
Storage and Baggage		Typical Service Loading IR	
Provisions .....	F 6-4	(AN/AAS-24) Equipment	
Stores Selector Panel .....	F 4-30	Installation .....	T 6-6
		Typical Service Loading SLAR	
<b>T</b>		(AN/APS-94F/AN/	
TACAN Control Panel		AKT-18B) Equipment	
(AN/ARN-103) .....	F 3-17	Installation .....	T 6-5
TACAN Set .....	3-15	T53-L-701 Engine	
Takeoff .....	8-24	Limitations .....	T 5-1
Takeoff and Landing Rollout		<b>U</b>	
(Asymmetric Stores Loading) .....	8-54	UHF Control Panel	
Takeoff Checklist .....	F 8-1	(AN/ARC-164(V)) .....	F 3-3
Takeoff - Normal:		UHF Set .....	3-5
Conditions .....	7-34	Use of Words Shall, Should,	
Data Basis .....	7-35	and May .....	1-14
Description .....	7-32		
Use of Chart .....	7-33	<b>V</b>	
Taxiing .....	8-20	VHF Control Panel	
Temperature Conversion		(AN/ARC-115) .....	F 3-5
Correction .....	F 7-2	VHF Set .....	3-7
Thermal Blankets .....	F 2-32	VOR Control Panel	
Thru-Flight Check .....	8-9	(AN/ARN-82) .....	F 3-7
		VOR Set .....	3-9

**ALPHABETICAL INDEX (continued)**

<i>Subject</i>	<i>Paragraph, Figure, Table, Number</i>	<i>Subject</i>	<i>Paragraph, Figure, Table, Number</i>
<b>W</b>		<b>W (continued)</b>	
Warning Page.....	WRN-1	Wind Limitations.....	5-27
Warnings, Cautions, and Notes ...	1-2	Wing Access Ladder.....	F2-14
Weather Control Panel.....	F2-23		
Weight and Balance Clearance		<b>X</b>	
Form F, DD 365F.....	6-11		
Weight, Balance, and Loading ....	8-3	<b>Y</b>	
Weight Definitions.....	6-8		
Weight Limitations .....	5-14	<b>Z</b>	

By Order of the Secretary of the Army:

**BERNARD W. ROGERS**  
*General, United States Army*  
*Chief of Staff*

Official:

**J. C. PENNINGTON**  
*Brigadier General, United States Army*  
*The Adjutant General*

**DISTRIBUTION:**

To be distributed in accordance with DA Form 12-31 Operator Maintenance Requirements for OV-1D aircraft.

\* U.S. GOVERNMENT PRINTING OFFICE : 1990 O - 262-842 (25152)





# The Metric System and Equivalents

## Linear Measure

1 centimeter = 10 millimeters = .39 inch  
 1 decimeter = 10 centimeters = 3.94 inches  
 1 meter = 10 decimeters = 39.37 inches  
 1 dekameter = 10 meters = 32.8 feet  
 1 hectometer = 10 dekameters = 328.08 feet  
 1 kilometer = 10 hectometers = 3,280.8 feet

## Weights

1 centigram = 10 milligrams = .15 grain  
 1 decigram = 10 centigrams = 1.54 grains  
 1 gram = 10 decigrams = .035 ounce  
 1 dekagram = 10 grams = .35 ounce  
 1 hectogram = 10 dekagrams = 3.52 ounces  
 1 kilogram = 10 hectograms = 2.2 pounds  
 1 quintal = 100 kilograms = 220.46 pounds  
 1 metric ton = 10 quintals = 1.1 short tons

## Liquid Measure

1 centiliter = 10 milliliters = .34 fl. ounce  
 1 deciliter = 10 centiliters = 3.38 fl. ounces  
 1 liter = 10 deciliters = 38.82 fl. ounces  
 1 dekaliter = 10 liters = 2.64 gallons  
 1 hectoliter = 10 dekaliters = 26.42 gallons  
 1 kiloliter = 10 hectoliters = 264.18 gallons

## Square Measure

1 sq. centimeter = 100 sq. millimeters = .155 sq. inch  
 1 sq. decimeter = 100 sq. centimeters = 15.5 sq. inches  
 1 sq. meter (centare) = 100 sq. decimeters = 10.76 sq. feet  
 1 sq. dekameter (are) = 100 sq. meters = 1,076.4 sq. feet  
 1 sq. hectometer (hectare) = 100 sq. dekameters = 2.47 acres  
 1 sq. kilometer = 100 sq. hectometers = .386 sq. mile

## Cubic Measure

1 cu. centimeter = 1000 cu. millimeters = .06 cu. inch  
 1 cu. decimeter = 1000 cu. centimeters = 61.02 cu. inches  
 1 cu. meter = 1000 cu. decimeters = 35.31 cu. feet

## Approximate Conversion Factors

To change	To	Multiply by	To change	To	Multiply by
inches	centimeters	2.540	ounce-inches	newton-meters	.007062
feet	meters	.305	centimeters	inches	3.94
yards	meters	.914	meters	feet	3.280
miles	kilometers	1.609	meters	yards	1.094
square inches	square centimeters	6.451	kilometers	miles	.621
square feet	square meters	.093	square centimeters	square inches	.155
square yards	square meters	.836	square meters	square feet	10.764
square miles	square kilometers	2.590	square meters	square yards	1.196
acres	square hectometers	.405	square kilometers	square miles	.386
cubic feet	cubic meters	.028	square hectometers	acres	2.471
cubic yards	cubic meters	.765	cubic meters	cubic feet	35.315
fluid ounces	milliliters	29.573	cubic meters	cubic yards	1.308
pints	liters	.473	milliliters	fluid ounces	.034
quarts	liters	.946	liters	pints	2.113
gallons	liters	3.785	liters	quarts	1.057
ounces	grams	28.349	liters	gallons	.264
pounds	kilograms	.454	grams	ounces	.035
short tons	metric tons	.907	kilograms	pounds	2.205
pound-feet	newton-meters	1.365	kilograms	short tons	1.102
pound-inches	newton-meters	.11375	metric tons		

## Temperature (Exact)

°F	Fahrenheit temperature	5/9 (after subtracting 32)	Celsius temperature	°C
----	------------------------	----------------------------	---------------------	----

