

RESTRICTED

AN 01-60JJA-1

*HANDBOOK*  
FLIGHT OPERATING INSTRUCTIONS  
USAF MODEL  
F-82E (P-82E)  
AIRCRAFT

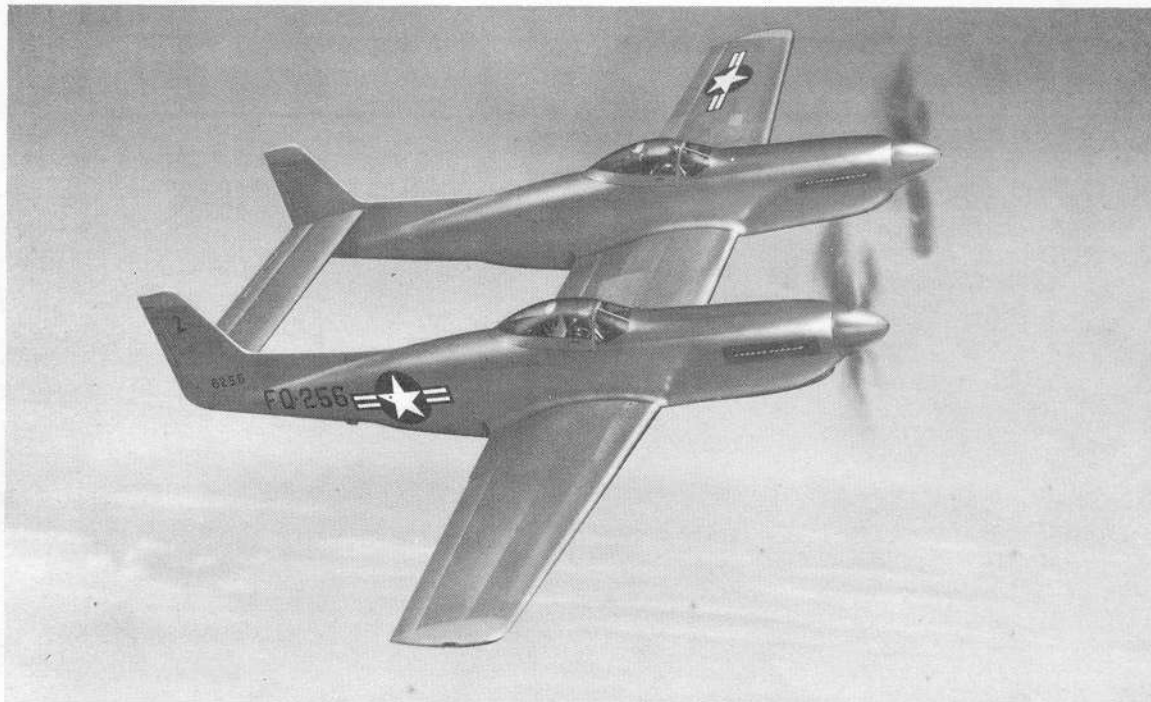

THIS PUBLICATION REPLACES AN 01-60JJA-1 DATED 30 SEPT. 1947

PUBLISHED UNDER AUTHORITY OF THE SECRETARY OF THE AIR FORCE  
AND THE CHIEF OF THE BUREAU OF AERONAUTICS

NOTICE: This document contains information affecting the national defense of the United States within the meaning of the Espionage Act, 50 U.S.C., 31 and 32 as amended. Its transmission or the revelation of its contents in any manner to an unauthorized person is prohibited by law.

RESTRICTED

## POLICY GOVERNING DISTRIBUTION AND USE OF THIS PUBLICATION

### Instructions Applicable to U. S. Army Personnel:

1. This publication is intended for technical aid and education of military and civilian personnel engaged in promoting the war effort. Its maximum distribution and use is therefore encouraged. However, since the publication is "restricted" within the meaning of AR 380-5, the following security regulations will be observed:

a. *Members of Armed Forces and civilian employees of War Department* will be given access to this publication whenever required to assist in the performance of their official duties (including expansion of their knowledge of AAF equipment, procedures, etc.).

b. *Personnel of War Department contractors and subcontractors* may be given possession of this publication, on a loan basis, or knowledge of its contents, only when required to assist in the performance of War Department contracts. Releases will be made in accordance with the requirements of T. O. No. 00-5-2.

c. *Representatives of other governments* will be given possession of this publication, or knowledge of its contents, only in accordance with AAF Letter No. 45-6.

2. This publication is restricted because the information contained in it is restricted. It does not follow that the physical article to which it relates is also restricted. Classification of the materiel or component must be ascertained independently of the classification of this document.

3. Neither this publication nor information contained herein will be communicated to press or public except through Public Relations channels.

### Instructions Applicable to U. S. Navy Personnel:

1. Navy Regulations, Article 76, contains the following statements relating to the handling of restricted matter:

"Par. (9) (a). Restricted matter may be disclosed to persons of the Military or Naval Establishments in accordance with special instructions issued by the originator or other competent authority, or in the absence of special instructions, as determined by the local administrative head charged with custody of the subject matter."

"(b) Restricted matter may be disclosed to persons of discretion in the Government service when it appears to be in the public interest."

"(c) Restricted matter may be disclosed, under special circumstances to persons not in the Government service when it appears to be in the public interest."

2. The Bureau of Aeronautics Aviation Circular Letter No. 90-44 contains the following paragraph relative to the use of aeronautical technical publications:

"Par. 8. *Distribution to All Interested Personnel.* In connection with the distribution of aeronautical publications within any activity, it should be borne in mind by the offices responsible for such distribution that technical publications, whether confidential or restricted, are issued for use not only by officer personnel, but also by responsible civilian and enlisted personnel working with or servicing equipment to which the information applies."

3. Disclosure of technical information in this publication may not be made to representatives of foreign governments except in instances where those foreign governments have been cleared to receive information concerning all equipment covered by this publication.

### LIST OF REVISED PAGES ISSUED

**NOTE:** A heavy black vertical line to the left or in outer margin of text on revised pages, indicates the extent of the revision. This line is omitted where more than 50 percent of the page is revised. A black horizontal line to the left of page numbers listed below indicates pages revised, added or deleted by current revision. This line is used only on second and subsequent revisions.

USAF

### ADDITIONAL COPIES OF THIS PUBLICATION MAY BE OBTAINED AS FOLLOWS:

USAF ACTIVITIES.—In accordance with Technical Order No. 00-5-2.

NAVY ACTIVITIES.—Submit request to nearest supply point listed below, using form NavAer-140:  
NAS, Alameda, Calif.; ASD, Guam; NAS, Jacksonville, Fla.; NAS, Norfolk, Va.; NASD, Oahu;  
NASD, Philadelphia, Pa.; NAS, San Diego, Calif.; NAS, Seattle, Wash.

For complete listing of available material and details of distribution see Naval Aeronautics Publications Index, NavAer 00-500.

**TABLE OF CONTENTS**

| <b>SECTION I</b>                     | <i>Description</i>                      | <b>PAGE</b> | <b>SECTION III</b>               | <i>Emergency Operating Instructions</i>               | <b>PAGE</b> |
|--------------------------------------|---|-------------|----------------------------------|---|-------------|
| 1-1.                                 | Airplane                                | 1           | 3-1.                             | Fire  | 29          |
| 1-9.                                 | Main Differences Table—F-82B and F-82E. | 1           | 3-6.                             | Engine Failure  | 29          |
| 1-11.                                | Power Plants                            | 3           | 3-25.                            | Bail-out  | 32          |
| 1-19.                                | Power Plant Controls                    | 3           | 3-27.                            | Forced Landing  | 33          |
| 1-34.                                | Engine Charge Air                       | 10          | 3-29.                            | Ditching  | 33          |
| 1-40.                                | Oil                                     | 10          | 3-31.                            | Fuel System Emergency Operation                       | 33          |
| 1-48.                                | Coolant                                 | 13          | 3-34.                            | Coolant Flap Emergency Operation                      | 33          |
| 1-54.                                | Fuel System                             | 14          | 3-36.                            | Landing Gear Emergency Operation                      | 33          |
| 1-69.                                | Hydraulic Systems                       | 15          | 3-38.                            | Wing Flap Emergency Operation                         | 34          |
| 1-71.                                | Flight Controls                         | 15          | 3-40.                            | Surface Control Booster System<br>Emergency Operation | 34          |
| 1-83.                                | Landing Gear                            | 16          | 3-42.                            | Electrical System Emergency Operation                 | 34          |
| 1-93.                                | Electrical System                       | 17          | 3-47.                            | Oxygen System Emergency Operation                     | 34          |
| 1-104.                               | Miscellaneous Controls and Equipment    | 18          | 3-49.                            | Bomb and Drop Tank Emergency Release                  | 34          |
| 1-115.                               | Operational Equipment                   | 18          |                                  |   |             |
| <br><b>SECTION II</b>                |   |             | <br><b>SECTION IV</b>            |   |             |
| <i>Normal Operating Instructions</i> |   |             | <i>Operational Equipment</i>     |   |             |
| 2-1.                                 | Before Entering Pilot's Compartment     | 19          | 4-1.                             | Gunnery Equipment                                     | 35          |
| 2-10.                                | On Entering Pilot's Compartment         | 20          | 4-19.                            | Rocket Equipment                                      | 36          |
| 2-12.                                | On Entering Copilot's Compartment       | 22          | 4-26.                            | Bombing Equipment                                     | 37          |
| 2-14.                                | Fuel System Management                  | 22          | 4-35.                            | Chemical Tanks  | 37          |
| 2-17.                                | Starting Engines                        | 22          | 4-38.                            | Oxygen  | 38          |
| 2-19.                                | Warm-up                                 | 23          | 4-40.                            | Communications Equipment                              | 38          |
| 2-21.                                | Ground Test                             | 23          | 4-46.                            | Cockpit Heating, Ventilating, and<br>Defrosting       | 39          |
| 2-23.                                | Taxiing Instructions                    | 23          | 4-54.                            | Thermal Anti-icing System                             | 40          |
| 2-25.                                | Before Take-off                         | 23          | 4-64.                            | Propeller De-icer System                              | 42          |
| 2-27.                                | Take-off                                | 26          | 4-68.                            | Anti-G Suit Provisions                                | 44          |
| 2-31.                                | Climb                                   | 26          | 4-70.                            | Lighting Equipment                                    | 44          |
| 2-33.                                | During Flight                           | 26          | 4-79.                            | Pitot Heater  | 44          |
| 2-39.                                | Stalls                                  | 27          |                                  |   |             |
| 2-41.                                | Spins                                   | 27          | <br><b>SECTION V</b>             |   |             |
| 2-44.                                | Permissible Acrobatics                  | 27          | <i>Extreme Weather Operation</i> |   |             |
| 2-46.                                | Diving                                  | 27          | 5-1.                             | Arctic Operation                                      | 45          |
| 2-49.                                | Approach                                | 27          | 5-13.                            | Desert Operation                                      | 47          |
| 2-51.                                | Landing                                 | 28          |                                  |   |             |
| 2-59.                                | Stopping of Engines                     | 28          | <br><b>APPENDIX I</b>            |   |             |
| 2-61.                                | Before Leaving Airplane                 | 28          | <i>Operating Charts</i>          |   |             |
|                                      |   |             | A-1.                             | Flight Planning                                       | 48          |
|                                      |   |             | A-5.                             | F-82E Sample Problem                                  | 48          |

**LIST OF ILLUSTRATIONS****Section I  
DESCRIPTION**

| FIGURE |                                      | PAGE |
|--------|--------------------------------------|------|
| 1-1    | Three-quarter View of Airplane ..... | iv   |
| 1-2    | Pilot's Cockpit—Forward View .....   | 2    |
| 1-3    | Pilot's Cockpit—Left Side .....      | 4    |
| 1-4    | Pilot's Cockpit—Right Side .....     | 5    |
| 1-5    | Copilot's Cockpit—Forward View ..... | 6    |
| 1-6    | Copilot's Cockpit—Left Side .....    | 8    |
| 1-7    | Copilot's Cockpit—Right Side .....   | 9    |
| 1-8    | Protection Against Gunfire .....     | 10   |
| 1-9    | Air Induction System .....           | 11   |
| 1-10   | Main Fuel System .....               | 12   |
| 1-11   | Fuel Transfer System .....           | 13   |
| 1-12   | Fuel Quantity Data—Gallons .....     | 14   |
| 1-13   | General Arrangement .....            | 16   |

**Section II  
NORMAL OPERATING INSTRUCTIONS**

|     |                                      |    |
|-----|--------------------------------------|----|
| 2-1 | Pilot's Fuel Control Panel .....     | 20 |
| 2-2 | Courses of Fuel Flow .....           | 21 |
| 2-3 | Copilot's Fuel Control Panel .....   | 22 |
| 2-4 | Diving Limitations—4G Pull-out ..... | 24 |
| 2-5 | Diving Limitations—6G Pull-out ..... | 25 |
| 2-6 | Indicated Stalling Speeds .....      | 28 |

**Section III  
EMERGENCY OPERATING INSTRUCTIONS**

|     |                                      |    |
|-----|--------------------------------------|----|
| 3-1 | Courses of Fuel Flow—Emergency ..... | 31 |
|-----|--------------------------------------|----|

**Section IV  
OPERATIONAL EQUIPMENT**

|     |  |    |
|-----|--|----|
| 4-1 | Rocket Firing Order .....                          | 37 |
| 4-2 | Oxygen Consumption Table .....                     | 39 |
| 4-3 | Heat Controls .....                                | 40 |
| 4-4 | Cockpit Heating, Ventilating, and Defrosting ..... | 41 |
| 4-5 | Surface Anti-icing System .....                    | 43 |

**Section V  
EXTREME WEATHER OPERATION**

|     |                             |    |
|-----|-----------------------------|----|
| 5-1 | Engine Ground Heating ..... | 46 |
|-----|-----------------------------|----|

**Appendix I  
OPERATING CHARTS**

|     |   |    |
|-----|---|----|
| A-1 | Airspeed Installation Correction Table .....  | 49 |
| A-2 | Compressibility Correction Table .....  | 49 |
| A-3 | Combat Allowance Chart .....  | 49 |
| A-4 | Instrument Dial Markings .....  | 51 |
| A-5 | Take-off, Climb, and Landing Chart .....  | 52 |
| A-6 | Flight Operation Instruction Chart—No External Load .....                           | 53 |
| A-7 | (Sheet 1 of 2 Sheets) Flight Operation Instruction Chart—Two 165-gallon Tanks ..... | 54 |
| A-7 | (Sheet 2 of 2 Sheets) Flight Operation Instruction Chart—Two 165-gallon Tanks ..... | 55 |
| A-8 | (Sheet 1 of 2 Sheets) Flight Operation Instruction Chart—5 Rocket Trees .....       | 56 |
| A-8 | (Sheet 2 of 2 Sheets) Flight Operation Instruction Chart—5 Rocket Trees .....       | 57 |
| A-9 | (Sheet 1 of 2 Sheets) Flight Operation Instruction Chart—Single Engine .....        | 58 |
| A-9 | (Sheet 2 of 2 Sheets) Flight Operation Instruction Chart—Single Engine .....        | 59 |

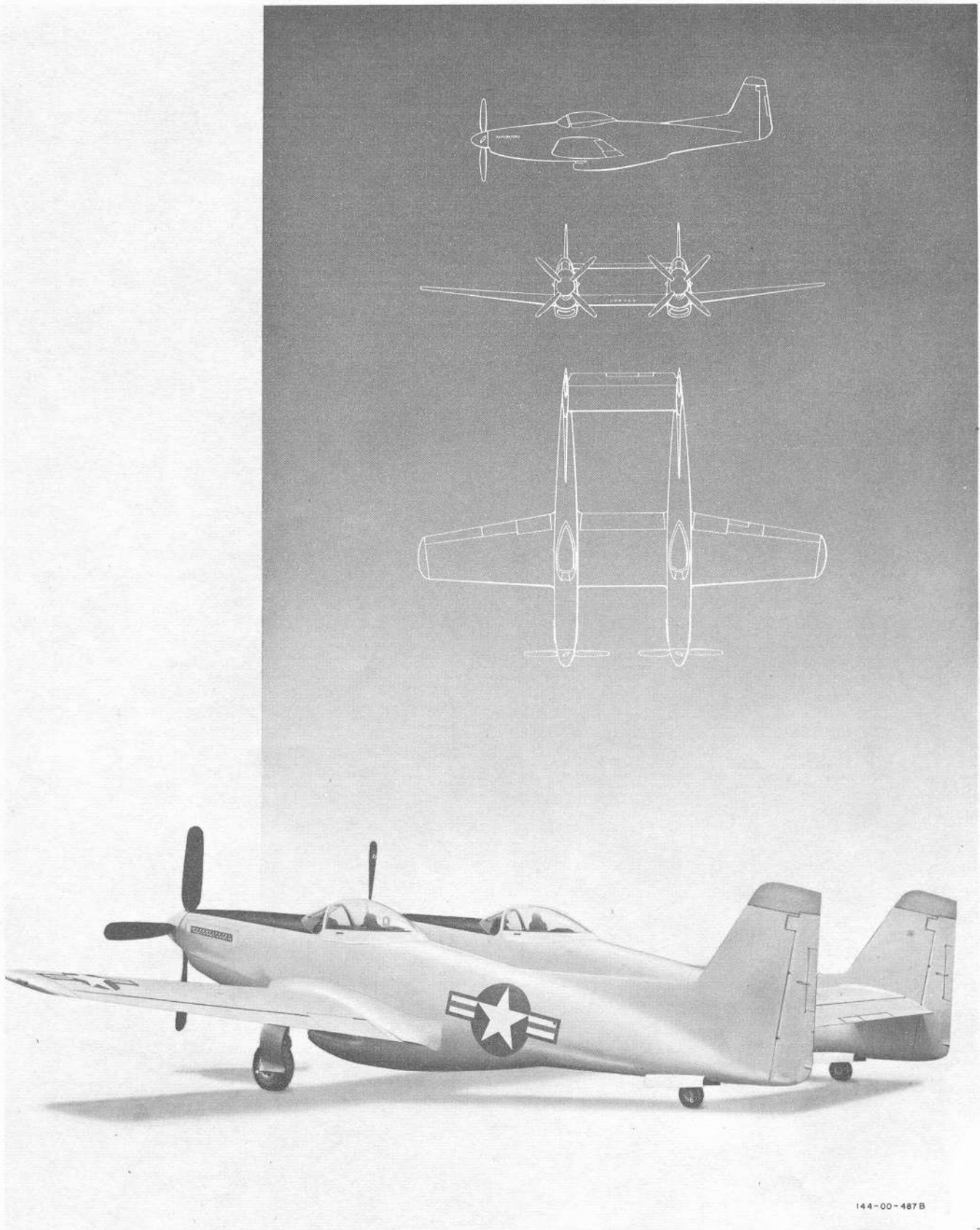

144-00-487 B

**Figure 1-1. Three-quarter View of Airplane**

## Section I

### DESCRIPTION

#### 1-1. AIRPLANE.

1-2. The North American F-82E Airplane is a two-engine, twin-fuselage, low-wing monoplane designed for long range and high-speed performance. Functional versatility is provided by various load combinations and use of alternate equipment which fit the airplane to operate as a long-range fighter, a long-range escort fighter, a fighter bomber, an attack fighter, or an interceptor. Normally operating as a two-place airplane, the F-82E can be converted to a single-place interceptor by removal of equipment from the copilot's cockpit in the right fuselage.

#### 1-3. AIRPLANE SIZE.

Wing span .....51 feet 3 inches  
Fuselage length .....39 feet  
Height (3-point position).....11 feet 10 inches

#### 1-4. GROSS WEIGHT.

1-5. The normal gross weight of the airplane is approximately 20,775 pounds.

#### 1-6. ARMAMENT AND SPECIAL FEATURES.

1-7. A bank of six .50-caliber machine guns is mounted in a wing center section; and bombs, chemical tanks, rockets, or drop tanks may be installed on racks beneath the wing panels. A release mechanism under the wing center section is provided for attaching a droppable gun nacelle. Figure 1-8 shows the angles of armor plate protection from gunfire.

1-8. INTERCOCKPIT CONTROL. Because of the design of the airplane, equipment necessary for a relief or emergency pilot is duplicated in the right cockpit. Essential power plant and flight controls are provided; and control of guns, fuel, engine charge heat, surface anti-icing, and the command radio can be transferred from one cockpit to the other by operation of control shift switches located in both cockpits. However, the copilot has no control over the following major items: landing gear and flaps (except emergency), ignition, water injection, surface control boost, or bombs (except salvo) and rockets. In the event of injury to the pilot, the copilot can, therefore, assume control of the airplane and effect a landing.

#### 1-9. MAIN DIFFERENCES TABLE—F-82B and F-82E.

1-10. The main differences between the F-82E Airplane and the F-82B Airplane are outlined in the following table:

| ITEM                     | F-82E   | F-82B                          |
|--------------------------|---|--------------------------------|
| Engine                   | Allison   | Packard-built Rolls Royce      |
| Supercharger             | Integral engine-stage single-speed,<br>and auxiliary-stage variable-speed | Integral two-stage, two-speed  |
| Carburetor               | Speed-density metering  | Airflow metering               |
| Surface control boost    | Elevator, rudder, and aileron boost                                       | Elevator and rudder boost only |
| Fire extinguisher system | Fire extinguisher system  | -----                          |
| Thermal anti-icing       | Wing, empennage, and windshield<br>anti-icing system installed            | Provisions for installation    |
| Propeller de-icer        | Propeller de-icer   | -----                          |
| Bomb salvo               | Electrical release  | Mechanical release             |

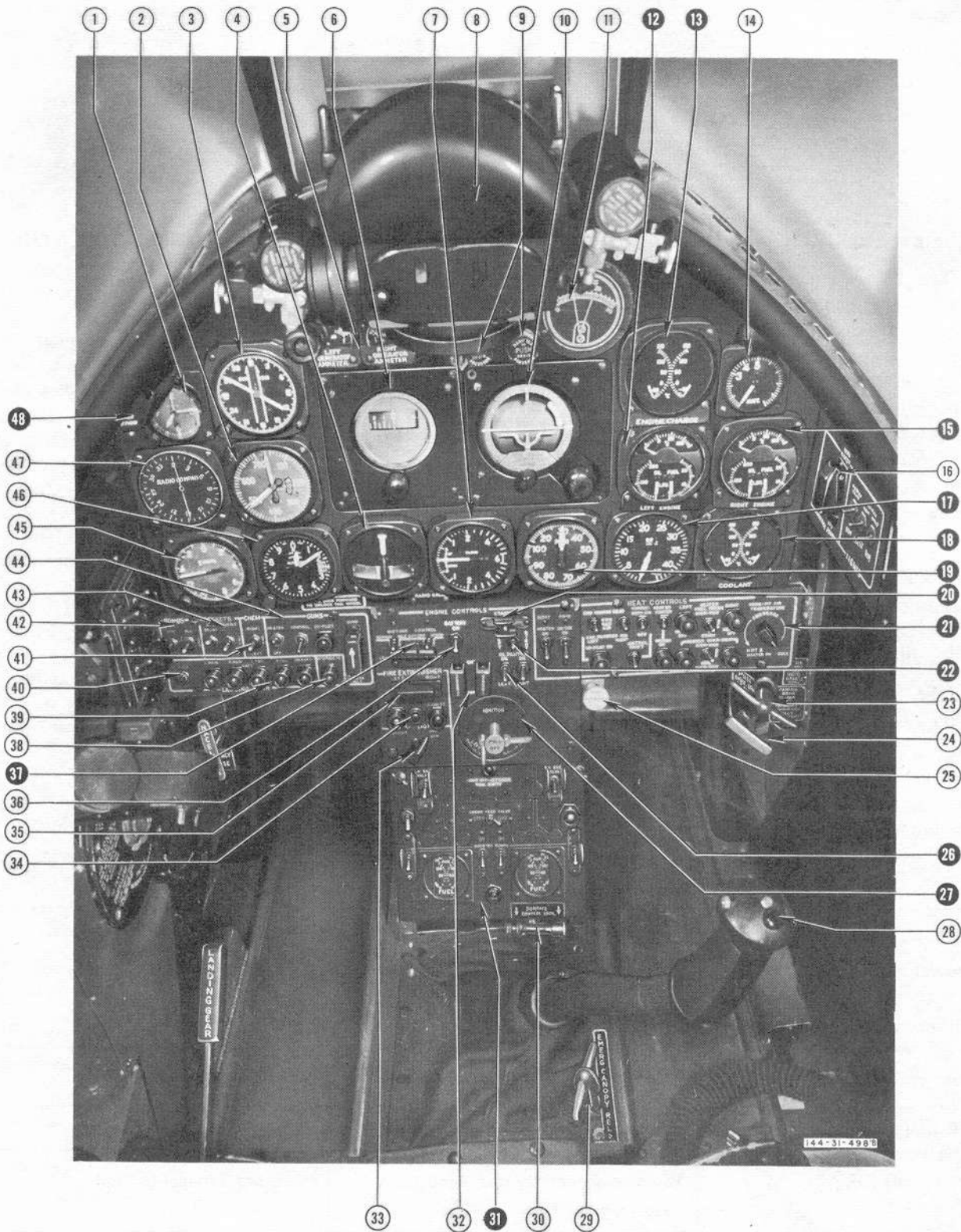

Figure 1-2. Pilot's Cockpit—Forward View

**1-11. POWER PLANTS.**

1-12. The airplane is powered by two 12-cylinder, liquid-cooled, V-type Allison engines (Model V-1710-145 in right fuselage, Model V-1710-143 in left fuselage) equipped with speed-density carburetors and water injection systems.

**1-13. SUPERCHARGERS.**

1-14. Both power plants are equipped with an engine stage, gear-driven, single-speed supercharger and an auxiliary-stage variable-speed supercharger. Entirely automatic in operation, the auxiliary-stage supercharger makes available a wide range of supercharger speeds which are determined by engine rpm, airplane altitude, and throttle-selected power setting.

**1-15. AUTOMATIC ENGINE POWER CONTROL UNITS.**

1-16. Each engine is provided with an automatic engine power control unit which is operated by the throttle. The automatic engine power control unit regulates throttle valve position and the output of the auxiliary-stage supercharger in a manner which keeps engine detonation limits from being exceeded regardless of altitude or throttle control position. When a given manifold pressure is selected, it will automatically be maintained up to a limited altitude. (This altitude will change with variations from standard day temperature because of the effects of inlet air temperature on the efficiency of the auxiliary stage impeller.) With additional increase in altitude, the manifold pressure will

decrease along a definite curve unless the throttle lever is advanced. However, at some powers and above a certain altitude, manifold pressure will drop off in a climb, even with the throttle at its full travel. This does not necessarily mean that the airplane has reached critical altitude, but might indicate that manifold pressure is being regulated along a schedule determined by the auxiliary stage supercharger control. If the operating oil supply to the control unit should fail, it is still possible to select any manifold pressure up to approximately 46 in. Hg at sea level.

**1-17. PROPELLERS.**

1-18. Each power plant drives a four-bladed, constant-speed, full-feathering, Aeroproducts propeller.

**1-19. POWER PLANT CONTROLS.**

**1-20. THROTTLES.**

1-21. Dual throttle levers, located on the quadrant at the left side of each cockpit (figure 1-3, reference 12; figure 1-6, reference 8), are mechanically connected to the automatic engine power control unit on each engine. The throttle quadrant is marked "CLOSE," "OPEN," "TAKE-OFF," and "WAR EMERGENCY." Engine power restrictions prohibit the use of "WAR EMERGENCY" position at any time. At the "TAKE-OFF" position, a spring-loaded gate prevents inadvertent throttle advancement to the war emergency powers. Two microswitches in the throttle control system are actuated by throttle movement: one to energize

- 
- |  |   |
|--|---|
| <ol style="list-style-type: none"> <li>1. Clock</li> <li>2. Airspeed and Mach Indicator</li> <li>3. Remote-indicating Compass</li> <li>4. Turn-and-Bank Indicator</li> <li>5. Left and Right Generator Ammeters</li> <li>6. Directional Gyro</li> <li>7. Rate-of-Climb Indicator</li> <li>8. K-18 Gun Sight</li> <li>9. Manifold Pressure Drain Controls</li> <li>10. Artificial Horizon</li> <li>11. Voltmeter</li> <li>12. Left Engine Gage</li> <li>13. Engine Charge Air Temperature Gage</li> <li>14. Suction Gage</li> <li>15. Right Engine Gage</li> <li>16. Hydraulic Boost Switch</li> <li>17. Tachometer</li> <li>18. Coolant Temperature Gage</li> <li>19. Manifold Pressure Gage</li> <li>20. Starter Switch</li> <li>21. Heat Control Panel</li> <li>22. Primer Switch</li> <li>23. Emergency Landing Gear Release</li> <li>24. Parking Brake Handle</li> </ol> | <ol style="list-style-type: none"> <li>25. Defrost Control</li> <li>26. Oil Dilution Switches</li> <li>27. Ignition Switches</li> <li>28. Bomb-Rocket Release</li> <li>29. Emergency Canopy Release</li> <li>30. Surface Control Lock</li> <li>31. Fuel Control Panel</li> <li>32. Generator Switches</li> <li>33. Cockpit Light Rheostat</li> <li>34. Fire Indicator Push-to-Test Button</li> <li>35. Fire Extinguisher Switch</li> <li>36. Battery Switch</li> <li>37. Mixture Control Switches</li> <li>38. Hydraulic Pressure Indicator Light</li> <li>39. Landing Gear Position Indicators</li> <li>40. Warning Horn Cutout Switch</li> <li>41. Chemical Tank Selector Switch</li> <li>42. Bomb Control Panel</li> <li>43. Rocket Control Panel</li> <li>44. Gun Control Panel</li> <li>45. Accelerometer</li> <li>46. Altimeter</li> <li>47. Radio Compass Indicator</li> <li>48. Water Injection Switch</li> </ol> |
|--|---|

⊗ Indicates power plant and fuel system controls and instruments.

**KEY TO FIGURE 1-2**



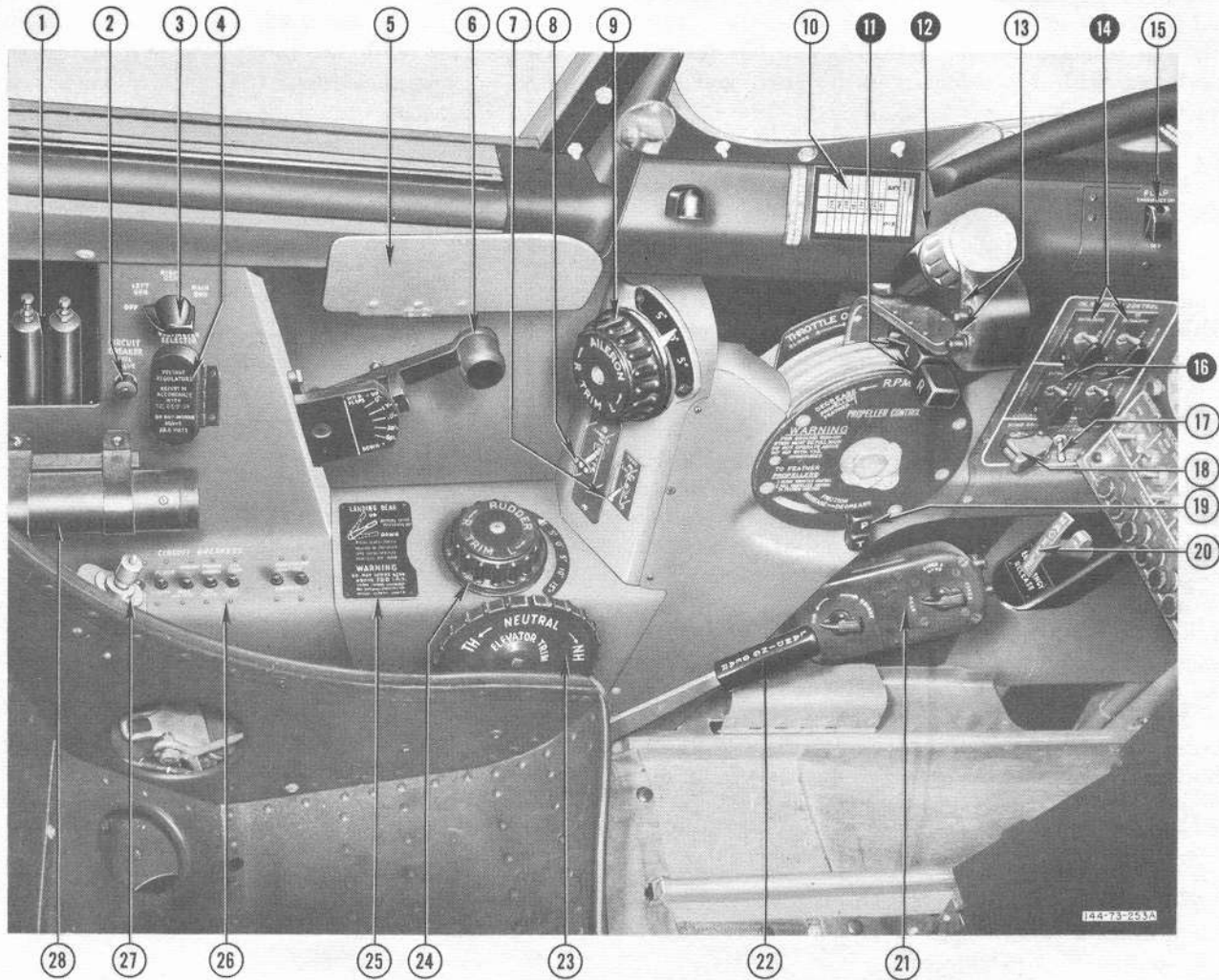

- |   |   |
|---|---|
| 1. Anti-G Suit Valve                      | 15. Flap Emergency Switch                 |
| 2. Fuel Valve Circuit Breaker             | 16. Coolant Radiator Switches             |
| 3. Voltmeter Selector                     | 17. Bomb Sequence Switch                  |
| 4. Voltage Regulators                     | 18. Bomb Salvo Switch                     |
| 5. Armrest and Standard Check List        | 19. Throttle and Propeller Friction Locks |
| 6. Wing Flap Handle                       | 20. Gun Nacelle Emergency Release         |
| 7. Taxi Light Switch                      | 21. Gun Sight Selector-Dimmer Switch      |
| 8. Landing Light Switch                   | 22. Landing Gear Handle                   |
| 9. Aileron Trim Tab Control               | 23. Elevator Trim Tab Control             |
| 10. Remote Compass Correction Card        | 24. Rudder Trim Tab Control               |
| 11. Propeller Controls                    | 25. Landing Gear Instruction Plate        |
| 12. Throttles (Gun Sight Ranging Control) | 26. Circuit Breaker Panel                 |
| 13. Radio Push-to-Talk Buttons            | 27. Anti-G Suit Connection                |
| 14. Oil Radiator Switches                 | 28. Heat and Vent Outlet                  |

⊗ Indicates power plant and fuel system controls and instruments.

Figure 1-3. Pilot's Cockpit—Left Side

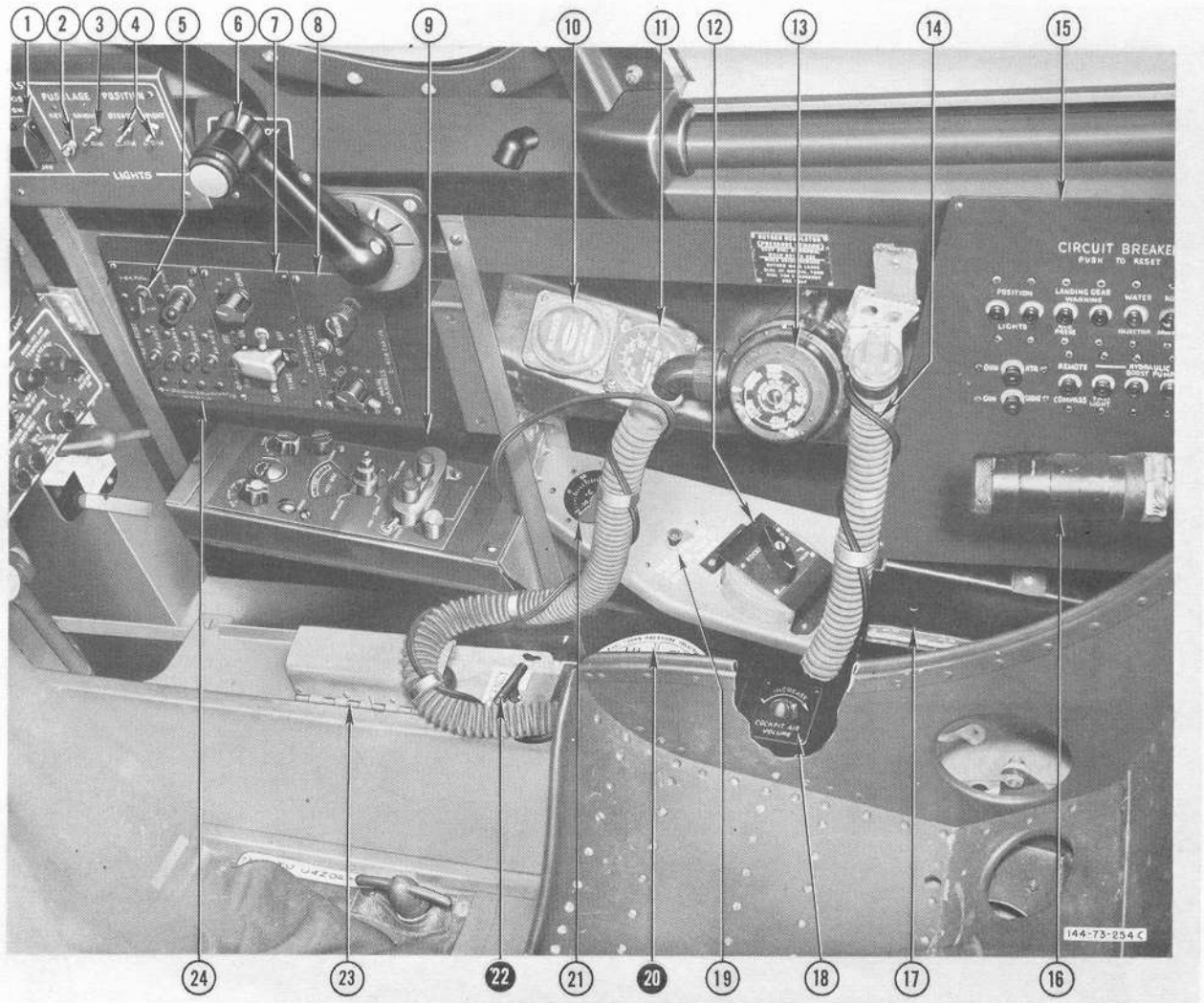

- |   |  |
|---|--|
| 1. Hydraulic Boost Switch               | 13. Oxygen Regulator                   |
| 2. Keying Switch                        | 14. Microphone Cord                    |
| 3. Fuselage Light Switch                | 15. Circuit Breaker Panel              |
| 4. Position Light Switches              | 16. Heat and Vent Outlet               |
| 5. Command Radio Transfer Switch        | 17. Data Case                          |
| 6. Canopy Handcrank                     | 18. Cockpit Air Volume Control         |
| 7. SCR-695B Radio Control Panel         | 19. Aileron Boost Circuit Breaker      |
| 8. AN/ARC-3 Radio Control Panel         | 20. Drop Tank Selector                 |
| 9. AN/ARN-6 Radio Compass Control Panel | 21. Free Air Temperature Gage          |
| 10. Oxygen Flow Indicator               | 22. Emergency Coolant Air Flap Release |
| 11. Oxygen Pressure Indicator           | 23. Rudder Pedal Disconnect Lever      |
| 12. Rocket Fire Control                 | 24. Radio Circuit Breaker Panel        |

⊗ Indicates power plant and fuel system controls and instruments.

Figure 1-4. Pilot's Cockpit—Right Side

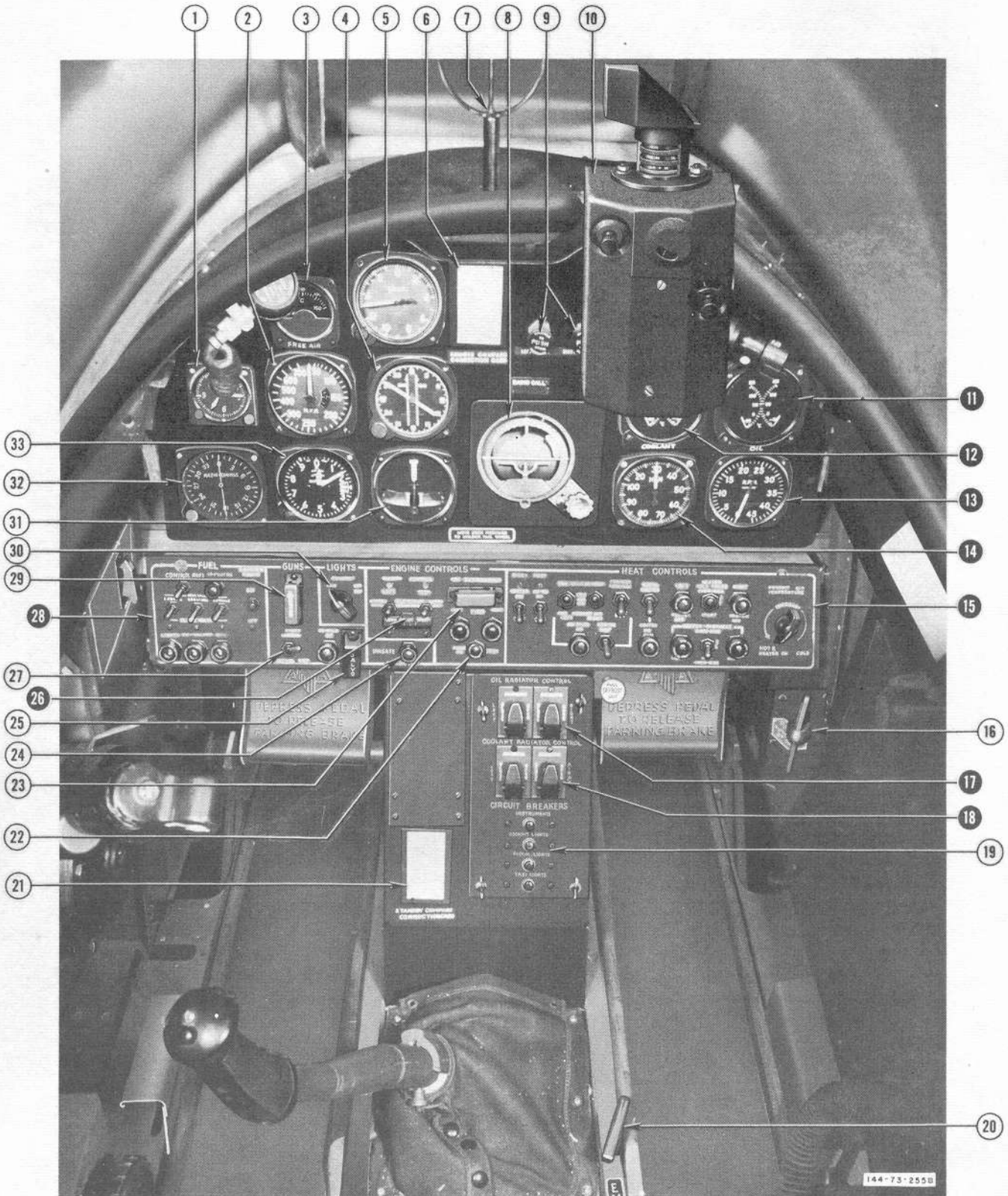

Figure 1-5. Copilot's Cockpit—Forward View

the water injection pump when the water injection switch is "ON" (figure 1-2, reference 48); one to activate the landing gear warning horn. Incorporated in the throttle handles in both cockpits are push-to-talk buttons (figure 1-3, reference 13; figure 1-6, reference 9) for the radio equipment. A gun sight ranging control (figure 1-3, reference 12) is installed on the right engine throttle in the pilot's cockpit only. A throttle friction lock (figure 1-3, reference 19) is provided on the bottom of the pilot's quadrant.

1-22. PROPELLER CONTROL.

1-23. Dual propeller control levers are located beneath the throttles on the power control quadrant in each cockpit. (See figure 1-3, reference 11; figure 1-6, reference 10.) Feathering is accomplished by pulling the desired propeller control to the extreme aft, "FEATHER," position, after first retarding the corresponding throttle to "CLOSE." No additional controls are provided or required for feathering the propeller. Unless the throttle is fully retarded, a stop in the quadrant prevents movement of the propeller control to the feathering range. A propeller control friction lock is provided on the pilot's quadrant. (See figure 1-3, reference 19.)

1-24. MIXTURE.

1-25. Two mixture control switches (one for each engine) are mounted on the engine control panel in both cockpits. (See figure 1-2, reference 37; figure 1-5, reference 26.) The switches have four positions: "NORMAL," "IDLE CUT-OFF," "LONG RANGE CRUISE," and a central position. The "NORMAL" and "IDLE CUT-OFF" positions are momentary-contact switches and either position is selected by holding the switches at the desired setting for approximately 3 seconds. When released, the switches will return to the central position and the engine will operate in the position selected by the momentary switch operation. A guard prevents inadvertent movement of the switches to the "LONG RANGE CRUISE" setting which is used only for long-range operation at low powers. After "LONG

RANGE CRUISE" has been selected, if manifold pressure is increased above 48 in. Hg, the mixture automatically goes to "NORMAL," regardless of switch position; if power is subsequently reduced, the mixture will automatically return to "LONG RANGE CRUISE." If the switch is moved out of the "LONG RANGE CRUISE" position, the mixture will automatically return to the "NORMAL" position.

1-26. WATER INJECTION.



At present, the water injection systems are inoperative. When modifications are completed permitting water injection, the engines may be operated in accordance with restrictions in paragraph 2-2.

1-27. A water injection system, including a 13.5-gallon water-alcohol tank, is provided on each engine. Both systems are controlled simultaneously from the pilot's cockpit by a water injection switch above the engine control quadrant (figure 1-2, reference 48) and a micro-switch incorporated in the throttle system. When the water injection switch is "ON" and the throttles are advanced to above 64 in. Hg manifold pressure at sea level, the pumps which supply water to the induction systems are started. When water pressure drops or the water supply is depleted, the pumps will automatically stop. Because the water flow may not be equal in both systems, the water supply pump stoppage may not occur simultaneously on both engines.

1-28. PRIMER.

1-29. The priming systems on both engines are controlled by a single spring-loaded switch (figure 1-2, reference 22) on the engine control panel in the pilot's cockpit. The switch has two positions: "LEFT" and "RIGHT."

- 
- |  |  |
|--|--|
| <ol style="list-style-type: none"> <li>1. Clock</li> <li>2. Airspeed and Mach Indicator</li> <li>3. Free Air Temperature Gage</li> <li>4. Remote-indicating Compass</li> <li>5. Accelerometer</li> <li>6. Remote Compass Correction Card</li> <li>7. Ring-and-Bead Sight</li> <li>8. Artificial Horizon</li> <li>9. Manifold Pressure Drain Controls</li> <li>10. Gun Camera</li> <li>11. Oil Temperature Gage</li> <li>12. Coolant Temperature Gage</li> <li>13. Tachometer</li> <li>14. Manifold Pressure Gage</li> <li>15. Heat Control Panel</li> <li>16. Emergency Landing Gear Release</li> <li>17. Oil Radiator Switches</li> </ol> | <ol style="list-style-type: none"> <li>18. Coolant Radiator Switches</li> <li>19. Circuit Breaker Panel</li> <li>20. Emergency Canopy Release</li> <li>21. Stand-by Compass Correction Card</li> <li>22. Fire Indicator Push-to-Test Button</li> <li>23. Fire Extinguisher Switch</li> <li>24. Landing Gear Position Indicator Light</li> <li>25. Bomb Salvo Switch</li> <li>26. Mixture Control Switches</li> <li>27. Gunnery Control Shift Switch</li> <li>28. Fuel Control Panel</li> <li>29. Gun Selector Switch</li> <li>30. Cockpit Light Rheostat</li> <li>31. Turn-and-Bank Indicator</li> <li>32. Radio Compass Indicator</li> <li>33. Altimeter</li> </ol> |
|--|--|

⊗ Indicates power plant and fuel system controls and instruments.

KEY TO FIGURE 1-5

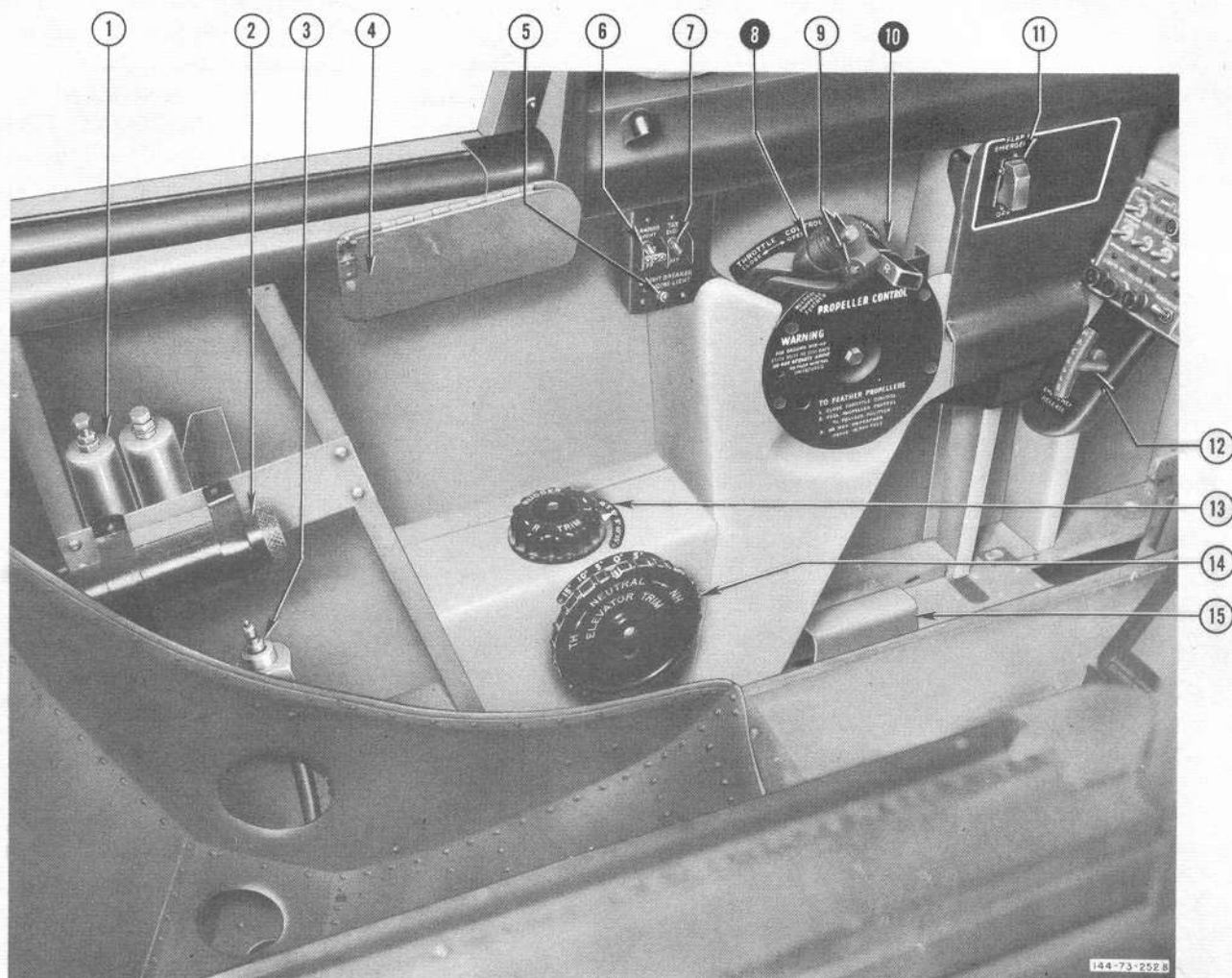

1. Anti-G Suit Valve
2. Heat and Vent Outlet
3. Anti-G Suit Connection
4. Armrest and Standard Check List
5. Landing Light Circuit Breaker
6. Landing Light Switch
7. Taxi Light Switch
8. Throttles

9. Radio Push-to-Talk Buttons
10. Propeller Controls
11. Wing Flap Emergency Switch
12. Nacelle Emergency Release
13. Rudder Trim Tab Control
14. Elevator Trim Tab Control
15. Rudder Pedal Disconnect Lever

⊗ Indicates power plant and fuel system controls and instruments.

Figure 1-6. Copilot's Cockpit—Left Side

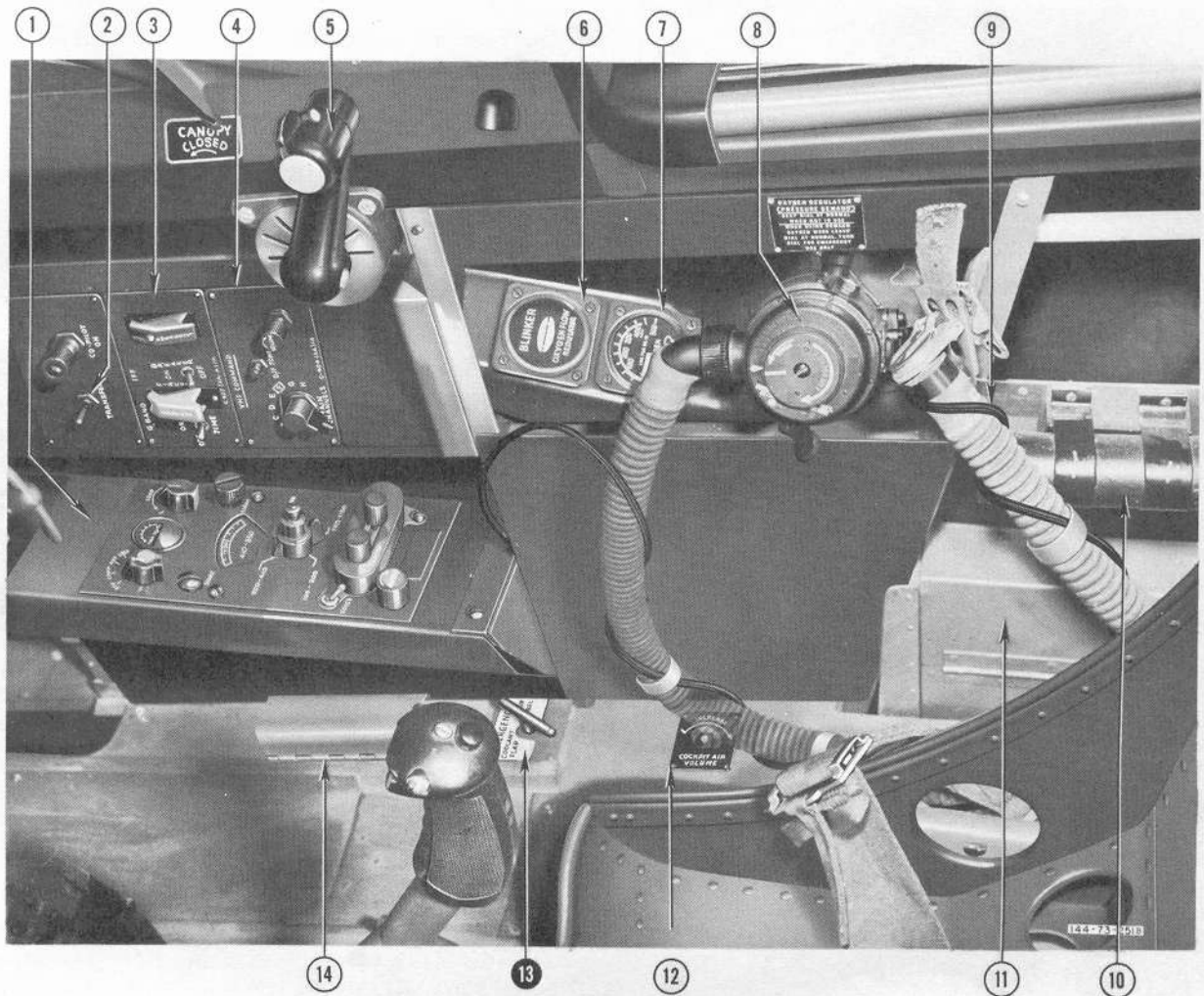

- 1. AN/ARN-6 Radio Compass Control Panel
- 2. Command Radio Transfer Switch
- 3. SCR-695B Radio Control Panel
- 4. AN/ARC-3 Radio Control Panel
- 5. Canopy Handcrank
- 6. Oxygen Flow Indicator
- 7. Oxygen Pressure Indicator

- 8. Oxygen Regulator
- 9. Microphone Cord
- 10. Heat and Vent Outlet
- 11. Data Case
- 12. Cockpit Air Volume Control
- 13. Emergency Coolant Air Flap Release
- 14. Rudder Pedal Disconnect Lever

⊗ Indicates power plant and fuel system controls and instruments.

Figure 1-7. Copilot's Cockpit--Right Side

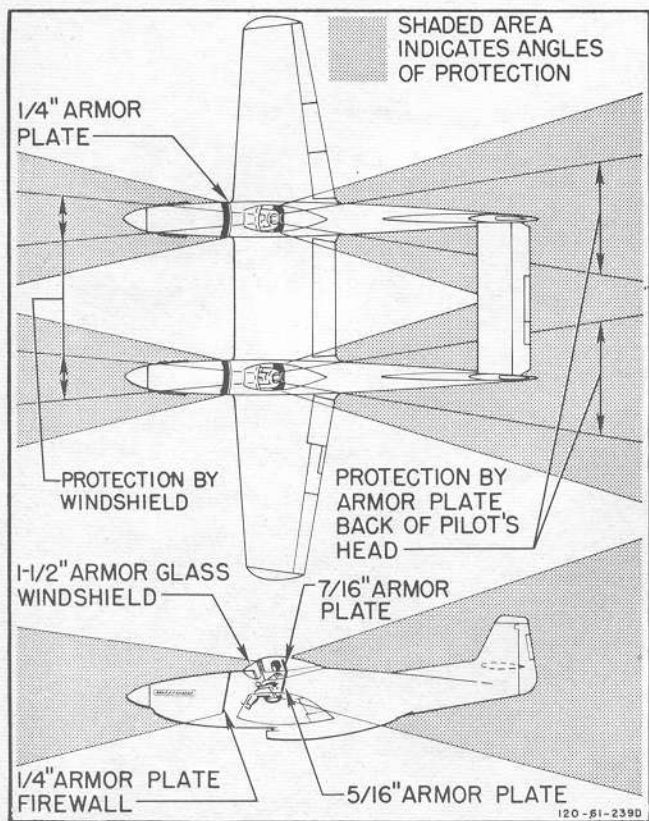

Figure 1-8. Protection Against Gunfire

1-30. IGNITION.

1-31. Standard ignition switches are located at the center of the pilot's engine control panel. (See figure 1-2, reference 27.)

1-32. STARTERS.

1-33. A single toggle switch on the pilot's engine control panel (figure 1-2, reference 20) actuates the direct-cranking starters on both engines. Holding the switch at one of the two spring-loaded positions, "LEFT" or "RIGHT," engages the starter on the corresponding engine.

1-34. ENGINE CHARGE AIR.

1-35. A separate and complete air induction system (figure 1-9) in each fuselage supplies the related engine with cold ram air, cold unrammed filtered air, or heated air. The cold air intake is located just below the propeller spinner, and filters are installed on either side of the cowling. Heated air is normally obtained from aft of the coolant radiator and routed through the surface anti-icing duct forward to the engine air intake duct. However, when the surface anti-icing system is in operation, heated induction air is supplied from the engine compartment through an alternate charge air inlet door in the intake duct. The heated induction air, provided to maintain desired mixture temperatures, helps prevent spark plug fouling during long-range cruise at low powers. The engine charge temperature

gauge indicates mixture temperature taken at the intake manifold; consequently, the desirable range is higher than that of conventional induction systems which measure ram air temperature.

**Note**

The engine compartment can be heated on the ground, prior to engine starting during cold weather operation, by use of a heater and blower installed in each fuselage. Refer to paragraph 5-3.b. for engine ground heating operation.

1-36. HEAT CONTROL SHIFT SWITCH.

1-37. Control of the air induction system may be transferred from one cockpit to the other by means of the heat control shift switch (figure 4-3) located on the heat control panel in each cockpit. A "COPILOT ON" indicator light, adjacent to the switch, illuminates when the copilot's controls are operative. When control is transferred, the engine air and anti-icing systems will assume the operating conditions selected on the panel to which control is shifted.

1-38. ENGINE AIR CONTROLS.

1-39. The engine air control switches (figure 1-2, reference 21), one for each engine, are located on the heat control panel in both cockpits. The switches have three positions: "ENG. RAM AIR," "ENG. FILTERED AIR," and "ENG. CHARGE HEAT." When the control switch is set for "ENG. RAM AIR," an inlet valve at the front of the air intake duct is opened, permitting cold ram air to enter the system. With the switch set for "ENG. FILTERED AIR," the main inlet valve is closed and cold unrammed air is drawn through the filters into the air intake duct. When "ENG. CHARGE HEAT" is selected, hot air obtained from behind the coolant radiator passes forward through the anti-icing duct to the intake duct. When operating with engine charge heat, cold air is metered through the main inlet valve as required to maintain proper mixture temperatures. If the surface anti-icing system is placed in operation when "ENG. CHARGE HEAT" is selected, heat supplied to the engine through the anti-icing duct is cut off and an alternate charge air inlet door in the air intake duct opens, supplying heated air from the engine compartment. (Refer to paragraph 4-55.)

1-40. OIL.

1-41. A separate oil system is provided for each engine. The lubricating oil is cooled in a radiator mounted in an air scoop in the lower portion of each fuselage (forward of the coolant radiator). Airflow through the radiators is regulated by movement of thermostatically controlled outlet flaps.

1-42. OIL SPECIFICATION AND GRADE.

1-43. Oil Specification AN-O-8, Grade 1120.

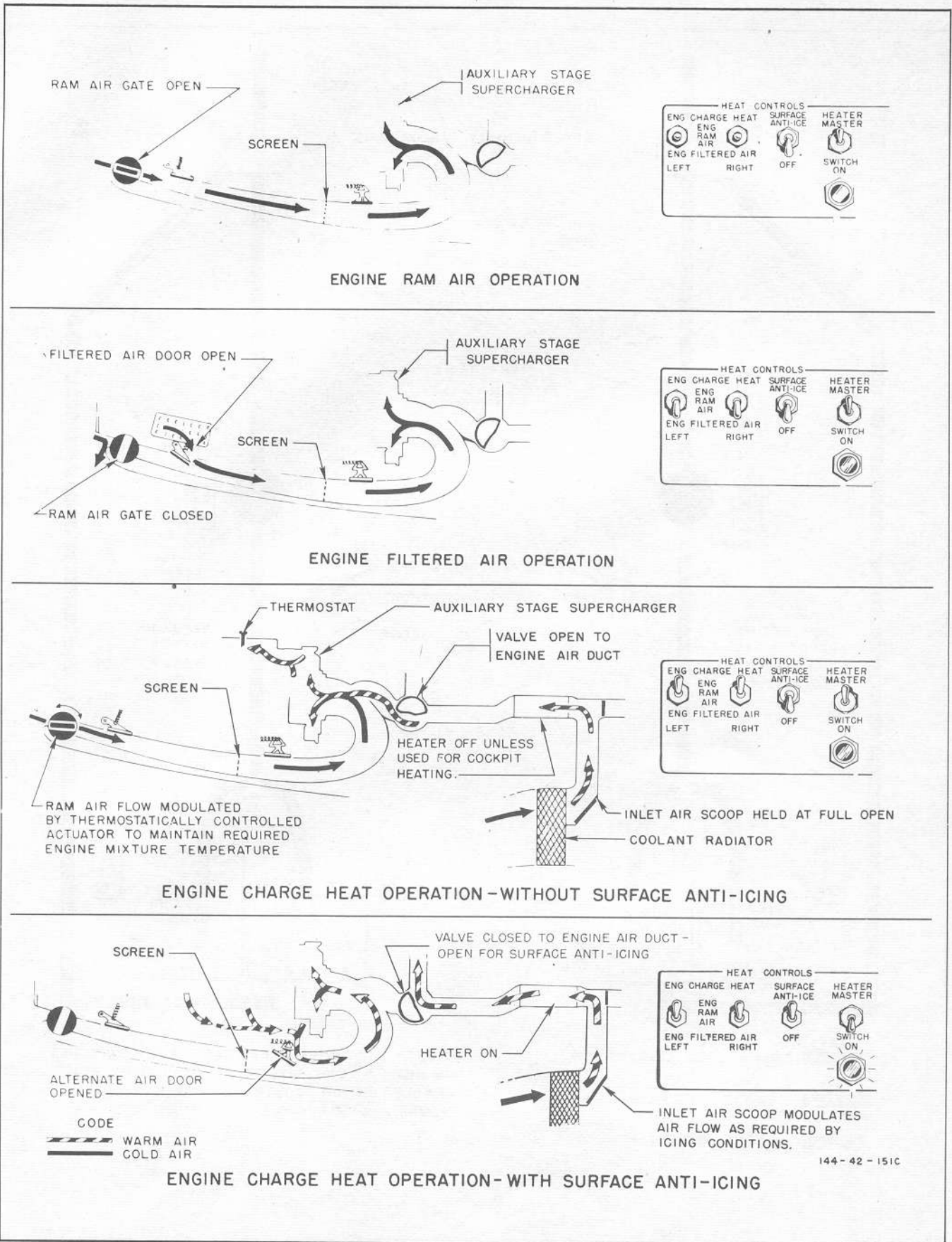
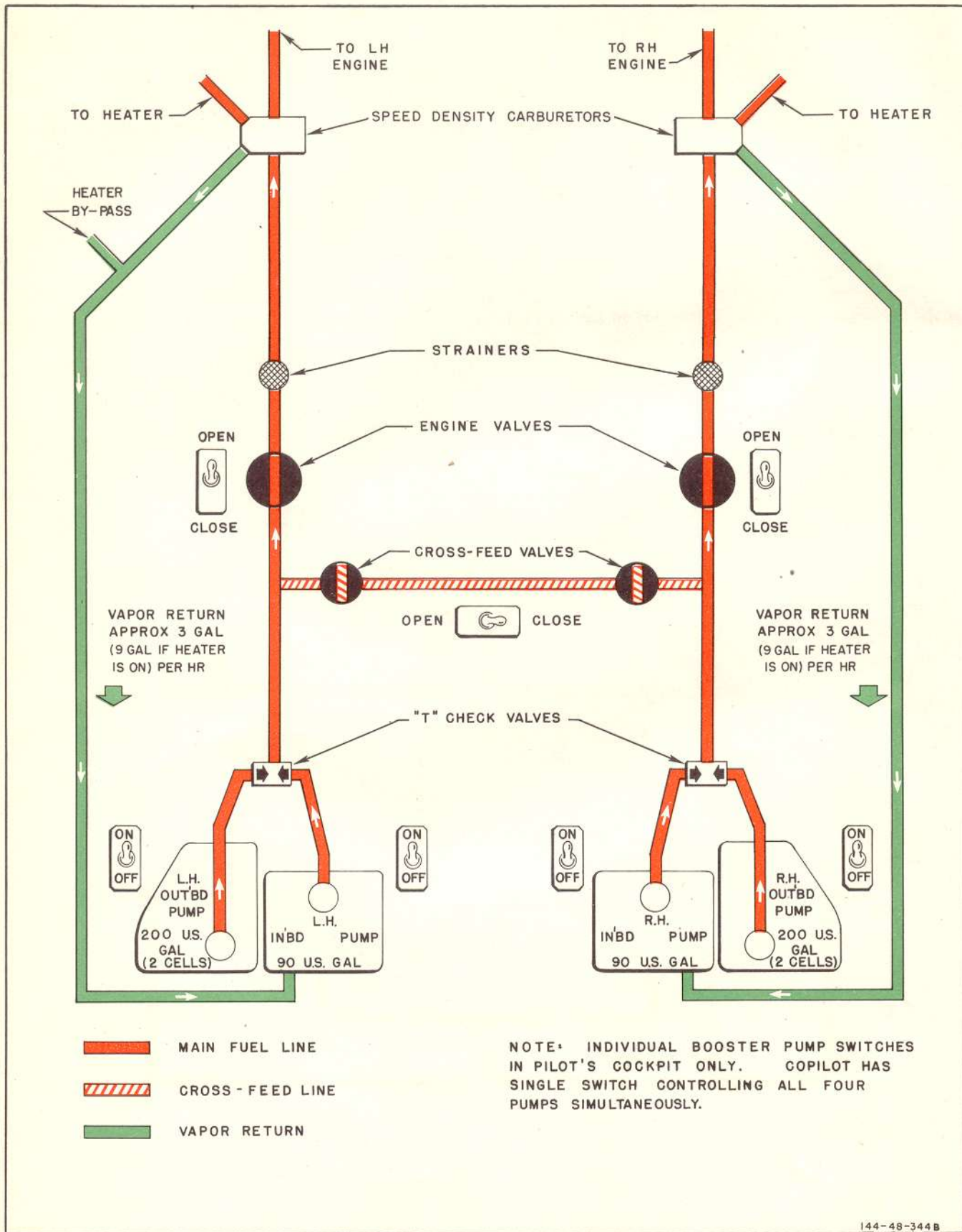

Figure 1-9. Air Induction System





144-48-344B

Figure 1-10. Main Fuel System

1-44. OIL RADIATOR CONTROL.

1-45. Two switches, one for each flap actuator, are provided in each cockpit, on the left switch panel (figure 1-3, reference 14) forward of the throttle quadrant in the pilot's cockpit, and on the center pedestal (figure 1-5, reference 17) in the copilot's cockpit. Each switch has four positions: two spring-loaded contacts, "OPEN" and "CLOSE"; and two maintained contacts, "AUTOMATIC" and a center or off position. Guards hold the switches at "AUTOMATIC," the normal operating position. The "OPEN" and "CLOSE" positions are provided for use in case of automatic control failure or during ground check. When automatic control of the flap actuators is desired, the switches in both cockpits must be in the "AUTOMATIC" position. The pilot can select "OPEN" or "CLOSE" independent of copilot's switch position; however, the "OPEN" and "CLOSE" positions of the copilot's switches are effective only when the pilot's switches are in "AUTOMATIC."

1-46. OIL DILUTION.

1-47. Two spring-loaded switches (figure 1-2, reference 26), one for the oil dilution system on each engine, are located on the pilot's engine control panel.

1-48. COOLANT.

1-49. Each engine is supplied with a separate liquid-cooling system. An air scoop in the lower portion of each fuselage houses a radiator (aft of oil radiator) for cooling the liquid after it has passed through the engine. Flow of cooling air through the radiator is regulated by a thermostatically controlled flap at the aft end of the scoop.

1-50. COOLANT RADIATOR CONTROL.

1-51. Two control switches, one for each coolant flap actuator, are located adjacent to the oil radiator controls in each cockpit. (See figure 1-3, reference 16; figure 1-5, reference 18.) Each switch has four positions: two spring-loaded contacts, "OPEN" and "CLOSE"; and two maintained contacts, "AUTOMATIC" and a center or off position. Guards hold the

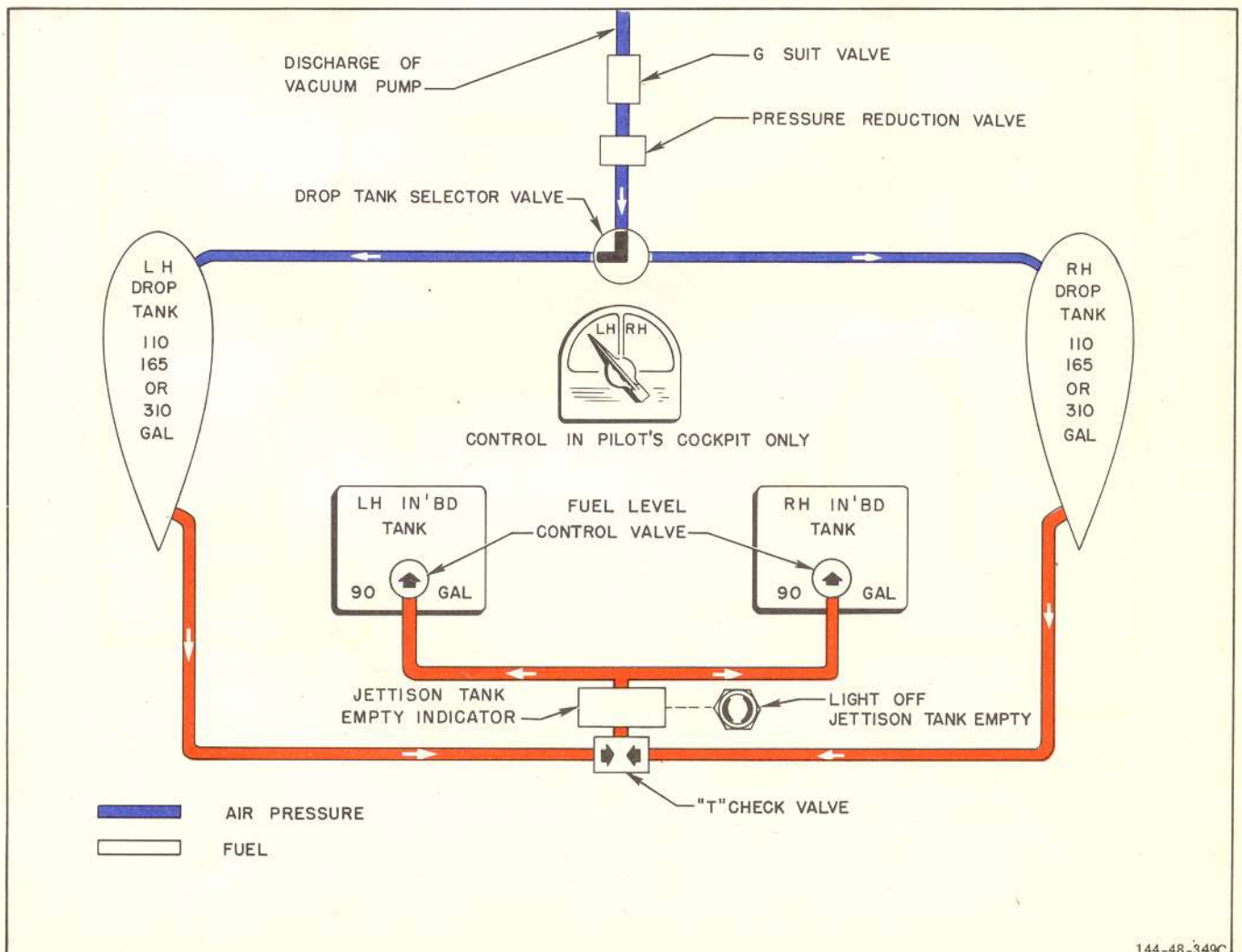

Figure 1-11. Fuel Transfer System

switches at "AUTOMATIC" where they should be kept for all normal operation. The "OPEN" and "CLOSE" positions are provided for use in case of automatic control failure or during ground check. When automatic control of the flap actuators is desired, the switches in both cockpits must be in the "AUTOMATIC" position. The pilot can select "OPEN" or "CLOSE" independent of copilot's switch position; however, the "OPEN" and "CLOSE" positions of the copilot's switches are effective only when the pilot's switches are in "AUTOMATIC." When the landing gear is extended, the coolant flaps are automatically maintained at a position safe for ground operation.

1-52. EMERGENCY COOLANT AIR FLAP RELEASE.

1-53. A mechanical coolant air flap emergency release (figure 1-4, reference 22; figure 1-7, reference 13) is provided in each fuselage to open the flap in the event of actuator failure. The release opens only the flap in the related fuselage. One quick pull will open the flap to a minimum of 6 inches or approximately 5½ inches beyond the flap setting at the time of release. There is no provision for emergency closing of the flap, nor can the emergency release be reset in flight.

1-54. FUEL SYSTEM.

1-55. MAIN FUEL SYSTEM.

1-56. Four self-sealing fuel tanks are installed in the airplane; one (consisting of two interconnected cells) in each outer wing panel and two in the wing center section. (See figure 1-10.) The total usable fuel in all tanks is approximately 575 U.S. gallons. Normally, the two tanks on either side of the airplane centerline supply fuel to the engine on the related side. This provides each engine with a separate and complete fuel system, the two systems being interconnected only by a cross-feed line. Fuel flow from each set of two tanks is controlled by operation of engine shut-off and cross-feed valves (electric motor actuated) and by selection of booster pumps. Vapor return lines from the right

and left engine speed-density carburetors are routed to the right and left inboard tanks, respectively.

1-57. FUEL TRANSFER SYSTEM.

1-58. To supplement the main fuel supply, one 110, 165, or 310-gallon drop tank can be installed under each outer wing panel. When the drop tanks are installed, fuel is routed from them to a fuel level control valve in each of the two inboard tanks. (See figure 1-11.) These valves automatically permit fuel flow from the selected drop tank when the level in one or both center section tanks drops below approximately 80 gallons.

1-59. FUEL SPECIFICATION AND GRADE.

1-60. Fuel Specification AN-F-48, recommended Grade 115/145, alternate Grade 100/130.

1-61. FUEL SYSTEM CONTROLS.

1-62. PILOT'S FUEL CONTROL PANEL. The pilot's fuel control panel (figure 2-1), located centrally below the engine control panel, provides a lighted schematic diagram of the main system. All of the fuel controls (except the drop tank selector valve) are mounted on this panel, and lights adjacent to the control switches indicate their operating condition. The panel also contains fuel quantity gages for the internal tanks and an indicator light for the drop tanks which turns off when the tank selected is empty.

1-63. COPILOT'S FUEL CONTROL PANEL. The fuel control panel (figure 2-3), at the lower left side of the copilot's instrument panel, contains all of the copilot's fuel controls: a single switch for all booster pumps, one switch for each engine fuel shut-off valve, one switch for the cross-feed valves, and a control shift switch. Indicator lights on the panel show the operating condition of the switches.

1-64. FUEL CONTROL SHIFT SWITCHES. A "CONTROLS SHIFT" switch, located on the fuel control panel in each cockpit (figures 2-1 and 2-3), transfers control of the fuel system from one cockpit to the

| FUEL QUANTITY DATA<br>GALLONS |     |                       |                           |  |                           |
|-------------------------------|-----|-----------------------|---------------------------|--|---------------------------|
| TANK                          | NO. | USABLE<br>FUEL (EACH) | EXPANSION<br>SPACE (EACH) | TRAPPED<br>FUEL (EACH)<br>LEVEL FLIGHT | TOTAL<br>VOLUME<br>(EACH) |
| L.H. IN'BD                    | 1   | 91                    | 4                         | NEGLIGIBLE                             | 98                        |
| L.H. OUT'BD                   | 1   | 198                   | 9                         | NEGLIGIBLE                             | 208                       |
| R.H. IN'BD                    | 1   | 91                    | 5                         | NEGLIGIBLE                             | 99                        |
| R.H. OUT'BD                   | 1   | 196                   | 10                        | NEGLIGIBLE                             | 207                       |

144-93-471-B

Figure 1-12. Fuel Quantity Data—Gallons

other. An amber "COPILOT ON" indicator light on both panels illuminates when the copilot's controls are operative.

1-65. ENGINE FUEL SHUT-OFF VALVES. Electrically operated fuel shut-off valves, one in the main fuel line to each engine, are controlled by the "LH ENGINE VALVE" and "RH ENGINE VALVE" switches located on the fuel control panel in each cockpit. (See figures 2-1 and 2-3.)

1-66. BOOSTER PUMPS. Four booster pumps, one in each of the fuel tanks, are controlled individually by four switches on the pilot's fuel control panel. (See figure 2-1.) Lights adjacent to the four switches identify them as "LH OUT'BD PUMP," "LH IN'BD PUMP," "RH IN'BD PUMP," and "RH OUT'BD PUMP." Tank selection is accomplished by selection of booster pumps. On the copilot's fuel control panel, a single booster pump switch (figure 2-3) turns all four pumps "ON" or "OFF" simultaneously.

1-67. CROSS-FEED VALVES. The cross-feed valves are controlled by a single cross-feed valve switch at the center of the pilot's fuel control panel. (See figure 2-1.) The switch has two positions, "OPEN" and "CLOSE." Operation of the cross-feed valves, in conjunction with the engine fuel shut-off valves and the booster pump switches, makes it possible for one engine to consume all of the fuel carried in the airplane, or for both engines to be fed by one tank system. For examples of cross-feed operation, see figure 3-1. On the copilot's fuel control panel, a single switch (figure 2-3), marked "CROSS OVER," controls the cross-feed valves. Fuel cannot be transferred from one set of tanks to the opposite set.

1-68. DROP TANK CONTROLS. The drop fuel tanks pressure selector valve (figure 1-4, reference 20), located on the floor to the right of the seat in the pilot's cockpit only, has only two positions, "LH DROP TANK" and "RH DROP TANK." No provision is made to turn fuel from drop tanks "OFF." If drop tanks are installed on airplane, all fuel is first supplied from either the left or right drop tank, according to the position of the selector valve, until tank is empty or selector valve is repositioned to opposite drop tank. Positioning the valve directs air pressure to the desired tank. When the selected tank is empty, a light on the pilot's fuel control panel turns off. Refer to paragraphs 4-32 and 4-34 for drop tank jettison controls.

#### 1-69. HYDRAULIC SYSTEMS.

1-70. The hydraulic systems on the airplane include the main system (which operates landing gear and wing flaps), the brake system, and three completely individual surface control booster systems. The main system is supplied with pressure by an engine-driven pump on the left engine only; the booster systems are

supplied with pressure by three electrically driven pumps. No hydraulic pressure gage is provided in the cockpits; therefore, failure of the hydraulic system will be evident only after an attempt to operate the wing flaps or landing gear.

#### 1-71. FLIGHT CONTROLS.

1-72. The primary flight control surfaces are conventionally operated from either cockpit; however, a hydraulic booster system affords boost assistance to the aileron, elevator, and rudder controls, reducing the amount of force required for their movement. The copilot's control stick may be removed from its socket and stowed on the floor to the left of the seat. A permanently installed surface control lock, located forward of the pilot's control stick, locks the ailerons and rudders in a neutral position, the elevators full down.

#### 1-73. RUDDER PEDALS.

1-74. The rudder pedals in both cockpits are adjustable, fore and aft. They may also be disengaged and folded forward to provide the nonpiloting crew member with more room. "RUDDER PEDAL DISCONNECT" levers (figure 1-4, reference 23) are located beneath covers on the floor in each cockpit (one at each side just forward of the seat). When the levers are pushed forward, the pedals will spring forward. The pedals are re-engaged by hooking the toes under the pedals and pulling back until the latches engage, or by pulling back on the release levers and snapping the pedals into the locked position with the toes.

#### 1-75. BOOSTER SYSTEM.

1-76. Surface control boost is supplied by three separate hydraulic systems: one providing aileron boost; and two identical systems (one in the rear of each fuselage), both providing elevator and rudder boost. Each system contains its own hydraulic reservoir and electrically driven pump. The two rudder and elevator boost systems operate independently; however, cable linkage between the control surfaces permits one system to operate effectively in the event the other fails. Pressure from the aileron boost system may be used for emergency lowering of the wing flaps.

1-77. BOOSTER SYSTEM CONTROL. All three surface control booster systems are controlled by a single "ON-OFF" hydraulic boost switch (figure 1-4, reference 1) located on the surface control switch panel at the right side of the pilot's cockpit.

#### 1-78. TRIM TABS.

1-79. Trim tabs on the rudders and elevators are conventionally adjusted in flight by wheels located at the left of the seat in each cockpit. (See figure 1-3, references 23 and 24; figure 1-6, references 13 and 14.) An aileron trim tab control is provided in the pilot's cockpit only. (See figure 1-3, reference 9.)

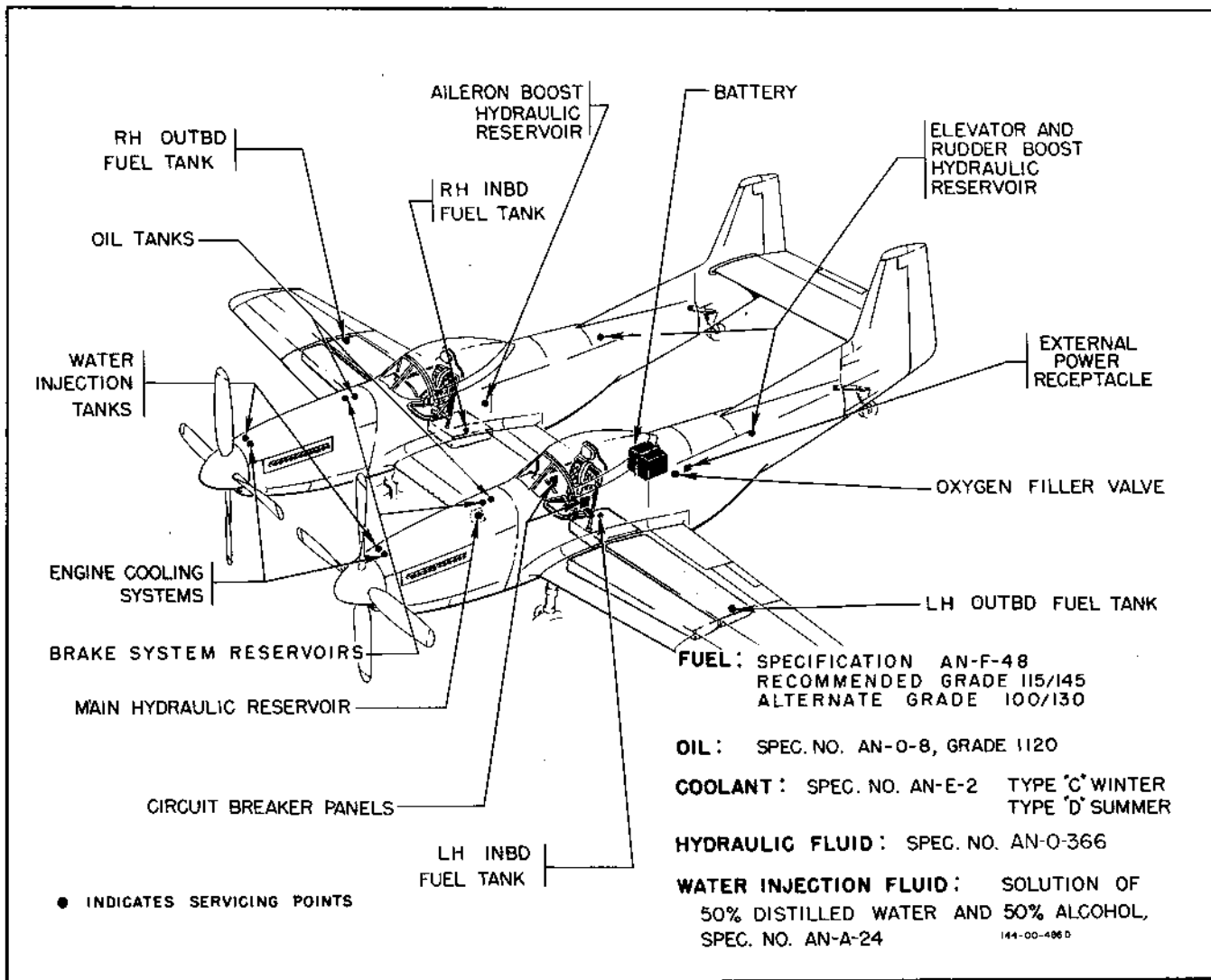

Figure 1-13. General Arrangement

1-80. WING FLAPS.

1-81. **NORMAL WING FLAP CONTROL.** Hydraulically operated wing flaps extend from the aileron to the fuselage on each wing panel and between the fuselages on the center section. They are interconnected and are controlled by a lever located on the left side of the pilot's cockpit only. (See figure 1-3, reference 6.) The lever moves on an indicator marked from 0° to 50°, and selective positioning of the flaps is accomplished by moving the flap lever to the desired setting. When the flaps reach the selected position, they will remain locked until the handle is moved again. Hydraulic pressure is supplied from an engine-driven pump on the left engine. In the event of left engine failure, a hydraulic accumulator may supply enough pressure to lower the flaps approximately 15 to 25 degrees.

1-82. **WING FLAP EMERGENCY SWITCH.** A wing flap emergency switch is located on the left side of each cockpit forward of the throttle quadrant. (See figure 1-3, reference 15; figure 1-6, reference 11.) Movement

of the switch to the "ON" position diverts pressure from the aileron boost system to the down side of the wing flap actuating cylinders. The resultant momentary pressure drop in the aileron boost system has no appreciable effect on aileron control action. The flaps lower approximately 10 degrees per second and may be stopped at any position desired by turning the flap emergency switch "OFF."

**WARNING**

The flaps cannot be raised by operation of the flap emergency switch.

1-83. **LANDING GEAR.**

1-84. The main landing gear and wheel fairing doors are operated hydraulically. The two tail wheels, connected to the main gear by cable linkage, extend and retract in conjunction with them. The tail wheels are locked by holding the control stick aft of neutral; when

locked, they may be turned 7 degrees right or left by using the rudder pedals. With the stick forward of neutral, the tail wheels are full-swiveling.



To prevent damage to tail wheel lock mechanisms, the control stick must be moved forward of neutral *before* a turn is started.

**1-85. LANDING GEAR CONTROL HANDLE.**

1-86. The gear is operated normally by the landing gear control handle on left side of pilot's cockpit only. (See figure 1-3, reference 22.) After the control handle is positioned at "UP" or "DOWN" and the gear reaches the selected position, a hydraulic pressure indicator light (to the right of the pilot's gear position indicators) will illuminate, signifying that system pressure has reached approximately 1250 psi. The control handle should then be returned to "NEUTRAL" to keep the hydraulic pump from operating continuously against pressure. When the weight of the airplane is on the gear, a mechanical lock prevents moving the landing gear control handle to the "UP" position. There is no provision for overriding the lock.

**1-87. EMERGENCY LANDING GEAR RELEASE.**

1-88. The emergency landing gear release handle (figure 1-2, reference 23) is located at the right side of both cockpits below the instrument panel. Pulling the emergency release mechanically unlocks the gear and fairing doors, and actuates a hydraulic dump valve which allows trapped fuel in the landing gear and wheel door cylinders to return to the system reservoir. This then allows the doors to open and the gear to extend by gravity without hydraulic pressure.

**1-89. GEAR POSITION INDICATORS.**

1-90. The landing gear position indicator lights are located below the left side of the pilot's instrument panel. (See figure 1-2, reference 39.) Four green lights (one for each gear) and a single red light (connected to all four gears) give a constant visual indication of landing gear position. Each green light illuminates when its respective gear is down and locked. The red light illuminates when the gear is in any position other than down and locked or up and locked, or if the gear is up and locked and the throttle is retarded below cruising rpm. A single red light on the copilot's engine control panel (figure 1-5, reference 24) illuminates simultaneously with the red light on the pilot's panel, indicating the same unsafe conditions. A warning horn, installed in the pilot's cockpit, sounds when the landing gear is in any position other than down and locked and the throttle is retarded below minimum cruising power. A horn cutout switch button (figure 1-2, reference 40), mounted at the left of the gear position indicator lights,

is provided to silence the horn for cruising at low power. Throttle advancement automatically resets the horn circuit.

**1-91. WHEEL BRAKES.**

1-92. Hydraulic brakes on the main wheels are conventionally operated from either cockpit. The brake system is separate from the main hydraulic system and contains its own hydraulic fluid supply. The parking brake handle (figure 1-2, reference 24) is located on the right side of pilot's cockpit below the instrument panel. To set parking brakes, pull out the parking brake handle, depress toe pedals, release toe pedals, and release the parking brake handle.

**1-93. ELECTRICAL SYSTEM.**

1-94. Two engine-driven 200-ampere generators supply power to the 28-volt, direct-current electrical system. A 24-volt, 34 ampere-hour storage battery serves as a stand-by and provides current for operation of the electrical equipment when the generator is inoperative or generator output is insufficient (below 26.5 volts) to close the reverse-current relays. Each relay closes when the related engine speed reaches approximately 1100 rpm. An external power receptacle (covered by a spring-loaded door) is located on the left side of the left fuselage, aft and above the trailing edge of the wing. Two ammeters and one voltmeter (figure 1-2, references 5 and 11) are located at the top of the pilot's instrument panel.

**1-95. ELECTRICALLY OPERATED EQUIPMENT.**

1-96. The system supplies power for operation of the following equipment and controls: lights; electrical instruments and transmitters; armament and communication equipment; oil and coolant flap actuators; fuel booster and water injection pumps; starters; primer and oil dilution solenoids; mixture controls; engine air, heating, and anti-icing systems; surface control booster motors; and warning systems.

**1-97. ELECTRICAL SYSTEM CONTROLS.**

1-98. BATTERY. A battery switch (figure 1-2, reference 36) is located at the center of the engine control switch panel in the pilot's cockpit only. The inverter is turned on with the battery switch.

1-99. GENERATOR. The generator switches (figure 1-2, reference 32) are located at the center of the engine control switch panel (in the pilot's cockpit only). Guards hold the switches in the "ON" position.

1-100. VOLTMETER SELECTOR. A voltmeter selector (figure 1-3, reference 3), located above the circuit breaker panel on left side of pilot's cockpit, provides for reading the voltage output of the "LEFT GEN," "RIGHT GEN," or the "MAIN BUS."

1-101. VOLTAGE REGULATORS. The voltage regulators are preset on the ground, but in an emergency

may be adjusted in flight by means of two rheostats (figure 1-3, reference 4), one for each generator, located to the left of the pilot's seat. At power settings above 1100 rpm, the voltmeter readings should be between 28 and 28.5 volts.

1-102. **CIRCUIT BREAKERS.** All electrical circuits are protected by push-to-reset circuit breakers. The main panel is located at the rear right side of the pilot's cockpit (figure 1-4, reference 15) and a small panel is located on the left side below the voltage regulators (figure 1-3, reference 26). A panel in the copilot's cockpit (figure 1-5, reference 19) contains circuit breakers for instruments and for cockpit, fluorescent, and taxi lights. Circuit breakers for the radio equipment are located on the radio control panel (figure 1-4, reference 24) at the right side of the pilot's cockpit.

1-103. **CONTROL SHIFT SWITCHES.** Control of engine air, thermal anti-icing, guns, fuel, and the command radio set may be shifted from pilot to copilot, or vice versa, by means of a control shift switch located by each set of controls. An amber indicator light, adjacent to each switch, illuminates when the copilot has control.

**1-104. MISCELLANEOUS CONTROLS AND EQUIPMENT.**

**1-105. FIRE EXTINGUISHER.**

1-106. The fire extinguishing system consists of a CO<sub>2</sub> cylinder installed in the left fuselage aft of the seat, fire indicator lights, and a guarded fire extinguisher switch (figure 1-2, reference 35). The fire indicator lights and guarded fire extinguisher switch are located on the engine control panel in each cockpit. When the push-to-test button (figure 1-2, reference 34) between the indicator lights is depressed, the lights will illuminate, indicating that the electrical circuits are operating properly. Should a fire occur in an engine, the related fire indicator light ("LEFT" or "RIGHT") will illuminate. When the fire extinguisher switch above the

light is moved to "LEFT" or "RIGHT" as required, CO<sub>2</sub> is discharged into the engine section.

**1-107. MANIFOLD PRESSURE DRAIN VALVES.**

1-108. The manifold pressure drain valves, located immediately above the artificial horizon in both cockpits, clear the manifold pressure instrument lines of moisture and vapors.

**1-109. CANOPIES.**

1-110. The clear-vision bubble canopies are operated normally by use of a handcrank (figure 1-4, reference 6) on the right side of each cockpit. The canopies are opened externally from the right side of the fuselage by means of a push-button release below the aft edge of the windshield and a handle on the canopy frame. An emergency release handle for jettisoning the canopy in flight is located on the floor of each cockpit to the right of the control stick. (See figure 1-2, reference 29; figure 1-5, reference 20.) An external canopy emergency release is located on each side of the fuselage, above and forward of flap.

**1-111. SEATS.**

1-112. The bucket seats may be vertically adjusted by a lever on the right side of the seat. Each seat is also adjustable for tilt by a lever at the right rear of the seat on the armor plate. The shoulder harness release lever is located at the left side of the seat. Removable back cushions provided in each cockpit are kapok-filled and may be used for life preservers.

**1-113. DROP MESSAGE CONTAINER.**

1-114. Provisions are made for stowing a drop message tube on the floor to the left of the copilot's seat.

**1-115. OPERATIONAL EQUIPMENT.**

1-116. Information concerning the following operational equipment is supplied in section IV: armament, oxygen, communication, heating, ventilating, anti-icing, and anti-G suit provisions.

## Section II

### NORMAL OPERATING INSTRUCTIONS

#### 2-1. BEFORE ENTERING PILOT'S COMPARTMENT.

#### 2-2. RESTRICTIONS.

- a. Inverted flight must be limited to 10 seconds because of loss of oil pressure.
- b. When external fuel tanks are installed, Chandelles, Immelman turns, inverted flight, rolls, and spins, are prohibited.
- c. When bombs or rockets are installed, spins are prohibited.
- d. Snap rolls are prohibited.
- e. Power-on spins are prohibited.
- f. Rapid reversal of aileron position is prohibited. (Refer to paragraph 2-37.)
- g. Do not extend gear or lower flaps fully above 190 MPH IAS.
- h. Maximum permissible indicated airspeed—see figures 2-4, 2-5, and 4-4.
- i. Do not unfeather propeller at temperatures below  $-12.2^{\circ}\text{C}$  ( $10^{\circ}\text{F}$ ).
- j. The engines in this airplane are restricted as follows:

|  |          |           |
|--|----------|-----------|
| Take-off—Dry (5 min max), and Military Power—Dry (15 min max), |          |           |
| Sea Level to 5000 feet   | 3200 rpm | 65 in. Hg |
| 5000 feet to 15,000 feet                                       | 3200 rpm | 60 in. Hg |
| 15,000 feet and above  | 3200 rpm | 57 in. Hg |

|   |          |           |
|---|----------|-----------|
| Single-engine take-off—Dry (5 min max), |          |           |
| Sea Level to 5000 feet                  | 3200 rpm | 67 in. Hg |

When modifications permit the use of water injection:

|   |          |           |
|---|----------|-----------|
| Take-off—Wet (5 min max), or Military Power—Wet (10 min max), |          |           |
| Sea Level to 5000 feet  | 3200 rpm | 74 in. Hg |
| 5000 feet to 15,000 feet                                      | 3200 rpm | 69 in. Hg |
| 15,000 feet and above   | 3200 rpm | 66 in. Hg |

Note: Use of water injection not to exceed a total of 10 minutes.

THESE LIMITATIONS AND RESTRICTIONS ARE SUBJECT TO CHANGE AND LATEST SERVICE DIRECTIVES AND ORDERS MUST BE CONSULTED.

#### 2-3. TAKE-OFF GROSS WEIGHT AND BALANCE.

2-4. Check take-off and anticipated landing gross weight, and center of gravity location. Make sure that the weight and balance clearance (Form F) is satisfactory.

a. Normal take-off gross weight (full internal fuel and ammunition) is approximately 20,775 pounds. Maximum gross weight (two 310-gallon drop tanks) is approximately 24,900 pounds; however, weights over 22,000 pounds are considered an overload condition.

b. Extreme center of gravity range is from 20.8% MAC (gear down) to 27% MAC (gear up). Probable range in flight: Max aft CG = 26.8%, Max fwd CG = 21.7%.

c. Make sure the total weight of fuel, oil, ammunition, and special equipment carried is suited to the mission to be performed.

#### Note

Refer to Handbook of Weight and Balance Data (AN 01-1B-40) for detailed loading information.



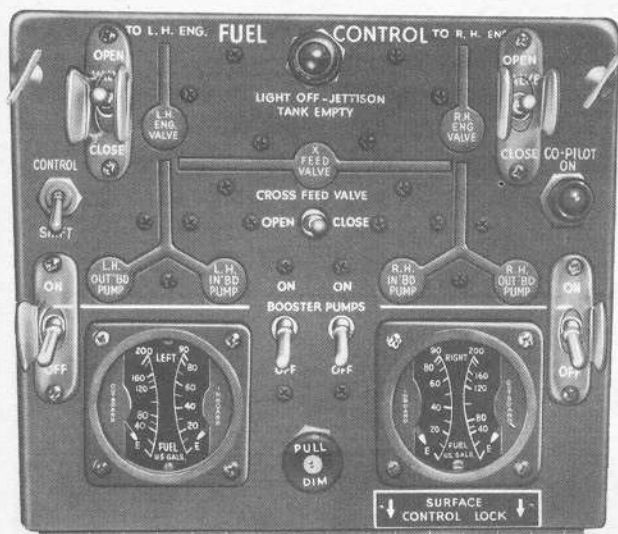

Figure 2-1. Pilot's Fuel Control Panel

## 2-5. EXTERIOR CHECK.

- Make sure the airplane has been serviced with proper quantities of fuel, oil, coolant, water injection fluid, hydraulic fluid, and oxygen. Check Forms 1 and 1A.
- Check security of cowling and all filler caps.
- Inspect air scoops.
- Examine propellers for nicks, cracks, and oil leakage. Make sure that blades are clean. Pull through three revolutions.
- Remove pitot tube cover and be sure tube opening is clear.
- Check landing gear oleo strut extension.
- Examine tires for general condition and inflation.
- Chock wheels.
- Inspect over-all exterior for obvious damage. Remove accumulations of dirt, dust, frost, snow, or ice.

## 2-6. MINIMUM CREW REQUIREMENT.

2-7. The minimum crew requirement for this airplane is one pilot in the left cockpit. Additional crew members as required to accomplish special missions will be added at the discretion of the Commanding Officer.

## 2-8. ENTRANCE TO AIRPLANE.

2-9. Each cockpit is accessible from the trailing edge of the wing on either side of the fuselage; however, the canopies can be opened from the right side only. Spring-loaded doors and handles are provided in the fuselage skin, and the wing fairings may be used as steps. To open the canopy, depress the release button on right side of fuselage just below windshield, and using handle, slide canopy aft on canopy frame.

## 2-10. ON ENTERING PILOT'S COMPARTMENT.

### Note

A Pilot's Check List is provided in each cockpit.

## 2-11. STANDARD CHECK FOR ALL FLIGHTS.

- Armament switches: bomb arming switch "SAFE," bomb selector switch "OFF," rockets "OFF," guns "SIGHT & CAMERA ONLY."
- Ignition "OFF."
- Generators check "ON."
- Unlock surface controls. Check controls for freedom of movement and proper travel, observing control surfaces for correct response.
- Adjust seat and rudder pedals.
- Set parking brakes.

### CAUTION

When setting brakes, do not pull parking brake handle excessively hard as it may damage the brake poppet valves.

- Have external power source connected. If not available, battery switch "ON."
- Landing gear handle "NEUTRAL." Check gear position lights.
  - Propeller controls "INCREASE RPM"; throttles "OPEN" one inch.
  - Oil and coolant radiator controls "AUTOMATIC."
  - Clock and altimeter set.
    - "COPILOT ON" indicator lights (guns, fuel, engine air controls, and command radio) off. If any light is on, move related "CONTROL SHIFT" switch to opposite position.
    - Hold mixture control switches at "IDLE CUT-OFF" for 3 seconds.
    - Check fuel quantity.
    - Cross-feed valve "CLOSE"; engine valves "OPEN." Make sure that copilot's engine valves are in the open position.
    - Booster pumps—check each pump separately for pressure of 10-14 psi. Pump switches "OFF" until ready to start engines.

### Note

If external power source is not available and booster pumps are checked with airplane's batteries, booster pump pressure will be less, depending on condition of the airplane's batteries.

- Engine air controls "ENG. RAM AIR," or "ENG. FILTERED AIR" as required.

VAPOR RETURN TO IN'BD TANKS 3 GAL (9 GAL IF HEATER IS ON)  
PER HR PER ENGINE

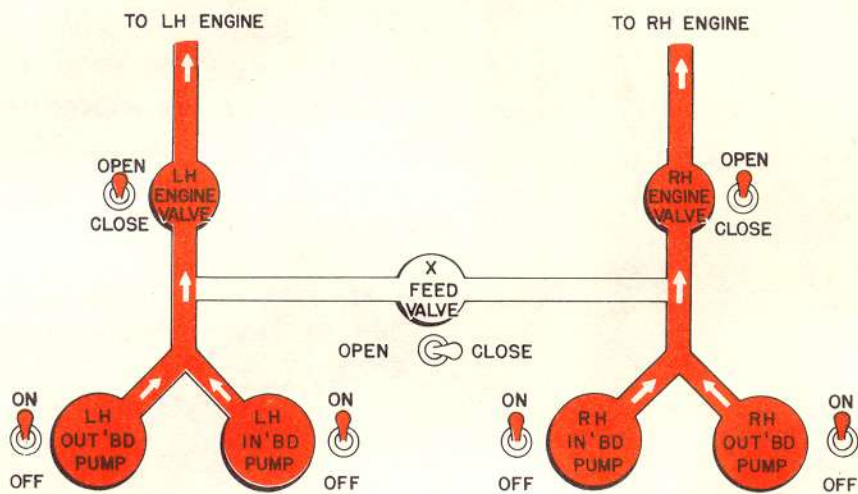

COURSE OF FUEL FLOW - WITHOUT DROP TANKS

TAKE-OFF AND CLIMB TO SAFE ALTITUDE: SELECT AS SHOWN. DURING FLIGHT:  
TURN OUT'BD PUMPS "OFF" AND USE FUEL FROM IN'BD TANKS FIRST; THEN SELECT  
OUT'BD PUMPS. LANDING: SELECT ALL PUMPS OF TANKS CONTAINING FUEL "ON".

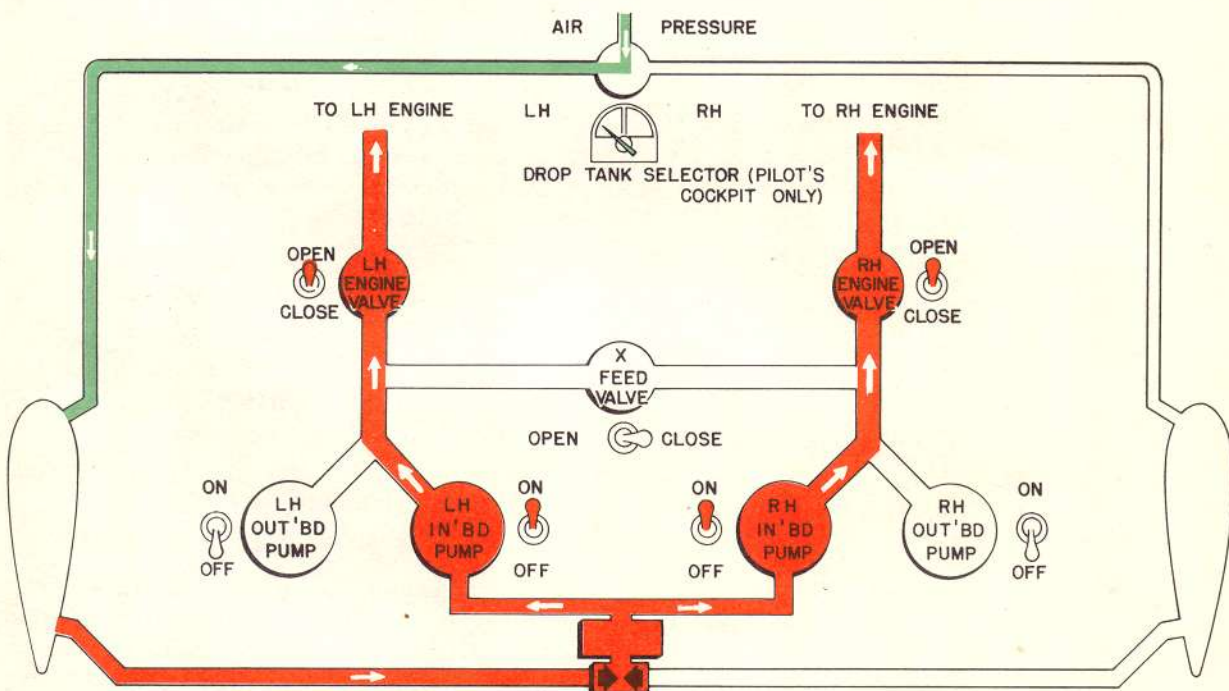

COURSE OF FUEL FLOW DURING FLIGHT - DROP TANKS INSTALLED

TAKE OFF WITH ALL PUMPS "ON" IN FLIGHT, TURN OUT'BD PUMPS "OFF" UNTIL DROP TANKS AND IN'BD  
TANKS ARE EMPTY. EITHER DROP TANK MAY BE SELECTED FIRST; SWITCH TO OPPOSITE TANK AS  
NECESSARY TO DRAIN TANKS EVENLY. WHEN INDICATOR LIGHT GOES OUT, SELECTED TANK IS EMPTY.

144-48-348A

Figure 2-2. Courses of Fuel Flow

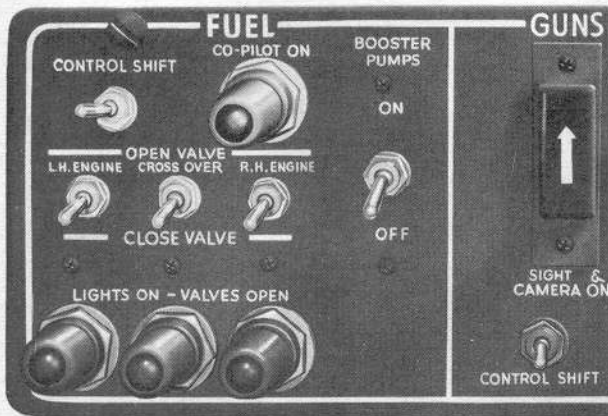

Figure 2-3. Copilot's Fuel Control Panel

**CAUTION**

Do not use engine charge heat during engine starts, take-offs, or landings, as an engine back-fire may cause severe damage to the induction and heating system. Use engine charge heat for all other operations, including ground run-up.

- r. Hydraulic boost "ON."

**Note**

To check operation of surface control booster system, turn hydraulic boost "ON" while moving control stick. A noticeable reduction in friction will be felt.

- s. Test operation of oxygen equipment.
- t. Test operation of communication equipment if external power is being used.
- u. Test operation of gun sight as instructed in paragraph 4-16 if external power is used. Make sure selector-dimmer control is at "GYRO" or "FIXED & GYRO" before starting engine.
- v. Before any night flight, check all lighting equipment.
- w. Water injection switch in "OFF" position.
- x. Heat, ventilating and anti-icing controls set as required.

**2-12. ON ENTERING COPILOT'S COMPARTMENT.**

**2-13. STANDARD CHECK FOR ALL FLIGHTS.**

- a. Adjust seat and rudder pedals.
- b. Set clock and altimeter.
- c. Gun switch "SIGHT & CAMERA ONLY."

d. Make sure oil and coolant radiator controls are in "AUTOMATIC."

e. Test operation of oxygen equipment.

f. Before any night flight, check all lighting equipment.

g. Make sure engine fuel valves are at "OPEN."

**2-14. FUEL SYSTEM MANAGEMENT.**

2-15. See figure 2-2 for fuel system management.

2-16. Alternate grade fuel (100/130) operating limits are the same as limits on recommended grade fuel (115/145).

**2-17. STARTING ENGINES.**

2-18. After completing all cockpit checks, start engines as follows:

**Note**

Start right engine first.

- a. Recheck throttle, propeller, and mixture control positions.
- b. Recheck engine air control switches to "ENG. RAM AIR" or "ENG. FILTERED AIR" as required.
- c. All booster pumps "ON."
- d. Prime engine 2 seconds when cold, one second when hot.
- e. Ignition switch "BOTH."
- f. Engage starter. Prime as required.

**Note**

If engine fails to start after one minute of continuous cranking, allow starter to cool for one minute before making another attempt to start engine.

g. As engine starts, hold mixture control switch at "NORMAL" for 3 seconds. Prime intermittently for smooth operation.

**CAUTION**

When engine is not firing, mixture control must be at "IDLE CUT-OFF."

**Note**

Should engine fail to start because of over-priming, turn off ignition, hold mixture switch at "IDLE CUT-OFF" for 3 seconds, and open throttle. Rotate propeller through about three revolutions by hand or with starter, then repeat starting procedure.

h. Check oil pressure. If not within limits in 30 seconds, stop engine and investigate.

i. Disconnect external power source and turn battery "ON" after both engines are started.

**Note**

Refer to paragraph 3-2 for instructions in case of fire during starting procedure.

**2-19. WARM-UP.**

**CAUTION**

Engine run-up with wheels chocked is limited to take-off power on one engine. For checks above that power, the tail must also be secured.

2-20. Move engine air control switches to "ENG. CHARGE HEAT" and warm up engines at 1300 rpm until oil temperature shows a definite increase and oil pressure remains steady when throttle is advanced. The desired oil and coolant temperatures will be maintained by having the radiator air controls in "AUTOMATIC." If the limits are exceeded with the controls in "AUTOMATIC," stop engines and investigate. (See figure A-4.)

**2-21. GROUND TEST.**

2-22. While engines are warming up, make the following tests:

- a. Hydraulic system—check by operating flaps.
- b. Oil and coolant radiator controls—check (assisted by outside observer or copilot) by using manual positions of each switch. Return switches to "AUTOMATIC."

**CAUTION**

Check with copilot that oil and coolant radiator controls in right cockpit are in "AUTOMATIC."

- c. With manifold pressures less than 25 in. Hg, depress manifold pressure drains for 3 seconds.
- d. Instruments—check for indication in desired ranges.
- e. Communication and armament equipment—test if check was not previously accomplished.

**2-23. TAXIING INSTRUCTIONS.**

2-24. Observe the following instructions and precautions for taxiing:

- a. To taxi straight, hold stick slightly aft of neutral to lock tail wheels.
- b. To make gradual turns, use rudder pedals when tail wheels are locked.
- c. To make sharp turns, neutralize rudders and push stick forward of neutral to allow tail wheels full swiveling action.

**CAUTION**

To prevent damage to tail wheel lock mechanisms, push control stick forward of neutral *before* a turn is started.

- d. Always taxi carefully to prevent possible damage to air scoops and flaps from rocks thrown against them by tires.

**Note**

Coolant flaps will automatically be maintained in a safe position for ground operation.

- e. Make sure wing flaps are up.
- f. Steer a zigzag course to obtain an unobstructed view.
- g. Use brakes as little as possible.

**2-25. BEFORE TAKE-OFF.**

2-26. After taxiing to take-off position, set brakes and complete engine ground test and controls check as follows:

- a. Advance throttle to 2300 rpm and check engine instruments for desired readings. (See figure A-4.)
- b. Check ammeters for positive reading; check voltmeter readings on "LEFT GEN," "RIGHT GEN," and "MAIN BUS" for 28.25 volts maximum.
- c. At 2300 rpm, retard propeller control to note drop of 300 rpm (maximum); then return control to full "INCREASE RPM." Manifold pressure should remain constant within one in. Hg.
- d. With propeller controls in the full "INCREASE RPM" position, advance throttle to obtain a manifold pressure of 30 in. Hg (approximately 2400 RPM), and check each magneto.

Maximum allowable drop in rpm:

Left magneto—100 rpm

Right magneto—150 rpm

- e. Move engine air control switches to "ENG. RAM AIR" or "ENG. FILTERED AIR" as desired.
- f. Advance throttle momentarily for high-power check. (Check each engine separately.)
- g. Wing flaps 20 degrees if desired.
- h. Trim tabs: elevator 5° TH, rudder 0°, aileron 0°.
- i. Check all booster pumps "ON."
- j. Canopy closed and locked.
- k. Safety belt and shoulder harness tightened and locked.
- l. Water injection switch "ON" if water is to be used for take-off.
- m. Parking brakes off.

TO USE CHART ENTER WITH

- (1) MACH NUMBER AND IAS,
- OR (2) ALTITUDE AND IAS,
- OR (3) ALTITUDE AND MACH NUMBER.

EXAMPLE: IF PULLOUT FROM VERTICAL DIVE IS STARTED AT 10,000 FEET AND 400 MPH IAS, 5900 FEET OF ALTITUDE IS LOST DURING RECOVERY WITH CONSTANT 4 G ACCELERATION.

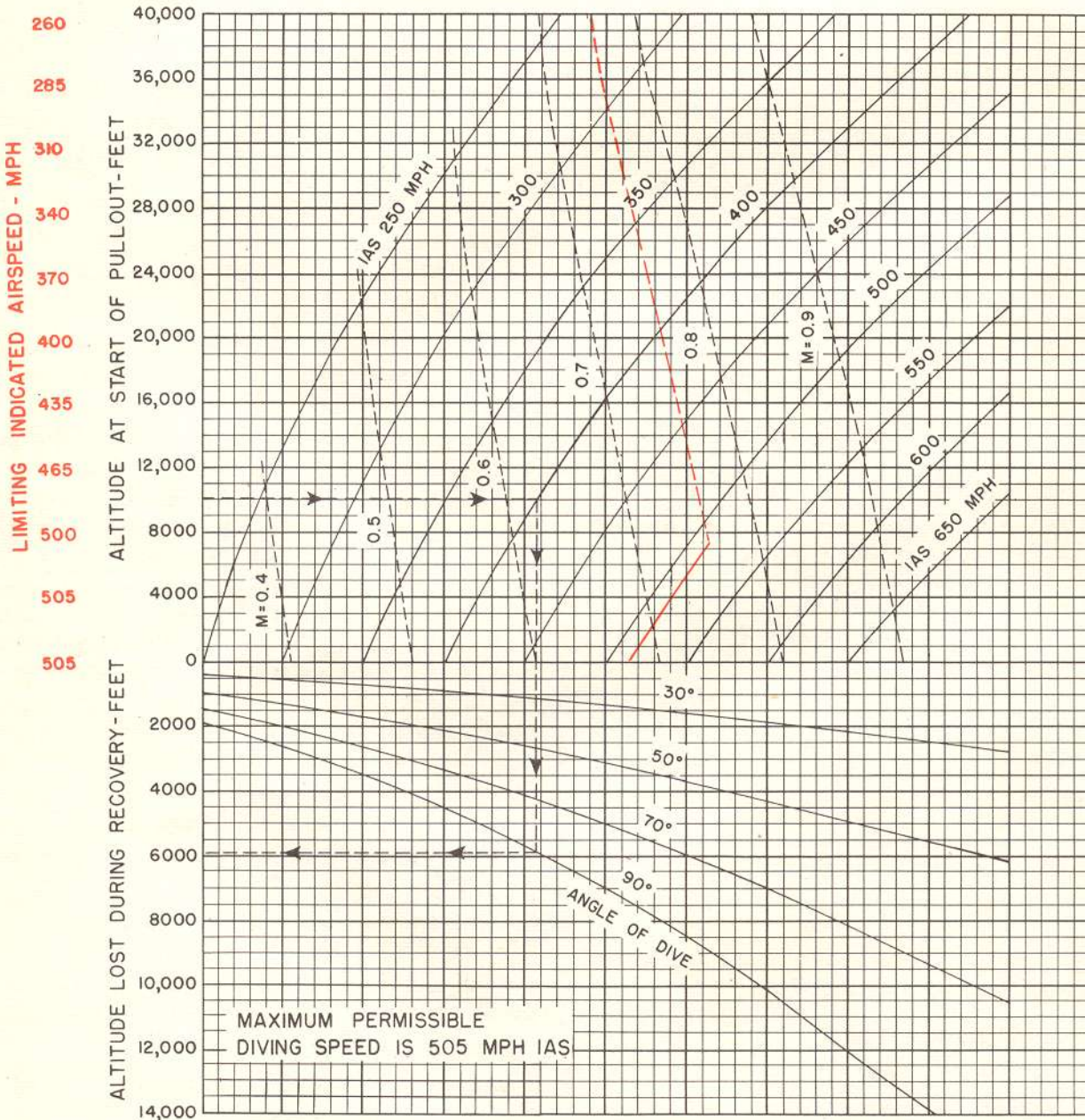

NOTE

RED FIGURES AND RED LINES ON CHART ARE FOR CLEAN AIRPLANE ONLY.

144-93-3740

Figure 2-4. Diving Limitations—4 G Pull-out

TO USE CHART ENTER WITH  
(1) MACH NUMBER AND IAS,  
OR (2) ALTITUDE AND IAS,  
(3) ALTITUDE AND MACH NUMBER.

EXAMPLE: IF PULLOUT FROM VERTICAL DIVE IS STARTED AT 10,000 FEET AND 400 MPH IAS, 4000 FEET OF ALTITUDE IS LOST DURING RECOVERY WITH CONSTANT 6G ACCELERATION.

FOR USE WITH "G" SUIT ONLY

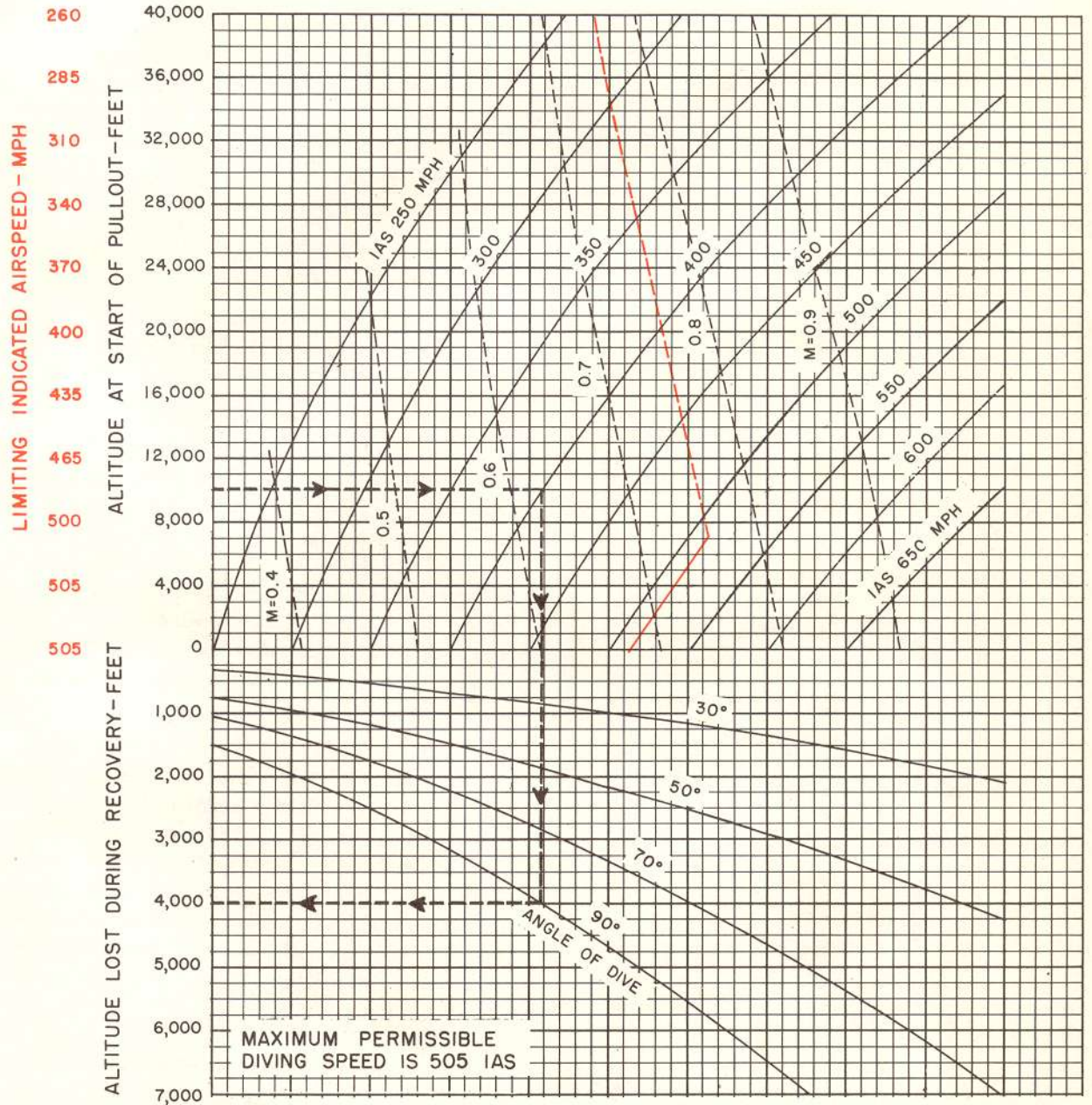

NOTE

RED FIGURES AND RED LINES ON CHART ARE FOR CLEAN AIRPLANE ONLY

144-93-4788

Figure 2-5. Diving Limitations—6G Pull-out

**2-27. TAKE-OFF.**

**2-28. NORMAL TAKE-OFF.**

- a. Hold stick back of neutral to lock tail wheels.
- b. Start take-off run advancing throttles to take-off power.

**WARNING**

Engine operation in excess of manifold pressure limitations listed in paragraph 2-2 may cause severe backfiring and damage to the engines.

- c. Normal take-off speeds are approximately as follows:

|             | NORMAL LOAD | MAXIMUM LOAD |
|-------------|-------------|--------------|
| Flaps "UP"  | 120 mph     | 130 mph      |
| Flaps "20°" | 115 mph     | 125 mph      |

- d. Refer to Take-off, Climb, and Landing Chart (Appendix) for estimated take-off distances.

**Note**

Refer to paragraph 3-13 for procedure in case of engine failure during take-off.

**2-29. MINIMUM RUN TAKE-OFF.**

- a. Wing flaps 20 degrees.
- b. With stick well back to lock tail wheels, hold brakes and advance throttles.
- c. As airplane begins to roll, release brakes and continue advancing throttles to take-off power.

**2-30. AFTER TAKE-OFF.**

- a. When definitely airborne, landing gear handle "UP." Wait until gear position lights (green and red) are out and hydraulic pressure light (amber) is on; then return gear control to "NEUTRAL." Approximately 14 seconds is required for gear retraction.

**CAUTION**

Do not reverse position of the landing gear handle before a retraction or extension cycle is completed.

- b. Start initial climb after attaining approximately 135 mph (normal load) or 155 mph (maximum load).
- c. Wing flaps "UP" after reaching a safe altitude.
- d. Reduce power and begin climb.
- e. Water injection switch "OFF."
- f. Move engine air control switches to "ENG. CHARGE HEAT."

**2-31. CLIMB.**

2-32. Refer to the Take-Off, Climb, and Landing Chart in Appendix for recommended indicated airspeeds to be used during climb, and for rate of climb and fuel consumption.

- a. Climb at maximum continuous power.
- b. With increase in altitude, advance throttle as necessary to maintain manifold pressure.

**2-33. DURING FLIGHT.**

**2-34. ENGINE OPERATION.**

- a. Set power plant controls to desired settings. (Refer to Flight Operation Instruction Charts in Appendix for cruise data.)
- b. Outboard booster pumps "OFF."
- c. Periodically check for desired instrument readings. (See figure A-4.)
- d. Check engine air control switches to "ENG. CHARGE HEAT."
- e. For long-range operation at or below 44 in. Hg and 2400 rpm, use "LONG RANGE CRUISE" position of mixture control.

**2-35. FLIGHT CHARACTERISTICS.**

2-36. Stability and control characteristics of the airplane are satisfactory, both in accelerated maneuvers and steady flight. Handling qualities are good, the control forces being well-balanced and varying normally with variation in load factor or speed. Rolling maneuvers feel quite natural, and there is no perceptible acceleration of the pilot or copilot about the centerline of the airplane during such maneuvers. Trim tab characteristics are normal, and adequate trim is available for control under all conditions, including single-engine cruise.

2-37. TAIL BOOM DEFLECTION. Rapid reversal of aileron position by stick movement (especially at speeds in excess of 190 mph) results in severe tail boom deflection or "wobbling." Such deflection is an undesirable flight condition and the control movement causing it is, therefore, prohibited. Should the deflection be induced inadvertently, the oscillation will immediately dampen if the stick is neutralized.

**2-38. USE OF WATER INJECTION.**

**WARNING**

Engine operation in excess of manifold pressure limitations listed in paragraph 2-2 may cause severe backfiring and damage to the engines.

**CAUTION**

If the oil has been diluted, operate the engine at maximum continuous power until normal oil temperatures and pressures are maintained.

- a. Water injection switch "ON."
- b. Propeller controls full "INCREASE RPM."
- c. Advance throttles to allowable manifold pressure.

**Note**

A drop in engine charge air temperature will occur when water injection system goes into operation.

**WARNING**

When water pressure drops or the water supply is depleted, an immediate rise in engine charge air temperature will occur. It is imperative that the manifold pressure be reduced immediately, to prevent engine damage and possible engine failure.

**2-39. STALLS.**

2-40. Power-off stalls in this airplane are very mild. Adequate warning in the form of general airplane buffet occurs approximately 9 mph above the stall with power on, flaps and gear up. However, there is little or no stall warning with the flaps and gear down, power on or off, and flaps and gear up, power off. Stalls, power on, are characterized by a moderate rolling tendency. Recovery, accomplished by releasing back pressure on the stick, is entirely normal. See figure 2-6 for stalling speeds.

**2-41. SPINS.**

**WARNING**

Power-on spins in this airplane are prohibited.

2-42. This airplane tends to resist all spins and must be forced into the maneuver. Spin entry is characterized by yaw and roll in the direction of the spin, coupled with a nose-down pitch and resultant increase in airspeed. During the following half turn, the airplane's angle of yaw decreases, followed by a nose-up pitch, and a decrease in airspeed. This yawing, pitching, and rolling stabilizes after the spin has progressed through 2½ to 3 turns. Altitude lost during spins is approximately 1000 feet per turn plus 4500 feet to regain level flight after recovery controls are applied. Pilots spinning this airplane should expect to experience moderate lateral

accelerations. These forces are not severe enough to restrict the pilot's movements within the cockpit.

2-43. Application of recovery controls, which is full rudder against the spin, ailerons neutral, and almost simultaneous movement of the elevator to neutral, results in instant response towards stopping the spin. Very little back pressure should be used in recovery in order to prevent buffeting and premature stalls.

**CAUTION**

Gear and flap-down spins, after the first turn, increase the intensity of the lateral accelerations on the pilot and cause heavy airplane buffeting.

**2-44. PERMISSIBLE ACROBATICS.**

2-45. All acrobatics are permitted, except snap rolls and power-on spins. Inverted flight must be limited to 10 seconds because of the loss of oil pressure.

**2-46. DIVING.**

2-47. The handling qualities of this airplane in a dive are not appreciably affected by compressibility up to the limit Mach number of .75. At that point, a mild airplane buffet starts. Below .75 Mach number, no wallowing, porpoising, or abnormal motions of the airplane are encountered. Trim tab settings established for level flight with normal rated power are satisfactory for diving; and during the dive a gradual increase in push force is required from the trim speed up to the limit speed. Rudder pedal forces do not increase appreciably and aileron stick forces retain good "feel."

**Note**

See figures 2-4, 2-5, and A-4, for airspeed and Mach number limitations.

**2-48. ENGINE OPERATION.**

a. It may be necessary to retard the throttles if it is desired to maintain a constant manifold pressure during a dive.

b. After pull-out, check manifold pressure and, if necessary, reduce power.

**2-49. APPROACH.**

2-50. During approach to field for landing, make the following checks:

a. Safety belt and shoulder harness tightened and locked.

b. Oil and coolant radiator controls "AUTOMATIC."

c. Armament switches "SAFE," "OFF," and "SIGHT & CAMERA ONLY."

d. Mixture control switches "NORMAL."

e. Engine air control switches positioned to "ENG. RAM AIR" or "ENG. FILTERED AIR" as required.



- f. All booster pumps of tanks containing fuel "ON."
  - g. Propeller controls 2700 rpm.
  - h. Landing gear handle "DOWN" below 190 mph.
- Check indicator lights; then return handle to "NEUTRAL."



After moving gear handle to "DOWN," do not attempt to raise gear until the extension cycle is complete.

- i. Do not lower flaps above 190 mph.
- j. Make initial approach at approximately 145 mph.

**2-51. LANDING.**

**Note**

Airplanes of high wing loading require a power-on approach for landing, because the rate of descent with power off is very high.

**2-52. NORMAL LANDING.**

- a. Make a power-on approach.
- b. Flaps 40° down on final. Maintain a flat glide angle at a speed of approximately 135 mph.
- c. Adjust trim.
- d. Start flare, reducing power to idling and speed to approximately 110 mph just above runway.

**2-53. AFTER LANDING.**

- a. Flaps "UP" before taxiing.

**2-54. CROSS WIND LANDING.**

2-55. The wide-tread landing gear and locked tail wheels of the airplane facilitate the execution of cross-wind landings. Crab, slip, or combination approach may be used.

**2-56. MINIMUM RUN LANDING.**

2-57. Make a power-on approach using full flaps. As obstacles are cleared, start flare, reducing power and speed as in a normal landing.

**2-58. GO-AROUND.**

- a. Propeller controls full "INCREASE RPM."
- b. Open throttles to take-off power.

c. Landing gear "UP." When gear is up and locked, return handle to "NEUTRAL."

d. When sufficient airspeed is attained, gradually raise flaps.

**2-59. STOPPING OF ENGINES.**

2-60. Stop engines as follows:

- a. Set parking brakes.
- b. Dilute oil as required. For oil dilution instructions, refer to paragraph 5-11.
- c. Run up engines to 1200-1400 rpm for approximately 1-2 minutes; then hold mixture control switches in "IDLE CUT-OFF" position for 3 seconds and advance throttles to gate.

**Note**

The above procedure will help prolong the life of the spark plugs.

d. When propellers stop rotating, ignition switches "OFF" and throttles "CLOSE."



If throttles are left open, overspeeding of the engines, which cannot be controlled by retarding the throttle levers, may occur on the subsequent starting attempt. This condition is caused by congealed throttle valve control oil which may be trapped in the throttle valve "open" line. By moving the throttle levers to "CLOSE" as soon as the engine stops, it will be possible for the spring-loaded throttle valve to force the warm control oil out of the "open" line and assume the fully closed position.

**2-61. BEFORE LEAVING AIRPLANE.**

2-62. Before leaving cockpit, make the following checks:

- a. Booster pump switches "OFF"; engine valves "CLOSE."
- b. All switches except generator switches "OFF"
- c. Release parking brakes after wheels are chocked.
- d. Lock surface controls.
- e. Complete Forms 1 and 1A.

| INDICATED STALLING SPEEDS — M P H |                       |          |              |          |                       |          |              |          |
|-----------------------------------|-----------------------|----------|--------------|----------|-----------------------|----------|--------------|----------|
| GROSS WEIGHT                      | FLAPS DOWN            |          |              |          | FLAPS UP              |          |              |          |
|                                   | POWER ON NORMAL RATED |          | POWER OFF    |          | POWER ON NORMAL RATED |          | POWER OFF    |          |
|                                   | LEVEL FLIGHT          | 45° BANK | LEVEL FLIGHT | 45° BANK | LEVEL FLIGHT          | 45° BANK | LEVEL FLIGHT | 45° BANK |
| 26,000 LB                         | 117                   | 139      | 133          | 158      | 127                   | 151      | 143          | 170      |
| 22,000 LB                         | 108                   | 128      | 122          | 145      | 117                   | 139      | 132          | 157      |
| 18,000 LB                         | 97                    | 116      | 111          | 132      | 106                   | 126      | 119          | 142      |

NOTE: LANDING GEAR POSITION DOES NOT AFFECT STALL SPEEDS

Figure 2-6. Indicated Stalling Speeds

RESTRICTED  
AN 01-60JJA-1

Section III  
Paragraph 3-1 to 3-11

## Section III

### EMERGENCY OPERATING INSTRUCTIONS

#### 3-1. FIRE.

##### 3-2. ENGINE FIRE DURING STARTING PROCEDURE.

- a. If possible, keep engine running. The fire may be sucked through engine and extinguished.
- b. Signal ground crew to use portable fire extinguishing equipment.
- c. Fire extinguisher switch "LEFT" or "RIGHT" as required.
- d. If fire persists, shut off fuel supply by moving engine fuel valve switches to "CLOSE." Ignition safety switch "OFF."
- e. Get out of airplane as quickly as possible.

##### 3-3. ENGINE FIRE DURING FLIGHT.

- a. Related engine valve switch (fuel shut-off) "CLOSE."
- b. Feather propeller.
- c. Ignition switch "OFF."
- d. Fire extinguisher switch "LEFT" or "RIGHT" as required.

**CAUTION**

Do not restart engine. A single discharge exhausts CO<sub>2</sub> supply, leaving none available in case of additional fire.

##### 3-4. ELECTRICAL FIRE.

- a. If source of fire can be determined, turn off switches controlling faulty circuits.
- b. When it is impossible to isolate origin of fire, turn battery and generator switches "OFF."

**CAUTION**

Land as soon as possible. Much of the airplane's equipment becomes inoperative when the electrical power source is shut off.

##### 3-5. WING FIRE.

- a. Turn off all switches controlling electrical installations in wing.
- b. When possible, attempt to extinguish fire by side-slipping airplane away from flame.

#### 3-6. ENGINE FAILURE.

##### 3-7. SINGLE-ENGINE CONTROL CHARACTERISTICS.

3-8. Single-engine control characteristics of this airplane are exceptionally good. Should engine failure occur either on take-off or during flight, control forces required to hold a constant heading are relatively light, and complete control is easily maintained down to stall speed. Adequate directional trim is also available for single-engine cruise with propeller feathered.

##### 3-9. ENGINE FAILURE CHARACTERISTICS.

3-10. Engine failure at cruising and higher speeds will not always be immediately apparent because of the slight amount of yaw induced by engine failure. Also, the instruments will not always give a positive indication of the engine failure until some time has passed. If flight speed is sufficiently high, the propeller on the dead engine will continue to govern at the rpm selected by the propeller control, and since the superchargers are engine-driven (engine stage supercharger through gears, and the auxiliary stage supercharger through a combination of gears and fluid coupling), manifold pressure will not drop, but will continue to indicate normal operation of the engine. Retarding the throttle will decrease manifold pressure; advancing the throttle will increase manifold pressure. Fuel and oil pressure may be normal, since they are controlled by engine-driven pumps and the automatic coolant flap will maintain coolant temperature within limits for a short time, depending on outside air temperature. The only immediate indication of an engine failure will be an increase in trim requirements. The amount will depend on power being used and airspeed at the time of the engine failure. At cruising powers and airspeeds, and in dives, the amount of yaw will be small and engine failure may not be discovered until increased power demands are made. If engine failure should occur during maneuvers or acrobatics, the resultant yaw might be attributed by the pilot to imperfect coordination or rough air. Engine failure at high powers and low airspeeds will cause considerable yaw and possibly a drop in engine rpm and manifold pressure, depending on airspeed. If the airspeed is so low that the propeller cannot windmill at rpm selected by the propeller control, engine rpm and manifold pressure will drop.

3-11. If it is suspected by the pilot that an engine is dead and windmilling, and there is sufficient altitude

Section III  
Paragraph 3-11 to 3-19

RESTRICTED  
AN 01-60JJA-1

available, the following procedure may be used to determine if the engine is dead:

- a. Retard the throttle on the good engine.
- b. Manipulate the throttle on the questionable engine and note any change in yaw and noise level. If there is no change in yaw and noise level, the engine is dead and windmilling.

3-12. Once it is determined that an engine is dead and windmilling, feather the propeller (paragraph 3-21), and use the single-engine procedure as described in paragraph 3-18.

3-13. ENGINE FAILURE DURING TAKE-OFF.

3-14. ENGINE FAILURE DURING TAKE-OFF RUN. If one engine fails during take-off run, close both throttles immediately and apply brakes. Inasmuch as the landing gear handle cannot be moved to "UP" when the airplane is on the ground, the gear cannot be collapsed. However, under certain conditions it may be desirable, when sufficient speed is available, to lift the airplane off the ground enough to permit moving the handle to "UP" so that the gear will collapse as the airplane settles back to the ground.

3-15. SINGLE-ENGINE FAILURE—CONTINUED FLIGHT. If an engine fails immediately after take-off, quickly determine whether the attained airspeed and altitude will permit continued flight, or if a forced landing must be made. Estimated single-engine stalling speeds are approximately 5 mph higher than normal. (See figure 2-6.) If continued flight is possible, proceed as follows:

- a. Immediately apply rudder to correct yaw, and depress nose slightly to maintain airspeed above stall.
- b. Increase manifold pressure on good engine as required, within limits specified in paragraph 2-2.

**Note**

If an obstacle must be cleared, best single-engine climbing speed (gear down, flaps 20°, and windmilling propeller) is 135 mph.

- c. Landing gear handle "UP" (if gear is not already retracted) when right engine is dead. If left engine is dead, the hydraulic pump is inoperative and the gear must be left down.

**Note**

If a safe altitude and airspeed have been reached, it is possible to retract the gear by allowing the dead left engine to windmill and drive the hydraulic pump.

- d. Release drop tanks or bombs.
- e. Feather propeller on failing engine.
- f. Raise wing flaps slowly. (Even if left engine is dead and hydraulic pump therefore inoperative, there will be enough pressure remaining in the system to raise flaps. The flap emergency switch can be used to lower flaps for subsequent landing.)

- g. Trim airplane to reduce rudder force.
- h. Gain as much speed as possible before starting climb. Best single-engine climbing speed with military power (gear and flaps up, propeller on dead engine feathered) is approximately 170 mph.

3-16. ENGINE FAILURE—FORCED LANDING. If it is impossible to maintain flight after an engine failure during take-off, accomplish as much of the following as time allows:

- a. Apply rudder to maintain straight flight, and depress nose of airplane to maintain flying speed.
- b. Release drop tanks or bombs if carried.

**Note**

If rockets are carried, they cannot be released in a safe condition.

- c. Landing gear handle "UP." (If left engine is dead and no hydraulic pressure is available, the gear will at least be unlocked and will collapse on landing.)
- d. If flaps have been raised, move control to desired setting. If left engine is dead and windmilling, the hydraulic pump will supply pressure for flap operation. The emergency flap switch may be utilized if desired.
- e. Both engine valves (fuel shut-off) "CLOSE."
- f. Ignition and battery switches "OFF."
- g. Jettison canopies.
- h. Land straight ahead, changing direction only as necessary to miss obstructions.

3-17. ENGINE FAILURE DURING FLIGHT.

3-18. SINGLE-ENGINE FAILURE. If one engine fails during flight, proceed as follows:

**Note**

- Estimated single-engine stalling speeds are approximately 5 mph higher than normal. (See figure 2-6.)
- Using normal rated power on single engine, altitude can be maintained up to 10,000 feet with airplane gross weight of 21,000 pounds, up to 5000 feet with airplane gross weight of 23,000 pounds.

- a. Hold airplane straight with rudder. A slight yaw is allowable.
- b. Feather propeller on failing engine.
- c. Adjust power settings on good engine.
- d. Trim airplane as required.
- e. See figure 3-1 for fuel selection during single-engine operation, figure A-9 for range data.

3-19. SINGLE-ENGINE LANDING. If it is impossible to maintain flight after one engine failure during flight, land as follows:

- a. When in position for normal approach and landing, lower gear. (If left engine is dead, use emergency landing gear release.) The airplane will maintain altitude on single engine with gear extended and propeller on dead engine feathered.

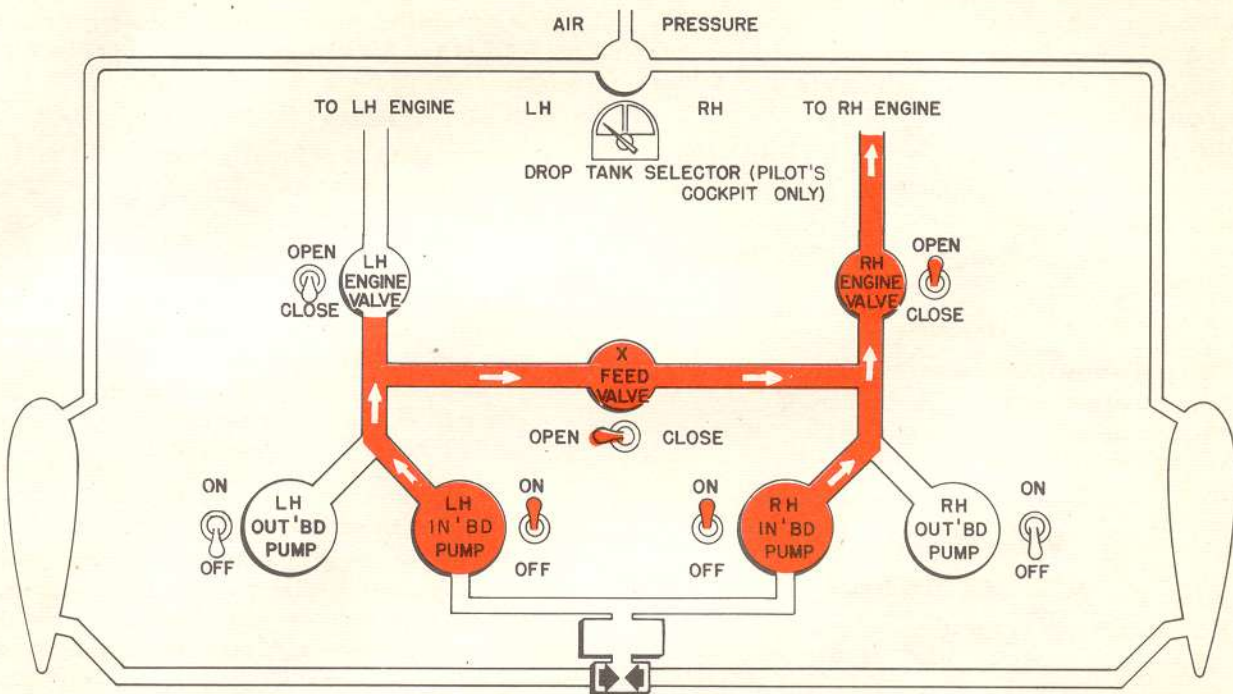

COURSE OF FUEL FLOW - LEFT ENGINE DEAD  
OUT'BD PUMPS MAY BE SELECTED WHEN IN'BD TANKS ARE EMPTY. IF DROP TANKS ARE INSTALLED, SELECT AS DESIRED WHILE IN'BD PUMPS ARE "ON"

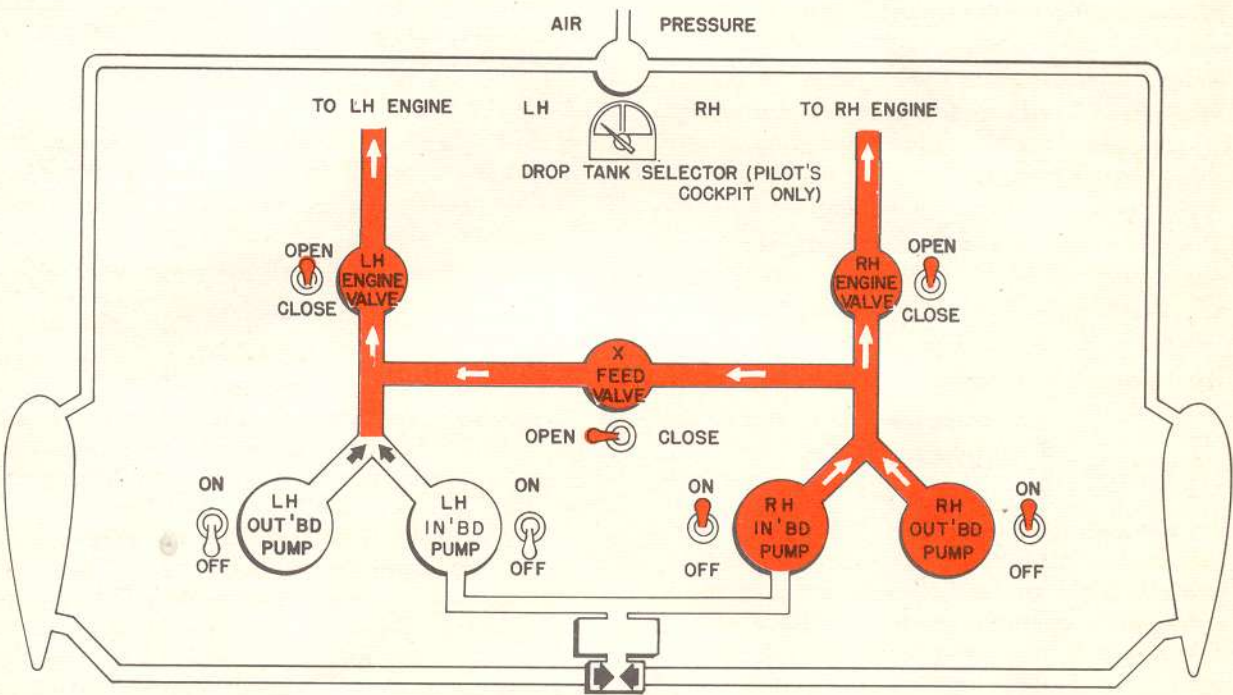

COURSE OF FUEL FLOW - LEFT TANKS EMPTY

144-48-347A

Figure 3-1. Courses of Fuel Flow—Emergency

**Section III**  
**Paragraph 3-19 to 3-26**

**RESTRICTED**  
**AN 01-60JJA-1**

b. Reduce rudder trim used for single-engine flight to prevent high rudder forces when good engine is throttled.

c. Use flaps and power on live engine to regulate glide angle. (If left engine is dead, lower flaps by use of flap emergency switch.)

3-20. PROPELLER—EMERGENCY OPERATION.

3-21. PROPELLER FEATHERING. To feather propeller, proceed as follows:

a. Throttle for dead engine "CLOSE"; propeller, "FEATHER."

**Note**

Unless throttle is fully retarded, propeller control cannot be moved to the feathering range. No additional controls are provided or required for feathering the propellers.

**WARNING**

If propeller does not feather completely when control is moved to "FEATHER," advance propeller control into governing position and then return to full feather position. If propeller cannot be feathered, leave propeller control in full high pitch (low rpm) position, to reduce drag from windmilling propeller.

b. Mixture switch for dead engine "IDLE CUT-OFF" for 3 seconds.

c. Trim rudder to reduce rudder force.

d. Move dead engine switches as follows: ignition "OFF," generator "OFF," engine valve (fuel shut-off) "CLOSE," booster pumps "OFF."

e. Adjust power setting on good engine.

f. Trim airplane for correct flight attitude.

g. See figure 3-1 for fuel selection during single-engine operation, and figure A-9 for range data.

3-22. PROPELLER UNFEATHERING. To unfeather propeller, proceed as follows:

**CAUTION**

Do not unfeather propeller at temperatures below  $-12.2^{\circ}\text{C}$  ( $10^{\circ}\text{F}$ ). Low temperatures may partially freeze coolant in engine cooling system while propeller is feathered. This condition results in poor circulation and excessive temperature rise when engine is restarted without first allowing time at a higher temperature for the solution to thaw.

a. Engine valve "OPEN," and inboard or outboard (whichever tank is fuller) booster pump switch "ON."

b. Throttle "OPEN" approximately one inch.

c. Ignition "BOTH."

d. Advance propeller control approximately 2 inches from "FEATHER" until propeller begins to turn.

e. As propeller starts turning, hold mixture switch at "NORMAL" for 3 seconds. Check oil pressure within range.

f. Generator switch "ON."

g. Run engine at reduced power until the oil and coolant temperatures indicate a safe operating condition.

**Note**

If an attempt to unfeather propeller is unsuccessful, place propeller control in cruising rpm range and engage the starter to start propeller rotating. Rotation of the propeller is required in order to actuate the integral propeller oil pump, and thus move the blades out of the feathered position.

3-23. RUNAWAY PROPELLER.

3-24. Failure of the propeller governor may result in a runaway propeller. When such a failure occurs, the propeller goes to full low pitch and engine speed may exceed allowable limits. It may be possible to reduce rpm as follows:

a. Retard throttle for related engine and reduce airspeed to minimum. (See figure A-4 for maximum allowable rpm.)

b. Attempt to feather propeller.

c. If feathering is not accomplished and rpm cannot be reduced below the maximum allowable, shut down engine completely.

**3-25. BAIL-OUT.**

3-26. In the event that an emergency exit must be made during flight, the following procedure is recommended:

a. If possible, reduce speed and trim airplane to fly "hands off."

b. Disconnect radio and oxygen equipment.

**CAUTION**

If bail-out is made at high altitude, remain connected to the regular airplane oxygen supply while all other preparations for leaving the airplane are being made. Just before leaving the airplane, disconnect oxygen mask from mask-to-regulator tubing and place the Type H-2 emergency oxygen cylinder in operation by pulling the rip cord cable of the oxygen cylinder (the caution tag and pin assembly having been removed prior to take-off).

c. Unfasten safety belt and shoulder harness.

d. Jettison canopy. If canopy does not fly off immediately when emergency canopy release is pulled, move handcrank enough to relieve pressure against windshield.

RESTRICTED  
AN 01-60JJA-1Section III  
Paragraph 3-26 to 3-37

- e. Raise seat to topmost position.
- f. Rise to a crouched position in the seat and dive *outboard* toward the wing tip.

**3-27. FORCED LANDING.**

3-28. Power-off landings in airplanes of high wing loading, such as the F-82E, demand exceptional pilot skill and should be executed only in an emergency. When failure of both engines requires it, prepare for such a landing as follows:

**Note**

Refer to paragraph 3-16 for single-engine landing instructions.

- a. Immediately depress nose of airplane to maintain flying speed.
- b. Release drop tanks or bombs.

**Note**

If rockets are carried, they cannot be released in a safe condition.

- c. When it is desirable to stretch the glide, feather both propellers. Windmilling propellers will shorten the glide.
- d. Both engine valves (fuel shut-off) "CLOSE."
- e. Ignition safety switch "OFF."
- f. Jettison canopies.
- g. Do not lower landing gear (unless absolutely certain that available area is suitable for wheels-down landing).
- h. Lower flaps as required by use of flap emergency switch.
- i. Without power the airplane will sink very rapidly. Maintain an airspeed well above stall during glide and flare.
- j. Battery switch "OFF" just before landing.

**Note**

Surface control booster system will be inoperative when electrical power source is cut off.

- k. After landing, get out of airplane as quickly as possible, and stay out.

**3-29. DITCHING.**

3-30. As a result of experience with airplanes of similar design, it is recommended that the airplane be ditched only as a last resort. If it is impossible to reach land when trouble arises over water, leave the airplane while in flight. When ditching is unavoidable, proceed as follows:

- a. Release drop tanks or bombs.

**Note**

If rockets are carried, they cannot be released in a safe condition.

- b. Unbuckle parachute, tighten safety belt, and lock shoulder harness.

- c. Jettison canopies.

- d. Lower flaps 20° to 30°. (Flaps will collapse on impact and do not tend to make the airplane dive.)

- e. Use as much power as possible.
- f. Reduce speed to just above stall.
- g. Maintain level attitude.

- h. If a wind is blowing, head into wind. Try to touch down just after a wave crest has passed. If wind velocity is under 5 mph, disregard wind and head airplane parallel to any swells that may be running. Try to touch down on the falling side of the swell.

**3-31. FUEL SYSTEM EMERGENCY OPERATION.**

3-32. COURSES OF FUEL FLOW—EMERGENCY.

3-33. See figure 3-1.

**3-34. COOLANT FLAP EMERGENCY OPERATION.**

3-35. If under any condition an excessive coolant temperature persists on either engine:

- a. First try the manual "OPEN" position of the coolant radiator control switch for the related flap. (Check flap visually from opposite cockpit.)

- b. If after approximately 20 to 30 seconds, the temperature remains high and failure of the coolant flap actuator is indicated, pull the emergency coolant air flap release lever in the related cockpit.

- c. After using the emergency release, hold the coolant radiator control switch in the "CLOSE" position for approximately 20 seconds. (This will ensure that the flap is not extended beyond 6 inches if the electrical actuator is functioning at all.)

- d. Place the switch at the central or off position for the remainder of the flight.

**CAUTION**

Use the emergency release with discretion. High coolant temperatures may be the result of high power settings, engine malfunction, or a broken indicator rather than actuator failure. When the emergency release has been used, low power operation should be avoided to prevent the coolant temperature from going below the minimum allowable limit as a result of the greater flap opening. There is no provision for emergency closing of the flap, nor can the emergency release be reset in flight.

**3-36. LANDING GEAR EMERGENCY OPERATION.**

3-37. To lower the landing gear in the event of hydraulic system failure (or if the left engine is dead), proceed as follows:

- a. Reduce airspeed to below 140 IAS. (Above that speed, air loads may hold the fairing doors closed.)
- b. Pull emergency landing gear handle in either cockpit. Hold handle out until gear is down.

**Section III**  
**Paragraph 3-37 to 3-50****RESTRICTED**  
**AN 01-60JJA-1**

c. If the gear does not lock down because of air pressure against fairings, yaw airplane until gear position indicators show a safe condition.

**3-38. WING FLAP EMERGENCY OPERATION.**

3-39. To lower the wing flaps when the normal system is inoperative:

a. Move flap emergency switch in either cockpit to "ON." (The flaps will lower approximately 10 degrees per second.)

b. To stop flaps at desired position, return switch to "OFF."

**WARNING**

The flaps cannot be raised by operation of the flap emergency switch.

**3-40. SURFACE CONTROL BOOSTER SYSTEM EMERGENCY OPERATION.**

3-41. No emergency system is provided.

**3-42. ELECTRICAL SYSTEM EMERGENCY OPERATION.**

3-43. GENERATOR FAILURE.

3-44. Should one or both generators fail, turn defective generator "OFF" and operate only essential electrical equipment to reduce the load on the remaining generator or the battery.

3-45. VOLTAGE REGULATOR FAILURE.

3-46. Excessively high voltage may result from failure of the voltage regulator.

a. Adjust voltage with voltage regulator rheostat. If voltage cannot be brought within allowable limit (28 volts), turn generator "OFF."

b. If one or both generators are turned off for any reason, operate as little electrical equipment as pos-

sible. If feasible, turn off surface control boost and radio equipment.

c. When it is necessary to disconnect both generators, periodically recharge the battery by turning one generator switch on for approximately 5 minutes. During this charging period, turn off any electrical equipment which may be damaged by excessively high voltage.

**Note**

Refer to paragraph 1-96 for list of equipment which will be rendered inoperative by failure of electrical system.

**3-47. OXYGEN SYSTEM EMERGENCY OPERATION.**

3-48. Should symptoms occur suggestive of the onset of anoxia, or the regulator become inoperative, descend below 10,000 feet. Whenever excessive carbon monoxide or other noxious or irritating gas is present or suspected, then, regardless of the altitude, the air valve should be set at "100% OXYGEN," and undiluted oxygen used until danger is past or flight is completed. Should brief removal of mask from face be necessary at high altitude, use the following procedure:

a. Take three or four deep breaths of undiluted oxygen (air valve at "100% OXYGEN").

b. Hold breath and remove mask from face.

c. As soon as practicable, replace mask to face and take three or four deep breaths of undiluted oxygen.

d. Reset air valve to "NORMAL."

**3-49. BOMB AND DROP TANK EMERGENCY RELEASE.**

3-50. Bombs and external fuel tanks can be released from either cockpit. Place bomb arming switch in "OFF" position in pilot's cockpit. Lift guard covering the bomb salvo switch in either cockpit and hold the switch on momentarily.

## Section IV

### OPERATIONAL EQUIPMENT

#### 4-1. GUNNERY EQUIPMENT.

4-2. Six .50-caliber fixed machine guns, with electric heaters, are installed in the wing center section. (Provisions are also made for mounting a droppable gun nacelle, beneath the wing center section.) Four hundred rounds of ammunition can be carried for each gun. All guns must be manually charged prior to flight, through gun bay doors in the upper surface of the wing. A K-18 compensating gun sight is mounted on the instrument panel shroud in the pilot's cockpit (figure 1-2, reference 8), and an electrical ranging control (figure 1-3, reference 12) is incorporated in the throttle grip. A fixed ring and bead sight and a gun camera are installed on the copilot's instrument shroud. (See figure 1-5, references 7 and 10.) Provisions are made for mounting a gun camera on the gun sight in the pilot's cockpit.

#### 4-3. GUNNERY CONTROLS.

4-4. GUNNERY CONTROL SHIFT SWITCH. The guns (and camera) are controllable from either cockpit. A gunnery control shift switch, located on the armament panel in each cockpit (figure 1-2, reference 44; figure 1-5, reference 27), provides for transferring gunnery firing control from one cockpit to the other. Illumination of the "COPILOT ON" indicator light, adjacent to the switch, indicates that the copilot has control of the gun.

4-5. GUN SELECTOR. The gun selector switch (figure 1-2, reference 44), equipped with a guard, is located on the armament panel in each cockpit. The switch may be positioned for operation on "GUNS" which includes sight and camera, or for "SIGHT & CAMERA ONLY." Whenever the guard is closed, the selector switch is automatically moved to the "OFF" position.

4-6. TRIGGER. The control stick grip in each cockpit contains a trigger switch for firing the guns, or for operating the camera alone when the gun selector switch is at "SIGHT & CAMERA ONLY."

4-7. GUN HEATER. The gun heaters are controlled from the pilot's cockpit only. The heater switch (figure 1-2, reference 44) is located on the armament panel.

4-8. K-18 GUN SIGHT.

4-9. The K-18 gun sight is installed in the pilot's cockpit and automatically computes the correct lead angle

for target crossing speed at ranges from 200 to 800 yards. Two optical systems, fixed and gyro, are contained in the sight. The reticle of the fixed sight, projected on the reflector glass, consists of a 70-mil circle with a small cross in the center, and a rocket scale located below the cross. Normally blanked out (by depressing the masking lever on left side of sight), the circle and scale are used only for firing rockets, for strafing, or in case of mechanical failure of the gyro. The reticle of the gyro sight projected on the reflector glass consists of a circle of six diamond-shaped images surrounding a central dot. The diameter of the circle is variable, and when the target is properly framed within the circle, the sight automatically computes the amount of lead required. When both reticles are used, the separation of the fixed cross from the central dot shows the lead angle which is computed. Gun sight spare lamps are located outboard of rocket selector on right side of pilot's cockpit.

#### 4-10. GUN SIGHT CONTROLS.

4-11. All controls for the sight are located in the pilot's cockpit. Power is supplied to the gun sight by the gun selector switch on the armament panel.

4-12. SELECTOR-DIMMER CONTROL. A selector-dimmer unit (figure 1-3, reference 21) located below the throttle quadrant in pilot's cockpit, consists of a selector switch that permits choice of reticle images ("FIXED & GYRO," "GYRO," or "FIXED"), and a rheostat for controlling intensity of reticle illumination from "DIM" to "BRIGHT."

4-13. SPAN SCALE KNOB. A span scale knob on the face of the sight (figure 1-2, reference 8) is used to preset the span scale in accordance with the dimensional wing span of the target plane. When the setting of the span scale is changed, the diameter of the circle in the gyro reticle is varied accordingly.

4-14. RANGING CONTROL. An electrical ranging control is incorporated in the throttle grip (figure 1-3, reference 12). The pilot maintains correct range by keeping the target framed within the circle of the gyro reticle; the diameter of the circle is varied by rotating the throttle grip.

4-15. NACELLE EMERGENCY RELEASE. A nacelle emergency release handle is located at the left side of each cockpit below the instrument panel. (See figure 1-3, reference 20; figure 1-6, reference 12.)



4-16. PREFLIGHT OPERATION OF GUN SIGHT. Before take-off, check the gun sight, as follows:

- a. Gun selector switch "SIGHT AND CAMERA ONLY."
- b. Selector switch on selector-dimmer control "FIXED & GYRO." Both reticles will appear on the reflector. If the circle and scale appear, blank them out with masking lever at left of sight.
- c. Rotate dimmer rheostat to obtain desired reticle brilliance.
- d. Make sure dot of gyro is superimposed on the fixed cross when aiming at point on horizon.
- e. Selector at "GYRO" or "FIXED & GYRO" as desired.



Keep selector switch on "GYRO" or "FIXED & GYRO" at all times when engine is running, as engine vibration and landing shocks may damage gyro pivots if unit is not operating.

f. Check throttle ranging control for operation of gyro reticle from minimum to maximum range.

4-17. COMBAT OPERATION OF GUN SIGHT. In combat, proceed as follows:

- a. Identify your opponent; then set the span scale to correspond with the enemy type.
- b. Fly airplane so that the enemy appears within the gyro reticle, and rotate the throttle ranging control until the diameter of the gyro reticle corresponds to the size of the enemy.

c. Continue to rotate ranging control, keeping the enemy within the gyro reticle—then fire.

4-18. GUN SIGHT OPERATIONAL NOTES. For most effective use of the K-18 sight, observe the following instructions:

- a. Keep sight operating at all times when encounter with enemy is possible.
- b. When maneuvering into position for attack, *keep the sight set at the shortest range* (large diameter gyro reticle) and decrease the diameter to correspond to the enemy size.
- c. *Always track the target before firing.* By operating the ranging control, continually frame the target while tracking for a minimum period of one second; then fire. Only after such tracking will the gyro sight compensate correctly.
- d. Learn to use the sight instead of your flight instruments. Notice that, with the selector set for normal operation ("FIXED & GYRO"), the relative positions of the fixed and gyro reticles indicate what your airplane is doing. If the cross and dot are superimposed, you are flying in a straight line.

e. For firing at a stationary ground target, use the fixed part of the sight.

#### 4-19. ROCKET EQUIPMENT.

4-20. A total of twenty-five 5-inch high-velocity aircraft rockets may be carried on five racks mounted beneath the wing. Two racks are mounted under each outer wing panel, and one rack beneath the wing center section. Rockets may be armed and fired from the pilot's cockpit only. Firing order of the rockets and firing sequence of the racks are not selective. Rockets are fired from the two inboard racks first, from the outboard racks next, and from the center rack last. (See figure 4-1.)

#### 4-21. ROCKET CONTROLS.

4-22. ROCKET ARMING. The rocket arming switch (figure 1-2, reference 43) is located on the pilot's armament panel. The rockets may be armed to detonate on impact ("INSTANT"), or for delayed detonation ("DELAY").

4-23. ROCKET FIRE CONTROL. A rocket fire control (figure 1-4, reference 12), located on right side of pilot's cockpit, provides for firing the rockets either singly or in pairs. With the switch at "SINGLES," one rocket is fired alternately from each outer wing rack; at "PAIRS," two rockets (one from each outer wing rack) are fired simultaneously. Rockets from the rack on the wing center section are fired last, and regardless of switch setting, the two outer rockets are fired simultaneously, the center rocket singly.

4-24. ROCKET SELECTOR. The rocket selector switch (figure 1-2, reference 43) is located on the armament switch panel in the pilot's cockpit. With the selector switch at "SINGLE," rockets are released singly or in pairs (as selected by the rocket fire switch) with each depression of the bomb-rocket release button (figure 1-2, reference 28) on the control stick grip; at "AUTO," rockets are fired in train, singly or in pairs, with one depression of the release button. The switch should remain in the "OFF" position until rockets are ready to be fired, as there is no safety position on the arming switch.

4-25. FIRING ROCKETS. The rockets are armed and fired as follows:

- a. Rocket fire control "SINGLES" or "PAIRS" as desired.



After rocket firing has once been started, do not change rocket fire control, as misfiring will result. If the rocket sequence is changed, some rockets will be skipped or previously fired rocket stations will be selected.

- b. Selector switch "SINGLE" or "AUTO" as desired.

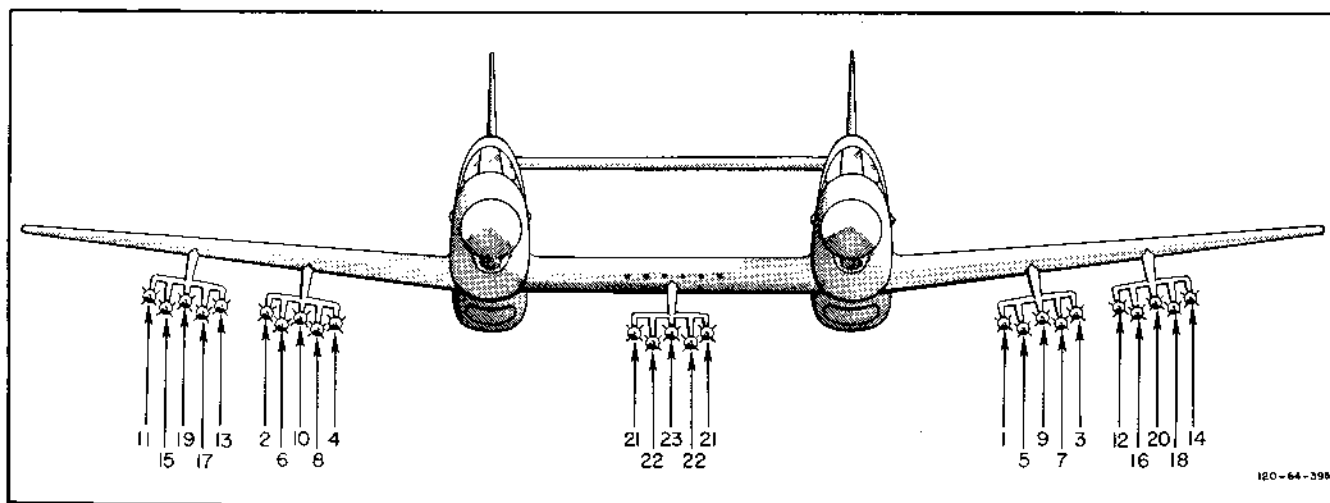

Figure 4-1. Rocket Firing Order

- c. Arming switch at "INSTANT" or "DELAY."
- d. To fire rockets, depress bomb-rocket release button.

**4-26. BOMBING EQUIPMENT.**

4-27. Bombs up to 1000 pounds can be carried on removable racks mounted one under each outer wing panel; bombs up to 2000 pounds can be carried on two racks under the wing center section. Bomb controls are provided in the pilot's cockpit only. The bomb-rocket release button, installed on the copilot's stick grip, is inoperative.

**4-28. BOMB CONTROLS.**

4-29. **BOMB ARMING.** The bomb arming switch (figure 1-2, reference 42) is on the pilot's armament panel. Bombs may be armed to detonate instantly on impact ("NOSE & TAIL") or for delayed detonation ("TAIL ONLY"). The bombs remain unarmed when switch is in the "SAFE" position.

4-30. **BOMB SEQUENCE.** The order in which bombs are dropped may be selected by the bomb sequence switch (figure 1-3, reference 17) located below the radiator switches in the pilot's cockpit. The switch may be positioned for dropping bombs from "IN'BD RACKS FIRST" or from "OUT'BD RACKS FIRST." On either setting, the left bomb is released first and then the right one.

4-31. **BOMB SELECTOR.** The bomb selector switch is located on the armament switch panel in the pilot's cockpit. (See figure 1-2, reference 42.) With the selector switch at "TRAIN," one bomb is dropped with each depression of the bomb-rocket release button on the control stick grip; at "ALL," simultaneous release of all bombs is effected with one depression of the release button.

4-32. **BOMB SALVO.** Emergency release of all bombs, external fuel tanks, or chemical tanks is provided by an electrical bomb salvo switch (figure 1-3, reference 18; figure 1-5, reference 25) which is equipped with a guard and located adjacent to the bomb sequence switch in the pilot's cockpit, and on the gun control panel in the copilot's cockpit.

4-33. **RELEASING BOMBS.** The bombs are armed and released as follows:

- a. Bomb rack sequence switch "IN'BD RACKS FIRST" or "OUT'BD RACKS FIRST" as desired.
- b. Selector switch "TRAIN" or "ALL" as desired.
- c. Arming switch "NOSE & TAIL" or "TAIL ONLY."
- d. To drop bombs, depress bomb-rocket release button.

e. After releasing bombs, move arming switch to "SAFE" and selector control to "OFF."

4-34. **RELEASING DROP FUEL TANKS.** The drop fuel tanks are released as follows:

- a. Reduce airspeed to 250 mph.
- b. To release tanks when no bombs are carried, depress bomb salvo switch.
- c. If bombs are being carried on center racks, place bomb sequence switch at "OUT'BD RACKS FIRST," bomb selector at "TRAIN," and depress bomb-rocket release twice.

**4-35. CHEMICAL TANKS.**

4-36. A chemical tank (Type AN-M10 or AN-M33) may be carried on each outer wing bomb rack. A chemical selector switch (figure 1-2, reference 41) on the pilot's armament switch panel provides for discharging "RIGHT" or "LEFT" tanks when the bomb-rocket release button on the control stick grip is depressed. The tanks may be released from the racks by the normal or emergency bomb release system.

4-37. DISCHARGING CHEMICAL TANKS.



Make sure bomb selector switch is "OFF," to prevent accidental release of the tanks.

- a. Chemical selector switch "RIGHT" or "LEFT" as desired.
- b. Press bomb-rocket release button on control stick grip to discharge chemicals.
- c. To jettison tanks, depress bomb salvo switch, or, if bombs are being carried on center racks, place bomb selector on "TRAIN," sequence switch at "OUT'BD RACKS FIRST," and then depress bomb-rocket release button twice.

4-38. OXYGEN.

4-39. A low-pressure oxygen system is provided in the airplane. Two Type F-2 oxygen cylinders are installed behind each seat; a Type G-1 cylinder is installed on the left side of each fuselage just aft of the wing trailing edge. Normal full pressure is 400 psi. In normal operation all cylinders are interconnected, with floating check valves in the lines. This allows the entire

oxygen supply to be available for both the pilot and copilot. Under this condition, if oxygen is released from either of the regulators, both cockpit gages will show a simultaneous loss in pressure. In the event of line failure, the check valves will automatically seat, because of the unbalanced pressure, resulting in an independent oxygen system in each fuselage. A diluter-demand regulator, a blinker flow indicator, and a pressure gage are located on the right side of each cockpit. (See figure 1-4, references 10, 11, and 13; figure 1-7, references 6, 7, and 8.) All oxygen cylinders may be refilled through a single filler valve located on the outboard side of the left fuselage.

**Note**

In the event violent maneuvers are executed with the airplane, it is possible the oxygen system check valves may seat. This will result in separate and independent oxygen systems in each fuselage. At such time as the oxygen system is refilled and serviced, the system will then revert to a common oxygen supply for both pilot and copilot.

4-40. COMMUNICATIONS EQUIPMENT.

4-41. TABLE OF COMMUNICATIONS EQUIPMENT.

| TYPE          | DESIGNATION | USE   | OPERATOR  | ILLUSTRATION                                       |
|---------------|-------------|---|---|--|
| Command       | AN/ARC-3    | Two-way voice communication.  | Pilot or copilot obtains complete control by operating radio control transfer switch.           | Figure 1-4, reference 8; figure 1-7, reference 4.  |
| Radio Compass | AN/ARN-6    | Reception of voice and code communications; position finding; homing. | Pilot or copilot.   | Figure 1-4, reference 9; figure 1-7, reference 1.  |
| IFF           | SCR-695B    | Automatic identification.   | All controls in pilot's cockpit. Copilot's cockpit contains all controls except code selection. | Figure 1-4, reference 7; figure 1-7, reference 3.  |
| Interphone    | AM-26A-AIC  | Intercockpit communication.   | Push-to-talk button on throttle in both cockpits.   | Figure 1-3, reference 13; figure 1-6, reference 9. |

4-42. OPERATION OF COMMAND SET.

- a. Turn radio control transfer switch on to obtain control of equipment.
- b. Turn command radio power switch "ON."
- c. Rotate selector to desired frequency channel and allow approximately 30 seconds for set to warm up.

When the audio tone heard in the earphone stops, the set is tuned and ready for operation.

- d. Adjust volume control for desired output.
- e. To transmit, press "TRANS" button on throttle.

4-43. OPERATION OF RADIO COMPASS.

- a. Turn compass control switch to desired type of operation: "ANT," "COMP," or "LOOP."

| MAN-HOUR OXYGEN CONSUMPTION TABLE                             |        |                           |        |        |        |        |        |            |
|---|--------|---------------------------|--------|--------|--------|--------|--------|------------|
| (APPROXIMATE DURATION-REGULATOR AIR VALVE AT "NORMAL OXYGEN") |        |                           |        |        |        |        |        |            |
| ALTITUDE  |        |                           |        |        |        |        |        |            |
| GAGE<br>DURATION  | 10,000 | 15,000                    | 20,000 | 25,000 | 30,000 | 35,000 | 40,000 |            |
|   | 400    | 14:50                     | 11:10  | 9:10   | 8:10   | 8:40   | 11:40  | 15:40      |
|   | 350    | 12:40                     | 9:30   | 7:50   | 7:00   | 7:20   | 10:00  | 13:20      |
|   | 300    | 10:40                     | 8:00   | 6:30   | 5:50   | 6:10   | 8:20   | 11:10      |
|   | 250    | 8:30                      | 6:20   | 5:20   | 4:40   | 5:00   | 6:40   | 9:00       |
|   | 200    | 6:20                      | 4:50   | 4:00   | 3:30   | 4:40   | 5:00   | 6:40       |
|   | 150    | 4:10                      | 3:10   | 2:40   | 2:20   | 2:30   | 3:20   | 4:30       |
|   | 100    | 2:10                      | 1:30   | 1:20   | 1:10   | 1:10   | 1:40   | 2:10       |
|   | 50     | DESCEND BELOW 10,000 FEET |        |        |        |        |        | 144-93-333 |

Figure 4-2. Oxygen Consumption Table

- b. Press red button in center of band selector knob for transfer of control.
- c. Select one of the four frequency bands.
- d. With the tuning crank, tune station desired, for "MAX" on tuning dial.
- e. Adjust audio control for desired output.
- f. The radio is turned off by rotating control switch to "OFF."

4-44. OPERATION OF IDENTIFICATION RADIO.



Before take-off, insert destructor plug in face of IFF equipment (accessible through radio compartment door on outboard side of right fuselage). Remove plug immediately after landing.

- a. Rotate code selector to position "1." (Leave in position "1" at all times when operating the equipment, unless directed by commanding officer to use one of the other positions).
- b. Move G-band switch to "ON" or hold it momentarily at "TIME" as desired.
- c. To turn off the radio, move the code selector and the G-band switch to "OFF."

4-45. OPERATION OF INTERPHONE. To transmit on interphone, press the button marked "INTER" on the throttle.

4-46. COCKPIT HEATING, VENTILATING, AND DEFROSTING.

4-47. A separate heating, ventilating, and defrosting system is provided in each fuselage. Heated air, obtained aft of the coolant radiator, is distributed to defroster outlets at the windshield, to a floor outlet at the pilot's feet, and to controllable outlets at each side of the seat.

(See figure 1-3, reference 28.) Ventilating air is secured from forward of the coolant radiator and distributed through the same system. Ground heating or defrosting can be accomplished by operating a combustion-type heater and blower provided in each fuselage. The blower will operate only when the landing gear is extended. During flight, the heater is normally operated only for anti-icing, but may be used to obtain additional cockpit heat under extreme conditions, or in case of engine failure. The system may be operated simultaneously with engine charge heat or surface anti-icing. (Refer to paragraphs 1-39 and 4-55.)

4-48. HEATING, VENTILATING AND DEFROSTING CONTROLS.

4-49. The system is controlled from the cockpit for which heating, ventilating, or defrosting is desired. Controls are identical in both cockpits.

4-50. COCKPIT AIR VOLUME. The amount of air directed to the system for heating or ventilating is controlled by the cockpit air volume control (figure 4-3) located on the floor to the right of the seat. Turning the control clockwise increases the volume. When the volume control is "OFF," no air is admitted to the system, and the heater cannot be operated for cockpit heating. In order to put heater in operation, it is necessary to move the cockpit volume control to any position between two-thirds and full open. (A microswitch is connected to this valve to prevent the heater from operating when the control is one-third or less closed.)

4-51. COCKPIT AIR TEMPERATURE. The air temperature control (figure 4-3) is located on the heat control panel in each cockpit. In the "COLD" position, only ventilating air is admitted to the system; rotating the rheostat counterclockwise increases the temperature accordingly until it reaches the full "HOT" position. The "HEATER ON" position must be used when the heater is operated for cockpit heating. (Refer to paragraph 4-53.c.)

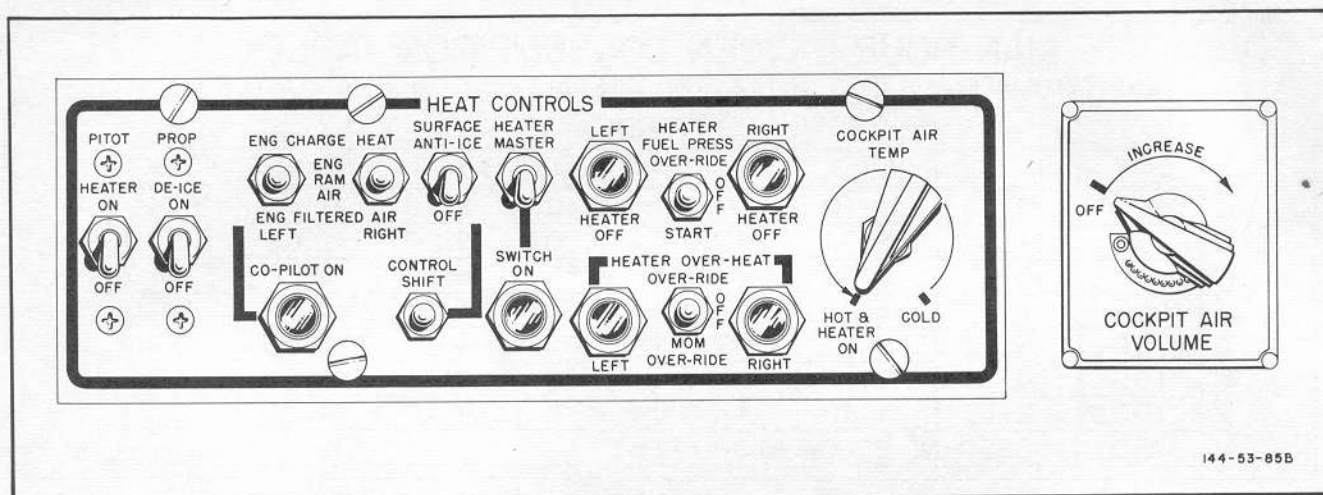

Figure 4-3. Heat Controls

4-52. DEFROST. All or part of the air normally supplied to the foot outlets may be directed to the inside of the windshield by means of a push-pull defroster control (figure 1-2, reference 25) located below the heat control panel in each cockpit.

4-53. OPERATING HEATING, VENTILATING, AND DEFROSTING SYSTEM. Operate the heating, ventilating, and defrosting system as follows:

a. To obtain ventilating air, turn temperature control to "COLD" and rotate volume control clockwise for desired output.

b. For cockpit heat, turn volume control on and adjust temperature control as desired.

c. To operate the heater for cockpit heating in flight, turn on volume control to between two-thirds and full open, and rotate air temperature control to "HEATER ON"; turn heater master switch on and then depress fuel pressure switch to start the heater. For ground operation, it is unnecessary to use the fuel pressure switch to start the heater. (Refer to paragraph 4-61.)

d. Adjust side outlets for desired volume and direction of airflow.

e. For windshield defrosting, pull defroster control to position desired.

**4-54. THERMAL ANTI-ICING SYSTEM.**

4-55. Hot air for anti-icing is obtained from aft of each coolant radiator, further heated by combustion heaters, and then routed through ducts to the leading edges of the wing and tail surfaces, and to the outer surface of the armor glass. The temperature of the air admitted to the surfaces is automatically controlled to maintain adequate protection against the particular icing conditions encountered. Heating systems in both fuselages supply heated air to their respective halves of the airplane. However, operation of the surface anti-ice switch in either cockpit starts both systems simultaneously. A

cross-feed fuel line is provided in the heater fuel system to permit continued operation of both heaters in event either engine is inoperative. The system may be used for defrosting the surfaces on the ground by means of the heater and a blower. The blower will operate only when the landing gear is down.

**4-56. ANTI-ICING CONTROLS.**

4-57. All controls for anti-icing are provided on a heat control panel (figure 4-3) in each cockpit. (See figure 1-2, reference 21.)

4-58. HEAT CONTROL SHIFT SWITCH. Control of the anti-icing system may be transferred by operation of a heat control shift switch. Illumination of the "CO-PILOT ON" indicator light adjacent to the shift switch, indicates that the copilot has control of the system. The same shift switch also transfers control of the engine air system. When control is transferred, the surface anti-icing and engine air systems will assume the operating condition selected on the panel to which control is shifted.

4-59. SURFACE ANTI-ICING. The surface anti-ice switch, located on the heat control panel in both cockpits, controls the valves which divert airflow to the wing and tail anti-icing ducts.

4-60. HEATER MASTER SWITCH. The heater master switch controls electrical circuits to the heater and must be on to obtain surface anti-icing. The master switch also controls the heater fuel system and turns on the blowers (when landing gear is down). An indicator light below the switch illuminates in both cockpits whenever either heater master switch is turned on.

4-61. HEATER FUEL PRESSURE. Fuel is supplied to the heaters during flight by depressing the fuel pressure switch to the "START" position (with heater

144-53-85B

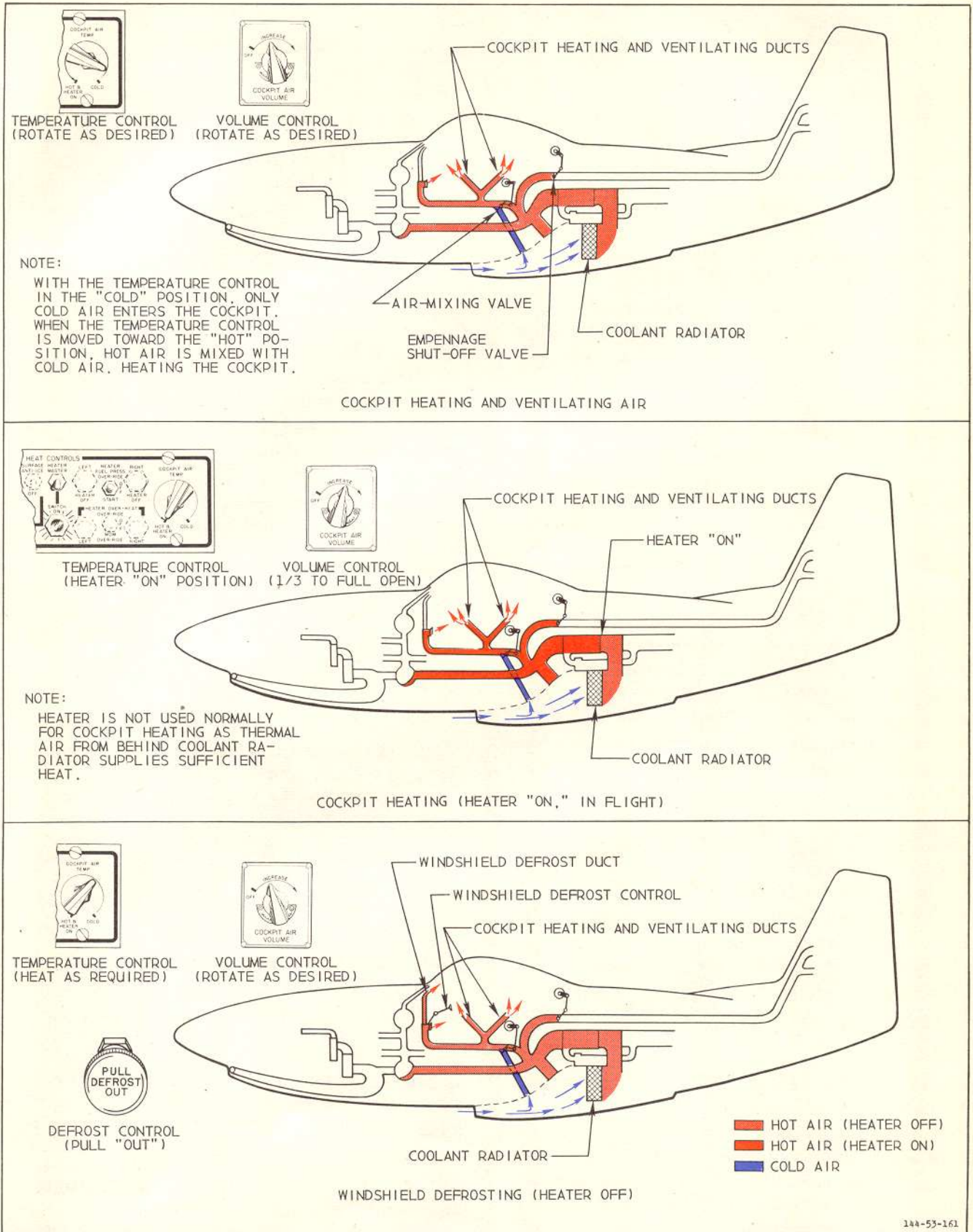

Figure 4-4. Cockpit Heating, Ventilating, and Defrosting

master switch "ON"). When the airplane is on the ground, it is unnecessary to use the fuel pressure switch to start the heater as fuel is supplied through a low pressure solenoid valve which is closed when airplane weight is on the gear.

**WARNING**

If heaters are operated during take-off, they will go out when airplane is airborne and must be restarted by depressing the fuel pressure switch to the "START" position.

An amber light on either side of the switch will illuminate when the heaters are first started for anti-icing; when both lights go out, it indicates that heaters are operating at sufficient temperature (above 275°F) to maintain heat for anti-icing symmetrical about the airplane centerline. (When operating the anti-icing system on the ground, the indicator lights will not go out, since the heater fuel supply is cycled to restrict heater output to 225°F.) During anti-icing operation, should just one of the lights illuminate again, it indicates that the respective heater is not operating at desired temperature and an uneven ice formation could result on the airplane unless the system were turned off. The heater indicator lights function only during anti-icing and are inoperative when the heaters are used for cockpit heating. A pressure switch in the heater fuel line automatically turns off the fuel supply in case of a broken fuel line. The "OVER-RIDE" position of the heater fuel pressure switch in the cockpit permits continued operation in an emergency or in event of malfunctioning of the pressure switch in the fuel line.

4-62. HEATER OVERHEAT. Should a heater exceed temperature limits (above 415°F), the fuel supply and electrical power to the spark plug are automatically shut off and the heater will go out. This condition is indicated by illumination of overheat lights, one for each heater, located on the heat control panel. An over-ride switch between the lights has three positions: "OFF," "OVER-RIDE," and a spring-loaded position "MOM OVER-RIDE." Moving the switch to either operating position restarts the heater. The momentary position merely restarts the heater, and if overheating reoccurs, the heater will go out again. The fixed "OVER-RIDE" position permits the heater to be operated above the overheat limits if required under extreme icing conditions. However, if the temperature is allowed to reach approximately 700°F when operating with the switch at "OVER-RIDE," a valve will open to dump all air overboard. Should this occur, the heater master switch should be turned off to cut off fuel supply to both heaters.

**WARNING**

Once the dump valve opens, the entire system will be inoperative, as the valve can be reset only on the ground. Heated induction air can be obtained under these conditions only by leaving surface anti-ice switch "ON," to allow hot air from the engine compartment to enter the intake duct through the alternate air door. (See figure 1-9.)

4-63. OPERATING ANTI-ICING SYSTEM.

- a. Obtain control of the system by operation of the heat control shift switch.
- b. Master heater switch "ON."
- c. Move surface anti-ice switch to "SURFACE ANTI-ICE" position; heater indicator lights will illuminate.
- d. Hold heater fuel pressure switch at the "START" position for approximately 10 seconds (necessary in flight only).
- e. When the heater indicator lights go off (in flight only), the heaters are operating at sufficient temperature to maintain anti-icing protection symmetrical about centerline of airplane.

**Note**

After ground operation, keep the master heater switch on momentarily to allow blower to clear heaters of unburned gases.

**Note**

If the icing condition is encountered in which, with the anti-icing system on, ice accumulates on the wings, the airplane should be flown above the icing condition if possible. If this is not possible, the airplane should be flown at as low an altitude as the terrain permits and at an airspeed below 200 mph IAS. Under these conditions the airplane is making best use of the anti-icing system.

4-64. PROPELLER DE-ICER SYSTEM.

4-65. The propellers are de-iced electrically through heating elements in rubber boots cemented on the leading edge of each propeller blade. The electrical power for the heating elements is supplied by a generator in each propeller hub. A cycling unit actuates the generator, directing current to the blades for 15 out of every 45 seconds.

4-66. PROPELLER DE-ICE CONTROL.

4-67. De-icing for both propellers is controlled by the propeller de-ice switch (figure 4-3), located on the heat control panel in both cockpits. The system must be turned off from the same cockpit from which it was turned on.

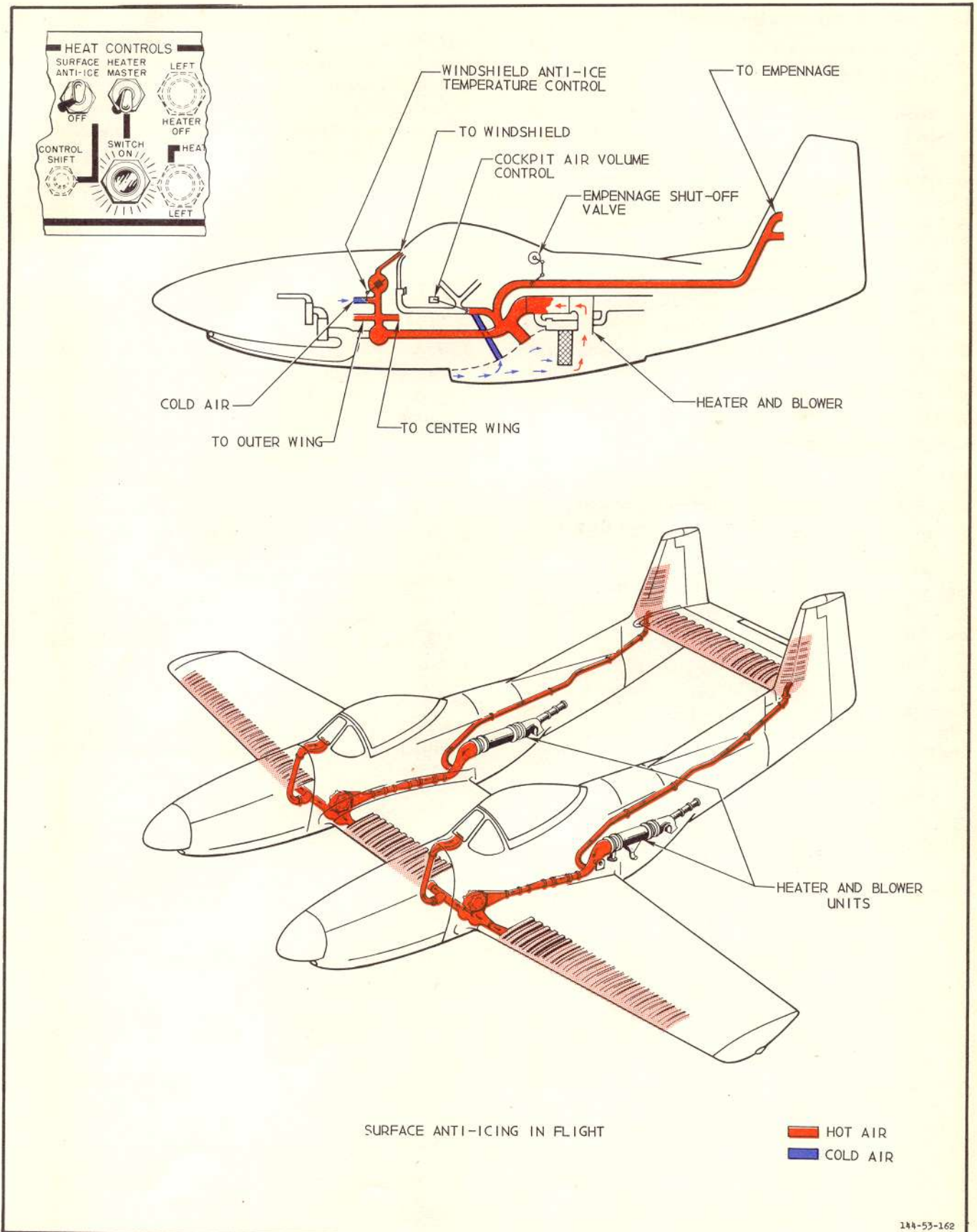

Figure 4-5. Surface Anti-icing System



#### 4-68. ANTI-G SUIT PROVISIONS.

4-69. An air pressure outlet connection on the left side of the seat in each cockpit (figure 1-3, reference 27; figure 1-6, reference 3) provides for attachment of the air pressure intake tube of the anti-G suit. Air pressure for the inflation of the anti-G suit bladders is supplied from the exhaust side of the engine-driven vacuum pump, and is regulated by a Type M-2 valve which is a junction point for pressures exerted in both the drop fuel tanks and the anti-G suit. If drop tanks are installed on the airplane, the accelerating force (G load) required to actuate the M-2 valve should be about 4 G because of the approximately 5 psi pressure exerted in the tanks. Without the drop tanks installed, the valve should open at 2.75 G. After the valve opens, pressure is passed through a regulator valve into the suit in proportion to the G force imposed. For every one G acceleration force, a corresponding one psi air pressure is exerted in the anti-G suit.

#### 4-70. LIGHTING EQUIPMENT.

##### 4-71. EXTERIOR LIGHTING EQUIPMENT.

4-72. POSITION LIGHTS. The position lights on the wing tips and rudders are controlled by two switches (figure 1-4, reference 4) on the right side of pilot's cockpit only. The lights are turned on by the aft switch, and may be placed at "FLASH" or "STEADY." The forward switch controls brilliancy and has "BRIGHT" and "DIM" positions.

4-73. FUSELAGE LIGHTS. The fuselage light switch (figure 1-4, reference 3) is located on the light switch panel in the pilot's cockpit. The lights are illuminated when the switch is placed at "BRIGHT" or "DIM." A keying switch (figure 1-4, reference 2) on the panel provides for manually flashing the fuselage lights.

4-74. LANDING LIGHT. The landing light, located inboard of the right gear, is controlled by a landing light switch above the trim tab controls in the pilot's cockpit (figure 1-3, reference 8) and just aft of throttle in the copilot's cockpit (figure 1-6, reference 6.) The light extends and retracts with the gear, and will illuminate only when the gear is down and locked.

4-75. TAXI LIGHTS. The taxi lights, one under each wing, extend and retract with the gear. The taxi light switch is located adjacent to the landing light switch in each cockpit. (See figure 1-3, reference 7, and figure 1-6, reference 7.)

##### 4-76. INTERIOR LIGHTING EQUIPMENT.

4-77. COCKPIT LIGHTS. The cockpit lights are controlled by a rheostat located on the left side of the engine control switch panel in each cockpit. (See figure 1-2, reference 33; figure 1-5, reference 30.) Indirect instrument panel lighting is provided by fluorescent lamps located one on either side under the shroud and controlled by a rheostat on the lamp itself.

4-78. SPARE LAMPS. Spare lamps for gun sight and cockpit lights are located at the right side of pilot's cockpit above the rocket selector. In the copilot's cockpit, spare lamps are located on left side below the instrument panel shroud. One spare fluorescent lamp is provided in each cockpit, above the pilot's surface control booster switch, and to right of copilot's instrument panel.

##### 4-79. PITOT HEATER.

4-80. The pitot heater is controlled by an on-off switch on the heat control panel in each cockpit. (See figure 4-3.)

## Section V

### EXTREME WEATHER OPERATION

#### 5-1. ARCTIC OPERATION.

#### 5-2. BEFORE ENTERING AIRPLANE.

a. Remove protective covers from engines, cockpits, air scoops, and wing and tail surfaces.

b. Be sure solid cowl doors are installed in place of the perforated filter doors normally used.

c. Remove snow and ice from surfaces, control hinges, propellers, pitot tube, fuel vents, and crankcase breather outlet.

d. Drain moisture from fuel strainers and drain cocks.

e. Check "Y" drains, oil tank sump drains, and oil cooler drains for free flow, and apply heat if flow is unsatisfactory.

f. Clean shock struts of dirt and ice; check for proper inflation.

g. Pull propellers through five or six revolutions. The ease with which this can be accomplished may aid in determining the amount of engine compartment heat required prior to starting.

h. When required to heat engine compartment, open the alternate air inlet door from left side of each engine cowl by loosening dzus fastener in access door and pulling tab full out.

#### 5-3. AFTER ENTERING AIRPLANE.

a. Make sure that a portable generator cart is connected.

b. With alternate air doors open, heat engine compartments approximately 15 to 30 minutes. Turn on heater master switch and any fuel booster pump; move engine air control switches to "ENG. CHARGE HEAT." (See figure 5-1.)

c. Turn on cockpit heat and windshield defroster if required.

#### 5-4. STARTING ENGINE.

a. Check engine air control switches to "ENG. RAM AIR."



**CAUTION**

Do not use engine charge heat during engine starts, take-offs, or landings, as an engine backfire may cause severe damage to the induction and heating system. Use engine charge heat for all other operations, including ground run-up.

b. Make crankability test, prior to starting, by holding starter on (ignition switch "OFF") and making sure that propeller will turn over at least 50 rpm. If 50 rpm cannot be attained, continue warming engine compartment.

c. Prime 5 to 10 seconds (or until raw fuel flows from supercharger drain).

d. Turn on ignition switch.

e. Depress starter and prime simultaneously.

#### Note

If engine fails to start after one minute of continuous cranking, allow starter to cool for one minute before making another attempt to start the engine.

f. As engine fires, hold mixture control switch at "NORMAL" for 3 seconds. Prime intermittently until engine is running smoothly.

g. If there is no oil pressure after 30 seconds running, or if pressure drops after a few minutes ground operation, stop engine and investigate.

h. After engines are started, have external power disconnected and turn on battery switch.

#### Note

If mission requires use of guns, turn gun heaters on immediately after starting engines.

#### 5-5. WARM-UP.

#### Note

Use firmly anchored wheel chocks for all engine run-ups. Should a full-power run-up be made, make sure that firmly anchored wheel chocks are used and, in addition, that tail is tied down.

a. Maintain engine rpm between 1300 and 1500 until oil temperatures and pressures reach desired limits.

b. Shut down engines and have ground crew close alternate air inlet doors; then restart.

c. If necessary, turn on surface anti-icing system.

d. Move engine air control switches to "ENG. CHARGE HEAT."

#### 5-6. BEFORE TAKE-OFF.

a. Check controls carefully for freedom of movement.

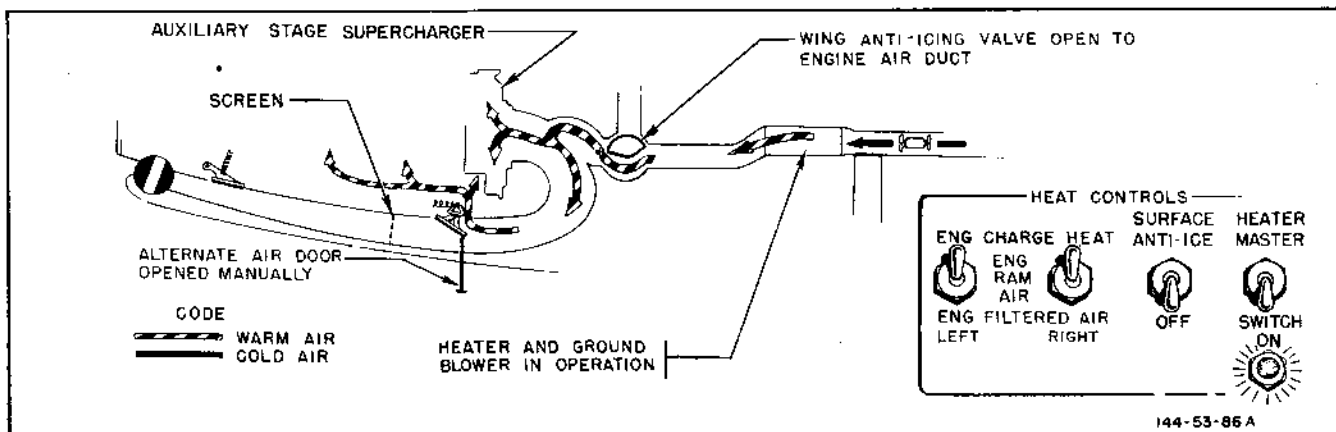

Figure 5-1. Engine Ground Heating

b. Hold brakes, and run up engine until spark plugs have burned clean and engine is operating smoothly. Then check magnetos.

c. At outside air temperatures of 0°F or below, use heated induction air for take-off by turning engine charge air switches to "ENG. FILTERED AIR." Since solid filter doors are installed and the ram air gate will be closed, warm air from the engine compartment will be drawn into the induction system.



Do not use "ENG. CHARGE HEAT" for take-off, as engine backfiring may result in damage to engine and heating system.

d. Turn pitot heater on just prior to rolling into position for take-off.

#### 5-7. TAKE-OFF.

5-8. At start of take-off run, advance throttles rapidly to take-off stops and ascertain that full take-off power is available. If full power is not obtained, immediately discontinue take-off.



If heaters are operating during take-off, they will go out when airplane is airborne. Depress fuel pressure switch to "START" position to restart heaters.

#### 5-9. DURING FLIGHT.

a. Operate anti-icing system and cockpit heating as required according to instructions in paragraphs 4-53 and 4-63.

b. To de-ice propellers, turn propeller de-icing switch "ON" from either cockpit.

c. Move engine air control switches to "ENG. CHARGE HEAT."

#### 5-10. APPROACH AND LANDING.

a. As temperature inversions are commonly encountered in the arctic, avoid engine overcooling during letdown.

b. When outside air temperatures are 0°F or below, use heated induction air by turning engine charge air control switches to the "ENG. FILTERED AIR" position.

c. If snow and ice tires are installed on the airplane, apply brakes intermittently and carefully to keep treads from filling and glazing over.

#### 5-11. STOPPING ENGINES.

a. If it is necessary to service oil tanks, shut down engines and service before diluting. Then (with chocks firmly anchored) restart engines and dilute.

b. To dilute oil, maintain 1500 rpm, oil temperature at 70°C or below and oil pressure above 25 psi. Hold oil dilution switches "ON" as required by the outside air temperature. The following table gives percentages and length of time for oil dilution, based on Grade 1100 oil:

|                         |     |       |       |       |       |
|-------------------------|-----|-------|-------|-------|-------|
| Outside Air Temperature | 4°C | -12°C | -29°C | -46°C | -54°C |
| Percent Dilution        | 0   | 10    | 20    | 30    | 35    |
| Time (Minutes)          | 0   | 2.5   | 4.5   | 7.0   | 8.5   |

c. Run up engines to 1200-1400 rpm for approximately 1-2 minutes; then hold the mixture control switches in "IDLE CUT-OFF" position for 3 seconds and advance throttles to gate.

#### Note

This procedure will prolong the life of spark plugs.

d. When propellers stop rotating, move ignition switches to "OFF," and throttles to "CLOSED."

5-12. BEFORE LEAVING AIRPLANE.

a. If heater and blower were used during ground operation, leave heater master switch on for 30 seconds, after turning other systems off, to allow blower to clear heater of unburned gases.

b. Release brakes.

c. Install protective covers on cockpits, engines, air scoops, and wing and tail surfaces.

d. Clean dirt and ice from shock struts.

e. Inspect fuel and oil tank vents and crankcase breathers, and remove ice.

f. Drain oil tank sumps, "Y" drains, and fuel drains

of condensate within 30 minutes after stopping engines.

g. If engines are expected to be idle for several days, battery should be removed and oil may be drained.

**5-13. DESERT OPERATION.**

5-14. Filter doors are installed in the air intake ducts on either side of the engine cowling. For all operations under dusty or sandy conditions, position engine air control switches at "ENG. FILTERED AIR." Cover all openings when the airplane is on the ground to prevent entrance of blowing sand.

## Appendix I

### OPERATING CHARTS

#### A-1. FLIGHT PLANNING.

A-2. A series of charts on the following pages is provided to aid in selecting the proper power and altitude to be used for obtaining optimum range of the airplane. Charts are provided for each airplane configuration with the probable ranges of gross weights. If the flight plan calls for a continuous flight where the desired cruising power and airspeed are reasonably constant after take-off and climb and the external load items are the same throughout the flight, the fuel required and flight time may be computed as a single section flight. If this is not the case, the flight may be broken up into sections, and each leg of the flight planned separately, since dropping of external bombs or tanks causes considerable change in range and airspeed for given power. (Within the limits of the airplane, the fuel required and flying time for a given mission depend largely upon the speed desired. With all other factors remaining equal in an airplane, speed is obtained at a sacrifice of range, and range is obtained at a sacrifice of speed.)

#### A-3. USE OF CHARTS.

A-4. Although instructions for their use are shown on the Flight Operation Instruction Charts, the following expanded information on proper use of the charts may be helpful.

a. Select the Flight Operation Instruction Chart for the gross weight, and external loading to be used at take-off. The amount of gasoline available for flight planning purposes depends upon the reserve required and the amount required for starting and warm-up. Reserve should be based on the type of mission, terrain over which the flight is to be made, and weather conditions. The fuel required for climb and time to climb to various altitudes is shown on the Take-off, Climb, and Landing Chart. Fuel remaining after subtracting reserve, warm-up, and climb fuel from total amount available is the amount to be used for flight planning.

b. Select a figure in the fuel column in the upper section of the chart equal to, or the next entry less than, the amount of fuel available for flight planning. Move horizontally to the right or left and select a figure equal to, or the next entry greater than, the distance (with no wind) to be flown. Operating values contained in the lower section of the column number in which this figure appears represent the highest cruising speeds possible at the range desired. It will be noted that the ranges listed in Column I are figured for the altitude which gives the least miles per gallon. The

ranges shown in Column II and other columns to the right of Column II can be obtained at any of the altitudes listed in the altitude column. All of the power settings listed in a column will give approximately the same number of miles per gallon if each is used at the altitude shown on the same horizontal line with it. Note that the time required for the flight may be shortened by selection of the higher altitudes. The flight duration may be obtained by dividing the true airspeed of the flight altitude into the air miles to be flown.

c. The flight plan may be readily changed at any time enroute, and the chart will show the balance of range available at various cruising powers by following the Instructions for Using Chart printed on each chart.

#### Note

The preceding instructions and following charts do not take into account the effect of wind. Adjustment to range values and flight duration to allow for wind may be made by any method familiar to the pilot, such as by the use of a flight calculator or a navigator's triangle of velocities.

#### A-5. F-82E SAMPLE PROBLEM.

A-6. PROBLEM 1. To fly 650 miles out at 30,000 feet and return to base after 15 minutes of combat over the target area.

a. Reference to the charts shows that two 165-gallon tanks will be needed, which will make the take-off gross weight around 23,500 pounds. Reference to the climb chart shows that 175 gallons of fuel will be used in climbing to 30,000 feet. This leaves 755 gallons for cruise and combat, assuming the climb was made near the base with a rendezvous at 30,000 feet.

b. The combat allowance chart shows that at 30,000 feet military power will use 4 gallons per minute per engine so that 15 minutes of combat will use 120 gallons. This will leave a balance for cruising of 635 gallons (755 less 120).

c. The range shown in Column IV for 600 gallons is 1330 miles, so the reserve will be approximately 40 gallons. Reference to paragraph d. following will show the method used to obtain the actual reserve.

d. Vertically below in the table and opposite 30,000 feet read 2450 RPM, F.T., 290 MPH, using 130 GPH with the mixtures set in the "NORMAL" position. The range to be covered divided by the TAS will give

| <b>AIRSPEED INSTALLATION CORRECTION TABLE</b>   |                  |                     |                  |
|---|------------------|---------------------|------------------|
| (WITH OR WITHOUT EXTERNAL LOAD)   |                  |                     |                  |
| SUBTRACT CORRECTION FROM CORRECTED INSTRUMENT READING<br>TO OBTAIN CALIBRATED INDICATED AIRSPEED. |                  |                     |                  |
| GEAR AND FLAPS UP   |                  | GEAR AND FLAPS DOWN |                  |
| IAS (MPH)   | CORRECTION (MPH) | IAS (MPH)           | CORRECTION (MPH) |
| 150   | 2                | 100                 | 4                |
| 200   | 1                | 120                 | 5                |
| 250   | 0                | 140                 | 6                |
| 300   | 0                | 160                 | 7                |
| 350   | 0                | 180                 | 8                |
| 400   | 0                | 200                 | 9                |

Figure A-1. Airspeed Installation Correction Table

| <b>COMPRESSIBILITY CORRECTION TABLE</b>  |                      |     |     |     |     |     |     |     |
|--|----------------------|-----|-----|-----|-----|-----|-----|-----|
| SUBTRACT CORRECTION BELOW FROM CALIBRATED INDICATED<br>AIRSPEED TO OBTAIN TRUE INDICATED AIRSPEED. |                      |     |     |     |     |     |     |     |
| PRESSURE<br>ALTITUDE   | CALIBRATED IAS (MPH) |     |     |     |     |     |     |     |
|  | 150                  | 200 | 250 | 300 | 350 | 400 | 450 | 500 |
| 10,000   | 0                    | 1   | 2   | 3   | 4   | 6   | 8   | 10  |
| 15,000   | 0                    | 1   | 3   | 4   | 7   | 10  | 13  | 17  |
| 20,000   | 1                    | 2   | 4   | 6   | 10  | 14  | 19  | 25  |
| 25,000   | 1                    | 3   | 5   | 9   | 13  | 19  | 26  |     |
| 30,000   | 2                    | 4   | 7   | 12  | 18  | 25  |     |     |
| 35,000   | 2                    | 5   | 10  | 16  | 24  |     |     |     |

Figure A-2. Compressibility Correction Table

| <b>COMBAT ALLOWANCE CHART</b> |             |                   |           |             |                   |
|-------------------------------|-------------|-------------------|-----------|-------------|-------------------|
| 74 in. Hg                     |             |                   | 65 in. Hg |             |                   |
| ALTITUDE                      | MAN. PRESS. | GPM<br>PER ENGINE | ALTITUDE  | MAN. PRESS. | GPM<br>PER ENGINE |
| SEA LEVEL                     | 74          | 4.0               | SEA LEVEL | 65          | 3.5               |
| 5,000                         | 74          | 4.0               | 5,000     | 65          | 3.5               |
| 10,000                        | 74          | 4.5               | 10,000    | 65          | 3.5               |
| 15,000                        | 74          | 4.5               | 15,000    | 65          | 3.5               |
| 20,000                        | F.T.        | 4                 | 20,000    | 65          | 3.5               |
| 25,000                        | F.T.        | 4                 | 25,000    | 65          | 3.5               |
| 30,000                        | F.T.        | 3.5               | 30,000    | F.T.        | 3.5               |
| 35,000                        | F.T.        | 3.0               | 35,000    | F.T.        | 3.0               |

Figure A-3. Combat Allowance Chart

NOTE: F. T. FULL THROTTLE

the hours of flight ( $650 \div 290 = 2.25$  hours one way). The hours multiplied by the fuel flow equals the gallons used ( $2.25 \times 130 = 295$  gallons). The return trip must be computed from the No External Load Chart, as the tanks will have been dropped before entering the combat zone. The operating conditions on the return trip will be 2500 RPM, F.T., 345 MPH using 150 GPH with the mixture set in "NORMAL." The time required will be 1.9 hours ( $650 \div 345$ ) and the fuel used will be 285 gallons ( $1.9 \times 150$ ). Thus the total fuel used for the cruise part of the trip will be 285 plus 295 or 580 gallons leaving a reserve of 55 gallons (635 from preceding paragraph b., less 580).

A-7. PROBLEM 2. During such a flight as that described in Problem 1, suppose one engine is shot up and is lost just after leaving the target area. The fuel remaining is 930 less 590 (175 climb + 120 combat +

295 cruise out) or 340 gallons. Reference to the single engine chart shows that it will be necessary to drop to 10,000 feet in order to obtain the needed range. The operating conditions at 10,000 feet will be 2400 RPM, 44 in. Hg M.A.P., 205 MPH and 81 GPH with the mixture set in "LONG RANGE CRUISE." The time required will be  $650 \div 205$  or 3.15 hours, and the fuel used will be  $3.15 \times 81$  or 260 gallons. Thus the reserve will be around 80 gallons (340 less 260). So in an emergency the range can be extended slightly by the use of only one engine if the gross weight is low enough and a low cruising altitude can be maintained.

A-8. SELECTION OF CRUISING CONDITIONS.

A-9. If arrival over a check point is late because of head winds, similar reference to the charts and calculations will allow the pilot, while in flight, to select new cruising conditions for safe arrival at his destination.

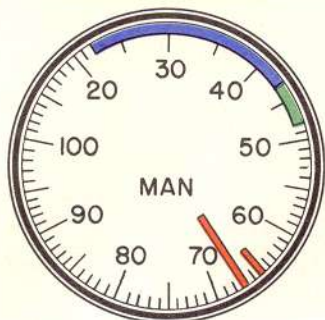

|  |              |
|--|--------------|
| Minimum Cruise   | 22" Hg       |
| Operation Permitted in "LONG RANGE CRUISE"                   | 22" - 44" Hg |
| Normal Operating Range                                       | 44" - 48" Hg |
| Max Continuous (Operation Above This Point Limited)          | 48" Hg       |
| Take-off—Dry (5 Min Max) and Military Power—Dry (15 Min Max) | 65" Hg       |
| Single-engine Take-off—Dry (5 Min Max)                       | 67" Hg       |

**NOTE**

When airplane modifications are completed permitting the use of water injection, a maximum manifold pressure of 74" Hg (Wet) may be used for take-off. Operation is limited to 5 minutes for take-off or 10 minutes in flight at this manifold pressure.

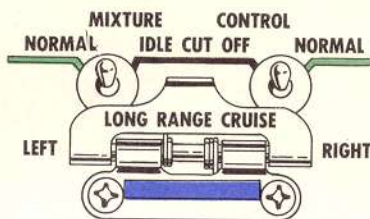

All indications in blue; operation in "LONG RANGE CRUISE" permitted. Either indicator (man. press. or tach) in green; normal mixture required.

FUEL—GRADE 115/145



|   |                 |
|---|-----------------|
| Minimum Cruise                                      | 1800 rpm        |
| Operation Permitted in "LONG RANGE CRUISE"          | 1800 - 2400 rpm |
| Normal Operating Range                              | 2400 - 2700 rpm |
| Max Continuous (Operation Above This Point Limited) | 2700 rpm        |
| Take-off, Military Power                            | 3200 rpm        |
| Max Diving Overspeed                                | 3300 rpm        |

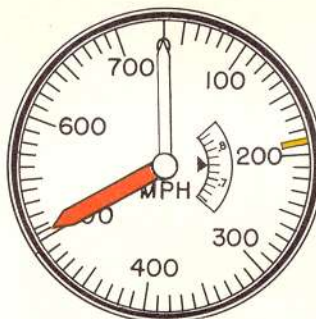

The instrument setting is such that the red pointer will move to indicate the limiting structural airspeed of 505 mph or the airspeed representing the limiting Mach No. of .75, whichever is less.

Max permissible IAS for lowering gear or flaps—190 mph.

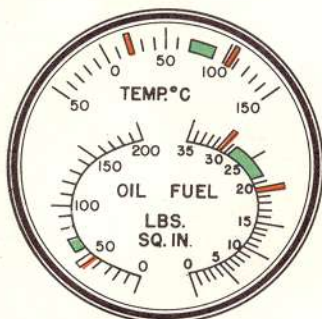

|                 |                    |             |
|-----------------|--------------------|-------------|
| OIL TEMPERATURE | Minimum for Flight | 20°C        |
|                 | Operating range    | 70° - 90°C  |
|                 | Maximum            | 105°C       |
| OIL PRESSURE    | Minimum            | 55 psi      |
|                 | Operating range    | 60 - 70 psi |
| FUEL PRESSURE   | Minimum            | 20 psi      |
|                 | Operating range    | 22 - 28 psi |
|                 | Maximum            | 30 psi      |

**COLOR CODE**

- █ — Operation permitted in "LONG RANGE CRUISE."
- █ — Normal operating range.
- █ — Caution.
- █ — Limit, or danger region.

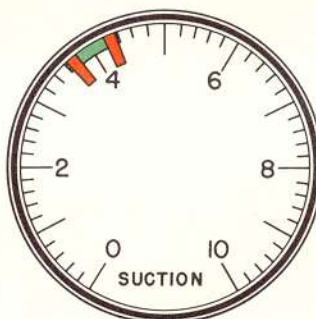

|                 |                  |
|-----------------|------------------|
| Minimum         | 3.75" Hg         |
| Operating range | 3.75" - 4.25" Hg |
| Maximum         | 4.25" Hg         |

| TAKE-OFF CONDITIONS |            |
|---------------------|------------|
| OIL TEMP            | 40°C MIN   |
| OIL PRESS           | 55 PSI MIN |
| COOLANT TEMP        | 85°C MIN   |

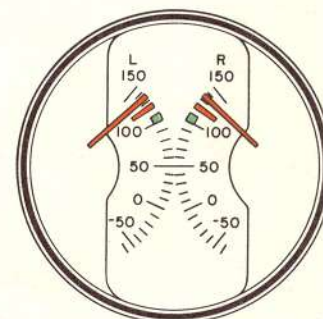

**COOLANT**

|                    |               |
|--------------------|---------------|
| Operating range    | 105°C - 115°C |
| Maximum            | 121°C         |
| Max Military Power | 135°C         |

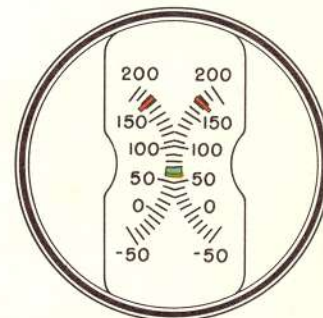

**ENGINE CHARGE TEMP**

|                        |              |
|------------------------|--------------|
| Operating range        | 60° - 71°C   |
| Danger of Plug Fouling | 60°C & Below |
| Maximum                | 175°C        |

123-51-181G

Figure A-4. Instrument Dial Markings



| AIRCRAFT MODEL(S)<br>F-82E |    | TAKE-OFF, CLIMB & LANDING CHART  |      |                                  |      |                                  |      |                                  |      |                                  |      | ENGINE MODEL(S)<br>ALLISON<br>V-1710-143<br>V-1710-145 |      |
|----------------------------|----|----------------------------------|------|----------------------------------|------|----------------------------------|------|----------------------------------|------|----------------------------------|------|--|------|
| GROSS WEIGHT<br>LB.        |    | HARD SURFACE RUNWAY - 65 IN. HG. |      | HARD SURFACE RUNWAY - 74 IN. HG. |      | HARD SURFACE RUNWAY - 74 IN. HG. |      | HARD SURFACE RUNWAY - 74 IN. HG. |      | HARD SURFACE RUNWAY - 74 IN. HG. |      | HARD SURFACE RUNWAY - 74 IN. HG.                       |      |
|                            |    | AT 3000 FEET                     |      | AT 3000 FEET                     |      | AT 3000 FEET                     |      | AT 3000 FEET                     |      | AT 3000 FEET                     |      | AT 3000 FEET   |      |
| HEAD WIND<br>M.P.H. KTS.   |    | GROUND TO CLEAR 50' OBJ. RUM     |      | GROUND TO CLEAR 50' OBJ. RUM     |      | GROUND TO CLEAR 50' OBJ. RUM     |      | GROUND TO CLEAR 50' OBJ. RUM     |      | GROUND TO CLEAR 50' OBJ. RUM     |      | GROUND TO CLEAR 50' OBJ. RUM                           |      |
| 26,000                     | 0  | 2950                             | 4500 | 3400                             | 5100 | 3900                             | 5800 | 4000                             | 2900 | 4500                             | 3400 | 5100   | 3400 |
|                            | 17 | 15                               | 2250 | 3800                             | 2600 | 4100                             | 3100 | 4700                             | 1950 | 3200                             | 2250 | 3600   | 2650 |
|                            | 34 | 30                               | 1650 | 2750                             | 1950 | 3200                             | 2300 | 3700                             | 1150 | 1700                             | 1700 | 2800   | 2000 |
| 24,000                     | 0  | 2400                             | 3800 | 2750                             | 4300 | 3200                             | 4900 | 3400                             | 2400 | 3800                             | 2400 | 3800   | 2800 |
|                            | 17 | 15                               | 1900 | 3000                             | 2100 | 3400                             | 2500 | 3900                             | 1600 | 2650                             | 1850 | 3000   | 2150 |
|                            | 34 | 30                               | 1300 | 2250                             | 1550 | 2550                             | 1850 | 3000                             | 1150 | 2000                             | 1350 | 2300   | 1600 |
| 22,000                     | 0  | 1950                             | 3200 | 2250                             | 3800 | 2800                             | 4000 | 3200                             | 1700 | 2800                             | 1950 | 3200   | 2300 |
|                            | 17 | 15                               | 1450 | 2450                             | 1700 | 2800                             | 1950 | 3200                             | 1300 | 2250                             | 1450 | 2500   | 1750 |
|                            | 34 | 30                               | 1050 | 1850                             | 1250 | 2100                             | 1450 | 2450                             | 900  | 1650                             | 1050 | 1900   | 1250 |

NOTE: INCREASE CHART DISTANCES AS FOLLOWS: 75°F & 10%; 100°F & 20%; 125°F & 30%; 150°F & 40%

OPTIMUM TAKE-OFF WITH 3200 RPM, 65 IN. HG. & 20 DEG. FLAP IS 80% OF CHART VALUES

OPTIMUM TAKE-OFF WITH 3200 RPM, 74 IN. HG. (WET) & 20 DEG. FLAP IS 80% OF CHART VALUES

DATA AS OF 6/7/48 BASED ON: FLIGHT TESTS

CLIMB DATA

| GROSS WEIGHT<br>LB. | AT SEA LEVEL    |                      | AT 10,000 FEET  |                      | AT 15,000 FEET  |                      | AT 20,000 FEET  |                      | AT 25,000 FEET  |                      | AT 30,000 FEET  |                      |
|---------------------|-----------------|----------------------|-----------------|----------------------|-----------------|----------------------|-----------------|----------------------|-----------------|----------------------|-----------------|----------------------|
|                     | BEST I.A.S. MPH | RATE OF CLIMB F.P.M. | BEST I.A.S. MPH | RATE OF CLIMB F.P.M. | BEST I.A.S. MPH | RATE OF CLIMB F.P.M. | BEST I.A.S. MPH | RATE OF CLIMB F.P.M. | BEST I.A.S. MPH | RATE OF CLIMB F.P.M. | BEST I.A.S. MPH | RATE OF CLIMB F.P.M. |
| 26,000              | 190             | 950                  | 190             | 950                  | 190             | 850                  | 16              | 125                  | 190             | 550                  | 22              | 155                  |
| 24,000              | 185             | 1200                 | 185             | 1250                 | 185             | 1150                 | 12              | 100                  | 185             | 950                  | 17              | 120                  |
| 22,000              | 180             | 1400                 | 180             | 1500                 | 180             | 1400                 | 10.5            | 90                   | 180             | 1200                 | 14              | 110                  |

FUEL USED (U.S. GAL.) INCLUDES WARM-UP & TAKE-OFF ALLOWANCE

POWER PLANT SETTINGS: 2700 RPM, 48 IN. HG. BASED ON: FLIGHT TESTS

LANDING DISTANCE FEET

| GROSS WEIGHT<br>LB. | BEST IAS APPROACH |              |     | HARD DRY SURFACE |              |              | HARD DRY SURFACE |              |              | WET OR SLIPPERY |              |              |
|---------------------|-------------------|--------------|-----|------------------|--------------|--------------|------------------|--------------|--------------|-----------------|--------------|--------------|
|                     | POWER OFF MPH     | POWER ON MPH | KTS | AT SEA LEVEL     | AT 3000 FEET | AT 6000 FEET | AT SEA LEVEL     | AT 3000 FEET | AT 6000 FEET | AT SEA LEVEL    | AT 3000 FEET | AT 6000 FEET |
| 20,000              | 130               | 115          | 105 | 2200             | 3300         | 2400         | 2600             | 3500         | 2600         | 3800            | 2600         | 3300         |
| 17,000              | 120               | 105          | 120 | 1900             | 2800         | 2000         | 2200             | 3000         | 2200         | 3300            | 2200         | 3000         |

REMARKS: DATA AS OF 6/7/48 BASED ON: FLIGHT TESTS

NOTE: TO DETERMINE FUEL CONSUMPTION IN BRITISH IMPERIAL GALLONS, MULTIPLY BY 10, THEN DIVIDE BY 12

FUEL - GRADE 115/145

149-93-504A

LEGEND  
I.A.S. : INDICATED AIRSPEED  
M.P.H. : MILES PER HOUR  
KTS. : KNOTS  
F.P.M. : FEET PER MINUTE

Figure A-5. Take-off, Climb, and Landing Chart

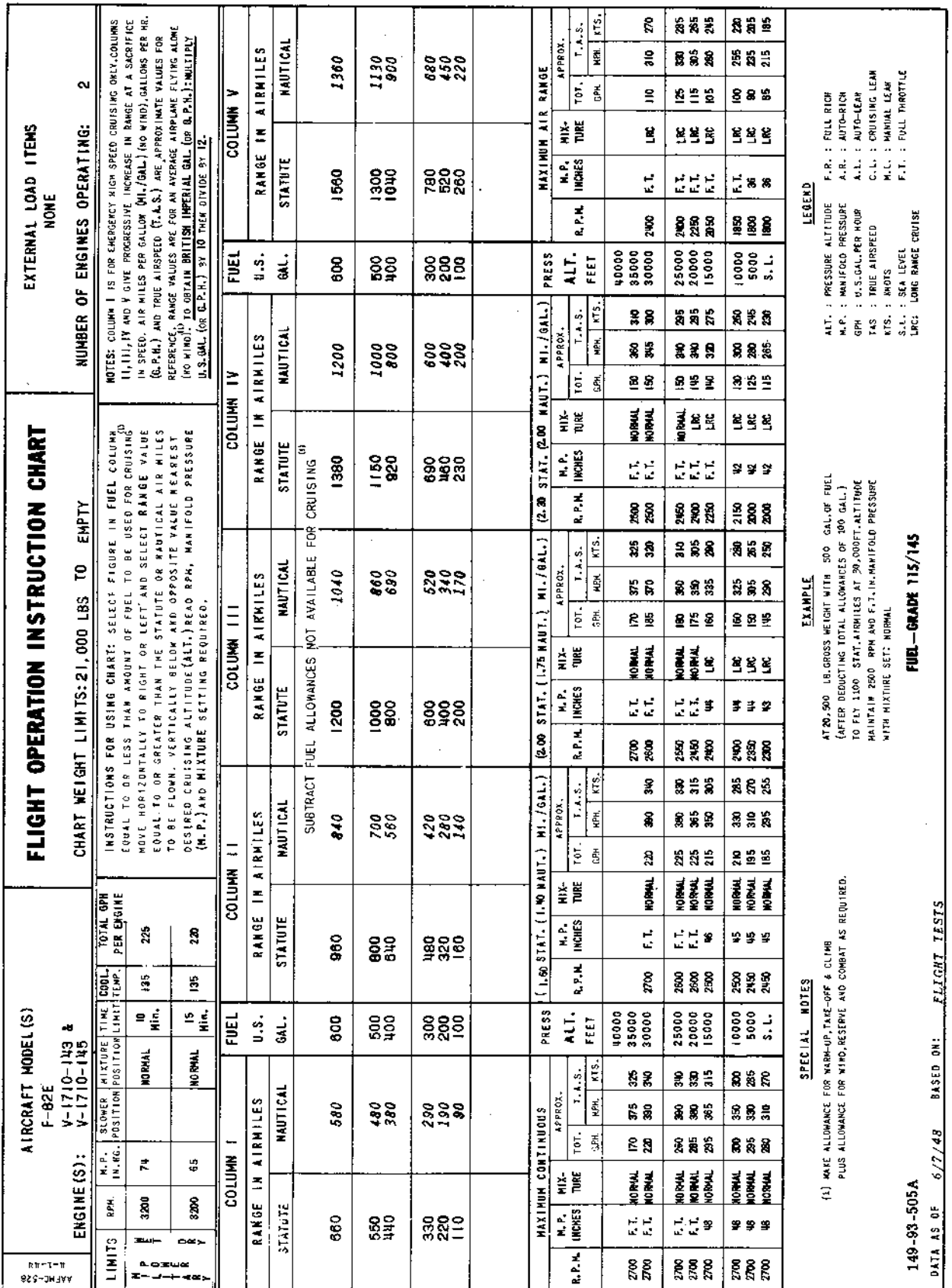

Figure A-6. Flight Operation Instruction Chart—No External Load

| AIRCRAFT MODEL(S)<br>F-82E         |        |                        |                  | FLIGHT OPERATION INSTRUCTION CHART           |             |                      |  | EXTERNAL LOAD ITEMS<br>TWO 165-GALLON TANKS |         |          |     |      |      |
|------------------------------------|--------|------------------------|------------------|--|-------------|----------------------|--|---|---------|----------|-----|------|------|
| ENGINE(S): V-1710-143 & V-1710-145 |        |                        |                  | CHART WEIGHT LIMITS: 23,000 TO 20,000 POUNDS |             |                      |  | NUMBER OF ENGINES OPERATING: TWO            |         |          |     |      |      |
| LIMITS                             | R.P.M. | M.P. (K-R.G. POSITION) | MIXTURE POSITION | TIME LIMIT                                   | COOL. TEMP. | TOTAL GPH PER ENGINE | INSTRUCTIONS FOR USING CHART: SELECT FIGURE IN FUEL COLUMN EQUAL TO OR LESS THAN AMOUNT OF FUEL TO BE USED FOR CRUISING. MOVE HORIZONTALLY TO RIGHT OR LEFT AND SELECT RANGE VALUE EQUAL TO OR GREATER THAN THE STATUTE OR NAUTICAL AIR MILES TO BE FLOWN, VERTICALLY BELOW AND OPPOSITE VALUE NEAREST DESIRED CRUISING ALTITUDE (ALT.) HEAD RPM, MANIFOLD PRESSURE (M.P.) AND MIXTURE SETTING REQUIRED. |   |         |          |     |      |      |
|                                    |        |                        |                  |  |             |                      | U.S.   | NAUTICAL                                    | STATUTE | NAUTICAL |     |      |      |
| 950                                | 3200   | 74                     | NORMAL           | 15   | 135         | 225                  | 1740   | 1510  | 2050    | 1780     | 930 | 2250 | 1950 |
| 840                                | 3200   | 65                     | NORMAL           | 15   | 135         | 220                  | 1540   | 1340  | 1810    | 1570     | 900 | 1980 | 1720 |
| 740                                | 3200   | 65                     | NORMAL           | 15   | 135         | 220                  | 1340   | 1160  | 1570    | 1360     | 800 | 1720 | 1490 |
| 630                                | 3200   | 65                     | NORMAL           | 15   | 135         | 220                  | 1140   | 990   | 1330    | 1150     | 600 | 1450 | 1260 |
| 520                                | 3200   | 65                     | NORMAL           | 15   | 135         | 220                  | 950  | 820   | 1100    | 950      | 500 | 1200 | 1040 |
| 420                                | 3200   | 65                     | NORMAL           | 15   | 135         | 220                  | 760  | 680   | 880     | 780      | 400 | 960  | 830  |

| R.P.M. | M.P. INCHES | MIX-TURE | APPROX. |        | R.P.M. | M.P. INCHES | MIX-TURE | APPROX. |        | R.P.M. | M.P. INCHES | MIX-TURE | APPROX. |        |
|--------|-------------|----------|---------|--------|--------|-------------|----------|---------|--------|--------|-------------|----------|---------|--------|
|        |             |          | TOT.    | T.A.S. |        |             |          | TOT.    | T.A.S. |        |             |          | TOT.    | T.A.S. |
| 2700   | F.T.        | NORMAL   | 170     | 335    | 2700   | F.T.        | NORMAL   | 170     | 335    | 2700   | F.T.        | NORMAL   | 170     | 335    |
| 2700   | F.T.        | NORMAL   | 220     | 360    | 2700   | F.T.        | NORMAL   | 175     | 335    | 2700   | F.T.        | NORMAL   | 175     | 335    |
| 2700   | F.T.        | NORMAL   | 280     | 365    | 2800   | F.T.        | NORMAL   | 175     | 335    | 2800   | F.T.        | NORMAL   | 175     | 335    |
| 2700   | F.T.        | NORMAL   | 285     | 360    | 2800   | F.T.        | NORMAL   | 170     | 330    | 2850   | F.T.        | NORMAL   | 170     | 330    |
| 2700   | F.T.        | NORMAL   | 295     | 345    | 2850   | F.T.        | NORMAL   | 160     | 315    | 2900   | F.T.        | NORMAL   | 160     | 315    |
| 2700   | F.T.        | NORMAL   | 300     | 330    | 2900   | F.T.        | NORMAL   | 160     | 305    | 2950   | F.T.        | NORMAL   | 160     | 305    |
| 2700   | F.T.        | NORMAL   | 295     | 310    | 2950   | F.T.        | NORMAL   | 155     | 280    | 1900   | F.T.        | NORMAL   | 115     | 295    |
| 2700   | F.T.        | NORMAL   | 290     | 295    | 295    | F.T.        | NORMAL   | 140     | 270    | 235    | F.T.        | NORMAL   | 110     | 240    |

| R.P.M. | M.P. INCHES | MIX-TURE | APPROX. |        | R.P.M. | M.P. INCHES | MIX-TURE | APPROX. |        | R.P.M. | M.P. INCHES | MIX-TURE | APPROX. |        |
|--------|-------------|----------|---------|--------|--------|-------------|----------|---------|--------|--------|-------------|----------|---------|--------|
|        |             |          | TOT.    | T.A.S. |        |             |          | TOT.    | T.A.S. |        |             |          | TOT.    | T.A.S. |
| 40000  | 40000       | 40000    | 40000   | 40000  | 40000  | 40000       | 40000    | 40000   | 40000  | 40000  | 40000       | 40000    | 40000   | 40000  |
| 35000  | 35000       | 35000    | 35000   | 35000  | 35000  | 35000       | 35000    | 35000   | 35000  | 35000  | 35000       | 35000    | 35000   | 35000  |
| 30000  | 30000       | 30000    | 30000   | 30000  | 30000  | 30000       | 30000    | 30000   | 30000  | 30000  | 30000       | 30000    | 30000   | 30000  |
| 25000  | 25000       | 25000    | 25000   | 25000  | 25000  | 25000       | 25000    | 25000   | 25000  | 25000  | 25000       | 25000    | 25000   | 25000  |
| 20000  | 20000       | 20000    | 20000   | 20000  | 20000  | 20000       | 20000    | 20000   | 20000  | 20000  | 20000       | 20000    | 20000   | 20000  |
| 15000  | 15000       | 15000    | 15000   | 15000  | 15000  | 15000       | 15000    | 15000   | 15000  | 15000  | 15000       | 15000    | 15000   | 15000  |
| 10000  | 10000       | 10000    | 10000   | 10000  | 10000  | 10000       | 10000    | 10000   | 10000  | 10000  | 10000       | 10000    | 10000   | 10000  |
| 5000   | 5000        | 5000     | 5000    | 5000   | 5000   | 5000        | 5000     | 5000    | 5000   | 5000   | 5000        | 5000     | 5000    | 5000   |
| S.L.   | S.L.        | S.L.     | S.L.    | S.L.   | S.L.   | S.L.        | S.L.     | S.L.    | S.L.   | S.L.   | S.L.        | S.L.     | S.L.    | S.L.   |

NOTES: COLUMN I IS FOR EMERGENCY HIGH SPEED CRUISING ONLY. COLUMNS II, III, IV AND V GIVE PROGRESSIVE INCREASE IN RANGE AT A SACRIFICE IN SPEED. AIR MILES PER GALLON (M.P./GAL.) (NO WIND) GALLONS PER HR. (G.P.H.) AND TRUE AIRSPEED (T.A.S.) ARE APPROXIMATE VALUES FOR REFERENCE. RANGE VALUES ARE FOR AN AVERAGE AIRPLANE FLYING ALONG (NO WIND) TO DESTROY BRITISH IMPERIAL GALL. (OR G.P.H.) MULTIPLY U.S. GAL. (OR G.P.H.) BY 10 THEN DIVIDE BY 12.

INSTRUCTIONS FOR USING CHART: SELECT FIGURE IN FUEL COLUMN EQUAL TO OR LESS THAN AMOUNT OF FUEL TO BE USED FOR CRUISING. MOVE HORIZONTALLY TO RIGHT OR LEFT AND SELECT RANGE VALUE EQUAL TO OR GREATER THAN THE STATUTE OR NAUTICAL AIR MILES TO BE FLOWN, VERTICALLY BELOW AND OPPOSITE VALUE NEAREST DESIRED CRUISING ALTITUDE (ALT.) HEAD RPM, MANIFOLD PRESSURE (M.P.) AND MIXTURE SETTING REQUIRED.

LEGEND  
 ALT. : PRESSURE ALTITUDE F.R. : FULL RICH  
 M.P. : MANIFOLD PRESSURE A.R. : AUTO-RICH  
 GPH : U.S. GAL-PER HOUR A.L. : AUTO-LEAN  
 TAS : TRUE AIRSPEED C.L. : CRUISING LEAN  
 KTS. : KNOTS M.L. : MANUAL LEAN  
 S.L. : SEA LEVEL F.T. : FULL THRUSTLE  
 LRC : LONG RANGE CRUISE

EXAMPLE  
 AT 22,500 LB. GROSS WEIGHT WITH 700 GAL. OF FUEL (AFTER DEDUCTING TOTAL ALLOWANCES OF 230 GAL.) TO FLY 1500 STAT. AIRMILES AT 30,000 FT. ALTITUDE MAINTAIN 3050 RPM AND F.T. IN MANIFOLD PRESSURE WITH MIXTURE SET: NORMAL

SPECIAL NOTES  
 (1) MAKE ALLOWANCE FOR WASH-UP, TAKE-OFF & CLIMB PLUS ALLOWANCE FOR WIND, RESERVE AND COMBAT AS REQUIRED.

149-93-506A  
 DATA AS OF 6/7/48  
 BASED ON: FLIGHT TESTS  
 FUEL-GRADE 115/145

Figure A-7 (Sheet 1 of 2 Sheets). Flight Operation Instruction Chart—Two 165-gallon Drop Tanks

| AIRCRAFT MODEL(S)<br>F-82E<br>V-1710-143 &<br>V-1710-145 |            | FLIGHT OPERATION INSTRUCTION CHART       |              |                   |                  | EXTERNAL LOAD ITEMS<br>TWO 165-GALLON TANKS |                        |                   |  |                   |            |                   |   |                   |  |                   |            |                   |  |                   |           |
|--|------------|--|--------------|-------------------|------------------|---|------------------------|-------------------|--|-------------------|------------|-------------------|---|-------------------|--|-------------------|------------|-------------------|--|-------------------|-----------|
| ENGINE(S):   |            | CHART WEIGHT LIMITS: 20,000 LBS TO EMPTY |              |                   |                  | NUMBER OF ENGINES OPERATING: TWO            |                        |                   |  |                   |            |                   |   |                   |  |                   |            |                   |  |                   |           |
| LIMITS   | M.P.H.     | R.P.M.                                   | M.P. IN. HG. | BLOWER POSITION   | MIXTURE POSITION | TIME LIMIT                                  | COOL. TEMP. PER ENGINE | TOTAL GPH         | INSTRUCTIONS FOR USING CHART: SELECT FIGURE IN FUEL COLUMN EQUAL TO OR LESS THAN AMOUNT OF FUEL TO BE USED FOR CRUISING. MOVE HORIZONTALLY TO RIGHT OR LEFT AND SELECT RANGE VALUE EQUAL TO OR GREATER THAN THE STATUTE OR NAUTICAL AIR MILES TO BE FLOWN, VERTICALLY BELOW AND OPPOSITE VALUE NEAREST DESIRED CRUISING ALTITUDE (ALT.) READ RPM, MANIFOLD PRESSURE (M.P.) AND MIXTURE SETTING REQUIRED. |                   |            |                   | NOTES: COLUMN I IS FOR EMERGENCY HIGH SPEED CRUISING ONLY. COLUMNS II, III, IV AND V GIVE PROGRESSIVE INCREASE IN RANGE AT A SACRIFICE IN SPEED. AIR MILES PER GALLON (MI./GAL.) (NO WIND), GALLONS PER HR. (G.P.H.) AND TRUE AIRSPEED (T.A.S.) ARE APPROXIMATE VALUES FOR REFERENCE. RANGE VALUES ARE FOR AN AVERAGE AIRPLANE FLYING ALONE (NO WIND). TO OBTAIN BRITISH IMPERIAL GAL. (OR G.P.H.): MULTIPLY U.S. GAL. (OR G.P.H.) BY 10 THEN DIVIDE BY 12. |                   |  |                   |            |                   |  |                   |           |
|  |            |  |              |                   |                  |   |                        |                   | COLUMN I   |                   |            |                   | COLUMN II   |                   |  |                   | COLUMN III |                   |  |                   | COLUMN IV |
| RANGE IN AIRMILES  |            | RANGE IN AIRMILES                        |              | RANGE IN AIRMILES |                  | RANGE IN AIRMILES                           |                        | RANGE IN AIRMILES |  | RANGE IN AIRMILES |            | RANGE IN AIRMILES |   | RANGE IN AIRMILES |  | RANGE IN AIRMILES |            | RANGE IN AIRMILES |  | RANGE IN AIRMILES |           |
| STATUTE  |            | NAUTICAL                                 |              | STATUTE           |                  | NAUTICAL                                    |                        | STATUTE           |  | NAUTICAL          |            | STATUTE           |   | NAUTICAL          |  | STATUTE           |            | NAUTICAL          |  | STATUTE           |           |
| 540  | 470        | 500                                      | 750          | 650               | 1000             | 860   | 1200                   | 1040              | 500  | 1320              | 1150       |                   |   |                   |  |                   |            |                   |  |                   |           |
| 430<br>320   | 370<br>280 | 400<br>300                               | 600<br>450   | 520<br>390        | 800<br>600       | 690<br>520                                  | 960<br>720             | 830<br>620        | 400<br>300   | 1060<br>790       | 920<br>690 |                   |   |                   |  |                   |            |                   |  |                   |           |
| 210<br>100   | 180<br>90  | 200<br>100                               | 300<br>150   | 260<br>150        | 400<br>200       | 340<br>170                                  | 480<br>240             | 410<br>210        | 200<br>100   | 530<br>260        | 460<br>230 |                   |   |                   |  |                   |            |                   |  |                   |           |

**LEGEND**  
 ALT. : PRESSURE ALTITUDE F.R. : FULL RICH  
 M.P. : MANIFOLD PRESSURE A.R. : AUTO-RICH  
 GPH : U.S. GAL. PER HOUR A.L. : AUTO-LEAN  
 TAS : TRUE AIRSPEED C.L. : CRUISING LEAN  
 KTS. : KNOTS M.L. : MANUAL LEAN  
 S.L. : SEA LEVEL F.T. : FILL THROTTLE  
 LRC : LONG RANGE CRUISE

**EXAMPLE**  
 AT 19,500 LB. GROSS WEIGHT WITH 400 GAL. OF FUEL (AFTER DEDUCTING TOTAL ALLOWANCES OF 100 GAL.) TO FLY 900 STAT. AIRMILES AT 30,000 FT. ALTITUDE MAINTAIN 2450 RPM AND F.T. IN MANIFOLD PRESSURE WITH MIXTURE SET: NORMAL

**SPECIAL NOTES**  
 (1) MAKE ALLOWANCE FOR WARM-UP, TAKE-OFF & CLIMB PLUS ALLOWANCE FOR WIND, RESERVE AND COMBAT AS REQUIRED.

FUEL—GRADE 115/145

DATA AS OF 6/7/48

149-93-507A

BASED ON: FLIGHT TESTS

Figure A-7 (Sheet 2 of 2 Sheets). Flight Operation Instruction Chart—Two 165-gallon Drop Tanks



| AIRCRAFT MODEL (S)<br>F-82E<br>V-1710-143 &<br>V-1710-145 |               | FLIGHT OPERATION INSTRUCTION CHART       |               |                    |                       | EXTERNAL LOAD ITEMS<br>5 ROCKET TREES  |               |                    |               |
|---|---------------|--|---------------|--------------------|-----------------------|--|---------------|--------------------|---------------|
| ENGINE (S):   |               | CHART WEIGHT LIMITS: 22,500 LBS TO EMPTY |               |                    |                       | NUMBER OF ENGINES OPERATING: TWO   |               |                    |               |
| LIMITS  | RPM           | M.P. IN. HG.                             | MIXTURE       | TIME LIMIT         | COOL-TEMP. PER ENGINE | INSTRUCTIONS FOR USING CHART: SELECT FIGURE IN FUEL COLUMN EQUAL TO OR LESS THAN AMOUNT OF FUEL TO BE USED FOR CRUISING. MOVE HORIZONTALLY TO RIGHT OR LEFT AND SELECT RANGE VALUE EQUAL TO OR GREATER THAN THE STATUTE OR NAUTICAL AIR MILES TO BE FLOWN. VERTICALLY BELOW AND OPPOSITE VALUE NEAREST DESIRED CRUISING ALTITUDE (ALT.) READ RPM, MANIFOLD PRESSURE (M.P.) AND MIXTURE SETTING REQUIRED. |               |                    |               |
|   |               |  |               |                    |                       | BLOWER POSITION  | MIN.          | MAX.               | TOTAL GPH     |
| 3200  | 74            | NORMAL                                   | 10            | 135                | 225                   |  |               |                    |               |
| 3200  | 65            | NORMAL                                   | 15            | 135                | 220                   |  |               |                    |               |
| COLUMN I  |               | COLUMN II                                |               | COLUMN III         |                       | COLUMN IV  |               | COLUMN V           |               |
| RANGE IN AIRMILES   |               | RANGE IN AIRMILES                        |               | RANGE IN AIRMILES  |                       | RANGE IN AIRMILES  |               | RANGE IN AIRMILES  |               |
| STATUTE   | NAUTICAL      | STATUTE                                  | NAUTICAL      | STATUTE            | NAUTICAL              | STATUTE  | NAUTICAL      | STATUTE            | NAUTICAL      |
| 370   | 320           | 480                                      | 410           | 660                | 570                   | 780  | 680           | 850                | 730           |
| 270   | 240           | 380                                      | 310           | 490                | 430                   | 580  | 500           | 640                | 550           |
| 130   | 160           | 240                                      | 210           | 330                | 280                   | 390  | 340           | 420                | 370           |
| 90  | 80            | 120                                      | 100           | 160                | 140                   | 190  | 170           | 210                | 180           |
| FUEL  |               | FUEL                                     |               | FUEL               |                       | FUEL   |               | FUEL               |               |
| U.S. GAL.   | NAUTICAL GAL. | U.S. GAL.                                | NAUTICAL GAL. | U.S. GAL.          | NAUTICAL GAL.         | U.S. GAL.  | NAUTICAL GAL. | U.S. GAL.          | NAUTICAL GAL. |
| 400   | 340           | 400                                      | 340           | 400                | 340                   | 400  | 340           | 400                | 340           |
| 300   | 260           | 300                                      | 260           | 300                | 260                   | 300  | 260           | 300                | 260           |
| 200   | 170           | 200                                      | 170           | 200                | 170                   | 200  | 170           | 200                | 170           |
| 100   | 80            | 100                                      | 80            | 100                | 80                    | 100  | 80            | 100                | 80            |
| MAXIMUM CONTINUOUS  |               | MAXIMUM CONTINUOUS                       |               | MAXIMUM CONTINUOUS |                       | MAXIMUM CONTINUOUS   |               | MAXIMUM CONTINUOUS |               |
| R.P.M.  | M.P. INCHES   | MIXTURE                                  | T.A.S. MPH    | ALT. FEET          | PRESS. ALT. FEET      | M.P. INCHES  | MIXTURE       | T.A.S. MPH         | ALT. FEET     |
| 2700  | 2700          | 2700                                     | 2700          | 2700               | 2700                  | 2700   | 2700          | 2700               | 2700          |
| 2700  | 2700          | 2700                                     | 2700          | 2700               | 2700                  | 2700   | 2700          | 2700               | 2700          |
| 2700  | 2700          | 2700                                     | 2700          | 2700               | 2700                  | 2700   | 2700          | 2700               | 2700          |
| 2700  | 2700          | 2700                                     | 2700          | 2700               | 2700                  | 2700   | 2700          | 2700               | 2700          |
| 2700  | 2700          | 2700                                     | 2700          | 2700               | 2700                  | 2700   | 2700          | 2700               | 2700          |

LEGEND  
 ALT. : PRESSURE ALTITUDE F.R. : FULL RICH  
 M.P. : MANIFOLD PRESSURE A.R. : AUTO-RICH  
 GPH : U.S.-GAL. PER HOUR A.L. : AUTO-LEAN  
 T.A.S. : TRUE AIRSPEED C.L. : CRUISING LEAN  
 KTS. : KNOTS M.L. : MANUAL LEAN  
 S.L. : SEA LEVEL F.T. : FULL THROTTLE  
 LRC : LONG RANGE CRUISE

EXAMPLE  
 AT 22,000 LB. GROSS WEIGHT WITH 300 GAL. OF FUEL  
 (AFTER DEDUCTING TOTAL ALLOWANCES OF 100 GAL.)  
 TO FLY 550 STAT. AIRMILES AT 20,000 FT. ALTITUDE  
 MAINTAIN 2400 RPM AND F.T. IN MANIFOLD PRESSURE  
 WITH MIXTURE SET: LONG RANGE CRUISE

SPECIAL NOTES  
 (1) MAKE ALLOWANCE FOR WARM-UP, TAKE-OFF & CLIMB  
 PLUS ALLOWANCE FOR WIND, RESERVE AND COMBAT AS REQUIRED.

149-93-509A  
 DATA AS OF 6/7/48 BASED ON: FLIGHT TESTS & ESTIMATED  
 FUEL—GRADE 115/145  
 RED FIGURES ARE PRELIMINARY DATA, SUBJECT TO REVISION AFTER FLIGHT CHECK

Figure A-8 (Sheet 2 of 2 Sheets). Flight Operation Instruction Chart—5 Rocket Trees

| AIRCRAFT MODEL(S)<br>F-82F<br>V-1710-143 &<br>ENGINE(S): V-1710-145   |              | FLIGHT OPERATION INSTRUCTION CHART           |                 |                      |  | EXTERNAL LOAD ITEMS<br>NONE   |             | NUMBER OF ENGINES OPERATING: ONE |                    |             |           |          |            |         |           |        |             |          |                   |             |                   |          |                   |     |                   |  |                   |  |         |          |             |          |          |            |         |          |         |             |          |        |             |          |          |            |      |      |        |             |          |        |             |          |          |            |      |        |     |     |     |       |      |     |        |      |      |      |       |     |       |      |     |     |      |      |      |      |     |     |     |      |     |        |      |     |       |      |    |        |     |     |     |       |     |       |      |     |    |    |      |     |     |     |     |     |      |     |        |     |     |       |      |    |        |     |     |     |       |     |       |      |    |    |    |      |    |    |     |     |     |      |    |        |     |     |      |      |    |        |     |     |     |       |     |      |      |    |    |    |      |    |    |     |     |     |      |    |        |     |     |       |      |    |        |     |     |     |       |     |       |      |    |    |    |      |    |    |     |     |     |
|---|--------------|--|-----------------|----------------------|--|---|-------------|----------------------------------|--------------------|-------------|-----------|----------|------------|---------|-----------|--------|-------------|----------|-------------------|-------------|-------------------|----------|-------------------|-----|-------------------|--|-------------------|--|---------|----------|-------------|----------|----------|------------|---------|----------|---------|-------------|----------|--------|-------------|----------|----------|------------|------|------|--------|-------------|----------|--------|-------------|----------|----------|------------|------|--------|-----|-----|-----|-------|------|-----|--------|------|------|------|-------|-----|-------|------|-----|-----|------|------|------|------|-----|-----|-----|------|-----|--------|------|-----|-------|------|----|--------|-----|-----|-----|-------|-----|-------|------|-----|----|----|------|-----|-----|-----|-----|-----|------|-----|--------|-----|-----|-------|------|----|--------|-----|-----|-----|-------|-----|-------|------|----|----|----|------|----|----|-----|-----|-----|------|----|--------|-----|-----|------|------|----|--------|-----|-----|-----|-------|-----|------|------|----|----|----|------|----|----|-----|-----|-----|------|----|--------|-----|-----|-------|------|----|--------|-----|-----|-----|-------|-----|-------|------|----|----|----|------|----|----|-----|-----|-----|
| LIMITS  |              | CHART WEIGHT LIMITS: 21,000 TO 19,000 POUNDS |                 |                      |  | NOTES: COLUMN I IS FOR EMERGENCY HIGH SPEED CRUISING ONLY. COLUMNS II, III, IV AND V GIVE PROGRESSIVE INCREASE IN RANGE AT A SACRIFICE IN SPEED. AIR MILES PER GALLON (M.P./GAL.) (NO WIND), GALLONS PER HOUR (G.P.H.) AND TRUE AIRSPEED (T.A.S.) ARE APPROXIMATE VALUES FOR REFERENCE. RANGE VALUES ARE FOR AN AVERAGE AIRPLANE FLIVING ALONE (NO WIND) TO OBTAIN BRITISH IMPERIAL GAL. (OR G.P.H.): MULTIPLY U.S. GAL. (OR G.P.H.) BY 10 THEN DIVIDE BY 12. |             | FUEL                             |                    |             |           |          |            |         |           |        |             |          |                   |             |                   |          |                   |     |                   |  |                   |  |         |          |             |          |          |            |         |          |         |             |          |        |             |          |          |            |      |      |        |             |          |        |             |          |          |            |      |        |     |     |     |       |      |     |        |      |      |      |       |     |       |      |     |     |      |      |      |      |     |     |     |      |     |        |      |     |       |      |    |        |     |     |     |       |     |       |      |     |    |    |      |     |     |     |     |     |      |     |        |     |     |       |      |    |        |     |     |     |       |     |       |      |    |    |    |      |    |    |     |     |     |      |    |        |     |     |      |      |    |        |     |     |     |       |     |      |      |    |    |    |      |    |    |     |     |     |      |    |        |     |     |       |      |    |        |     |     |     |       |     |       |      |    |    |    |      |    |    |     |     |     |
| RPM   | M.P. IN. HG. | BLOWER MIXTURE POSITION                      | TIME PER ENGINE | TOTAL GPH PER ENGINE | INSTRUCTIONS FOR USING CHART: SELECT FIGURE IN FUEL COLUMN EQUAL TO OR LESS THAN AMOUNT OF FUEL TO BE USED FOR CRUISING. MOVE HORIZONTALLY TO RIGHT OR LEFT AND SELECT RANGE VALUE EQUAL TO OR GREATER THAN THE STATUTE OR NAUTICAL AIR MILES TO BE FLOWN. VERTICALLY BELOW AND OPPOSITE VALUE NEAREST DESIRED CRUISING ALTITUDE (ALT.) READ RPM, MANIFOLD PRESSURE (M.P.) AND MIXTURE SETTING REQUIRED. |   | U.S. GAL.   | IMPERIAL GAL.                    |                    |             |           |          |            |         |           |        |             |          |                   |             |                   |          |                   |     |                   |  |                   |  |         |          |             |          |          |            |         |          |         |             |          |        |             |          |          |            |      |      |        |             |          |        |             |          |          |            |      |        |     |     |     |       |      |     |        |      |      |      |       |     |       |      |     |     |      |      |      |      |     |     |     |      |     |        |      |     |       |      |    |        |     |     |     |       |     |       |      |     |    |    |      |     |     |     |     |     |      |     |        |     |     |       |      |    |        |     |     |     |       |     |       |      |    |    |    |      |    |    |     |     |     |      |    |        |     |     |      |      |    |        |     |     |     |       |     |      |      |    |    |    |      |    |    |     |     |     |      |    |        |     |     |       |      |    |        |     |     |     |       |     |       |      |    |    |    |      |    |    |     |     |     |
| MIN   | 74           | NORMAL                                       | 10              | 225                  |  |   | 600         | 1470                             |                    |             |           |          |            |         |           |        |             |          |                   |             |                   |          |                   |     |                   |  |                   |  |         |          |             |          |          |            |         |          |         |             |          |        |             |          |          |            |      |      |        |             |          |        |             |          |          |            |      |        |     |     |     |       |      |     |        |      |      |      |       |     |       |      |     |     |      |      |      |      |     |     |     |      |     |        |      |     |       |      |    |        |     |     |     |       |     |       |      |     |    |    |      |     |     |     |     |     |      |     |        |     |     |       |      |    |        |     |     |     |       |     |       |      |    |    |    |      |    |    |     |     |     |      |    |        |     |     |      |      |    |        |     |     |     |       |     |      |      |    |    |    |      |    |    |     |     |     |      |    |        |     |     |       |      |    |        |     |     |     |       |     |       |      |    |    |    |      |    |    |     |     |     |
| MAX   | 65           | NORMAL                                       | 15              | 220                  |  |   | 550         | 1340                             |                    |             |           |          |            |         |           |        |             |          |                   |             |                   |          |                   |     |                   |  |                   |  |         |          |             |          |          |            |         |          |         |             |          |        |             |          |          |            |      |      |        |             |          |        |             |          |          |            |      |        |     |     |     |       |      |     |        |      |      |      |       |     |       |      |     |     |      |      |      |      |     |     |     |      |     |        |      |     |       |      |    |        |     |     |     |       |     |       |      |     |    |    |      |     |     |     |     |     |      |     |        |     |     |       |      |    |        |     |     |     |       |     |       |      |    |    |    |      |    |    |     |     |     |      |    |        |     |     |      |      |    |        |     |     |     |       |     |      |      |    |    |    |      |    |    |     |     |     |      |    |        |     |     |       |      |    |        |     |     |     |       |     |       |      |    |    |    |      |    |    |     |     |     |
|   |              |  |                 |                      |  |   | 500         | 1220                             |                    |             |           |          |            |         |           |        |             |          |                   |             |                   |          |                   |     |                   |  |                   |  |         |          |             |          |          |            |         |          |         |             |          |        |             |          |          |            |      |      |        |             |          |        |             |          |          |            |      |        |     |     |     |       |      |     |        |      |      |      |       |     |       |      |     |     |      |      |      |      |     |     |     |      |     |        |      |     |       |      |    |        |     |     |     |       |     |       |      |     |    |    |      |     |     |     |     |     |      |     |        |     |     |       |      |    |        |     |     |     |       |     |       |      |    |    |    |      |    |    |     |     |     |      |    |        |     |     |      |      |    |        |     |     |     |       |     |      |      |    |    |    |      |    |    |     |     |     |      |    |        |     |     |       |      |    |        |     |     |     |       |     |       |      |    |    |    |      |    |    |     |     |     |
|   |              |  |                 |                      |  |   | 450         | 1090                             |                    |             |           |          |            |         |           |        |             |          |                   |             |                   |          |                   |     |                   |  |                   |  |         |          |             |          |          |            |         |          |         |             |          |        |             |          |          |            |      |      |        |             |          |        |             |          |          |            |      |        |     |     |     |       |      |     |        |      |      |      |       |     |       |      |     |     |      |      |      |      |     |     |     |      |     |        |      |     |       |      |    |        |     |     |     |       |     |       |      |     |    |    |      |     |     |     |     |     |      |     |        |     |     |       |      |    |        |     |     |     |       |     |       |      |    |    |    |      |    |    |     |     |     |      |    |        |     |     |      |      |    |        |     |     |     |       |     |      |      |    |    |    |      |    |    |     |     |     |      |    |        |     |     |       |      |    |        |     |     |     |       |     |       |      |    |    |    |      |    |    |     |     |     |
|   |              |  |                 |                      |  |   | 400         | 970                              |                    |             |           |          |            |         |           |        |             |          |                   |             |                   |          |                   |     |                   |  |                   |  |         |          |             |          |          |            |         |          |         |             |          |        |             |          |          |            |      |      |        |             |          |        |             |          |          |            |      |        |     |     |     |       |      |     |        |      |      |      |       |     |       |      |     |     |      |      |      |      |     |     |     |      |     |        |      |     |       |      |    |        |     |     |     |       |     |       |      |     |    |    |      |     |     |     |     |     |      |     |        |     |     |       |      |    |        |     |     |     |       |     |       |      |    |    |    |      |    |    |     |     |     |      |    |        |     |     |      |      |    |        |     |     |     |       |     |      |      |    |    |    |      |    |    |     |     |     |      |    |        |     |     |       |      |    |        |     |     |     |       |     |       |      |    |    |    |      |    |    |     |     |     |
|   |              |  |                 |                      |  |   | 350         | 840                              |                    |             |           |          |            |         |           |        |             |          |                   |             |                   |          |                   |     |                   |  |                   |  |         |          |             |          |          |            |         |          |         |             |          |        |             |          |          |            |      |      |        |             |          |        |             |          |          |            |      |        |     |     |     |       |      |     |        |      |      |      |       |     |       |      |     |     |      |      |      |      |     |     |     |      |     |        |      |     |       |      |    |        |     |     |     |       |     |       |      |     |    |    |      |     |     |     |     |     |      |     |        |     |     |       |      |    |        |     |     |     |       |     |       |      |    |    |    |      |    |    |     |     |     |      |    |        |     |     |      |      |    |        |     |     |     |       |     |      |      |    |    |    |      |    |    |     |     |     |      |    |        |     |     |       |      |    |        |     |     |     |       |     |       |      |    |    |    |      |    |    |     |     |     |
|   |              |  |                 |                      |  |   | 300         | 720                              |                    |             |           |          |            |         |           |        |             |          |                   |             |                   |          |                   |     |                   |  |                   |  |         |          |             |          |          |            |         |          |         |             |          |        |             |          |          |            |      |      |        |             |          |        |             |          |          |            |      |        |     |     |     |       |      |     |        |      |      |      |       |     |       |      |     |     |      |      |      |      |     |     |     |      |     |        |      |     |       |      |    |        |     |     |     |       |     |       |      |     |    |    |      |     |     |     |     |     |      |     |        |     |     |       |      |    |        |     |     |     |       |     |       |      |    |    |    |      |    |    |     |     |     |      |    |        |     |     |      |      |    |        |     |     |     |       |     |      |      |    |    |    |      |    |    |     |     |     |      |    |        |     |     |       |      |    |        |     |     |     |       |     |       |      |    |    |    |      |    |    |     |     |     |
| <table border="1"> <thead> <tr> <th colspan="2">COLUMN I</th> <th colspan="2">COLUMN II</th> <th colspan="2">COLUMN III</th> <th colspan="2">COLUMN IV</th> <th colspan="2">COLUMN V</th> </tr> <tr> <th colspan="2">RANGE IN AIRMILES</th> <th colspan="2">RANGE IN AIRMILES</th> <th colspan="2">RANGE IN AIRMILES</th> <th colspan="2">RANGE IN AIRMILES</th> <th colspan="2">RANGE IN AIRMILES</th> </tr> <tr> <th>STATUTE</th> <th>NAUTICAL</th> <th>STATUTE</th> <th>NAUTICAL</th> <th>STATUTE</th> <th>NAUTICAL</th> <th>STATUTE</th> <th>NAUTICAL</th> <th>STATUTE</th> <th>NAUTICAL</th> </tr> </thead> <tbody> <tr> <td>910</td> <td>790</td> <td>1210</td> <td>1050</td> <td>1580</td> <td>1350</td> <td>1700</td> <td>1470</td> <td></td> <td></td> </tr> <tr> <td>830</td> <td>720</td> <td>1110</td> <td>960</td> <td>1420</td> <td>1230</td> <td>1550</td> <td>1340</td> <td></td> <td></td> </tr> <tr> <td>750</td> <td>650</td> <td>1010</td> <td>870</td> <td>1280</td> <td>1120</td> <td>1410</td> <td>1220</td> <td></td> <td></td> </tr> <tr> <td>680</td> <td>590</td> <td>900</td> <td>780</td> <td>1180</td> <td>1000</td> <td>1280</td> <td>1090</td> <td></td> <td></td> </tr> <tr> <td>600</td> <td>520</td> <td>800</td> <td>690</td> <td>1030</td> <td>890</td> <td>1120</td> <td>970</td> <td></td> <td></td> </tr> <tr> <td>520</td> <td>450</td> <td>700</td> <td>600</td> <td>890</td> <td>770</td> <td>970</td> <td>840</td> <td></td> <td></td> </tr> <tr> <td>450</td> <td>390</td> <td>600</td> <td>520</td> <td>780</td> <td>660</td> <td>830</td> <td>720</td> <td></td> <td></td> </tr> </tbody> </table>   |              |  |                 |                      |  |   |             |                                  | COLUMN I           |             | COLUMN II |          | COLUMN III |         | COLUMN IV |        | COLUMN V    |          | RANGE IN AIRMILES |             | RANGE IN AIRMILES |          | RANGE IN AIRMILES |     | RANGE IN AIRMILES |  | RANGE IN AIRMILES |  | STATUTE | NAUTICAL | STATUTE     | NAUTICAL | STATUTE  | NAUTICAL   | STATUTE | NAUTICAL | STATUTE | NAUTICAL    | 910      | 790    | 1210        | 1050     | 1580     | 1350       | 1700 | 1470 |        |             | 830      | 720    | 1110        | 960      | 1420     | 1230       | 1550 | 1340   |     |     | 750 | 650   | 1010 | 870 | 1280   | 1120 | 1410 | 1220 |       |     | 680   | 590  | 900 | 780 | 1180 | 1000 | 1280 | 1090 |     |     | 600 | 520  | 800 | 690    | 1030 | 890 | 1120  | 970  |    |        | 520 | 450 | 700 | 600   | 890 | 770   | 970  | 840 |    |    | 450  | 390 | 600 | 520 | 780 | 660 | 830  | 720 |        |     |     |       |      |    |        |     |     |     |       |     |       |      |    |    |    |      |    |    |     |     |     |      |    |        |     |     |      |      |    |        |     |     |     |       |     |      |      |    |    |    |      |    |    |     |     |     |      |    |        |     |     |       |      |    |        |     |     |     |       |     |       |      |    |    |    |      |    |    |     |     |     |
| COLUMN I  |              | COLUMN II                                    |                 | COLUMN III           |  | COLUMN IV   |             | COLUMN V                         |                    |             |           |          |            |         |           |        |             |          |                   |             |                   |          |                   |     |                   |  |                   |  |         |          |             |          |          |            |         |          |         |             |          |        |             |          |          |            |      |      |        |             |          |        |             |          |          |            |      |        |     |     |     |       |      |     |        |      |      |      |       |     |       |      |     |     |      |      |      |      |     |     |     |      |     |        |      |     |       |      |    |        |     |     |     |       |     |       |      |     |    |    |      |     |     |     |     |     |      |     |        |     |     |       |      |    |        |     |     |     |       |     |       |      |    |    |    |      |    |    |     |     |     |      |    |        |     |     |      |      |    |        |     |     |     |       |     |      |      |    |    |    |      |    |    |     |     |     |      |    |        |     |     |       |      |    |        |     |     |     |       |     |       |      |    |    |    |      |    |    |     |     |     |
| RANGE IN AIRMILES   |              | RANGE IN AIRMILES                            |                 | RANGE IN AIRMILES    |  | RANGE IN AIRMILES   |             | RANGE IN AIRMILES                |                    |             |           |          |            |         |           |        |             |          |                   |             |                   |          |                   |     |                   |  |                   |  |         |          |             |          |          |            |         |          |         |             |          |        |             |          |          |            |      |      |        |             |          |        |             |          |          |            |      |        |     |     |     |       |      |     |        |      |      |      |       |     |       |      |     |     |      |      |      |      |     |     |     |      |     |        |      |     |       |      |    |        |     |     |     |       |     |       |      |     |    |    |      |     |     |     |     |     |      |     |        |     |     |       |      |    |        |     |     |     |       |     |       |      |    |    |    |      |    |    |     |     |     |      |    |        |     |     |      |      |    |        |     |     |     |       |     |      |      |    |    |    |      |    |    |     |     |     |      |    |        |     |     |       |      |    |        |     |     |     |       |     |       |      |    |    |    |      |    |    |     |     |     |
| STATUTE   | NAUTICAL     | STATUTE                                      | NAUTICAL        | STATUTE              | NAUTICAL   | STATUTE   | NAUTICAL    | STATUTE                          | NAUTICAL           |             |           |          |            |         |           |        |             |          |                   |             |                   |          |                   |     |                   |  |                   |  |         |          |             |          |          |            |         |          |         |             |          |        |             |          |          |            |      |      |        |             |          |        |             |          |          |            |      |        |     |     |     |       |      |     |        |      |      |      |       |     |       |      |     |     |      |      |      |      |     |     |     |      |     |        |      |     |       |      |    |        |     |     |     |       |     |       |      |     |    |    |      |     |     |     |     |     |      |     |        |     |     |       |      |    |        |     |     |     |       |     |       |      |    |    |    |      |    |    |     |     |     |      |    |        |     |     |      |      |    |        |     |     |     |       |     |      |      |    |    |    |      |    |    |     |     |     |      |    |        |     |     |       |      |    |        |     |     |     |       |     |       |      |    |    |    |      |    |    |     |     |     |
| 910   | 790          | 1210   | 1050            | 1580                 | 1350   | 1700  | 1470        |                                  |                    |             |           |          |            |         |           |        |             |          |                   |             |                   |          |                   |     |                   |  |                   |  |         |          |             |          |          |            |         |          |         |             |          |        |             |          |          |            |      |      |        |             |          |        |             |          |          |            |      |        |     |     |     |       |      |     |        |      |      |      |       |     |       |      |     |     |      |      |      |      |     |     |     |      |     |        |      |     |       |      |    |        |     |     |     |       |     |       |      |     |    |    |      |     |     |     |     |     |      |     |        |     |     |       |      |    |        |     |     |     |       |     |       |      |    |    |    |      |    |    |     |     |     |      |    |        |     |     |      |      |    |        |     |     |     |       |     |      |      |    |    |    |      |    |    |     |     |     |      |    |        |     |     |       |      |    |        |     |     |     |       |     |       |      |    |    |    |      |    |    |     |     |     |
| 830   | 720          | 1110   | 960             | 1420                 | 1230   | 1550  | 1340        |                                  |                    |             |           |          |            |         |           |        |             |          |                   |             |                   |          |                   |     |                   |  |                   |  |         |          |             |          |          |            |         |          |         |             |          |        |             |          |          |            |      |      |        |             |          |        |             |          |          |            |      |        |     |     |     |       |      |     |        |      |      |      |       |     |       |      |     |     |      |      |      |      |     |     |     |      |     |        |      |     |       |      |    |        |     |     |     |       |     |       |      |     |    |    |      |     |     |     |     |     |      |     |        |     |     |       |      |    |        |     |     |     |       |     |       |      |    |    |    |      |    |    |     |     |     |      |    |        |     |     |      |      |    |        |     |     |     |       |     |      |      |    |    |    |      |    |    |     |     |     |      |    |        |     |     |       |      |    |        |     |     |     |       |     |       |      |    |    |    |      |    |    |     |     |     |
| 750   | 650          | 1010   | 870             | 1280                 | 1120   | 1410  | 1220        |                                  |                    |             |           |          |            |         |           |        |             |          |                   |             |                   |          |                   |     |                   |  |                   |  |         |          |             |          |          |            |         |          |         |             |          |        |             |          |          |            |      |      |        |             |          |        |             |          |          |            |      |        |     |     |     |       |      |     |        |      |      |      |       |     |       |      |     |     |      |      |      |      |     |     |     |      |     |        |      |     |       |      |    |        |     |     |     |       |     |       |      |     |    |    |      |     |     |     |     |     |      |     |        |     |     |       |      |    |        |     |     |     |       |     |       |      |    |    |    |      |    |    |     |     |     |      |    |        |     |     |      |      |    |        |     |     |     |       |     |      |      |    |    |    |      |    |    |     |     |     |      |    |        |     |     |       |      |    |        |     |     |     |       |     |       |      |    |    |    |      |    |    |     |     |     |
| 680   | 590          | 900  | 780             | 1180                 | 1000   | 1280  | 1090        |                                  |                    |             |           |          |            |         |           |        |             |          |                   |             |                   |          |                   |     |                   |  |                   |  |         |          |             |          |          |            |         |          |         |             |          |        |             |          |          |            |      |      |        |             |          |        |             |          |          |            |      |        |     |     |     |       |      |     |        |      |      |      |       |     |       |      |     |     |      |      |      |      |     |     |     |      |     |        |      |     |       |      |    |        |     |     |     |       |     |       |      |     |    |    |      |     |     |     |     |     |      |     |        |     |     |       |      |    |        |     |     |     |       |     |       |      |    |    |    |      |    |    |     |     |     |      |    |        |     |     |      |      |    |        |     |     |     |       |     |      |      |    |    |    |      |    |    |     |     |     |      |    |        |     |     |       |      |    |        |     |     |     |       |     |       |      |    |    |    |      |    |    |     |     |     |
| 600   | 520          | 800  | 690             | 1030                 | 890  | 1120  | 970         |                                  |                    |             |           |          |            |         |           |        |             |          |                   |             |                   |          |                   |     |                   |  |                   |  |         |          |             |          |          |            |         |          |         |             |          |        |             |          |          |            |      |      |        |             |          |        |             |          |          |            |      |        |     |     |     |       |      |     |        |      |      |      |       |     |       |      |     |     |      |      |      |      |     |     |     |      |     |        |      |     |       |      |    |        |     |     |     |       |     |       |      |     |    |    |      |     |     |     |     |     |      |     |        |     |     |       |      |    |        |     |     |     |       |     |       |      |    |    |    |      |    |    |     |     |     |      |    |        |     |     |      |      |    |        |     |     |     |       |     |      |      |    |    |    |      |    |    |     |     |     |      |    |        |     |     |       |      |    |        |     |     |     |       |     |       |      |    |    |    |      |    |    |     |     |     |
| 520   | 450          | 700  | 600             | 890                  | 770  | 970   | 840         |                                  |                    |             |           |          |            |         |           |        |             |          |                   |             |                   |          |                   |     |                   |  |                   |  |         |          |             |          |          |            |         |          |         |             |          |        |             |          |          |            |      |      |        |             |          |        |             |          |          |            |      |        |     |     |     |       |      |     |        |      |      |      |       |     |       |      |     |     |      |      |      |      |     |     |     |      |     |        |      |     |       |      |    |        |     |     |     |       |     |       |      |     |    |    |      |     |     |     |     |     |      |     |        |     |     |       |      |    |        |     |     |     |       |     |       |      |    |    |    |      |    |    |     |     |     |      |    |        |     |     |      |      |    |        |     |     |     |       |     |      |      |    |    |    |      |    |    |     |     |     |      |    |        |     |     |       |      |    |        |     |     |     |       |     |       |      |    |    |    |      |    |    |     |     |     |
| 450   | 390          | 600  | 520             | 780                  | 660  | 830   | 720         |                                  |                    |             |           |          |            |         |           |        |             |          |                   |             |                   |          |                   |     |                   |  |                   |  |         |          |             |          |          |            |         |          |         |             |          |        |             |          |          |            |      |      |        |             |          |        |             |          |          |            |      |        |     |     |     |       |      |     |        |      |      |      |       |     |       |      |     |     |      |      |      |      |     |     |     |      |     |        |      |     |       |      |    |        |     |     |     |       |     |       |      |     |    |    |      |     |     |     |     |     |      |     |        |     |     |       |      |    |        |     |     |     |       |     |       |      |    |    |    |      |    |    |     |     |     |      |    |        |     |     |      |      |    |        |     |     |     |       |     |      |      |    |    |    |      |    |    |     |     |     |      |    |        |     |     |       |      |    |        |     |     |     |       |     |       |      |    |    |    |      |    |    |     |     |     |
| <table border="1"> <thead> <tr> <th colspan="2">MAXIMUM CONTINUOUS</th> <th colspan="2">PRESS</th> <th colspan="2">ALT.</th> <th colspan="2">MIXTURE</th> <th colspan="2">R.P.M.</th> <th colspan="2">M.P.</th> <th colspan="2">T.A.S.</th> <th colspan="2">MIXTURE</th> <th colspan="2">R.P.M.</th> <th colspan="2">M.P.</th> <th colspan="2">T.A.S.</th> </tr> <tr> <th>M.P. INCHES</th> <th>MIX-TURE</th> <th>TOT. GPH</th> <th>T.A.S. MPH</th> <th>FEET</th> <th>FEET</th> <th>R.P.M.</th> <th>M.P. INCHES</th> <th>MIX-TURE</th> <th>R.P.M.</th> <th>M.P. INCHES</th> <th>MIX-TURE</th> <th>TOT. GPH</th> <th>T.A.S. MPH</th> <th>FEET</th> <th>FEET</th> <th>R.P.M.</th> <th>M.P. INCHES</th> <th>MIX-TURE</th> <th>R.P.M.</th> <th>M.P. INCHES</th> <th>MIX-TURE</th> <th>TOT. GPH</th> <th>T.A.S. MPH</th> </tr> </thead> <tbody> <tr> <td>2700</td> <td>NORMAL</td> <td>185</td> <td>235</td> <td>205</td> <td>20000</td> <td>2500</td> <td>45</td> <td>NORMAL</td> <td>110</td> <td>215</td> <td>185</td> <td>25000</td> <td>205</td> <td>20000</td> <td>2500</td> <td>45</td> <td>44</td> <td>44</td> <td>2400</td> <td>44</td> <td>44</td> <td>200</td> <td>185</td> <td>170</td> </tr> <tr> <td>2700</td> <td>48</td> <td>NORMAL</td> <td>150</td> <td>235</td> <td>15000</td> <td>2500</td> <td>45</td> <td>NORMAL</td> <td>110</td> <td>215</td> <td>185</td> <td>30000</td> <td>205</td> <td>15000</td> <td>2500</td> <td>45</td> <td>44</td> <td>44</td> <td>2400</td> <td>44</td> <td>44</td> <td>200</td> <td>185</td> <td>170</td> </tr> <tr> <td>2700</td> <td>48</td> <td>NORMAL</td> <td>150</td> <td>230</td> <td>10000</td> <td>2500</td> <td>45</td> <td>NORMAL</td> <td>110</td> <td>215</td> <td>185</td> <td>40000</td> <td>200</td> <td>10000</td> <td>2500</td> <td>45</td> <td>44</td> <td>44</td> <td>2400</td> <td>44</td> <td>44</td> <td>200</td> <td>185</td> <td>170</td> </tr> <tr> <td>2700</td> <td>48</td> <td>NORMAL</td> <td>145</td> <td>220</td> <td>5000</td> <td>2500</td> <td>45</td> <td>NORMAL</td> <td>105</td> <td>205</td> <td>180</td> <td>50000</td> <td>190</td> <td>5000</td> <td>2500</td> <td>45</td> <td>44</td> <td>44</td> <td>2400</td> <td>44</td> <td>44</td> <td>200</td> <td>185</td> <td>170</td> </tr> <tr> <td>2700</td> <td>48</td> <td>NORMAL</td> <td>140</td> <td>210</td> <td>S. L.</td> <td>2500</td> <td>45</td> <td>NORMAL</td> <td>100</td> <td>200</td> <td>175</td> <td>S. L.</td> <td>180</td> <td>S. L.</td> <td>2500</td> <td>45</td> <td>44</td> <td>44</td> <td>2400</td> <td>44</td> <td>44</td> <td>200</td> <td>185</td> <td>170</td> </tr> </tbody> </table> |              |  |                 |                      |  |   |             |                                  | MAXIMUM CONTINUOUS |             | PRESS     |          | ALT.       |         | MIXTURE   |        | R.P.M.      |          | M.P.              |             | T.A.S.            |          | MIXTURE           |     | R.P.M.            |  | M.P.              |  | T.A.S.  |          | M.P. INCHES | MIX-TURE | TOT. GPH | T.A.S. MPH | FEET    | FEET     | R.P.M.  | M.P. INCHES | MIX-TURE | R.P.M. | M.P. INCHES | MIX-TURE | TOT. GPH | T.A.S. MPH | FEET | FEET | R.P.M. | M.P. INCHES | MIX-TURE | R.P.M. | M.P. INCHES | MIX-TURE | TOT. GPH | T.A.S. MPH | 2700 | NORMAL | 185 | 235 | 205 | 20000 | 2500 | 45  | NORMAL | 110  | 215  | 185  | 25000 | 205 | 20000 | 2500 | 45  | 44  | 44   | 2400 | 44   | 44   | 200 | 185 | 170 | 2700 | 48  | NORMAL | 150  | 235 | 15000 | 2500 | 45 | NORMAL | 110 | 215 | 185 | 30000 | 205 | 15000 | 2500 | 45  | 44 | 44 | 2400 | 44  | 44  | 200 | 185 | 170 | 2700 | 48  | NORMAL | 150 | 230 | 10000 | 2500 | 45 | NORMAL | 110 | 215 | 185 | 40000 | 200 | 10000 | 2500 | 45 | 44 | 44 | 2400 | 44 | 44 | 200 | 185 | 170 | 2700 | 48 | NORMAL | 145 | 220 | 5000 | 2500 | 45 | NORMAL | 105 | 205 | 180 | 50000 | 190 | 5000 | 2500 | 45 | 44 | 44 | 2400 | 44 | 44 | 200 | 185 | 170 | 2700 | 48 | NORMAL | 140 | 210 | S. L. | 2500 | 45 | NORMAL | 100 | 200 | 175 | S. L. | 180 | S. L. | 2500 | 45 | 44 | 44 | 2400 | 44 | 44 | 200 | 185 | 170 |
| MAXIMUM CONTINUOUS  |              | PRESS  |                 | ALT.                 |  | MIXTURE   |             | R.P.M.                           |                    | M.P.        |           | T.A.S.   |            | MIXTURE |           | R.P.M. |             | M.P.     |                   | T.A.S.      |                   |          |                   |     |                   |  |                   |  |         |          |             |          |          |            |         |          |         |             |          |        |             |          |          |            |      |      |        |             |          |        |             |          |          |            |      |        |     |     |     |       |      |     |        |      |      |      |       |     |       |      |     |     |      |      |      |      |     |     |     |      |     |        |      |     |       |      |    |        |     |     |     |       |     |       |      |     |    |    |      |     |     |     |     |     |      |     |        |     |     |       |      |    |        |     |     |     |       |     |       |      |    |    |    |      |    |    |     |     |     |      |    |        |     |     |      |      |    |        |     |     |     |       |     |      |      |    |    |    |      |    |    |     |     |     |      |    |        |     |     |       |      |    |        |     |     |     |       |     |       |      |    |    |    |      |    |    |     |     |     |
| M.P. INCHES   | MIX-TURE     | TOT. GPH                                     | T.A.S. MPH      | FEET                 | FEET   | R.P.M.  | M.P. INCHES | MIX-TURE                         | R.P.M.             | M.P. INCHES | MIX-TURE  | TOT. GPH | T.A.S. MPH | FEET    | FEET      | R.P.M. | M.P. INCHES | MIX-TURE | R.P.M.            | M.P. INCHES | MIX-TURE          | TOT. GPH | T.A.S. MPH        |     |                   |  |                   |  |         |          |             |          |          |            |         |          |         |             |          |        |             |          |          |            |      |      |        |             |          |        |             |          |          |            |      |        |     |     |     |       |      |     |        |      |      |      |       |     |       |      |     |     |      |      |      |      |     |     |     |      |     |        |      |     |       |      |    |        |     |     |     |       |     |       |      |     |    |    |      |     |     |     |     |     |      |     |        |     |     |       |      |    |        |     |     |     |       |     |       |      |    |    |    |      |    |    |     |     |     |      |    |        |     |     |      |      |    |        |     |     |     |       |     |      |      |    |    |    |      |    |    |     |     |     |      |    |        |     |     |       |      |    |        |     |     |     |       |     |       |      |    |    |    |      |    |    |     |     |     |
| 2700  | NORMAL       | 185  | 235             | 205                  | 20000  | 2500  | 45          | NORMAL                           | 110                | 215         | 185       | 25000    | 205        | 20000   | 2500      | 45     | 44          | 44       | 2400              | 44          | 44                | 200      | 185               | 170 |                   |  |                   |  |         |          |             |          |          |            |         |          |         |             |          |        |             |          |          |            |      |      |        |             |          |        |             |          |          |            |      |        |     |     |     |       |      |     |        |      |      |      |       |     |       |      |     |     |      |      |      |      |     |     |     |      |     |        |      |     |       |      |    |        |     |     |     |       |     |       |      |     |    |    |      |     |     |     |     |     |      |     |        |     |     |       |      |    |        |     |     |     |       |     |       |      |    |    |    |      |    |    |     |     |     |      |    |        |     |     |      |      |    |        |     |     |     |       |     |      |      |    |    |    |      |    |    |     |     |     |      |    |        |     |     |       |      |    |        |     |     |     |       |     |       |      |    |    |    |      |    |    |     |     |     |
| 2700  | 48           | NORMAL                                       | 150             | 235                  | 15000  | 2500  | 45          | NORMAL                           | 110                | 215         | 185       | 30000    | 205        | 15000   | 2500      | 45     | 44          | 44       | 2400              | 44          | 44                | 200      | 185               | 170 |                   |  |                   |  |         |          |             |          |          |            |         |          |         |             |          |        |             |          |          |            |      |      |        |             |          |        |             |          |          |            |      |        |     |     |     |       |      |     |        |      |      |      |       |     |       |      |     |     |      |      |      |      |     |     |     |      |     |        |      |     |       |      |    |        |     |     |     |       |     |       |      |     |    |    |      |     |     |     |     |     |      |     |        |     |     |       |      |    |        |     |     |     |       |     |       |      |    |    |    |      |    |    |     |     |     |      |    |        |     |     |      |      |    |        |     |     |     |       |     |      |      |    |    |    |      |    |    |     |     |     |      |    |        |     |     |       |      |    |        |     |     |     |       |     |       |      |    |    |    |      |    |    |     |     |     |
| 2700  | 48           | NORMAL                                       | 150             | 230                  | 10000  | 2500  | 45          | NORMAL                           | 110                | 215         | 185       | 40000    | 200        | 10000   | 2500      | 45     | 44          | 44       | 2400              | 44          | 44                | 200      | 185               | 170 |                   |  |                   |  |         |          |             |          |          |            |         |          |         |             |          |        |             |          |          |            |      |      |        |             |          |        |             |          |          |            |      |        |     |     |     |       |      |     |        |      |      |      |       |     |       |      |     |     |      |      |      |      |     |     |     |      |     |        |      |     |       |      |    |        |     |     |     |       |     |       |      |     |    |    |      |     |     |     |     |     |      |     |        |     |     |       |      |    |        |     |     |     |       |     |       |      |    |    |    |      |    |    |     |     |     |      |    |        |     |     |      |      |    |        |     |     |     |       |     |      |      |    |    |    |      |    |    |     |     |     |      |    |        |     |     |       |      |    |        |     |     |     |       |     |       |      |    |    |    |      |    |    |     |     |     |
| 2700  | 48           | NORMAL                                       | 145             | 220                  | 5000   | 2500  | 45          | NORMAL                           | 105                | 205         | 180       | 50000    | 190        | 5000    | 2500      | 45     | 44          | 44       | 2400              | 44          | 44                | 200      | 185               | 170 |                   |  |                   |  |         |          |             |          |          |            |         |          |         |             |          |        |             |          |          |            |      |      |        |             |          |        |             |          |          |            |      |        |     |     |     |       |      |     |        |      |      |      |       |     |       |      |     |     |      |      |      |      |     |     |     |      |     |        |      |     |       |      |    |        |     |     |     |       |     |       |      |     |    |    |      |     |     |     |     |     |      |     |        |     |     |       |      |    |        |     |     |     |       |     |       |      |    |    |    |      |    |    |     |     |     |      |    |        |     |     |      |      |    |        |     |     |     |       |     |      |      |    |    |    |      |    |    |     |     |     |      |    |        |     |     |       |      |    |        |     |     |     |       |     |       |      |    |    |    |      |    |    |     |     |     |
| 2700  | 48           | NORMAL                                       | 140             | 210                  | S. L.  | 2500  | 45          | NORMAL                           | 100                | 200         | 175       | S. L.    | 180        | S. L.   | 2500      | 45     | 44          | 44       | 2400              | 44          | 44                | 200      | 185               | 170 |                   |  |                   |  |         |          |             |          |          |            |         |          |         |             |          |        |             |          |          |            |      |      |        |             |          |        |             |          |          |            |      |        |     |     |     |       |      |     |        |      |      |      |       |     |       |      |     |     |      |      |      |      |     |     |     |      |     |        |      |     |       |      |    |        |     |     |     |       |     |       |      |     |    |    |      |     |     |     |     |     |      |     |        |     |     |       |      |    |        |     |     |     |       |     |       |      |    |    |    |      |    |    |     |     |     |      |    |        |     |     |      |      |    |        |     |     |     |       |     |      |      |    |    |    |      |    |    |     |     |     |      |    |        |     |     |       |      |    |        |     |     |     |       |     |       |      |    |    |    |      |    |    |     |     |     |

**LEGEND**  
 ALT. : PRESSURE ALTITUDE F. R. : FULL RICH  
 M.P. : MANIFOLD PRESSURE A. R. : AUTO-RICH  
 GPH : U.S. GAL. PER HOUR A. L. : AUTO-LEAN  
 T.A.S. : TRUE AIRSPEED C. L. : CRUISING LEAN  
 KTS. : KNOTS M. L. : MANUAL LEAN  
 S. L. : SEA LEVEL F. T. : FULL THROTTLE  
 LRC : LONG RANGE CRUISE

**EXAMPLE**  
 AT 20,500 LB. GROSS WEIGHT WITH 500 GAL. OF FUEL  
 (AFTER DEDUCTING TOTAL ALLOWANCES OF 800 GAL.)  
 TO FLY 1250 STAT. AIRMILES AT 10,000 FT. ALTITUDE  
 MAINTAIN 2400 RPM AND 44 IN. MANIFOLD PRESSURE  
 WITH MIXTURE SET: LONG RANGE CRUISE

**FUEL—GRADE 115/145**

**SPECIAL NOTES**  
 (1) MAKE ALLOWANCE FOR WARM-UP, TAKE-OFF & CLIMB  
 PLUS ALLOWANCE FOR WIND, RESERVE AND COMBAT AS REQUIRED.

**FLIGHT TESTS**

149-83-511A  
 DATA AS OF 6/7/48  
 BASED ON:

Figure A-9 (Sheet 1 of 2 Sheets). Flight Operation Instruction Chart—Single Engine





