

1934

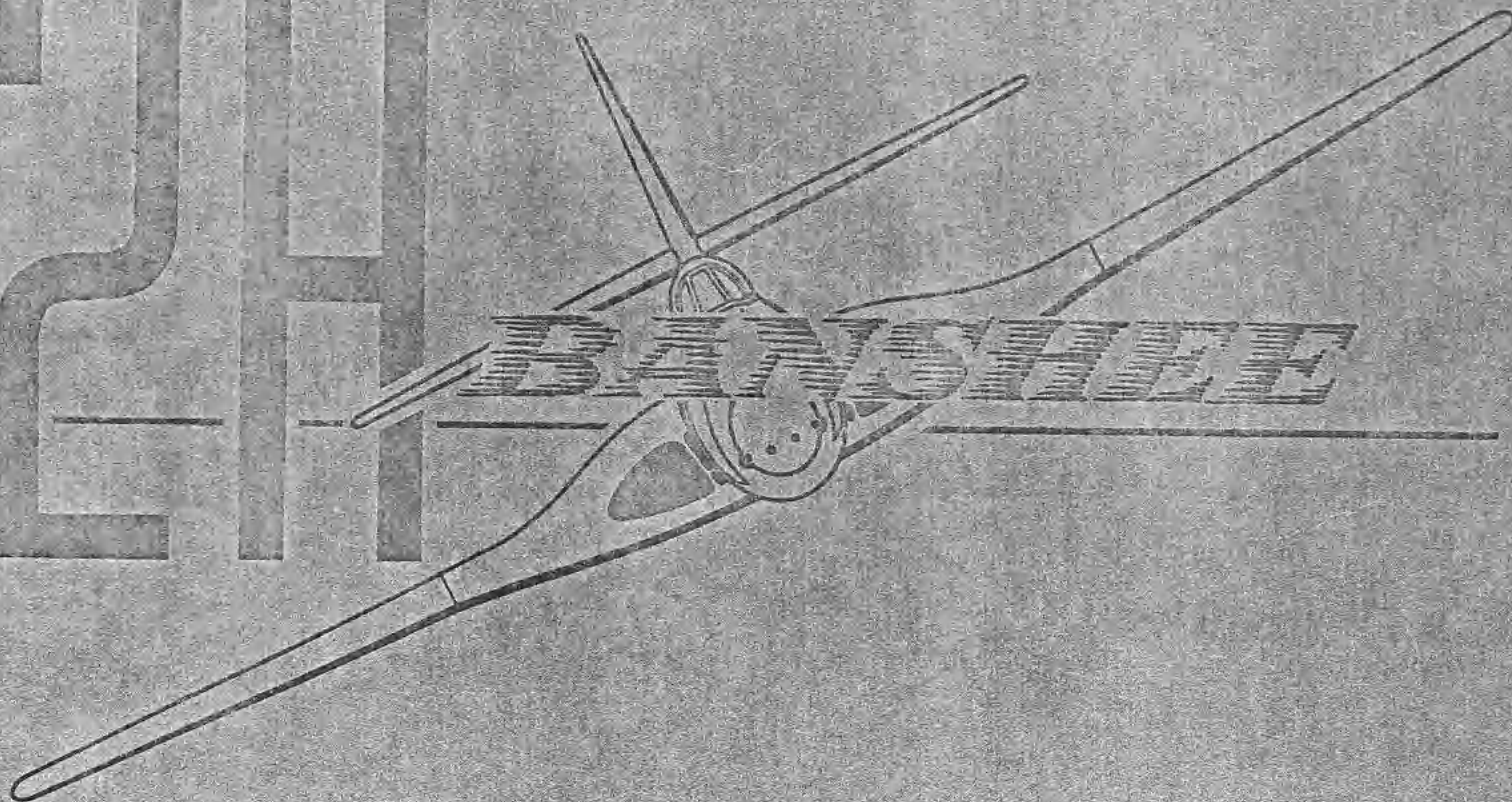

MCDONNELL *Aircraft Corporation*

S A I N T L O U I S

John A. Aldridge

Foreword . . .

This booklet was prepared so that Navy personnel could become better acquainted with the BANSHEE and its capabilities. There was no attempt made, therefore, to dissect the airplane in detail, but instead, to present its salient features in an easily digested manner.

MCDONNELL *Aircraft Corporation*

Mc DONNELL F2H BANSHEE

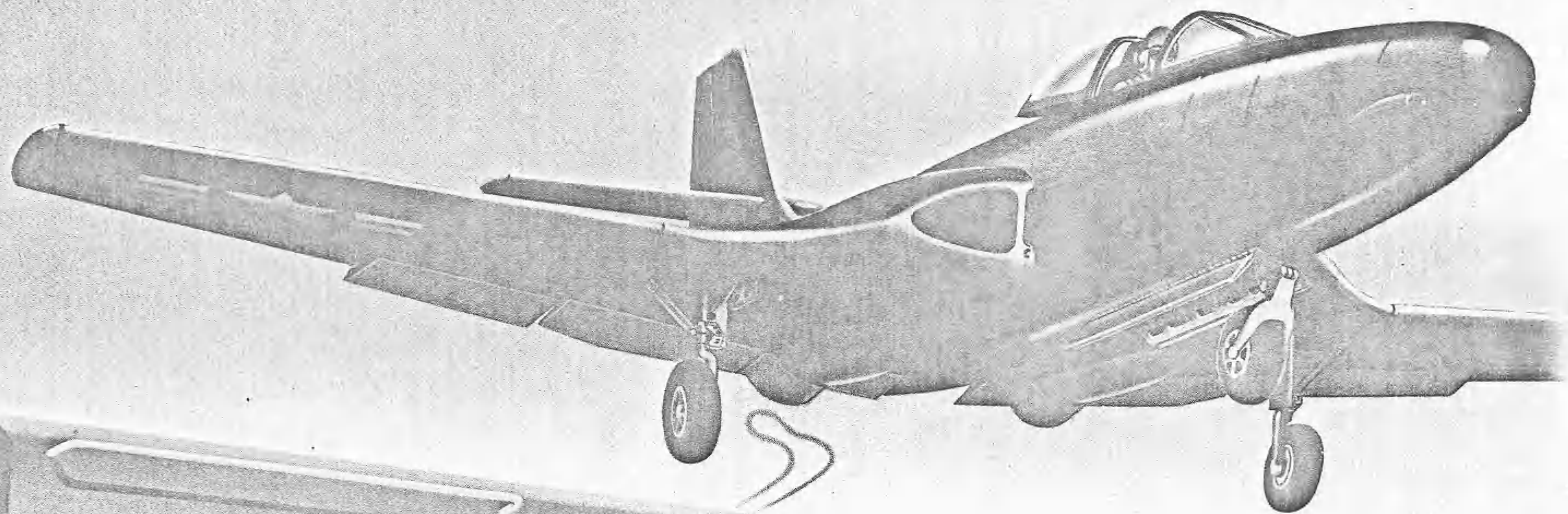

Carrier Based Fighter

	WITHOUT TIP-TANK PROVISIONS	WITH TIP-TANK PROVISIONS
Gross Weight, Combat.....	14,162 lbs.	16,193 lbs.
Fuel, internal.....	558 gals.	723 gals.
Fuel, external.....	0 gals.	0 gals.
Gross Weight, Maximum Fuel.....	16,076 lbs.	19,817 lbs.
Fuel, internal.....	877 gals.	877 gals.
Fuel, external.....	0 gals.	400 gals.
Wing Area.....	294 sq. ft.	294 sq. ft.
Wing Loading, Combat.....	49 lbs./sq. ft.	55 lbs./sq. ft.
Power Plants, Westinghouse.....	J34-WE-22	J34-WE-34
Thrust, Total Static.....	6000 lbs.	6500 lbs.
Guns.....	Four 20 mm. (Pneumatic Chargers)	
Ammunition, Total.....	600 rounds	
Fuel System.....	Automatic, continuous flow including the two 200 gal. droppable tip tanks	
Pilot's Compartment.....	Pressurized and air-conditioned with ejection seat power operated for normal adjustment	
Armor.....	Pilot protection front and rear provided by bullet-resistant glass, steel armor plate and aluminum deflector plate.	

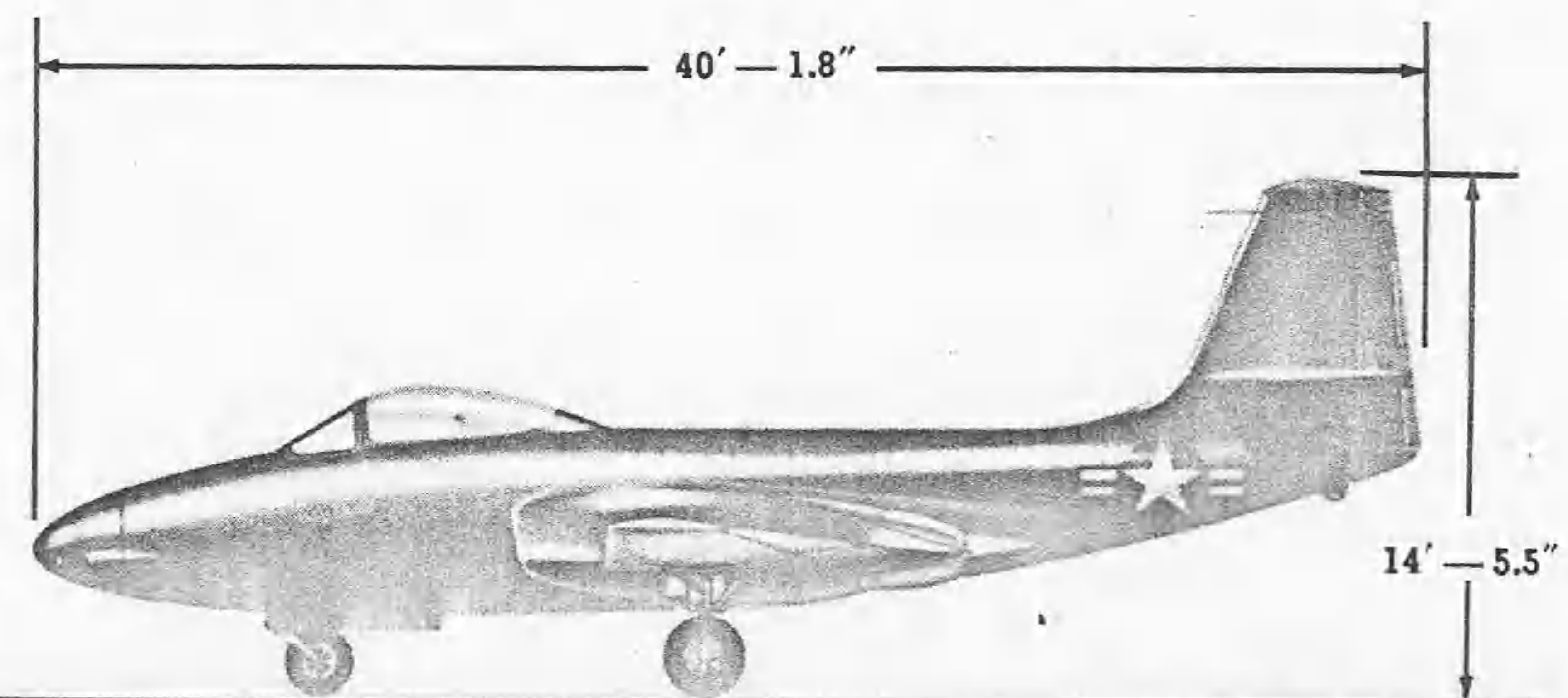
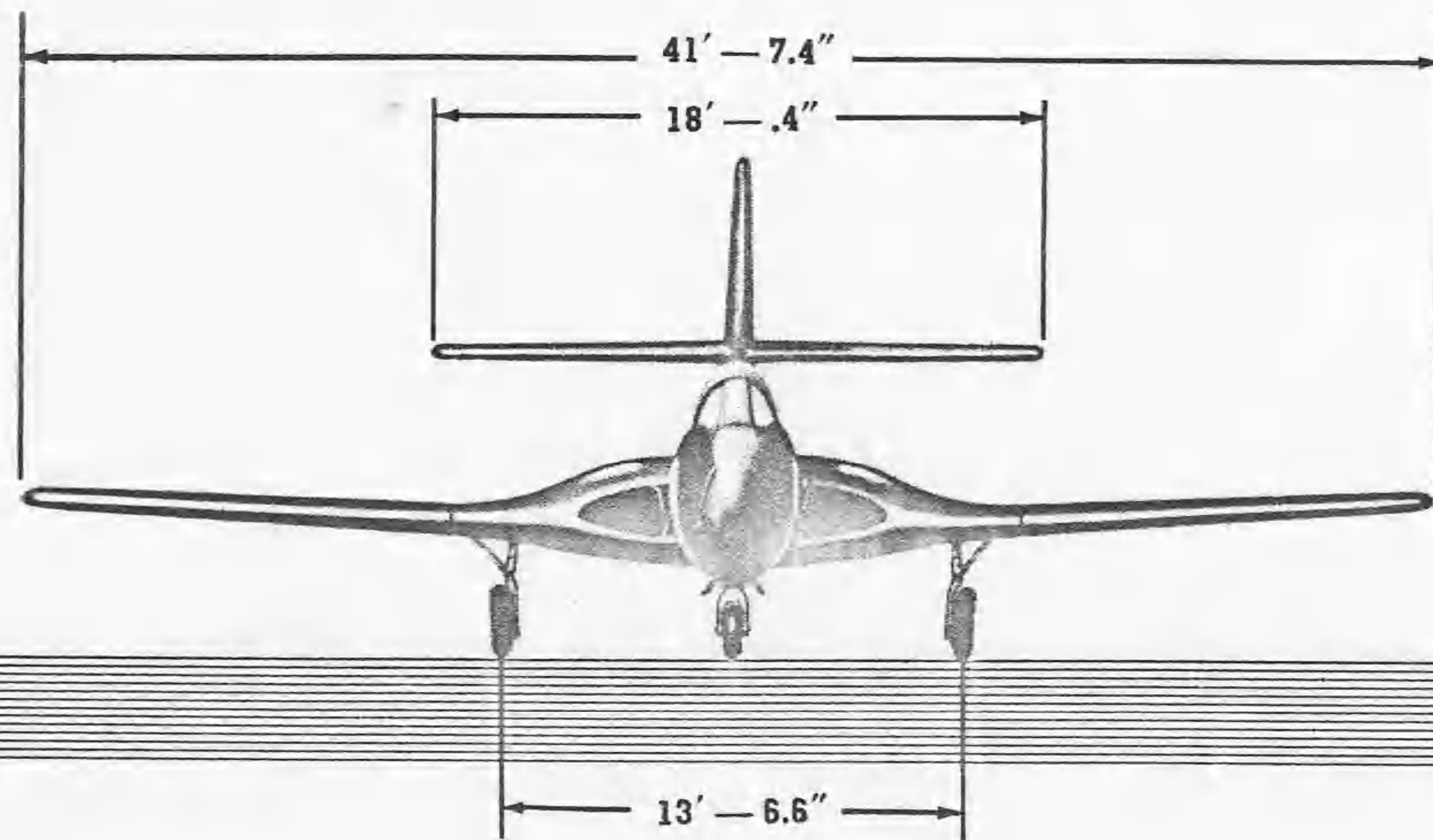

McDonnell F2H BANSHEE

- | | | | |
|-------------------------|-------------------------|---------------------------------|---------------------------------|
| 1. ARN-6 ANT. LOOP | 10. THROTTLE QUADRANT | 19. CABLE EJECTOR | 28. REFRIGERATION UNIT |
| 2. ARN-6 RADIO | 11. CANOPY ANTENNA | 20. ARRESTING GEAR MECHANISM | 29. OXYGEN TANK |
| 3. ARR-2 RADIO | 12. FWD. FUEL CELL | 21. TRANSFORMER INVERTER | 30. NOSE GEAR ACTUATOR |
| 4. COMPRESSOR | 13. CENTER FUEL CELL | 22. RADIO ALTIMETER | 31. BRAKE CYLINDER |
| 5. BATTERY AN 3150 | 14. AFT. FUEL CELL | 23. AMPLIFIER | 32. CABIN PRESSURE RELIEF VALVE |
| 6. APX-1 RADIO (I.F.F.) | 15. ARC-1 RADIO | 24. ANTENNA FILTER | 33. KNEELING DOLLY |
| 7. AMMUNITION BOX | 16. FIN ANTENNA | 25. CATAPULT HOLD-BACK FITTING | 34. 4—20 MM., M3 GUNS |
| 8. GUN SIGHT CONTROLLER | 17. COMPASS TRANSMITTER | 26. CONTROL CABLES INSIDE TUBES | 35. APPROACH LIGHT |
| 9. GUN SIGHT | 18. ARRESTING HOOK | 27. CABIN PRESSURE REGULATOR | |

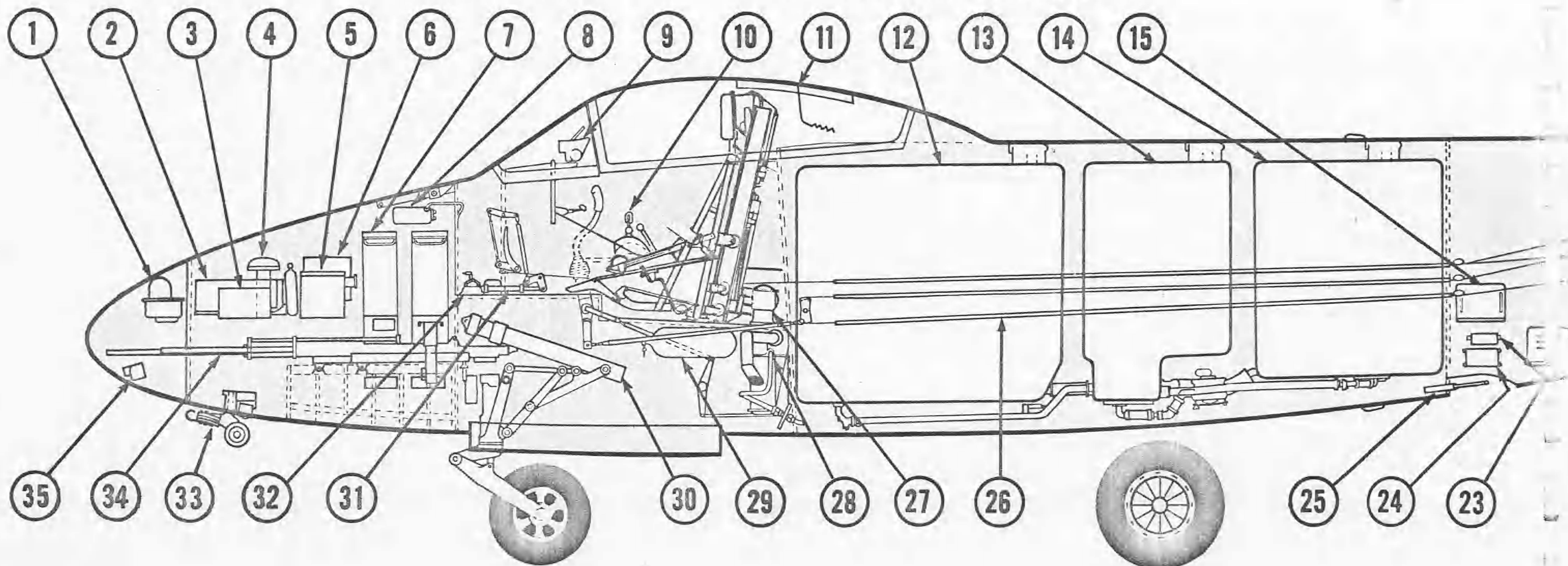

Interior Arrangement

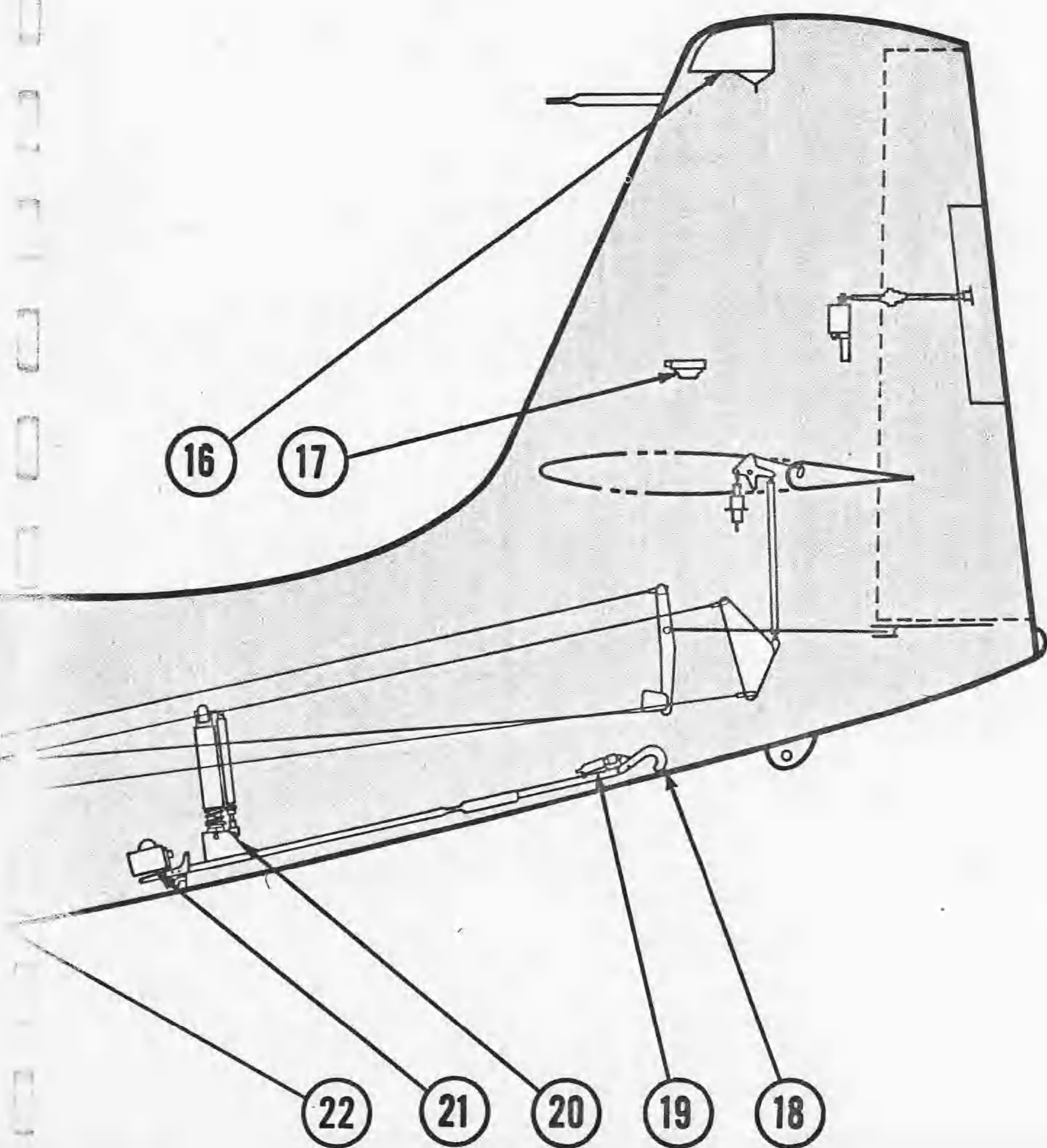

With the large amount of fuel required in a modern jet airplane the problem of locating the fuel tanks has become acute. The BAN-SHEE'S 877 gals. of internal fuel are carried in the best possible location, i. e., at the center of gravity of the airplane. This reduces the trim change with fuel consumption and also permits the most efficient possible fuel tanks and the simplest completely automatic fuel system. The pilot is located ahead of the wing and all guns, ammunition, and radios are in the nose for compactness and unexcelled access for maintenance. The arresting and catapulting hooks are located with extreme care so as to avoid pitching during catapulting and arresting. All radio antennas are of the flush type for complete aerodynamic smoothness. Except for aileron boost and arresting hook, all actuators are electrical.

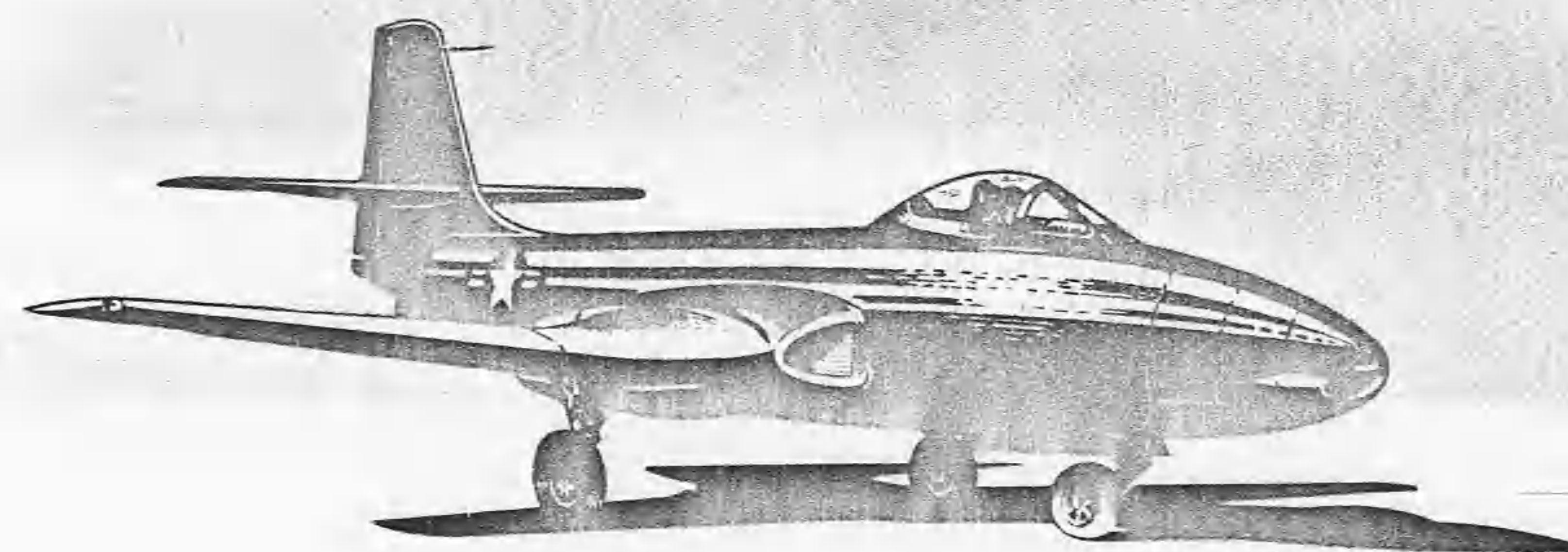

Mc DONNELL F2H BANSHEE

1. TAKE-OFF

GROSS WEIGHT—16076 lbs.
J34 — WE — 22 ENGINE

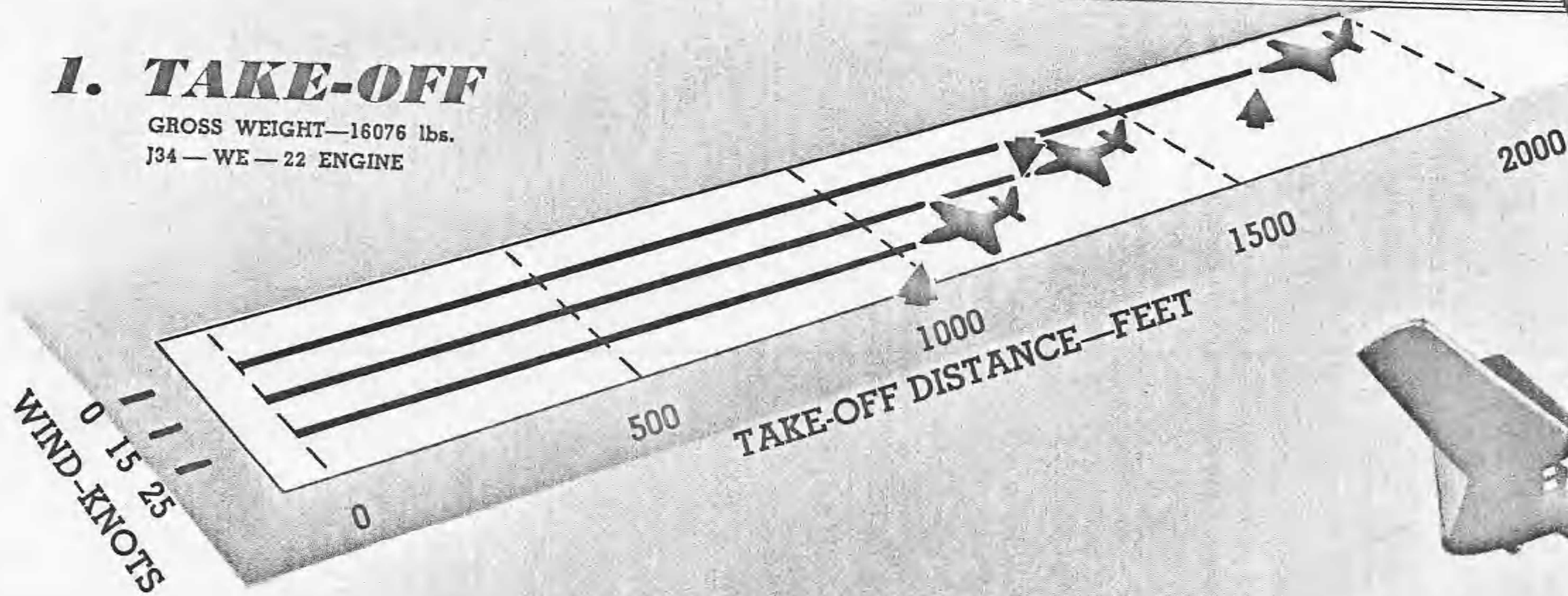

2. CLIMB

GROSS WEIGHT—14162 lbs.
J34 — WE — 22 ENGINE

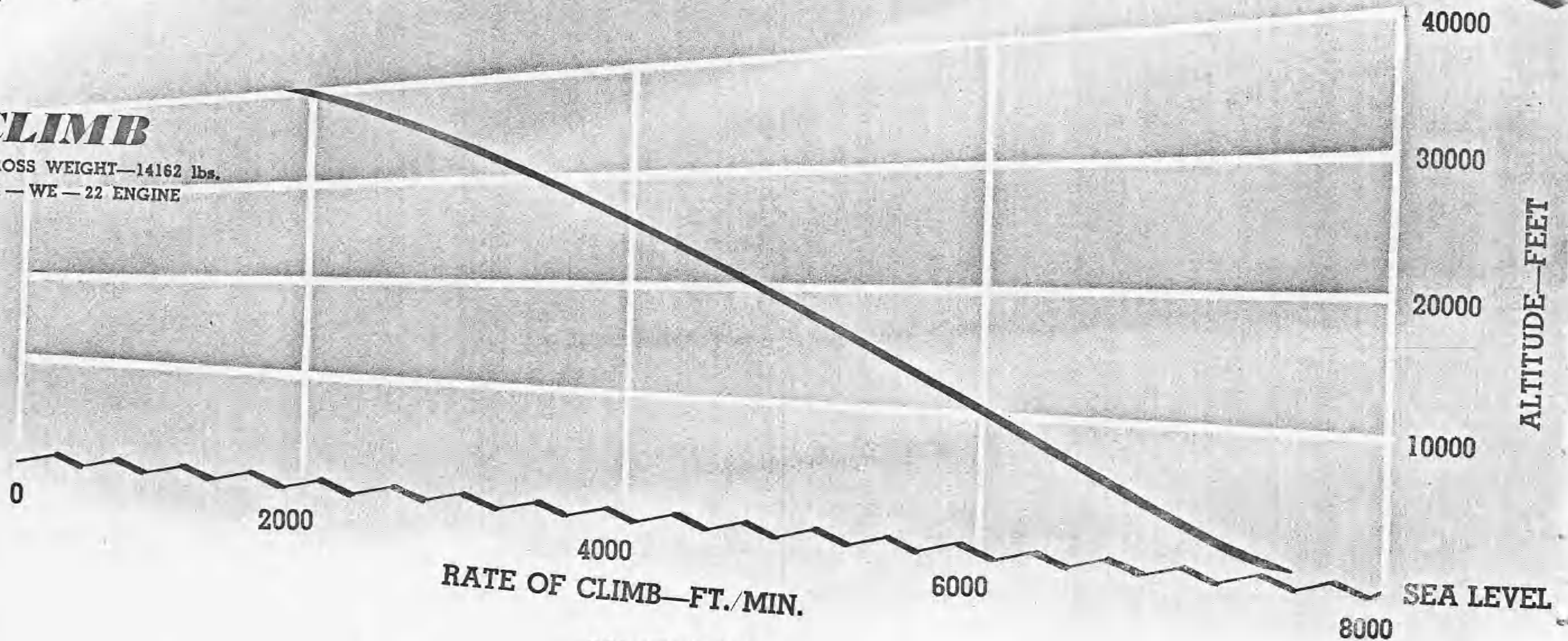

CONFIDENTIAL

Designed for Performance

3. HIGH SPEED

GROSS WEIGHT—14162 lbs.
J34 — WE — 22 ENGINE

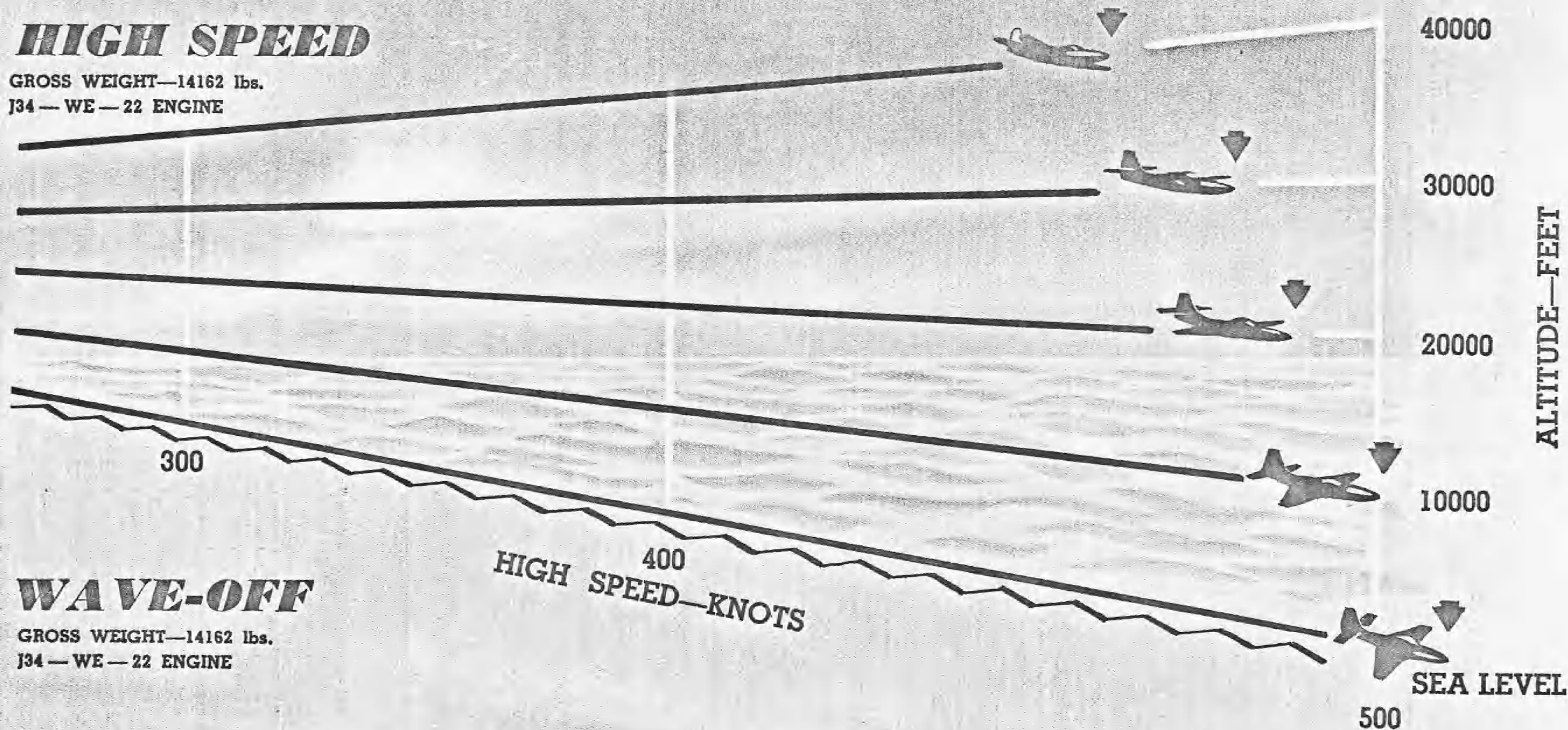

4. WAVE-OFF

GROSS WEIGHT—14162 lbs.
J34 — WE — 22 ENGINE

WAVE-OFF
RATE OF CLIMB
1631 FT./MIN.

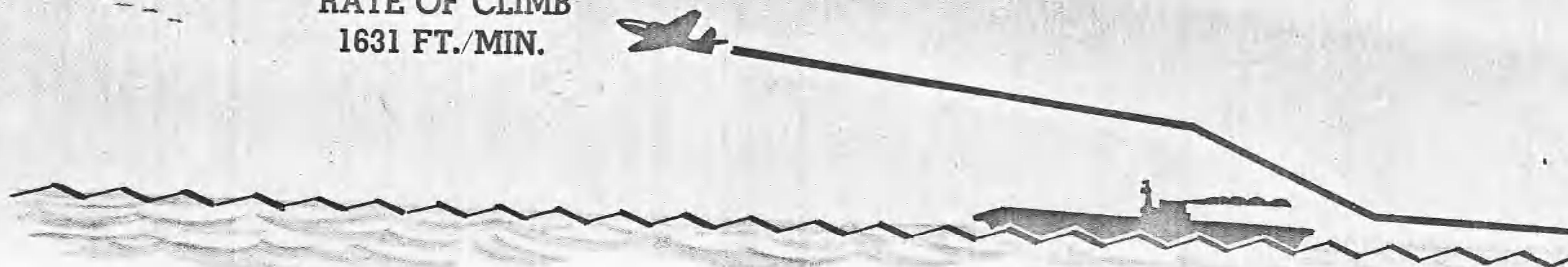

McDonnell F2H BANSHEE

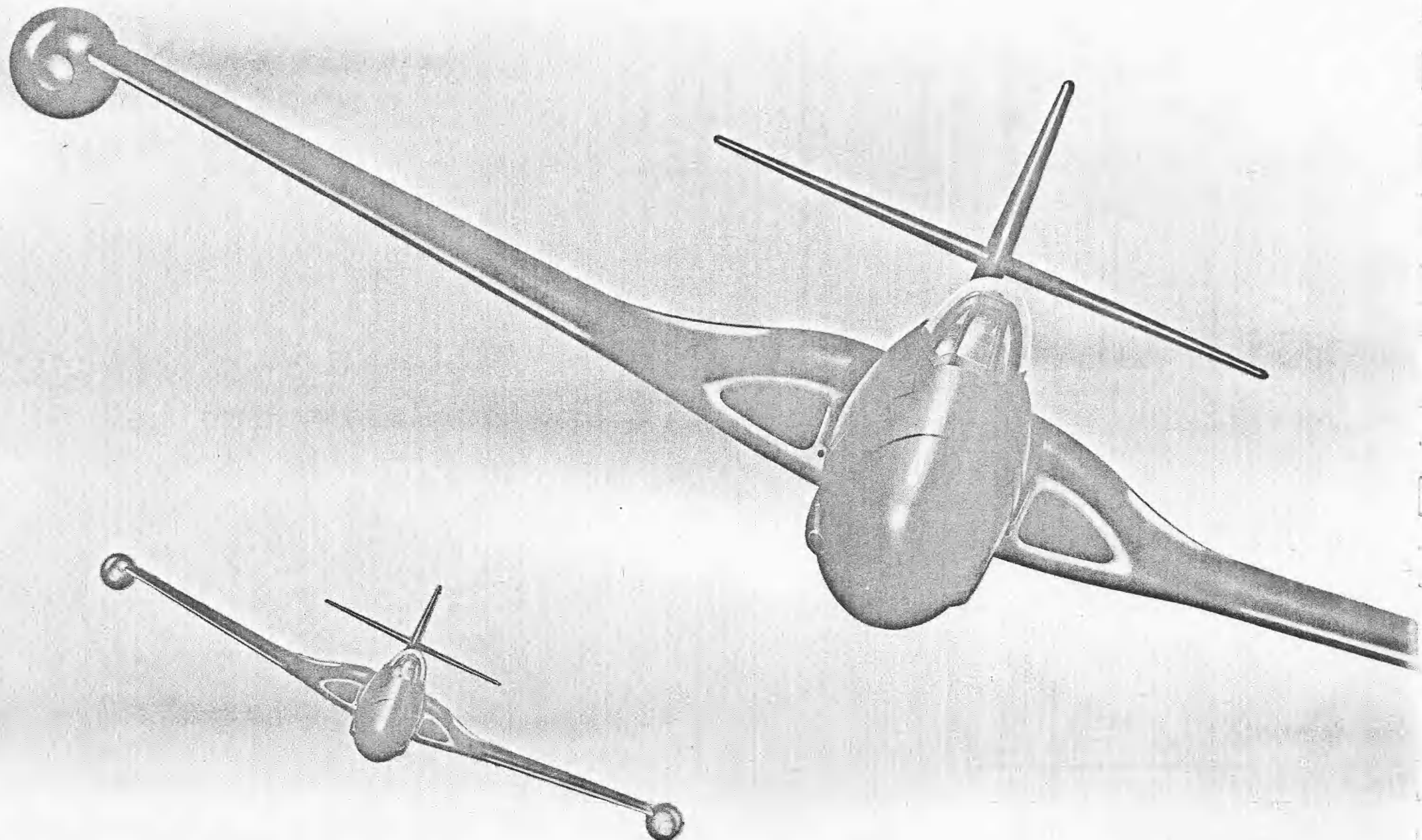

Designed for Long Range

ALL BANSHEES after the initial production run will be equipped to carry jettisonable tip tanks of 200 gals. each. These tanks are integrated into the automatic fuel system and require no attention from the pilot except for jettisoning. This gives the BANSHEE the greatest range of any single seat Naval fighter now being produced in the world. At an altitude of 35,000 ft. the BANSHEE is capable of staying aloft over 5 hours.

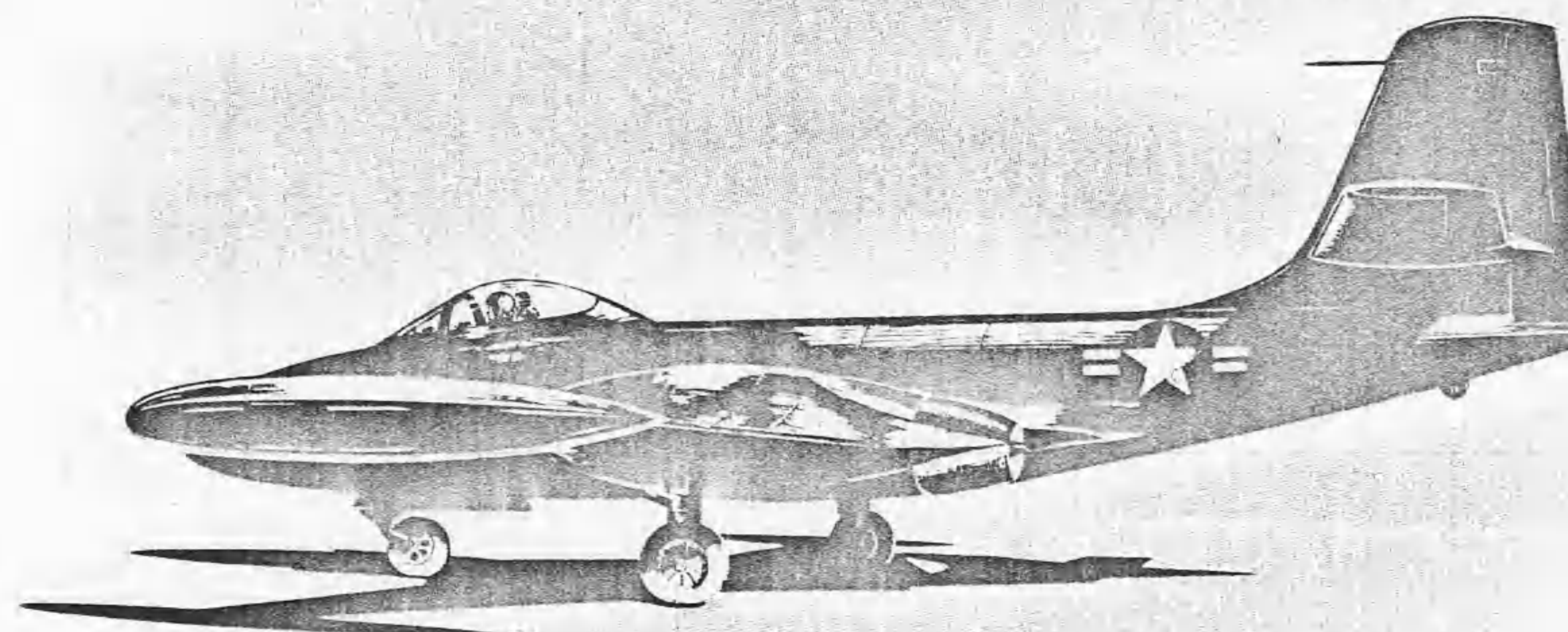
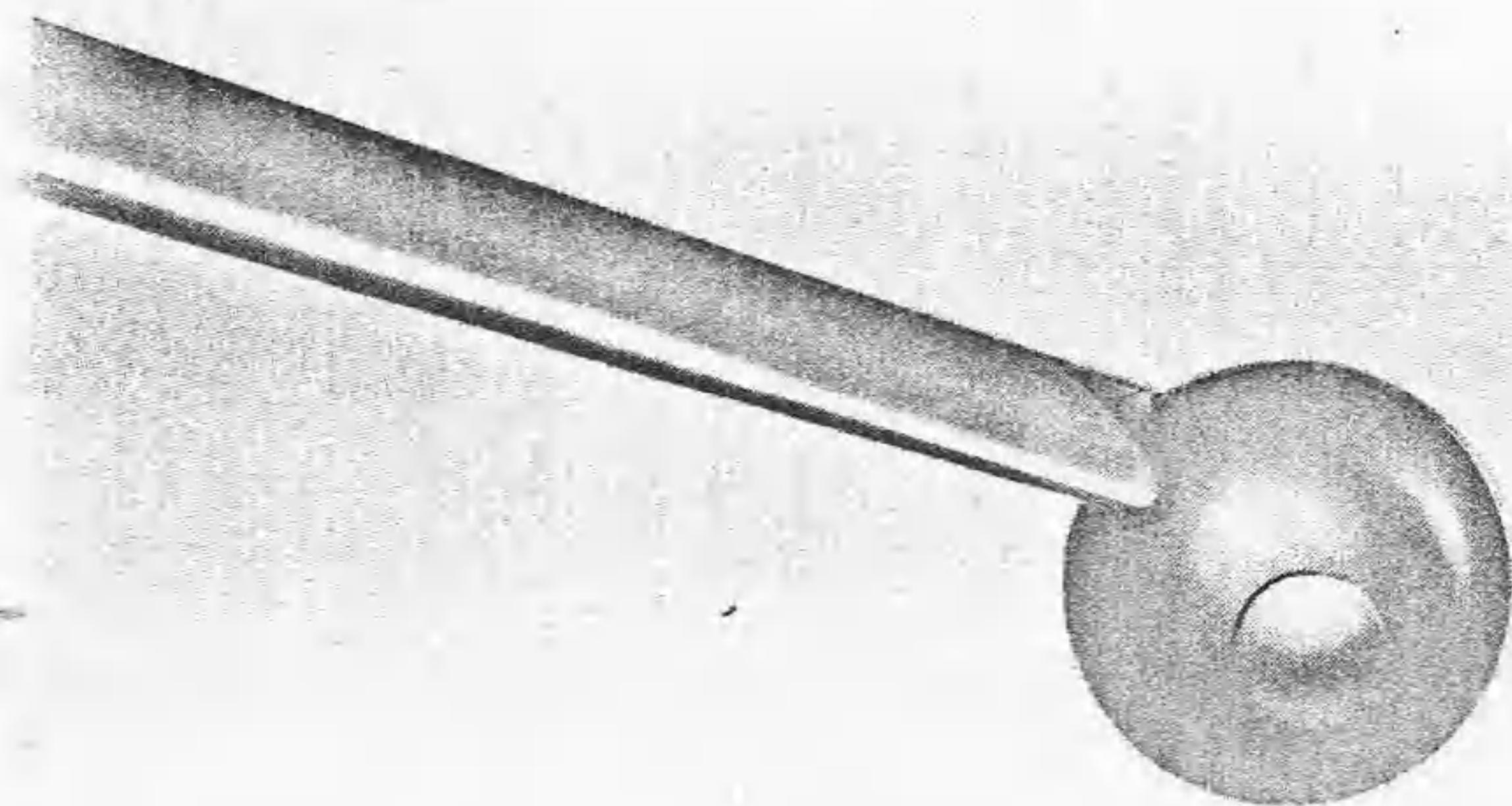

CONFIDENTIAL

McDonnell F2H BANSHEE

Strike

The dotted lines on this chart show the BANSHEE'S striking radius of action when used as an independent offensive weapon for strafing, rocket launching, etc.

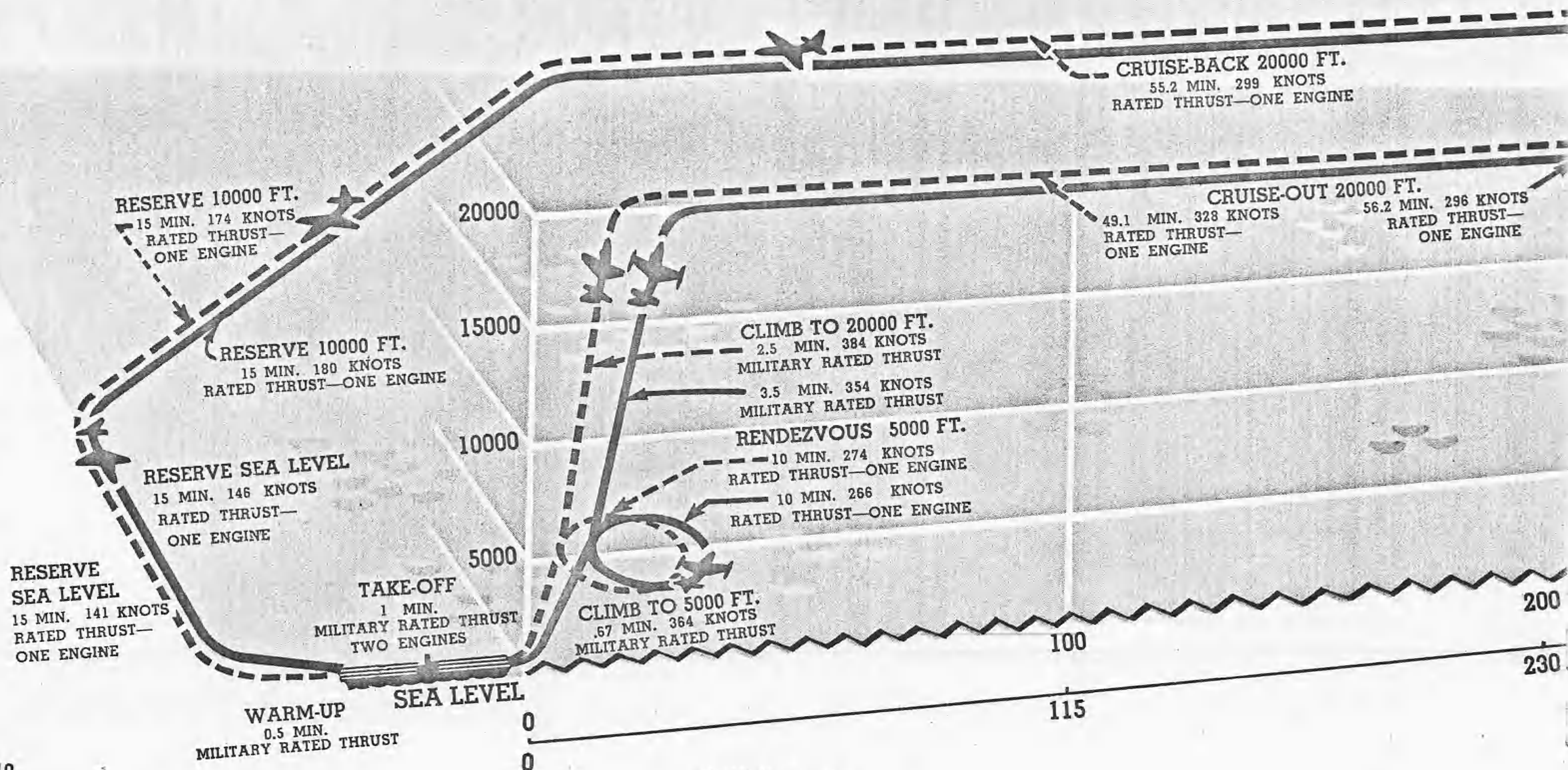

Radius of Action

Escort

The solid lines on the chart show the BANSHEE'S routine radius of action. This airplane can provide spot air defense for striking groups up to a distance of 500 n. mi. (575 stat. mi.) from point of take-off. At this distance the BANSHEE can meet enemy fighters on equal or better than equal terms.

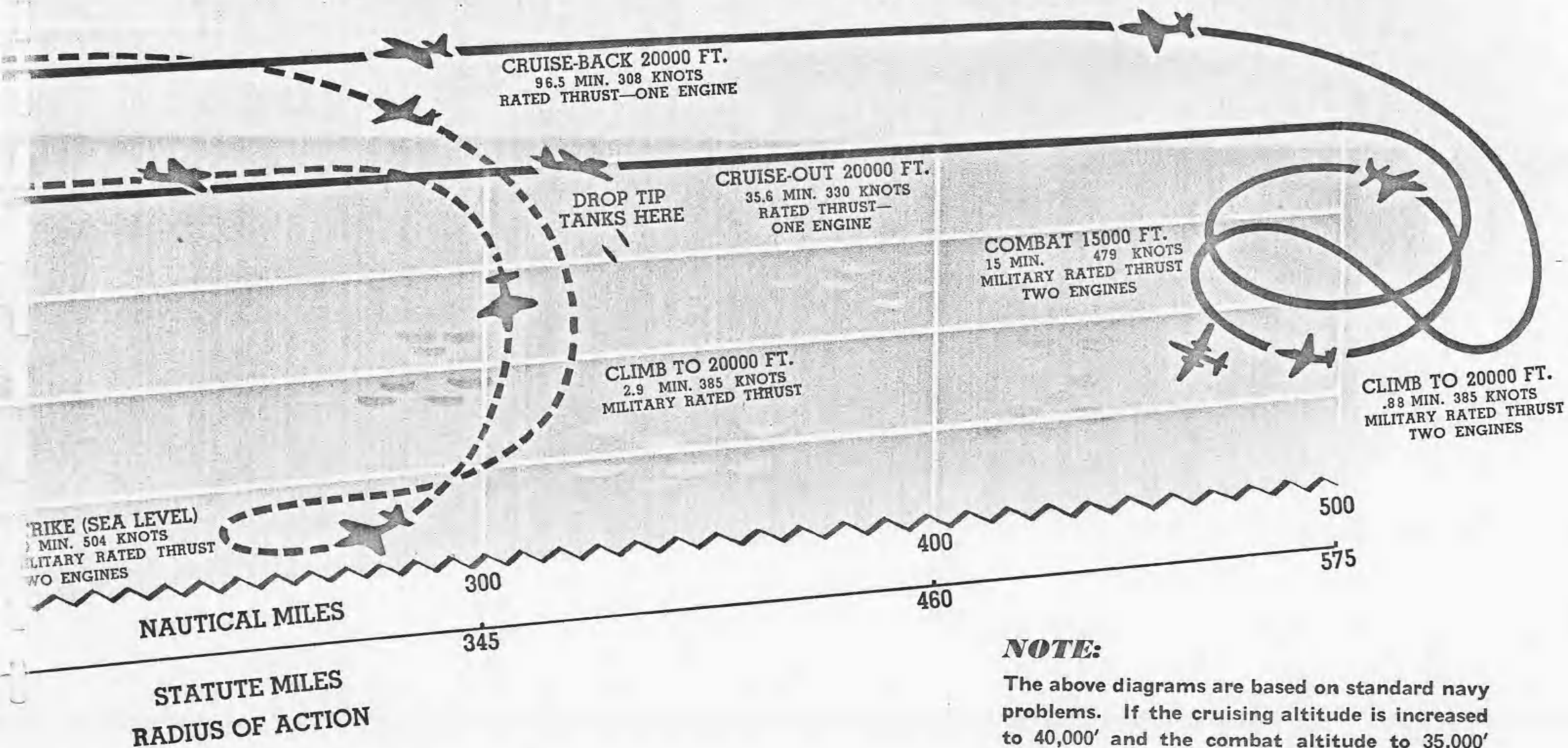

NOTE:

The above diagrams are based on standard navy problems. If the cruising altitude is increased to 40,000' and the combat altitude to 35,000' (the F-5 problem), the escort radius is increased to 628 n.mi. (723 stat. mi.).

Mc DONNELL F2H BANSHEE ▲ ▲ ▲

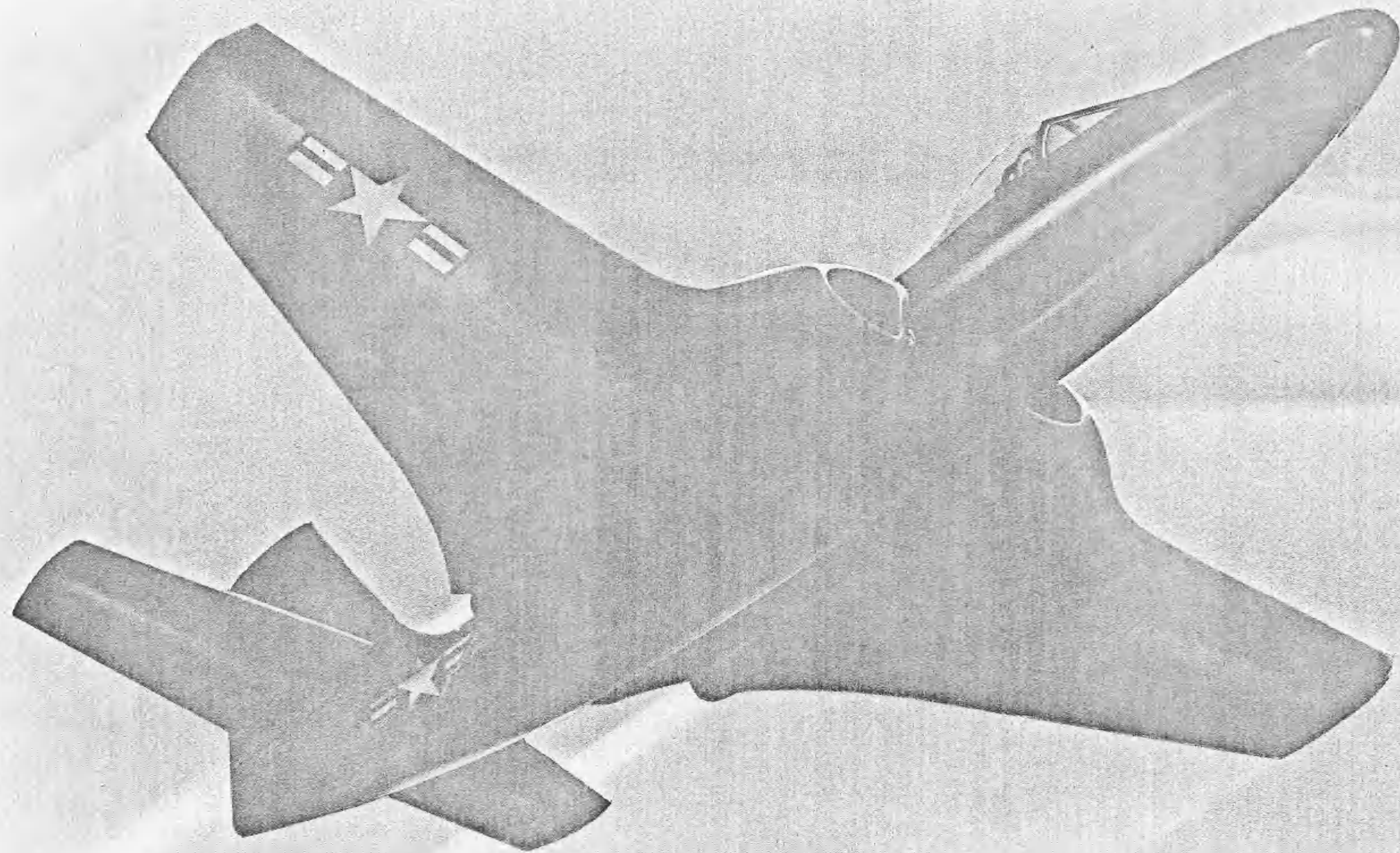

Designed for Fleet Defense

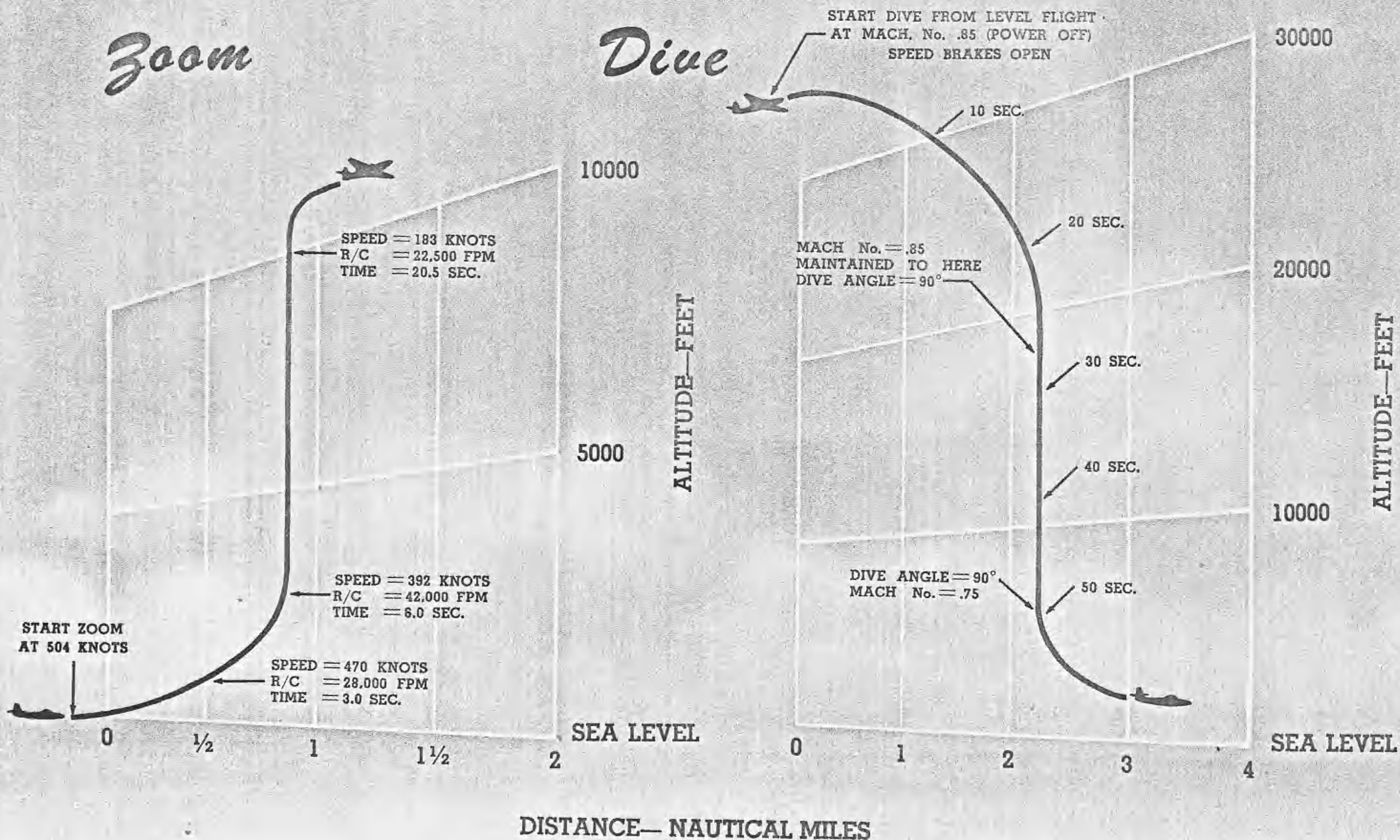

Mc DONNELL F2H BANSHEE ▲ ▲ ▲

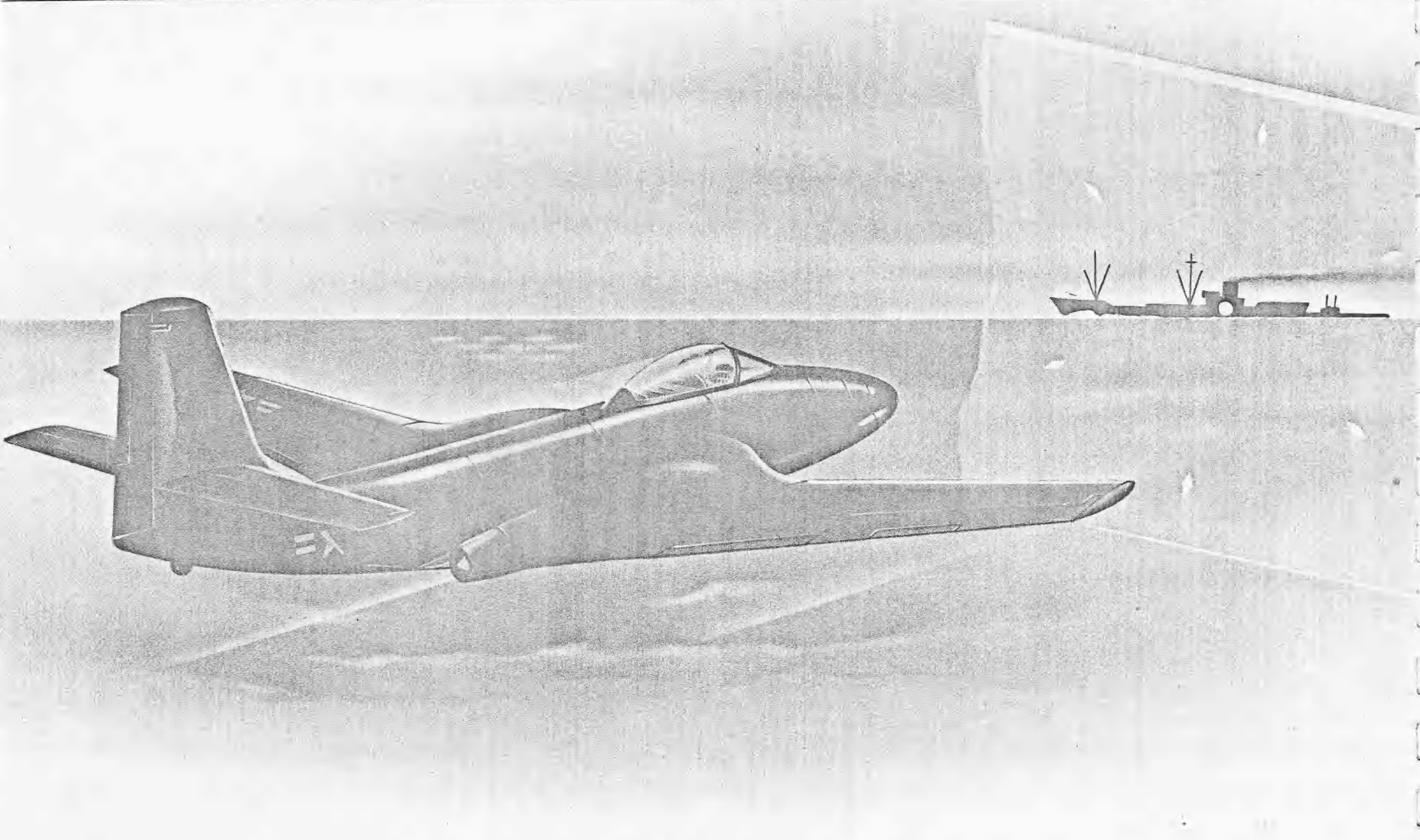

Designed for Attack

Due to its high approach and retirement speeds the BANSHEE makes an excellent auxiliary strike weapon. It is particularly suited to diversionary attacks on light Naval targets even when heavily covered by air defense. Inland targets such as enemy airfields, transport and industry are extremely vulnerable to attack by these airplanes. Twin engine reliability gives the airplane the greatest possible chance of completing its mission and returning safely. Because of its high cruising speeds, many more beachhead attacks can be made, in a given period, than with slower airplanes.

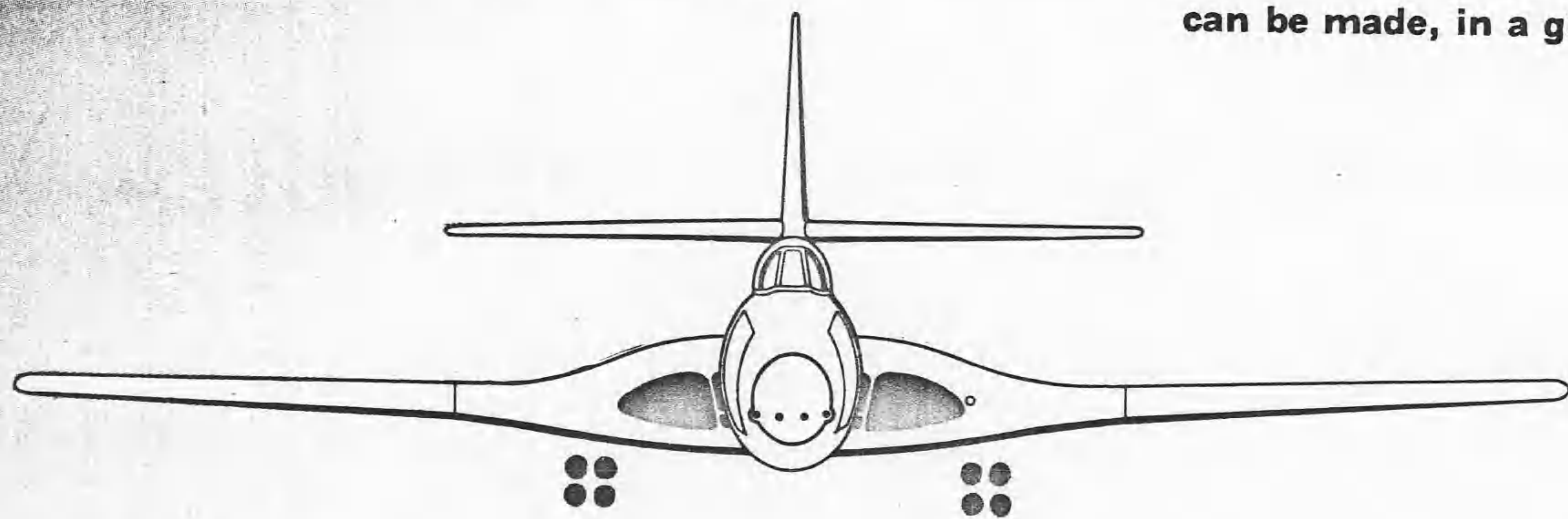

Rocket mounts can be added. Space is available for carrying Eight 5.0" rockets

OR

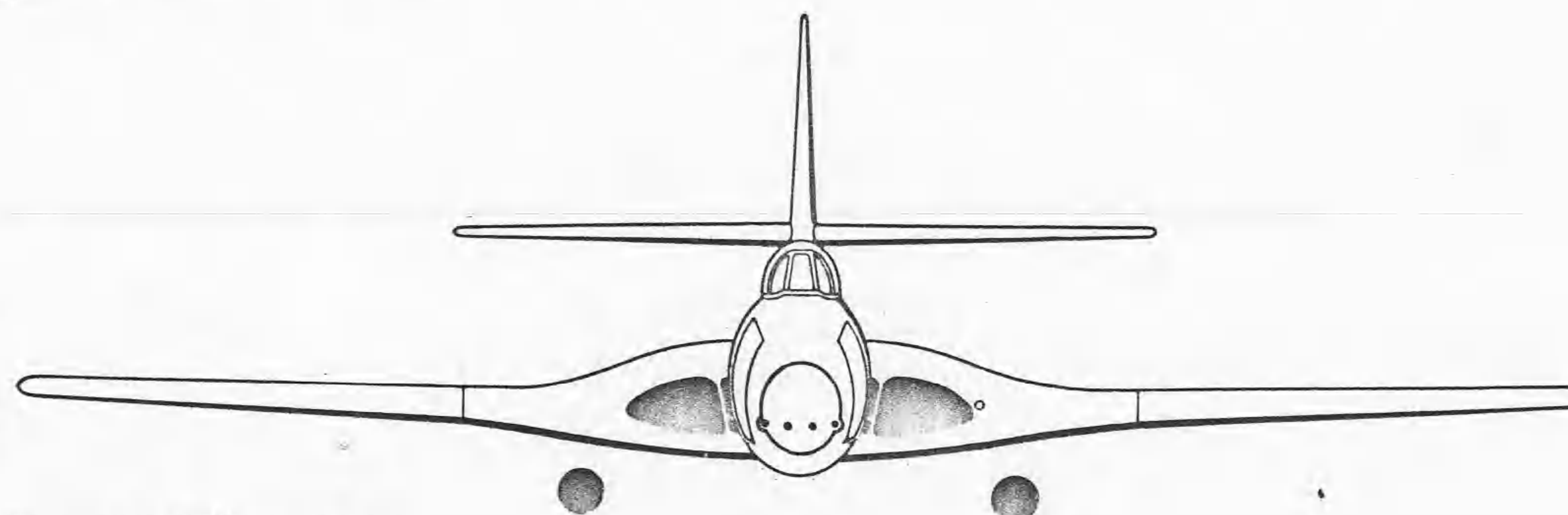

Two 11.75" rockets.

Mc DONNELL F2H BANSHEE



Designed for Darkness

The versatility of the BANSHEE is apparent in this design modification which installs radar equipment required for night and bad weather operations. The scanner is located in the unobstructed nose compartment, which retains its usual complement of armament. There is thus provided a high performance fighter combining twin-engine reliability and heavy fire power which IS CAPABLE OF CARRYING OUT ITS MISSION ON AN ALL-WEATHER, ROUND-THE-CLOCK BASIS. The need of air strategists for a fighter which can operate at night or "in the soup" without sacrifice in performance is thus fulfilled.

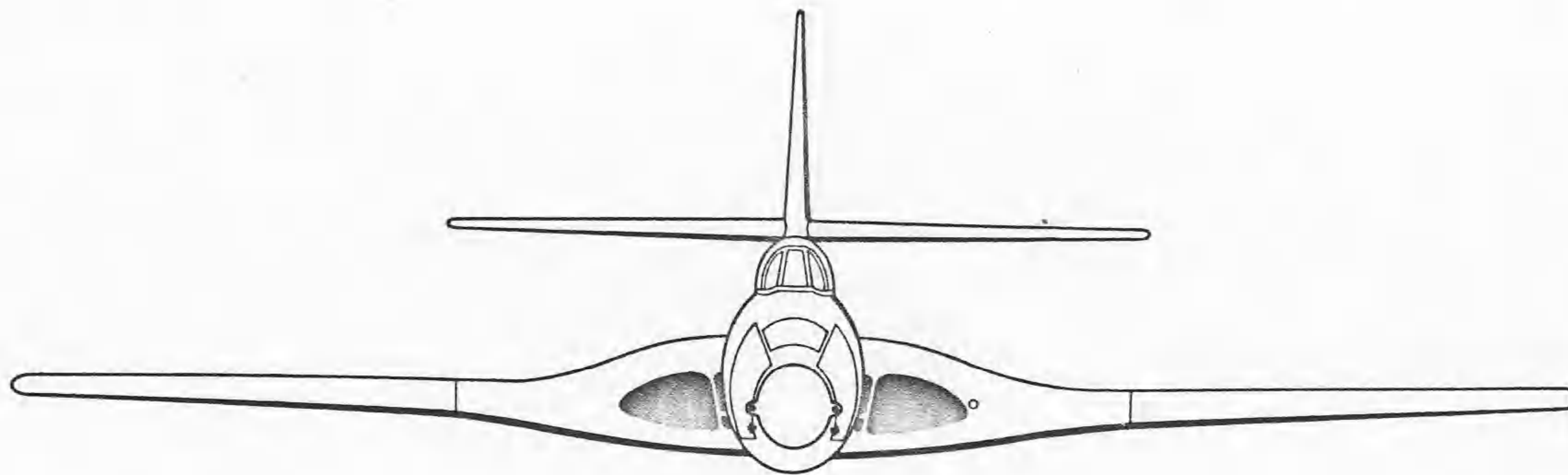

Mc DONNELL F2H BANSHEE

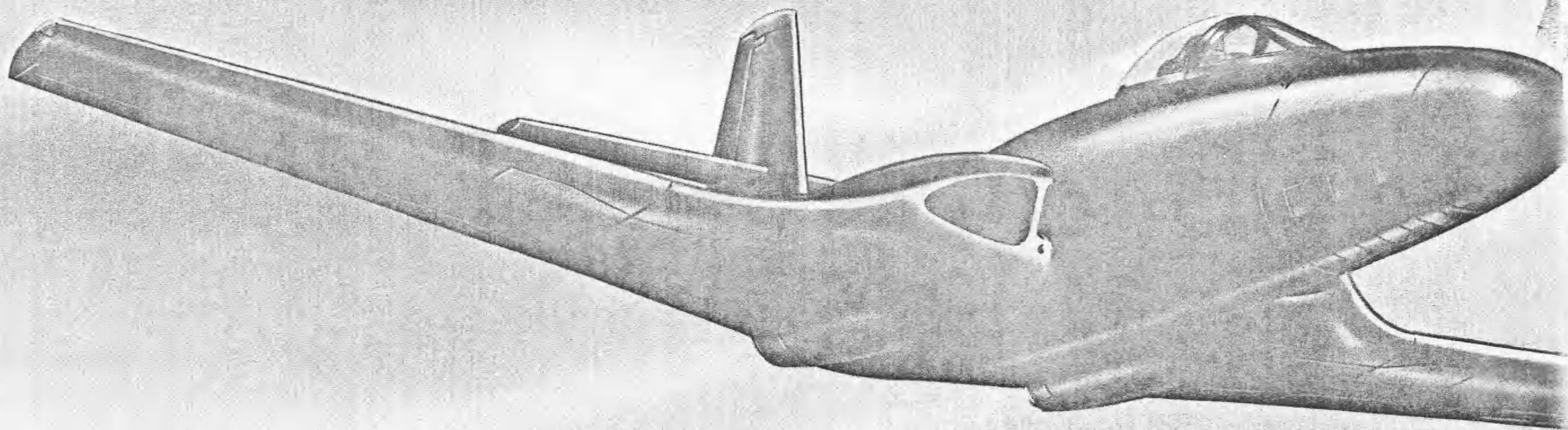

Designed for Air Intelligence

By installing a special-purpose, replaceable nose, quickly attached by bolts, the BANSHEE can be converted into a high or low flying photographic airplane. The BANSHEE in this configuration can streak out to an objective at 456 knots at 10,000'; obtain photographs and return in a minimum of time. With present print developing facilities, photographic intelligence can thus be available to tactical planners while the information is still "hot".

Three basic camera arrangements are listed. Additional versions are possible as combinations of these.



VERSION I Three K-17 cameras, using A-5 or A-7 magazines. Each on rotatable mount, controllable through five positions. 6", 12" and 24" lens cones.

VERSION II K-18 camera, 24" lens cone, with A-8 or A-9 magazine, on rotatable mount, controllable through five positions.

VERSION III S-7S continuous strip camera, with stereoscopic lens cone and automatic electronic scanner. A cycloram camera, operating in conjunction with the S-7S, may be installed. Both automatic and manual film synchronization are provided.



McDonnell F2H BANSHEE

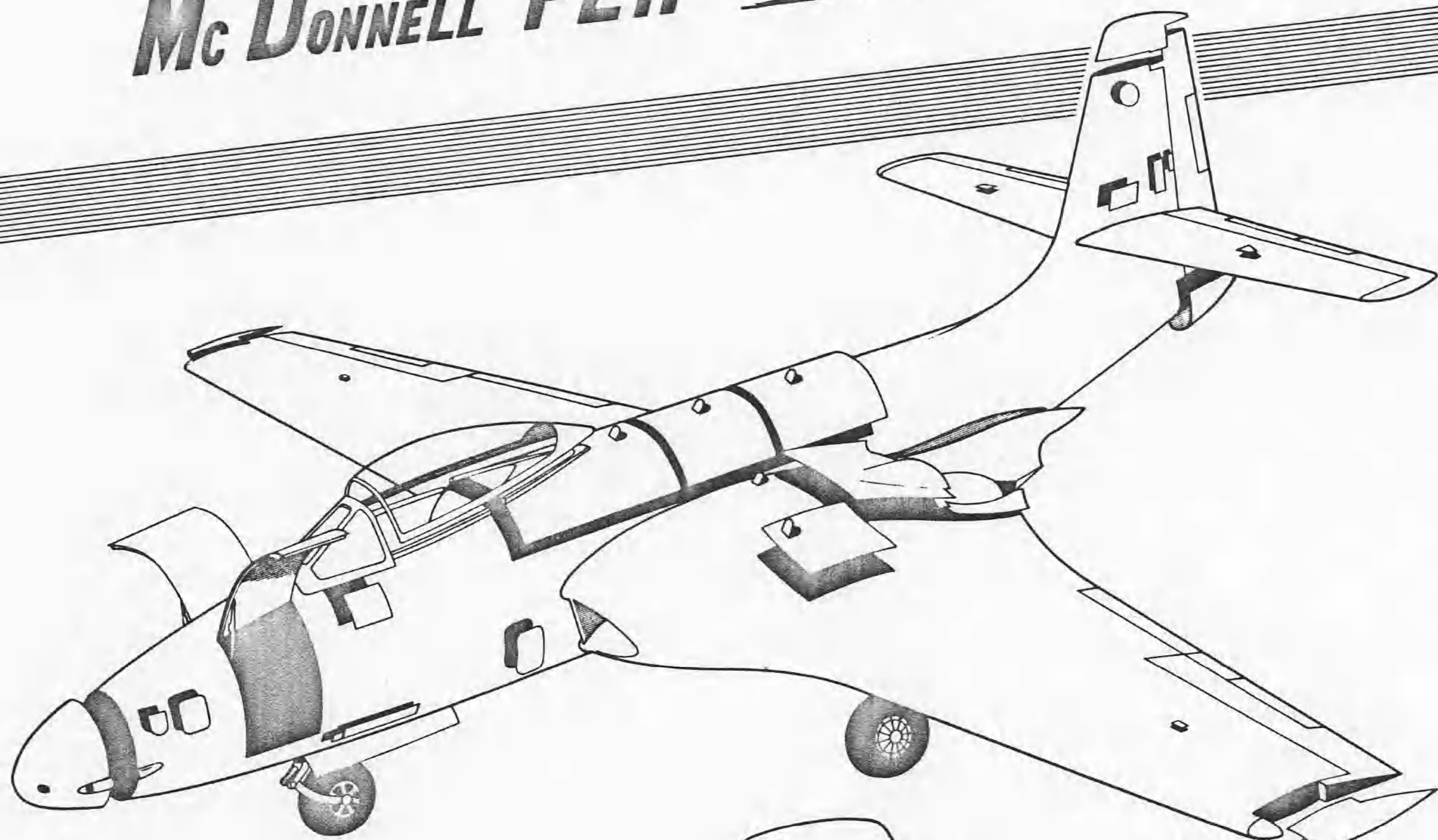

Access

No effort has been spared to provide quick access for routine inspection and adjustments. Wherever possible, quick-opening finger-tip latches are used. The low position of the airplane on the deck makes it possible for maintenance personnel to do most of their work without using cumbersome work stands.

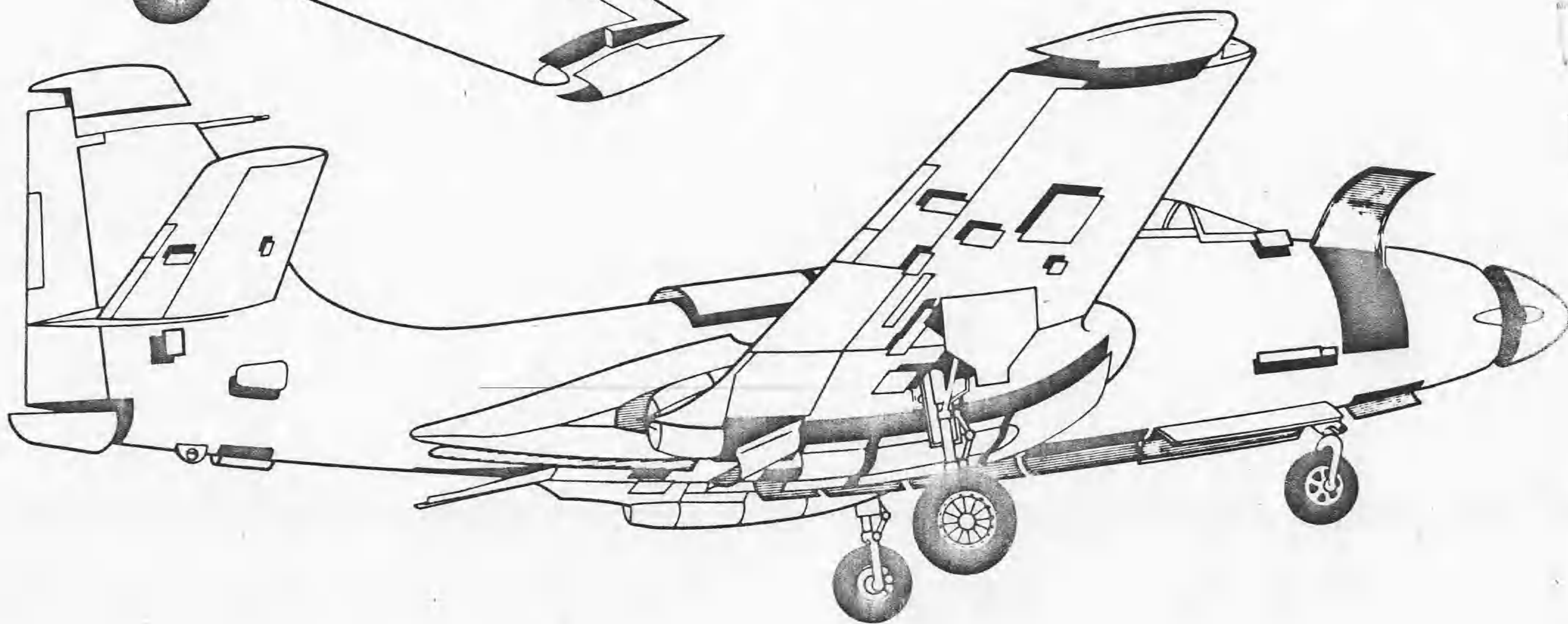

Designed for Maintenance

Armament

Grouped compactly in the nose, the four 20 mm. guns and ammunition containers are available at workbench height for quick rearming. Gun removal and replacement is straight forward through the quickly removable nose. Rearmament time is thus cut to the minimum. All ammunition can be replenished in 6 minutes.

Radio

Many of the items of radio equipment are handily located in the nose compartment just above the guns. This location tends to minimize any interference caused by the engines, and with the nose section removed, easy access is afforded for servicing or replacement at comfortable working heights.

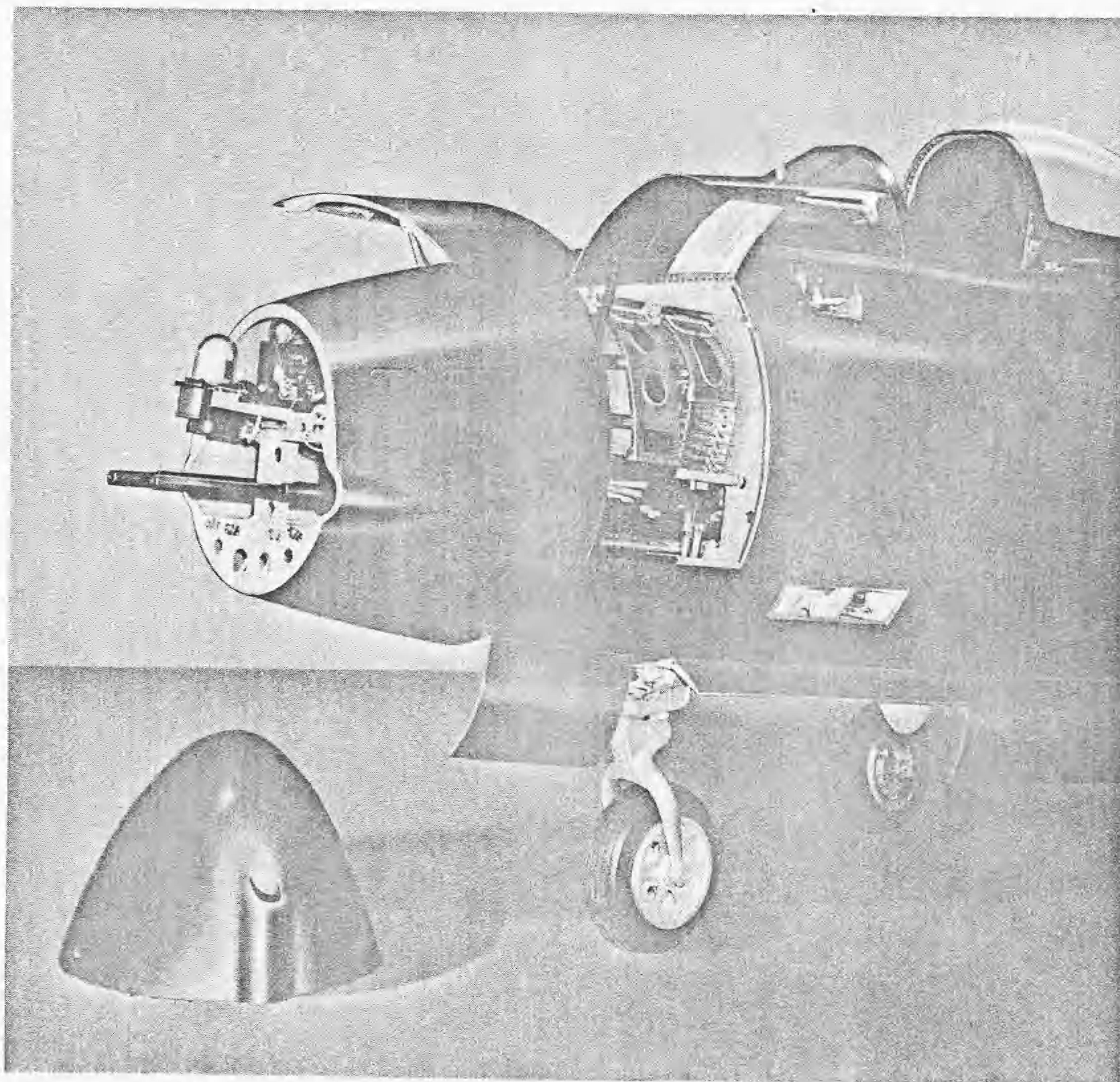

McDONNELL F2H BANSHEE

Removal

Engine removal and replacement is through the trailing edge of the wing root. The entire lower portion of the engine is exposed by quickly removable panels.

20 Minute Change

Both engines can be removed simultaneously so that engine replacement time is the same for one or two engines. Both complete engine assemblies can be removed and replaced in less than 20 minutes.

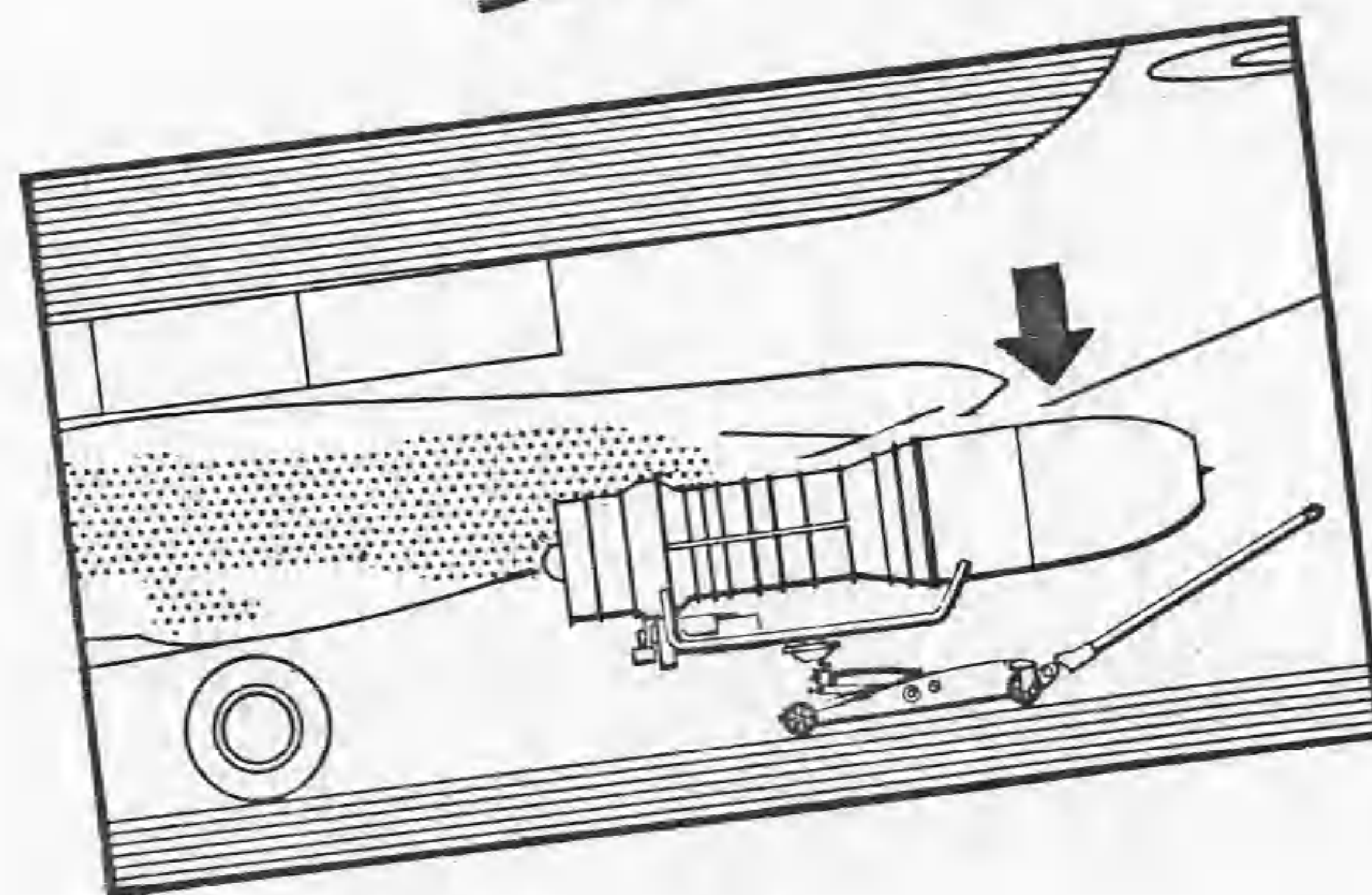
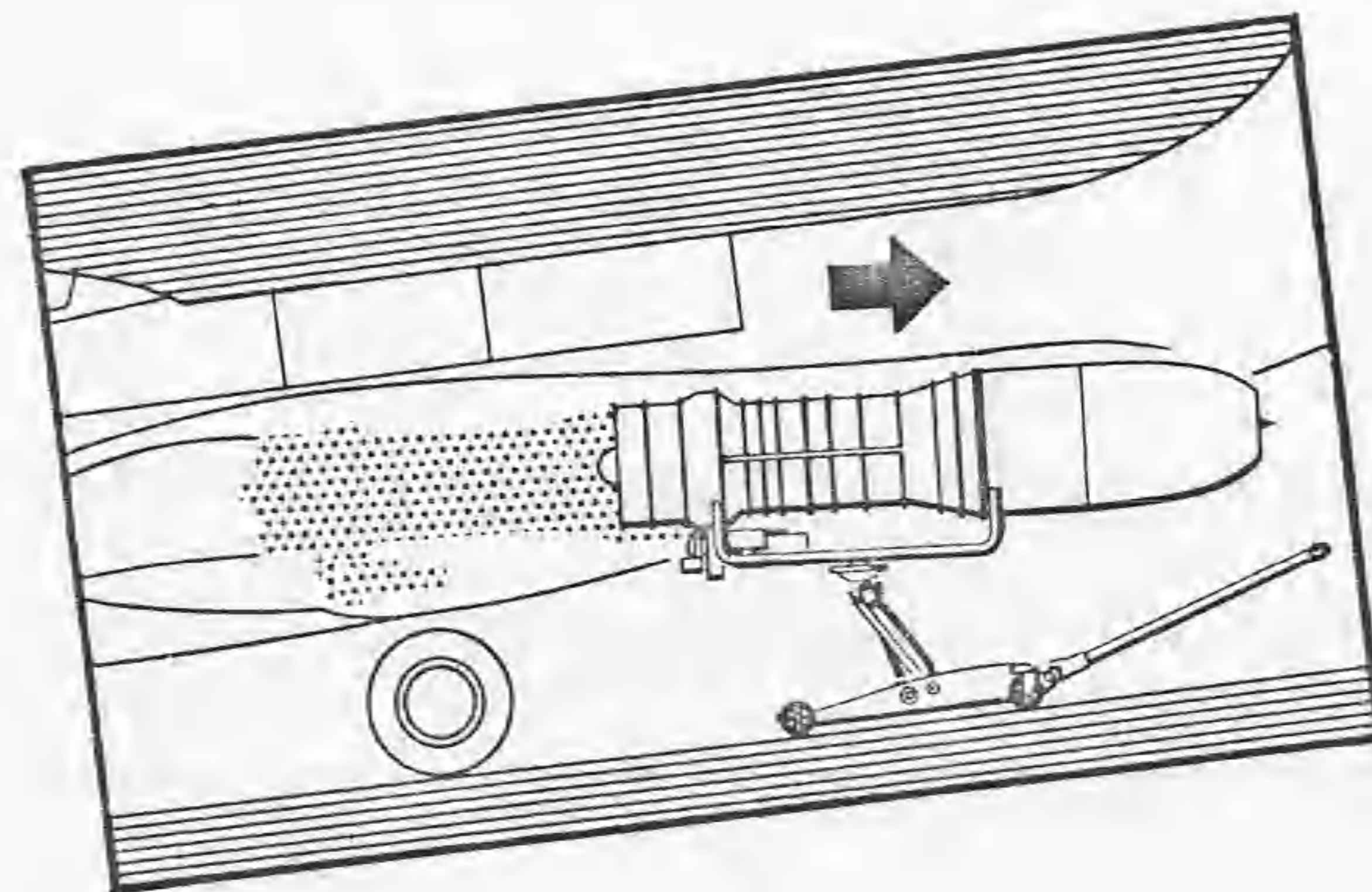
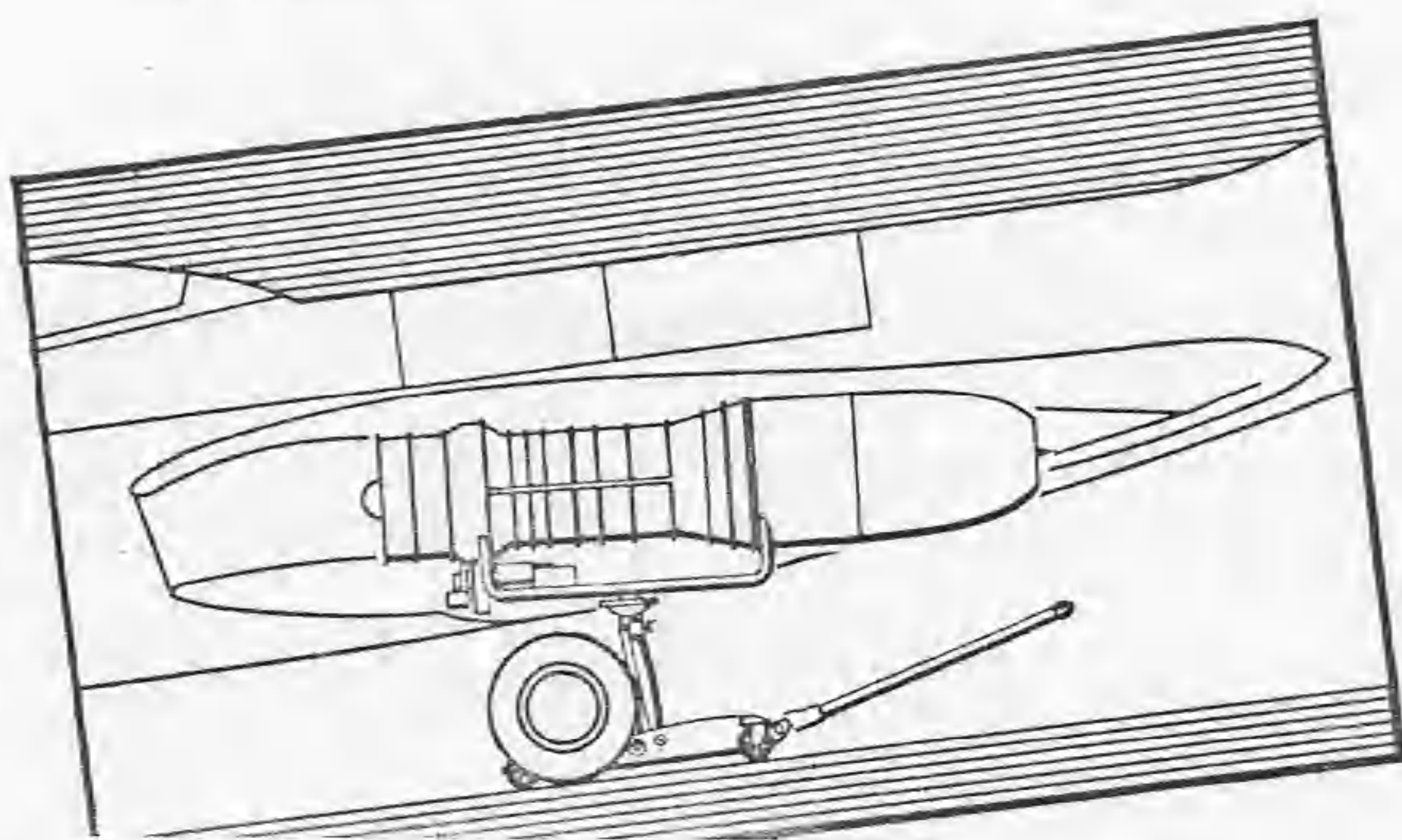
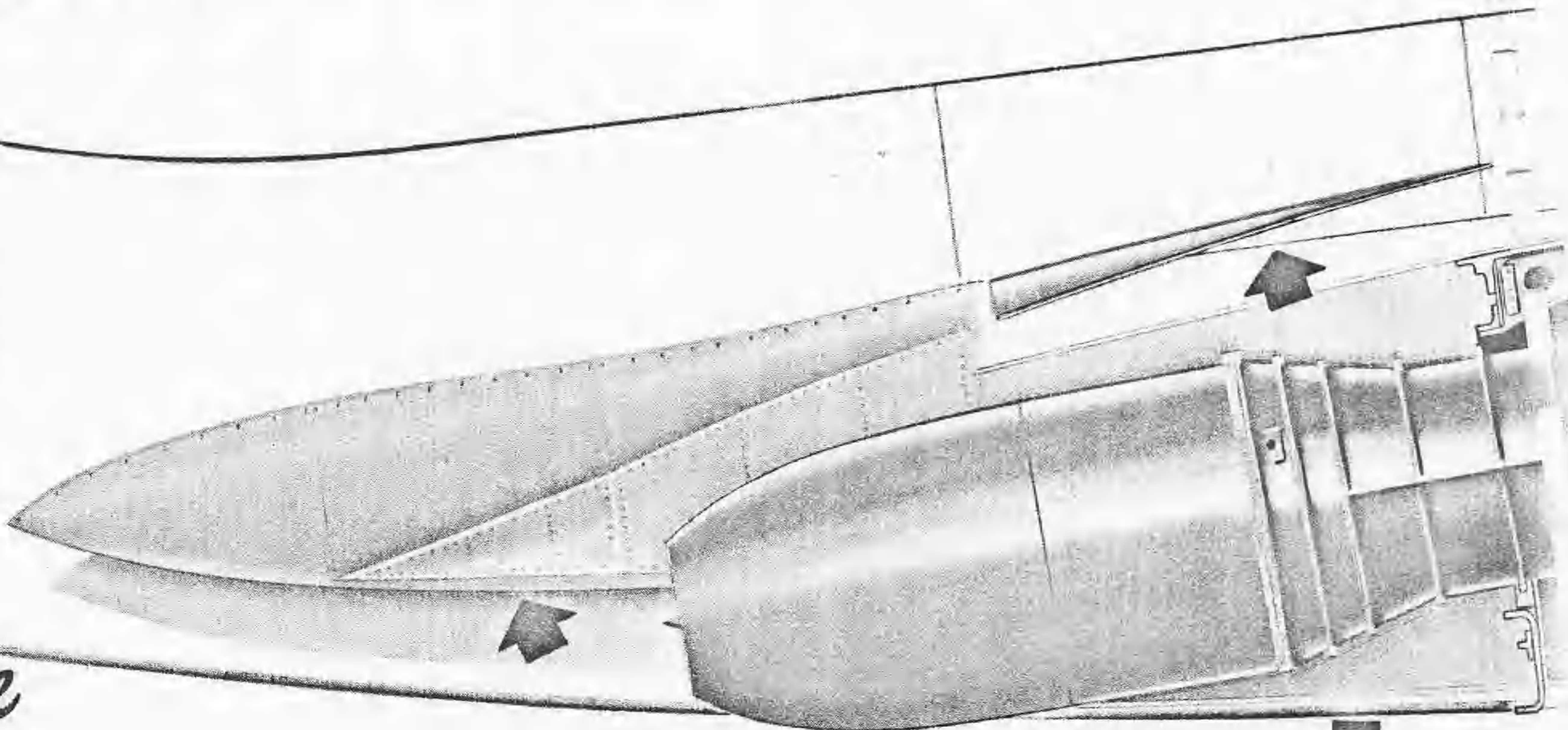

Power Plant

Access

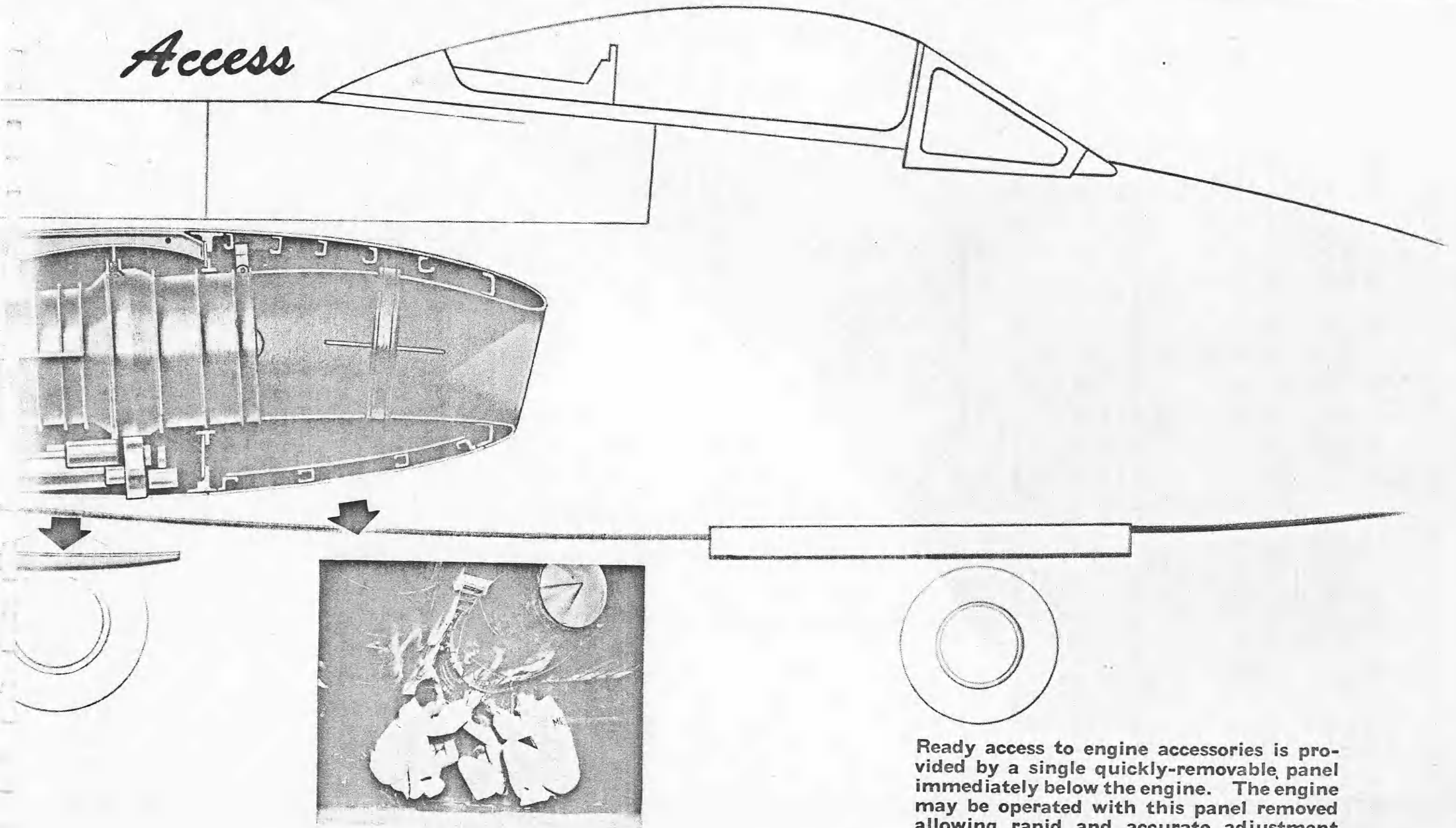

Ready access to engine accessories is provided by a single quickly-removable panel immediately below the engine. The engine may be operated with this panel removed allowing rapid and accurate adjustment of accessories.

Mc DONNELL F2H BANSHEE



Kneeling

—a feature provided in the BANSHEE which substantially improves the all-important deck spotting problems. In a matter of seconds the kneeling dolly can be placed in position and the airplane brought to its kneeled attitude by actuation of a cockpit switch. The airplane can then be readily spotted in the intermeshing fashion that this feature allows. Since the kneeling operation deflects the exhausts upward, it is possible to operate the engines of all the closely packed airplanes.

Wing Folding

—is accomplished electrically by separate actuators in each wing. Safety is provided by manually operated warning flags and safety pins which until withdrawn by the pilot positively prevent actuation of the hinge pins.

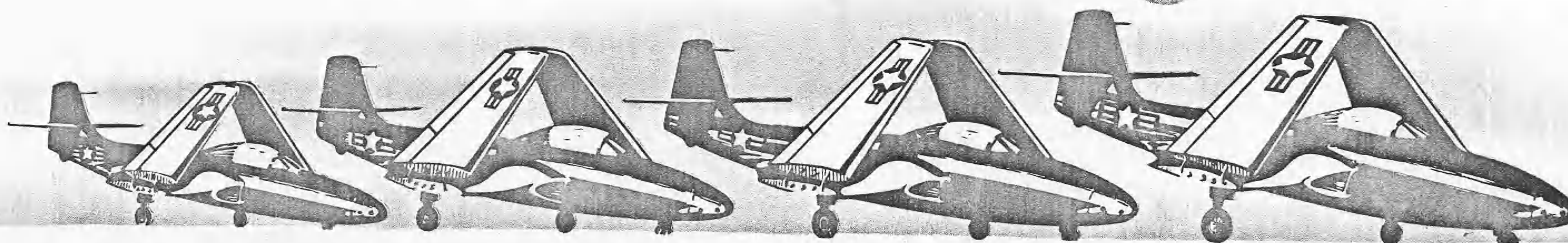

Designed for Seagoing Efficiency

Cable Ejecting Hook

Welcome to operating units is the BANSHEE'S cable ejecting hook which automatically ejects the arresting wire during retraction. Time for retraction is remarkably short. From the time the pilot hits the Hook Handle until the hook is fully retracted, is less than 2 seconds. Since gravity provides the means of lowering the hook reliable operation is assured.

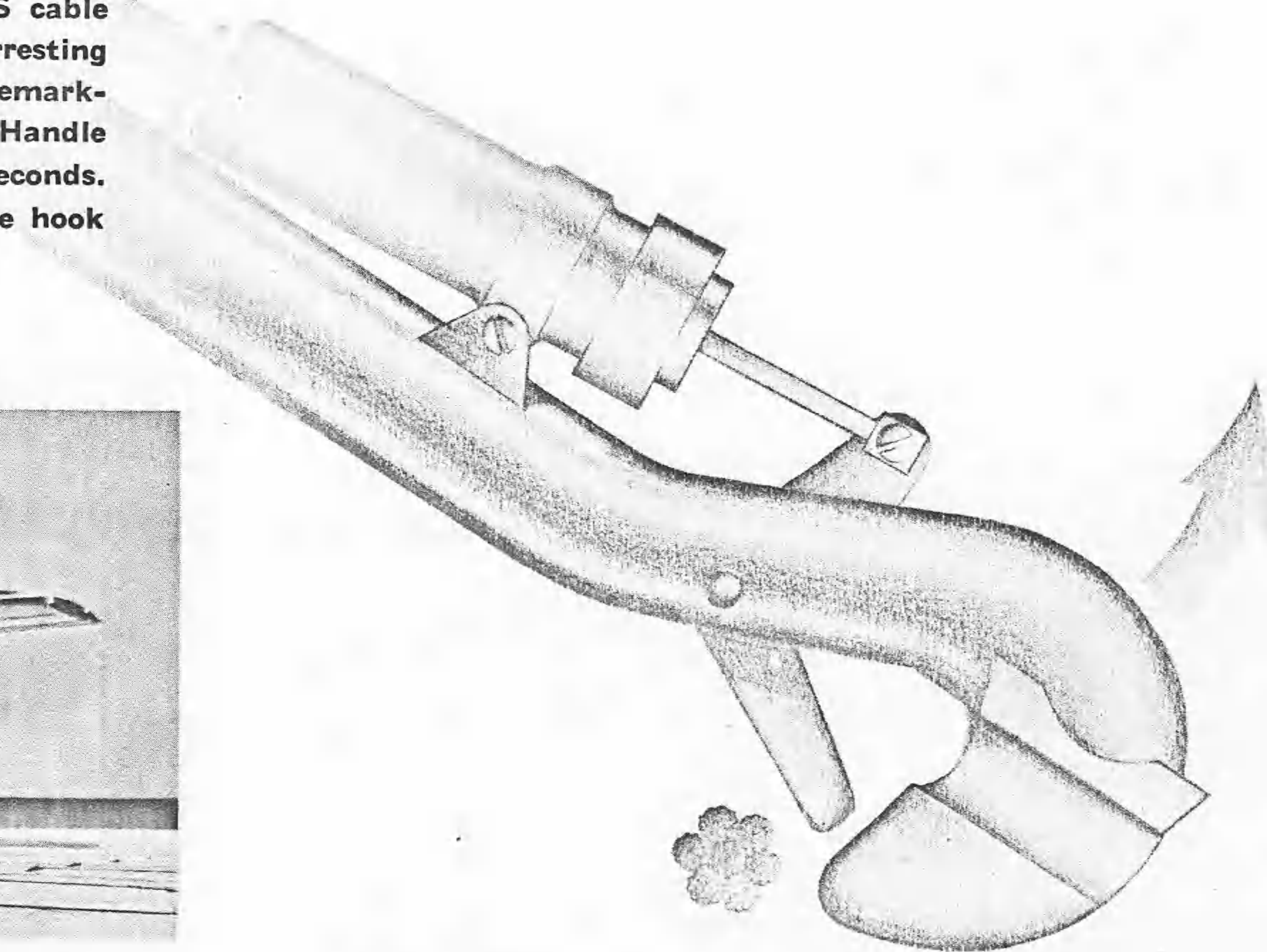
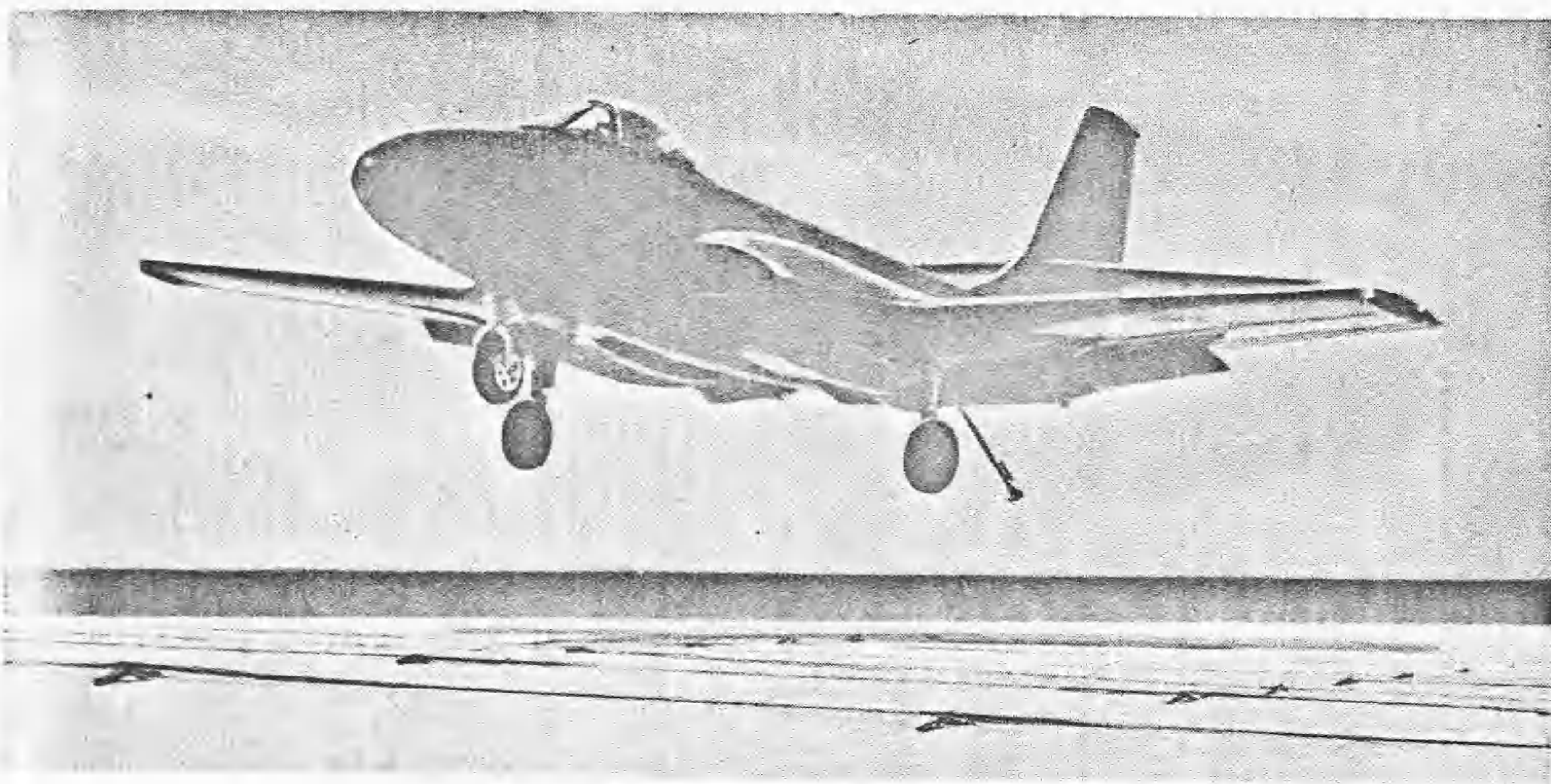

McDonnell F2H BANSHEE

Visibility

Sitting well ahead of the wing, the pilot enjoys a wide field of vision. Angular vision over the nose is 15° at V_{max} and adequate for a full view of the carrier deck during approach and landing.

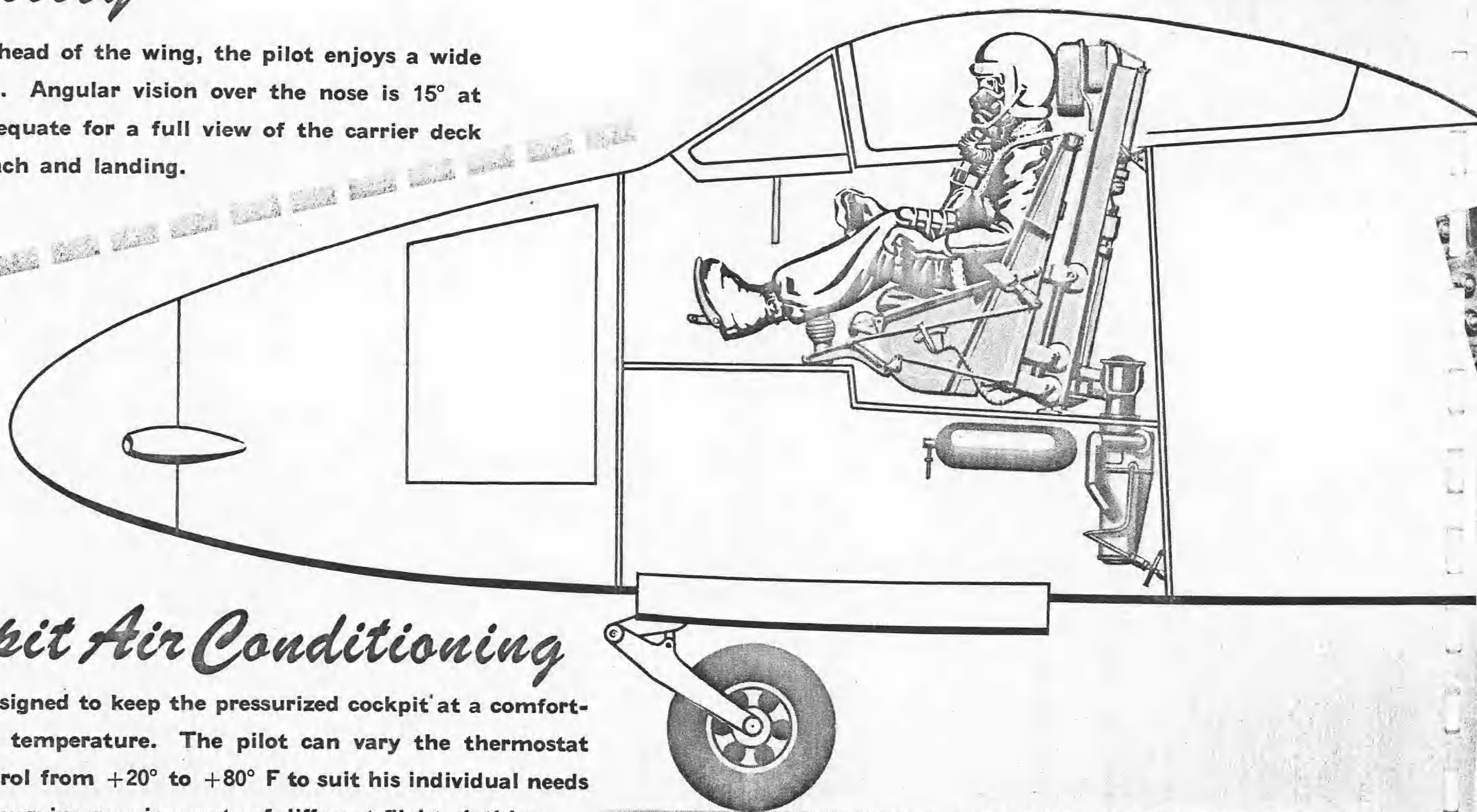

Cockpit Air Conditioning

—designed to keep the pressurized cockpit at a comfortable temperature. The pilot can vary the thermostat control from $+20^\circ$ to $+80^\circ$ F to suit his individual needs and varying requirements of different flight clothing.

Designed for Pilot Efficiency

Power-Operated Canopy

—is controlled by a switch on the left side of the cockpit. Jettisoning and "one shot" manual (emergency) opening are directly aft along the same path used for normal opening.

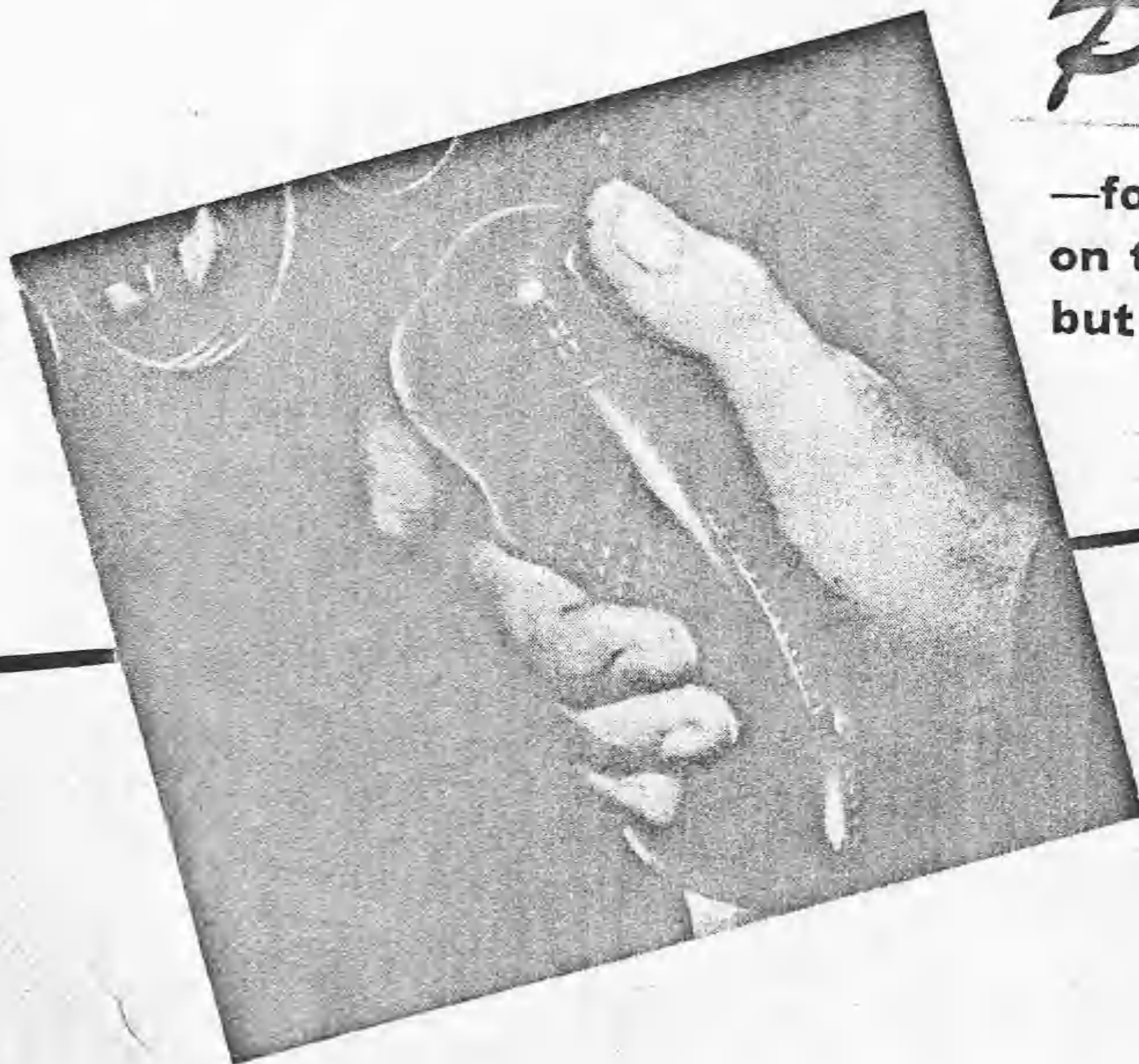
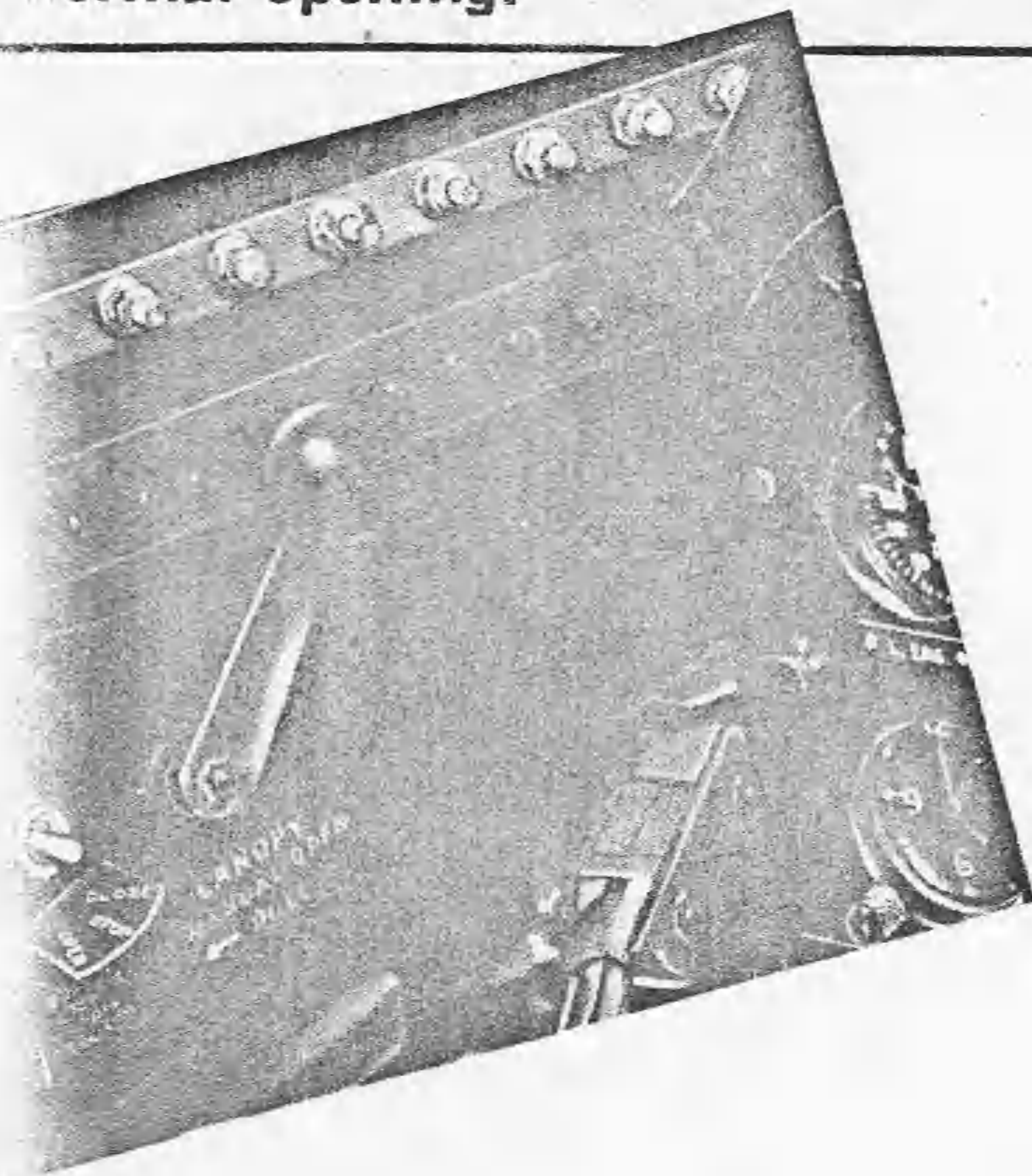

Push Button Trim Tabs

—for aileron and elevator are controlled by a single switch on the stick. The BANSHEE requires little rudder trim, but such as is required is accomplished electrically.

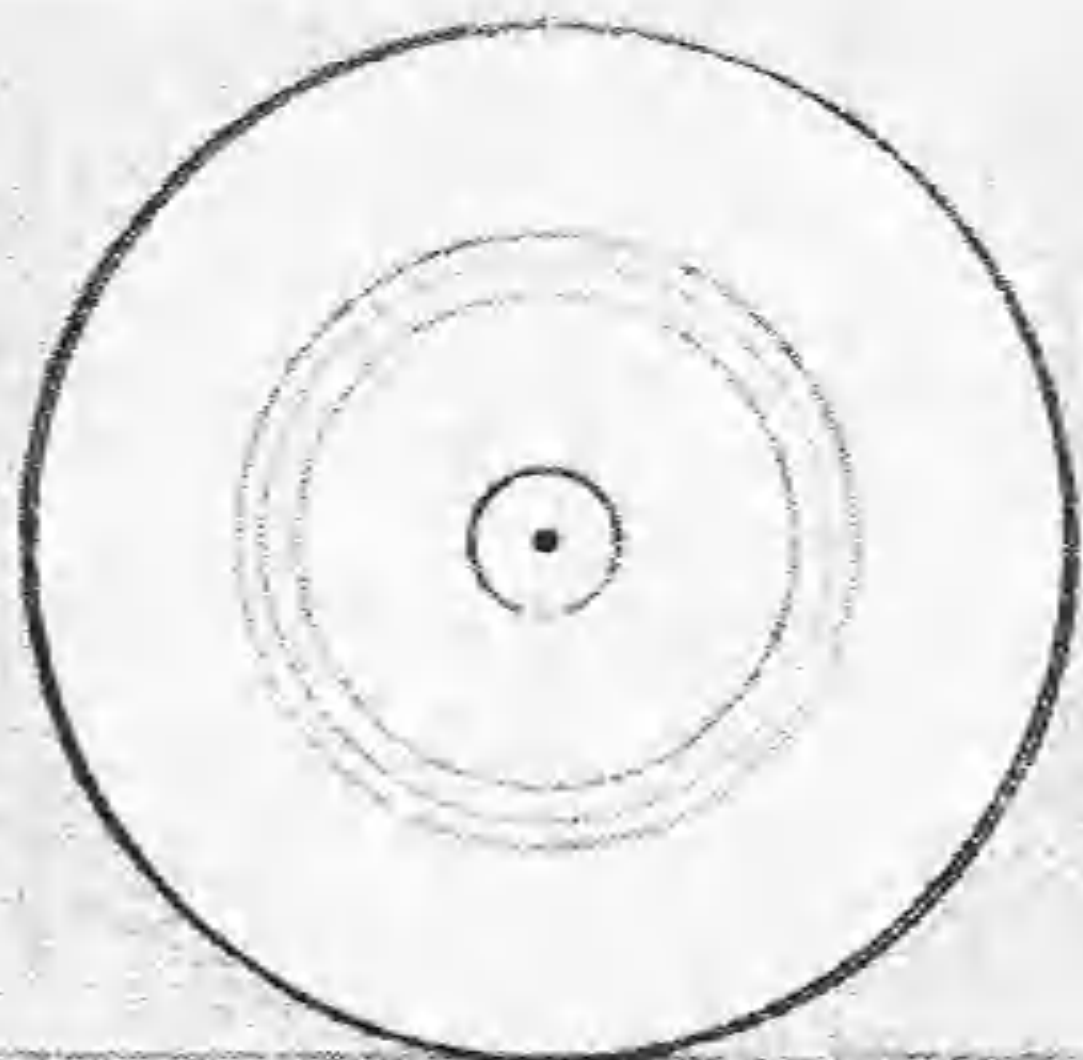

Pilot Ejection

—is provided by a Navy-type pilot ejection seat incorporating a face mask. Normal adjustment of the seat is accomplished by an electric switch on the left console.

McDONNELL F2H BANSHEE



McDONNELL SHORT AFTERBURNER

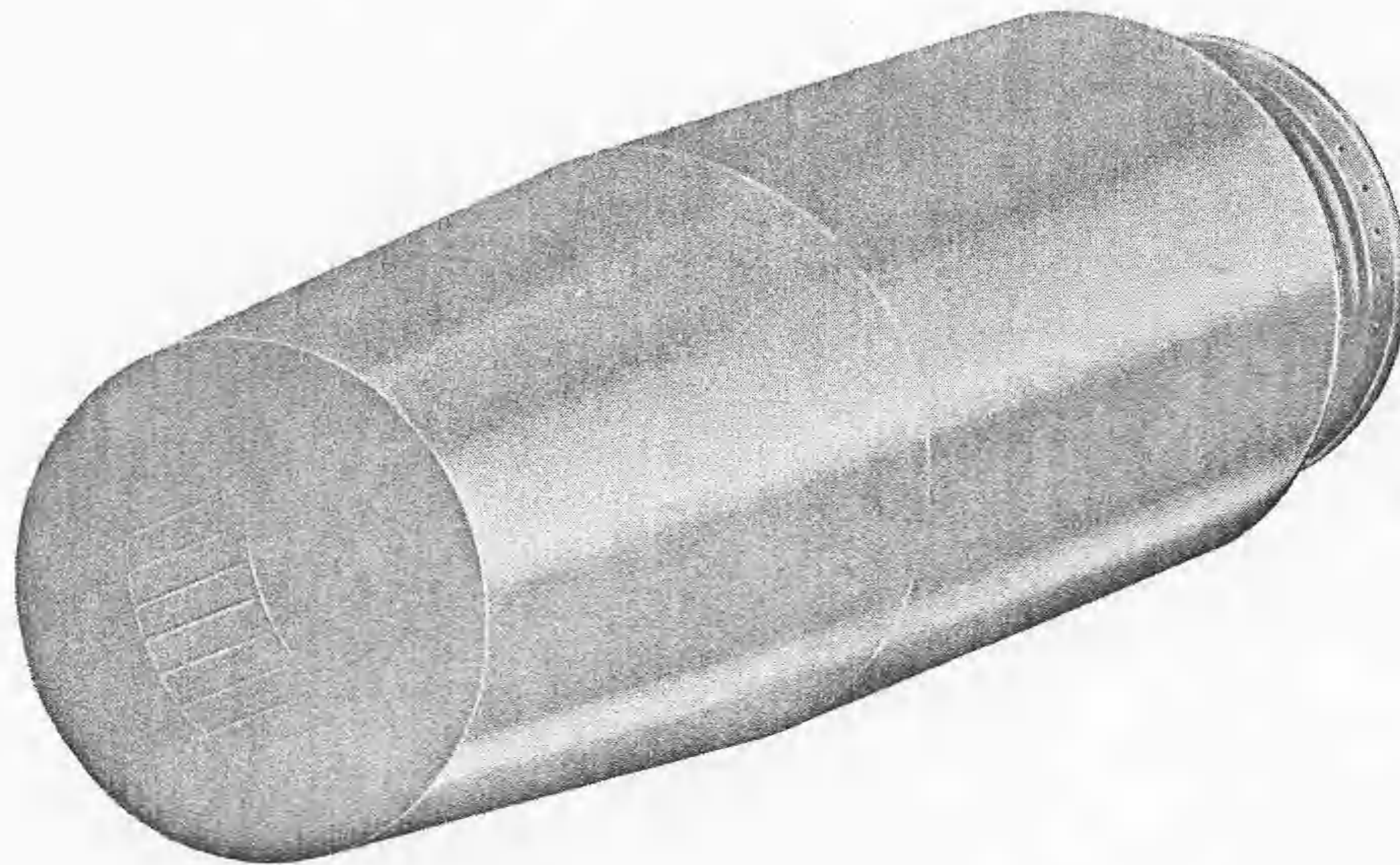

Shown at left is the McDonnell short afterburner which is capable of increasing engine thrust tremendously. The charts at right show the performance of the basic BANSHEE with three different Westinghouse engines installed. The J34-WE-22 engine is installed in the first production BANSHEES.

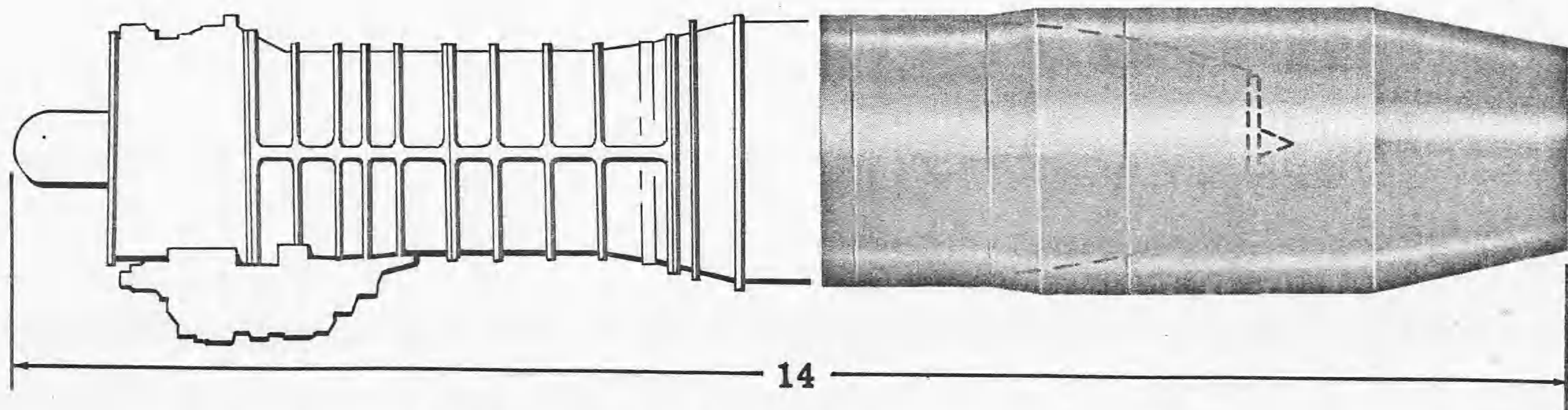

J34-WE-38 ENGINE WITH McDonnell SHORT AFTERBURNER

Designed for Tomorrow's Power

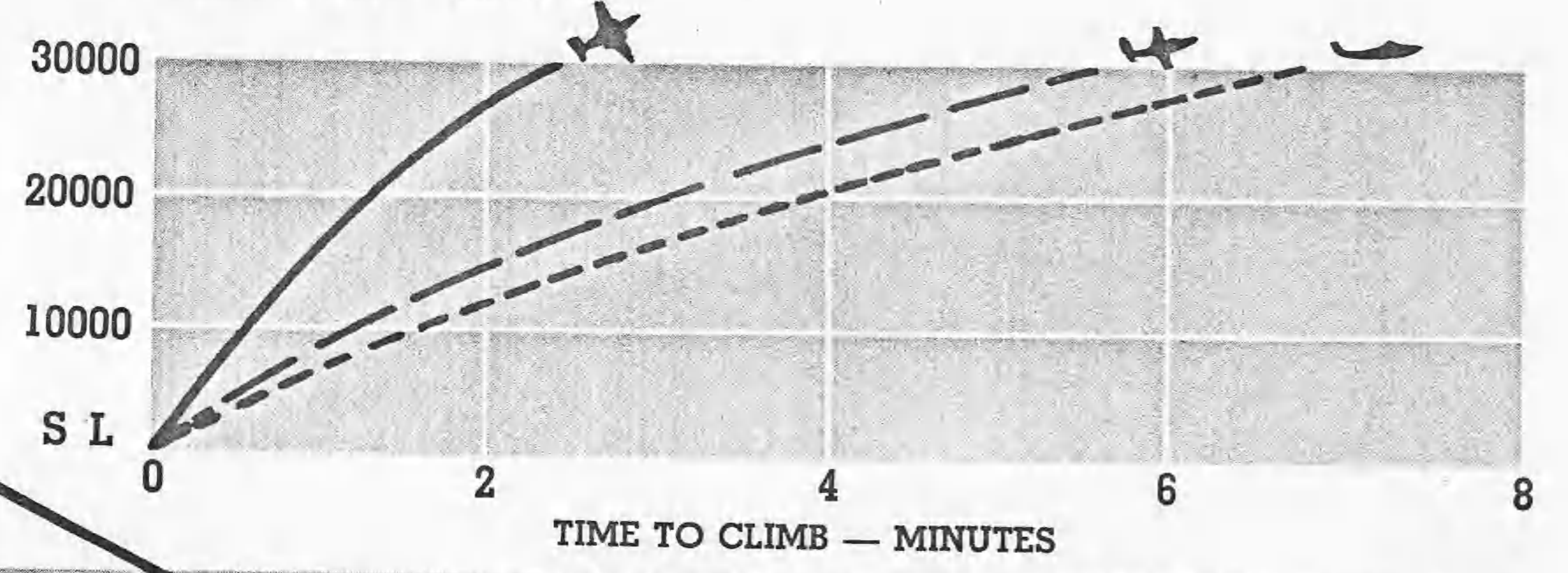
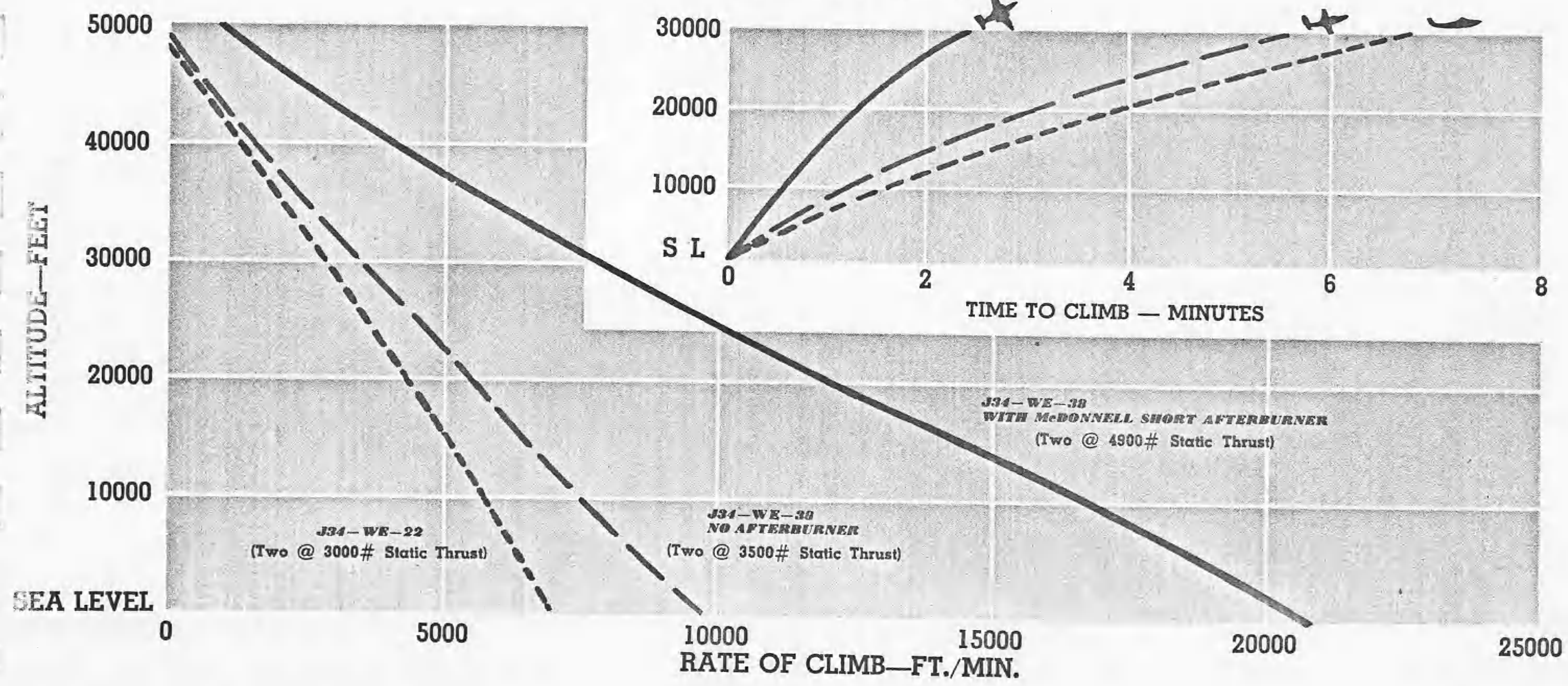
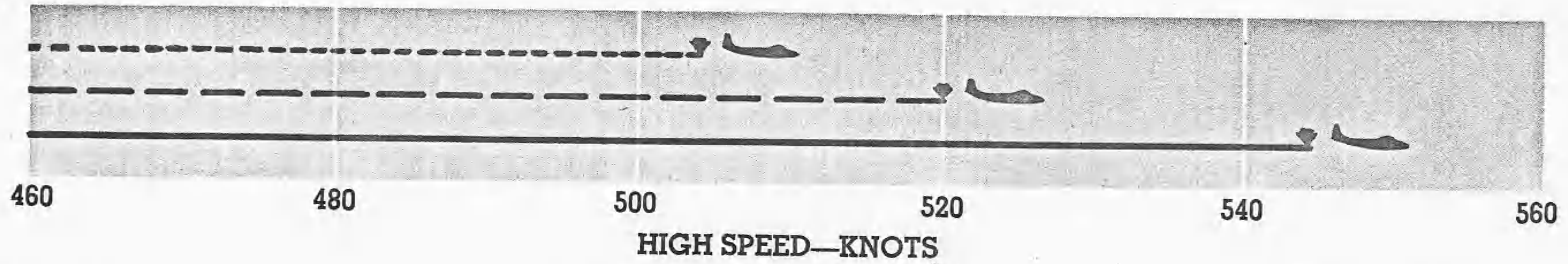

J34-WE-22
(Two @ 3000# Static Thrust)

J34-WE-30
NO AFTERBURNER
(Two @ 3500# Static Thrust)

J34-WE-30
WITH McDONNELL SHORT AFTERBURNER
(Two @ 4900# Static Thrust)

CONFIDENTIAL

MCDONNELL *Aircraft Corporation*



Helicopter Division

Airplane



XHJD-1 UTILITY HELICOPTER

World's first twin-engine helicopter.



LITTLE HENRY

World's first ram-jet helicopter.

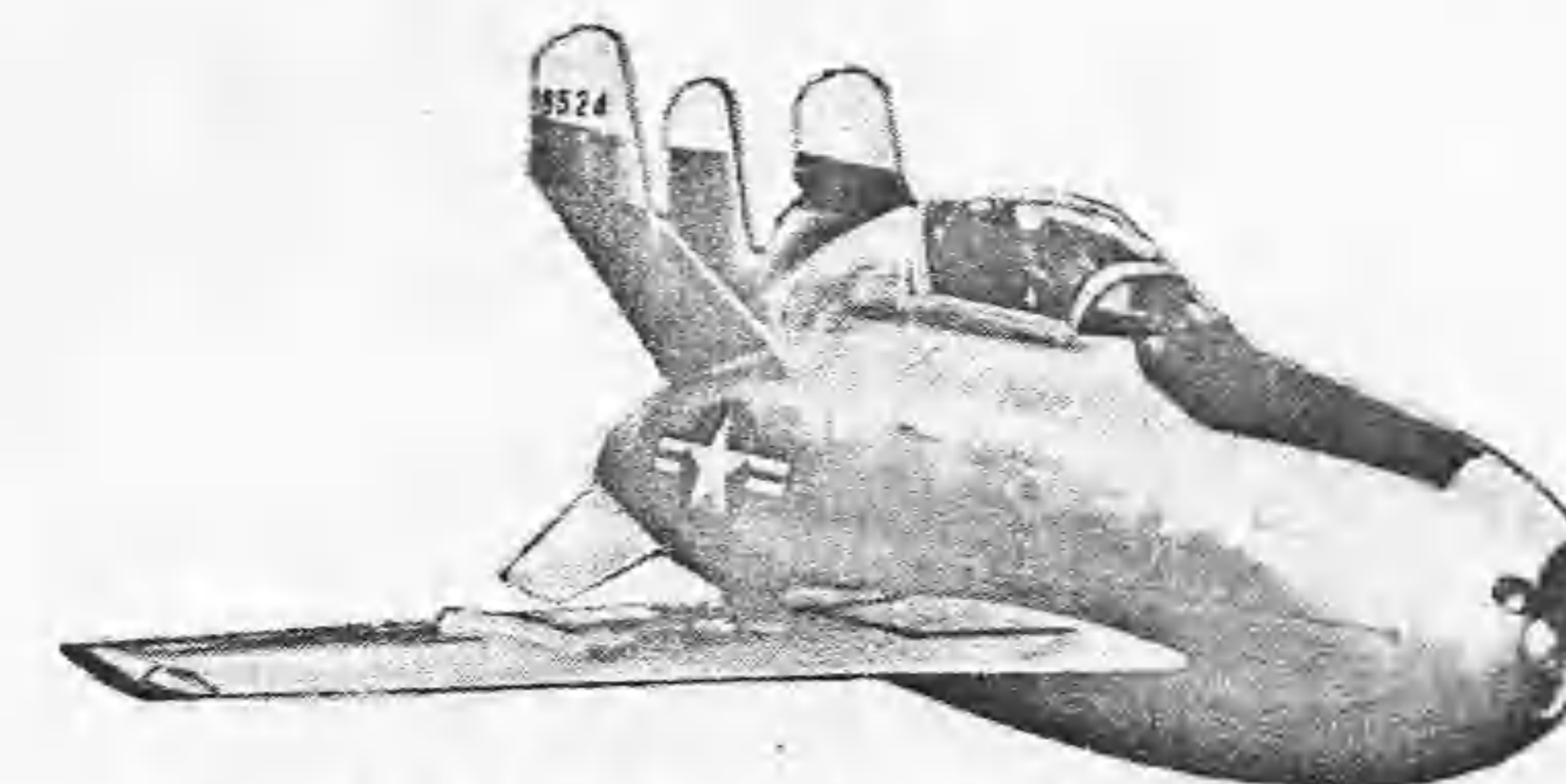

XF-85 PARASITE

Jet fighter protection for large bombers at their maximum radius of action.

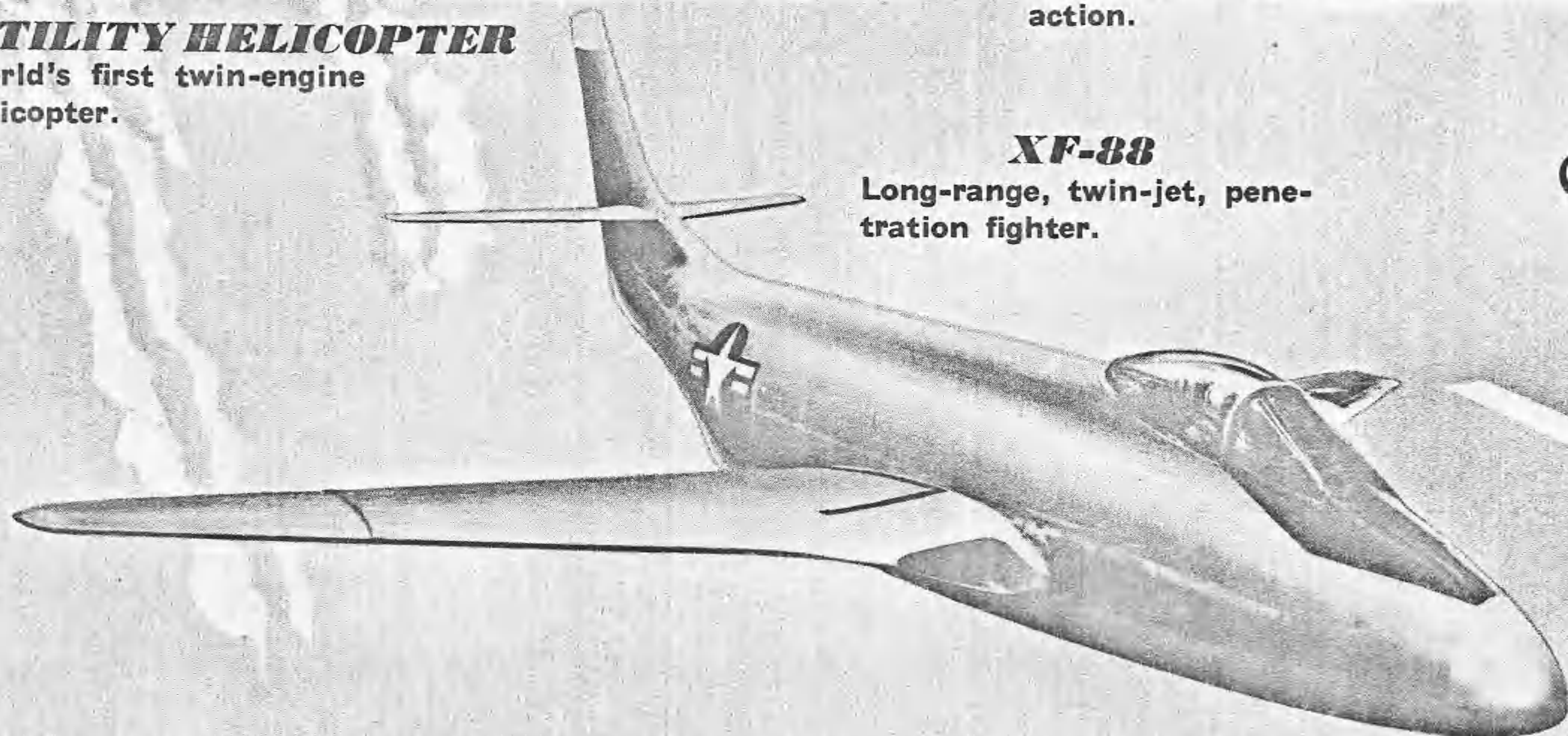

XF-88

Long-range, twin-jet, penetration fighter.

St.

Leaders In Jet Design

Division



FH-1 PHANTOM
Used by the world's first carrier-based jet squadron.

Propulsion Division



PULSE-JETS
8", 11", 14", and 17" diameters.



RAM-JET
For LITTLE HENRY jet helicopter.

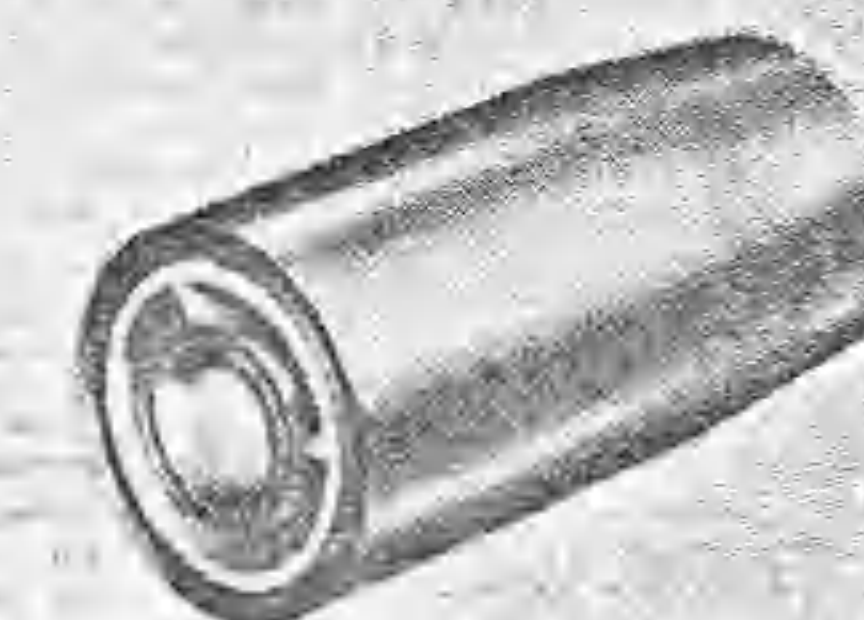

SHORT AFTERBURNER
For turbo-jet engines.

Louis

F2H BANSHEE
Twin-jet, big-brother of the PHANTOM. Production BANSHEES now being delivered for use by fighting squadrons of the fleet.

