

RESTRICTED

AN 01-60AAA-1

Pilot's Handbook
for
AJ-1
AIRCRAFT

This publication supersedes AN 01-60AAA-1 dated 1 March 1949
revised 1 June 1949

PUBLISHED UNDER AUTHORITY OF THE SECRETARY OF THE AIR FORCE
AND THE CHIEF OF THE BUREAU OF AERONAUTICS

NOTICE—This document contains information affecting the national defense of the United States within the meaning of the Espionage Laws, Title 18, U. S. C., 793 and 794. Its transmission or the revelation of its contents in any manner to an unauthorized person is prohibited by law.

RESTRICTED

RESTRICTED

AN 01-60AAA-1

Pilot's Handbook

for

AJ-1

AIRCRAFT



This publication supersedes AN 01-60AAA-1 dated 1 March 1949
revised 1 June 1949

PUBLISHED UNDER AUTHORITY OF THE SECRETARY OF THE AIR FORCE
AND THE CHIEF OF THE BUREAU OF AERONAUTICS

NOTICE—This document contains information affecting the national defense of the United States within the meaning of the Espionage Laws, Title 18, U. S. C., 793 and 794. Its transmission or the revelation of its contents in any manner to an unauthorized person is prohibited by law.

RESTRICTED

1 September 1949

RESTRICTED
AN 01-60AAA-1

Reproduction of the information or illustrations contained in this publication is not permitted without specific approval of the issuing service. The policy for use of Classified Publications is established for the Air Force in AFR 205-1 and for the Navy in Navy Regulations, Article 1509.

LIST OF REVISED PAGES ISSUED

INSERT LATEST REVISED PAGES. DESTROY SUPERSEDED PAGES.

NOTE: The portion of the text affected by the current revision is indicated by a vertical line in the outer margins of the page.

* The asterisk indicates pages revised, added or deleted by the current revision.

ADDITIONAL COPIES OF THIS PUBLICATION MAY BE OBTAINED AS FOLLOWS:

USAF ACTIVITIES.—In accordance with Technical Order No. 00-5-2.

NAVY ACTIVITIES.—Submit request to nearest supply point listed below, using form NavAer-140; NAS, Alameda, Calif.; ASD, Orote, Guam; NAS, Jacksonville, Fla.; NAS, Norfolk, Va.; NASD, Pearl City, Oahu; NASD, Philadelphia, Pa.; NAS, San Diego, Calif.; NAS, Seattle, Wash.

For listing of available material and details of distribution see Naval Aeronautics Publications Index NavAer 00-500.

RESTRICTED

BuAer

TABLE OF CONTENTS

SECTION I	Description	Page
Paragraph		
1-1	Airplane	1
1-11	Reciprocating Engines	1
1-41	Propellers	7
1-51	Turbo-jet Engine	8
1-61	Oil Systems	10
1-74	Fuel Systems	11
1-91	Electrical System	13
1-111	Hydraulic Systems	16
1-125	Flight Controls	20
1-143	Wing Flaps	22
1-148	Automatic Pilot	22
1-157	Landing Gear	23
1-170	Canopy	23
1-177	Arresting Gear Hook	24
1-179	Catapult Equipment	24
1-181	Wing and Vertical Fin Folding	24
1-183	Engine Fire Detector System	26
1-185	Instruments	26
1-190	Miscellaneous Equipment	26
1-215	Operational Equipment	27
SECTION II	Normal Operating Instructions	
2-1	Before Entering Airplane	28
2-7	On Entering Crew Entry Compartment	28
2-8	On Entering Pilot's Compartment	28
2-12	Fuel System Management	29
2-14	Starting Reciprocating Engines	30
2-16	Warm-up and Ground Test - Reciprocating Engines	30
2-22	Starting Jet Engine	31
2-25	Ground Tests - Jet Engine	32
2-27	Taxiing	32
2-28	Before Take-off	32
2-30	Take-off	32
2-35	Climb	34
2-37	During Flight	34
2-47	Stalls	35
2-51	Spins	35
2-53	Diving	35
2-55	Approach	35
2-57	Landing	35
2-61	Stopping Engines	36
SECTION III	Emergency Operating Instructions	
3-1	Fire	37
3-8	Engine Failure	37
3-21	Propeller Emergency Operation	40
3-29	Forced Landing	41
3-31	Emergency Exit	41
3-35	Ditching	42
3-46	Fuel System Emergency Operation	44
3-57	Electrical System Emergency Operation	44
3-66	Jet Air Intake Door Emergency Operation	45
3-68	Surface Control Booster System Emergency Operation	45

Paragraph		Page
3-77	Wing Flap Emergency Operation	46
3-80	Landing Gear Emergency Operation	46
3-83	Wheel Brake Emergency Operation	47
3-85	Arresting Hook Emergency Operation	47
3-87	Bomb Bay Door Emergency Operation	47
3-90	Sliding Canopy Emergency Operation	47
3-93	Exit Door Emergency Operation	48
3-95	Filling Hydraulic Reservoirs in Flight	48
3-97	Oxygen System Emergency Operation	48
3-99	Cabin Pressurization and Heating Emergency Operation	48
3-105	Automatic Pilot Emergency Release	49
3-110	IFF Radio Emergency Operation	49
SECTION IV	Operational Equipment	
4-1	Bombing Equipment	50
4-16	Oxygen System	52
4-28	Communications and Associated Electronic Equipment	54
4-68	Cabin Heating, Ventilating and Pressurization	61
4-86	Heated Clothing	63
4-88	Pitot Heater	63
4-90	Lighting Equipment	63
APPENDIX		
A-1	Airspeed Correction Tables	64

LIST OF ILLUSTRATIONS

SECTION I
DESCRIPTION

Fig.		Page
1-1	AJ-1 Airplane	iv
1-2	Pilot's Compartment - Forward View	2
1-3	Pilot's Compartment - Left Side	3
1-4	Pilot's Pedestal	4
1-5	Air Induction System - R-2800-44W Engines	5
1-6	Throttle Quadrant and Propeller Synchronization Panel	7
1-7	Jet Engine Fuel Control	9
1-8	Fuel System	12
1-9	Electrically Operated Equipment	14
1-10	AC Power Control Panel	15
1-11	Generator Control Panel	15
1-12	AC Fuse and Circuit Breaker Panel	16
1-13	Emergency Hydraulic Controls	17
1-14	Hydraulic System (Sheet 1 of 2 Sheets)	18
1-14	Hydraulic System (Sheet 2 of 2 Sheets)	19
1-15	Emergency Exit Door and Canopy Valve	24
1-16	Servicing Diagram	25

SECTION II
NORMAL OPERATING INSTRUCTIONS

2-1	Estimated Indicated Stalling Speeds	33
-----	---	----

SECTION III
EMERGENCY OPERATING INSTRUCTIONS

3-1	Maximum Weights for Continued Flight After Engine Failure on Take-off	39
3-2	Estimated Single-engine Service Ceilings	40
3-3	Emergency Exit - Bail-out	42
3-4	Ditching Positions and Exits	43

SECTION IV
OPERATIONAL EQUIPMENT

4-1	Bomber-Navigator's Station	51
4-2	Adapter Bomb Control Panel	52
4-3	Master Bomb Control Panel	52
4-4	Oxygen Consumption Table	53
4-5	Communication Controls	55
4-6	Bomber-Navigator's Station - Forward View	58
4-7	Control Unit - AN/APA-5A	60
4-8	Exterior Lights Panel	61
4-9	Third Crew Member's Station	62

APPENDIX

A-1	Temporary Airspeed Installation Correction Table	64
A-2	Compressibility Correction Table	64
A-3	Instrument Dial Markings (Sheet 1 of 2 Sheets)	65
A-3	Instrument Dial Markings (Sheet 2 of 2 Sheets)	66
A-4	Power Plant Chart - R-2800-44W Engines	67
A-5	Power Plant Chart - J33A-10 Engine	68
A-6	Take-off, Climb, and Landing Chart	69
A-7	Flight Operation Instruction Chart (Sheet 1 of 3 Sheets)	70
A-7	Flight Operation Instruction Chart (Sheet 2 of 3 Sheets)	71
A-7	Flight Operation Instruction Chart (Sheet 3 of 3 Sheets)	72
A-8	Flight Operation Instruction Chart, Single-engine (Sheet 1 of 2 Sheets)	73
A-8	Flight Operation Instruction Chart, Single-engine (Sheet 2 of 2 Sheets)	74

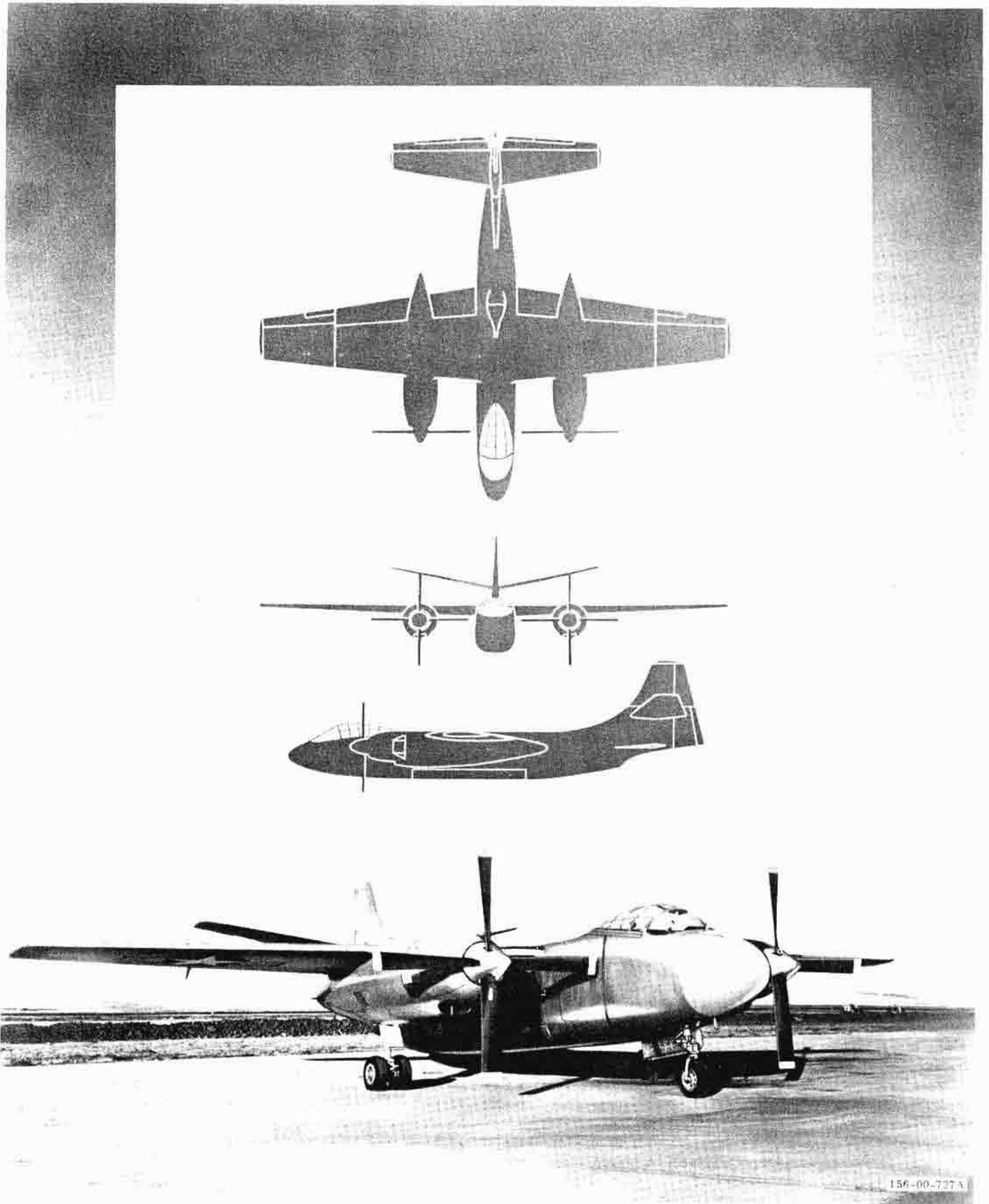

156-00-727A

Figure 1-1. AJ-1 Airplane

SECTION I

DESCRIPTION

1-1. AIRPLANE.

1-2. The AJ-1 attack bomber, built by North American Aviation, Inc, is a high-wing airplane powered by two reciprocating engines and a single turbo-jet engine. The airplane can be operated from a land base or from a CVB class carrier. For carrier stowage the outer wing panels and the vertical tail can be folded. A 9600-pound bomb load can be carried in the fuselage bomb bay, the primary mission of the airplane being the execution of a horizontal bombing attack from high altitudes. A basic flight crew consists of two, pilot and bomber-navigator; however, provisions are made for carrying a third crew member.

1-3. AIRPLANE DIMENSIONS.

1-4. Over-all dimensions of the airplane are as follows:

Wing Span -----	71.4 feet
Length -----	63.1 feet
Height -----	20.4 feet

1-5. AIRPLANE GROSS WEIGHT.

1-6. Normal gross weight of the airplane is approximately 47,000 pounds.

1-7. INTERIOR ARRANGEMENT.

1-8. The fuselage contains five compartments: a pilot's compartment with stations for pilot and bomber-navigator, a crew entry compartment with provisions for a third crew member's station, a bomb bay, an intermediate section aft of the bomb bay where a catapult hold-back fitting is located, and a jet-engine compartment. Hatches at each end of the bomb bay permit crew access to the jet engine in flight. Bomb doors serve as a walkway when doors are closed.

1-9. POWER PLANTS.

1-10. The AJ-1 Airplane is powered by two Pratt and Whitney reciprocating engines, R-2800-44W, and a single Allison turbo-jet engine, J33-A-10. The turbo-jet engine is housed in the aft portion of the fuselage.

1-11. RECIPROCATING ENGINES.

1-12. Each reciprocating engine is an 18-cylinder, twin-row, radial, air-cooled engine, equipped with a manifold pressure regulator, a Bendix-Stromberg pressure-type carburetor, an exhaust-driven turbo-supercharger, an internal engine-driven supercharger, a water injection system, and a torque-meter.

1-13. THROTTLES.

1-14. Dual throttle levers are located on a quadrant at the left side of the pilot's compartment. (See 16, figure 1-3.) As a safety measure, neither throttle can be advanced until surface controls are unlocked. Throttle friction is adjusted by means of a throttle friction lock on the inboard side of the quadrant. (See 30, figure 1-3.) An interphone push-to-talk button is mounted on the right engine throttle lever. A throttle catapult handle, located just forward of the quadrant (19, figure 1-3), is provided to assist the pilot in holding throttles open during catapult take-off.

1-15. MANIFOLD PRESSURE REGULATORS. Each throttle is mechanically connected to a manifold pressure regulator (Eclipse Pioneer, Type 1509-4B), which automatically maintains the manifold pressure setting selected by the pilot, regardless of altitude changes. The regulator operates to hold the manifold pressure setting selected by regulating the engine carburetor throttle valve. To assure sufficient carburetor inlet pressure for manifold pressures higher than those obtainable with wide-open throttle and an inlet pressure equal to atmospheric pressure, turbo-supercharging is necessary.

1-16. TURBO-SUPERCHARGERS.

1-17. An exhaust-driven turbo-supercharger on each engine makes possible high-altitude operation, and provides increased power at sea level. The turbo-supercharger is essentially a centrifugal air compressor directly connected to a gas turbine which is driven by waste gases from the engine exhaust. Air entering the ram air intake (located in the nacelle, below the engine) flows to the compressor, where it is compressed and delivered through two intercoolers to the carburetor. The degree of compression is determined by the position of a waste gate in the exhaust system which controls the amount of gas allowed to pass through the turbine driving the compressor. With the waste gate closed, all the exhaust gases will go through the turbine, and the wheel will revolve at high speed. With the waste gate wide open, most of the gas will be discharged into the atmosphere, and the turbine wheel will idle. In this way the speed of the turbine can be varied indefinitely throughout its speed range, so that the amount of supercharging is that required by the power schedule of the engine. A turbo-supercharger regulator automatically opens or closes the waste gate, providing sufficient pressure at the carburetor inlet for the manifold pressure regulator to maintain the selected manifold pressure. In a climb from sea level, the manifold pressure

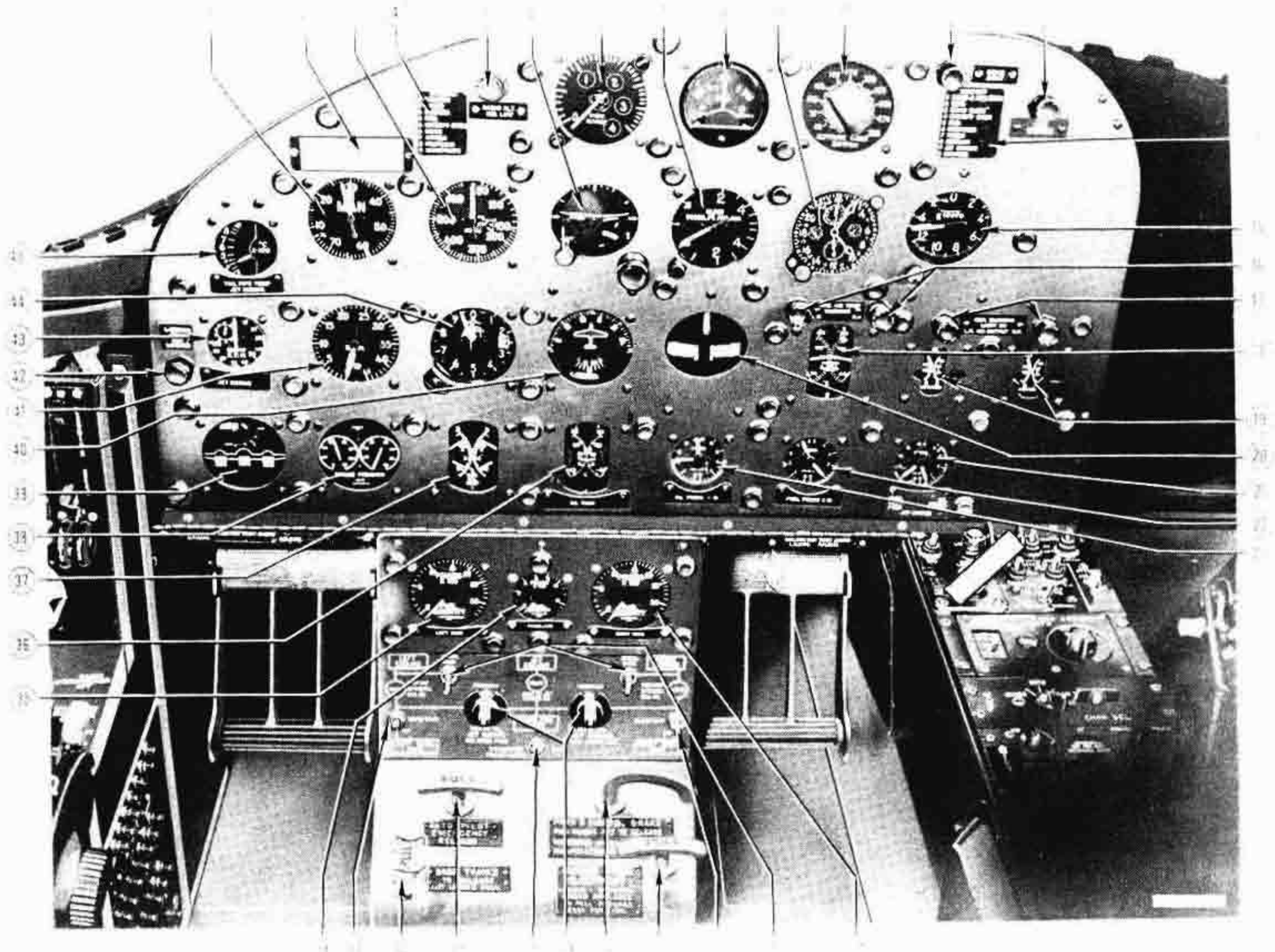

1. Manifold Pressure Indicator
2. Airspeed Correction Card
3. Airspeed Indicator
4. Landing Check List
5. Radio Altimeter Low-level Warning Light
6. Gyro Horizon Indicator
7. Radio Altimeter
8. Rate-of-climb Indicator
9. Pilot's Direction Indicator
10. Clock
11. Altitude Limit Switch
12. Bombs-away Indicator Light
13. Master Fire Warning Light
14. Take-off Check List
15. Accelerometer
16. Carburetor Air Temperature Warning Lights
17. Generator Warning Lights
18. Carburetor Air Temperature Indicator
19. DC Volt-ammeters
20. Turn-and-Bank Indicator
21. Jet-engine Fuel and Oil Pressure Indicator
22. Reciprocating-engine Fuel Pressure Indicator
23. Reciprocating-engine Oil Pressure Indicator
24. Right Wing Tank Fuel Quantity Indicator
25. Emergency Fuel Pump Switches
26. Fuel Boost Pump Switch
27. Rudder Pedal Adjustment Handle
28. Parking and Emergency Brake Handle
29. Fuel Cross-feed Valve Switches
30. Fuel Transfer Pump Switch
31. Automatic Pilot Emergency Release Handle
32. Tip Tank Release Handle
33. Fuel Boost Pump Switch
34. Fuselage Tank Fuel Quantity Indicator
35. Left Wing Tank Fuel Quantity Indicator
36. Reciprocating-engine Oil Temperature Indicator
37. Cylinder Head Temperature Indicator
38. Torque Pressure Indicator
39. Landing Gear and Wing Flap Position Indicator
40. Master Direction Indicator
41. Reciprocating-engine Tachometer
42. Landing Gear Warning Light
43. Jet-engine Tachometer
44. Altimeter
45. Jet-engine Tail-pipe Temperature Indicator

Figure 1-2. Pilot's Compartment - Forward View

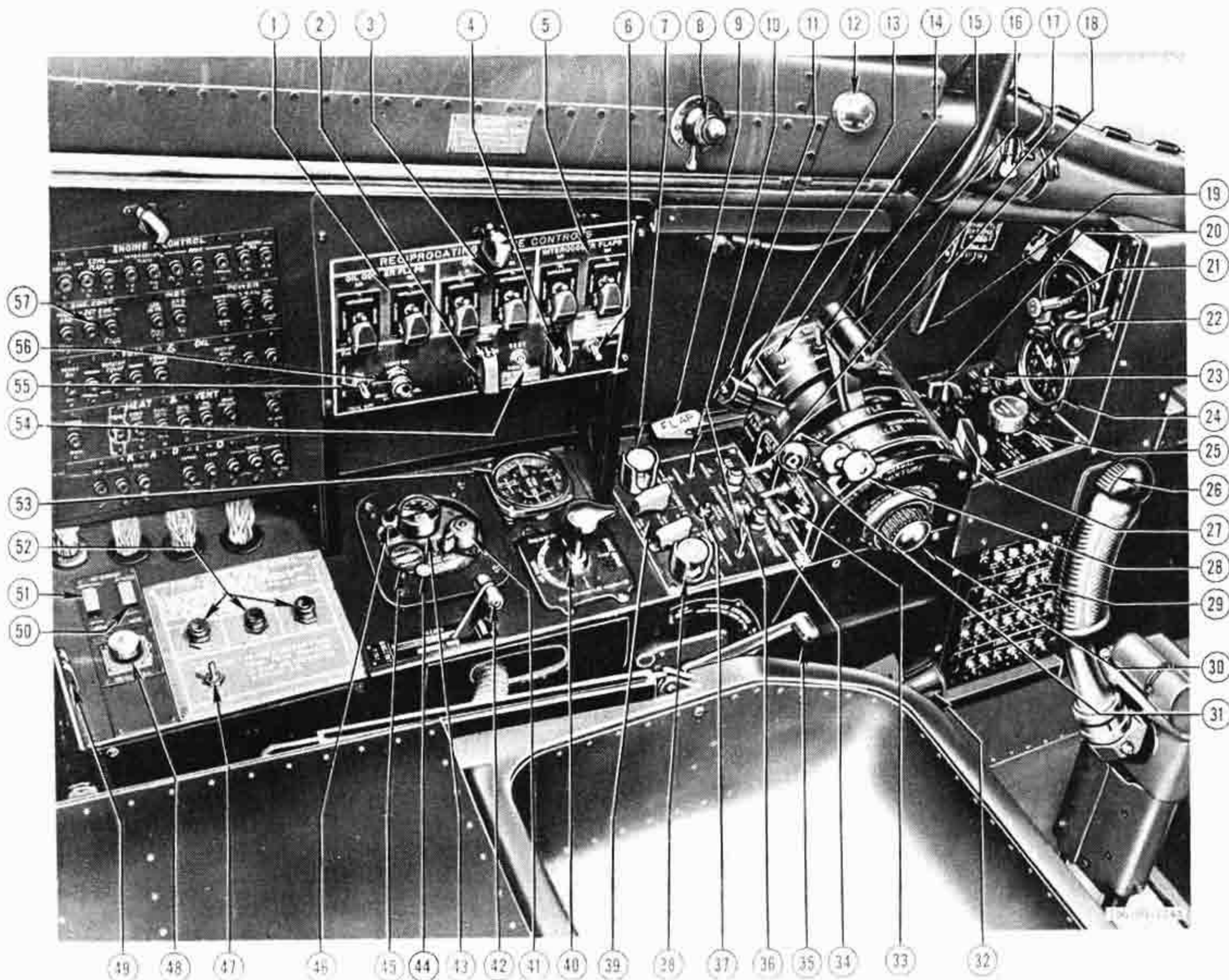

- | | |
|---|--|
| 1. Oil Cooler Flap Switches | 30. Throttle Friction Lock |
| 2. Aileron Boost Switch | 31. Propeller Master Lever |
| 3. Cowl Flap Switches | 32. Relief Tube |
| 4. Water Injection Switch | 33. Turbo Control Switches |
| 5. Intercooler Flap Switches | 34. Propeller Governor Limit Lights |
| 6. Canopy Switch | 35. Surface Control (and Throttle) Lock |
| 7. Propeller Feathering Button | 36. Propeller Resynchronize Button |
| 8. Cabin Air Outlet | 37. Propeller Master Selector Switch |
| 9. Wing Flap Control Handle | 38. Propeller Feathering Button |
| 10. Propeller Toggle Switches | 39. Emergency Engine Control Switches |
| 11. Jet-engine Throttle Fuel Start Switch | 40. Trim Tab Control Stick |
| 12. Canopy Defrost Knob | 41. Oxygen Regulator Air Valve |
| 13. Jet-engine Throttle | 42. Aileron Mechanical Ratio Control Handle |
| 14. Rudder Boost Switch | 43. Oxygen Pressure Gage |
| 15. Elevator Boost Switch | 44. Oxygen Safety Press Button |
| 16. Reciprocating-engine Throttles | 45. Oxygen Flow Indicator |
| 17. Jet-engine Master Switch | 46. Oxygen Emergency Valve |
| 18. Microphone Switch | 47. Fire Detector Test Switch |
| 19. Throttle Catapult Handle | 48. Suit Heat Outlet |
| 20. Cabin Temperature Control Selector | 49. Turbo Power Switches |
| 21. Ignition Switch Panel | 50. Jet-engine Starting Selector Switch |
| 22. Landing Gear Control Handle | 51. Jet-engine Emergency Fuel System Test Switch |
| 23. Heater Master Switch | 52. Fire Detector Lights |
| 24. Cabin Altimeter | 53. Trim Tab Position Indicator |
| 25. Cabin Pressure Control Knob | 54. Rudder Limiting System Test Switch |
| 26. Elevator Trim Switch | 55. Jet-engine Fuel System Selector Switch |
| 27. Windshield Defrost Control | 56. Jet-engine Emergency Fuel System Warning Light |
| 28. Mixture Control Levers | 57. Circuit Breaker Panel |
| 29. Circuit Breaker Panel | |

Figure 1-3. Pilot's Compartment - Left Side

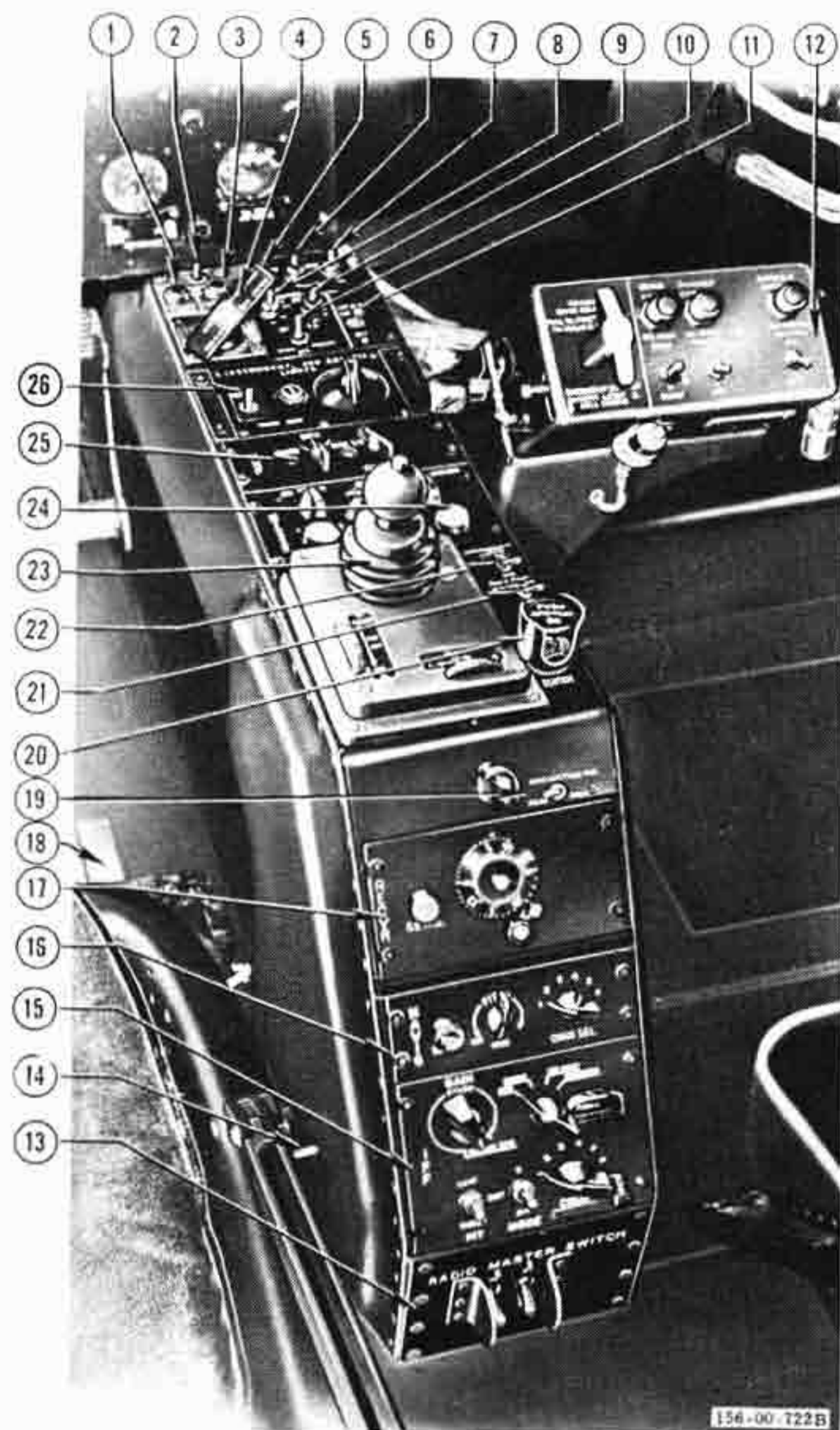

1. Arresting Gear Hook Indicator Light
2. Arresting Gear Hook Retract Switch
3. Arresting Gear Hook Indicator Light
4. Arresting Gear Hook Release Handle
5. Battery Switch
6. Generator Switch, LH
7. Generator Switch, RH
8. Starter Switch
9. Primer
10. Oil Dilution Switch
11. Pitot Heat Switch
12. Master Bomb Control Panel
13. Radio Master Switch Panel
14. Seat Adjustment Switch
15. AN/APX-2 Radio Control Panel
16. AN/ARR-2A Radio Control Panel
17. R-23/ARC-5 Radio Control Panel
18. Seat Back Lever
19. Receiver Change-over Switch
20. Automatic Pilot Clutch Switch
21. Pilot's Direction Indicator - Bomb Sight Tie-in Switch
22. Pilot's Direction Indicator Switch
23. Automatic Pilot Controller
24. AN/AIC-4 Radio Control Panel
25. AN/ARC-1A Radio Control Panel
26. Instrument and Cockpit Light Panel

Figure 1-4. Pilot's Pedestal

regulator gradually opens the carburetor throttle valve until the valve is wide open and carburetor inlet pressure is insufficient for desired manifold pressure. The turbo regulator then starts closing the waste gate, so that turbo speed will increase and supply sufficient pressure to the carburetor inlet. Manifold pressure will be maintained during the rest of the climb by increasing turbo speed. If maximum turbo speed is reached, the turbo regulator will control the waste gate to prevent overspeeding of the turbo.

1-18. TURBO CONTROL SWITCHES. Turbo control switches, located on the lower part of the throttle quadrant (33, figure 1-3), control the turbo regulators. With switches at "NORMAL," the turbo regulators operate in conjunction with the manifold pressure regulators to maintain automatically the selected manifold pressure at all powers and altitudes. When the turbo control switches are placed at "TAKE OFF AND LAND," the waste gates are held open, making the turbo-superchargers inoperative. The turbo

switches should be positioned at "NORMAL" when the water injection system is used for take-off, in order to obtain the higher power.

1-19. TURBO POWER SWITCHES. Electrical power to the turbo-supercharger regulators is controlled by two switches located on a vertical panel at the aft end of the left console. (See 49, figure 1-3.) When the switches are in the guarded, "AUTO" position, electrical power for automatic control of the waste gate for each turbo-supercharger is supplied by the generator on the related engine. Should a generator fail, moving the corresponding switch to "EMER. (BAT)" connects the regulator to the battery bus so that automatic control of the waste gate is continued. If the switch is left at "AUTO" after generator failure, the waste gate opens fully, and, depending on altitude and power setting, a drop in manifold pressure may occur.

1-20. INTERCOOLERS.

1-21. Two intercoolers on each engine provide control

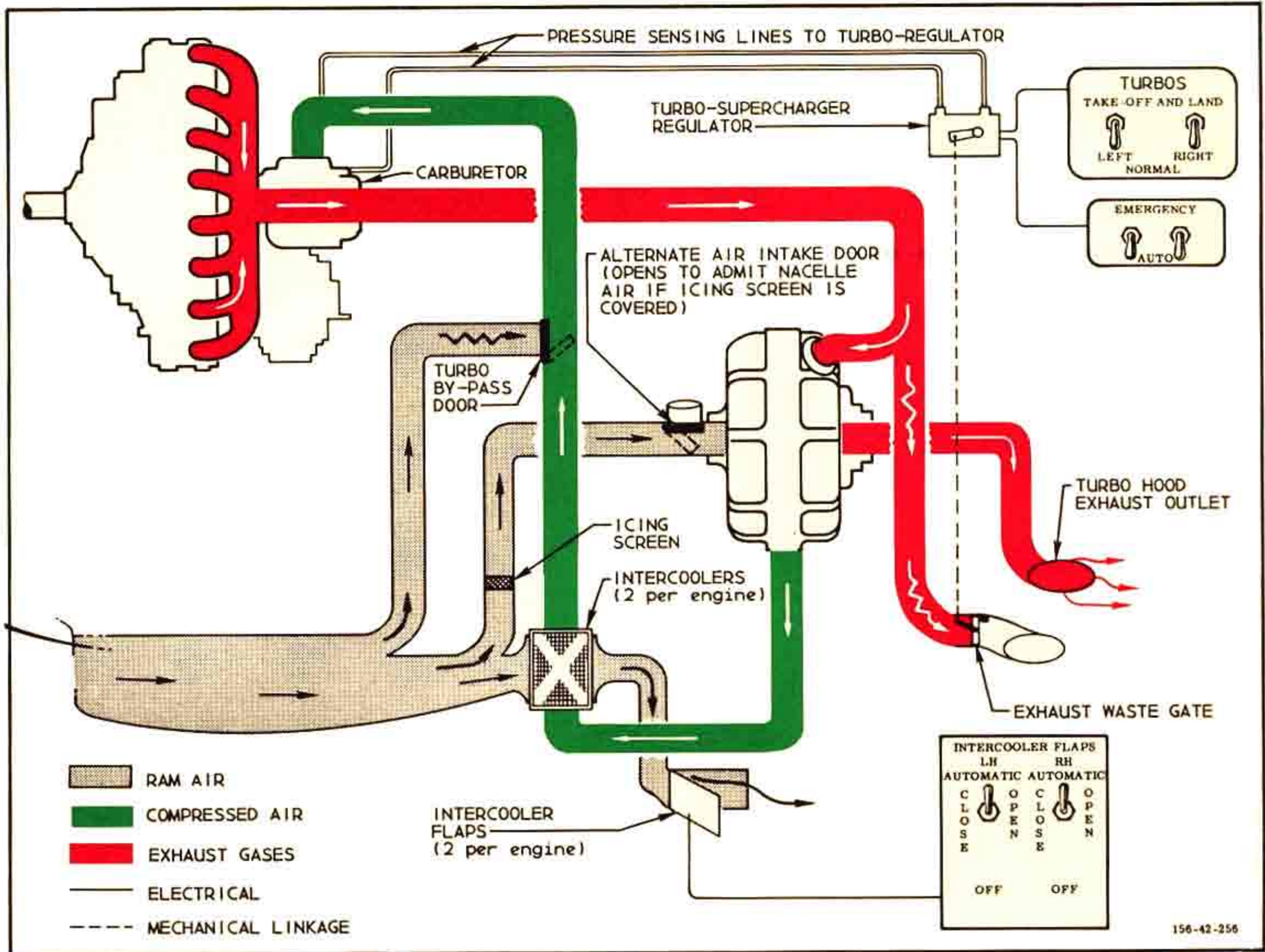

Figure 1-5. Air Induction System - R-2800-44W Engines

of carburetor air temperature by cooling the air compressed by the turbo-superchargers before it enters the carburetors. Cooling the supercharged air maintains carburetor air temperature below a specified maximum, thereby preventing detonation. Flow of cooling air through the intercoolers is regulated by thermostatically controlled intercooler flaps. A carburetor air temperature indicator and two indicator lights are located on the instrument panel. (See figure 1-2.) If carburetor air temperature exceeds 38°C (maximum dry), the related indicator light illuminates.

1-22. INTERCOOLER FLAP SWITCHES. Switches controlling intercooler flaps for both engines are located above the left console. (See 5, figure 1-3.) Each switch has four positions: two maintained contacts, "AUTOMATIC" and "OFF"; and two spring-loaded contacts, "OPEN" and "CLOSE." Switches are guarded in the "AUTOMATIC" position for thermostatic control of the flaps. "OPEN" and "CLOSE" positions provide manual control of the flaps.

NOTE

- Position of the intercooler flaps may be controlled only when the turbo-superchargers

are operating (turbo control switches "NORMAL").

- Intercooler flaps automatically go to the full open position when the emergency engine control switch is placed at "FUEL AND OIL SHUT OFF." To close the flaps after this automatic operation, the emergency engine control switch must be moved to "CONTROL OFF" before the intercooler flap switch will be effective when moved to "CLOSE."

1-23. COWL FLAPS.

1-24. Cowl flap position can be automatically or manually controlled to maintain engine cylinder head temperature within a desired range. Switches controlling cowl flaps for both engines are located above the left console. (See 3, figure 1-3.) Each switch has four positions: two maintained contacts, "AUTOMATIC" and "OFF," and two spring-loaded contacts, "OPEN," and "CLOSE." When switch is at "AUTOMATIC," an electrical control system automatically positions the flaps to maintain cylinder head temperature within one of two ranges: the low

band of temperature range (210°C to 232°C) for engine operation below 46 in. Hg manifold pressure, and the high band temperature range (238°C to 260°C) for engine operation at manifold pressure above 46 in. Hg manifold pressure. When the throttle is advanced beyond 46 in. Hg, a microswitch in the throttle system is closed, causing the electrical control system to shift automatically from low band to high band, thus permitting higher cylinder head temperature for operation at higher manifold pressure.

NOTE

Cowl flaps automatically go to the full open position when the emergency engine control switch is placed at "FUEL AND OIL SHUT OFF." To close the flaps after this automatic operation, the emergency engine control switch must be moved to "CONTROL OFF" before the cowl flap switch will be effective when moved to "CLOSE."

1-25. WATER INJECTION.

1-26. A water injection system is provided for each reciprocating engine. Each system incorporates an electrically operated water pump, a water-alcohol tank of 10.5 gallons capacity, and a water pressure gage located in the lower right side of each nacelle. Water tank capacity permits use of water injection for a total of 5 minutes.

1-27. WATER INJECTION CONTROLS. Both water injection systems are controlled by a single switch, above the left console (4, figure 1-3), which should be placed at "ON" in advance of anticipated use of water. When the switch is "ON," movement of one or both throttles beyond 46 in. Hg manifold pressure starts both water pumps by means of a microswitch in the throttle system. Simultaneously, the manifold pressure regulators reset to provide a higher manifold pressure range, and the cowl flap thermostatic control automatically goes into the high-temperature band, permitting control of the cowl flaps at higher engine temperatures. When the water supply is exhausted, the switch should be placed at "OFF" to avoid unnecessary operation of the water pumps. No indicator of water level or water pressure is provided in the pilot's compartment; however, within a few seconds after water supply is exhausted, manifold pressure automatically resets to a maximum of 59 in. Hg.

1-28. MIXTURE.

1-29. Mixture control levers, located on the throttle quadrant (28, figure 1-3), have three positions: "IDLE CUT OFF," "NORMAL," and "RICH." Controls can be held in the selected position by adjustment of the throttle friction lock.

1-30. PRIMER.

1-31. The priming systems for both engines are controlled by a single spring-loaded switch (9, figure 1-4) on the forward part of the pilot's pedestal. The

switch has two positions, "L.H." and "R.H."

1-32. IGNITION.

1-33. Standard ignition switches are mounted on a panel forward and above the power control quadrant. (See 21, figure 1-3.) A center master ignition switch must be pushed into the "ON" position before either individual ignition switch is effective. Pulling the master switch out to the "OFF" position cuts off both engines by grounding all magnetos simultaneously.

1-34. STARTERS.

1-35. A single toggle switch on the pilot's pedestal (8, figure 1-4) actuates the direct-cranking starters on both engines. The switch is spring-loaded to neutral, and when held either to left or right, actuates the starter on the corresponding engine.

1-36. EMERGENCY ENGINE CONTROL SWITCHES.

1-37. Control of the fuel, oil, and hydraulic fluid supply to the engines is accomplished by emergency engine control switches. These two switches are located on the left console (39, figure 1-3), and are guarded in the "ON" position for all normal operation. When either switch is moved to "FUEL AND OIL SHUT OFF," the supply of fuel and hydraulic fluid is immediately shut off at the firewall of the related engine; however, oil supply is not shut off until the propeller is feathered. Whenever an emergency engine control switch is moved to "FUEL AND OIL SHUT OFF," oil cooler flaps, cowl flaps, and intercooler flaps of the related engine are automatically opened. In order to close the flaps after this automatic operation, the emergency engine control switch must be moved to a third position, "CONTROL OFF," before any movement of the flap controls will be effective.

1-38. TORQUEMETERS.

1-39. A torque meter is installed on each reciprocating engine to measure the torque, or turning moment, delivered by the propeller shaft. This measurement, converted to pounds per square inch, is indicated on a dual torque pressure indicator in the instrument panel. (See 38, figure 1-2.) At any given rpm, the torque pressure reading is directly proportional to the power being delivered to the propeller, that is, brake horsepower. No correction is required for variations in altitude, humidity, engine operating temperatures, amount of supercharging, spark advance, exhaust back pressure, or mixture setting. Torque pressure at a given rpm and manifold pressure will vary slightly between engines, however, because of differences in engine friction losses. It will also be affected by failure of an engine-driven accessory, because the power required for operation of accessories reduces the total available to the propeller.

1-40. RELATIONSHIP BETWEEN TORQUE PRESSURE AND MANIFOLD PRESSURE. While torque pressure and rpm together furnish precise data on engine output (and consequently airplane performance), a comparison

of torque pressure and manifold pressure furnishes a means of evaluating engine condition. A damaged or malfunctioning part of the engine will decrease the energy otherwise available to the propeller, requiring increased power input (manifold pressure) to maintain the same power output. For example, if one cylinder were to cut out, the power loss could easily be regained by advancing the throttle to restore the original torque pressure. However, the increase in manifold pressure would result in an increased load on the remaining good cylinders. Other factors also affect the relationship between torque pressure and manifold pressure. If the engine is held at a given power output (measured by constant rpm and torque pressure), it may be necessary to change manifold pressure with variations in the following: altitude, humidity, amount of supercharging, carburetor air temperature, engine temperature, fuel-air ratio, exhaust back pressure, and accessory load. It is evident, therefore, that the torque pressure indicator does not replace the manifold pressure indicator, but is complementary to it. Proper engine operating technique is to use manifold pressure and rpm to determine power settings, and torque pressure to measure power output. At all times, the pilot should know the correct relationship between these two, as well as the meaning of any change in this relationship. (See figures A-4, A-7, and A-8, and refer to paragraph 2-39.)

CAUTION

Manifold pressure and rpm must be considered the primary basis for engine operation. Torque pressure is to be used only as a cross-check. Disregarding manifold pressure may lead to incorrect power settings and abuse of the engine.

1-41. PROPELLERS.

1-42. Each engine drives a four-bladed, full-feathering Hamilton Standard Hydromatic propeller. The propellers are automatically controlled through governors to maintain constant engine speed, as selected by the pilot, and to operate at the most efficient blade angle for all airspeeds and rpm settings. An electric synchronizer provides automatic synchronization of propeller speeds. Propeller feathering or unfeathering is accomplished by supplying additional oil under pressure from an electric pump to the governor. Oil for feathering is obtained from a reserve supply in the main oil tank. In case of complete electrical failure, constant-speed operation will continue at the rpm setting at which failure occurs.

1-43. PROPELLER CONTROLS.

1-44. The propeller controls provide two methods of controlling engine rpm. Propeller toggle switches permit adjustment of rpm setting for each engine individually, and a propeller master lever provides simultaneous control of the engine speeds. Synchronization of propeller speeds by means of the electric synchronizer is completely automatic. All propeller

controls are located on a propeller synchronization panel on the left console. (See figure 1-6.)

1-45. PROPELLER MASTER SELECTOR SWITCH. Method of propeller control is determined by positioning a master selector switch, located on the synchronization panel. With the switch at "TOGGLE SWITCHES ONLY," the toggle switches are the only effective propeller control. Selecting the "TOGGLE SWITCHES AND MASTER LEVER" position renders both controls effective. With the master selector switch at "NORMAL," either the toggle switches or master lever may be used to change propeller speed, and in addition, the electric synchronizer is in operation to synchronize propeller speeds automatically.

1-46. PROPELLER TOGGLE SWITCHES. The two propeller toggle switches are located on the synchronization panel. Each toggle switch is spring-loaded to neutral, and when held at either "INCREASE" or "DECREASE," changes speed of the corresponding engine. The switches may be operated individually

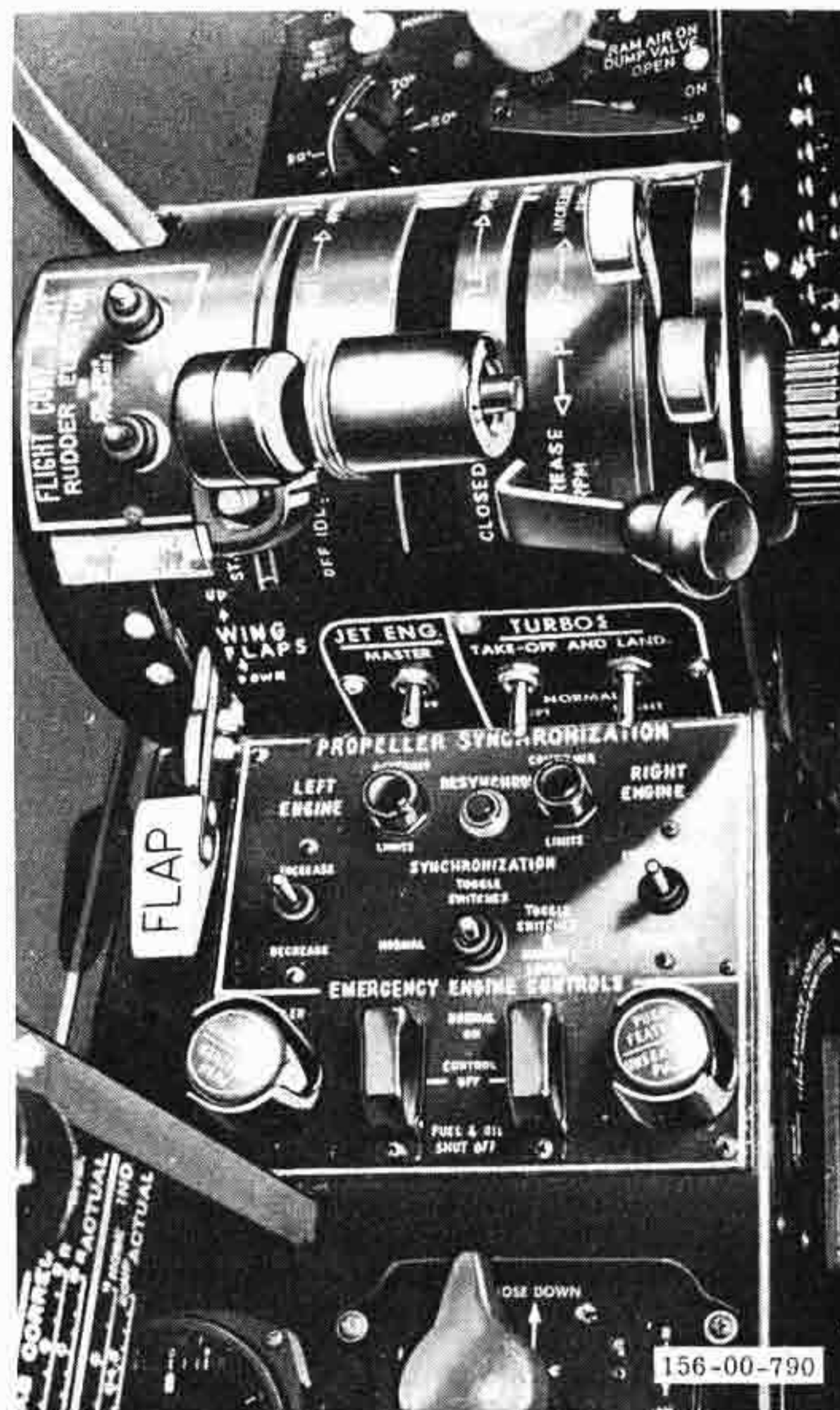

Figure 1-6. Throttle Quadrant and Propeller Synchronization Panel

or together.

1-47. **PROPELLER MASTER LEVER.** Movement of the propeller master lever, located on the throttle quadrant changes the setting of both propeller governors simultaneously. The rpm of the two engines is increased or decreased the same amount. When necessary to "line up" the two engine speeds, the master lever can be advanced to full "INCREASE" position, where both propeller governors are set for maximum rpm. Thereafter, movement of the master lever selects approximately the same speeds for both engines.

1-48. **GOVERNOR LIMIT INDICATOR LIGHTS.** Two governor limit indicator lights on the synchronization panel illuminate when the governors are in either the full "INCREASE" or full "DECREASE" rpm positions.

1-49. **PROPELLER SYNCHRONIZER.** The electric propeller synchronizer is a Hamilton Standard, Model 4C, and provides automatic propeller synchronization when desired. In this system, the left engine is designated as the "master" engine, and the right engine the "slave." Once the master engine's speed has been selected, the slave engine synchronizes its speed to that of the master engine. The synchronizer cuts out whenever the governors are at full increase rpm setting, so that failure of the master engine on take-off will have no effect on the slave engine. To prevent the slave engine from following the master engine in event of failure or overspeeding during flight, a limiting device is provided which restricts the number of rpm that the slave engine can follow the master engine. The limiting device centers itself on the original rpm of the slave engine and will allow the slave engine to increase or decrease only 3% of its rpm. This gives the slave engine a 6% range, but only 3% either way of center (original rpm). If the master engine rpm is increased, the slave engine will follow up 3% of its rpm, where it reaches its top limit. If the master engine rpm is then decreased, the slave engine will follow down 6% of its original rpm, past center to its lower limit. If the difference between the rpm of the master engine and slave engine is greater than the limited range of the slave engine, a resynchronize button, located on the synchronization panel, may be used. When the resynchronize button is depressed momentarily and released, it recenters the limiting device, allowing the slave engine to change another 3% toward that of the master. This procedure may be repeated until the engines are synchronized. When either the toggle switches or master lever is being moved, the synchronizer is temporarily inoperative, becoming operative when movement of these controls ceases.

1-50. **PROPELLER FEATHERING.** Propeller feathering is initiated by momentarily depressing the buttons located just aft of the synchronization panel. Pressing either button starts the related feathering pump, and the button will stay down until the propeller is feathered. When the electric pump stops, the button pops back to neutral. The feathering action can be stopped at any time by pulling the feathering button up to neutral manually. Unfeathering is accomplished by

pulling the button up past neutral and holding it for one second. If the propeller does not start to windmill within 10 seconds, the feathering button should be pulled up again momentarily, but should never be held up for more than one second at a time.

1-51. TURBO-JET ENGINE.

1-52. The turbo-jet engine, housed in the aft fuselage, is an Allison Model J33-A-10. Air is supplied to the jet engine through an intake duct located on top of the fuselage. A door covering the duct is automatically opened when the jet engine is started, and closed when the engine is shut down. Air from the intake duct is compressed by a centrifugal compressor and passed through air adapters into the combustion chambers, where fuel is introduced, mixed with the air, and burned. Fuel is metered to the combustion chambers automatically by three fuel metering units: a starting fuel system, a main fuel system, and an emergency fuel system. (See figure 1-7.)

1-53. JET ENGINE AUTOMATIC FUEL METERING.

1-54. For automatic starting, fuel under pressure from the dual pump is metered by the starting fuel system to two combustion chambers where "light-up" (ignition) occurs. The starting fuel system continues to meter fuel in increasing quantities to the remaining combustion chambers until the engine accelerates to a predetermined rpm. The main fuel system then takes over, metering fuel as required to maintain a constant engine speed (as selected by the pilot) regardless of changes in altitude and airspeed. The emergency system serves as a stand-by for engine operation in case of main fuel system failure.

1-55. JET ENGINE CONTROLS.

1-56. **MASTER SWITCH.** A jet engine master switch, located on the throttle quadrant (17, figure 1-3), directly controls fuel flow to the engine and indirectly controls electrical power for jet air intake door operation, starting, and ignition.

1-57. **THROTTLE AND THROTTLE FUEL START SWITCH.** A jet engine throttle, located on the throttle quadrant (13, figure 1-3), has four positions: "OFF," "START," "IDLE," and "OPEN." A throttle fuel start switch is mounted on the handle of the jet throttle. (See 11, figure 1-3.) Moving the throttle from "OFF" to "START" opens the jet air intake door and energizes the starter and ignition system. When engine cranking speed reaches 8.5% rpm, momentarily pressing the fuel start switch energizes the starting fuel system which directs fuel to two combustion chambers for ignition, and then meters fuel to the other chambers for acceleration. When engine speed stabilizes at 24% rpm (higher rpm at altitude), the throttle should be advanced to "IDLE." The starting cycle can be stopped at any time by closing throttle and moving jet master switch to "OFF."

1-58. **STARTING SELECTOR SWITCH.** Normally, all engine starts should be accomplished by use of the starting fuel system for an "automatic" start. A

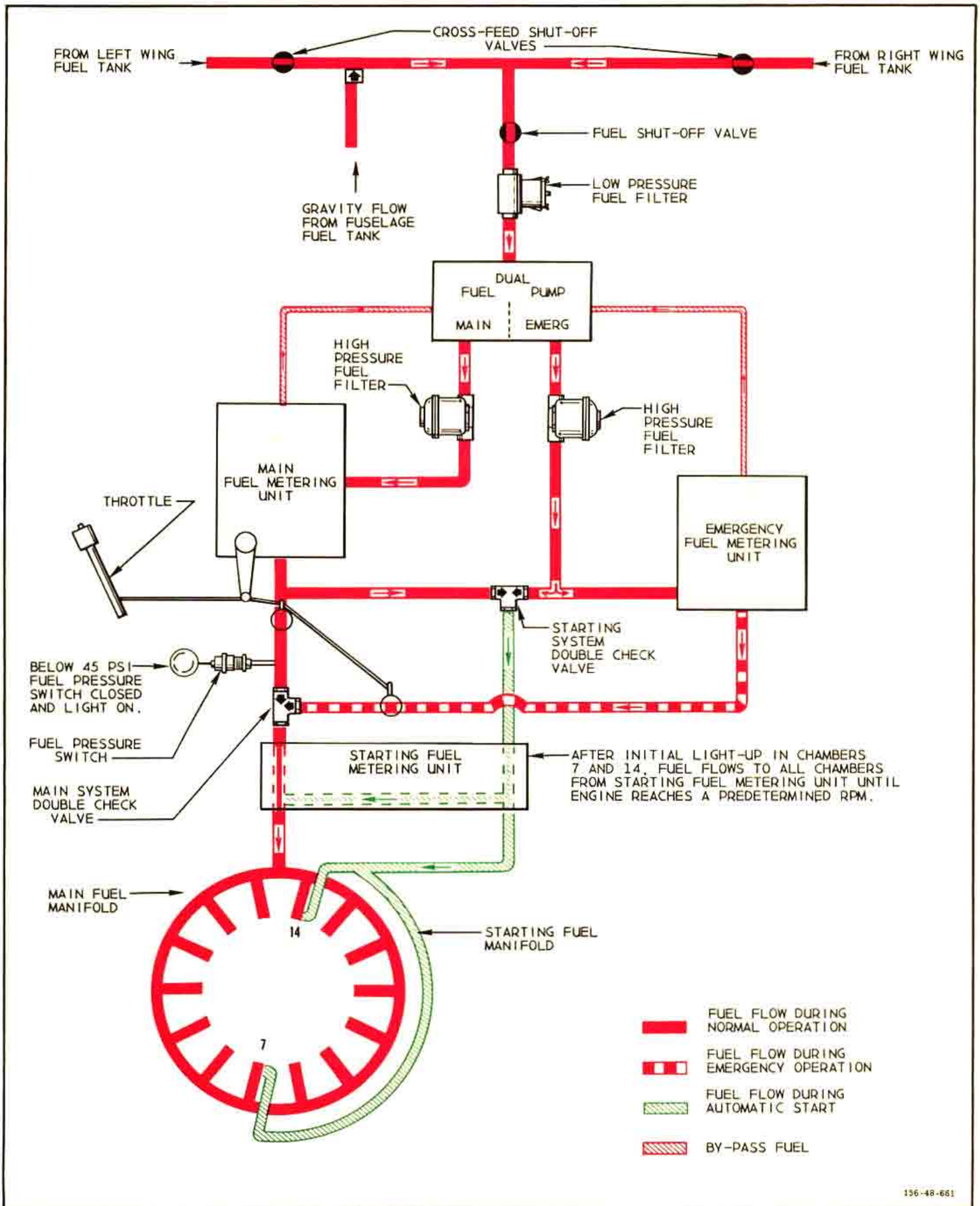

136-48-661

Figure 1-7. Jet Engine Fuel Control

starting selector switch, located on the aft portion of the left console (50, figure 1-3), should be placed at "AUTO." In emergencies, when the starting fuel system is inoperative, the switch may be positioned at "MANUAL" for a manual start.

1-59. FUEL SYSTEM SELECTOR SWITCH. A fuel system selector switch, located above the left console (55, figure 1-3), allows the pilot to select operation on either the main or the emergency fuel system, or the main system with automatic change-over to emergency system when needed. When the switch is positioned at "OFF," the engine is operated on the main fuel system, and the emergency fuel system is bypassing. In case of main fuel system failure, the emergency system can be selected by moving the switch to "EMERG." When the switch is at "TAKE OFF," engine operates on the main fuel system, but the emergency system will take over automatically if fuel pressure falls below a preset value of 45 psi.

1-60. EMERGENCY FUEL SYSTEM TEST SWITCH. A ground check of the emergency fuel system may be accomplished before take-off by means of an emergency fuel system test switch, located on the aft portion of the left console. (See 51, figure 1-3.) When this switch is moved to "TEST," output of the main fuel pump is by-passed to simulate failure of the main fuel system. Engine speed will drop momentarily and an indicator light above the left console (56, figure 1-3) will illuminate, indicating that the engine is operating on the emergency fuel system. When the switch is at "NORMAL," operation of the emergency fuel system is determined by the position of the fuel system selector switch.



When testing the emergency fuel system, the fuel system selector switch must be at "OFF." If this switch is at "TAKE OFF," the main fuel system does not automatically take over after the test is completed. For a subsequent take-off, fuel metering would be accomplished by the emergency system with no possible automatic emergency control.

1-61. OIL SYSTEMS.

1-62. A separate oil system is provided for each of the three engines and for each turbo-supercharger. Each reciprocating engine has a dry-sump, pressure-type lubricating system, with an oil tank and oil cooler. A propeller feathering pump for each engine receives oil from a reserve supply at the bottom of the related engine oil tank. The jet engine has a wet-sump, integral oil system. Oil temperature and pressure indicators for the engines are mounted on the pilot's instrument panel. (See 21, 23, and 36, figure 1-2.)

1-63. OIL GRADE AND SPECIFICATION.

1-64. Reciprocating engines: Specification No. AN-O-8, Grade 1120, or Grade 1100 for extreme cold weather operation.

Turbo-superchargers: Specification No. AN-O-9, Grade 1010.

Jet engine: Specification No. AN-O-9, Grade 1010.

1-65. OIL TANKS.

1-66. RECIPROCATING ENGINES. An oil tank for each reciprocating engine is installed in the engine nacelle, aft of the firewall. Each oil tank has a capacity of 28.7 gallons of usable engine oil, with a reserve of 1.5 gallons for the propeller feathering pump.

1-67. TURBO-SUPERCHARGERS. An oil tank for each exhaust-driven turbo-supercharger is installed just aft of the engine oil tank and has a capacity of 1.5 gallons.

1-68. JET ENGINE. The jet engine is equipped with an integral oil system, the capacity of which is 12 quarts; however, the system is normally serviced with 4 quarts.

1-69. OIL SYSTEM CONTROLS.

1-70. The reciprocating engines have oil system controls operable by the pilot, but no control is provided for the oil system of the jet engine.

1-71. OIL SHUT-OFF VALVES. Two electrically operated shut-off valves, one on the firewall of each reciprocating engine, are controlled by the emergency engine control switches located on the emergency engine control panel. (See 39, figure 1-3.) Normally, the switches are guarded in the "ON" position. To shut off the oil supply to an engine, the related switch must be placed at "FUEL AND OIL SHUT OFF" and the propeller feathered. (Refer to paragraph 1-37 for function of these switches in engine control.)

1-72. OIL COOLER FLAPS. Oil cooler flaps are controlled by two switches, one for each engine, located above the left console. (See 1, figure 1-3.) Each switch has four positions: two maintained contacts, "AUTOMATIC" and "OFF"; and two spring-loaded contacts, "OPEN" and "CLOSE." The switches are guarded in the "AUTOMATIC" position for thermostatic control of the flaps. "OPEN" and "CLOSE" positions are provided for manual control of the oil cooler flaps.

NOTE

Oil cooler flaps automatically go to the full open position when the emergency engine control switch is placed at "FUEL AND OIL SHUT OFF." To close the flaps after this automatic operation, the switch must be moved to "CONTROL OFF" before the oil cooler flap switch will be effective when moved to "CLOSE."

1-73. OIL DILUTION SWITCH. A switch for oil dilution is located on the pilot's pedestal. (See 10, figure 1-4.) The switch should be at "NORMAL" for all

normal operation. When the switch is held at "DILUTE," fuel is supplied to the oil lines of both engines simultaneously. After oil dilution the switch should be placed at "OFF," so that diluted oil will return to the hopper in the oil tank rather than to the reserve compartment of the tank.

NOTE

An oil dilution shut-off valve in each nacelle, accessible through the engine accessory access door, is safetied off, and must be manually opened before oil dilution.

1-74. FUEL SYSTEMS.

1-75. Three self-sealing fuel tanks are installed in the airplane: one (consisting of three interconnected cells) in each wing, and one in the fuselage above the crew entry compartment. (See figure 1-8.) Normally, each wing tank supplies fuel under booster pump pressure to the reciprocating engine on the related side of the airplane. This provides each reciprocating engine with a completely independent fuel system, the two systems being connected by a cross-feed line. Fuel for the jet engine is supplied from either or both systems through the cross-feed line. Fuselage tank fuel is automatically transferred to both wing tanks by operation of a transfer pump mounted in the fuselage tank. In the event of booster pump failure, fuel will flow to the engines by gravity feed through a by-pass valve in each booster pump, and through a gravity feed line provided from each wing tank to the related main fuel line. A gravity feed line from the fuselage tank to the cross-feed line is provided so that fuselage tank fuel is available in case of transfer pump failure. An electrically driven emergency fuel pump is provided for each reciprocating engine to supply fuel to the engine in case of engine-driven pump failure. To supplement the main fuel supply, a tip tank can be installed on each wing. Fuel in each tip tank is transferred to the related wing tank through a fuel level control valve which opens automatically when fuel quantity in the wing tank is decreased by approximately 45 gallons. Air pressure for transfer of tip tank fuel is supplied by the cabin air compressor.

1-76. FUEL GRADE AND SPECIFICATION.

1-77. Fuel Specification No. AN-F-48, Grade 115/145.

1-78. FUEL TANK CAPACITIES.

1-79. Total internal fuel capacity is approximately 1245 US. gallons, or 7470 pounds; total fuel capacity including tip tanks is approximately 1847 US. gallons, or 11,082 pounds. Individual tank capacities are approximately as follows:

	US. GALLONS	POUNDS
Left wing tank	520	3120
Right wing tank	520	3120
Fuselage tank	205	1230
Wing tip tanks (each)	301	1806

NOTE

- The weight of fuel required to fill fuel tanks completely may differ from one filling to another, because of the effect of temperature variation on fuel density.
- Inasmuch as the attitude of the airplane in the three-point position does not differ from the attitude of the airplane in normal flight beyond the required accuracy of the fuel quantity gage system, no calibration plate is required in this airplane.

1-80. SEQUENCE OF TANK USAGE.

1-81. All fuel is supplied to the engines from the wing tanks; however, after approximately 90 gallons of fuel is used from the wing tanks (45 gallons from each), they are replenished by tip tank fuel until tip tanks are emptied. After tip tanks are drained and three-fourths of the wing tank fuel is consumed, fuel from the fuselage tank is transferred to the wing tanks. When fuselage tank fuel is depleted, the remainder of the fuel in the wing tanks is used.

NOTE

Tip tank fuel is not transferred until gear is retracted, as the cabin air compressor (which supplies air pressure for transfer of fuel) is off whenever gear is down. To preclude the possibility of tip tank fuel flowing to the cabin air compressor, a shut-off valve in the air pressure line to the tip tanks automatically closes when the cabin air compressor is off.

1-82. FUEL SYSTEM CONTROLS.

1-83. FUEL CONTROL PANEL. The fuel control panel, located centrally beneath the instrument panel (figure 1-2), includes a schematic diagram of the internal fuel system. All fuel system controls, except those for engine fuel shut-off and tip tank release, are mounted on the panel. Fuel quantity indicators for right wing tank, left wing tank, and fuselage tank are at the top of the panel (24, 34, and 35, figure 1-2) and are calibrated in pounds. No indicator is provided for the tip tanks, but a continued decrease of fuel quantity in the wing tanks indicates that the tip tanks are empty.

1-84. RECIPROCATING-ENGINE FUEL SHUT-OFF VALVES. Electric fuel shut-off valves, one in the main fuel line to each reciprocating engine, are controlled by emergency engine control switches located on the emergency engine control panel. The switches are guarded in the "ON" position for normal operation and are moved to "FUEL AND OIL SHUT OFF" to shut off the fuel supply to the engines. (Refer to paragraph 1-37 for function of these switches in engine control.)

1-85. JET-ENGINE FUEL SHUT-OFF VALVE. An electric shut-off valve controlling fuel flow to the jet

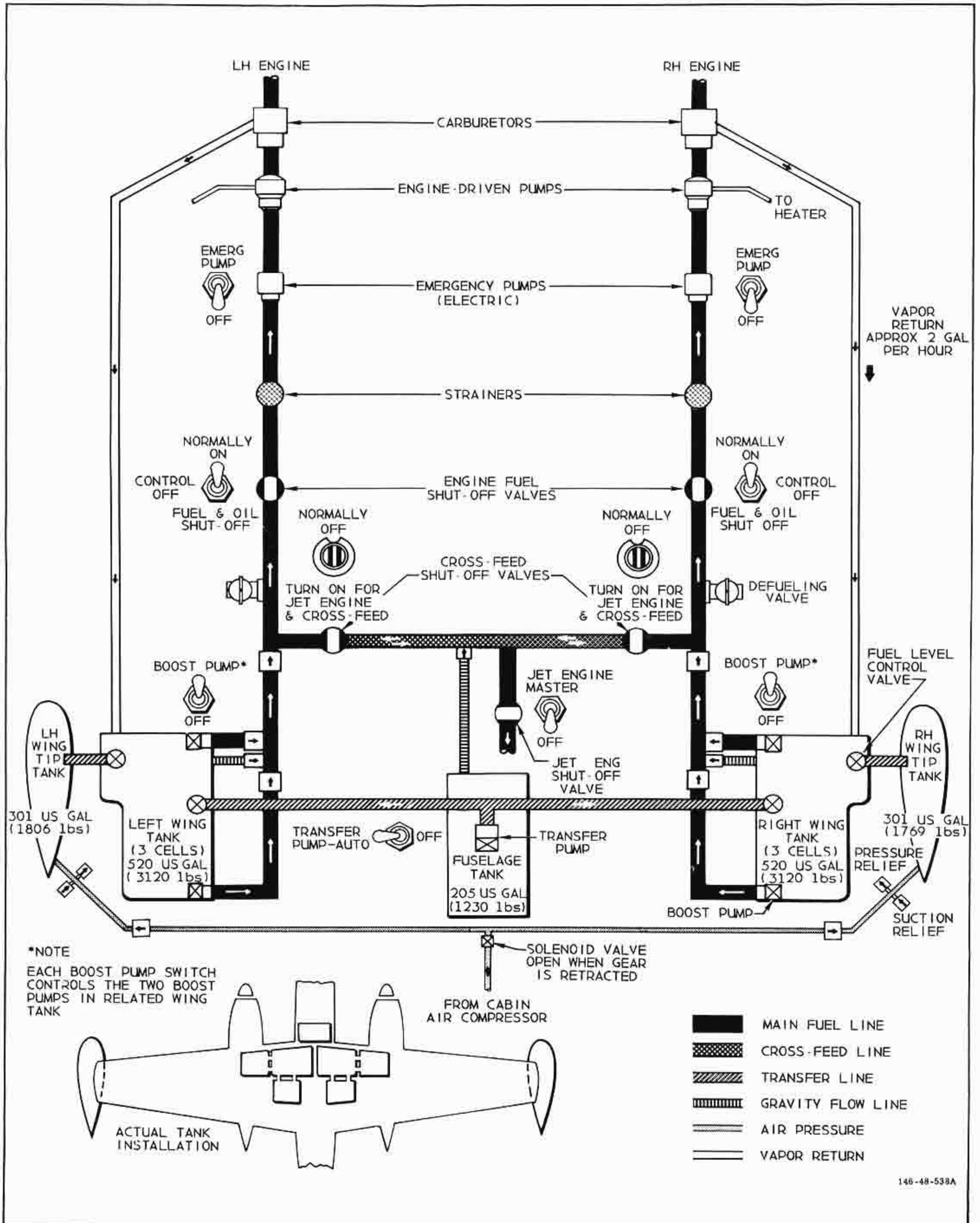

146-48-538A

Figure 1-8. Fuel System

engine is actuated by the jet master switch located on the lower half of the throttle quadrant. (See 17, figure 1-3.) Placing the switch at "ON" allows fuel flow to the jet engine when one or both cross-feed valves are open.

1-86. CROSS-FEED VALVES. Electric cross-feed valves, one at each end of the cross-feed line, are controlled by two rotary-type switches on the fuel control panel. (See 29, figure 1-2.) The switches have two positions, "ON" and "NORMALLY OFF." Operation of the cross-feed valves, in conjunction with the fuel shut-off valves and booster pump switches, makes it possible for one engine to consume all fuel carried in the airplane, or for both engines to be fed by one fuel system. (Fuel cannot be cross-fed, however, from one wing tank to the other.) For jet-engine operation, one or both cross-feed valves and the jet engine master switch must be "ON."

1-87. BOOSTER PUMPS. Two booster pumps (Thompson, Type TFG-31400-5, -6) are installed in each wing tank, one in the forward cell and one in the aft cell. Two switches on the fuel control panel (26 and 33, figure 1-2) control the four pumps, one switch for the pair of pumps in the left wing tank and one switch for the pair in the right tank.

1-88. TRANSFER PUMP. A transfer pump switch on the fuel control panel (30, figure 1-2) controls the electric transfer pump (Thompson, Type TFG-31400-5) in the fuselage tank. The switch has two positions, "AUTO" and "OFF," and is normally positioned at "AUTO." A fuel level control valve in each wing tank automatically opens when three-fourths of the wing tank fuel is consumed, and fuselage tank fuel is then transferred to the wing tanks (when the transfer pump switch is at "AUTO").

1-89. EMERGENCY FUEL PUMPS. Two electric emergency fuel pumps (Thompson, Type TFD-11900) are provided for use in case of failure of the engine-driven fuel pumps. Two emergency fuel pump switches, one for each pump, are mounted on the fuel control panel. (See 25, figure 1-2.)

1-90. TIP TANK RELEASE. A release handle, located below the left side of the fuel control panel (32, figure 1-2), is provided for jettisoning the wing tip tanks. When the handle is pulled out, the two tanks are released simultaneously.

1-91. ELECTRICAL SYSTEM.

1-92. Electrical energy is supplied by a 28-volt direct-current system, powered by two engine-driven generators (General Electric, Type 2CM76), one on each reciprocating engine. A 24-volt, 34 ampere-hour storage battery serves as a stand-by in case of generator failure, or if the generator output is insufficient to close the reverse-current relay. Alternating-current is supplied by four inverters, one 400-cycle three-phase and one 400-cycle single-phase, with a stand-by for each for emergency use.

1-93. ELECTRICAL POWER DISTRIBUTION.

1-94. Power distribution is made through three busses: essential, main, and monitor. All three busses are energized through bus tie-in relays when both generators are operating or an external source is powering the system. Equipment necessary for flight is powered by the essential and main busses, the essential bus powering the most essential equipment, and the main bus powering equipment next in importance. The monitor bus powers equipment not essential to flight, and requiring current heavier than that furnished by one generator. In case of failure of one generator, the monitor bus is automatically disconnected from the system. If both generators fail, the main bus is also without power, leaving only the essential bus energized; however, if the battery switch is positioned at "EMERGENCY," the main bus will be connected to the essential bus and equipment normally powered by both busses will be operative from the battery power source.

NOTE

When landing gear is "DOWN," the main bus is automatically connected to the essential bus.

1-95. ELECTRICALLY OPERATED EQUIPMENT.

1-96. See figure 1-9.

1-97. INVERTERS.

1-98. Alternating current is supplied in the system by four inverters, a main 400-cycle three-phase and a main 400-cycle single-phase, with a stand-by for each for emergency use. In case of main inverter failure (either three-phase or single-phase), the stand-by inverter is automatically turned on.

1-99. ELECTRICAL SYSTEM INDICATORS.

1-100. Two volt-ammeter indicators are mounted on the lower right side of the instrument panel. (See 19, figure 1-2.) An alternating-current voltmeter and a rotary-type voltmeter switch are installed on the a-c power control panel, located on the right side of the cockpit. (See figure 1-10.) Placing the switch at "A" and "C" produces a reading on the voltmeter for the three-phase inverter; placing the switch at "SINGLE PHASE" produces a reading on the voltmeter for the single-phase inverter.

1-101. ELECTRICAL SYSTEM CONTROLS.

1-102. BATTERY SWITCH. A battery switch, mounted on the pilot's pedestal (5, figure 1-4), has three positions, "BATTERY," "OFF," and "EMERG." For normal operation, the switch is placed at "BATTERY." In case both generators fail, the switch may be placed at "EMERG." and main bus equipment will be operative. The switch is guarded by a removable pin to prevent the switch from being inadvertently moved to "EMERG."

ELECTRICALLY OPERATED EQUIPMENT

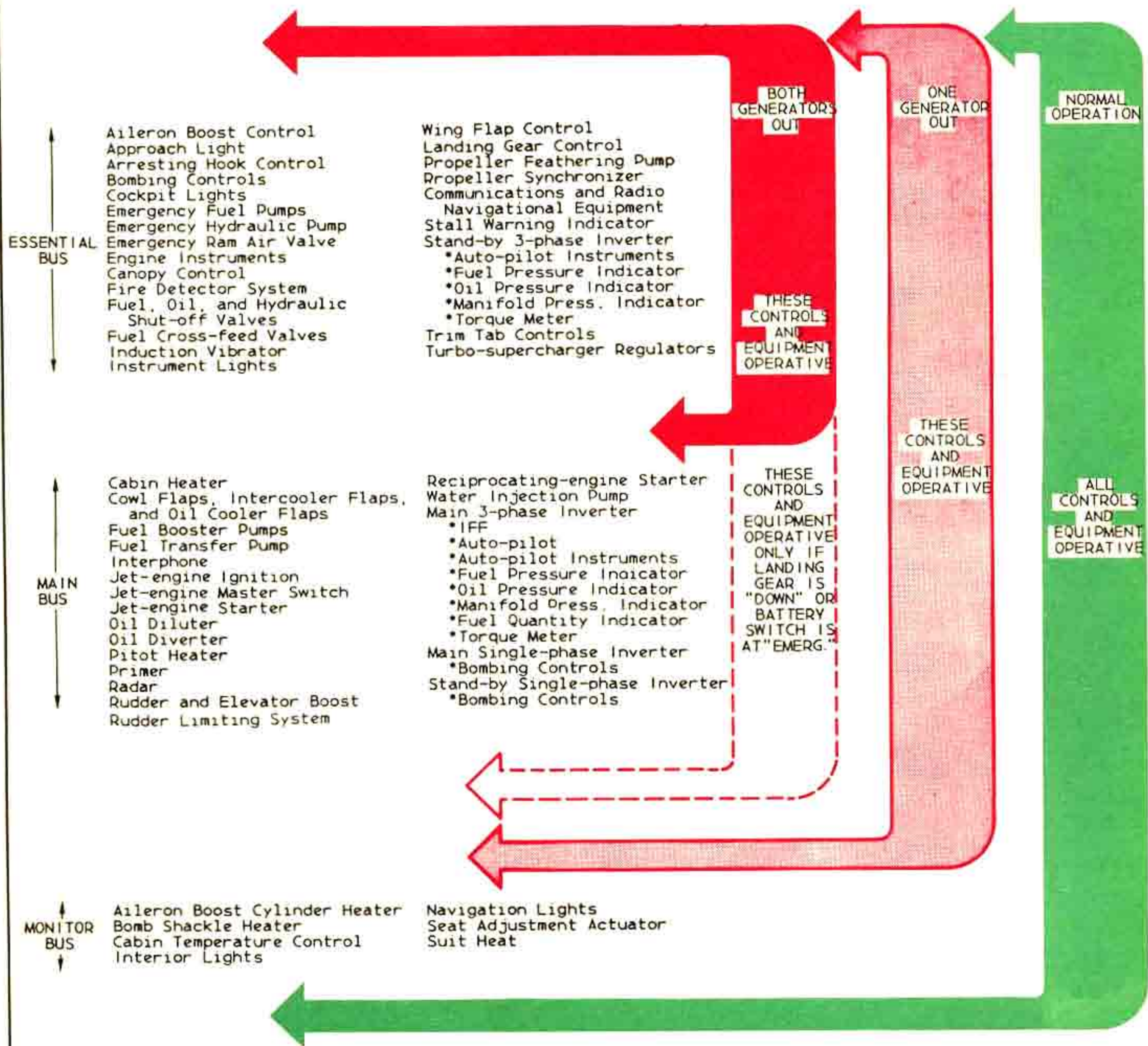

NOTE

Whenever landing gear is "DOWN," main bus equipment is connected to the essential bus. If both generators fail in flight, battery switch may be placed at "EMERG" and main bus equipment will be operative.

WARNING

Turn off all nonessential equipment before using this emergency procedure.

*Equipment operated on ac power

Figure 1-9. Electrically Operated Equipment

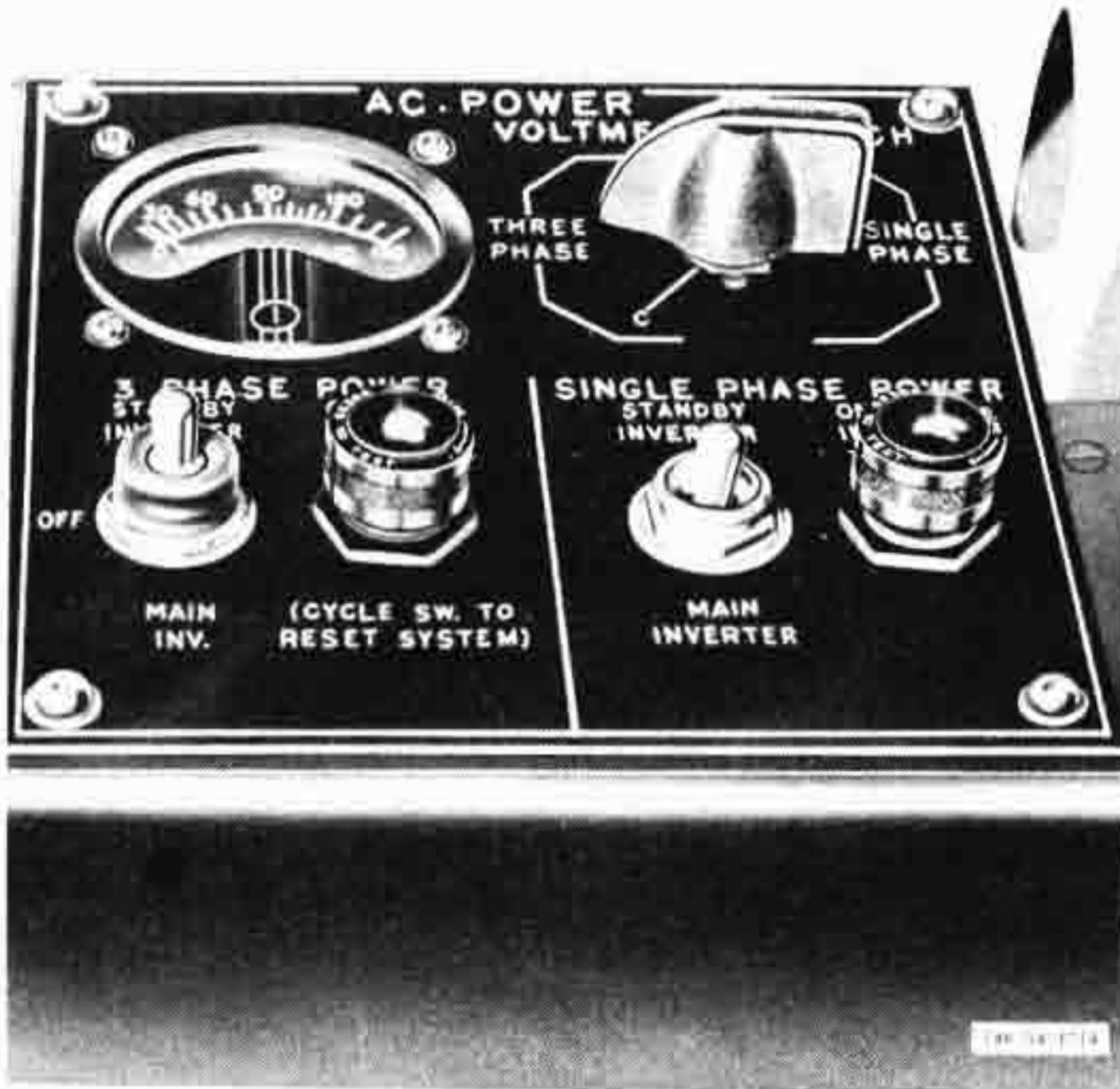

Figure 1-10. AC Power Control Panel

WARNING

In case of generator system failure, all non-essential loads should be turned off before the battery switch is placed in the "EMERG." position.

1-103. GENERATOR SWITCHES. Two generator switches are mounted on the pilot's pedestal, adjacent to the battery switch, and are marked "R.H." and "L.H." (See 6 and 7, figure 1-4.) Each switch has three positions, "ON," "OFF," and "RESET." The "RESET" position is provided for turning the generator on after it has been temporarily disconnected by an overvoltage relay.

1-104. GENERATOR EMERGENCY RESET. An "EMERGENCY RESET" button is mounted on each of two generator control panels (one for the generator on each engine) in the crew entry compartment. (See figure 1-11.) The related emergency reset button is to be used if a generator cannot be re-established in the circuit, at least momentarily, by moving the generator switch to the "RESET" position.

1-105. GENERATOR WARNING LIGHTS. Should generator voltage become excessive, an overvoltage relay automatically cuts the affected generator out of the electrical circuit. This condition is indicated by illumination of a red light, one for each generator, located above the volt-ammeter indicators. (See 17, figure 1-2.) An attempt may be made to turn the generator on again by placing the related generator switch momentarily at the "RESET" position, and back to "ON." If the light illuminates after being out momentarily, the overvoltage condition still exists and the generator is inoperative. However, if the light

cannot be extinguished even momentarily, the emergency reset button may be used. If the light still illuminates, the generator is inoperative.

1-106. INVERTER SWITCHES. Two switches for control of the inverters are mounted on the a-c power control panel. (See figure 1-10.) The switch marked "THREE PHASE POWER" has three positions, "MAIN INV.," "OFF," and "STANDBY INVERTER." A warning light adjacent to the switch is illuminated if the main inverter fails. Normally, the stand-by inverter automatically takes over when main inverter failure occurs. However, if the automatic control malfunctions, the stand-by inverter may be selected by positioning the switch at "STANDBY INVERTER."

NOTE

After checking the stand-by inverter, the inverter switch must be cycled to "OFF" and back to "MAIN INV." for normal operation. The instructional marking "CYCLE SW TO RESET SYSTEM" refers to this procedure.

The single-phase inverter switch on the a-c control panel has only two positions, "MAIN INVERTER" and "STANDBY INVERTER." If the main inverter fails, a warning light adjacent to the switch will illuminate, and the stand-by inverter will turn on. If the automatic control malfunctions, the switch must be positioned at "STANDBY INVERTER."

1-107. SPECIAL EQUIPMENT A-C POWER PANEL. A special equipment a-c power panel, located in the crew entry compartment (6, figure 4-9), contains a power switch guarded in the "OFF" position. A green light adjacent to the switch is illuminated when the switch is "ON." When the single-phase inverters



Figure 1-11. Generator Control Panel

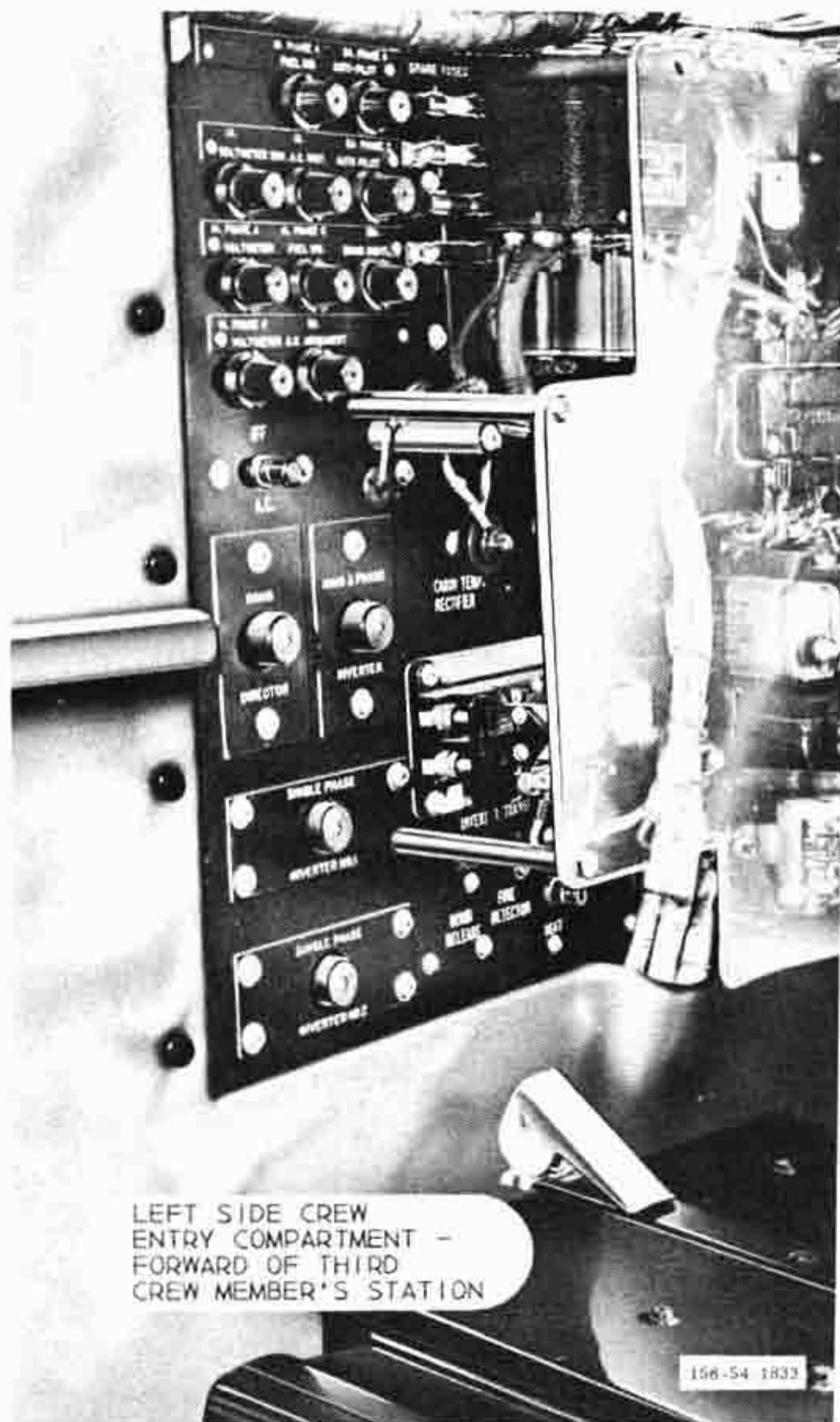

Figure 1-12. AC Fuse and Circuit Breaker Panel

are being checked, the special equipment a-c power switch must be turned "ON" temporarily while the cockpit switch is moved to "MAIN INVERTER" and "STANDBY INVERTER."

1-108. VOLTAGE REGULATORS. The voltage regulators are preset on the ground, but in an emergency may be adjusted in flight by means of two rheostats, one on each generator control panel. The rheostats are guarded by a fixed cover, held in place by one screw which must be removed for access to the rheostat.

1-109. CIRCUIT BREAKERS AND FUSES. Circuits in the direct-current system are protected by push-pull circuit breakers or circuit-breaker switches. Two circuit-breaker panels are located on the left side of the pilot's compartment; one near the left rudder pedal and the other above the fire detector panel. (See 29 and 57, figure 1-3.) Alternating-current circuits are protected by replaceable fuses and push-pull circuit breakers mounted on a panel at the

left side of the crew entry compartment. (See figure 1-12.)

1-110. POWER RECEPTACLES. Two external power receptacles are located on the right side of the fuselage, aft of the bomb bay. Two internal power receptacles are located in the crew entry compartment and are used in conjunction with operation of special equipment.

1-111. HYDRAULIC SYSTEMS.

1-112. The hydraulic systems in the airplane include a main or utility system, an emergency system and three surface control boost systems. (Refer to paragraph 1-136.)

1-113. HYDRAULIC FLUID SPECIFICATION.

1-114. Specification No. AN-O-366.

1-115. UTILITY HYDRAULIC SYSTEM.

1-116. The utility hydraulic system supplies power for normal operation of landing gear and fairing doors, wheel brakes, wing flaps, jet-engine air intake doors, bomb doors, cabin air compressor, canopy, and arresting gear hook. Operating pressure for the utility hydraulic system is provided by two variable-volume engine-driven pumps (New York Air Brake, Type 67WF300), one on each reciprocating engine. Fluid for the system is stored in a 4.4-gallon reservoir located in the forward section of the bomb bay. A system pressure gage is located above the hatch leading to the bomb bay from the crew entry compartment, and two fluid level indicators are mounted on the reservoir. In this system, fluid flows under pump pressure to the cabin air compressor unit and returns to the reservoir when no other unit in the system is being operated. When a unit in the system is operated, a selector valve controlling flow of fluid to the cabin air compressor is automatically energized, diverting fluid to valves for the other units in the system and turning the cabin air compressor off temporarily. Hydraulic selector valves which control the various units in the utility system are located in the crew entry compartment. (See figure 1-13.) Normally, these selector valves are electrically actuated by movement of controls provided in the pilot's compartment. In case of electrical failure, each valve can be manually operated.

NOTE

To operate a unit in the utility hydraulic system when no electrical power is available, two valves must be actuated: the valve controlling the unit which is to be operated, and the cabin air compressor valve. Both valves must be depressed and held until operation of the unit is completed.

1-117. CABIN AIR COMPRESSOR CIRCUIT GROUND TEST SWITCH. A switch for ground test of the cabin air compressor circuit is located on the aft bulkhead of the crew entry compartment. (See figure 1-13.) Normally, the cabin air compressor is off when landing

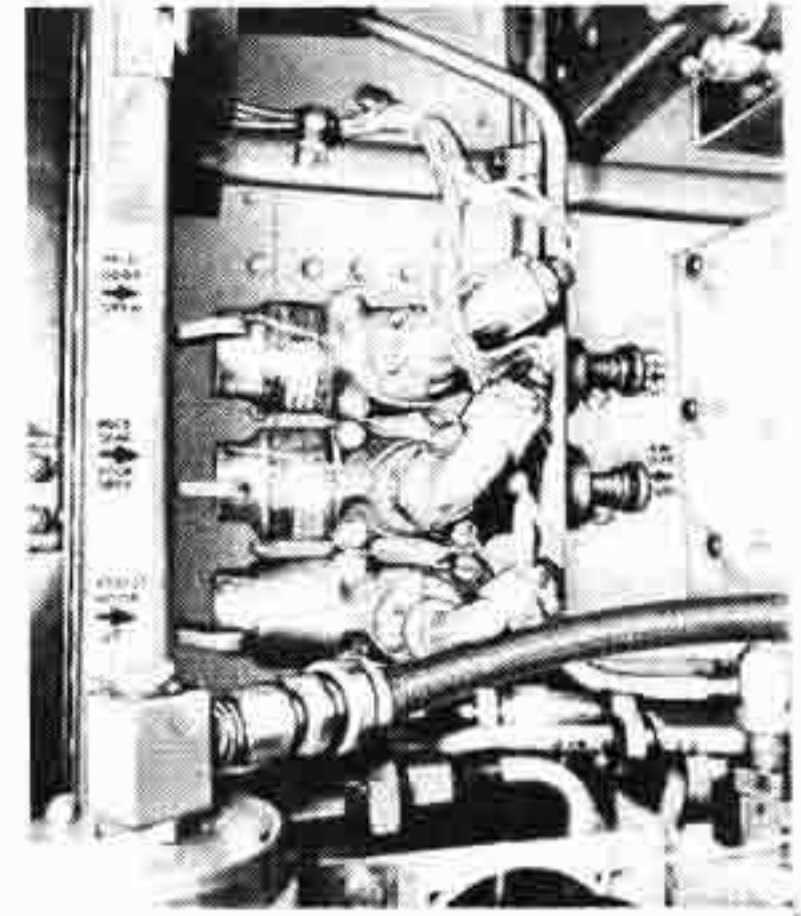
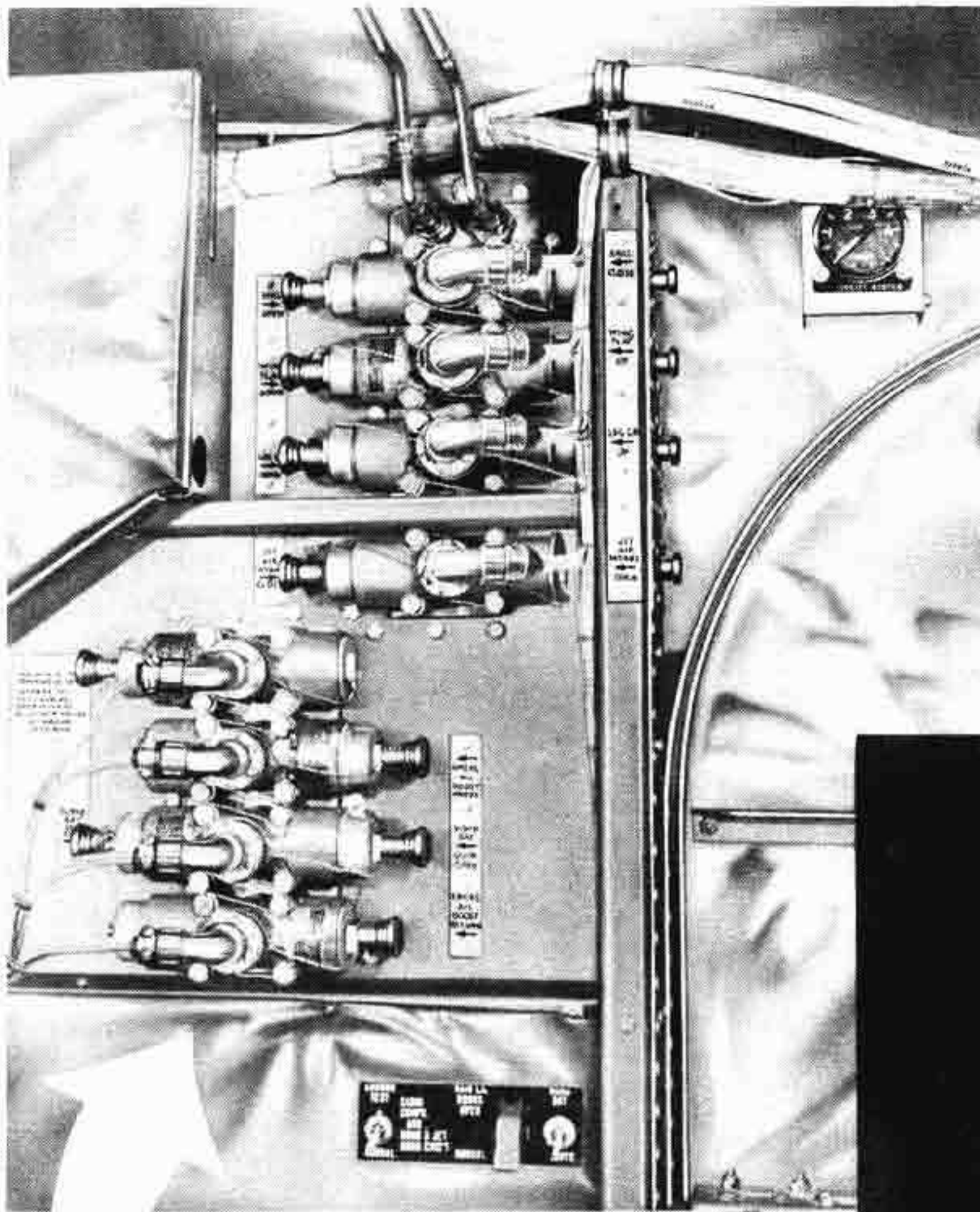

HYDRAULIC SELECTOR VALVES

HYDRAULIC SELECTOR VALVES

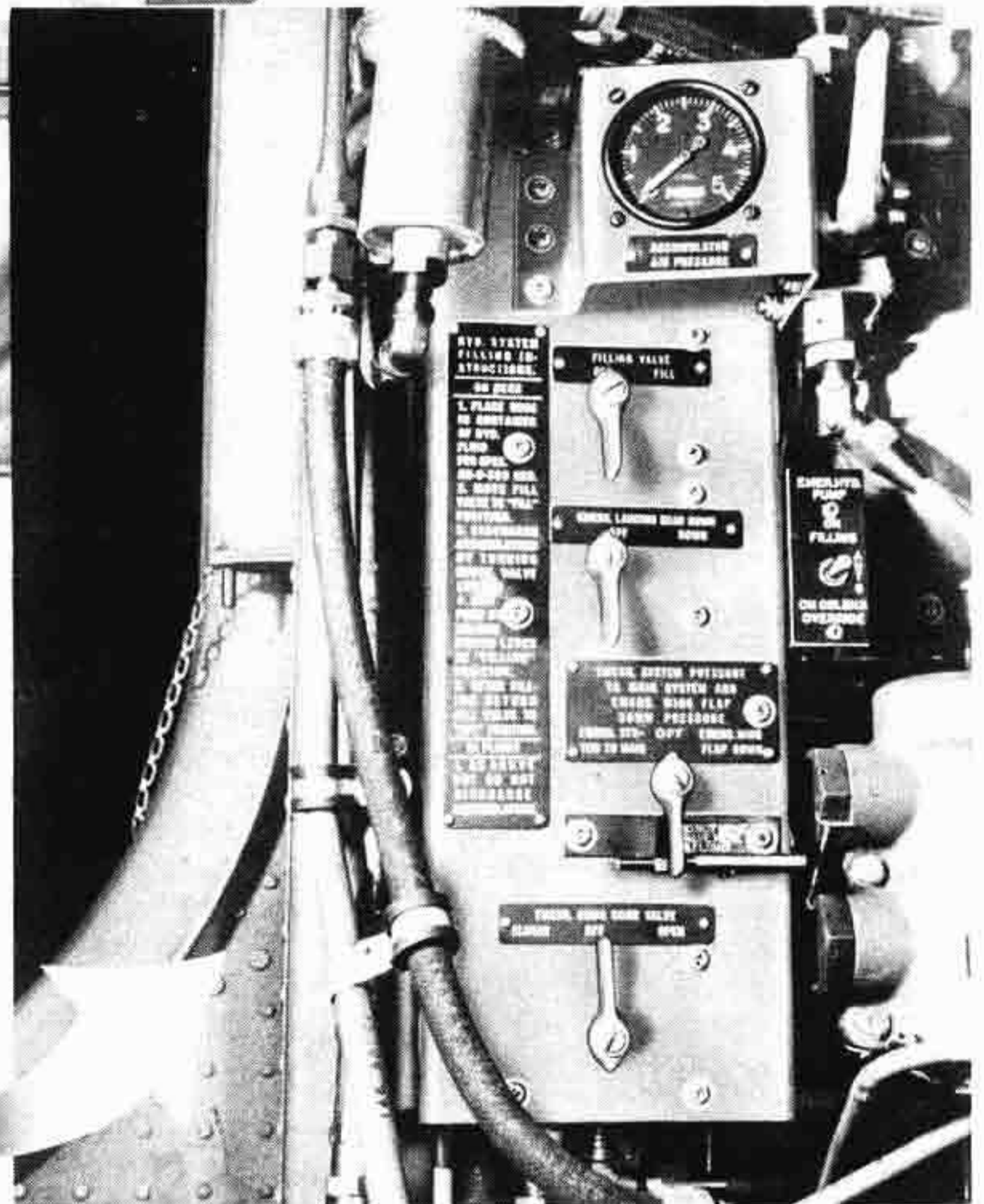

EMERGENCY HYDRAULIC PANEL

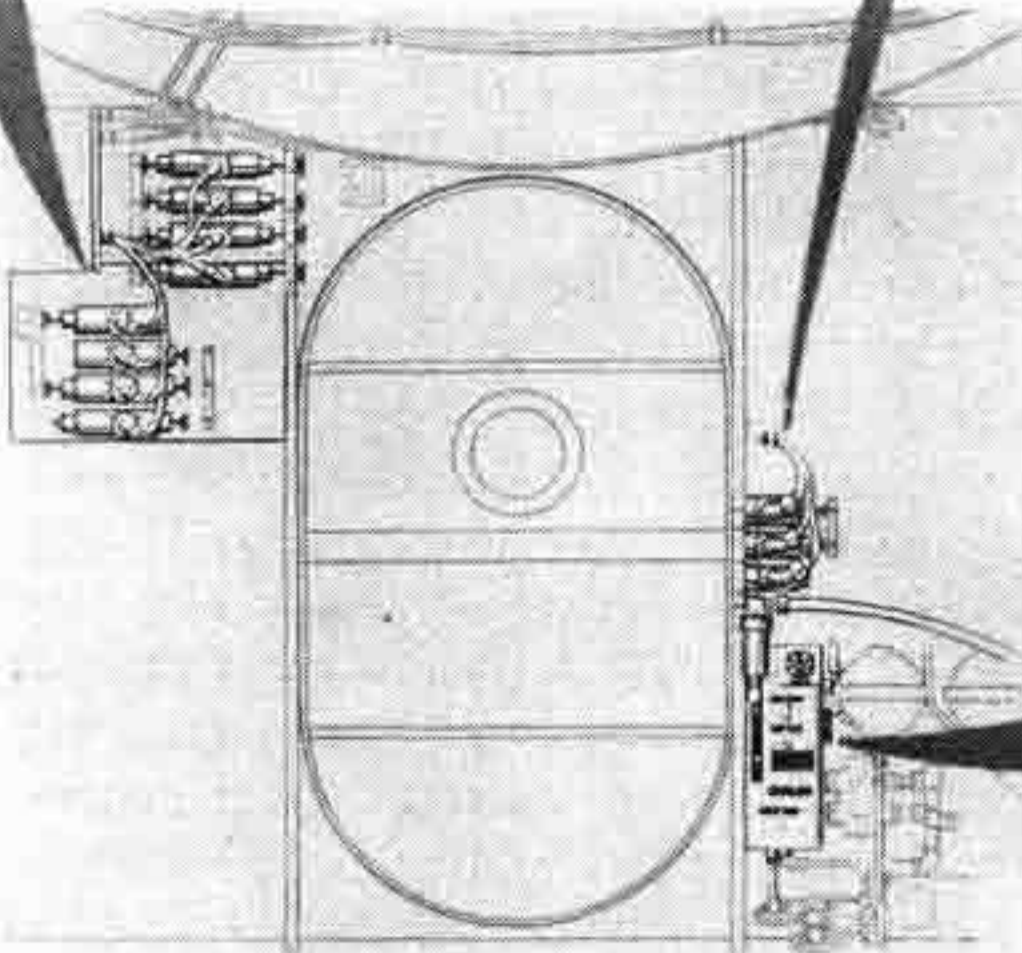

AFT BULKHEAD - CREW ENTRY COMPARTMENT

NOTE: Always attempt emergency hydraulic operation by means of emergency hydraulic valves before manually operating the hydraulic selector valves.

Figure 1-13. Emergency Hydraulic Controls

NOTES

- 1 Fluid flows to compressor when no other unit in utility system is being operated. Operation of another unit renders compressor inoperative temporarily.
- 2 When aileron boost switch is at "EMERG.." diverter valves are actuated to supply utility system pressure to aileron boost system and return fluid to utility reservoir; other units in utility system are inoperative. When switch is at "OFF," aileron boost by-pass valves open.
- 3 Hydraulically operated canopy - Airplanes 122590-122601 only.
- 4 Emergency pump automatically started when a valve on emergency hydraulic panel (except filling valve) is moved from "OFF."

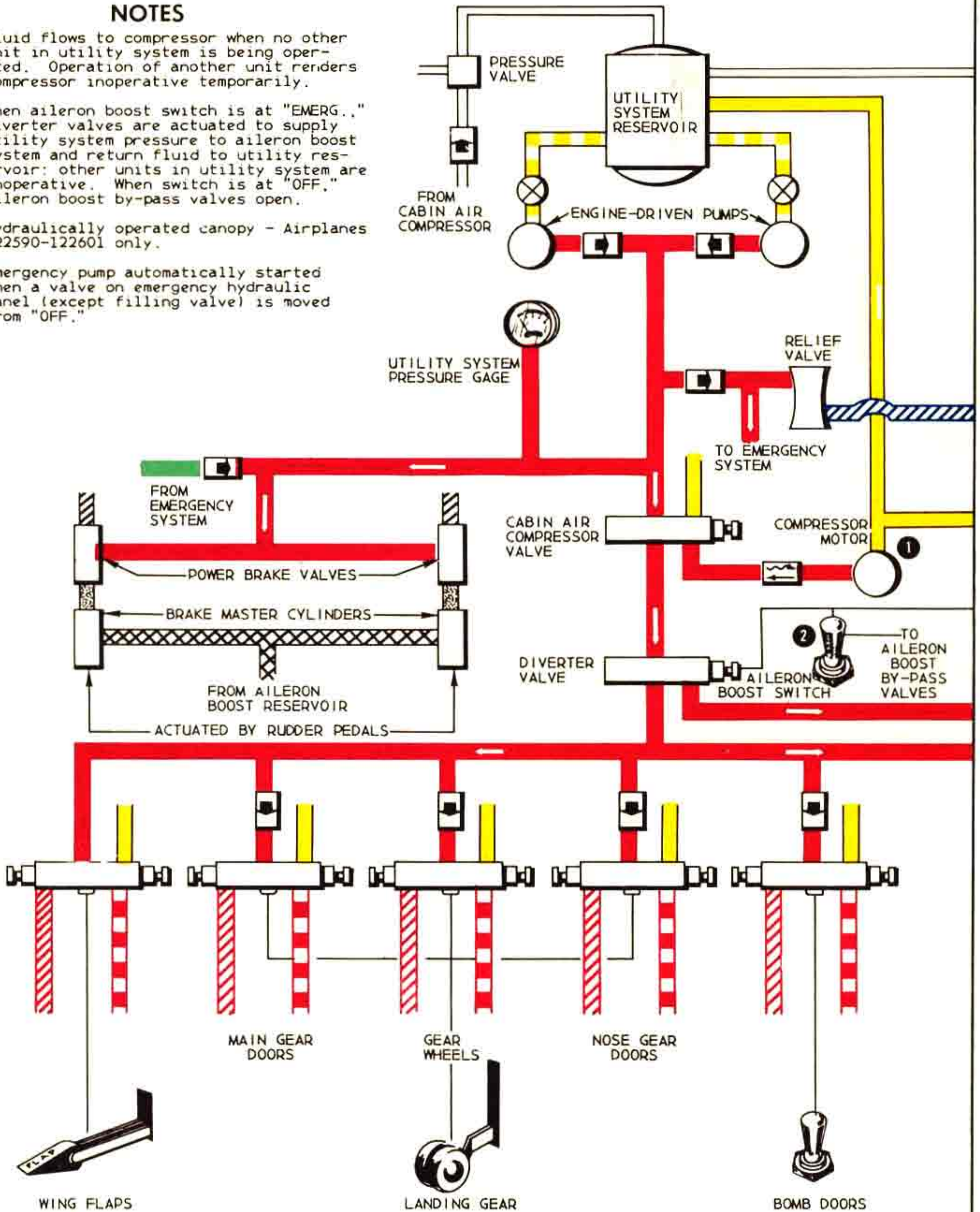

156-58-936

Figure 1-14 (Sheet 1 of 2 Sheets). Hydraulic System

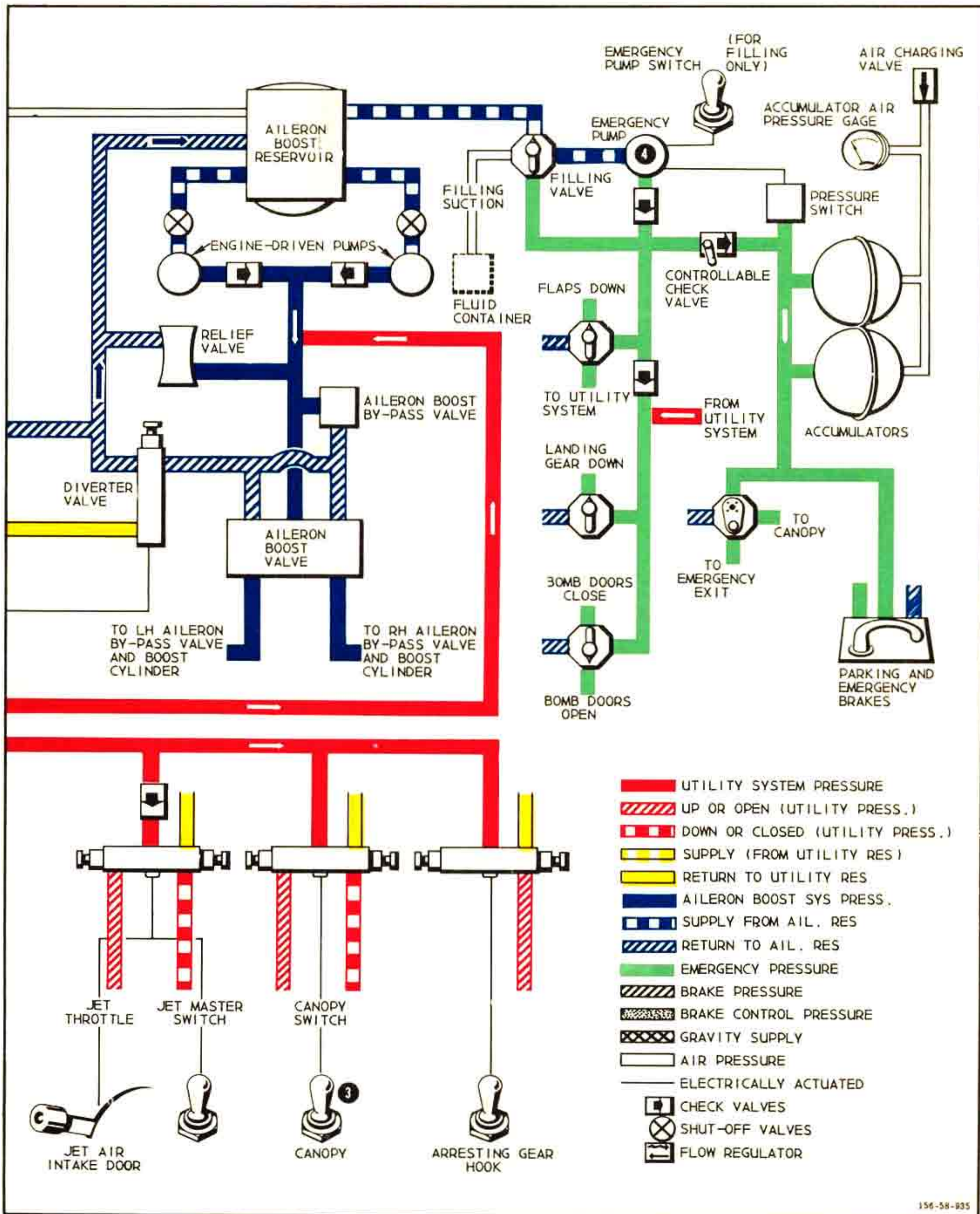

Figure 1-14 (Sheet 2 of 2 Sheets). Hydraulic System

gear is extended, assuring full pressure to the gear. When the switch is moved from "NORMAL" to "TEST," a flight condition is simulated and the cabin air compressor valve is de-energized, starting the compressor. The test switch is primarily for maintenance check.

1-118. EMERGENCY HYDRAULIC SYSTEM.

1-119. An electrically driven pump (Vickers, Type AA-19020) supplies pressure for emergency operation of the landing gear, wing flaps, bomb doors, canopy, crew exit door, and emergency and parking brakes. Fluid is supplied to the emergency pump from the aileron boost system reservoir, located next to the utility system reservoir in the bomb bay. Two fluid level indicators are mounted on the reservoir. The canopy, crew exit door, and parking brake are operated by pressure from two accumulators, making these three units operable when neither hydraulic pressure nor electrical power is available. An accumulator air pressure gage is mounted on the hydraulic emergency panel, located on the right side (facing aft) of the hatch leading to the bomb bay. The various units operated by the emergency system are controlled by manual operation of emergency selector valves in the crew entry compartment. (See figure 1-13.)

NOTE

Before operating an emergency selector valve, the proper normal system circuit breaker should be pulled out. This procedure is necessary, as the equipment operated by emergency pressure may return to the position preselected in the cockpit when utility system failure is due only to a momentary restriction in the lines.

1-120. EMERGENCY HYDRAULIC PUMP SWITCH.

An emergency pump switch, located on the emergency hydraulic panel (figure 1-13), controls the electric emergency pump. Normally, the switch is at "AUTO," and the electric pump will automatically start operating whenever a hydraulic emergency valve on the emergency panel is moved from "OFF" to an operating position, or accumulator pressure drops to 2550 psi. A spring-loaded "ON FILLING" position of the switch is used when the pump is operated for reservoir filling purposes. The third position for the emergency pump switch, "ON CIR BKR OVERRIDE" (circuit breaker), should be used only in an extreme emergency, as the continuous electrical overload which originally caused the circuit breaker to function could cause the equipment to become completely inoperative.

1-121. EMERGENCY REFILLING VALVE. If necessary, the hydraulic reservoirs can be refilled in flight. A filling hose is stowed at the top of the emergency hydraulic panel (figure 1-13), to provide for filling reservoirs from a 5-gallon container. A filling valve at the top of the panel, when moved from "OFF" to "FILL," allows fluid to be pumped from the container to the reservoirs when the emergency pump switch is held at "ON FILLING."

1-122. EMERGENCY SYSTEM TO MAIN SYSTEM VALVE. A valve on the emergency hydraulic panel is marked "EMERG. SYSTEM TO MAIN," and when operated, directs emergency pressure to the utility system lines. This valve is provided primarily for a ground check of hydraulic system operation and should not be used for emergency purposes in flight, as it could cause all hydraulic fluid to be pumped overboard through a damaged line or unit.

1-123. HYDRAULIC SHUT-OFF VALVES.

1-124. To shut off the flow of hydraulic fluid to the engine-driven hydraulic pumps in case of fire, two electric-motor-actuated shut-off valves are mounted at the firewall of each engine. The valves, one in each hydraulic pump suction line, are controlled by the emergency engine control switches. (See 39, figure 1-3.) When the switches are at "NORMAL ON," the valves are open; when switches are at "FUEL AND OIL SHUT OFF," the valves are closed and hydraulic fluid does not flow to the pumps.

1-125. FLIGHT CONTROLS.

1-126. Primary flight controls are conventionally operated; however, hydraulic boost systems supply boost assistance to the ailerons, elevators, and rudder, reducing the amount of force required for the movement of controls. Surface controls may be locked in the neutral position by operation of a single lever in the cockpit.

1-127. CONTROL STICK.

1-128. The control stick is of conventional design, and is equipped with a pistol-type handgrip. A thumb slide-switch for control of the elevator trim tab is mounted near the top of the grip. (See 26, figure 1-3.)

1-129. STALL WARNING SYSTEM. A stall warning system installed in the airplane consists of a static and a pressure air vent on the upper surface of the right wing, a pressure switch, and an electric motor attached to the control stick. When a stall condition is approached, the decrease in pressure differential between the two vents closes the pressure switch, energizing the electric motor, and causing the stick to shake. When the weight of the airplane is on the gear, the system is rendered inoperative through connection with a landing gear ground safety switch.

1-130. RUDDER PEDALS.

1-131. Rudder pedals are adjustable, fore and aft, by means of a rudder pedal adjustment handle, located on a panel forward of the control stick. (See 27, figure 1-2.) When the adjustment handle is pulled up, both pedals can be adjusted simultaneously by moving either pedal to desired position.

NOTE

When rudder pedals are adjusted to the full

forward, or "rest" position, rudder travel is restricted to 9 degrees either side of neutral, which is inadequate at airspeeds below 200 knots (IAS). Therefore, for flight in gusty air, or for maneuvers at airspeeds below 200 knots, rudder pedals should not be in "rest" position, whether the airplane is being flown manually or on automatic pilot.

1-132. RUDDER LIMITING SYSTEM.

1-133. An electrical rudder limiting system prevents rudder deflection beyond a safe allowable maximum by regulating the amount of rudder boost pressure available at different airspeeds. At airspeeds below 220 knots IAS, full rudder boost pressure is available; however, if rudder deflection exceeds a predetermined safe allowable limit, a boost pressure relief valve is actuated to relieve all rudder boost pressure. The allowable limit of rudder deflection (point at which rudder boost becomes ineffective) varies with indicated airspeed. Below 100 knots IAS, full rudder travel is available, but as airspeed is increased, the available rudder travel gradually decreases to 15 degrees at 140 knots IAS and 7.5 degrees at 200 knots IAS. At airspeeds above 220 knots, a boost limiting valve is automatically actuated to reduce boost pressure to one-half normal value. High control forces then prevent the pilot from exceeding the safe allowable maximum of rudder deflection.

1-134. RUDDER LIMITING TEST SWITCH. To check operation of the rudder limiting system, a test switch is provided above the left console. (See 54, figure 1-3.) When the test switch is moved to "ON," test resistors create a condition within the rudder limiting system that is similar to a flight condition of 140 knots. As 15 degrees rudder deflection is the safe limit for 140 knots, rudder pedal may be moved half of full travel to check that rudder boost becomes ineffective at this point. The system should be checked before take-off, and may be checked in flight. (Refer to paragraph 2-41.)

WARNING

The rudder limiting test switch should not be moved to "ON" when at an airspeed above 140 knots IAS. When the test switch is "ON," rudder boost remains effective until rudder is deflected 15 degrees, regardless of actual indicated airspeed, and the safe limit of rudder deflection may be exceeded.

1-135. SURFACE CONTROL BOOST SYSTEMS.

1-136. Three individual hydraulic systems supply surface control boost pressure in a ratio directly proportional to the forces required to overcome surface loads. Each system contains its own hydraulic fluid reservoir, the aileron reservoir having a fluid capacity of 4.74 gallons, and the rudder and elevator reservoirs each a fluid capacity of approximately one quart. Operating pressure is supplied to the aileron

boost system by two constant-volume engine-driven pumps (New York Air Brake, Type 67WB200), one on each reciprocating engine. Three electrically operated by-pass valves, controlled by one switch in the pilot's compartment, are provided to eliminate fluid friction when the aileron boost is inoperative and the ailerons must be operated manually. The rudder and elevator boost systems each have an electric pump (Vickers, Type AA-19021) to supply operating pressure. A by-pass valve is installed in each system (rudder and elevator), and is automatically operated by fluid pressure to eliminate fluid friction in case of boost system failure.

1-137. AILERON BOOST SWITCH. An aileron boost switch, mounted on a panel above the left console (2, figure 1-3), is guarded in the "NORMAL" position for normal operation. In case of failure of the aileron boost system, the switch is positioned at "EMERG." for operation of the aileron boost system with utility system pressure.

NOTE

When the aileron boost switch is at "EMERG.," no hydraulic pressure is available for other units operated by utility system pressure.

When it is impractical to use main system pressure for emergency operation, the switch should be positioned at "OFF" to open the aileron boost by-pass valves.

1-138. AILERON MECHANICAL RATIO CONTROL HANDLE. A mechanical ratio control handle, located on the left console (42, figure 1-3), has two positions, "NORMAL" and "BOOST OUT 2 to 1." When aileron boost is in operation, the control handle is placed at "NORMAL." When aileron boost is inoperative, the handle may be placed to "BOOST OUT 2 to 1" to obtain a mechanical advantage of 2 to 1 for ease of aileron movement. The aileron control ratio mechanism is held in the selected position by an automatic lock.

WARNING

When aileron mechanical ratio control handle is at "BOOST OUT 2 to 1," aileron travel is restricted to one-half of normal travel.

1-139. FLIGHT CONTROL BOOST SWITCHES (RUDDER AND ELEVATOR). Two flight control boost switches, one for elevator boost and one for rudder boost, are mounted on the power control quadrant. (See 14 and 15, figure 1-3.) The switch should be placed at "ON NORMAL" for normal operation. In case of failure of either rudder or elevator boost system, the related switch should be moved to "OFF." In case an electrical overload trips the remotely controlled circuit breaker for either rudder or elevator boost, a "CIR. BRKR. OVERRIDE" position for each switch is provided for emergency use. The switch must be held in that position to override the circuit breaker.

1-140. **SURFACE CONTROL (AND THROTTLE) LOCK HANDLE.** A locking mechanism for each surface control is operated by a single handle on the left console. (See 35, figure 1-3.) When the surface control lock handle is in the "LOCK" position, the surface controls are held in neutral, the throttles are locked in the "CLOSED" position, and the boost systems are automatically turned off. The surface control locks cannot be engaged when any throttle is advanced.

1-141. **TRIM TABS.**

1-142. Elevator, aileron, and rudder trim tabs are electrically operated, and controlled manually by a trim tab control stick on the left console. (See 40, figure 1-3.) The trim tab control stick is moved fore and aft to operate elevator trim tab, sideways for aileron trim, and is rotated left or right for rudder trim. A thumb slide-switch, mounted on the grip of the control stick is an additional elevator trim tab control, and may be rotated fore or aft for a corresponding nose-down or nose-up airplane attitude. An indicator for trim tab position is located on the left console, adjacent to the trim tab control stick. (See 53, figure 1-3.)

1-143. **WING FLAPS.**

1-144. **NORMAL WING FLAP CONTROL.**

1-145. Electrically controlled, hydraulically actuated wing flaps on each wing panel extend from aileron to nacelle, and from nacelle to fuselage. A wing flap control handle is located on the power control quadrant. (See 9, figure 1-3.) Indentations at the top and bottom of the lever guide are provided to secure the lever in full "UP" or full "DOWN" positions. A flap position indicator, located on the pilot's instrument panel (39, figure 1-2), is marked "UP," "1/2" and "DOWN" with a line at the 1/4 and 3/4 positions. As the flap control is marked only "UP" and "DOWN," intermediate flap positions must be selected by correlating movement of the flap handle with the flap position indicator. The flaps remain in the selected position until the flap handle is repositioned.

1-146. **EMERGENCY WING FLAP CONTROL.**

1-147. In the event of main hydraulic system failure, the flaps can be lowered by means of the emergency wing flap down valve, located on the emergency hydraulic panel in the crew entry compartment. By positioning the valve handle at "EMERG. WING FLAP DOWN" (after pulling out "LANDING FLAP VALVE" circuit breaker), the emergency hydraulic pump is actuated, and emergency system pressure operates the flaps to the full down position. To obtain an intermediate flap position, the valve handle must be turned "OFF" when flaps are at desired position. There is no emergency means for raising flaps when main hydraulic pressure is not available. If hydraulic pressure is available, but electrical power is lost, the flaps may be raised or lowered (after pulling out "LANDING FLAP VALVE" circuit breaker) by depressing the manual control knob on the cabin air compressor selector valve and the wing flap selector

valve. Both knobs must be held in the depressed position until desired flap position is reached.

1-148. **AUTOMATIC PILOT.**

1-149. An electrically operated automatic pilot (Type P-1) is installed in the airplane. The following automatic pilot flight instruments are mounted on the pilot's instrument panel: gyro horizon indicator, turn-and-bank indicator, and master direction indicator. (See 6, 20, and 40, figure 1-2.) Alternating current for operation of the automatic pilot is supplied by the main three-phase inverter, and direct current by the main bus. Alternating-current power is supplied to the automatic pilot flight instruments from the main three-phase inverter even when the automatic pilot is off. In case of main inverter failure, the stand-by inverter supplies power for operation of the flight instruments, but not for automatic pilot operation.

1-150. **AUTOMATIC PILOT CONTROLS.**

1-151. Controls for the automatic pilot are located on a panel on the pilot's pedestal, with the exception of the auto-pilot emergency release handle.

1-152. **AUTOMATIC PILOT CLUTCH SWITCH.** A clutch switch, mounted on the automatic pilot control panel (20, figure 1-4), is provided to engage or disengage all the clutches in the automatic pilot system. The clutch switch is marked "PUSH AUTO PILOT ON." When the switch is placed in the "ON" position, it is held in place by a solenoid, and the automatic pilot takes over in whatever attitude the airplane is in when the clutch is engaged. However, the clutch should not be engaged when the airplane is in a turn, or a bank of more than 10 degrees.

1-153. **AUTOMATIC PILOT CONTROLLER.** While under automatic pilot control, the airplane may be made to climb, dive, and execute coordinated turns by means of a controller, provided on the automatic pilot control panel. (See 23, figure 1-4.) The controller is a single unit containing three controls. A pitch trim wheel may be turned "UP" or "DOWN" to change the airplane's angle of attack within a limit of 40 degrees either way. A bank trim wheel may be turned toward "L" or "R" to increase or decrease the bank up to 10 degrees in either direction. A small control stick on top of the controller may be moved right or left to produce a coordinated turn in the selected direction. Normally, the stick is locked in the neutral position and must be released for movement by depressing a release button on top of the stick. As long as the release button is depressed, the stick can be moved freely; when the button is released, it locks the stick in the selected position. When the stick is off-center, the lock can be overpowered when necessary by exerting force on the stick, but when the stick is in neutral, the lock is positive and cannot be overpowered.

1-154. **AUTOMATIC PILOT EMERGENCY RELEASE.** In case of electrical failure, the automatic pilot may be mechanically disengaged by pulling up on the "AUTO PILOT EMERGENCY RELEASE" handle, located

on a panel forward of the control stick. (See 31, figure 1-2.) When automatic pilot has been disengaged by emergency release, it cannot be re-engaged in flight.

1-155. PILOT'S DIRECTION INDICATOR SWITCH. On Airplanes 122593 and subsequent, a pilot's direction indicator switch is located on the automatic pilot control panel. (See 22, figure 1-4.) The switch can be positioned "ON" or "OFF" for operation of pilot's direction indicator, located on instrument panel. (See 9, figure 1-2.)

1-156. PILOT'S DIRECTION INDICATOR-BOMB SIGHT TIE-IN SWITCH. On Airplanes 122593 and subsequent, an "ON-OFF" switch on the automatic pilot control panel (21, figure 1-4) is provided to tie in the pilot's direction indicator and the bombing equipment. The switch may be used to transfer airplane directional control to the bomber-navigator.

1-157. LANDING GEAR.

1-158. The landing gear and fairing doors are hydraulically actuated and electrically controlled; the main gear retracts aft into the nacelles, and the nose gear retracts aft into the fuselage. The nose gear assembly incorporates a conventional shimmy damper and a self-centering device which is effective within a range of 20 degrees right or left of center. The main gear fairing doors close after extension or retraction of the gear, but the nose gear door closes only when nose gear is retracted. For maintenance purposes, the main landing gear doors can be left open after extension of landing gear. A switch located on the aft bulkhead of the crew entry compartment (figure 1-13) can be moved from "NORMAL" to "MAIN LG DOORS OPEN" for this purpose. A safety switch on the landing gear prevents retraction of the landing gear when the weight of the airplane is on the oleo strut.

1-159. NORMAL LANDING GEAR CONTROL.

1-160. The gear is operated normally by the landing gear control handle on the left side of the cockpit. (See 22, figure 1-3.) When the control handle is placed in the "UP" or "DOWN" position, fairing doors open fully, gear travels to the desired position and locks, and fairing doors close. If the control handle is moved to "UP" when the airplane is on the ground, the gear will not retract because of the safety switch. If the weight of the airplane is removed from the wheels while the control handle is in the "UP" position, the gear will not retract until handle is moved to "DOWN" and back to "UP."

1-161. EMERGENCY LANDING GEAR RELEASE.

1-162. The landing gear may be lowered in the event of hydraulic system failure by operation of an emergency landing gear down valve, located on the emergency hydraulic panel. When the valve handle is moved to "DOWN" (after pulling out "LANDING GEAR CONTROL" circuit breaker), emergency fluid pressure is directed to the down side of the landing gear actuating cylinders. With the first movement of the gear, the fairing doors are mechanically unlocked and are

opened by the weight of the gear. If failure of normal gear operation is due to complete electrical failure (rendering electric gear control system and emergency hydraulic pump inoperative), but utility system hydraulic pressure is available, pressure will automatically be supplied by the utility system through emergency system lines when the emergency valve is "DOWN."

1-163. The preceding emergency procedure should always be employed first when normal gear operation fails. However, in case of electrical failure, but with utility system pressure available, the gear may be lowered or raised (after pulling out "LANDING GEAR CONTROL" circuit breaker) by depressing and holding "OFF" the cabin air compressor selector valve and holding the fairing door valves at "OPEN" until doors are fully open. With the cabin air compressor valve still held at "OFF," the landing gear valve must be held at "UP" or "DOWN" as desired, until lock engages. By the same procedure, the main gear fairing doors may be closed. (Nose wheel fairing doors do not close when gear is lowered.)

1-164. LANDING GEAR POSITION INDICATORS.

1-165. The position of the landing gear is shown by a wheel position indicator mounted on the pilot's instrument panel. (See 39, figure 1-2.) When the gear is up and the fairing doors closed, the word "UP" appears in the indicator windows. When the gear is extended and locked, wheels appear in the indicator windows. Any unlocked condition when the gear is extended, or failure of the wheel doors to close during the retraction cycle, is indicated by yellow and red cross marks in the indicator windows.

1-166. LANDING GEAR WARNING LIGHT.

1-167. A light on the pilot's instrument panel marked "LANDING GEAR NOT LOCKED" (42, figure 1-2), illuminates whenever the landing gear is unlocked. As soon as the gear is locked (either up or down), the light is extinguished.

1-168. WHEEL BRAKES.

1-169. Hydraulic brakes on the main wheels are conventionally operated by toe pedals. The parking brake handle is located on a panel forward of the control stick. Emergency operation of both wheel brakes is accomplished by manual operation of the parking and emergency brake handle. (See 28, figure 1-2.)

NOTE

Brakes cannot be applied selectively by means of the parking and emergency brake handle.

1-170. CANOPY.

1-171. Airplanes 122590 through 122601 are equipped with a sliding canopy, hydraulically operated and electrically controlled. Airplanes 122602 and subsequent are provided with a fixed canopy which has two sliding panels, one on either side of the pilot's compartment.

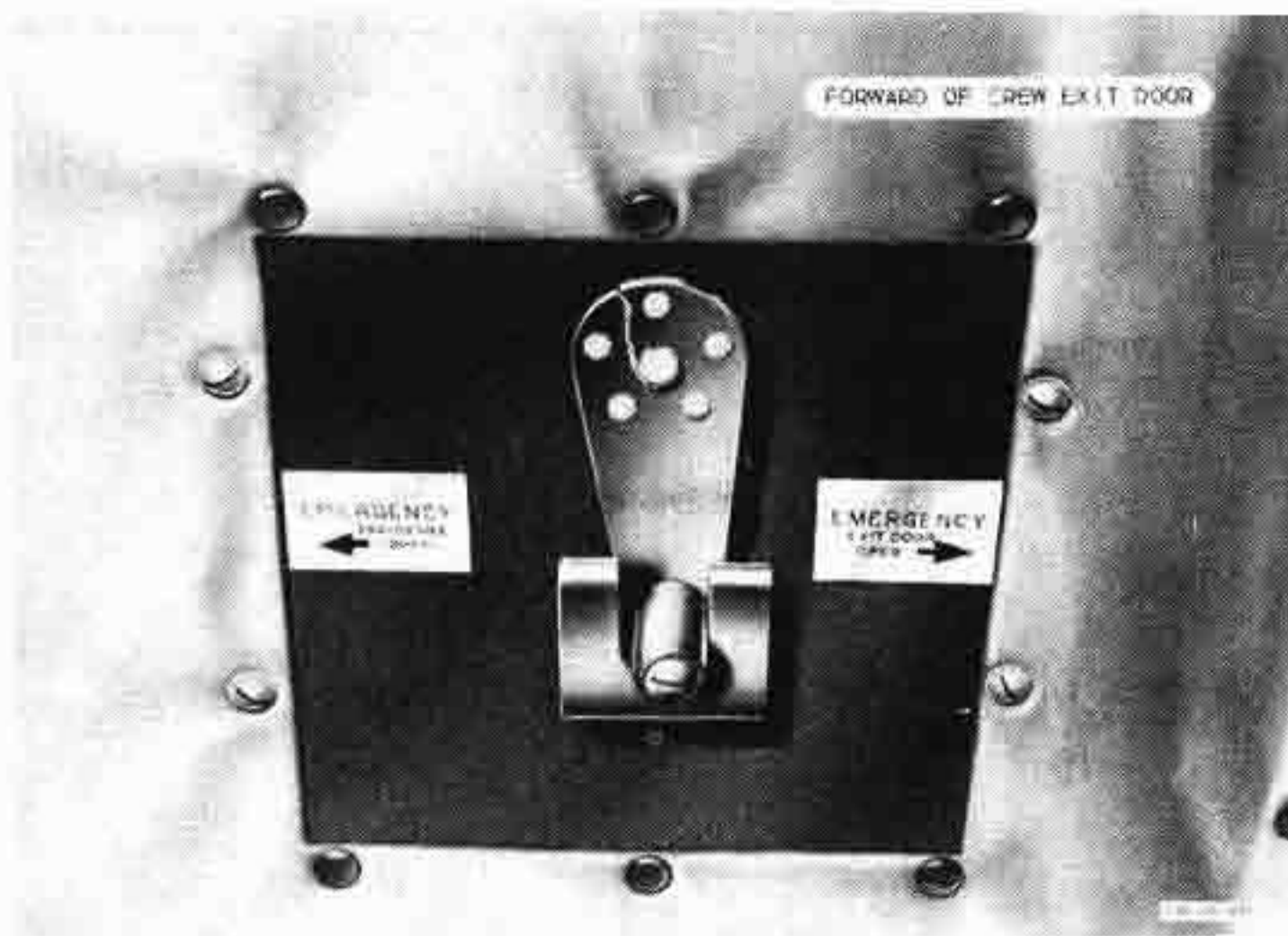

Figure 1-15. Emergency Exit Door and Canopy Valve

1-172. SLIDING CANOPY (AIRPLANES 122590 THROUGH 122601).

1-173. The sliding canopy is controlled by a toggle switch located above the left console. (See 6, figure 1-3.) The canopy switch must be held at "OPEN" or "CLOSE" until the canopy reaches the desired position. Two controls are provided for emergency operation of the canopy, one located in the pilot's compartment and one in the crew entry compartment. Each control has an alternate position for emergency operation of the crew exit door. The emergency exit lever in the pilot's compartment is installed on the floor under the bomber-navigator's seat, within reach of pilot and bomber-navigator. When the lever is moved forward to "OPEN CANOPY," the canopy opens fully under accumulator air pressure, and locks. The control in the crew entry compartment for emergency operation of canopy and exit door is located just forward of the crew exit door. (See figure 1-15.) When the valve handle is positioned at "ENCLOSURE OPEN," the canopy opens fully under accumulator air pressure, and locks.

WARNING

If both canopy and crew exit door are to be opened, canopy should be opened first, as operation of canopy requires more accumulator pressure than the door. If the door is opened first, canopy may not open fully.

A release handle for disengaging the canopy actuator mechanism is located in the aft portion of the pilot's compartment, and is to be used for maintenance and ground operation only.

1-174. FIXED CANOPY (AIRPLANES 122602 AND SUBSEQUENT).

1-175. The fixed canopy has two sliding panels, one

on either side of the enclosure, which may be manually opened and closed. Each panel has two control handles: a lock handle, located on the forward part of a slide track; and a panel control handle, located on the forward part of the panel. (See figure 3-4.) When the lock handle is in the forward position, the sliding panel is locked closed; when lock handle is pulled aft, panel is unlocked and can be slid aft and open by means of the panel control handle. The panel control handle must be squeezed before panel can be moved on the track; when handle is released, the panel automatically locks in the selected position.

1-176. EQUIPMENT INSTALLATION PANEL. A panel of the enclosure, adjacent to the right-hand sliding panel and above the bomber-navigator's station, may be removed for installation of equipment. To remove the equipment installation panel, the right-hand sliding panel must be opened and the forward upper track of the sliding panel must be removed by pulling two lockpins. Then, when two latches securing the equipment installation panel are opened, the panel can be lowered into the pilot's compartment.

1-177. ARRESTING GEAR HOOK.

1-178. The arresting gear hook, located on the bottom of the aft part of the fuselage, is lowered by free fall and by air pressure, and is retracted by a hydraulically operated cylinder. The arresting gear hook handle is located on the pilot's pedestal (4, figure 1-4), and is marked "PULL TO RELEASE." Two lights mounted forward of the release handle indicate the position of the arresting gear hook. (See 1 and 3, figure 1-4.) The red light is illuminated whenever the hook is in an intermediate or unsafe position. When the hook is extended, the green light is illuminated and the red light extinguished. For retraction of the hook, a toggle switch is mounted forward of the lights. (See 2, figure 1-4.) The switch is marked "TO RETRACT" and "OFF." The switch is held at the "TO RETRACT" position until both lights are extinguished, indicating that the arresting gear hook is up and locked. A switch for ground crew operation of the arresting gear hook is located on the aft part of the fuselage on the right side.

1-179. CATAPULT EQUIPMENT.

1-180. Provisions for catapulting the airplane from a carrier deck consist of a catapult hook and a holdback fitting. The hook is located just aft of the nose wheel well, and the holdback fitting is aft of the bomb bay. Holdback fitting and hook are faired by small doors when in the retracted position. The hook can be extended by pulling a manual release handle located to the left of the hook. When the nose gear is retracted, the hook retracts automatically. The holdback fitting can be extended manually by pushing a handle in the holdback fairing door. After airplane is released, the holdback fitting retracts automatically. A throttle catapult handle is located forward of the throttle quadrant. (See 19, figure 1-3.)

1-181. WING AND VERTICAL FIN FOLDING.

1-182. To facilitate storage of the airplane aboard

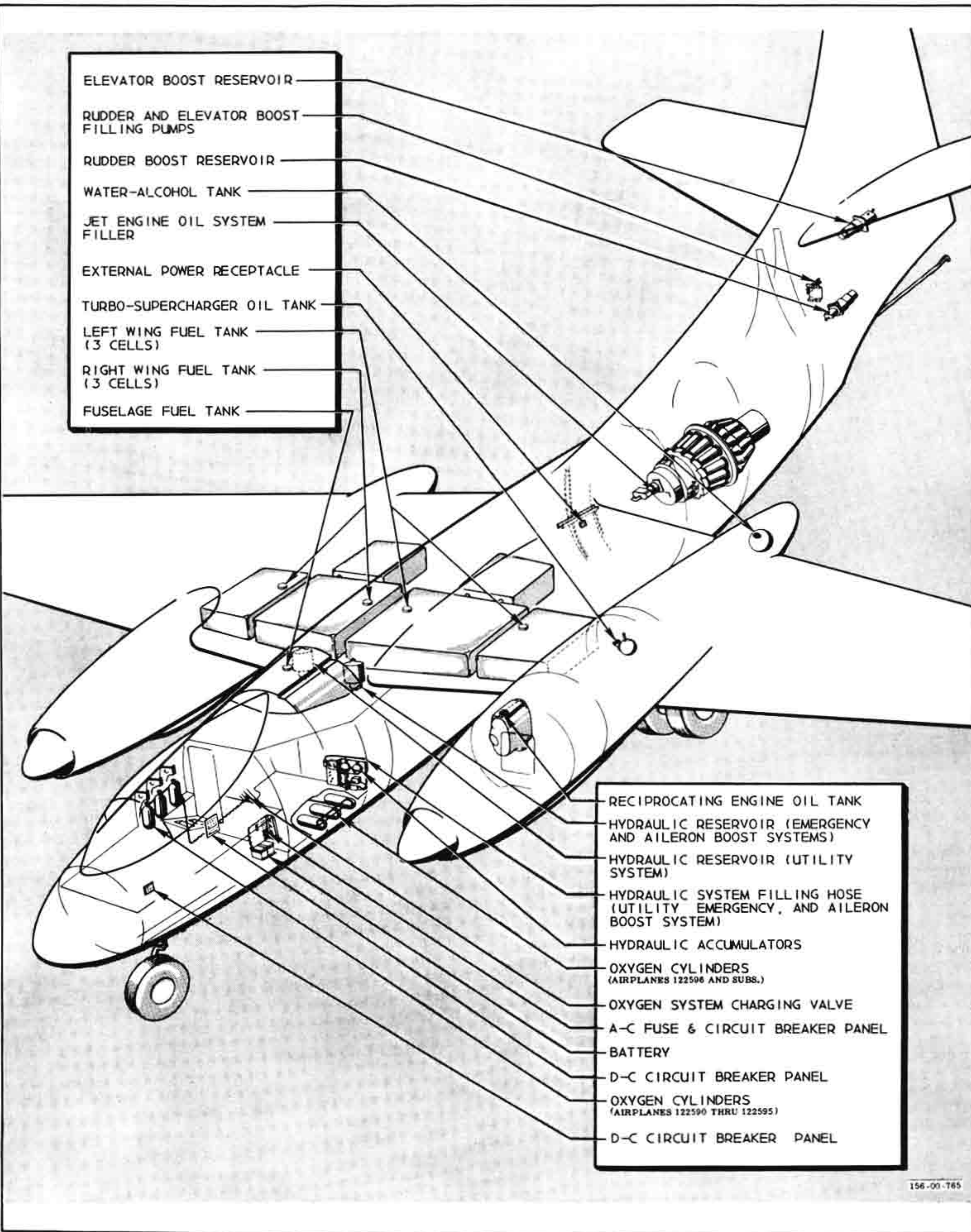

Figure 1-16. Servicing Diagram

ship, provisions are made for folding the outboard wing panels and the vertical fin. Portable hydraulic cylinders are furnished and may be bolted to the inboard wing panel for the wing folding operation. For fin folding operation, a hand-operated screw jack is furnished as portable equipment.



- The gyro horizon indicator must be caged before wing folding, to prevent damage to the flux gate transmitter in the wing.

- Do not fold wings when tip tanks are installed.

1-183. ENGINE FIRE DETECTOR SYSTEM.

1-184. A fire detector system is provided for all three engines. Three fire detector lights, one for each engine, mounted on the fire detector panel (52, figure 1-3), illuminate in case of engine fire. A push-to-test switch is mounted on the panel, permitting a check of bulb illumination. A master fire warning light, mounted on the instrument panel (13, figure 1-2), will illuminate in case of fire in any engine.

1-185. INSTRUMENTS.

1-186. FLIGHT INSTRUMENTS.

1-187. The automatic pilot instruments, consisting of master direction indicator, gyro horizon, and turn-and-bank indicator, operate on a-c electrical power supplied by the airplane's inverters. The Type R-88-I-474 airspeed indicator is essentially a conventional airspeed indicator with the addition of a maximum airspeed indicating mechanism which automatically indicates maximum allowable airspeed for the existing flight altitude. A yellow pointer shows indicated airspeed; a red and black striped pointer, maximum allowable airspeed. The instrument is preset for the limiting Mach number of the airplane, and the maximum airspeed indicating pointer moves to indicate the airspeed corresponding to the limiting Mach number at the existing flight altitude. Clockwise movement of the pointer is limited by presetting of a stop at the limiting structural airspeed of the airplane. When the two hands meet, the airplane is moving at the maximum allowable speed or the critical Mach number. At no time should the yellow pointer be allowed to cross over the striped pointer.

1-188. ENGINE INSTRUMENTS.

1-189. Manifold pressure, oil pressure, fuel pressure and torque pressure for reciprocating engines, and fuel and oil pressure for the jet engine are indicated by means of Autosyn and Magnesyn-type (remote-indicating) instruments which operate on a-c electrical power. The oil temperature indicator and carburetor air temperature indicator for reciprocating engines operate on the airplane's d-c electrical system. Tachometers, cylinder head temperature indicator, and tail-pipe temperature indicator are self-generated

electrical instruments which do not require power from the airplane's electrical system.

1-190. MISCELLANEOUS EQUIPMENT.

1-191. BOMB DOOR GROUND LOCKPINS.

1-192. Bomb doors can be locked in the half-open or fully open position when the airplane is on the ground. At the middle of the hinge point of each bomb door, a lockpin is secured by means of a chain and spring clip. A blade at the end of each lockpin can be used to pry out one of two circular skin plugs located in the upper part of each bomb door, and the pin inserted in the correct safety lock (one for half-open and one for fully open position). Whenever bomb doors are to be left open, while on the ground, the lockpins must be installed.

1-193. BOMB BAY WORK PLATFORMS.

1-194. Fore and aft bomb bay work platforms are provided to facilitate work in the bomb bay while the airplane is on the ground.



Do not carry platforms aloft. They may become detached under negative "G."

1-195. SEATS.

1-196. Three seats are provided; two are located in the pilot's compartment for pilot's and bomber-navigator's use, and one in the crew entry compartment for use by a third crew member when carried. Provisions for Navy pararaft kits are incorporated in the seats. The backs of the pilot's and bomber-navigator's seats can be lowered by pulling up a lever on the right side of each seat. (See 18, figure 1-4.) The pilot's seat is adjustable by operation of a toggle switch on the right side of the seat. (See 14, figure 1-4.) The switch is spring-loaded to neutral, and when held up, the seat adjusts forward and up. When the switch is held down, the seat adjusts aft and down.

1-197. ARMRESTS.

1-198. The armrests on the pilot's seat are movable and can be stowed by pulling them up and aft. A fixed armrest is provided on the right side of the bomber-navigator's seat. (See 4, figure 4-1.)

1-199. HEADRESTS.

1-200. Headrests are provided on the seats for the pilot and bomber-navigator. When the back of the bomber-navigator's seat is lowered, the headrest folds down so that it will not interfere with exit from the compartment.

1-201. REARVIEW MIRRORS.

1-202. Two rearview mirrors are attached to the top of the windshield bow.

1-203. RELIEF TUBES.

1-204. A relief tube is located under each seat. (See figure 1-3 and figure 4-9.)

1-205. WATER CANTEEN.

1-206. A water canteen is located on the forward side of the bulkhead aft of the pilot.

1-207. DATA CASE AND WRITING TABLE.

1-208. A data case is provided in the fuselage side, forward and to the right of the bomber-navigator's seat. (See 19, figure 4-1.) A writing table is provided at the third crew member's station. (See 4, figure 4-9.)

1-209. CREW ENTRANCE LADDER.

1-210. A ladder for crew entrance is stowed in the

crew entry compartment, aft of the crew entry door.

1-211. SUNSHADES.

2-212. Two sunshades, mounted on roller assemblies, are located on the canopy directly above the pilot's and bomber-navigator's seats.

1-213. ASH TRAYS.

1-214. Three ash trays are provided, one adjacent to each crew member's station. (See 15, figure 4-1, and 5, figure 4-9.)

1-215. OPERATIONAL EQUIPMENT.

1-216. Section IV of this handbook contains information on the following equipment: bombing, communications, oxygen, lighting, heating, ventilating, and pressurization.

SECTION II

NORMAL OPERATING INSTRUCTIONS

2-1. BEFORE ENTERING AIRPLANE.

2-2. RESTRICTIONS.

- a. Do not extend landing gear, or fully lower wing flaps, above 175 knots IAS.
- b. Do not lower arresting hook above 175 knots IAS.
- c. Maximum speed for opening canopy or canopy sliding panels is 175 knots IAS.
- d. Maximum permissible indicated airspeed will be furnished when available.

THESE LIMITATIONS AND RESTRICTIONS ARE SUBJECT TO CHANGE, AND LATEST SERVICE DIRECTIVES AND ORDERS MUST BE CONSULTED.

2-3. TAKE-OFF GROSS WEIGHT AND BALANCE.

a. Check gross weight and center of gravity location for take-off, and check anticipated loading for landing.

b. Maximum recommended gross weights:

Take-off	51,750 Lb
Catapulting	51,750 Lb
Landing - Land	42,300 Lb
Landing - Carrier	31,800 Lb

c. Make sure total weight of fuel, oil, bombs, and special equipment carried is suited to the mission to be performed.

2-4. EXTERIOR CHECK.

a. Make sure airplane has been serviced with proper quantities of fuel, oil, water injection fluid, hydraulic fluid, and oxygen.

b. Make sure all drain plugs and covers are safetied; check security of cowling.

c. Inspect air scoops for cracks, and remove any foreign material.

d. Examine propellers for nicks, cracks, and oil leakage. Make sure blades are clean.

e. Remove ground lockpins from bomb bay doors.

f. Remove pitot tube cover.

g. Check landing gear oleo strut extension. Examine tires for general condition and inflation.

h. Wheels chocked.

i. Inspect over-all exterior for obvious damage.

j. Make sure that folding portions of wings and tail are locked in flight position.

2-5. ENTRANCE TO AIRPLANE.

2-6. Approach the airplane from the rear right side between the nacelle and fuselage. The entrance door is located on the right side of the fuselage just forward of the wing leading edge. A ladder for crew entrance is stowed in the crew entry compartment aft of the entrance door.

2-7. ON ENTERING CREW ENTRY COMPARTMENT.

a. Cabin air compressor ground test switch "NORMAL."

b. Main landing gear door ground test switch "NORMAL."

c. Emergency hydraulic selector valves "OFF."

d. Bomb bay hatch closed.

e. Emergency valve handle for crew exit door (and sliding-type canopy) in vertical position.

2-8. ON ENTERING PILOT'S COMPARTMENT.

2-9. PILOT'S CHECK.

a. Ignition switches "OFF."

b. Generator switches "ON."

c. Oil dilution switch "NORMAL."

d. Master bomb control switch "OFF"; bomb arming switch "OFF."

e. Unlock surface controls. Check controls for freedom of movement and proper travel, observing control surfaces for correct response.

f. Set parking brakes.

g. Adjust seat and rudder pedals.

h. Battery switch "BATTERY"; external power connected.

i. Press fire detector test switch and check fire warning lights (lights should illuminate in 15 seconds maximum).

j. Aileron mechanical ratio control handle "NORMAL."

k. Check operation of trim tabs, observing tabs and indicator for correct response. Set tabs for take-off.

l. Emergency engine control switches "NORMAL ON."

m. Propeller master selector switch "TOGGLE SWITCHES & MASTER LEVER."

n. Jet-engine master switch "OFF."

o. Turbo control switches "NORMAL" ("TAKE-OFF & LAND" if water injection is not used).

p. Turbo power switches "AUTO."

q. Water injection switch "OFF."

r. Mixture controls "IDLE CUT-OFF."

s. Propeller master lever full "INCREASE RPM."

t. Throttles cracked 1-1/2 to 2 inches.

u. Jet throttle "OFF."

v. Wing-flap control "UP."

w. Windshield defrost control "OFF."

x. Cabin air control "NORMAL."

y. Cabin heater switch "NORMAL."

z. Landing gear control "DOWN."

aa. Circuit breakers in.

ab. Fuel transfer pump "OFF"; boost pumps "OFF"; cross-feed valves "OFF"; emergency pumps "OFF." Check fuel quantity.

NOTE

If fuel quantity indicators read off scale (below zero or above full mark), check indicator

system before flight.

ac. Clock, altimeters, and accelerometer set.

ad. Arresting hook retracted - check indicator lights off.

ae. Pitot heater "OFF."

af. Have bomber-navigator check a-c power controls.

ag. Test operation of communication equipment.

ah. Test operation of automatic pilot. Disengage auto-pilot after check by means of clutch switch.

ai. Test operation of oxygen equipment. Oxygen pressure 1800 psi. (Refer to paragraph 4-22.)

aj. Before night or instrument flight, check all lights and instruments.

2-10. BOMBER-NAVIGATOR'S CHECK.

2-11. Check a-c power controls at pilot's direction as follows:

a. Turn on special equipment a-c power switch in crew entry compartment (to obtain single-phase power).

b. Position voltmeter switch at "SINGLE PHASE." Check voltmeter for reading of 115 volts with single-phase power switch at "STANDBY INVERTER" and "MAIN INVERTER." Cycle switch to "OFF" and back to "MAIN INVERTER."

c. Move three-phase power switch to "STANDBY INVERTER" and check for 115 volts at "A" and "C" positions of voltmeter switch. Then select "MAIN INVERTER" and repeat check. Leave switch at "MAIN INVERTER."

2-12. FUEL SYSTEM MANAGEMENT.

2-13. Fuel flow from tip tanks, wing and fuselage tanks is entirely automatic, and no tank selection is necessary. However, the following fuel management is required:

a. Boost pumps on for starting and all subsequent operation.

b. Cross-feed valves normally "OFF"; "ON" for jet-engine operation.

c. Engine shut-off valves open (emergency engine control switches "ON") for all normal operation.

d. Fuselage tank transfer pump "AUTO" for all normal operation.

e. Emergency fuel pumps on for take-off and landing.

f. Just before take-off with jet engine operating, check jet-engine emergency fuel system operation.

g. To jettison wing tip tanks, pull tip tank release handle. (A continued decrease of fuel quantity in wing tanks indicates tip tanks are empty.)

2-14. STARTING RECIPROCATING ENGINES.

2-15. Start each reciprocating engine as follows:

- a. Recheck throttle, propeller, and mixture control positions.
- b. Boost pump on. Check fuel pressure 10-14 psi.
- c. Check propellers clear.
- d. With ignition switch "OFF," engage starter and turn engine over four revolutions (count 16 blades).

NOTE

If propeller falters or stops rotating, disengage starter, turn off boost pump, and investigate.

e. Continue cranking, push master ignition switch in, and turn individual ignition switch to "BOTH."

f. Prime while cranking - intermittently if engine is warm, continuously if cold.



If engine fails to start after one minute of continuous cranking, allow starter to cool for one minute before another attempt to start engine. After second starting attempt, allow 5 minutes for starter cooling.

g. As engine starts, move mixture control to "RICH." Operate primer until engine is running smoothly. Do not pump the throttle.

NOTE

If engine stops after mixture control has been moved to "RICH," move to "IDLE CUT-OFF" immediately, and continue cranking and priming until engine starts. (Do not exceed time limit for continuous use of starter.)

h. Check oil pressure. If pressure does not reach 40 psi in 30 seconds, shut down engine and investigate.

NOTE

Normally, oil pressure will be approximately 200 psi upon starting. When pressure drops to 80 psi, the engine is warm enough to make ground checks.

i. After starting both engines, have external power unit disconnected and turn battery switch "ON."

NOTE

Refer to paragraph 3-3 for instructions in

case of fire during starting procedure.

2-16. WARM-UP AND GROUND TEST - RECIPROCATING ENGINES.

2-17. WARM-UP.

2-18. Warm up engines at 1000 rpm until oil temperature reaches 40°C and oil pressure drops to 80 psi. The desired oil and carburetor air temperatures should be maintained by having the oil cooler flap and inter-cooler flap controls in "AUTOMATIC." If limits are exceeded with the controls in "AUTOMATIC," stop engines and investigate. Leave cowl flaps full open for all ground operation.

2-19. GROUND TESTS.

2-20. After warm-up, make the following checks:

a. Aileron boost switch "NORMAL."

b. Rudder and elevator boost switches "ON NORMAL."

c. Surface controls - check with boost on. Turn aileron boost switch "OFF" and check aileron mechanical ratio control at the "BOOST OUT" position. Return both controls to "NORMAL."

d. Rudder limiting system - with rudder boost "ON," make sure that full left and right rudder travel is available. Move rudder limiting test switch to "TEST," slowly deflect rudder, and make sure that rudder boost becomes ineffective at one-half rudder pedal travel. Repeat test for opposite rudder pedal. Return test switch to "NORMAL."

e. Hydraulic system - check by operating wing flaps. Have crew member check accumulator and system hydraulic pressure on gages in crew entry compartment.

f. Electrical system - check generator output. Voltage readings should be 27.9 ($\pm .3$) volts. Amperage readings should be approximately equal and must not exceed 400 amperes per generator.

g. Instruments - check for indications in desired ranges.

h. Make ignition safety check at 1000 rpm - switch ignition to "R," back to "BOTH"; to "L," back to "BOTH"; and then to "OFF" momentarily, and back to "BOTH." A slight rpm drop when operating on each magneto and complete engine cutout at "OFF" indicate proper connection of ignition leads.

2-21. Check engines as follows:

a. At 30 in. Hg, check each magneto for maximum drop of 100 rpm. Normally, differences in drop-off between right or left magneto are 40 rpm or less.

b. Run up each engine to full throttle and make sure that 2800 rpm is obtained. Check manifold pressure

for approximately 55 in. Hg at sea level with turbo switch at "TAKE-OFF AND LAND"; then turn turbo switch to "NORMAL" and note that manifold pressure increases to 59 in. Hg.

c. Check operation of controls for oil cooler flaps, cowl flaps, and intercooler flaps by holding switch at "OPEN" and "CLOSE." Return oil cooler and intercooler flap controls to "AUTOMATIC"; have cowl flaps full open (switch "OFF").

NOTE

- The oil cooler, intercooler, and cowl flaps will operate only when the generators are supplying current to the electrical system, or when external power is connected (and emergency engine control switches "NORMAL ON").
- Intercooler flaps will operate only if turbo control switches are at "NORMAL." The intercooler flaps can be seen from the pilot's seat only when canopy is open.

d. Test propeller synchronizer with propeller master selector switch at "NORMAL." Set both throttles at 30 in. Hg, and then set master lever for 2000 rpm. Push "RESYNCHRONIZE" button momentarily. Hold left engine toggle switch at "DECREASE RPM" until it reaches 1800 rpm, and check to see that right (slave) engine follows only 50 to 80 rpm. Then hold left engine toggle switch at "INCREASE RPM" until it reaches 2200 rpm, and make sure that right engine follows only 120-180 rpm. Toggle left engine to 2000 rpm - both engines should synchronize at 2000 rpm. Return master lever to full "INCREASE RPM." Place propeller master selector switch at "TOGGLE SWITCHES & MASTER LEVER."

e. Throttle back to idling rpm, and check carburetor idling mixture strength. Watch tachometer while slowly moving mixture control to "IDLE CUT-OFF." A rise of approximately 20 rpm should occur before normal drop-off. Return mixture to "RICH" before engine cuts out.

2-22. STARTING JET ENGINE.

WARNING

Before starting jet engine, make sure that area aft of tail pipe is clear of personnel.

2-23. AUTOMATIC START.

- a. Fuel cross-feed valves "ON."
- b. Jet-engine throttle "OFF."
- c. Jet-engine emergency fuel system test switch "NORMAL."
- d. Jet-engine starting selector switch "AUTO."

- e. Jet-engine fuel system selector switch "OFF."
- f. Jet-engine master switch "ON."
- g. Hold jet throttle outboard at "START" for approximately 5 seconds.
- h. When jet-engine speed reaches 8.5% rpm, press throttle fuel start switch for approximately 2 seconds.

NOTE

If ignition does not occur after 5 to 10 seconds, close throttle and turn jet master switch "OFF." Wait 3 minutes for engine to stop rotating and unburned fuel to drain before another attempt to start.

i. After jet-engine speed stabilizes (24% rpm), check for positive indication of oil pressure. If oil pressure is not noted within 30 seconds, shut down engine and investigate.

NOTE

Do not attempt another start until the engine has completely stopped rotating and unburned fuel has drained from the engine.

j. Advance throttle to "IDLE."

WARNING

If a hot start occurs (tail-pipe temperature above 1000°C), enter it on the aircraft forms. After 10 hot starts, the engine must be inspected before flight.

2-24. MANUAL START.

- a. Fuel cross-feed valves "ON."
- b. Jet-engine throttle "OFF."
- c. Jet-engine emergency fuel system test switch "NORMAL."
- d. Jet-engine starting selector switch "MANUAL."
- e. Jet engine fuel system selector switch "OFF."
- f. Jet master switch "ON."
- g. Hold jet throttle outboard at "START" for approximately 5 seconds.
- h. When jet-engine speed reaches approximately 8.5% rpm, advance throttle to about one-third to one-half open.
- i. At the first indication of fuel pressure, retard throttle (near the "OFF" position) to hold fuel pressure at approximately 40 psi until ignition occurs.

NOTE

If ignition does not occur within 5-10 seconds, close the throttle, turn jet master switch "OFF," and wait 3 minutes before attempting another start.

j. After ignition, adjust throttle to hold approximately 650°C tail-pipe temperature as engine accelerates to 34% rpm.

WARNING

If a hot start occurs (tail-pipe temperature above 1000°C), enter it on the aircraft forms. After 10 hot starts, the engine must be inspected before flight.

2-25. GROUND TESTS - JET ENGINE.

2-26. No warm-up period is necessary, but the following ground tests should be made:

a. As soon as engine stabilizes at idling speed with normal gage readings, advance throttle to full open position and make sure that rpm does not exceed 100%. Tail-pipe temperature should be between 670°C and 700°C. Check to see that all jet-engine instruments are in desired ranges.

b. Above 93% rpm, make sure that jet-engine fuel system selector switch is "OFF," and move emergency fuel system test switch to "TEST." Light should illuminate and a slight change in rpm should be noted, indicating operation on emergency system. Return emergency fuel system test switch to "NORMAL." In order to prevent high tail-pipe temperature, the throttle opening must be quickly reduced at the instant switch is repositioned to "NORMAL."

NOTE

● When changing from main to emergency fuel system, or vice versa, if an excessive drop in rpm occurs, indicating a malfunctioning fuel system, immediately switch back to the other fuel system to prevent possible damage to the engine. Then shut down engine and investigate.

● When testing the emergency fuel system, the jet-engine fuel system selector switch should be at "OFF." If this switch is at "TAKE-OFF" when the test is made, the main fuel system does not automatically take over after the test is completed. For a subsequent take-off, fuel metering would be accomplished by the emergency system with no possible automatic emergency control.

2-27. TAXIING.

- a. Bomb bay doors closed.
- b. Entrance hatch closed.

2-28. BEFORE TAKE-OFF.

2-29. At take-off position, make following checks:

- a. Trim tabs set: rudder and aileron 0°, elevator 5° nose up.
- b. Canopy or canopy sliding panels open.
- c. Propeller synchronization switch "NORMAL." Check propeller master lever in full "INCREASE RPM" and propeller governor lights on.
- d. Mixture "RICH."
- e. Emergency fuel pumps and transfer pump on.
- f. Check fuel booster pumps on.
- g. Start jet-engine just prior to take-off.
- h. Test jet-engine emergency fuel system.
- i. Jet-engine fuel system selector switch "TAKE-OFF."
- j. Lower wing flaps as desired.
- k. Safety belt and shoulder harness tightened and locked.
- l. Cowl, intercooler, and oil flap switches "AUTO."

2-30. TAKE-OFF.

NOTE

The jet engine is to be used for all take-offs. While the airplane is designed to operate as a two-engine airplane during flight, the jet engine provides the additional thrust necessary for maximum performance when required, and is intended to be used at all times for take-off.

2-31. NORMAL FIELD TAKE-OFF.

- a. Turbo control switches "TAKE OFF AND LAND" ("NORMAL" if water injection is used).
- b. Wing flaps "1/2."
- c. Roll into take-off position and make sure nose wheel is straight.
- d. Hold brakes, and open throttles (jet and reciprocating engines) to take-off power. (Brakes will hold with all three engines at military power.) Check manifold pressure on reciprocating engines. (See figure A-4.) Release brakes and start take-off run.
- e. Normal take-off speeds using 1/2 flaps are approximately as follows:

GROSS WEIGHT	INDICATED AIRSPEED
50,000 Lb	95 Knots
45,000 Lb	90 Knots
40,000 Lb	80 Knots
35,000 Lb	70 Knots

f. Immediately after take-off, level off to gain a safe margin above minimum single-engine control speed (estimated to be 115 knots IAS with military power). See figure A-6 for take-off distances.

2-32. CARRIER (OR MINIMUM-RUN) TAKE-OFF.

NOTE

For carrier (or minimum-run) take-off, always use water injection when available.

- a. Water injection switch "ON."
- b. Turbo control switches "NORMAL."
- c. Wing flaps full "DOWN."
- d. Hold brakes on and advance jet throttle to full take-off power. Then open other two throttles rapidly and smoothly to full power.
- e. Check to see that maximum wet manifold pressure is obtained at full throttle.
- f. Release brakes and take off. Approximate take-off speeds with full flaps are as follows:

WEIGHT	INDICATED AIRSPEED
50,000 Lb	80 Knots
45,000 Lb	75 Knots
40,000 Lb	70 Knots
35,000 Lb	60 Knots

g. Immediately after take-off, level off to gain a safe margin above minimum single-engine control speed (estimated to be 120 knots IAS with water injection

power).

2-33. CATAPULT TAKE-OFF.

- a. Water injection switch "ON."
- b. Turbo control switches "NORMAL."
- c. Flaps full "DOWN."
- d. Open all three throttles and hold with catapult grip.
- e. Take-off speed is estimated to be approximately 85 knots IAS at maximum take-off gross weight.

2-34. AFTER TAKE-OFF.

- a. When airborne, landing gear control "UP." Check gear position indicators. (Approximately 5 seconds is required for gear retraction.)
- b. After altitude of at least 200 feet is attained, raise flaps gradually. (See figure 2-1 for flaps-up stalling speed.)
- c. With flaps and gear up, increase airspeed to best climbing speed; then close jet throttle, turn jet-engine master switch "OFF," and jet fuel control switch "OFF."



The throttle must be closed before the jet-engine master switch is turned "OFF." Should the jet air intake door close when the engine is at high rpm, there will be undue stress on the fuselage skin because of reduced internal air pressure.

- d. Reduce reciprocating-engine power to maximum continuous. Move mixture controls to "NORMAL."
- e. Water injection switch "OFF" (after carrier take-off).
- f. Turbo control switches "NORMAL."

ESTIMATED INDICATED STALLING SPEEDS-KNOTS

Gross Weight	FLAPS FULL DOWN				FLAPS UP			
	POWER ON		POWER OFF		POWER ON		POWER OFF	
	Normal Rated		Windmilling Props		Normal Rated		Windmilling Props	
	Level Flight	30° Bank	Level Flight	30° Bank	Level Flight	30° Bank	Level Flight	30° Bank
50,000 lb	85	90	105	115	95	100	115	125
40,000 lb	70	75	95	105	75	80	105	110
30,000 lb	55	60	85	90	60	65	90	95

146-93-671

Figure 2-1. Estimated Indicated Stalling Speeds

g. Emergency fuel pumps "OFF."

h. Close canopy or canopy sliding panels.

2-35. CLIMB.

2-36. See figure A-6 for recommended indicated airspeeds to be used during climb, and for rate of climb and fuel consumption.

a. Climb at maximum continuous power.

b. Periodically check cylinder head temperature, and increase airspeed if necessary to prevent exceeding limits.

2-37. DURING FLIGHT.

2-38. RECIPROCATING-ENGINE OPERATION.

a. Retard throttles and propeller master lever to desired settings for cruise.

b. Periodically check for desired instrument readings. (See figure A-3.)

NOTE

Under some flight conditions, such as a sustained power-off descent, overcooling of the cylinders may occur, even with fully closed cowl flaps. Spark-plug fouling and inability of the engine to accelerate satisfactorily may result. This may be avoided by intermittent use of power to prevent cylinder head temperature from falling below 150°C.

2-39. USE OF TORQUE PRESSURE IN ENGINE CONTROL. Use torque pressure as a check that desired power is being obtained. If torque pressure reading is not normal for the manifold pressure and rpm settings selected, consider the following instructions before making any manifold pressure adjustment:

a. Check airspeed against applicable value obtained from Flight Operation Instruction Chart. (See Appendix I.)

NOTE

Airspeed values shown on Flight Operation Instruction Charts are TAS and the necessary conversion must be made.

b. When torque pressure is low:

If airspeed is correct, torque pressure reading is probably inaccurate.

If airspeed is low, engine malfunction is probable and manifold pressure should not be increased, since such increase may result in damage to the engine.

c. When torque pressure is high:

If airspeed is correct, torque pressure reading is probably inaccurate.

If airspeed is high, ignore the high torque pressure unless it exceeds the value for maximum continuous power (168 psi), in which case the manifold pressure should be reduced.

2-40. Magneto checks can be made in flight by reference to torque pressure reading. Although no rpm drop will occur when operating on a single magneto, torque pressure will decrease. A drop in pressure up to approximately 10% of the "BOTH" value indicates satisfactory ignition condition.

2-41. **RUDDER LIMITING SYSTEM CHECK.** If it is necessary to check operation of rudder limiting system in flight:

a. Establish airspeed of 210 knots IAS, hold slight rudder pressure, and increase airspeed to 225 knots IAS. At approximately 220 knots IAS, a distinct "thump" on rudder pedals should be felt, indicating that rudder boost pressure has been limited to one-half of normal pressure.

b. Reduce airspeed to 120 knots IAS; then move rudder limiting test switch to "TEST." Slowly deflect rudder pedal, and check to see that rudder boost pressure becomes ineffective at one-half rudder pedal travel. Return test switch to "NORMAL."

WARNING

Do not move rudder limiting test switch to "TEST" when above 140 knots IAS. With test switch at "TEST," rudder boost remains effective until rudder is deflected 15 degrees, regardless of actual indicated airspeed, and the safe limit of rudder deflection may be exceeded.

c. With test switch at "NORMAL," increase airspeed to 140 knots IAS, move rudder pedal to the same position (one-half rudder travel), and check to make sure that rudder boost becomes ineffective at this point.

2-42. JET-ENGINE OPERATION.

2-43. STARTING JET ENGINE IN FLIGHT.

2-44. To start the jet engine in flight, use the ground automatic start procedure. At altitude, rpm during start and acceleration will be considerably higher than ground start rpm. Under some altitude conditions, rpm at which the engine stabilizes (before throttle is advanced to "IDLE") may be slightly higher than rpm obtained when throttle is advanced to "IDLE."

WARNING

To prevent high tail-pipe temperature, do

not advance throttle to "IDLE" until rpm stabilizes.

If an automatic start cannot be accomplished at altitude, a manual start can be made.

2-45. FLIGHT CHARACTERISTICS.

2-46. Flight characteristics of the AJ-1 Airplane are completely normal, with good stability throughout the flight range. Trim change due to operation of the jet engine is small, even with jet engine at maximum rpm. When full power is applied to the jet engine, the nose of the airplane tends to rise slightly, causing a very light change in stick force.

2-47. STALLS.

2-48. Stall warning, in the form of light control buffeting, starts at 3 to 7 knots above stall speed, and increases in intensity during approach to the stall. With power off, flaps and gear down or up, there is a slight tendency to roll to the left, which can be corrected by use of rudder and aileron. With power on, flaps and gear up, the tendency to roll to the left is greater but is controllable by use of rudder and aileron. With power on, flaps and gear down, the left roll tendency becomes very pronounced and there is a nose-up pitch at the stall. Down elevator must be applied to correct for high angle of attack and left roll.



Because of the unusual characteristics of the power-on, flaps and gear-down stall, it is recommended that recovery be started at the first indication of stall warning whenever a stall in this configuration is approached.

2-49. STICK SHAKER.

2-50. Since insufficient natural stall warning is present in the flaps and gear-down configuration, an artificial warning in the form of a stick shaker is provided. The stick shaker will vibrate at 3 to 7 knots above stall speed. The stick shaker does not operate when the airplane's weight is on the landing gear.

2-51. SPINS.

2-52. Intentional spins are prohibited. In case a spin is entered accidentally, normal recovery procedure is recommended.

2-53. DIVING.

2-54. Information to be supplied when available.

2-55. APPROACH.

2-56. During approach for landing, make the following checks:

- a. Safety belt and shoulder harness tightened and

locked.

- b. Master bomb control switch "OFF."
- c. Emergency fuel pumps on.
- d. Turbo control switches "TAKE-OFF AND LAND."
- e. Mixture controls "RICH."
- f. Propeller control 2600 rpm.
- g. Canopy open below 175 knots IAS.
- h. Landing gear "DOWN" below 175 knots IAS. Check gear position indicator.

i. Arresting hook down for carrier landing (green indicator light on); hook up for field landing (both indicator lights off).

2-57. LANDING.

2-58. NORMAL LANDING.

NOTE

See figure A-6 for estimated landing distances.

- a. Lower full flaps on final approach.
- b. Maintain approach speed according to the following:

GROSS WEIGHT	INDICATED AIRSPEED
40,000 Lb	115 Knots
35,000 Lb	110 Knots
30,000 Lb	100 Knots

c. Adjust elevator trim constantly throughout landing, to afford better control in case of elevator boost failure.

d. Touch main wheels first, tail slightly down; then lower nose wheel.

2-59. AFTER LANDING.

- a. Propeller master lever full "INCREASE RPM."
- b. Arresting hook retracted after carrier landing; check both indicator lights off.
- c. Flaps "UP."
- d. Emergency fuel pumps "OFF."
- e. Manually open cowl flaps fully.

2-60. WAVE-OFF.

- a. Open throttles to take-off power.
- b. Propeller master lever full "INCREASE RPM."
- c. Gear "UP"; check gear position indicator.

d. When sufficient airspeed (above flaps-up stalling speed) and altitude are attained, gradually raise wing flaps.

2-61. STOPPING ENGINES.

2-62. Stop jet engine as follows:

a. Jet throttle "OFF." Either hold against "OFF" stop or set friction lock until engine stops windmilling.



The throttle must be closed before the jet master switch is turned to "OFF." Should the jet air intake door close when the engine is at high rpm, there will be undue stress on the fuselage skin because of reduced internal air pressure.

b. Jet-engine master switch "OFF."

2-63. Stop reciprocating engines as follows:

a. Set parking brakes.

b. Dilute oil as required.

c. Idle engines until cylinder head temperature is

less than 200°C.

d. With throttles at 1000 rpm, move mixture controls to "IDLE CUT-OFF."

e. When propellers stop rotating, ignition switches "OFF."

2-64. BEFORE LEAVING AIRPLANE.

2-65. Before leaving airplane, make the following checks:

a. Boost pump switches "OFF"; emergency engine control switches "FUEL & OIL SHUT OFF."

b. Canopy closed.

c. All switches off (except generator switches).

d. Wheels chocked; release brakes.

e. Surface controls locked.

f. Cage attitude gyro indicator before folding wings, to prevent damage to the flux gate transmitter.



Do not fold wings when tip tanks are installed.

SECTION III

EMERGENCY OPERATING INSTRUCTIONS

3-1. FIRE.

3-2. ENGINE FIRE DURING STARTING PROCEDURE.

3-3. RECIPROCATING ENGINE. If fire occurs during start:

a. Keep engine running and open throttle, as fire may be drawn through engine and extinguished. (If engine is not yet running when fire occurs, open throttle and keep engine turning on starter.)

b. If fire does not go out, move mixture control to "IDLE CUT-OFF" and turn ignition "OFF."

c. Press feathering button.

d. If fire is not out by the time engine stops, move emergency engine control switch to "FUEL & OIL SHUT-OFF."

e. Battery switch "OFF."

f. Shut down other engine.

g. Notify crew to abandon airplane.

3-4. JET ENGINE. If fire occurs during ground start:

a. Jet throttle "OFF."

b. Jet-engine master switch "OFF."

c. Shut down reciprocating engines.

d. Notify crew to abandon airplane.

3-5. ENGINE FIRE DURING FLIGHT.

3-6. RECIPROCATING ENGINE. If an engine fire occurs during flight:

a. Feather propeller.

b. Throttle "CLOSED."

c. Emergency engine control switch at "FUEL & OIL SHUT-OFF."

d. Mixture control "IDLE CUT-OFF."

e. Ignition "OFF."

f. Lower landing gear if practicable.

3-7. JET ENGINE. If fire occurs on the jet engine during flight:

a. Reduce power to see if fire detector light will go out.

b. If detector light goes out, continue flight at reduced power.

c. If light does not go out, shut down engine immediately - jet throttle "OFF," jet master switch "OFF."

CAUTION

The throttle must be closed before the jet master switch is turned "OFF." Should the jet air intake door close when the engine is at high rpm, there will be undue stress on the fuselage skin because of reduced internal air pressure.

3-8. ENGINE FAILURE.

WARNING

Unless the jet engine is used for take-off, failure of a reciprocating engine immediately after airplane leaves the ground compels a forced landing.

3-9. JET-ENGINE FAILURE DURING TAKE-OFF.

3-10. If the jet engine fails during take-off, ground run and distance to clear an obstacle are considerably increased. The amount of increase varies with air-speed at the point of engine failure and is greatest when gross weight is high and take-off is made from airfields of high elevation. Should the engine failure occur shortly after the airplane leaves the ground, continued flight is possible, provided a high angle of climb is not required for obstacle clearance. The following table, based on conditions of military power and no wind, shows estimated percentage increase in take-off distance if jet engine is not operating.

GROSS WEIGHT	ALTITUDE	INCREASE IN GROUND RUN	INCREASE IN TOTAL TO CLEAR 50-FT OBSTACLE
51,500	Sea Level	65%	75%
51,500	6000 Ft	70%	130%
37,000	Sea Level	45%	35%
37,000	6000 Ft	45%	40%

3-11. RECIPROCATING-ENGINE FAILURE DURING TAKE-OFF.

3-12. DURING TAKE-OFF RUN. If one reciprocating engine fails during take-off run, retard all throttles immediately and apply brakes. The landing gear cannot be retracted with the weight of the airplane on the gear.

3-13. DURING TAKE-OFF - CONTINUED FLIGHT. Even if the jet engine is operating when a reciprocating engine fails during take-off, possibility of continued flight is marginal, depending on conditions existing when the engine fails. Adequate directional control is available only if safe single-engine airspeed (estimated to be 115 knots IAS at military power, 120 knots IAS at water injection power) has been attained. Ability to climb at single-engine control speed depends on gross weight and other variables tabulated in figure 3-1. If airspeed is higher than minimum for single-engine control, flight can be continued at higher gross weights than those shown in the table, or the rate of climb can be increased. Note that the table considers the propeller on the dead engine to be windmilling and the cowl flaps open. When time and altitude are available to raise gear, feather the propeller, close cowl flaps, and reduce other drag items, the possibility of continued flight is increased considerably. If continued flight is possible, take immediate action as follows:

a. Immediately apply rudder to correct yaw, and depress nose to keep airspeed safely above single-engine control speed - 115 knots IAS at military power, 120 knots IAS at water injection power.

b. Landing gear control "UP" immediately.

c. Feather propeller on dead engine.

d. Jettison bombs and wing-tip tanks if advisable.

e. Close cowl, intercooler, and oil cooler flaps on dead engine.

f. Raise wing flaps gradually to full "UP" as soon as power-off, flaps-up stalling speed is exceeded and safe altitude is reached.

g. Trim out rudder force.

h. Gain as much speed as possible before starting

climb. Estimated best single-engine climbing speed (sea level), using military power with gear and flaps up and propeller on dead engine feathered, is approximately 155 knots IAS (reciprocating engine only) or 195 knots IAS (one reciprocating engine and jet engine).

3-14. EMERGENCY LANDING AFTER TAKE-OFF.

3-15. If flight cannot be continued after engine failure during take-off, prepare for an immediate landing by accomplishing as much of the following as time permits:

a. Maintain directional control by using rudder and reducing power on good reciprocating engine if necessary. Lower nose to maintain flying speed. Land straight ahead, changing direction only enough to miss obstacles.

b. Landing gear control "UP" immediately.

c. Jettison wing-tip tanks if over uninhabited area.

d. Wing flaps full "DOWN."

e. Feather propeller on dead engine.

f. Retard throttles; jet master switch "OFF"; emergency engine switches "FUEL & OIL SHUT-OFF"; ignition master switch "OFF," and battery switch "OFF" - just before ground contact.

3-16. RECIPROCATING-ENGINE FAILURE DURING FLIGHT.

NOTE

Torque pressure reading provides an immediate and positive indication of engine failure in flight. Even if windmilling rpm should remain high and manifold pressure decrease slowly, torque pressure drops rapidly, thus identifying the failing engine.

3-17. If an engine fails during flight, proceed as follows:

a. Hold airplane straight with rudder.

b. Feather propeller on failing engine, according to procedure in paragraph 3-22.

c. Adjust power settings on good engine.

ESTIMATED DATA

MAXIMUM WEIGHTS FOR CONTINUED FLIGHT
AFTER ENGINE FAILURE ON TAKE-OFF

Weights at which a 100 feet per minute climb can be maintained at single-engine control speed with one windmilling propeller and cowl flaps open. Table is based on standard temperature at each altitude. Decrease weights 1000 lb for each 10° F above standard.

ONE R-2800 AT WATER INJECTION POWER, J-33 AT MILITARY POWER, 120 KNOTS IAS			
	Sea Level	3000 FT	6000 FT
Flaps up, Gear up	Continued Flight Possible at Any Weight		
Flaps 1/2, Gear up	Any Weight	50,000 lb	47,000 lb
Flaps 1/2, Gear down	49,000 lb	46,000 lb	43,000 lb
Flaps full down, Gear up	41,000 lb	38,000 lb	36,000 lb
Flaps full down, Gear down	Continued Flt Impossible at Any Practical Take-off Wt.		

ONE R-2800 AT MILITARY POWER, J-33 AT MILITARY POWER, 115 KNOTS IAS			
	Sea Level	3000 ft	6000 ft
Flaps up, Gear up	Continued Flt Possible at Any Weight		
Flaps 1/2, Gear up	50,000 lb	47,000 lb	45,000 lb
Flaps 1/2, Gear down	46,000 lb	44,000 lb	42,000 lb
Flaps full down, Gear up	39,000 lb	37,000 lb	35,000 lb
Flaps full down, Gear down	Continued Flt Impossible at Any Practical Take-off Wt.		

146-73-445A

Figure 3-1. Maximum Weights for Continued Flight After Engine Failure on Take-off

d. Trim airplane as required. Adequate trim is available for good control on single engine at all normal flight speeds.

e. Cross-feed valve switches "ON."

f. Jettison unnecessary load items if over uninhabited area, but do not drop tip tanks until empty if maximum range must be considered.

g. See figure 3-2 for estimated single-engine service ceilings.

h. See figure A-8 for range data on single engine. When maximum range is a consideration, fly at lowest practicable altitude, and use reciprocating engine military power (30-minute time limit) in preference to starting the jet engine.

3-18. USE OF JET ENGINE IN SINGLE RECIPROCATING ENGINE FLIGHT. If gross weight is high, it may be necessary to start the jet engine to maintain the desired altitude. Best fuel economy is then obtained

by using the highest practicable power on the reciprocating engine and the minimum required rpm from the jet engine. As soon as gross weight and altitude permit, shut down the jet engine.

3-19. SINGLE-ENGINE LANDING.

3-20. When a single-engine landing must be made, proceed as follows:

a. Accomplish normal prelanding checks.

b. If remaining fuel permits, operate jet engine in conjunction with good reciprocating engine. Adjust jet throttle as necessary to reduce rate of descent.

c. Lower gear after turning on final approach. Below approximately 32,000 pounds gross weight, the airplane will maintain altitude with military power of one reciprocating engine and gear down (propeller on dead engine feathered). At higher gross weights, altitude can be maintained with gear down only if jet engine is operating.

ESTIMATED SINGLE-ENGINE SERVICE CEILINGS				
GROSS WEIGHT	NORMAL RATED POWER		MILITARY POWER	
	R-2800-44W ONLY	R-2800-44W & J33-A-10	R-2800-44W ONLY	R-2800-44W & J33-A-10
50,000 Lb	-----	20,000 Ft	-----	28,000 Ft
45,000 Lb	-----	26,000 Ft	2000 Ft	33,000 Ft
40,000 Lb	-----	31,000 Ft	11,000 Ft	36,000 Ft
35,000 Lb	8000 Ft	36,000 Ft	21,000 Ft	39,000 Ft

146-93-670

Figure 3-2. Estimated Single-engine Service Ceilings

d. Reduce rudder trim used for single-engine flight, but leave a small amount on in case it is necessary to increase power on good engine.

e. Use flaps and power on good engine to regulate glide angle. Maintain approach speed of 120 knots IAS (35,000 pounds or less gross weight) until flaps are lowered. Then reduce airspeed to normal approach speed.

WARNING

o During approach, do not allow airspeed to drop below safe single-engine control speed (115 knots IAS at military power) until landing is assured.

o When jet engine is not operating, go-around is impossible after any appreciable degree of flaps has been lowered.

f. Over end of runway, reduce power and make normal flare-out.

3-21. PROPELLER EMERGENCY OPERATION.

3-22. EMERGENCY PROPELLER FEATHERING.

- a. Depress feathering switch.
- b. Throttle "CLOSED."
- c. Mixture control "IDLE CUT-OFF."
- d. Emergency engine control switch "FUEL & OIL SHUT-OFF."
- e. Ignition switch "OFF" after propeller stops.
- f. Propeller master selector switch "TOGGLE SWITCHES & MASTER LEVER."
- g. Fuel cross-feed switch "ON."

h. Move emergency engine control switch to "CONTROL OFF."

i. Move oil cooler, cowl, and intercooler flap switches to "CLOSE" and hold until flaps are closed.

NOTE

If for any reason the propeller cannot be feathered in an emergency according to this procedure, minimize drag from the windmilling propeller by putting it in full high pitch. (Move propeller master selector switch to "TOGGLE SWITCHES ONLY" and hold propeller control toggle switch at "DECREASE.")

3-23. PRACTICE PROPELLER FEATHERING.

CAUTION

To avoid hydraulic lock and excessive oil cooling in lower engine cylinders, minimize time propeller is feathered for practice.

- a. Propeller master selector switch "TOGGLE SWITCHES ONLY."
- b. Hold propeller control toggle switch at "DECREASE" until propeller governor limit light illuminates.
- c. Throttle "CLOSED."
- d. Depress feathering switch.
- e. Mixture control "IDLE CUT-OFF."
- f. Emergency engine control switch "FUEL & OIL SHUT-OFF."
- g. Ignition switch "OFF" after propeller stops turning.

h. Move emergency engine control switch to "CONTROL OFF" (to restore automatic temperature control to oil cooler, cowl, and intercooler flaps).

3-24. PROPELLER UNFEATHERING.

NOTE

If propeller was feathered by emergency method, first move propeller master selector switch to "TOGGLE SWITCHES ONLY," and hold propeller control toggle switch at "DECREASE" until propeller governor limit light illuminates.

- a. Emergency engine control switch "NORMAL ON."
- b. Pull out feathering switch momentarily (one second maximum). Propeller should start out of the feathered position. If propeller does not start to windmill within approximately 10 seconds, again pull out feathering switch momentarily. Several attempts may be required to unfeather, but under no condition should the switch be held out for more than one second at a time. Allow time between switch operations for propeller action to occur.
- c. After propeller has unfeathered, ignition switch "BOTH."
- d. As propeller starts turning, mixture control "NORMAL." Check oil pressure for 40 psi minimum.
- e. Oil cooler, cowl, and intercooler flap switches "AUTO."
- f. Advance throttle for warm-up, and run engine at reduced power until oil and cylinder head temperatures indicate a safe operating condition.
- g. Bring up rpm by propeller control toggle switch; then move propeller master selector switch to "NORMAL."

3-25. PROPELLER SYNCHRONIZER FAILURE.

3-26. Should the propeller synchronizer fail, move propeller master selector switch to "TOGGLE SWITCHES ONLY" or "TOGGLE SWITCHES & MASTER LEVER," and adjust rpm by operation of individual propeller control toggle switches or master lever.

3-27. PROPELLER GOVERNOR FAILURE.

3-28. Depending upon the cause of malfunction, governor failure may cause a propeller to be held in constant speed as set at the time of failure or to go to full low pitch (runaway propeller). Any kind of electrical failure is most likely to result in the constant-speed condition, and no remedial action is possible other than to check operation of the propeller control toggle switch and the master lever. A runaway propeller may cause the engine speed to exceed allowable limits, but it may be possible to reduce rpm as follows:

- a. Retard throttle and reduce airspeed as much as

possible.

- b. Move propeller master selector switch to "TOGGLE SWITCHES & MASTER LEVER" and attempt to lower rpm by using both the related propeller control toggle switch and the master lever. (Adjust rpm of good engine as desired by use of related toggle switch.)

- c. Attempt to feather propeller.

- d. If feathering switch is ineffective and rpm cannot be brought within limits by airspeed and throttle reduction, shut down engine completely.

3-29. FORCED LANDING.

3-30. If it is necessary to make a forced landing:

- a. Warn crew.
- b. Jettison bombs and tip tanks.
- c. Jettison crew exit door to prevent jamming on impact.
- d. Unbuckle parachute; tighten and lock safety belt and shoulder harness.
- e. Lower gear only when terrain is suitable for wheels-down landing.
- f. Make a normal full flap approach.
- g. Do not feather propellers unless you have to prolong the glide. With propellers feathered, tips do not bend aside on impact but dig into the ground, breaking engine mounts, and adding to fire hazard.
- h. Just before ground contact, warn crew; then cut all switches to reduce possibility of fire.
- i. After landing, leave airplane immediately and make sure that all crew members get out.

3-31. EMERGENCY EXIT.

3-32. BAIL-OUT.

3-33. When it is necessary to abandon the airplane (figure 3-3), proceed as follows:

NOTE

Procedure identical for pilot, bomber-navigator, and third crew member except as noted.

- a. Warn crew of impending bail-out.
- b. Reduce speed as much as possible, and trim airplane "hands off" (pilot).
- c. Make sure that bomb doors are closed (pilot). There is danger of striking the bomb doors if exit is made through the crew exit door when the bomb doors are open.
- d. Give command to abandon airplane (pilot).

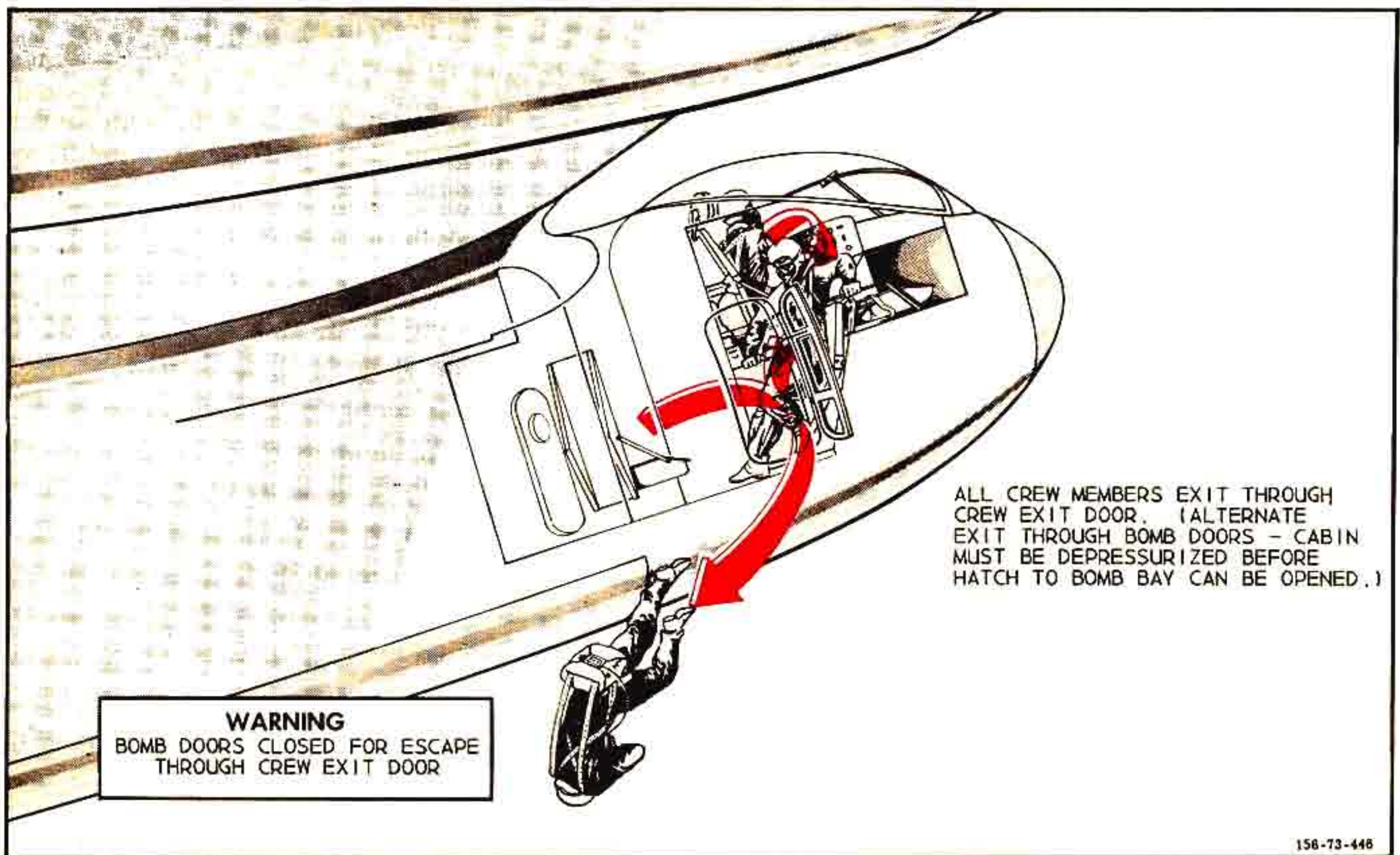

Figure 3-3. Emergency Exit - Bail-out

- e. Unfasten safety belt and shoulder harness.
- f. Lower back of seat by pulling up seat-back lever handle to allow exit from pilot's compartment (pilot and bomber-navigator).
- g. Open crew exit door by positioning the emergency exit lever in pilot's compartment to "OPEN DOOR" or by moving the emergency valve handle in crew entry compartment to "EXIT DOOR OPEN" (third crew member or bomber-navigator). The aft part of the door will be jettisoned and the forward part will be held open to serve as a windguard.

3-34. If plenty of time is available before abandoning the airplane, exit may be made through the bomb bay.

NOTE

Pilot must position emergency cabin air valve to "RAM AIR ON - DUMP VALVE OPEN" to depressurize the cabin before the hatch leading to the bomb bay can be opened.

3-35. DITCHING.

3-36. PREPARING FOR DITCHING.

3-37. PILOT. When ditching is necessary, make preparation as follows (figure 3-4):

- a. Give command, "Prepare for ditching."
- b. Jettison tip tanks and bombs.

c. Unbuckle parachute. Make sure safety belt and shoulder harness are tightened and locked.

d. Open canopy before landing. On airplanes with fixed canopies, open canopy sliding panels. If ample time is available, remove equipment installation panel.

e. Warn crew 5 seconds before landing.

3-38. BOMBER-NAVIGATOR. When ditching is necessary, make preparation as follows (figure 3-4):

- a. Start emergency radio procedure immediately.
- b. If third crew member is not carried, make sure hatch leading to bomb bay is closed and locked.
- c. Unbuckle parachute. Make sure safety belt and shoulder harness are tightened and locked.
- d. Notify pilot "Ready for ditching."

3-39. THIRD CREW MEMBER. When ditching is necessary, make preparation as follows (figure 3-4):

- a. Make sure that hatch leading to bomb bay is closed and locked.
- b. Unbuckle parachute. Make sure that safety belt and shoulder harness are tightened and locked.
- c. Notify pilot "Ready for ditching."

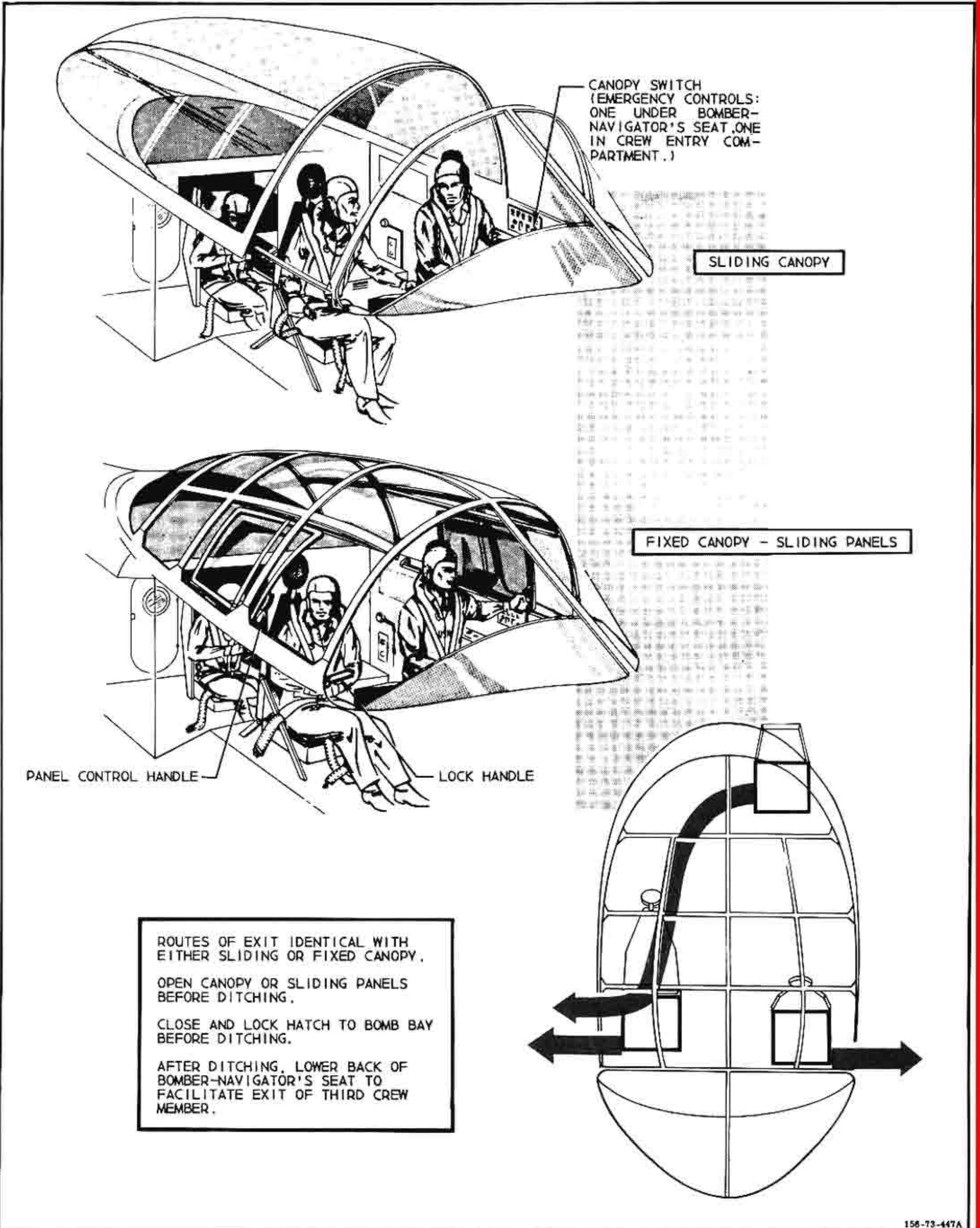

Figure 3-4. Ditching Positions and Exits

3-40. HANDLING THE AIRPLANE.

3-41. Information to be supplied when available.

3-42. ABANDONING THE AIRPLANE.

3-43. Hold ditching positions until the airplane comes to a stop; then proceed as follows:

3-44. PILOT AND BOMBER-NAVIGATOR.

- a. Unfasten safety belt and shoulder harness.
- b. Pull up seat-back lever to lower back of seat.
- c. Exit through canopy opening and inflate pararaft.

3-45. THIRD CREW MEMBER.

- a. Unfasten safety belt and shoulder harness.
- b. Exit through canopy opening as soon as bomber-navigator lowers back of seat, and inflate pararaft.

3-46. FUEL SYSTEM EMERGENCY OPERATION.

3-47. FUEL PUMP FAILURE - RECIPROCATING ENGINES.

3-48. If drop in fuel pressure indicates failure of an engine-driven pump, turn related emergency fuel pump on. If the pump failure is not detected before the engine cuts out, retard throttle before turning emergency pump on, in order to prevent possible engine backfire.

3-49. FUEL PUMP FAILURE - JET ENGINE.

3-50. Sudden drop in fuel pressure and loss of engine rpm on the jet engine usually indicate failure of some part of the fuel system. In case of such failure, move jet-engine fuel control switch to "EMERG" to obtain pressure from the emergency fuel system. If complete flame-out should occur before loss of power is detected, proceed as follows:

- a. Retard jet throttle to "OFF."
- b. Nose airplane up sharply several times to drain any fuel which may have accumulated in the combustion chambers.
- c. Move jet-engine fuel control switch to "EMERG," and make a normal automatic start.

3-51. If start is not accomplished by the procedure given in paragraph 3-50, it may be due to the fact that the jet air intake door is open and the engine windmilling. It is possible that engine windmilling might prevent starter engagement, and both starter and ignition could automatically cut out before a start is completed. To correct this condition, make start as follows:

- a. Retard jet throttle to "OFF."
- b. Nose airplane up sharply several times to drain

fuel.

c. Jet master switch "OFF." Wait approximately 2 minutes for jet intake door to close and engine to stop turning; then turn jet master switch "ON," jet engine fuel control switch to "EMERG," and make a normal automatic start.

3-52. TRANSFER PUMP FAILURE.

3-53. If the fuselage tank fuel quantity indicator shows that fuselage tank fuel is not being transferred (after approximately 270 pounds fuel from each wing tank is used), fuselage tank fuel can be utilized as follows: At low altitude (10,000 feet or below), where suction feed is sufficient for normal engine operation, open cross-feed valves, and turn transfer pump and booster pumps "OFF." Fuselage tank fuel will flow to cross-feed line by suction feed. After fuselage tank fuel has been consumed, turn booster pumps "ON."

3-54. CROSS-FEED OPERATION.

3-55. ENGINE FAILURE. In case of engine failure, all fuel in the airplane can be supplied to the operating engine or engines (jet and reciprocating) as follows:

- a. Move emergency engine control switch for dead engine to "FUEL & OIL SHUT-OFF."
- b. Cross-feed valves "ON."

3-56. DAMAGED TANKS. If one set of wing tanks is damaged or a severe leak is suspected, proceed as follows:

- a. If practicable, use fuel from damaged tanks first by turning cross-feed valves "ON" and booster pump switch for good tanks "OFF."
- b. If leak is believed to be in either wing tank, move fuselage tank transfer switch to "OFF" so that fuselage tank fuel will not be lost by automatic transfer to the leaking tank.

c. When damaged tanks are nearly empty or if wing heaviness becomes excessive, turn booster pump switch for good tanks on. Leave cross-feed valves "ON" and leave transfer pump switch "OFF." Turn booster pump switch for damaged tanks "OFF" when tanks indicate empty.

d. If leak is known to be in either wing tank, fuselage tank fuel can be salvaged by the following method: Use wing tank fuel as instructed in steps b. and c. When wing tanks are empty, at low altitude (10,000 feet or below) where suction feed is sufficient for normal engine operation, leave cross-feed valves "ON," turn all booster pumps "OFF," and leave transfer pump "OFF." Fuel will flow from the fuselage tank to the cross-feed line by suction feed for operation of both engines.

3-57. ELECTRICAL SYSTEM EMERGENCY OPERATION.

3-58. GENERATOR OVERVOLTAGE.

3-59. Should voltage output of either generator become

excessive, an overvoltage relay cuts the affected generator out of the electrical circuit. If this condition is indicated by illumination of a generator warning light:

- a. Hold related generator switch at "RESET" momentarily. Then return to "ON."
- b. If warning light goes out and remains out when the switch is turned "ON," the overvoltage was temporary.
- c. If light illuminates again, move switch to "OFF."
- d. If use of the reset position is ineffective, push "EMERG RESET" button momentarily.
- e. If use of the emergency reset button is ineffective, attempt to reduce voltage by adjustment on voltage regulator rheostat (in crew entry compartment); then turn generator switch "ON" and recheck voltage.
- f. If voltage cannot be brought within allowable limit (30 volts maximum emergency), leave generator switch "OFF."

3-60. GENERATOR FAILURE.

3-61. If one generator is inoperative, only equipment that is nonessential to flight will become inoperative. (See figure 1-9 for electrical equipment powered by monitor bus.)

3-62. If both generators are inoperative, the length of time that the battery will supply power depends on the electrical load and the condition of the battery. With electrical load reduced to a minimum and the battery fully charged, electrical power will be available for approximately 20 minutes.

WARNING

Immediately reduce electrical load by turning off all nonessential equipment. (See figure 1-9 for electrical equipment powered by the essential bus.)

If the battery switch is left in the "BATTERY" position, operation of the airplane will be affected as follows:

- a. Elevator and rudder boost systems will be inoperative.
- b. Switches controlling the oil cooler, cowl, and intercooler flaps will be inoperative; consequently, engine temperatures must be checked closely and operation limited to keep within allowable limits.
- c. Jet engine cannot be started; however, if jet engine is operating at time of generator system failure, operation may continue, or the jet engine may be shut down.
- d. Fuel booster and transfer pumps will be inoperative. It may be necessary to reduce altitude for

satisfactory engine operation.

- e. Turbo-superchargers will be inoperative; if operation of turbos is desired, place emergency turbo switches at "EMERG. BAT."

3-63. If it is necessary to operate any of the equipment listed in paragraph 3-62, place the battery switch at "EMERG."

WARNING

Before placing battery switch at "EMERG," turn off all nonessential loads that are powered normally by the essential and main busses. (See figure 1-9 for electrical equipment powered by essential and main busses.)

NOTE

Turbo-superchargers will still be inoperative unless turbo power switches are at "EMERG. BAT."

3-64. INVERTER FAILURE.

3-65. Failure of either main inverter will be indicated by illumination of the related warning light, and the stand-by inverter will automatically take-over. If alternating-current powered equipment fails to operate after failure of a main inverter, position voltmeter switch as necessary ("SINGLE PHASE" or "THREE PHASE") and check a-c voltmeter. If no reading indicates that automatic change-over has failed, move inverter switch to "STANDBY INVERTER."

3-66. JET AIR INTAKE DOOR EMERGENCY OPERATION.

3-67. If jet air intake door fails to open or close normally:

NOTE

The normal closing cycle requires approximately 40 seconds. Allow sufficient time for normal operation.

- a. Cabin air compressor valve - depress and hold "OFF."
- b. Push jet air intake valve to "OPEN" or "CLOSE" as desired.

NOTE

If failure of normal operation is due to hydraulic failure, no emergency means of opening or closing the intake door is available.

3-68. SURFACE CONTROL BOOSTER SYSTEM EMERGENCY OPERATION.

3-69. In the event hydraulic boost to any control surface fails, control forces will be high, but the

airplane can be controlled by means of the trim tabs. An emergency system for aileron boost is provided, but there is no emergency system for rudder and elevator boost. Without elevator boost, control forces required to flare for landing are very high and use of elevator trim is necessary for control. It is recommended that during normal approach and landing, the airplane be kept in constant trim to afford better control in case of elevator boost failure.

3-70. AILERON BOOST EMERGENCY OPERATION.

3-71. To obtain hydraulic pressure from the main hydraulic system in case of failure of the aileron boost system pressure supply, move aileron boost switch to "EMERG."

NOTE

When the boost switch is at "EMERG," no hydraulic pressure will be available for normal operation of other hydraulically actuated units.

3-72. In case of complete hydraulic failure or when it is impractical to use main system pressure for emergency aileron boost:

- a. Move aileron boost switch to "OFF" to open by-pass valves at aileron boost cylinders.
- b. Move aileron mechanical ratio control to "BOOST OUT 2 TO 1."

WARNING

When aileron mechanical ratio control handle is at "BOOST OUT 2 TO 1," aileron travel is restricted to one-half normal travel.

3-73. In case one engine is inoperative or one aileron boost pump fails, aileron boost will still be available; however, the rapidity of control response will be considerably decreased.

3-74. Manual operation of the emergency aileron boost pressure and return valves (to secure emergency boost pressure from the main hydraulic system in case of failure of the electrical control system) is impractical in flight, inasmuch as the two valves, as well as the cabin air compressor valve, must be held on for operation.

3-75. ELEVATOR AND RUDDER BOOST EMERGENCY OPERATION.

3-76. If elevator boost pressure is lost, a by-pass valve in the system automatically opens, permitting free flow of fluid between the two sides of the boost cylinder. A similar valve in the rudder boost system opens automatically if rudder boost pressure is lost. If either elevator or rudder boost system should fail, move related flight control boost switch to "OFF."

3-77. WING FLAP EMERGENCY OPERATION.

3-78. If failure of normal wing flap operation is due to failure of utility hydraulic system, the flaps can be lowered (but not raised) as follows:

- a. Pull out "LANDING FLAP VALVE" circuit breaker.
- b. Position emergency wing flap down valve at "EMERG WING FLAP DOWN."
- c. When flaps reach desired position, return emergency wing flap down valve to "OFF."

3-79. If failure of normal wing flap operation is due to malfunction of the electrical control system, the wing flaps can be raised or lowered as follows:

- a. Pull out "LANDING FLAP VALVE" circuit breaker.
- b. Depress and hold cabin air compressor valve "OFF" while operating wing flap valve.
- c. Push wing flap valve to "UP" or "DOWN" and hold until desired flap position is reached.

3-80. LANDING GEAR EMERGENCY OPERATION.

3-81. If normal gear operation fails, gear can be lowered (but not raised) as follows:

- a. Pull out "LANDING GEAR CONTROL" circuit breaker.
- b. Position emergency landing gear down valve at "DOWN."
- c. Check gear position indicator for safe gear condition.
- d. Leave emergency landing gear down valve at "DOWN" for landing.

e. If failure of normal gear operation is due to complete electrical failure (rendering electric gear control system and electric emergency hydraulic pump inoperative), but utility system pressure is available, pressure will be automatically supplied by the utility hydraulic system through the emergency system lines.

3-82. If failure of normal gear operation is caused by malfunction of the electrical system, and utility system pressure is available, the gear can be raised or lowered as follows:

CAUTION

The gear can be lowered by the following procedure; however, the emergency procedure outlined in paragraph 3-81 should always

be employed first when normal gear operation fails. A hydraulic failure in the utility system such as a broken line in the landing gear system itself, plus complete electrical failure, might make it impossible to lower the gear at all if the following procedure (manual operation of the landing gear valve) is used before the emergency system.

a. Pull out "LANDING GEAR CONTROL" circuit breaker.

b. Depress and hold cabin air compressor valve "OFF" while operating gear and gear door valves in the following steps.

c. Push nose gear door valve to "OPEN." Release when door is fully opened. (Wait at least 10 seconds.)

d. Push main landing gear door valve to "OPEN." Release when door is fully opened. (Wait at least 10 seconds.)

e. Push landing gear valve to "UP" or "DOWN" as desired. Hold up or down until lock engages. Check gear position indicator "DOWN." (For "up" cycle, wait at least 20 seconds.)

f. If gear is being lowered - when it reaches the down position, push main gear door valve to "CLOSE." (Nose gear door is not closed when gear is lowered.)

g. If gear is being raised - when it reaches the up position, push main and nose gear door valves to "CLOSE" and check position indicators for full up and locked condition.

3-83. WHEEL BRAKE EMERGENCY OPERATION.

3-84. If wheel brakes fail to respond to pressure on toe pedals, pull out on parking and emergency brake handle. (If utility hydraulic system is known to be inoperative, before landing instruct a crew member to check accumulator pressure.)

3-85. ARRESTING HOOK EMERGENCY OPERATION.

3-86. No emergency means of extending the arresting hook is necessary, as the mechanism is so designed that it will extend if the release cable is broken. However, if the electrical control system for retraction is inoperative, the hook can be retracted as follows:

a. Depress and hold cabin air compressor valve "OFF."

b. Push arresting hook valve to "UP."

3-87. BOMB BAY DOOR EMERGENCY OPERATION.

3-88. If normal bomb door operation fails, bomb bay doors can be either opened or closed as follows:

a. Pull out "BOMB DOOR VALVE" circuit breaker.

b. Emergency bomb door valve "OPEN" or "CLOSED" as desired.

c. Return valve to "OFF" when desired operation is complete.

d. If failure of normal bomb door operation is due to complete electrical failure (resulting in failure of electrical bomb door control system and of the electrically driven emergency hydraulic pump), but utility system pressure is available, pressure will be automatically supplied by the utility hydraulic system through the emergency system lines to the doors.

3-89. If failure of normal bomb door operation is caused by malfunction of the electrical control system, bomb bay doors can be either opened or closed as follows:



The bomb bay doors can be opened or closed by the following procedure; however, the emergency procedure outlined in paragraph 3-88 should always be employed first when normal door operation fails. A broken line in the bomb bay door system itself, plus complete electrical failure, might make it impossible to operate the doors at all if the following procedure (manual override of the bomb door valve) is used before the emergency system.

a. Pull out "BOMB DOOR VALVE" circuit breaker.

b. Depress and hold cabin air compressor valve "OFF."

c. Push bomb bay door valve to "OPEN" or "CLOSE" and hold until door reaches desired position.

3-90. SLIDING CANOPY EMERGENCY OPERATION.

3-91. If failure of normal operation is due to malfunction of the utility hydraulic system, open sliding canopy by positioning the emergency exit lever in pilot's compartment to "CANOPY OPEN" or by moving the emergency valve handle in crew entry compartment to "ENCLOSURE OPEN."

WARNING

If both sliding canopy and crew exit door are to be opened, open canopy first, as operation of canopy requires more accumulator pressure than the door. If the door is opened first, canopy may not open fully.

3-92. If there is no accumulator pressure, and if failure is due to electrical malfunction, but utility system pressure is available:

a. Pull out "CANOPY CONTROL VALVE" circuit

breaker.

b. Depress and hold cabin air compressor valve "OFF."

c. Push enclosure valve to "OPEN" or "CLOSE" for desired operation.

3-93. EXIT DOOR EMERGENCY OPERATION.

3-94. In an emergency, open crew exit door by positioning the emergency exit lever in pilot's compartment to "OPEN DOOR" or by moving the emergency valve handle in crew entry compartment to "EXIT DOOR OPEN." The aft part of the door will be jettisoned and the forward part will be held open to serve as a windguard.

WARNING

If both sliding canopy and crew exit door are to be opened, open canopy first, as operation of canopy requires more accumulator pressure than the door. If the door is opened first, canopy may not open fully.

3-95. FILLING HYDRAULIC RESERVOIRS IN FLIGHT.

3-96. If necessary to refill hydraulic reservoirs in flight, proceed as follows:

NOTE

Hydraulic fluid level indicators are located on the reservoirs in the bomb bay. To open hatch leading to bomb bay, cabin must first be depressurized.

- a. Insert hose in fluid container.
- b. Turn filling valve to "FILL."
- c. Place emergency pump switch at "ON FILLING" and hold.
- d. When reservoirs are full, release filling switch.
- e. Move filling valve to "OFF."
- f. Stow hose.

NOTE

Both reservoirs must be full before utility pressure will be available, as the aileron reservoir fills first and then the utility reservoir.

3-97. OXYGEN SYSTEM EMERGENCY OPERATION.

3-98. Should symptoms occur suggestive of the onset of anoxia, or the regulator become inoperative, immediately open "EMERGENCY" valve and descend below 10,000 feet.

WARNING

Open the emergency valve slowly to minimum flow required - maximum flow may cause oxygen mask to be blown off.

(If altitude is reduced, remember that fuel consumption will be greatly increased.) Whenever excessive carbon monoxide or other noxious or irritating gas is present or suspected, then, regardless of altitude, the air valve should be set at "100% OXYGEN" and undiluted oxygen used until danger is passed or flight is completed. Should brief removal of mask from the face be necessary at high altitude, use the following procedure:

- a. Take three or four deep breaths of undiluted oxygen (air valve at "100% OXYGEN").
- b. Hold breath and remove mask from face.
- c. As soon as practicable, replace mask to face and take three or four deep breaths of undiluted oxygen.
- d. Reset air valve to "NORMAL OXYGEN."

3-99. CABIN PRESSURIZATION AND HEATING EMERGENCY OPERATION.

3-100. DEPRESSURIZATION.

WARNING

Always have oxygen available for immediate use when flying above 10,000 feet (airplane altitude).

3-101. If cabin air compressor should fail, or if cabin depressurization is necessary, proceed as follows:

- a. Put on oxygen mask (if at altitude) and adjust regulator. Instruct crew to use oxygen.
- b. Turn emergency cabin air control to "RAM AIR ON - DUMP VALVE OPEN."

3-102. HEATER EMERGENCY OPERATION.

3-103. Should the automatic temperature control fail and the cabin become excessively cold, proceed as follows:

- a. Put on oxygen mask (if at altitude) and warn crew to use oxygen.
- b. Place emergency cabin air control at "RAM AIR ON - DUMP VALVE OPEN."
- c. Place heater master switch at "EMERG. HEAT."
- d. Periodically move heater master switch to "OFF" as necessary to maintain a comfortable cabin air

temperature.

3-104. If cabin heater should fail, and airflow to cabin is too cold, proceed as follows:

a. Put on oxygen mask (if at altitude) and adjust regulator. Instruct crew to use oxygen.

b. Turn emergency cabin air control to "COMPRESSOR OFF."

3-105. AUTOMATIC PILOT EMERGENCY RELEASE.

3-106. To disengage the automatic pilot mechanically in case of electrical failure, pull up "AUTO PILOT EMERGENCY RELEASE" handle, located on a panel just forward of the control stick.

NOTE

Automatic pilot cannot be re-engaged in flight after emergency release.

3-107. BOMB SALVO (ADAPTER INSTALLED).

3-108. To salvo bombs when bomb rack adapter is installed, press bomb salvo switch and hold for 5 seconds.

3-109. To salvo bomb load mechanically (bombs and rack adapter) in case of bomb salvo switch malfunctions, proceed as follows:

a. Hold bomb door switch momentarily at "OPEN" and check indicator light.

b. Push down latch adjacent to manual release handle and pull handle full out.

3-110. IFF RADIO EMERGENCY OPERATION.

3-111. For emergency operation of IFF equipment, push guard latch to the right and rotate code selector switch clockwise to "EMERGENCY." In this position the identification radio will transmit signals indicating the airplane is in distress. To destroy IFF transmitter-receiver unit, raise guard of "DESTRUCT" switch, breaking safety wire, and move switch to "ON."

NOTE

"EMERGENCY" position is never used except when the airplane, during flight, is in distress. Pilots will be governed by existing regulations dealing with emergency operation of IFF equipment.

SECTION IV

OPERATIONAL EQUIPMENT

4-1. BOMBING EQUIPMENT.

4-2. The bomb bay is capable of carrying bomb loads up to 9600 pounds by use of a single shackle and bomb adapter rack which are suspended from the top center of the bomb bay. Bomb doors are hydraulically actuated and electrically controlled. Radar bomb sight (AN/APA-5A) and radar antenna equipment (AN/APS-31) are installed in Airplanes 122593 and subsequent. Space provisions are made for installation of AN/ASB-1 radar bombing and navigation equipment.

4-3. BOMB CONTROLS.

4-4. Controls for bombing equipment are located on two panels, a master bomb control panel attached to the pilot's pedestal (figure 4-3), and an adapter bomb control panel installed at the right of the bomber-navigator's station. (See figure 4-2.) Bombs may be released either automatically through operation of the radar bombing system or by means of an electrical release button stowed under the master bomb control panel. Emergency salvo can be accomplished electrically or mechanically.

4-5. **BOMB DOOR SWITCH.** Bomb doors are controlled by a three-position switch on the master control panel. The switch is spring-loaded to "OFF" and must be held momentarily at "OPEN" or "CLOSE" to operate the doors. A green indicator light above the switch is illuminated when bomb doors are open. Bomb doors close automatically after the last bomb is released from the adapter.

4-6. **MASTER SWITCH.** A master switch on the master control panel supplies electrical power to bomb release controls, except the emergency bomb salvo button. A shackle circuit indicator light above the master switch illuminates when the master switch is "ON."

4-7. **SHACKLE HEATER SWITCH.** A shackle heater switch is located on the master control panel. When the switch is turned "ON," an electric heater in the single shackle will operate whenever the temperature drops to 40°F. A light above the shackle heater switch illuminates whenever the switch is turned "ON," but does not necessarily mean that the heater is operating. In freezing weather, the shackle heater should be on at least 30 minutes before shackle operation.

4-8. **INTERVALOMETER.** A Type K-2 intervalometer control is provided on the adapter control panel to preset the interval (in feet) between bombs, and a counter to select the number of bombs to be dropped. A switch is also provided for selecting "train" or "selective" (single) release of bombs. A light on

the panel illuminates whenever selective release is selected or when the counter is set above zero when train release is selected.

4-9. **BOMB ARMING PANEL.** A bomb arming panel on the adapter panel contains a three-position arming switch. Normally at "SAFE," the arming switch may be moved to "TAIL ONLY" to arm bombs for delayed detonation, or to "NOSE AND TAIL" to arm bombs for instantaneous detonation. An indicator light above the switch is illuminated when bombs are armed.

4-10. **BOMB STATION INDICATOR LIGHTS.** Sixteen indicator lamps, one for each bomb station, are located on the adapter panel and are controlled by a toggle switch adjacent to the lights. When the toggle switch is "ON," an indicator lamp for each loaded bomb station is illuminated. When a bomb is released, the related indicator lamp goes out. A rotary-type test switch is provided for testing indicator lamps. Circuit breakers and spare lamps are mounted on the panel.

4-11. **BOMB SALVO SWITCH.** An emergency salvo switch is located forward of the adapter control panel. When the switch is depressed and held for 5 seconds, bomb doors open, bombs are salvoed unarmed, and bomb doors close in proper sequence.

4-12. **MANUAL RELEASE HANDLE.** In case of electrical failure, the complete assembly, bombs and bomb rack adapter, can be released mechanically by means of a manual release handle on the pedestal bomb control panel. The manual release handle is normally full forward, and the shackle is locked. When the handle is pulled, the first portion of travel unlocks the shackle. Further extension is prevented by a safety latch adjacent to the handle. This latch must be pushed down and the handle then pulled full out to release the adapter and bombs.

NOTE

Bomb doors must be open before the handle can be pulled full out.

4-13. BOMB SHACKLE CONTROLS.

4-14. By special Navy instruction, the bomb shackle may be used to carry a single store, without the use of the bomb rack adapter. The shackle store can be released either automatically through operation of radar bombing equipment or by means of the electrical bomb release button. Only the controls on the master panel are used to release the single store; the adapter panel is ineffective. Before release can be accomplished, the manual release handle must be

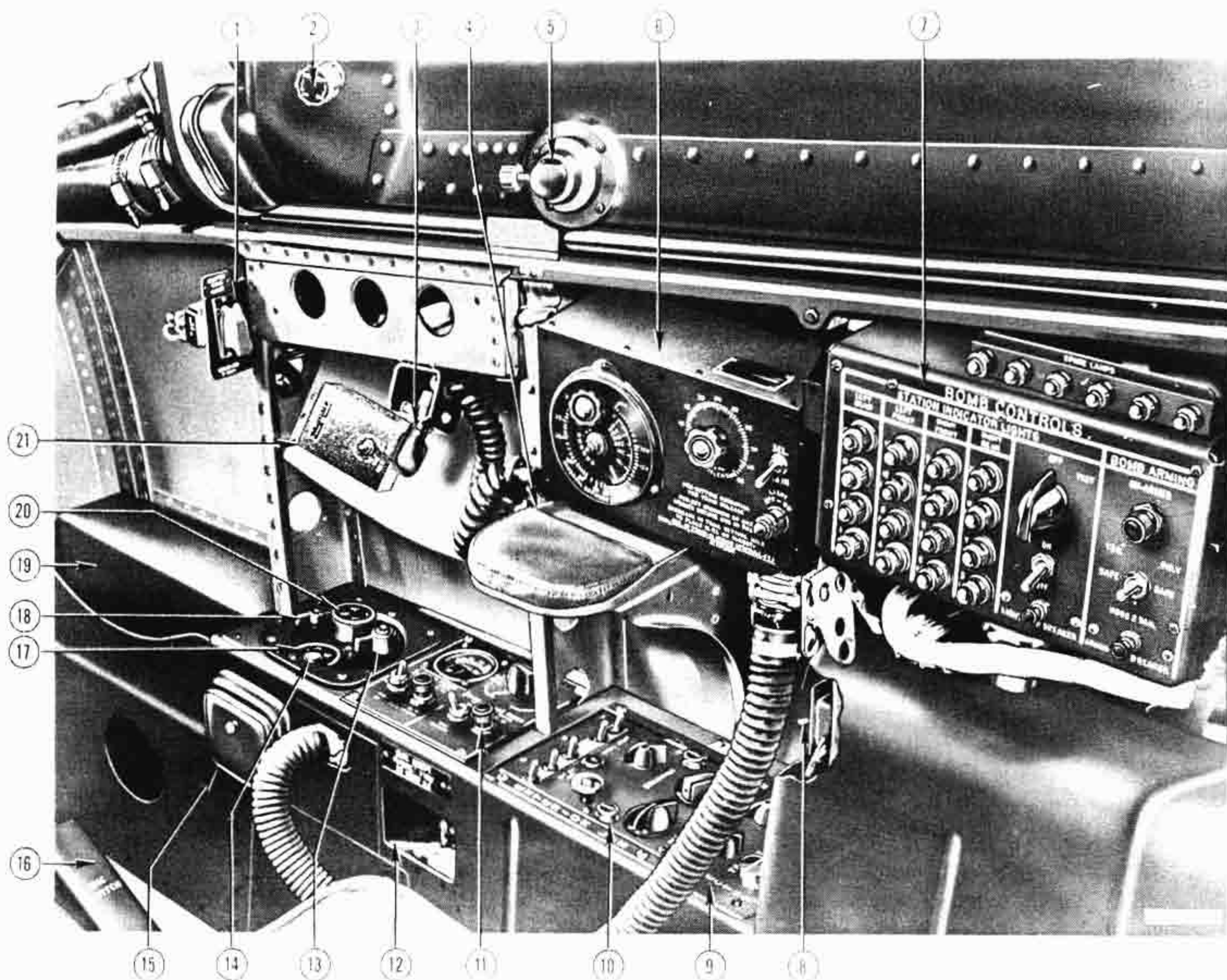

- | | |
|---------------------------------------|--|
| 1. Emergency Bomb Salvo Switch | 12. Suit Heat Outlet |
| 2. Canopy Defrost Control | 13. Oxygen Regulator Air Valve |
| 3. Cockpit Light | 14. Oxygen Safety Press Button |
| 4. Armrest | 15. Ash Tray |
| 5. Cabin Air Outlet | 16. Microphone Switch |
| 6. Intervalometer | 17. Oxygen Flow Indicator |
| 7. Bomb Station and Bomb Arming Panel | 18. Oxygen Emergency Valve |
| 8. Approach Light Switch | 19. Data Case |
| 9. Radio and Interphone Panel | 20. Oxygen Pressure Gage |
| 10. Exterior Lights Panel | 21. Variable Auto-Transformer
(AN/APS-31) |
| 11. AC Power Control Panel | |

Figure 4-1. Bomber-Navigator's Station - Right Side

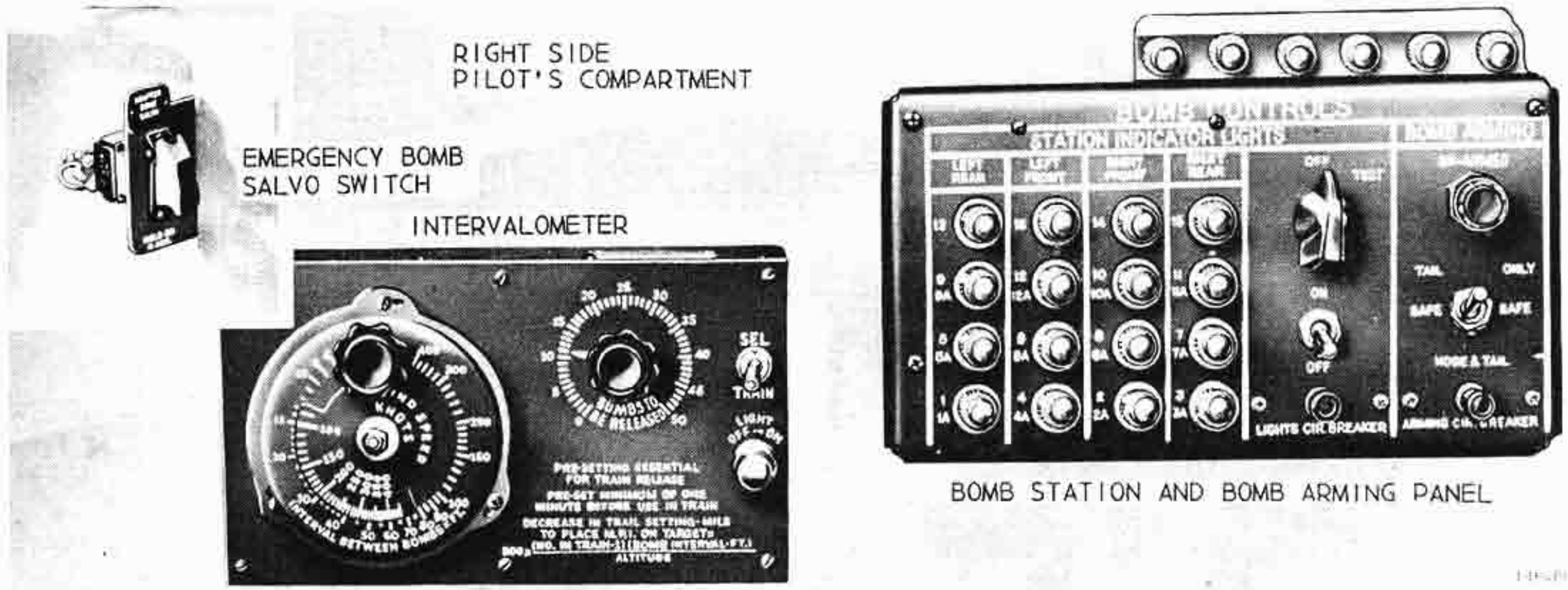

Figure 4-2. Adapter Bomb Control Panel

pulled out to the latch stop to unlock the shackle. When the shackle store is released, an indicator light on the pilot's instrument panel (12, figure 1-2) illuminates. In an emergency, the shackle can be released mechanically, by pushing down the safety latch and pulling the manual release handle to full out position. (Refer to paragraph 4-12.)

NOTE

Bomb doors close automatically after bomb release only when the adapter is carried.

4-15. **NORMAL BOMB RELEASE (WITH ADAPTER).** For normal release of bombs from the bomb rack adapter, either automatically through operation of the radar bombing equipment or by means of the electrical release button, proceed as follows:



Figure 4-3. Master Bomb Control Panel

NOTE

In freezing weather, the single shackle heater should be on at least 30 minutes before shackle operation. Check that shackle heater switch is "ON" and indicator light illuminated.

- a. Master switch "ON."
- b. Preset radar bombing equipment if automatic release is desired.
- c. Bomb station indicator light switch "ON." Check bomb station indicator lights.
- d. Set bomb intervalometer.
- e. Set bomb arming switch at "TAIL ONLY" or "NOSE AND TAIL," as desired.
- f. Hold bomb door switch momentarily at "OPEN" and check indicator light.
- g. If radar automatic release is not used, press bomb release button at correct release point.
- h. Check bomb station indicator lights for bomb release.

4-16. OXYGEN SYSTEM.

4-17. Oxygen is supplied from three high-pressure oxygen cylinders installed under the floor of the crew entry compartment (Airplanes 122590 through 122595, on right side of pilot's compartment.) The three cylinders are connected to one main oxygen supply line. Normal full pressure for the system is 1800 psi. All oxygen cylinders can be refilled at a single filler valve accessible through an access door located on the right side of the fuselage, just aft of the crew entry door. (See figure 1-16.)

4-18. OXYGEN REGULATORS.

4-19. Each crew member's station is provided with a

GAGE PRESSURE	ALTITUDE							
	5,000	10,000	15,000	20,000	25,000	30,000	35,000	40,000
1800	8:0	9:0	8:30	6:50	4:05	3:05	4:10	6:50
1500	6:20	7:10	6:45	5:30	3:15	2:30	3:20	5:30
1200	4:45	5:20	5:05	4:05	2:20	1:50	2:30	4:05
900	3:10	3:35	3:20	2:45	1:35	1:10	1:40	2:45
600	1:35	1:45	1:40	1:20	:45	:35	:45	1:20
300	DESCEND BELOW 10,000 FEET							

THREE 514 CU IN. CYLINDERS-DILUTER DEMAND REGULATORS
APPLICABLE TO 2862-AI AND 2864-AI REGULATORS

146-00-720

Figure 4-4. Oxygen Consumption Table

positive-pressure, diluter-demand type oxygen regulator for pressure breathing. (See figure 1-3, figure 4-1, and figure 4-9.) Each regulator automatically mixes varying quantities of air and oxygen, the ratio depending on altitude, and delivers the quantity demanded upon inhalation. In addition to conventional regulator air valve and emergency valve, a safety pressure button on the regulator (normally pulled out) can be depressed to provide oxygen flow under a positive pressure (about 2 psi) while operating on either normal oxygen or on 100% oxygen. When the safety pressure button is depressed, oxygen flows freely upon inhalation, and stops flowing upon exhalation.

NOTE

Use oxygen on all flights when above 10,000 feet (cabin altitude), on all night flights when above 5000 feet (cabin altitude), and on combat missions and training missions simulating combat.

4-20. OXYGEN MASK STOWAGE BAGS.

4-21. Stowage bags for pilot's and bomber-navigator's oxygen masks are located in the pilot's compartment, aft of the left console. An oxygen mask stowage bag for a third crew member is located on the bulkhead forward of the third crew member's station.

4-22. OXYGEN SYSTEM PREFLIGHT CHECK.

4-23. Before each flight requiring use of oxygen, inspect oxygen equipment as follows:

- a. Emergency valve "OFF."
- b. Turn on supply pressure. Pressure gage should read approximately 1800 psi if cylinders are fully charged.
- c. Turn off supply pressure. After a few minutes, observe pressure gage and simultaneously turn on

supply pressure. If gage pointer jumps, leakage is indicated and system must be checked by ground crew prior to use.

d. Put on mask. To check mask fit, place thumb over disconnect at end of mask tube and inhale lightly. If there is no leakage, the mask adheres tightly to face and a definite resistance to inhalation is encountered. If mask leaks, tighten mask suspension straps and adjust nose wire. **DO NOT USE MASK THAT LEAKS.**

e. Fully engage mating portions of disconnect coupling so that mask is connected to oxygen system breathing tube.

f. Turn on supply pressure and breathe several times with regulator air valve in both "NORMAL OXYGEN" and "100% OXYGEN" positions to check regulator operation. Observe oxygen flow indicator for "blink" verifying positive flow of oxygen.

g. Open regulator emergency valve slowly to check for oxygen flow; then close valve.



While emergency valve is open, do not obstruct free flow of oxygen through regulator and breathing tube, as serious damage to regulator may result.

4-24. OXYGEN SYSTEM FLIGHT OPERATION.

4-25. When oxygen is to be used in flight:

- a. Turn on oxygen supply pressure. Pressure gage should read 1800 psi if cylinders are fully charged.
- b. Set air valve to "NORMAL OXYGEN" for all normal flight conditions.
- c. Put on mask. Check fit of mask as soon as you

put it on. (Refer to paragraph 4-23, d.)

d. Fully engage mating portions of disconnect coupling to connect mask to oxygen system breathing tube, and attach clip to parachute harness (or clothing) sufficiently high on chest to permit free movement of head.

e. Breathe normally and observe flow indicator for "blink" which verifies positive flow of oxygen.

f. Frequently check pressure gage and flow indicator.

g. Frequently check mask fit for leak-tightness; check disconnect coupling to ensure that it is fully engaged.

h. When needed, or desired, depress safety pressure

button for positive pressure breathing.

i. Do not exhaust supply cylinder below 300 psi except in an emergency.

j. Refer to paragraph 3-98 for emergency operation.

4-26. OXYGEN SYSTEM CHECK AFTER FLIGHT.

4-27. Following each flight during which oxygen is used:

a. Turn off oxygen supply.

b. Make sure all oxygen equipment is in proper condition before leaving airplane. Report all difficulties and see that they are corrected.

4-28. COMMUNICATIONS AND ASSOCIATED ELECTRONIC EQUIPMENT.

TABLE OF COMMUNICATIONS AND ASSOCIATED ELECTRONIC EQUIPMENT

TYPE	DESIGNATION	USE	OPERATOR	ILLUSTRATION
VHF Transmitter-Receiver	AN/ARC-1A	Two-way voice communication.	Pilot (other crew members can transmit and receive).	figure 4-5
Homing Receiver	AN/ARR-2A	Reception of navigational signals or voice.	Pilot and bomber-navigator.	figure 4-5
Range Receiver	R-23/ARC-5	Reception of radio range signals and voice.	Pilot and bomber-navigator.	figure 4-5
Radio Altimeter	AN/APN-1	Indicates vertical distance between airplane and ground.	Pilot.	figure 4-5
IFF	AN/APX-2	Automatic identification; transponder and interrogator-responder.	All crew members.	figure 4-5
Interphone	AN/AIC-4	Intercrew communication; simultaneous reception of all receivers.	All crew members.	figure 4-5
Radar *	AN/APS-31	Search and navigation.	Bomber-navigator.	figures 4-1 and 4-6
Radar *	AN/APA-5A	Bombing equipment.	Bomber-navigator.	figures 4-6 and 4-7

WARNING

Radar ground checks must not be made within 50 feet of operations involving fuel. Tests indicate that electrical energy from radar equipment may ground through steel tools, common pencils, etc, causing ignition of fuel vapors.

* Installed in Airplanes 122593 and subsequent.

4-29. RADIO MASTER SWITCHES.

4-30. Two radio master switches, located at the bottom of the pilot's pedestal, control power supply to all

radio equipment except IFF and radio altimeter. (See figure 4-5.) The master switch on the left controls the interphone equipment (AN/AIC-4); the right-hand master switch controls other radio equipment, except

IFF and radio altimeter. For normal operation, both master switches should be "CN." If one generator should fail, radio equipment will still be operative (figure 1-9); however, if both generators should fail, the interphone will become inoperative, and other radio equipment will operate on battery power. If feasible, the electrical load on the battery may be quickly reduced by moving the right-hand master switch to "OFF," thereby turning off the AN/ARC-1A, AN/ARR-2A, and R-23/ARC-5 equipment.

4-31. INTERPHONE AND MIXER PANEL.

4-32. The interphone and mixer panel (figure 4-5) consists of a selector switch for voice transmission on vhf or interphone, two volume controls (receivers and interphone), a vhf receiver switch, and an interphone amplifier switch marked "RADIO." The vhf set, navigation receiver, and range receiver may be operated for simultaneous reception. When the interphone amplifier switch is at "NORMAL," all receiver signals will be amplified. The "ALTERNATE" position is provided for use in case the interphone amplifier malfunctions. Controls are provided on the panel for high-frequency equipment when installed.

4-33. RECEIVER CHANGE-OVER SWITCH.

4-34. The homing receiver and range receiver (AN/ARR-2A and R-23/ARC-5) can be operated by either the pilot or bomber-navigator; however, the audio output of these receivers cannot be received by the pilot and bomber-navigator simultaneously. A receiver change-over switch, located at the top of the pilot's pedestal, can be positioned at either "PILOT" or "NAV."

4-35. VHF TRANSMITTER-RECEIVER - AN/ARC-1A.

4-36. The vhf control unit, located on the pilot's pedestal (figure 4-5), provides two-way voice communication on any of nine preset frequencies or on a guard channel frequency. A channel selector ("CHAN SEL") switch is used to select one of the nine main channels, and a window adjacent to the switch shows the number of the selected main channel (or "OFF"). A guard-main switch may be moved to "MAIN T/R" for operation on a main channel only, to "GUARD" for operation on the guard channel only, or to "BOTH" for operation on a main channel while monitoring the guard channel. A window adjacent to the guard switch shows "OFF," "R," or "T/R," indicating that the guard channel is off, is set for reception only, or is set for transmission and reception.

4-37. OPERATION OF VHF TRANSMITTER-RECEIVER. These instructions are subject to local limitations regarding radio silence.

NOTE

Each time the equipment is turned on, allow approximately 20 seconds for warm-up before operating microphone switch.

- a. Turn on master radio switches on master panel.

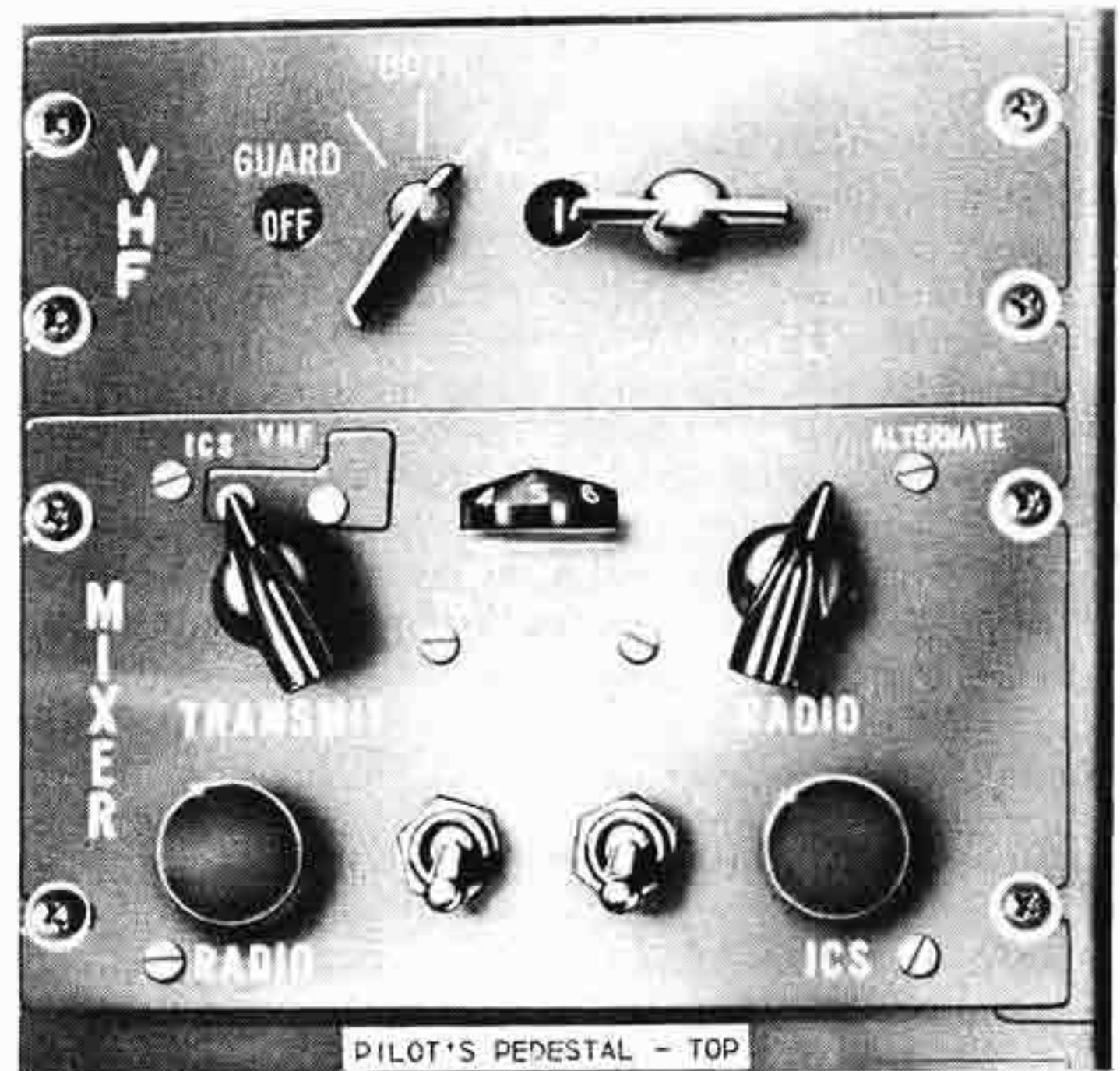

Figure 4-5. Communication Controls

b. Move guard-main switch to "BOTH," "GUARD," or "MAIN T/R," as desired.

c. Rotate channel selector switch to desired main channel.

d. On mixer panel (interphone panel), place transmit switch at "VHF," and receiver switch at "VHF."

e. Adjust volume as necessary with audio control (marked "RADIO") on mixer panel.

f. To transmit, press microphone switch. After each transmission, the switch must be released so the set can operate for reception of signals.

4-38. NAVIGATING EQUIPMENT - AN/ARR-2A.

4-39. The AN/ARR-2A radio equipment receives navigation or voice signals on any of six preset frequency channels. The control unit, marked "NAVIG," located on the pilot's pedestal (figure 4-5), consists of a channel selector ("CHAN SEL") switch to select any of the six frequency channels, a pitch control to vary tone of navigation signal received or to select voice reception, and a sensitivity ("SENS") control to adjust gain of receiver. When the navigation receiver is operated in conjunction with the command set, signals from both receivers are heard in the headphones simultaneously.

4-40. OPERATION OF NAVIGATING EQUIPMENT. To operate the homing receiver, proceed as follows:

a. Move master radio switches to "ON."

b. Place receiver change-over switch at "PILOT" or "NAV" as required.

c. Rotate channel selector switch to desired channel.

d. Turn pitch control to "NAV" or "VOICE" as required.

e. With volume control on mixer panel at minimum output, adjust navigation receiver sensitivity control to lowest clearly audible signal.

4-41. RANGE RECEIVER - R-23/ARC-5.

4-42. The range receiver provides for reception of voice weather forecasts and beacon signals in the range from .19 to .55 megacycle. The control unit, marked "RECVR," is located on the pilot's pedestal. (See figure 4-5.) When the receiver is operated in conjunction with the command set, signals from both receivers are heard in the headphones simultaneously.

4-43. OPERATION OF RANGE RECEIVER. Operate the range receiver as follows:

a. Turn on master radio switches.

b. Place receiver change-over switch at "PILOT" or "NAV" as required.

c. Tune range receiver selector dial to desired frequency.

d. With volume control on mixer panel at minimum output, adjust sensitivity control to lowest audible signal.

4-44. RADIO ALTIMETER - AN/APN-1.

4-45. The radio altimeter equipment provides a reading of "absolute altitude" (terrain clearance) during flight by measuring electrically the time interval required for a transmitted radio signal to travel to earth and return to the airplane. The altitude indicator located on the instrument panel (7, figure 1-2) has a power switch knob, which is used to turn on the equipment, and a "range" switch knob, used to select the desired altitude range (low range - 0 to 400 feet, high range - 400 to 4000 feet). The scale numerals are changed by operation of the range switch so that the scale reads directly in hundreds of feet for either range. An altitude limit switch (11, figure 1-2) may be set for the altitude at which the low-level limit light (5, figure 1-2) will illuminate. The altitude limit switch scale is calibrated directly in feet for the low range; the same scale reads in tens of feet for the high range.

4-46. OPERATION OF RADIO ALTIMETER. Operate the radio altimeter as follows:

a. Set range switch for required range. When on ground, or in flight at an altitude below 400 feet, always use low range. When in flight at an altitude above 400 feet, use high range.

WARNING

The high range must not be used at altitudes below 400 feet.

b. Set altitude limit switch for desired preset altitude.

c. Turn power switch clockwise to "ON." After approximately one minute, pointer of altitude indicator will move from its subzero stop position, indicating that equipment is operating.

4-47. IFF EQUIPMENT - AN/APX-2A.

4-48. The IFF equipment consists of two elements: a transponder, which enables the airplane to identify itself as friendly when challenged by appropriately equipped air, ship, or ground forces; and an interrogator-responder, which enables the airplane to challenge unidentified craft. The equipment also may be used to indicate distress. Two control units are provided: one located on the pilot's pedestal in the pilot's compartment (figure 4-5), and one located at the third crew member's station. (See 2, figure 4-9.)

4-49. PILOT'S IFF CONTROLS.

4-50. IFF MASTER CONTROL SWITCH. A master

control switch turns the equipment on when rotated from "OFF." When the switch is at "NORM," the transponder will automatically reply when challenged. At "INT ONLY" (interrogation only), the transponder is turned off. The "ROOSTER" position is to be used only for designated tactical purposes, and the "EMERGENCY" position for cases of extreme distress.

4-51. INTERROGATOR SWITCH. To challenge unidentified craft, an interrogator switch (marked "INT") may be placed at "CONT" (continuous) or held at "TMPRY" (temporary). If the challenged craft is friendly, an audio signal will be received.

4-52. IFF GAIN CONTROL. A gain control is used to adjust the volume of the signal received from a challenged craft. When rotated to "RADAR OPR," volume control is transferred to third crew member's control unit.

4-53. IFF CODE SELECTOR SWITCH. A code selector switch selects the reply impulses to be transmitted by the transponder, and is normally at position No. 1.

4-54. IFF G-BAND SWITCH. A G-band switch is used in conjunction with the "ROOSTER" position of the master switch for designated tactical purposes only.

4-55. IFF DESTRUCT SWITCH. A destruct switch, provided for operating internal detonators, is safetied at "OFF," and cannot be turned "ON" without first breaking a safety wire and lifting a guard.

WARNING

Before take-off (combat mission only), insert destructors in eight jacks on face of IFF equipment (located aft of third crew member's station). Remove destructors immediately after landing.

4-56. THIRD CREW MEMBER'S IFF CONTROLS.

4-57. The third crew member is provided with an interrogator switch and a gain control. The gain control is effective only if pilot's gain control is at "RADAR OPR."

4-58. OPERATION OF IFF EQUIPMENT. To operate IFF equipment, use the following procedure:

NOTE

The interrogator-responder controls are inoperative with present radar installation.

a. Rotate master control switch from "OFF" to desired operating position.

b. Place code selector switch at "1." (Leave in position "1" at all times, unless directed by commanding officer to use another position.)

c. To challenge unidentified craft, either: (1) leave

master switch at "NORMAL" and operate interrogator switch (transponder will "share time" with interrogator-receiver); or (2) place master switch at "INT ONLY" and operate interrogator switch (transponder will be inoperative).

d. To turn off IFF radio, rotate master switch counterclockwise to "OFF."

4-59. RADAR EQUIPMENT - AN/APS-31.

4-60. The AN/APS-31 radar may be used for search, navigation (beacon), and, with AN/APA-5A radar attachment, bombing operations. Maximum range on search and navigation operations is 200 nautical miles; minimum range is 200 yards. When used as search equipment, surface vessels, aircraft, land, and landmarks are reproduced on an indicator scope at the bomber-navigator's station. (See 2, figure 4-6.) Luminous range and altitude markers are provided on the indicator. A sweep line moves with the antenna in the nose of the airplane; therefore, the location of a "blip" on the scope indicates the approximate azimuth direction of the object detected. The airplane heading is always indicated by a black line on the scope. A marker control is provided for determining exact azimuth position. If desired, a 5 or 30-mile sector of the area scanned may be shown on the scope as an enlarged view. When the set is used for navigation, signals transmitted from the airplane are received by a beacon station which automatically sends out coded signals. These signals are shown on the scope, and homing on the beacon is accomplished by turning the airplane until the black line on the scope intersects the beacon code signal. Distance to the station is indicated by the range markers, and azimuth direction is determined by the marker dial.

4-61. OPERATION OF AN/APS-31 RADAR SET. Before starting equipment, check controls as follows:

a. Power control "OFF."

b. Brilliancy controls ("MASTER BRILL" and "MKR BRILL") on indicator turned fully counterclockwise.

c. Gain control on control unit "0."

d. "BIAS" control on indicator turned fully counterclockwise.

e. Gyro switch "CAGE."

f. Marker control "0"; delay control "NORM"; tilt switch "0" or at its optimum setting if known.

g. Slow-fast switch "SLOW"; pulse switch "SHORT."

h. "AFC-MAN" switch "AFC"; range control "10"; scan switch position "1"; anti-clutter switch "OFF."

i. Magnetron current control ("MAG CUR") on variable auto-transformer turned to about three-fourths of its total range.

4-62. Start and check the radar equipment as follows:

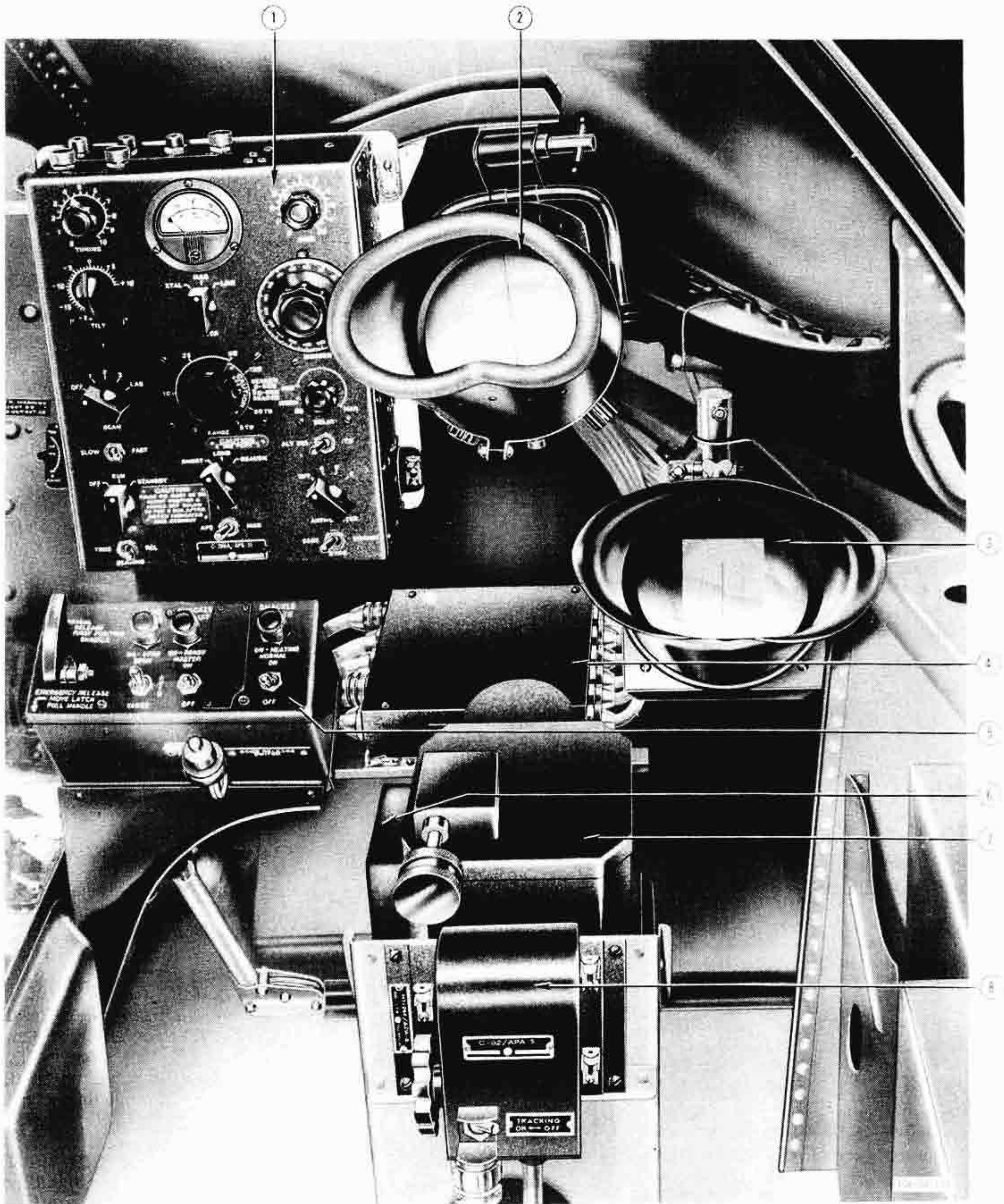

Figure 4-6. Bomber-Navigator's Station - Forward View

- a. Turn meter switch to "LINE."
- b. Turn power switch to "STANDBY" and check that the line voltage is indicated within the green range marked on the meter.
- c. Adjust "BIAS" control on indicator in a clockwise direction until the sweep lines are plainly visible on the scope; then rotate "BIAS" control counterclockwise until the sweep lines are barely visible.
- d. Turn gain control on control unit to position "5" and rotate master brilliancy control on indicator clockwise until noise appears on scope.
- e. Adjust marker brilliancy control clockwise until markers appear at a desirable brilliance.
- f. Check focus control to see that sweep lines and range markers appear sharp and clear. No further adjustment of this control should be necessary.
- g. Place meter switch on control unit at "MAG" position, turn scan switch to position "2," and place power switch at "RUN." Adjust magnetron current control on variable auto-transformer for 6-milliampere magnetron current, as read on the 0-20 scale of the meter.



Pulse switch must be at "SHORT" and range control below 60 for 3 minutes after magnetron current is indicated on meter. Failure to do this may cause damage to equipment.

- h. Move pulse switch to "LONG," and adjust magnetron current control on variable auto-transformer for 15 milliamperes, as read on the 0-20 scale of the meter mounted on the control unit. Place pulse switch at "BEACON"; magnetron current should be between 13.5 and 16 milliamperes, as read on the 0-20 scale of the meter. Place pulse switch in "SHORT" position; magnetron current should be from 5.5 to 7.0 milliamperes on the 0-20 scale of the meter.



It is possible, when switching from short pulse to long or beacon pulses, that the equipment will operate unstably; therefore, when

changing setting of pulse switch, turn power switch to "STANDBY," set pulse switch, then turn power switch to "RUN."

- i. Set pulse switch to "SHORT" and meter switch to "XTAL." The crystal current should be approximately 0.6 milliamperes, as read on the 0-1 scale of the meter, and should hold steady at this point. At this time, signals should appear on the scope. If no signals appear on the scope, observe if alternate bright and dull sectors are visible on the scope, while the crystal current is unsteady and varies in a pulsating manner. This condition is caused by the afc circuit not locking-in, and further adjustment of the afc circuit is necessary.

- j. Turn power switch to "STANDBY"; then turn pulse switch to "LONG" and power switch to "RUN." Crystal current should be approximately 0.6 milliamperes on the 0-1 scale and should hold steady at this point. Signals should appear on the scope.

NOTE

Crystal current may vary in flight ± 0.15 milliamperes about the nominal value of 0.6 milliamperes.

- k. Turn pulse switch to "BEACON." The meter should read between 0.25 and 1.0 milliamperes on the 0-1 scale and should hold steady.

- l. Return pulse switch to "SHORT," move "AFC-MAN" switch to "MAN," and adjust tuning control for best signals. No difference should be observed in the signals as seen on the scope, and the crystal current should be approximately the same as it was in "AFC" position. If any difference between "AFC" and "MAN" positions is observed, adjustment of the equipment is necessary.

- m. Turn power switch to "STANDBY"; then turn pulse switch to "LONG" and power switch to "RUN." Repeat step l. with pulse switch set at "LONG."

- n. Place pulse switch at "BEACON," with "AFC-MAN" switch on "MAN." Observe the setting of the tuning control. Vary tuning control slightly while observing the meter, to determine whether the control was set for maximum crystal current. If it is impossible to adjust the tuning control for maximum crystal current within the range of this control in either "SHORT," "LONG," or "BEACON" positions of the pulse switch, adjustment of the equipment is necessary.

- | | |
|-----------------------------|------------------------------------|
| 1. Control Unit (AN/APS-31) | 5. Master Bomb Control Panel |
| 2. Indicator (AN/APS-31) | 6. Bomb Sight Adapter (AN/APA-5A) |
| 3. Indicator (AN/APA-5A) | 7. Mark 18 Stabilizer |
| 4. Junction Box (AN/APA-5A) | 8. Range Tracking Unit (AN/APA-5A) |

KEY TO FIGURE 4-6.

o. Check marker control by rotating it from 300 degrees through 0 to 60 degrees, and observe that a luminous line (azimuth-marker line) appears on the scope, moving from left to right, and disappears as the marker control is rotated beyond 60 degrees.

p. Set range control at "SEARCH 0-200," and pulse switch at "LONG"; vary delay control from "MIN" to "MAX," and observe that the delay marker line varies from the bottom to the top of the scope, and that range-marker lamps 50 and D are illuminated.

q. Set range control at "10"; place delay control in "OC" (open center) and observe that a blank area approximately 1.5 nautical miles in range, from the previous starting of the sweep, appears on the scope. Return delay control to "NORM." The equipment is now ready for normal search operation.

4-63. To stop the equipment, place power switch in "OFF" position.

NOTE

While the gyro will always be automatically caged when the equipment is turned off, even though the gyro switch is in "UNCAGE," it is good operating practice to set the gyro switch to "CAGE" position before the equipment is turned off.

4-64. RADAR BOMB SIGHT - AN/APA-5A.

4-65. The radar bomb sight equipment is used in conjunction with the search radar equipment (AN/APS-31) to permit accurate bombing of surface targets under conditions which preclude use of optical bombing instruments. The equipment may be operated on either low range (up to 3500 feet) or high range (up to 35,000 feet). An indicator scope is installed at the bomber-navigator's station. (See 3, figure 4-6.) A reference range mark on the scope is located in the center of a one-mile sweep for low-range operation, or a three-mile sweep in high-range operation. The range marker and sweep can be moved toward zero range at a rate corresponding to relative velocity of the airplane and target. This rate may be adjusted during the bombing run so the target always coincides with the reference marker. When the proper bomb release point is reached, the bombs are dropped automatically.

4-66. OPERATION OF AN/APA-5A RADAR BOMB SIGHT. To start the equipment, proceed as follows:

CAUTION

Do not operate the set on the ground without the engines running unless an external power source is connected.

a. Before applying any power to the equipment, be sure that the switches associated with the altitude, trail-and-lead, and time-of-fall dials are in the

AFT OF PILOT'S STATION

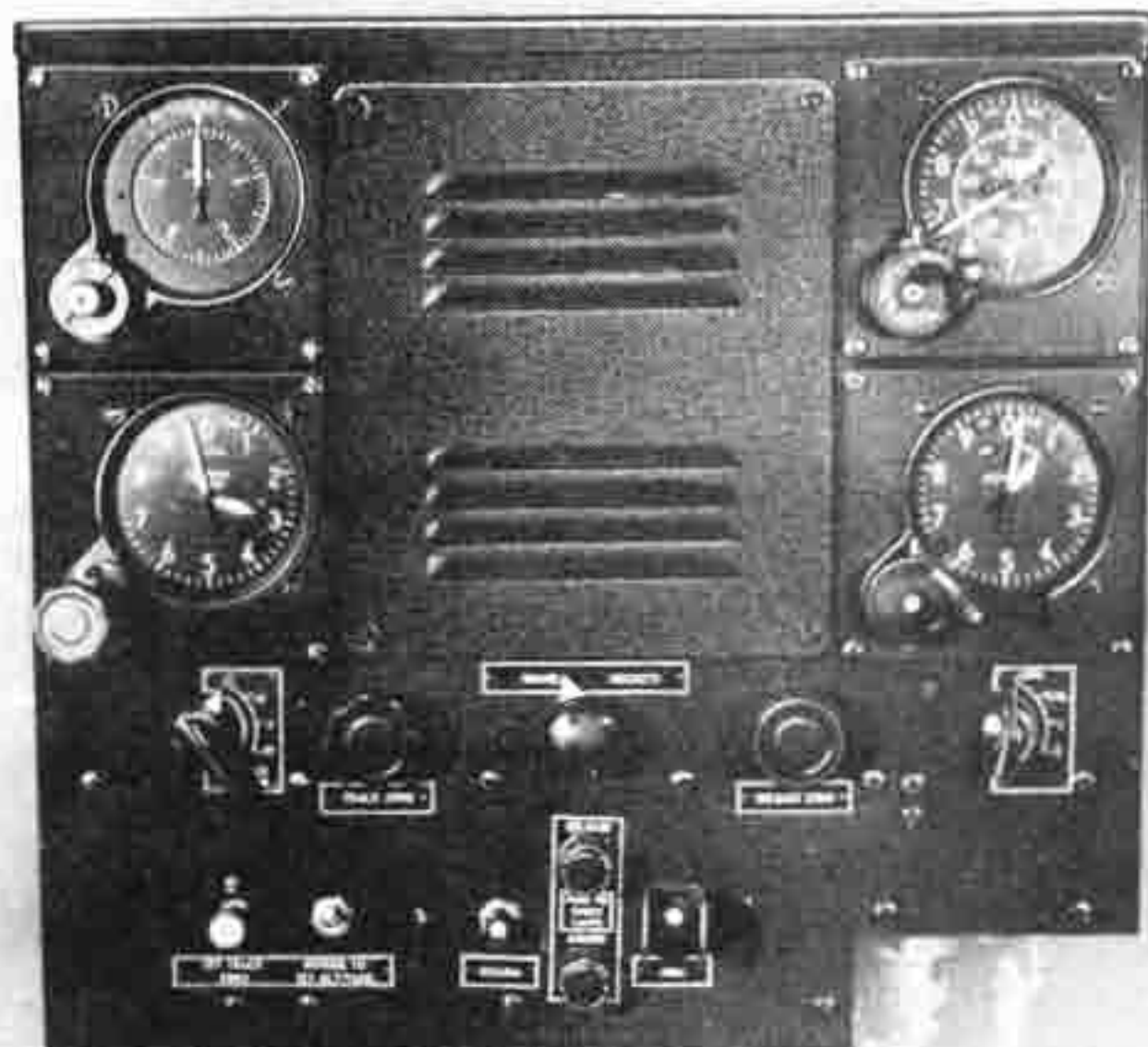

138-100-196

Figure 4-7. Control Unit - AN/APA-5A

vertical position and the range selector switch is in the 10 (mile) position for low-altitude operation. For high-altitude operation, the switches which are associated with the altitude, trail-and-lead, and time-of-fall dials should be in the horizontal position, and the range selector switch should be in the 30 (mile) position.

CAUTION

Do not attempt to change position of the switch associated with the time-of-fall dial unless pointers of dial are set exactly at zero. The meter will be permanently damaged if this precaution is not observed.

b. Check that AN/APS-31 radar equipment is turned on.

c. Be sure that bomb bay door is closed, and bomb door indicator light is out.

d. Check that arm switch is at "SAFE." This is necessary because the bomb release relay will operate during operating checks.

e. Turn on power switch on control box.

f. Rotate the "OPR-CAL" switch to "OPR."

g. Set altitude dial to 3000 feet if on low range, 30,000 feet if on high range.

h. Momentarily depress arm switch on control box.

i. The red lamp on the control box should light and remain lighted, and lamp in indicator should not light.

j. Slowly rotate locator knob on range tracking unit from extreme counterclockwise position. At some point during rotation, green lamp on control box should become illuminated, while continued rotation should extinguish it. Pushing the disarm push-button should extinguish red lamp on control box. This is a sufficient check of the arming and coincident circuits.

k. Rotate "OPR-CAL" switch to "CAL" position. Pull out release zero knob on control box and slowly rotate clockwise until green light is illuminated.

l. Rotate "OPR-CAL" switch to "OPR" position. Pull out track zero knob and rotate clockwise until green lamp is illuminated. Leave knob in this position.

m. This procedure should be performed on the range which will be used in the bombing operation.

4-67. To stop the equipment, proceed as follows:

a. Check position of arm switch to make sure that it is on "SAFE."

b. Turn power switch on control box to "OFF."

4-68. CABIN HEATING, VENTILATING AND PRESSURIZATION.

4-69. Air for heating, cooling and pressurizing the cabin is supplied from either a ram air intake in the fuselage nose or from both engine air induction systems, whichever source is at the higher pressure. The air is compressed by a compressor, which is driven by a hydraulic motor. From the compressor, air is routed either to a combustion heater or to a cooling unit, by means of a mixing valve which is regulated by an automatic temperature control system. A pressure regulator automatically maintains cabin pressure equivalent to a 5000-foot altitude from 5000 feet to 11,800 feet; above that, up to 37,800 feet a constant pressure differential of 2.75 psi is maintained between cabin and outside air pressure. Above 37,800 feet, the regulator adjusts to a reduced ratio of 2.3, thereby minimizing the effect of sudden decompression in event of loss of canopy or rupture of cabin sealing. Should the compressor fail, an emergency ram air source may be selected. The system is controlled by the pilot from a heat and vent control panel on the left console. A cabin pressure altimeter is located above the left console. (See 24, figure 1-3.)

NOTE

The compressor is normally in operation at all times during flight; however, as the compressor motor operates on the utility system hydraulic pressure, the compressor will be inoperative when any other unit in the utility hydraulic system is being operated. The compressor is also inoperative whenever the landing gear is down, to assure full hydraulic system pressure to the gear.



Figure 4-8. Exterior Lights Panel

4-70. CABIN AIR COMPRESSOR CIRCUIT GROUND TEST SWITCH.

4-71. A switch for ground test of the cabin air compressor circuit is located on the aft bulkhead of the crew entry compartment. (See figure 1-13.) When the switch is moved from "NORMAL" to "TEST," a flight condition is simulated and the cabin air compressor valve is de-energized, starting the compressor. The test switch is primarily for maintenance check.

4-72. CABIN AIR CONTROL.

4-73. A cabin pressure control (marked "EMERGENCY CABIN AIR CONTROL") is located on the heat and vent panel (25, figure 1-3), and should be positioned at "NORMAL" for normal cabin ventilation and pressurization. Rotating the control to "CABIN COMPRESSOR OFF" turns off the compressor by shutting off hydraulic pressure to the compressor motor. When the control is moved to "RAM AIR ON - DUMP VALVE OPEN," the cabin is immediately depressurized, and ram air is allowed to enter the system. Ram air is routed through the combustion heater, so that air temperature control is available when the emergency ram air source is used.

4-74. CABIN TEMPERATURE CONTROL.

4-75. A cabin temperature control selector, located on the heat and vent panel (20, figure 1-3), can be set to select a cabin temperature in the range of 40°F to 90°F. A thermostatically controlled air-mixing valve diverts intake air either to the combustion heater or to a cooling unit, or partially to both, as required by the preselected cabin temperature.

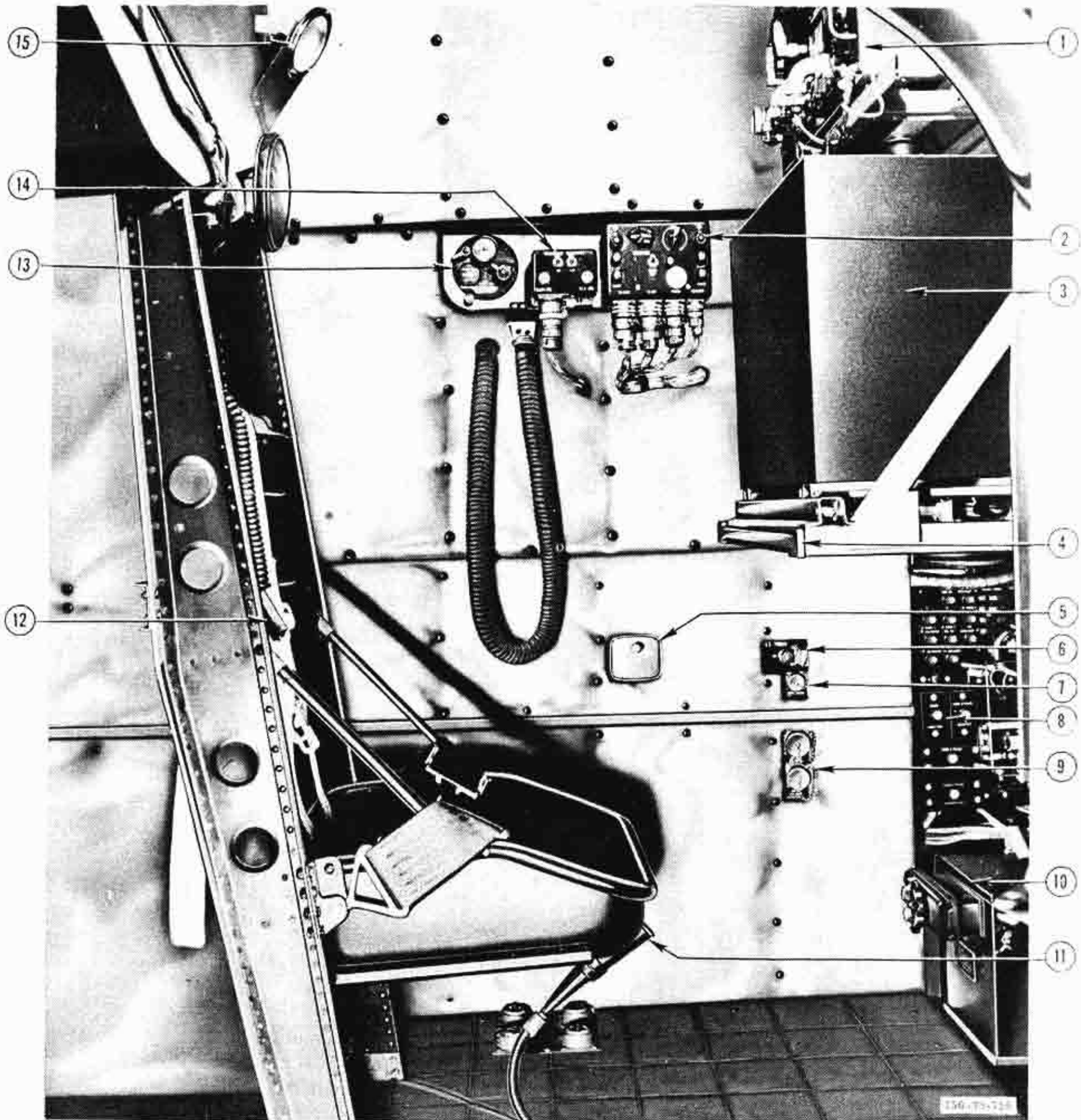

- | | |
|---------------------------------------|--|
| 1. AN/APN-1 Receiver Transmitter | 9. Special Equipment Power Receptacles |
| 2. AN/APX-2A Control Panel | 10. Battery |
| 3. Special Armament | 11. Relief Tube |
| 4. Writing Table | 12. Headset and Microphone Jacks |
| 5. Ash Tray | 13. Oxygen Regulator |
| 6. Special Equipment A-C Power Panel | 14. AN/AIC-4 Control Panel |
| 7. Suit Heat Outlet | 15. Dome Light |
| 8. A-C Fuse and Circuit Breaker Panel | |

Figure 4-9. Third Crew Member's Station

4-76. HEATER MASTER SWITCH.

4-77. A combustion heater, which operates on fuel received from both engine-driven fuel pumps, is controlled by a heater master switch on the heat and vent panel. (See 23, figure 1-3.) For automatic operation, the switch should be placed at "NORMAL" and the heater will be cycled on and off as required to maintain the selected cabin air temperature. Should the cabin temperature control system be inoperative, the heater can be operated by placing the heater master switch at "EMERG HEAT" and emergency cabin air control at "RAM AIR ON - DUMP VALVE OPEN." If the heater should overheat (above 350°F), it will be turned off automatically, and a heater circuit breaker will prevent further operation until it is reset on the ground.

4-78. CREW STATION OUTLETS.

4-79. Floor outlets at pilot's and bomber-navigator's stations provide fixed-direction airflow, but side outlets (8, figure 1-3) are adjustable for direction and amount of airflow. The third crew member's station is provided with a single, fixed-direction outlet which is adjustable to either a diffused air spray or to an air jet flow.

4-80. WINDSHIELD DEFROST CONTROL.

4-81. A windshield defrost control is located on the heat and vent panel. (See 27, figure 1-3.) The control can be moved to "ON," "OFF," or intermediate positions to divert all or part of the floor outlet air to the windshield.

4-82. CANOPY DEFROST CONTROLS.

4-83. Airflow to the canopy is controlled by defrost controls located, one on either side, below the canopy sill. (See 12, figure 1-3.) Rotating the knobs to "ON" diverts part of airflow from side outlets to the canopy. All side outlet air can be directed to the canopy by closing the side outlets.

4-84. CABIN INSULATION.

4-85. The interiors of the pilot's compartment and the crew entry compartment are insulated with a glass cloth covering. Some panels in the crew entry compartment have snap-button fasteners so that the panels are readily removable for access to equipment. For good heating and cooling qualities, the removable panels should be removed only temporarily and returned to

place as soon as possible.

4-86. HEATED CLOTHING.

4-87. Each crew station is provided with an outlet for heated clothing. (See 48, figure 1-3; 12, figure 4-1; and 7, figure 4-9.)

4-88. PITOT HEATER.

4-89. The pitot heater is controlled by a switch on the pilot's pedestal. (See 11, figure 1-4.)

4-90. LIGHTING EQUIPMENT.

4-91. INTERIOR LIGHTING.

4-92. COCKPIT AND INSTRUMENT LIGHTS. A panel on the pilot's pedestal (figure 4-8) contains a switch and a brilliancy rheostat for control of the cockpit and instrument lights. The switch may be positioned at "FLIGHT" for illumination of flight instruments or at "ENGINE" for illumination of flight and engine instruments and the fuel quantity indicators. When the switch is moved to "COCKPIT," in addition to fuel quantity indicators and flight and engine instruments, the fuel panel schematic diagram and the cockpit lights are illuminated.

4-93. DOME LIGHTS. A dome light is provided for the pilot's compartment and one for the crew entry compartment. A switch is mounted on each light assembly.

4-94. EMERGENCY HYDRAULIC PANEL LIGHT. A light is installed on the back of the third crew member's seat for illumination of the emergency hydraulic panel. A switch is mounted on the light assembly.

4-95. BOMB BAY LIGHTS. Five dome lights are installed in the bomb bay. The lights may be turned "ON" or "OFF" from three different compartments. In the bomb bay, the light switch is installed left of the hatch leading to the crew entry compartment. In the compartment aft of the bomb bay a switch is located at the right of the door leading to the bomb bay. In the crew entry compartment, a bomb bay light switch is located at the right (facing aft) of the bomb bay hatch.

4-96. EXTERIOR LIGHTING.

4-97. All exterior lights, except the approach light, are controlled from a panel on the right console.

APPENDIX

A-1. AIRSPEED CORRECTION TABLES.

A-2. Three corrections must be applied to indicated airspeed to obtain true indicated airspeed. The first correction is for instrument error, the second for

TEMPORARY AIRSPEED INSTALLATION CORRECTION TABLE APPLY CORRECTION TO CORRECTED INSTRUMENT READING TO OBTAIN CALIBRATED AIRSPEED			
GEAR & FLAPS UP		GEAR & FLAPS DOWN	
IAS - KNOTS	CORRECTION	IAS - KNOTS	CORRECTION
100	+2	60	- 5
150	+1	80	- 6
200	+1	100	- 8
250	0	120	-10
300	0	140	-11
350	-1	160	-13

156-93-620A

Figure A-1. Temporary Airspeed Installation Correction Table

airspeed system installation (position error), and the third for compressibility effects. Refer to the airspeed correction card provided on the instrument panel (2,

figure 1-2) for the instrument error. With the reading corrected for instrument error, use the Airspeed Installation Correction Table (figure A-1) to find calibrated airspeed. To obtain true indicated airspeed, refer to the Compressibility Correction Table (figure A-2.)

A-3. EXAMPLE OF USE OF AIRSPEED CORRECTION TABLES.

A-4. Airplane is flying at 20,000 foot pressure altitude, outside air temperature -20°C (-4°F), and the airspeed indicator reads 200 knots. What is the true airspeed?

	KNOTS
Instrument reading	200
Correction for instrument error	-2
	198
Correction for installation error	1
	199

The value of 199 is calibrated airspeed (CAS). Use this value of CAS with an airspeed computer to determine the TAS of 270 knots. When using the dead reckoning computer, Type AN5835-1, the CAS must be corrected for compressibility. The Compressibility Correction Table shows that 3 knots must be subtracted from the CAS, 199, to obtain true indicated airspeed, 196. Use the dead reckoning computer and the value of 196 to determine a true airspeed of 270 knots.

COMPRESSIBILITY CORRECTION TABLE SUBTRACT CORRECTION FROM CALIBRATED AIRSPEED TO OBTAIN TRUE INDICATED AIRSPEED							
CALIBRATED AIRSPEED (KNOTS)	PRESSURE ALTITUDE						
	5000	10,000	15,000	20,000	25,000	30,000	35,000
150	0	0	1	1	2	2	3
200	0	1	2	3	4	5	7
250	1	2	3	5	7	9	12
300	2	3	6	8	11	15	20
350	2	5	8	12	17		
400	3	7	12	17			

156-93-624

Figure A-2. Compressibility Correction Table

R-2800-44W ENGINES

POWER LIMITS BASED ON
FUEL GRADE 115/145



OIL PRESSURE
□ 50 To 110 PSI
Operating Range

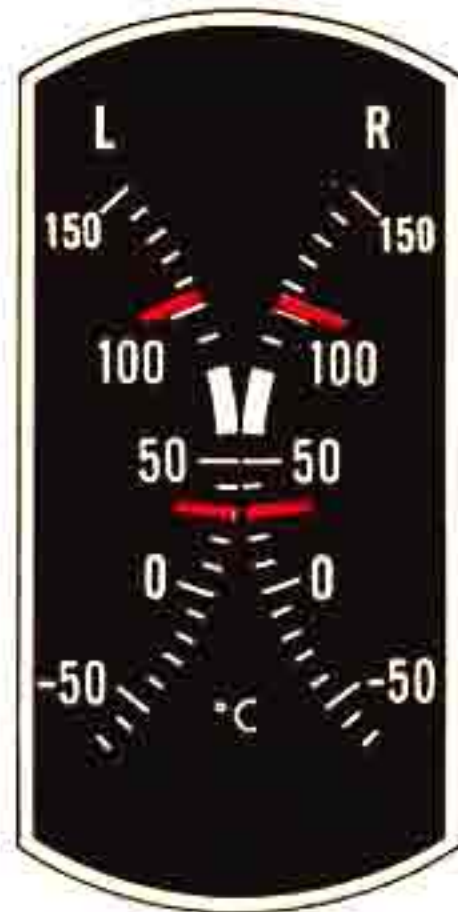

OIL TEMPERATURE
■ 30° C Minimum for Take-off or flight
□ 60° C To 80° C Operating Range
■ 102° C Maximum



FUEL PRESSURE
□ 21 To 23 PSI
Operating Range



TACHOMETER
■ 2800 RPM Maximum Take-off and Military Power



MANIFOLD PRESSURE
■ 59" Hg Maximum Take-off Dry and Military Power

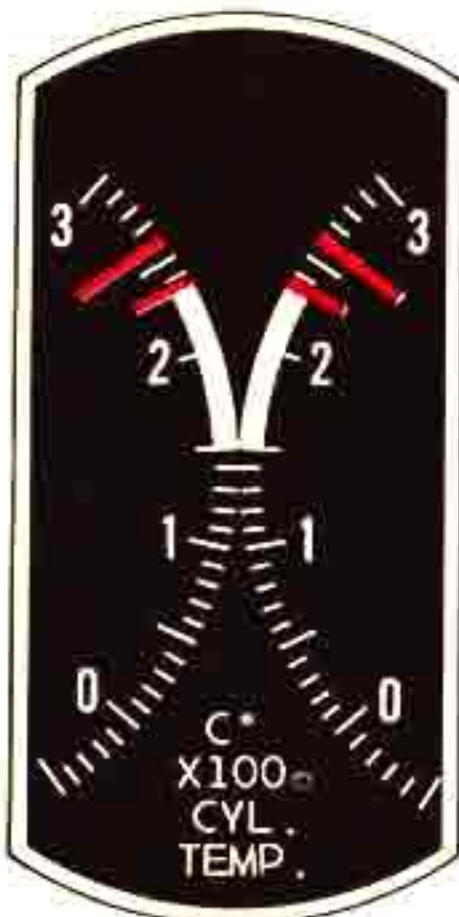

CYLINDER HEAD TEMPERATURE
□ 150° C To 232° C Operating Range
■ 232° C Maximum-Continuous Operation
■ 260° C Maximum Take-off and Military Power

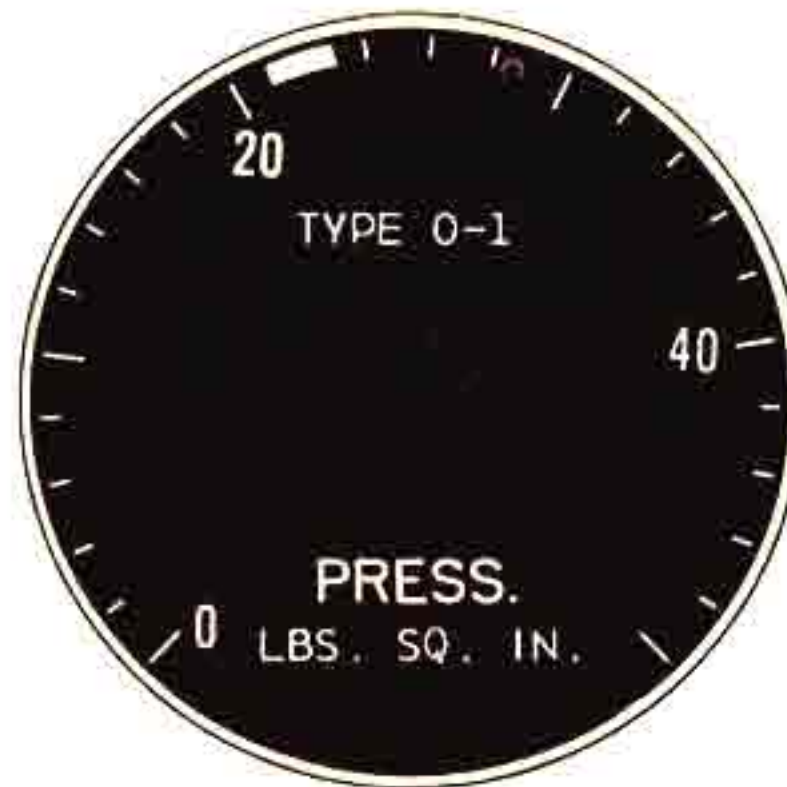

WATER PRESSURE
□ 21 To 23 PSI
Operating Range



CARBURETOR AIR TEMPERATURE
■ 5° C Minimum
□ 8° C To 30° C Operating Range
■ 38° C Maximum, Dry
■ 60° C Maximum, Wet

156-51-363

Figure A-3 (Sheet 1 of 2 Sheets). Instrument Dial Markings

J33-A-10 ENGINE

POWER LIMITS BASED ON
FUEL GRADE 115/145



TACHOMETER

- █ 34% RPM Minimum
- 34%-96% RPM Operating Range
- █ 100% RPM Maximum



FUEL PRESSURE

OIL PRESSURE

- █ 45 PSI Minimum
- 55-370 PSI Operating Range

- █ 2 PSI Minimum
- 20-42 PSI Operating Range
- █ 50 PSI Maximum

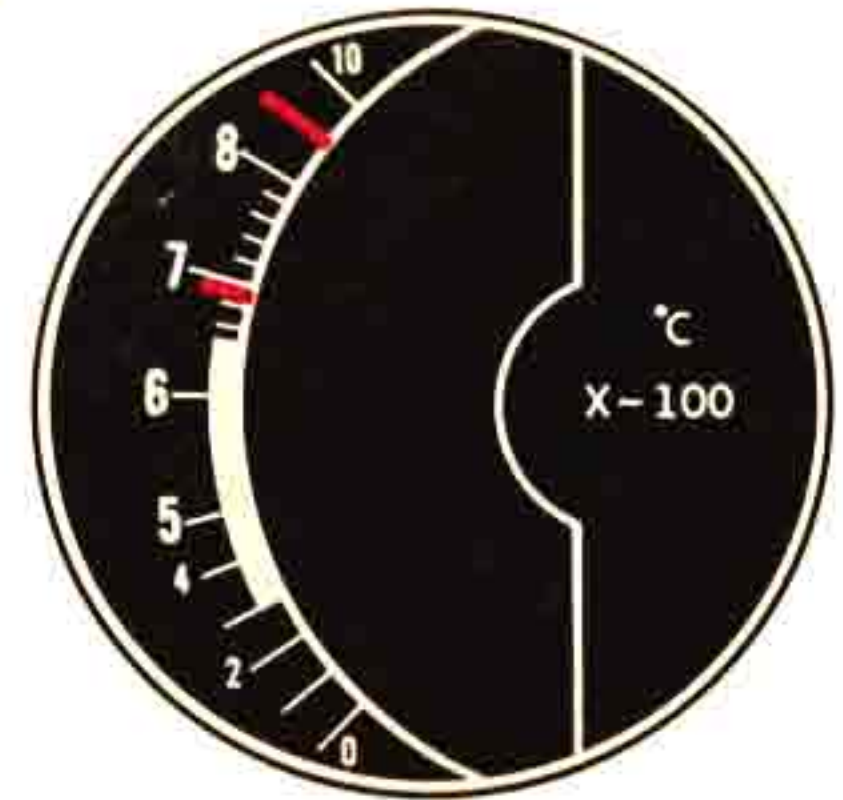

TAIL-PIPE TEMPERATURE

- 300°C To 654°C Operating Range for Normal Rated Power and Below
- █ 698°C Maximum-Take-off and Military Power
- █ 900°C Maximum-Start or Acceleration



AIRSPEED INDICATOR

- █ 175 Knots (IAS) Maximum Airspeed for Lowering Gear or Flaps

Maximum Permissible Airspeed and Mach Number to be supplied when available.

Figure A-3 (Sheet 2 of 2 Sheets). Instrument Dial Markings

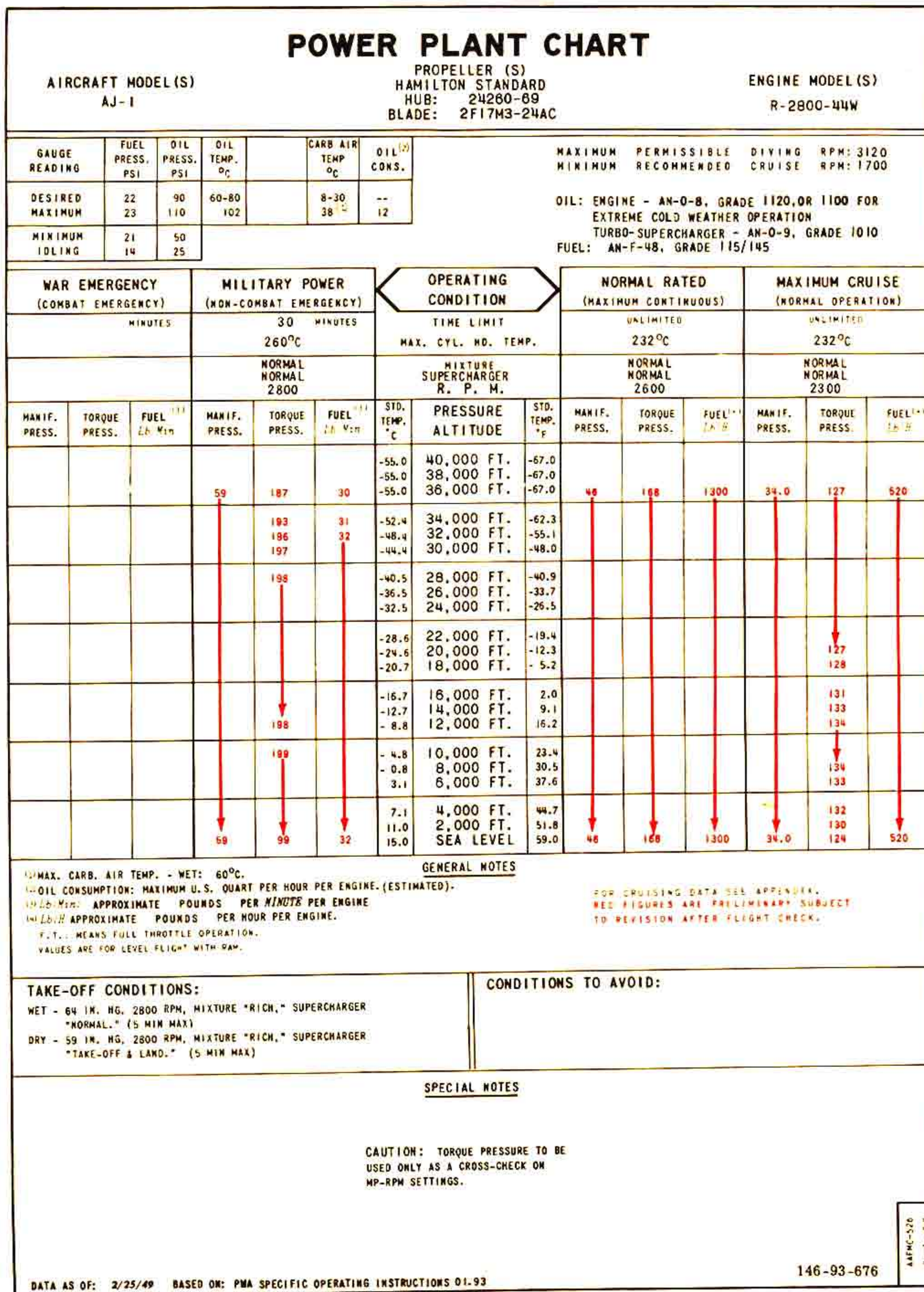

Figure A-4. Power Plant Chart - R-2800-44W Engines

POWER PLANT CHARTAIRCRAFT MODEL
AJ-1ENGINE MODEL
J-33-A-10

ENGINE INSTRUMENT	FUEL PRESSURE PSI	OIL PRESSURE PSI	OIL TEMPERATURE °C	TAIL PIPE TEMPERATURE °C
MINIMUM	45	2		
OPERATING RANGE	55-370	20-42		MAX CONTINUOUS POWER & BELOW 300 to 654
MAXIMUM		50	80	MAX T. O. AND MILITARY POWER 698 MAX START OR ACCELERATION 900

FUEL: AN-F-48, GRADE 115/145
OIL⁽¹⁾: AN-O-9, GRADE 1010**FUEL FLOW**

MILITARY POWER ⁽²⁾ FUEL FLOW—LB/MIN ⁽⁴⁾	STD TEMP °C	PRESSURE ALTITUDE	STD TEMP °F	MAX CONTINUOUS ⁽³⁾ FUEL FLOW—LB/MIN ⁽⁴⁾
35	-54.3	35,000	-65.8	30
40	-44.4	30,000	-48.0	35
45	-34.5	25,000	-30.2	40
55	-24.6	20,000	-12.3	45
60	- 5.5	15,000	-14.7	50
70	- 4.8	10,000	23.4	60
80	5.1	5,000	41.2	65
90	15.0	Sea Level	59.0	75

GENERAL NOTES

- (1) OIL CONSUMPTION: APPROXIMATELY ONE QUART PER HOUR
 (2) MILITARY POWER—100% RPM
 (3) MAX CONTINUOUS—96% RPM
 (4) LB/MIN—APPROXIMATE POUNDS PER MINUTE

RED FIGURES ARE
 PRELIMINARY SUBJECT
 TO REVISION AFTER FLIGHT
 CHECK.

SPECIAL NOTES

FUEL FLOW FOR JET ENGINES INCREASES AS TAS INCREASES. THEREFORE, FIGURES FOR FUEL FLOW OF THE J-33-A-10 ARE BASED ON THE ASSUMPTION THAT ALL ENGINES ARE OPERATING AT THE STATED POWER RATINGS

DATA AS OF 5-20-49, BASED ON ALLISON ENGINE SPEC. 258-D

146-93-684

Figure A-5. Power Plant Chart - J33A-10 Engine

AIRCRAFT MODEL AJ-1		TAKE-OFF, CLIMB & LANDING CHART										ENGINE MODELS R-2800-44W J33-A-10	
GROSS WEIGHT LB.		TAKE-OFF DISTANCE FEET											
		RECIPROCATING AND JET ENGINES OPERATING											
		AT SEA LEVEL		AT 3000 FEET		AT 6000 FEET							
		GROUND RUN	TO CLEAR 50' OBJ.	GROUND RUN	TO CLEAR 50' OBJ.	GROUND RUN	TO CLEAR 50' OBJ.						
HEAD WIND KTS.													
0		2600	3900	3100	4500	3700	5300						
15		2000	3100	2500	3600	3000	4300						
30		1500	2400	1900	2900	2300	3400						
0		1600	2500	1900	3000	2300	3400						
15		1200	2100	1500	2600	1800	2700						
30		900	1500	1100	1800	1400	2100						
0		1000	1800	1200	2000	1400	2200						
15		700	1300	900	1500	1100	1700						
30		500	1000	600	1100	800	1300						
NOTE: INCREASE CHART DISTANCES AS FOLLOWS: 75°F+ 10%; 100°F+ 20%; 125°F+ 30%; 150°F+ 40%													
DATA AS OF: 5/24/48 BASED ON: WIND TUNNEL & ESTIMATED DATA													
GROSS WEIGHT LB.		CLIMB DATA											
		AT SEA LEVEL		AT 5000 FEET		AT 10,000 FEET		AT 15,000 FEET		AT 25,000 FEET		AT 30,000 FEET	
		BEST I.A.S. KTS	RATE OF CLIMB F.P.M.	BEST I.A.S. KTS	RATE OF CLIMB F.P.M.	BEST I.A.S. KTS	RATE OF CLIMB F.P.M.	BEST I.A.S. KTS	RATE OF CLIMB F.P.M.	BEST I.A.S. KTS	RATE OF CLIMB F.P.M.	BEST I.A.S. KTS	RATE OF CLIMB F.P.M.
51,500 (TIP TAKES)		190	800	160	700	140	600	150	500	155	300	150	600
41,000 (TIP TAKES)		150	1350	150	1250	150	1150	150	1050	150	800	150	1000
47,500 (CLEAN)		165	850	150	850	160	750	150	1150	155	350	150	150
37,000 (CLEAN)		155	1600	150	1500	150	1400	150	1300	150	1050	150	850
POWER PLANT SETTINGS: NORMAL RATED POWER - TWO RECIPROCATING ENGINES DATA AS OF 5/24/48 - BASED ON: WIND TUNNEL & ESTIMATED DATA FULL USED INCREASED 15% FROM ESTIMATES. FUEL USED (POUNDS) INCLUDES WARM-UP & TAKE-OFF ALLOWANCE													
GROSS WEIGHT LB.		LANDING DISTANCE FEET											
		BEST IAS APPROACH		ZERO WIND		15 KNOT WIND		30 KNOT WIND					
		POWER OFF	POWER ON	AT SEA LEVEL	AT 3000 FEET	AT 6000 FEET	AT 10,000 FEET	AT 15,000 FEET	AT 25,000 FEET	AT 30,000 FEET	AT 6000 FEET	AT 10,000 FEET	AT 15,000 FEET
		KTS	KTS	GROUND ROLL	TO CLEAR 50' OBJ.	GROUND ROLL	TO CLEAR 50' OBJ.	GROUND ROLL	TO CLEAR 50' OBJ.	GROUND ROLL	TO CLEAR 50' OBJ.	GROUND ROLL	TO CLEAR 50' OBJ.
42,000		120	120	1700	2700	1900	3200	1300	2000	1500	2300	300	1300
36,000		110	110	1500	2400	1600	2800	1000	1700	1300	2000	700	1100
30,000		100	100	1300	2100	1300	2400	800	1400	1000	1700	500	900
DATA AS OF 5/24/48 - BASED ON: WIND TUNNEL & ESTIMATED DATA FLAPS FULL DOWN OPTIMUM LANDING IS 100% OF CHART VALUES													
REMARKS:													
NOTE: TO DETERMINE FUEL CONSUMPTION IN BRITISH IMPERIAL GALLONS, MULTIPLY BY 10, THEN DIVIDE BY 12													
LEGEND I.A.S. = INDICATED AIRSPEED M.P.H. = MILES PER HOUR KTS. = KNOTS F.P.M. = FEET PER MINUTE													
156-93-586B													

Figure A-6. Take-off, Climb, and Landing Chart

AIRCRAFT MODEL(S)		AJ-1		FLIGHT OPERATION INSTRUCTION CHART										EXTERNAL LOAD ITEMS				
ENGINE(S):		R-2800-44W		CHART WEIGHT LIMITS: 51,200 TO 44,000 POUNDS										NUMBER OF ENGINES OPERATING: TWO				
LIMITS	RPM	M.P. IN. HG.	MIXTURE POSITION	TIME CYL. LIMIT TEMP.	TOTAL LB/HR PER ENGINE	COLUMN I		COLUMN II		COLUMN III		COLUMN IV		COLUMN V				
						RANGE IN AIRMILES (3)		RANGE IN AIRMILES (3)		RANGE IN AIRMILES (3)		RANGE IN AIRMILES (3)		RANGE IN AIRMILES (3)				
WAR EMERG.	2800	59	NORMAL	30	260°	2150	STATUTE	NAUTICAL	STATUTE	NAUTICAL	STATUTE	NAUTICAL	STATUTE	NAUTICAL	STATUTE	NAUTICAL		
	1030		900		1370		1190	1360	1570	1770	1540	1930	10,900		1870			
	980		850		1300		1130	1290	1490	1680	1460	1820	10,500		1580			
	930		810		1230		1070	1220	1410	1580	1380	1720	9500		1490			
	880		770		1160		1010	1150	1330	1490	1300	1620	9000		1400			
	830		720		1090		950	1080	1250	1400	1220	1520	8500		1310			
	780		680		1020		890	1010	1170	1310	1140	1410	8000		1220			
	730		640		950		820	940	1090	1220	1060	1310	7500		1130			
	680		580		890		770	870	1010	1130	980	1210	7000		1050			
	630		550		820		710	810	930	1050	910	1130	6500		980			
	580		510		760		660	750	860	970	840	1040	6000		900			
	540		460		700		600	690	790	880	770	950	5500		830			
	490		420		630		550	620	720	800	700	870	5000		750			
	440		380		570		490	560	650	720	630	780	4500		680			
	390		340		510		440	500	590	640	560	690	4000		600			
MAXIMUM CONTINUOUS																		
R.P.M.	T.P. PSI (2)	TOT. (3) LB/HR	T.A.S. KTS.	ALT. FEET	R.P.H. INCHES	T.P. PSI (2)	TOT. (3) LB/HR	T.A.S. KTS.	R.P.H. INCHES	T.P. PSI (2)	TOT. (3) LB/HR	T.A.S. KTS.	R.P.H. INCHES	T.P. PSI (2)	TOT. (3) LB/HR	T.A.S. KTS.		
2600	165	3000	325	280	2450	153	2150	270	235	2400	148	1850	265	230	2400	148		
2600	166	3000	325	280	2450	154	2200	280	245	2400	148	1850	270	235	2400	148		
2600	166	3000	315	275	2450	153	2150	270	235	2400	146	1800	260	225	2400	146		
2500	166	3000	305	265	2500	155	2250	285	250	2400	148	1850	270	235	2400	148		
2600	168	3000	300	260	2450	154	2200	280	245	2400	148	1850	270	235	2400	148		
2600	168	3000	290	250	2450	153	2150	270	235	2400	146	1800	260	225	2400	146		
MAXIMUM AIR RANGE																		
R.P.H.	T.P. PSI (2)	ALT. FEET	R.P.H. INCHES	T.P. PSI (2)	TOT. (3) LB/HR	T.A.S. KTS.	R.P.H. INCHES	T.P. PSI (2)	TOT. (3) LB/HR	T.A.S. KTS.	R.P.H. INCHES	T.P. PSI (2)	TOT. (3) LB/HR	T.A.S. KTS.	R.P.H. INCHES	T.P. PSI (2)	TOT. (3) LB/HR	T.A.S. KTS.
		40000																
		35000																
		30000																
		25000																
		20000																
		15000																
		10000																
		5000																
		S.L.																

NOTES: COLUMN I IS FOR EMERGENCY HIGH SPEED CRUISING ONLY. COLUMNS II, III, IV AND V GIVE PROGRESSIVE INCREASE IN RANGE AT A SACRIFICE IN SPEED. AIR MILES PER POUND (MI./LB) (NO WIND). POUNDS PER HOUR (LB/HR) AND TRUE AIRSPEED (T.A.S.) ARE APPROXIMATE VALUES FOR REFERENCE. RANGE VALUES ARE FOR AN AVERAGE AIRPLANE FLYING ALONE (NO WIND).

INSTRUCTIONS FOR USING CHART: SELECT FIGURE IN FUEL COLUMN EQUAL TO OR LESS THAN AMOUNT OF FUEL TO BE USED FOR CRUISING. MOVE HORIZONTALLY TO RIGHT OR LEFT AND SELECT RANGE VALUE EQUAL TO OR GREATER THAN THE STATUTE OR NAUTICAL AIR MILES TO BE FLOWN. VERTICALLY BELOW AND OPPOSITE VALUE READ DESIRED CRUISING ALTITUDE (ALT.) READ RPM, MANIFOLD PRESSURE (M.P.) AND TORQUE PRESSURE (T.P.) REQUIRED.

LEGEND
ALT. : PRESSURE ALTITUDE
M.P. : MANIFOLD PRESSURE
LB/HR : POUNDS PER HOUR
T.A.S. : TRUE AIRSPEED
KTS. : KNOTS
S.L. : SEA LEVEL
T.P. : TORQUE PRESSURE

EXAMPLE
AT 45,000 LB. GROSS WEIGHT WITH 8000 LBS. OF FUEL (AFTER DEDUCTING TOTAL ALLOWANCES OF 1000 LBS.) TO FLY 1000 NAUT. AIRMILES AT 15,000 FT. ALTITUDE MAINTAIN 2400 RPM AND 38 IN. MANIFOLD PRESSURE WITH MIXTURE SET: NORMAL. WHEN GROSS WEIGHT REACHES 44,000 POUNDS, USE SHEET 2, COLUMN III.

SPECIAL NOTES
(1) MAKE ALLOWANCE FOR WARM-UP, TAKE-OFF & CLIMB PLUS ALLOWANCE FOR WIND, RESERVE AND COMBAT AS REQUIRED.
(2) TORQUE PRESSURE TO BE USED ONLY AS A CROSS-CHECK ON MP-RPM SETTINGS.
(3) RANGES HAVE BEEN DECREASED 15% FROM ESTIMATES. FUEL FLOWS INCREASED 15%.

MIXTURE "NORMAL" FOR ALL CRUISE CONDITIONS
RED FIGURES ARE PRELIMINARY DATA, SUBJECT TO REVISION AFTER FLIGHT CHECK
DATA AS OF 9/15/48 BASED ON: WIND TUNNEL & ESTIMATED DATA
156-93-621B

Figure A-7 (Sheet 1 of 3 Sheets). Flight Operation Instruction Chart

AIRCRAFT MODEL(S) AJ-1		ENGINE(S): R-2800-44W				CHART WEIGHT LIMITS: 44,000 TO 37,000 POUNDS				EXTERNAL LOAD ITEMS NONE OR TWO WING TIP TANKS				NUMBER OF ENGINES OPERATING: TWO			
LIMITS		M.P. IN. HG.		CYL. POSITION		MIXTURE POSITION		TIME LIMIT		TOTAL LB/HR PER ENGINE		NOTES: COLUMN I IS FOR EMERGENCY HIGH SPEED CRUISING ONLY. COLUMNS II, III, IV AND V GIVE PROGRESSIVE INCREASE IN RANGE AT A SACRIFICE IN SPEED. AIR MILES PER POUND (MI./LB.) ARE APPROXIMATE VALUES FOR (LB/HR) AND TRUE AIRSPEED (T.A.S.) ARE APPROXIMATE VALUES FOR REFERENCE. RANGE VALUES ARE FOR AN AVERAGE AIRPLANE FLYING ALONE (NO WIND). ⁽¹⁾					
WAR EMERG.		2800		59		NORMAL		39 MIN		2150							
MILITARY POWER		2800		59		NORMAL		39 MIN		2150							
RANGE IN AIRMILES ⁽¹⁾		STATUTE		NAUTICAL		STATUTE		NAUTICAL		STATUTE		NAUTICAL		STATUTE		NAUTICAL	
1010	900	800	700	600	500	400	300	200	100	1120	1270	1120	970	840	720	600	480
680	790	700	610	520	430	350	260	170	90	1230	1100	970	840	720	600	480	360
1070	1660	1450	1240	1070	890	710	530	350	180	1680	1500	1310	1140	980	840	700	550
2180	1920	1670	1430	1230	1020	820	610	480	160	1850	1730	1510	1290	1130	970	800	640
1070	1660	1450	1240	1070	890	710	530	350	180	1680	1500	1310	1140	980	840	700	550
1070	1660	1450	1240	1070	890	710	530	350	180	1680	1500	1310	1140	980	840	700	550
1070	1660	1450	1240	1070	890	710	530	350	180	1680	1500	1310	1140	980	840	700	550
1070	1660	1450	1240	1070	890	710	530	350	180	1680	1500	1310	1140	980	840	700	550
1070	1660	1450	1240	1070	890	710	530	350	180	1680	1500	1310	1140	980	840	700	550
1070	1660	1450	1240	1070	890	710	530	350	180	1680	1500	1310	1140	980	840	700	550
1070	1660	1450	1240	1070	890	710	530	350	180	1680	1500	1310	1140	980	840	700	550
1070	1660	1450	1240	1070	890	710	530	350	180	1680	1500	1310	1140	980	840	700	550
1070	1660	1450	1240	1070	890	710	530	350	180	1680	1500	1310	1140	980	840	700	550
1070	1660	1450	1240	1070	890	710	530	350	180	1680	1500	1310	1140	980	840	700	550
1070	1660	1450	1240	1070	890	710	530	350	180	1680	1500	1310	1140	980	840	700	550
1070	1660	1450	1240	1070	890	710	530	350	180	1680	1500	1310	1140	980	840	700	550
1070	1660	1450	1240	1070	890	710	530	350	180	1680	1500	1310	1140	980	840	700	550
1070	1660	1450	1240	1070	890	710	530	350	180	1680	1500	1310	1140	980	840	700	550
1070	1660	1450	1240	1070	890	710	530	350	180	1680	1500	1310	1140	980	840	700	550
1070	1660	1450	1240	1070	890	710	530	350	180	1680	1500	1310	1140	980	840	700	550
1070	1660	1450	1240	1070	890	710	530	350	180	1680	1500	1310	1140	980	840	700	550
1070	1660	1450	1240	1070	890	710	530	350	180	1680	1500	1310	1140	980	840	700	550
1070	1660	1450	1240	1070	890	710	530	350	180	1680	1500	1310	1140	980	840	700	550
1070	1660	1450	1240	1070	890	710	530	350	180	1680	1500	1310	1140	980	840	700	550
1070	1660	1450	1240	1070	890	710	530	350	180	1680	1500	1310	1140	980	840	700	550
1070	1660	1450	1240	1070	890	710	530	350	180	1680	1500	1310	1140	980	840	700	550
1070	1660	1450	1240	1070	890	710	530	350	180	1680	1500	1310	1140	980	840	700	550
1070	1660	1450	1240	1070	890	710	530	350	180	1680	1500	1310	1140	980	840	700	550
1070	1660	1450	1240	1070	890	710	530	350	180	1680	1500	1310	1140	980	840	700	550
1070	1660	1450	1240	1070	890	710	530	350	180	1680	1500	1310	1140	980	840	700	550
1070	1660	1450	1240	1070	890	710	530	350	180	1680	1500	1310	1140	980	840	700	550
1070	1660	1450	1240	1070	890	710	530	350	180	1680	1500	1310	1140	980	840	700	550
1070	1660	1450	1240	1070	890	710	530	350	180	1680	1500	1310	1140	980	840	700	550
1070	1660	1450	1240	1070	890	710	530	350	180	1680	1500	1310	1140	980	840	700	550
1070	1660	1450	1240	1070	890	710	530	350	180	1680	1500	1310	1140	980	840	700	550
1070	1660	1450	1240	1070	890	710	530	350	180	1680	1500	1310	1140	980	840	700	550
1070	1660	1450	1240	1070	890	710	530	350	180	1680	1500	1310	1140	980	840	700	550
1070	1660	1450	1240	1070	890	710	530	350	180	1680	1500	1310	1140	980	840	700	550
1070	1660	1450	1240	1070	890	710	530	350	180	1680	1500	1310	1140	980	840	700	550
1070	1660	1450	1240	1070	890	710	530	350	180	1680	1500	1310	1140	980	840	700	550
1070	1660	1450	1240	1070	890	710	530	350	180	1680	1500	1310	1140	980	840	700	550
1070	1660	1450	1240	1070	890	710	530	350	180	1680	1500	1310	1140	980	840	700	550
1070	1660	1450	1240	1070	890	710	530	350	180	1680	1500	1310	1140	980	840	700	550
1070	1660	1450	1240	1070	890	710	530	350	180	1680	1500	1310	1140	980	840	700	550
1070	1660	1450	1240	1070	890	710	530	350	180	1680	1500	1310	1140	980	840	700	550
1070	1660	1450	1240	1070	890	710	530	350	180	1680	1500	1310	1140	980	840	700	550
1070	1660	1450	1240	1070	890	710	530	350	180	1680	1500	1310	1140	980	840	700	550
1070	1660	1450	1240	1070	890	710	530	350	180	1680	1500	1310	1140	980	840	700	550
1070	1660	1450	1240	1070	890	710	530	350	180	1680	1500	1310	1140	980	840	700	550
1070	1660	1450	1240	1070	890	710	530	350	180	1680	1500	1310	1140	980	840	700	550
1070	1660	1450	1240	1070	890	710	530	350	180	1680	1500	1310	1140	980	840	700	550
1070	1660	1450	1240	1070	890	710	530	350	180	1680	1500	1310	1140	980	840	700	550
1070	1660	1450	1240	1070	890	710	530	350	180	1680	1500	1310	1140	980	840	700	550
1070	1660	1450	1240	1070	890	710	530	350	180	1680	1500	1310	1140	980	840	700	550
1070	1660	1450	1240	1070	890	710	530	350	180	1680	1500	1310	1140	980	840	700	550
1070	1660	1450	1240	1070	890	710	530	350	180	1680	1500	1310	1140	980	840	700	550
1070	1660	1450	1240	1070	890	710	530	350	180	1680	1500	1310	1140	980	840	700	550
1070	1660	1450	1240	1070	890	710	530	350	180	1680	1500	1310	1140	980	840	700	550
1070	1660	1450	1240	1070	890	710	530	350	180	1680	1500	1310	1140	980	840	700	550
1070	1660	1450	1240	1070	890	710	530	350	180	1680	1500	1310	1140	980	840	700	550
1070	1660	1450	1240	1070	890	710	530	350	180	1680	1500	1310	1140	980	840	700	550
1070	1660	1450	1240	1070	890	710	530	350	180	1680	1500	1310	1140	980	840	700	550
1070	1660	1450	1240	1070	890	710	530	350	180	1680	1500	1310	1140	980	840	700	550
1070	1660	1450	1240	1070	890	710	530	350	180	1680	1500	1310	1140	980	840	700	550
1070	1660	1450	1240	1070	890	710	530	350	180	1680	1500	1310	1140	980	840	700	550
1070	1660	1450	1240	1070	890	710											

AIRCRAFT MODEL (S)		AJ-1		FLIGHT OPERATION INSTRUCTION CHART										EXTERNAL LOAD ITEMS					
ENGINE (S):		R-2800-44W		CHART WEIGHT LIMITS: 37,000 POUNDS OR LESS										NUMBER OF ENGINES OPERATING: TWO					
LIMITS	RPM	M.P. IN. HG.	BLOWER POSITION	MIXTURE	TIME LIMIT	CYL. TEMP.	TOTAL LB/HR PER ENGINE	COLUMN I		COLUMN II		COLUMN III		COLUMN IV		COLUMN V			
								STATUTE	NAUTICAL	STATUTE	NAUTICAL	STATUTE	NAUTICAL	STATUTE	NAUTICAL	STATUTE	NAUTICAL	STATUTE	NAUTICAL
WAR EMERG.	2600	59	NORMAL	30	260°	2150													
MILITARY POWER	2600	59	NORMAL	30	260°	2150													
INSTRUCTIONS FOR USING CHART: SELECT FIGURE IN FUEL COLUMN EQUAL TO OR LESS THAN AMOUNT OF FUEL TO BE USED FOR CRUISING. MOVE HORIZONTALLY TO RIGHT OR LEFT AND SELECT RANGE VALUE EQUAL TO OR GREATER THAN THE STATUTE OR NAUTICAL AIR MILES TO BE FLOWN. VERTICALLY BELOW AND OPPOSITE VALUE NEAREST DESIRED CRUISING ALTITUDE (ALT.) READ RPM, MANIFOLD PRESSURE (M.P.) AND TORQUE PRESSURE (T.P.) REQUIRED.																			
NOTES: COLUMN I IS FOR EMERGENCY HIGH SPEED CRUISING ONLY. COLUMNS II, III, IV AND V GIVE PROGRESSIVE INCREASE IN RANGE AT A SACRIFICE IN SPEED. AIR MILES PER POUND (MI./LB) (NO WIND), POUNDS PER HP. (LB/HP) AND TRUE AIRSPEED (T.A.S.) ARE APPROXIMATE VALUES FOR REFERENCE. RANGE VALUES ARE FOR AN AVERAGE AIRPLANE FLYING ALONE (NO WIND).																			
RANGE IN AIRMILES (1)		NAUTICAL		RANGE IN AIRMILES (1)		NAUTICAL		RANGE IN AIRMILES (1)		NAUTICAL		RANGE IN AIRMILES (1)		NAUTICAL		RANGE IN AIRMILES (1)			
770	670	1120	970	1380	1200	1640	1420	1840	1200	1640	1420	1840	1200	1640	1420	1840	1200		
710	620	1050	910	1290	1120	1530	1330	1530	1120	1530	1330	1530	1120	1530	1330	1530	1120		
660	580	970	840	1200	1040	1420	1230	1420	1040	1420	1230	1420	1040	1420	1230	1420	1040		
610	530	900	780	1110	960	1310	1140	1310	960	1310	1140	1310	960	1310	1140	1310	960		
560	490	820	710	1010	880	1200	1040	1200	880	1200	1040	1200	880	1200	1040	1200	880		
510	440	750	650	920	800	1090	950	1090	800	1090	950	1090	800	1090	950	1090	800		
460	400	670	580	830	720	980	850	980	720	980	850	980	720	980	850	980	720		
410	350	600	520	740	640	870	760	870	640	870	760	870	640	870	760	870	640		
360	310	520	450	640	560	770	660	770	560	770	660	770	560	770	660	770	560		
310	270	450	390	550	480	680	570	680	480	680	570	680	480	680	570	680	480		
260	220	370	320	460	400	550	470	550	400	550	470	550	400	550	470	550	400		
200	180	300	260	370	320	440	380	440	320	440	380	440	320	440	380	440	320		
150	130	220	190	280	240	330	280	330	240	330	280	330	240	330	280	330	240		
100	80	150	130	180	160	220	190	220	160	220	190	220	160	220	190	220	160		
MAXIMUM CONTINUOUS		APPROX.		R.P.M.		T.P. PSI		M.P. INCHES		R.P.M.		T.P. PSI		M.P. INCHES		R.P.M.		T.P. PSI	
2600	46	168	3000	385	335	2500	42	158	2400	37	148	2300	35	148	2200	33	138	2100	31
2600	46	168	3000	385	335	2500	41.5	158	2400	36.5	148	2300	34.5	148	2200	32.5	138	2100	30.5
2600	46	168	3000	370	320	2500	41	156	2400	36	146	2300	34	146	2200	32	136	2100	30
2600	46	168	3000	355	310	2450	40.5	154	2350	35	145	2250	33	145	2150	31	135	2000	29
2600	46	168	3000	340	295	2400	39.5	153	2300	34.5	143	2200	32	143	2100	30	133	1950	28.5
2600	46	168	3000	325	285	2350	38.5	151	2250	33.5	141	2150	31	141	2050	29	131	1900	28
2600	46	168	3000	315	275	2300	38	150	2200	33	140	2100	30	140	2000	28	130	1850	27.5
2600	46	168	3000	305	265	2250	38	148	2150	32.5	137	2050	29	137	1950	27.5	129	1800	27
MAXIMUM AIR RANGE		APPROX.		R.P.M.		T.P. PSI		M.P. INCHES		R.P.M.		T.P. PSI		M.P. INCHES		R.P.M.		T.P. PSI	
40000	46	168	3000	385	335	2500	42	158	2400	37	148	2300	35	148	2200	33	138	2100	31
35000	46	168	3000	385	335	2500	41.5	158	2400	36.5	148	2300	34.5	148	2200	32.5	138	2050	30.5
30000	46	168	3000	370	320	2500	41	156	2400	36	146	2300	34	146	2200	32	136	2000	30
25000	46	168	3000	355	310	2450	40.5	154	2350	35	145	2250	33	145	2150	31	135	1950	29
20000	46	168	3000	340	295	2400	39.5	153	2300	34.5	143	2200	32	143	2100	30	133	1900	28.5
15000	46	168	3000	325	285	2350	38.5	151	2250	33.5	141	2150	31	141	2050	29	131	1850	28
10000	46	168	3000	315	275	2300	38	150	2200	33	140	2100	30	140	2000	28	130	1800	27.5
5000	46	168	3000	305	265	2250	38	148	2150	32.5	137	2050	29	137	1950	27.5	129	1750	27
S.L.	46	168	3000	305	265	2250	38	148	2150	32.5	137	2050	29	137	1950	27.5	129	1700	26.5

LEGEND

ALT. : PRESSURE ALTITUDE
 M.P. : MANIFOLD PRESSURE
 LB/HR : POUNDS PER HOUR
 TAS : TRUE AIRSPEED
 KTS. : KNOTS
 S.L. : SEA LEVEL
 T.P. : TORQUE PRESSURE

EXAMPLE

AT 36,000 LB. GROSS WEIGHT WITH 5500 LBS. OF FUEL (AFTER DEDUCTING TOTAL ALLOWANCES OF 1000 LBS.) TO FLY 800 NAUT. AIRMILES AT 30,000 FT. ALTITUDE MAINTAIN 2400 RPM AND 30 IN. MANIFOLD PRESSURE WITH MIXTURE SET: **NORMAL**

MIXTURE "NORMAL" FOR ALL CRUISE CONDITIONS

SPECIAL NOTES

(1) MAKE ALLOWANCE FOR WIND-UP, TAKE-OFF & CLIMB PLUS ALLOWANCE FOR WIND, RESERVE AND COMBAT AS REQUIRED.
 (2) TORQUE PRESSURE TO BE USED ONLY AS A CROSS-CHECK ON MP-RPM SETTINGS.
 (3) RANGES HAVE BEEN DECREASED 15% FROM ESTIMATES; FUEL FLOWS INCREASED 15%.

DATA AS OF 9/15/48 BASED ON: WIND TUNNEL & ESTIMATED DATA

RED FIGURES ARE PRELIMINARY DATA, SUBJECT TO REVISION AFTER FLIGHT CHECK

156-93-623B

Figure A-7 (Sheet 3 of 3 Sheets). Flight Operation Instruction Chart

AIRCRAFT MODEL(S) AJ-1		FLIGHT OPERATION INSTRUCTION CHART				EXTERNAL LOAD ITEMS NONE	
ENGINE(S): R-2800-44W		CHART WEIGHT LIMITS: 35,000 TO 32,500 POUNDS				NUMBER OF ENGINES OPERATING: ONE	
LIMITS WAR EMERG. MILITARY POWER	RPM	M.P. IN. HG.	BLOWER POSITION	MIXTURE POSITION	TIME LIMIT	CYL. TEMP.	TOTAL LB/HR PER ENGINE
	2800	59	NORMAL	NORMAL	30 MIN.	260°	2150
INSTRUCTIONS FOR USING CHART: SELECT FIGURE IN FUEL COLUMN EQUAL TO OR LESS THAN AMOUNT OF FUEL TO BE USED FOR CRUISING. MOVE HORIZONTALLY TO RIGHT OR LEFT AND SELECT RANGE VALUE EQUAL TO OR GREATER THAN THE STATUTE OR NAUTICAL AIR MILES TO BE FLOWN. VERTICALLY BELOW AND OPPOSITE VALUE NEAREST DESIRED CRUISING ALTITUDE (ALT.) READ RPM, MANIFOLD PRESSURE (M.P.) AND TORQUE PRESSURE (T.P.) REQUIRED.							
COLUMN I		COLUMN II		COLUMN III		COLUMN IV	
RANGE IN AIRMILES (3)		RANGE IN AIRMILES (3)		RANGE IN AIRMILES (3)		RANGE IN AIRMILES (3)	
STATUTE		STATUTE		STATUTE		STATUTE	
NAUTICAL		NAUTICAL		NAUTICAL		NAUTICAL	
FUEL POUNDS		FUEL POUNDS		FUEL POUNDS		FUEL POUNDS	
800	940	810	1070	930	5500	1140	990
720	850	740	960	840	5000	1030	890
650	760	660	880	750	4500	920	800
580	670	580	760	660	4000	800	700
500	580	500	650	570	3500	690	600
430	490	430	550	480	3000	580	500
360	400	350	450	390	2500	470	400
MAXIMUM CONTINUOUS		STAT. (151) NAUT. (14)		STAT. (155) NAUT. (179)		MAXIMUM AIR RANGE	
R.P.M.		R.P.M.		R.P.M.		R.P.M.	
T.P. PSI (2)		T.P. PSI (2)		T.P. PSI (2)		T.P. PSI (2)	
TOT (3) LB/HR		TOT (3) LB/HR		TOT (3) LB/HR		TOT (3) LB/HR	
T.A.S. KTS.		T.A.S. KTS.		T.A.S. KTS.		T.A.S. KTS.	
ALT. FEET		ALT. FEET		ALT. FEET		ALT. FEET	
40000		40000		40000		40000	
35000		35000		35000		35000	
30000		30000		30000		30000	
25000		25000		25000		25000	
20000		20000		20000		20000	
15000		15000		15000		15000	
10000		10000		10000		10000	
5000		5000		5000		5000	
S. L.		S. L.		S. L.		S. L.	
2600	168	1500	215	185	2600	168	1500
2600	168	1500	220	190	2600	168	1500
2600	168	1500	215	185	2600	168	1500

LEGEND

ALT. : PRESSURE ALTITUDE
M.P. : MANIFOLD PRESSURE
LB/HR: POUNDS PER HOUR
TAS : TRUE AIRSPEED
KTS. : KNOTS
S.L. : SEA LEVEL
T.P. : TORQUE PRESSURE

EXAMPLE

AT 25,000 LB. GROSS WEIGHT WITH 4500 LB. OF FUEL (AFTER DEDUCTING TOTAL ALLOWANCES OF 500 LB.) TO FLY 800 NAUT. AIRMILES AT 5000 FT. ALTITUDE MAINTAINING 2500 RPM AND 40.5 IN. MANIFOLD PRESSURE WITH MIXTURE SET: NORMAL WHEN GROSS WEIGHT REACHES 32,500 LB., USE SHEET 2, COLUMN 11.

SPECIAL NOTES

(1) MAKE ALLOWANCE FOR WASH-UP, TAKE-OFF & CLIMB PLUS ALLOWANCE FOR WIND, RESERVE AND COMBAT AS REQUIRED.
(2) TORQUE PRESSURE TO BE USED ONLY AS A CROSS-CHECK ON MP-RPM SETTINGS.
(3) RANGES HAVE BEEN DECREASED 15% FROM ESTIMATES; FUEL FLOWS INCREASED 15%.

MIXTURE *NORMAL* FOR ALL CRUISE CONDITIONS.
RED FIGURES ARE PRELIMINARY DATA, SUBJECT TO REVISION AFTER FLIGHT CHECK

DATA AS OF 4/27/49 BASED ON: WIND TUNNEL & ESTIMATED DATA

Figure A-8 (Sheet 1 of 2 Sheets), Flight Operation Instruction Chart, Single-engine

RESTRICTED

RESTRICTED