



*PILOT'S FLIGHT OPERATING  
INSTRUCTIONS*

*FOR*

**ARMY MODEL  
P-39Q-1  
AIRPLANE**

**This publication shall not be carried in aircraft on combat missions or when there is a reasonable chance of its falling into the hands of the enemy.**

***NOTICE: This document contains information affecting the National Defense of the United States within the meaning of the Espionage Act, 50 U. S. C., 31 and 32, as amended. Its transmission or the revelation of its contents in any manner to an unauthorized person is prohibited by law.***



## BELL AIRACOBRA SPECIFICATIONS

	XP-39	YP-39	YP-39A	XP-39B	P-39C	P-39D	XP-39E	P-39F	P-39J	P-39K	P-39L	P-39M	P-39N	P-39Q	P-400
Powerplant & hp- Allison	V-1710-17 (1150)	V-1710-37 (1090)	V-1710-31 (1150)	V-1710-37 (1090)	V-1710-35 (1150)	V-1710-35 (1150)	V-1710-47 (1325)	V-1710-35 (1150)	V-1710-59 (1100)	V-1710-63 (1325)	V-1710-63 (1325)	V-1710-83 (1200)	V-1710-85 (1200)	V-1710-85 (1200)	V-1710-35 (1150)
Span	35' 10"	34' 0"	34' 0"	34' 0"	34' 0"	34' 0"	35' 10"	34' 0"	34' 0"	34' 0"	34' 0"	34' 0"	34' 0"	34' 0"	34' 0"
Length	28' 8"	29' 9"	30' 2"	29' 9"	30' 2"	30' 2"	31' 11"	30' 2"	30' 2"	30' 2"	30' 2"	30' 2"	30' 2"	30' 2"	30' 2"
Height		9' 3"					11' 10"								12' 5"
Wing area (sq. ft.)		213	213		213	213		213	213	213	213	213	213	213	213
Gross weight (lbs.)	6204	6662	7250	6450	7180	7830	8918	7500	8260	8400	8500	8400	8200	8350	
Empty weight (lbs.)		4955				6300								6400	
Top speed	390	368	384	375	379	368	386	368	360	368	365	360	379	385	
Cruise speed						325									
Stall speed														88	
Rate of climb (ft./min.)						2500								2600	
Service ceiling						30,000'								35,000'	
Range (mi.)		1560				1100								1100	

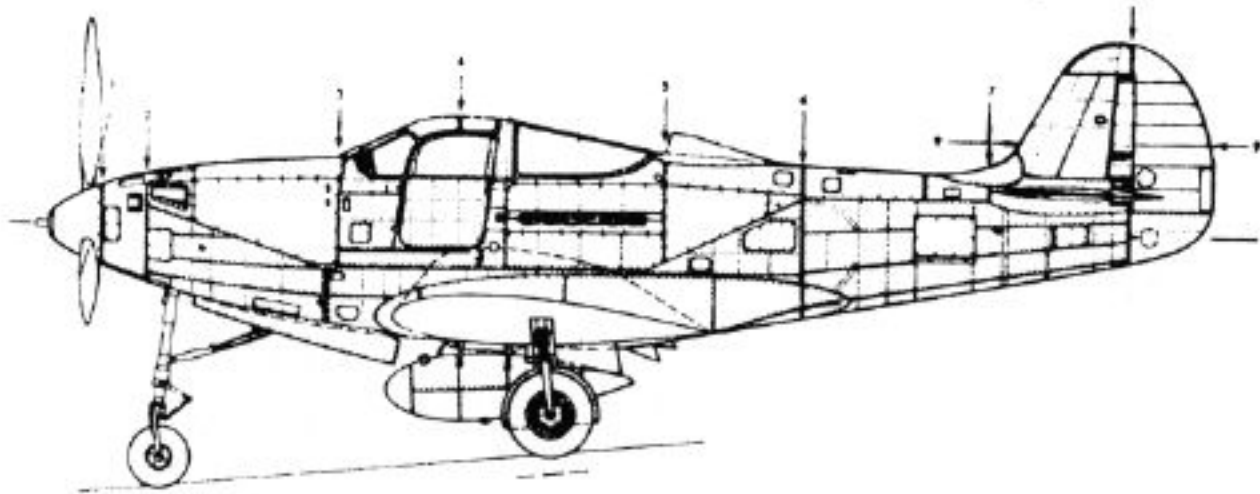
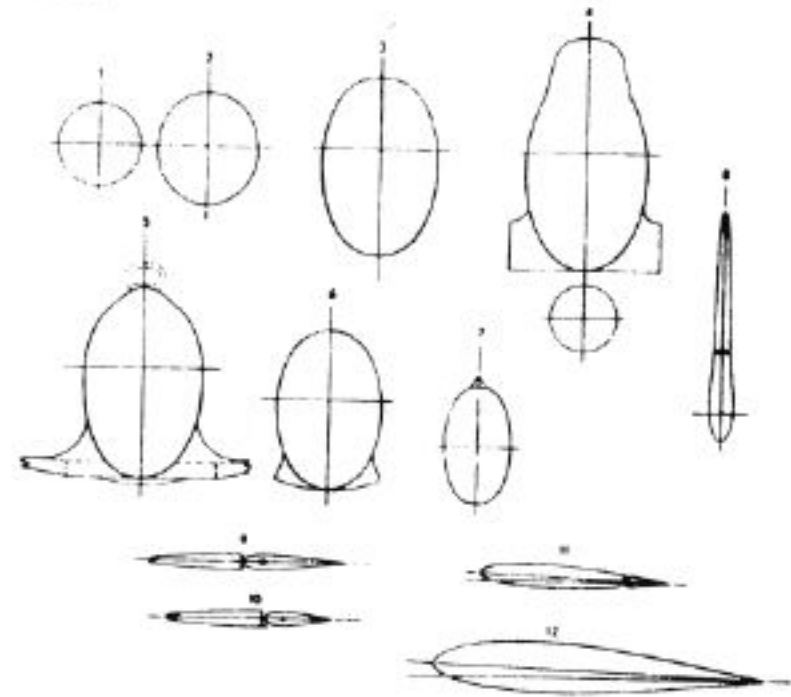
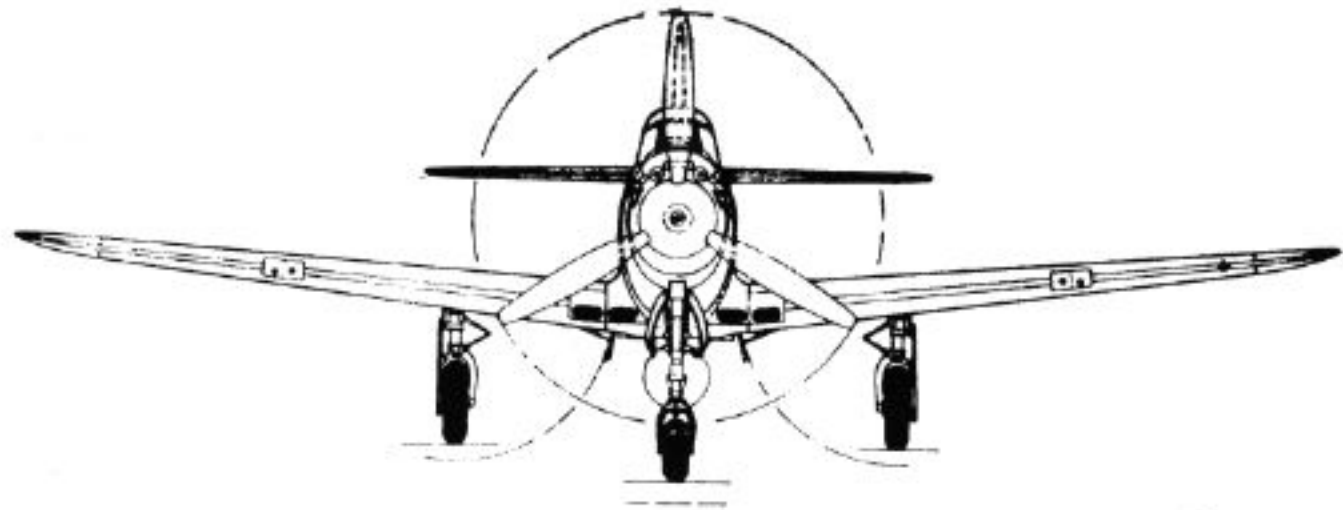
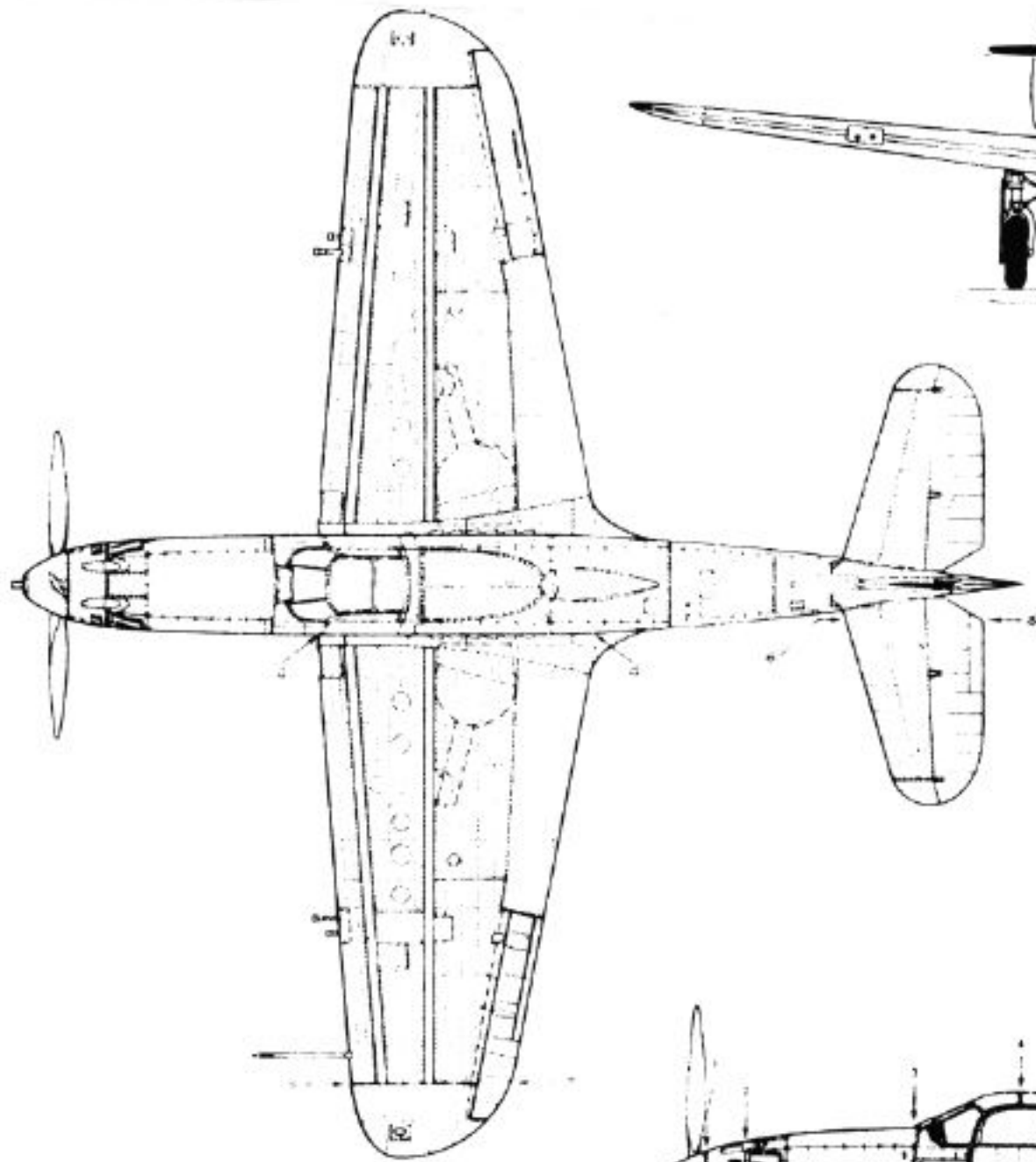

BELL AIRACOBRA, P-39

## TABLE OF CONTENTS

Section	Page	Section	Page
I	Description . . . . .	1	
	1. Airplane . . . . .	1	
	2. Fuel, Oil, and Coolant . . . . .	1	
	3. Pilot Protection . . . . .	1	
	4. Power Plant . . . . .	2	
	5. Controls and Operative Equipment . . . . .	2	
	6. Engine Controls . . . . .	3	
	7. Propeller Controls . . . . .	3	
	8. Carburetor Air Filter and Heater . . . . .	3	
	9. Miscellaneous Equipment . . . . .	3	
II	Pilot Operating Instructions . . . . .	11	
	1. Before Entering Cockpit . . . . .	11	
	2. On Entering Cockpit . . . . .	12	
	3. Starting Engine . . . . .	12	
	4. Engine Warm-up . . . . .	13	
	5. Engine and Accessories Ground Check . . . . .	13	
	6. Taxiing Instructions . . . . .	14	
	7. Take-off . . . . .	14	
	8. Engine Failure During Take-off . . . . .	14	
	9. Climb . . . . .	15	
	10. Flight Operation . . . . .	15	
	11. General Flying Characteristics . . . . .	15	
	12. Engine Failure During Flight . . . . .	15	
	13. Stalls . . . . .	16	
	14. Spins . . . . .	16	
	15. Acrobatics . . . . .	16	
	16. Diving . . . . .	16	
	17. Night Flying . . . . .	16	
	18. Emergency Exit . . . . .	17	
	19. Approach for Landing . . . . .	17	
	20. Stopping the Engine . . . . .	18	
	21. Before Leaving Cockpit . . . . .	18	
	22. Oil Dilution . . . . .	18	
	23. Maneuvers Prohibited . . . . .	19	
	24. Maneuvers Not Recommended . . . . .	19	
	25. In Case of Fire . . . . .	19	
III	Flight Operation Data . . . . .	20	
	1. Determining Gross Weight . . . . .	20	
	2. Flight Planning . . . . .	20	
	Balance Diagram, P-39Q-1 . . . . .	20A	
	Weight and Balance Chart, P-39Q-1 . . . . .	21	
	Specific Engine Flight Chart, P-39Q-1 . . . . .	22	
	Take-off, Climb and Landing Chart, P-39Q-1 . . . . .	23	
	Flight Operation Instruction Chart, P-39Q-1 . . . . .	24	
	Flight Operation Instruction Chart, With Belly Tank, P-39Q-1 . . . . .	25	
IV	Operative Equipment . . . . .	26	
	1. Oxygen Equipment . . . . .	26	
	2. Auxiliary Fuel Tank or Bomb Release . . . . .	26	
	3. Operation of Communication Equipment . . . . .	26	
V	Armament . . . . .	28	
	1. Gun Sight Operation . . . . .	28	
	2. Guns . . . . .	28	
	3. Gun Operation . . . . .	28	
	4. Bombing Equipment . . . . .	28	
	Appendix - Winter Operation . . . . .	29	
	1. Landing Procedure . . . . .	29	
	2. Propeller Anti-icers . . . . .	29	
	3. Clear View Windshield Panel . . . . .	29	
	4. Carburetor Air Filter and Heater . . . . .	30	
	5. Starting System . . . . .	30	
	6. Engine Priming System . . . . .	30	
	7. Oil Dilution . . . . .	30	
	8. Surge Valve . . . . .	31	
	9. Cold Weather Mooring . . . . .	31	
	10. Parking on Snow or Ice . . . . .	31	
	11. Oxygen Equipment . . . . .	31	
	12. Communication Equipment . . . . .	31	
	13. Latches . . . . .	31	
	14. Procedure Prior to Start- ing . . . . .	31	
	U.S.A. British Glossary of Nomenclature . . . . .	32	

# P-39

## AIRPLANE

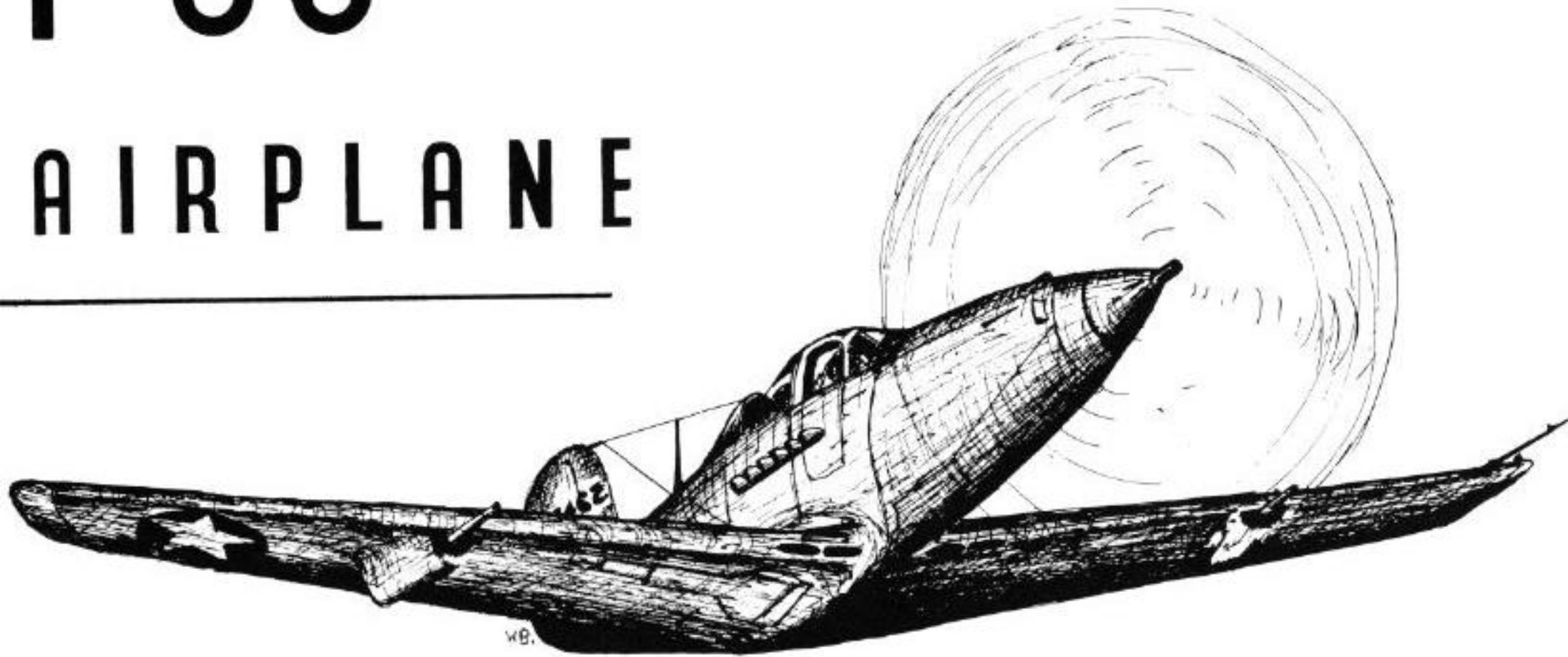

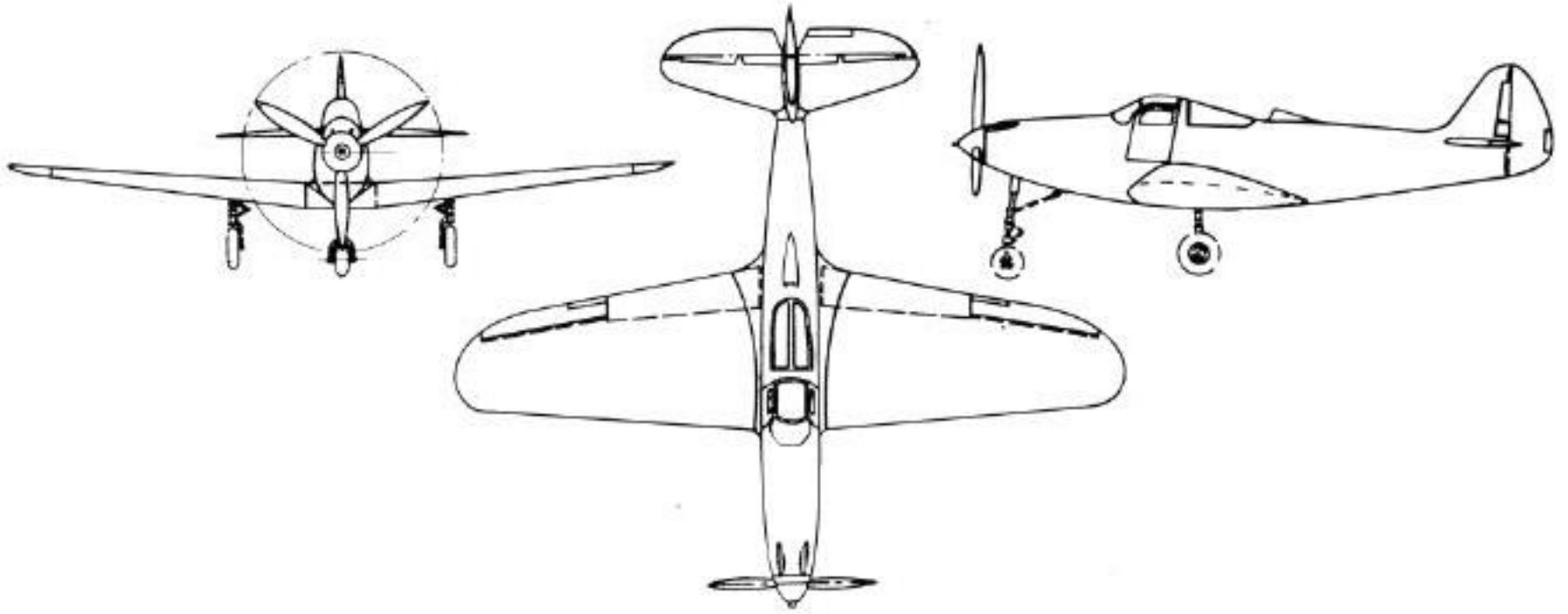

SECTION I  
DESCRIPTION

1. AIRPLANE.

a. GENERAL. - The Model P-39Q-1 Fighter Airplane is a low-wing land monoplane, powered with an Allison V-1710-85 engine which drives an Aero Products three-blade, hydraulic, selective, or automatic, controllable pitch propeller. The tricycle landing gear and the split-type wing flaps are electrically controlled. The brakes on the two main wheels are hydraulically operated. The over-all dimensions of the airplane are as follows:

Length	30 feet 2 inches
Height, taxiing position	9 feet 3-1/4 inches
Span	34 feet

b. ENTRANCE TO THE COCKPIT. - Entrance to the cockpit is made through the automobile-type door on the right side of the cabin. The left-hand door is recommended for entrance or exit only in case of emergency. An auxiliary latch (figure 5) is provided at the top of each door to secure it shut in flight. An emergency door release handle (figure 5) is located forward of each door.

2. FUEL, OIL, AND COOLANT.

Fuel	Specification No. AN-VV-F-781
	Octane 100
Oil	Specification No. AN-VV-O-446
Normal Temperature	Grade 1120 (SAE No. 60)
Low Temperature	Grade 1100 (SAE No. 50)

Coolant - Ethylene Glycol Specification No. AN-E-2

3. PILOT PROTECTION.

Sections of armor plate and armor glass are installed in front of and behind the pilot, as well as at other points in the airplane. He is protected from enemy fire within the shaded areas shown in figure 2.

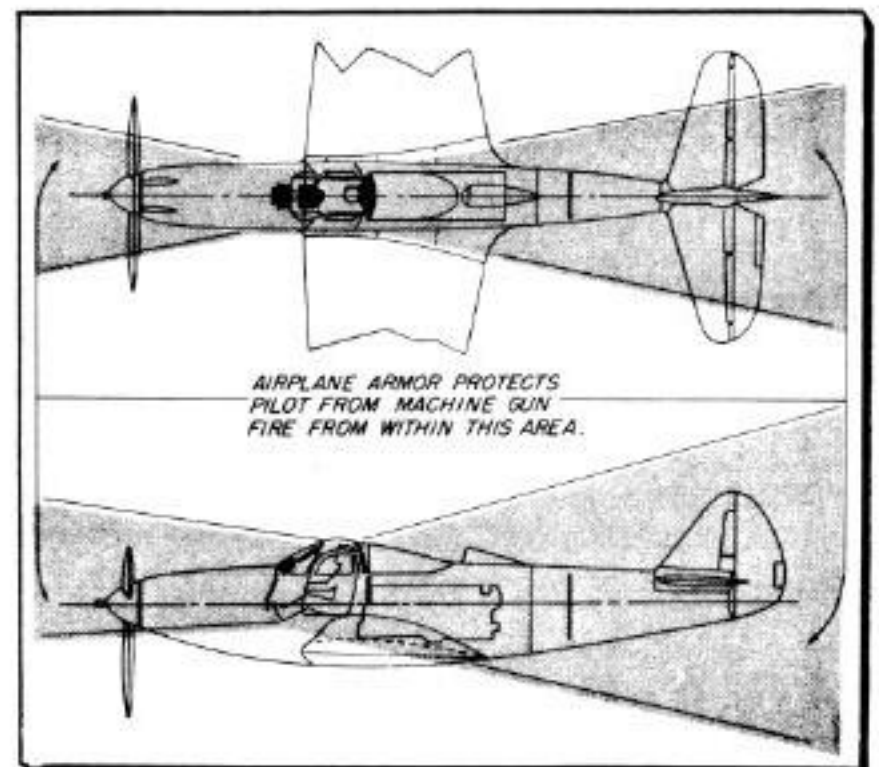

Figure 2 - Armor Plate

#### 4. POWER PLANT.

The Allison V-1710-85 engine in the P-39Q-1 airplane is a vertical "V" type, ethylene glycol cooled engine, connected with the reduction gear box in the nose of the airplane by an extension drive shaft.

#### 5. CONTROLS AND OPERATIVE EQUIPMENT.

a. **PILOT'S SEAT.** - The pilot's seat (figure 9) is nonadjustable and is equipped with a conventional-type safety belt and shoulder harness with locking and unlocking adjustments. The shoulder harness is adjustable for individual size by operating the buckles located at the shoulder of the harness. The shoulder harness lock is the lever at the left-hand side of the seat.

For freedom of movement lean forward on the shoulder harness approximately 7 inches and push control lever at side of seat to the back position. The above action locks shoulder harness in the slack position.

UPON TAKE-OFF, EMERGENCY LANDINGS, AND NORMAL LANDINGS the pilot must always secure himself in the seat by pushing forward on the control lever and leaning back in the seat, this will put tension on the shoulder harness.

**CAUTION**

Lock the harness to the rear before all take-offs and landings.

b. **AILERON AND ELEVATOR CONTROLS.** - A conventional control stick is equipped with a "squeeze-type" trigger (figure 3) for firing the fuselage and wing machine guns, and a push button (figure 3) for firing the .37-mm cannon.

c. **RUDDER CONTROL.** - Conventional foot pedals are provided. (See figure 5.) Each pedal is equipped with toe brakes for control of either or both main wheels as desired. The pedals are adjustable to suit the leg length.

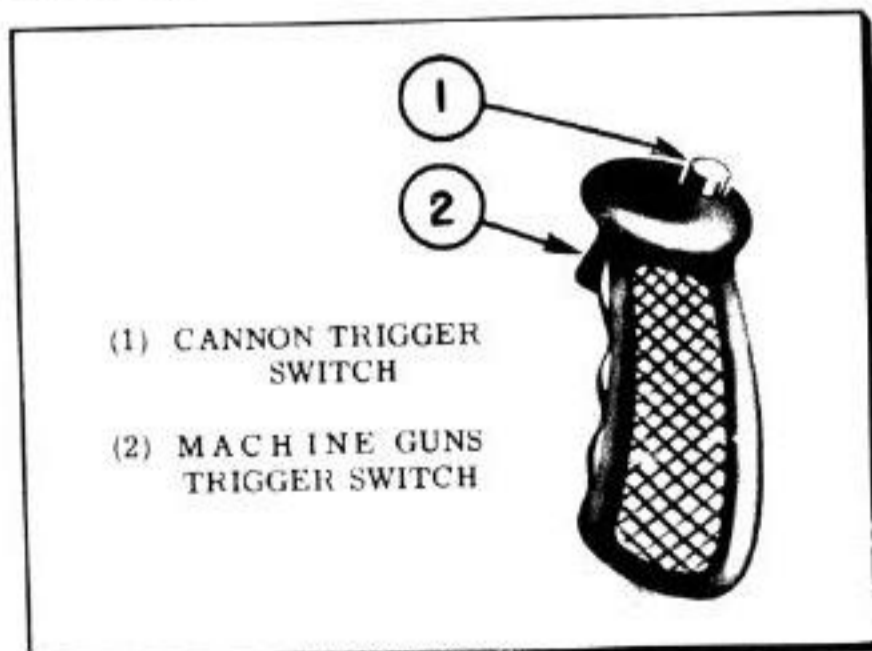

Figure 3 - Control Stick Grip

d. **AILERON TRIM TAB CONTROL.** - The aileron trim tab control knob (figure 8) is installed on the floor at the left of the pilot.

e. **ELEVATOR TRIM TAB CONTROL.** - The elevator trim tab control wheel (figure 8) is located on the floor at the left of the pilot.

f. **RUDDER TRIM TAB CONTROL.** - The rudder trim tab control knob (figure 8) is located on the floor at the left of the pilot.

g. **LANDING GEAR CONTROLS.** - An electric toggle switch for control of the landing gear is mounted to the left of the instrument panel approximately 6 inches below the plexiglas cabin enclosure. (See figure 5.) It is plainly marked "UP," "DOWN," and "OFF." A landing gear clutch handle (figure 9) and an emergency hand crank (figure 9) is located on the floor to the right of the pilot to be used to raise or lower the landing gear in case the electric power fails. A landing gear warning light located on the tubular support at the left of the main instrument panel glows when the throttle is cut to one-third and the landing gear is not in the locked down position.

h. **HEATING AND VENTILATION.** - The airplane cabin is heated or cooled by two ducts located on the cabin floor beneath the pilot's seat.

Two L-shaped control handles adjacent to one another on the floor to the right of the pilot's seat operate the butterfly flaps and regulate the temperature in the cabin. The air supply in the cabin is constant and only the temperature may be regulated. The forward control handle regulates the heat or cold from the right-hand duct, and the rear control handle (figure 9) regulates the heat or cold from the left-hand duct. Push the handles down to supply heated air. Pull the handles up to supply cold air. Intermediate adjustments of the handles will give the temperatures desired.

**CAUTION**

In case fumes begin entering the cockpit the cockpit heater should immediately be switched to cold air. This is to prevent prestone fumes entering cockpit through hot air duct in case of bursted radiator or prestone line.

i. **FUEL TANK GAGES.** - The fuel gage, (figure 5) located on the instrument panel, is put into operation when the ignition switch (figure 5) and battery switch (figure 5) are turned "ON."



Total fuel capacity of this airplane (less auxiliary tank) is 86 U. S. gallons (71.6 Imperial gallons). No fuel gage is provided for the auxiliary tank when it is installed.

j. **FUEL SELECTOR VALVE.** - The fuel selector valve (figure 8), located on the floor to the left of the pilot, is the conventional type with positions for "OFF," "LEFT," "RIGHT," "RES," and "AUX" (belly tank).

**k. RADIATOR SHUTTER CONTROLS.** - There are two radiator shutter controls.

(1) **COOLANT SHUTTERS.** - The coolant shutter control (figure 9) marked "OPEN" and "CLOSE" is located on the cockpit floor to the right of the pilot's seat.

(2) **OIL SHUTTERS.** - The oil shutters control handle (figure 9) marked "OPEN" and "CLOSE" is located on the fuselage turn-over beam at the pilot's right hand.

**l. PARKING BRAKE.** - The parking brake handle (figure 5) is located at the bottom center of the instrument panel.

## 6. ENGINE CONTROLS.

The engine controls are of the conventional type. The throttle control may be locked in place by the friction lock knob, located on the quadrant. Turn the lock knob (figure 5) clockwise to lock the throttle in place. A take-off stop is located approximately at the top of the throttle quadrant to indicate the proper setting for the take-off. This stop may be released by raising the metal clip at the base of the knob and pushing the lever forward.

### WAR EMERGENCY THROTTLE SETTING

The throttle quadrant on the P-39Q-1 airplane is equipped with a "War Emergency Throttle Stop." This consists principally of a light wire stop across the throttle lever slot at the usual 50.5 inches Hg limit. In an emergency, push the lever forward, breaking the wire. This will increase the manifold pressure to 57 inches Hg. Do not maintain the pressure for more than 5 minutes at the most, and use it only in emergency. The broken wire will indicate to service mechanics that the ship will require special attention.

## 7. PROPELLER CONTROLS.

The P-39Q-1 airplane is equipped with an Aero Products hydraulic propeller. The propeller pitch control lever (figure 5) is located on the inboard side of the throttle quadrant.

## 8. CARBURETOR AIR FILTER AND HEATER.

**a.** Two controls for operation of the filter and heater (figure 8) are located in the cockpit at the left of the pilot's seat on the turn-over beam. These controls operate dampers in the air ducts. The first control selects the desired amount of cold rammed unfiltered air which is led directly to the carburetor through a duct leading from the air scoop located on the top cowling directly over the carburetor. The second control permits the selection of hot unfiltered or cold filtered air to the carburetor.

**b.** It is recommended that under extreme frigid conditions, and when the airplane is kept in outside air, that a cover be placed over the carburetor air scoop to prevent snow or ice from forming on the scoop or entering the carburetor. In case a cover is not placed over the air scoop, it is necessary to thaw out the carburetor and scoop preflight. The heat of the engine alone should not be relied upon to thaw out these units because the extreme warm-up that would be required would overheat the engine.

**c.** A carburetor air thermometer is installed on the main instrument panel in the cockpit to calibrate the temperature of carburetor air at all times.

**d.** Carburetor icing usually occurs with carburetor air temperatures below 50°F (10°C) in high humidity air. It is evidenced by roughness or loss of manifold pressure.

## 9. MISCELLANEOUS EQUIPMENT.

**a. RELIEF TUBE.** - A relief tube is located beneath the right side of the pilot's seat.

**b. DATA CASE.** (See figure 4.) - The data case is attached to the under side of the left-hand section of the forward fuselage gun compartment cowl.

**c. FIRST-AID KIT.** (See figure 4.) - A first-aid kit is located on the left-hand cabin door.

**d. MOORING KIT.** (See figure 4.) - A mooring kit is located on the deck of the aft fuselage.

**e. SIGNAL LIGHT.** - An AN-3089 signal light is located on the right-hand cabin door.

**f. FLASHLIGHT.** - A flashlight is clamped to the lower edge of the plexiglas frame on the left-hand side of the cabin.





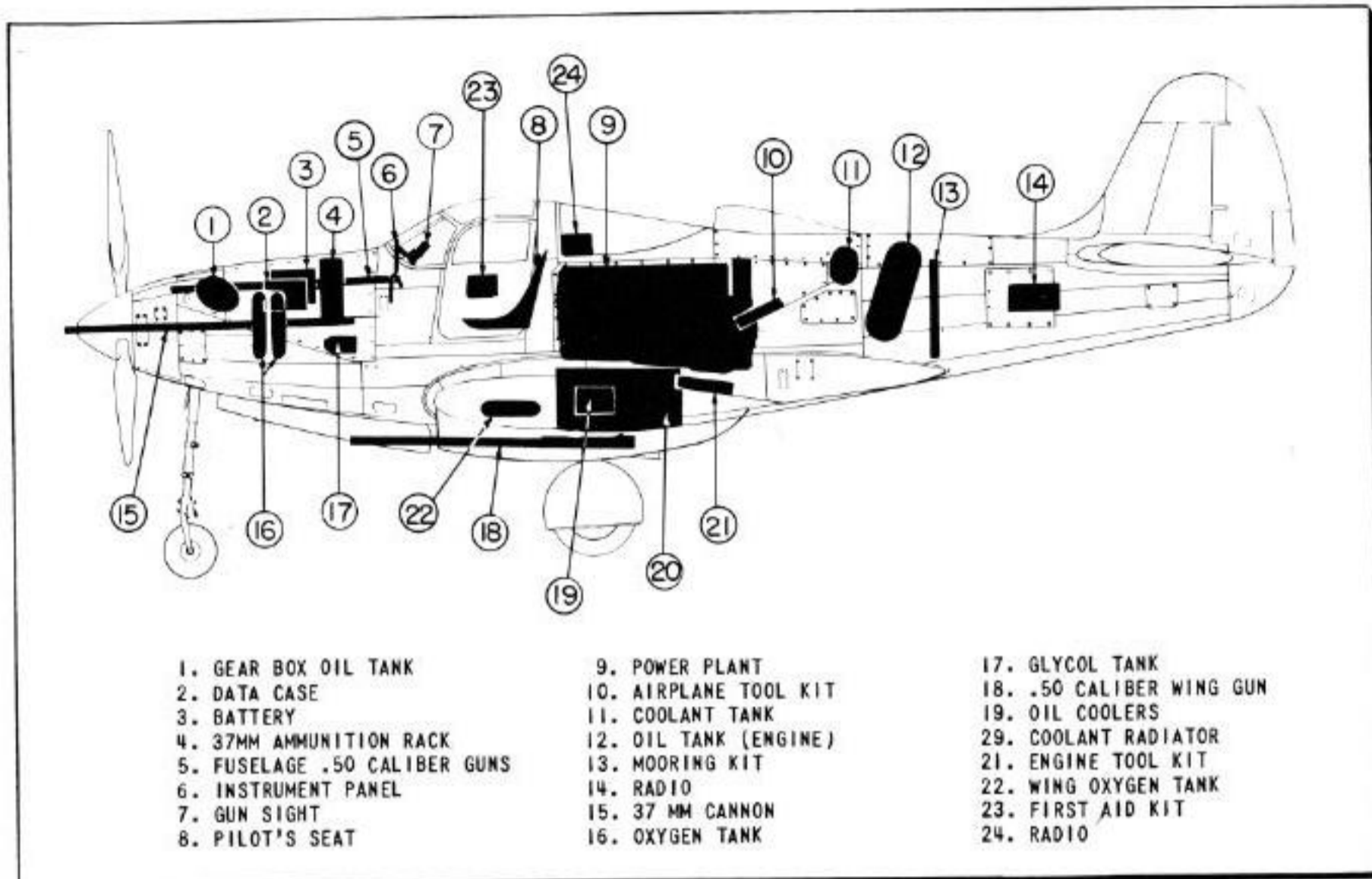

Figure 4 - General Arrangement

LEGEND FOR FIGURE 5

- |                                   |                                   |  |
|-----------------------------------|-----------------------------------|--|
| 1. GUN SIGHT VISOR                | 24. PITOT HEATER SWITCH           | 48. CARBURETOR AIR TEMPERATURE GAGE    |
| 2. AUXILIARY LATCH-CABIN DOOR     | 25. NAVIGATION LIGHT SWITCH-WING  | 49. CONTACT HEATER SWITCH              |
| 3. FLUORESCENT LIGHT              | 26. THROTTLE FRICTION BEARING NUT | 50. OXYGEN PRESSURE WARNING LIGHT      |
| 4. CLEAR VISION WINDSHIELD PANEL  | 27. PROPELLER CONTROL LEVER       | 51. OXYGEN VALVE                       |
| 5. ALTIMETER                      | 28. NAVIGATION LIGHT SWITCH TAIL  | 52. WINDSHIELD DE-ICER CONTROL         |
| 6. GUN SIGHT                      | 29. GENERATOR SWITCH              | 53. EMERGENCY DOOR RELEASE HANDLE      |
| 7. TURN INDICATOR                 | 30. BATTERY SWITCH                | 54. OXYGEN PRESSURE AND FLOW INDICATOR |
| 8. LANDING GEAR WARNING LIGHT     | 31. BRAKE PEDAL                   | 55. MANIFOLD PRESSURE GAGE             |
| 9. CLIMB INDICATOR                | 32. CONTROL STICK                 | 56. GUN CHARGING HANDLE                |
| 10. AIR-SPEED INDICATOR           | 33. RUDDER BAR                    | 57. PROPELLER DE-ICER CONTROL          |
| 11. COCKPIT LIGHT                 | 34. CANNON LOADING HANDLE         | 58. FUSELAGE GUN                       |
| 12. WING GUNS SWITCH              | 35. BOMB RELEASE HANDLE           | 59. RADIO CONTROL BOX                  |
| 13. FUSELAGE GUNS SWITCH          | 36. IGNITION SWITCH               | 60. ENGINE GAGE UNIT                   |
| 14. CANNON SWITCH                 | 37. CANNON CHARGING HANDLE        | 61. TACHOMETER                         |
| 15. FLAPS SWITCH                  | 38. ENGINE PRIMER PUMP            | 62. RADIO RELAY SWITCH BOX             |
| 16. LANDING GEAR CONTROL SWITCH   | 39. GUN CHARGING HANDLE           | 63. BANK AND TURN INDICATOR            |
| 17. EMERGENCY DOOR RELEASE HANDLE | 40. RADIO CONTROL PANEL           | 64. WING AND TAIL DE-ICER SWITCH       |
| 18. GUN SIGHT RHEOSTAT            | 41. LIQUIDOMETER                  | 65. FLIGHT INDICATOR                   |
| 19. FUEL BOOSTER PUMP SWITCH      | 42. GEAR BOX PRESSURE GAGE        | 66. REMOTE READING COMPASS             |
| 20. AMMETER                       | 43. PARKING BRAKE HANDLE          | 67. AUXILIARY LATCH-CABIN DOOR         |
| 21. THROTTLE CONTROL              | 44. CLOCK                         | 68. FLUORESCENT LIGHT                  |
| 22. CAMERA SWITCH                 | 45. SUCTION GAGE                  |  |
| 23. MIXTURE CONTROL LEVER         | 46. COOLANT TEMPERATURE GAGE      |  |
|                                   | 47. RADIO CLOCK                   |  |

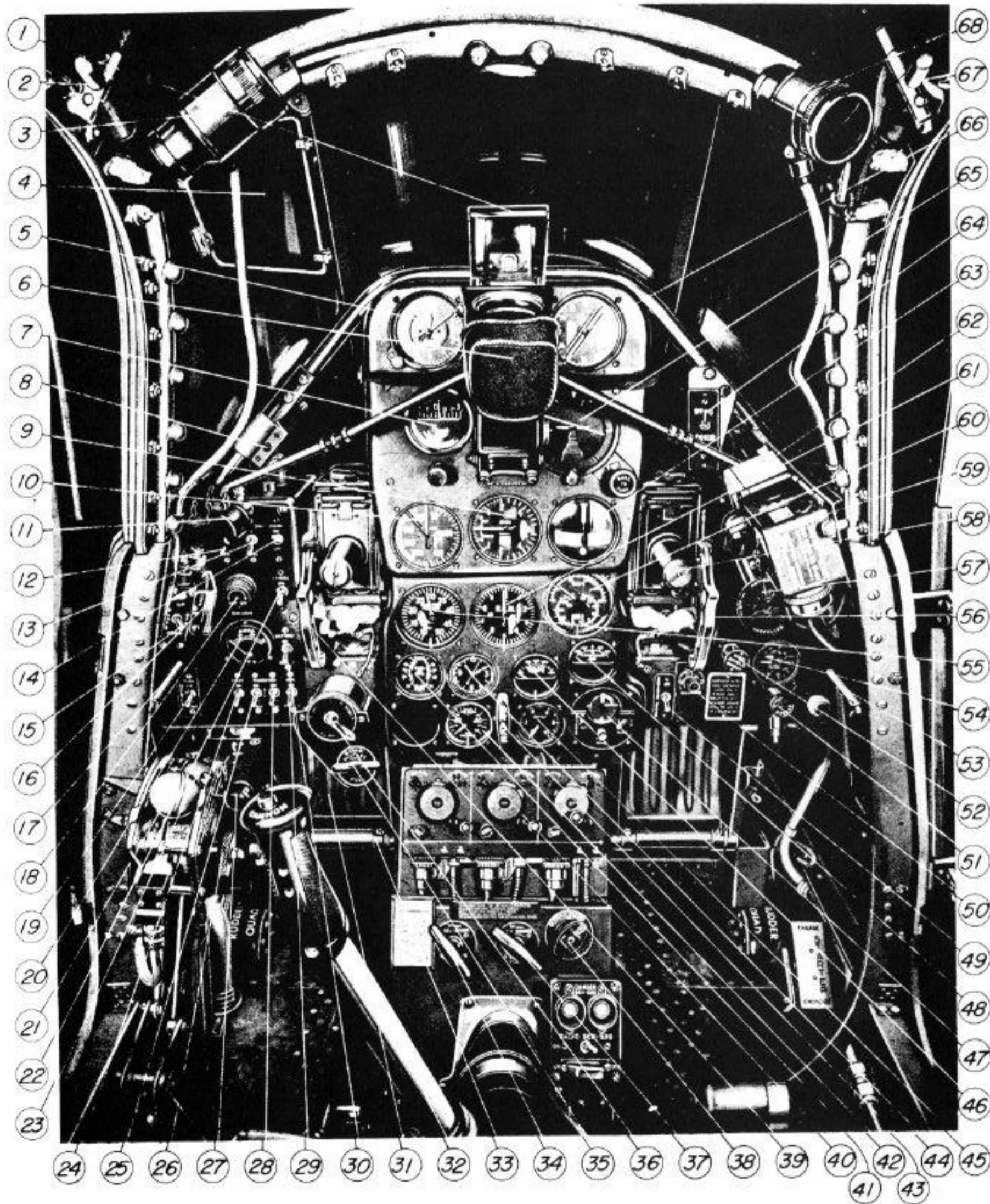
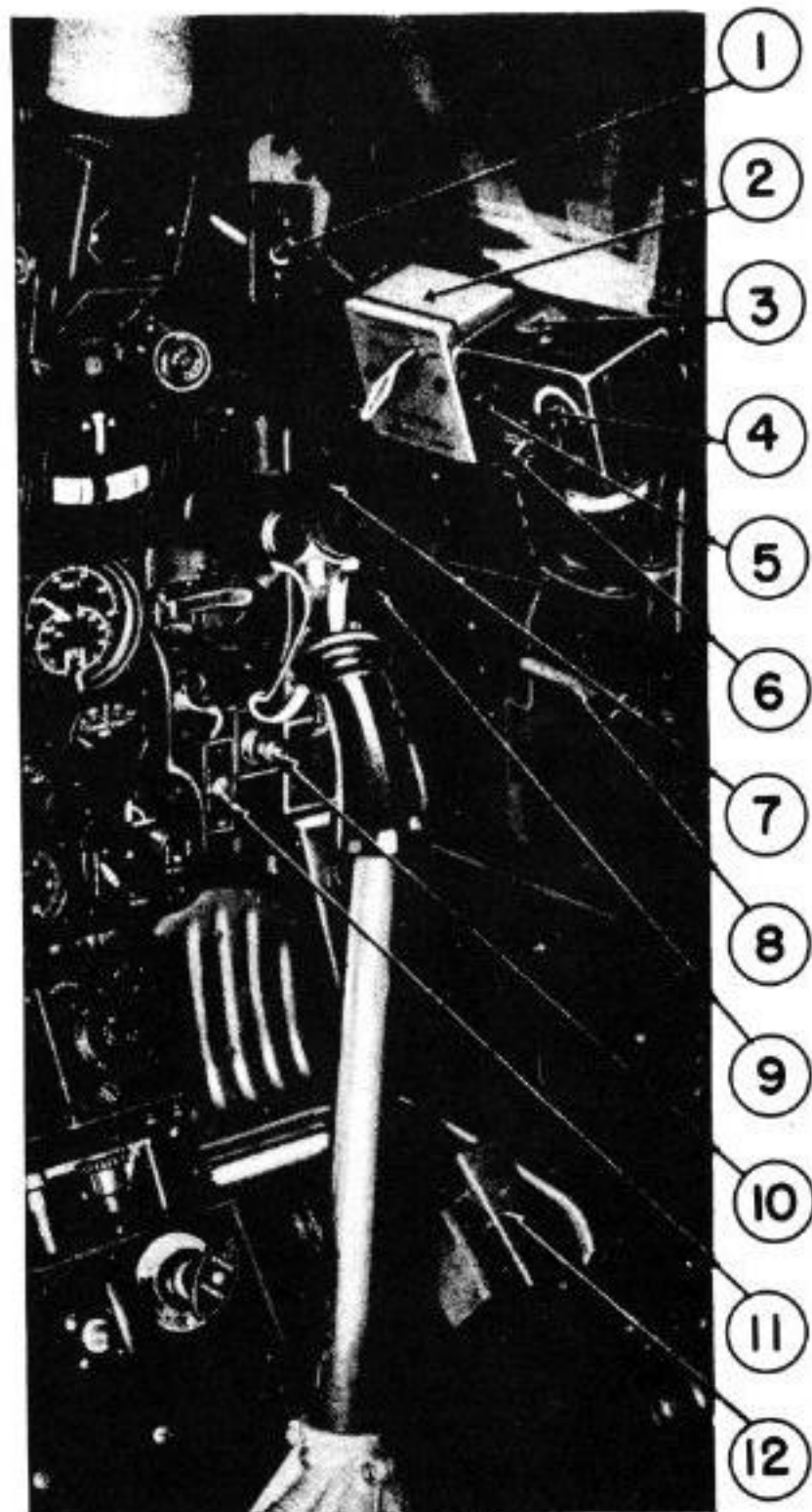
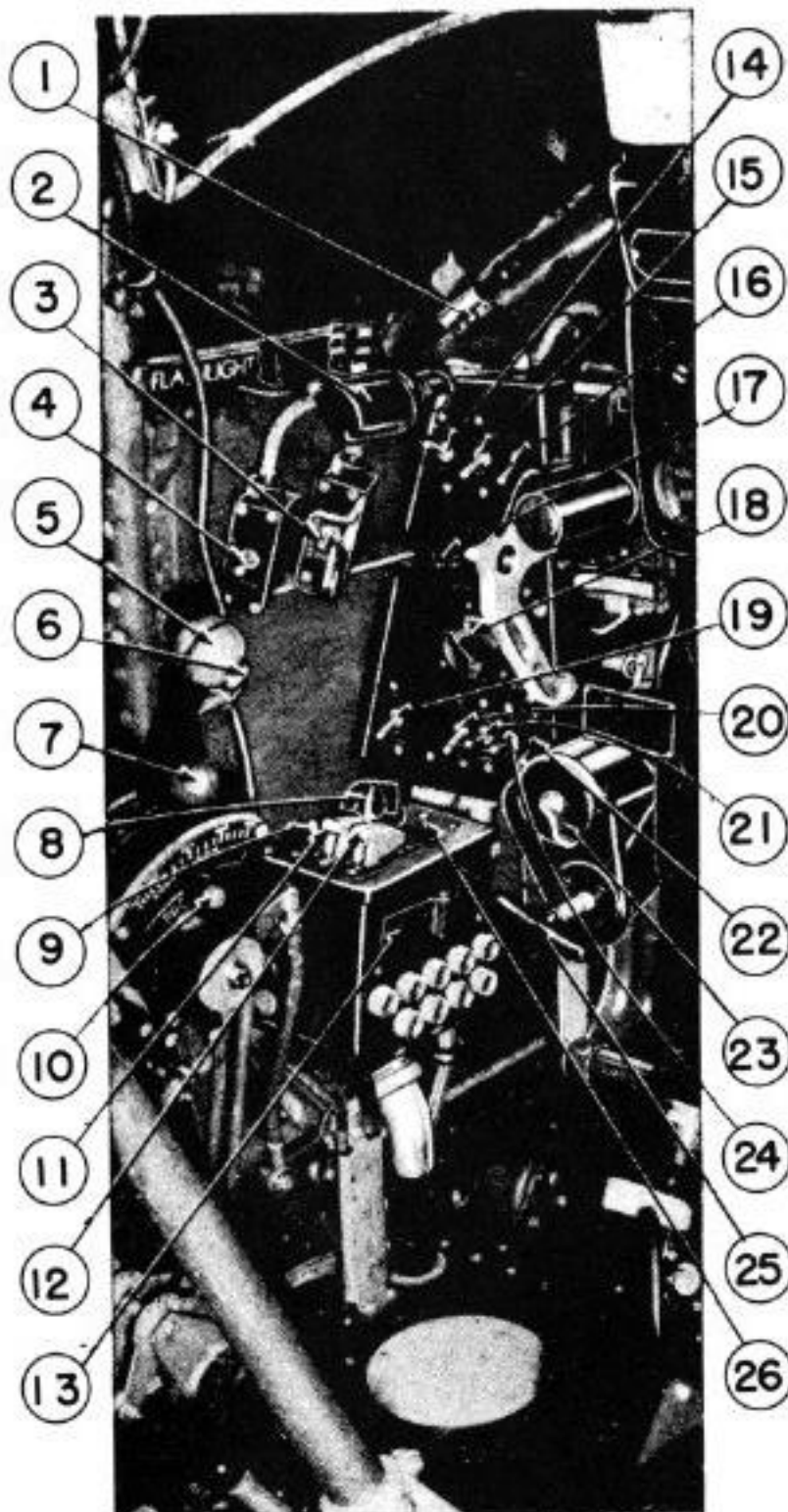

Figure 5 - Cockpit - Front View



- |                                |                                   |
|--------------------------------|-----------------------------------|
| 1. LANDING GEAR WARNING LIGHT  | 14. WING GUNS SWITCH              |
| 2. COCKPIT LIGHT               | 15. FUSELAGE GUNS SWITCH          |
| 3. LANDING GEAR SWITCH         | 16. CANNON SWITCH                 |
| 4. FLAPS SWITCH                | 17. GUN SIGHT RHEOSTAT            |
| 5. THROTTLE CONTROL LEVER      | 18. AMMETER                       |
| 6. MICROPHONE CONTROL BUTTON   | 19. FUEL BOOSTER PUMP SWITCH      |
| 7. MIXTURE CONTROL LEVER       | 20. PITOT HEATER SWITCH           |
| 8. FLUORESCENT LIGHT RHEOSTAT  | 21. NAVIGATION LIGHT SWITCH, WING |
| 9. COCKPIT LIGHT SWITCH        | 22. GENERATOR CONTROL SWITCH      |
| 10. PROPELLER CONTROL          | 23. IGNITION SWITCH               |
| 11. LANDING LIGHT SWITCH       | 24. NAVIGATION LIGHT SWITCH, TAIL |
| 12. LANDING LIGHT MOTOR SWITCH | 25. BOMB RELEASE HANDLE           |
| 13. AUXILIARY FUSE BOX         | 26. OIL DILUTION SWITCH           |

Figure 6 - Cockpit - Left-hand Side

- |                                  |
|----------------------------------|
| 1. WING DE-ICER SWITCH           |
| 2. RADIO RELAY SWITCH BOX        |
| 3. KEY                           |
| 4. TRANSMITTER SELECTOR          |
| 5. VOICE AND TONE CONTROL        |
| 6. TRANSMITTER POWER SWITCH      |
| 7. FLUORESCENT LIGHT RHEOSTAT    |
| 8. EMERGENCY DOOR RELEASE HANDLE |
| 9. PROPELLER DE-ICER CONTROL     |
| 10. OXYGEN WARNING LIGHT         |
| 11. CONTACTOR HEATER SWITCH      |
| 12. STARTER PEDAL                |

Figure 7 - Cockpit - Right-hand Side

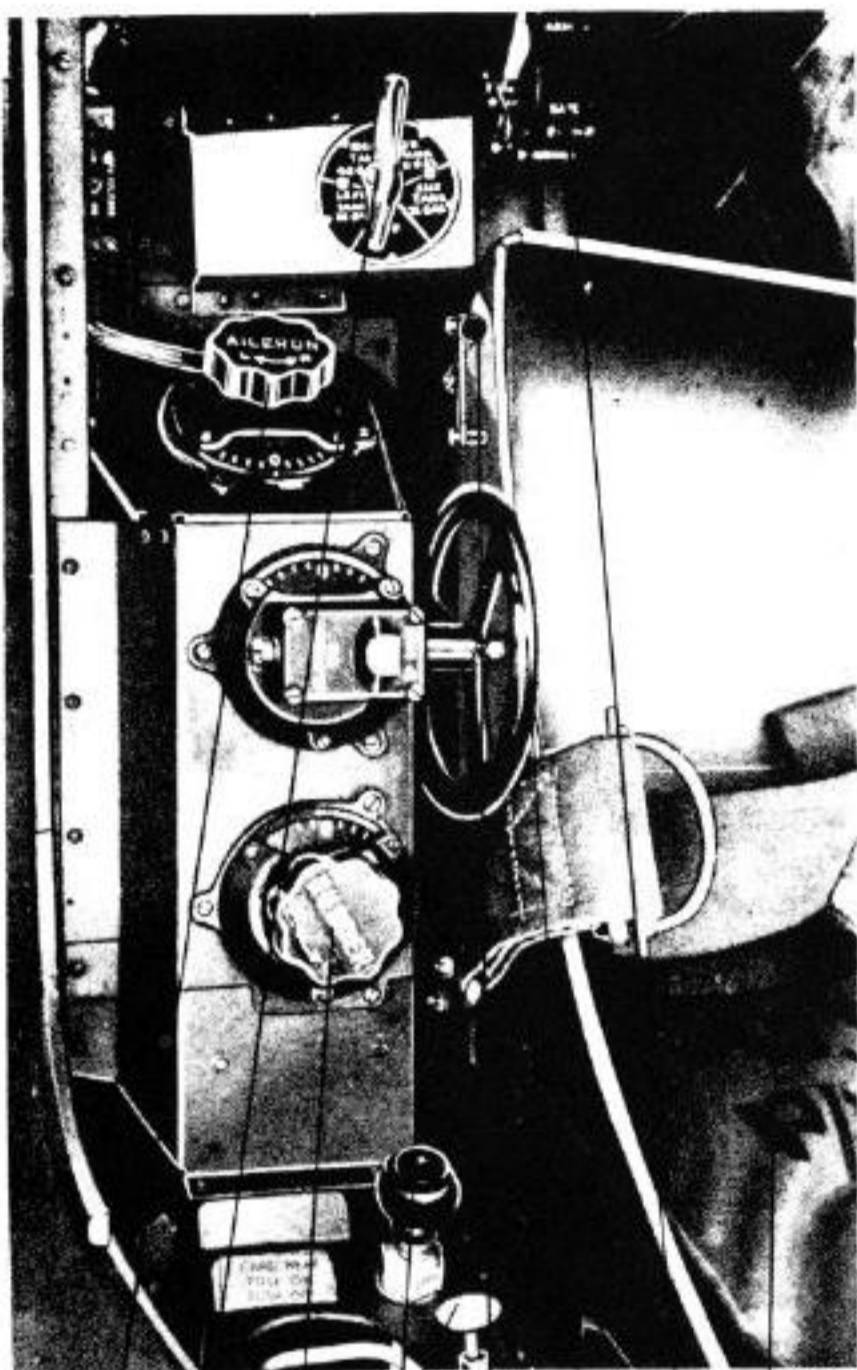

1 2 3 4 5 6 7 8

1. AILERON TRIM TAB CONTROL KNOB
2. FUEL SELECTOR VALVE
3. RUDDER TRIM TAB CONTROL KNOB
4. CARBURETOR AIR HEAT CONTROLS
5. HARNESS LOCK CONTROL
6. ELEVATOR TRIM TAB CONTROL
7. BOMB ARM AND SAFE LEVER
8. SEAT CUSHION AND LIFE PRESERVER

Figure 8 -  
Controls - Left Side of Seat

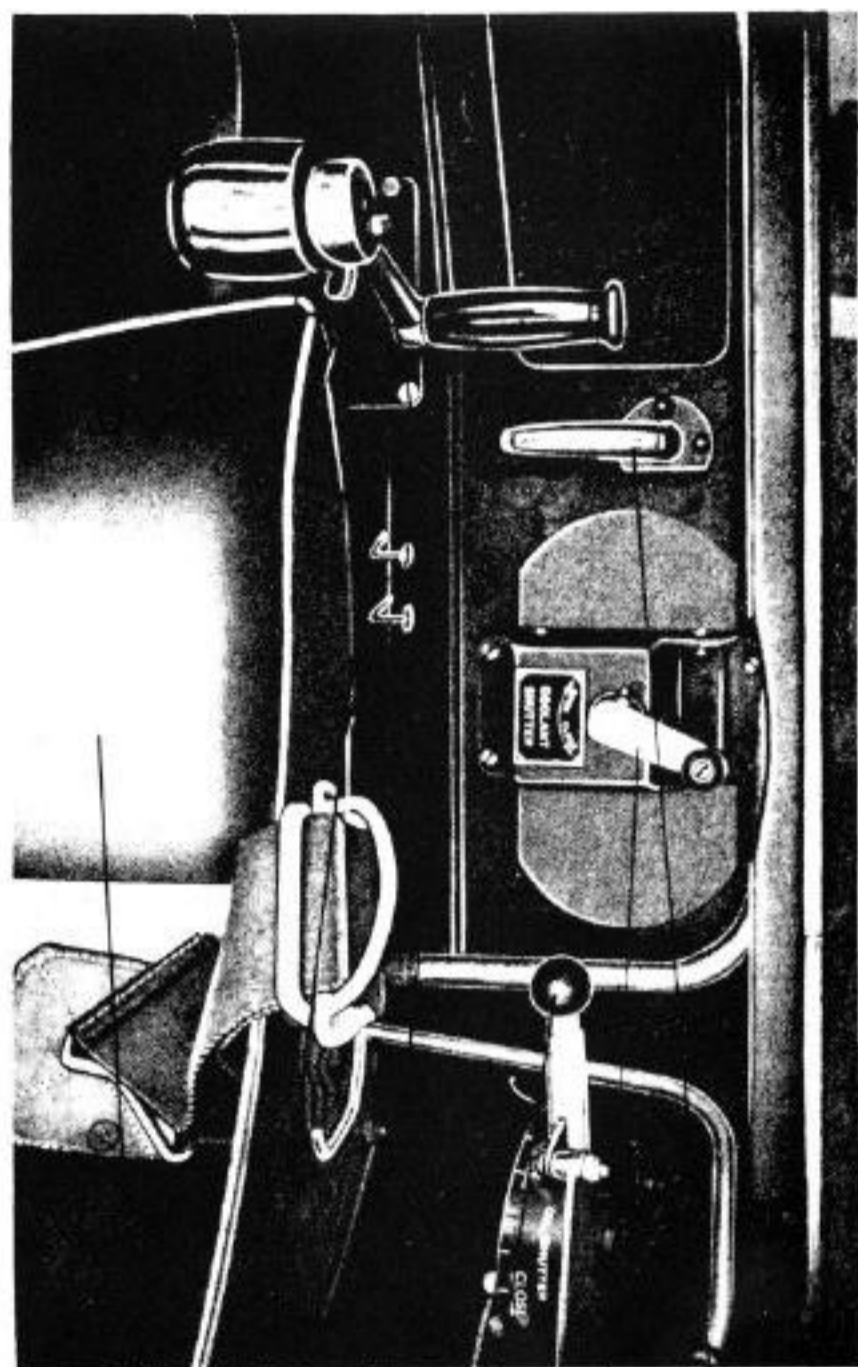

1 2 3 4 5 6

1. PILOT'S SEAT
2. CABIN HEATER CONTROLS
3. LANDING GEAR EMERGENCY HAND CRANK
4. OIL SHUTTER CONTROL
5. COOLANT SHUTTER CONTROL
6. LANDING GEAR CLUTCH HANDLE

Figure 9 -  
Cabin Floor - Right Side

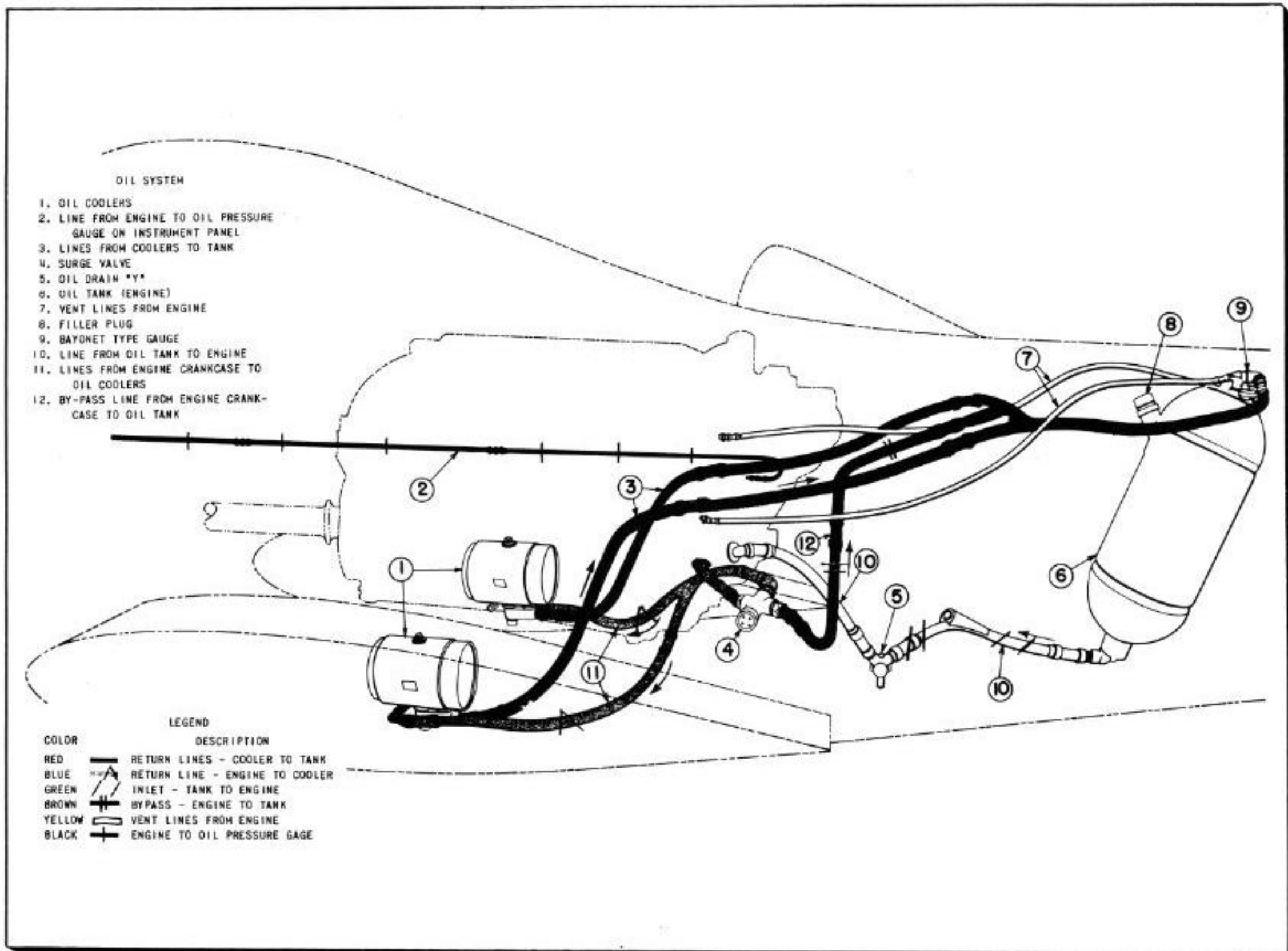

Figure 10 - Oil System

- COOLING SYSTEM
1. LINES FROM ENGINE TO COOLANT RADIATOR
  2. LINES FROM ENGINE DRIVEN COOLANT PUMP TO ENGINE
  3. VENT LINE FROM ENGINE TO EXPANSION TANK
  4. EXPANSION TANK
  5. LINE FROM EXPANSION TANK TO COOLANT PUMP
  6. LINES FROM RADIATOR PUMP TO COOLANT PUMP
  7. PUMP DRAIN LINE
  8. COOLANT RADIATOR
  9. OVERFLOW LINE

LEGEND

COLOR	DESCRIPTION
RED	LINES FROM ENGINE TO COOLANT RADIATOR
BLUE	LINES FROM COOLANT PUMP TO ENGINE
GREEN	LINES FROM COOLANT RADIATOR TO COOLANT PUMP
BROWN	LINE FROM EXPANSION TANK TO COOLANT PUMP
YELLOW	VENT LINE FROM ENGINE TO EXPANSION TANK
RED & WHITE	PUMP DRAIN LINE
BLACK	OVERFLOW LINE

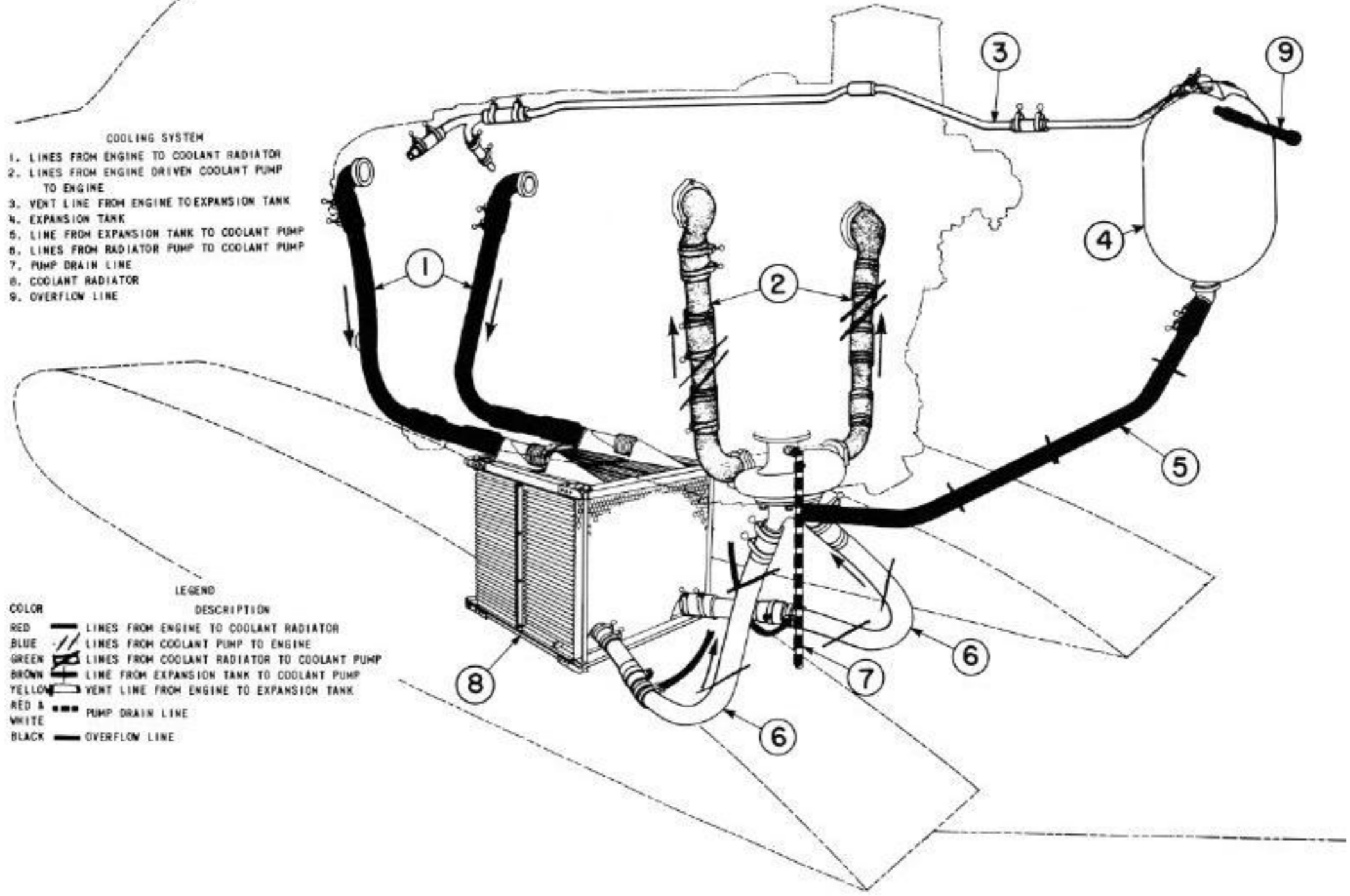

Figure 11 - Cooling System

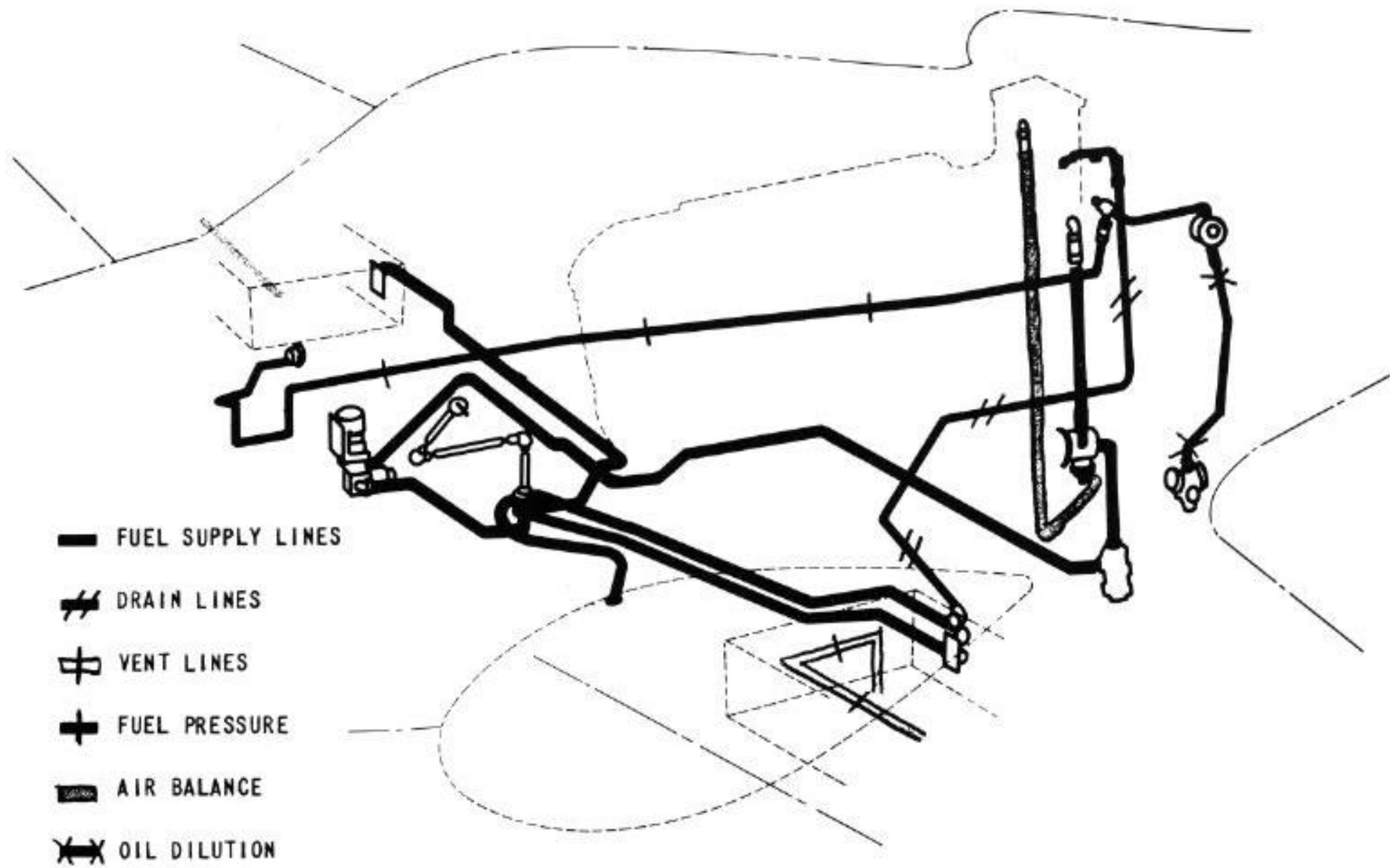

Figure 12 - Fuel System

## SECTION II

### PILOT OPERATING INSTRUCTIONS

#### 1. BEFORE ENTERING COCKPIT.

a. **BALANCE DIAGRAM AND CHART.** - Pilot should make a thorough study of the balance diagram and chart in section III.

b. It is essential that the pilot **DETERMINE THE GROSS WEIGHT** by referring to the **WEIGHT AND BALANCE CHART** in section III. Check the listed basic and alternate tabulated items against those loaded in the airplane. If the airplane is loaded in accordance with the "Basic Load Items" whose weights are entered under two loading conditions in the "Alternate Loading (Pounds)" column, the gross weight will be found listed at the bottom of the chart. If any items tabulated in the "Pounds" columns are omitted in the loading of the airplane, deduct the weight of these missing items from the "Gross Weight" and the answer will be the correct gross weight as the airplane is actually loaded.

c. **FLIGHT OPERATION INSTRUCTION CHART** in section III is provided for flight planning purposes. The following outline may be used as a guide to assist personnel in their use in **FLIGHT PLANNING**.

#### NOTE

If the flight plan calls for a continuous flight where the desired cruising power and air speed are reasonably constant after take-off and climb to 5000 feet, the **FUEL REQUIRED** and **FLIGHT TIME** may be computed as a "single section flight."

(1) Within the limits of the airplane, the fuel required and flying time for a given mission depend largely upon the speed desired. With all other factors remaining equal in an airplane, speed is obtained at a sacrifice of range, and range is obtained at a sacrifice of speed. The speed is usually determined after considering the urgency of the flight plotted against the range required. The time of take-off is adjusted so as to have the flight arrive at its destination at the predetermined time.

(2) Select the **FLIGHT OPERATION INSTRUCTION CHART** for the model airplane and gross weight to be used at take-off. Locate the largest figure entered under "gph" (gallons per hour) in column I on the lower half of the chart. Multiply this figure by the number and/or fraction of hours desired for reserve fuel. Add the resulting figure to the number of gallons set forth in the chart footnote No. 2, and subtract the total from the amount of fuel in the airplane prior to starting of engine. The figure obtained as a result of this computation will represent the amount of gasoline

available and applicable for flight planning purposes on the **RANGE IN AIR MILES** section of the **FLIGHT OPERATION INSTRUCTION CHART**.

(3) Select a figure in the fuel column equal to, or the next entry less than, the available amount of fuel in the airplane as determined in paragraph 1.c.(2) preceding. Move horizontally to the right or left and select a figure equal to, or the next entry greater than, the air miles (with no wind) to be flown. Operating values contained in the column number in which this figure appears, represent the highest cruising speed possible at the range desired; however, the airplane may be operated in accordance with values contained under **OPERATING DATA** in any column of a higher number with the flight plan being completed at a sacrifice of speed but at an increase in fuel economy.

(4) Using the same column number selected by application of instructions contained in paragraph 1.c.(3), determine the indicated air speed and gallons per hour listed at sea level in the lower section of the chart under the subtitle **OPERATING DATA**. Divide this "IAS" into the air miles to be flown and obtain the calculated flight duration in minutes, which can then be converted into hours and minutes and deducted from the desired arrival time at destination in order to obtain the take-off time (without consideration for wind). To allow for wind, use the above "IAS" as ground speed and calculate a new corrected ground speed with the aid of a flight calculator or by a navigator's triangle of velocities.

(5) The airplane and engine operating values listed below **OPERATING DATA** in any single numbered column are calculated to give constant miles per gallon at any altitude listed. Therefore, the airplane may be operated at any altitude and at the corresponding set of values given so long as they are in same column listing the range desired.



**RANGES** listed in column I under "Max Cont Power" are correct only at the altitude given in the chart footnote 1, and the engine and airplane operating data listed under **OPERATING DATA** will give constant miles per gallon if operation is consistent with values set opposite the listed altitudes.

(6) The flight plan may be readily changed at any time enroute, and the chart will show the balance of range at various cruising powers by following the "INSTRUCTIONS FOR USING CHART" printed on each chart.



d. If the original flight plan calls for a mission requiring changes in power, speed, gross load or external load, in accordance with "GR WT" or "EXTERNAL ITEMS" increments shown in the series of "FLIGHT OPERATION INSTRUCTION CHARTS" provided, the total flight should be broken down into a series of individual short flights, each computed as outlined in paragraph 1.c. in its entirety, and then added together to make up the total flight and its requirements.

e. **OBTAIN FLIGHT CLEARANCE.**

(1) In the event of war operations, secure radio frequency assignment for the flight.

(2) If radio model SCR274-N is installed in the airplane, be sure correct transmitter is installed and tuned for proper frequency.

(3) If radio model SCR522 is installed in the airplane, be sure correct crystals are installed for proper frequency.

(4) **ENTRANCE TO THE COCKPIT** is made through the right-hand door. The door is opened by pushing in the upper end of the flush handle causing it to hinge out, upon which it can be pulled upward, opening the door.

2. **ON ENTERING THE COCKPIT.**

a. **Special check for night flying.**

(1) Turn battery switch (figure 5) "ON."

(2) Turn cockpit lights (figure 5) "ON." The three cockpit lights are all controlled by the one switch.

(3) Turn left fluorescent light (figure 5) "ON."

(4) Turn right fluorescent light (figure 5) "ON."

(5) Test-operate gun sight rheostat (figure 5).

(6) Test-operate the landing light by first operating landing light motor switch (figure 6). When light is extended turn on the light switch (figure 6) for not over 3 to 5 seconds. Test complete, operate motor switch retracting the light.

(7) **SIGNAL LIGHT.** - A removable signal light is located on the right-hand cabin door. The light is operated by a switch located on the light.

b. **Check for all flights.**

(1) Ignition switch (figure 5) "OFF."

(2) Fuselage guns switch (figure 5) "OFF."

(3) Wing gun switch (figure 5) "OFF."

(4) Cannon switch (figure 5) "OFF."

(5) Landing gear control switch (figure 5) "OFF."



**HEY! DON'T GET IN THIS WAY, FOLLOW YOUR INSTRUCTIONS**

(6) See that control of landing gear clutch handle (figure 9) is in position for electric operation of the landing gear.

(7) Flap control switch (figure 5) "OFF."

(8) Generator switch (figure 6) "ON."

(9) Parking brake "ON." To set parking brakes depress brake pedals (figure 5), and pull out on parking brake handle. (See figure 5.)

(10) Adjust rudder pedals for correct leg length by pushing outboard on the spring-loaded lever on the outer side of each rudder pedal, adjusting them to length and then release the lever, locking them in place. **BE SURE BOTH PEDALS ARE ADJUSTED EQUALLY.** Check for full right and left movements of the rudder.

(11) Check for free movement of control surfaces.

(12) Check oxygen control valve and supply.

3. **STARTING ENGINE.**

a. **WITH AIRPLANE IGNITION SWITCH "OFF"** turn propeller over two or three complete revolutions by hand.

- b. Turn battery switch (figure 5) "ON."
- c. Check fuel supply of right and left tanks.

d. Turn ignition switch on (figure 5) to "BOTH." The fuel quantity gage, the carburetor air, and the coolant give readings upon operation of the ignition switch. (The coolant will not register if its temperature is below 50°C (122°F).)

e. Turn fuel selector valve (figure 8) to "RES TANK."

#### NOTE

Selection of the reserve tank is recommended as it provides sufficient fuel for both "WARM-UP" and "TAKE-OFF."

f. Set the mixture control lever (figure 5) to the "IDLE CUT-OFF" range.

g. Crack the throttle (figure 5) open approximately 1 inch.

h. Turn electric booster fuel pump switch "ON" and prime engine. Priming completed, TURN ELECTRIC BOOSTER FUEL PUMP SWITCH "OFF."

i. Give the primer (figure 5) two or three full strokes when engine is cold and one-half or one full stroke when engine is warm.

j. Energize the starter by pressing the starter pedal (figure 7) downward with the heel and hold until the inertia flywheel at the starter sounds as though it has reached maximum rpm. Then engage the starter by tipping the starter pedal forward with the toe. Hold pedal until the engine fires regularly, then release. WHEN THE ENGINE STARTS, PUSH MIXTURE CONTROL HANDLE (figure 5) FORWARD TO "AUTOMATIC RICH."

#### NOTE

Should engine stop, return the mixture control to "IDLE CUT-OFF" position immediately to avoid flooding the engine with fuel, as the fuel pressure will build to normal operating pressure of 16 pounds per square inch when engine starts firing.

If engine is not overloaded, another start can be made using the same procedure. In case of overloading, the next start should be attempted without priming.

#### 4. ENGINE WARM-UP.

a. The engine should be warmed up at a speed that is free from vibration, under 1400 rpm. During engine warm-up test-operate the flaps by placing the flap switch (figure 5) in the "DOWN" position until the indicator on the top surface of the left-hand outer wing

panel at the flap shows fully down. Then place the flap switch in the "UP" position until the indicator shows fully up.

b. Operation is assured for flight when the OIL TEMPERATURE GAGE (figure 5) shows a temperature of not less than 30°C (86°F) and the COOLANT TEMPERATURE GAGE (figure 5) shows a temperature of not less than 85°C (185°F). The oil pressure gage may fluctuate during warm-up, but this should subside when the oil temperature increases, eventually becoming practically steady.

If the oil pressure is not established within approximately 15 to 30 seconds after starting, STOP THE ENGINE by setting manual mixture control in "IDLE CUT-OFF" and investigate the trouble.

c. Allowable engine operation for take-off as follows:

(1) Maximum rpm 3000 at sea level manifold pressure, fuel, Specification No. AN-VV-F-781 amendment 5. 50.5 inches Hg (5 minutes operation only).

#### WAR EMERGENCY RATING

(2) Maximum rpm 3000 at sea level manifold pressure, fuel, Specification No. AN-VV-F-781 amendment 5. 57 inches Hg (5 minutes operation only).

(3) Oil pressure 55 pounds minimum, 85 pounds maximum.

(4) Oil temperature: Grade 1100, oil 85°C (185°F). Grade 1120, oil 95°C (203°F).

(5) Coolant temperature: 125°C (257°F) maximum, 85°C (185°F) minimum.

(6) Reduction gear oil pressure: 190 pounds maximum, 70 pounds minimum.

(7) Fuel pressure: 15-16 pounds. When using amendment 4 fuel, reduce engine operation and performance 10 percent.

#### 5. ENGINE AND ACCESSORIES GROUND CHECK.

a. Magnetos should be tested individually when the engine is warm to check for loss of engine revolutions and manifold pressure.

Single magneto checks should be made at an engine speed of 2300 rpm with the propeller control lever set at "TAKE-OFF" (full low pitch) and mixture control lever in "AUTOMATIC RICH" position.

It is normal for the right magneto (exhaust) to decrease 80 rpm and the left magneto (intake) to decrease 60 rpm.

Loss of speed in excess of 100 rpm generally indicates faulty ignition or spark plugs.

**b. PROPELLER.** - To assure efficient operation of the Aero Products propeller, move the propeller pitch control lever, located on the engine control quadrant (figure 5), back and forth from 1400 rpm to 2300 rpm several times to free the oil in the hydraulic system; then push forward to take off.



Do not make single magneto checks over 2300 rpm and 30 inches Hg manifold pressure. The checking of the ignition switch for proper "ground" when in "OFF" position should be accomplished at "idling" speed only.

## 6. TAXYING INSTRUCTIONS.

**a.** Release the parking brakes by depressing both brake pedals.



### **BEFORE ATTEMPTING "TAKE OFF" RELEASE PARKING BRAKES**

**b.** From a standing start it is not possible to start a sharp turn in one direction if the airplane has been stopped with the nose wheel pointed in the opposite direction. Get the airplane moving and then apply brakes in direction of the desired turn.

**c.** Clear the engine by a "burst" of throttle and taxi down the runway for take-off position. It is recommended that the oil and coolant shutters be open when taxiing. When the throttle is applied quickly there is a tendency for the airplane to swing to the left. This is due to engine and propeller torque and may be easily corrected by application of "full right rudder" or a combination of "right rudder" and "right brake."



Turning the airplane with one wheel locked is very bad practice, as it grinds rubber from the tire and may overstrain the spindles of the main landing gear to a point where they will later fail on landing or take-off.

## 7. TAKE-OFF.

**a.** Both cabin doors must be tightly closed and the auxiliary latch (figure 5) above each door securely

fastened. This latch prevents the door from opening at high speeds. In case of an emergency rest assured that the cabin doors can be immediately released as the emergency release handles (figure 5) break all door fastenings.

**b.** Set mixture control to "FULL RICH."

**c.** It is recommended that the trim tabs be set for the take-off as follows:

Rudder trim tab - 4 graduations "Right Rudder."

Elevator trim tab - 3 or 4 graduations "Nose Up."

Aileron trim tabs - "Zero" setting.

### NOTE

PROLONGED IDLING OR TAXYING WILL RESULT IN FOULED PLUGS; THIS CAN BE REMEDIED BY A BURST OF THROTTLE TO APPROXIMATELY 2200 RPM.

**d.** The coolant shutter control (figure 9) and the oil shutter control (figure 9) must be adjusted prior to take-off to suit prevailing climatic conditions. Further adjustment must also be made in flight to maintain the necessary operating temperatures.

**e.** It is recommended that a mechanical take-off be made. If flaps are desired for take-off do not lower over one-fourth. Because of the tricycle landing gear, it is a good practice to ease the ship from the ground when an indicated air speed of 100 mph is attained. A tendency to pull to the left will be noticed but can be corrected by application of right rudder. The tendency to pull to the left will disappear as the airplane gains speed.

**f.** After reasonable altitude has been gained, turn the landing gear switch (figure 5) to "UP," raising the landing gear.

**g.** Turn the flap switch (figure 5) to "UP" (assuming the flaps have been used in take-off).

**h.** Place the landing gear and flap switches to the "OFF" position.

**i.** Now throttle down to a manifold pressure of approximately 37.5 inches Hg, reducing the engine speed to about 2600 rpm.

## 8. ENGINE FAILURE DURING TAKE-OFF.

Should the engine fail during take-off, put the nose of the airplane down and maintain flying speed. Raise the landing gear if the ground is not level ahead and fully lower the flaps. Then turn the ignition switch off and land straight ahead.

### ATTENTION

Drop belly tank or bomb before a forced landing.

## NOTE

**Dropping Belly Tank.** - When it is necessary to drop the belly tank in flight, pull the release handle and at the same time lift the airplane gently from the falling tank by pulling back slightly on the stick. **DO NOT PULL THE NOSE UP SO SHARPLY THAT THE TAIL DROPS ENOUGH TO STRIKE THE TANK.**



## 9. CLIMB.

The best climbing speed of this airplane is as follows:

- |   |         |
|---|---------|
| a. Altitudes up to 5000 feet  | 162 IAS |
| b. Altitudes 5000 feet to 10,000 feet   | 160 IAS |
| c. Altitudes above 10,000 feet<br>with a drop of one mph for every 1000 feet additional altitude. | 158 IAS |

## 10. FLIGHT OPERATION.

a. To increase engine power during flight, set the mixture control lever (figure 5) in the "AUTO-RICH" position, adjust the propeller control lever (figure 5) to the desired rpm and increase manifold pressure as desired.

b. To decrease engine power during flight, adjust the throttle (figure 5) to the desired manifold pressure, adjust the propeller control lever (figure 5) to obtain the desired rpm, and then readjust the mixture control lever as necessary.

## 11. GENERAL FLYING CHARACTERISTICS.

a. Fuel selection was noted "reserve tank" for "take-off." After take-off proceed as follows:

- (1) After about 20 minutes switch to belly tank ("AUX") and run it dry.
- (2) Run "right tank" dry.
- (3) Run "left tank" dry.
- (4) Switch to "reserve."

## NOTE

"Left tank" will partially refill in flight due to vent return lines.



Never turn selector valve to "AUX," (belly tank) when it is not installed.

b. In cruising flight, the following gages and their respective readings give the most satisfactory indication of the engine's performance:

RPM	1600 to 2400
Oil Inlet Temperature	60°C (140°F) to 80°C (176°F)
Oil Pressure (Pounds Per Square Inch)	60 to 70
Coolant Outlet Temperature	100°C (212°F) to 120°C (248°F)



**IF YOUR INSTRUMENTS ARE OFF —  
DON'T TRY TO FIX 'EM  
LAND AND HAVE A MECHANIC DO THE JOB**

## CAUTION

In the event any of the above-mentioned operation gages appear very irregular, it is recommended that the engine be throttled down. Then, if the cause of the irregularity is not apparent, land the airplane and have the trouble investigated and corrected.

When flying with the auxiliary (or belly tank) it will be noticed that the airplane is slightly unstable when making a sharp bank at slow speeds. It is therefore recommended that the pilot maintain his flying speed and avoid sharp turns and banks with auxiliary tank.

## 12. ENGINE FAILURE DURING FLIGHT.

Should the engine fail during flight the altitude at which the airplane is flying will greatly determine the action of the pilot.

Ignition switch, booster fuel pump and fuel selector must be turned "OFF." Drop belly tank or bomb before landing.

a. If flying at a reasonably high altitude, proceed as follows:

Judging from the landscape determine the best place to land and put nose of airplane down sufficiently to maintain flying speed 130 mph IAS to successfully reach point where landing is to be made. The pilot must decide whether or not it is advisable to lower the landing gear.



If the field is rough, leave the landing gear retracted. If field is smooth, extend landing gear. If in doubt leave it retracted. Use full flaps and land straight ahead.

b. If the airplane is flying at a rather low altitude it is recommended that the pilot proceed as follows:

Ignition switch, booster fuel pump and fuel selector must be turned "OFF."

Leave landing gear retracted, and keep nose of the airplane down to help maintain flying speed - 130 mph IAS. As the airplane nears the ground it is advisable to lower the flaps and land with as high an angle of attack as possible (that is, tail down).

### 13. STALLS.

This airplane has good stalling characteristics (about 105 mph flaps "UP" or 90 mph with flaps "DOWN"). The airplane will mush considerably at stalling speeds. The stall occurs first at the center section of each wing panel and progresses outboard. To recover, allow the speed to build up sufficiently or approximately between 130 and 140 mph so as to completely unstall the center section.

### 14. SPINS.

Deliberate spinning is not recommended. However, if a spin occurs, rapid recovery can be made as follows:

#### a. PRERECOVERY.

- (1) Throttle must be off.
- (2) Propeller control must be in the low rpm position.
- (3) Stick full back.

#### b. RECOVERY.

- (1) Apply full opposite rudder when spin is at its slowest.
- (2) Wait until rudder effect is noticeable, then apply full forward stick and ailerons against the spin regardless of ammunition load in the wings.

c. The spin is usually oscillatory in rate, and it is mandatory that the opposite rudder be applied when the spin is at its slowest.

d. If the procedure above is followed, the airplane, will recover in one-half turn. If the procedure is not followed closely, the airplane may not recover.

### 15. ACROBATICS.

a. Normal loops, slow rolls and Immelmans are all done with ease.

b. Cage flight indicator before doing acrobatics.

### 16. DIVING.

a. It is necessary to trim nose heavy when diving this airplane, otherwise the airplane will make a severe pull-out as speed is attained. Also when diving, the airplane will tend to yaw to the right, and left rudder must be used to overcome this. The maximum permissible diving speed is 523 mph. 475 mph is the maximum recommended indicated air speed.

b. To decrease the possibility of the engine malfunctioning and missing considerably, upon opening the throttle, after pull-out from POWER OFF DIVES, the following precautions will be rigidly observed:

"DO NOT CLOSE THE THROTTLE TO ALLOW A MANIFOLD PRESSURE OF LESS THAN 20 INCHES HG DURING DIVE."

#### WARNING

PULL-OUTS FROM DIVES ARE TO BE STARTED AT 10,000 FEET MINIMUM ALTITUDE.

### 17. NIGHT FLYING.

a. The operation of the fluorescent lights is as follows:

- (1) For visible light for map reading, etc., shutters should be full open.
- (2) For fluorescent light (invisible) to irradiate instruments, rotate the knurled knob until the shutters are closed.

#### NOTE

PROPERLY SET FOR THIS POSITION (IRRADIATION OF INSTRUMENTS) THE INSTRUMENT PANEL AND THE INSTRUMENT FACES ARE NOT LIGHTED. ONLY THE MARKINGS (FIGURES, HANDS, POINTERS, KNOBS, ETC.) WILL BE VISIBLE.

b. When lowering the landing light a sharp nibbling on the control stick is felt. Do not lower landing light over 130 mph indicated air speed.

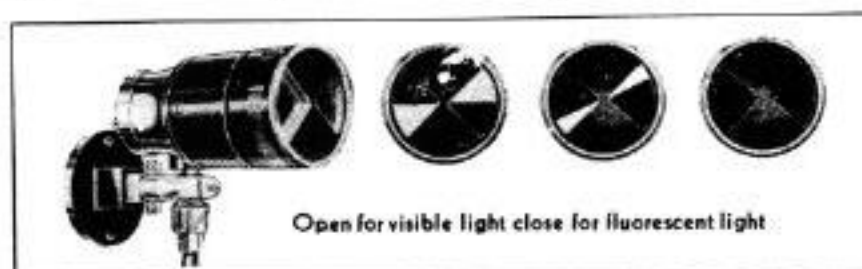
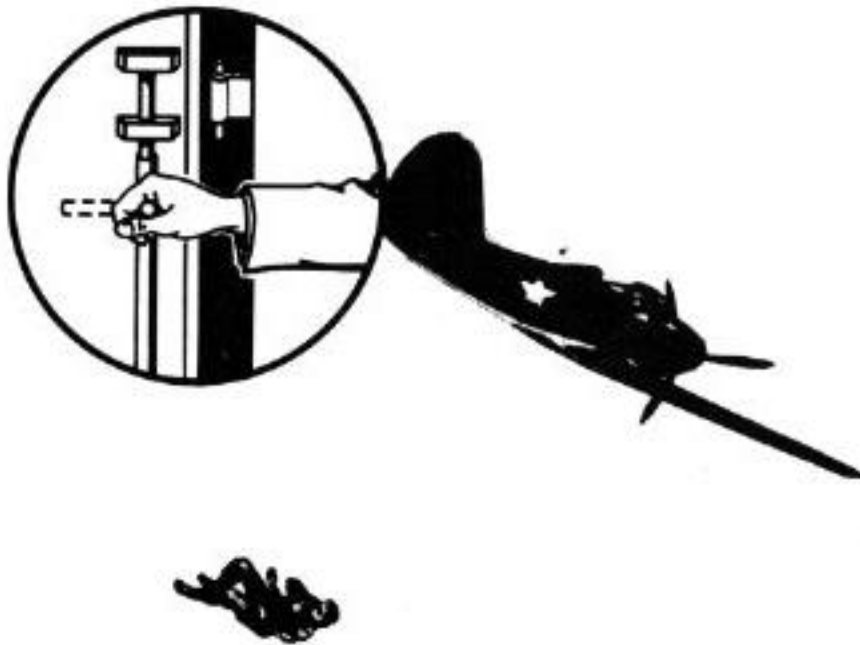

Figure 13 - Fluorescent Light



#### 18. EMERGENCY EXIT.

Trim airplane nose heavy and turn ignition and battery switches off. Pull emergency release handle and push out on door. (Right-hand door recommended as it provides no obstruction.)

#### NOTE

Door will release when handle is approximately 90 degrees to side of airplane. Slightly bank airplane to the right and slide off wing.

#### 19. APPROACH FOR LANDING.

a. Turn the fuel selector (figure 8) to reserve tank and turn on electric booster fuel pump. Move mixture control to "FULL RICH."

#### CAUTION

Never use left tank for take-off or landing.

b. Next lower the landing gear at a speed not over 200 mph. A warning light, located on the tubular support at the left-hand side of the main instrument panel (figure 5) glows when the throttle is cut to one-third and the landing gear is not in the locked down position.

c. Lower the flaps if desired, or if necessary because of a short field (full flap may be used when landing). Position of the flaps is shown by a direct indicator on the left wing, over the flap area and near its outboard edge. This indicator is a semicircular piece of plastic that projects from a slot in the trailing edge of the wing. When the flap is fully up, the indicator is not visible. When the flap is one-third down, the yellow portion of the indicator projects above the wing surface. At full down position, the indicator shows one-third yellow and two-thirds red.

d. Return "landing gear switch" to "OFF."

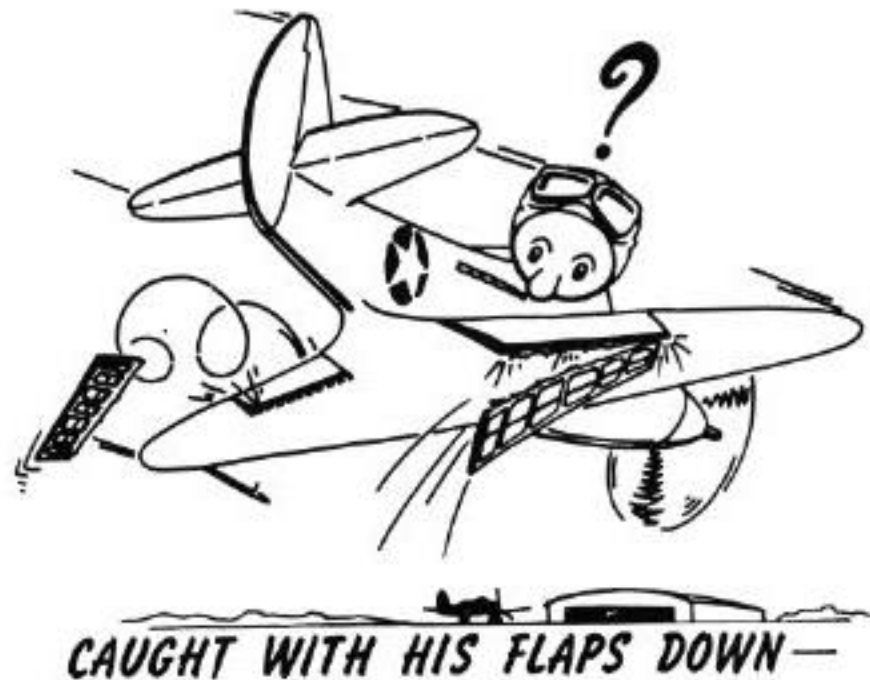

e. Return "flap switch" to "OFF."

f. Emergency operation of landing gear.



In the event the landing gear does not extend, crank it down manually by means of the emergency hand crank.

(1) Place landing gear switch in "OFF" position.

(2) Turn the landing gear clutch handle rearward; slow the airplane down to 130 mph or slightly less and by means of the ratchet emergency hand crank, operate the landing gear down. If unsuccessful, reverse the ratchet and operate the landing gear up. Then reverse the ratchet again and repeat.

(3) A normal approach is a glide. With flaps full down and power off, the glide path and glide attitude of the airplane are extremely steep, and it is necessary to maintain a gliding speed of about 130 mph IAS in order to have sufficient control to level out before contacting the ground. If a power on approach is made with the airplane in about the landing attitude, a gliding speed of 110 mph IAS is required.

g. THEN LAND.

(1) Forget that the ship has a tricycle-type landing gear and make a normal type landing. This type landing should be one where the nose of the airplane is well up and the main wheels touch the ground before the nose wheel. (In other words a landing attitude equivalent to that with a conventional gear.) This type landing will result in a landing speed between 95 and 100 mph IAS. Once the main wheels touch the ground, the plane will without any help from the pilot, nose down until the nose wheel is on the ground. There will be no tendency whatsoever for the airplane to ground loop or bounce.

(2) During the landing run, do not lock the brakes

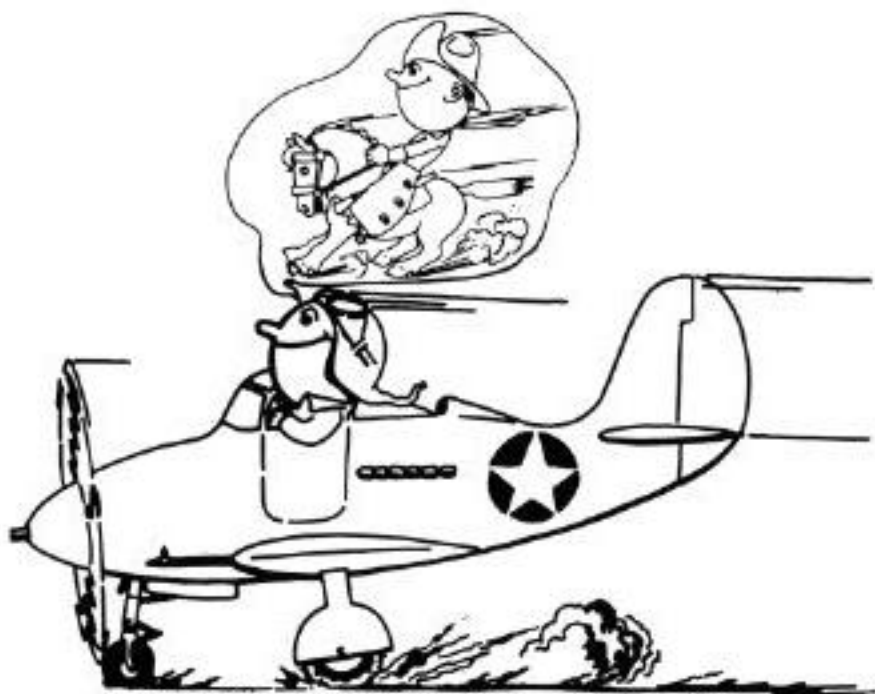

**BE CONTENT TO BE A PILOT  
USE YOUR BRAKES AS RECOMMENDED  
DON'T BE A COWBOY**

or apply them continuously. It is recommended that they be applied, then released numerous times, thus preventing severe wear on the tires and overheating of the brakes. Stopping will be accomplished equally as well if done in this manner, as it would by applying and holding on full brake.

#### NOTE

This point is stressed as application and holding on full brake will lock the wheels and cause skidding, which will in all probability, ruin the tires on the main wheels.

(3) It should also be emphasized that due to the favorable landing characteristics of this airplane, it is not necessary to land at speeds above 95 to 100 mph IAS. In fact, the landing run increases greatly in relation to the landing speed, that is, a pilot landing at 140 mph IAS requires two times the landing run necessary for a landing accomplished at 95 mph IAS.

(4) In approach for landing in cold weather, it is advisable not to idle engines at low speed. They should be run up and checked frequently for ability to accelerate.

(5) While taxiing back to the hangar, the flaps should be retracted, the oil and coolant shutters should be "OPEN."

#### 20. STOPPING THE ENGINE.

a. Place the propeller governor lever in the "INCREASE RPM" position.

b. Set the mixture control lever to the "IDLE CUT-OFF" position, and at the same time move the throttle to the "FULL OPEN" position.

c. When the engine ceases firing, turn the ignition switch to the "OFF" position.

#### 21. BEFORE LEAVING COCKPIT.

a. Place all cockpit light switches, pitot heater switch, fuselage light switches, etc., in "OFF" position. (See figure 5.)

b. Place battery switch in "OFF" position. (See figure 5.)

c. Cage flight indicator.

d. Unlock auxiliary door latches prior to opening cabin doors.

e. If oxygen has been used during flight, close valves to prevent leakage.

#### 22. OIL DILUTION.

Oil dilution is recommended when outside temperature is below 32°F (0°C). The dilution of the oil is accomplished prior to stopping the engine by operating the oil dilution valve switch (figure 6) to "ON" for approximately 4 minutes with the engine running at approximately 800 rpm. The 4-minute operation of the oil dilution valve switch is recommended as this



**THIS GUY DIDN'T USE HIS HEAD,  
NOW HE'S LUCKY HE ISN'T DEAD.**

period has given most satisfactory dilution when oil and coolant temperatures have not been too high at the time of dilution. When coolant temperatures are too high (over 100°C (212°F) for coolant and 40°C (104°F) for oil), it will be necessary to shut the engine off and allow to cool; then again start the engine and proceed as described above.

#### NOTE

One quart of gasoline enters the oil system per each minute of operation of the switch at approximately 800 rpm. This will vary at different rpm, but there is very little danger of overdilution.

#### 23. MANEUVERS PROHIBITED.

a. The following acrobatics are prohibited:

(1) Outside loops and spins.

(2) Never try any acrobatics with a tail-heavy airplane.

#### 24. MANEUVERS NOT RECOMMENDED.

a. The following acrobatics are not recommended:

(1) Snap rolls.

(2) Spinning.

#### 25. IN CASE OF FIRE.

Procedure in case of fire depends principally on the pilot's judgment, type and extent of the fire, and altitude. Fires outside the cabin enclosure sometimes may be blown out at reasonable altitudes by putting the airplane into a dive. If the fire has gained such great headway that it is impossible to extinguish the flames, bail out.

If too near the ground to bail out, land the airplane at once.

#### CAUTION

In case fumes begin entering the cockpit the cockpit heater should immediately be switched to cold air. This is to prevent prestone fumes entering cockpit through hot air duct in case of burst radiator or prestone line.

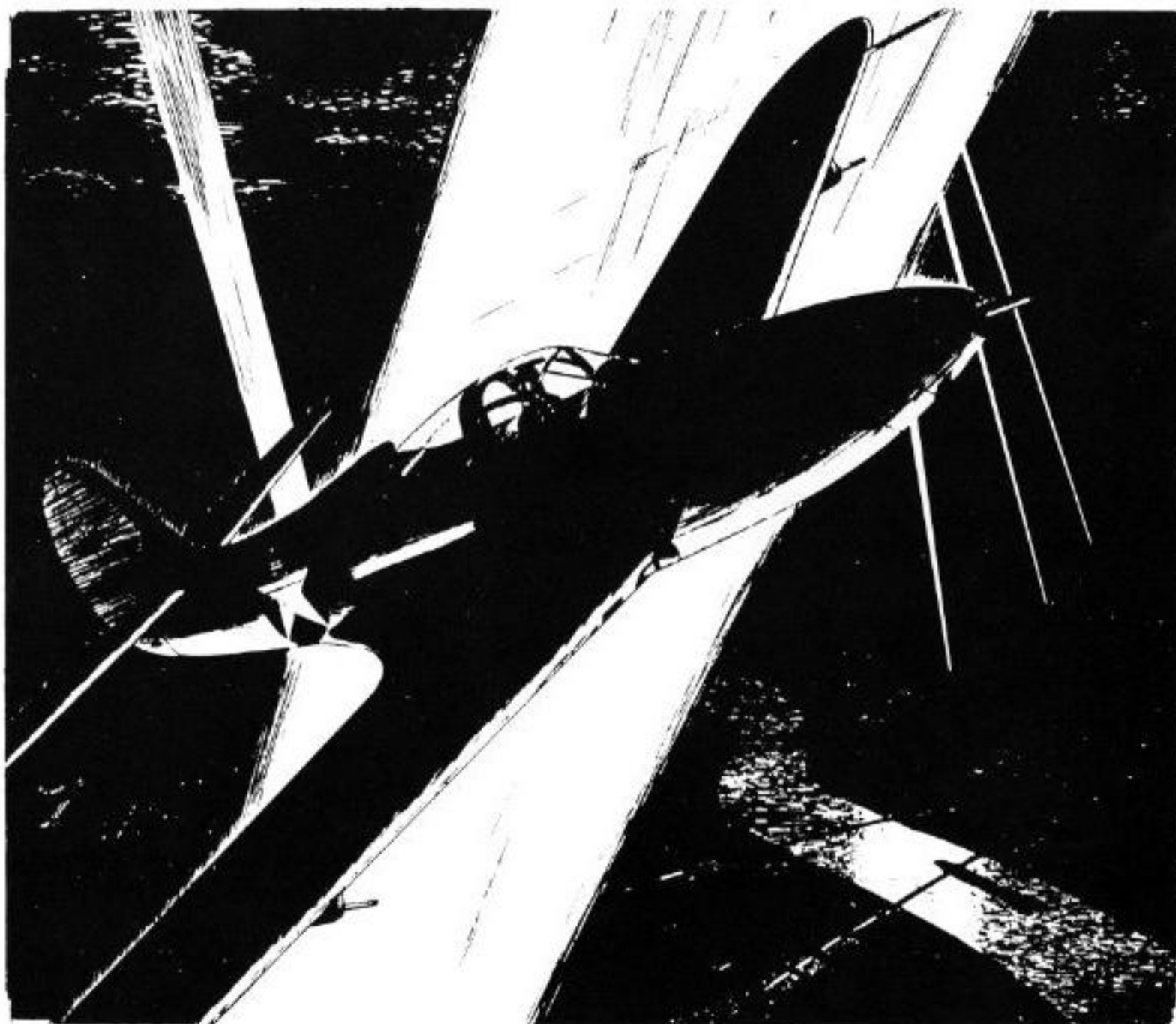



## SECTION III

### FLIGHT OPERATION DATA

#### 1. DETERMINING GROSS WEIGHT.

Refer to the WEIGHT AND BALANCE CHART in this section and check the listed basic and alternate tabulated items against those loaded in the airplane. If the airplane is loaded in accordance with the "Basic Load Items" whose weights are entered in the "Pounds" column, and the "Alternate Items" whose weights are entered under four loading conditions in the "Alternate Loading (Pounds)" column, the gross weight will be found listed at the bottom of the chart. If any items tabulated in the "Pounds" columns are omitted in the loading of the airplane, deduct the weight of the missing items from the "Gross Weight," and the resulting figure will be the correct gross weight as the airplane is actually loaded.

#### 2. FLIGHT PLANNING.

##### a. GENERAL.

(1) A series of the charts on the following pages is provided to aid in selecting the proper power and altitude to be used for obtaining optimum range of the airplane. A chart is provided for each airplane configuration with its probable range of gross weight.

(2) If the flight plan calls for a continuous flight where the desired cruising power and airspeed are reasonably constant after take-off and climb and the external load items are the same throughout the flight, the fuel required and flight time may be computed as a "single section flight." If this is not the case, the flight should be broken up into sections, and each leg of the flight planned separate since dropping of external bombs or tanks causes considerable changes in range and the air speed for given power. (Within the limits of the airplane, the fuel required and flying time for a given mission depend largely upon the speed desired. With all other factors remaining equal in an airplane, speed is obtained at a sacrifice of range, and range is obtained at a sacrifice of speed.)

##### b. USE OF CHARTS.

(1) Although instructions for their use are shown on the FLIGHT OPERATION INSTRUCTION CHARTS, the following expanded information on proper use of the charts may be helpful.

(2) Select the FLIGHT OPERATION INSTRUCTION CHART for the model airplane, gross weight and external loading to be used at take-off. The

amount of gasoline available for flight planning purposes depends upon the reserve required and the amount required for starting and warm-up. The fuel required for warm-up is set forth on the chart. Reserve should be based on the type of mission, terrain over which the flight is to be made, and weather conditions. The fuel required for climb and time to climb to various altitudes is shown on the TAKE-OFF, CLIMB, AND LANDING CHART. Fuel remaining after subtracting reserve, warm-up, and climb fuel from total amount available is the amount to be used for flight planning.

(3) Select a figure in the fuel column in the upper section of the chart equal to, or the next entry less than, the amount of fuel available for flight planning. Move horizontally to the right or left and select a figure equal to, or the next entry greater than, the distance (with no wind) to be flown. Operating values contained in the lower section of the column number in which this figure appears, represent the highest cruising speeds possible at the range desired. It will be noted that the ranges listed in column I under "Maximum Continuous Power" are correct only at the altitude shown by the note on the chart for this column. The ranges shown in column II and other columns to the right of column II can be obtained at any of the altitudes listed in the Density Altitude column. All of the power settings listed in a column will give approximately the same number of miles per gallon if each is used at the altitude shown on the same horizontal line with it. Note that the time required for the flight may be shortened by selection of the higher altitudes. In long range cruising, it is important that altitude, air speed and rpm be held constant. The manifold pressure should be changed as required to hold the above values reasonably constant.

(4) In order to obtain the flight duration, pilot's indicated air speed must be converted to true air speed and this true air speed divided into the air miles to be flown. True air speed may be obtained first by correcting pilot's indicated air speed for position error to obtain an approximate calibrated indicated air speed, then apply the pertinent altitude correction factor to this calibrated indicated air speed. (The air-speed indicator on the P-39 series airplanes reads about two (2) miles per hour slow at 150 miles per hour and about ten miles per hour slow at 300 miles per hour.) The following table shows the approximate true air speed corresponding to pilot's indicated air speed on the P-39 series airplanes.

Pilot's IAS	Approximate True Air Speed			
	5,000	10,000	15,000	20,000
150	165	180	190	210
200	220	240	260	280
250	270	300	320	350
300	330	360	390	415
350	390	420	450	480

the INSTRUCTIONS FOR USING CHART printed on each chart.

### IMPORTANT

The above instructions and following charts do not take into account the effect of wind. Adjustments to range values and flight duration to allow for wind may be made by any method familiar to the pilot such as by the use of a flight calculator or a navigator's triangle of velocities.

(5) The flight plan may be readily changed at any time enroute, and the chart will show the balance of range available at various cruising powers by following

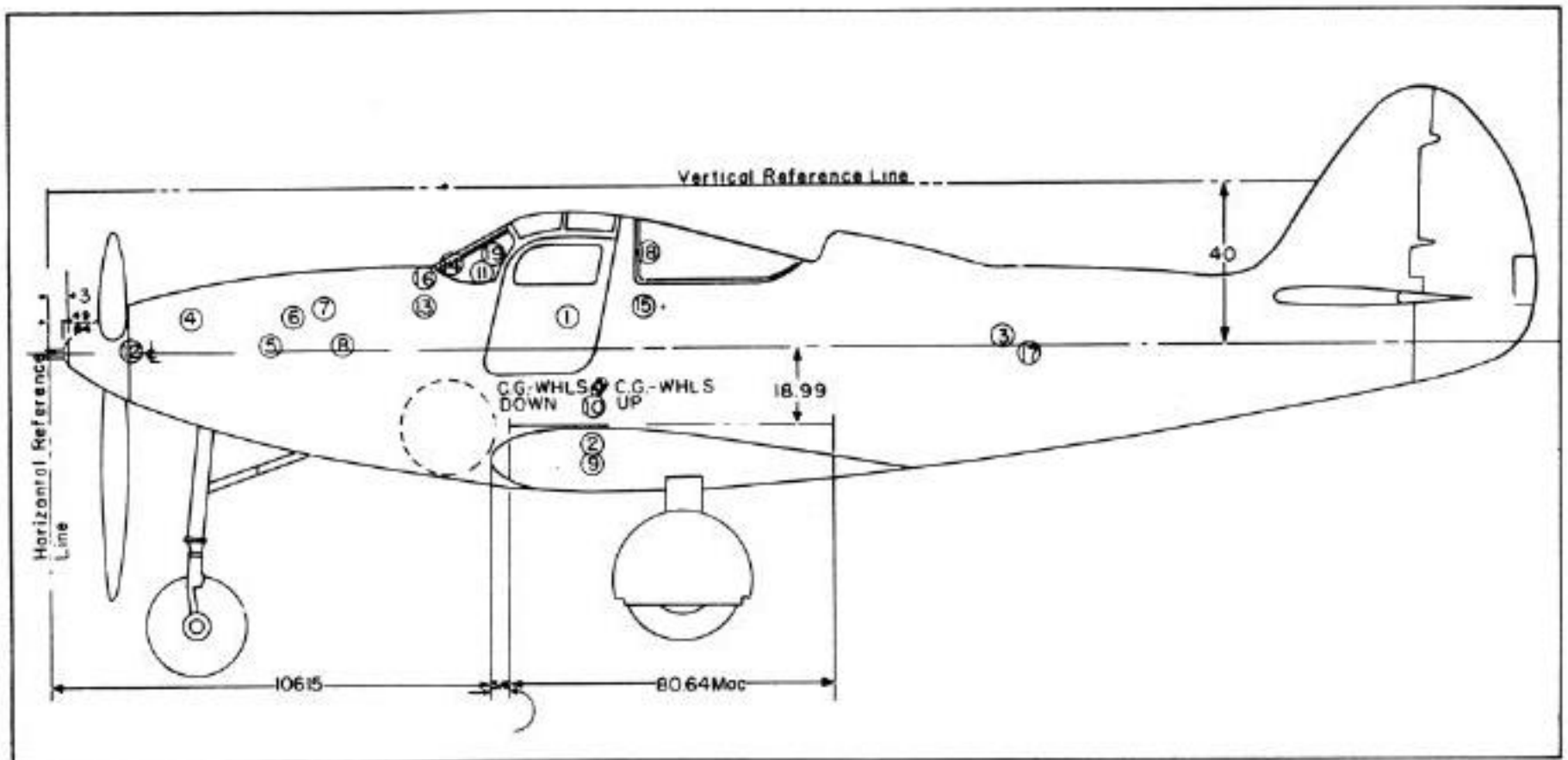

P-39Q-1-BE NORMAL GROSS WEIGHT													
NO.	ITEM	WEIGHT	HORIZONTAL ARM	MOMENT	VERTICAL ARM	MOMENT	NO.	ITEM	WEIGHT	HORIZONTAL ARM	MOMENT	VERTICAL ARM	MOMENT
1.	PILOT AND CHUTE	200.0	125	25000	34	6800	14.	ARMOR PLATE-WIND-SHIELD	8.2	95	779	18	148
2.	FUEL (87 GAL.)	522.0	134	69948	62	32364	15.	ARMOR PLATE-TURNOVER	15.8	142	2244	30	474
3.	OIL ENGINE (6.2 GAL)	46.5	238	11067	38	1767	16.	ARMOR PLATE-INST. BOARD	2.8	90	252	22	62
4.	OIL GEAR BOX (2 GAL)	15.0	38	570	32	480	17.	ARMOR PLATE-OIL TANK	29.0	248	7192	42	1218
5.	37MM INSTALLATION	238.4	57	13549	39	9247	18.	ARMOR PLATE-AFT CABIN	18.2	143	2603	18	328
6.	37MM AMMUNITION	60.0	67	4020	31	1860	19.	ARMOR GLASS-WIND-SHIELD	21.7	106	2300	14	304
7.	50 CAL. INSTALLATION (FUS.)	151.7	78	11761	29	4331		USEFUL LOAD	1886.4	111.18	209726	46.49	87693
8.	50 CAL. AMMUNITION	124.0	80	9920	40	4960		WEIGHT EMPTY (WHEELS DOWN)	5683.6		801327		287629
9.	50 CAL. INSTALLATION (WING)	145.0	134	19399	65	9425		GROSS WEIGHT (WHEELS DOWN)	7570.0	133.56	1011053	49.58	375322
10.	50 CAL. AMMUNITION	186.0	133	24738	55	10230		LANDING GEAR UP			+4999		-8065
11.	GUN SIGHT INSTALLATION	4.4	107	469	19	84		GROSS WEIGHT (WHEELS UP)	7570.0	134.22	1016052	48.51	367257
12.	ARMOR PLATE-GEAR BOX	70.7	21	1485	40	2828							
13.	ARMOR PLATE-FUSE	27.0	90	2430	29	783							

# WEIGHT & BALANCE CHART

SPEC. AN-H-8  
DEC. 18, 1942

FORM ASC-513

AIRPLANE MODELS

CG LIMITS (IN INCHES) AFT OF REFERENCE DATUM LINE

CONDITION

F'W'D

AFT

TAKE-OFF

LANDING

P-390-1-BE

## BASIC WEIGHT ITEMS

POUNDS

WEIGHT EMPTY (INCLUDING TRAPPED FUEL AND OIL) INCLUDING RADIO

**EQUIPMENT:**

NAVIGATION \_\_\_\_\_ LB. PHOTOGRAPHIC \_\_\_\_\_ LB. OXYGEN \_\_\_\_\_ LB.

ARMOR PLATE & GLASS

193

PYROTECHNICS (FLARES, ETC.) \_\_\_\_\_ LB.

**ARMAMENT:**

FIXED GUN INSTALLATION(S): ( 4 ) .50 CAL. 297 LB.; ( ) \_\_\_\_\_ CAL. \_\_\_\_\_ LB.; GUN SIGHT 4 LB. 301

FLEXIBLE GUN INSTALLATION(S): ( ) \_\_\_\_\_ CAL. \_\_\_\_\_ LB.; ( ) \_\_\_\_\_ CAL. \_\_\_\_\_ LB.

CANNON INSTALLATION(S): ( 1 ) 37 MM. 238 LB.; ( ) \_\_\_\_\_ MM. \_\_\_\_\_ LB. 238

RADIO: MODEL(S) SCR-522 & SCR-535

**TOTAL BASIC WEIGHT** (CG \_\_\_\_\_ INCHES AFT OF REFERENCE DATUM LINE)

6416

**ITEMS OF USEFUL LOAD**

**ALTERNATE LOADINGS (POUNDS)**

MAXIMUM FUEL

BOMBER

NORMAL LOAD

PILOT (200 LB. INCLUDING PARACHUTE)

200

200

200

CREW (200 LB. EACH INCLUDING PARACHUTE)

PASSENGERS (200 LB. EACH INCLUDING PARACHUTES)

BAGGAGE ( \_\_\_\_\_ LB. MAXIMUM)

FUEL (6 LB/U.S. GAL. OR 7.2 LB/IMP. GAL.): U.S. GAL. (IMP. GAL.)

WING TANKS 87 ( 72.5 ) 522 522 522

AUX. TANK 75 ( 62.5 ) 450

OIL (7.5 LB/U.S. GAL. OR 9 LB/IMP. GAL.): \* 8.2 ( 6.8 ) 62 62 62

EXTRA 5.4 ( 4.5 ) 41

EXTRA TANK(S) INSTALLATION

45

BOMB INSTALLATION(S): ( ) INTERNAL AT \_\_\_\_\_ LB. EACH

( ) EXTERNAL AT 500 LB. EACH

516

TORPEDO INSTALLATION

**AMMUNITION**

(1000) RD. OF .50 CAL.; ( ) RD. OF \_\_\_\_\_ CAL.

( 30 ) RD. OF 37 MM.; ( ) RD. OF \_\_\_\_\_ MM. 370 370 370

\* INCLUDES 2 U.S. GAL. IN GEARBOX

8106

8086

7570

## GROSS WEIGHT

DISTANCE (IN INCHES) THAT CG IS AFT OF REFERENCE DATUM LINE

SPEC. AN-H-8  
DEC. 18, 1942

FORM 45C-512

**AIRPLANE MODELS**

P-39Q-1-BE

**SPECIFIC ENGINE  
FLIGHT CHART**

**ENGINE MODELS**

V-1710-85

CONDITION	FUEL PRESSURE (LB/SQ. IN.)	OIL PRESSURE (LB/SQ. IN.)	OIL TEMP.		COOLANT TEMP.				MAX. PERMISSIBLE DIVING RPM:.....
			°C	°F	°C	°F			
DESIRED	12-16	60-70	60-80	140-176	105-115				
MAXIMUM	16	85	95	203	125				
MINIMUM	12	55			85		RED. GEAR OIL		
IDLING	10	15					PRESSURE **		

CONDITION	ALLOWABLE OIL CONSUMPTION
MAX. CONT.	..13.3.. U.S.QT/HR.. 22.2 .IMP.PT/HR
MAX. CRUISE	..10.0.. U.S.QT/HR.. 16.7 .IMP.PT/HR
MIN. SPECIFIC	..5-7.. U.S.QT/HR.. 8-12 .IMP.PT/HR

OIL GRADE: (S).....1120.....(W).....1100.....

SUPERCHARGER TYPE: SINGLE SPEED, SINGLE STAGE, GEAR DRIVEN

FUEL GRADE: 100\*

OCTANE

OPERATING CONDITION	RPM	MANIFOLD PRESSURE (BOOST)	HORSE-POWER	CRITICAL ALTITUDE		BLOWER	USE LOW BLOWER BELOW:	MIXTURE CONTROL POSITION	FUEL FLOW (GAL/HR/ENG.)		MAXIMUM CYL. TEMP.		MAXIMUM DURATION (MINUTES)
				WITH RAM	NO RAM				U.S.	IMP.	°C	°F	
				TAKE-OFF	3000				50.5	1200	SEA LEVEL		
WAR EMERGENCY	3000	57.0	1420	8,000		SINGLE SPEED		FULL RICH	170	142	SEE		5
MILITARY	3000	44.5	1125	15,500				AUTO RICH	138	118	COOLANT		15
MAXIMUM CONTINUOUS	2600	39.2	1000	14,000				AUTO RICH	109	91	TEMP.		
MAXIMUM CRUISE	2280	31.7	750	14,000				AUTO RICH	74	61			
MINIMUM SPECIFIC CONSUMPTION													

REMARKS: \* FUEL GRADE - AN-VV-F-781 (AMEND. 5)

\*\* REDUCTION GEARBOX OIL PRESSURE: IDLING 15 LB/SQ.IN.; MINIMUM CRUISE (1800 RPM) 40 LB/SQ IN.

**AIRPLANE MODELS**

**P-39Q-1-BE**

**TAKE-OFF, CLIMB & LANDING CHART**

**ENGINE MODELS**

**V-1710-85**

**TAKE-OFF DISTANCE (IN FEET)**

GROSS WEIGHT (IN LBS.)	HEAD WIND (MPH)	HARD SURFACE RUNWAY						SOD-TURF RUNWAY						SOFT SURFACE RUNWAY					
		AT SEA LEVEL		AT 3,000 FT.		AT 6,000 FT.		AT SEA LEVEL		AT 3,000 FT.		AT 6,000 FT.		AT SEA LEVEL		AT 3,000 FT.		AT 6,000 FT.	
		GROUND RUN	TO CLEAR 50' OBJ.	GROUND RUN	TO CLEAR 50' OBJ.	GROUND RUN	TO CLEAR 50' OBJ.	GROUND RUN	TO CLEAR 50' OBJ.	GROUND RUN	TO CLEAR 50' OBJ.	GROUND RUN	TO CLEAR 50' OBJ.	GROUND RUN	TO CLEAR 50' OBJ.	GROUND RUN	TO CLEAR 50' OBJ.	GROUND RUN	TO CLEAR 50' OBJ.
8100	0	1650	2600	2000	3050	2250	3450	1700	2650	2050	3150	2300	3500	1800	2750	2150	3250	2450	3650
	20	1150	1950	1400	2350	1650	2650	1200	2000	1450	2400	1650	2700	1250	2050	1550	2500	1800	2800
	40	700	1350	900	1650	1100	1900	750	1400	950	1700	1150	1950	800	1450	1000	1750	1200	2000
7800	0	1350	2150	1650	2500	1950	2950	1400	2200	1700	2550	2000	3000	1450	2250	1750	2650	2100	3150
	20	900	1550	1150	1850	1400	2250	950	1600	1200	1900	1450	2300	1000	1650	1250	1950	1500	2350
	40	550	1050	700	1300	900	1550	600	1100	750	1350	950	1600	650	1150	800	1400	1000	1650
7200	0	1150	1850	1400	2200	1700	2600	1200	1900	1450	2300	1750	2650	1250	1950	1500	2350	1800	2700
	20	800	1350	950	1600	1200	1950	850	1400	1000	1650	1250	2000	900	1450	1050	1700	1300	2050
	40	450	900	600	1100	750	1300	500	950	650	1150	800	1350	550	1000	700	1200	850	1400

NOTE: INCREASE DISTANCE 10% FOR EACH 10°C (50°F) ABOVE 0°C (32°F)

ENGINE LIMITS FOR TAKE-OFF 3000 RPM & 51.5 IN. HG

COMBAT MISSIONS USE 3000 \* RPM & 44.5 IN. HG

**CLIMB DATA**

FERRY MISSIONS USE 2300 RPM & 31 IN. HG

GROSS WEIGHT (IN LBS.)	TYPE OF CLIMB	S.L. TO 3000 FT. ALT.			AT 5000 FT. ALT.				AT 10000 FT. ALT.				AT 15000 FT. ALT.				AT 25000 FT. ALT.				BLOWER CHANGE
		BEST I.A.S.	FT./MIN.	TIME FROM S.L.	BEST I.A.S.	FT./MIN.	TIME FROM S.L.	FUEL FROM S.L.	BEST I.A.S.	FT./MIN.	TIME FROM S.L.	FUEL FROM S.L.	BEST I.A.S.	FT./MIN.	TIME FROM S.L.	FUEL FROM S.L.	BEST I.A.S.	FT./MIN.	TIME FROM S.L.	FUEL FROM S.L.	
8100	COMBAT FERRY	160	2700	1.1	160	2650	1.9	25	155	2550	3.8	30	155	2050	6.0	34	135	750	13.1	39	SINGLE
		140	950	3.1	140	950	5.2	25	140	900	10.5	31	140	750	16.4	39	140	650	30.7	42	
7800	COMBAT FERRY	175	3200	0.9	175	3200	1.6	24	175	3150	3.1	28	175	2600	4.9	32	150	1200	10.1	34	SPEED
		150	1300	2.3	150	1300	3.9	24	150	1250	7.7	28	160	1200	11.8	34	160	1050	20.8	35	
7200	COMBAT FERRY	175	3450	0.9	175	3450	1.4	24	175	3350	2.9	28	175	2800	4.5	31	145	1350	9.3	33	BLOWER
		150	1450	2.1	150	1450	3.5	23	150	1450	7.0	27	150	1300	10.6	32	150	1200	18.5	33	

NOTE: INCREASED ELAPSED CLIMBING TIME % FOR EACH 10°C ABOVE 0°C FREE AIR TEMPERATURE ( % FOR EACH 20°F ABOVE 32°F) FUEL INCLUDES WARM-UP AND TAKE-OFF ALLOWANCE

\* COMBAT MISSIONS USE TAKE-OFF POWER FOR 5 MINUTES & EMERGENCY MAXIMUM FOR 15 MINUTES.

**LANDING DISTANCE (IN FEET)**

GROSS WEIGHT (IN LBS.)	BEST I.A.S. Approach	HARD DRY SURFACE						FIRM DRY SOD						WET OR SLIPPERY					
		AT SEA LEVEL		AT 3,000 FT.		AT 6,000 FT.		AT SEA LEVEL		AT 3,000 FT.		AT 6,000 FT.		AT SEA LEVEL		AT 3,000 FT.		AT 6,000 FT.	
		TO CLEAR 50' OBJ.	GROUND ROLL	TO CLEAR 50' OBJ.	GROUND ROLL	TO CLEAR 50' OBJ.	GROUND ROLL	TO CLEAR 50' OBJ.	GROUND ROLL	TO CLEAR 50' OBJ.	GROUND ROLL	TO CLEAR 50' OBJ.	GROUND ROLL	TO CLEAR 50' OBJ.	GROUND ROLL	TO CLEAR 50' OBJ.	GROUND ROLL	TO CLEAR 50' OBJ.	GROUND ROLL
7200	130	1800	1050	1950	1150	2100	1300	1900	1200	2050	1300	2200	1400	3250	2500	3500	2750	3800	3000
8700	110	1700	1000	1800	1100	1950	1200	1800	1100	1950	1200	2100	1300	3050	2300	3300	2550	3550	2800

NOTE: FOR GROUND TEMPERATURES ABOVE 35°C (95°F) INCREASE APPROACH I.A.S. 10% AND ALLOW 20% INCREASE IN GROUND ROLL.

**REMARKS**

+ 130 BEST I.A.S. APPROACH POWER OFF; 110 BEST I.A.S. APPROACH POWER ON.

**LEGEND**

I. A. S.: Indicated Air Speed  
 NOTE: All distances are average, and subject to considerable variations because of differences in pilot technique, load, C.G., etc.  
 RED FIGURES HAVE NOT BEEN FLIGHT CHECKED.

SPEC. AN-H-B DEC. 18, 1962	FORM ASC-311	MODEL (S)	FLIGHT OPERATION INSTRUCTION CHART	EXTERNAL LOAD ITEMS NONE
		P-39Q-1-BE	SHEET 1 OF 1 SHEETS	
			GR. WT. 7600 TO 7200 POUNDS	

CONDITION	R.P.M.	M.P. (IN. HG.)	BLOWER POSITION	MIXTURE POSITION	DURATION IN MIN.	U.S. G.P.H.	IMP. G.P.H.
TAKE-OFF	3000	50.5	-	F. R.	5	142	118
MILITARY POWER	3000	44.5	-	A. R.	15	138	116
ENGINE IS:	V-1710-85						

**INSTRUCTIONS FOR USING CHART:** Select figure in fuel column equal to or less than total amount of fuel in airplane. Move horizontally to the right or left and select a figure equal to or greater than the air miles to be flown. Vertically below and opposite desired cruising altitude, read optimum cruising conditions. **NOTES:** (A) Avoid continuous cruising in Column I except in emergency. (B) Columns (II, III, IV & V) toward the right progressively give increase in range at sacrifice in speed. (C) Manifold Pressure (M.P.), Gallons Per Hour (G.P.H.), are approximate maximum values for reference. (D) For quick reference, take-off and military power data are listed in the upper left corner of chart.

(NO WIND) ALTERNATE CRUISING CONDITIONS (NO RESERVE FUEL ALLOWANCE)

I (MAX. CONT. POWER)				FUEL U. S. GALS. ①	II		III		IV		FUEL IMP. GALS. ②	V (MAX. RANGE)		
RANGE IN AIR MILES					RANGE IN AIR MILES		RANGE IN AIR MILES		RANGE IN AIR MILES			RANGE IN AIR MILES		
STATUTE		NAUTICAL			STATUTE	NAUTICAL	STATUTE	NAUTICAL	STATUTE	NAUTICAL		STATUTE	NAUTICAL	
AT S.L.	AT 12,000	AT S.L.	AT 12,000	16 U.S. (13.3 IMP.) GALLONS NOT AVAILABLE IN FLIGHT								STATUTE	NAUTICAL	
	215			88							71.6			
			185	70	260	225		300	260	345	300	58.3	430	375
	175			60	220	190		255	220	295	255	50	370	320
			125	50	185	160		215	185	245	215	42	310	270
	115			40	150	130		170	150	195	170	33	245	215
			75	30	110	95		130	115	145	125	25	185	160
	85			20	75	65		85	75	100	85	17	125	110
			50	10	35	30		40	35	50	45	8.3	60	50
	60													
			25											
	30													

OPERATING DATA						① DENSITY ALT. IN FEET	OPERATING DATA						① DENSITY ALT. IN FEET	OPERATING DATA																	
R.P.M.	I.A.S. M.P.H.	I.A.S. KNOTS	M.P. IN. HG.	U.S. G.P.H.	IMP. G.P.H.		R.P.M.	I.A.S. M.P.H.	I.A.S. KNOTS	M.P. IN. HG.	U.S. G.P.H.	IMP. G.P.H.		R.P.M.	I.A.S. M.P.H.	I.A.S. KNOTS	M.P. IN. HG.	U.S. G.P.H.	IMP. G.P.H.	R.P.M.	I.A.S. M.P.H.	I.A.S. KNOTS	M.P. IN. HG.	U.S. G.P.H.	IMP. G.P.H.						
						30000																									
						25000																									
						20000	2600	224	195	30	77	64	2400	223	194	28	66	55	2600	222	193	26	60	50	20000	2200	200	174	24	41	34
						15000	2600	247	215	30	78	65	2400	240	209	28	65	54	2600	219	190	24	52	43	15000	2000	204	177	24	39	32
						12000	2600	247	215	30	74	62	2400	244	212	28	63	53	2400	221	192	25	50	42	12000	2000	208	181	24	37	31
						9000	2600	249	217	30	71	59	2400	245	213	28	60	50	2200	246	214	30	53	44	9000	1800	207	180	26	35	29
						6000	2600	252	219	30	69	58	2400	244	212	28	58	48	2000	245	213	31	50	42	6000	1600	207	180	28	34	28
						3000	2600	257	224	30	67	56	2400	243	211	28	55	46	2000	247	215	31	48	40	3000	1600	211	183	29	33	28
						S.L.	2600	258	224	31	64	53	2400	239	208	28	51	42	2000	245	213	31	46	29	S.L.	1600	211	183	29	32	27

**LEGEND**

① INDICATED ALTITUDE CORRECTED FOR FREE AIR TEMPERATURE.  
 ② ALLOW 16 U. S. GALS. 13.3 IMP. GALS. FOR WARM UP, TAKE-OFF AND CLIMB TO 5,000 FEET ALTITUDE. RETURN FUEL FLOWS TO TANK. USE FUEL FROM TANKS IN THE FOLLOWING ORDER:

REFER TO "SPECIFIC ENGINE FLIGHT CHART" FOR ADDITIONAL ENGINE OPERATION DATA.

**BOLD NUMBERS:** Use Auto-Rich  
**LIGHT NUMBERS:** Use Auto-Lean  
 WITH TWO SPEED BLOWER: Use high blower above heavy line only

I.A.S.: Indicated Air Speed  
 M.P.: Manifold Pressure (In. Hg)  
 U.S.G.P.H.: U. S. Gallons Per Hour  
 IMP.G.P.H.: Imperial Gallons Per Hour  
 F.T.: Full Throttle  
 S.L.: Sea Level

RED FIGURES ARE PRELIMINARY: SUBJECT TO REVISION AFTER FLIGHT CHECK

**MODEL (S)**

**FLIGHT OPERATION INSTRUCTION CHART**

**EXTERNAL LOAD ITEMS**  
75 GAL. BELLY TANK

DEC. 1947  
AC-55  
111

SHEET 1 OF 1 SHEETS

GR. WT. 8100 TO 7200 POUNDS

CONDITION	R.P.M.	M.P. (IN HG)	BLOWER POSITION	MIXTURE POSITION	DURATION IN MIN.	U.S. G.P.H.	IMP. G.P.H.
T/XI-OFF	3000	50.5	-	F. R.	5	142	118
MILITARY POWER	3000	44.5	-	A. R.	15	138	118
ENGINE 15	V-1710-85						

INSTRUCTIONS FOR USING CHART: Select figure in fuel column equal to or less than total amount of fuel in airplanes. Move horizontally to the right or left and select a figure equal to or greater than the air miles to be flown. Vertically below and opposite desired cruising altitude read optimum cruising conditions. NOTES: (A) Avoid continuous cruising in Column I except in emergency. (B) Columns II, III, IV & V toward the right progressively give increase in range at sacrifice in speed. (C) Manifold Pressure (M.P.), Gallons Per Hour (G.P.H.), are approximate maximum values for reference. (D) For quick reference, take-off and military power data are listed in the upper left corner of chart.

**ALTERNATE CRUISING CONDITIONS (NO RESERVE FUEL ALLOWANCE)**

I (MAX. CONT. POWER)	II (NO WIND)						III						IV						V (MAX. RANGE)											
	RANGE IN AIR MILES						RANGE IN AIR MILES						RANGE IN AIR MILES						RANGE IN AIR MILES						RANGE IN AIR MILES					
	STATUTE	NAUTICAL		U.S. GALS.	IMP. GALS.		STATUTE	NAUTICAL		U.S. GALS.	IMP. GALS.		STATUTE	NAUTICAL		U.S. GALS.	IMP. GALS.		STATUTE	NAUTICAL		U.S. GALS.	IMP. GALS.							
AT S.L.	AT 12,000	AT S.L.		AT 12,000		20 U.S. (16.7 IMP.) GALLONS NOT AVAILABLE IN FLIGHT.												3												
365	315	325	280	130	145	430	375	445	365	500	435	620	550	475	800	137	120.3	108	96	83	71	58	46	33	21	8.3				
290	250	215	185	85	100	390	340	295	250	210	180	155	135	115	85	35	30	270	235	210	180	155	135	115	85	35				
250	215	180	150	70	85	340	295	255	215	180	145	120	105	85	25	25	25	270	235	210	180	155	135	115	85	25				
215	185	150	120	55	70	290	250	215	180	145	120	105	85	25	25	25	25	270	235	210	180	155	135	115	85	25				
175	150	120	100	40	55	240	210	180	150	120	105	85	25	25	25	25	25	270	235	210	180	155	135	115	85	25				
140	120	100	85	25	40	190	165	145	120	105	85	25	25	25	25	25	25	270	235	210	180	155	135	115	85	25				
100	85	70	55	20	30	135	115	105	85	25	25	25	25	25	25	25	25	270	235	210	180	155	135	115	85	25				
85	70	55	40	10	20	85	75	65	55	40	30	25	25	25	25	25	25	270	235	210	180	155	135	115	85	25				
25	20	15	10	5	10	35	30	25	20	15	10	5	5	5	5	5	5	270	235	210	180	155	135	115	85	25				

OPERATING DATA	OPERATING DATA						OPERATING DATA						OPERATING DATA						OPERATING DATA											
	DENSITY ALT. IN FEET						DENSITY ALT. IN FEET						DENSITY ALT. IN FEET						DENSITY ALT. IN FEET						DENSITY ALT. IN FEET					
	R.P.M.	T.A.S. M.P.H.	T.A.S. KNOTS	M.P. IN. HG	U.S. G.P.H.	IMP. G.P.H.	R.P.M.	I.A.S. M.P.H.	I.A.S. KNOTS	M.P. IN. HG	U.S. G.P.H.	IMP. G.P.H.	R.P.M.	I.A.S. M.P.H.	I.A.S. KNOTS	M.P. IN. HG	U.S. G.P.H.	IMP. G.P.H.	R.P.M.	I.A.S. M.P.H.	I.A.S. KNOTS	M.P. IN. HG	U.S. G.P.H.	IMP. G.P.H.	R.P.M.	I.A.S. M.P.H.	I.A.S. KNOTS	M.P. IN. HG	U.S. G.P.H.	IMP. G.P.H.
2600	267	232	F.T. 62	52	63	30000	2600	179	156	30	76	63	2600	203	177	29	69	58	2600	203	177	29	69	58	2600	203	177	29	69	58
2600	292	254	F.T. 82	68	68	20000	2600	207	180	32	82	68	2600	205	178	29	67	56	2600	205	178	29	67	56	2600	205	178	29	67	56
2600	304	264	F.T. 104	87	68	15000	2600	214	186	32	80	67	2600	207	180	29	65	54	2600	207	180	29	65	54	2600	207	180	29	65	54
2600	298	259	39	107	89	12000	2600	217	189	32	77	64	2600	211	183	30	63	53	2600	211	183	30	63	53	2600	211	183	30	63	53
2600	289	252	39	104	87	9000	2600	220	191	32	75	63	2600	216	188	30	61	51	2600	216	188	30	61	51	2600	216	188	30	61	51
2600	279	243	39	102	85	6000	2600	223	194	31	72	60	2600	217	189	30	59	49	2600	217	189	30	59	49	2600	217	189	30	59	49
2600	269	234	39	98	82	3000	2600	226	197	32	70	58	2600	218	190	30	57	47	2600	218	190	30	57	47	2600	218	190	30	57	47
2600	259	225	39	96	80	S.L.	2600						2600	219	191	30	55	45	2600	219	191	30	55	45	2600	219	191	30	55	45

INDICATED ALTITUDE CORRECTED FOR FREE AIR TEMPERATURE.

ALLOW 20 U.S. GALS. 16.7 IMP. GALS. FOR WARM UP.

TAKE-OFF AND CLIMB TO 5000 FEET ALTITUDE

RETURN FUEL FLOWS TO TANK

USE FUEL FROM TANKS IN THE FOLLOWING ORDER.

REFER TO "SPECIFIC ENGINE FLIGHT CHART" FOR ADDITIONAL ENGINE OPERATION DATA.

BOLD NUMBERS: Use Auto-Rich

LIGHT NUMBERS: Use Auto-Lean

WITH TWO SPEED BLOWER: Use High

Blower above heavy line only

I.A.S.: Indicated Air Speed

M.P.: Manifold Pressure (In. Hg)

U.S.G.P.H.: U.S. Gallons Per Hour

IMP.G.P.H.: Imperial Gallons Per Hour

F.T.: Feet Above Sea Level

S.L.: Sea Level

RED FIGURES ARE PRELIMINARY: SUBJECT TO REVISION AFTER FLIGHT CHECK

## SECTION IV

### OPERATIVE EQUIPMENT

#### 1. OXYGEN EQUIPMENT.

a. Oxygen will be used when operating above 12,000 feet pressure altitude.

b. The pilot's oxygen mask hose has a rubber bayonet connector. Be absolutely sure the mask connector will fit the regulator output connections before starting the airplane engine.

c. Oxygen duration with a type A-12 demand regulator is as follows: Low pressure oxygen endurance in hours for one man.

Bottles	15,000 Ft	20,000 Ft	25,000 Ft	30,000 Ft	35,000 Ft
(1) D-2	1.7 hrs	1.4 hrs	1.2 hrs	1.0 hrs	0.9 hrs
(2) D-2	3.4	2.9	2.4	2.0	1.8
(4) D-2	6.8	5.6	4.8	4.0	3.6

#### 2. AUXILIARY FUEL TANK OR BOMB RELEASE.

a. The auxiliary fuel tank release handle (used also for release of the bomb) is located on the lower left-hand side of the main panel just under the ignition switch. (See figure 5.)

b. Before releasing the belly tank, be sure that the selector valve has been turned to one of the wing tanks. Then pull the release control.

The belly tank fuel line will automatically pull out of the retainer inside the tank which holds it in place.

#### NOTE

The auxiliary belly tank should always be released before engaging in combat.

#### 3. OPERATION OF COMMUNICATION EQUIPMENT.

##### a. RADIO SET - SCR-535-A OPERATING INSTRUCTIONS.

(1) Before attempting to operate the SCR-535-A radio set, the detonator circuit should be checked as follows:

(2) The detonator located in the radio receiver (BC-647-A) is set off when a voltage of the required value or higher is placed across its terminals. This will occur if the inertia or crash switch is operated, or the two buttons marked "DANGER" (located on the right-hand side of the radio control panel in the cabin), are both pressed at the same time.

(3) When the airplane is on the ground for any length of time, the detonator plug should be disconnected from the detonator. (The detonator plug attaches to the detonator located in the left-hand side of the radio receiver, which is on the aft cabin deck.)

(4) Always test the detonator circuit to make certain there is no voltage at the plug before attaching it to the detonator. A test lamp, attached to a bracket on the aft left-hand side of the turn-over beam is used to test for voltage in the detonator circuit. Attach the detonator plug to the test lamp circuit at the male receptacle near the test lamp. If the lamp lights there is voltage at the detonator plug and it should not be attached to the detonator or destruction of the radio receiver will result.

(5) If there is current at the detonator plug, as indicated by a lighted test lamp, it is probably due to the inertia switch being tripped. To reset the inertia switch, proceed as follows:

(a) Remove the small adjustment setting wheel from its storage location on the top of the inertia switch and use it to turn the small square shaft, on the forward left-hand side of the switch, in a clockwise direction until the stop is reached. Then press the button on the top of the inertia switch, remove the adjustment setting wheel, and then release the pressure on the button. (A spring in the inertia switch will rotate the small square shaft in a counterclockwise direction until it is automatically stopped.) The inertia switch is now reset and the test lamp should be out indicating no voltage at the detonator plug.

#### NOTE

Reattach the adjustment setting wheel to the top of the inertia switch.

(b) Rap the inertia switch lightly with the knuckles and if correctly set, the switch will not be tripped by this test jarring and the test lamp will remain off.

(6) The detonator may be fired not only by the inertia or crash switch but also by a manual control on the radio control panel in the cabin. This manual control consists of two protected buttons marked "DANGER." To fire the detonator both of these buttons must be pressed at the same time. To make certain this manual detonator control circuit is in operation, attach the detonator plug to test lamp circuit and press both "DANGER" buttons at the same time. This should light the test lamp, indicating that the circuit is in operation.



(7) If the test lamp does not light when the two "DANGER" buttons are pressed at the same time, either the circuit is not in operation or the test lamp is burned out or broken. Replace the test lamp with a new one and again test the circuit by pressing the buttons. If the test lamp lights, the system is in operation.

(8) The detonator circuit controlled by the two "DANGER" buttons bypasses the inertia switch and is entirely independent of it. Therefore, pressing the "DANGER" buttons will not trip the inertia switch.

(9) The above tests have indicated that the inertia switch and the push buttons are in working condition and since the inertia switch has been reset and the test lamp is not lighted it is permissible to attach the detonator plug to the detonator at the left-hand side of the radio receiver.

(10) The detonator plug should not be inserted in the detonator until the airplane is ready to leave on a mission over enemy territory and should be disconnected when the airplane is on the ground for any length of time.

#### NOTE

Always test the detonator circuit before attaching the detonator plug, to the radio receiver.

b. The SCR-535-A radio set is a recognition set only and cannot be used for communication.

(1) To start the radio equipment, make certain that the switch on the control box (BC-648-A) located in the aft fuselage is on the "ON" position, then push to "ON" the radio switch on the radio control panel in the cabin.

(2) To stop the equipment, push the radio switch on the radio control panel to the "OFF" position.

#### c. RADIO SET - SCR-522-A OPERATING INSTRUCTIONS.

(1) To start the radio equipment, push the button "A," "B," "C," or "D" on control box BC-602-A, which is located on the radio control panel. Each button mentioned above selects a different crystal controlled frequency channel. (The commanding officer will give instructions regarding the frequency channel to be used.) An indicator lamp below each channel-selector button shows the operator which channel is being used. Dimmer masks are provided to prevent glare from the channel-indicator lamps during night operation. Move the dimmer mask lever to the left to cover the channel-indicator lamps.

(2) After pressing the channel-selector button, allow approximately 1 minute for the vacuum tubes to warm up before attempting to use the radio.

(3) Place the "T.-R.-V.O." switch in the "V.O." position for throttle button control of the transmitter.

(4) To transmit, hold in the button on the throttle handle, close the microphone switch (located in the oxygen mask) and speak into the microphone. Always turn off the microphone switch when the radio is not in use. This will prevent the transmission of extraneous noise of engine, machine guns, and side tones, which would be constantly received by the pilot, tending to jam the radio channel.

(5) Since there is a slight delay in transferring from the receive to the transmit condition, due to relay operation, it is advisable to begin the messages with a meaningless word like "hello" which will actuate the switching mechanism and insure that the message is transmitted in full.

(6) To receive, release the button on the throttle handle.

(7) To stop the equipment, press the "OFF" button on the "T.-R.-V.O." switch panel.

#### WARNING

The operation of this radio equipment involves the use of high voltages which are dangerous to life. A dangerous potential exists on both the transmitter and receiver whenever the equipment is in either the transmit or receive condition.

#### d. RADIO SET - SCR-274-N OPERATING INSTRUCTIONS.

(1) The SCR-274-N radio installation incorporates a control box composed of individual controls for three separate receiver units of various range; from 3 to 6 megacycles, from 190 to 550 kilocycles and from 6 to 9.1 megacycles. To operate these receivers, move the battery switch from "OFF" to the "CW" (continuous wave) or the "M.C.W." (modulated continuous wave) positions. Place the "TEL" switch to either "A" or "B" to correspond to the jack used for the headset plug. Set the filter switch box control to "RANGE," "VOICE," or "BOTH," as desired. Tuning is accomplished with the large "tuning" knob while adjusting for suitable volume with the "increase output" control knob.

(2) Two transmitters are installed, only one being used at a time, and are preset with the different frequencies recorded on the "write-in" space on the transmitter control. When transmitting, move the "transmitter selection" switch to the frequency desired. Set the "transmitter power" toggle switch to the "ON." It requires 15 seconds to warm up the transmitter tubes. Set the emission switch to "TONE," "CW," or "VOICE," as required. If the emission switch is on "VOICE" press the "microphone control" button on the throttle control, and talk clearly

and distinctly into the microphone. In the "VOICE" position, the transmitting dynamotor will not start until the microphone control button has been closed. Side tone should be heard distinctly whenever transmitting. With the emission switch on "TONE" or "CW," the dynamotor will be running continuously but the transmitter will not be on the air until the transmitter key is pressed.

(3) The "transmitter power" toggle switch should be left "ON" throughout the flight to avoid repetition of the 15-second warm-up period.

(4) To reduce battery drain and increase dynamotor life, the emission selector switch should remain on "VOICE," unless continued use on "TONE" or "CW" is anticipated.

motor life, the emission selector switch should remain on "VOICE," unless continued use on "TONE" or "CW" is anticipated.

#### CAUTION

The dynamotor generates 600 volts dc. Before attempting to connect or disconnect a transmitter or power plug, determine that it is not running by touching the dynamotor to note the absence of vibration.

While tuning up the antenna circuit of the transmitter, do NOT touch the antenna when the power is "ON."

## SECTION V

### ARMAMENT

#### 1. GUN SIGHT OPERATION.

The P-39Q-1 airplane is equipped with an electrically operated gun sight located in the cabin above the main instrument panel (figure 5) in line with the pilot's eyes. The gun sight is controlled by a rheostat (figure 5) located on the left-hand auxiliary switch panel.

#### 2. GUNS.

a. DESCRIPTION. - The airplane is equipped with a 37-mm cannon located in the forward fuselage and firing through the nose of the airplane, two .50-caliber machine guns located in the forward fuselage of the airplane and synchronized to fire through the propeller blades and two .50-caliber machine guns located one under each wing. The cannon and machine guns are manually charged by the pilot and electrically fired from the cockpit.

#### b. LOADING.

.50-CALIBER FUSELAGE GUNS. - Pull the operating handle completely to the rear to charge. Release operating handle to load. (Do not hold onto handle while it is returning to the forward position.) To lock mechanism to the rear (gun safe), pull operating lever full rear and down. Lever should then stay to the rear. To return to battery position, knock lever up. After guns have been fired and barrel is hot, do not lock action in the intermediate position. Reason: The heat of the barrel will explode the cartridge. With the gun action open this will cause flashback into the cockpit and armament compartment.

.50-CALIBER WING GUNS. - The wing guns are manually charged before take-off. A small door in the fairing provides access to the gun charging handles

(one in each wing) which are attached directly to the gun.

37-MM CANNON. - To load the 37-mm cannon on the ground, pull the charging handle once and the loading handle once. This will leave a live round of ammunition in the chamber ready to fire. (If the cannon jams in the air, pull the charging handle once and the loading handle once.)

#### 3. GUN OPERATION.

The gun switches (toggle type) (figure 5) are located on the left-hand auxiliary switch panel; these switches select the gun to be fired. Firing is then accomplished by depressing the trigger (figure 3) located on the forward side of the pilot's control stick. It will fire simultaneously all the guns selected by the toggle selector switches. The cannon toggle switch is located on the left-hand auxiliary switch panel; firing is accomplished by depressing the push button located on the top of the handle of the pilot's control stick. In the event one or more guns jam, the others will continue to operate.

#### NOTE

Be sure all gun switches are in the "OFF" position before landing.

#### 4. BOMBING EQUIPMENT.

Provisions are made on the P-39Q-1 airplane for the optional installation of a 500- or 600-pound bomb or auxiliary fuel tank to be carried on the bottom of the airplane. The installation consists of a bomb release handle (figure 5), "ARMED" and "SAFE" lever (figure 8) and the type B-7 bomb shackle to which the bomb or tank is attached.

a. The bomb release handle is located on the left-hand side of the center instrument panel. To release pull upward and aft.

b. The "ARMED" and "SAFE" lever is located on the left-hand side of the cabin floor adjacent to the pilot's seat. The lever pushed to the forward position arms the bomb for explosion before it is released. This lever incorporates a spring-loaded handle which must be pushed down to release the locking pin from the sector before the handle can be moved.

c. A type B-7 bomb shackle is installed on the lower surface of the wing center section and includes a spring-loaded hook device which releases the bomb automatically, when the bomb release handle is pulled in the cockpit.

#### CAUTION

If it is desirable to remove a bomb after landing, make certain the "ARM" and "SAFE" handle is secured in the "SAFE" position before releasing it.

## APPENDIX I

### WINTER OPERATION

#### 1. LANDING PROCEDURE.

Present procedure for landing an airplane that has come through an icing region, on which ice formation is noticeable, is to come in with a reasonable margin of speed above the stall, depending on the amount of ice carried, and land on the main wheels with the tail high. It is an essential part of the taxiing procedure, particularly on a field with slushy spots on the runways, to position all control surfaces so that they will be least subject to damage caused by pieces of ice that may be blown against them by the slip stream. Similar care must also be exercised during take-off and landing runs.

Before each take-off the de-icer system should be checked for proper operation.

#### 2. PROPELLER ANTI-ICERS. (See figure 14.)

When flying in icing areas, turn on the propeller anti-icer by operating the propeller anti-icer rheostat on the right-hand instrument panel (figure 5). This

causes anti-icing fluid to be pumped to anti-icer boots on the propeller blades.

#### 3. CLEAR VIEW WINDSHIELD PANEL.

In cases where the windshield becomes covered with ice, sleet, or oil, a panel (figure 15) which is located in the left-hand section of the windshield may be opened to afford clear vision. This panel is a hinged door which opens inboard. When not in use the panel is held closed by one small cam latch. The panel is held open by an automatic spring clip.

#### NOTE

When the airplane is parked for the night, it is advisable to leave the clear view windshield panel slightly opened. This is to permit the circulation of air inside the cabin which will prevent frosting up of the windows. If a cover is available, it is a good practice also to cover the complete glass portion of the cabin assembly to prevent ice or sleet formation when the airplane is grounded.

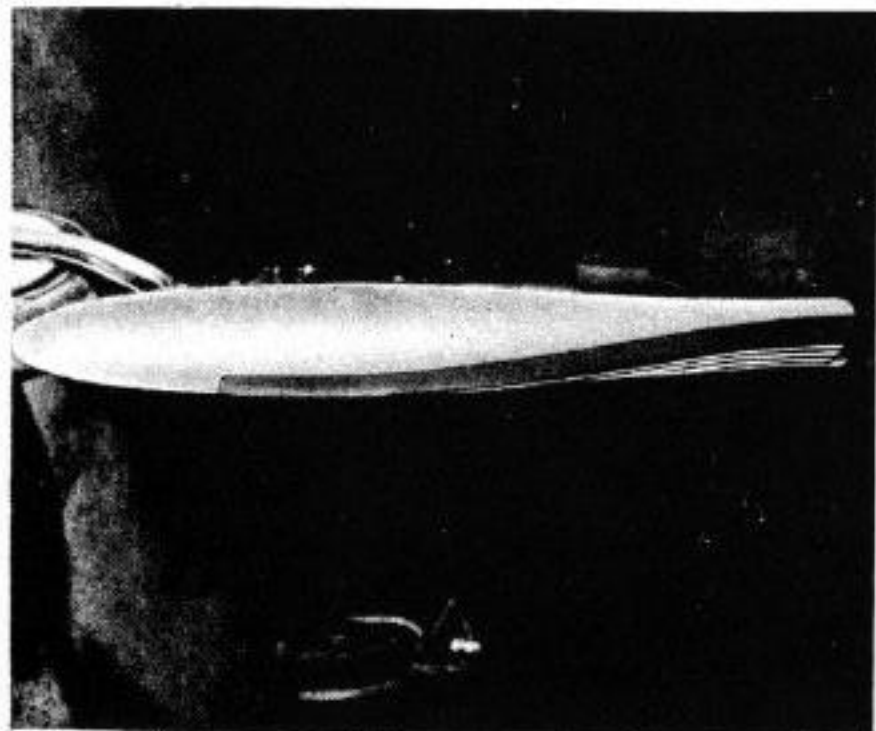

Figure 14 - Propeller De-icer

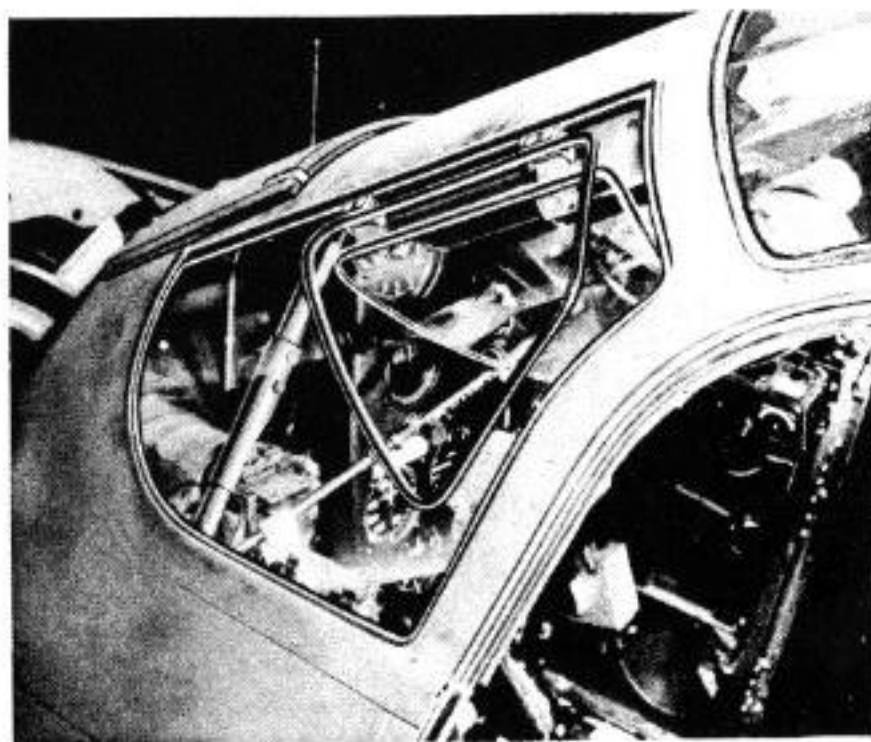

Figure 15 - Clear View Windshield Panel

#### 4. CARBURETOR AIR FILTER AND HEATER.

Two controls for operation of the filter and heater (figure 8) are located in the cockpit at the left of the pilot's seat on the turn-over beam. These controls operate dampers in the air ducts. The first control selects the desired amount of cold rammed unfiltered air which is led directly to the carburetor through a duct leading from the air scoop located on the top cowling directly over the carburetor. The second control permits the selection of hot unfiltered or cold filtered air to the carburetor.

It is recommended that under extreme frigid conditions, and when the plane is kept in outside air, that a cover be placed over the carburetor air scoop to prevent snow or ice from forming on the scoop or entering the carburetor. In case a cover is not placed over the air scoop, it is necessary to thaw out the carburetor and scoop before flight. The heat of the engine alone should not be relied upon for thawing ice from these units because the extreme warm-up required to completely thaw these units would overheat the engine.

A carburetor air thermometer is installed on the main instrument panel in the cockpit to calibrate the temperature of carburetor air at all times.

#### 5. STARTING SYSTEM.

To facilitate starting of the engine in low temperatures, the following units are included with the starter system. A small access door is located on the trailing

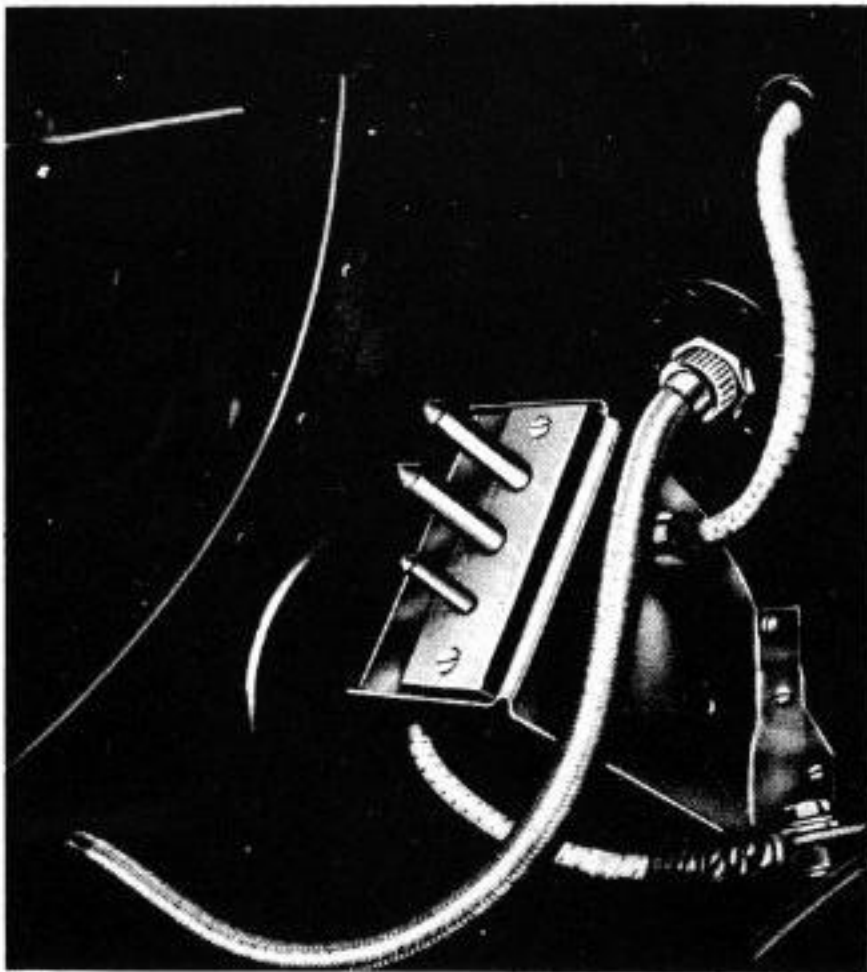

Figure 16 - Plug - External Power Source

edge section of the left-hand wing fillet and affords access to a plug (figure 16) which can be connected to an outside battery to aid in energizing and engaging the starter in rough weather.

#### 6. ENGINE PRIMING SYSTEM.

A hand-operated engine primer pump is incorporated with the airplane to aid in cold weather starting. The primer pump is located on the lower right-hand side of the radio control panel (figure 5) in the cockpit, and draws engine fuel from the Lunkenheimer strainer, and injects the fuel into the engine intake manifold system. Two or three strokes of the primer pump are sufficient in extremely cold temperatures. Avoid overpriming as this will aggravate starting conditions.

A propane induction system is installed in the airplane to aid in cold weather starting. A fitting and cap are located in the fuselage skin just aft of the trailing edge of the left wing. A tube leads from the bulkhead fitting to the engine supercharger mixture intake elbow. The propane is injected into the line by removing the cap from the fitting and attaching an external hose.

#### 7. OIL DILUTION.

The use of oil dilution is recommended when outside temperature is below  $0^{\circ}\text{C}$  ( $32^{\circ}\text{F}$ ). Dilution of the oil is accomplished prior to stopping the engine by placing the oil dilution valve switch (figure 6) in the "ON" position for approximately 4 minutes with the engine running at about 800 rpm. This period of operation is recommended as it has given most satisfactory dilution when oil and coolant temperatures have not been too high. When coolant and oil temperatures are high (over  $100^{\circ}\text{C}$  ( $212^{\circ}\text{F}$ ) for coolant and  $40^{\circ}\text{C}$  ( $104^{\circ}\text{F}$ ) for oil) it will be necessary to shut off the engine and allow to cool; then start the engine and proceed as outlined above.

#### NOTE

One quart of gasoline enters the oil system per each minute of operation of the switch at about 800 rpm. Dilution will vary at different rpm's but there is very little danger of over-dilution. Opening the oil dilution valve injects a quantity of engine fuel into the oil lines thus diluting the oil. Diluted oil is gradually circulated to the engine oil tank where it is deposited in a hopper compartment inside the tank. As the engine is started, the diluted oil moves into the oil system. As the diluted oil circulates through the engine, it is heated and carried back to the hopper compartment. Heat from the oil in this compartment gradually warms the oil in the tank outside the compartment and causes it to flow into the lines. Continuous heat in the engine crankcase eventually vaporizes fuel in the oil and exhausts the vapor through the engine breather line.

## 8. SURGE VALVE.

The oil system incorporates a bypass surge valve (figure 10) that guides the oil flow through or around the oil coolers. When the airplane has been idle for any length of time in cold weather the oil in the coolers congeals and would ordinarily cause damage from oil pump pressure when the engine is started. If the oil pressure exceeds 60 pounds per square inch the surge valve opens releasing the pressure in the coolers and sends the majority of oil flow directly to the engine oil tank from the engine. When the seepage of warm oil loosens the congealed oil in the coolers, the valve closes allowing the oil to flow normally through the coolers again.

## 9. COLD WEATHER MOORING.

If no fixed anchorage is available and the ground is frozen too solid to use the mooring arrows provided in the D-1 mooring kit, the following procedure may be used: Dig holes in the ground 8 inches deep and 8 inches square. Dig the holes below or adjacent to the mooring points of the airplane. Coil as much manila rope as possible in each hole; or lean deeply notched stakes cornerwise in the hole, so the top of the stake will be as nearly as possible at right angles to the line of mooring, and so the notches will hold firmly when frozen in ice; or tie a short stake crosswise on the mooring rope and place it flat from corner to corner in the hole. The free ends of the rope should be of sufficient length to reach the mooring points of the airplane. Fill the holes with water, and after the water has frozen, attach the free ends of the ropes to the mooring points of the airplane.

### NOTE

When the ground is frozen to such an extent that it is impossible to drive the mooring pins, or to dig suitable holes, first prepare the ground by building fires over the desired mooring points or using a hand-operated portable heater to thaw the ground sufficiently to permit placement of the mooring pins or equipment.

## 10. PARKING ON SNOW OR ICE.

In parking the airplane on snow or ice, if possible, provide a layer of fabric, grass, straw, green boughs, or other insulating material under the wheels to prevent their freezing into the surface. Lack of such precautions frequently result in tearing off large chunks of rubber from the tires when the airplane is again moved. Never leave parking brakes applied for any period of time. Apply foot brakes several times just prior to take-off and in flight just before landing to insure operation.

## 11. OXYGEN EQUIPMENT.

Operate all oxygen valves carefully in cold weath-

er, opening and closing them slowly. A rapid opening may cause a sudden surge of pressure which may result in an explosion.

## 12. COMMUNICATION EQUIPMENT.

The hand microphone is unsatisfactory for use in cold weather, as moisture collects and freezes in the small holes of the microphone mouthpiece. Throat-type microphones should be used for all cold weather operation. All antennae will be cleaned of ice, moisture and snow before each flight. Icing is prevalent on all types of antenna. In transmitters, frequency shift occurs with wide changes in temperature. Consequently, the transmitter must be returned and checked until a relatively stable temperature is reached.

## 13. LATCHES.

When operating under extreme cold weather conditions, all safety latches, emergency exit and entrance door latches will be carefully checked for freedom of operation prior to take-off. In cold weather when washing down the airplane or cleaning with steam, water or moisture may enter latches causing them to freeze. Check and free any that are found inoperative.

## 14. PROCEDURE PRIOR TO STARTING.

a. The procedure to starting is largely dependent upon the extent of the cold weather steps which were taken after the previous landing, and upon the outside air temperatures encountered. In temperatures down to  $-23^{\circ}\text{C}$  ( $-10^{\circ}\text{F}$ ) no special procedures are required. When the temperature is at  $-23^{\circ}\text{C}$  ( $-10^{\circ}\text{F}$ ) or below, it is necessary to preheat the engine and accessory compartment prior to attempting a start.

b. To preheat the engine, the oil temperature regulators, air ducts and shutters should be closed and the heat applied through the openings in the engine and at the accessory compartment. At least 2 hours are required to heat an engine at extremely low temperatures. If a 6-8 minute oil dilution has not been performed, it may be necessary to heat the oil system and the lines from the engine accessory compartment to the openings in the wings to assure satisfactory operation. If the engine oil has been drained, it is necessary to preheat it to  $93^{\circ}\text{C}$  ( $200^{\circ}\text{F}$ ) before pouring it back into the tank. This should be done a few minutes prior to the actual starting of the engines. If the electric heaters have been used at the oil tanks, it is assumed that the oil system will be sufficiently warm to permit a start.

c. Do not permit excessively hot air to blast against ignition harness, flexible hose, self-sealing tanks, or other rubberized or fabric materials. The blast will be too hot unless the hand can be comfortably held for 1 minute in the same position as the part in question.

d. The cockpit and battery compartments should be heated, utilizing the openings provided in the bottom of the fuselage.

#### WARNING

If ice, frost, or snow is present on the airplane wings, or flight surfaces, it must be removed by brushing or flushing prior to take-off.

e. Operate all ailerons, elevators, rudders and all trim tabs through their complete travels three or four times, noting the forces required. If forces are excessive, check system for cause.

f. When it is necessary to remove frost or ice from areas of the airplane, melt a small area of the ice

covered surface at a time, using hot water or heat from a portable ground heater; then flush this area with denatured alcohol before the hot water freezes. Pay particular attention to the hinges and controls.

g. The two heater controls on the floor control the air entering the cockpit through two ducts under the pilot's seat. A volume of air is constantly flowing through these ducts and the two controls only control the mixing of hot and cold air. No shut-off is provided. The air that enters the cockpit through these ducts travels through outlets in the rudder pedal wells to the guns and cannons. This air is then drawn forward and expelled overboard by means of four external louvres.

### U.S.A. - BRITISH GLOSSARY OF NOMENCLATURE

Accumulator

Battery

Check valve

Cotter pin

Inverter

Lean mixture

Life raft

Lock washer

Manifold pressure

(Inches of mercury above zero)

Change of 2.036 inches

29.92 inches of mercury

50.2 inches of mercury

Oleo strut

Piston pin

Propeller

Low pitch

High pitch

Radio mast

Reticle (gun sight)

Snap roll

Stabilizer

Tachometer

Tow target

Wrench

Pressure reservoir

Accumulator

Nonreturn valve

Split pin

Motor generator (ac to dc)

Weak mixture

Dinghy

Spring washer

Boost

(Pounds per square inch from 0 at sea level)

Change of 1 pound boost

0 pounds boost

10 pounds boost

Compression leg

Gudgeon pin

Airscrew

Fine pitch

Coarse pitch

Rod aerial

Graticule

Flick roll

Tail plane

Revolution counter

Drouge target

Spanner

d. The cockpit and battery compartments should be heated, utilizing the openings provided in the bottom of the fuselage.

#### WARNING

If ice, frost, or snow is present on the airplane wings, or flight surfaces, it must be removed by brushing or flushing prior to take-off.

e. Operate all ailerons, elevators, rudders and all

trim tabs through their complete travels three or four times, noting the forces required. If forces are excessive, check system for cause.

f. When it is necessary to remove frost or ice from areas of the airplane, melt a small area of the ice covered surface at a time, using hot water or heat from a portable ground heater; then flush this area with denatured alcohol before the hot water freezes. Pay particular attention to the hinges and controls.

#### U.S.A. - BRITISH GLOSSARY OF NOMENCLATURE

Accumulator

Battery

Check valve

Coffer pin

Inverter

Lean mixture

Life raft

Lock washer

Manifold pressure

(Inches of mercury above zero)

Change of 2.036 inches

29.92 inches of mercury

50.2 inches of mercury

Oleo strut

Piston pin

Propeller

Low pitch

High pitch

Radio mast

Reticle (gun sight)

Snap roll

Stabilizer

Tachometer

Tow target

Wrench

Pressure reservoir

Accumulator

Nonreturn valve

Split pin

Motor generator (ac to dc)

Weak mixture

Dinghy

Spring washer

Boost

(Pounds per square inch from 0 at sea level)

Change of 1 pound boost

0 pounds boost

10 pounds boost

Compression leg

Gudgeon pin

Airscrew

Fine pitch

Coarse pitch

Rod aerial

Graticule

Flick roll

Tail plane

Revolution counter

Drouge target

Spanner