

NAVAIR 01-OV10D-1

NATOPS FLIGHT MANUAL

NAVY MODEL

OV-10D

AIRCRAFT

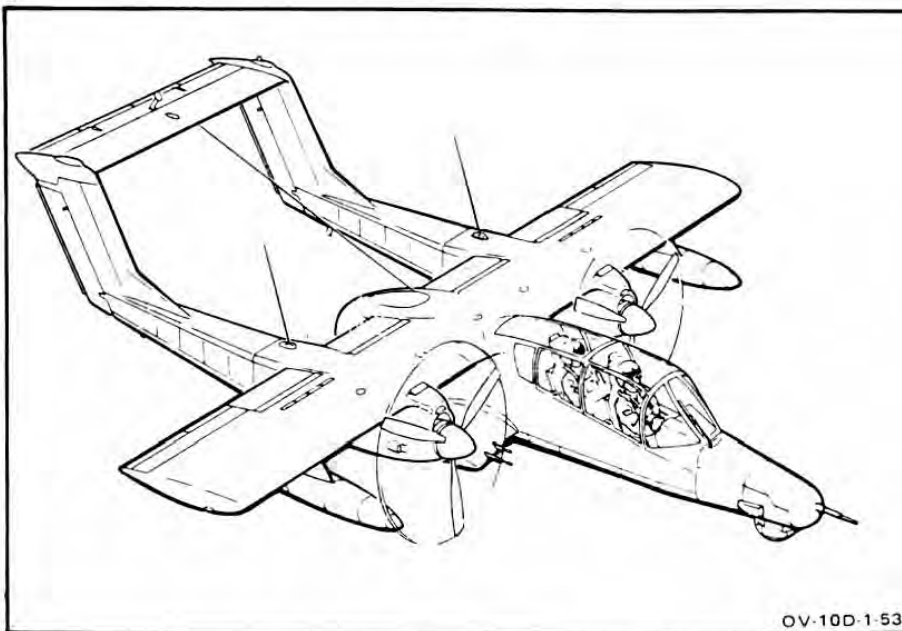

OV-10D-1-53

This manual supersedes NAVAIR 01-OV10D-1,
dated 1 November 1979

This publication is required for official use or for administrative or operational purposes only. Distribution is limited to U.S. Government agencies. Other requests for the document must be referred to Commanding Officer, Naval Air Technical Services Facility, 700 Robbins Avenue, Philadelphia, PA 19111.

ISSUED BY AUTHORITY OF THE CHIEF OF NAVAL OPERATIONS
AND UNDER THE DIRECTION OF THE COMMANDER,
NAVAL AIR SYSTEMS COMMAND

I THE AIRCRAFT

II INDOCTRINATION AND TRAINING

III NORMAL OPERATING PROCEDURES

IV FLIGHT CHARACTERISTICS

V EMERGENCY PROCEDURES

VI ALL-WEATHER OPERATION

VII ELECTRONIC EQUIPMENT AND COMMUNICATIONS

VIII WEAPONS SYSTEMS

IX FLIGHT CREW COORDINATION

X NATOPS EVALUATION

XI PERFORMANCE DATA

ALPHABETICAL INDEX

1 FEBRUARY 1982

Reproduction for non-military use of the information or illustrations contained in this publication is not permitted without specific approval of the Commander, Naval Air Systems Command.

LIST OF EFFECTIVE PAGES

Total number of pages in this manual is 336 consisting of the following:

<i>Page No.</i>	<i>Issue</i>	<i>Page No.</i>	<i>Issue</i>
Cover.....	0	8-7 — 8-18	0
A — B.....	0	8-19/(8-20 blank)	0
C/(D blank).....	0	9-1 — 9-2	0
i — iv	0	10-1 — 10-18	0
(v blank)/vi	0	10-19/(10-20 blank)	0
1-1 — 1-8	0	11-1 — 11-20	0
1-9/(1-10 blank).....	0	11-21/(11-22 blank)	0
1-11 — 1-56	0	11-23 — 11-40	0
1-58/(1-58 blank)	0	11-41/(11-42 blank)	0
1-59 — 1-74	0	11-43 — 11-62	0
2-1 — 2-2	0	11-63/(11-64 blank)	0
3-1 — 3-2	0	11-65 — 11-66	0
3-3/(3-4 blank)	0	11-67/(11-68 blank)	0
3-5 — 3-28	0	11-69 — 11-78	0
3-29/(3-30 blank)	0	11-79/(11-80)	0
4-1 — 4-8	0	11-81 — 11-84	0
5-1 — 5-4	0	11-85/(11-86 blank)	0
5-5/(5-6 blank)	0	FO-1/(FO-2 blank).....	0
5-7 — 5-24.....	0	FO-3/(FO-4 blank).....	0
6-1 — 6-8	0	FO-5/(FO-6 blank).....	0
7-1 — 7-20.....	0	FO-7/(FO-8 blank).....	0
7-21/(7-22 blank)	0	FO-9/(FO-10 blank)	0
8-1 — 8-4	0	Index 1 — Index 20.....	0
8-5/(8-6 blank)	0		

INTERIM CHANGE SUMMARY

The following Interim Changes have been canceled or previously incorporated in this manual:

INTERIM CHANGE NUMBER(S)	REMARKS/PURPOSE

The following Interim Changes have been incorporated in this Change/Revision:

INTERIM CHANGE NUMBER	REMARKS/PURPOSE

Interim Changes Outstanding - To be maintained by the custodian of this manual:

INTERIM CHANGE NUMBER	ORIGINATOR/DATE (or DATE/TIME GROUP)	PAGES AFFECTED	REMARKS/PURPOSE

THIS SUBSCRIPTION IS ACCOUNTABLE TO THE QUALITY CONTROL DIVISION

NAME OF SUB. _____

COPY NO. _____

SUMMARY OF APPLICABLE TECHNICAL DIRECTIVES

Information relating to the following recent technical directives has been incorporated in this manual

CHANGE NUMBER	DESCRIPTION	DATE INC. IN MANUAL	VISUAL IDENTIFICATION
AFC 82	Installation of AN/ALE-39 Countermeasures Dispensing Set		Dispenser Module in each Tail Boom and Instrument Panel

Information relating to the following recent technical directives will be incorporated in a future change

CHANGE NUMBER	DESCRIPTION	VISUAL IDENTIFICATION



DEPARTMENT OF THE NAVY
OFFICE OF THE CHIEF OF NAVAL OPERATIONS
WASHINGTON, D.C. 20350

LETTER OF PROMULGATION

1. The Naval Air Training and Operating Procedures Standardization Program (NATOPS) is a positive approach toward improving combat readiness and achieving a substantial reduction in the aircraft accident rate. Standardization, based on professional knowledge and experience, provides the basis for development of an efficient and sound operational procedure. The standardization program is not planned to stifle individual initiative, but rather to aid the Commanding Officer in increasing his unit's combat potential without reducing his command prestige or responsibility.
2. This manual standardizes ground and flight procedures but does not include tactical doctrine. Compliance with the stipulated manual procedure is mandatory except as authorized herein. In order to remain effective, NATOPS must be dynamic and stimulate rather than suppress individual thinking. Since aviation is a continuing, progressive profession, it is both desirable and necessary that new ideas and new techniques be expeditiously evaluated and incorporated if proven to be sound. To this end, Commanding Officers of aviation units are authorized to modify procedures contained herein, in accordance with the waiver provisions established by OPNAVINST 3510.9 series, for the purpose of assessing new ideas prior to initiating recommendations for permanent changes. This manual is prepared and kept current by the users in order to achieve maximum readiness and safety in the most efficient and economical manner. Should conflict exist between the training and operating procedures found in this manual and those found in other publications, this manual will govern.
3. Checklists and other pertinent extracts from this publication necessary to normal operations and training should be made and may be carried in Naval Aircraft for use therein. It is forbidden to make copies of this entire publication or major portions thereof without specific authority of the Chief of Naval Operations.

W. L. McDONALD
Vice Admiral, USN
Deputy Chief of Naval Operations
(Air Warfare)

TABLE OF CONTENTS

Section I	THE AIRCRAFT	1-1
Part 1	Description	1-1
Part 2	Systems	1-11
Part 3	Aircraft Servicing	1-53
Part 4	Aircraft Operating Limitations	1-59
Section II	INDOCTRINATION AND TRAINING	2-1
Section III	NORMAL OPERATING PROCEDURES	3-1
Part 1	Briefing and Debriefing	3-1
Part 2	Mission Planning	3-3
Part 3	Shore-based Procedures	3-5
Part 4	Carrier-based Procedures	3-21
Part 5	Functional Check Flight Procedures	3-23
Section IV	FLIGHT CHARACTERISTICS AND PROCEDURES	4-1
Section V	EMERGENCY PROCEDURES	5-1
Part 1	Ground Emergencies	5-1
Part 2	Take-off Emergencies	5-7
Part 3	In-flight Emergencies	5-9
Part 4	Landing Emergencies	5-15
Part 5	Ejection	5-23
Section VI	ALL-WEATHER OPERATION	6-1
Section VII	ELECTRONIC EQUIPMENT AND COMMUNICATIONS	7-1
Part 1	Electronic Equipment	7-1
Part 2	Communications	7-21
Section VIII	WEAPONS SYSTEMS	8-1
Part 1	Armament Systems	8-1
Part 2	Avionics	8-7
Section IX	FLIGHT CREW COORDINATION	9-1
Section X	NATOPS EVALUATION	10-1
Part 1	NATOPS Evaluation Program	10-1
Part 2	NATOPS Evaluation Question Bank	10-5
Part 3	NATOPS Evaluation Forms	10-15
Section XI	PERFORMANCE DATA	11-1
Part 1	Basic Data	11-1
Part 2	Take-off Data	11-7
Part 3	Climb Data	11-23
Part 4	Range Data	11-43
Part 5	Endurance Data	11-65
Part 6	Flight Characteristics Data	11-69
Part 7	Descent Data	11-77
Part 8	Landing Data	11-81
Alphabetical Index		Index 1
Foldout Illustrations		FO-1

FOREWORD

SCOPE

The NATOPS Flight Manual (NAVAIR 01-OV10D-1) is issued by the authority of the Chief of Naval Operations and under the direction of Commander, Naval Air Systems Command in conjunction with the Naval Air Training and Operating Procedures Standardization (NATOPS) Program. This manual contains information on all aircraft systems, performance data, and operating procedures required for safe and effective operations. However, it is not a substitute for sound judgment. Compound emergencies, available facilities, adverse weather or terrain, or considerations affecting the lives and property of others may require modification of the procedures contained herein. Read this manual from cover to cover. It's your responsibility to have a complete knowledge of its contents.

APPLICABLE PUBLICATIONS

The following applicable publications complement this manual:

- NAVAIR 01-OV10D-1B (NATOPS Pilot's Pocket Checklist)
- NAVAIR 01-OV10D-1F (NATOPS Functional Checklist)
- CV NATOPS
- LPH/ LHA NATOPS
- LSO NATOPS

HOW TO GET COPIES

AUTOMATIC DISTRIBUTION

To receive future changes and revisions to this manual or any other NAVAIR aeronautical publication automatically, a unit must be established on an automatic distribution list maintained by the Naval Air Technical Services Facility (NATSF). To become established on the list or to change existing NAVAIR publication requirements, a unit must submit the appropriate tables from NAVAIR 00-25 DRT-1 (Naval Aeronautic Publications Automatic Distribution Requirements Tables) to NATSF, 700 Robbins Ave., Philadelphia, Pa. 19111, listing this manual and all other NAVAIR publications required. For additional instructions refer to NAVAIRINST 5605.4 series and Introduction to Navy Stocklist of Publications and Forms NAVSUP Publication 2002 (S/N 0535-LP-004-0001).

UPDATING THE MANUAL

To ensure that the manual contains the latest procedures and information, NATOPS review conferences are held in accordance with OPNAVINST 3510.9 series.

CHANGE RECOMMENDATIONS

Recommended changes to this manual or other NATOPS publications may be submitted by anyone in accordance with OPNAVINST 3510.9 series.

Routine change recommendations are submitted directly to the Model Manager on OPNAV Form 3500-22 shown on the next page. The address of the Model Manager of this aircraft is:

Commanding Officer
VMO-2, Det, MAG-16, 3d MAW, FMFPAC
MCB Camp Pendleton, California 92055
ATTN: NATOPS Coordinator (OV-10D)

Change recommendations of an URGENT nature (safety of flight, etc) should be submitted directly to the NATOPS Advisory Group Member in the chain of command by priority message.

YOUR RESPONSIBILITY

NATOPS Flight Manuals are kept current through an active manual change program. Any corrections, additions, or constructive suggestions for improvement of its content should be submitted by routine or urgent change recommendations, as appropriate, at once.

NATOPS FLIGHT MANUAL INTERIM CHANGES

Flight Manual Interim Changes are changes or corrections to the NATOPS Flight Manuals promulgated by CNO or NAVAIRSYSCOM. Interim Changes are issued either as printed pages, or as a naval message. The Interim Change Summary page is provided as a record of all interim changes. Upon receipt of a change or revision, the custodian of the manual should check the updated Interim Change Summary to ascertain that all outstanding interim changes have been either incorporated or canceled; those not incorporated shall be recorded as outstanding in the section provided.

NATOPS/TACTICAL CHANGE RECOMMENDATION
 OPNAV FORM 3500/22 (5-69) 0107-722-2002

DATE

TO BE FILLED IN BY ORIGINATOR AND FORWARDED TO MODEL MANAGER

FROM (originator)		Unit			
TO (Model Manager)		Unit			
Complete Name of Manual/Checklist	Revision Date	Change Date	Section/Chapter	Page	Paragraph

Recommendation (be specific)

CHECK IF CONTINUED ON BACK

Justification

Signature	Rank	Title
-----------	------	-------

Address of Unit or Command

TO BE FILLED IN BY MODEL MANAGER (Return to Originator)

FROM	DATE
------	------

TO

REFERENCE

(a) Your Change Recommendation Dated _____

Your change recommendation dated _____ is acknowledged. It will be held for action of the review conference planned for _____ to be held at _____.

Your change recommendation is reclassified URGENT and forwarded for approval to _____ by my DTG _____.

/s/ _____ MODEL MANAGER, _____ AIRCRAFT

CHANGE SYMBOLS

Revised text is indicated by a black vertical line in either margin of the page, adjacent to the affected text, like the one printed next to this paragraph. The change symbol identifies the addition of either new information, a changed procedure, the correction of an error, or a rephrasing of the previous material.

WARNINGS, CAUTIONS, AND NOTES

The following definitions apply to "WARNINGS", "CAUTIONS," and "NOTES" found throughout the manual.

WARNING

An operating procedure, practice, or condition, etc, which may result in injury or death, if not carefully observed or followed.

CAUTION

An operating procedure, practice, or condition, etc, which may result in damage to equipment, if not carefully observed or followed.

Note

An operating procedure, practice, or condition, etc, which is essential to emphasize.

WORDING

The concept of word usage and intended meaning which has been adhered to in preparing this Manual is as follows:

"Shall" has been used only when application of a procedure is mandatory.

"Should" has been used only when application of a procedure is recommended.

"May" and "need not" have been used only when application of a procedure is optional.

"Will" has been used only to indicate futurity, never to indicate any degree of requirement for application of a procedure.

OV-10D

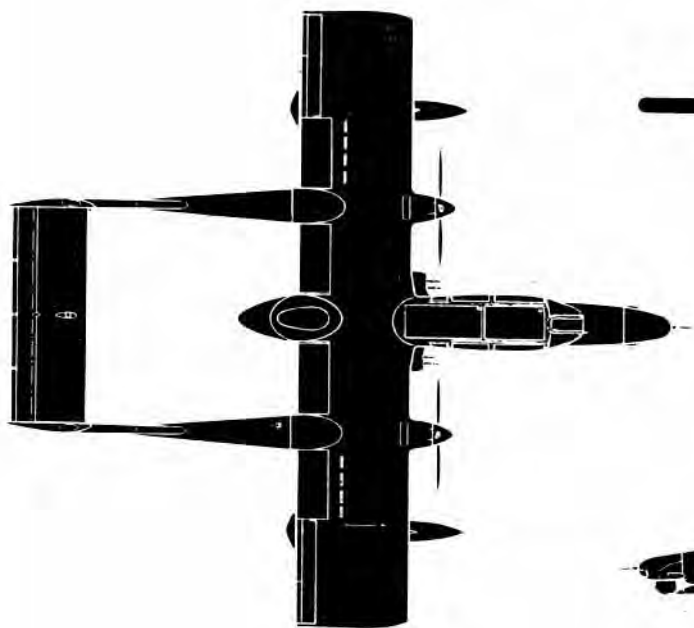

Figure 1-0

OV-10D-1-1D

SECTION I—THE AIRCRAFT**TABLE OF CONTENTS**

PART 1—DESCRIPTION	1-1	Emergency Equipment	1-45
The Aircraft	1-1	Mission Equipment	1-47
PART 2 — SYSTEMS	1-11	Miscellaneous Equipment	1-51
Engines	1-11	PART 3—AIRCRAFT SERVICING	1-53
Aircraft Fuel Supply System	1-20	Aircraft Servicing	1-53
Electrical Power System	1-23	Material Specifications	1-53
Hydraulic Power System	1-28	External Power	1-53
Flight Control Systems	1-28	Refueling	1-53
Wing Flaps	1-31	Systems Servicing	1-55
Landing Gear	1-31	PART 4 — AIRCRAFT OPERATING	
Wheel Brakes	1-32	LIMITATIONS	1-59
Nose Wheel Steering	1-33	Introduction	1-59
Instruments	1-33	Instrument Markings	1-59
Angle-of-Attack System	1-34	Engine Limits	1-59
Lighting Systems	1-35	Engine Temperature Limits	1-62
Heating, Ventilation, and		Airspeed Limits	1-62
Defrost Systems	1-37	Acceleration Limits	1-62
Windshield Wiper	1-39	External Store Limits	1-62
Oxygen System	1-39	Prohibited Maneuvers	1-62
Cockpit Enclosure	1-41	Landing Sink Rates	1-64
Ejection Seats	1-43	Center-of-Gravity Limits	1-64
		Weight Limits	1-64

PART 1 — DESCRIPTION**THE AIRCRAFT**

The Rockwell International OV-10D is a twin-turboprop, Night Observation System (NOS) aircraft designed for day and night tactical operations. Main identification features include a shoulder-mounted, straight wing; a large, glass enclosed cockpit; extended nose section mounting the FLIR/LRD sensor turret; aerodynamic splitter plates on the nose wheel door, twin tail booms; and swept vertical stabilizers with a high-set horizontal stabilizer. The cockpit section contains a second flight crew station (observer's) with message drop capability. The cockpit section is partially armor plated to provide protection from small arms penetration. Two canted sponsons are mounted on the lower fuselage, providing four external store stations and housing for four 7.62 mm guns with integral ammunition supply. Additional weapons or a single external fuel tank may be installed at a centerline store station under the fuselage. An external store station under each wing provides capability for carrying pylon-mounted armament or auxiliary fuel tanks. See figures 1-1 through 1-5. On some aircraft,* an AN/ALE-39 Countermeasures Dispenser module mounted in each tail boom provides capability for dispensing countermeasures materials.

DIMENSIONS

Overall static dimensions of the aircraft are as follows:

Span	40 feet
Height (vertical stabilizer)	15.1 feet
Length	44.08 feet
Tread Width	14.83 feet

See figure 1-6 for additional aircraft dimensions.

GROSS WEIGHT

Clean aircraft take-off gross weight with sponsons, centerline pylon, armor plate, observer's equipment, full internal fuel (JP-4) and a crew of two is approximately 11,370 pounds. When wing pylons and full wing external fuel tanks (JP-4) are installed, the take-off gross weight is increased to 12,750 pounds. For additional weight data, refer to Section XI, Part 1. For detailed weight data, refer to the Weight and Balance Data Manual (NAVAIR 01-1B-40).

*Aircraft having AFC 82 incorporated

GENERAL ARRANGEMENT

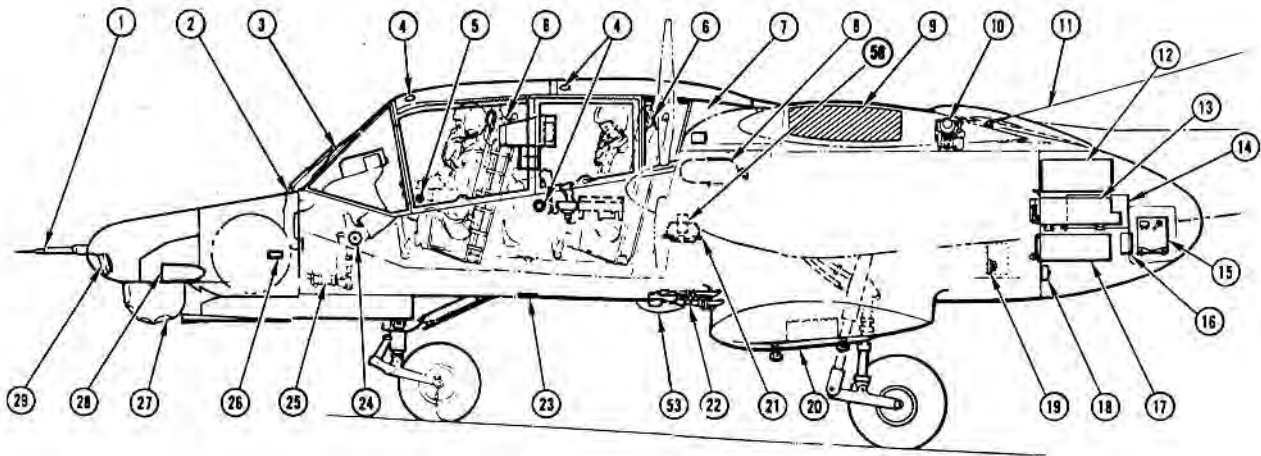
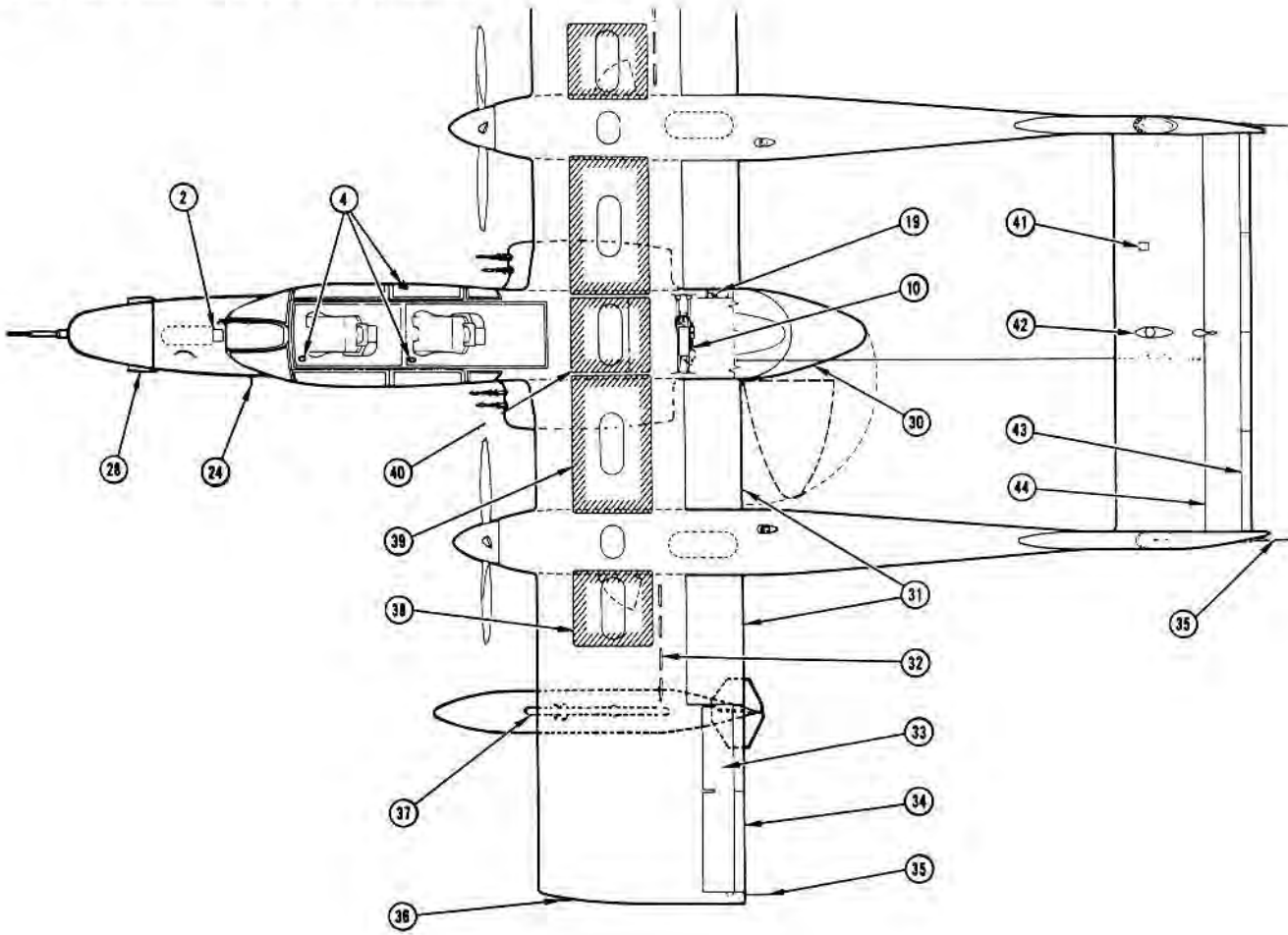

OV-10D-1-2D

Figure 1-1 (Sheet 1)

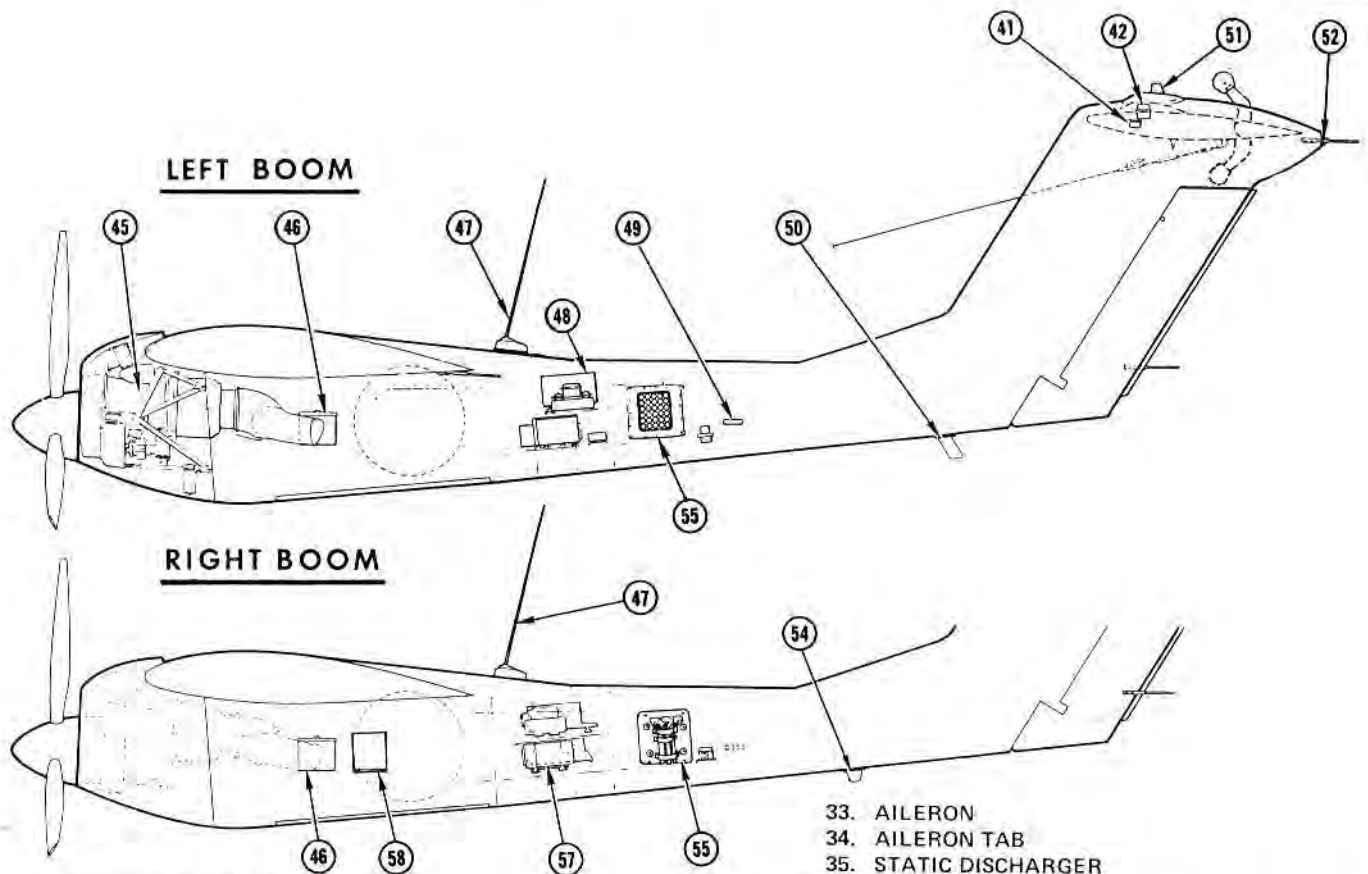

1. PITOT-STATIC TUBE
2. RAM AIR INLET
3. WINDSHIELD WIPER
4. COCKPIT AIR VENT
5. OAT INDICATOR
6. LW-38 EJECTION SEAT
7. ELECTRICAL EQUIPMENT BAY
8. OXYGEN SUPPLY BOTTLES
9. FUEL CELL
10. HYDRAULIC POWER SYSTEM
11. HF RADIO ANTENNA
12. VIDEO TRACKER
13. HF RADIO SET, AN/ARC-120 (LH)
14. SPACE PROVISIONS FOR VIDEO RECORDER
15. FLIR/LRD/AVT INVERTER
16. FLIR/LRD/AVT CIRCUIT-BREAKER PANEL
17. FLIR POWER SUPPLY (LH) AND FLIR CONTROL SERVOMECHANISM (RH)
18. BIT FAILURE INDICATOR
19. EXTERNAL ELECTRICAL POWER RECEPTACLE (RIGHT SIDE)
20. SPONSON
21. MD-1 GYRO
22. M60C 7.62 mm GUNS
23. MESSAGE DROP DOOR
24. ANGLE-OF-ATTACK PROBE
25. BRAKE MASTER CYLINDER
26. FORMATION LIGHT (BOTH SIDES)
27. FLIR/LRD TURRET
28. AIR SCOOP
29. LANDING/TAXI LIGHT
30. CARGO BAY DOOR
31. FLAPS (INBOARD AND OUTBOARD SECTIONS)
32. SPOILERS
33. AILERON
34. AILERON TAB
35. STATIC DISCHARGER
36. POSITION LIGHT
37. WING PYLON AND AUXILIARY FUEL TANK
38. OUTBOARD WING FUEL TANK
39. INBOARD WING FUEL TANK
40. CENTER-FEED FUEL TANK
41. MAGNETIC COMPASS TRANSMITTER
42. UPPER ANTI-COLLISION LIGHT
43. ELEVATOR TAB
44. ELEVATOR
45. T76G-420 ENGINE (-421 RIGHT)
46. BATTERY
47. VHF-FM ANTENNA (2)
48. ELECTRONIC EQUIPMENT BAY (LEFT) VHF-FM SET NO. 2, AN/ARC-54 OR AN/ARC-131 TACAN, AN/ARN-52(V) UHF SET, AN/ARC-51 ADF SET, AN/ARA-50 COMPASS CONTROLLER, AN/ASN-75
49. FORMATION LIGHT (BOTH BOOMS)
50. UHF COMM ANTENNA
51. TACAN ANTENNA (LEFT SIDE) IFF ANTENNA (RIGHT SIDE)
52. POSITION LIGHT (LEFT ONLY)
53. LOWER ANTI COLLISION LIGHT
54. IFF-SIF ANTENNA
55. D27/ALE-29A DISPENSER MODULE*
56. ABU-13A ACCELEROMETER
57. ELECTRONICS EQUIPMENT BAY (RIGHT) INVERTERS IFF-SIF, AN/APX-64(V) FM SET NO. 1, AN/ARC-54
58. MX-9254/ALE-39 PROGRAMMER*

* AIRCRAFT HAVING AFC 82 INCORPORATED

OV-10D-1-3H

Figure 1-1 (Sheet 2)

MISSIONS

The aircraft may be configured for Night Observation Surveillance (NOS), strike-reconnaissance, forward air control, or cargo transport missions.

The AN/AAS-37, Infrared Laser Detecting-Ranging Set provides the OV-10D aircraft with a night and day battlefield surveillance, a primary mission of target acquisition and a secondary mission of target designation for high performance attack aircraft carrying laser-guided weapons.

STRIKE-RECONNAISSANCE OR TAC(A)

For a strike, strike-recon, or tactical air control (airborne) mission, external armament, integral guns, and communications equipment provide the capabilities required.

NIGHT OBSERVATION SURVEILLANCE (NOS)

For Night Observation Surveillance, the aircraft configuration includes a FLIR/LRD sensor turret and pilot's and observer's cockpit controls and indicators for operation of the FLIR/LRD system. Sponsons, centerline store station, and wing pylons (when installed) provide additional capabilities to carry auxiliary fuel tanks or other external stores required for mission accomplishment.

CARGO TRANSPORT

By adding the cargo configuration package, internal loads of up to 3200 pounds may be carried.

PILOT'S LEFT CONSOLE

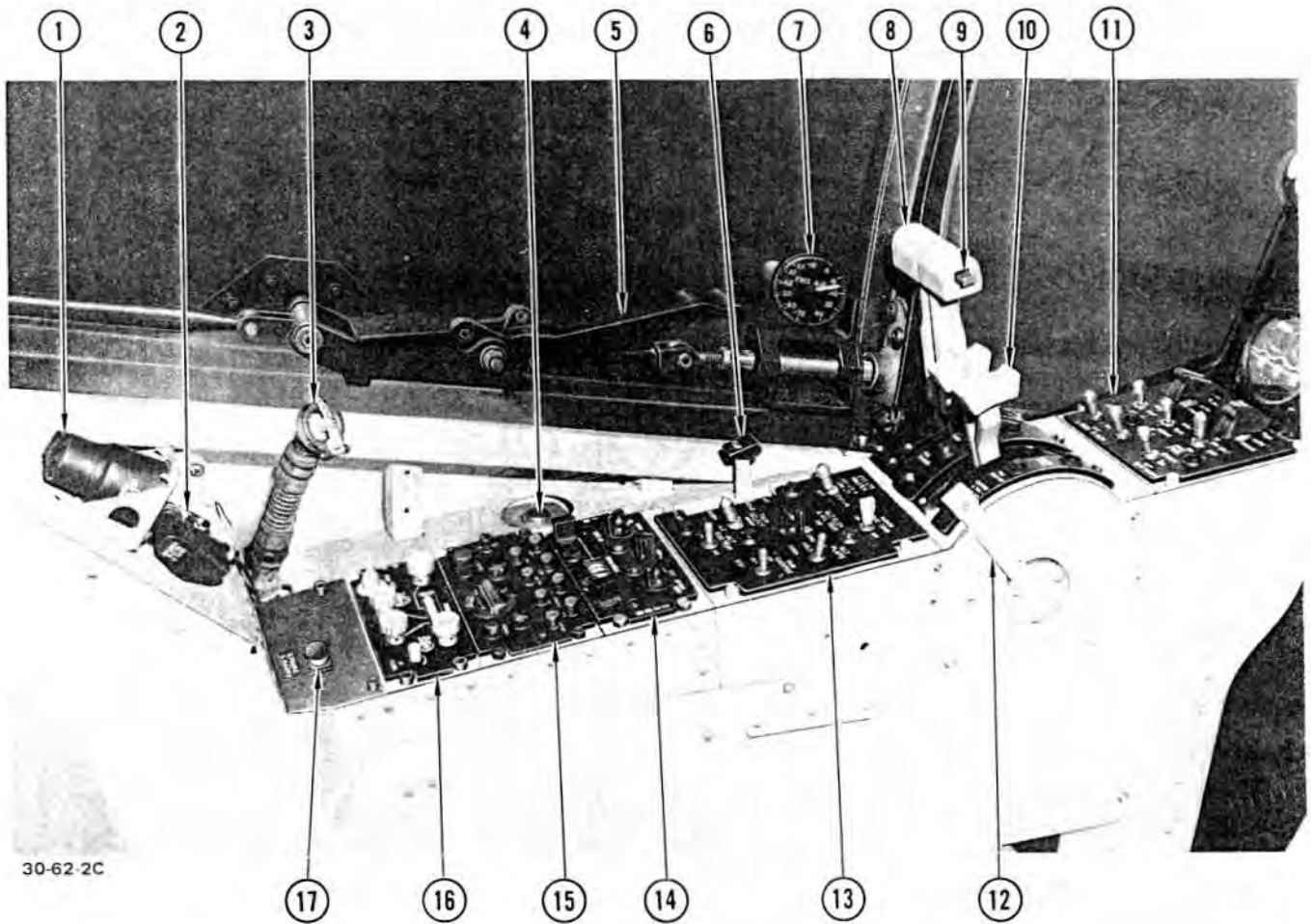

30-62-2C

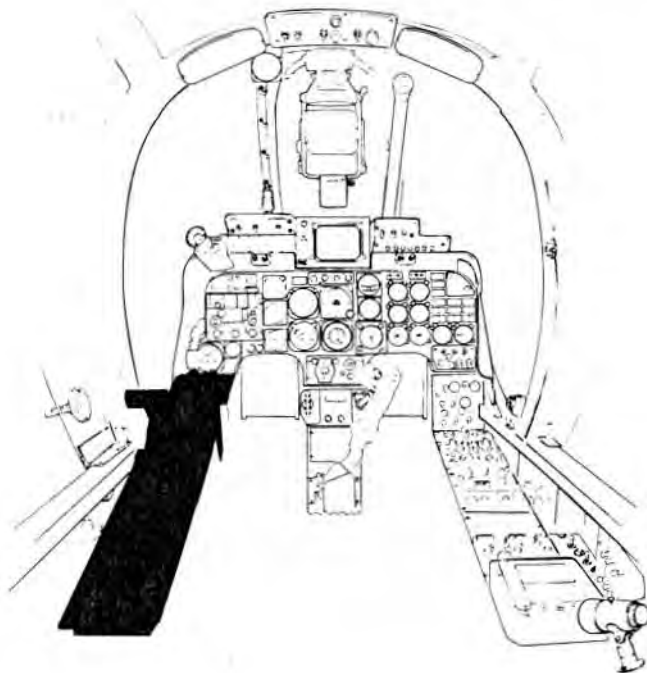

1. HIGH INTENSITY LIGHT
2. CONSOLE FLOODLIGHT
3. ANTI-G SUIT HOSE
4. ANTI-G VALVE
5. CANOPY DOOR LOCK HANDLE
6. FLAP HANDLE
7. FREE AIR TEMPERATURE INDICATOR
8. ENGINE POWER LEVERS
9. MICROPHONE SWITCH
10. ENGINE CONDITION LEVERS
11. START-ELECTRICAL CONTROL PANEL
12. POWER LEVER FRICTION LEVER
13. FLAP-TRIM CONTROL PANEL
14. VHF-FM NO. 1 CONTROL PANEL
15. INTERCOM (ICS) CONTROL PANEL
16. HF COMM CONTROL PANEL
17. SPARE LAMPS

OV-10D-1-11C

Figure 1-2

PILOT'S INSTRUMENT PANEL

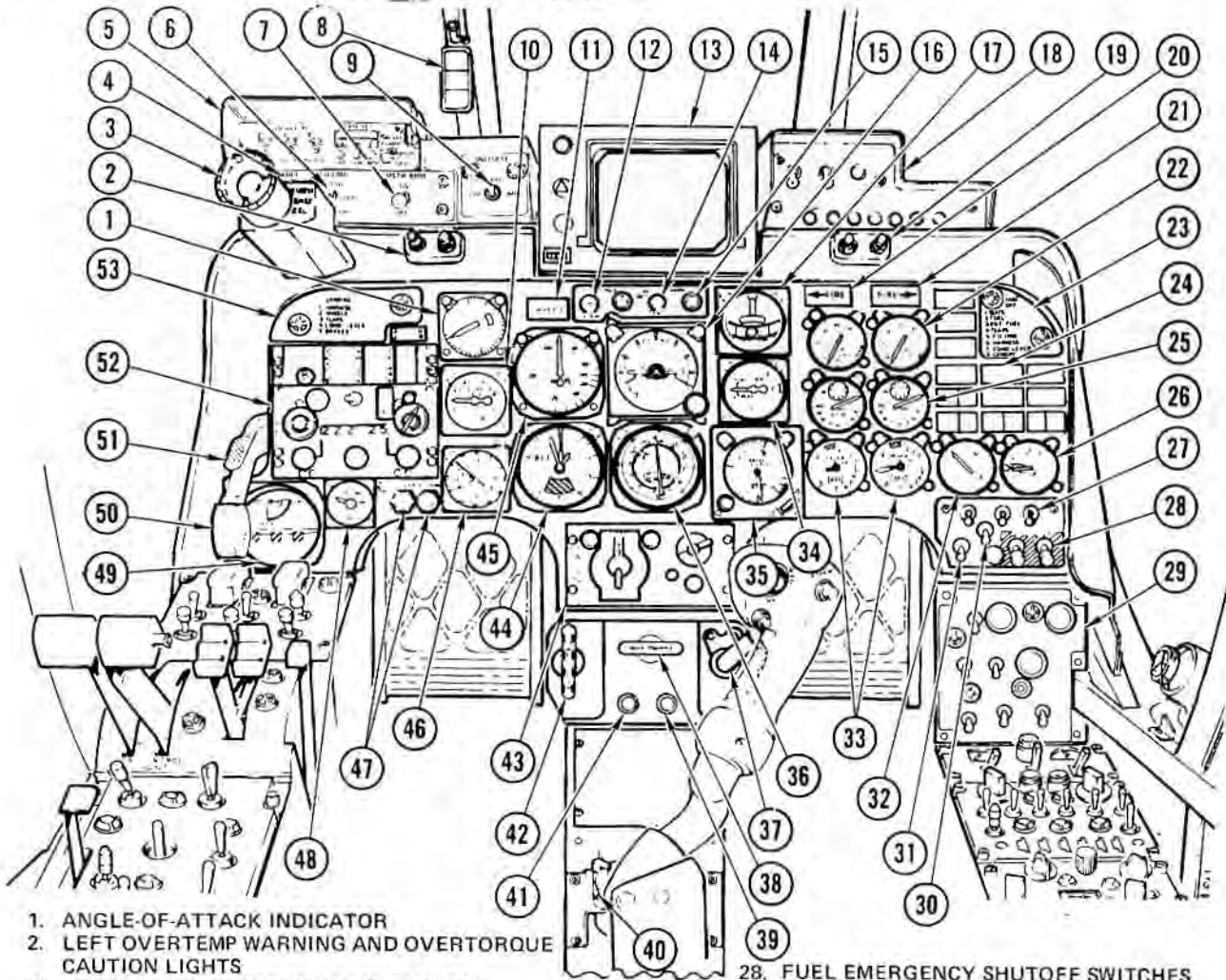

- | | |
|--|--|
| <ol style="list-style-type: none"> 1. ANGLE-OF-ATTACK INDICATOR 2. LEFT OVERTEMP WARNING AND OVERTORQUE CAUTION LIGHTS 3. STORES EMERGENCY RELEASE BUTTON 4. LASER ENABLE SWITCH 5. AN/ALE-39 COUNTERMEASURES DISPENSER CONTROL PANEL* 6. FLIR COMMAND SWITCH 7. MASTER ARMAMENT SWITCH 8. APPROACH INDEXER 9. AN/ALE-39 INITIATE SWITCH* 10. ACCELEROMETER 11. WHEELS WARNING LIGHT 12. TACAN POWER SWITCH 13. PILOT'S FLIR DISPLAY 14. ATTITUDE GYRO ERECT SWITCH 15. LIGHTS TEST SWITCH 16. ATTITUDE INDICATOR ARU-13/A 17. TURN-AND-SLIP INDICATOR 18. WEAPONS CONTROL PANEL 19. RIGHT OVERTEMP WARNING AND OVERTORQUE CAUTION LIGHTS 20. LEFT ENGINE FIRE WARNING LIGHT 21. RIGHT ENGINE FIRE WARNING LIGHT 22. ENGINE TORQUE INDICATORS 23. TAKE-OFF CHECKLIST 24. WARNING AND CAUTION LIGHTS 25. ENGINE TACHOMETERS 26. OIL PRESSURE INDICATOR 27. EXTERNAL FUEL TRANSFER SWITCHES | <ol style="list-style-type: none"> 28. FUEL EMERGENCY SHUTOFF SWITCHES 29. HEAT-VENT-DEFROST CONTROL PANEL 30. FUEL GAGE TEST SWITCH 31. FUEL GAGE SELECT SWITCH 32. FUEL QUANTITY INDICATOR 33. TURBINE INLET TEMPERATURE INDICATORS 34. VERTICAL VELOCITY INDICATOR 35. RADAR ALTIMETER INDICATOR 36. BEARING-DISTANCE-HEADING INDICATOR 37. PEDAL ADJUST CRANK 38. PARK BRAKE HANDLE 39. HYDRAULIC PRESSURE CAUTION LIGHT 40. VOLTAMMETER 41. HYDRAULIC PUMP INDICATOR LIGHT 42. EMERGENCY STORES JETTISON HANDLE 43. TACAN CONTROL PANEL 44. ALTIMETER 45. AIRSPEED INDICATOR 46. CLOCK 47. TRIM NEUTRAL LIGHTS (RUDDER-AILERON) 48. ELEVATOR TRIM INDICATOR 49. GEAR-FLAP POSITION INDICATOR 50. LANDING GEAR HANDLE 51. GEAR HANDLE RELEASE LEVER 52. UHF COMM CONTROL PANEL 53. LANDING CHECKLIST |
|--|--|

*AIRCRAFT HAVING AFC 82 INCORPORATED

OV-10D-1-4F

Figure 1-3

PILOT'S RIGHT CONSOLE

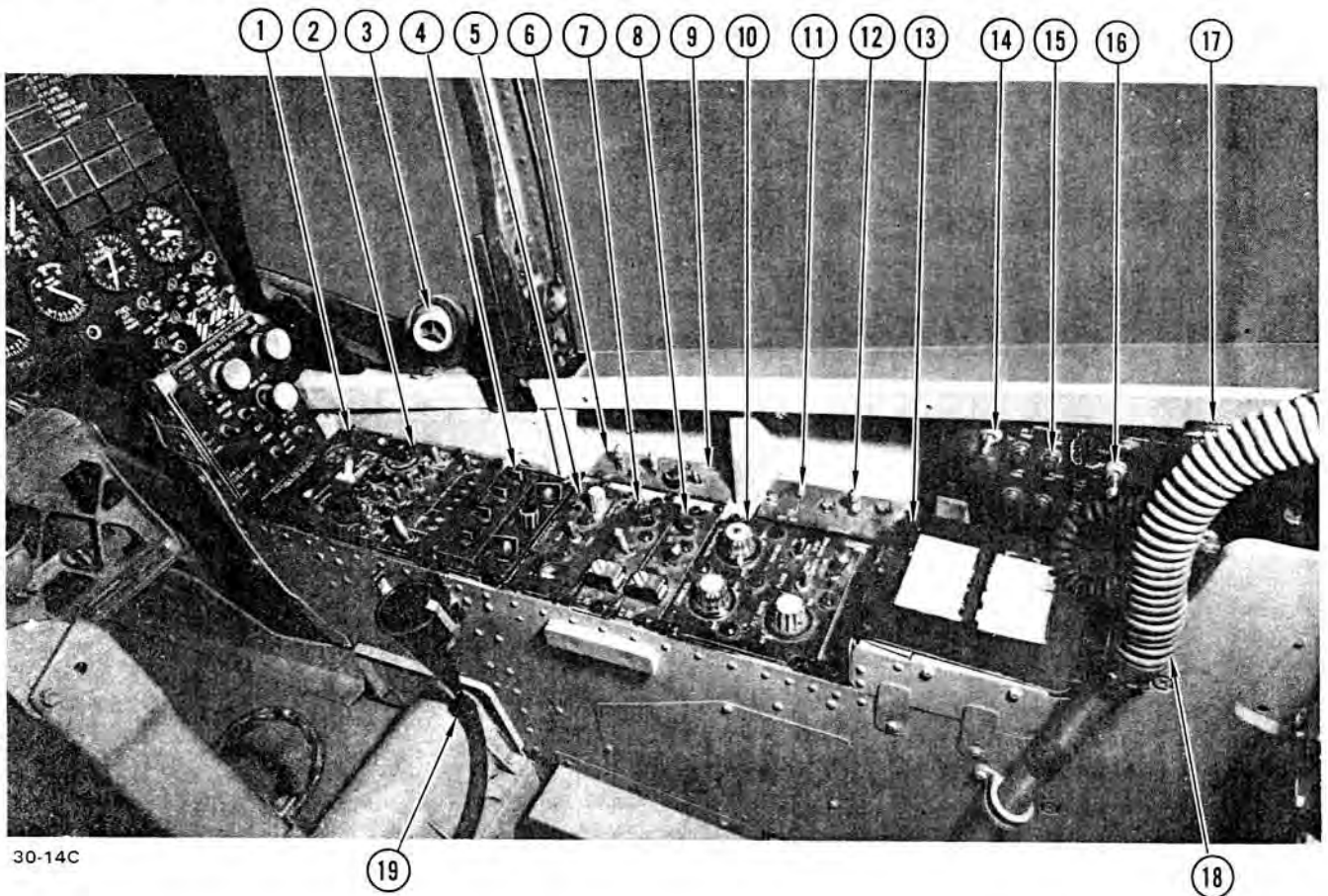

30-14C

1. OXYGEN REGULATOR
2. IFF-SIF CONTROL PANEL
3. DEFROST DUCT SWIVEL NOZZLE
4. VHF-FM NO. 2 CONTROL PANEL
5. COMPASS CONTROL PANEL
6. BLEED AIR SWITCHES
7. KY-28 CONTROL PANEL (VHF)
8. KY-28 CONTROL PANEL (UHF)
9. VHF-FM TAKE COMMAND SWITCH AND LIGHT
10. INTERIOR LIGHTS CONTROL PANEL
11. AMMETER SELECT SWITCH
12. IFF ANTENNA SELECT SWITCH
13. MAP CASE
14. SEAT ADJUST SWITCH
15. CIRCUIT BREAKERS
16. CARGO BAY LIGHTS SWITCH
17. UTILITY LIGHT
18. OXYGEN HOSE
19. RELIEF TUBE

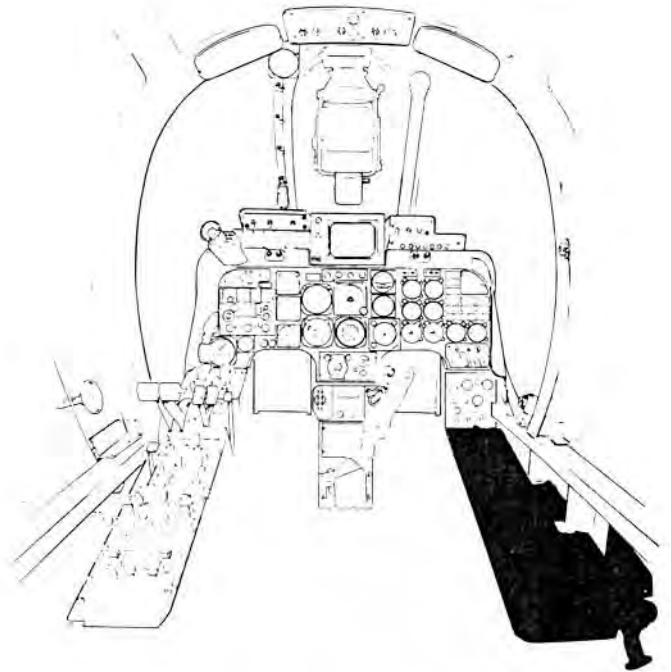

OV-10D-1-12B

Figure 1-4

OBSERVER'S COCKPIT

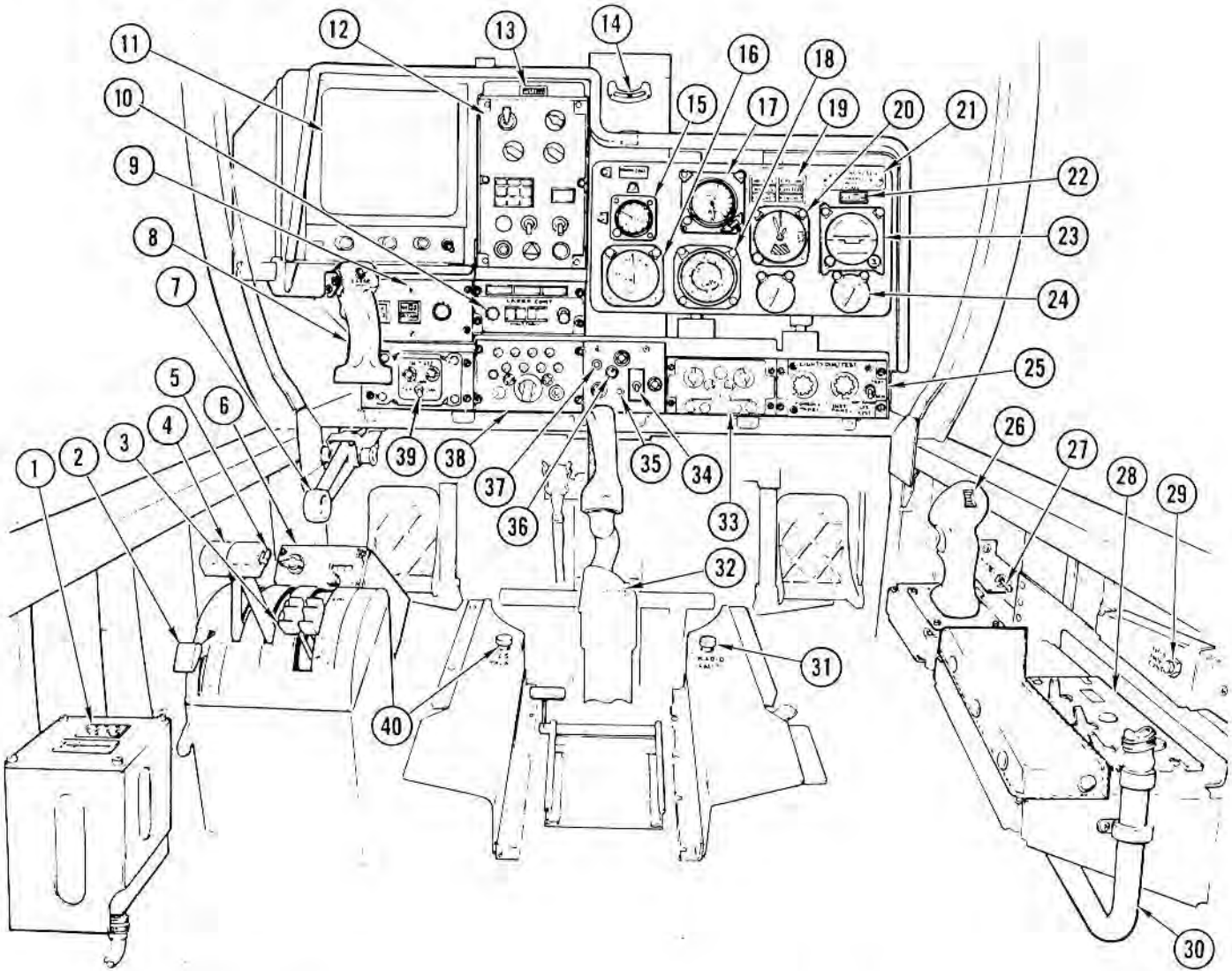

- 1. PULSE CODER GENERATOR
- 2. FLAP HANDLE
- 3. ENGINE CONDITION LEVERS
- 4. POWER LEVERS
- 5. MICROPHONE SWITCH
- 6. FLIR RECEIVER-TRANSMITTER-CONVERTER CONTROL
- 7. LANDING GEAR HANDLE
- 8. FIRE CONTROL GRIP ASSEMBLY
- 9. VIDEO TRACKER CONTROL
- 10. LASER CONTROL PANEL
- 11. VIDEO INDICATOR
- 12. FLIR CONTROL PANEL
- 13. FLIR "PILOT CONTROL" LIGHT
- 14. SLIP INDICATOR
- 15. CLOCK
- 16. AIRSPEED INDICATOR
- 17. RADAR ALTIMETER
- 18. BEARING-DISTANCE-HEADING INDICATOR
- 19. WARNING AND CAUTION LIGHTS
- 20. BAROMETRIC ALTIMETER

- 21. LANDING CHECKLIST
- 22. FUEL LOW WARNING LIGHT
- 23. GYRO HORIZON INDICATOR
- 24. TIT INDICATORS
- 25. LIGHT DIMMING CONTROL PANEL
- 26. TARGET TRACKING SIGHT CONTROL
- 27. SEAT ADJUST SWITCH
- 28. OXYGEN REGULATOR
- 29. NO. 3 INVERTER CONTROL CIRCUIT BREAKER
- 30. OXYGEN HOSE
- 31. RADIO TRANSMIT SWITCH
- 32. COCKPIT AIR CONTROL VALVE
- 33. VHF-FM CONTROL PANEL
- 34. EMERGENCY IFF SWITCH
- 35. MIC SELECT SWITCH
- 36. VHF-FM COMMAND LIGHT
- 37. VHF-FM TAKE COMMAND SWITCH
- 38. INTERCOM (ICS) CONTROL PANEL
- 39. AN/ALE-39 INITIATE SWITCH*
- 40. ICS TALK SWITCH

*AIRCRAFT HAVING AFC 82 INCORPORATED OV 10D-1-14E

Figure 1-5

PRINCIPAL DIMENSIONS

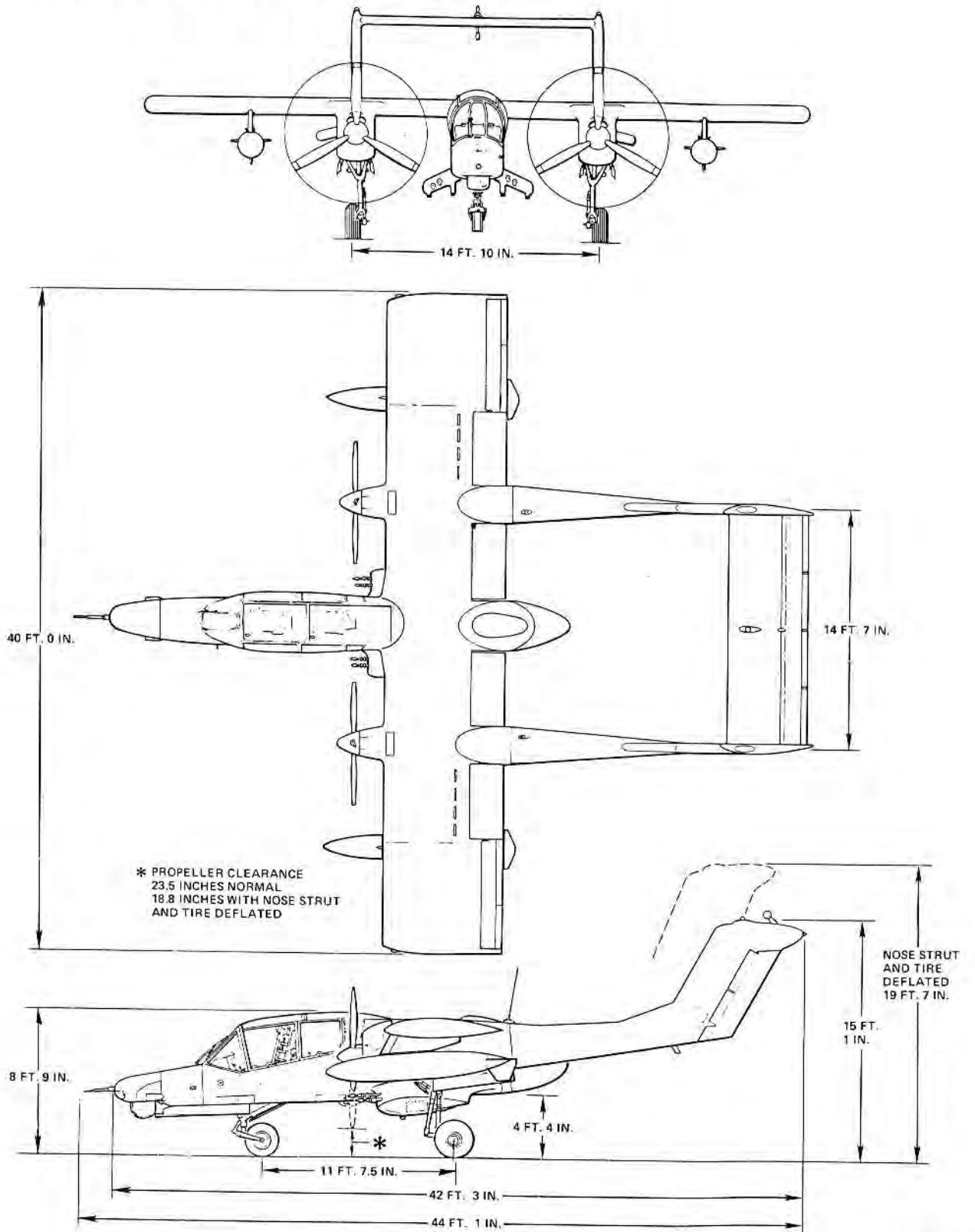

OV 100.1 13C

Figure 1-6

PART 2 — SYSTEMS

ENGINES

The aircraft is powered by two Garrett-AiResearch T76-G-420 (left) and -G-421 (right) fixed-shaft turboprop engines, rated 1040 shaft horsepower. The major engine components consist of the reduction gearbox, a two-stage centrifugal compressor, a three-stage axial turbine surrounded by an annular combustion chamber and the accessory section. See figures 1-7 and 1-8. The engine is attached to a tubular truss, with three vibration isolation mounts, which is attached to the nacelle in four places.

ENGINE EXHAUST SYSTEM

IR suppression exhaust stacks are provided on all aircraft. The IR suppression system wraparound deflectors produce incremental exhaust gas pressure losses; however, aircraft propulsion performance degradation is less than 2 percent.

ENGINE FUEL SYSTEMS

Fuel is supplied to the engines from the wing center/feed tank in which a submerged boost pump is installed. Fuel at low pressure is then directed to the combination low/high pressure fuel pumps, which supply fuel at high pressure to the fuel control units. The fuel control units provide engine overspeed protection through an automatic flow limiting feature of the overspeed governor which is set at 103.8% to 104.3% rpm. An underspeed governor on each engine sets minimum propeller rpm for selected flight conditions. To provide for cold temperature and high altitude engine starting, a fuel enrichment system provides supplemental starting fuel which bypasses the fuel control and fuel shutoff valve and is fed directly into the engine.

FUEL ENRICHMENT SYSTEM

The start fuel enrichment system provides automatic fuel enrichment during engine starting when the exhaust gas temperature is less than 450 (± 50)°C. When the START switch is positioned to START, this supplemental fuel flow will be provided automatically at 10% rpm by powering the fuel enrichment solenoid valve through the engine speed

sense switch. (Ignition also occurs at 10%). This fuel is provided to the engine independent of the position of the condition lever since it bypasses the engine fuel shutoff valve. Holding the AIRSTART (IGNITION & UNFEATHER) switch in the CRANK position will interrupt this fuel flow. Should the temperature sensing switch 450 (± 50)°C fail to cut off start during a ground start, it will be automatically terminated at approximately 50% rpm by the engine speed sense switch. Shutting the engine down during a ground start when the engine has not reached 50% rpm will require moving the condition lever to FUEL SHUT-OFF and repositioning the START switch to ABORT; otherwise the start fuel system will continue to supply the engine with fuel and it will continue to run at approximately 20% rpm and 400 to 500 EGT. During engine airtarts, positioning the AIRSTART switch to ON provides immediate, direct power to the fuel enrichment solenoid valve when the exhaust gas temperature is less than 450 (± 50)°C. The ON position also directs power to the unfeather and ignition circuits immediately. With ignition and fuel present, the engine will run even if the condition lever is in the FUEL SHUT-OFF position.

Note

Failure of the engine temperature sensing switch to cut off start fuel at 450 (± 50)°C may prevent a successful airtart attempt by inducing high EGTs prior to reaching 10% rpm, since both ignition and start fuel are available immediately upon actuation of the AIRSTART switch.

ENGINE IGNITION SYSTEMS

Each independent engine ignition system consists of an ignition unit and a single igniter plug mounted in the engine combustor. For ground starts the system is energized by the engine speed sensing switches as the rpm passes approximately 10%. Igniter operation is cut out automatically as rpm passes 50%, discontinuing the start cycle and preventing the ignition unit duty cycle from being exceeded. For airtarts, the ignition system is manually energized when the IGNITION & UNFEATHER switch is moved to ON. To discontinue the ignition cycle this switch must be moved to the AUTO position.

T76 ENGINE

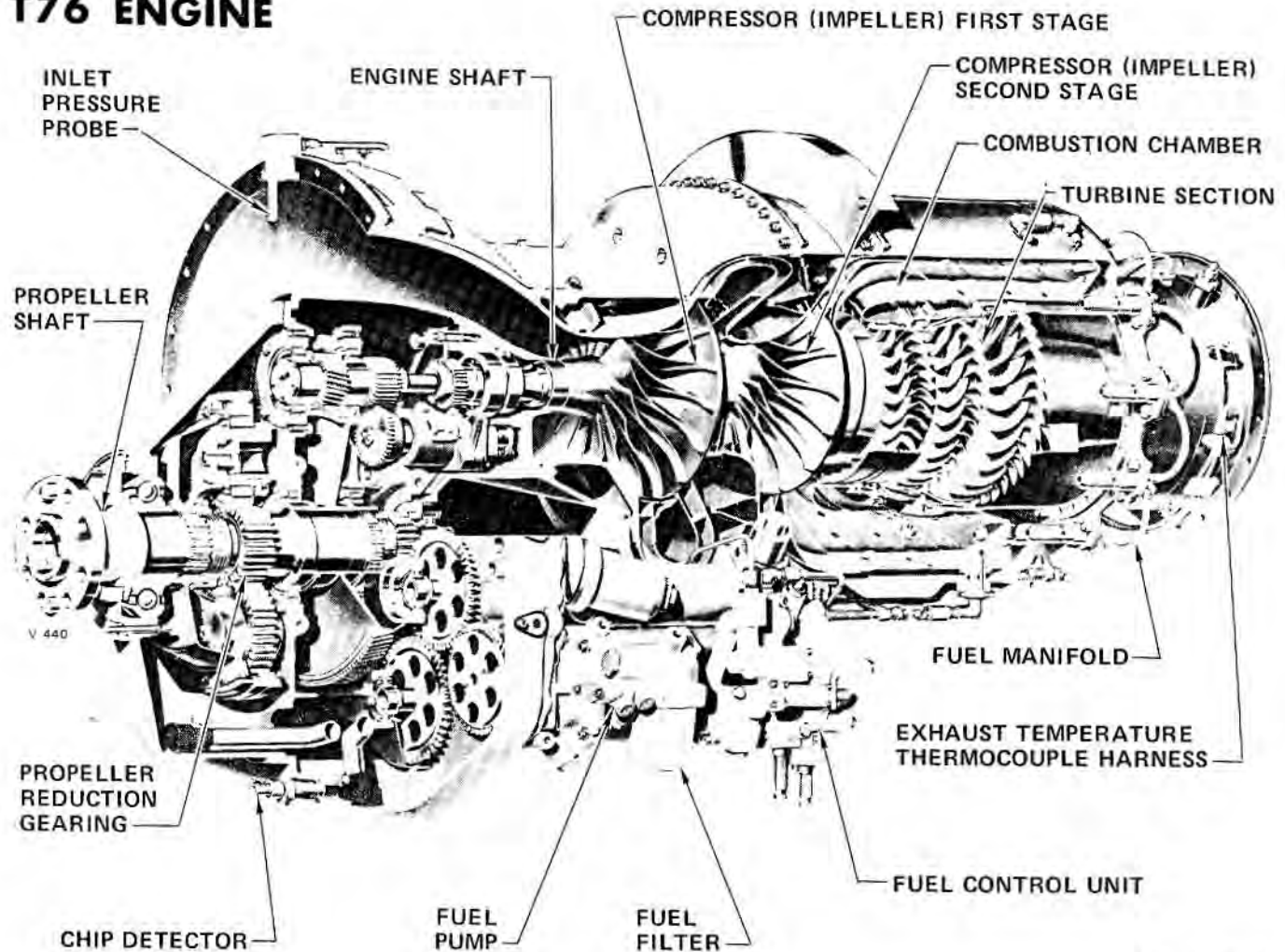

OV-10D-1-126

Figure 1-7

ENGINE OIL SYSTEMS

An independent, dry sump oil system is provided for each engine. These systems provide both engine lubrication and propeller control system supply. Total oil system capacity is 2.25 gallons with a flow rate of 4 to 7 gallons per minute. Oil is stored in a 1.5-gallon tank on each engine, 1.25 gallons of which are usable. At ground idle (65% rpm), minimum oil pressure is 48 psi. Above 91% rpm, oil pressure is regulated at 105 (± 15) psi by the return of excess oil from the engine-driven pump back to the inlet side of the oil pump. For limits at all rpm, refer to OIL PRESSURE LIMITS, Part 4, in this section. Each system includes an air-oil cooler and oil cooler door system to maintain oil temperature at approximately 190°F (87.7°C). The air-oil cooler incorporates a thermostatic valve and a pressure relief valve to direct scavenge oil to the cooler core or directly to the oil tank. The air-oil cooler doors, located on the wing leading edge above each nacelle,

open when the landing gear extend to ensure airflow through the air-oil cooler during ground operations. Both engine accessory gearcases are equipped with a magnetic drain plug which attracts any ferrous particles present in the lower area of the sump. The plugs provide the electrical ground for operations of the engine chip warning lights.

ENGINE CHIP CAUTION LIGHTS

The L CHIP and R CHIP caution lights (figure 5-1) are located on the pilot's instrument panel. Collection of sufficient ferrous particles on either engine accessory case chip detector will cause the associated caution light to illuminate. The 28-volt d-c primary bus provides electrical power for light operation.

ENGINE – EXTERNAL VIEW

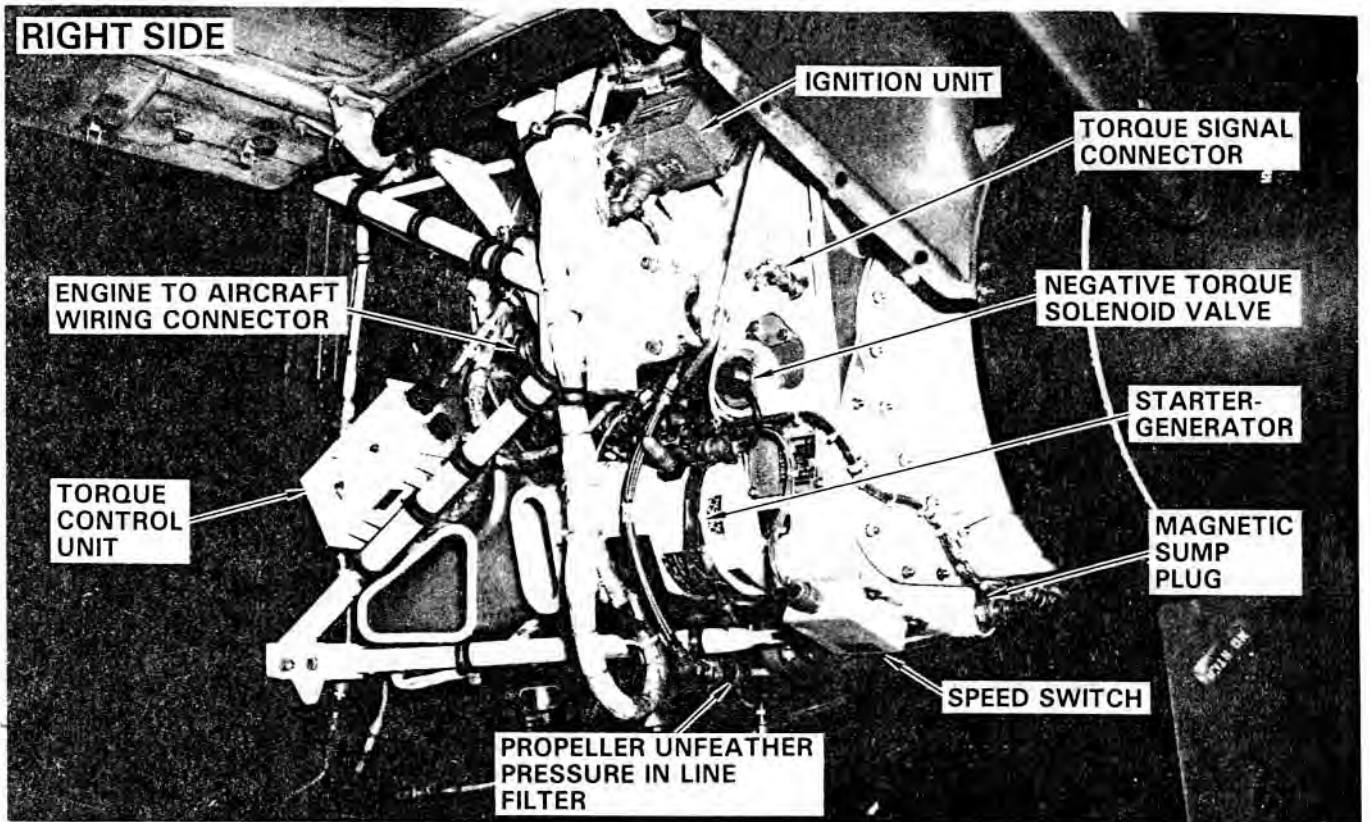

-40-5B

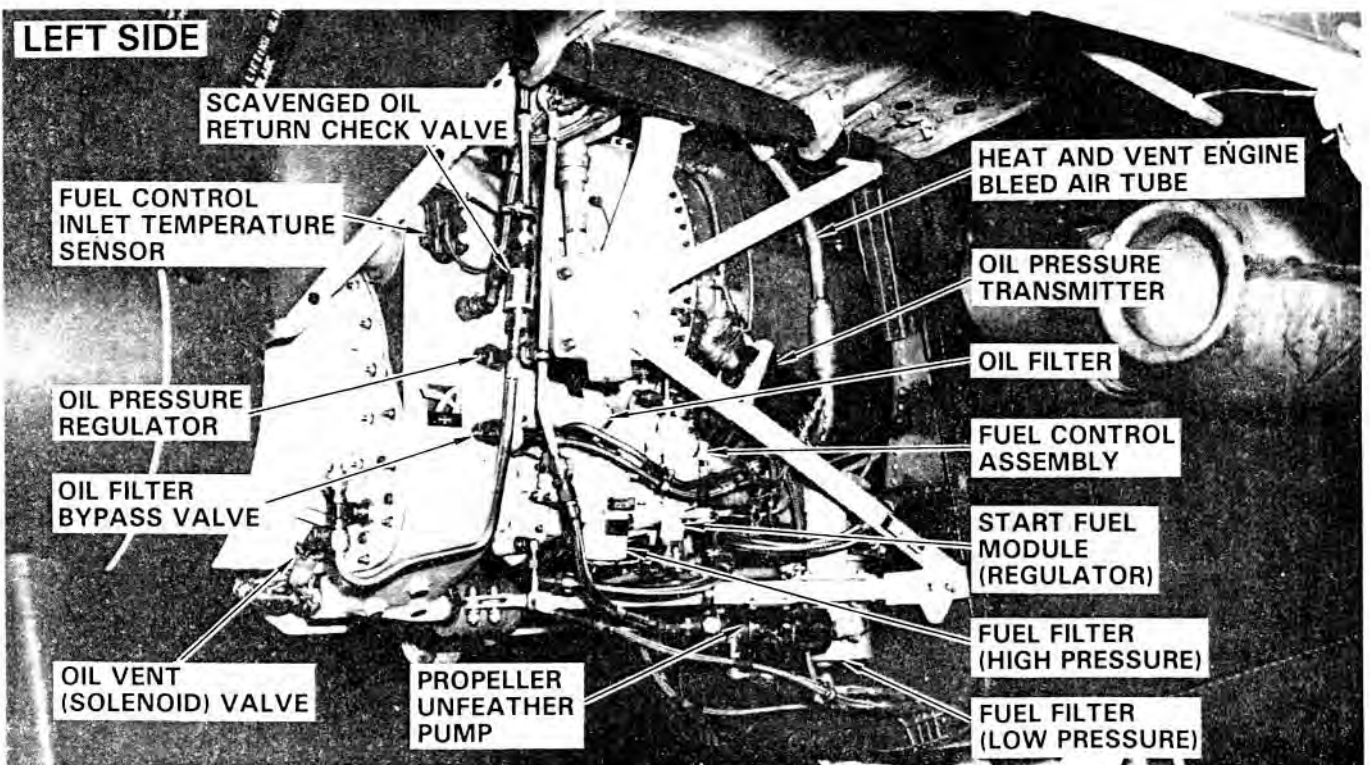

-40-5D

OV-10D-1-173

Figure 1-8

NACELLE FIRE WARNING SYSTEM

The nacelle fire warning system for each engine consists of an independent fire detector control assembly in each boom, a continuous-sensing element routed around each engine compartment, the nacelle FIRE warning lights, and a system test switch. The fire warning system normally operates on 115-volt a-c power but automatically operates on 28-volt d-c power in the event of a-c power failure. As engine compartment temperature rises, the resistance of the sensing element lowers and is monitored by the control assembly. This signal energizes a relay to illuminate the FIRE warning light.

NACELLE FIRE WARNING LIGHTS

Two nacelle fire warning lights are located on the pilot's (figure 1-3) and observer's instrument panels (figure 1-5). When illuminated, these lights point toward the engine compartment in which overheat or fire is detected. The entire fire warning system may be tested by holding the lights test switch in the FIRE DET position. A-C (primary) electrical power is provided by the 115-volt a-c, 400-cycle primary bus and d-c (secondary) electrical power is taken from the d-c battery bus.

AIR START (IGNITION AND UNFEATHER SWITCHES)

The AIR START (IGNITION & UNFEATHER) switches (figure 1-11) are located on the pilot's engine start and electrical control panel. These switches are covered with red guards labeled "AIR START" and have ON, AUTO, and CRANK positions. In AUTO (guards down), the ignition systems are armed for ground starts and controlled by the engine rpm sensing switches. With the main d-c bus energized, the ON position activates the propeller unfeathering pump, provides continuous ignition system operation, furnishes supplemental starting fuel by means of the start fuel enrichment, and trips the generator. The ON position is used for air starting the engine; the switch must be returned to the AUTO position after the start to shut off the ignition system and the unfeather pump, and to allow the generator to reset automatically.

CAUTION

The ignition system is not continuous duty. Limits are 2 minutes ON, 3 minutes OFF, 2 minutes ON, and 23 minutes OFF.

Note

When the AIR START switch is placed in the ON position, the cockpit temperature gage indicates EGT.

With the BATTERY switch ON or external d-c power applied, holding either switch in CRANK activates the corresponding unfeathering pump, and interrupts the fuel enrichment and igniters to the applicable engine. Refer to ENGINE OPERATION, in this section.

STARTER SWITCHES

The L START and R START switches (figure 1-11) are located on the pilot's engine start and electrical control panel. These three-position lever-lock-type switches are marked START, RUN, and ABORT, and require positive, lift-to-unlock action to select the START position. With the BATTERY switch ON (with or without external d-c power applied), holding the desired switch momentarily in START initiates engine starter operation through a holding relay. The ABORT position deenergizes the automatic ignition circuit, disengages the starter, and cuts off fuel enrichment flow. During flight, the ground start system is not functional since electrical power is removed from the ground start switches by the landing gear safety relay when the aircraft is airborne.

WARNING

If the START switch is energized and the engine fails to crank, move the START switch to ABORT to deenergize the automatic ignition circuit prior to attempting any further corrective action. Failure to do so may cause inadvertent engine start if the circuit is later completed.

START IGNITION ON LIGHT

The START IGN ON advisory light is installed on the pilot's instrument panel. This amber light is illuminated whenever an engine is started as in a normal ground start (one engine at a time) or when either or both engines are started on the air start system. The START IGN ON light should extinguish at 50% rpm during a normal ground start, and when the AIR START switches are moved to AUTO following air start. This light receives 28-volt d-c power from the main bus.

FIRE DETECTION/WARNING LIGHTS TEST SWITCH

The FIRE DET/WARN LTS TEST switch on the pilot's instrument panel (figure 1-3) is used to provide an operational test of the nacelle fire detection and warning system, and to test illumination of all warning and caution light bulbs and the engine overtemperature audible warning tone. With primary d-c bus power available, holding the switch in FIRE DET tests the continuity of the nacelle fire detection and warning system. With primary d-c bus power available, holding the switch in WARN LTS tests all warning and caution lights and the audio level of the overtemperature warning tone. The WARN LTS TEST switch on the observer's interior lights panel (figure 1-5) is used to test illumination of all warning and caution light bulbs on the observer's instrument panel. For warning lights information, see figures 5-1 and 5-2.

PROPELLERS

Each engine drives an 8.5-foot, three-blade, fully reversible aluminum spar, fiberglass covered propeller. At Military rated engine rpm (41,730), the propellers rotate at 2000 rpm. To reduce torque effect, the left propeller rotates clockwise and the right propeller rotates counterclockwise. Normal operation of the propeller is achieved by the propeller control system using high-pressure oil to hold the propeller blades at the required position to maintain rpm. The propeller control systems use engine oil boosted in pressure by the propeller governors. In the event of complete control oil pressure loss, the propeller will automatically be driven to a near-feathered position by the force applied against the propeller blade pitch control piston by a stack of compression washers. The propeller control systems incorporate dump (feather) valves which allow the pilot to manually select feathering as required.

TURBINE INLET TEMPERATURE SYSTEM

The turbine inlet temperature system consists of the engine thermocouple harness, a d-c powered resistor, an a-c powered temperature computer for each engine, and the d-c powered indicators.

During engine starts (at less than 50%), the TIT indicators display exhaust gas temperature (EGT). At engine speeds above minimum generator cut-in rpm (50% to 53%), the turbine inlet temperature system provides simplified engine temperature in the form of computed turbine inlet temperature. As the known temperature differential between exhaust gas temperature and TIT changes with operation conditions, the computed output varies as a function of the ratio of compressor discharge pressure to turbine discharge pressure. The final product is a computed temperature indication which accounts for airspeed, altitude, and outside air temperature variations. Operation of the overtemperature warning lights and audible warning tone is a direct function of the TIT indicators. These lights and tone allow pilot attention to be directed outside the cockpit when operationally required. By adjusting the power levers to prevent actuation of the TEMP warning system, the pilot is assured that engine temperature limits are not being exceeded. If electrical power failure to a TIT indicator occurs during engine start or in flight, the indicator pointer shall return to a reading less than 100°C from any point on the dial, and the overtemperature warning system is inoperative.

OVERTEMPERATURE WARNING

Two red TIT (L, R) warning lights are installed above the instrument panel shroud in the pilot's cockpit (figure 1-3). These warning lights operate in conjunction with the turbine inlet temperature indicators, illuminating when the respective TIT needle reaches 1125 (+4/-0)°C position. To aid in monitoring TIT during flight, a 1000-hertz audible tone (three per second) provides additional warning of impending overtemperature to the pilot. The tone operates in parallel with each TIT overtemperature warning light. Should engine overtemperature be encountered, retarding the affected engine power lever(s) will extinguish the light(s) and stop the tone when TIT drops 6°C below the temperature at which the light was illuminated. Illumination of the light and initiation of the tone occurs at less than the maximum allowable temperature limit to call attention to the indicators. Electric power for the lights and the circuit through the indicator switch is 28 volts from the main d-c bus. Holding the warning lights TEST switch in WARN LTS position actuates both the tone and the lights.

ENGINE AND PROPELLER INDICATORS

TURBINE INLET TEMPERATURE INDICATORS

Two turbine inlet temperature indicators (figures 1-3 and 1-5) are installed on the pilot's instrument panel and observer's instrument panel. The indicators operate on 28-volt d-c power provided by the battery bus. The indicators are calibrated from 100° to 1200°C. In the event of a suspected malfunction of the TIT system, EGT may be determined by placing the AIR START switch in the ON position as long as 28-volt d-c power is available to the indicator.

During ground starts (below 50% rpm or generator cut-in speed) or when the AIR START switch is in the ON position, the indicators reflect exhaust gas temperature (EGT). At 50% rpm and with instrument power switch ON, the system switches from EGT to TIT and the needle movement to the higher TIT reading is very rapid, for example from 650° to 850°C. For engine temperature limits, refer to Section I, Part 4.

TACHOMETERS

Two engine tachometers (figure 1-3) are installed on the pilot's instrument panel. These electrically independent indicators reflect engine rpm in percent of Military rated rpm and do not require any electrical power from the aircraft.

ENGINE TORQUE INDICATORS

Two engine torque indicators are located on the pilot's instrument panel (figure 1-3). These indicators are calibrated in pound-feet from 500 to 3500. The torque indicators are controlled by the engine torque unit and powered by the 28-volt d-c primary bus.

OVERTORQUE CAUTION LIGHTS

Two amber TOR (L, R) caution lights are installed above the instrument panel shroud in the pilot's cockpit (figure 1-3). These caution lights operate in conjunction with the engine torque indicators, illuminating at 3282 to 3318 pound-feet torque. Should overtorque be encountered, recording the affected engine power lever(s) will extinguish the light(s) when torque has been decreased by approximately 37 pound-feet. Holding the lights TEST switch in TEST checks the TOR caution light bulb circuits. The overtorque caution lights receive electrical power from the d-c primary bus.

OIL PRESSURE INDICATOR

A dual-needle oil pressure indicator (figure 1-3) is located on the pilot's instrument panel. This indicator is calibrated in pounds per square inch from 0 to 200. Electrical a-c power for the oil pressure indicators is provided by a static inverter.

ENGINE OPERATION

Air is drawn through an inlet above the propeller, hub, compressed by a two-stage centrifugal compressor

(impeller), mixed with fuel, and ignited within a reverse-flow annular combustor. The resultant expanded gases drive a three-stage turbine. The compressor and turbine sections rotate on a common shaft where power is extracted to drive the propeller reduction gears. The reduction gears convert the high speed, low torque of the turbine to the lower speeds and higher torques necessary to drive the propeller and the components that control engine operation. Military power (100% rpm) is achieved at 41,730 rpm of the compressor-turbine shaft (propeller shaft rotation 2000 rpm). The engine fuel control units schedule fuel flow through inputs of the power lever position, compressor inlet pressure and temperature, compressor discharge pressure, and engine rpm. Engine rpm and propeller blade angle are scheduled through condition and power levers by an independent power management control system.

POWER MANAGEMENT CONTROL SYSTEM (PMCS)

The PMCS simplifies power/thrust management by automatic control and correlation of all functions of the engine and the propeller into a single-point input to the cockpit power lever. A separate power lever and a condition lever are provided for each engine/propeller. The PMCS provides both governing-type control mode and a beta-type control mode. The system automatically transitions from one mode to the other as flight conditions and power lever positions dictate.

POWER LEVERS

The power levers are located on the left console quadrants (figures 1-2 and 1-5). The quadrants are marked at FULL REVERSE, GROUND START, GROUND IDLE, FLIGHT IDLE, and MILITARY positions. The power levers are linked to the engine fuel control units and the propeller governor units through the power management control systems. The primary functions of the power levers are to control engine fuel flow and propeller speed (rpm) setting, and to select reverse thrust. Selection of FULL REVERSE drives the propeller blades against the reverse pitch stops to obtain maximum reverse thrust, and also automatically provides the required fuel flow for reverse thrust conditions. The GROUND START position of the power levers approximates the area of minimum torque. Placement at the FLIGHT IDLE mark provides in-flight minimum fuel flow and torque, depending on airspeed. Reverse thrust is obtained by retarding the power levers into the reverse thrust range. Inadvertent in-flight selection of reverse thrust is prevented by a solenoid-operated gate in the pilot's power quadrant at the FLIGHT IDLE position. The gate is automatically retracted with the weight of the aircraft on the left main landing gear through the action of the ground safety switch. In the event of malfunction, the gate can be bypassed by lifting the power levers approximately 1/4 inch and then going to the reverse thrust position.

CAUTION

The power levers shall not be retarded aft of the "gate" in flight.

CONDITION LEVERS

The condition levers are located on the left console quadrants (figures 1-2 and 1-5), inboard of the power levers. The quadrants are marked T.O./LAND, NORMAL FLIGHT, FUEL SHUT-OFF, and FEATHER & FUEL SHUT-OFF. The condition levers are linked to the engine fuel shutoff valve, and the propeller feather valve through the power management system. The primary function of the condition levers is to permit selection of any engine power setting at high propeller rpm for rapid thrust transients at all power lever settings, to initiate or shut off fuel flow to the engines (FUEL SHUT-OFF), and to manually feather the propellers and shut off fuel to the engines (FEATHER & FUEL SHUT-OFF).

WARNING

Placing a condition lever in NORMAL FLIGHT position when the engine is not running will cause the fuel trapped under pressure between the engine-driven fuel pump and the fuel shut-off valve to be injected directly into the combustion chamber. A fire is highly probable if the engine is hot.

FRICITION LEVER

Operating friction of the pilot's and observer's power levers may be adjusted through a friction lever on the pilot's quadrant in the front cockpit only (figure 1-2). Operating friction of the engine condition levers is ground-adjusted.

Governing Control Mode

In the governing mode, the engine shaft horsepower output and speed (rpm) are variables selected and set by the pilot. Fuel flow to the engine is selected by manipulation of the engine fuel control input through the cockpit power lever to set the power delivered to the propeller. Simultaneously through the PMCS, the operating speed (rpm) of the system is established by a speed set input signal to the propeller control. The propeller governor automatically provides propeller blade angle pitch control to maintain the selected speed (rpm) so that the power delivered by the engine is equal to that absorbed by the propeller. During normal flight operations, governing-type speed control is provided.

Propeller Governor

The propeller governor regulates and controls the operating speed (rpm) of the engine-propeller combination by hydraulic modulation of the propeller blade angle, as required to absorb the power output of the engine at the selected set speed. The propeller governor incorporates an internal set of spring-balanced flyweights

which are mechanically coupled to the engine-propeller shaft through appropriate gearing and directly senses the operating rpm. A pilot valve, actuated by the flyweights, controls the flow (volume) of oil to and from the propeller to control blade angle. The pilot valve acts to port oil to the propeller (which decreases blade angle) in the event of insufficient rpm, and to port oil away from the propeller (which increases blade angle) in the event of excessive rpm. The propeller governor provides an isochronous speed control characteristic (rpm control is independent and does not vary with load). Basic speed set to the propeller governor is derived from the power lever, and except as overridden by the condition lever input, sets the operation rpm from a minimum governing speed of 70% to a maximum of 101%.

Underspeed Governor (USG)

The underspeed governor (USG) is physically an integral component of the engine fuel control. The purpose of the USG is to provide supplementary fuel flow to that fuel flow scheduled and provided by the fuel control main fuel metering valve if this latter fuel flow is insufficient to permit attainment of the USG set engine speed. This device, combined with the beta valve, permits achievement of reverse thrust and beta-type control mode operation. Basic speed set to the USG is derived from the power lever, and except as overridden by the condition lever input, sets the minimum operating rpm. To prevent control interaction, USG set rpm (65%–66%) must always be below the propeller governor set rpm (70%–71%).

Overspeed Governor (OSG)

The purpose of the overspeed governor is to limit the maximum rpm within safe limits in the event of propeller governor or underspeed governor speed control failure or malfunction. The overspeed governor is physically an integral component of the engine fuel control, and acts to limit/reduce fuel flow in accordance with a speed (rpm) input. OSG action takes precedence over all other fuel inputs to the engine. The engine OSG provides a speed-droop characteristic and nominally is set to provide a limiting rpm of 104% when the propeller blades are locked and positioned on the shutdown pitch stop (minimum torque—zero airspeed).

Beta Valve

The beta valve schedules the minimum blade angle to which the propeller governor may drive the propeller. In the beta mode, this valve is positioned by the power lever and hydraulically controls the propeller blade angle.

Beta Control Mode

In the beta mode of control, propeller blade angle is set by the power lever and the fuel control underspeed governor automatically adjusts the fuel flow and power output of the engine to maintain the selected rpm at the

selected blade angle. The PMCS simultaneously coordinates these functions as selected through movement of the power lever to maintain the engine speed desired. During beta mode of control, the propeller governor speed set is rescheduled to a high level to eliminate its interaction with the underspeed governor on the engine.

NEGATIVE TORQUE SENSING OPERATION

In the event of flame-out or sudden power loss, the airflow will attempt to turn the propeller and thus drive the engine (negative torque). This high drag condition is undesirable. The negative torque sensing (NTS) system in the T76 engine will automatically sense negative torque and will act to drive the propeller toward high pitch (feather), resulting in a low drag (only slightly higher than in feather),

no-thrust condition with the engine windmilling. When the negative torque condition no longer exists, the NTS system will return control of the propeller to the normal propeller control system. At any time during this sequence, the pilot may elect to feather the propeller with the condition lever. The NTS system removes the urgency from the feathering procedure. If an engine failure occurs, the pilot has time to identify the malfunctioning engine and take appropriate action. Although this low-drag operation will continue as long as oil pressure is available, the propeller of the failed engine should be feathered as soon as practical.

ENGINE CONDITIONS

For graphic presentation of engine operation under various conditions, see figure 1-9.

ENGINE SPEED CONTROL

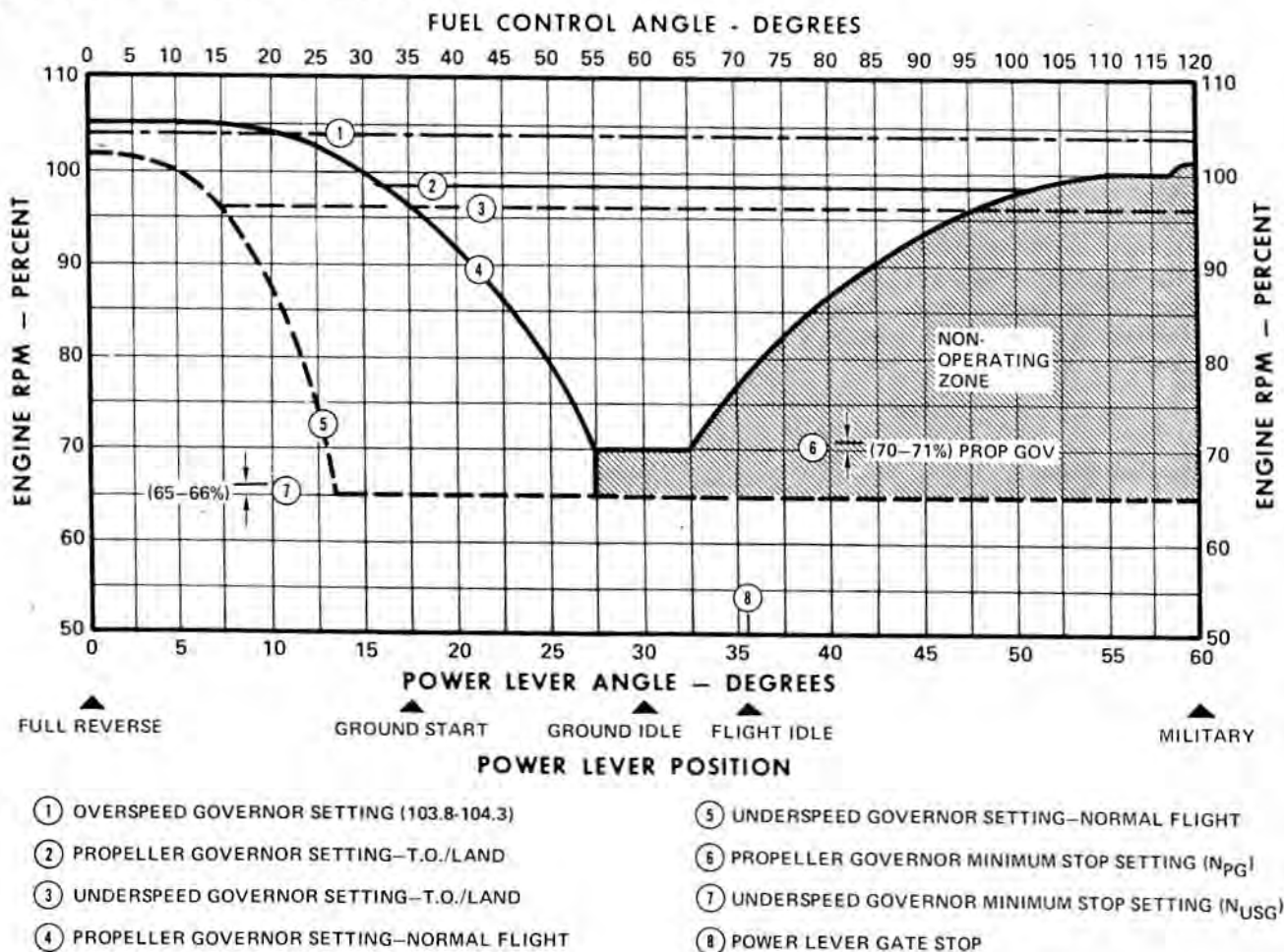

Figure 1-9

OV 10D-1-21A

Engine Starts

Engine starts may be performed by the pilot only, and can be achieved using battery power only or battery and external d-c electrical power. During battery starts of the first engine, all buses except the main and battery buses are disconnected from the system when the START switch is moved to the START position and remain disconnected until generator cut-in speed of approximately 50% is reached. If the propellers were feathered on the preceding shutdown, they shall be unfeathered and set in flat pitch, one at a time, prior to start to avoid hot or hanging starts. To accomplish unfeathering, the power levers are set in the reverse thrust range and the AIR START switches are held in CRANK until the propeller blades reach the full reverse position. Subsequently advancing the power levers into the positive thrust region releases unfeather pump oil pressure in the propeller dome, allowing the feathering mechanism to drive the blades toward feather position, engaging the flat pitch locks. For normal starts, the desired condition lever is positioned at FUEL SHUT-OFF, the corresponding power lever is set at GROUND IDLE, the corresponding starter switch is held momentarily in START, and the condition lever is moved to NORMAL FLIGHT. The resulting sequence of engine cranking, light-off, and acceleration is automatic. Light-off (EGT rise) normally occurs between 10% and 12% rpm. The START IGN ON light should illuminate when either engine start switch is held in START, and go out at 52% rpm for both battery-powered and externally powered starts. The START IGN ON light should illuminate when either AIR START switch is moved to ON and go out when the switch is returned to AUTO position.

CAUTION

Should the electrical external power unit fail on initiating engine start, overtemperature could occur. With BATTERY switch ON and engine START switch held momentarily in START, the engine selected will be motored by the starter if the external unit plug is extracted from the receptacle. To prevent undesired engine rotation, hold the applicable START switch in ABORT and/or move the BATTERY switch to OFF in the event of a bog-down failure of the external power unit. (Procedure outlined in Section V.)

Ground Operation

Prior to taxi, the propellers must be unlocked by retarding the power levers into the reverse thrust range momentarily until propeller unlocking action is detected. Unlocking action is confirmed by aircraft reaction to reverse thrust as the blades leave flat pitch and an rpm of 65% minimum to 71% maximum when the power lever is returned to GROUND IDLE. A slight rise in torque indication may be noted during unlocking. Taxiing may be accomplished in either the T.O./LAND or NORMAL FLIGHT position of the condition levers. Selection of NORMAL FLIGHT results in reduced propeller rpm, reduced thrust, and lower noise level.

Note

When the engines are to be operated for any length of time prior to take-off, the pilot may elect to place the condition levers to NORMAL FLIGHT and the power levers to GROUND START positions to provide lower fuel consumption, minimum thrust (essentially zero thrust), and the lowest noise level.

Take-off

With the condition lever in either the NORMAL FLIGHT or T.O./LAND position, when the power lever is advanced to MILITARY, maximum thrust is attained. The propeller governor is set at approximately 100% (increasing to 101% in the last 2 to 3 degrees of travel for use during propeller synchronization) and the propeller governor schedules blade angle as required to maintain rpm, absorb power, and develop thrust. Propeller rpm is essentially constant in the T.O./LAND condition. Changes in airspeed and power setting do not result in sound level variations.

Flight in Take-off and Land (T.O./LAND)

As the power lever is retarded from MILITARY, the propeller governor is reset to 99% and the power lever schedules fuel to the engine. The propeller governor schedules blade angle as required by power and airspeed. At low airspeeds and power, the desired blade angle may be below the minimum blade angle schedule. Since the propeller governor may not schedule below this minimum, the propeller load is too great for the power available and rpm begins to drop. The rpm lowers to the USG set point of 96% and then the USG adds fuel to maintain rpm. Thus, as the aircraft slows further, power is increased. This is known as beta mode operation.

Flight in NORMAL FLIGHT

As the power lever is retarded from MILITARY, the propeller governor is reset to the appropriate rpm for the power desired, down to a minimum of 70%. Transition to beta mode at 65% occurs below normal flight speeds and thus should not be observed in flight. It should be noted that during power changes along the portion of the schedule where both rpm and fuel flow vary, the propeller governor will correct rpm first, then absorb the increased power. Thus an increase in power lever will result in a momentary decrease in thrust until rpm reaches the new value; this condition is reversed when retarding the power levers.

Landing in T.O./LAND

In T.O./LAND, the aircraft transitions to beta mode at FLIGHT IDLE during deceleration. As the aircraft slows following touchdown, if the power lever is not retarded below the gate, positive thrust will be maintained and the landing roll will be increased. When the left main gear ground safety switch is closed, the gate stops are retracted and the power lever can be retarded to the GROUND START position or below. This action reduces the blade

angle and the USG then adds fuel, providing propeller drag (reverse thrust) instead of forward or positive thrust. The rpm remains at the USG setting. For limitations on use of reverse thrust, refer to REVERSE THRUST LIMITS, Part 4, in this section.

Reverse Power

As the power lever is retarded below GROUND START increasing negative blade angle, the USG begins to add fuel to support the propeller load. When full reverse is reached, the USG has been reset to a high rpm to provide more power in reverse. To avoid interference between the propeller governor and USG, the propeller governor is reset in reverse to 105% rpm so that it always senses underspeed and attempts to decrease blade angle, holding it on the reverse schedule. The maximum power (fuel flow) available from the engine due to underspeed governor action varies with engine rpm. Typically, reducing engine speed from 100% to 90% rpm reduces maximum power available by 300 shaft horsepower; an additional 10 shaft horsepower per percent rpm is lost below 90% rpm. Movement of the power levers below GROUND IDLE changes both the speed set of the underspeed governor and propeller blade angle. Due to the relative difference in the transient response of the engine speed/torque characteristics and propeller blade pitch control dynamics, under certain conditions, such as condition lever in NORMAL FLIGHT, it is possible to obtain a full reverse blade angle on the propeller without obtaining sufficient engine power and rpm to support this demand. Also at higher landing speeds, full reverse may require more propeller power than is available from the engine. Under these conditions, an engine bog-down is precipitated and immediate advancement of the power lever to the GROUND START position is required to move the propeller blade pitch to a position requiring less engine power. An engine bog-down is usually typified by a rapid decrease in engine rpm and an equally rapid rise in TIT. If this condition is not immediately arrested, severe temperature damage to the engine will occur. To preclude engine bog-down, landings should not be made when the condition lever is positioned to NORMAL FLIGHT. The NORMAL FLIGHT position permits the power lever to schedule engine rpm as low as 65% rpm during reverse thrust operation, which will not support power demands during rapid transient acceleration to full reverse thrust conditions. With the condition levers in T.O./LAND, engine rpm is never scheduled less than 94% so that engine-propeller power balance is maintained.

Engine Shutdown

Normal (Flat Pitch). For operational convenience (turn-around flights), engines are normally shut down with the propeller blades locked at flat pitch. To achieve shutdown in flat pitch, the power levers are adjusted to obtain minimum available indicated torque until TIT stabilizes. For shutdown, the condition levers are pulled to the FUEL SHUT-OFF position, immediately followed by retarding the power levers to FULL REVERSE and

holding until engine rotation stops. Advancing the power levers to GROUND IDLE will drive the blades from full reverse toward feather, engaging the flat pitch locks.

Feathered. As required, the engines may be shut down with the propellers feathered. To obtain feathering on shutdown, adjust power lever position to obtain minimum torque and pull the condition levers full aft to FEATHER & FUEL SHUT-OFF. Subsequent start procedure must then include unfeathering. Refer to ENGINE STARTS, in this section.

CAUTION

Failure of engine to stop running when the condition levers are placed in FUEL SHUT-OFF may indicate a broken or disconnected fuel control linkage or shutoff valve. Positioning the power lever to FULL REVERSE or the condition lever to FEATHER and FUEL SHUT-OFF under these circumstances may result in engine OVERTEMP/FIRE. When linkage failure occurs, shut down the engine using the EMERGENCY FUEL SHUT-OFF switch.

AIRCRAFT FUEL SUPPLY SYSTEM

Internal fuel is carried in five self-sealing, unpressurized wing cells: two inboard, two outboard, and center. The center cell includes a sump portion, which acts as an engine feed tank. All wing tanks are bladder-type cells, backed with cellular plastic foam and filled with foam baffling material. The center tank receives all fuel from the inboard and outboard tanks. The engine feed portion of the center tank has limited inverted flight capability and receives all fuel before it is distributed to the engines. Wing and center tank fuel is transferred by gravity and ejector-type transfer pumps which are operated by motive flow returned from the low-pressure port of the engine-driven fuel pumps. Fuel from the feed tank is supplied by a submerged boost pump to the engine fuel lines. In the event of boost pump failure, feed tank fuel is available to the engine-driven fuel pumps by gravity flow. Should wing or center tank ejector pump action fail, fuel will continue to flow into the feed tank by gravity. Refueling is accomplished manually through five filler points on top of the wing. For a schematic of the fuel system, see figure FO-1. For fuel quantity, see figure 1-10.

EXTERNAL FUEL TANKS

External fuel may be carried in a single 150-gallon auxiliary fuel tank, which may be installed at the centerline fuselage station and/or two 100-gallon auxiliary fuel tanks which can be installed on the wing pylons. Each wing pylon contains an electrical fuel transfer pump to transfer fuel from the 100-gallon auxiliary tanks to the outboard wing tanks. Fuel is transferred from the centerline tank to the wing center feed tank by an electrically driven transfer pump in the external fuel transfer line. There are two versions of the 150-gallon external fuel tank which can be carried: the Aero 1C and the FPU-3/A. Special procedures

FUEL QUANTITY DATA

BASED ON: ESTIMATED DATA JP-4 = 6.5 LBS/GAL
DATA AS OF: 1 OCTOBER 1976 JP-5 = 6.8 LBS/GAL

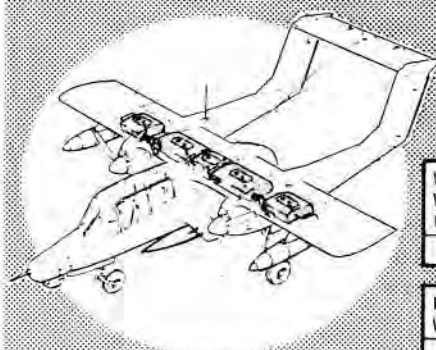

- ① TANK PACKED (NOSE RAISED 4 DEGREES)
- ② TANK REFUELED IN NORMAL ATTITUDE

	TANK CAPACITY				USABLE		
	GALLONS	LITERS	JP-4 POUNDS	JP-5 POUNDS	GALLONS	JP-4 POUNDS	JP-5 POUNDS
WING OUTBOARD (2)	75.2	285.0	489.5	511.4	72.4	470.6	492.3
WING INBOARD (2)	133.6	506.2	868.4	908.6	129.7	843.0	882.0
CENTER	37.6	142.5	244.4	255.5	36.5	237.0	248.0
TOTAL INTERNAL	246.4	933.7	1602.3	1675.5	238.6	1550.6	1622.3
INTERNAL TOTAL	246.4	933.7	1602.3	1675.5	238.6	1550.6	1622.3
WING AUXILIARY (2)	192.0	727.7	1248.0	1305.6	180.0	1170.0	1224.0
TOTAL	438.4	1661.4	2850.3	2981.1	418.6	2720.6	2846.3
INTERNAL TOTAL	246.4	933.7	1602.3	1675.5	238.6	1550.6	1622.3
CENTERLINE TANK (FPU-3/A) OR (AERO 1C)	150.0	568.0	975.0	1020.0	150.0	975.0	1020.0
TOTAL	396.4	1501.7	2577.3	2695.5	388.6	2525.6	2642.3
INTERNAL TOTAL	246.4	933.7	1602.3	1675.5	238.6	1550.6	1622.3
CENTERLINE TANK (AERO 1C)	122.0	462.0	793.0	829.6	122.0	793.0	829.6
TOTAL	368.4	1395.7	2395.3	2505.1	360.6	2343.6	2451.9

OV 10D-1-6G

Figure 1-10

must be used for filling the Aero 1C to 150 gallons of fuel. The aircraft must be elevated approximately 4 degrees nose up (to level the tank), or the tank will accept only 122 gallons. The FPU-3/A tank has an aft gravity filler cap in the aft section of the tank. The aircraft does not have to be elevated to fill the tank with 150 gallons of fuel.

FUEL SYSTEM CONTROLS AND INDICATORS

CONDITION LEVERS

Normal turn-on and shutoff of engine fuel flow are controlled through the condition levers. Advancing these levers from FUEL SHUT-OFF to NORMAL FLIGHT during ground starts allows the main fuel shutoff valve on the respective engine to open when 10% rpm is reached. Retarding these levers to FUEL SHUT-OFF or FEATHER & FUEL SHUT-OFF closes the main fuel shutoff valves.

FUEL QUANTITY INDICATOR

The fuel quantity indicator (figure 1-3) on the pilot's instrument panel reflects the weight of fuel in pounds x 100 remaining in the center wing tank, the internal tanks or the centerline external tank as selected by the FUEL GAGE SELECT switch. The indicator is powered by the 115-volt primary a-c bus.

The fuel quantity system design and calibration results in fuel quantity indications that are above the nominal throughout the range, and an indication of approximately 50 pounds when all usable fuel is consumed (i.e., engine

flame-out). With a full load of fuel the nominal usable fuel is 1623 pounds whereas the nominal fuel quantity indication is 1750 pounds.

Note

Fuel quantity indicating system tolerance is 6% of the indicated fuel plus 3% of full scale indication. Total allowable error is 154 pounds.

FUEL GAGE SELECT SWITCH

The fuel GAGE SELECT switch (figure 1-3) is installed on the pilot's instrument panel below the fuel quantity indicator. With the fuel GAGE SELECT switch in the FEED position, the indicator shows the weight of fuel remaining in the center tank. When the switch is placed in the INT or CTR EXT position, combined weight of fuel in all internal tanks or weight of fuel remaining in the centerline external tank is indicated.

FUEL GAGE TEST SWITCH

The fuel GAGE TEST switch (figure 1-3) is located on pilot's instrument panel near the fuel GAGE SELECT switch. When the fuel GAGE TEST switch is held in TEST, fuel quantity indicator normal operation results in the indicator motoring toward zero. The indicator may be checked in any position of the fuel GAGE SELECT switch.

FUEL LEVEL WINDOW ASSEMBLY

Each 100-gallon wing drop tank has a fuel level window assembly installed at a high point on each side of the nose

cone, providing a means of verifying a "full" auxiliary fuel tank. The window assembly provides a high visual contrast between "wet" and "dry" conditions. The window assembly reflects incident light when the tank is less than full. When the auxiliary fuel tank is full, the window assembly reflects no light and appears as a dark black color.

EXTERNAL FUEL TRANSFER SWITCH

The EXT FUEL TRANS switches (figure 1-3) are located on the pilot's instrument panel above the FUEL GAGE TEST switch. The external tank fuel transfer pumps are powered by the primary d-c bus and are turned on by moving the L, CTR, R switches to ON, as applicable.

Depending on engine fuel flow, the rate of transfer from the external tanks (720 to 750 pounds per hour each) may be sufficient to fill the center tank. When this occurs, fuel will enter the inboard wing tanks through the inter-tank vent lines. The outboard tanks will then be filled by the same method when the inboard tanks are full. Transfer switches should be turned OFF before the internal tanks are full, or after all fuel is transferred. If fuel overboard venting from the wing tank vents (under each wing) is noted, moving the EXT FUEL TRANS switches to OFF allows normal fuel consumption to reduce wing tank level. The auxiliary fuel transfer pumps shut off automatically (illuminating the respective AUX FUEL caution light) when fuel flow has stopped for 10 seconds. If auxiliary fuel transfer is interrupted for 10 seconds or more (auxiliary tank not empty) turn the transfer switch OFF and allow 60 seconds (minimum) for thermal relay reset before attempting to regain fuel transfer by cycling the transfer switch to ON. An additional 60 seconds is required for pump re-prime. Automatic transfer flow interruption (flow rate less than 1 gpm) can be caused by low engine demand and full internal tanks (fuel tank vent relief valve causes back pressure on auxiliary transfer pump) or by a steep nose down attitude uncovering the auxiliary tank fuel pickup for more than 10 seconds.



If external fuel transfer switch is left on after internal fuel tanks are full, overpressurization could occur causing venting of fuel past fuel seals and possible damage to cells.

FUEL EMERGENCY SHUTOFF SWITCHES

The FUEL EMERG SHUT OFF switches (figure 1-3) are located on the lower right corner of the pilot's instrument panel. These switches are powered by the main d-c bus and operate fuel shutoff valves installed on the outer bulkhead of each inboard wing fuel tank. See figure FO-1. The shutoff valve for the applicable engine is closed by moving the appropriate switch to the SHUT OFF position.

Note

The applicable engine will continue to operate up to a maximum of 1 minute after the emergency fuel shutoff valve is closed.

FUEL LOW CAUTION LIGHT

The FUEL LOW caution light on the pilot's (figure 1-3) and observer's (figure 1-5) instrument panel illuminates whenever center tank fuel quantity falls below approximately 220 (± 15) pounds. The FUEL LOW caution lights should illuminate when the lights TEST switch is held in WARN LTS.

WARNING

Do NOT maneuver aircraft into steep bank angles or pitch attitudes if fuel level in center tank indicates less than full. Possible ingestion of air into fuel feed lines and subsequent engine flameout may result.

FUEL FEED WARNING LIGHTS

The FUEL FEED warning lights on the pilot's (figure 1-3) and observer's (figure 1-5) instrument panel illuminate whenever fuel level in the engine tank is reduced from full to approximately 50 pounds or less (approximately 5 minutes of flight). The FUEL FEED warning lights should illuminate when the lights TEST switch is held in WARN LTS.

WARNING

In the event of FUEL FEED warning light illumination, maintain a nose-high attitude to ensure adequate fuel supply to the engines.

BOOST PUMP CAUTION LIGHT

The BOOST PUMP caution light (figure 5-1) is installed on the pilot's instrument panel. The light illuminates when the center wing fuel feed tank boost pump output pressure drops to 4 (± 1) psi. This light illuminates when the lights TEST switch is held in WARN LTS.

MOTIVE FLOW CAUTION LIGHTS

The L MTV FUEL and R MTV FUEL caution lights (figure 5-1) are installed on the pilot's instrument panel. These lights illuminate when motive flow output fuel pressure from the respective engine fuel boost pump low pressure connection decreases from normal to 4 (± 1) psi. The lights illuminate when the lights TEST switch is held in WARN LTS.

AUXILIARY FUEL CAUTION LIGHTS

The L AUX FUEL, CTR AUX FUEL, and R AUX FUEL caution lights (figure 5-1) are installed on the pilot's instrument panel. These lights illuminate when the respective external fuel tank transfer flow rate is less than 1.0 gpm. The lights illuminate when the lights TEST switch is held in the WARN LTS position.

ELECTRICAL POWER SYSTEM

The normal electrical power system consists of two d-c generators and three d-c to a-c inverters. Emergency d-c power is supplied by two nickel-cadmium storage batteries. For block schematics of a-c and d-c electrical power distribution, see figure FO-2.

D-C ELECTRICAL POWER SYSTEM

STARTER-GENERATORS

Above approximately 50% engine rpm, each engine starter-generator functions as an independent generator, supplying up to 400 amperes of 30-volt d-c power to the d-c buses. Proper generator output is 28 (± 0.8) volts. During normal operation, generator output is paralleled, providing a total load capacity of 760 amperes. Single-generator operation is capable of supplying sufficient power required for all electrical loads.

GENERATOR SWITCHES

The L GEN and R GEN switches (figure 1-11) are located on the pilot's engine start and electrical panel. These lift-to-unlock switches have RESET NORM and TRIP positions, spring-loaded to NORM. When engine rpm passes approximately 50% during battery start with the GEN switch in NORM, generator output is automatically supplied. The RESET position is used to attempt to restore generator operation. Placing the switches to TRIP disconnects generator output from the electrical system, illuminating the generator-out caution lights. The generator reset function is delayed during air starts until the AIR START switch is returned to AUTO.

VOLTAMMETER

The voltammeter (figure 1-3) is located on the center pedestal. The voltmeter indicates primary d-c voltage. The ammeter indicates system load as selected by the AM SEL switch. Steady-state ammeter readings above 200 may indicate an excessive load (defective equipment) and action should be taken to isolate the defective equipment.

AMMETER SELECT SWITCH

The AM SEL (ammeter select) switch (figure 1-4) is located on the pilot's right console. Either generator system may be checked, individually, by reading the NO. 1 GEN or selecting and reading the NO. 2 GEN position.

GENERATOR-OUT CAUTION LIGHTS

The L GEN and R GEN caution lights are located on the pilot's instrument panel. With the primary d-c bus energized

(battery or external power), these lights are on whenever the respective generator is disconnected from the electrical system. When starting on battery power only, the respective generator-out caution lights should extinguish during engine start as rpm passes approximately 50%. When external power is used during an engine start, the generator-out caution lights will not extinguish until external power plug is disconnected.

BATTERIES

Two 24-volt, 30-ampere-hour air-cooled, nickel-cadmium batteries are installed for engine starting and emergency electrical power. A solution of potassium hydroxide and distilled water is used as the electrolyte. Fully charged batteries are capable of providing sufficient power for three unsuccessful engine ground start attempts and a fourth (successful) start without recharge. The batteries can be charged with generator power when the BATTERY switch is positioned to ON or EMERG. The batteries cannot be charged by external d-c power. The amperage used when charging the batteries, not the specific gravity reading, determines the battery state of charge.

Note

Twenty minutes flying time with both generators operating should assure two fully charged batteries. Assuming fully charged batteries with both generators failed in flight, emergency power for essential systems is available for a period of 20 minutes. This includes interior lights, anti-collision light, inverter and UHF radio ON and transmitting 1 minute out of each 5-minute period.

BATTERY SWITCH

The ON position of the BATTERY switch located on the pilot's start and electrical panel (figure 1-11), connects the battery bus to the main d-c bus. In event of a dual-generator failure in flight, the EMERG position will recover secondary d-c bus power.

MAIN BUS

The main 28 VDC bus is the central distribution point for all sources of d-c power, which enables use of a single external power source for both utility power and engine starts.

BATTERY BUS

The battery bus provides power to emergency equipment and is powered by the batteries at all times regardless of BATTERY switch position. With both generators off, the battery bus can power all the buses except the monitor and armament buses by positioning the BATTERY switch to ON or EMERG. During either engine battery start, all buses except the main and battery buses deenergize to ensure sufficient power for starting and to prevent battery overload.

START-ELECTRICAL CONTROLS

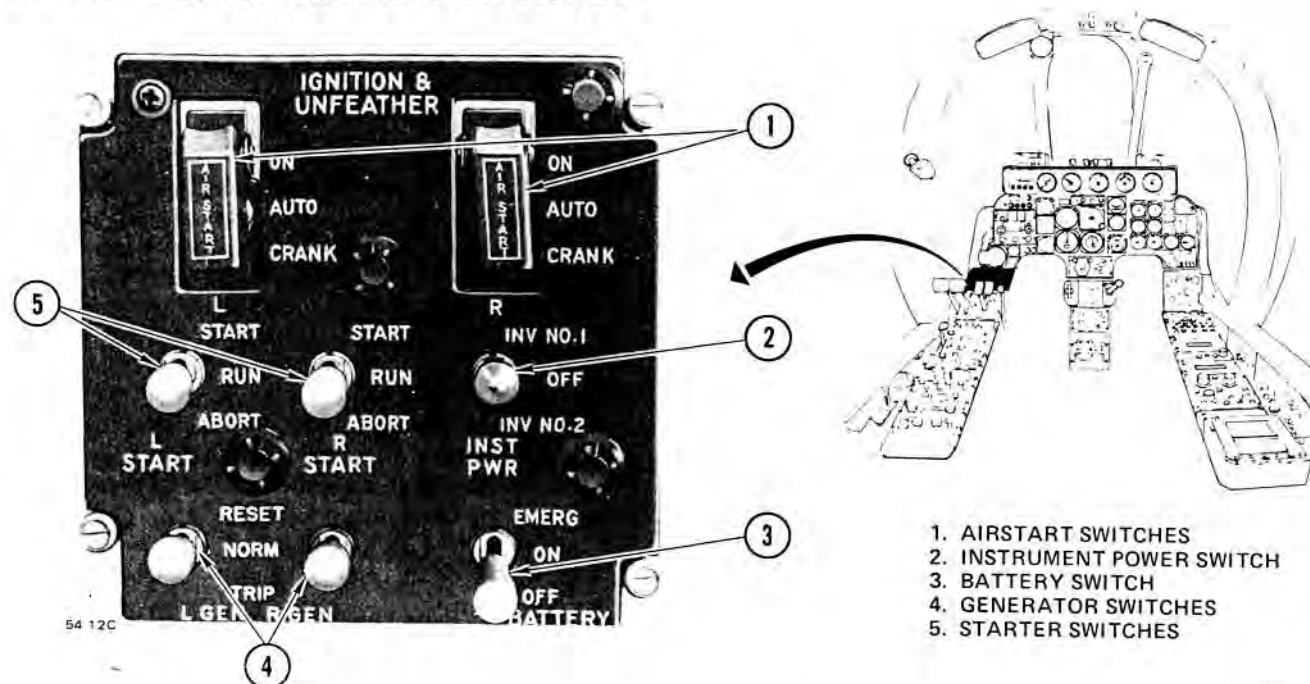

1. AIRSTART SWITCHES
2. INSTRUMENT POWER SWITCH
3. BATTERY SWITCH
4. GENERATOR SWITCHES
5. STARTER SWITCHES

OV-10D-1-15A

Figure 1-11

PRIMARY BUS

The primary d-c bus provides power to all normal mission d-c powered equipment and provides control of the secondary d-c bus, No. 1 monitor d-c bus, armament d-c bus, and the a-c buses. The primary d-c bus receives battery, generator, or external d-c power from the main bus. In the absence of aircraft generator or external d-c power, the primary bus may be energized by moving the BATTERY switch to ON or EMERG. During the start of either engine, and until the generator is energized, the primary bus is disconnected from the main bus.

SECONDARY BUS

The secondary d-c bus provides power to lighting and communications equipment and receives power from the main bus. In the event of failure of both generators in flight, secondary bus power may be provided by the aircraft batteries through the main bus by moving the BATTERY switch to EMERG or placing the landing gear handle down.

MONITOR BUS

The NO. 1 monitor d-c bus provides power to items considered nonessential and receives power from the main bus, providing at least one generator is operating or external d-c power is applied.

ARMAMENT BUS

The armament d-c bus receives power from the main d-c bus, providing the monitor d-c bus is energized, and the pilot's MASTER ARM switch is ON, and the landing gear handle is up. When the gear handle is down, the armament bus may be energized by moving the MASTER ARM switch to ON and holding the ARMT SAFETY DISABLE switch (left main gear well) momentarily in the DISABLE position. Subsequent armament ground safety operation is restored by moving the MASTER ARM switch to OFF, or deenergizing all electrical power.

D-C CIRCUIT BREAKERS

Push-pull-type circuit breakers (figure 1-12), function to protect the d-c power system by disengaging automatically whenever an overloaded or short circuit exists. Should a circuit breaker pop out, it can be reset by manually pushing in on the circuit breaker. A d-c circuit can also be opened manually by pulling out on the respective circuit breaker for that line.

A-C ELECTRICAL POWER SYSTEM**INVERTERS AND INSTRUMENT POWER SWITCH**

A-C 115-volt, 400-cycle, three phase electrical power is provided to the aircraft systems by two 750-volt-ampere d-c to a-c inverters. A third 2500-volt-ampere d-c to a-c inverter provides a-c power to FLIR/LRD system components. The NO. 1 inverter is powered by the primary d-c bus. By moving the INST PWR switch, located on the Pilot's Engine Start and Electrical Control Panel, to the INV NO. 1 position, the NO. 1 inverter will run and supply power to the primary a-c bus. The OFF position of the INST PWR switch turns the NO. 1 inverter OFF. The NO. 2 inverter is powered by the monitor d-c bus and cannot be turned OFF as long as external power is applied or either generator is operative. The NO. 2 inverter supplies power directly to the NO. 1 monitor a-c bus regardless of the position of the INST PWR switch. With the INST PWR switch moved to the INV NO. 2 position, the NO. 2 inverter will supply a-c power to the primary a-c bus in addition to the NO. 1 monitor a-c bus. The NO. 3 inverter receives power from the NO. 1 monitor d-c bus, controlled by a circuit breaker in the observer's cockpit. The NO. 3 inverter supplies the FLIR/LRD components with a-c power.

A static inverter is installed in the cargo bay, which provides a-c power solely for the oil pressure indication system. This inverter's 115-volt a-c output is reduced to 26-volt a-c by a stepdown transformer. D-C power for this inverter is provided by the battery bus.

INSTRUMENT POWER CAUTION LIGHT

The INST PWR caution light is located on the pilot's instrument panel. This light illuminates in the event of failure of primary a-c bus power. Primary a-c bus power may be restored by selecting the INV NO. 2 position of the INST PWR switch. Should the No. 1 inverter fail, the light may be extinguished and electrical loads transferred by selecting INV NO. 2.

Note

Failure of the No. 2 inverter with INV NO. 1 selected is indicated by loss of monitor a-c bus powered systems.

A-C FUSES AND CIRCUIT BREAKERS

The aircraft a-c electrical power supply system is protected by fuses, which are mounted on a panel located in the right boom. The FLIR/LRD a-c electrical power supply system is protected by circuit breakers located in the cargo bay door.

PRIMARY A-C BUS

The primary (three-phase) a-c bus is normally powered by the No. 1 inverter when the INST PWR switch is in the INV NO. 1 position. Should the No. 1 inverter fail, the No. 2 inverter will restore primary a-c bus power by selecting INV NO. 2 position.

INSTRUMENT A-C BUS

The instrument a-c bus receives primary a-c bus power through an instrument transformer, supplying 26-volt a-c power for navigation and engine instrument operation.

MONITOR A-C BUS

The monitor a-c bus provides nonessential instrument power and receives power from the No. 2 inverter only. In the event of failure of the monitor a-c bus (failure of the No. 2 inverter), loss of TACAN operation will be noted with the alternate TACAN power switch in the NORM position. TACAN operation may then be restored by moving the alternate TACAN power switch to ALT.

Note

In the event of failure of both generators, monitor a-c bus power is not recoverable.

EXTERNAL POWER

External d-c power may be applied for engine starts or for energizing the d-c system for maintenance purposes. The external power access is located on the right side of the fuselage, forward of the cargo door. The rectangular receptacle accommodates the oval external power plug for both start and utility d-c power. The external power receptacle incorporates a switch which prevents the batteries from powering the main bus when the external power plug is inserted. Engine start cannot be accomplished with external power only. Batteries are required to energize the start relays. For acceptable start and service electrical power units, refer to AIRCRAFT SERVICING, Part 3, in this section.

INTER-AIRCRAFT STARTING POWER

The external power receptacle may be used as a 28-volt d-c power output. With an engine running and UTILITY PWR SELECT switch (in the external power receptacle access) positioned to PWR OUT, a jumper cable may be used to supply power to another aircraft. The UTILITY PWR SELECT switch must be in NORM (guard closed) position at all other times.

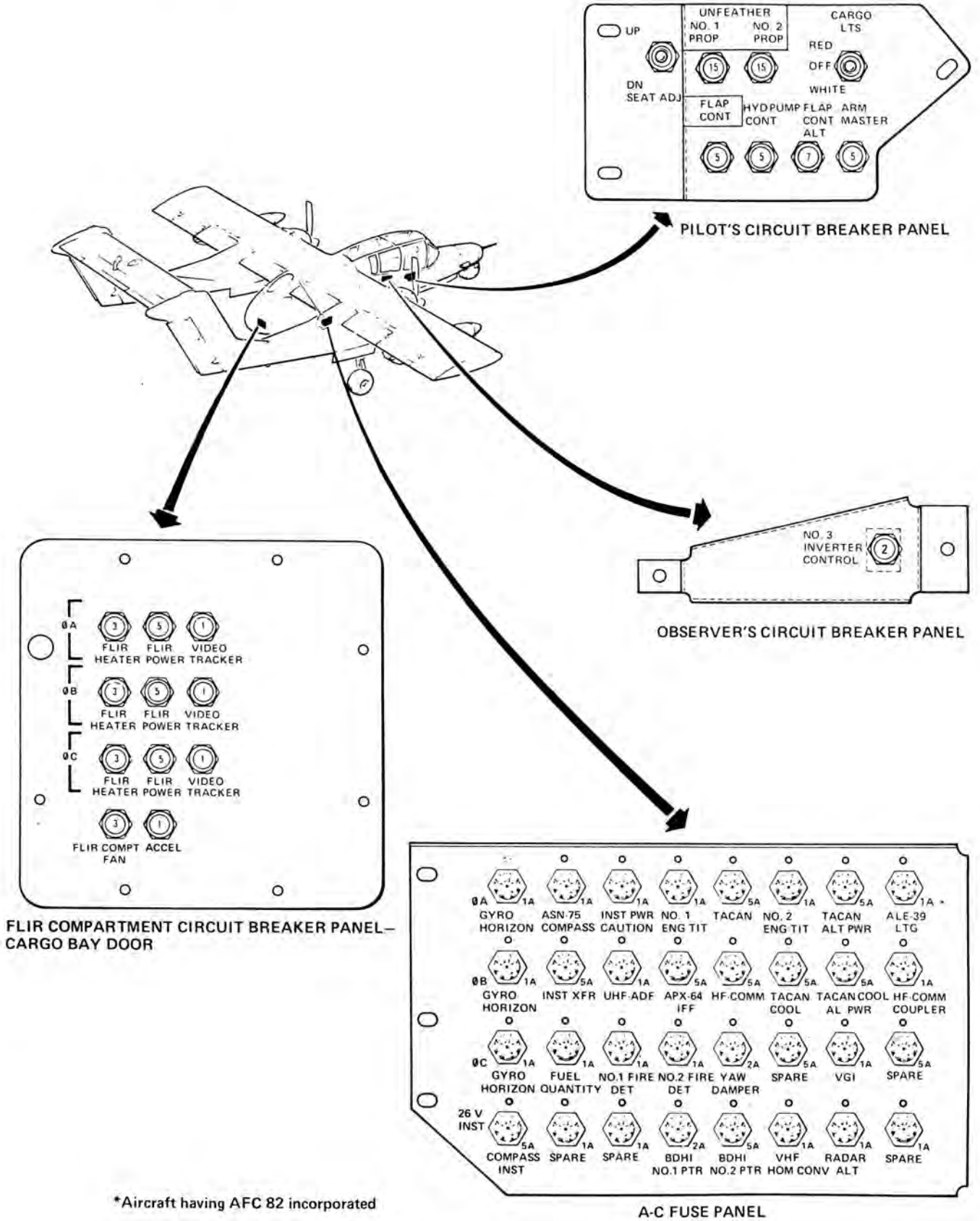

*Aircraft having AFC 82 incorporated

Figure 1-12 (Sheet 2)

HYDRAULIC POWER SYSTEM

Hydraulic power at 1500 to 1550 psi is supplied by a closed-center, intermittent duty system. The hydraulic power package, including the reservoir and electrically operated hydraulic pump, is installed above the cargo bay aft of the wing. A clear plastic sight gage is mounted on the side of the reservoir. Full level lines are marked on the sight and may be used in checking fluid level. Hydraulic fluid level can also be checked through external access door on upper aft fuselage by checking fill pipe level. Hydraulic power is supplied to operate the landing gear normal extension and retraction, wing flap normal extension and retraction, and nose wheel steering systems. During non-duty periods, the hydraulic pump is turned off, leaving slowly reducing residual pressure in the lines last pressurized. The hydraulic system does not provide sufficient flow to allow simultaneous, full-rate operation of the landing gear, and flap extend-retract functions. If both are selected in rapid order, both will operate at a reduced rate. For a schematic of the hydraulic power system, see figure FO-3.

CAUTION

The hydraulic pump is not continuous duty, it requires a 3-minute rest after the following operations: 5 minutes of nose wheel steering, or three flap cycles, or three landing gear cycles, or any combination thereof.

HYDRAULIC PUMP INDICATING LIGHT

A HYD-PUMP indicating light (figure 1-3) is installed on the pilot's center pedestal. This green light illuminates whenever the hydraulic pump is operating so that the pilot can monitor pump requirements.

HYDRAULIC PRESSURE CAUTION LIGHT

A HYD PRESS caution light (figure 1-3) is installed on the pilot's center pedestal. This amber light illuminates in the event hydraulic system pressure fails to build up to more than at least 200 psi on demand (gear, flap, or nose wheel

steering operation). The nose wheel steering button may be used to operate the hydraulic pump at any time, providing operation in the event of failure of the pump to provide pressure through normal control circuits.

CAUTION

If it is suspected that the hydraulic pump is running continuously, pulling the hydraulic circuit breaker in the front cockpit will preclude pump overheating and possible system failure.

FLIGHT CONTROL SYSTEMS

The elevator aileron/spoiler, and rudder systems are reversible, balanced mechanical systems operated by cables, rods, and bellcranks. Primary in-flight movement of the ailerons and elevator is achieved by the aerodynamic action of spring and gear-operated boost tabs. Control force trim is achieved by electrically operated trim bungees which move the flight control systems to no-load positions as required. For flight control characteristics, refer to Section IV, Part 1, and see figure FO-4.

LONGITUDINAL SYSTEM

The longitudinal system consists of a horizontal stabilizer and a tab-boosted, mechanically damped, overbalanced elevator. The tab system consists of four trailing edge segments extending the entire span of the elevator. In flight, the spring (outboard) tabs are driven by the control stick in the direction opposing desired elevator movement, displacing the elevator by aerodynamic reaction until spring tab stops are contacted. The geared tab (inboard) segments are driven directly by the elevator to the same limits as the spring tabs. Movements of the control stick beyond the tab stops, either nose up or nose down, physically drive the elevator in the desired direction. Pitch trim is achieved through the action of a trim actuator/torsion bar assembly which adjusts the no-load position of the system (including the control stick) as required.

DIRECTIONAL SYSTEM

The directional system consists of twin vertical stabilizers, twin rudders, and an electromechanical yaw damper system. The rudders are not tab-boosted, and are displaced by direct mechanical action through the rudder pedals. Rudder trim is provided by an electrical actuator/bungee assembly which displaces the control linkage, adjusting the directional system to no-load position as required.

YAW DAMPER

The yaw damper system supplies a control torque to the rudders proportional to aircraft yaw rate and oscillation frequency and in the opposite direction of the yaw motion. The system, powered by the monitored d-c bus, contains three major components—the yaw rate gyro, yaw damper amplifier, and servo actuator. The yaw rate gyro signal is fed to a differential rate d-c amplifier through a capacitor to drive a pair of magnetic clutch coils in the actuator. The actuator transmits torque through an integral gearbox to a bellcrank coupled to the directional control system. Pilot control of the system is obtained through a three-position (ON, OFF, TEST) toggle switch. The TEST position is selected for ground checkout only and bypasses the ground safety relay contacts. The pilot can override yaw damper action by exerting approximately 100 pounds force on the rudder pedals. When the aircraft is on the ground (struts compressed), the yaw damper is automatically disengaged.

LATERAL SYSTEM

The lateral system consists of spring and gear tab-boosted ailerons, augmented by spoilers. Operation of the outboard (spring) tabs is similar to that of the elevator spring tabs, in that in-flight control stick initial movement displaces the tabs, driving the ailerons by aerodynamic reaction until spring tab stops are contacted. Further lateral movement of the control stick then drives the ailerons directly.

SPOILERS

Four fan-shaped, upward rotating, axially hinged spoiler plates are installed in each wing. Movement of the ailerons displaces mechanical linkage to rotate upward

from the down-going wing, creating additional rolling reaction due to lift loss. The spoilers are positioned with their leading edges 10 degrees below the wing upper mold line with the ailerons neutral. At full stick lateral travel, the spoilers are displaced approximately 86 degrees. Delayed operation, due to the submerged neutral spoiler position, prevents projection at neutral trim and allows aileron trim operation without causing spoiler deflection.

FLIGHT CONTROLS AND INDICATORS

CONTROL STICKS AND RUDDER PEDALS

A pedestal-type, pivot-mounted control stick and rudder/wheel brake control pedals are installed in the pilot's cockpit. The pilot's stick grip (figure 1-13) contains a conventional roll/pitch trim switch, as well as a nose wheel steering button, bomb release button, and a gun trigger switch. A control stick and rudder/brake pedals are installed in the rear cockpit area as part of the observer's cockpit package. The observer's control stick grip does not incorporate armament or trim controls and the rear cockpit rudder pedals are not adjustable.

PEDAL ADJUST CRANK

A rudder pedal adjust crank (figure 1-3) is installed on the center pedestal in the pilot's cockpit. This fold-away crank allows pedal adjustment through a 9-inch range.

TRIM SELECT SWITCH

The TRIM SELECT switch (figure 1-14) is located on the pilot's trim control panel. In the NORM position, aileron, elevator, and rudder trim is powered by the primary d-c bus and controlled through the pilot's stick grip trim and normal rudder trim control system, the ALT position provides an alternate source of primary d-c bus power and trim is controlled through use of the alternate elevator and aileron trim and alternate rudder trim switches.

PILOT'S STICK GRIP

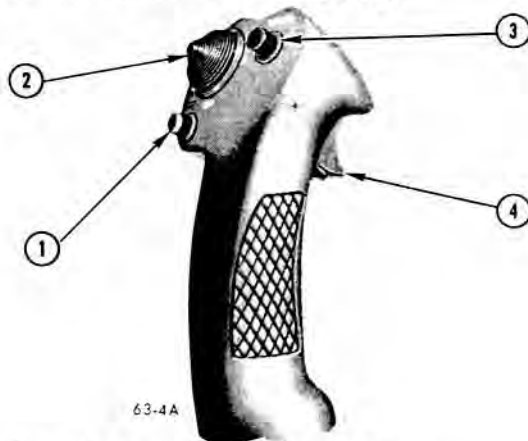

1. BOMB RELEASE BUTTON
2. PITCH AND ROLL TRIM SWITCH
3. NOSE WHEEL STEER BUTTON
4. TRIGGER

OV-10D-1-127

Figure 1-13

FLAP-TRIM PANEL

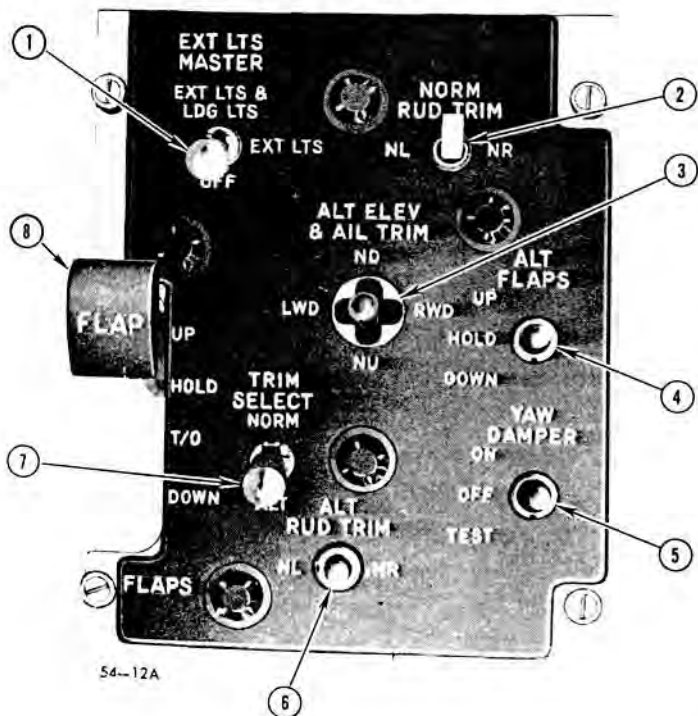

1. EXTERIOR LIGHTS MASTER SWITCH
2. NORMAL RUDDER TRIM SWITCH
3. ALTERNATE ELEVATOR AND AILERON TRIM SWITCH
4. ALTERNATE FLAPS SWITCH
5. YAW DAMPER SWITCH
6. ALTERNATE RUDDER TRIM SWITCH
7. TRIM SELECT SWITCH
8. FLAPS HANDLE

OV-10D-1-128

Figure 1-14

AILERON AND ELEVATOR TRIM SWITCHES

The normal aileron and elevator (roll and pitch) trim switch (figure 1-13) is located on the pilot's control stick grip. The ALT ELEV & AIL TRIM switch (figure 1-14) is located on the pilot's trim control panel.

RUDDER TRIM SWITCHES

The NORM RUD TRIM and ALT RUD TRIM switches (figure 1-14) are located on the pilot's trim control panel.

YAW DAMPER SWITCH

The YAW DAMPER switch (figure 1-14) is located on the pilot's trim control panel. The switch has OFF, ON, and TEST positions. In OFF, the yaw damper clutch is disengaged. The momentary TEST position overrides the damper ground safety function, permitting damper system operational testing on the ground. When the aircraft is airborne, selection of ON allows the yaw damper to operate normally.

ELEVATOR TRIM INDICATOR

The elevator trim indicator (figure 1-3) is located on the pilot's instrument panel. This primary d-c bus powered indicator reflects pitch trim assembly position from 2 units up to 2 units down, calibrated in one-half unit increments.

TRIM NEUTRAL LIGHTS

Aileron and rudder trim neutral lights (figure 1-3) are installed on the pilot's instrument panel. These green, press-to-test lights, powered by the primary d-c bus, are on when roll and yaw trim is set at the neutral (take-off) position. The brightness of the trim neutral lights may be adjusted through use of the INSTRUMENTS knob on the interior lights control panel.

WING FLAPS

A four-section, slotted wing flap system is installed. One section is located inboard and one section outboard of the tail boom on each wing. Normal extension and retraction are provided by hydraulic system power through a separate mechanical jackscrew for the flaps on each wing. Control of boundary layer airflow is provided by slot doors on the lower wing surfaces which extend mechanically with the flaps. An electrically powered alternate flap system is provided for extend-retract control in the event of hydraulic system failure or normal flap control circuit failure.

FLAP CONTROLS AND INDICATOR**FLAP HANDLES**

A FLAP handle (figure 1-14) is located on the left console in the pilot's cockpit, and on the left side of the rear cockpit (figure 1-5). Power is supplied from the primary d-c bus. Repositioning the flap handle completes a circuit to move the flap selector valve and starts operation of the hydraulic pump. The circuit is broken and all power is removed from the hydraulic pump when the flaps reach the desired position. The flaps may be operated through a 40-degree range, or stopped at any intermediate position by selecting UP, T/O (20 degrees), HOLD, or DOWN as desired. The flaps may be fully extended or retracted without airload in approximately 8 seconds.

ALTERNATE FLAPS SWITCH

The ALT FLAPS switch (figure 1-14) is located on the pilot's trim control panel. Power is supplied from the primary d-c bus. The switch has UP, HOLD, and DOWN positions and is spring-loaded from UP to HOLD. The alternate flaps switch may be used to obtain flap extension and retraction as desired in the event of failure of normal flap hydraulic power or electrical control. Full extension during alternate flap operation may require up to 1 minute.

Note

Ensure the FLAP handle is in HOLD when using the ALT FLAPS switch to prevent inadvertent retraction or extension.

FLAP POSITION INDICATOR

The flap position indicator (figure 1-3) is integral with the landing gear position indicator on the pilot's instrument panel. Flap position indications at UP, $\frac{1}{4}$, $\frac{1}{2}$, $\frac{3}{4}$, and DOWN are provided.

LANDING GEAR

Folding drag-link, trailing-arm, tricycle landing gear is installed. Gear retraction is hydraulically powered, with the mains retracting upward and aft, and the nose gear retracting forward. Emergency retraction is not provided.

Emergency extension is accomplished by gravity, assisted by the spring bungees on the main landing gear. The landing gear control system consists of the landing gear handles, mechanical linkage to the extend-retract control valve, the hydraulic power system, and position and warning indicators. The landing gear well doors remain open when the gear is extended and are closed mechanically by the gear on retraction. In the event of hydraulic failure or normal extension circuit failure, normal gear extension procedures will extend the gear at speeds below approximately 120 knots. Normal retraction requires approximately 10 seconds; extension requires approximately 7 seconds.

GROUND SAFETY SWITCH

The ground safety switch is located on the left main landing gear strut. When the landing gear is compressed (on the ground), the ground safety switch deactivates the following systems, approach lights, angle-of-attack heater, pitot heater, yaw damper, stall warning system, emergency stores jettison, and activates nose wheel steering and power lever gate override system.

WARNING

If the ground safety switch is misaligned, the functions of the ground safety switch might be reversed.

Note

The nose gear up and locked switch operates the nose gear up and locked relay on the Miscellaneous Electrical Systems Panel. This relay prevents laser firing if the nose gear is not up and locked.

LANDING GEAR CONTROLS AND INDICATORS

LANDING GEAR HANDLES

A landing gear handle (figure 1-3) is installed in the pilot's cockpit. An observer's gear handle (figure 1-5) is installed as part of the observer's cockpit package. The pilot's handle is equipped with a release lever (figure 1-3), which must be depressed to unlock the handle for upward movement. Movement of the handle to the up position selects the retract condition of the landing gear control valve, turns on the hydraulic system pump, and hydraulically retracts the landing gear downlocks. Selection of the down position moves the landing gear control valve to extend condition and mechanically retracts the landing gear uplocks. The rear

cockpit landing gear handle can be used to extend the landing gear only, and does not incorporate a handle release lever or gear unsafe warning light.

Note

A landing gear safety relay deactivates the hydraulic system pump power relay if the landing gear handle is placed in the up position while the aircraft is on the ground to prevent inadvertent retraction of the landing gear.

LANDING GEAR UNSAFE LIGHT

The pilot's landing gear handle incorporates a gear unsafe light. This red light is illuminated whenever the landing gear is not locked in the position demanded by the gear handle.

LANDING GEAR POSITION INDICATOR

The landing gear position indicator (figure 1-3) is located on the pilot's instrument panel, integral with the flap position indicator. Landing gear position is reflected by a separate solenoid-operated window-indicator for each gear. Landing gear UP, DN, and intermediate (barber pole) positions are indicated. With primary d-c power removed, the barber-pole indication is displayed.

WHEELS WARNING LIGHTS

A WHEELS warning light is located on the pilot's instrument panel (figure 1-3) and on the observer's instrument panel (figure 1-5). With primary d-c bus power available, these red warning lights flash whenever any landing gear is not locked down, either engine condition lever is at T.O./LAND, and (1) both power levers are retarded more than halfway from MILITARY to FLIGHT IDLE, or (2) the flaps are extended to 30 degrees or more.

CAUTION

During single-engine operations, place failed engine power lever in the FLIGHT IDLE position, or operate the power levers simultaneously to ensure WHEELS warning light capability.

WHEEL BRAKES

Manually operated, hydraulically independent wheel brakes are installed. Pressure applied at the rudder pedals in either cockpit operates a separate brake master cylinder for each wheel. The brakes include integral parking brake provisions, utilizing pedal pressure by a valve mechanism which traps pressure generated in the master cylinders.

PARKING BRAKE HANDLE

The PARK BRAKE handle (figure 1-3) is installed on the pilot's center pedestal. Brakes are set for parking by applying pedal pressure as desired, then pulling the handle out and releasing pedal pressure. The parking brakes are released by applying sufficient pedal pressure to exceed the level of trapped pressure.

NOSE WHEEL STEERING

Nose wheel steering is available up to 55 degrees left or right of center, through a hydraulically operated nose wheel steer-damper system. Nose wheel steering is less effective to the left than to the right. With the weight of the aircraft on the landing gear, hydraulic system pressure is ported through a steering control valve to the steer-damper unit as long as the nose wheel steering button is held depressed.

NOSE WHEEL STEERING BUTTON

The nose wheel STEER button (figure 1-13) is located on the face of the pilot's stick grip. Operation of the nose wheel steering system requires that the weight of the aircraft be on the landing gear and the button be depressed and held.

INSTRUMENTS**PITOT-STATIC SYSTEM**

Ram-air pressure and static air pressure are sensed by a pitot-static tube located on the nose. The altimeter, airspeed indicator, vertical velocity indicator, and ejection seat speed-altitude sensor are operated by the pitot-static system. Selective pitot tube electrical heating is provided for flight in visible moisture or during flight at freezing temperatures.

AIRSPEED INDICATOR

A 40- to 400-knot airspeed indicator (figure 1-3) is installed on the pilot's instrument panel. A rear cockpit airspeed indicator (figure 1-5) may be installed as part of the observer's equipment package.

ALTIMETERS, AAU-21/A AND AAU-24/A

An AAU-21/A counter drum pointer altimeter (figure 1-3) is installed on the pilot's instrument panel. An AAU-24/A altimeter (figure 1-5) is installed on the rear cockpit observer's instrument panel. The AAU-21/A is a barometrically operated counter drum pointer altimeter that incorporates a servo-driven encoder which provides an altitude signal to the aircraft transponder for transmission to a ground station when Mode C of the transponder is operating. The single sweep hand and digital counter drum of the instrument are mechanically linked through a gear train in an evacuated bellows, plus the hand being linked to an electrical servomotor. The face of the instrument is marked from 0 to 9 (x 100) feet with graduated increments for each 50 feet. A counter window, adjacent to the sweep hand, contains three digital drums which rotate to indicate

altitude in thousands and hundreds of feet. At altitudes below 10,000 feet, a barber pole appears in place of the left digit. Another window in the upper left of the instrument face indicates coder "ON," coder "OFF" modes of operation and a window in the lower right of the face indicates barometric pressure. A knob on the lower left front of the instrument case permits manual correction of the instrument for barometric pressure variations from the standard gradient. The AAU-24/A, located in the aft cockpit, is identical to the AAU-21/A except it has no servo-driven encoder incorporated and no mode window on the face.

VERTICAL VELOCITY INDICATOR

The vertical velocity indicator (figure 1-3) is installed on the pilot's instrument panel. This indicator is calibrated from 0 to 6000 feet per minute.

PITOT HEAT SWITCH

The PITOT HEAT switch (figure 1-16) on the pilot's heat-vent panel allows selection of electrical heat element operation in the pitot static tube and the stall warning transducer when the aircraft is airborne.

OUTSIDE AIR TEMPERATURE INDICATOR

An outside air temperature indicating thermometer (figure 1-2) is installed in the glass panel of the pilot's left-hand canopy door. This indicator is calibrated from -70° to 40°C .

ACCELEROMETER

A standard, three-pointer accelerometer (figure 1-3) is installed on the instrument panel in the pilot's cockpit. The instrument incorporates a reset button which may be depressed to return the positive and negative acceleration recording pointers to 1 "g" as desired. An ABU-13A accelerometer is installed in the cargo bay to supply acceleration information to the FLIR/LRD system.

VERTICAL GYRO INDICATING SYSTEM

An ARU-13/A attitude indicator (figure 1-3) is installed on the pilot's instrument panel, and an MD-1 roll and pitch displacement gyroscope is installed in the cargo compartment. An MB-1 attitude gyro indicator is installed in the rear cockpit (figure 1-5) as part of the observer's equipment package. Both the ARU-13/A and MB-1 attitude indicators require primary a-c bus power and will operate with either inverter selected. Power failure causes an OFF flag to be displayed within the face of either indicator. The MD-1 gyroscope also supplies pitch and roll information to the FLIR/LRD system.

Note

The OFF flag indicates insufficient electrical power only, and does not appear with malfunctions of components within either of the indicators.

ARU-13/A ATTITUDE INDICATOR

The ARU-13/A attitude indicator provides the pilot with a constant visual indication of the simultaneous pitch-roll attitude of the aircraft relative to a horizontal plane parallel to the earth's surface. An MD-1 roll and pitch displacement gyro senses direction and rate of turn and supplies reference signals for roll and pitch attitude position to the remote attitude indicator. A pitch trim knob allows the attitude sphere horizon line to be adjusted to desired pitch-axis presentation relative to a miniature aircraft. The indicator will show aircraft attitude correctly and continuously through 360 degrees of roll and 82 (± 2) degrees of climb or dive.

ATTITUDE GYRO ERECT SWITCH

The attitude gyro erect switch (figure 1-3) is located on the pilot's instrument panel, with NORM and FAST ERECT positions. This two-position toggle switch is spring-loaded to the NORM position and allows selection of the fast erect mode of MD-1 vertical gyro erection. The fast erect mode of erection is selected by holding the switch in the FAST ERECT position. During operation of the fast erect cycle, the OFF flag will appear in the face of the ARU-13/A indicator.

MB-1 ATTITUDE INDICATOR

The MB-1 attitude indicator incorporates a pitch angle readout within a range of 5 to 80 degrees of climb or dive. The MB-1 permits 360-degree aircraft rotation about the pitch and bank axes (roll and yaw) without tumbling. Maximum up and down travel of the horizon bar is 27 degrees. Beyond these limits, further rotation of the sphere reveals CLIMB and DIVE markings, each immediately followed by a bullseye which marks the area around 90 degrees of pitch. As the aircraft approaches vertical, the indicator sphere rotates 180 degrees counterclockwise in a climb, clockwise in a dive. Maneuvering may cause considerable pitch precession. If in-flight caging is required, ensure the aircraft is in straight and level flight before pulling and releasing the caging knob.

STANDBY MAGNETIC COMPASS

A standby magnetic compass is installed on the upper left portion of the windshield bow in the pilot's cockpit. A compass correction card (figure 1-4) is installed on the pilot's right console.

TURN-AND-SLIP INDICATOR

A primary d-c bus powered turn-and-slip indicator (figure 1-3) is installed on the pilot's instrument panel. An additional slip indicator is provided as an integral part of the weapons delivery optical sight. A slip indicator (ball-type clinometer) is installed on the aft face of the pilot's ejection seat post for use by the observer.

CLOCK

An A-13A aircraft clock (figure 1-3) is installed on the pilot's instrument panel. An additional clock (figure

1-5) is installed in the aft cockpit as part of the observer's equipment package.

NAVIGATION INSTRUMENTS

Radio navigation displays in the pilot's cockpit are provided by an ID-663B/U bearing-distance-heading indicator (BDHI). For a description of the ADF, TACAN, and compass functions of these indicators, refer to Section VII.

ANGLE-OF-ATTACK SYSTEM

The angle-of-attack system consists of a relative airstream probe mounted on the left side of the forward fuselage, an angle-of-attack transmitter, the angle-of-attack indicator, an approach indexer, and approach lights. Angle of attack is indicated from 0 to 30 units by the angle-of-attack indicator. On-speed indication for landing approach is indicated by the approach indexer and approach lights.

WARNING

The angle-of-attack system shall not be used as a primary reference.

ANGLE-OF-ATTACK INDICATOR

The angle-of-attack indicator (figure 1-3), mounted on the pilot's instrument panel, displays aircraft local angle of attack as sensed by the relative airstream probe. This indicator is operated by primary d-c power and is operative whenever primary power is available (external power connected, battery on, or either generator operating). The face of the indicator is adjusted to place the nominal approach angle of attack in units under an index at the 3-o'clock position. An OFF flag, located near the center of the indicator, appears in the event of failure. In the event of failure or when not powered, the indicator pointer rests at zero. A system of cam-operated switches within the indicator operates the approach indexer and approach lights.

APPROACH INDEXER

The red-lighted approach indexer (figure 1-3) is located above the pilot's instrument panel as a visual aid in determining the optimum landing approach airspeed. No control action is required from the pilot to utilize the approach lights and approach indexer systems. The indexer and approach lights function only when the landing gear is locked down and aircraft weight is not on the landing gear.

APPROACH LIGHTS

The approach lights, installed on the nose gear strut, aid in determining aircraft landing approach airspeed. These lights signify "fast" (red), "on-speed" (amber), and "slow" (green) approach speeds. The approach

lights system is automatic and is controlled by the angle-of-attack indicator. Refer to ANGLE-OF-ATTACK INDICATOR, in this section. The approach lights are dimmed for night operations by placing the EXT LTS MASTER switch to EXT LTS or EXT LTS & LDG LTS. The approach lights are extinguished when the weight of the aircraft compresses the landing gear struts.

APPROACH LIGHTS TEST SWITCH

Ground test of the approach lights may be accomplished through an approach lights test switch in the nose gear well.

STALL WARNING SYSTEM

A stall warning system is incorporated, consisting of a lift detector-transducer and heating element installed on the right wing, an amplifier, and a motor-operated pedal shaker. The pedal shaker system is powered by the primary d-c bus and is disabled from operating with the weight of the aircraft depressing the landing gear ground safety switches. Stall warning system operation is not related to the angle-of-attack indicating system (indicator and indexer), but operates when wing lift generated decreases to approximately 6 grams at the transducer. Indicated angle of attack at stall warning may vary from 22 to 30 units, depending on gross weight, flap setting, power setting, and "g" load. The pedal shaker may be checked for operation by holding the lights TEST switch in WARN LTS position.

WARNING

Depending on power and aircraft configuration, the rudder pedal shaker is activated 1 to 7 knots above stall speed during normal 1-g stalls. Dependent on rate of entry, the pedal shaker may not activate prior to accelerated stall.

LIGHTING SYSTEMS

INTERIOR LIGHTS

The pilot's and observer's cockpits are equipped with the following interior lighting equipment:

PILOT'S COCKPIT

- Instrument integral lights (red).
- Console edge lights (red).
- Console and instrument floodlights (red).
- High-intensity lights (white).
- Standby compass light (red).
- Utility light (red or white).

OBSERVER'S COCKPIT

- Instrument integral lights (red).
- Console edge lights (red).
- Utility light (red or white).

CARGO BAY LIGHTS

Two dome-type cargo bay lights are installed on the right side of the cargo bay. A third dome-type cargo bay light is installed in the ceiling at the aft end of the cargo bay and is used during maintenance of the FLIR/LRD system. These lights provide red or white illumination of the cargo bay interior or cargo bay door as selected.

INTERIOR LIGHTS CONTROLS

Floodlights Switch

DIM, OFF, and BRIGHT selection of the console and instrument panel floodlights is available to the pilot through the FLOOD switch (figure 1-15) on the interior lights control panel.

High-intensity Lights Switch

The high-intensity (thunderstorm) lights are controlled through the HIGH INTENSITY switch (figure 1-15) on the interior lights control panel.

Instrument Lights Knob

Brightness of the pilot's individual instrument integral lights and trim neutral lights may be adjusted as desired through the INSTRUMENTS knob (figure 1-15) on the interior lights control panel. With the INSTRUMENTS knob rotated from OFF, potential brightness of all caution lights is reduced to a dim setting. Intensity of the pilot's optical sight inclinometer post light is also controlled by the INSTRUMENTS knob. The INST PANEL knob on the observer's light dimming panel (figure 1-15) controls the brightness of the observer's instrument lights.

Console Lights Knob

Brightness of the observer's console panel edge lighting, FLIR control, laser control, and receiver/transmitter converter control panels lighting may be adjusted as desired through the CONSOLE PANEL knob (figure 1-15) on the interior lights control panel.

Brightness of the pilot's console panel edge lighting may be adjusted as desired through the CONSOLES knob (figure 1-15) on the interior lights control panel. The pilot's console floodlights are controlled by the CONSOLES knob, as are the instrument panel floodlights, when the FLOOD switch is in the BRIGHT position.

Flight Instruments Light Knob

Brightness of seven primary flight instruments (airspeed, attitude, turn-and-slip, vertical velocity, altimeter, BDHI, and course indicators) may be adjusted through the FLT INSTR knob (figure 1-15) on the interior lights control panel.

Indexer Lights Switch

With the pilot's INSTRUMENTS knob rotated from OFF, brightness of the approach indexer lights may be selected to either DIM or MEDIUM through the INDEXER switch (figure 1-15) on the interior lights control panel. With the INSTRUMENTS knob in the OFF position, bright indexer lighting is selected.

LIGHTING CONTROLS

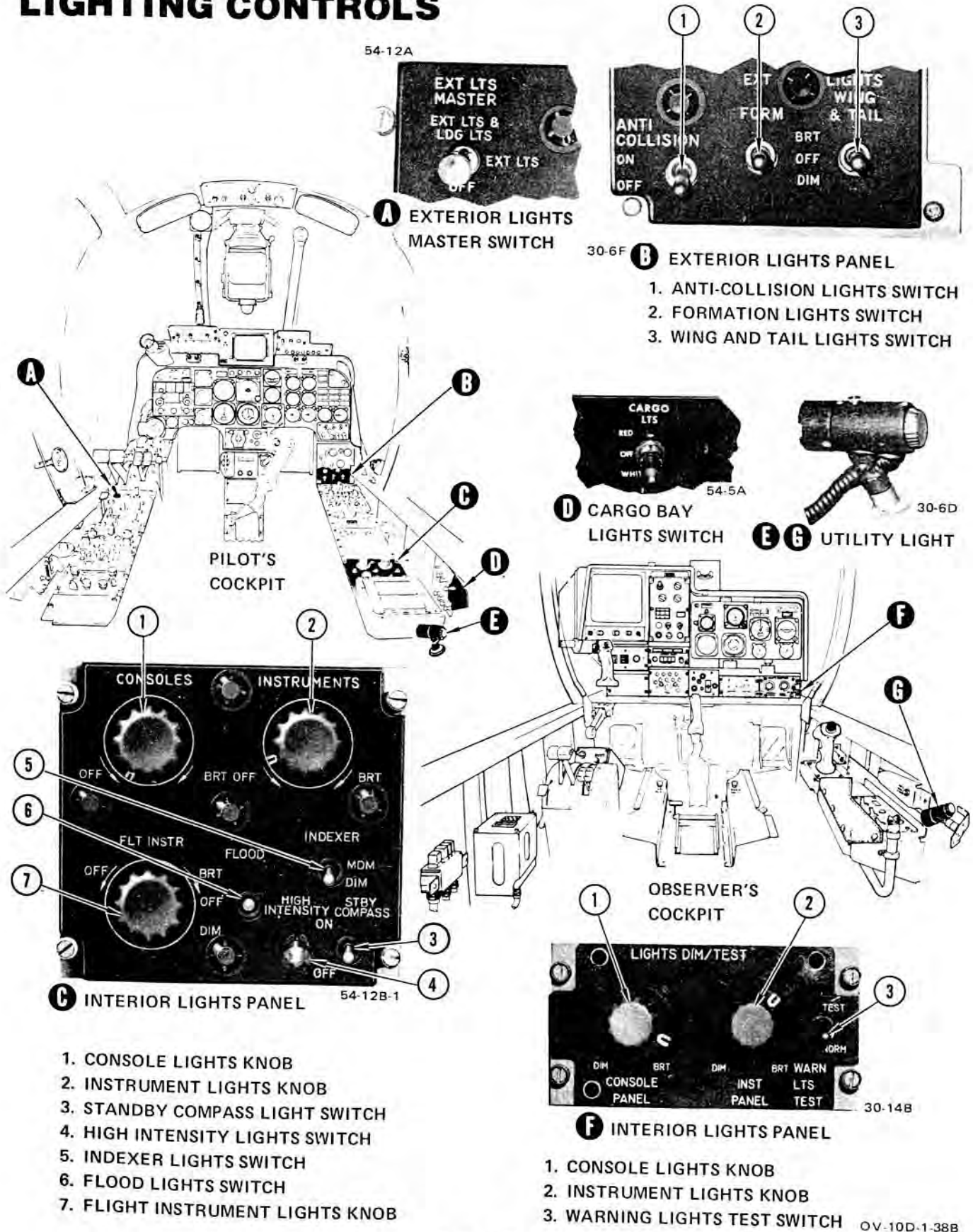

A EXTERIOR LIGHTS MASTER SWITCH

B EXTERIOR LIGHTS PANEL

1. ANTI-COLLISION LIGHTS SWITCH
2. FORMATION LIGHTS SWITCH
3. WING AND TAIL LIGHTS SWITCH

D CARGO BAY LIGHTS SWITCH

E UTILITY LIGHT

C INTERIOR LIGHTS PANEL

1. CONSOLE LIGHTS KNOB
2. INSTRUMENT LIGHTS KNOB
3. STANDBY COMPASS LIGHT SWITCH
4. HIGH INTENSITY LIGHTS SWITCH
5. INDEXER LIGHTS SWITCH
6. FLOOD LIGHTS SWITCH
7. FLIGHT INSTRUMENT LIGHTS KNOB

F INTERIOR LIGHTS PANEL

1. CONSOLE LIGHTS KNOB
2. INSTRUMENT LIGHTS KNOB
3. WARNING LIGHTS TEST SWITCH

Figure 1-15

Standby Compass Light Switch

Internal lighting of the standby compass is controlled through the ON and OFF positions of the STBY COMPASS switch (figure 1-15) on the pilot's interior lights control panel. On some aircraft, the optical sight inclinometer post light illumination is controlled by this

Cargo Bay Lights Switch

The CARGO LTS switch (figure 1-15) is located on the pilot's circuit-breaker panel aft of the right console. The CARGO LTS switch provides OFF, RED, or WHITE selection. A cargo bay maintenance light switch is located on the left-hand side of the cargo bay. The maintenance light switch provides OFF, RED, or WHITE selection. The light is automatically turned off when the cargo bay door is closed.

EXTERIOR LIGHTS

Aircraft exterior lighting consists of wing and tail position lights, formation lights, anticollision lights, and a fixed landing and taxi light.

EXTERIOR LIGHTS CONTROL**Exterior Lights Master Switch**

The EXT LTS MASTER switch (figure 1-15), a three-position lever lock switch is located on the pilot's flap and trim control panel on the left console. Exterior lighting, as selected through individual exterior lights switches, is energized through the EXT LTS and EXT LTS & LDG LTS positions of the EXT LTS MASTER switch. The switch is detented in the EXT LTS & LDG LTS position, requiring it to be lifted in order to select or turn off the landing light.

Wing and Tail Lights Switch

The WING & TAIL lights switch, located on the pilot's exterior lights control panel (figure 1-15), provides BRT, DIM, and OFF selection of wing and tail position light illumination.

Anticollision Lights Switch

Operation of the anticollision lights is controlled through the ON and OFF positions of the pilot's ANTI COLLISION lights switch (figure 1-15) on the exterior lights control panel.

Formation Lights Switch

The FORM lights switch (figure 1-15), located on the pilot's exterior lights control panel, provides BRT, DIM, and OFF selection of formation light illumination.

HEATING, VENTILATION, AND DEFROST SYSTEMS

Hot air from the engine compressors is used in combination with ram air to provide controlled temperature air for cockpit heat and to provide defrost air. Engine compressor bleed air is routed to an air mixing chamber forward of the pilot's instrument panel, and directly to anti-G valves on the left side of both cockpits. Mixing chamber air, controlled to desired temperature, is

directed into the pilot's cockpit through the windshield defrost duct and footwarmer, and into the observer's cockpit by jet pump action through an air distribution tube, and through an aft footwarmer below the observer's instrument panel. For a system block schematic, see figure 1-16.

HEAT, VENT, AND DEFROST CONTROLS**BLEED AIR SWITCHES**

The BLEED AIR switches (figure 1-16) on the pilot's right console are marked LH and RH (left and right engines), with NORM and EMERG OFF positions. These switches are used to close pressure-operated engine bleed air valves which open normally on engine start, and close normally as pressure drops following engine shutdown. The switches are normally left in NORM but may be positioned to EMERG OFF as desired or in the event of wing battle damage.

TEMPERATURE KNOB

The TEMP knob (figure 1-16) on the pilot's heat-vent panel mechanically controls a shutoff valve in the compressor air line leading to the air mixing chamber. Pulling the TEMP knob outward increases heat input to the chamber.

Note

Selection of full heat (TEMP knob full out) results in a reduction of available engine torque by approximately 150 pound-feet per engine at Military power at sea level on a Standard Day.

RAM-AIR KNOB

The RAM AIR knob (figure 1-16) mechanically operates a valve which controls the flow of ram air into the top of the air mixing chamber. Pulling the RAM AIR knob outward increases ram-air flow through the footwarmers and defrost air tubes. Turning the RAM AIR knob to the right locks the knob and ram-air door at the desired position.

COCKPIT AIR/DEFROST KNOB

The CKPT AIR/DEFROST knob (figure 1-16) on the pilot's heat-vent panel mechanically controls a diverter valve in the mixing chamber outlet duct. Pulling the knob outward decreases the amount of air directed to the windshield defrost ducts and diverts air to the cockpit. A certain amount of air bleeds through the defrost ducts under these conditions. With the knob pushed full forward, maximum air is supplied to the defrost ducts. The pilot's defrost tube is equipped with swivel nozzles which allow control of airflow direction as desired.

HEAT-VENT-DEFROST SYSTEM

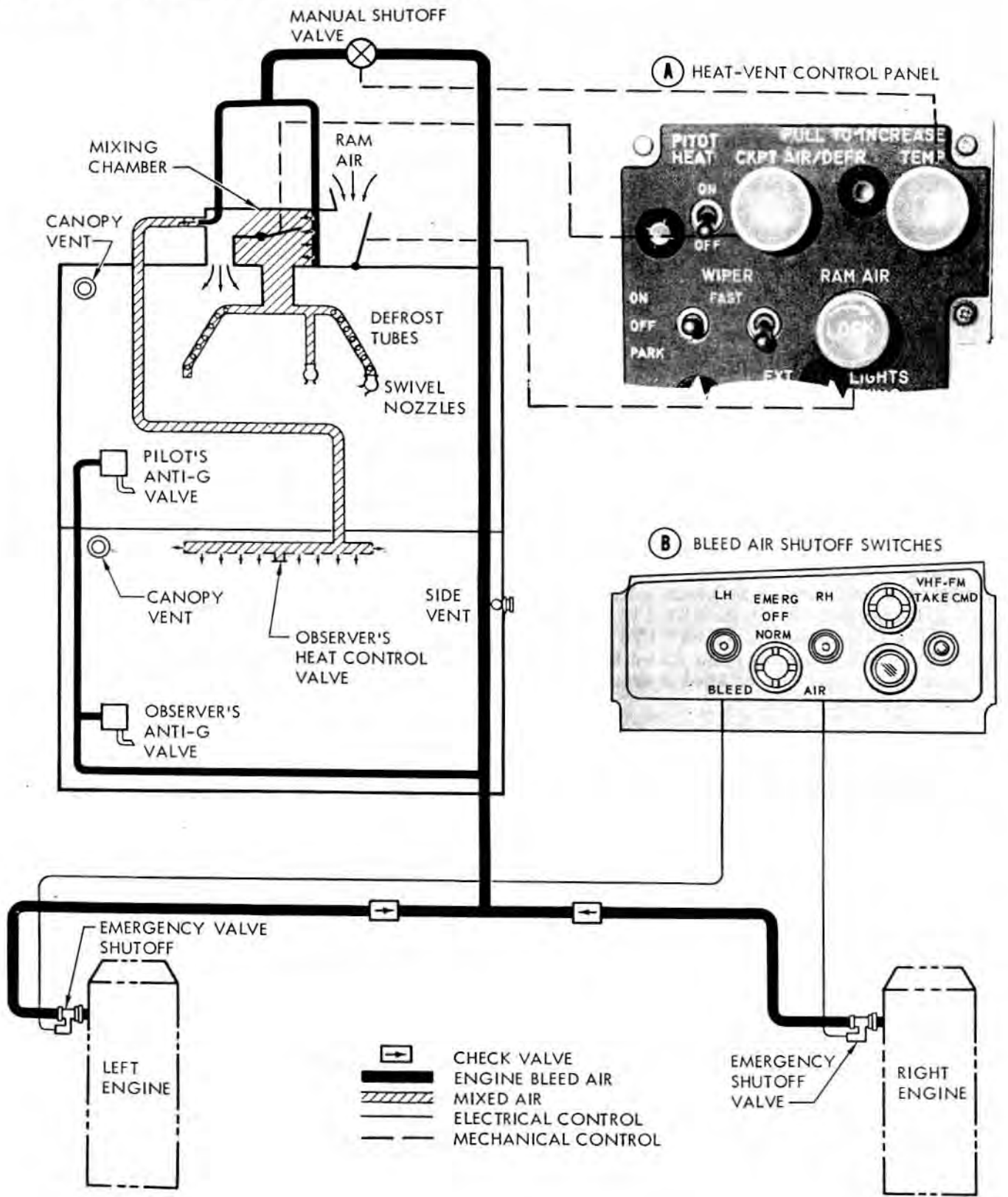

OV-10D-1-105

Figure 1-16

OBSERVER'S COCKPIT AIR VALVE

Aft cockpit footwarmer tube airflow may be controlled by a foot-operated slide valve (figure 1-5). Airflow is increased by moving the valve to the left, or closed off by moving the valve to the right.

CANOPY VENTILATORS

An adjustable ventilation valve (figure 1-1) is installed in the left forward corner of the canopy center panel above each crew member's seat. Pushing the valve body upward allows air to flow into the cockpit. Airflow direction may be adjusted by turning the valve body as desired. Pulling the valve body downward shuts off airflow. By turning the valve body to the rear, the ram inlet may be used as an air ventilation outlet.

OBSERVER'S AIR VENTILATION VALVE

A swivel-ball air valve (figure 1-5) is installed on the right side of the observer's cockpit area. This valve is pushed outward to open and pulled inward to close. The swivel provides control of air direction as desired.

HEAT, VENT, DEFROST OPERATION

To obtain warm airflow for cold weather operation, pull the RAM AIR knob out and lock as desired, then pull the TEMP knob out as required to provide sufficient heat at desired volume. Pulling the TEMP knob only, with the RAM AIR knob in, may result in insufficient airflow for comfort, even though air temperature is sufficiently high. By opening the ram-air valve, additional airflow is generated through jet pump action of the heat input diffuser in the mixing chamber. To obtain footwarmer flow, push the CKPT AIR/DEFROST knob in as desired. To obtain ventilation for hot weather operation, ensure the TEMP knob is pushed completely in, pull the RAM AIR knob out, and adjust the canopy ventilators and side ventilation valve as desired. To obtain maximum defrost, pull the RAM AIR and TEMP knobs as required, and push the CKPT AIR/DEFROST knob full in.

CAUTION

Pulling the TEMP knob full out with the RAM AIR knob pushed full in may result in over-heat damage to the windshield panels.

ANTI-G SUIT SYSTEM

Engine compressor bleed air is directed to an anti-G suit valve (figure 1-2) in the pilot's cockpit and on the left side of the observer's cockpit. During maneuvering flight, air pressure regulated to between 1.5 and 2.0 psi per "g" (over and above 1.0 "g") is directed into the crew member's anti-G suits. A manual valve override button is provided on top of each valve, which is used to check anti-G system operation.

WINDSHIELD WIPER

An electrically operated windshield wiper is installed for use in rain removal from the windshield forward panel. The wiper system is designed to operate normally at a maximum speed of 200 KIAS.

WIPER CONTROL SWITCHES

The WIPER control switches (figure 1-16) are located on the pilot's heat-vent control panel. One switch provides OFF-ON-PARK selections; the other provides FAST speed selection. FAST position provides 250 sweep cycles per minute with the opposing switch in ON. On selection of OFF, the wiper blade stops in place. The PARK position moves the blade to the right side of the windshield.

CAUTION

The windshield wiper shall not be operated on dry glass.

OXYGEN SYSTEM**OXYGEN SYSTEM CONTROLS AND INDICATORS**

A diluter-demand, regulated, gaseous oxygen system may be installed. The oxygen regulators are installed on the pilot's right console and on the right side of the observer's cockpit. Oxygen supply is stored in two 514-cubic-inch bottles, which are installed on the cargo bay ceiling behind the observer's cockpit. For oxygen duration data, see figure 1-17.

OXYGEN REGULATOR

A CRU-44/A diluter-demand regulator panel (figure 1-18) is installed on the pilot's right console and on the right side of the rear cockpit as part of the observer's cockpit package. These regulators automatically supply the proper mixture of air and oxygen at all altitudes.

OXYGEN DURATION (HOURS)

TWO CREW MEMBERS
DOUBLE VALUES FOR SINGLE CREW MEMBER

ALTITUDE (FEET)	GAGE PRESSURE - PSI						BELOW 300
	1800	1500	1200	900	600	300	
NORMAL OXYGEN							
25,000	5.4	4.5	3.6	2.7	1.8	0.9	DESCEND BELOW 10,000 FEET
20,000	6.1	5.1	4.1	3.0	2.0	1.0	
15,000	7.4	6.2	5.0	3.7	2.5	1.2	
10,000	9.9	8.2	7.4	4.9	3.7	1.8	
100% OXYGEN							
25,000	4.3	3.6	2.8	2.1	1.4	0.7	DESCEND BELOW 10,000 FEET
20,000	3.3	2.7	2.2	1.6	1.1	0.5	
15,000	2.6	2.2	1.7	1.3	0.8	0.4	
10,000	2.1	1.7	1.4	1.0	0.7	0.3	

OV-10D-1-129

Figure 1-17

OXYGEN REGULATOR



71-33T

OV-10D-1-130

Figure 1-18

SUPPLY LEVER

The oxygen supply lever must be positioned to ON to provide oxygen pressure in the regulator. The OFF position does not affect system pressure indication, which is reflected by the pressure indicator on the regulator panel.

DILUTER LEVER

The diluter lever is used to select normal regulator diluter-demand operation (NORMAL OXYGEN) or undiluted pure oxygen (100% OXYGEN). The diluter lever should be placed at 100% OXYGEN for all ground operations and for other phases of flight as desired. Operation in 100% OXYGEN position reduces the available oxygen duration. See figure 1-17. The 100% OXYGEN position should also be used any time smoke or fumes are detected in the cockpit.

OXYGEN PRESSURE INDICATOR

The oxygen pressure (OXYGEN P.S.I.) indicator on the regulator panel indicates the total pressure remaining in the oxygen supply bottles. The indicator should be checked prior to flight to ensure sufficient oxygen service to complete the planned mission. The indicator should also be checked periodically in flight to guard against inadvertent use of 100% OXYGEN, or a leak in the system.

EMERGENCY LEVER

The emergency lever is used to select NORMAL operation (spring-loaded to return from TEST MASK), to select EMERGENCY flow pressure, or to check oxygen mask fit and system flow (TEST MASK position).

FLOW INDICATOR

The flow indicator should blink white on each inhalation, returning to black on exhalation, reflecting proper passage of air or oxygen through the regulator. Though this indicator does not reflect proper oxygen ratio or flow, lack of positive indication should be interpreted as a regulator malfunction. With the emergency lever in TEST MASK or EMERGENCY, the indicator remains in "white" condition.

OXYGEN SYSTEM CHECK

The following preflight check should be performed on all flights with the oxygen system installed:

1. Oxygen pressure indicator—MINIMUM FOR FLIGHT (Full = 1800 psi).
2. Aircraft and mask hoses—CHECK CONDITION AND FITTINGS.
3. SUPPLY lever — OFF.

4. Attempt to obtain oxygen from aircraft base.

Note

It should not be possible to obtain oxygen with the supply lever OFF.

5. SUPPLY lever — ON.

6. Diluter lever—100% OXYGEN.

Perform blow-back check to ensure regulator diaphragm continuity.

Note

Little or no resistance to blow-back check indicates a faulty regulator diaphragm.

7. Mask-hose connections—SECURE.

8. Diluter lever — NORMAL OXYGEN OR 100% OXYGEN, as desired.

9. Mask — SECURE AND TIGHT.

10. Emergency lever — TEST MASK (hold and check for leaks).

OXYGEN SYSTEM NORMAL OPERATION

During flight with the oxygen system installed, check the system as follows:

1. Diluter lever — NORMAL OXYGEN.
2. Flow indicator—CHECK PERIODICALLY FOR NORMAL INDICATIONS.
3. OXYGEN P.S.I. indicator — CHECK PERIODICALLY FOR NORMAL DEPLETION.

OXYGEN SYSTEM EMERGENCY OPERATION

If symptoms of hypoxia occur, or with smoke or fumes in the cockpit, set the diluter lever to 100% OXYGEN. If necessary, set emergency lever to EMERGENCY. After the emergency is over, return the emergency lever to NORMAL, as supply will be rapidly depleted.

COCKPIT ENCLOSURE

The unpressurized cockpit section is enclosed by a three-piece windshield and a six-piece canopy. Entrance or exit from the cockpits is accomplished through two upward swinging doors on both sides of the enclosure. All four doors are equipped with overcenter latch handles. The top panels are penetrated by the seats in the event of ejection.

CANOPY DOORS

The right-hand canopy doors are normally used for entrance and exit of the flight crew. See figure 1-19. These doors are equipped with bungees which act to

ENTRY AND EXIT

COCKPIT AREA

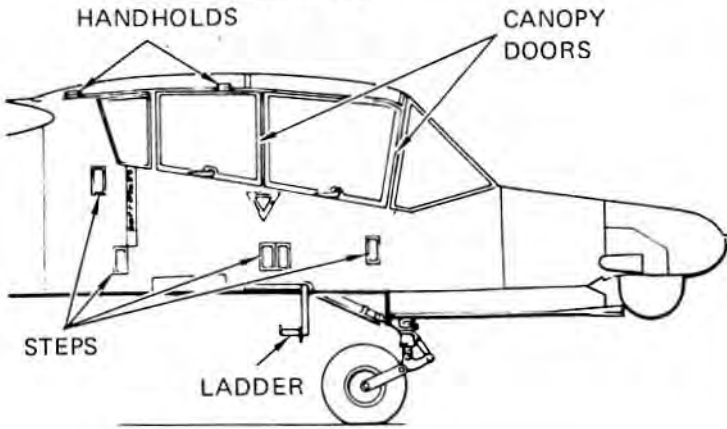

CANOPY HANDLES

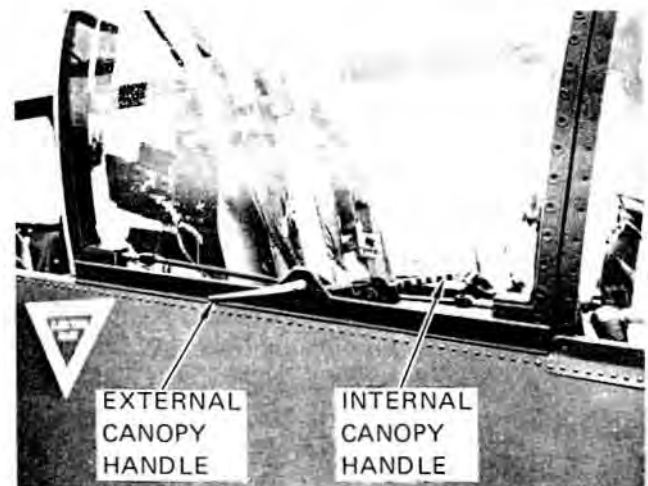
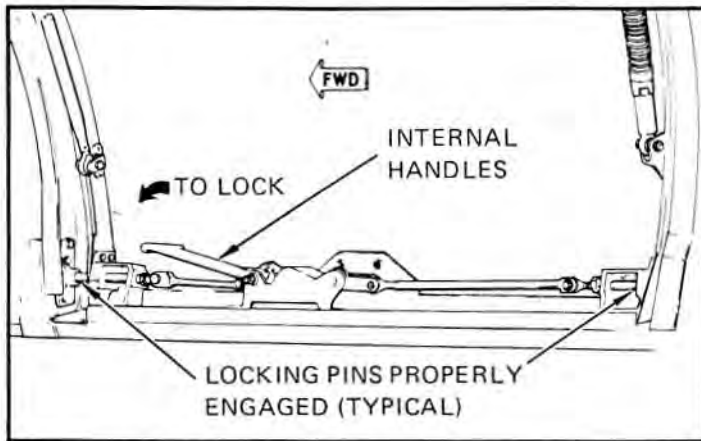
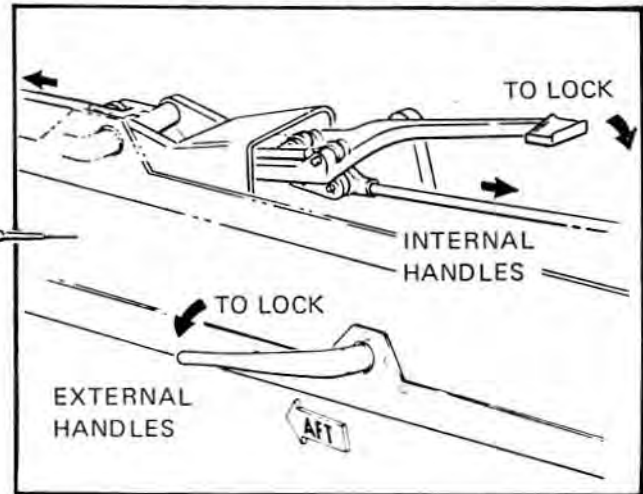

RIGHT-HAND CANOPY HANDLE (INTERNAL VIEW)

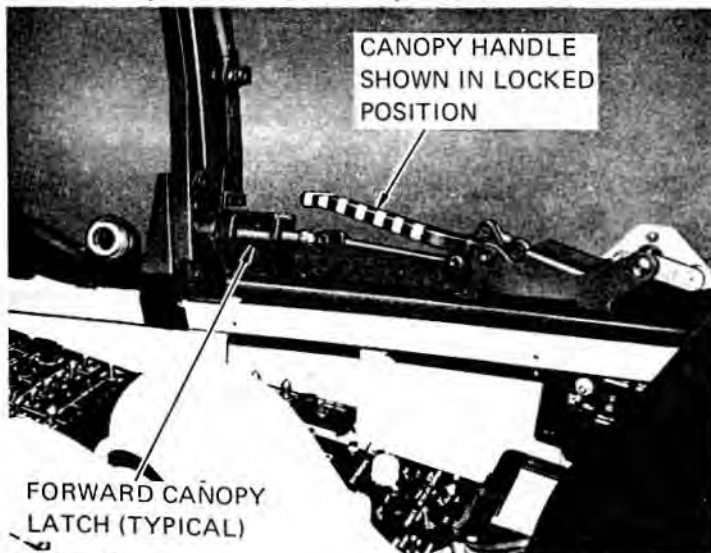

H930-199B

H930-199D RIGHT-HAND CANOPY HANDLE (EXTERNAL VIEW)

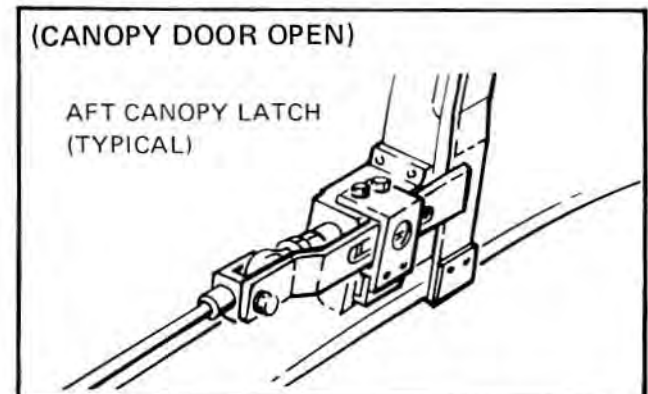

OV-10D-1-50

Figure 1-19

hold the doors in the fully open position. The pilot's doors are equipped with hold-open rods which may be used during ground operation. The left door rod holds the door approximately one-half open; the right door rod holds the door full open. These rods are secured with lever-released positive lock devices. After release and before closing the doors, the rods may be stowed in spring clip retainers on the door frames.

CAUTION

Do not use the canopy door bungees or rod as handholds for cockpit entry.

CANOPY DOOR HANDLES

All four doors are locked closed or unlocked by latch handles installed at the door bottom frames. See figure 1-19. The doors are unlocked from inside by grasping the handle and rotating upward (aft) approximately 120 degrees, or until the locking overcenter linkage is operated. The door is then free to raise vertically the right side doors being raised by holding bungees. Locking operation is the reverse, with the handle being rotated forward (and overcenter) with the door fully down. Proper locking of each canopy door necessitates that both forward and aft latch pins be engaged and the handle in the full forward position. A lock bar installation on the aft latch of each canopy door prevents the latch handle from being placed in the locked position if the aft canopy latch lockpin is misaligned with the door lockpin hold-down fitting.

CAUTION

Before take-off, visually check the canopy door locking pins fully seated with the latch handles fully seated in the locked position.

STEPS AND HANDHOLDS

A folding stepladder is provided on the right side of the fuselage and additional spring-loaded step/handholds are provided for use in entering the cockpit or mounting the wing for refueling purposes. See figure 1-19.

EJECTION SEATS

LW-3B ejection seats (figure 1-20) are installed in the aircraft. This seat provides safe recovery under nearly all speed-altitude conditions. Once initiated, the entire ejection sequence is automatic. After the seat penetrates the top canopy panel and clears the aircraft, the recovery parachute is deployed by a ballistically operated thruster which forces the pilot chute canopy into the air stream. Forced deployment of the personnel parachute provides

extremely rapid canopy inflation and low-altitude/low-speed recovery capability. With the observer's cockpit package installed, the seats are interconnected so that ejection initiated by the pilot will eject the aft seat after 0.4-second delay of catapult initiators, which allows harness retraction to position occupant in the seat. The system sequencing further delays front seat ejection by 0.4 second to allow separation between front and aft cockpit. The total elapsed time for front seat ejection is 0.8 second. The 0.8 second delay operates on front seat ejection even if the aft seat is ejected separately or is removed. No high-altitude oxygen supply is provided.

WARNING

Alternate escape (overside bail-out) is NOT POSSIBLE due to the design and mounting of the recovery parachute, which is an integral part of the seat. The advantage of forced chute deployment and the reliability of dual systems outweigh the lack of an alternate bail-out capability.

RECOVERY PARACHUTE

A 28-foot, flat-canopy parachute (figure 1-20) is mounted in a special elongated pack behind the seat back. The parachute canopy is forcibly deployed by a ballistic thruster (figure 1-20) which expels a 1-pound slug. The slug is tied to a lanyard, which is connected to the apex of the pilot chute. Deployment thruster operation, seat acceleration, and pilot chute action combine to provide rapid parachute deployment in both the high- and low-speed/altitude modes of ejection seat operation. The recovery parachute on the pilot's seat is mounted on the left side, and the observer's on the right side of the seat back. The effective offset in ejected mass center of gravity provides lateral separation of the two seats in the event of pilot-initiated dual ejection.

SPEED/ALTITUDE SENSOR

An ejection speed/altitude sensor (figure 1-21) operates with the aircraft pitot-static system, providing a 2.0-second time delay in the firing of the parachute thruster during ejections above 10,000 ($\pm 1,200$) feet pressure altitude, or at speeds in excess of 200 (+35/-0) knots. On ejection below 200 knots and 10,000 feet, a plunger on the sensor is extended, allowing contact with a striker (figure 1-20) on the seat, firing the short-delay cartridge (0.125 second). On ejection at speeds above 200 (+35/-0) knots or at altitudes above 10,000 ($\pm 1,200$) feet, the sensor plunger remains retracted and the long-delay (2.0 seconds) cartridge is fired by a static lanyard (figure 1-20) as the seat rises. Actuation tolerances for the speed sensor diaphragm and arming key provide high/low mode transition at 200 (+35/-0) knots. During preflight, the pilot should check the small inspection port on the top of the speed altitude sensor.

EJECTION SEAT

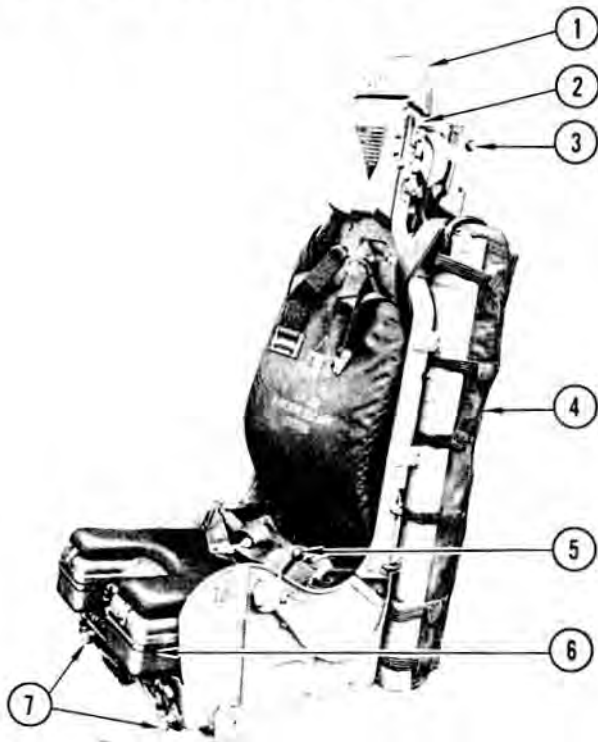

53-28K

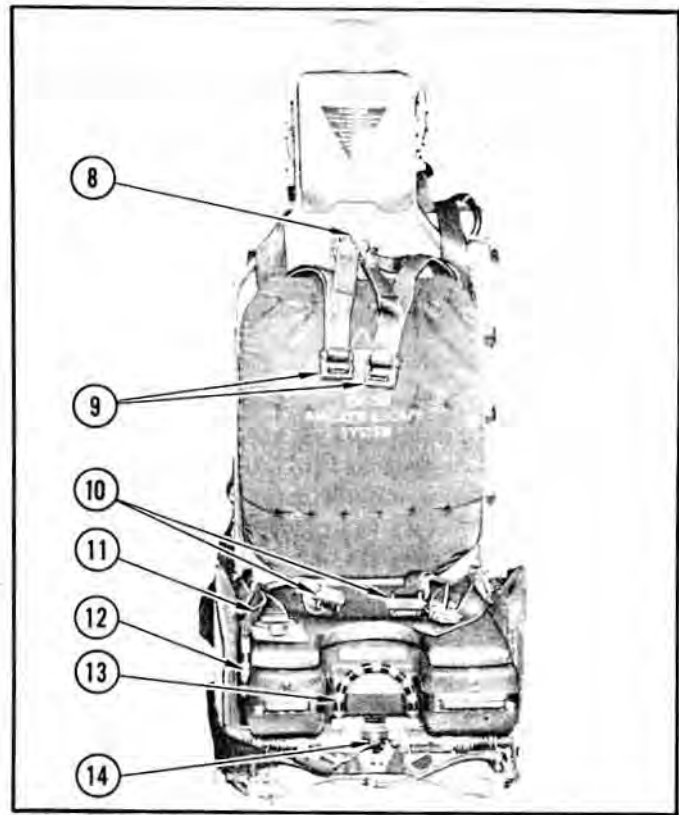

930-190A-1

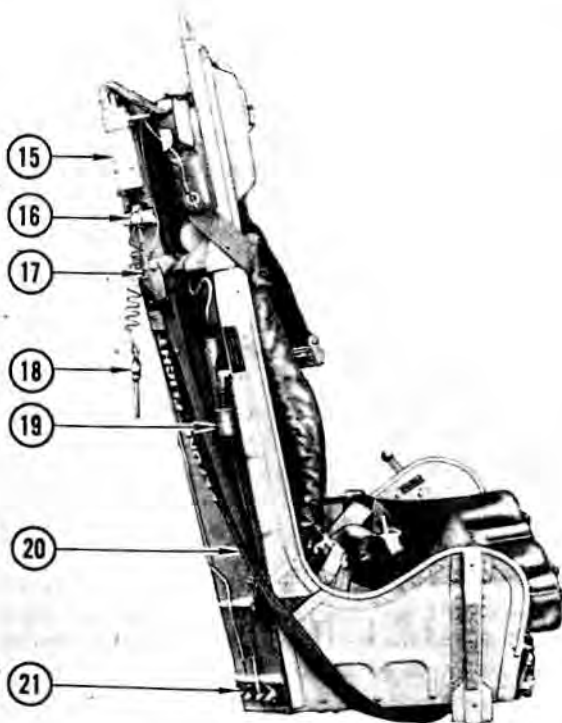

53-28G

1. CANOPY BREAKER
2. PARACHUTE (AND SHOULDER HARNESS) EMERGENCY RELEASE HANDLE
3. CATAPULT ATTACHMENT BOLT
4. RECOVERY PARACHUTE*
5. INERTIA REEL LOCK HANDLE
6. RSSK-9 SURVIVAL KIT
7. GASLINE QUICK-DISCONNECTS
8. HARNESS/INERTIA REEL ADAPTER
9. PARACHUTE HARNESS RISER FITTINGS
10. SURVIVAL KIT ATTACHMENT FITTINGS
11. LAP BELT
12. SURVIVAL KIT DEPLOYMENT HANDLE
13. EJECTION "D" RING
14. EJECTION "D" RING SAFETY PIN
15. PARACHUTE DEPLOYMENT THRUSTER
16. PARACHUTE THRUSTER SAFETY PIN
17. SEAT/MAN SEPARATION LATCH
18. HIGH MODE STATIC LANYARD
19. INERTIA REEL GAS GENERATOR
20. SEAT SAFETY HARNESS (PIN FLAG)
21. SPEED/ALTITUDE SENSOR STRIKER (LOW MODE)

*PILOT'S SEAT SHOWN, OBSERVER'S PARACHUTE MOUNTED ON OPPOSITE SIDE

Figure 1-20

SPEED / ALTITUDE SENSOR



NOTE: PILOT'S SEAT SHOWN
OBSERVER'S SPEED/ALTITUDE
SENSOR MOUNTED ON
OPPOSITE SIDE OF BULKHEAD



OV-10D-1-131

Figure 1-21

Normally the inspection port will begin to show red at approximately 3000 feet altitude and will show all red at 8,000 to 10,000 feet altitude, indicating the shift from the low to the high mode.

Note

The long-delay cartridge operates in both modes. On ejections below 10,000 feet and 200 knots, the short-delay sequence overrides long-delay operation.

PARACHUTE HARNESS AND LAP BELT

The MA-2P integrated harness garment is used. Koch fittings are used to secure the parachute risers to the harness garment. Fittings at the lower attach points are used with rocket-jet fasteners (figure 1-20) to secure the survival kit straps to the harness. Seat/man retention is provided by a standard lap belt (figure 1-20).

WARNING

The ejection seat and RSSK-9 survival kit are equipped with all necessary padding and cushioning materials. Do not add any seat or back pad devices, as such added material may disturb seat/man center of gravity enough to cause severe tumbling and injury on ejection.

INERTIA REEL

A ballistically operated inertia reel provides crew member retention in an upright position during maneuvering, deceleration, and ejection. The reel may be manually locked and unlocked during normal use by the inertia reel lock handle. The reel mechanism is attached to the upper portion of the parachute harness by a strap which, when in the unlocked condition of the reel, allows the crew member to lean forward as desired. When locked by the handle or a 2- to 3-g deceleration, the reel prevents any further play-out. On ejection, the inertia reel ballistic device is actuated, winding in the strap and restraining the crew member in the retracted position in the seat.

EMERGENCY EQUIPMENT

FIRST AID KIT

A first aid kit is installed between cockpit areas on the right side of the aircraft.

SURVIVAL KIT

An RSSK-9 rigid survival kit (figure 1-20) is installed in each ejection seat. The delivered kit contains standard PK-2 survival equipment.

A personnel locator beacon which can be set for automatic or manual operation is also installed in the survival kit.

KIT DEPLOYMENT HANDLE

A survival kit deployment handle (figure 1-20) is mounted on the right side of the survival kit. After ejections over water, this handle is pulled upward to deploy the survival kit and inflate the life raft.

AUTOMATIC EMERGENCY IFF

Ejection departure of the pilot's seat closes a switch which activates the emergency mode of IFF-SIF operation for emergency radar tracking purposes. When the ejection switch is open (seat installed), manual selection of the emergency mode is required. Ejection emergency IFF operation overrides all previously selected IFF modes except OFF and automatically selects the proper SIF code for emergency operation and IFF interrogation.

EJECTION SEAT CONTROLS

SEAT ADJUST SWITCHES

A SEAT ADJUST switch is located above the right console (figure 1-4) in the pilot's cockpit and on the right side of the observer's cockpit (figure 1-5). The seats may be adjusted through a 5-inch vertical range.

EJECTION "D" RING

An ejection "D" ring (figure 1-20) is mounted on the seat bucket between the crew member's legs. Ejection is initiated by pulling the ring upward approximately 2 inches, which fires a set of dual initiators. A "D" ring safety pin (figure 1-20) is provided for insertion when the aircraft is on the ground.

INERTIA REEL LOCK HANDLE

The inertia reel lock handle (figure 1-20) is mounted on the left side of the seat. Moving the handle to LOCKED (forward) prevents the crew member from leaning forward by locking the inertia reel. The reel may be unlocked by leaning back to remove tension from the reel and moving the handle aft to UNLOCK. If the reel is locked automatically, it may be unlocked by cycling the handle.

PARACHUTE EMERGENCY RELEASE HANDLE

The parachute emergency release handle (figure 1-20) is located on the left side of the seat headrest. Should the parachute deployment thruster fail to fire, chute deployment and seat separation may be initiated by pulling this handle. Pulling the handle fully down fires a ballistic cutter which severs the lanyard between the chute canopy and the thruster slug. A spring-loaded lever holds the parachute emergency release handle in place until the ejection seat has left the aircraft. This prevents inadvertent operation of the parachute emergency handle. Separate action also opens the parachute pack through a cable-operated rip cord. Deployment of the parachute then accomplishes the seat/man separation sequence.

WARNING

The parachute emergency release handles are operable with the seats in the cockpits with all safety pins inserted. Inadvertent operation of the handle pulls the parachute rip cord and fires the parachute thruster lanyard cutter, rendering the seat unsafe for ejection.

The parachute emergency release handle also accomplishes positive actuation of the shoulder harness release cable, providing a manual backup release action in the event the normal seat/man separation sequence does not occur.

SEAT SAFETY HARNESS

Two safety pins are installed on the seat when not occupied for flight. One pin secures the ejection "D" ring (figure 1-20) and the other (figure 1-20) safeties the parachute deployment thruster on the aft right side of the pilot's seat and the aft left side on the observer's seat. These pins are connected by a red banner (figure 1-20), which should be stowed after the crew member is strapped in. The observer's seat is provided with a survival kit/seat cushion harness which retains the kit in place when the seat is unoccupied.

CAUTION

The observer's seat lap belt does not provide sufficient survival kit restraint and the seat cushion harness must be used during solo flight.

EJECTION SEAT OPERATION

On ejections below 10,000 feet and 200 knots, the recovery parachute is deployed immediately as the seat clears the cockpit. Above 10,000 ($\pm 1,200$) feet and/or 200 (+35/-0) knots, a 2-second delay in deployment thruster firing is provided for deceleration, prior to parachute deployment and separation. The thruster partially deploys the parachute canopy and the pilot chute continues inflation and deployment action. Deployment of the chute automatically provides seat/man separation. Force on the risers from the inflating parachute separates the seat back from the seat bucket sufficiently to operate an overcenter device which releases the riser attach fittings from the inertia reel adapter to leave the seat with the parachute risers. The same action also releases the lap belt end fittings. As the drag of the inflating parachute decelerates the crew member, the released seat assembly is carried upward and ahead, providing positive seat/man separation.

WARNING

If parachute deployment does not occur immediately following ejection, pull the parachute emergency release handle.

SHOULDER HARNESS MANUAL RELEASE

A shoulder harness manual release function is provided through the parachute emergency release handle for backup in the event normal seat/man separation does not occur. If hesitation in separation from the seat is encountered, pulling the parachute emergency release handle releases the shoulder harness attach fittings from the crewman, after which manually opening the lap belt (if necessary) allows positive release from the seat.

RECOVERY CAPABILITY

Figure 1-22 shows the recovery capability of the LW-3B escape system in terms of required terrain clearance at initiation of ejection for successful recovery from various aircraft flight conditions. Altitudes shown are absolute minimums at which the system will consistently provide recovery capability. The recovery charts show initiation requirements for both pilot and observer.

To illustrate the use of the charts, assume the seat system is in the low mode, aircraft velocity is 200 KIAS, and a dive angle of 90 degrees exists. For both crewmen to be safely recovered, the pilot must initiate the system above 710 feet. The observer could initiate his escape system above 520 feet and safely recover. To depict the influence

of sink rate, ground level recovery for both crewmen at 200 KIAS is possible with zero sink rate. However, with the system in low mode, aircraft velocity 200 KIAS, and sink rate of 5000 feet per minute, the pilot must initiate ejection above 96 feet for successful recovery.

MISSION EQUIPMENT**CARGO COMPARTMENT**

The cargo compartment, excluding the interior of the cargo door, with the observer's equipment package installed, measures 30 inches wide, 39 inches high, and 105 inches long, providing approximately 76 cubic feet of usable volume on 22 square feet of flooring. Care must be taken when loading the cargo bay to ensure that aircraft cg locations remain within prescribed limits. The cargo floor is capable of supporting a maximum of 200 pounds per square foot, or a maximum of 3200 pounds total cargo weight.

CARGO DOOR

A manually operated cargo door is installed. The door is hinged on the port side and swings open 90 degrees, providing unlimited access to the cargo compartment entrance. The cargo door handle is mounted on the right side of the fuselage (inside and outside), forward of the entrance. To unlock, rotate the handle down to the UNLOCK position. To lock, once the door is fully closed, firmly rotate the handle to LOCK position (aligned with the fuselage).

CARGO DOOR HOLD-OPEN ROD

A telescoping hold-open rod is installed in the apex of the cargo door cone. This rod may be used to secure the door to receiving rings on the left boom (90 degrees open). To lock the door in an open position, depress the release button adjacent to the stowed rod and pull the rod to the length desired. The rod and its door retainer lock into the ring, securing the door in position. To release the rod, depress the locking collar at the base of the retainer and push the rod fully into the stowage tube in the cargo bay door.

Note

A nylon cord bungee restricts door travel to approximately 108 degrees to prevent damage to cargo bay door components and wiring in the event of wind gusts.

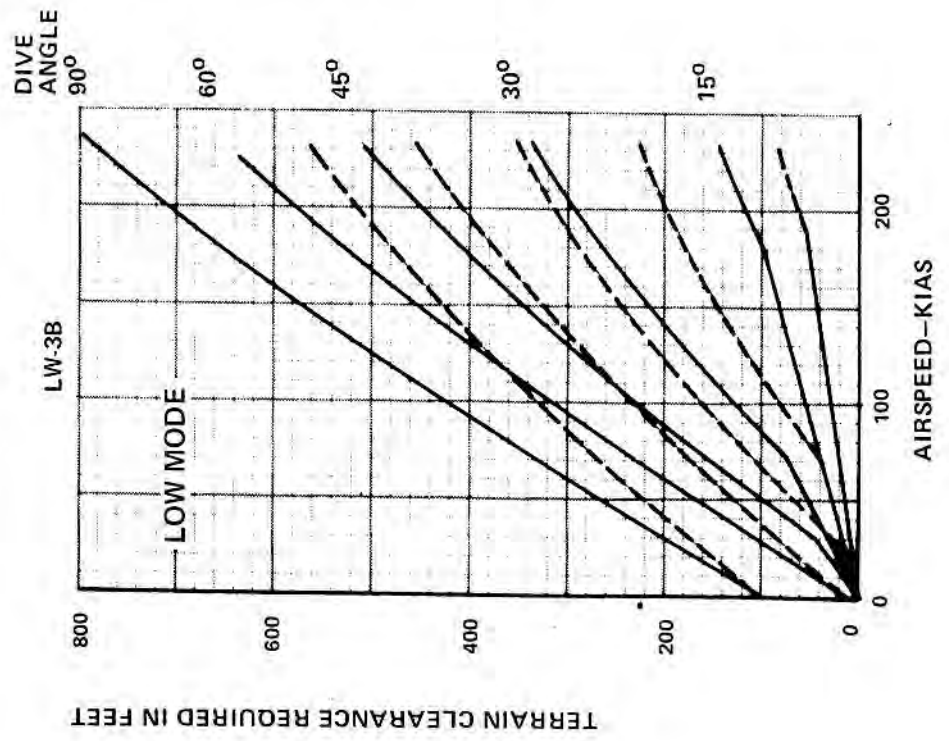
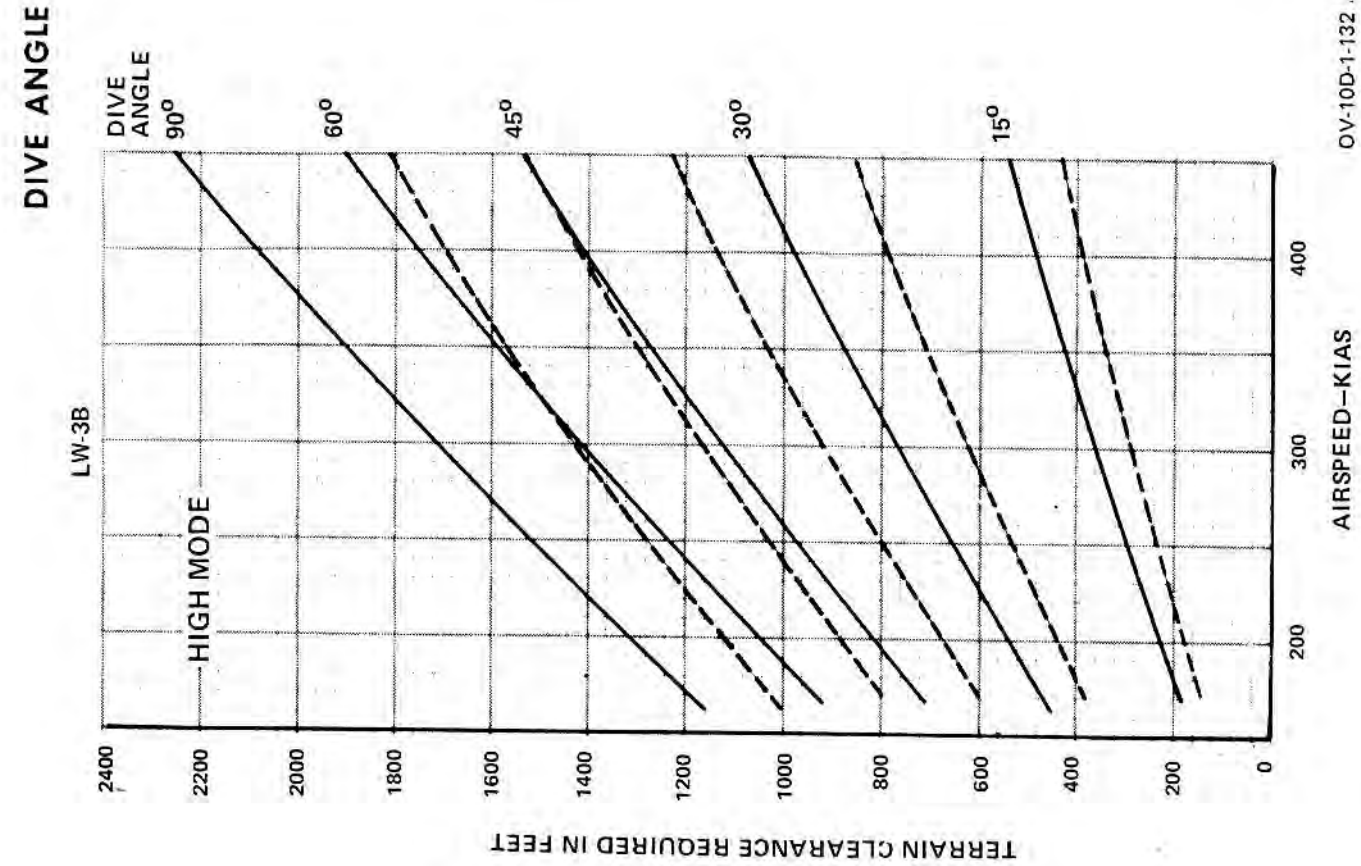
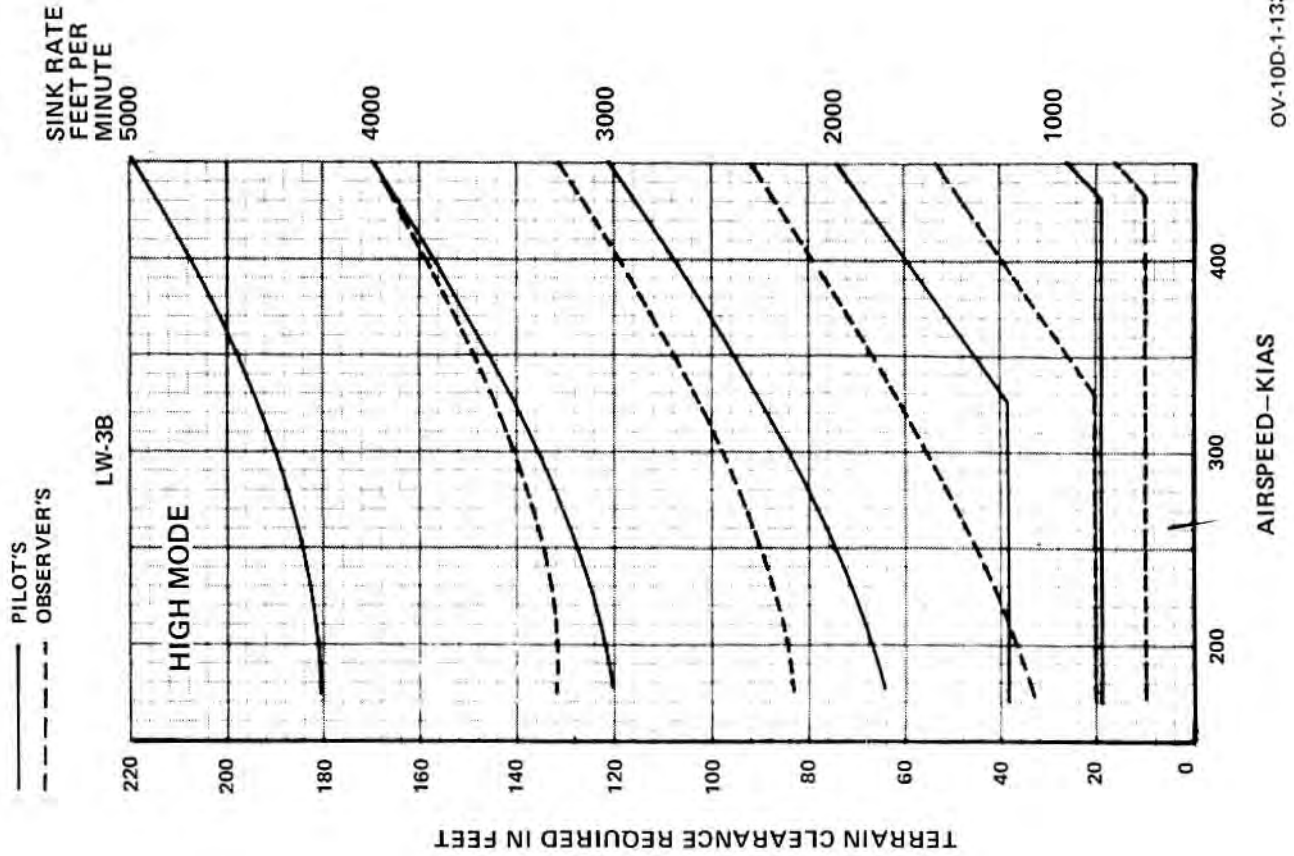

Figure 1-22 (Sheet 1)

SINK RATE



RECOVERY CAPABILITY

ALTITUDE VS SINK RATE

NOTE:
TERRAIN CLEARANCE REQUIRED
IS MEASURED TO THE POINT
OF INITIATION

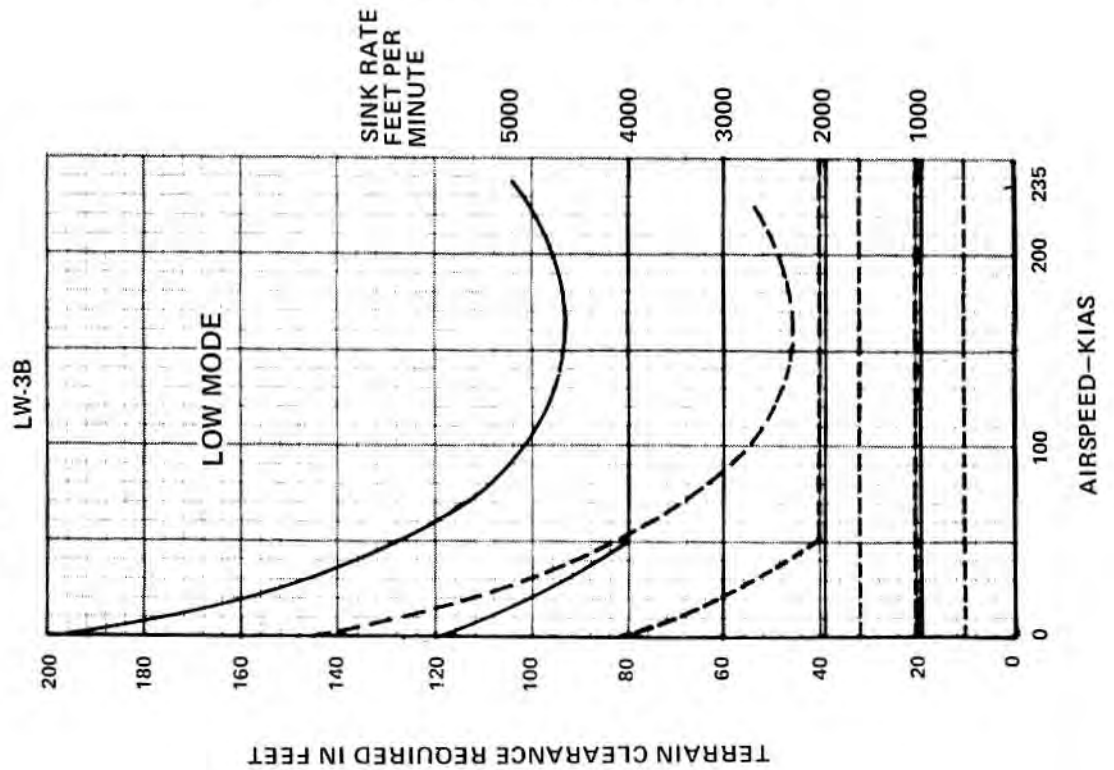
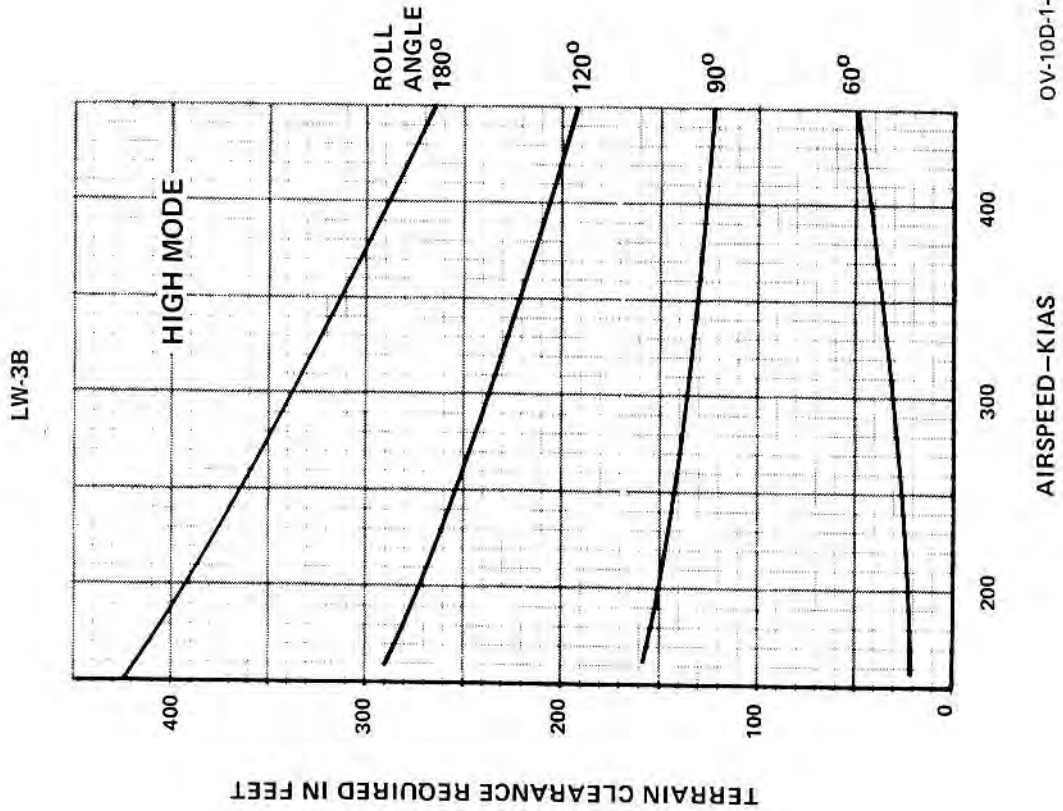

Figure 1-22 (Sheet 2)

ROLL ANGLE



OV-10D-1-134

RECOVERY CAPABILITY

ALTITUDE VS ROLL ANGLE

NOTE:

1. TERRAIN CLEARANCE REQUIRED IS MEASURED TO THE POINT OF INITIATION
2. CURVES ARE FOR BOTH THE PILOT AND OBSERVER

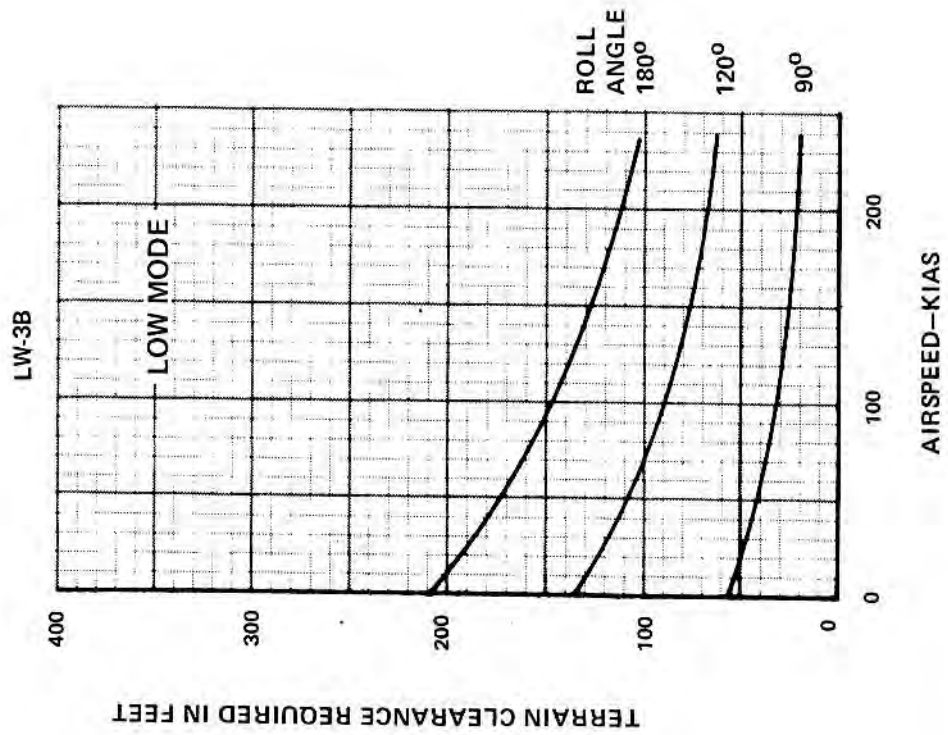

OV-10D-1-134

Figure 1-22 (Sheet 3)

MISCELLANEOUS EQUIPMENT

MESSAGE DROP DOOR

A foot-operated, spring-loaded message drop door system is installed in the aft cockpit. The door and foot pedal are located on the cockpit floor forward of the observer's control stick (figure 1-23). The system is operated by depressing the pedal lever forward with the left foot, which simultaneously opens the inner and outer doors. An overcenter mechanism overrides the spring-closing feature, holding the doors open with the pedal depressed full forward.

SMOKE GENERATING SYSTEM

A smoke generating system is incorporated so the aircraft may be more easily identified by airborne or ground personnel. The system consists of an oil tank, pressure pump, nozzle, necessary lines, and a cockpit control switch and circuit breaker. Components of the system are located in the left wheel well and in the cockpit. The smoke generating system utilizes fog oil (MIL-F-12070) and has a capacity of approximately 2.3 gallons. When smoke is desired, placing the SMOKE GEN switch (figure 8-1) to ON will cause oil to be pumped under pressure through a nozzle into the exhaust duct of the left engine. This atomized oil vaporizes in the exhaust gases, leaving a heavy smoke trail.

SMOKE GENERATING SYSTEM OIL TANK

A smoke generating system oil tank is mounted on the inboard side of the left wheel well. Capacity is approxi-

mately 2.3 gallons and the filler access cap is located on top of the tank. The wheel well installation includes a pump mounted on the bottom of the tank.

SMOKE GENERATING SYSTEM CONTROL SWITCH

The smoke generating system control switch (SMOKE GEN) is located on the left side of the camera and gunsight control panel (figure 8-1) in the pilot's cockpit. The switch has ON and OFF positions and is powered from the monitored 28-volt d-c bus. The circuit breaker for the system is located on the d-c circuit-breaker panel behind the observer's headrest.

RELIEF TUBES

A relief tube is installed on the right side of the pilot's cockpit (figure 1-4) and in the aft cockpit (figure 1-5) as part of the observer's equipment package.

REARVIEW MIRRORS

Two rearview mirrors are installed on the pilot's windshield bow. A rearview mirror is installed in the observer's compartment for view of circuit breaker panel.

MAP AND DATA CASES

A map and publications case is installed above the pilot's instrument panel (figure 1-3) and additional storage space is provided on the pilot's right console (figure 1-4). A map stowage case is installed on the right side of the aft cockpit as part of the observer's equipment package.

MESSAGE DROP INSTALLATION

OBSERVER'S COCKPIT

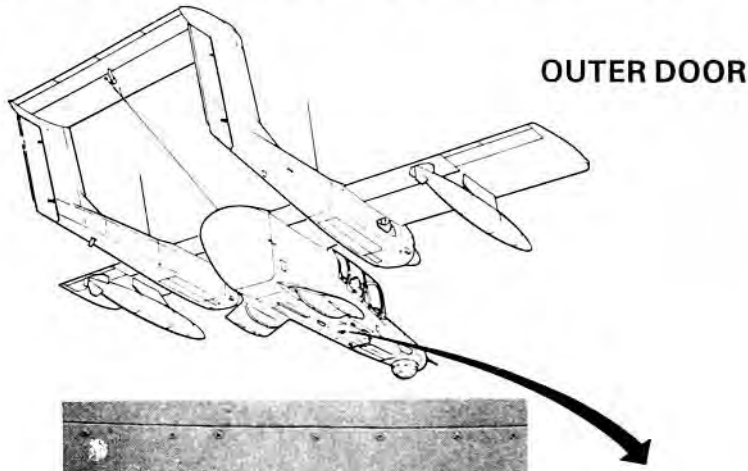

OUTER DOOR

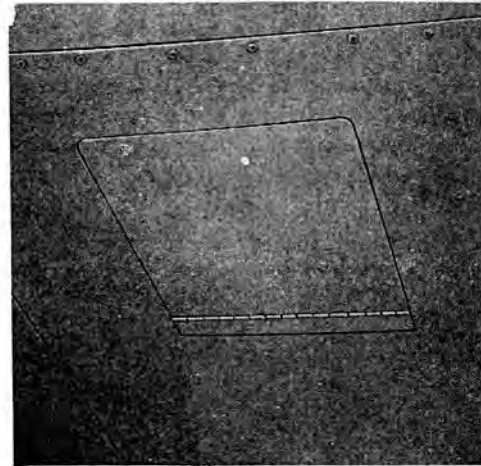

31-4D **CLOSED**

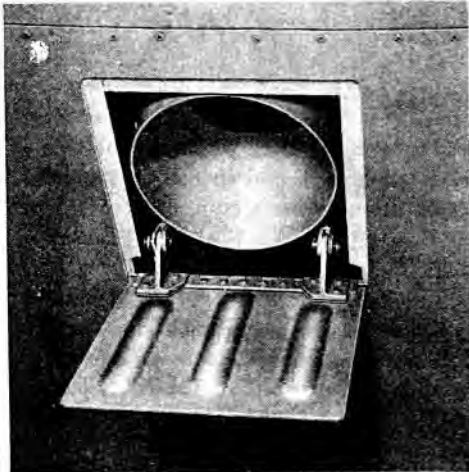

31-4C **OPEN**

INNER DOOR

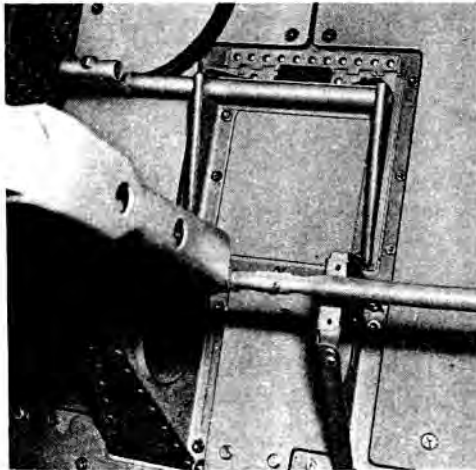
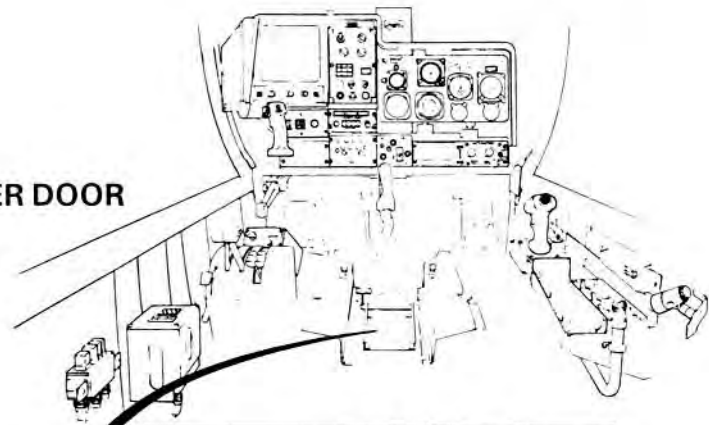

31-4A **CLOSED**

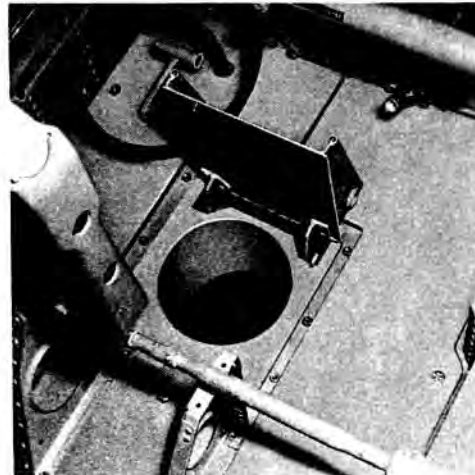

31-4B **OPEN**

OV-10D-1-135

Figure 1-23

PART 3 — AIRCRAFT SERVICING

AIRCRAFT SERVICING

For servicing locations, see figure 1-24.

MATERIAL SPECIFICATIONS

MATERIALS	MILITARY SPECIFICATIONS	FLIP CODES	NATO CODES
Fuel			
Primary	MIL-T-5624	J5	F-44
Alternate	MIL-T-5624	J4	F-40
Alternate	MIL-T-83133	J8	F-34
Alternate	ASTM (Civil Jet A-1)	TA1	F-34
Alternate	ASTM (Civil Jet B)		F-40
Emergency	MIL-G-5572	A+	F-22
Hydraulic Fluid	MIL-H-83282	None	None
Oil			
Engine	MIL-L-23699	None	O-156
Smoke Generator System	MIL-F-12070	None	None
Oxygen Gaseous	MIL-O-27210	LPOX	None
Nitrogen	MIL-N-6011, Grade A	None	None

EXTERNAL POWER

The aircraft electrical system is designed to permit normal engine starts with battery power; however, when tactically feasible, engine starts may be made using external electrical starting power. Starting units should be capable of providing 28-volt d-c power at a minimum of 300 amperes for utility power and 1000 amperes for starting power with a maximum of 1250 amperes.



- If external power unit fails when initiating start, overtemperature could occur. Proceed as outlined in Section V.
- Use of higher rated units may cause damage to the starter-generator, which do not contain current limiters.

Usable electrical power units are as follows:

USN UNITS	USAF UNITS
NC-5*	C-26 (1200 amp)
NC-7*	C-26 (1000 amp)*
NC-8A (with 1100 amp/28 VDC adapter)*	MD-3*
NC-10A-1†	
NC-12A	
60G20S (Navy-Hobart)*	
JEX-EX (Hobart Commercial)*	

† Switch must be in the 1100 AMP position for start.

Note

*The OV-10D aircraft is configured to require only one cable and will use only the oval plug cable from a two-cable cart.

REFUELING

Refueling is accomplished manually through tank filler receptacles. To refuel the aircraft, proceed as follows:

1. If used, ensure fuel truck properly grounded.
2. Ensure aircraft properly grounded.
3. Ensure fuel vent outlets open.
4. Check wing tank drains closed (lower surface of wings).
5. Check remote water drain closed (valve in cargo bay).
6. Check all electrical equipment off.
7. Fill each auxiliary tank as applicable and replace filler cap.

Note

Unless special procedures are followed to elevate the nose of the aircraft to about 4 degrees nose-up, the AERO 1C external fuel tank will accept a maximum of only 122 gallons of fuel.

8. Fill center wing tank to bottom of standpipe and replace filler cap.
9. Fill left and right inboard wing tanks to bottom of standpipes and replace filler cap.
10. Fill outboard wing tanks to bottom of standpipes and replace filler caps.

SERVICING



ENGINE OIL FILLER CAP ACCESS (TYPICAL BOTH NACELLES)

0 15

(A) OIL SYSTEMS
EACH TANK-1.5 GALLONS



31-8

(D) EXTERNAL ELECTRICAL POWER RECEPTACLE



A-242

(G) SMOKE GENERATOR OIL TANK
(2.3 GALLONS)



48 1R 1

(B) REFUELING (GRAVITY FILL)
TYPICAL FILLER CAP

TANK	CAPACITY (GALLONS)
CTR WING TANK	37.6
LH OUTBD WING TANK	37.6
RH OUTBD WING TANK	37.6
LH INBD WING TANK	66.8
RH INBD WING TANK	66.8
TOTAL INTERNAL	246.4
DROP TANKS (2)	192.0
(TOTAL)	438.4
C/L TANK (FPU-3/A)	150.0
(TOTAL)	396.4

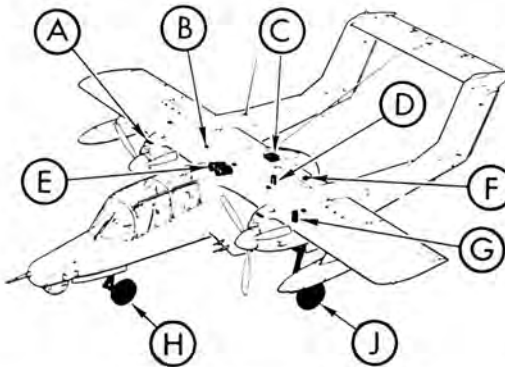

30 118

(H) NOSE GEAR

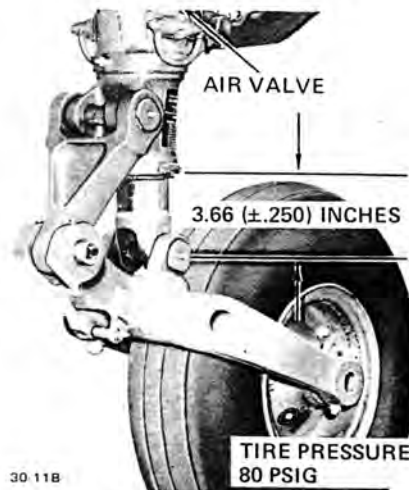

AIR VALVE

3.66 (±.250) INCHES

TIRE PRESSURE
80 PSIG

HYDRAULIC RESERVOIR FILLER CAP

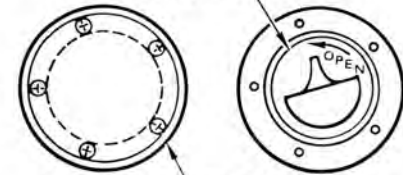

ACCESS COVER PLATE

(C) HYDRAULIC SYSTEM

SYSTEM (COMPLETE)-1.5 GALLONS
RESERVOIR-0.6 GALLON



733-2

(E) OXYGEN BOTTLES

OXYGEN FILL RECEPTACLE (LOCATED LH SIDE AFT END OF CARGO BAY)

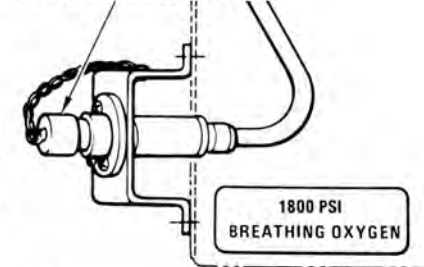

1800 PSI
BREATHING OXYGEN

(F) OXYGEN 1800 (± 50) PSI

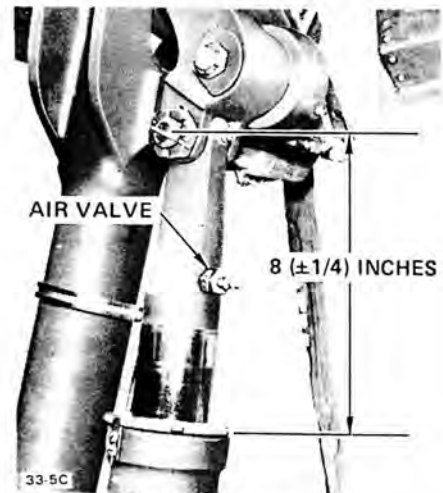

AIR VALVE

8 (±1/4) INCHES

33-5C

(J) MAIN GEAR

TIRE PRESSURE 65 PSIG

OV-10D-1-7E

Figure 1-24

PRIMARY, ALTERNATE, AND EMERGENCY FUELS

Operational primary fuel is JP-5. Alternate fuels are JP-4 and JP-8. When neither the primary nor alternate fuels are available, emergency fuel is Aviation Gasoline, 115/145 Octane (MIL-G-5572).

FUEL CONTROL

To ensure proper engine operation, the specific gravity setting of the fuel control should be reset whenever the type of fuel is changed. See figure 1-25.

SYSTEMS SERVICING

OIL SYSTEMS

Use MIL-L-23699 turbine oil.

1. Unlock and lift oil filler on cowl.
2. Fill to full mark on filler neck.
3. Reseat filler, turn cap 45 degrees aft, and lock by depressing lock lever. Check cap fully seated and locked.
4. Repeat for opposite engine.

Note

When a propeller is cranked out of feather after engine shutdown, the oil reservoir will indicate approximately 2 quarts low. The oil used by the unfeathering pump is not returned to the reservoir until the engine is motored for at least 10 seconds or started. If serviced prior to starting, the excess oil will vent overboard.

HYDRAULIC SYSTEM

Use MIL-H-83282 hydraulic fluid. To service, proceed as follows:

1. Disengage HYD PUMP CONT circuit breaker.
2. Open external hydraulic reservoir access door on upper aft portion of fuselage top deck.
3. Remove filler and vent cap.
4. Fill reservoir.

Note

Reservoir is full when fluid is up to middle of fill pipe (even with machined land at middle of filler pipe).

FUEL CONTROL

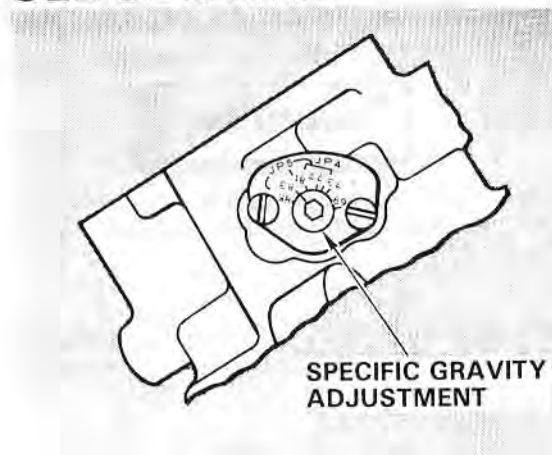

Fuel Used	Specific Gravity Setting
MIL-T-5624, JP-5	0.83
MIL-T-83133, JP-8	0.81
MIL-T-5624, JP-4	0.77
Grade 115/145	0.71

OV-10D-1-136A

Figure 1-25

5. Replace filler cap and hydraulic reservoir fuselage access door.
6. Engage HYD PUMP CONT circuit breaker.

OXYGEN SYSTEM

Use MIL-O-27210 high-pressure breathing oxygen. To service the oxygen system, refer to Maintenance Instructions—Oxygen Equipment (NAVAIR 03-50-1) and proceed as follows:

1. Open cargo door.

Note

Oxygen fill receptacle is located on left hand aft end of cargo bay.



Ensure that filler valve and surrounding area are free of contamination. Oils, grease, and solvents may burn or explode spontaneously when contacted by oxygen under pressure.

2. Remove filler cap.



If system has been depleted of oxygen or dropped below 50 psi for a period of 2 hours or more, the entire system must be purged. Refer to Purging—Environmental Systems Manual (NAVAIR 01-OV10A/D-2-3.1).

3. Connect gaseous oxygen supply (MIL-O-27210) to bottle filler valve. Charge bottle to correct pressure compensated for ambient air temperature.

WARNING

Rapid filling of oxygen cylinder creates severe internal heat, which may result in explosion or fire.

Fill the oxygen bottle in stages as follows, allowing not less than 3 minutes for each filling stage and 2 minutes for cooling between stages.

- Stage 1—Fill to 500 psi
- Stage 2—Fill to 1000 psi
- Stage 3—Fill to 1500 psi
- Stage 4—Fill to 1800 psi

Note

Oxygen bottles should be charged with a pressure of 1800 plus or minus 50 psi at ambient temperature of 70°F (21°C). For every 10°F, plus or minus, charging pressure will vary approximately 25 to 50 psi, plus or minus, respectively.

4. Remove oxygen supply and install filler cap.
5. Close and lock cargo bay door.

TIRES

Tires are normally inflated with dry air. Dry nitrogen (MIL-N-6011) may be used if an adequate source is available. Tire specifications and pressures are as follows:

TIRE	SIZE	PRESSURE
Nose	7.50 x 10, Type III	80 psig
Mains	29 x 11, Type III	65 psig

STRUTS

Struts are serviced with dry nitrogen (MIL-N-6011). Strut servicing may be accomplished using dry air only if an adequate dry nitrogen source is not available.

Note

If struts are serviced with air, reservicing should be accomplished when a source of dry nitrogen is available.

Service landing gear struts as follows:

1. Remove air valve dust cap, connect pressure source and loosen hex nut one-quarter turn.
2. Inflate strut to specified dimension and tighten hex nut; remove pressure source and install dust cap.

3. Ensure accuracy by rocking aircraft to settle struts and remeasuring.

Nose gear (strut flange to fork nut) = 3.66 (+1/4) inches.

Main gear (oleo flange to connector nut) = 8.00 (+1/4) inches.

JACK/MOOR PADS

Jack/moor pads are normally carried in each aircraft in a canvas bag attached to the cargo door. For jacking or mooring, these pads are attached to the wing outboard of the engines and underneath the fuselage at a point marked MOOR/JACK. See figure 1-26.

SMOKE GENERATOR OIL TANK

To fill smoke generator oil tank, proceed as follows:

1. Gain access to left wheel well.
2. Remove filler cap.
3. Fill tank (2.3-gallon capacity) with fog oil (MIL-F-12070).
4. Install filler cap by turning clockwise.
5. POSITION CAP LEVER DOWN TO LOCK CAP.

BATTERIES

For servicing and maintenance of nickel-cadmium batteries, refer to Servicing and Maintenance Instructions, Naval Aircraft Batteries (NAVAIR 17-15BAD-1).

CAUTION

No maintenance of batteries should be performed on the flight line or with the batteries installed in the aircraft. Batteries requiring maintenance must be removed and serviced by a shop which specializes in nickel-cadmium battery maintenance.

Note

An external power source should always be applied to the aircraft when electrical power is required for trouble shooting or other maintenance functions. This is necessary to conserve battery power for its intended use, supplying an alternate source of power in an emergency or for starting engines.

ICE REMOVAL

To de-ice parked aircraft, refer to Anti-icing, De-icing, and Defrosting of Parked Aircraft Manual (NAVWEPs 01-1A-520).

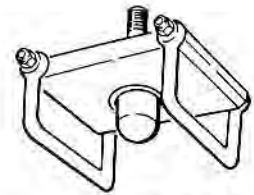
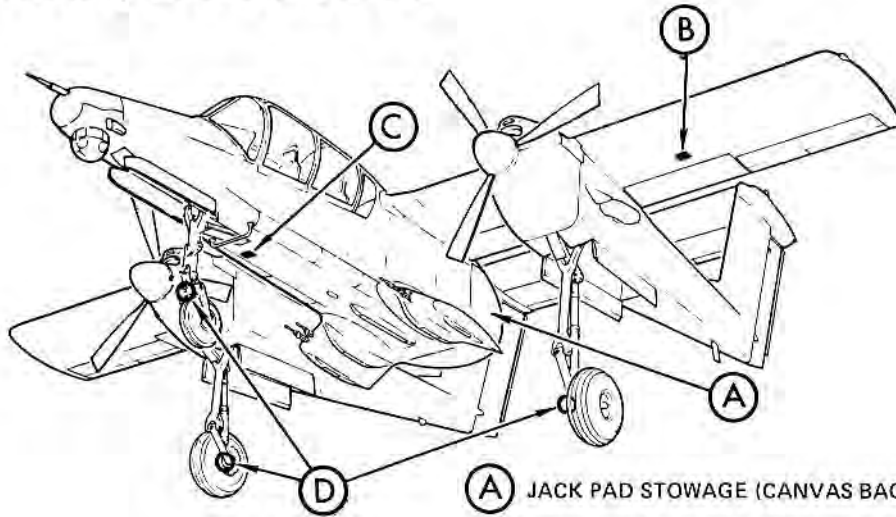
JACK/MOOR PADS

E13710 JACK PAD

- (A) JACK PAD STOWAGE (CANVAS BAG ATTACHED TO CARGO DOOR).
- (B) WING JACK PAD INSTALL POINT (ONE ON LOWER SURFACE OF EACH WING).
REQUIRES HYDRAULIC TRIPOD (10-TON), TYPE B-6 JACK
- (C) FORWARD FUSELAGE JACK PAD INSTALL POINT
REQUIRES HYDRAULIC TRIPOD (5-TON), TYPE B-5 JACK
- (D) AXLE JACKING POINTS
REQUIRE 5-TON AXLE JACK

OV-10D-1-106

Figure 1-26

PART 4 — AIRCRAFT OPERATING LIMITATIONS

INTRODUCTION

This part presents operating limitations applicable to military aircrews. Only those stores and operating limitations listed in figure 1-31 are authorized to be carried and released or fired to the limits shown.

INSTRUMENT MARKINGS

Instrument markings are presented in figure 1-27. Careful attention should be given to these markings, as the limits and parameters shown are not necessarily repeated in this or other sections of the manual.

ENGINE LIMITS

STARTER-GENERATOR DUTY CYCLE

The engine starter-generators are limited to four consecutive cranking/motoring cycles of 15 seconds maximum duration each to engine light-off, with the following cooling periods between start attempts:

1. One-minute cooling period prior to second attempt.
2. Two-minute cooling period prior to third attempt.
3. Ten-minute cooling period prior to fourth attempt.

A 60-minute cooling period is required prior to a repeat of the starter-generator duty cycle or damage may result to the starter-generator.

IGNITION SYSTEM

The ignition system is limited to 2 minutes ON, 3 minutes OFF, 2 minutes ON, 23 minutes OFF.

MILITARY POWER

Military power is defined as the maximum power available which does not exceed the limits of 101% rpm and either 1108°C TIT or 3282 pounds torque. Operation at Military power is restricted to a maximum of 30 minutes.

Note

Maximum engine temperature and torque should be verified at the 115- to 117-degree position of the power levers. Maximum take-off thrust will be obtained at the FULL FORWARD (120 degrees) position of the levers.

NORMAL POWER

Normal power is defined as that combined rpm/torque/engine temperature setting which is not time-limited. Normal power is the same as "maximum continuous" power, and is reached at a maximum torque setting of 2625 pound-feet and/or 1034°C TIT.

RPM LIMITS

Engine rpm limits are shown in figure 1-28. RPM is NOT time limited up to 101%. Operation between 101% and 103% is limited to 1 minute regardless of torque setting. Operation between 103% and 105% for 5 seconds is acceptable on ground run-up with the propellers on the start locks to allow for overspeed governor check. If 105% is exceeded in flight, reduce torque to minimum practical and land as soon as practicable. An inspection of power plant and fuel systems must be accomplished if any of these limits are exceeded.

ENGINE TURBINE INLET TEMPERATURE LIMITS

The rpm, temperature, and duration of any engine over-temperature operation shall be recorded so that the prescribed engine inspection can be performed. Engine turbine inlet temperature (TIT) limits are shown in figure 1-28. The turbine inlet temperature limits for the engines are established as follows:

NORMAL POWER OPERATION—1034°C

The engines may be operated at 1034°C or less with no time limitations.

MILITARY POWER OPERATION—1108°C

Engine operation between 1035° and 1108°C shall be limited to periods of 30 minutes or less. Operation at these temperatures should be limited to those times where maximum or near maximum power is required to accomplish mission requirements. By minimizing operation at this temperature, turbine component life will be maximized. During engine rigging and trimming operation this temperature shall never be exceeded. A yellow line on the turbine inlet temperature gage will aid the pilot in keeping within this limit.

TRANSIENT OPERATING CONDITIONS—1129°C

Engine operation between 1109° and 1129°C is allowed for transient conditions only. Operating time at these temperatures shall be limited to periods of 1 minute or less. During periods of maximum power operation there may be times when the turbine inlet temperature exceeds 1108°C. This can be expected during maximum power climbouts, sideslips, and maneuvering. No pilot action is required during these transient conditions so long as 1129°C is not exceeded and the duration of the event is less than 1 minute. A red warning line on the turbine inlet temperature

INSTRUMENT MARKINGS

AIRSPPEED INDICATOR

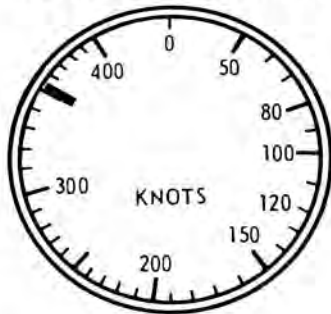

LIMIT - 350 KIAS

ACCELEROMETER

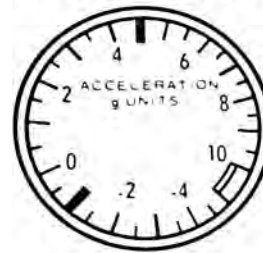

+4.5
-1.0

OIL PRESSURE INDICATOR



48 PSI (MINIMUM—IDLE RPM)
48—120 PSI (NORMAL RANGE)
120 PSI (MAXIMUM)

ENGINE RPM INDICATORS

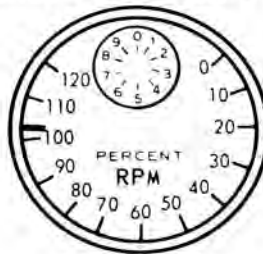

103—105% 5 SECONDS
101—103% 1 MINUTE
101% OR LESS NO LIMIT

ENGINE TORQUE INDICATORS

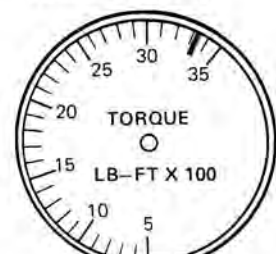

0—2625 NO LIMIT
2626—3282 30 MINUTES
3283—3348 45 SECONDS
REVERSE THRUST TORQUE LIMITS
0—2300 1 MINUTE
2301-2640 5 SECONDS

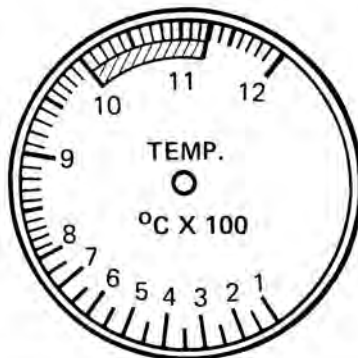

TURBINE INLET TEMPERATURE INDICATORS

T.I.T.	
1040°C (815°C EGT)	ENGINE START PEAK (1 SECOND LIMIT)
1034°C OR LOWER	NORMAL POWER (NO TIME LIMIT)
1108°C (YELLOW LINE)	MILITARY POWER LIMIT (30 MINUTES)
1129°C (RED LINE)	ACCELERATION TRANSIENT LIMIT (1 MINUTE)

OV-10D-1-8H

Figure 1-27

gauge, a red warning light, and aural warning tone will alert the pilot to the fact that the 1129°C limit has been approached. The red light and warning tone will be activated in the range of 1125° to 1129°C. When the warning is activated the TIT must be immediately brought back to the yellow caution line or below.

Note

If for some reason (aircraft emergency, combat tactics) these limits are exceeded, the pilot must report the overtemperature event to maintenance personnel for determination if the engine is suitable for further use.

as practicable. For reverse thrust operation, transient peaks to 2640 pound-feet are permissible for 5 seconds. Reverse thrust torque settings up to 2300 pound-feet are not time-limited.

Note

Maximum allowable torque indicator difference between engines is 200 pound-feet during flight or ground operation.

TORQUE LIMITS

Engine torque limits are shown in figure 1-28. Torque is not time-limited up to 2625 pound-feet. Operation between 2626 and 3282 pound-feet is limited to 30 minutes duration. Operation between 3283 and 3348 pound-feet is limited to 45 seconds for acceleration transients. If 3348 pound-feet is exceeded on the ground for any duration, shut down the engine. If 3348 pound-feet is exceeded in flight, reduce torque to minimum practical and land as soon

OIL PRESSURE LIMITS



If oil pressure is below minimum at GROUND IDLE with propellers on the start locks, take-off is not recommended, due to possible engine failure. Engine inspection should be accomplished prior to further operations.

ENGINE LIMITS

ENGINES: T76G-420/-421
FUEL: JP-4 (MIL-T-5624)
JP-5 (MIL-T-5624)

OPERATION	TURBINE INLET TEMP (°C)	RPM (%)	TORQUE (LB-FT)	TIME LIMIT
STARTING PEAK (LESS THAN 50% RPM)	1040	—	—	1 SECOND
	815 (EGT)			
TRANSIENTS	1109-1129	101-103	—	1 MINUTE
		—	3283-3348	45 SECONDS
		103-105	—	5 SECONDS
MILITARY POWER (INTERMEDIATE)	1035-1108	101.0	2626-3282	30 MINUTES
NORMAL POWER (MAXIMUM CONTINUOUS)	1034	101.0	2625	
FULL REVERSE	1120-1129	101.0	2301-2640	5 SECONDS
	999	100.0-100.5	2300	

OV-10D-1-9F

Figure 1-28

Oil pressure limits are shown in figure 1-27. Minimum acceptable oil pressure is 48 psi. Maximum pressure limit is 120 psi. Minimum operating oil pressure depends on rpm setting as follows:

RPM (%)	MINIMUM OIL PRESSURE (PSI)
65 (Idle)	48
70	56
75	64
80	72
85	80
88	85
91-101	90

HYDRAULIC SYSTEM OPERATION LIMITS

A 3-minute cooling period is required after 5 minutes of continuous nose wheel steering, or three continuous flap cycles, or three continuous landing gear cycles, or a combination thereof.

REVERSE THRUST LIMITS

Use of reverse thrust is prohibited in flight.



The pilot shall ensure that the condition levers are in the T.O./LAND position for all landings. After landing, the power levers shall not be retarded below the GROUND START position until airspeed is below 100 KIAS (OAT 100°F/37.8°C or less), or 75 KIAS (OAT in excess of 100°F/37.8°C). When FULL REVERSE is required, the power levers will be retarded to FULL REVERSE, smoothly but rapidly; do not modulate thrust until FULL REVERSE (100.0% to 100.5%) has been obtained. If rpm decreases to 94% during reverse thrust operation, power levers shall be immediately advanced to prevent further rpm decay and engine overtemperature. For static ground operations, reverse thrust is limited to 1 minute.

AIRSPEED LIMITS

MAXIMUM ALLOWABLE AIRSPEED

For operating flight limits, see figure 1-29. Limit airspeed with or without external stores and FLIR turret is 350 KIAS.

LANDING GEAR LIMIT SPEED

Maximum speed for operation with the landing gear extended, extending, or retracting (in transit) is 158 KIAS.

FLAP LIMIT SPEEDS

Maximum speed for flap extension and flap limit to T/O setting (20 degrees) is 158 KIAS. Maximum speed for flap extension and flap limit to DN (40 degrees) is 130 KIAS.

MINIMUM SPEEDS—NORMAL OPERATIONS

TAKE-OFF

Refer to Section XI, Part 2.

LANDING

Refer to Section XI, Part 8.

MINIMUM SPEEDS—STOL OPERATIONS

STOL operations must be planned with care and accuracy. For minimum speeds, refer to Section XI, Parts 2 and 8.

CROSSWIND COMPONENT

The crosswind component limit is 20 knots at 90 degrees for take-off and landing. See figure 11-5.

ACCELERATION LIMITS

For aircraft design acceleration limits, see figure 1-30. (Limits with stores, which in many cases are more restrictive, are shown in figure 1-31.) Symmetrical "g" limits (auxiliary fuel tanks on or off) are minus 1.0 to plus 4.5 "g's" at gross weights up to 13,142 pounds. At higher gross weights, the load factor decreases linearly to 4.0 "g's" maximum. Rolling pull-out "g" limits are 0 to 3.6 "g's." With flaps down (20 degrees only) and at 158 KIAS or less, the acceleration limits are minus 1.0 "g" to maximum attainable.

EXTERNAL STORE LIMITS

AUXILIARY FUEL TANKS

Maximum airspeed for jettisoning centerline or wing pylon auxiliary fuel tanks is 150 KIAS; jettison is restricted to level flight at +1.0 "g," full or empty. For external stores limitations, see figure 1-31.

PROHIBITED MANEUVERS

The following maneuvers are prohibited:

1. Intentional spins.
2. Abrupt lateral control deflections, greater than one-half stick input and bank angle changes of greater than 90 degrees, at airspeeds greater than the maximum attainable in level flight.
3. Intentional practice single-engine landings.
4. Power settings less than the gate stop in flight.
5. Landings on other than smooth, hard paved surfaces.
6. Flight at zero or negative "g" in excess of 10 seconds.

V-N DIAGRAM

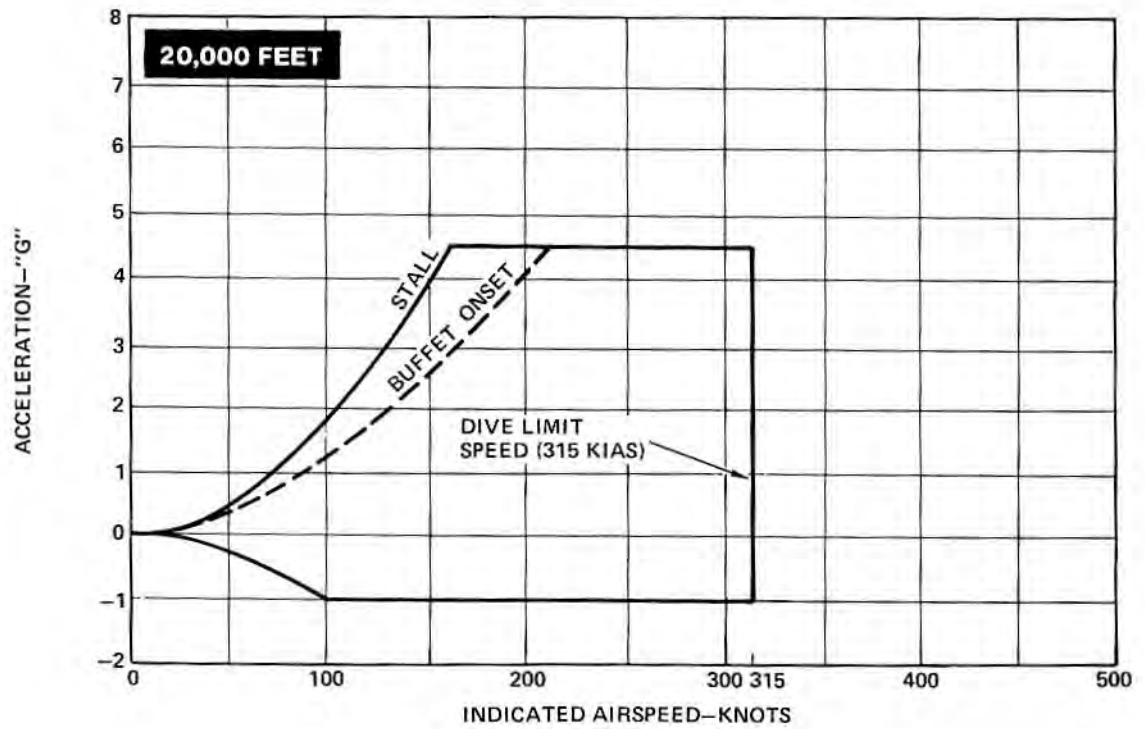
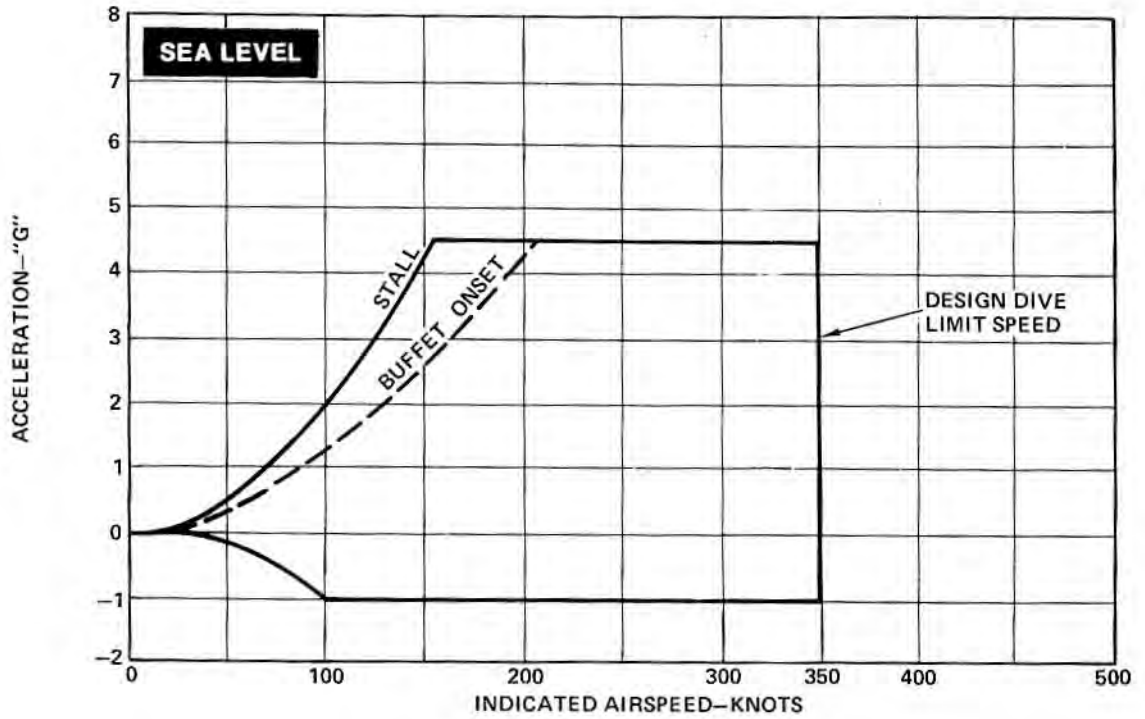

OV-10D-1-198

Figure 1-29

AIRCRAFT "G" LIMITS

FOR STORE LIMITATIONS SEE FIGURE 1-31

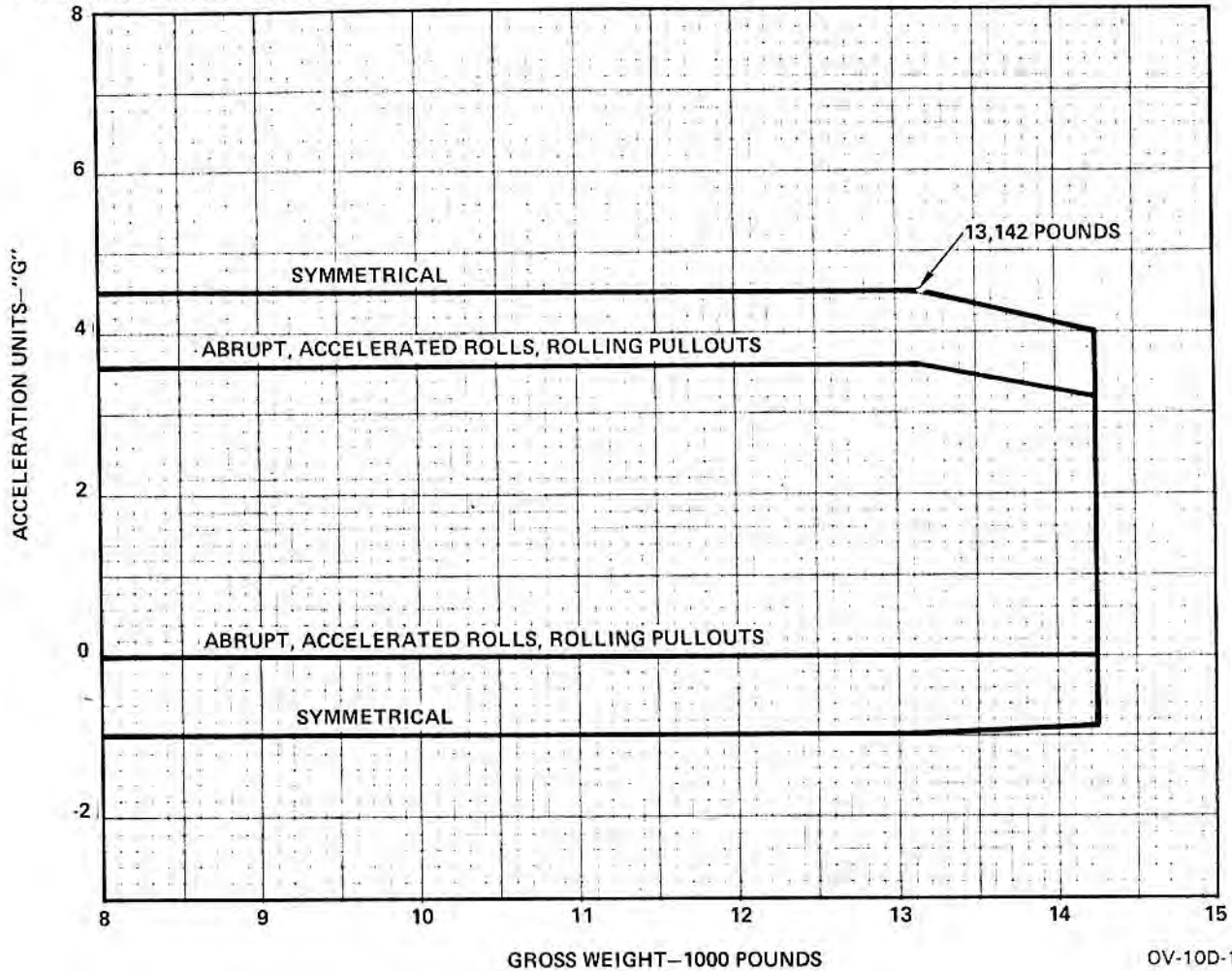

Figure 1-30

OV-10D-1-20C

LANDING SINK RATES

Maximum landing sink rates with wings level are as follows:

1. Smooth, hard paved surfaces:
Normal landing—600 FPM.

CENTER-OF-GRAVITY LIMITS

For all usable aircraft configurations, center of gravity must be restricted to a range between 19.0% and 28.5% MAC. For factors controlling center-of-gravity and loading limits, refer to the Weight and Balance Data Manual (NAVAIR 01-1B-40).

Note

Removal of FLIR/LRD equipment from the aircraft will cause CG shift. Weight and balance of the aircraft, using the Weight and Balance Data Manual (NAVAIR 01-1B-40), shall be determined any time that FLIR/LRD or sub-components are removed. The FLIR/LRD close-out cover, P/N 8692-311031, shall be installed for flight operations with the FLIR/LRD turret removed.

WEIGHT LIMITS

Weight limits under various conditions are as follows:

1. Smooth hard paved surfaces:
 - (a) Maximum weight for take-off is 14,444 pounds.
 - (b) Maximum weight for normal landing with minimum rate of descent is 13,000 pounds.
2. Maximum external stores loading is 3600 pounds for stations 1 through 5, not to exceed individual station limits (1200 pounds centerline and 600 pounds each sponson station). Maximum wing pylon loading is 750 pounds for each station.

EXTERNAL STORES LIMITATIONS

NOTE: STORES ARE SUSPENDED FROM AERO 65A1 OR 65A1/B1 RACK UNLESS OTHERWISE SPECIFIED

WEAPON OR STORE	LINE NUMBER	STATION LOADING					MAXIMUM AIRSPEED (KIAS)				ACCELERATION "g"				MAX DIVE ANGLE (Degrees)	RELEASE INTERVAL (MODE)	REMARKS
		1	2	3	4	5	CARRIAGE	LAUNCH/FIRE	RELEASE	JETTISON	CARRIAGE	LAUNCH/FIRE	RELEASE	JETTISON			
MACHINE GUNS	1																
M60C	2						350	350	-	-	LBA	+0.5 to +4.0	-	-	-	-	Two Mounted in Each Sponson.
	3																
EXTERNAL FUEL TANKS P/N 8478-16100-1 100 GALLON	4						350	-	-	150	-1.0 to +4.5	-	-	+1.0 (Full or Empty)	-	-	
FPU-3/A 150 GALLON	5						350	-	-	150	0.0 to +4.5	-	-	+1.0 (Full or Empty)	-	-	See Note 1.
	6																
	7																
MK81 (CONICAL FINS)	8	X	X	X	X	X	350	-	290	-	LBA	+0.8 to +4.0	-	-	45	Single or Dual	(Outboard to Inboard)
MK81 (SNAKEYE FIN)	9	X	X	X	X	X	350	-	300	-	LBA	+0.8 to +4.0	-	-	45	Single, Dual, Salvo	See Note 2.
MK-82 CONICAL FIN OR SNAKEYE (RETARDED OR UNRETARDED)	10	X	X	X	X	X	350	-	350	-	0.0 to +4.5	+1.0	-	-	45	SINGLE	
MK-83 CONICAL FIN	11					X	350	-	350	-	0.0 to +4.5	+1.0	-	-	45	SINGLE	
	12																

OV-100-1-39

Figure 1-31 (Sheet 1)

NOTE: STORES ARE SUSPENDED FROM AERO 65A1 OR 65A1/B1 RACK UNLESS OTHERWISE SPECIFIED

EXTERNAL STORES LIMITATIONS

WEAPON OR STORE	LINE NUMBER	STATION LOADING					MAXIMUM AIRSPEED (KIAS)				ACCELERATION "g"				MAX DIVE ANGLE (Degrees)	RELEASE INTERVAL (MODE)	REMARKS
		1	2	3	4	5	CARRIAGE	LAUNCH/FIRE	RELEASE	JETTISON	CARRIAGE	LAUNCH/FIRE	RELEASE	JETTISON LEVEL FLIGHT			
FIRE BOMB MK77 MOD 2,4	1																
	2	X	X	X	X	X	300	-	200	-	0.0 to +4.0	-	+1.0 to +2.0	-	5	Single	
CLUSTER BOMB CBU-55/B (FAE) OR CBU-55A/B (FAE)	3																
	4																
	5																
	6																
	7																
	8	X	X	X	X	X	350	-	300	-	0.0 to +4.5	-	0.0 to +4.0	-	60	Single, Dual, Salvo	(1) Single or Pairs Release Must Follow Outboard to Inboard.
CBU-55/B (FAE) OR CBU-55A/B (FAE)	9	X	X	X	X	350	-	150 to 250	-	+0.5 to +4.0	-	+0.8 to +1.0	-	Level to 30	Single, Dual	(2) With Five CBU: Acft Stas 1, 3, and 5 Must be Empty Prior to Release of Stas 2 and 4.	
	10	X	X	X	X	350	-	150 to 210	-	+0.5 to +3.0	-	+1.0	-	0 (Level Flight)	Triple (1, 3, 5) or Salvo	(3) Recommend Varied Fuze Settings on Salvo Release. (4) Release from Sta 1 and 5 Acceleration "g" +0.8 to +1.0 Dive Angle (Degrees) 0 to 30 Release from Sta 2, 3, and 4 Acceleration "g" +0.9 to +1.0 Dive Angle (Degrees) 0 to 15	
CBU-55/B (FAE) OR CBU-55 A/B (FAE)	11	X	X	X	X	350	-	150 to 250	-	+0.5 to +3.0	-	See Remark (4)	-	See Remark (4)	Single, Dual	(5) See Specific Note 11.	
	12																

Figure 1-31 (Sheet 2)

EXTERNAL STORES LIMITATIONS

NOTE: STORES ARE SUSPENDED FROM AERO 65A1 OR 65A1/B1 RACK UNLESS OTHERWISE SPECIFIED

WEAPON OR STORE	LINE NUMBER	STATION LOADING					MAXIMUM AIRSPEED (KIAS)				ACCELERATION "g"				MAX DIVE ANGLE (Degrees)	RELEASE INTERVAL (MODE)	REMARKS
		1	2	3	4	5	CARRIAGE	LAUNCH/FIRE	RELEASE	JETTISON	CARRIAGE	LAUNCH/FIRE	RELEASE	JETTISON			
PRACTICE BOMB	1																
MK86	2	X	X	X	X	X	350	-	290	-	0.0 to +4.5	+0.8 to +4.0	-	45	Single or Dual	See Note 3. (Outboard to Inboard)	
MK76 WITH PMBR, MK106 WITH PMBR	4	X	X	X	X	X	350	-	325	150 With PMBR	0.0 to +4.5	+0.8 to +4.0	+1.0 With PMBR	45	No Limit	See Note 4.	
MK 76 WITH PMBR, MK 106 WITH PMBR	7	WING PYLONS					350	-	325	150 With PMBR	0.0 to +4.5	+0.8 to +4.0	+1.0 With PMBR	45	No Limit	See Note 8.	
	8																
	9																
	10																
	11																
	12																OV-10D-1-41A

Figure 1-31 (Sheet 3)

NOTE: STORES ARE SUSPENDED FROM AERO 65A1 OR 65A1/B1 RACK UNLESS OTHERWISE SPECIFIED

EXTERNAL STORES LIMITATIONS

WEAPON OR STORE	LINE NUMBER	STATION LOADING					MAXIMUM AIRSPEED (KIAS)				ACCELERATION "g"				MAX DIVE ANGLE (Degrees)	RELEASE INTERVAL (MODE)	REMARKS	
		1	2	3	4	5	CARRIAGE	LAUNCH/FIRE	RELEASE	JETTISON	CARRIAGE	LAUNCH/FIRE	RELEASE	JETTISON LEVEL FLIGHT				
ROCKET LAUNCHER (2.75 IN. FFAR) LAU-3A/A (19 RKTS) LAU-32/A (7 RKTS), LAU-32A/A (7 RKTS), LAU-32B/A (7 RKTS), LAU-59/A (7 RKTS), LAU-60/A (19 RKTS), LAU-61/A (19 RKTS), LAU-61A/A (19 RKTS), LAU-68/A (7 RKTS), LAU-68B/A (7 RKTS), LAU-69/A (19 RKTS) LAU-68/A (7 RKTS) LAU-69/A (19 RKTS) (WITH OR WITHOUT FAIRINGS)	1	X	X		X	X	350	325	-	150	0.0 to +4.5	+0.8 to +4.0	-	+1.0	45	Single or Ripple	No Aircraft Station Limit. See Note 13.	
	2																See Notes 5, 6, and 10.	
	3																	
	4																	
	5				WING PYLONS		350	350 Max 200 Min (Ripple)	-	150 Max (Empty) 200 Max (Full)	0.0 to +4.5	+0.7 to +1.0	-	+1.0	45			
ROCKET LAUNCHER (5.0 IN. FFAR) LAU-10/A (4 RKTS), LAU-10A/A (4 RKTS) LAU-10/A (4 RKTS) LAU-10A/A (4 RKTS)	6																	
	7	X	X		X	X	350		-	150	0.0 to +4.5		-	+1.0	45		See Notes 5 and 12.	
	8																	
	9				WING PYLONS		350	350 Max 200 Min (Ripple)	-	150 Max (Empty) 200 Max (Full)	0.0 to +4.5	+0.7 to +1.0	-	+1.0	45			
	10																	
11																		
12																	OV-10D-1-42E	

(Figure 1-31 (Sheet 4))

EXTERNAL STORES LIMITATIONS

NOTE: STORES ARE SUSPENDED FROM AERO 65A1 OR 65A1/B1 RACK UNLESS OTHERWISE SPECIFIED

WEAPON OR STORE	LINE NUMBER	STATION LOADING					MAXIMUM AIRSPEED (KIAS)				ACCELERATION "g"				MAX DIVE ANGLE (Degrees)	RELEASE INTERVAL (MODE)	REMARKS	
		1	2	3	4	5	CARRIAGE	LAUNCH/FIRE	RELEASE	JETTISON	CARRIAGE	LAUNCH/FIRE	RELEASE	JETTISON				
GUN POD GPU-2/A (M-197 GUN)	1		X	X	X		350	350	-	250	0.0 to +4.5	+0.5 to +4.0	-	+1.0	60	No Limit	Do Not Load Adjacent Stations. Pods May Be Fired Singly or in Pairs. Only Low Rate of Fire Authorized for Pods Without AAC-716.	
	2	X	X	X	X	X	350	350	-	150	+0.5 to +4.5	+0.5 to +4.0	-	+1.0	70	No Limit		
FLARE, (PARACHUTE) • MK24 MOD 2A, 3, 4 WITH PMBR, MK45 MOD 0 WITH PMBR	3																	
	4																	
	5																	
	6																	
	7	X	X	X and WING PYLONS	X	X	350	350	260	+1.0 With PMBR	0.0 to +4.5	-	+0.8 to +4.0	+1.0 With PMBR	10	No Limit	See Notes 8 and 9.	
	8																	
	9																	
	10																	
	11																	
	12																	OV-10D-1-43D

Figure 1-31 (Sheet 5)

NOTE: STORES ARE SUSPENDED FROM AERO 65A1 OR 65A1/B1 RACK UNLESS OTHERWISE SPECIFIED

EXTERNAL STORES LIMITATIONS

WEAPON OR STORE	LINE NUMBER	STATION LOADING					MAXIMUM AIRSPEED (KIAS)				ACCELERATION "g"				RELEASE INTERVAL (MODE)	REMARKS	
		1	2	3	4	5	CARRIAGE	LAUNCH/FIRE	RELEASE	JETTISON	CARRIAGE	LAUNCH/FIRE	RELEASE	JETTISON			MAX DIVE ANGLE (Degrees)
DISPENSERS FLARES (PARACHUTE) (MK24, MK45)	1	X	X	X	X	X	350	-	250	200	0.0 to +4.5	-	+1.0	+1.0	10	No Limit	
	2																
	3						350	-	150 Min 350 Max	150 Max	0.0 to +4.5	-	+0.7 to +1.0	+1.0	45		See Note 7.
SUU-44/A																	
SUU-44/A																	
	4																
	5																
	6																
SIGNAL MARKER	7	X	X	X	X	X	350	-	325	150 With PMBR	0.0 to +4.5	-	+0.8 to +2.0	+1.0 With PMBR	30	No Limit	
MK6 MOD 3 WITH PMBR	8																
LUU-2B	9						350		325		0.0 to +4.5		+0.8 to +2.0	+1.0	30	-	See Note 8.
	10																
	11																
	12																

OV-10D-1-44C

Figure 1-31 (Sheet 6)

EXTERNAL STORES LIMITATIONS

NOTE: STORES ARE SUSPENDED FROM AERO 65A1 OR 65A1/B1 RACK UNLESS OTHERWISE SPECIFIED

WEAPON OR STORE	LINE NUMBER	STATION LOADING					MAXIMUM AIRSPEED (KIAS)				ACCELERATION "g"				MAX DIVE ANGLE (Degrees)	RELEASE INTERVAL (MODE)	REMARKS
		1	2	3	4	5	CARRIAGE	LAUNCH/FIRE	RELEASE	JETTISON	CARRIAGE	LAUNCH/FIRE	RELEASE	JETTISON			
SENSORS (SEISMIC)	1																
	2																
	3																
	4	X				X	350	—	250	150 with PMBR	0.0 to +4.5	—	+1.0 Level Flight	—	No Limit		
	5	X		X		X	350	—	250	150 with PMBR	0.0 to +4.5	—	+1.0 Level Flight	0	—	Load ADSID III (N) on PMBR stations 2, 3 and 4 only.	
	6		X	X		X	350	—	250	150 with PMBR	0.0 to +4.5	—	+1.0 Level Flight	0	—	Load ADSID III (N) on PMBR stations 2, 3 and 4 only.	
SENSORS (ACOUSTIC) (GSO-141)	7	X	X		X	350	—	325	150	0.0 to +4.5	—	+1.0 Level Flight	—	No Limit			
	8																
SUU-44/A	9																
	10																
	11																
	12																OV-10D-1-45B

Figure 1-31 (Sheet 7)

EXTERNAL STORES LIMITATIONS

NOTE: STORES ARE SUSPENDED FROM AERO 65A1 OR 65A1/B1 RACK UNLESS OTHERWISE SPECIFIED

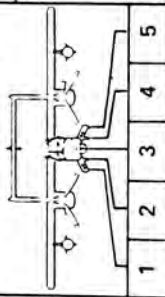
WEAPON OR STORE	LINE NUMBER	STATION LOADING					MAXIMUM AIRSPEED (KIAS)				ACCELERATION "g"				RELEASE INTERVAL (MODE)	REMARKS	
		1	2	3	4	5	CARRIAGE	LAUNCH/FIRE	RELEASE	JETTISON	CARRIAGE	LAUNCH/FIRE	RELEASE	JETTISON			
SMOKE TANK MK 12 MOD 0	1						350		350	150	0.0 to +4.5		+1.0 Level Flight	+1.0		Releasing smoke should be initiated at 300-350 KIAS in level flight.	
	2																
	3																
	4																
	5																
CHAFF/FLARE DISPENSER AN/ALE-39	6	TAIL BOOMS															
	7																
	8																
	9																
	10																
	11																
	12																

OV-10D-1-46A

Figure 1-31 (Sheet 8)

EXTERNAL STORES LIMITATIONS

NOTES

General

- A. LBA~Limits of the basic OV-10D aircraft without External Stores or Racks

- B. Mixed loadings of listed stores are authorized subject to the following constraints:
 - 1. Carriage limitations for the most restrictive store carried; release and jettison limitations for the individual store apply.
 - 2. Stores may be carried only on stations for which they are specifically authorized in the external stores limitations table.
 - 3. Adjacent sponson stations shall not be loaded when carrying the A/A37B-3 PMBR.
 - 4. Adjacent sponson stations are limited to stores with a diameter of not more than fourteen inches when carrying the MK-77 fire bomb.
 - 5. Sponson stations 2 and 4 are limited to stores with a diameter of not more than 12 inches when carrying the Aero-1C or FPU-3/A fuel tank.

Specific

- 1. Installation and carriage of Aero 1C or FPU-3/A external fuel tank requires the Aero 1A adapter with the Aero 65A rack.
- 2. MK-81 Snakeye finned bombs may be released, retarded or unretarded.

3. Use wet sand fill only.
4. Multiple weapon carriage employs the A/A37B-3 PMBR attached to the Aero 65A rack.
5. Tail fairings should be installed on all rocket launchers.
6. 2.75 inch rockets with MK-40 motors (scarfed) may be launched only from seven round launchers or half loaded 19 round launchers (tubes number 1A, 2B, 3B, 4A, 5B, 6A, 7B, 9A, 10). M423 point detonating fuzes are not authorized.
7. Forward flare in each tube may hang up in dispenser during flare dispensing at normal accelerations above +1.0 "g." Drogue trays fail to reliably arm flares, when dispensing occurs below 150 KIAS.
8. Clearance for flight on the OV-10D wing pylons has not been released by NAVAIR.
9. For MK24 parachute flare installation, refer to AAB 347 and AAC 494.
10. 2.75 in. FFAR with M-229 or WDU-4A/A warhead is cleared for carriage/launch from LAU-61/A, LAU-68/A and LAU-69/A. Pullup should be made immediately after firing 2.75 in. FFAR with WDU-4A/A warheads to preclude flying through flechettes.
11. For carriage of 4 or more CBU-55, one or more of the fins must be folded to prevent physical interference. The fin(s) to be folded is (are) designated as upper or lower, left or right as seen when looking from the tail to the nose of the store.
12. Not cleared for firing from stations 1, 2, 4, and 5.
13. Ripple firing is limited to single aircraft station with the exception of:
LAU-61/A or LAU-69/A: Any two adjacent stations.
LAU-61A/A or LAU-68B/A: Up to four aircraft stations.

SECTION II—INDOCTRINATION AND TRAINING

TABLE OF CONTENTS

Introduction	2-1	Flight Crew Designations, Qualifications, and Requirements	2-2
Ground Training	2-1	Personal Flying Equipment	2-2
Flight Qualifications	2-1		

INTRODUCTION

This section establishes minimum requirements for training, initial qualification, and currency in specified areas. The operational information considered necessary to ensure safe and efficient operation, when used in conjunction with the Naval Warfare Publications series, is provided in subsequent sections. Procedures for requesting waivers from the provisions of this section are contained in OPNAVINST 3510.3 (current revision). Training requirements, checkout procedures, evaluation procedures, and weather minimum for ferry squadrons are governed by OPNAVINST 3710.6 (current revision).

GROUND TRAINING

Ground training should be continuous throughout the career of OV-10D aircrew personnel. The overall syllabus will vary according to local conditions, facilities, directions from higher authority, and the unit commanders estimation of squadron readiness. However, there are certain specific requirements which shall be met to ensure that the aircrew is properly indoctrinated and briefed prior to flight.

REQUIREMENTS

Ground training and other related requirements for all aircrew personnel prior to familiarization flights are as follows:

1. Current medical clearance.
2. Aviation physiological training as set forth in OPNAVINST 3710.7 (current revision).
3. NAMO Pilot Familiarization course (if available) or equivalent lectures by other qualified personnel.
4. Lectures from qualified personnel on the following subjects:
 - (a) Flight characteristics and operating limitations.
 - (b) Use of safety and survival equipment and related procedures.
 - (c) Aircraft preflight, ground handling, hand signals, and normal flight procedures.
 - (d) Emergency procedures.
 - (e) Past aircraft accidents as an aid in preventing future accidents of like nature.
 - (f) Local course rules, flying area, instrument procedures, and SAR facilities.
5. Satisfactory completion of open-book NATOPS and emergency procedures examinations.
6. Supervised engine start and cockpit check.

SUBJECTS

The following subjects should be included in the normal ground training syllabus, depending upon the squadron mission and qualifications of the pilot.

MISSION TRAINING

1. Map reading.
2. Visual recon/observation.
3. FAC/TAC(A) procedures.
4. Artillery spot/naval gunfire spotting.
5. Close-air support procedures.
6. Ordnance, theory, and delivery procedures.
7. Aviation ordnance and weapons loading.
8. Pertinent publications in the NWP and NWIP series.
9. Night Observation Surveillance (NOS).

INSTRUMENT TRAINING

1. Instrument flight procedures.

FLIGHT SAFETY

1. AAR/incident reviews.
2. Aircraft emergencies.
3. Laser safety.
4. Oral or written review of emergency procedures should be required after any lay-off from flying in excess of 2 weeks.

INTELLIGENCE

1. Mission planning material.
2. Orders of battle.
3. Recognition.
4. Escape and evasion.
5. Authentication procedures.

SURVIVAL

1. Physiological and medical aspects.
2. First aid.
3. Survival on land or sea.
4. Pilot rescue techniques.

FLIGHT QUALIFICATIONS

The flight syllabus as set forth in the current Training and Readiness Manual or OPNAVINST will be used for initial pilot checkout. Command prerogative should be

exercised to waive certain flights where pilot qualification in similar type aircraft and/or mission warrants. Minimum requirements for qualification and currency for each phase of flight are as follows:

FAMILIARIZATION

1. Completion of the ground training requirements is required prior to flight.
2. Fam flights will be conducted. Refer to Section IV, Part 2.
3. Initial checkout flights will consist of a minimum of 5 hours.

INSTRUMENTS

Minimum requirements prior to actual instrument flight are as follows:

1. 10 hours in OV-10D aircraft in the last 6 months.
2. At least one OV-10D flight in the last 30 days.
3. Valid instrument rating.
4. Demonstration of instrument proficiency in model.

NIGHT FLYING

Minimum requirements prior to night flights are as follows:

1. Valid instrument rating.
2. 10 hours in OV-10D aircraft within the last 3 months.

CURRENCY REQUIREMENTS

Currency requirements are to be in accordance with OPNAVINST 3710.7H.

MISSION AND WEAPON TRAINING

Prerequisites for mission and weapon training are as follows:

1. Completion of appropriate ground training as set forth in this section.
2. Minimum of 10 hours in the OV-10D aircraft.

Minimum requirements prior to night mission and weapon training are as follows:

1. Same as night flying missions, plus 25 hours in the OV-10D aircraft and 10 hours in the last 30 days.
2. Day proficiency in type mission or delivery in the OV-10D aircraft.
3. Familiarity with operating area/target and procedures.

CROSS-COUNTRY FLIGHT

Minimum requirements prior to cross-country flight are as follows:

1. Valid instrument rating.
2. 15 hours in OV-10D aircraft to include 3.0 hours instrument time and 1.5 hours of night time.
3. Familiarity with aircraft servicing.

FLIGHT CREW DESIGNATIONS, QUALIFICATIONS, AND REQUIREMENTS

FUNCTIONAL CHECK PILOT (FCP)

A functional check pilot must have a minimum of 100 hours in model and be designated in writing by the unit commanding officer.

PILOT QUALIFIED IN MODEL (PQM)

A pilot qualified in model must have satisfactorily completed a NATOPS evaluation.

PERSONAL FLYING EQUIPMENT

The personal flying equipment in OPNAVINST 3710.7 series shall be carried or worn by all personnel on every flight.

SECTION III—NORMAL OPERATING PROCEDURES**TABLE OF CONTENTS**

PART 1—BRIEFING AND DEBRIEFING	3-1	Flight Characteristics	3-14
Introduction	3-1	Descent	3-14
Briefing Guide	3-1	Before Landing	3-14
Debriefing	3-2	Landing	3-14
PART 2—MISSION PLANNING	3-3	Wave-off	3-15
General	3-3	After Landing (When Clear of Runway)	3-15
Planning	3-3	Shutdown	3-15
PART 3 — SHORE-BASED PROCEDURES	3-5	Before Leaving Aircraft	3-16
Preparation for Flight	3-5	STOL Operations	3-16
Preflight Checks	3-5	Aerobatics	3-18
Cockpit Check	3-6	Simulated Engine(s)-	
Before Start	3-8	Out Operations	3-18
Unfeathering (If Required)	3-8	Formation	3-18
Starting Engines	3-8	Night Flying Procedures	3-20
Before Taxi	3-11	PART 4 — CARRIER-BASED PROCEDURES	3-21
Taxi Checks	3-11	PART 5 — FUNCTIONAL CHECKFLIGHT	
Before Take-off	3-11	PROCEDURES	3-23
Take-off	3-11	Introduction	3-23
After Take-off	3-12	Conditions Requiring	
Climb	3-14	Functional Checkflights	3-23
Cruise	3-14	Procedures	3-23

PART 1 — BRIEFING AND DEBRIEFING**INTRODUCTION**

Briefings will be conducted using a prepared briefing guide and the appropriate mission card. The briefing shall cover those items pertinent to the specific mission assigned. Any format which is complete, concise, and orderly, and which can be readily used by the Flight Leader as a briefing guide is suitable. Each pilot should record all data necessary to successively assume the lead and complete the assigned mission. This, however, does not relieve the Flight Leader of the responsibility for all pilots in the operation and conduct of the flight.

BRIEFING GUIDE

The briefing guide will include the following items, when applicable.

GENERAL

1. Aircraft, call sign, event numbers.
2. Flight assignments.
3. Take-off/landing times.

4. Aircraft configuration/fuel load/gross weight.
5. DD-175, stereo routes, flights routes.
6. Controlling agencies.
7. Communications/ IFF-SIF.
8. Night brief (as required).

WEATHER

1. Local/operating area/destination.
2. Alternates/diverts.
3. DD-175-1.

MISSION PROFILE

1. Mission plan/primary/secondary.
2. Intelligence/authentication/safety/E and E.
3. Operating/restricted areas.
4. Range/target/enroute times.
5. Frequencies/agencies.

NAVAIR 01-OV10D-1

6. Bingo/low fuel.
7. Recovery.
8. Instrument recovery.
9. Divert/alternate/emergency fields.

4. "G" versus weight.
5. Duds, hung ordnance, jettison.
6. Dearth.
7. Safety.

FORMATION

1. Succession to lead.
2. Taxi, take-off, climb/rendezvous.
3. Tactical formation.
4. Flight discipline/communication/procedures.
5. Hand and light signals.
6. Emergencies, HEFOE.
7. Lost sight/inadvertent IFR.

EMERGENCIES

1. Ground emergencies.
2. Aborts (ground, take-off, in flight).
3. System failures.
4. Lost/lost comm/lost NAVAID.
5. Ejection/SAR.

DEBRIEFING

Each flight shall be followed with a thorough debriefing by the Flight Leader as soon as practicable. All phases of the flight shall be covered, paying particular attention to those areas where difficulties were encountered and to the effectiveness of any tactics employed or weapons expended. To derive maximum benefit, constructive criticism and suggested improvements as to doctrine, tactics, and techniques should be given and received with the frankness, purpose, and spirit of improving the proficiency of the unit, as well as that of the individual pilot.

WEAPONS

1. Loading/arming procedures.
2. Enroute target flight route.
3. Delivery (TACMAN).
 - a. Mil setting.
 - b. Altitudes.
 - c. Pattern.
 - d. Switches.

PART 2 — MISSION PLANNING

GENERAL

Mission planning is concerned with two requirements. The first is for pilots to calculate normal and emergency aircraft operating capabilities concurrent with existing ambient conditions and mission requirements prior to each flight. The second requirement is preparation of planning documents for future missions and is normally prepared from weather summaries and predicted weather and geographic studies in the area to be considered.

PLANNING

1. For performance data applicable to mission planning, refer to Section XI, Parts 1 through 8.
2. For aircraft engine operating limits and weight and balance data, refer to Section I, Part 4. For loading information, refer to the Weight and Balance Data Manual (NAVAIR 01-1B-40).
3. For weapons delivery, refer to the appropriate NWP/NWIPS and Section I, Part 4, Section VIII, and Section XI, Part 1.

PART 3 — SHORE-BASED PROCEDURES**PREPARATION FOR FLIGHT****Note**

Procedures in this section are coded as follows:

(O)—Applicable to observer

(P, O)—Applicable to both crew members

Unmarked—Applicable to pilot only

FLIGHT RESTRICTIONS

For aircraft and engine operating limits, refer to Section I, Part 4.

FLIGHT PLANNING

For performance data applicable to mission planning, refer to Section XI, Parts 1 through 8.

WEIGHT AND BALANCE

For weight and balance limits, refer to **WEIGHT LIMITS**, in Section I, Part 4. For loading information, refer to the **Weight and Balance Data Manual** (NAVAIR 01-1B-40).

PREFLIGHT CHECKS**INTERIOR INSPECTION—PILOT'S**

1. BATTERY—OFF.
2. Landing gear handle—DOWN AND LATCHED.
3. MASTER ARM switch—OFF.
4. LASER ENABLE—OFF.
5. Gust lock—REMOVED.
6. Battery—ON.
Check voltage, power lever gates retracted and gear indication.
7. INST PWR switch—INV NO. 1.
8. Fuel quantity—CHECK.
9. INST PWR switch—OFF.
10. Battery—OFF.

INTERIOR INSPECTION—OBSERVER'S

1. NO. 3 INV CB—OUT (IN—Solo).
2. FLIR mode switch—OFF.
3. VIDEO power switch—ON.
4. Radar altimeter—OFF.
5. LASER ARM switch—OFF.

EXTERIOR INSPECTION

1. Chocks—AS REQUIRED.
2. Right propeller and hub—CHECK.
3. Right engine intake—CLEAR.
4. Right engine and cowling—CHECK.
5. Right engine oil cap—SECURED.
6. Right engine exhaust stack—CHECK.
7. Right wing and control surfaces—CHECK.
8. Stall warning sensor—CHECK.
9. Right main landing gear door and brake/wheel assembly—CHECK.
10. Right battery cover—SECURED.
11. Right avionics bay cover—SECURED.
12. Right wing pylon/drop tank—CHECK.
13. Right sponson access doors—SECURED.
14. External stores—CHECK.
15. Cargo bay for loose equipment—SECURED.
16. Automatic video tracker boresight and reticle position thumbwheel settings—PROPER SETTINGS.
17. BIT fault indicator panel (4 indicators reset)—CHECK.
18. Cargo bay door mounted equipment circuit breakers—ON.
19. Cargo bay door—CLOSED AND LOCKED.
20. Right boom for structural integrity—CHECK.
21. Visual inspection of tail and horizontal stabilizer—CHECK.
22. Left boom for structural integrity—CHECK.
23. Left avionics bay cover—SECURED.
24. Left battery cover—SECURED.
25. Left main landing gear door and brake/wheel assembly—CHECK.
26. Ground safety switch—CHECK CONDITION AND PROPERLY POSITIONED.
27. Left wing pylon/drop tank—CHECK.
28. Left sponson access doors—SECURED.
29. External stores—CHECK.
30. Left engine exhaust stack—CHECK.
31. Left wing control surfaces—CHECK.
32. Left engine and cowling—CHECK.
33. Left engine intake—CLEAR.
34. Left engine oil cap—SECURED.
35. Left propeller and hub—CHECK.
36. Nose wheel strut wheel assembly—CHECK.

37. Nose wheel steering/shimmy damper—CHECK.
38. Angle-of-attack probe—COVER REMOVED.
39. Approach lights—CHECK.
40. Nose wheel doors—CHECK.
41. Ground test protective covers removed from FLIR turret—CHECK.
42. FLIR and LRD windows for cleanliness—CHECK.
43. FLIR turret in stowed position—CHECK.
44. LASER safety plug not installed (unless required for mission)—CHECK.
45. FLIR GIMBLE DRIVE DSBL switch—NORM.
46. FLIR GIMBLE BRAKE RELEASE switch—NORM.
47. Nose turret access door secured—CHECK.
48. Landing light—CHECK.
49. Pitot tube—COVER REMOVED.
50. Fuel caps—SECURED.
51. Hydraulic reservoir access door secured—CHECK.
52. Circuit-breaker panel—CHECK.
53. EMERG IFF switch—NORMAL (O).
54. Aft cockpit—SECURED, seat cushion harness installed (SOLO).
55. Aft cockpit doors—CLOSED, LOCKED, PINS IN (SOLO).
56. Cockpit enclosure—CHECK CONDITION.

EJECTION SEAT INSPECTION (P, O)

See figure 3-1.

1. Ejection "D" ring safety pin — INSTALLED.
2. Emergency radio beacon lanyard — SECURED.
3. Seat quick-disconnects — SECURE.
4. Speed sensor lines — SECURE.
5. Speed/altitude sensor — CHECK.
6. Seat/man separator latch — SECURE.
7. Thruster safety pin — REMOVE.

WARNING

Ensure that streamer is not routed through or entangled in the "D" ring handle.

8. Thruster line slug—SECURE.
9. Chute thruster static line—SECURE.
10. Catapult retention bolt—SECURE.

COCKPIT CHECK

1. Canopy brace—INSTALLED.

CAUTION

Ground operations without canopy brace installed may cause damage to the canopy hinge.

2. Survival kit—FASTEN (P, O).
3. Lap belt—FASTEN (P, O).
4. Riser straps—FASTEN (P, O).
5. Landing gear and drop tank safety pins—REMOVED AND STOWED IN STARBOARD MAP CASE.
6. HF selector switch—OFF.
7. ICS—SET, as desired (P, O).
8. FM selector switch—OFF.
9. FLAP handle — UP.
10. TRIM SELECT — NORM.
11. YAW DAMPER switch—OFF.
12. EXT LTS MASTER switch—EXT LTS.
13. Power levers—GROUND IDLE.
14. Condition levers—FUEL SHUT-OFF.

CAUTION

If the condition levers are found forward of the FUEL SHUT-OFF position, any attempt to start the engine may result in an engine fire.

15. BATTERY switch—OFF.
16. Generator switches—NORM.
17. INST PWR switch—OFF.
18. AIR START switches—AUTO.
19. UHF selector switch—OFF.
20. MASTER ARM switch—OFF.
21. FLIR COMD switch—OPERATOR.
22. LASER ENABLE switch—OFF.
23. Countermeasures POWER/FLARE SALVO switch—OFF.
24. Clock—SET (P, O).
25. Radar altimeter—OFF.
26. ALT/TCN PWR switch—NORM.
27. TACAN selector switch—OFF.
28. Fuel GAGE SEL switch—INT.
29. EXT FUEL TRANS switches—OFF.
30. FUEL EMERG SHUT OFF switches—NORM.
31. PITOT HEAT switch—OFF.
32. Windshield WIPER switch—OFF.
33. ANTI COLLISION switch—ON.
34. EXT LIGHTS switch—AS DESIRED.
35. Oxygen regulator—CHECK (P, O).
36. Diluter switch—100% OXYGEN (P, O).
37. IFF MASTER switch—OFF.
38. FM NO. 2 SELECTOR switch — OFF.

EJECTION SEAT INSPECTION

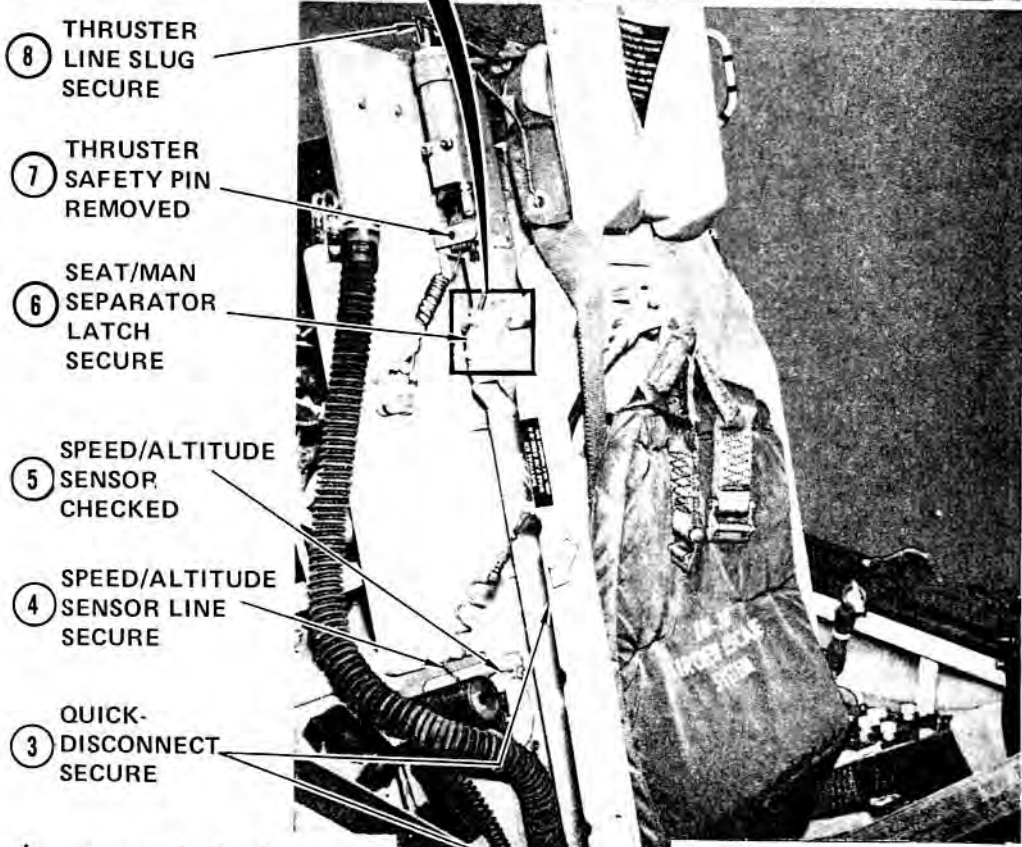
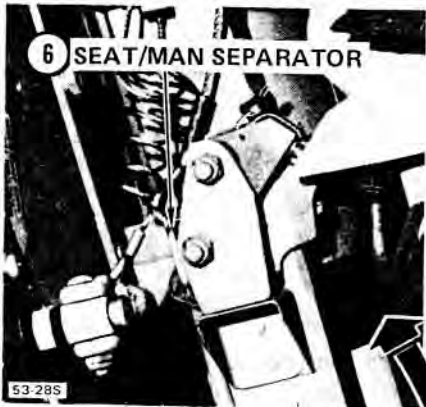

1 EJECTION "D" RING
SAFETY PIN
INSTALLED
(FRONT OF SEAT)

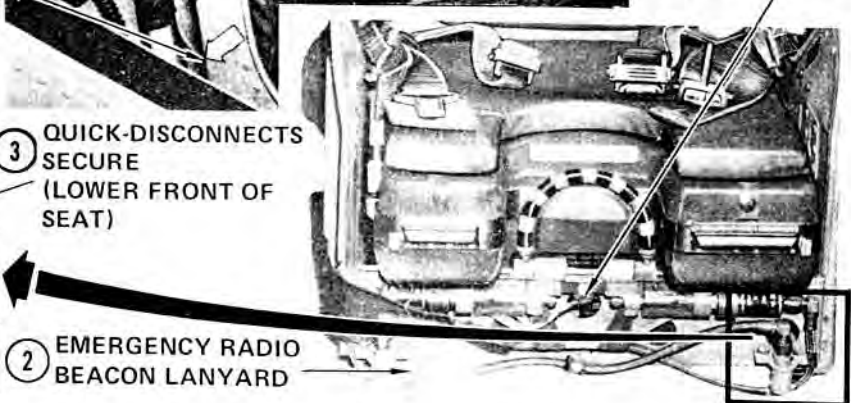
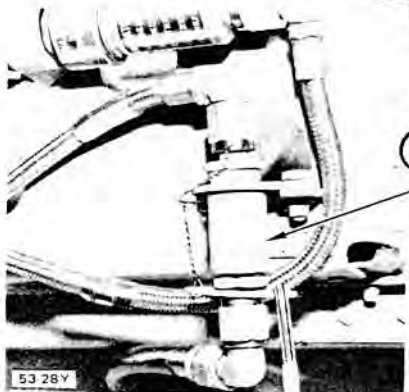

OV-10D-1-55A

Figure 3-1

39. COMPASS—SLAVED.
40. BLEED AIR switches—NORM.
41. Interior lights—AS DESIRED (P, O).
42. Circuit breakers—IN.
43. Cargo bay light—OFF.
44. IFF ANT SEL—BOTH.
45. Utility light—AS DESIRED.
46. NO. 3 INV CB—OUT (IN, if Solo).

BEFORE START

1. Parking brake—SET.
2. Access steps—CLOSED.
3. Chocks—REMOVE.
4. Propeller—CLEAR (P, O).

CAUTION

If propellers are feathered to any degree, unfeathering procedure shall be followed prior to starting engines.

5. BATTERY switch—ON; check voltage.
6. ICS—CHECK OPERATION (P, O).
7. ICS TALK foot switch—CHECK OPERATION (O).
8. FIRE DET/WARN LTS—TEST.
Hold TEST switch in FIRE DET for d-c check, then hold in WARN LTS to test all warning lights, caution lights, the audio level of the overtemperature warning tone, and rudder pedal shaker operation. The amber and green hydraulic lights must be separately pressed to test.
9. WARN LTS TEST—TEST (O).
10. External power—APPLIED, as required.

UNFEATHERING (IF REQUIRED)

1. Condition levers—FUEL SHUT-OFF.
2. Power lever—FULL REVERSE.
3. AIR START switch—CRANK.
Hold in CRANK until blades reach full reverse, then release to AUTO.
4. Power lever—GROUND IDLE.
5. Repeat for other engine.

STARTING ENGINES

Engine starts may be made, either engine first, using aircraft battery power or external electrical power. For engine limits, including starter limits, refer to Section I, Part 4. For additional information on starting, see figure 3-2 and refer to Section I, Part 2.

1. Propeller—CLEAR (P, O).
2. START switch—START.
Hold desired START switch momentarily in START and check the START IGN ON light illuminated at approximately 10% RPM.
3. Condition lever—NORMAL FLIGHT ON PROPELLER ROTATION.

Observe EGT rise at 10% to 12% rpm.

CAUTION

If external power unit fails during start, overtemperature could occur. Proceed as outlined in Section V.

4. Monitor rpm, oil pressure, EGT, and observe START IGN ON light and BOOST PUMP light out at approximately 52% rpm.

WARNING

If external electrical power unit fails when initiating start, the engine will be motored by the starter if the external power cable is unplugged. To prevent undesired engine rotation, execute ABORTED/HUNG START procedure.

CAUTION

Abort start if light-off is not indicated within 15-seconds or if rpm hangup occurs after initiating start. Four consecutive 15-second maximum duration start attempts, each to engine light-off, may be made with a 1-minute cooling period prior to a second attempt, a 2-minute cooling period prior to a third attempt, and a 10-minute cooling period prior to a fourth attempt. A 60-minute cooling period shall be observed prior to a repeat of the starter-generator duty cycle.

5. Power lever—minimum RPM (65% rpm).
6. INST PWR switch—INV NO. 1.
Check GEN, BOOST PUMP lights out (battery start only).

Note

For external power starts GEN and BOOST PUMP lights remain on until external power plug is removed.

7. Radios—ON.
8. External power—DISCONNECT, if applicable.
Check GEN and BOOST PUMP lights out.

Note

Pull external power control circuit breaker. Then turn off the ground power cart prior to disconnecting the ground power plug. Reset the external power control circuit breaker after ground power plug has been disconnected from aircraft.

9. Compute temperature and torque limits.

10. Repeat procedures for second engine.

Note

- If battery start, wait until generator has recharged battery and ammeter shows less than 100 amperes.
- If rpm of running engine decays more than 4%, abort start of second engine.

11. FLIR system—ON. (Ensure NO. 3 INV CB—IN.)
Rotate to forward azimuth position.

Note

On SOLO flights, place FLIR COMD switch to WIDE position. The FLIR turret will drive to approximately zero degrees azimuth and elevation. Placing FLIR COMD switch to OPERATOR will turn FLIR system off with turret locked in forward pointing position.

ABORTED/HUNG START

1. Condition lever—FUEL SHUT-OFF.
2. START switch—ABORT.

GROUND OPERATION

TURN RADIUS

- A** WING TIP—33.2 FEET
- B** VERTICAL—28.6 FEET
- C** PITOT BOOM—28.4 FEET
- D** NOSE WHEEL—22.7 FEET
- E** LEFT MAIN WHEEL—20.6 FEET
- F** RIGHT MAIN WHEEL—5.6 FEET

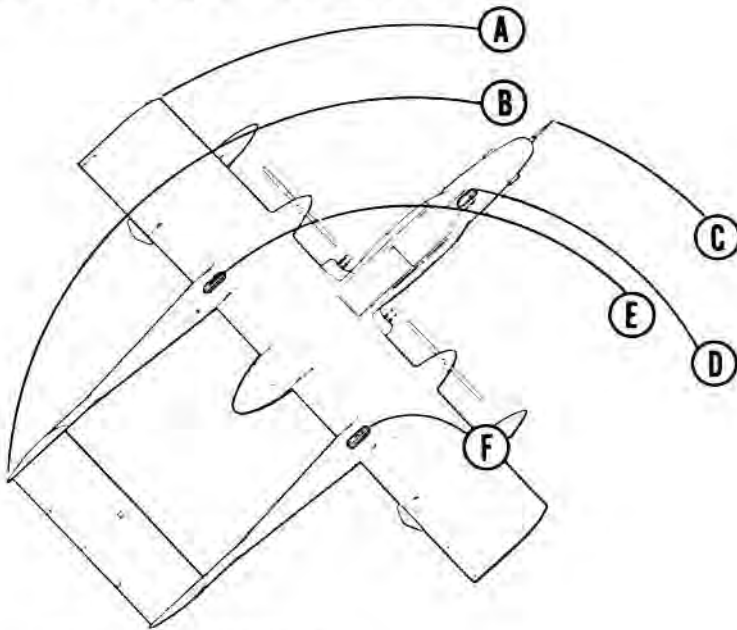

GROUND CLEARANCE

- G** PITOT BOOM—46.3 INCHES
- H** FLIR/LRD TURRET—26 INCHES
- J** PROPELLERS—23.5 INCHES
- K** WING DROP TANK—56.75 INCHES
- L** C DROP TANK—18 INCHES
- M** CARGO DOOR—52 INCHES
- N** RUDDERS—94 INCHES

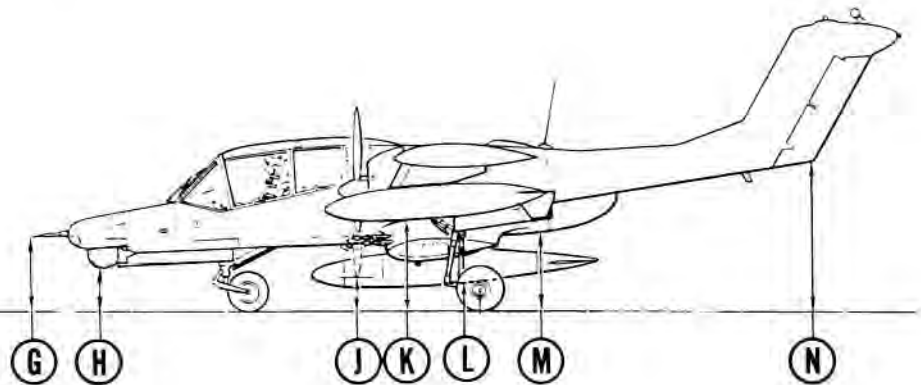

DANGER AREAS

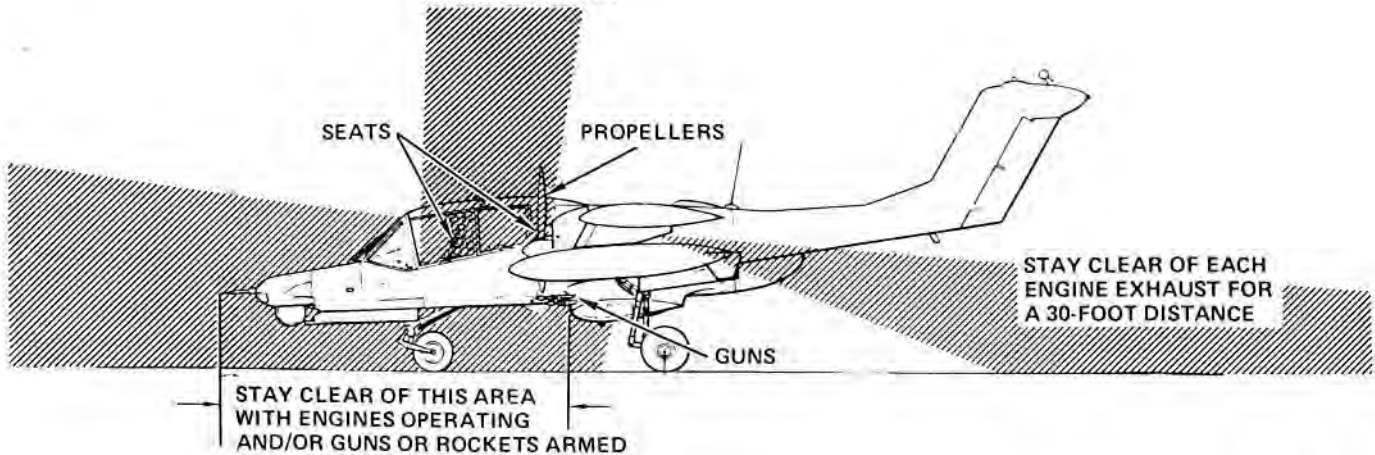

Figure 3-2

WARNING

If the start switch is energized and the engine fails to crank, move the start switch to ABORT to deenergize the automatic ignition circuit prior to attempting any further corrective action. Failure to do so may cause inadvertent engine start if the circuit is later completed.

BEFORE TAXI

1. INST PWR INV NO. 2—CHECK.
Reset to INV NO. 1.
2. Radar altimeter—ON.
3. AM SEL switch—CHECK NO. 1 GEN AND NO. 2 GEN.
4. Compass PUSH TO SET knob—SET.
5. Trim—CHECK.
Set for take-off:
 - (a) Normal take-off:
 - (1) ELEVATOR—1/2 UNIT DOWN.
 - (2) Aileron—NEUTRAL.
 - (3) Rudder—NEUTRAL.
6. ATTITUDE GYRO ERECT switch—NORM.
7. Attitude indicator—CAGED (O).
8. TACAN—SET, as required.
9. Cargo bay door caution light—CHECK.
10. FUEL GAGE switch—TEST.
11. Fuel quantity—CHECK.
12. IFF switch—STBY.
13. Radar altimeter—TEST AND SET.
14. Flight controls—CHECK FULL TRAVEL.
15. Flaps—CHECK OPERATION.
Note operation of hydraulic pump indicating light.
16. Ejection seat "D" ring pin—REMOVED (P, O).
17. Power levers—REVERSE MOMENTARILY.
Observe slight RPM increase after propellers unlock.
18. Altimeter—SET (P, O).

TAXI CHECKS

1. Brakes—CHECK.

CAUTION

To prolong life of brake assemblies, maximum use of reverse thrust and differential power should be used, and condition levers should be maintained at NORMAL FLIGHT for taxiing.

2. Nose wheel steering—CHECK.
3. YAW DAMPER switch—TEST/OFF.
Hold YAW DAMPER switch in TEST while taxiing. Check for normal rudder pedal movement opposing turns.
4. L, CTR, R EXT FUEL TRANS switches—ON.
Check applicable AUX FUEL caution lights on, then out, indicating transfer flow. Turn switches OFF after check.

BEFORE TAKE-OFF

1. Seats—ARMED (P, O).
2. Fuel quantity—CHECK.
3. Center tank—240 TO 280 POUNDS.
4. L, CTR, R AUX FUEL TRANS switches—OFF.
5. PITOT HEAT switch—AS DESIRED.
6. Cockpit heat—AS DESIRED.
7. FLAPS—AS DESIRED.
8. Trim—SET FOR TAKE-OFF.
 - (a) Rudder/Aileron—NEUTRAL.
 - (b) Elevator (NORMAL)—1/2 UNIT DOWN.
9. Canopy—LOCKED (P, O).
10. Harness—LOCKED (P, O).
11. Condition levers—T.O./LAND (94%—96%).
12. IFF switch—NORM.
13. Controls—CHECK.

CAUTION

To preclude foreign object damage, the FLIR turret should be pointed forward on take-off.

14. Power levers—MILITARY (101%).
Maximum available torque is attained at 115-degree detent position (99.8%—100.2%) which is slightly aft of the MILITARY position. The maximum available thrust is attained at the MILITARY (101%) position. Do not exceed TIT and torque limits.

Note

- A 200-pound-foot torque split between engines is acceptable for take-off. If engine torque indication is below rated torque, refer to power correction chart, figure 11-11. For engine limits, refer to ENGINE LIMITS in Section I, Part 4.
- Under colder than Standard Day conditions, the brakes may not hold the aircraft at maximum power.

TAKE-OFF

Normal take-offs at gross weights below 12,000 pounds near Standard Day conditions result in short take-off runs. Take-off airspeed and distance should be computed from the performance data charts in Section XI, Part 2.

NORMAL TAKE-OFF

For typical take-off procedure, see figure 3-3. Directional control with rudder alone is adequate and accurate under most conditions immediately on brake release. Nose wheel steering reduces the directional control task during initial acceleration on unprepared surfaces and for crosswinds. Smooth, positive back pressure application for rotation to take-off attitude should be initiated 5 KIAS below recommended take-off speed, so as to arrive at the proper attitude for lift-off. A no-flap take-off is recommended when runway length, terrain clearance, or operational requirements are not a factor. The no-flap configuration affords a more favorable safety margin between lift-off speed and minimum safe single-engine speed, especially at high gross weight and high ambient temperature conditions.

CAUTION

Check engine torque and temperature indications during take-off, retarding the power levers as necessary to avoid exceeding limits as speed increases.

CROSSWIND TAKE-OFF

For crosswind component, refer to the WIND COMPONENT chart, in Section XI, Part 2. Use nose wheel steering as required during take-off run until directional control can be maintained with rudder. Aileron into the wind and/or slightly higher torque on the upwind engine will assist in maintaining wings level; however, reducing power on the downwind engine will result in significantly increased take-off distance. For take-off under near-limit crosswind component (20 knots), delay rotation to lift-off attitude until airspeed approaches recommended take-off speed; then, apply back pressure to make a positive break from the ground. Correct for drift after lift-off by making a coordinated turn into the wind.

AFTER TAKE-OFF

1. Landing gear—UP.
When safely airborne, retract the gear. Ensure the gear is fully retracted before exceeding 158 KIAS.
2. FLAP handle—UP.
Above 110 KIAS, retract flaps. Ensure flaps are fully retracted before exceeding 158 KIAS.

TAKE-OFF

NORMAL PERFORMANCE

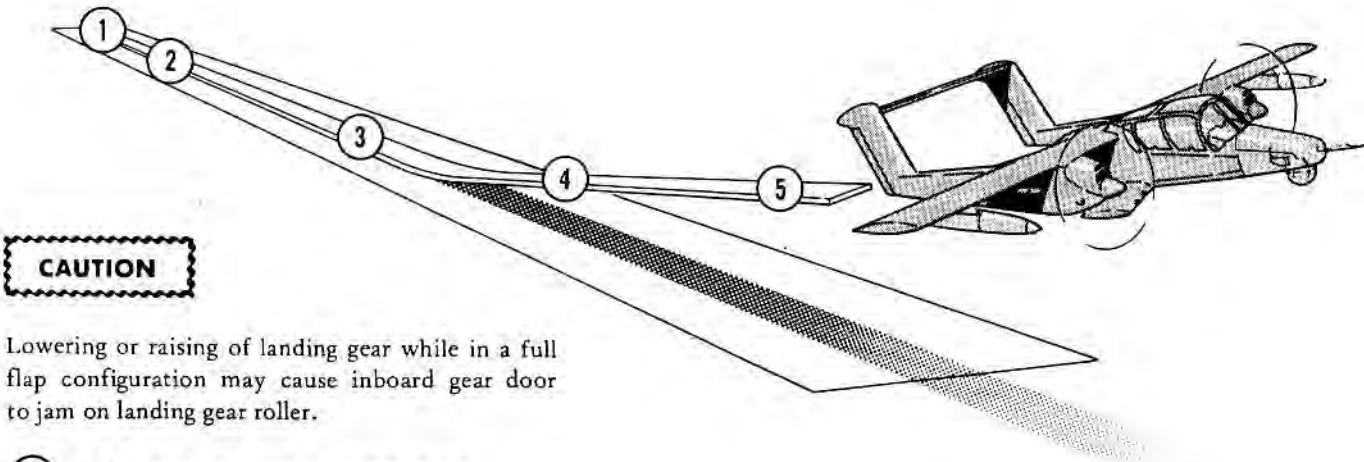

CAUTION

Lowering or raising of landing gear while in a full flap configuration may cause inboard gear door to jam on landing gear roller.

- ① Advance power to maximum available within limits, check engine instruments, and release brakes.
- ② Use rudder and/or nose wheel steering as required.
- ③ When speed approaches 5 Kias below recommended take-off speed, use positive back stick pressure to rotate to lift-off attitude.
- ④ When safely airborne, retract landing gear.
- ⑤ Above 110 KIAS, retract flaps, if used.

OV-10D-1-107

Figure 3-3

TYPICAL LANDING AND TOUCH-AND-GO PATTERN

NOTE
REFER TO SECTION XI FOR APPROACH
SPEEDS vs GROSS WEIGHT

INITIAL
• 160-200 KIAS
• CONDITION LEVERS—T.O./LAND

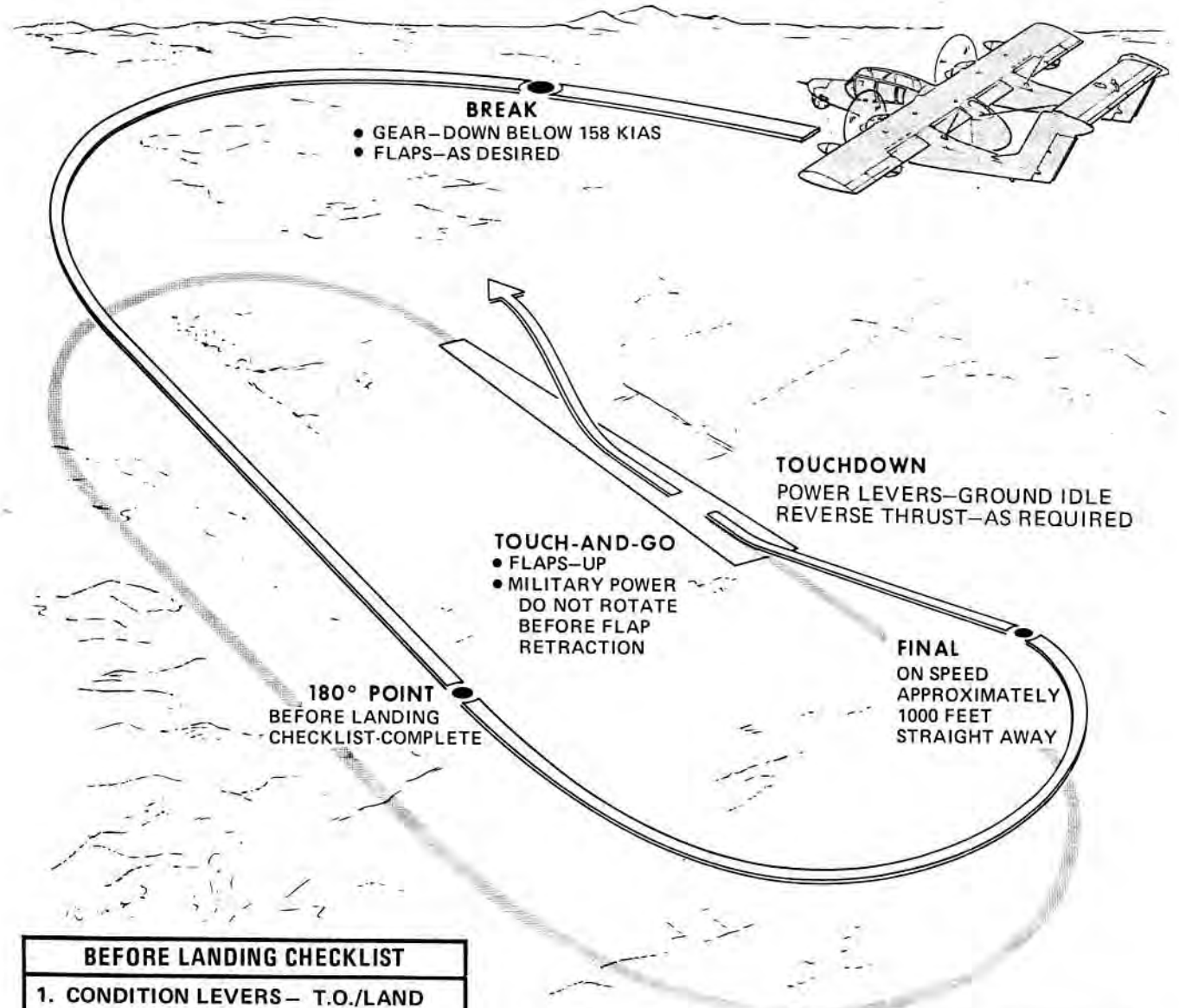

BEFORE LANDING CHECKLIST	
1. CONDITION LEVERS—	T.O./LAND
2. LANDING GEAR	— DOWN
3. FLAPS	— AS DESIRED
4. BRAKES	— CHECKED
5. HARNESS	— LOCKED
6. MESSAGE DROP DOOR	— CLOSED
7. LANDING LIGHT	— AS REQUIRED
8. EXT FUEL TRANS SWITCH	— OFF
9. FLIR POINTING FORWARD	— ON

WAVE-OFF	
POWER LEVERS	— MILITARY
GEAR	— UP
FLAPS	— UP
	(MINIMUM 110 KIAS)

Figure 3-4

OV-10D-1-108

3. Oxygen diluter lever—NORMAL OXYGEN, as required (P, O).
4. YAW DAMPER switch—ON, as desired.
5. L AUX, CTR, R AUX EXT FUEL TRANS switches—ON, as required. Check AUX FUEL caution lights go out.
6. Condition levers—NORMAL FLIGHT, individually as desired above 1000 feet AGL.

Note

When retarding to NORMAL FLIGHT, take care not to inadvertently select FUEL SHUT-OFF.

CLIMB

For climb speed schedules and climb performance data, refer to Section XI, Part 3.

CRUISE

For cruise performance data, refer to Section XI, Part 4. To initially set up cruise power, move the condition levers to NORMAL FLIGHT and adjust the power levers to maintain the desired airspeed.

FLIGHT CHARACTERISTICS

For flight characteristics data, refer to Section IV and Section XI, Part 6.

DESCENT

For optimum descent, set condition levers to NORMAL FLIGHT and power levers to FLIGHT IDLE. For airspeed distance, time, and fuel usage, refer to Section XI, Part 7. Prior to descent, proceed as follows:

1. CKPT AIR/DEFER knob—AS REQUIRED.
2. Altimeter—SET.
Set altimeter to destination barometric pressure.
3. Radar altimeter minimum altitude—SET.
4. Oxygen—100%.

BEFORE LANDING

1. Condition lever—T.O./LAND.
2. Landing gear—DOWN.
3. Flaps—AS DESIRED.
4. Brakes—CHECK.
5. Harness — LOCKED (P,O).
6. Message drop door — CLOSED.
7. Landing light — AS REQUIRED.
8. EXT FUEL TRANS switches—OFF.
9. MASTER ARM switch—OFF.
10. Countermeasures POWER/FLARE SALVO switch—OFF.
11. LASER ENABLE switch—OFF.
12. FLIR—ON (O).
FLIR turret pointing forward.

CAUTION

To preclude foreign object damage, the FLIR turret should be pointing forward on landing.

LANDING

Approach the break with condition levers in T.O./ LAND. At the break, roll into approximately 45 to 60 degrees of bank and reduce power levers to FLIGHT IDLE. As the aircraft decelerates below 158 KIAS, lower landing gear and T/O flaps. As the flaps extend, a pitch trim change will occur and power must be adjusted to arrive at the 180-degree position with the desired airspeed commensurate with gross weight. Complete the landing checklist (figure 3-4) and check wheel brakes prior to reaching the 180-degree position. Begin the turn into the base leg at a point slightly downwind of the landing end of the runway in order to have a straightaway of approximately 1000 feet. If a full flap landing is desired, lower the flaps to the 40-degree position when wings level on final. A normal power-controlled approach is flown utilizing airspeeds as indicated in Section XI, Part 8 (101 KIAS for 12,000 pounds, with T/O flaps). Rapid power changes result in large lift changes due to the amount of wing and tail surface directly in the propeller wash envelope. Approach speed and glide slope control are simplified by making small, smooth power changes. Torque setting and glide slope angle are primary for airspeed control on final approach. With propeller rpm being relatively constant, changes in airspeed and power setting do not result in the sound variations normally expected.

After touchdown, lower the nose and select reverse thrust as desired, exercising caution not to exceed engine limits.

CAUTION

After landing, power levers shall not be retarded aft of GROUND START position until airspeed is less than 75 KIAS (OAT in excess of 100°F/37.8°C) or 100 KIAS (OAT less than 100°F/37.8°C).

Nose wheel steering may be used for directional control if desired; however, directional control can easily be maintained using rudder and differential reverse thrust.

CAUTION

Do not attempt to maintain a nose-high attitude for aerodynamic braking below approximately 50 knots. Loss of pitch control authority in a nose-high attitude may cause overrotation and damage to the rudders. If landing rollout overrotation is encountered, apply brake pressure to rotate the aircraft nose down to the normal attitude. For 13,000 pounds landing weight, recommend brake application at speed no higher than 60 knots.

Note

If "gate" does not retract, raise the power levers $\frac{1}{4}$ inch and pull back to obtain reverse thrust.

2. Rotate nose up to arrest sink rate.
3. FLAP handle—T/O.
4. Landing gear handle—UP.
5. FLAP handle — UP, as desired (minimum 110 KIAS).

CAUTION

Under certain air loads which develop during wave-offs with full flaps selected, the main landing gear doors may NOT be fully open and may prevent the landing gear from retracting normally. If this occurs, relower the landing gear and land.

TOUCH-AND-GO PATTERN

Following touchdown, raise the flaps, if they are down, and smoothly add Military power. When 5 KIAS below computed take-off speed, rotate the nose and fly aircraft into the air. When safely airborne, raise the gear if desired. (Normally the gear is left in the down position to decrease wear on the hydraulic system.) Climb to a minimum of 300 feet AGL and accelerate to 120 KIAS prior to turning downwind. Maintain 120 KIAS in the turn and on the downwind leg. Prior to the 180-degree point, complete the landing checklist and slow to approach speed. Adjust the turn-off to the 180-degree point to arrive on final with approximately 1000 feet of straightaway, 200 to 300 feet AGL. Touchdown airspeed is determined by weight and landing configuration.

AFTER LANDING (WHEN CLEAR OF RUNWAY)

1. FLAP handle—UP.
2. Condition levers—NORMAL FLIGHT.

CAUTION

To prevent engine overtemperature, monitor TIT when operating in the normal flight mode and utilizing full or partial reverse. Overtemperature is more likely to occur when a headwind component exists.

CROSSWIND LANDING

Refer to the crosswind chart in Section XI, Part 2, to determine crosswind limit component. Adjust position of the downwind for wind to avoid overshooting the final approach. The normal (wing-down) approach procedure is effective, but may produce easily controllable lateral oscillations under gusting conditions. After touchdown, retract flaps as soon as practicable; hold the stick into the wind and use differential reverse thrust and nose wheel steering for directional control.

3. Nonessential COMM/NAV—OFF.
4. Landing light—AS REQUIRED.

WARNING

The observer shall not release his harness fittings until cleared by the pilot after the front seat is safe. An inadvertent ejection by the pilot will eject the rear seat even with all rear seat safety pins installed.

SLIPPERY RUNWAYS

Refer to ICE AND RAIN, in Section VI.

5. LASER ARM switch—OFF (O).
6. Radar altimeter—OFF (O).
7. FLIR mode switch—STBY (O).
8. FLIR mode switch—OFF (O).
9. NO. 3 INV CB—OUT (O).

WAVE-OFF

1. Power levers—MILITARY.

CAUTION

Monitor engine indicators to avoid exceeding torque or temperature limits.

SHUTDOWN

For operational convenience, shut down the engines with the propellers in flat pitch. Proceed as follows:

1. "D" ring safety pin—INSERT (P, O).
2. PARK BRAKE—SET.

3. Condition levers—FUEL SHUT-OFF.
Power levers—FULL REVERSE (monitor TIT).

CAUTION

Failure of an engine to stop running when condition levers are placed in FUEL SHUT-OFF may indicate a broken or disconnected fuel control linkage or shutoff valve. Positioning the power lever to FULL REVERSE or the condition lever to FEATHER & FUEL SHUT-OFF under these circumstances may result in engine overtemp/fire. When linkage failure occurs, shut down the engine using the EMERGENCY FUEL SHUT-OFF switch.

Hold in FULL REVERSE until engine rotation stops. Advance power lever to GROUND IDLE and check that the propeller blades move to and stop at the flat pitch position.

or

4. For shutdown with propellers feathered, pull condition levers full aft to FEATHER & FUEL SHUT-OFF.

Note

On feathered shutdown, expect higher than normal temperatures and possible smoke from the intakes due to rapid wind-down of the engines.

5. All radios/navigation equipment—OFF (P, O).
6. INST PWR switch—OFF.
7. BATTERY switch—OFF.
8. External/interior lights—OFF.

BEFORE LEAVING AIRCRAFT

1. Wheel chocks—IN PLACE.
2. PARK BRAKE—SET, as desired.
3. Oxygen diluter lever—100%—OFF (P, O).
4. Control gust lock—INSTALL.
5. Parachute thruster safety pin—INSTALLED (P, O).
6. Landing gear and drop tank safety pins—INSTALL.
7. Engine oil quantity—CHECK.
8. LASER safety plug removed—CHECK.

STOL OPERATIONS

Short-field take-off and landings (STOL) are achieved through practice. Short-field technique should be perfected

under controlled conditions on hard-surface runways. The objective of safely taking off or landing the aircraft in the shortest feasible distance depends on variables such as: runway length, obstacle heights, aircraft weight, center of gravity, and existing weather (including wind, temperature, and pressure altitude).

WARNING

STOL operations should be performed only by experienced OV-10D pilots.

Note

The OV-10D is prohibited from take-off and landings on other than smooth, hard paved surfaces.

STOL TAKE-OFF

Take-off performance can be improved by utilizing lower lift-off airspeeds and a higher climb angle after lift-off. The airspeeds for STOL take-off are based upon the minimum single-engine control speed of the aircraft. Engine failure at these airspeeds will result in an immediate yaw and roll into the failed engine. Full rudder deflection and almost full aileron deflection will be required immediately to maintain a wings-level attitude. In the STOL configuration, the aircraft cannot maintain level flight with only one engine operating. Loss of an engine will result in a rate of descent and crash landing; however, rapid rudder and aileron deflection on engine failure should allow a wings-level attitude to be regained. Existing conditions of runway remaining, altitude on engine loss, and surrounding terrain will dictate whether a crash landing or ejection is required for survival.

The technique for STOL take-offs is similar to normal take-offs. Set the flaps at 20 degrees and trim one unit nose down. Compute take-off distance and airspeed, climb-out flight path, engine performance, and complete take-off checklist before taxiing into take-off position. In take-off position, advance power levers to MILITARY, letting torque build to maximum possible while being careful not to exceed engine limits.

WARNING

Recompute performance data if expected performance is not realized.

Brakes may be unable to hold the aircraft on a hard, dry runway at military power settings, at aircraft gross weights below 13,500 pounds.

At 10 knots below computed take-off speed, rotate the nose to approximately 20 degrees above the horizon and fly the aircraft off the deck at lift-off speed. When safely airborne, raise gear and flaps and continue normal climb. Positive forward stick pressure will be required to stop the rotation at 20 degrees and to prevent an overrotation as airspeed increases. For an obstacle take-off, raise the gear after take-off. Leave flaps down, and climb out at take-off speed until clear of the obstacle.

WARNING

STOL take-offs should be performed only as required for operational necessity.

STOL LANDING

Landing performance can be improved by utilizing lower approach speeds at 20 degrees flaps or by utilizing a 40-degree flap setting. The airspeeds for STOL (20 degrees flaps) are based on minimum single-engine control speed. Engine failure at these airspeeds will result in a yaw and roll into the failed engine. This roll and yaw, although less rapid than during STOL take-offs due to reduced engine power, will require almost full rudder and aileron deflection to

regain wings-level flight. In the STOL configuration, the aircraft cannot maintain level flight with only one engine operating. Loss of an engine will result in an increased rate of descent and a crash landing. Existing conditions of runway remaining, altitude on engine loss, and surrounding terrain will dictate whether a crash landing or ejection is required for survival. Altitude permitting, retraction of gear and flaps may allow sufficient time to accelerate to a positive rate-of-climb airspeed at light gross weights. Maximum authorized landing weight for STOL landing is 13,000 pounds. The STOL landing pattern is flown the same as the normal pattern. Slow to recommended approach speed and lower flaps (to 40 degrees if required). Prior to being established on final, maintain minimum safe single-engine speed. Establish and maintain the computed touchdown speed and fly a power-controlled approach to a touchdown. Care should be taken to safe clearance of obstacles and to remain below the maximum allowable touchdown rate of descent (no greater than 600 FPM on prepared hard surfaces). On touchdown, retard the power control levers to GROUND START, apply slight forward stick, and commence moderate braking. When below 100 KIAS (OAT 100°F/37.8°C or less) or 75 KIAS (OAT in excess of 100°F/37.8°C), smoothly but rapidly retard the power levers to FULL REVERSE and apply maximum braking without skidding.

WARNING

STOL landings should be conducted only as required for operational necessity.



With reverse thrust selected, prevailing conditions of dust or precipitation can result in momentary obstruction of visibility.

Note

- To ensure maximum braking capability, it is necessary to pump the brakes just prior to landing. The brakes will bleed down from the 180-degree position and full pedal travel will not be available without pumping the brakes on final approach.

REMOTE SITE OPERATIONS

Preliminary remote site selection will require an in-depth map reconnaissance and input by both squadron personnel and the Landing Force Intelligence personnel. Attention must be given to all areas of site evaluation to ensure adequate landing, parking, ordnance, and fueling areas are available. Modifications to the site should include only that necessary to ensure safety and camouflage. Ground support personnel and aircraft should both have the capability of rapid displacement from the site.

Obstacles and touchdown zones must be marked and identified to aircrews prior to commencement of site operations. In a training environment personnel should if possible, physically walk the entire remote site to familiarize themselves with its characteristics and obstacles.

A runway control officer will be the controlling official at the site and as such may institute or remove from effect any restrictions on aircraft operation he may deem necessary to ensure safe standardized operation from the site. He is also responsible for landing surface marking, obstacle marking or removal security, instruction and positioning of support personnel, and initiating or terminating flight operations at the site.

Pilots operating from the remote sites will normally receive a briefing on the site by the runway control officer to

include length of landing area, normal approach corridors, and prevailing wind direction. In addition, pilots shall have demonstrated their ability to remain on centerline during STOL landings.

AEROBATICS

Before starting an aerobatic flight, the pilot will ensure that the criteria set forth in OPNAVINST 3710 current series can be complied with. For aerobatic maneuver parameters, see figure 3-5.

SIMULATED ENGINE(S) - OUT OPERATIONS

For pilot training purposes, the following definitions will apply:

- *Actual engine-out operations are those in which an air start would be required to regain use of the engine.*
- *Simulated engine-out operations are those in which immediate use of the engine is available.*

Actual engine-out operations will not be intentionally conducted below 4000 feet AGL. Simulated engine-out operations will not be induced below 500 feet AGL. Engine(s)-out operations can be simulated by retarding power lever(s) to FLIGHT IDLE and advancing the condition levers to 90% rpm. This should result in a rate of descent of 1200 to 1400 fpm at 130 KIAS in the clean configuration.

FORMATION

The basic principles, signals, and maneuvers promulgated in NWP-41 and supplements thereto, are generally applicable. The following instructions apply specifically to the OV-10D aircraft. For all parade formation, the wingman will position the condition levers to T.O./LAND.

PARADE FORMATION

Parade formation will normally be employed when operating around home base or during low visibility conditions. It is recommended that all power changes, climbs,

glides, and turns be signaled by the leader. Bearing and stepdown are determined by placing the propeller spinner on the lead pilot's shoulder. Wing-tip separation should be adjusted to approximately 5 feet. On turns away, the wingman should turn about his own axis; on turns into the wingman, he should rotate about the leader's axis. The instrument parade position is flown in the same manner except that all turns are conducted about the leader's axis.

CROSSUNDER

Upon receipt of the crossunder signal, the wingman will acknowledge and commence an arcing crossunder by reducing power, dropping the nose slightly, and sliding aft to clear the leader's tail section and prop-wash. As the nose passes approximately 20 feet below and directly aft of the leader's tail, smoothly add power and complete the crossunder by sliding up and forward to the proper wing position.

FREE CRUISE

Free cruise formation provides better look-out capabilities and maximum freedom of movement for the leader and

other members of the flight. Normal cruise is flown within a 60-degree triangle, 30 degrees on either side of the leader's axis with 20 feet nose-to-tail clearance and sufficient vertical separation to clear the leader's prop-wash. A step-up position may be utilized to ensure mutual visual coverage.

TAIL CHASE

The tail chase position is flown in the leader's 6-o'clock position with a 10- to 20-foot stepdown and 20-foot nose-to-tail clearance. The leader will perform climbs, dives, and turns gradually increasing pitch and bank angles. Positive "g" will be maintained at all times.

RENDEZVOUS

TURNING RENDEZVOUS

The turning rendezvous is made at 150 KIAS (unless otherwise briefed). After the second aircraft is in a loose trail position, the leader starts a 180-degree turn, using 20 degrees of bank. The second aircraft waits until the lead aircraft has started his rendezvous turn before rolling into 45 degrees of banked turn to the inside of the

AEROBATIC MANEUVER PARAMETERS

MANEUVER	COND LEVER	RPM	ENTRY AIRSPEED	MINIMUM MANEUVER SPEED
AILERON	NORMAL FLIGHT	95-98%	150-200	--
WINGOVER			200	100-110
BARREL ROLL			200	100-110
LOOP			250	100-110
CUBAN EIGHT			250	100-110
IMMELMANN			250	100-110
SPLIT S			120	--

NOTE: MANEUVERS LISTED ABOVE ARE EXAMPLES ONLY. MANEUVERS NOT LISTED SHOULD BE ENTERED AND COMPLETED AT SPEEDS WITHIN THE AIRCRAFT LIMITS FOUND IN SECTION I, PART 4.

Figure 3-5

aircraft. The angle of bank is adjusted as necessary to maintain the 45-degree bearing until joining on the leader. As the joining aircraft approaches the leader, the closure rate is adjusted so as to join on the inside of the leader's turn. After joining on the inside of the leader, a crossunder is made to the outside, assuming the normal wing position.

RUNNING RENDEZVOUS

A running rendezvous is effected by closing from the rear on a prebriefed heading or radial. This rendezvous should be accomplished with the flight leader climbing at 130 knots and 95% to 96% rpm (unless otherwise briefed). If a level rendezvous is made, the leader should normally be at 150 KIAS at the designated altitude.

SAFETY RULES FOR RENDEZVOUS

The safety rules for rendezvous are as follows:

1. Keep the aircraft ahead constantly in view.
2. During rendezvous, maintain the leader on the horizon until within three wing spans, then take step down required for the crossunder.
3. When necessary, a wingman should abort the rendezvous by leveling his wings and flying to the outside. Stabilize outside the turn, then adjust power as necessary to join on the outside of the turn.
4. All relative motions should be stopped when joining on an inside wing position. A crossunder to the outside may then be made.
5. During a running rendezvous, use caution in the final stage of join-up as relative motion is difficult to discern when approaching from astern.

SECTION TAKE-OFF

After obtaining clearance to taxi into take-off position, the leader will take the downwind side of the runway. The wingman should position his aircraft with a 20-foot wing tip separation. Both aircraft will perform power checks on the leader's signal and the leader will set his power with 100 pounds torque less than MILITARY power.

On signal, both aircraft will commence take-off roll simultaneously. At recommended lift-off speed, the leader will smoothly transition to the take-off attitude. After the wingman is safely airborne, the leader will signal for raising the gear. If during take-off roll, the leader must abort his take-off, the wingman will continue or abort as appropriate.

SECTION APPROACHES

Section approaches shall be flown in accordance with the OPNAVINST 3710.7 series at a minimum recommended airspeed of 120 KIAS.

NIGHT FLYING PROCEDURES

Night flying procedures are identical to day procedures with the following exceptions. For night lighting information, refer to Section I, Part 2.

NIGHT FORMATION

It is important to maintain the correct bearing so that the wingman can be seen by the leader. Ensure that wingtip clearance is maintained at all times. Avoid staring at the lead aircraft and getting fixation on its lights. Instrument parade turns will be made with a 30-degree maximum angle of bank.

NIGHT RENDEZVOUS

Night rendezvous are similar to daytime, except that in the final portion the pilot should try to close to a position slightly astern rather than directly toward the aircraft. Pilots must be sure not to carry excess airspeed in the rendezvous. The leader must maintain a constant airspeed and altitude. Whenever it is necessary for a pilot to go to the outside of the rendezvous, he will report this to the Flight Leader. Stay on the outside of the rendezvous until stabilized and then add power as necessary to join up. Pilots joining from astern will move out to the side in order to enhance their judgment of closure rates, as well as to ensure safe clearance.

PART 4 — CARRIER-BASED PROCEDURES

INTRODUCTION

The carrier landing is the end result of all field training. The effectiveness of the OV-10 weapons system depends on the overall efficiency of carrier landing operations if peak combat readiness is to be maintained. To ultimately carry out any assigned mission, each aviator must be able to perform carrier landings and take-offs within the standards set for these evolutions.

Note

Only experienced and appropriately trained aircrews should take part in Carrier-Based Operations.

FIELD CARRIER LANDING PRACTICE

Field Carrier Landing Practice (FCLP) is defined as that phase of required flight training which precedes carrier landing operations. It must simulate, as nearly as practicable, the conditions encountered during carrier operations, including the configurations of the aircraft. The Landing Signal Officer (LSO) is responsible for maintaining the rigid standards of performance demanded for carrier operations. In order to maintain these standards, the LSO must demand that each FCLP approach represent the maximum capability of the individual pilot.

GROUND TRAINING

Prior to and during FCLP training, the following subjects shall be covered in lectures by the LSO.

1. Optical landing systems.
2. Nonoptical landing system approaches.
3. Communications.
4. General FCLP procedures.
5. Specific FCLP procedures.
6. Postflight debriefings.

FLIGHT PROCEDURES

Pilots shall be briefed by the LSO prior to each FCLP period in accordance with the NATOPS Briefing Guide. The following items shall also be included:

1. Take-off/Recovery times.
2. Weather.

3. Bingo fields.
4. Formation procedures.
5. Traffic rules and terrain of FCLP field.
6. Patterns.
7. Gross weight limitations.
8. Communications.
9. Emergencies.
10. Practice wave-offs.
11. Final recovery procedures.
12. Debrief time/location.

THE FCLP PATTERN

The FCLP pattern shall be flown in accordance with the pattern depicted in figure 3-6. It should simulate to the maximum extent possible the carrier landing pattern. The distances and altitudes depicted are examples of the normal 180-degree positions for both day and night operations. The turns and pattern altitudes from the 180-degree position will be flown in such a manner as to ensure an adequate wings-level groove.

PILOT CERTIFICATION

The FCLP training must be completed to the satisfaction of the senior LSO prior to carrier qualification. During this training the pilot will demonstrate his ability to operate with appropriate configurations and simulated emergency condition. When this has been completed, a recommendation will be submitted by the LSO to the Commanding Officer certifying the pilot as FCLP qualified. The LSO will also recommend revocation of a certification at any time a pilot's standard of performance is less than satisfactory.

PRE-CARRIER BRIEFING

The following subjects shall be covered by the LSO in briefings for pilots prior to and during carrier operations.

1. Carrier configuration.
2. Recovery systems.
3. Communications.
4. General carrier operating procedures.

STANDARD FCLP PATTERN

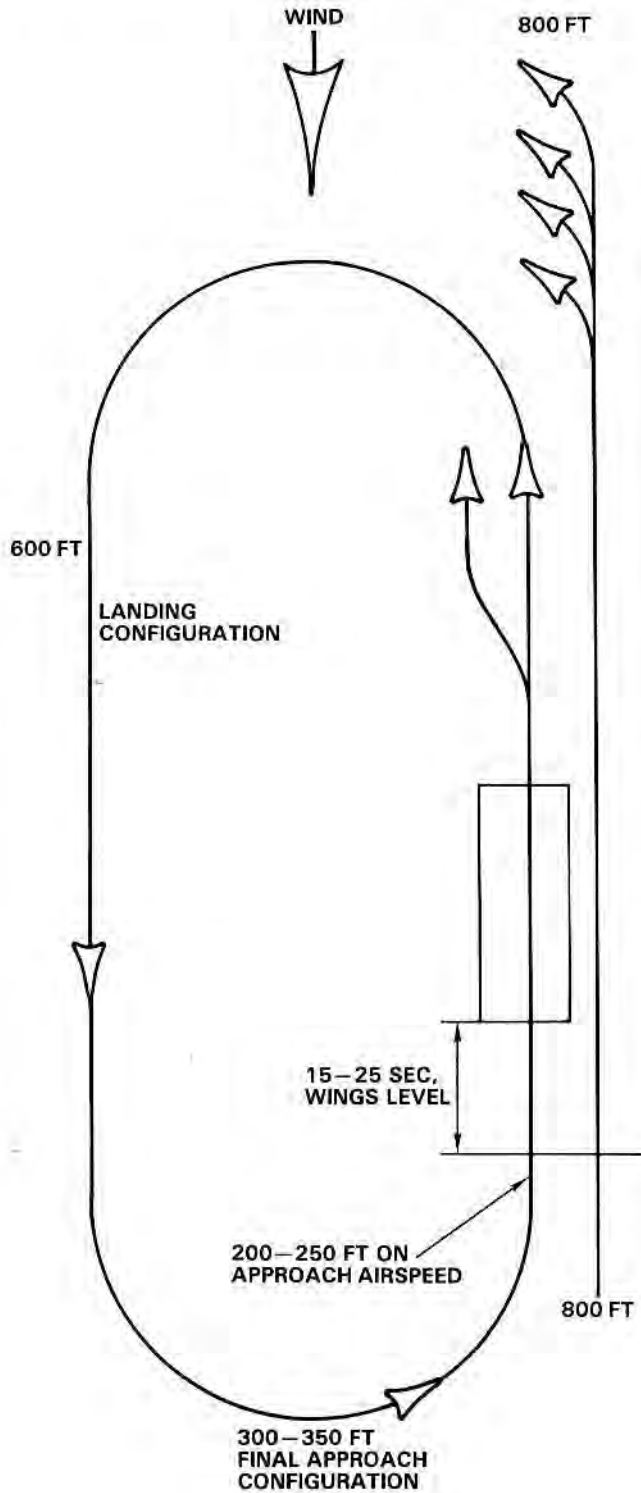

Note

Clearing turns will not be commenced below 400 feet AGL.

OV-10D-1-174

Figure 3-6

5. Specific carrier operating procedures.
6. Emergencies.
7. Operations and air department briefings.
8. Landing pattern and recovery procedures.
9. Postflight briefings.

LANDING PATTERN AND RECOVERY PROCEDURES

Day VFR Pattern

To be provided at a later date.

Night VFR Pattern

To be provided at a later date.

AIRCRAFT HANDLING AND LAUNCH PROCEDURES

Launches shall not be commenced when less than 700 feet of clear, unobstructed take-off distance is available. All carrier launches are to be made using 20-degree flaps and one unit of nose-down trim. Primary consideration is to obtain safe single-engine speed prior to lift-off, vice becoming airborne as quickly as possible. Safe single-engine speed where a loss of control about any one of the aircraft axes occurs with one engine feathered and the other at military power. It does not mean that a safe flyaway will always be possible, but it does assure the pilot of sufficient time to eject, jettison the external load, or ditch, whichever is appropriate. The minimum wind over deck (WOD) requirements for a safe take-off are contained in the charts in shipboard operating bulletin. It is the responsibility of the pilot to ensure that the conditions required for launch are met.

WARNING

Launches with wind over deck lower than those delineated in shipboard operating bulletin are prohibited.

The take-off technique recommended is application of military power prior to commencing the roll and a positive rotation to a fly-away attitude 5 to 10 KIAS prior to obtaining take-off speed.

Note

A power degradation in excess of 5 percent below computed rated torque will require recomputation of wind-over-deck requirements. If power degradation is in excess of 10 percent, do not attempt take-off.

PART 5 — FUNCTIONAL CHECKFLIGHT PROCEDURES

INTRODUCTION

A "Functional Checkflight" is an operation conducted to determine if the aircraft and its systems are in a satisfactory condition for the performance of regular missions. It differs from regular or normal operations flying, since the pilot is flying in accordance with a specific plan designated to test all functional systems and determine if any operational discrepancies exist.

CHECK PILOTS

An important factor in obtaining good checkflights on the aircraft is the selection of experienced and conscientious check pilots. Commanding Officers shall designate, in writing, those pilots within their command who are currently qualified to perform this duty.

CHECKFLIGHTS AND FORMS

Checkflights will be performed when directed by, and in accordance with OPNAVINST 4790.2 series and the directions of NAVAIRSYSCOM, type Commanders, or other appropriate authority. Functional checkflight requirements and applicable minimums are described. Functional checkflight checklists are promulgated separately.

FLIR/LRD SYSTEM CHECKS

Certain conditions may require flight checks to determine if the FLIR/LRD is in satisfactory condition for the performance of regular missions. These flights should be accomplished by a fully qualified aerial observer occupying the rear cockpit.

CONDITIONS REQUIRING FUNCTIONAL CHECKFLIGHTS

Perform applicable flight profile and associated checks in accordance with the following conditions:

A. At the completion of aircraft rework and appropriate phase inspections (all checkflight items required are prefixed A).

B. Following major structural repair of airframe components that could affect aerodynamic reaction during flight. When fixed flight surfaces have been installed or reinstalled, or when movable flight surfaces or flight control system components have been installed or reinstalled, adjusted or reregged, and improper adjustment or replacement could cause an unsafe operational condition (all checkflight items are prefixed B).

CHECKFLIGHT PROFILE

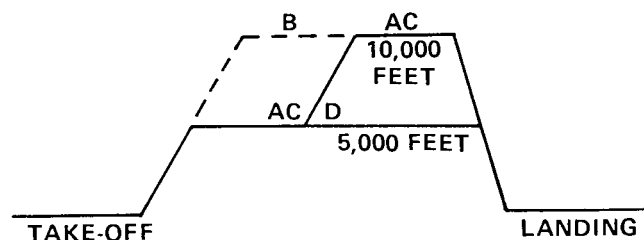

OV-10D-1-139

Figure 3-7

C. Installation or reinstallation of engine, propeller, propeller governor, major fuel system components, or any component or mechanism which cannot be checked during ground operations (all checkflight items are prefixed C).

D. When landing gear components are installed or reinstalled and ground checks are not adequate due to absence of air loads (all checkflight items are prefixed D).

PROCEDURES

The following items provide a detailed description of the functional checks, sequenced in the order in which they should be performed. In order to complete the required checks in the most efficient and logical order, a flight profile has been established for each checkflight condition and identified by the letter corresponding to the purpose for which the checkflight is being flown, A through D. The applicable letter identifying the profile prefixes each check both in the following text and in the NATOPS Functional Checkflight Checklist (NAVAIR 01-OV10D-1F). Checkflight personnel will familiarize themselves with these requirements prior to the flight. NATOPS procedures will apply during the entire checkflight unless specific deviation is required by the functional check to record data or ensure proper operation within the approved aircraft envelope. A Daily inspection is required prior to any checkflight.

PROFILE

BEFORE START

A C

1. Unfeather pump check – Place left power lever in FULL REVERSE and move NO. 1 AIRSTART switch to CRANK. Note movement of propeller toward reverse. Return AIRSTART switch to AUTO and power lever to GROUND IDLE. Repeat for right engine.

PRETAXI CHECK

AB

2. Trim.
 - a. Check trim controls on all three axes for rates, full deflections, and set take-off positions.
 - b. Check alternate trim operations.

AB

3. Check flaps for proper operation and indication.

AB

4. Check controls for full deflection in proper direction and ease of operation.

A

5. AN/ASN-75 Compass System – Set the compass system for normal magnetic slaved operation with the SLAVED-FREE switch in the SLAVED position. Approximately 3 minutes after starting the engine, rotate the PUSH TO SET knob to cause the indicators to indicate the heading of the aircraft. Note that the annunciator needle is close to the zero position.

A

6. Interior lights – Check operation of all cockpit lights.

A

7. Oxygen system – Check all modes of operation.

A

8. Exterior lights – Check (with plane captain).

A

9. Smoke generator – Check.

A

10. Clock – Sweep second hand.

A C

11. Engine Performance.
 - a. Overspeed governor (prior to unlocking).
 - (1) Propellers locked in flat pitch.
 - (2) Power levers at GROUND IDLE and condition levers at NORMAL FLIGHT.
 - (3) After stabilization, advance condition levers to T.O./LAND. Advance power levers to MILITARY slowly to avoid overspeed.
 - (4) Engine rpm should stabilize from 103.8% to 104.3% (5-second limit).
 - (5) Record maximum rpm observed.
 - (6) Record oil pressure. (90-120 psi acceptable)
 - b. Underspeed governor. (prior to unlocking).
 - (1) Power levers to GROUND IDLE and condition levers to NORMAL FLIGHT.
 - (2) Slowly retard power lever aft of GROUND IDLE to GROUND START.
 - (3) Minimum rpm should be 65.5 (±0.5)%.
 - (4) Record minimum rpm observed.
 - (5) Record oil pressure. (48 psi min.).

PROFILE

TAXI CHECK

ABCD

12. Brakes.

- a. Check brakes for dragging or chattering.
- b. Brake forces required for stopping should be moderate to heavy and brakes should not require pumping.

A D

13. Nose Wheel Steering.

- a. Check nose wheel steering for approximately 55-degree turn angle left and right of center.
- b. Check for shimmy during turns.

A

14. Magnetic Compass and Needle Ball—Check for proper indication during turns.

AB

15. Yaw Damper—With YAW DAMPER switch in TEST position, rudder pedal pressure opposite to direction of turn should be evident.

AB

16. Gunsight check — Check brightness of both filaments, mil adjustment ring operating freely, both clear and red filter intact. Check alignment through taxi check.

PRETAKE-OFF

A C

17. Engine Performance.

a. Idle rpm (NORMAL FLIGHT).

- (1) Condition lever at NORMAL FLIGHT and power lever at GROUND IDLE.
- (2) Record rpm (65% minimum to 71% maximum).
- (3) Record oil pressure (minimum 48 psi).

b. Idle rpm (T.O./LAND).

- (1) Power levers at GROUND IDLE and condition levers to T. O./LAND.
- (2) Record rpm (94% to 96%).
- (3) Record oil pressure (90 to 120 psi).

c. Maximum thrust.

- (1) Refer to AIRCRAFT OPERATING LIMITATIONS, Section I, Part 4, or NATOPS Pilot's Pocket Checklist (NAVAIR 01-OV10D-1B) for maximum TIT and minimum torque. (Record.)
- (2) With condition levers at T.O./LAND, advance power levers to MILITARY position within 1 second.
- (3) Check rpm stabilized between 99.8% and 101%.
- (4) Check development of 95% maximum rated torque in approximately 4 seconds.
- (5) Check oil pressure (90 to 120 psi).

d. Military rated power (maximum torque).

- (1) Condition levers to T.O./LAND and power levers to 115- to 117-degree detent position (slightly aft of the MILITARY position).
- (2) Check rpm 99.8% to 100.2%.
- (3) TIT and torque should rise slightly above that obtained at maximum thrust.
- (4) Record maximum torque when maximum TIT is obtained.
- (5) Check oil pressure (90 to 120 psi).

PROFILE

e. Deceleration.

- (1) After maximum torque, pull power levers to GROUND IDLE.
- (2) RPM should decrease to 94% to 96% within 3 seconds.
- (3) Check oil pressure (90 to 120 psi).

f. Reverse thrust.

- (1) Condition levers to T.O./LAND and power levers to FULL REVERSE.
- (2) Check rpm (100.0% to 100.5%).
- (3) Record torque (2300 MAX continuous and 2640 for 5 seconds limit).



FLIR should be pointed forward for all take-offs to preclude glass damage.

TAKE-OFF

A C

18. Engine Performance.

Check engine instruments during take-off and initial climb-out. Note any tendency for engines to exceed torque and temperature limits and any substantial differential torque output between the two engines.

ABC

19. Check Nose Wheel Vibration After Lift-off.

CLIMB 5000 FEET (PROFILES ABCD)

A

20. Observe Vertical Velocity Indicator.

A

21. Observe operation of Radar Altimeter for proper altitude indication.

- a. Press Push-to-test knob; check indication 100 (± 15) feet. Release knob, pointer should return to appropriate altitude.
- b. Note proper operation of the low altitude warning light.

LEVEL FLIGHT 5000 FEET

A C

22. Aircraft Performance.

Trim at Military rated power and stabilize for 3 to 5 minutes and record instrument readings:

- a. OAT.
- b. Torque.
- c. RPM.
- d. TIT.
- e. Oil pressure.
- f. Airspeed.

AB

23. Flight Control Trim.

- a. Trim aircraft at 180 KIAS with RUDDER and AILERON trim neutral lights on and record position of the ball.
- b. Check both normal and alternate trim systems.

PROFILE

AB

24. Stability Checks.
- Longitudinal. Trim the aircraft in level flight between 5,000 to 10,000 feet at 180 KIAS. The aircraft is statically stable if a push force is required to increase and stabilize 50 knots above trim and a pull force is required to decrease and stabilize 50 knots below trim.
 - Dynamic lateral-directional. With the YAW DAMPER ON, trim the aircraft in level flight between 5,000 to 10,000 feet at 180 KIAS. Apply a rudder pedal force (approximately 100 pounds) in either direction and release all controls abruptly. Observe aircraft lateral-directional oscillation characteristics. Repeat the maneuver with YAW DAMPER OFF. The aircraft lateral-directional oscillations should damp in one and one-half cycles or less with the YAW DAMPER ON.
 - Static lateral-directional. The aircraft is laterally statically stable if left aileron force is required for left sideslips and right aileron force is required for right sideslips. The aircraft is directionally statically stable if left rudder pedal force is required for right sideslips and right rudder pedal force required for left sideslips. With the YAW DAMPER ON, trim the aircraft in level flight at 180 KIAS between 5,000 to 10,000 feet to establish a constant heading 20-degree bank. The aircraft should return to approximately level flight when the controls are released. Repeat the maneuver with the YAW DAMPER OFF.
 - Aileron rolls. Right and left aileron rolls shall be performed in level flight between 5,000 to 10,000 feet at 180 KIAS. Full throw lateral stick should be obtained smoothly with no restrictions. Abnormally low roll rates should be noted. Full aileron control deflections should produce 360-degree rolls in 4 seconds or less at 180 KIAS.
 - Stalls. Perform stalls in the take-off, cruise, power approach, and landing configurations. Check for the presence of stall warning buffet, rudder pedal shaker operation, yawing, and excessive roll-off. A mild roll-off in either direction at the stall break is acceptable. An abrupt roll-off with 45 degrees or more angle of bank is unacceptable.
25. BETA CHECK.
- Trim the aircraft out at Military power at approximately 150 KIAS.
 - With the condition levers in T.O./LAND mode, pull the power levers to the hard stop. Continue to decelerate to 85 KIAS.
 - Note any excessive yaw tendencies. Ball displacement should not normally exceed one ball width, left or right, during this check.

CLIMB AND LEVEL FLIGHT 10,000 FEET (PROFILES ABC)

ABC

26. Aircraft Performance.
- Trim the aircraft at Military power, stabilize for 3 to 5 minutes, and record instrument readings.
- OAT.
 - Torque.
 - RPM.
 - TIT.
 - Oil pressure.
 - Airspeed.

A

27. Anti-G Suit Valve.
- The anti-G suit system should be checked for adequate pneumatic pressure.
 - Check modulating valve for ease of operation and absence of sticking by manually depressing it several times.

PROFILE

- A** 28. Heat-Vent-Defrost Operation.
- a. Pull RAM AIR knob and check for airflow from defrost ducts.
 - b. Pull TEMP knob and check for increase in air temperature.
 - c. Pull CKPT AIR/DEFER knob and check for airflow diverted from defrost ducts to cockpit vents.
 - d. Position BLEED AIR switches to EMERG OFF to test for proper operation.
- A D** 29. Landing Gear.
- a. Slow aircraft to 120 KIAS. Check emergency extension by pulling the hydraulic pump control circuit breaker and placing landing gear handle down. Reset circuit breaker.
 - b. Check normal operation by cycling landing gear two times. Retraction should require approximately 10 seconds; extension should require approximately 7 seconds.
- ABC** 30. WHEELS Warning Light.
- a. Set condition levers to T.O./LAND, gear and flaps up, and retard power levers—Ensure illumination of wheels warning light.
 - b. Below 158 knots lower landing gear, light should go out.
 - c. Lower 40° flaps below 130 knots; light should remain OUT.
 - d. Raise landing gear; light should flash at any power setting.
 - e. Position power levers well forward in quadrant and raise flaps; light should extinguish as flaps pass 30° position
- AB** 31. Flaps.
- a. Cycle flaps two times by normal control system and note proper indication of flap position.
 - b. Place flap handle in HOLD, cycle flaps with the ALT FLAPS switch. Extension should not require more than 60 seconds.
- A** 32. Electrical System.
- a. Check generator voltage at 28 (± 0.8) volts. Trip each generator (individually) and reset.
 - b. Check generator-out caution light comes on and goes out immediately after RESET is selected. No equipment should fail as a result of one generator being off.
- CAUTION**

Ensure FLIR system is OFF prior to electrical system check and engine shutdown to preclude unnecessary electrical load on single generator.
- A C** 33. Engine Shutdown.
- a. NTS check. Move the left condition lever to FUEL SHUTOFF while power lever is at Military RPM; RPM should decrease to below 40% within 30 seconds or less.
 - b. Feather check. Retard left condition lever to FEATHER & FUEL SHUT-OFF. Propeller should be fully feathered in 2 seconds or less.
 - c. Perform air start and repeat procedures for right engine.
- A** 34. UHF Radio (AN/ARC-51).
- a. Check transmission and reception for signal strength, quality of speech, and noise at various frequencies, altitudes, and distances.
 - b. Proper function of squelch disable mode.
- A** 35. UHF/ADF (AN/ARA-50).
- a. ADF for audio reception on known station location within 110 miles.
 - b. Indicated bearing should be within ± 5 degrees true bearing and bearing needle should not “hunt” more than ± 1 degree.

PROFILE

- A** 36. VHF-FM Radio (AN/ARC-54 and AN/ARC-131).
- Check transmission and reception for signal strength, speech quality, and noise at various altitudes, relative bearings to station, and distances up to 50 miles.
 - Proper function of squelch disable mode.
 - Check homing on No. 2. VHF-FM.
- A** 37. TACAN [AN/ARN-52(V)].
- Check I.D. signal.
 - Check bearing indication.
 - Switch function to T/R and check for absence of "OFF" flag and indication of distance to go in range window.
 - Check air-to-air DME functions.
- A** 38. IFF-SIF [AN/APX-64(V)].
- Check all modes.
- A** 39. Compass System (AN/ASN-75) Check.
- Check for agreement with magnetic compass on three cardinal headings.
 - Check reset capability by offsetting and recentering annunciator indicator.
- A** 40. HF Radio (AN/ARC-120).
- Transmission and reception for signal strength, speech quality, and noise in all three modes.
 - RF sensitivity control for proper operation.
 - Check frequency retuning for satisfactory performance.
- A** 41. FLIR/AVT (AN/AAS-37)
- Turn FLIR system ON. Check proper operation of indicator lights.
 - Check intensity of background and target display and focus of target display on video indicators.
 - Check proper function of FLIR modes of operation.
 - Perform BIT check of FLIR and AVT system.
 - Check that system control can be assumed by pilot when FLIR COMD switch is in WIDE or NARROW position.
 - Check via video indicator that FLIR turret goes to stowed position when MODE switch is in STBY.

DESCENT

- AB** 42. High-Speed Dive.
- In a dive, obtain 350 KIAS. Roll 60 degrees left and right with lateral control deflections no greater than one-half stick input to check stick force gradient.
 - Perform symmetrical pull-out at maximum allowable "g's" and check for airframe buffet. (Do not overtemp.)

LANDING

CAUTION

To preclude foreign object damage, the FLIR turret should be pointing forward on landing.

- A C** 43. Reverse Thrust—Check for rpm, torque effectiveness, and directional control.
- A** 44. Wheel Brakes—Check for equal pressure and effectiveness during taxi.
- A** 45. Nose Wheel Steering—Directional control during roll-out.

SECTION IV—FLIGHT CHARACTERISTICS

TABLE OF CONTENTS

Introduction	4-1	Spin Avoidance	4-5
Flight Control Characteristics	4-1	Spins	4-5
Flight Characteristics	4-2	Flight with External Stores	4-7
Normal Stalls	4-3	Single-engine Characteristics	4-7
Accelerated Stalls	4-3		
Stall Procedures	4-5		

INTRODUCTION

The unique design of the lateral control system, coupled with the conventional arrangement of the longitudinal and directional systems, provides for acceptable handling qualities throughout a wide range of airspeeds and configurations within operational center-of-gravity loadings. Control harmony is excellent and trim rates and limits are more than adequate for most flight conditions. The flight characteristics of this aircraft in general are similar to those of other straight-winged, conventionally controlled aircraft with the exception of high-speed rolling, sudden engine failure, and longitudinal oscillation characteristics.

FLIGHT CONTROL CHARACTERISTICS

LONGITUDINAL CONTROL CHARACTERISTICS

Longitudinal control is accomplished through conventional dual control sticks in the forward and aft cockpit which are connected by bellcranks, rods, and cables to two spring tabs in the trailing edge of the elevator. When the control stick is moved forward or aft, the elevator spring tabs (outboard) are mechanically positioned up or down proportionate to stick travel. These tabs act as aerodynamic boost surfaces utilizing airflow to position the elevator. Two geared tabs (inboard) are incorporated to provide aerodynamic boost. External counterweights are installed at the chordwise centerline of the upper and lower portions of the elevator leading edge for maneuvering balancing and a viscous damper is installed in the system to reduce longitudinal oscillations. At zero airspeed, the elevator system, including the control stick, rests in the position determined by the pitch trim setting. To move the spring tabs in this condition, the stick must be pulled or pushed far enough to drive the elevator to the surface travel limits. At this point, stick forces increase and further stick movement moves the spring tabs. With flight speed dynamic pressure loading, the spring tab/elevator sequence is reversed, making the stick operate the tabs initially and

operating the elevator directly when the tab spring force is overcome. The pitch trim system provides positive, stable elevator trim, permitting long-period stability for "hands-off" attitude control. Below 150 KIAS, pitch trim capacity is approximately 20 pounds stick force, nose up or nose down. Elevator travel is 35 degrees trailing edge up and 25 degrees trailing edge down. Spring tab travel is 28 degrees trailing edge down and 20 degrees trailing edge up.

LATERAL CONTROL SYSTEM

Lateral control is accomplished through an aileron-spoiler system. The control stick, located in the pilot's cockpit, is connected by bellcranks, rods, and cables to full-span spring tabs in the trailing edge of each aileron. The spoilers, consisting of four rotating spoiler plates located in each wing, are linked to the aileron and rotate out of the wing when the trailing edge of the respective aileron is deflected upward by stick movement. Under no-load conditions, the lateral control system presents an unfamiliar, "disconnected" feel. The force gradient with lateral movement of the stick is very light, control stick centering is totally absent, and no positive "neutral" point is apparent. As in the longitudinal system, the stick must be deflected laterally until the aileron travel limit is reached (approximately half stick) to move the spring tab under no-load conditions. A slight increase in force gradient is then felt and further stick movement moves the spring tabs. Flight dynamic pressure (speeds above 20 knots) loading reverses the tab/aileron sequence with stick movement initially moving the spring tab and driving the ailerons when full tab spring force is overcome. Proper operation of the lateral system is evident if the spoilers, which can be seen from the cockpit, operate (rotate upward) on the side toward which the stick is deflected. A spring between the tab linkage and aileron provides for positive force gradients and the ailerons are interconnected by cables and linkages to prevent up float and to assure synchronized action. The stick force

relief capacity of the lateral trim system is 5 pounds left or right. Maximum aileron travel is 25 degrees up or down.

and flap retraction are light and climb-out attitudes are easily maintained.

DIRECTIONAL CONTROL SYSTEM

Directional control is accomplished through rudders in the right- and left-hand vertical stabilizers that travel to a maximum of 25 degrees left or right. Crew member control is exercised through two conventional pedals in the forward and aft cockpits, connected by bellcranks, rods, and cables to the rudders. The left-hand pedal moves both rudders to a trailing edge left position, and the right-hand pedal moves both rudders to a trailing edge right position. The yaw trim system provides pedal force relief capacity of 85 pounds left or right.

FLIGHT CHARACTERISTICS

TAKE-OFF

Directional control is available almost immediately after initiation of ground roll as propeller wash covers nearly the entire span of both vertical stabilizers. Light brake application or nose wheel steering may be necessary for fine alignment adjustment below 20 knots.

Note

Nose wheel steering to the left is extremely weak and a slight amount of left brake may be required to achieve effective steering to the left.

Lateral control starts to become effective at 20 knots and longitudinal control is sufficient to rotate the aircraft 10 knots below the take-off speeds. Refer to Section XI, Part 2. With normal trim setting of 1/2 unit nose down, a slight positive stick force is required to rotate the aircraft to a normal take-off attitude. For maximum performance take-off, the control stick must be pulled full aft 5 knots below minimum take-off speeds. In crosswinds in excess of 10 knots, a pronounced up-wind wing rise is evident. Though lateral control is insufficient to maintain wings-level attitude until just prior to lift-off, directional control with rudders is more than adequate to maintain heading in crosswinds up to 20 knots. Rotational longitudinal control effectiveness is sensitive to center-of-gravity loadings with force requirements reducing as center-of-gravity location shifts aft; however, even at the aft service loading, longitudinal force requirements are sufficient to preclude unintentional overrotation. Trim requirements with gear

LOW-SPEED FLIGHT

The aircraft is responsive and maneuverable to near stalling speeds in all configurations and loadings. Though maneuvering stick force requirements are somewhat high below 140 KIAS with flaps up, maximum available load factors ("g's") are well within normal pilot capabilities. Lowering the flaps to T/O (20 degrees) reduces maneuvering stick force requirements, increases rate of turn, and reduces radius of turn providing an excellent reconnaissance or station keeping platform. Full flaps (40 degrees) allow for very slow airspeeds and minimum radius of turn. Care must be taken with light stick forces and slow acceleration characteristics which are associated with full flap operations. Refer to LANDING, in Section III, Part 3. Though yaw from roll becomes adverse below 140 KIAS, it is of small magnitude and easily countered with rudder at all flying speeds. Lateral response may appear sluggish until the pilot becomes familiar with aircraft handling characteristics. Lateral control effectiveness is adequate for all flight conditions. The aircraft is primarily a "tab-flow" platform; longitudinal and lateral control surfaces may be moved when tab limits are reached, the resultant increase in pitch or roll rate is negligible.

HIGH-SPEED FLIGHT

LONGITUDINAL

Steep, power-on dives from altitudes above 12,000 feet allow speeds near design limit to be attained. As speed increases, nose-up stick forces build up rapidly and maneuvering force requirements are greatly reduced. Due to this design characteristic, ensure that "g" limits during pullouts or pitch maneuvers at high airspeed are not exceeded. Stick forces are easily trimmed out throughout the flight envelope to near limit speed. On entry into turbulent air above 150 knots, a low-frequency vertical oscillation may be evident in the forward cockpit. This effect is due to natural flexing of the wing between the booms and the fuselage and is most noticeable between 200 and 210 knots.

LATERAL

Abrupt lateral control deflections, greater than one-half stick input, and bank angle changes of greater than 90 degrees are prohibited at airspeeds greater than the maximum attainable in level flight. Roll response increases greatly with increasing airspeed. At high speeds, steady-state roll rates of 128 degrees per second, can be attained. Abrupt rolling maneuvers (reversals) at high speeds cause fairly large sideslip angles to be generated on recovery. A moderate amount of favorable yaw (in the direction of the roll) exists above 160 knots.

WARNING

Rapid lateral cycling of the control stick at high speed may excite the aircraft natural frequency. One-half lateral stick deflections are restricted to no greater than 1 cps.

LATERAL-DIRECTIONAL

Abruptly executed rolling maneuvers at speeds below 150 KIAS generate a moderate amount of adverse yaw (away from the direction of roll). At speeds above 160 KIAS, yaw generated as a function of roll reverses to become favorable. Aircraft directional damping is somewhat weak and appears as a slight "Dutch-Roll" to the pilot. A yaw damper system is installed to reduce directional oscillations during air-to-ground weapons deliveries. With the yaw damper engaged, system signal inputs to the rudder will be felt at the rudder pedals. Approximately 100-pound pedal force is required to overcome yaw damper authority.

NORMAL STALLS

Though stall characteristics vary slightly with configuration and power, the stall itself is mild and recovery positive. Power-on stalls are characterized by high pitch angles (angles of attack up to 30 degrees), slight directional wandering, stick force lightening, random pitch oscillations, and increasing rate of sink. Airframe buffet is unnoticeable and rapid roll-off occurs at stall break.

Roll-off at stall is generally in the direction of the engine which is producing the least amount of torque. Lowering the flaps or reducing power increases the amount of airframe prestall vertical buffet and reduces roll-off rate at stall. Stick force lightening and directional wandering are apparent regardless of flap or power setting. At stall, the aircraft pitches down and rate of roll-off is dependent on yaw excursion rate accompanying the stall. Control may be regained at any point by relaxing control stick back pressure. A stall warning (pedal shaker) system provides warning 1 to 7 knots above stall.

WARNING

Stalls in the power approach configuration result in steep nose-down attitudes (up to 70 degrees) with airspeeds in excess of the flap limit speed and altitude loss up to 400 feet before recovery is effected.

Depending on power and aircraft configuration, the rudder pedal shaker is activated 1 to 7 knots above stall speed during normal 1-g stalls. Dependent on rate of entry, the pedal shaker may not activate prior to accelerated stall.

ACCELERATED STALLS

Accelerated stall warning is experienced in the form of buffet with severity and warning margin depending upon initial speed, "g" load, gross weight, and how rapidly "g" is applied. At stall, the aircraft usually pitches down and, as in normal stalls, rolls into the engine developing the lower torque. Directional oscillations prior to stall increase with higher flap settings. With full flaps (40 degrees), yaw excursions as great as 30 degrees have been noted.

Note

For stall speeds, see figures 4-1 and 11-49.

STALL SPEEDS

INDICATED AIRSPEED—KNOTS

POWER OFF

FLAPS	GROSS WEIGHT— POUNDS	ANGLE OF BANK—0° LOAD FACTOR—1.0		ANGLE OF BANK—30° LOAD FACTOR—1.2		ANGLE OF BANK—60° LOAD FACTOR—2.0	
		GEAR UP	GEAR DOWN	GEAR UP	GEAR DOWN	GEAR UP	GEAR DOWN
0°	10,000	84	91	90	98	119	129
	12,000	92	100	99	107	130	141
	14,000	99	109	106	117	140	154
20°	10,000	72	76	77	82	102	107
	12,000	85	88	91	95	120	125
	14,000	95	98	102	105	134	139
40°	10,000	68	68	73	73	96	96
	12,000	79	79	85	85	112	112
	14,000	90	90	97	97	127	127

POWER ON

0°	10,000	65	65	71	71	92	92
	12,000	76	76	83	83	107	107
	14,000	86	86	94	94	122	122
20°	10,000	55	55	60	60	78	78
	12,000	65	65	71	71	92	92
	14,000	73	73	79	79	103	103
40°	10,000	48	48	52	52	68	68
	12,000	59	59	63	63	84	84
	14,000	77	77	83	83	109	109

Figure 4-1

OV-10D-1-56A

STALL PROCEDURES

All stall maneuvers should be performed with the condition levers in the T.O./LAND position and be fully recovered by 4000 feet AGL. Prior to commencing any stall maneuvers, the pilot will ensure the area required to clear the maneuver is clear. All stall maneuvers should be approached with the thought in mind of minimizing altitude loss.

POWER ON

The power-on stall is accomplished at Military power by raising the nose 30 degrees above the horizon and holding this attitude until the stall. Recovery is effected by lowering the nose and raising the landing gear if extended.

POWER OFF

The power-off stall is accomplished with the power levers at FLIGHT IDLE by raising the nose 30 degrees above the horizon and holding this attitude until the stall. Recovery is effected by lowering the nose, applying Military power, and raising the landing gear if extended. This stall maneuver with a power-off recovery is accomplished by establishing a 130-knot descent with power set to simulate a flamed-out condition. Trim the aircraft for this attitude. Raise the nose 30 degrees above the horizon and hold this attitude until the stall. Recovery is effected by lowering the nose slightly below the 130-knot attitude. Maintain this attitude until regaining the 130-knot descent.

APPROACH TURN

The approach turn stall is accomplished in the normal landing configuration and power levers set at FLIGHT IDLE. Establish a wings-level descent at approach airspeed, determined by gross weight and trim aircraft for this attitude. Roll into a 30-degree angle of bank and raise the nose 10 degrees above the horizon. Hold this attitude until the stall. Recovery is effected by lowering the nose, applying Military power, leveling the wings, and raising the landing gear.

ACCELERATED

The accelerated stall is accomplished with flaps set at 20 degrees and power set as required to maintain 110 KIAS. Roll into 60-degree angle of bank and apply back stick until stall occurs. Recovery is effected by relaxing back pressure, applying Military power, and rolling to the wings-level attitude. High-speed accelerated stall can be accomplished in the same manner with the exception of an entry airspeed of 160 KIAS and flaps up.

SPIN AVOIDANCE

A spin requires the simultaneous achievement of stalled angle of attack and yaw. If either of these conditions is absent, the aircraft will not enter a spin. For erect stalls, angle-of-attack information is displayed on the angle-of-attack indicator and indirectly through the rudder pedal shaker. Maintaining angle of attack below 25 units or below that required to activate the rudder pedal shaker is an effective means of avoiding a stall. Maintaining zero sideslip is effected by keeping the ball of the turn-and-bank indicator centered.

SPINS

Note

Intentional spins in the OV-10D aircraft are prohibited.

Tests indicate that the aircraft is not prone to unintentional spins in symmetric power or pretrimmed asymmetric power configurations. However, the aircraft will spin easily from untrimmed asymmetric power configurations and will readily spin in any configuration provided pro-spin controls are applied and held. Recoveries are positive and rapid in all configurations. Positive application of the recommended recovery controls will produce the most consistent recovery characteristics. Simply releasing controls will effect recovery in most cases, but is not recommended because a developed spin mode does exist (asymmetric power-oscillatory mode) from which recovery cannot be effected using this method. Further, positive control action will preclude nonrecovery due to an inadvertent application of full nose-up trim during the spin.

ERECT SPINS

SYMMETRIC POWER

Symmetric power is defined as any combination of condition lever and/or power lever position that results in an indicated torque difference between engines of 150 foot-pounds or less. Elevator effectiveness is reduced at idle power settings and forward center-of-gravity positions. The aircraft is less prone to stall and spin under these conditions and attempted spin entry usually results in a diving spiral. However, normal center-of-gravity positions (25%–27% MAC) and low torque power settings are conditions from which spins are easily achieved.

There is a definite departure from controlled flight in a 1.0-g spin entry. The entry is characterized by little or no poststall gyration with the nose of the aircraft falling sharply through to 90 degrees (straight down) in one-half turn and then pitching up to 60 degrees (down) during the next one-half turn. Succeeding turns are characterized by steep nose-down attitudes, fast rotation rates about the roll axis, and considerable airframe buffet.

The spin will normally become steady-state within one and one-half to two and one-half turns. Lateral control opposite to spin direction (cross controls) applied concurrently with departure from controlled flight will often prevent the development of a spin by opposing the build-up of both yaw and roll. Aileron applied opposite to spin direction, once the spin has developed, has the effect of slowing the turn rate and flattening the pitch angle slightly. Aileron applied with the spin will increase turn rate to approximately 200 degrees per second. Turn rates of this magnitude are best described as "extremely fast" and multiturn spins can cause disorientation and dizziness. External stores can produce high yaw and turn rates (sometimes exceeding those obtainable in the clean configuration); however, overall spin and recovery characteristics are not appreciably altered with external stores. There is no tendency toward a flat spin mode. Spins entered from accelerated flight conditions are characterized by a sudden departure from controlled flight and a one and one-half to two and one-half turn snap roll. The nose falls through to a near vertical attitude and the ensuing spin closely resembles the spin resulting from a 1.0-g entry. Spins entered from vertical, climbing flight are characterized by tail-sliding (if zero airspeed is obtained) or rolling pitchover. Aerodynamic feedback in the control system is experienced during tailslide, but the pilot's counteracting force requirements are light. A typical erect spin results after one-half to one incipient-type turn. Altitude loss during the preceding spins varies between 300 and 700 feet per turn. Spins in the power approach configuration, with either 20- or 40-degree flap deflection, are much the same as the spins in the preceding description. The steep nose-down attitude that follows the first one-half turn will result in recovery airspeed approaching flap and landing gear limit. Spins in excess of one turn will likely result in limit speeds being exceeded during recovery. Altitude loss during recovery from landing gear and flaps down spins is approximately 2000 feet.

ASYMMETRIC POWER

Spins entered with a large asymmetric power condition result in large pitch oscillations and high turn rates. Spins with one engine at MIL and the other engine at IDLE power can become violent. Developed spins can occur under these conditions without application of pro-spin rudder. Departure from controlled flight is characterized by sudden yaw and roll into the inoperative engine. If pro-spin rudder is applied concurrently with this departure, the ensuing roll rate exceeds the turn rate to the extent that an apparent outside snap roll occurs with the nose passing vertically down, then returning

to level or above by the completion of one turn. This gyration resembles an oblique cartwheel. A sudden slowing of roll and pitch rate occurs in the second or third turn. This usually appears to the pilot as a momentary slowing and flattening of the spin. Very deep stall penetrations (70 degrees angle of attack or greater) can occur during the most violent of these spins. Yaw, roll, and pitch excursions are of such rate and amplitude that high "g" forces are exerted on the pilot's body and control placement requires considerable force. However, all asymmetric power spins do not develop to such violent proportions. Forward center-of-gravity positions, reduced asymmetric power, and internal fuel consumption (to reduce lateral moment of inertia) all have a moderating effect upon the spin. Nevertheless, it is important for the pilots to realize the magnitude that the gyrations can assume so that if a pilot should encounter such a spin, it can be recognized as a known aerodynamic characteristic and one from which recovery can be positively effected. Spins of this type can be easily avoided by flying in balanced flight when maneuvering with an inoperative engine and/or by quickly recovering from asymmetric power stalls.

ERECT SPIN RECOVERY

The spin recovery technique for all configurations is rudder opposite to spin direction, neutral aileron, neutral to slightly forward stick. (Neutral stick requires forward stick pressure due to the high "up" float forces on the elevator during the spin.) True spin direction is always indicated by the turn needle; therefore, the turn needle should be used as the primary instrument for determining spin direction. This is especially true if accurate outside visual cues are not available. Normally, control forces required for spin recovery are moderate. However, pilots must be aware that asymmetric power spins can sometimes produce deep stall penetrations which require strong forward stick pressure to ensure proper recovery control placement. The required forward stick force may reach 115 pounds and it is recommended that the pilot use both hands to position the stick in these cases. Improper recovery control placement during asymmetric power spins may significantly delay or entirely preclude spin recovery. Recovery in all configurations is positive with proper flight control placement. Asymmetric power spins usually require one and one-half turns for recovery, while symmetric power spins usually require only one-half turn to recover. The nose-down attitude will be steep and altitude loss from initiation of recovery controls to wings-level flight is approximately 2500 feet. Airspeed build-up during the dive recovery is rapid and significant "g" force is quickly available for pull-out.

Progressive stalls/spins will normally not be encountered. The aircraft will recover from all spins, with correct flight control placement, regardless of power control lever position (including asymmetric). However, power increases turn rate and altitude loss during the recovery dive. Power opposite to spin direction has very little effect once the spin has developed and, therefore, is of no value as a spin recovery technique. For standardization and simplification, it is recommended that the power control levers be placed in FLIGHT IDLE during recovery.

ERECT RECOVERY PROCEDURE

1. Power lever—FLIGHT IDLE.
2. Rudder—FULL AGAINST SPIN.
3. Elevator—NEUTRAL TO SLIGHTLY FORWARD.
4. Aileron—NEUTRAL.
5. Gear and flaps—UP.
6. When rotation ceases, neutralize rudder, allow build-up of airspeed, and effect pull-out.

INVERTED SPINS

Inverted spins from vertical or -1.0 -g flight conditions are characterized by the nose falling through to the 60-degree nose-down attitude as the aircraft rotates in the direction of applied rudder. The inverted spin has steady, moderate turn rates (100 degrees per second), nose-down attitudes of 40 to 70 degrees, and negative "g" ranging from -2.0 to $+1.0$ "g's." Altitude loss during inverted spins varies between 200 and 650 feet per turn.

INVERTED SPIN RECOVERY

Recovery procedure consists of opposite rudder (push the rudder in the direction it tends to go) and neutral stick. Recovery will be in a split "S" requiring 800 to 1500 feet from initiation of recovery controls to wings-level flight after recovery. It is recommended that both propellers be feathered immediately to prevent engine overtemperature. This action also places the aircraft in a known value of symmetrical thrust and allows straight forward recovery. Engines are restarted normally following recovery. This procedure of feathering engines to obtain known thrust values during spins is unorthodox, but not unsafe, provided the pilot is mentally ready to perform the proper restart procedures immediately upon recovery. The aircraft glides very well with a glide ratio equal to that of both engines providing 400- to 450-pound thrust symmetrically. The characteristics of the power plant system can cause high asymmetrical drag/thrust relationships between engines. Retarding the engine power levers to FLIGHT IDLE will usually cure the situation, but if the propeller governor senses a low oil pressure, the propeller may move toward the feathered position. With the engine still ignited, high drag will result on that side, thus feathering the propeller will protect the engine. In an inverted spin, it is

difficult for a pilot to monitor his engine instruments, and feathering both propellers, recovering, and restarting are recommended if altitude permits.

INVERTED SPIN PROCEDURE

1. Condition lever—FEATHER & FUEL SHUT-OFF.
2. Rudder—FULL AGAINST SPIN.
3. Stick—NEUTRAL.
4. Gear and flaps—UP.
5. When rotation ceases, neutralize rudder and effect pull-out.
6. Execute air start.

FLIGHT WITH EXTERNAL STORES

External stores effects, other than those of weight and drag are relatively slight. Large external loads result in decreased climb and cruise performance but no adverse rolling inertia or yaw characteristics are exhibited. Near-limit airspeed with an Aero 1C external fuel tank at the centerline station, speed warning in the form of moderate airframe buffet is noted.

SINGLE-ENGINE CHARACTERISTICS

ENGINE FAILURE

The aircraft power plant installation incorporates a negative torque sensing (NTS) feature in order to reduce propeller drag if engine failure occurs. The NTS system will drive the propeller to a near-feathered condition if a negative torque is applied to the engine by the propeller (loss of fuel, fuel control failure, etc). Provisions are not made for catastrophic failure of the propeller or gearbox. Engine failure characteristics in which NTS system is in operation are as follows:

1. Yaw excursion into the failed engine. The rate of this excursion is dependent on flight speed in relation to single-engine stall speed. The nearer to stall, the more rapid the excursion in yaw.
2. Rapid roll-off into the failed engine coupled with a rapid nose-down pitch movement.

Aircraft response to engine failure with the NTS system inoperative will greatly magnify the characteristics as previously described.

The minimum static airspeed (no yaw, pitch, or roll excursions) is nearly the same for the negative torque sensing condition as for the full feather condition; however,

the pilot should select the FEATHER & FUEL SHUT-OFF position of the condition lever once engine failure has been determined.

MINIMUM SINGLE-ENGINE CONTROL SPEED

The minimum single-engine control speed is that airspeed where sudden loss of one engine (NTS system operating) with maximum power on the operating engine, requires full lateral and directional control input to fly the aircraft in a straight path over the ground with wings level; however, the aircraft may descend. Slowing the aircraft 1 to 2 knots below this speed results in loss of directional control. This speed is essentially the same as the power-off stall speed. The minimum single-engine control speeds for various gross weights are shown in figures 11-50 and 11-51.

The minimum single-engine control speeds delineated were determined from a series of flight tests where full aileron and rudder were applied 1 second after simulated engine failure. As in any twin-engine conventional aircraft, yaw excursion following engine failure is the most important concern to the pilot. Though initial aircraft motion following engine failure may appear to the pilot as an uncontrollable excursion in roll, it must be remembered that the aircraft is, in fact, yawing and the RUDDER is the primary recovery control. It is important to increase airspeed which will result in more effective lateral-directional control power. As airspeed approaches stall speed, the violence and rapidity of the roll and yaw will increase and the aircraft may not be controllable with rudder and aileron inputs against the rolling tendency. The aircraft will roll into a spiral regardless of maximum control deflections. The proper corrective action to stop the roll in its incipient stages is to retard the power lever of the operable engine to attain a more nearly balanced thrust condition, lower the nose to attain a safe airspeed (altitude permitting), and reapply power on the operable engine.

MINIMUM SAFE SINGLE-ENGINE SPEED

The minimum safe single-engine speed is defined as that airspeed required to maintain wings level and a 100 fpm rate of climb with one engine at maximum power. This speed is a function of aircraft gross weight and outside air temperature. These speeds are depicted in figures 11-50 and 11-51. Numerous factors influence the aircraft's fly-away capability during single-engine operations. These include delay in reducing drag (such as failing to raise the gear or jettison the stores), inadvertently increasing drag by premature initiation of a climb or allowing airspeed to decrease below the minimum safe speed. Once the aircraft

is stabilized and trimmed, handling characteristics with one engine shut down and the propeller feathered are good. Exercise caution and carefully cross-check airspeed, vertical velocity, and altitude. The airspeed differential for rudder shaker operation may decrease to within 1 knot above stall speed.

WARNING

Should engine failure occur at or near stall speed, or if the aircraft is stalled during single-engine operation at altitudes below 1000 feet AGL, safe recovery may not be possible.

SINGLE-ENGINE HANDLING

Once the aircraft is stabilized and trimmed, handling characteristics with one engine shut down and the propeller feathered are good. Relatively high rates of descent may be generated, which are deceptive if the flight instruments are not cross-checked, particularly under conditions of poor visibility. Under these conditions, exercise caution and carefully cross-check airspeed, vertical velocity, and altitude. The airspeed differential for rudder shaker operation may decrease to within 1 knot above stall speed.

WARNING

Intentional single-engine proficiency maneuvers shall not be carried below 4000 feet terrain clearance. Such maneuvers conducted below single-engine minimum control speed may result in one-fourth to one-half turn incipient spins due to wing stall.

ANGLE-OF-ATTACK RELATIONSHIP

Figure 11-53 shows the relationship of aircraft angle of attack in degrees at the fuselage reference line and in units indicated angle of attack to gross weight, dive angle, and calibrated airspeed. By examining the angle-of-attack block, it is seen that the effects of power change (between cruise power and Military power) have a large effect on angle of attack.

SECTION V—EMERGENCY PROCEDURES**TABLE OF CONTENTS**

PART 1—GROUND EMERGENCIES	5-1	Cargo Bay Door Open in Flight	5-14
Introduction	5-2	Structural Damage/Control Malfunction	5-14
Fire	5-4	Emergency Jettison	5-14
Emergency Ground Egress	5-5		
PART 2—TAKE-OFF EMERGENCIES	5-7	PART 4—LANDING EMERGENCIES	5-15
Aborted Take-off (Two Engines)	5-7	Forced Landing	5-15
Engine Failure	5-7	Ditching (Water Landing).....	5-15
		Precautionary Approach	5-16
PART 3—IN-FLIGHT EMERGENCIES	5-9	Single-engine Landing.....	5-16
Engine Failure During Flight	5-9	Hydraulic System Failure	5-19
Electrical Fire	5-12	Tire Failures	5-19
Fuel System Failures	5-12	Unsafe Landing Gear	5-19
Electrical System Failures	5-13	Wheel Brake Failure	5-20
Trim Systems Failures	5-13	Emergency Rescue	5-20
Landing Gear Emergency Extension	5-14	PART 5—EJECTION	5-23
Canopy Open in Flight	5-14	Ejection	5-23
		Survival Equipment	5-23

PART 1 — GROUND EMERGENCIES**INTRODUCTION**

The procedures contained in this section are considered best for handling various emergencies that may be expected to occur. Only single failures are considered; however, each failure presents a different problem. A thorough knowledge of these procedures will better equip you to handle emergencies. Even though the procedures are considered to be the best possible, sound judgment must be used when confronted with multiple emergencies, adverse weather, low altitudes, etc. The recommended procedures in this section are meant to cover actions to be taken by the **PILOT ONLY**. Under most conditions, the trained observer or copilot may be expected to offer assistance in radio coordination, check-list reading, or other such assistance as the pilot may require.

The pilot's and observer's warning and caution lights (figures 5-1 and 5-2) will aid in determining the nature of the equipment malfunction.

SPECIAL INSTRUCTIONS

The following terms indicate the degree of urgency in landing the aircraft.

1. Land immediately—Self explanatory.
2. Land as soon as possible—Means land at the first site at which a safe landing can be made.
3. Land as soon as practicable—Means extended flight is not recommended. The landing site and duration of flight is at the discretion of the pilot in command.

Procedures with an asterisk (*) before each step are considered critical action and must be performed immediately without reference to the checklist if the emergency is not to be aggravated, and injury or damage is to be avoided. Procedures appearing without an asterisk (*) are noncritical and reference to the checklist is recommended.

PILOT'S WARNING AND CAUTION LIGHTS

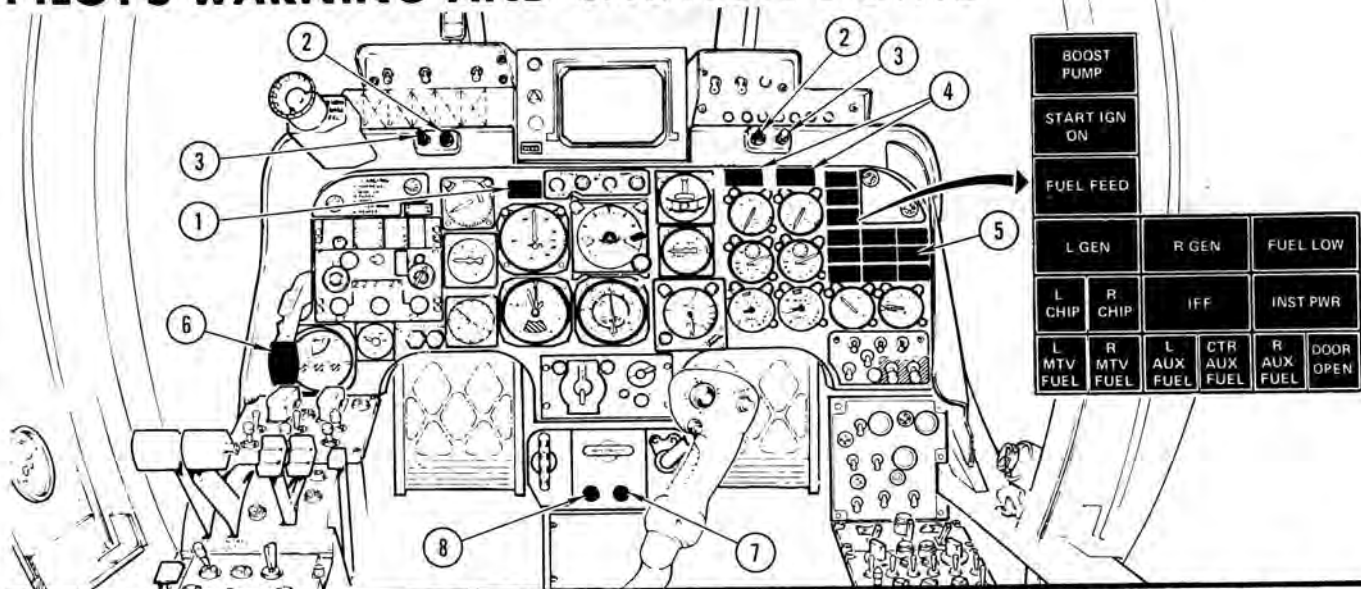

LIGHT	COLOR	CONDITION	CORRECTIVE ACTION
1. WHEELS WARNING (0)	RED (FLASHING)	ANY GEAR NOT EXTENDED AND LOCKED, EITHER CONDITION LEVER AT T.O./LAND AND: 1. POWER LEVERS RETARDED, OR 2. FLAPS 30 DEGREES OR MORE	ADVISORY
2. OVERTEMP WARNING	RED	ENGINE TURBINE INLET TEMPERATURE ABOVE 1125°(+4°/-0°)C	REDUCE POWER UNTIL TIT IS WITHIN LIMITS
3. OVERTORQUE CAUTION	AMBER	ENGINE TORQUE ABOVE 3282 POUND-FEET	RETARD POWER UNTIL TORQUE IS WITHIN LIMITS
4. FIRE WARNING (0)	RED	OVERHEAT OR FIRE IN NACELLE.	EXECUTE EMERGENCY PROCEDURE
5. WARNING AND CAUTION LIGHTS FUEL FEED WARNING (0)	RED	LESS THAN 50 POUNDS FUEL IN FEED TANK	EXECUTE EMERGENCY PROCEDURE
L CHIP, R CHIP CAUTION	AMBER	IRON-METALLIC PARTICLES ON CHIP DETECTOR	EXECUTE EMERGENCY PROCEDURE
BOOST PUMP CAUTION	AMBER	LOSS OF BOOST PUMP PRESSURE	EXECUTE EMERGENCY PROCEDURE
START IGN ON CAUTION	AMBER	EITHER ENGINE STARTER OR IGNITION OPERATING	ADVISORY
L GEN, R GEN CAUTION	AMBER	GENERATOR OFF LINE	EXECUTE EMERGENCY PROCEDURE
FUEL LOW CAUTION (0)	AMBER	LESS THAN 220 (±15) POUNDS FUEL REMAINING IN CENTER TANK	EXECUTE EMERGENCY PROCEDURE
INST PWR CAUTION	AMBER	PRIMARY A-C BUS POWER FAILURE	EXECUTE EMERGENCY PROCEDURE
L MOTIVE FUEL, R MOTIVE FUEL	AMBER	FUEL TRANSFER PRESSURE (MOTIVE FLOW OUTPUT) LOW	EXECUTE EMERGENCY PROCEDURE
L AUX FUEL, CTR AUX FUEL R AUX FUEL	AMBER	NO AUXILIARY FUEL TRANSFER	EXECUTE EMERGENCY PROCEDURE
IFF CAUTION	AMBER	MODE 4 INTERROGATIONS RECEIVED BUT REPLIES NOT GENERATED	ADVISORY
DOOR OPEN	AMBER	CARGO BAY DOOR NOT CLOSED AND LATCHED	ENSURE DOOR IS CLOSED AND LATCHED PRIOR TO TAXI
6. LANDING GEAR UNSAFE PILOT'S GEAR HANDLE	RED	GEAR NOT LOCKED IN SELECTED POSITION	RECHECK GEAR
7. HYDRAULIC PRESSURE	AMBER	LESS THAN 200 PSI ON DEMAND	ADVISORY
8. HYDRAULIC PUMP	GREEN	HYDRAULIC PUMP OPERATING	ADVISORY

0 = INSTALLED IN OBSERVER'S COCKPIT

OV-10D-1-5H

Figure 5-1

OBSERVER'S WARNING AND CAUTION LIGHTS

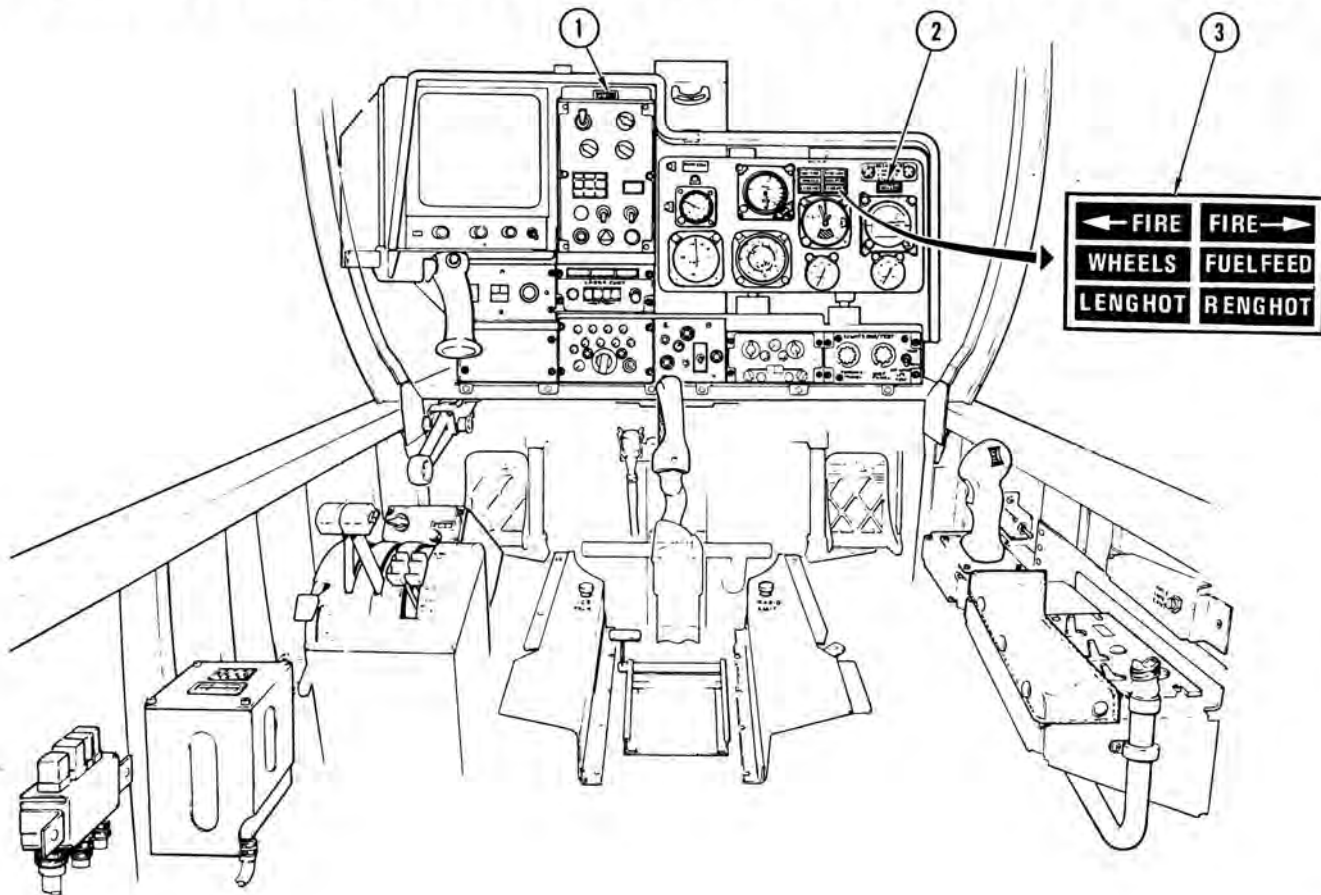

LIGHT	COLOR	CONDITION	CORRECTIVE ACTION
1. PILOT CONTROL	GREEN	PILOT HAS CONTROL OF FLIR SYSTEM	ADVISORY
2. FUEL LOW CAUTION (P)	AMBER	LESS THAN 220 (±15) POUNDS REMAINING IN CENTER TANK	EXECUTE EMERGENCY PROCEDURE
3. WARNING LIGHTS			
FIRE WARNING (P)	RED	OVERHEAT OR FIRE IN NACELLE	EXECUTE EMERGENCY PROCEDURE
WHEELS WARNING (P)	RED (FLASHING)	ANY GEAR NOT EXTENDED AND LOCKED, EITHER CONDITION LEVER AT T.O./LAND AND: 1. POWER LEVERS RETARDED, OR 2. FLAPS 30 DEGREES OR MORE	ADVISORY
FUEL FEED WARNING (P)	RED	LESS THAN 50 POUNDS FUEL IN FEED TANK	EXECUTE EMERGENCY PROCEDURE
OVERTEMP WARNING (P)	RED	ENGINE TURBINE INLET TEMPERATURE ABOVE 1125° (+4°/-0°)C	REDUCE POWER UNTIL TEMPERATURE IS WITHIN LIMITS

P = ALSO INSTALLED IN PILOT'S COCKPIT

OV-10D-1-26B

Figure 5-2

FIRE

ENGINE FIRE ON START/HOT START

An engine fire/hot start will be indicated by an excessive EGT beyond limits. Proceed as follows:

- * 1. Condition lever—FUEL SHUT-OFF.
- * 2. FUEL EMERG SHUT OFF switch—SHUT OFF.
- * 3. AIR START switch—CRANK.
4. If fire persists, call for fire fighting assistance.
- * 5. START switch—ABORT.
6. AIR START switch—RELEASE.

CAUTION

It is imperative that the START switch be moved to ABORT prior to release of the AIRSTART switch. If these steps are reversed, the start cycle will be momentarily reinitiated introducing ignition and start fuel into the combustion chamber increasing the probability of residual fire.

7. BATTERY switch—OFF.
8. External power—DISCONNECT, if used.
9. Abandon aircraft. (Refer to EMERGENCY GROUND EGRESS.)

EXTERNAL ELECTRICAL POWER APPLIED FOR START

If external power unit fails when initiating start, over-temperature could occur. Proceed as follows:

- * 1. Condition lever—FUEL SHUT-OFF.
- * 2. FUEL EMERG SHUT OFF switch—SHUT OFF.
- * 3. Signal ground crew to disconnect external power cables.
- * 4. AIR START switch—HOLD IN CRANK.
- * 5. START switch—ABORT.
6. AIR START switch—RELEASE.

CAUTION

It is imperative that the START switch be moved to ABORT prior to release of the AIR START switch. If these steps are reversed, the start cycle will be momentarily reinitiated, introducing ignition and start fuel into the combustion chamber increasing the probability of residual fire.

7. BATTERY switch—OFF.
8. Abandon aircraft. (Refer to EMERGENCY GROUND EGRESS.)

ENGINE NACELLE FIRE

An engine nacelle fire will be indicated by a nacelle fire warning light.

- * 1. Condition lever—FEATHER & FUEL SHUT-OFF.
- * 2. FUEL EMERG SHUT OFF switch—SHUT OFF.
3. START switch—ABORT (when starting).
4. BATTERY switch—OFF.
5. Abandon aircraft. (Refer to EMERGENCY GROUND EGRESS.)

WARNING

Placing the condition lever in the FEATHER & FUEL SHUT-OFF position prior to having taken the propeller off the "start locks" will NOT feather the propeller. It will continue to windmill as after a normal shutdown. Therefore, extreme caution should be used in executing emergency ground egress procedures.

ENGINE FIRE ON SHUTDOWN (PROPELLERS UNFEATHERED)

- * 1. Condition lever—FUEL SHUT-OFF.
- * 2. FUEL EMERG SHUT OFF switch—SHUT OFF.
3. BATTERY switch—ON.
4. AIR START switch—HOLD IN CRANK.
5. START switch—START.
6. Power lever—GROUND START.

CAUTION

Starter limits should not be exceeded.

7. If fire persists, call for fire fighting assistance.
8. START switch—ABORT.
9. AIR START switch—RELEASE.
10. BATTERY switch—OFF.
11. Abandon aircraft. (Refer to EMERGENCY GROUND EGRESS.)

ENGINE FIRE ON SHUTDOWN (PROPELLERS FEATHERED)

During engine shutdown, inadvertently placing the condition levers to FEATHER & FUEL SHUT-OFF instead of FUEL SHUT-OFF, may cause an internal fire as a result of raw fuel having been dumped into the hot combustion chamber from the fuel control. If fire results, proceed as follows:

1. Propellers—CLEAR.
2. BATTERY switch—ON.
3. Fuel emergency shut-off switch—SHUT-OFF.
4. Power levers—FULL REVERSE.
5. Condition levers—FUEL SHUT-OFF.
6. AIR START switch—HOLD IN CRANK.

CAUTION

It is imperative that the AIRSTART switch be held in the CRANK position before the START switch is moved to START to ensure that ignition and start fuel are not momentarily activated.

7. Power levers—GROUND IDLE (when blades are unfeathered).
8. START switch—START.

CAUTION

Starter limits should not be exceeded.

9. Crank engine(s) until fire is blown out; if fire persists, call for fire fighting assistance.
10. START switch—ABORT.
11. AIR START switch—RELEASE.

CAUTION

The START switch must be moved to ABORT prior to releasing the AIRSTART switch to prevent momentary reactivation of the normal start sequence.

12. BATTERY switch—OFF.

13. Abandon aircraft. (Refer to EMERGENCY GROUND EGRESS.)

EMERGENCY GROUND EGRESS

Should emergency ground egress become necessary, install seat pin if time permits. Retain helmet and exit by the right canopy door if possible. Egress while propellers are rotating is not recommended.

1. Condition levers — FEATHER & FUEL SHUT-OFF.
2. Lap belt—OPEN.
3. Survival kit fittings—RELEASE.
4. Riser attach fittings—RELEASE.
5. Personal leads — DISCONNECT (if time permits).
6. Canopy—OPEN.
7. Abandon aircraft.

WARNING

Placing the condition lever in FEATHER & FUEL SHUT-OFF position prior to having taken the propeller off the "start locks" will NOT feather the propeller. It will continue to windmill as after a normal shutdown. Therefore, extreme caution should be used in executing emergency ground egress procedures.

PART 2—TAKE-OFF EMERGENCIES

ABORTED TAKE-OFF (TWO ENGINES)

The procedure required for aborting a take-off is basically the same for any emergency except on failure of an engine. Proceed as follows for any emergency requiring abort not involving failure of an engine:

1. Power levers—REVERSE THRUST RANGE, as required.
2. Brakes—APPLY, as required.

CAUTION

If fire is involved, shut down engines as soon as the aircraft is under complete control and stopping is no longer a problem.

3. If unable to stop on runway, condition lever—FEATHER & FUEL SHUT-OFF.
4. FUEL EMERG SHUT OFF switches—SHUT OFF.
5. BATTERY switch—OFF.

ENGINE FAILURE

Engine failures fall into two main categories: those which occur instantly and those which give ample warning. Instant failures are most often encountered and usually occur on sudden complete mechanical malfunctions such as propeller shaft failure, fuel control failure, engine fuel pump shaft failure, or turbine wheel failure. Some engine failures are gradual, giving the pilot time to take corrective action before complete failure occurs. Sudden engine vibration, sudden or uncontrollable rise in temperature, propeller overspeed, or flame-out with loss of torque are typical indications of failure.

ENGINE FAILURE/GROSS POWER LOSS DURING TAKE-OFF ROLL

If engine failure/gross power loss occurs at any time during take-off roll, the take-off must be aborted, since it is impossible to take off fly away single engine at most operating gross weights. If failure occurs above refusal speed for runway length and take-off cannot be aborted safely, due to obstructions or other factors, immediate ejection is recommended. The pilot shall refer to Section XI, Part 6, during mission planning.

ABORTED TAKE-OFF (ONE ENGINE)

Aborting a take-off run at near lift-off speed presents a different problem than that posed by a two-engine abort. Single-engine reverse thrust is not usable except under optimum conditions on a hard-surface runway. Low power reverse thrust used carefully on the operating engine may prove effective, only if surface condition provides sufficient braking coefficient to prevent skidding of the opposing wheel. At speeds above approximately 80 knots, the use of opposing brake can easily result in a blown tire. In a typical aborted take-off, following one engine failure, use a combination of single-engine reverse thrust, flaps up, brakes, and nose wheel steering to maintain directional control and to stop the aircraft. Nose wheel steering may prove only marginally effective. Use rudder and brakes as required.

WARNING

Manually jettisoning external stores should be considered a last resort procedure, as stores/nose wheel interference is a definite possibility.

ENGINE FAILURE/FIRE AFTER TAKE-OFF

Should an engine failure occur immediately after take-off, the aircraft will yaw and roll rapidly into the failed engine. Immediately apply FULL RUDDER and FULL AILERON to level the wings. (A reduction of power on the operating engine may be necessary.) The best possible course of action, runway/terrain and/or aircraft control permitting, is to re-land the aircraft if the gear is down. If any of these conditions cannot be met, eject immediately. If the engine failure occurs after gear retraction has been initiated, the best possible course of action, aircraft control permitting, is to fly away. The external stores must be jettisoned IMMEDIATELY to ensure a fly-away capability. In the event of a fire, if airspeed is critical and a gross loss of power is not evident, the pilot may elect to maintain maximum power on both engines until a safe single-engine airspeed is attained. In either situation, a failure or fire, a premature climb will result in a loss of airspeed and significantly degrade aircraft controllability.

During mission planning, the pilot shall compute his minimum single-engine control speed and that airspeed required to maintain level flight. Refer to MINIMUM SINGLE-ENGINE CONTROL AND FLYAWAY SPEEDS charts, in Section XI, Part 6.

WARNING

If, for any reason, a safe recovery cannot be made, or if a fire is accompanied by a gross loss of power, EJECT IMMEDIATELY.

- * 1. Landing gear—UP.
- * 2. Maintain minimum safe single-engine speed.
- * 3. External stores—JETTISON, if necessary.
- * 4. Engine condition lever—FEATHER & FUEL SHUT OFF (affected engine).
- * 5. FUEL EMERG SHUT OFF switch—SHUT OFF (affected engine).
- 6. FLAP handle—UP, as desired (above 110 KIAS).
- 7. If fire goes out, land as soon as practicable.
- 8. If fire persists—EJECT.

CAUTION

Operate both power levers together in order to actuate WHEELS warning light.

Note

- When all obstructions have been cleared, accelerate to the best climb speed. Before making any turns, conditions permitting, climb straight ahead to a minimum of 1000 feet AGL and accelerate to at least 120 knots. All turns should be made using shallow bank angles. If possible, all turns should be made into the operating engine. Once positive aircraft control is established, control pressures should be trimmed out to assist in maintaining coordinated flight.
- Prior to maneuvering for final approach the rudder trim should be reduced to near neutral. This is accomplished by trimming until the trim neutral light illuminates or by observing rudder pedal

position. Failure to neutralize rudder trim will induce adverse yaw tendencies as power is reduced for touchdown and roll-out.

NOSE TIRE FAILURE ON TAKE-OFF

If a nose tire fails early in the take-off run, take-off should be aborted, using differential reverse thrust and light wheel braking as required for directional control. Reverse thrust will act to lighten loads on the nose gear at low speed.

CAUTION

Leave the gear extended after take-off to prevent possible gear well damage and to permit a prelanding visual inspection.

MAIN TIRE FAILURE ON TAKE-OFF

If a main tire fails early in the take-off run, abort take-off, using differential reverse thrust and nose wheel steering as required. If a main tire fails just prior to lift-off, it may be desirable to continue take-off in order to stop the aircraft at reduced weight on a subsequent landing.

CAUTION

When take-off is continued, leave the gear extended to prevent possible wheel well damage and to provide prelanding visual inspection.

WARNING

Left main tire failure may result in damage to the ground safety switch linkage. This damage may cause loss of NOSE WHEEL STEERING and the POWER LEVER GATE SOLENOID. In this event, use of reverse thrust can only be gained by lifting the throttles approximately 1/4 inch to bypass the reverse gate (solenoid) to apply reverse thrust. Directional control may then be maintained by use of flight controls, differential braking, and differential reverse thrust. (Nose wheel steering will not be available.)

PART 3 — IN-FLIGHT EMERGENCIES**ENGINE FAILURE DURING FLIGHT**

Should an engine fail during flight, proceed as follows:

1. Determine which engine has failed.
The aircraft will roll and yaw into the failed engine. Check engine instruments and rudder pressure to determine definitely which engine failed.
2. Operative engine power lever—AS REQUIRED.
Maintain minimum safe single-engine speed.
3. Landing gear—UP.
4. Flaps—UP (minimum 110 KIAS).
5. External stores—JETTISON, if necessary.

Note

For optimum rate-of-climb performance, allow shallow angle of bank into the good engine and maintain zero sideslip.

6. Condition lever—FEATHER & FUEL SHUT-OFF (affected engine).
The feathered propeller may rotate slowly.
7. Attempt air starts (if applicable).
8. Land as soon as practicable.

Note

If mechanical malfunction is apparent, do not attempt air start of failed engine. Turn FUEL EMERG SHUT OFF switch to SHUT OFF position (failed side only).

ENGINE FAILURE BELOW MINIMUM SINGLE-ENGINE CONTROL SPEED

As airspeed approaches minimum control speed, the violence and rapidity of the roll and yaw will increase. Below minimum control speed, aircraft will not be controllable with rudder and aileron inputs against the

rolling tendency. The aircraft will roll into a spiral in spite of maximum control deflections. The proper corrective actions to regain control are as follows:

1. Retard power lever on operable engine to obtain a more nearly balanced thrust condition.
2. Lower nose of the aircraft to obtain a safe air-speed (altitude permitting); otherwise EJECT.
3. Reapply power on operable engine.

FAILURE OF BOTH ENGINES IN FLIGHT

Simultaneous failure of both engines is rarely encountered. Should such a condition occur at low altitude, EJECT. If altitude permits, proceed as follows:

1. Maintain 130 KIAS.
2. Fuel quantity — CHECK.
3. Attempt air starts.

WARNING

If air starts cannot be obtained and optimum forced landing is not feasible, EJECT.

Note

- Engines may be started simultaneously.
- External fuel cannot be transferred in flight without generator power.

MAXIMUM GLIDE

The maximum glide distances available with both propellers feathered are shown in figure 5-3. These distances are obtained under no-wind conditions by maintaining 130 KIAS. At an aircraft gross weight of 11,000 to 12,000 pounds (flaps and gear up with no external stores) a glide

GLIDE DISTANCE

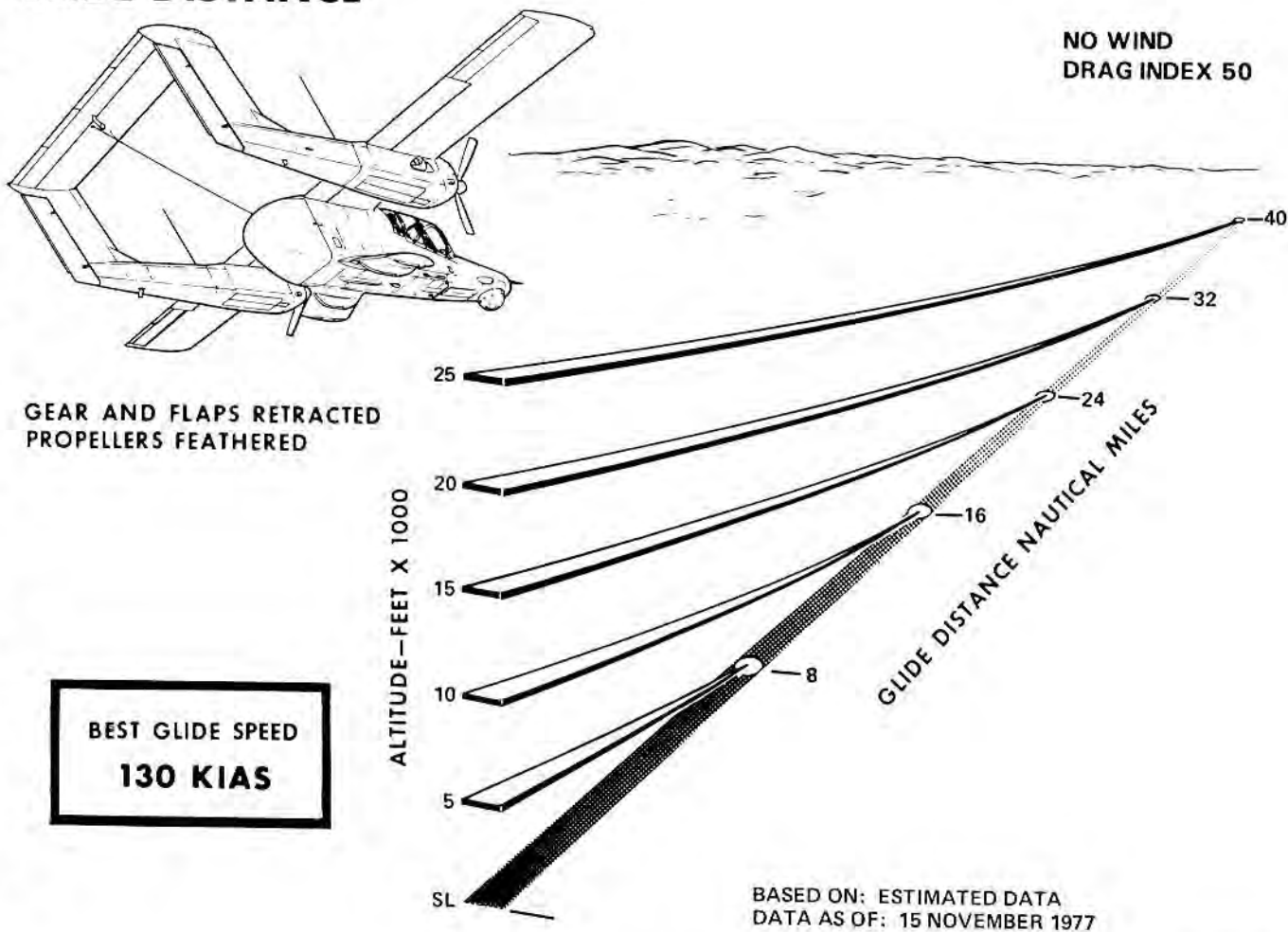

Figure 5-3

OV-10D-1-63A

distance of 8.2 nautical miles per 5000 feet of altitude can be expected.

ENGINE AIR START

Air starts may be obtained below 20,000 feet over a wide range of airspeeds.

1. FUEL EMERG SHUT OFF switch—NORM.
2. Condition lever—FUEL SHUT-OFF.
3. Power lever—FLIGHT IDLE.

4. AIR START switch—ON.
Check START IGN ON light ON. Monitor EGT.

CAUTION

The prop will slowly accelerate. Do not move condition lever to NORMAL FLIGHT with less than 10% rpm if time and altitude permit. If necessary, increase airspeed. At very low altitude and airspeed, move condition lever to NORMAL FLIGHT on propeller rotation.

5. Condition lever—NORMAL FLIGHT AT 10% RPM.

Note

Light-off is primarily noted by a rise in EGT.

6. AIR START switch—AUTO ABOVE 50% RPM.
Monitor TIT.
7. Power lever—ADJUST.

CAUTION

The ignition system is not continuous duty.
Limits: 2 minutes ON, 3 minutes OFF, 2 minutes ON, and 23 minutes OFF.

UNSUCCESSFUL AIR START

In the event of an unsuccessful air start attempt, proceed as follows:

1. Condition lever—FEATHER & FUEL SHUT-OFF.
2. AIR START switch—AUTO.
Check START IGN ON light OFF.
3. FUEL EMERG SHUT OFF switch—SHUT OFF.
4. Power lever—AS DESIRED (affected engine).

OIL SYSTEM FAILURE

Impending failure of an engine oil system may be indicated by fluctuating and/or abnormal oil pressure, accompanied by surges in engine rpm and torque. Should impending failure of an oil system be suspected, the affected engine should be shut down as soon as possible. Loss of oil pressure eventually results in initiation of automatic feathering of the propeller accompanied by uncontrolled rise in temperature. Intentionally retarding the condition lever to FEATHER & FUEL SHUT-OFF provides an earlier and a smoother propeller feathering drag transient than that produced by the torque sensing system. If oil system failure occurs, proceed as follows:

1. Condition lever — FEATHER & FUEL SHUT-OFF.
2. FUEL EMERG SHUT OFF switch—SHUT OFF.
3. Power lever—AS DESIRED.
4. Land as soon as practicable.

Note

- Slight engine surge may be the result of air in the oil system rather than an indication of impending engine failure. Feathering the affected engine will allow trapped air to escape and usually results in normal engine operation after air start.
- During single-engine operations, place failed engine power lever in the FLIGHT IDLE position, or operate the power levers simultaneously to ensure WHEELS warning light capability.

HIGH OIL PRESSURE (ABOVE 120 PSI)

1. Condition levers—NORMAL FLIGHT.
2. Power lever—RETARD (affected engine).
Reduce engine rpm in an attempt to reduce oil pressure below 120 psi.
3. Land as soon as practicable.

CAUTION

With high oil pressure and other abnormal engine indications, secure engine.

CHIP DETECTOR CAUTION LIGHT ILLUMINATION

If chip detector caution light illuminates:

1. Check engine instruments for abnormal indication.
2. If abnormal, secure the engine.
3. If abnormal indications not present, continue to monitor engine instruments.
4. Land as soon as practicable.

ENGINE/NACELLE FIRE

Should a FIRE warning light and/or other evidence of fire be noted in flight, proceed as follows:

- * 1. Condition lever—FEATHER & FUEL SHUT-OFF (affected engine).
- * 2. FUEL EMERG SHUT OFF switch—SHUT OFF (affected engine).
3. External stores—JETTISON, as required.
4. If fire is extinguished—LAND AS SOON AS PRACTICABLE.
5. If fire persists—EJECT.

Note

Gear and flaps may have to be retracted to maintain minimum safe single-engine speed; however, if conditions permit, putting the gear down may preclude further damage by the tire exploding in the nacelle.

ELECTRICAL FIRE

Circuit breakers and fuses isolate most electrical circuits, automatically interrupting power to prevent fire in the event of a short circuit. If electrical fire does occur, usually accompanied by acrid fumes, ozone smell, and smoke, proceed as follows:

1. Generator switches (L GEN, R GEN)—TRIP.
2. Bleed Air switch—EMERG OFF.
3. BATTERY switch—OFF.
4. RAM AIR knob—PULL FULL OUT.
5. Oxygen diluter lever—100% OXYGEN (P,O).
6. All electrical equipment—OFF.
7. BATTERY switch—ON.
8. Generator switches (L GEN, R GEN)—RESET, separately.
9. Voltammeter—CHECK.
10. Isolate defective equipment.
Turn on individually, checking for high-load indication.
11. Defective equipment—OFF.
12. Land as soon as practicable.

ELIMINATION OF SMOKE OR FUMES

If smoke or fuel fumes enter the cockpit, proceed as follows:

1. Oxygen diluter lever—100% OXYGEN (P,O).
2. BLEED AIR switches—EMERG OFF.
3. RAM AIR knob—PULL, as desired.
4. Cockpit air vents—OPEN.
5. CKPT AIR/DEFR knob—AS REQUIRED.
6. All nonessential electrical equipment—OFF.
7. Land as soon as practicable.

FUEL SYSTEM FAILURES

BOOST PUMP CAUTION

Illumination of the boost pump caution light indicates reduced output of the center tank fuel boost pump. Should this light come on, proceed as follows:

1. GAGE SEL switch—FEED.

2. Maintain internal tanks near full with auxiliary tank fuel transfer, if available.
3. If necessary, reduce altitude, and maintain at least 90% rpm to retain motive flow pressure (L MTV FUEL R MTV FUEL lights out).
4. Plan to land before feed tank quantity reaches FUEL FEED warning, regardless of total fuel on board.

FUEL FEED WARNING

Illumination of the FUEL FEED warning light indicates that the level of fuel in the engine feed tank has dropped to approximately 50 pounds (approximately 5 minutes of flight), and may indicate that only this amount of fuel is usable before flame-out will occur. Should the FUEL FEED warning light illuminate, proceed as follows:

1. Power levers—RETARD to minimum practical torque, and reduce speed to obtain a nose-high attitude.
2. EXT FUEL TRANS switches—ON, if applicable.
3. Check INT tank gage periodically; if available, assist internal fuel transfer with alternating wing down maneuvers.
4. Remain at current altitude until a suitable landing area is accessible.
5. Land as soon as possible, using a precautionary approach pattern.
6. Monitor feed tank quantity, and prepare for possible complete power failure.

MTV FUEL CAUTION

Illumination of a motive fuel flow caution light indicates reduced output at the respective engine fuel pump. Should one or both lights come on with pump failure, proceed as follows:

1. GAGE SEL switch—FEED.
2. Maintain at least 90% rpm, and transfer auxiliary tank fuel, if applicable.
3. Plan to land before feed tank quantity reaches FUEL FEED warning, regardless of total fuel on board.

Note

If gravity transfer rate is insufficient, descend to lower altitude.

**AUXILIARY FUEL TANK
TRANSFER FAILURE**

Malfunction of the electrical transfer pump is indicated by illumination of an AUX FUEL caution light. If this occurs while external fuel transfer is in progress, automatic pump shutoff by the fuel flow sensing switch may have resulted from full internal wing tanks, or a steep, nose-down attitude for more than 10 seconds. The probability of regaining auxiliary fuel transfer is improved if a descent to below 8000 feet is practicable. Proceed as follows:

1. Affected EXT FUEL TRANS switch—OFF.
2. After a minimum of 60 seconds, EXT FUEL TRANS switch—ON.
3. Maintain straight and level flight for 10 to 60 seconds, until AUX FUEL caution light goes out.
4. If unsuccessful after several recycling attempts (external fuel is not recoverable from the affected tanks), consider straight-in approach at 100 KIAS for asymmetric wing loading, or jettisoning both external wing tanks by depressing STORES EMER REL button (150 KIAS).

ELECTRICAL SYSTEM FAILURES**BATTERY CHECK**

- Pilots should monitor the ammeter indication at least every 15 minutes while in flight. Normally the total ampere load with all electrical equipment operating is less than 200 amperes. If the pilot observes readings in excess of 200 amperes, he should immediately secure the battery switch to determine if the batteries are the cause of the abnormally high load. If so, the battery switch should be left OFF and the aircraft landed as soon as practicable.

Note

Turning the battery off will result in no EGT/TIT and unreliable oil pressure indication.

GENERATOR FAILURE

Should one generator fail, the applicable GEN caution light will illuminate, and, on selection of the applicable ammeter select (AM SEL) switch position, the voltammeter reads 0 amperes. In this case, all electrical loads are being supplied by the remaining generator. In the event of a generator failure, proceed as follows:

1. Applicable GEN switch — RESET.
2. If reset does not occur, select TRIP, then RESET.
3. If failed generator will not reset, continue mission at pilot's discretion.
4. FLIR SYSTEM—OFF. (Unless Required for Mission). (to preclude unnecessary load on single generator)

BOTH GENERATORS OUT

Failure of both generators is a rare occurrence. Should failure of both generators occur, all equipment serviced by the monitor buses is deenergized and all power is provided by the batteries and the No. 1 inverter. Proceed as follows:

1. All unnecessary electrical equipment — OFF.
2. GEN switches — RESET.
3. If reset does not occur, select TRIP, then RESET.
4. BATTERY switch — EMERG, as required.
Prior to landing, select EMERG to recover secondary bus powered equipment.
5. Land as soon as practicable.

Note

Placing the landing gear handle in the down position also restores secondary bus power.

INSTRUMENT POWER FAILURE

Failure of the primary a-c bus is indicated by illumination of the INST PWR caution light. Should the INST PWR caution light illuminate, proceed as follows:

1. INST PWR switch — INV NO. 2.

Note

Failure of the No. 2 inverter results in loss of TACAN and illumination of the INST PWR caution light on selection of INV NO. 2.

TRIM SYSTEMS FAILURES**NORMAL FAILURE**

Failure or runaway of a normal trim system (pitch, roll, or rudder) requires that the ALT position of the TRIM SELECT switch be selected, and that only the alternate trim switches be used. Should trim failure be encountered, proceed as follows:

1. TRIM SELECT switch — ALT.
2. Alternate trim switches — TRIM, as required.

NORMAL AND ALTERNATE PITCH TRIM FAILURE

If failure of both the normal and alternate pitch trim systems occurs, proceed as follows:

1. With full nose-up failure, land with 0 degrees flaps.
2. With full nose-down failure, land with 40 degrees flaps.
3. With neutral failure, use normal landing procedure.

LANDING GEAR EMERGENCY EXTENSION

Emergency extension of the landing gear is accomplished by using the normal procedure, with the following additions:

1. Hydraulic pump circuit breaker—PULL.
2. Landing gear handle—DOWN, below 158 KIAS.
3. Airspeed—REDUCE TO 120 KIAS.
4. Increase "g," if required, to lock main gear.

FLAP ALTERNATE OPERATION

If the flaps fail to respond to normal selection, proceed as follows:

1. HYD PRESS light—CHECK.
 - (a) If light is illuminated, utilize alternate operation.
 - (b) If light is not illuminated, depress nose wheel steer button.
2. FLAP handle — HOLD.
3. ALT FLAPS switch — AS REQUIRED.
Place ALT FLAPS switch in UP, DOWN, or move to HOLD as required.

Note

Alternate extension of flaps may require up to 1 minute.

ASYMMETRIC FLAPS

If asymmetric flaps occur, return the wing flap select lever to previous position. If the condition is corrected by this method, do NOT attempt to change the flap setting. If not, perform controllability check and recover.

CANOPY OPEN IN FLIGHT

1. Airspeed—REDUCE TO 90 KIAS.
2. FLAP handle — T/O.
3. Canopy — CLOSED.
4. If canopy cannot be closed and locked, land as soon as practicable maintaining 10 KIAS above normal approach speed.

Note

If canopy remains on the aircraft, yawing toward the open canopy will reduce the force required to close and lock the door (left door—left rudder).

WARNING

If canopy is lost in flight, slow-flight the aircraft for handling characteristics before landing.

CARGO BAY DOOR OPEN IN FLIGHT

Illumination of the DOOR OPEN caution light indicates that the cargo bay door is open or unlatched. The aircraft may exhibit low-frequency oscillations and/or cargo bay noises. Land as soon as practicable.

CAUTION

A no-flap landing is recommended. Damage to the left inboard flap and the upper surface of the cargo bay door may result if the flaps are lowered in flight.

STRUCTURAL DAMAGE/CONTROL MALFUNCTION

In the event of structural damage or flight control malfunction, determine the speed at which control effectiveness becomes marginal in the landing configuration. Maintain a minimum approach speed at least 10 KIAS higher. If possible, a straight-in approach should be made.

EMERGENCY JETTISON

All external stores can be released electrically. All stores except the centerline-mounted store and the wing-mounted stores can also be jettisoned manually.

Note

A complete electrical failure, including loss of battery power, prevents release of the centerline store and the wing-mounted stores under any conditions.

1. STORES EMER REL button—PRESS.
This button releases all external stores as long as battery bus power is available and the aircraft is airborne.
2. EMER ST JETT handle—PULL.
This handle mechanically releases all external stores except the centerline store and wing-mounted stores on the ground or in flight.

PART 4 — LANDING EMERGENCIES**FORCED LANDING**

The "zero-zero" capability of the LW-3B ejection seat should always be considered when faced with an actual power-off emergency, especially at night, in weather, or over unknown terrain. Flight tests have determined that power-off landings can be made from an overhead pattern, starting at a high-key altitude of 3000 feet above the terrain. Refer to FLAME-OUT PATTERN, in this section.

DITCHING (WATER LANDING)

Under all conditions, the ejection capability afforded overrides any conceivable advantages of ditching. Safety studies show that when compared to ditching, ejections offer much higher chances of safe escape. If ditching is unavoidable, proceed as follows:

1. Follow radio distress procedure.
2. External stores—JETTISON.
3. Loose equipment—STOW.
4. G-suit hose and communications lead--DISCONNECT.
5. Harness, survival kit straps, and lap belt—TIGHTEN.
6. Oxygen diluter lever—100% OXYGEN.
7. Landing gear handle—UP.
8. FLAP handle—40 DEGREES.
9. Harness—LOCK.
10. Fly power-on approach, if possible.

Note

Use normal approach speeds to maintain full control. Unless wind is high or the surface is rough, plan to approach parallel to the swell pattern and attempt to touch down along a wavecrest just after the crest passes. If high wind or rough surface prevails, best procedure is to approach into the wind, attempting to touch down on the falling side of a wave.

11. Condition levers—FEATHER & FUEL SHUT-OFF, before impact.
12. Continue to "fly" the aircraft until forward motion stops.
13. Lap belt—OPEN.
14. Parachute riser fittings—RELEASE.

WARNING

The survival kit release handle shall not be pulled until clear of the aircraft.

15. Oxygen mask—OFF.
16. Cockpit door—OPEN.
17. Abandon aircraft.

IMMEDIATE LANDING — LOW ALTITUDE

Should you be faced with two failed engines at low altitude, and terrain features are such that a successful landing can be made, proceed as follows:

1. STORES EMER REL button—DEPRESS, as required.
2. Landing gear handle—DOWN.

WARNING

If installed, a full or partially full centerline external fuel tank should be jettisoned.

3. FLAP handle—T/O.
4. Maintain 100 KIAS minimum.
5. Harness—LOCKED.
6. Condition levers—FEATHER & FUEL SHUT-OFF.
7. FUEL EMERG SHUT OFF switches—SHUT OFF.
8. BATTERY switch—OFF.
9. Abandon aircraft when stopped.

WARNING

- Forced landings with the gear retracted present a much higher hazard potential due to the high wing and propellers, and reduced impact absorption capability.
- If a successful landing looks doubtful at any time, EJECT.

WARNING

DO NOT ATTEMPT POWER-OFF LANDING AT NIGHT UNDER ANY CIRCUMSTANCES.

PRECAUTIONARY APPROACH

If an engine fails with sufficient altitude to arrive at high key (figure 5-4), and aircraft gross weight and/or ambient conditions make a normal single-engine approach inadvisable, proceed as follows:

1. Prior to high key:
 - (a) Landing gear—DOWN.
 - (b) Slow to minimum safe single-engine speed.
2. High key:
 - (a) 3000 AGL.
 - (b) Maintain minimum safe single-engine speed.
 - (c) Use approximately 15 degrees angle of bank to low key.
3. Low key:
 - (a) 2000 feet AGL.
 - (b) Flaps—as desired.
 - (c) Landing check—COMPLETE.
 - (d) Use approximately 30 degrees angle of bank to final.
 - (e) Maintain minimum safe single-engine speed.
4. Landing:
 - (a) Flare as required.

SINGLE-ENGINE LANDING

If continued operation of the remaining engine is in doubt, use of the precautionary approach should be considered. For a single-engine landing, either a downwind entry or a straight-in approach may be used. See figure 5-5. No major problems are encountered if the aircraft is properly trimmed and gross weight is reduced to normal. Single-engine approaches should be made with no flaps and the following minimum airspeeds:

GROSS WEIGHT (POUNDS)	KIAS
10,000	110
11,000	115
12,000	120
13,000	125
14,000	130

Note

Prior to maneuvering for final approach, the rudder trim should be reduced to near neutral. Failure to reduce the amount of rudder trim from at or near maximum deflection will induce adverse yaw as power is reduced for touchdown and roll-out.

1. Downwind:
 - (a) Maintain at least minimum recommended airspeed.
 - (b) 1000 feet AGL minimum.
2. 180-degree position.
 - (a) Condition lever—T.O./LAND (operable engine).
 - (b) Landing gear—DOWN.
 - (c) Flaps—UP.
3. Final:
 - (a) Maintain at least minimum recommended airspeed.
 - (b) Flaps — T/O may be selected when landing is assured.
4. Touchdown—SMOOTH FLARE.

To maintain directional control and stop the aircraft, use rudder/nose wheel steering, brakes, and minimal single-engine reverse thrust.

PRECAUTIONARY APPROACH

REFER TO PRECAUTIONARY
APPROACH PROCEDURES

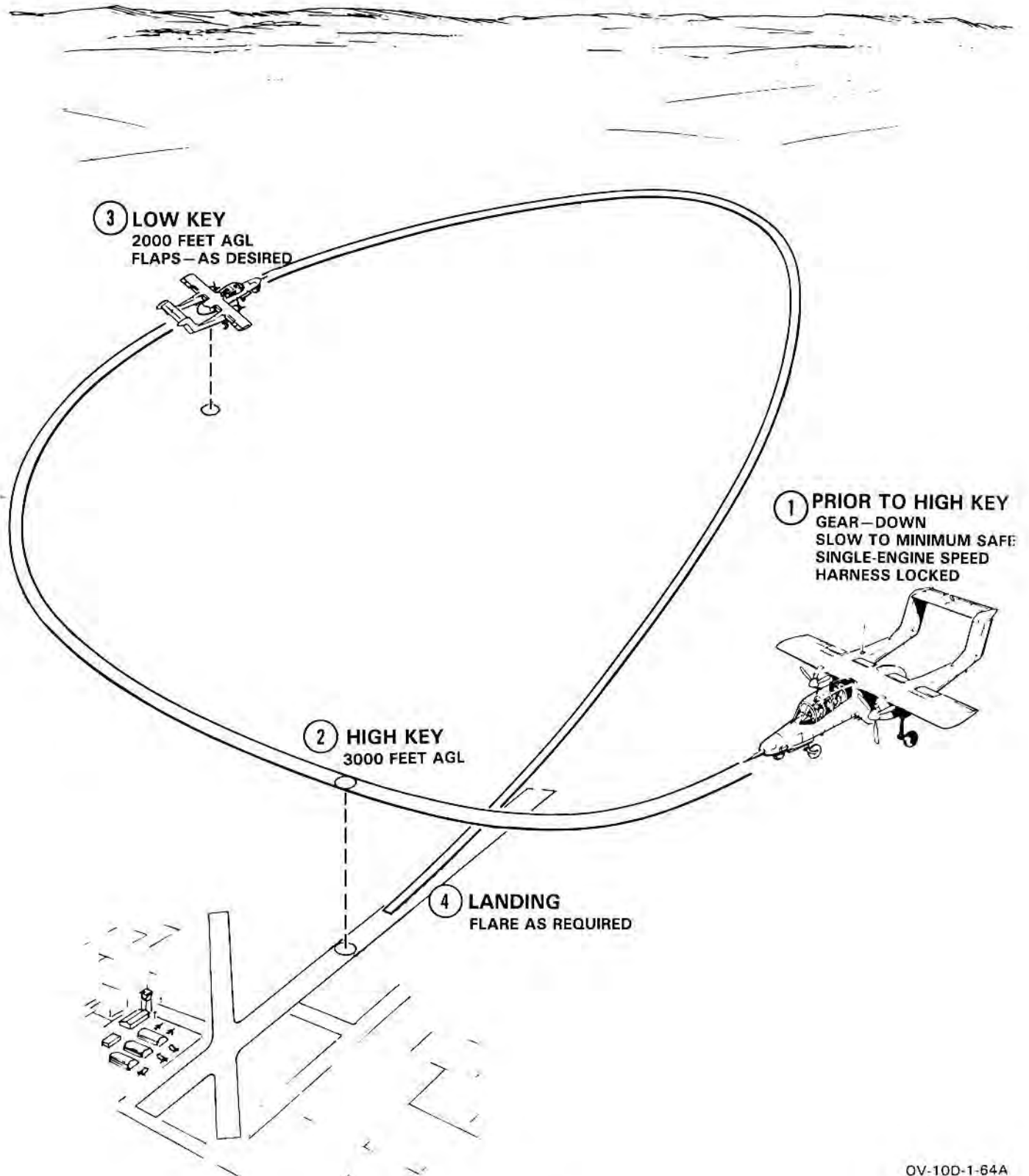

OV-10D-1-64A

Figure 5-4

TYPICAL SINGLE ENGINE LANDING PATTERN

12,000 POUNDS GROSS WEIGHT

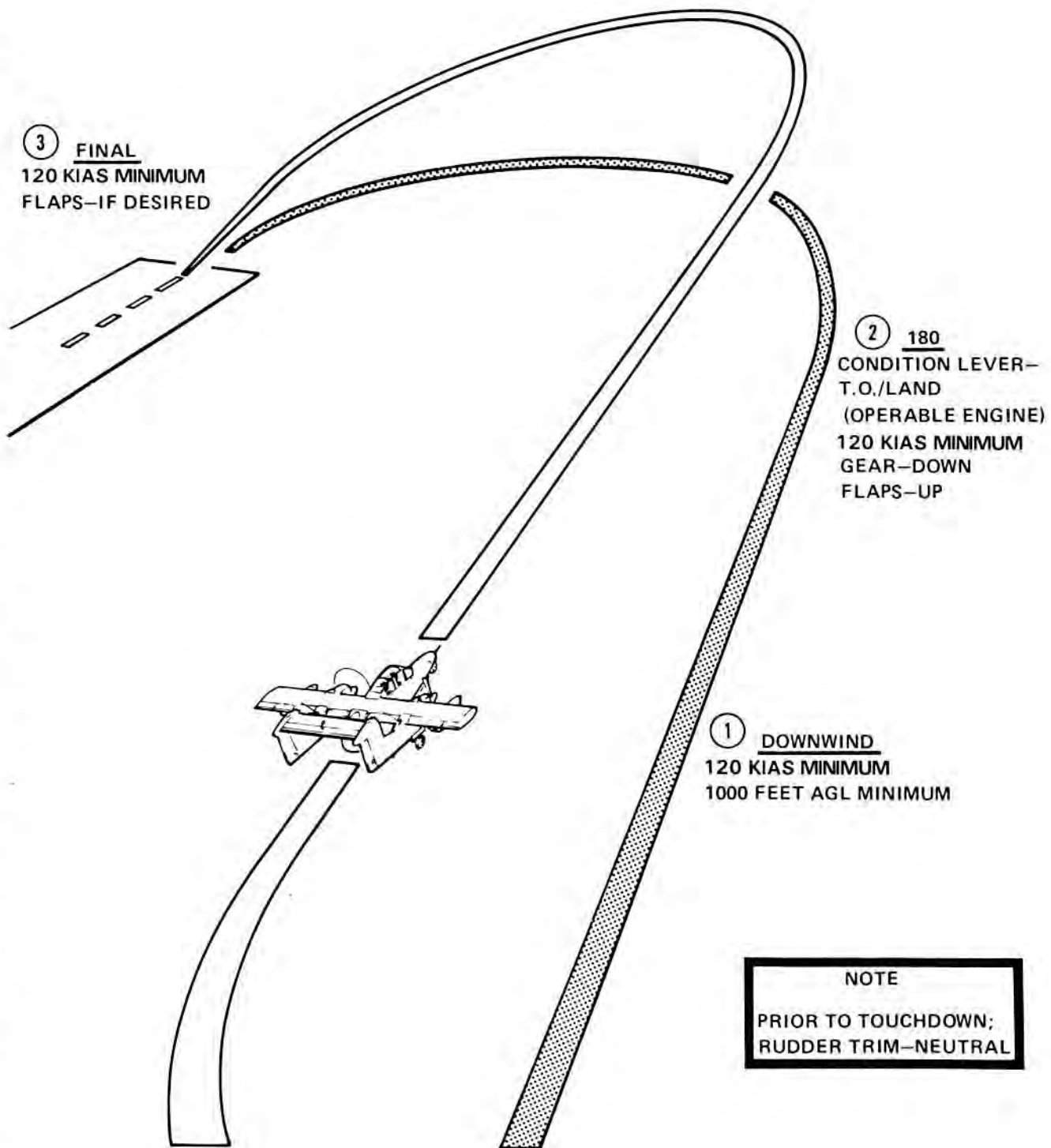

Figure 5-5

HYDRAULIC SYSTEM FAILURE

Failure of the hydraulic system, due to pump malfunction or a broken line, would be noted by failure of the gear to retract or the flaps to operate on selection and illumination of the HYD PRESS warning light on the pilot's service panel. Should this occur, the nose wheel STEER button should be depressed to check for failure of a normal gear or flap electrical circuit. If systems operate normally through the nose wheel STEER button, failure has occurred due to an electrical circuit malfunction. In the event of pump failure or hydraulic fluid loss, landing gear emergency extension and alternate flap extension procedure must be used.

CAUTION

Retraction of the landing gear must not be attempted with hydraulic system failure.

HYDRAULIC PUMP SHUT-OFF FAILURE

If the hydraulic pump fails to shut-off normally; pull HYD PUMP CONT circuit breaker.

WARNING

Failure of the hydraulic pump to shut-off normally will cause overheating the pump and fluid. This may result in pump failure or fluid loss into the cargo bay introducing a potential fire hazard.

Note

Power may be temporarily restored to lower gear and flaps, and then removed again.

TIRE FAILURES

Following a tire failure, directional control and braking present the greatest problems. Aircraft structural damage, broken lines, and related fire potential must also be considered. The degree of difficulty depends on such variables as gross weight, speed, which tire fails, and availability of effective nose wheel steering.

Note

Nose wheel steering may prove entirely ineffective during rollout with tire failure.

NOSE TIRE FAILURE ON LANDING

For landing with a failed nose tire, gross weight should be reduced as much as practical and a normal approach

and touchdown accomplished. Use reverse thrust to stop, while maintaining directional control with light differential braking. Use of nose wheel steering may not prove effective until late in the landing rollout with a flat or shredded nose tire. Reverse thrust will act to lighten loads on the nose gear as speed decreases during the rollout.

MAIN TIRE FAILURE ON LANDING

For landing with a failed main tire, reduce weight as much as practical and make a normal approach, utilizing full flaps and touchdown at the minimum allowable air-speed, planning to touch down on the side of the runway opposite the failed tire. After touchdown, use differential reverse thrust and nose wheel steering as required to control and stop the aircraft.

WARNING

Left main tire failure may result in damage to the ground safety switch linkage. This damage may cause loss of NOSE WHEEL STEERING and the POWER LEVER GATE SOLENOID. In this event, use of reverse thrust can only be gained by lifting the throttles approximately 1/4 inch to bypass the reverse gate (solenoid) to apply reverse thrust. Directional control may then be maintained by use of flight controls, differential braking, and differential reverse thrust. (Nose wheel steering will not be available).

UNSAFE LANDING GEAR

The capability of the landing gear to extend by gravity and bungee force makes the incidence of actual unsafe landing gear a rarity. If any gear indicates unsafe down, cycle it, apply "g" or increase airspeed, as applicable, to attempt to get a safe down indication. Allowing the gear to freefall (HYD PUMP circuit breaker pulled) will eliminate some false unsafe indications.

Whenever a main landing gear is confirmed to be unsafe down and all attempts to achieve a safe down and locked configuration have failed, attempt to achieve a gear up landing configuration. Use figure 5-6 to determine proper procedures based on final landing configuration. In this chart, the term "indicated unsafe" means that the gear appears to be in the down and locked position to an outside observer, but cockpit indications are to the contrary.

LANDING WITH UNSAFE LANDING GEAR

FINAL CONFIGURATION	LAND/EJECT	NOTES
NOSE INDICATES UNSAFE	LAND	1, 2, 6
NOSE CONFIRMED UNSAFE OR UP	LAND	1, 2, 3, 4, 6, 7, 9
ONE MAIN INDICATED UNSAFE	LAND	1, 2
ONE MAIN CONFIRMED UNSAFE OR UP	EJECT	10
ONE MAIN AND NOSE CONFIRMED UNSAFE OR UP	EJECT	10
BOTH MAIN CONFIRMED UNSAFE OR UP	LAND	1, 2, 3, 4, 5, 8, 9
ALL GEAR UP	LAND	2, 3, 4, 5, 8, 9

NOTES:

1. If pulled, reset HYD PUMP circuit breaker prior to landing.
2. Land on a smooth prepared surface. Perform the Before Landing checklist.
3. Jettison all external stores. If centerline fuel tank can be emptied or is empty, do not jettison.
4. Arresting gear should be removed.
5. Prior to touchdown, feather both propellers.
6. After touchdown avoid using brakes. Lower the nose smoothly to the runway. Do NOT attempt to hold a nose-high attitude below 50 KIAS.
7. After nose is on runway, feather both propellers.
8. Rudder control after touchdown may be marginal since the base of the surfaces may be in contact with the ground.
9. After the aircraft has come to a stop, FUEL EMERG SHUT-OFF—SHUT-OFF, BATTERY—OFF, and EGRESS.
10. If ejection is not feasible and a landing is attempted, observe Notes 1, 2, 3, and 4. Prior to touchdown, feather the propeller on the side of the unsafe main gear. Reverse thrust will then be available for directional control after touchdown.

OV-10D-1-125B

Figure 5-6

WHEEL BRAKE FAILURE

Wheel brake failure should be countered through use of reverse thrust, or allowing a free landing ground roll after touchdown, using differential reverse thrust as required late in the roll for directional control. Should complete failure of the brake system occur, proceed as follows:

1. Use reverse thrust to stop.
2. Block the nose wheel if feasible.
3. Condition levers — FEATHER & FUEL SHUT-OFF.

CAUTION

Do not attempt to taxi unless operationally necessary.

HOT BRAKES

If prolonged or heavy braking is used during abort or landing roll-out, hot brakes may occur.

1. Use reverse thrust to stop aircraft away from personnel and other aircraft, if feasible.
2. Chock the nose wheel.

WARNING

Overheated brakes may cause the wheel to explode. If so, it will explode to the side. Therefore, approach the main landing gear from the rear only.

3. Request fire fighting assistance.

Note

Lowering the flaps with the engines running will increase cooling airflow over the brakes.

4. When available fire fighting assistance is in position, complete normal shutdown procedures.

CAUTION

Engine shutdown causes excess fuel to be vented in the immediate vicinity of the brakes.

EMERGENCY RESCUE

For emergency rescue procedures, see figure 5-7.

EMERGENCY RESCUE

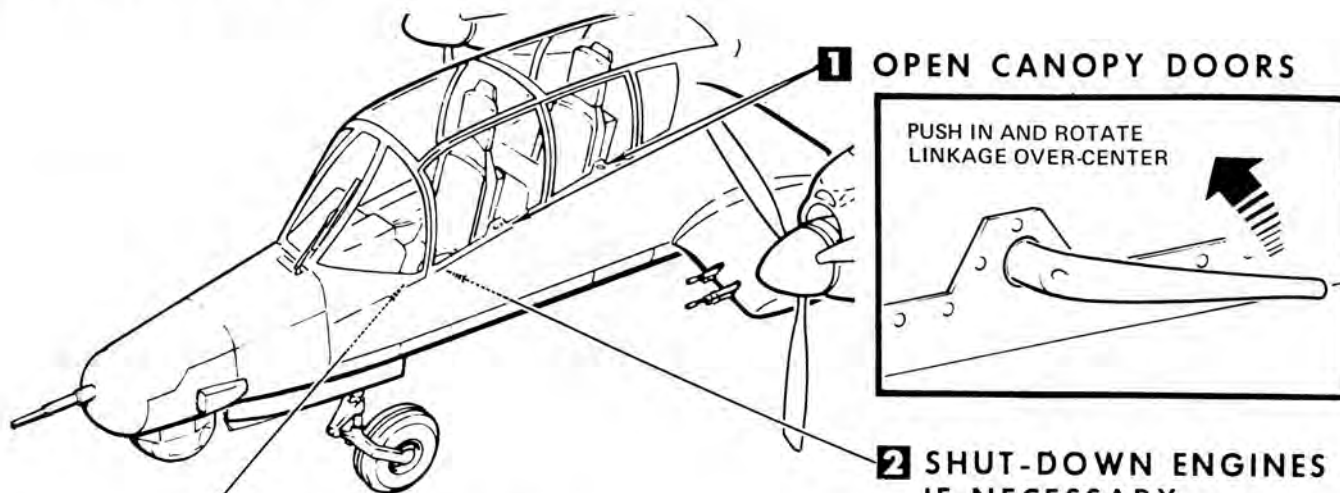

2 SHUT-DOWN ENGINES IF NECESSARY

3 BATTERY SWITCH

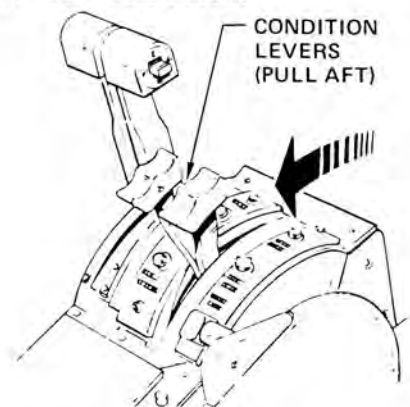
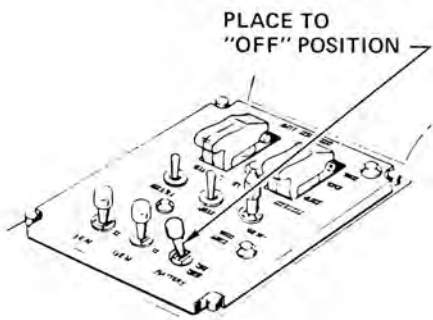

4 DISARM SEATS

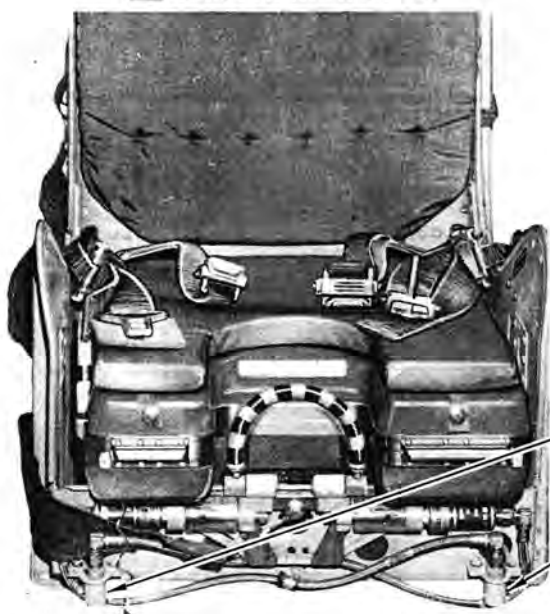

CUT OR BREAK SAFETY WIRE AND PULL DISCONNECT DOWN SHARPLY

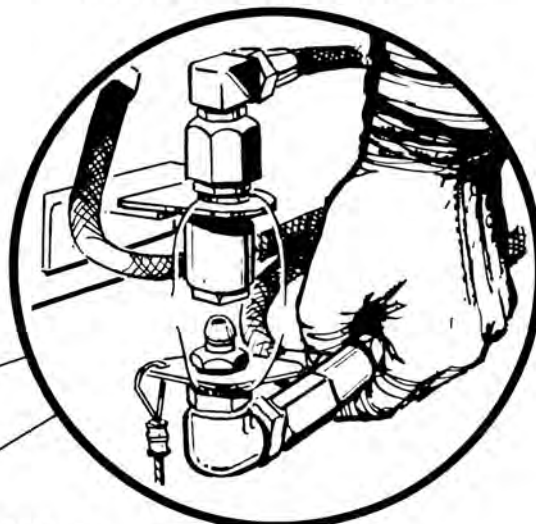

WARNING: D-RING INITIATORS CAN STILL FIRE IF SAFETY PINS ARE NOT INSTALLED.

OV-10D-1-109

Figure 5-7 (Sheet 1)

5 DISCONNECT CREWMEN

- A** REMOVE MASK, IF WORN
- B** DISCONNECT ALLIGATOR CLIP. SEPARATE MASK HOSE FROM AIRCRAFT OXYGEN HOSE
- C** DISCONNECT RADIO CORD
- D** OPEN LAP BELT
- E** OPEN KIT ATTACH FITTINGS, IF TIME PERMITS.
- F** DISCONNECT G-SUIT
- G** RELEASE RISER FITTINGS

WARNING

WHILE DISCONNECTING CREWMAN, AVOID INADVERTENTLY PULLING PARACHUTE EMERGENCY RELEASE HANDLE.

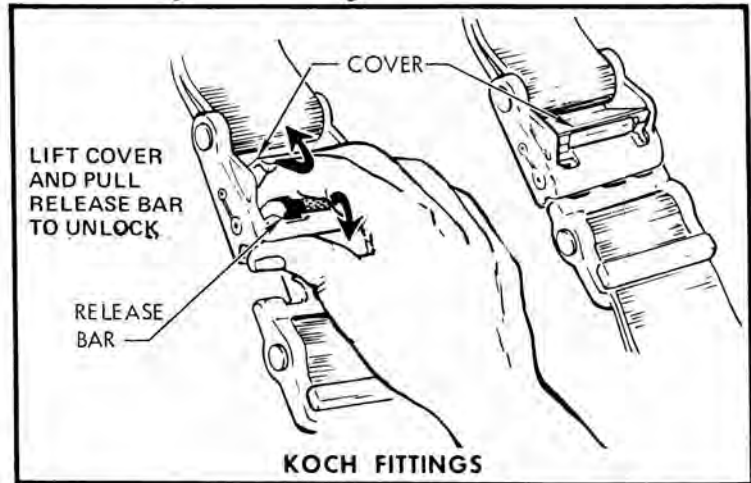
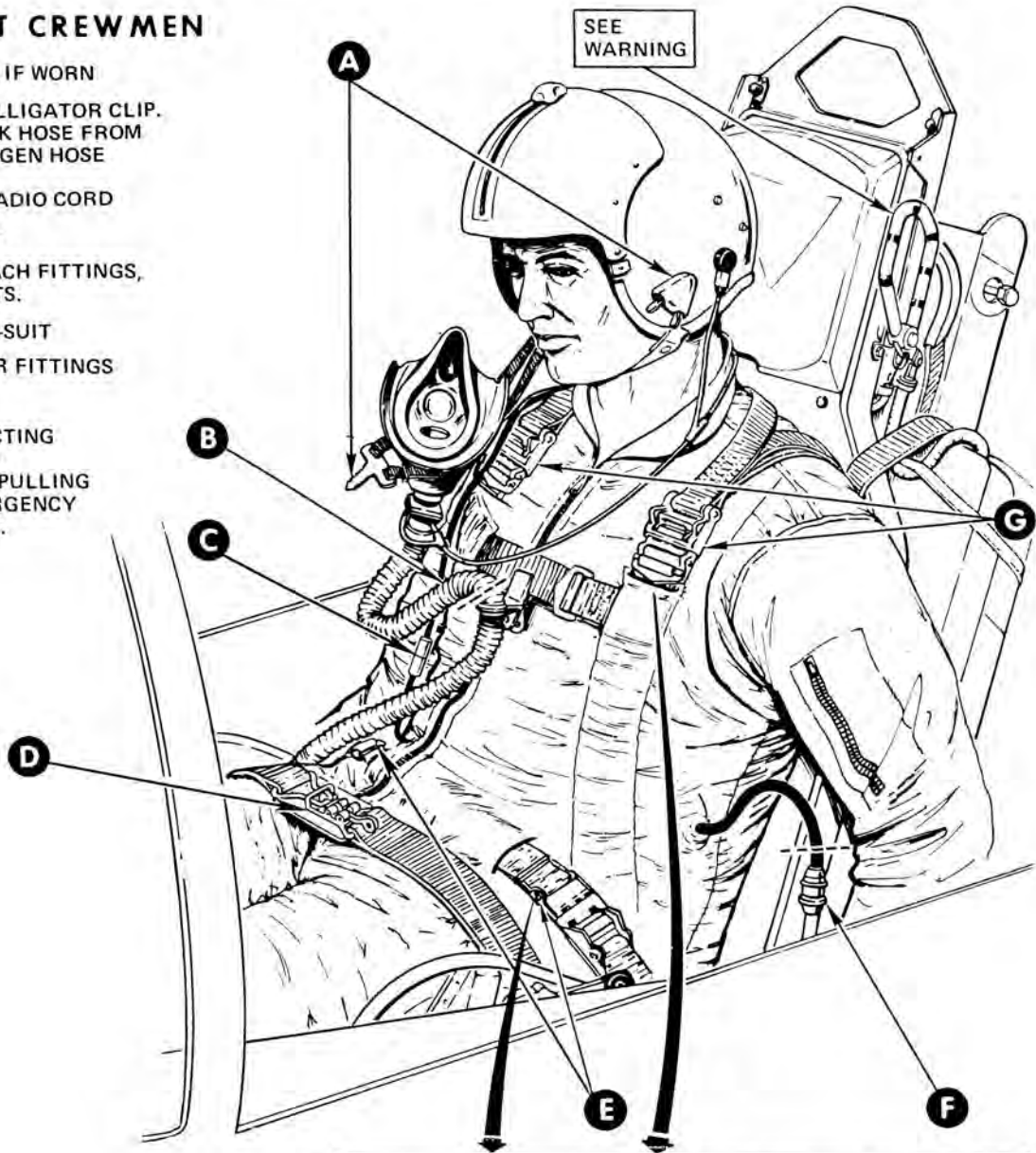

OV-10D-1-140

Figure 5-7 (Sheet 2)

PART 5 — EJECTION**EJECTION**

Prior to ejecting from a flyable or controllable aircraft, it is the pilot's responsibility to do everything reasonable to ensure that his abandoned craft will inflict the least possible damage on impact.

The LW-3B ejection seat affords exceptional escape capability. For ejection seat operation sequence, see figure 5-8. Common sense should be used in establishing ejection minimums to increase ejection capability and reliability. The following rules are presented as a guide for establishing ejection criteria:

- Under controlled, wings-level conditions, eject at least 1000 feet above the terrain if feasible.
- Under spin or dive conditions, eject at least 2500 feet above the terrain if feasible.
- If ejection is necessary, eject at whatever altitude and speed exist, as this offers the only chance of survival.

EJECTION PROCEDURE

If time and altitude permit before ejection, notify other crew member.

1. IFF MASTER knob—EMER.
2. Transmit MAYDAY and intentions.
3. Helmet visor—DOWN.
4. Guide aircraft away from populated areas.
5. Radio leads and oxygen hose—DISCONNECT.
6. Trade excess airspeed for altitude (100 KIAS minimum).
7. EJECTION "D" RING—PULL.
8. OXYGEN MASK—OFF.
9. OVER LAND:
 - (a) Survival kit—JETTISON, RETAIN, OR DEPLOY (as situation dictates).
 - (b) Prepare for landing.

OR

OVER WATER:

- (a) Raise helmet visor and remove gloves.
 - (b) Survival kit release handle—PULL.
 - (c) If MK-3C worn, inflate life preserver.
- OR

If LPA-1 worn, loosen helmet chin strap to prevent possible strangulation, then inflate life preserver.

- (d) Locate parachute riser release fittings with hands and release upon water entry.

WARNING

- If automatic seat/man separation does not occur, pull parachute emergency release. Also, open lap belt manually to assure separation.
- In the event seat/man separation does not occur after parachute deployment:

Over land—Do not release lap belt. Land with legs extended and slightly bent at knees.

Over water—Release lap belt (if still attached) and inflate life vest. Release riser Koch fittings immediately upon water entry.
- The design of the escape system is such that unejected bail-out is NOT POSSIBLE.

SURVIVAL EQUIPMENT

The survival kit should be deployed over water only after the parachute has stabilized. With the kit deployed, rate of descent at touchdown is slightly reduced and the crew member is not encumbered with the kit weight. In addition, the weight of the life raft and kit at the end of the lanyard serves as a stabilizing device, damping parachute oscillations to some extent.

EJECTION SYSTEM OPERATION SEQUENCE

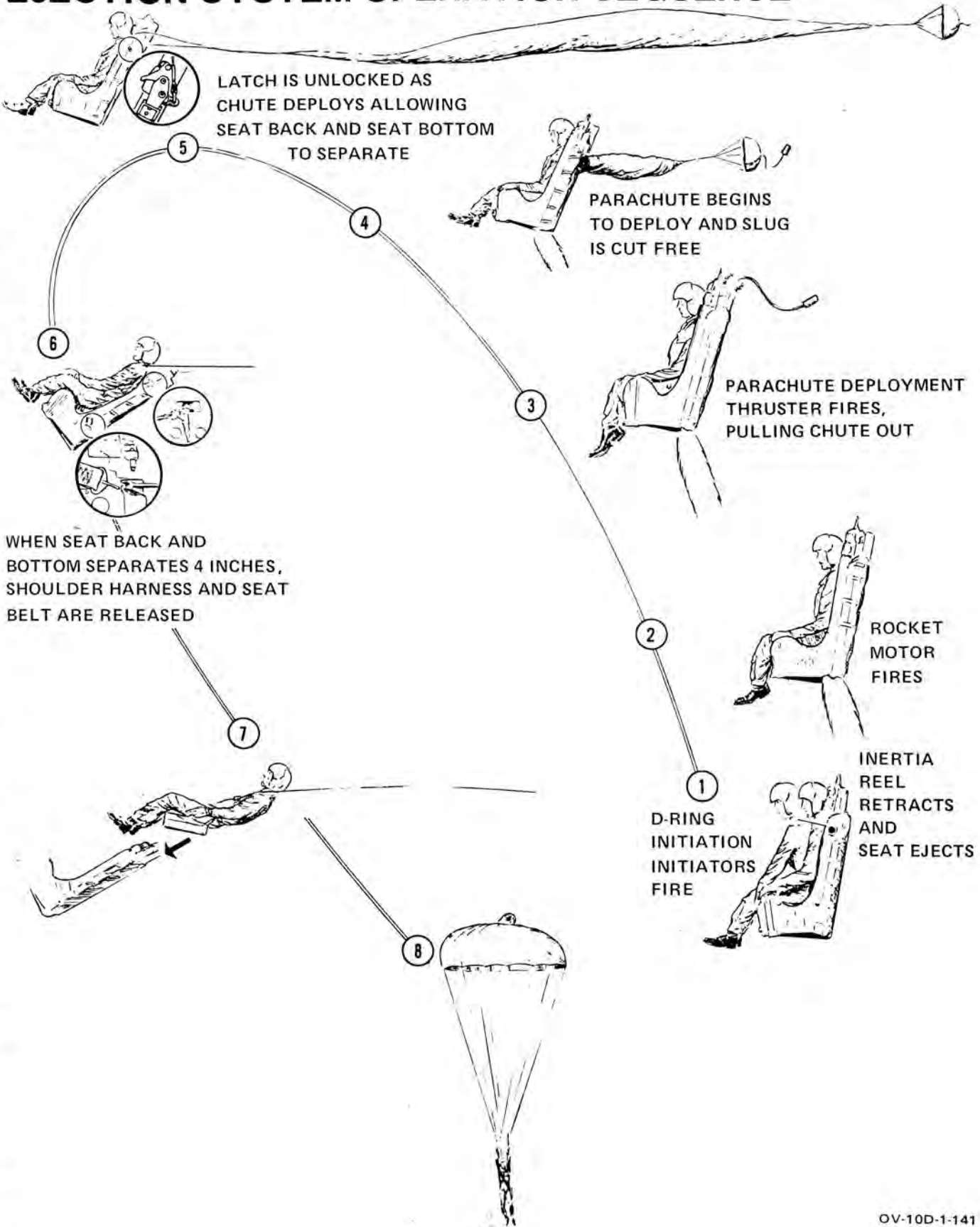

Figure 5-8

SECTION VI—ALL-WEATHER OPERATION

TABLE OF CONTENTS

Instrument Flight Procedures	6-1	Night Flying	6-6
Ice and Rain	6-2	Cold-weather Procedures	6-6
Turbulence and Thunderstorms	6-2	Hot-weather and Desert Procedures	6-8

INSTRUMENT FLIGHT PROCEDURES

Except where repetition is necessary for clarity, emphasis, or continuity of thought, this section contains only those procedures that differ from, or are in addition to, the normal procedures in Section III, Part 3.

WARNING

Intentional flight in known areas of icing shall not be attempted, as there are no provisions installed for wing, empennage, and engine anti-icing.

INSTRUMENT FLIGHT CHECKLIST

1. PITOT HEAT switch—ON.
2. WIPER control switches—AS REQUIRED.

CAUTION

Do not operate the windshield wiper on dry glass.

3. IFF-SIF—AS REQUIRED.
4. Flight instruments—CHECK OPERATION.
 - (a) Compass—SET, SLAVED.
 - (b) Attitude indicator — SET AT 4 DEGREES (NOSE DOWN) ON RUNWAY PRIOR TO APPLYING POWER FOR TAKE-OFF.
 - (c) Altimeter—SET (error noted, if any).
 - (d) Radar altimeter—SET.
 - (e) Wet compass—FLOATING FREELY.
 - (f) Clock—SET AND RUNNING (second hand operating).
 - (g) Turn-and-slip indicator — OPERATING PROPERLY (ball floating freely).
 - (h) Vertical velocity indicator—INDICATING 0.
 - (j) Airspeed indicator—INDICATING 0.

5. Radio and navigation equipment—CHECK OPERATION.

INSTRUMENT TAKE-OFF

Complete the normal procedures outlined in Section III, Part 3. If taxiing and taking off in visible moisture, the windshield wiper should be on as required and pitot heat should be turned on before taxiing into take-off position. When lined up, check BDHI and standby compass for agreement with known runway heading and check sync signal for null. After cross-checking all engine instruments for proper operation at Military power, release brakes and begin take-off roll. Use rudder or nose wheel steering as required. During the take-off run, BDHI heading is primary for directional reference; however, if runway markings are visible, they should be used as an aid in maintaining directional control. At 5 knots below recommended take-off speed, smoothly apply stick back pressure to establish a take-off attitude of approximately 4 to 6 degrees (nose up) on the attitude indicator. On becoming airborne, the attitude indicator is primary for determining pitch and bank angles. When the altimeter and vertical velocity indicator reflect a definite climb, retract the landing gear, and at approximately 110 knots, retract the flaps, if utilized. Maintain a 500- to 1000-foot per minute climb until best climb speed is attained, then adjust nose attitude to hold climb schedule.

INSTRUMENT CLIMB

Turns should not be attempted below 500 feet above the terrain on instruments and bank angle should not exceed 30 degrees while establishing the recommended climb schedule.

INSTRUMENT CRUISE

After level-off, it may be necessary to hold climb power until cruising airspeed is established. A bank of 30 degrees should not be exceeded except in unusual situations; however, the aircraft can be easily controlled in turns up to 60 degrees of bank. Handling characteristics are good during instrument flight within all normal speed ranges. Refer to Section XI, Part 4.

COMMUNICATION AND NAVIGATION EQUIPMENT

Installed avionics equipment permits navigation in the low-altitude route structure using TACAN with the UHF-ADF as an emergency backup system. For operation of electronic equipment, refer to Section VII, Part 1. With the exception of the HF equipment, all navigation and communication equipment is limited to line-of-sight reception and flight should be conducted at altitudes high enough to receive stations enroute. UHF-ADF and radar vectoring using IFF can be used to supplement TACAN.

WARNING

UHF-ADF is unreliable with external stores.

HOLDING

Reduce speed to holding speed (150 KIAS) and maintain power as required.

DESCENT

Economical descent is achieved by retarding the power levers to minimum torque and maintaining 130 KIAS. If a penetration descent is required, retard power to 80% rpm, slowly advance condition levers to T.O./LAND, and establish a rate of descent of approximately 4000 feet per minute at 220 to 230 KIAS. Adjust defrost air as necessary before beginning descent. The cockpit and windshield should be kept as warm as possible before and during descents, to eliminate fogging conditions on the transparent surfaces.

INSTRUMENT APPROACHES

TACAN or radar approaches may be made. Proper trim technique is important during approaches. With each change of power, attitude, configuration, or airspeed, retrimming is required. See figures 6-1 through 6-3 for typical instrument approaches.

MISSED APPROACH

If a missed approach occurs, proceed as follows:

1. Power levers—MILITARY.

CAUTION

Monitor engine indicators to avoid exceeding torque or temperature limits.

2. Level wings.
3. Establish a positive rate of climb.
4. Gear—UP.
5. Flaps—UP AS DESIRED.

ICE AND RAIN

With visible moisture and freezing temperatures, ice will form on the windshield, wing leading edge, and empennage. Altitude should be changed immediately on the first sign of ice accumulation. The resultant drag and weight increase acts to reduce airspeed and increase power requirements, with consequent reductions in range.

WARNING

Heavy ice accumulations can cause stalling speed to be greatly increased. Extreme caution must be used when landing under such conditions.

If you are *inadvertently* caught in icing conditions, proceed as follows:

1. Change altitude rapidly by climb or descent or vary course to avoid cloud formations.
2. Increase airspeed to decrease time spent in icing conditions.
3. If ice or frost forms on the windshield or canopy, push the CKPT AIR/DEFROST knob full in and adjust TEMP and RAM AIR knobs as required.

LANDING IN RAIN

The windshield wiper provides improved visibility in most forms of precipitation. At low airspeeds, such as in the landing pattern, visibility may remain impaired in extremely heavy rain or in snow. Braking action on wet runways is generally poor, requiring longer landing rolls. Plan to use reverse thrust or all the available runway when landing during wet runway conditions.

Note

Reverse thrust may cause momentary loss of all forward visibility at approximately 20 knots during deceleration.

TURBULENCE AND THUNDERSTORMS

Flight in heavy turbulence or thunderstorms should be avoided if at all possible. Under night-flying conditions, avoiding these areas may be difficult. The condition levers should be set to T.O./LAND. The power settings and pitch attitude required for desired penetration speed should be established before entering the storm. The recommended penetration speed for turbulence is 160 KIAS. The proper power setting and pitch attitude, if maintained throughout the storm, will result in a relatively constant average airspeed, regardless of false readings on the airspeed indicator.

HIGH ALTITUDE APPROACH (TYPICAL)

SINGLE ENGINE
 MAINTAIN A MINIMUM OF 120 KIAS
 (GROSS WEIGHT LESS THAN 12,000 LBS)
 GEAR AND FLAP EXTENSION MAY BE
 DELAYED UNTIL LANDING IS ASSURED.

① **INITIAL APPROACH FIX**
 CONDITION LEVERS—T.O./LAND
 POWER LEVERS—AS REQUIRED
 200-230 KIAS
 4000 FT/MIN

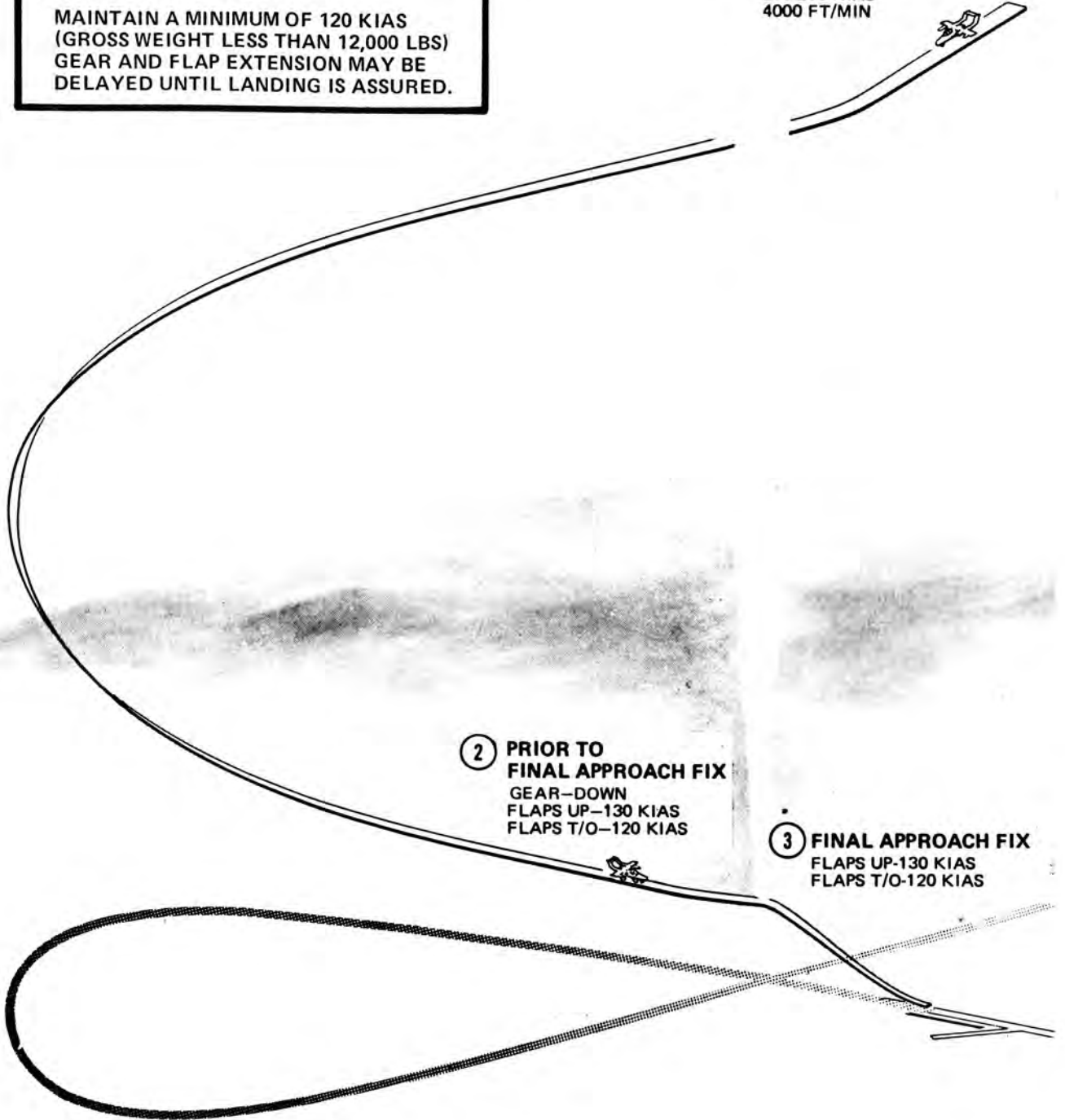

② **PRIOR TO FINAL APPROACH FIX**
 GEAR—DOWN
 FLAPS UP—130 KIAS
 FLAPS T/O—120 KIAS

③ **FINAL APPROACH FIX**
 FLAPS UP—130 KIAS
 FLAPS T/O—120 KIAS

OV-10D-1-142

Figure 6-1

LOW ALTITUDE APPROACH (TYPICAL)

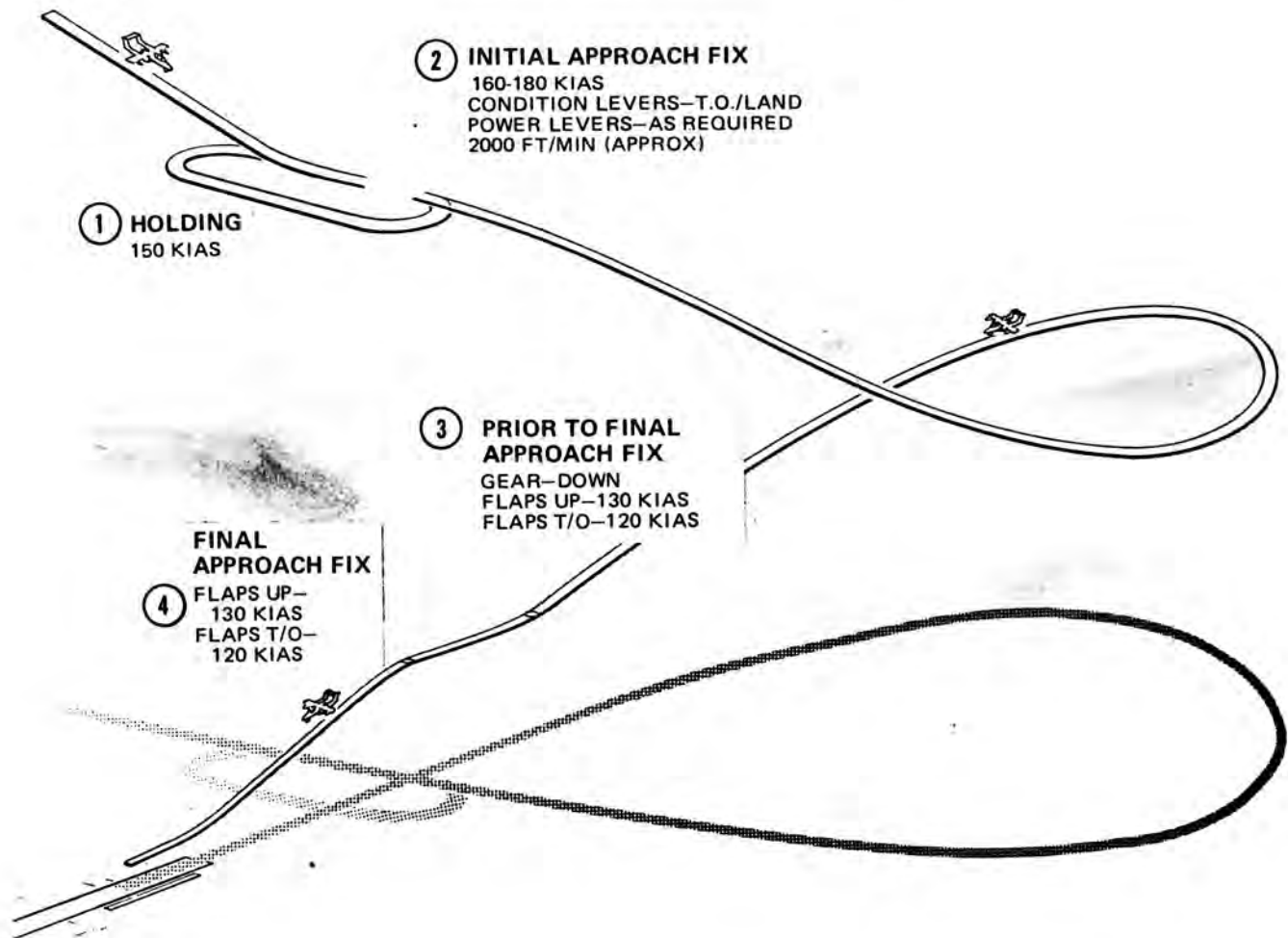

SINGLE ENGINE

MAINTAIN A MINIMUM OF 120 KIAS
(GROSS WEIGHT LESS THAN 12,000 LBS)
GEAR AND FLAP EXTENSION MAY BE
DELAYED UNTIL LANDING IS ASSURED.

OV-10D-1-143

Figure 6-2

RADAR APPROACH (TYPICAL)

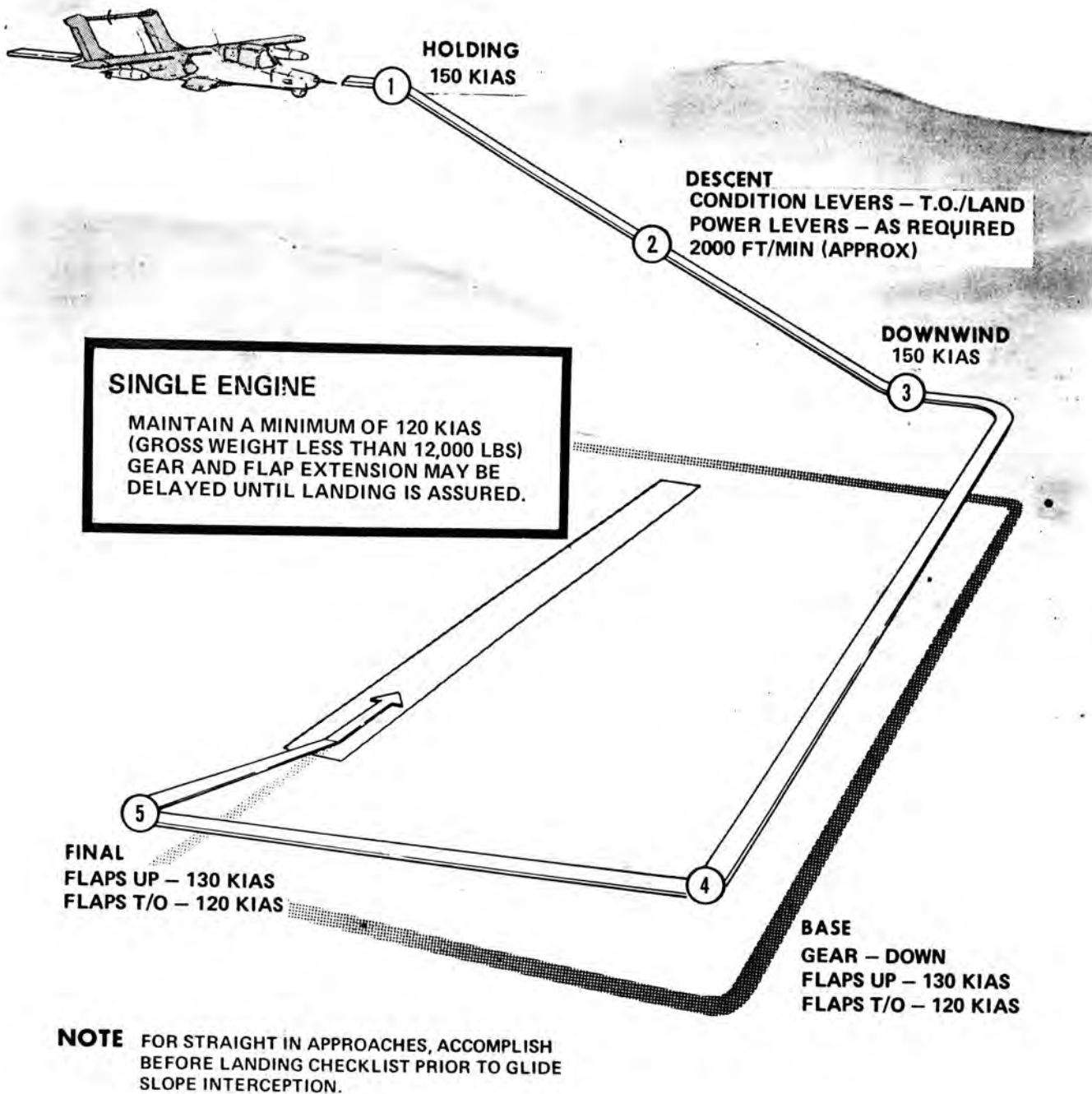

OV-10-1-110

Figure 6-3

APPROACHING THE STORM

Be sure to check for proper operation of all flight instruments, navigation equipment, pitot heater, and instrument panel lights before attempting flight into thunderstorm areas. Adjust the power levers to obtain the recommended penetration speed of about 160 KIAS. Be sure to check the following:

1. PITOT HEAT switch at ON.
2. Gyro instruments for proper indication.
3. Lap belt and harness straps tightened.
4. Seat adjusted for adequate head clearance.
5. All loose equipment secured.
6. Cockpit lights full bright.

IN THE STORM

Maintain constant power setting and average bank and pitch attitude throughout the storm. Hold these constant and the airspeed will remain relatively constant regardless of airspeed indication. Devote full attention to attitude control. The turbulence, lightning, and precipitation may be extreme; however, do not allow these conditions to cause you undue concern. Concentrate principally on holding level attitude by reference to the attitude indicator. Do not chase airspeed or altimeter indications because doing so could result in extreme attitudes. Differential barometric pressures within the storm will make the airspeed indicator and altimeter unreliable.

NIGHT FLYING

There are no specific techniques for flying at night which differ from those required for daylight operation. If a slight amount of canopy glare is noted in the rear cockpit, it can be relieved by dimming the instrument lights in the front cockpit. Before starting a night flight, be sure both crew members are equipped with an operable flashlight.

COLD-WEATHER PROCEDURES

The majority of cold-weather operating difficulties is encountered on the ground. The following instructions supplement the normal operating instructions when arctic-type weather is encountered. Extreme diligence on the part of both the ground and flight crews is required for successful arctic operation.

EXTERIOR INSPECTION

1. Check all protective covers are removed.
2. Perform exterior inspection. Refer to EXTERIOR INSPECTION, in Section III, Part 3.
3. Check to ascertain that the entire aircraft is free of snow, frost, and ice. Brush off light snow and frost. Remove all ice and encrusted snow. For de-icing information, refer to Section I, Part 3.

WARNING

- Remove all snow and ice from the wings, fuselage, and tail before flight. Depending on the weight and distribution of the snow and ice, take-off distances and climb-out performance can be adversely affected. The roughness, pattern, and location of the snow and ice can affect stall speeds and handling characteristics to a dangerous degree. In-flight structural damage may also result, due to the vibrations induced by unbalanced loads of accumulated ice and snow.
- Be sure to check all spring tab hinges, spoiler openings, and flap slot door areas for ice. Ice build-up on elevator and aileron tabs can cause serious control surface unbalance.

Note

During freezing rain conditions, ice which is not visible during visual inspection, may form on propeller blade seals. This will result in oil leakage from the propeller assembly on engine start.

CAUTION

Do not chip or scrape ice from aircraft surfaces, as this may cause damage.

4. Check to see that engines are free of internal ice. If equipment is available, the engines may be preheated as necessary.

5. Check to ensure all dirt and ice are removed from shock struts, actuating cylinder pistons, and all limit switches. Clean struts and pistons with a rag soaked in hydraulic fluid to avoid damaging packings and seals.
6. Inspect the area behind the aircraft to ensure that loose snow and ice will not be blown into personnel, other aircraft or equipment during engine start.
7. If equipment is available, the cockpit area, propeller hub, and tail boom electronic compartments should be preheated.

ENTERING AIRCRAFT

Use caution on the retractable steps. The metal steps may become extremely slippery as snow, ice, or water is deposited by personnel entering the aircraft.

ALTERNATE FUEL USE

When alternate fuels are used, specific attention must be given to alternate fuel limitations. Refer to PRIMARY, ALTERNATE, AND EMERGENCY FUELS, in Section I, Part 3.

Note

Ground and air starts characteristics may be improved in cold temperatures by using JP-4 fuel.

STARTING ENGINES

At temperatures below 0°C (32°F), external d-c starting power should be used. Battery power may not be adequate to provide the rpm required for normal starting after prolonged exposure to below -0°C temperatures.

CAUTION

Below -22°F (-30°C), engine starts should not be attempted until the engines are thoroughly preheated. This procedure will lessen slow-starting effects. Under extreme cold conditions, propellers should be manually unfeathered and pulled through for 30 seconds, before engines are started to prevent possible overload of the unfeathering pumps.

GROUND CHECKS

1. Normally, engine warm-up is unnecessary and as soon as the engines stabilize at idle rpm with normal oil pressure and the propellers are unlocked, the power levers may be advanced to MILITARY. However, if the engine has been "cold-soaked" at temperatures below 0°F (-18°C), a 2-minute warm-up at GROUND IDLE is recommended.

Note

Difficulty may be encountered in unlocking propellers unless the engines are preheated. If unlocking cannot be obtained, allow time for engine temperatures to increase and reattempt unlocking.

2. Before taxi, conduct a thorough check of full-travel operation of all flight control surfaces and the flaps. Ensure proper operation of tabs and spoilers with flaps extended and retracted.
3. Check all communications-navigation equipment and instruments for proper operation, allowing at least 3 minutes for warm-up before checking.

TAXIING

The aircraft should not be taxied through water or slush if it can be avoided. Water or slush splashed into the wheel wells will freeze, causing possible gear retraction malfunctions. If taxiing behind another aircraft, maintain a greater interval than normal to avoid ice and slush from being blown onto the aircraft.

TAKE-OFF

Monitor engine torque closely during take-off acceleration, as torque increase with ram effect in cold weather could result in exceeding engine limits.

AFTER TAKE-OFF

After take-off from wet snow or slush-covered surfaces, leave the landing gear down for a short period, or operate the gear and flaps through several complete cycles to prevent freezing in the retracted position. Use care to avoid exceeding gear and flap limit speeds during these cycles.

LANDING

The basic, normal landing techniques apply to landing on slippery surfaces, except that the effects of crosswind are multiplied. Except as necessary to control direction on unprepared surfaces, the use of nose wheel steering is NOT recommended for landing rollout. More precise directional control is available using differential propeller thrust and rudder.

Note

Under conditions of intense rain, sleet, or snow, or when a depth of loose, dry snow, or standing water is present, use short bursts of partial reverse thrust as feasible. Full reverse thrust may cause momentary complete visual obstruction.

BEFORE LEAVING

1. When feasible, ensure fuel servicing as soon as possible.

2. If the aircraft is to be idle for more than 4 hours at temperatures below -20°F (-29°C), remove batteries and store to a warm area.
3. Check that all protective covers are installed and that the aircraft is chocked and tied down as required.

HOT-WEATHER AND DESERT PROCEDURES

Hot-weather and desert procedures differ from normal procedures when high temperatures, coupled with blowing sand and dust, are encountered. Extreme caution must be exercised by both the ground and flight crews to prevent damage to systems during desert operations. Proper protection and inspection of the aircraft while on the ground and observance of the precautions covered in this section will ensure the most successful operation.

EXTERIOR INSPECTION

1. Remove all protective covers.
2. Clean dust and sand from struts, hydraulic pistons and switches, and wipe down struts with hydraulic fluid.
3. Always place the aircraft in a position to avoid sandblasting equipment and personnel during engine starts and ground checks.
4. Check the intake ducts and remove any accumulation of dust and sand.
5. Clean dust and sand from windscreen and canopy with very wet cloth to prevent scratching and clouding surfaces.

CAUTION

Use gloves during exterior inspection to prevent serious burns from contact with extremely hot aircraft surfaces.

BEFORE STARTING ENGINES

1. Check instruments and electrical equipment for excessive moisture from high humidity and use ground heat, as necessary, to dry them.
2. Check cockpit for excessive accumulations of dust or sand.

Note

High temperatures may cause circuit breakers to pop when electrical power is applied.

STARTING

Monitor starting EGT closely. Due to increased OAT, starting temperatures tend to be higher than normal.

BEFORE TAKE-OFF

1. Expect the engines to accelerate to idle more slowly than on a normal or cold day.
2. Minimize the duration of engine ground operation. The engine temperature may be reduced by advancing the condition levers slightly forward of the NORMAL FLIGHT position while waiting for take-off.
3. Keep sufficient distance between aircraft during taxiing to prevent sand and dust from being blown into the engines.

TAKE-OFF

Delay rotation, if the take-off roll is not critical, until reaching take-off speed, to provide positive control and a higher initial rate of climb. Expect gusts and turbulence at low altitudes.

WARNING

Engine power decreases rapidly with increases in ambient temperature and take-off distances are greatly increased.

APPROACH AND LANDING

Maintain recommended approach and landing speeds. Refer to Section XI, Part 8. Allow for longer landing rolls resulting from slightly increased ground speeds with high outside air temperatures.

BEFORE LEAVING

1. Ensure that protective covers are installed on the pitot-static tube, angle-of-attack probe, and engine intakes and exhaust pipes.
2. If the aircraft is parked in the sun, leave the cargo bay door slightly ajar and one cockpit door open to allow air circulation if wind-blown sand is not a problem.
3. Ensure the aircraft is tied down, central gust locks installed, and parking brake set if the possibility of a windstorm exists.

SECTION VII— ELECTRONIC EQUIPMENT AND COMMUNICATIONS

TABLE OF CONTENTS

Part 1—ELECTRONIC EQUIPMENT	7-1	ELECTRONIC COUNTERMEASURES	
Compass System, AN/ASN-75	7-1	EQUIPMENT	7-16
Radar Altimeter System, AN/APN-171(V)	7-2	PART 2—COMMUNICATIONS	7-21
Communications Systems	7-2	General	7-21
Navigation Systems	7-10	Operation	7-21
Identification Systems	7-12	Visual Communications	7-21

PART 1 — ELECTRONIC EQUIPMENT

COMPASS SYSTEM, AN/ASN-75

The compass system consists of a directional gyro-controller remote compensator unit in the left boom, a remote compass transmitter in the horizontal stabilizer, and a compass control panel. Compass heading is indicated by the heading ring of the bearing-distance-heading indicator (BDHI). The compass operates in either a SLAVED or a FREE mode at latitudes up to 60 degrees. The SLAVED mode of operation orientates the system in relation to the earth's magnetic field as determined by the transmitter. When used in the FREE mode, where magnetic sensing is not reliable, the compass system references some predetermined fixed point with a known directional heading.

COMPASS CONTROLS

The compass control panel (figure 7-1) is installed on the right console in the pilot's cockpit.

COMPASS CONTROLS



51-4

OV-10D-1-145

Figure 7-1

SLAVED-FREE SWITCH

The SLAVED-FREE switch selects compass mode of operation. In the FREE mode, BDHI heading indication must be periodically corrected for gyro drift and apparent precession.

ANNUNCIATOR

The annunciator (+, •), operative only in SLAVED mode, shows agreement or disagreement between the compass gyro and the magnetic compass transmitter. A plus (+) indication reflects clockwise error and a minus (•) indication reflects counterclockwise heading error. Annunciator oscillation during SLAVED mode operation is normal, indicating continuous corrective synchronization.

PUSH-TO-SET KNOB

The PUSH TO SET knob is used in the SLAVED mode to set annunciator indication as required and to set the desired aircraft heading while operating in a FREE mode.

COMPASS OPERATION

With a-c primary and instrument bus power available (either inverter on) and SLAVED mode selected, compass normal operation is automatic. If an error between BDHI and standby compass indication is noted, or if heading indication does not agree with known aircraft heading, momentarily select FREE, then return to SLAVED. If the error is not corrected, select FREE, correct the error with the PUSH TO SET knob, and reselect SLAVED. When operating in areas of high latitude the gyro should be unslaved to prevent unreliable readings.

Note

When the slaved mode is selected, AN/ASN-75 will automatically slave to the correct heading at a rate of 2.5 (±1.25) degrees per minute. The correct heading may be immediately selected with the PUSH TO SET knob.

RADAR ALTIMETER SYSTEM, AN/APN-171(V)

The radar altimeter system consists of a receiver-transmitter and two antennas mounted in the right wing and a remote indicator located on the pilot's instrument panel. The transistorized receiver-transmitter generates high-resolution pulse radar that automatically locates the closest terrain and performs a continuous, selective, precision range track of this signal. The computing circuitry is mechanized to allow altitude measurement from a maximum of 5000 feet to touchdown, displaying absolute altitude above the terrain. The system is immune to false readings or accuracy degradation in very heavy rainfall. In addition to altitude indication, the system provides for presetting desired minimum altitude and display of a LOW warning light when below preset minimum, and displays an OFF flag to indicate improper radar system operation. The system requires 3 to 5 minutes for warm-up and is powered from the primary a-c bus except for the OFF flag and the LOW level light which are powered from the primary d-c bus.

RADAR ALTIMETER INDICATOR AND CONTROLS

All controls for the radar altimeter are located on the face of the indicator case (figure 7-2). The indicator is a null-balance servo device with a pointer and nonlinear dial markings from 0 to 5000 feet. A mask, located in the lower right corner of the dial face, covers the pointer tip when above the maximum radar altitude range or when the altimeter is not tracking. An OFF flag will appear in the low center of the dial if the set malfunctions.

RADAR ALTIMETER INDICATOR & CONTROLS



OV-10D-1-146

Figure 7-2

OFF—SET—PUSH-TO-TEST KNOB

An OFF, SET, and PUSH TO TEST knurled knob, located on the lower left of the indicator case, functions to control the system power ON and OFF, to perform self-test and set low-altitude index. Turning the knob clockwise from OFF provides power to the system and moves low-altitude indexer clockwise as desired. After 3 to 5 minutes warm-up time, press the knurled knob to perform SELF TEST and observe reading of 100 (± 15) feet. Return of the knob to the OFF position will return the low-altitude indexer to less than 0 feet.

LOW-ALTITUDE LIGHT

An amber, low-altitude warning light is located on the lower right corner of the indicator case. This light functions to indicate LOW when altitude above terrain is less than indexer selected minimum altitude.

RADAR ALTIMETER OPERATION

1. Radar Altimeter Control – ON – set index at 50 feet.
2. Allow at least 3-minute warm-up or wait for disappearance of barber pole and pointer-indicator repositioned at zero altitude.
3. Push to test – altitude 100 (± 15) feet and low altitude warning light out.
4. Release press to test – low altitude warning light should illuminate when pointer passes 50 feet as it returns to zero feet indication.
5. Reset low-altitude warning index to setting desired.

Note

Allow 3- to 5-minute warm-up for stabilized operation.

COMMUNICATIONS SYSTEMS

Communications systems include high, very-high, and ultra-high frequency radios, monitored through the inter-communications set. For a list of communications-navigation-identification equipment, see figure 7-3.

INTERCOMMUNICATIONS SET, AN/AIC-18

The intercommunications set (ICS), AN/AIC-18, is a transistorized intercom and radio monitor, providing audio and transmit selection by the pilot and observer. Remote ICS jackboxes are provided in the nose compartment and in the external power plug compartment for maintenance and operate on HOT MIKE only. ICS operation requires main d-c bus power only.

TABLE OF ELECTRONIC EQUIPMENT

TYPE	DESIGNATION	WARM-UP		FUNCTION	RANGE
		Time (Minutes)	Prior to		
COMMUNICATIONS SYSTEMS					
INTERCOM	AN/AIC-18	NONE		INTERCOMMUNICATIONS, TRANSMISSION SELECTION, SIGNAL AMPLIFICATION	
UHF RADIO	AN/ARC-51	3	TRANSMIT	TWO-WAY VOICE	LINE-OF-SIGHT
VHF FM RADIO NO. 1	AN/ARC-54	3	TRANSMIT	TWO-WAY VOICE	80 MILES AVERAGE
VHF FM RADIO NO. 2	AN/ARC-54 OR AN/ARC-131	3	TRANSMIT	TWO WAY VOICE, RETRANSMISSION AND HOMING	80 MILES AVERAGE
HF RADIO	AN/ARC-120	5	TRANSMIT	TWO-WAY VOICE, LONG-RANGE SINGLE SIDE-BAND	UP TO 2500 MILES
NAVIGATION SYSTEMS					
COMPASS	AN/ASN-75	3	BEARING INDICATION	MAGNETIC COMPENSATED GYRO	
TACAN	AN/ARN-52(V)	3	DISTANCE READOUT	AZIMUTH, AIR OR GROUND RANGE	LINE-OF-SIGHT TO 196 N. MI. (GROUND) 300 N. MI. (AIR)
UHF ADF	AN/ARA-50	1	BEARING INDICATION	BEARING TO UHF FACILITIES	LINE-OF-SIGHT
RADAR ALTIMETER	AN/APN-171 (V)	3-5	ALTITUDE INDICATION	ALTITUDE ABOVE GROUND LEVEL	0-5000 FEET
IDENTIFICATION SYSTEMS					
IFF-SIF	AN/APX-64(V)	5	INTERROGATION RESPONSE	RADAR IDENTIFICATION (AIMS)	LINE-OF-SIGHT
ELECTRONIC COUNTERMEASURES SYSTEM					
COUNTER-MEASURES DISPENSING SET*	AN/ALE-39	NONE		DISPENSE COUNTER-MEASURES MATERIALS	LINE-OF-SIGHT
*AIRCRAFT HAVING AFC 82 INCORPORATED					
SECURITY SYSTEM					
KY-28	—			SPEECH SECURITY (ARC-51/54)	—

OV-10D-1-66B

Figure 7-3

ICS CONTROLS

An ICS control panel (figure 7-4) is installed on the pilot's left console and in the observer's cockpit (figure 1-5) as permanent equipment.

Transmit Select Knob

The transmit select knob (figure 7-4) is positioned to select the desired system for audio voice transmission. The transmit select knob provides INT (internal), UHF, VHF, No. 1, VHF No. 2, and HF positions. Transmission selection negates on-off function of the respective ICS monitor knob.

HOT MIKE (Listen) Knob

The hot microphone (listen) knob (HM) (figure 7-4), when pulled up, provides volume control of continuous intercom reception.

Hot Mike (Talk) Knob

The hot microphone (talk) knob (figure 7-4), when pulled up, provides continuous, hands-free transmit capability to the opposite cockpit. Cold mike (knob down) operation requires use of the CALL button or the power lever microphone switch ICS position. In addition, the observer may use the ICS microphone select switch or the ICS TALK foot switch.

Master Volume Knob

The master volume knob (VOL) (figure 7-4), is used to adjust audio level to the associated headphones.

ICS Monitor Knobs

The ICS monitor knobs (figure 7-4) are pulled up to select audio monitoring of the INT, UHF, VHF NO. 1, VHF NO. 2, HF, and TCN (TACAN), systems. The individual signals level can be adjusted by rotating the knobs once they are pulled to the "listen" position.

Call Button

The momentary CALL button (figure 7-4), when held depressed, will allow emergency transmission to the other cockpit at the volume level set by the receiving master VOL knob regardless of ICS select or monitor knobs selection.

Microphone Switches

A microphone switch is installed on the No. 2 engine power lever grip in both cockpits. Holding the switch upward (XMIT) keys the transmit relay for the radio set selected through the transmit select knob. With the switch in the ICS (down) position, the intercom system talk circuit is operative while the hot microphone (talk)

ICS CONTROLS

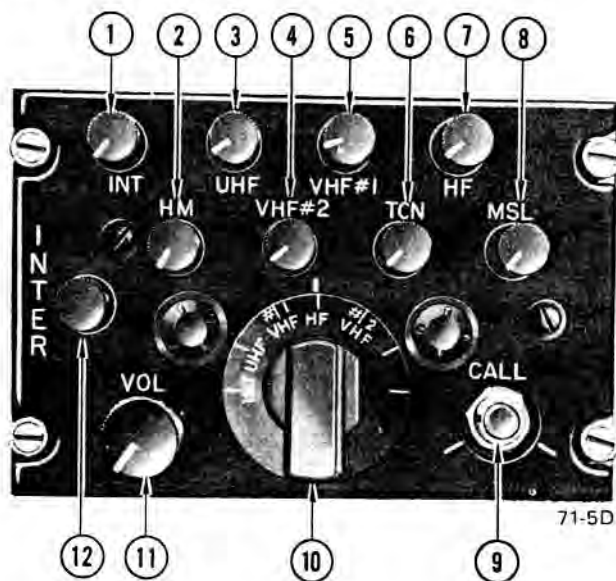

1. INTERCOM MONITOR KNOB
2. HOT MIKE (LISTEN) KNOB
3. UHF MONITOR KNOB
4. VHF NO. 2 MONITOR KNOB
5. VHF NO. 1 MONITOR KNOB
6. TACAN MONITOR KNOB
7. HF MONITOR KNOB
8. MISSILE MONITOR KNOB
9. CALL BUTTON
10. TRANSMIT SELECT KNOB
11. MASTER VOLUME KNOB
12. HOT MIKE (TALK) KNOB

OV-10D-1-22A

Figure 7-4

knob is down (cold microphone operation.) Two additional microphone foot switches are installed on the observer's cockpit floor. Stepping on the RADIO XMIT switch keys the transmit relay for the radio transmission system. Stepping on the ICS TALK switch operates the intercom system talk circuit while the hot microphone (talk) knob is down (cold microphone operation).

Microphone Select Switch (Observer)

The ICS microphone select switch (figure 1-5) is installed on the observer's communications switch panel in the rear cockpit and may be positioned to ICS, OFF, or TRANSMIT. Selection of ICS or TRANSMIT provides microphone switch operation for intercom or transmitter systems.

INTERCOM OPERATION

With main d-c bus power available (battery, external power, or generator, the ICS is ready for operation and is operable throughout the engine start sequence. To use the ICS, set the transmit select knob as desired for external transmission, pull the desired monitor knobs, and adjust volume as desired. Intercockpit "hot" communications are available at all times with the hot mike (listen) (HM) and hot mike (talk) knobs pulled. External transmission is made by holding the microphone switch to XMIT or stepping down on the RADIO XMIT foot switch in the observer's cockpit.

UHF COMMUNICATIONS SET, AN/ARC-51

The UHF transceiver, AN/ARC-51, provides communications in the UHF band from 225.00 to 399.95 MHz on 20 preset channels or 3500 manually set frequencies. The required d-c electrical power is provided by the secondary bus. An additional receiver permits monitor of military guard frequency (243.00 MHz), while operating on any other frequency. The unit may be adjusted to provide a 400-cycle off-channel tone which is present until channel or frequency has changed (approximately 6 seconds). UHF COMM controls are located on the pilot's instrument panel only; however, the observer may monitor and transmit. Relative bearing to a transmitting UHF facility is provided through the ADF set, AN/ARA-50.

UHF COMM CONTROLS

The UHF COMM control panel (figure 7-5) is located on the instrument panel in the pilot's cockpit.

Mode Knob

The mode knob (figure 7-5) has three positions: PRESET CHAN, MAN, and GD XMIT. The positions of the mode knob function as follows:

POSITION	FUNCTION
PRESET CHAN	Allows selection of 20 preset channels.
MAN	Allows selection of 3500 manual frequencies.
GD XMIT	Tunes main unit to 243.00 MHz for transmission.

UHF Volume Knob

The UHF VOL knob (figure 7-5) is used to adjust the level of receiver audio.

Preset Channel Knob

The PRESET CHAN knob (figure 7-5) is used to select 20 preset channels. Channel selection is displayed in a small window (figure 7-5) on the upper part of the control panel.

UHF Function Knob

The UHF function knob (figure 7-5) has four positions: OFF, T/R, T/R+G, and ADF. These positions function as follows:

POSITION	FUNCTION
OFF	UHF COMM set power off.
T/R	Transmit and receive operation.
T/R+G	Transmit-receive and monitor guard.
ADF	Receive AN/ARA-50—Transmit AN/ARC-51. BDHI No. 1 pointer displays bearing.

Manual Frequency Knobs

The manual frequency knobs (figure 7-5) are used to select any of 3500 frequencies for transmission and reception in the MAN position of the mode knob. The left knob selects hundreds of MHz in even numbers from 22 to 39. The center knob selects tens from 0 to 9. The right knob selects hundredths from 0.00 to 0.95.



Frequencies between 220.00 and 224.95 MHz are not usable. Selection may cause malfunction.

Squelch Disable Switch

The SQ DISABLE switch (figure 7-5) allows cutout of the preadjusted receiver squelch (reception threshold) setting. This allows all detected signals to be amplified to the headsets for reception of weak signals. The OFF position provides normal squelched operation, in which only signals of a preset strength are amplified.

UHF COMM CONTROLS

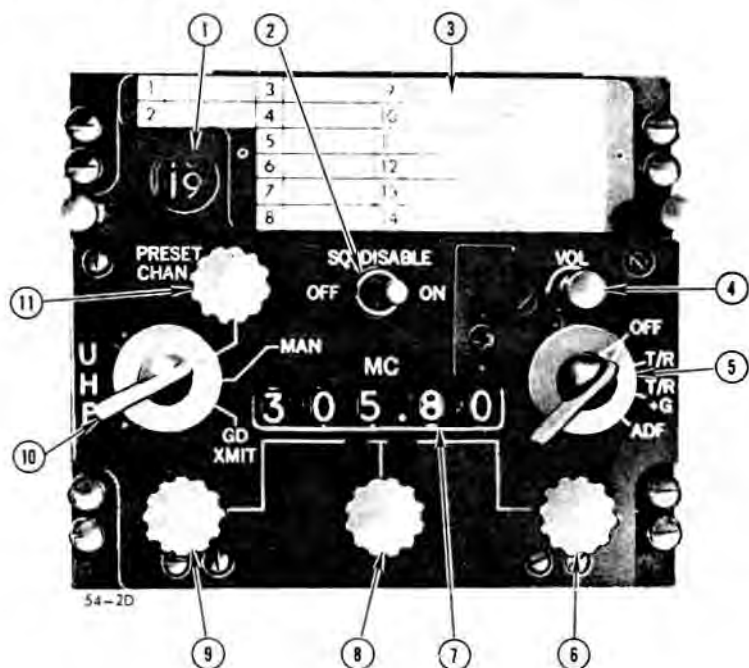

1. PRESET CHANNEL INDICATOR
2. SQUELCH DISABLE SWITCH
3. PRESET FREQUENCY INDEX
4. VOLUME KNOB
5. UHF FUNCTION KNOB
6. FREQUENCY (DECIMAL) KNOB
7. MANUAL FREQUENCY INDICATOR
8. FREQUENCY (UNITS) KNOB
9. FREQUENCY (TENS-HUNDREDS) KNOB
10. MODE KNOB
11. PRESET CHANNEL KNOB

OV-10D-1-147

Figure 7-5

UHF COMM OPERATION

To operate the UHF COMM set, proceed as follows:

1. After engine start, move UHF function knob to T/R+G.
2. UHF mode knob—PRESET CHAN.
3. PRESET CHAN knob—DESIRED CHANNEL.
4. SQ DISABLE switch—OFF.
5. VOL knob—ADJUST for desired sidetone.
6. ICS monitor knob UHF—PULL.
7. To cut out guard frequency monitor, select T/R.
8. To transmit, move ICS mode knob to UHF and depress microphone switch to XMIT.

CAUTION

Allow 3 minutes for warm-up prior to transmitting.

9. To set up a manual frequency, move mode knob to MAN and set desired frequency.

10. To select bearing indication to UHF transmitter, move function knob to ADF. Bearing is indicated by the BDHI No. 1 pointer.
11. To augment loudness of weak audio signals due to distance, move SQ DISABLE switch to ON.

VHF-FM COMMUNICATIONS SET

Two VHF-FM COMM sets provide FM communications on 920 frequencies between 30.00 and 75.95 MHz. D-C power is supplied by the secondary bus. The VHF-FM No. 1, AN/ARC-54, can be controlled by the pilot or observer. The VHF-FM No. 2 set is either the AN/ARC-131 or the AN/ARC-54, which are interchangeable, and is controlled by the pilot. The use of two sets provides VHF-FM retransmission capability. The VHF-FM No. 2 set can be used for homing through reference to the No. 2 pointer of the course indicator, ID-663B/U BDHI.

VHF-FM CONTROLS

A VHF-FM NO. 1 control panel (figure 7-6) is installed on the pilot's left console and on the rear cockpit instrument panel. A VHF-FM NO. 2 control panel (figure 7-6 or figure 7-7) is installed on the pilot's right console.

VHF-FM Take-Command Switch

The pilot's VHF-FM TAKE CMD switch (figure 1-4) and green indicator light are located on the right console. The observer's switch and light are located on the aft instrument panel. Command of the VHF-FM NO. 1 set is assumed by moving the VHF-FM TAKE CMD switch to the position which illuminates the light.

Mode Knob

The FM mode knob (figure 7-6) for VHF-FM NO. 1 set provides control of set power and transmit-receiver operations. These functions are selected through the OFF and PTT (push-to-talk) positions. The FM mode knob for VHF-FM NO. 2 set provides control of set power (OFF), transmit/receive (T/R), Retransmit (RETRAN), and HOME operations. During two-set operation, the pilot must coordinate operation to achieve retransmission. Refer to VHF-FM OPERATION, in this section.

Note

The HOME position is inoperative on NO. 1 VHF-FM.

Volume Knob

The VOL knob allows adjustment of incoming FM audio level.

Squelch Knob

The SQUELCH knob permits selection of squelch disabling (DIS) for reception of weak signals and carrier-wave (CARR) which is the normal operating position.

Frequency Knobs

The frequency knobs are used to select FM set operating frequency in 50-KHz increments. Off-frequency time is nominally 5 seconds, during which a tone is present in the headsets.

VHF-FM OPERATION

Normal Voice Communications (Either or Both Sets)

Normal voice operation may be conducted as follows:



Allow 3 minutes for warm-up prior to transmitting.

1. VHF FM mode knob—T/R (PTT).
2. SQUELCH knob—CARR.
3. Frequency—SET AS DESIRED.

FM CONTROLS

AN/ARC-54



1. SQUELCH KNOB
2. VOLUME KNOB
3. MODE KNOB
4. FREQUENCY DECIMAL KNOB
5. FREQUENCY MHz KNOB

OV-10D-1-111

Figure 7-6

FM CONTROLS

AN/ARC-131

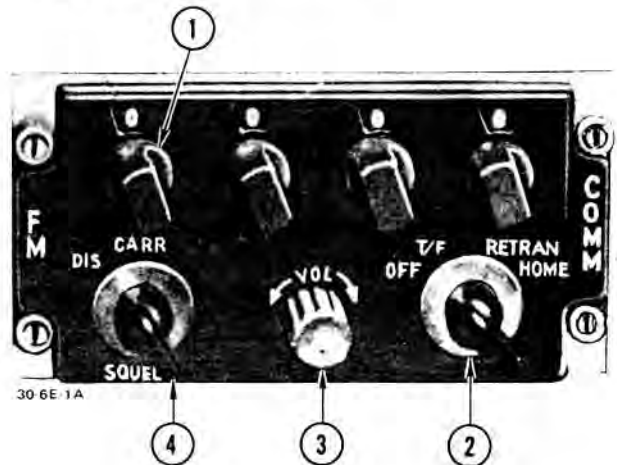

1. FREQUENCY KNOBS
2. MODE KNOB
3. VOLUME KNOB
4. SQUELCH KNOB

OV-10D-1-112

Figure 7-7

4. Transmit select knob—VHF.
5. VHF No.1 and VHF No. 2 ICS monitor knobs—PULL.

Note

Both sets may be monitored by either crew member.

6. VHF-FM volume knob—ADJUST VOL and VHF monitor knobs for proper balance and signal-to-noise ratio.
7. To transmit, depress microphone switch to XMIT.
8. To turn off VHF/FM, move FM mode knob to OFF.

Retransmission

VHF-FM communications may be received and retransmitted automatically using both VHF-FM sets as an operational link for two remote stations. Either set can be used as the receiver or transmitter; however, the following procedure is recommended for simplification and standardization:

1. Turn on both VHF-FM sets in normal T/R mode.
2. VHF/FM No. 1 frequency—SET to receive incoming signal.
3. VHF/FM No. 2 frequency—SET to desired transmit frequency.
4. VHF/FM mode knobs—RETRAN.

Note

- VHF/FM No. 1 and No. 2 sets must be tuned to separate frequencies at least 5 MHz apart. Otherwise the transmit/receive functions of the two sets may interfere with each other. Frequency separation of greater than 5 MHz may enhance the retransmit capability.
- Once RETRAN is selected on both sets, the remote stations may transmit and receive as required.

VHF-FM Homing

The VHF-FM (No. 2) set may be used with the BDHI, ID-663B/U, to home on ground-based VHF-FM stations within approximately 50 miles line-of-sight distance. With desired frequency selected, moving the mode knob to HOME places the homing function in operation. In this mode, "fly-to" heading deviations up to 20 degrees left or right of "on course" homing heading are provided on the No. 2 pointer of the BDHI.

Note

When No. 2 VHF-FM is placed in HOME, TACAN azimuth will be lost.

HF COMMUNICATIONS SET, AN/ARC-120

The HF COMM set provides long-range voice communications on 28,000 separate frequencies between 2.000 and 29.999 MHz. Single-sideband or amplitude modulation (center frequency) reception and transmission are available over the entire frequency range.

HF COMM CONTROLS

An HF COMM control panel (figure 7-8) is installed on the pilot's left console.

HF Frequency Knobs

The HF frequency knobs (figure 7-8) allow adjustment of operating frequency. Using the four knobs provided, frequency indication may be set in 1-kHz increments over the operating range.

HF COMM CONTROLS

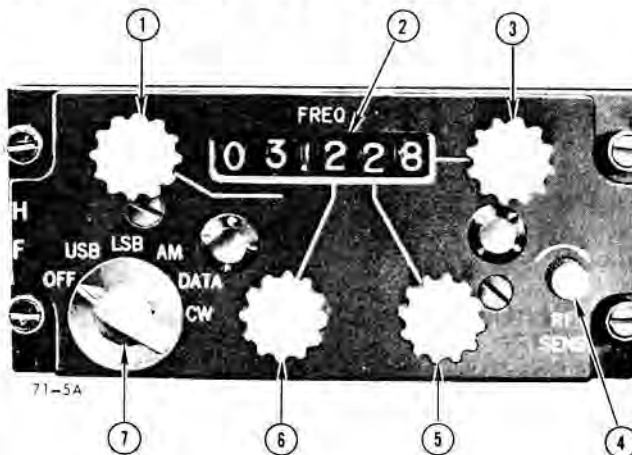

1. FREQUENCY KNOB (2-29 MHz)
2. FREQUENCY INDICATOR
3. FREQUENCY KNOB (.000-.009 MHz)
4. RF SENSITIVITY KNOB
5. FREQUENCY KNOB (.000-.090 MHz)
6. FREQUENCY KNOB (.000-.900 MHz)
7. MODE KNOB

OV-10D-1-148

Figure 7-8

HF Mode Knob

The HF mode knob (figure 7-8) provides control of set power and selection of the AM (amplitude modulation), USB (upper sideband), and LSB (lower sideband) modes of operation. The DATA and CW modes are not used. When more than one frequency is available at a station, selection depends on weather conditions, time of day, and other variables which affect the ionospheric layer of the atmosphere.

RF Sensitivity Knob

The RF SENS knob (figure 7-8) is used to achieve the best available signal-to-noise ratio in all operating modes.

HF COMM OPERATION

1. HF mode knob—USB, LSB, AM.
2. HF frequency knobs—SET, as desired.
3. HF ICS monitor knob—PULL.
4. Adjust RF SENS for best reception.

CAUTION

Allow 5 minutes for warm-up time prior to transmitting.

Note

If the mode is moved from OFF to an operating position, with desired frequency already set, change frequency one digit and return to desired frequency. This will allow the set to retune to the exact frequency.

5. To transmit, move the ICS select knob to HF and depress microphone switch to XMIT. A 1000 Hz tone should be audible while the antenna coupler tunes. Tuning time is normally 1 to 5 seconds. When the tone ceases, transmit message.

Note

If tone does not cease within 8 to 10 seconds, attempt to retune set on another frequency. If unsuccessful, secure set to prevent damage to antenna coupler mechanism.

6. The RF sensitivity knob and the HF ICS monitor knob must be adjusted to obtain best signal-to-noise ratio. Proper balance is indicated when background

noise is barely audible and a weak audio signal is raised to comfortable listening level.

KY-28 SYSTEM

A KY-28 system may be installed. The control panel (figure 7-9) may be installed on the pilot's right console to permit secure communication through the AN/ARC-54 and the AN/ARC-51 communication equipment. The KY-28 control should be left in the plain (P) position when the coder is not installed and the function knob is OFF. Power for the KY-28 system is provided by the 28 VDC secondary bus.

KY-28 CONTROLS

Function Knob

When the function knob is moved to ON, power is applied to the system. The knob has three positions: OFF, ON, and RLY. Function knob positions operate the KY-28 as follows:

POSITION	FUNCTION
OFF	System secured
ON	Power applied to system
RLY	Relay

Mode Switch

This switch is used to select plain (P) or cipher (C) speech operation. When the switch is positioned to (P), normal operation of appropriate radio is available and only uncoded reception and transmission is possible. With the switch in the (C) position, secure speech is available through the appropriate radio.

KY-28 CONTROL PANEL

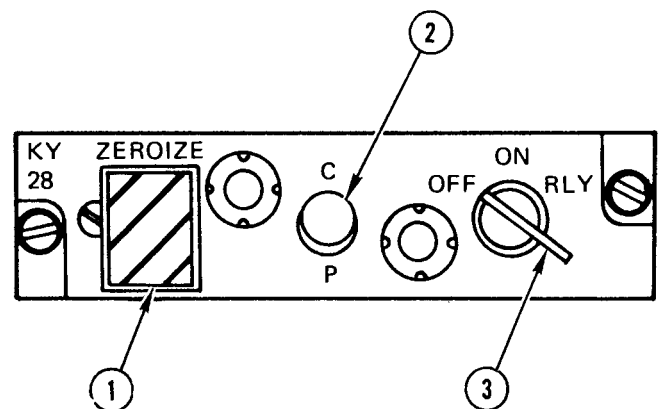

1. ZEROIZE SWITCH
2. MODE SWITCH
3. KY-28 FUNCTION KNOB

OV-10D-1-149

Figure 7-9

Zeroize Switch

The ZEROIZE switch is a button guarded in the OFF position. If it becomes necessary to zero out the codes set into the system, the guard should be raised and the button depressed momentarily. Nullify codes only when security compromise is imminent

Note

After codes are nullified, secure transmission cannot be made until system codes are reset.

KY-28 OPERATION

Note

- If operation does not proceed as outlined, switch to P mode. **DO NOT PASS CLASSIFIED INFORMATION.**
- UNSECURE transmission on any radio is prohibited during transmission or reception of secure information.

KY-28 Control Unit

1. Function knob—ON.
2. Mode switch—P (plain).
3. Make test transmission.
4. Mode switch—C (cipher).
5. Microphone switch—XMIT.

Listen for steady tone, then an alternating two-tone signal in headset, prior to releasing microphone button.

Note

- Step 5 is necessary only on initial operation after function knob is placed ON.
 - Prolonged steady tone indicates the codes have been nullified or a malfunction has occurred.
 - If alternating two-tone signal does not stop, depress and hold microphone button to XMIT, then release. If signal continues, switch to P (plain) mode and **DO NOT PASS CLASSIFIED INFORMATION.**
6. Microphone switch—XMIT.
Wait for beep tone which indicates system is ready for operation. Beep tone is necessary prior to each secure transmission.

Note

If no beep tone is heard, turn function knob to OFF and ON again. Repeat steps 5 and 6. If beep tone is still not heard, switch to P mode and **DO NOT PASS CLASSIFIED INFORMATION.**

7. System ready for operation.

NAVIGATION SYSTEMS

TACAN, AN/ARN-52(V)

The TACAN unit (Tactical Air Navigation) operates with ground- or ship-based beacons in the UHF band between 962 and 1213 MHz. This band is divided into 126 operating channels. The TACAN unit provides displays of magnetic bearing to station and slant-range distance to selected station. Bearing and distance up to 300 nautical miles are displayed to the pilot by the bearing-distance-heading indicator. The TACAN incorporates an air-to-air ranging function, capable of displaying line-of-sight distance only to like-equipped aircraft.

TACAN CONTROLS

The TACAN control panel (figure 7-10) is mounted on the pilot's instrument panel.

TACAN CONTROLS



1. FUNCTION KNOB (A/A)
2. VOLUME KNOB
3. CHANNEL KNOBS

OV-10D-1-150

Figure 7-10

Function Knob

The TACAN function knob (figure 7-10) controls operation and mode. The knob has four positions: OFF, REC, T/R, and A/A. Function knob positions operate TACAN as follows:

POSITION	FUNCTION
OFF	System secured.
REC (Receive)	System receives and indicates magnetic bearing only to selected station.
T/R (Transmit/ Receive)	System receives and indicates magnetic bearing and slant-range distance in nautical miles to selected station.
A/A (Air-to- Air)	System transmits, receives, and indicates slant-range distance in nautical miles to TACAN-equipped aircraft when 63-channel frequency separation is obtained.

Channel Knobs

The TACAN channel knobs (figure 7-10) are used to select operating channels 001 through 126. Channels 127, 128, and 129 may be selected but are inoperative. After an initial 90-second warm-up period, up to 12 seconds are normally required to achieve lock-on after changing channels.

Volume Knob

The VOL knob (figure 7-10) allows control of station identification audio signals as selected through the ICS monitor knob TCN. Ground- or ship-based stations transmit a Morse code identification signal every 15 or 30 seconds. No identification signal is present during the absence of station lock-on and in the A/A mode.

TACAN Power Switch

The TACAN power switch (figure 1-3) selects the primary a-c bus as a source of power in the event of failure of the No. 2 inverter, resulting in loss of No. 1 monitor a-c bus power. The TACAN power switch, normally maintained in the NORM position, should be moved to the ALT position if the No. 2 inverter fails. 28 VDC power is provided by the NO. 1 MONITOR bus.

TACAN OPERATION

The TACAN system presents precision displays of bearing and distance to the pilot through the BDHI. Bearing is accurate to within an average of +1 degree. Distance is accurate to within 0.1 nautical mile at less than 50 miles and to 0.2 nautical mile from 50 to 300 miles,

the maximum obtainable. Bearing and distance memory circuits allow continuous indications and lock-on retention during mild maneuvers or spurious signal operation. The bearing indication holds for 3 to 8 seconds and the distance indication will hold for 8 to 15 seconds. The unit is capable of maintaining bearing track during turns of up to 20 degrees per second, depending upon clear line-of-sight access to the station.

Audio Identifier

In the REC or T/R mode, a garbled or unreadable station identifier is an indication of malfunction of the aircraft unit or the surface station. Unless confirmed by known landmarks or ship sighting, range and bearing displays accompanied by an unreadable identifier should not be trusted.

False Bearings

TACAN will occasionally lock on to a false bearing which will be 40 degrees, or any multiple of 40 degrees, in error on either side of the correct bearing. Switching to another channel and then returning to the desired channel should recycle the search mode. This deficiency does not affect the distance indication provided.

Air-to-Air Ranging

TACAN airborne ranging provides line-of-sight distance indication up to 300 nautical miles between any suitably equipped transponder (like-equipped aircraft acting as the station) and up to five suitably equipped interrogator (homing) aircraft. A/A mode mechanization requires that the transponder and interrogator systems be set 63 channels apart. Use of the A/A mode requires prearrangement and preflight or in-flight briefing as necessary. The following table is a partial listing of compatible channel combinations.

TRANSPONDER CHANNEL	INTERROGATOR CHANNEL
001	064
020	083
100	037
120	057
126	063
064	001
083	020
037	100
057	120
063	126

Note

- When transponding to more than one interrogator, the distance displayed in the transponder aircraft will probably be to the closest interrogator beyond 0.1 nautical mile. With two or more interrogators at approximately the same distance, it is unknown which interrogator distance is being displayed.
- During A/A mode of operation, the BDHI No. 2 (bearing) pointer searches (no bearing is displayed). The ADF function of the UHF COMM must be set and used periodically to determine bearing between transponder and interrogator.

3. Function knob—A/A.
4. UHF COMM—AS DESIRED (ADF function).
5. Note distance to interrogator on BDHI.

TACAN PROCEDURES

Normal Navigation

1. Function knob—REC.
2. Select desired station channel.
3. ICS monitor knob TCN—PULL AND ADJUST.
4. TACAN VOL knob—ADJUST.
5. After lock-on, adjust volume and identify station.
6. Function selector—T/R.

Note

A 3-minute warm-up time is required to obtain distance readout.

7. Observe bearing and distance on BDHI.

Note

When No. 2 VHF-FM is placed in HOME, TACAN azimuth will be lost.

Air-to-Air Ranging (Homing)

1. Normal T/R mode operation—CHECK.
2. Prebriefed channel—SELECT.
3. Function knob—A/A.
4. UHF COMM—AS DESIRED (ADF function).
5. Note distance to transponder on BDHI.
6. To determine bearing to transponder, request transmission, and note BDHI No. 1 bearing indication.
7. With transponder in sight and confirmed, move function selector knob to T/R, REC, or OFF, as briefed.

Air-to-Air Ranging (Homer)

1. Normal T/R mode operation—CHECK.
2. Prebriefed channel—SELECT.

BEARING-DISTANCE-HEADING INDICATOR (BDHI)

An ID-663B/U BDHI (figure 7-11) is installed on the pilot's instrument panel. A repeater BDHI is installed on the observer's instrument panel. The BDHI provides a heading card, No. 1 and No. 2 bearing pointers, and a digital distance (range) indicator. The No. 1 pointer reflects UHF/ADF bearing. The no. 2 pointer reflects No. 2 VHF-FM or TACAN bearing. The distance (range) indicator displays slant range to surface-based TACAN beacons or line-of-sight distance to AN/ARN-52(V) equipped aircraft in the A/A mode.

IDENTIFICATION SYSTEMS

IFF-SIF, AN/APX-64(V)

The IFF-SIF system provides radar positive identification and specialized displays in four basic modes as part of the FAA/DOD AIMS (MK XII) system. Operating modes and codes are as follows:

MODE	SIF CODES	PURPOSE
1	32	Military Rapcon
2	None	Military Identification
3/A	4096	FAA Identification
4		(Operationally classified)
C	None	Altitude Reporting

IFF-SIF CONTROLS AND INDICATORS

The IFF-SIF control panel (figure 7-12) is located on the pilot's right console.

Master Knob

The MASTER knob (figure 7-12) selects IFF mode of operation as follows:

POSITION	FUNCTION
OFF	System secured.
STBY	Warm-up power only; no response to interrogation.
LOW	Receiver sensitivity reduced to interrogation with selected modes responding as interrogated.

- NORM** Receiver sensitivity normal to interrogation with selected modes responding as interrogated.
- EMER** Automatic emergency response to all interrogations.

Mode Select Switches

The mode select switches (figure 7-12) are used to select IFF mode response to interrogation and to test these modes through an integral self-test feature. The mode select switches operate in conjunction with the associated reply light for test purposes. Mode select switch operation is as follows:

POSITION	FUNCTION
OUT	Mode does not respond to interrogation.
ON	Mode responds to interrogation with MASTER knob at LOW or NORM .
TEST	Reply light illuminates for normal self-test of selected mode during ground self-test.

Identification Switch

The identification switch (figure 7-12) allows an individual aircraft, in a high-density traffic area, to be identi-

fied upon request. Holding the switch momentarily in IDENT provides a 30-second identification response, after which normal transponder operation resumes.

SIF Code Dials

SIF codes for IF MODE 1 and MODE 3/A are selected by use of vernier-type, direct-reading dials (figure 7-12) on the IFF control panel.

IFF Emergency Switch

The observer's IFF emergency switch (figure 1-5) guarded in **NORMAL** position, may be placed in **ON** to select emergency response to interrogation if required.

ANTENNA SELECT SWITCH

The IFF ANT SEL switch is a three-position switch located on the pilot's right console (figure 1-4). It is marked center position **BOTH**, up position **TOP**, and down position **BOTTOM**. When the switch is in **BOTH**, the system automatically alternates between the top and bottom antennas. Either of the other two positions locks the systems to the appropriate antenna. Normally, the switch is used in the center **BOTH** position. If poor pattern reception is detected by a ground station, switching to either the **TOP** or **BOTTOM** position may eliminate the problem.

BEARING-DISTANCE-HEADING INDICATOR

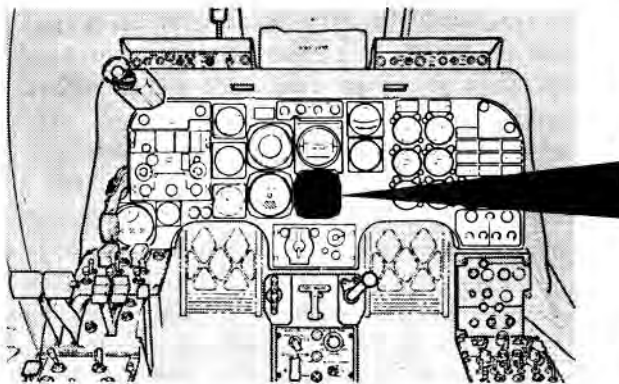

1. TOP (HEADING) INDEX.
2. No. 1 (ADF) POINTER.
3. ROTATING COMPASS CARD.
4. RANGE INDICATOR AND WARNING FLAG
5. NO. 2 (VHF-FM/TACAN) POINTER

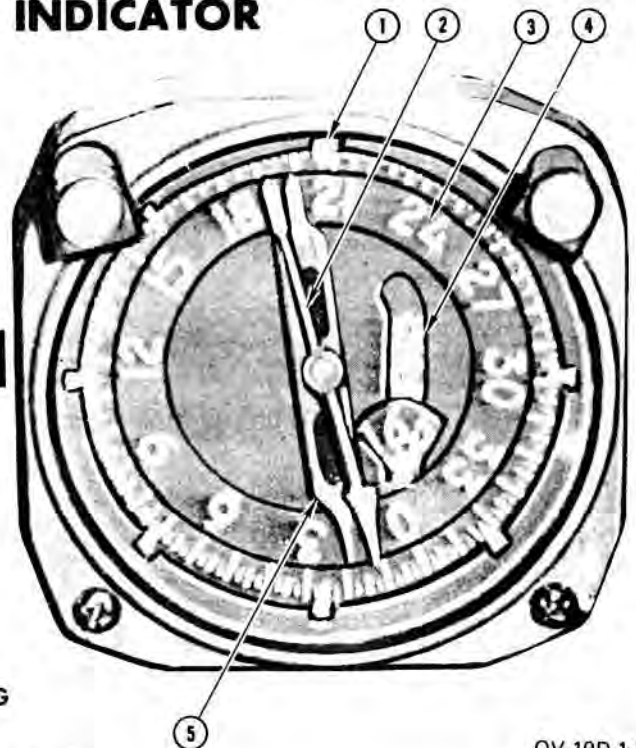
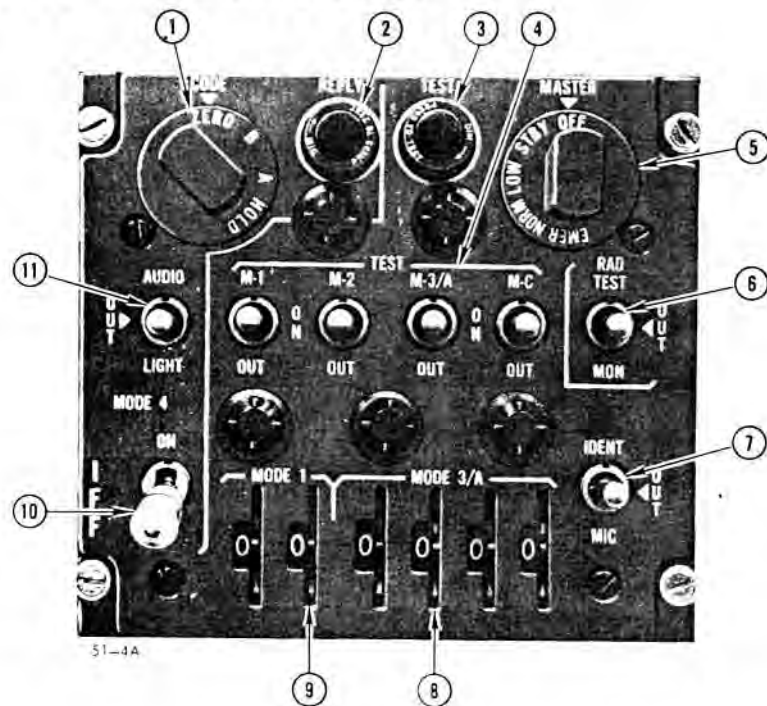

Figure 7-11

OV-10D-1-151

IFF—SIF CONTROLS



1. MODE 4 CODE KNOB
2. MODE 4 REPLY LIGHT
3. TEST LIGHT
4. MODE SELECT SWITCHES
5. IFF MASTER KNOB
6. RAD/TEST MON SWITCH
7. IDENT SWITCH
8. MODE 3/A SIF CODE DIALS
9. MODE 1 SIF CODE DIALS
10. MODE 4 SELECT SWITCH
11. MODE 4 AUDIO/LIGHT SWITCH

OV-10D-1-152

Figure 7-12

IFF-SIF OPERATION

To operate the AN/APX-64(V) system, proceed as follows:

1. MASTER knob—STBY.
2. AUDIO switch—OUT.
3. M-1 switch—ON.
4. M-2 switch—AS REQUIRED.
5. M-3/A switch—ON.
6. M-C switch—OUT.
7. RAD TEST switch—OUT.
8. MODE 4 switch—OUT.
9. MODE 1 code—AS REQUIRED.
10. MODE 3/A code—AS REQUIRED.
11. IDENT switch—OUT.
12. Before take-off, move MASTER knob to NORM.

Note

A 5-minute warm-up time is required to obtain response to interrogation.

AIMS SYSTEM

ALTIMETER-ENCODER, AAU-21/A

The AAU-21/A altimeter-encoder combines a conventional pneumatic altimeter and an altitude reporting encoder in one self-contained unit. Altitude readout is displayed by a counter-drum-pointer system. The counters display by direct digital output 10,000 and 1,000 feet increments while the drum displays 100 feet increments. Direct digital readout can be made from minus 1,000 to 38,000 feet. The single pointer repeats the indications of the 100-foot drum and provides a quick indication of the rate of altitude changes. The digital readout is referenced to 29.92 inches Hg and is not affected by changes of barometric setting. The encoder provides coded altitude information in 100-foot increments for automatic transmission when the transponder is interrogated on Mode C and the mode select switch M-C is in the ON position. A code "OFF" flag will appear in the upper left portion of the instrument face if power to the encoder is lost. The code "OFF" flag only monitors the encoder function of the altimeter. It does not indicate transponder condition. Altitude reporting may be inoperative without the code "OFF" flag showing if the transponder fails or controls are improperly set. If the code "OFF" flag appears, check that a-c power is available and circuit breakers are in. If the flag is still visible, contact a ground radar to determine altitude reporting operation and proceed

accordingly. In the event of encoder failure, the instrument continues to function as a normal barometric altimeter. The altimeter is set by turning the barometric setting knob on the lower left, front side of the case until the proper setting is visible in the Kollsman dial on the lower right side of the instrument display (range 28.1 to 31.0 inches Hg). The instrument also contains an internal vibrator which operates whenever d-c power is on. The vibrator provides for smooth display changes by minimizing mechanical friction effect. If the vibrator fails, the instrument will continue to function pneumatically, but a less smooth movement of the instrument display will be evident. The 100-foot pointer may stick when passing the 12-o'clock position. This effect can be lessened by tapping the instrument case.

Mode 4

Mode 4 is a military secure mode. It will operate only when the cryptographic transponder-computer (KIT-1A/TSEC) is installed. Controls and indicators for this mode are located on the left side and top of the AN/APX-64(V) control unit outlined by a white line. Mode 4 interrogation is received by a cryptographic transponder-computer which encodes and triggers a proper identification response signal. The IFF MASTER knob (figure 7-11) controls the transponder in all modes. When the MODE 4 select switch is selected ON, Mode 4 is inoperative in either STBY or OFF position of the IFF MASTER knob. To operate Mode 4, the MODE 4 select switch must be in the ON position, selected codes must be inserted into the system, and CODE A or B selected on the Mode 4 CODE knob. Should Mode 4 fail to reply to a valid interrogation, the IFF caution light will illuminate.

The amber IFF caution light is located on the pilot's instrument panel. It illuminates to alert the pilot that the AN/APX-64(V) has failed to reply to a valid Mode 4 interrogation provided that the aircraft power is on and the IFF MASTER knob is not OFF. The IFF caution light circuitry monitors for: (1) Mode 4 codes zeroized, (2) transponder failure to reply to proper interrogation, and (3) automatic self-test function of the computer revealing a computer malfunction. Should the IFF caution light illuminate, check IFF MASTER knob NORM, MODE 4 select switch ON, and Mode 4 CODE knob in proper A or B code position for current time period. If the light remains on, avoid operation in a known Mode 4 interrogating environment or if already in one, take appropriate corrective or emergency action as operationally directed for this condition (inoperative Mode 4).

The MODE 4 select switch is provided for control of Mode 4 operation. It is labeled ON and OUT. It is a positive action, lift-lock switch which must be pulled out to be placed OFF.

The MODE 4 AUDIO/LIGHT switch is a three-position toggle switch with LIGHT, OUT (center), and AUDIO positions. When the switch is placed in the LIGHT position, only the reply light of Mode 4 is enabled. The AUDIO position enables both the reply light and an aural indication. With the switch in AUDIO, an aural signal indicates that Mode 4 interrogations are being received and illumination of the reply light indicates that replies are transmitted. This switch must be placed in either AUDIO or LIGHT position when operating Mode 4. In the OUT position, both the light and audio indications are inoperative.

A green Mode 4 REPLY light is provided to indicate that Mode 4 replies are being transmitted when the MODE 4 AUDIO/LIGHT select switch is in either the LIGHT or AUDIO position. The REPLY light will not illuminate when pressed-to-test unless the MODE 4 AUDIO/LIGHT switch is in either the LIGHT or AUDIO position.

The Mode 4 CODE knob is a four-position (HOLD, A, B, and ZERO) rotary knob. A and B codes are preset daily as operationally directed by the single insertion of a code changer key. A is the present code and B is the next succeeding code, thus enabling the set to properly reply to any valid Mode 4 interrogation during a given time period. The ZERO position zeroizes the code setting. Both codes are normally zeroized when the IFF MASTER knob is turned to OFF after the aircraft has landed. If a second flight is anticipated during the installed code time periods, the code setting may be retained by selecting the HOLD position of the knob. The HOLD position is spring-loaded to return to the A position. To hold codes, the knob must be held momentarily (2 to 3 seconds) to the HOLD position before power is removed from the transponder. Allow transponder power to remain on for at least 15 seconds after the knob is released, and then turn off as desired. The code setting is now mechanically latched and will be retained when aircraft power is turned off. To hold the code setting, the aircraft weight must be on the landing gear. The HOLD function will remain in effect until the aircraft weight is off the landing gear. If power is removed from the transponder less than 15 seconds after selecting HOLD, either by turning the transponder off or by turning off aircraft electrical power, the code setting will zeroize when transponder power is lost. Both A and B codes may be zeroized any time the aircraft has electrical power on and the IFF MASTER knob is in any position except OFF by placing the Mode 4 CODE knob to the ZERO position. The Mode 4 CODE knob must be pulled out before it can be turned to the ZERO position.

Any time (in flight or on the ground), the IFF MASTER knob is placed in the OFF position, the A and B codes are zeroized unless the HOLD function has been properly actuated.

TRANSPONDER TEST SET

When the transponder test set (TS-1843) is installed and operated in the self-test mode by placing one of the mode select switches in the TEST position, the test set generates interrogation pulse pairs for the desired mode. These interrogations are applied to the transponder to check for proper receiver frequency, sensitivity, and decoding. The test set analyzes the resulting replies for bracket spacing, frequency, power, and antenna circuitry and provides a go/no-go indication to the operator. If the TEST light does not illuminate, the selected mode is in a no-go condition. The self-test modes will operate only if the IFF MASTER knob is set to the NORM position, the transponder test set indicates transponder performance by illuminating the TEST light when interrogation replies are made. RAD TEST position is used for ground test operation and requires additional equipment. The AN/APX-64(V) will operate normally without the test set installed but the operator is deprived of all test capabilities.

OPERATION OF TRANSPONDER

1. IFF MASTER knob—STBY (warm-up for 2 minutes).
2. Mode select switches—ON (desired modes).
3. Mode SIF code dials—SET (as desired).
4. RAD TEST/MON switch—OUT or MON (as desired).
5. IFF MASTER knob—NORM (before take-off).
6. Mode select switches—If the test set is installed, hold desired switch to TEST until TEST light illuminates. If light does not come on, the selected mode is inoperative. (There is no test for Mode 4.)

To Operate Mode 4

(IFF MASTER control knob LOW, NORM, or EMER)

7. MODE 4 select switch—ON.
8. MODE 4 AUDIO/LIGHT switch—AUDIO (as desired).
9. Mode 4 CODE knob—A or B (as required by time period).

ELECTRONIC COUNTERMEASURES EQUIPMENT

AN/ALE-39 COUNTERMEASURES DISPENSING SET

On aircraft having AFC 82 incorporated, the countermeasures dispensing set, AN/ALE-39, is installed and is

used to dispense countermeasures materials (metallic chaff, flares, and jammers) aft of the aircraft. The ejected countermeasures materials deceive enemy radars and infrared sensors, and jam communications frequencies, which enables the aircraft to evade air-to-air and surface-to-air attacks. A sequencer switch and dispenser module are located in each of the tail booms of the aircraft. Each dispenser has 30 cylindrical discharge tubes, electrically partitioned into sections of 10 and 20 discharge tubes. The dispenser module sections are identified as L10 (left 10), L20 (left 20), R10 (right 10), and R20 (right 20) to distinguish payload locations and controlling circuits. The cartridges containing the countermeasures materials are carried in the discharge tubes of the two dispensers. After loading the dispensers, the ground personnel set the programmer LOAD switches to indicate which type of load is in each of the four sections. The countermeasures materials are ejected from the dispenser tubes by electrical signals controlled by the pilot. The programmer search and fire circuitry automatically senses the location of the selected type of payload in the dispensing sections. If the desired type of payload is not loaded or has been expended from one section, the system cascades to the next loaded dispenser section from which the dispensing sequence is completed.

Manual (single) dispensing or multiple programmed dispensing sequences of countermeasures materials can be selected on the pilot's cockpit control unit and dispensing initiated by either the pilot or observer, by depressing the INITIATE switch. Manual dispensing can be performed during a programmed dispensing sequence without disrupting the program. Flare salvo dispensing can also be initiated by placing the POWER/FLARE SALVO switch on the pilot's cockpit control panel to the FLARE SALVO position. All remaining flares, regardless of loaded location, are dispensed in a rapid-fire sequence. The MX-9254/ALE-39 programmer is located in the right-hand wheel well. Programmed dispensing routines for chaff, flares, and jammers are set into the programmer and LOAD switches set to indicate which type of load is in each of the dispenser sections. Programmer controls for the programmed dispensing of countermeasures materials can be set to control the number of bursts (single firings) and the time lapse between bursts. In addition to burst quantity and interval control the chaff programmed payload dispensing control includes the number of chaff salvos and the time lapse between chaff salvos in a programmed sequence.

COUNTERMEASURES DISPENSING SET CONTROLS AND INDICATORS

All controls and indicators for the countermeasures dispensing set are on the programmer control panel, located in the right-hand wheel well, the countermeasures dispenser control panel, located on the pilot's instrument panel, and two INITIATE switches, one located on the pilot's instrument panel and one located on the observer's instrument panel.

COUNTERMEASURES DISPENSER CONTROL PANEL

The countermeasures dispenser control panel (figure 7-13) is mounted above the upper left shroud of the pilot's instrument panel.

POWER/FLARE SALVO Switch

A POWER/FLARE SALVO lever lock toggle switch (figure 7-13) has ON, OFF, and FLARE SALVO positions and is used to control primary 28 vdc power to the AN/ALE-39 programmer and to initiate the programmer flare salvo sequence.

Mode Selector Control Switches

Three rotary selector switches are provided for selection of chaff (CHF), flare (FLR), and jammer (JMR) dispensing modes. The chaff and jammer mode selector switches have four positions: O (off), S (single), P (program), and R (RWR). The flare mode selector switch has eight positions: O (off), S (single), M (multiple), O (off), P (program), G (group), O (off), and R (RWR). These positions function as follows:

POSITION	FUNCTION
O (off)	Initiation of dispensing is not possible.
S (single)	Causes a single dispense command to the programmer for each actuation of the dispense INITIATE switch.
P (program)	Causes a programmed dispense command to be sent to the programmer for each activation of the dispense INITIATE switch.
R (RWR)	Causes a single dispense command to be sent to the programmer for each activation of the dispense INITIATE switch and additional functions not used on this installation.
M (multiple)	A command to the programmer to cause it to dispense flare payloads in parallel if available, and is initiated by activation of the flare dispense INITIATE switch.
G (group)	A combination command of P and M modes, which causes the programmer to expand flare payloads from all available sections in parallel in the quantity and time interval selected by the programmer.

LOAD REMAIN Display Counter

Three LOAD REMAIN subtractive counters are provided to indicate the number of unfired CHF (chaff), FLR (flare), and JMR (jammer) cartridges remaining in the dispensers. Each counter has a reset knob to allow manual setting or resetting of each display to all integers between 00 and 99. The counters have mechanical stops at 00 and are not damaged by additional decrementing counter signals.

PROGRAMMER CONTROL PANEL

The programmer control panel (figure 7-13) is located in the right-hand wheel well. The programmer unit accepts command signals from the cockpit control unit and provides the two sequencer switches with stepping pulses for dispensing countermeasures payloads from the dispensers. The programmer controls are set prior to flight and cannot be changed during flight.

CHAFF B QTY Switch

The CHAFF B QTY switch has positions 1, 2, 3, 4, C, and R which select the number of chaff bursts in one salvo. The C position permits continuous dispensing of individual bursts at the rate selected on the CHAFF B INTV switch. Dispensing continues until all chaff has been expended or until the dispenser control POWER/FLARE SALVO switch is positioned to OFF. The R position permits a random number of bursts in one salvo (4 minimum or 6 maximum).

CHAFF B INTV Switch

The CHAFF B INTV switch has positions .1 (0.125 second), .2 (0.250 second), .5 (0.500 second), .7 (0.750 second), 1.0 (1.0 second), and R (Random) which select the time interval in seconds between each chaff burst in a salvo. With the CHAFF B INTV switch in RANDOM, the first three bursts of the first salvo are 0.125 second apart. Additional bursts of 1, 2, or 3 are fired at random time intervals of either 0.25, 0.50, 0.75, 1.00, 1.50, 2.00, 3.00, or 4.00 seconds when CHAFF B QTY switch is at R or C. If CHAFF B INTV switch is on R and CHAFF B QTY is not on R or C, a single chaff payload is dispensed.

CHAFF S QTY Switch

The CHAFF S QTY switch has positions of 2, 4, 6, 8, 10, and 15 which select the number of chaff salvos in one programmed sequence.

CHAFF S INTV Switch

The CHAFF S INTV switch has positions of 2, 4, 6, 8, and 10 which select the time interval in seconds between ejection of each salvo in an automatic sequence.

AN/ALE-39 COUNTERMEASURES DISPENSING SET CONTROLS (AIRCRAFT HAVING AFC 82 COMPLIED WITH)

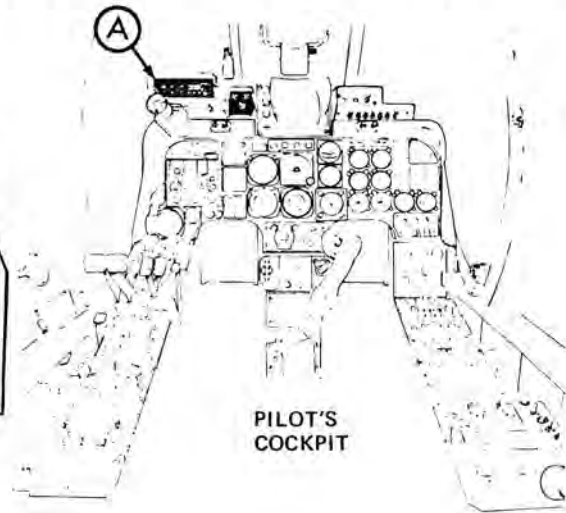
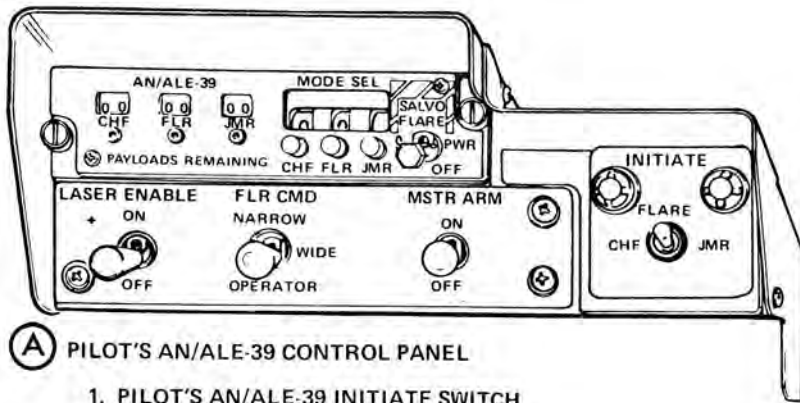

A PILOT'S AN/ALE-39 CONTROL PANEL

1. PILOT'S AN/ALE-39 INITIATE SWITCH
2. PILOT'S COUNTERMEASURES DISPENSER CONTROL PANEL

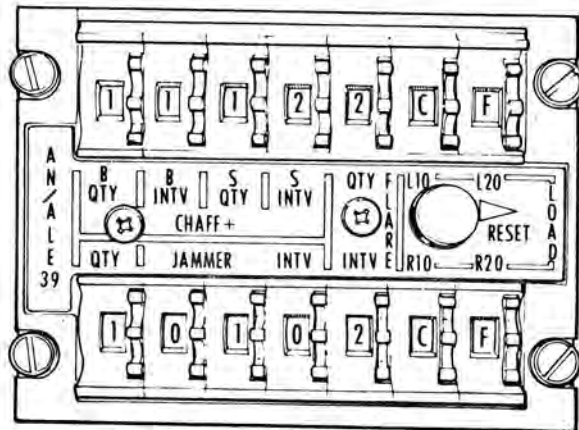
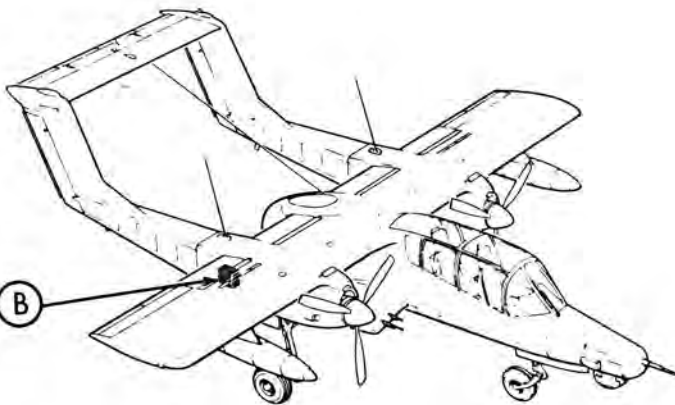

B PROGRAMMER CONTROL PANEL

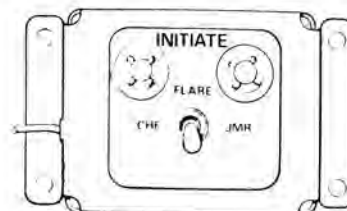
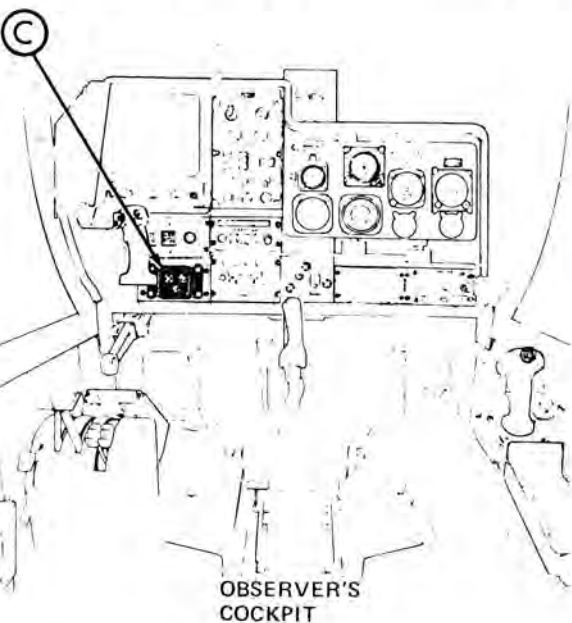

C OBSERVER'S AN/ALE-39 INITIATE SWITCH

Figure 7-13

JAMMER QTY Switch

The JAMMER QTY switch has positions of 1, 2, 3, and 4 which select the number of jammer bursts in one programmed sequence.

JAMMER INTV Switches

The three JAMMER INTV switches provide for selection of time interval between jammer bursts from 001 to 299 seconds.

FLARE QTY Switch

The FLARE QTY switch has positions 2, 3, 4, 6, 8, and 10 which select the number of flare bursts in one flare programmed sequence.

FLARE INTV Switch

The FLARE INTV switch has positions of 2, 4, 6, 8, and 10 which select the time interval in seconds between flare bursts during flare programmed sequence.

L10, L20, R10, R20 LOAD Switches

The four LOAD switches have positions of C (chaff), F (flares), and J (jammers) which are set by ground personnel to indicate which type of load is in each of the four dispenser sections.

RESET Switch

The RESET switch is used to clear all registers in the programmer and resets the sequencer switches (cancels remainder of a program).

INITIATE SWITCH PANEL

An INITIATE switch panel is located above the upper left shroud of the pilot's instrument panel (figure 7-13) and the left side of the rear cockpit instrument panel (figure 7-13). The multiposition, momentary toggle switch has positions of CHF, FLR, and JMR with center position off. Momentarily depressing the switch to CHF, FLR, or JMR will initiate a dispense function to the programmer as selected on the pilot's countermeasures dispenser control panel.

COUNTERMEASURES DISPENSING SET OPERATION

The countermeasures dispensing set is placed in operation by positioning the POWER/FLARE SALVO switch to the ON position. This applies +28 vdc to the programmer and enables the search and fire circuitry. Countermeasures materials may be dispensed manually or automatically (programmed). Manual (single) dispensing of chaff, flares, or jammers can be performed during a programmed dispensing sequence without disrupting the program.

The programmer is located in the right-hand wheel well and programmer controls for programmed dispensing of payloads must be set prior to flight. The number of bursts and the time lapse between bursts for programmed dispensing of chaff, flares, and jammers and the number of chaff salvos and the time lapse between chaff salvos in a programmed sequence are selected on the programmer control panel.

On the pilot's countermeasures dispenser control panel, set the LOAD REMAIN display counters to indicate the number of each type payload material (chaff, flares, jammer) loaded in the dispensers.

Flares may be salvoed at any time (in flight) by placing the POWER/FLARE SALVO switch to the FLARE SALVO position. All remaining flares, regardless of loaded location are dispensed in a rapid-fire sequence.

MANUAL OPERATION (Single Dispensing)

After the dispensing system is placed in operation by positioning the POWER/FLARE SALVO switch to ON, position the mode selector switches on the pilot's dispenser control panel to the indicated position.

1. CHF mode switch—"S" (single).
2. FLR mode switch—"S" (single) or "M" (multiple).
3. JMR mode switch—"S" (single).

With the mode switches in "S" position, momentarily depressing the pilot's or observer's INITIATE switch to either CHF, FLR, or JMR will dispense one payload of selected countermeasures material. With the FLR mode switch in "M" position, depressing the INITIATE switch to FLR will dispense from one to four flares simultaneously as a single dispense, depending on how the four sections of the dispensers are loaded. If three sections have flares loaded, three flares can be fired simultaneously, or if only one section has flares loaded, a single flare will be fired.

AUTOMATIC OPERATION (Programmed Dispensing)

After the dispensing system is placed in operation by positioning the POWER/FLARE SALVO switch to ON, position the mode selector switches on the pilot's dispenser control panel to the desired position.

Chaff Dispensing

Place CHF mode switch to "P" position. With the mode switch in "P" position, momentarily depressing the pilot's or observer's INITIATE switch to CHF will initiate a programmed sequence of dispensing chaff payloads from the dispensers. The number of salvos, number of bursts for

each salvo, time interval between bursts, and time interval between salvos are determined by the setting (prior to flight) of the programmer switches (CHAFF B QTY, CHAFF B INTV, CHAFF S QTY, and CHAFF S INTV). With the CHAFF B QTY switch in "C" (continuous) the individual bursts are dispensed continuously at the rate determined by the position of the CHAFF B INTV switch.

Note

Continuous dispensing can only be terminated by positioning the POWER/FLARE SALVO switch to OFF.

The positions of the CHAFF S QTY and CHAFF S INTV switches are meaningless when the CHAFF B QTY switch is in "C."

Jammer Dispensing

Place JMR mode switch to "P" position. With the mode switch in "P" position, momentarily depressing the pilot's or observer's INITIATE switch to JMR will initiate a programmed sequence of dispensing jammer payloads from the dispensers. The number of jammer bursts in one programmed sequence and the time interval between jammer bursts are determined by the setting (prior to flight) of the

programmer switches (JAMMER QTY and JAMMER INTV).

Flare Dispensing

1. Place FLR mode switch to "P" position. With the FLR mode switch in "P" position, momentarily depressing the pilot's or observer's INITIATE switch to FLR will initiate a programmed sequence of dispensing flare payloads from the dispensers. The number of flare bursts in one programmed sequence and the time intervals between flare bursts are determined by the settings (prior to flight) of the programmer switches (FLARE QTY and FLARE INTV).
2. Place FLR mode switch to "G" position. With the FLR mode switch in "G" position, momentarily depressing the pilot's or observer's INITIATE switch to FLR will initiate a programmed sequence of dispensing multiple flare payloads (up to four flares dispensed simultaneously) from the dispensers. The number of multiple flare bursts in one programmed sequence and the time intervals between flare bursts are determined by the settings (prior to flight) of the programmer switches (FLR QTY and FLARE INTV).

PART 2 — COMMUNICATIONS

GENERAL

Communications and associated electronic equipment are described in Part 1 of this section. The installed radio equipment requires various times for warm-up, usually not less than a 3-minute warm-up period is recommended prior to operation. For specific warm-up periods, see figure 7-3.

OPERATION

The mission requirements dictate that pilots and observers adhere to proper voice procedures and strict radio discipline as standardized by the current editions of NWP 16, 32, 37, and 41. Guard frequency must be continuously monitored but transmissions will be made only in an emergency situation. Ground-to-air signals, including aircraft maneuvers as acknowledgements, will be in accordance

with NWP 41 and NAVAIR 00-25-513. Channelization of installed radios will be in accordance with the appropriate communication plan.

VISUAL COMMUNICATIONS

Communications between aircraft within a formation will be conducted visually whenever practicable, provided no sacrifice in operational efficiency is involved. Flight leaders will ensure that all aircraft in the formation receive and acknowledge signals when given. Visual signals as set forth in NWP 41 will be used. For emergency signaling, the FAA standard HEFOE system should be used:

1 finger H Hydraulic
2 fingers E Electrical
3 fingers F Fuel
4 fingers O Oxygen
5 fingers E Engine

SECTION VIII—WEAPONS SYSTEMS**TABLE OF CONTENTS**

PART 1—ARMAMENT SYSTEMS.....	8-1	Forward Looking Infrared Detecting Set (FLIR)	8-7
Armament Equipment	8-1	Laser Rangefinder Designator (LRD)	8-8
Weapon Delivery Procedures	8-4	Infrared Laser Detecting-Ranging Set, AN/AAS-37 Controls and Indicators	8-8
PART 2—AVIONICS	8-7	Infrared Laser Detecting-Ranging Set, AN/AAS-37 Operation	8-15
Infrared Laser Detecting-Ranging Set, AN/AAS-37	8-7		

PART 1—ARMAMENT SYSTEMS**ARMAMENT EQUIPMENT**

The aircraft is capable of carrying varied conventional weapons loads, including gun pods, bombs, rocket pods, and napalm. Only those stores listed in AIRCRAFT OPERATING LIMITATIONS, in Section I, Part 4, are authorized to be carried and released or fired to the limits shown.

GUNNERY EQUIPMENT**SPONSON GUNS**

Two M60C 7.62-millimeter NATO machine guns are integrally installed in each sponson. The M60C is an electrically charged, gas-operated weapon which is adapted from the M60 NATO automatic rifle. Each pair of guns (left and right) may be charged separately on the ground or in flight. Ground use of the sponson-mounted charging switches requires application of external d-c power or that the BATTERY switch be placed to ON; the MASTER ARM switch must be moved to ON. Tracer, ball, and armor-piercing ammunition are available for use with the M60C gun.

BOMBING EQUIPMENT

A variety of conventional weapons may be carried on seven external store stations. One pylon may be installed under each wing, two pylons are installed on each sponson, and one pylon may be installed at centerline on the fuselage. The centerline station will carry a single store weighing up to 1200 pounds at design "g" limits, and may be adapted for stores requiring 14-inch or 30-inch suspension spacing. The remaining stations are designed for 14-inch suspension spacing and will carry stores weighing up to 600 pounds at design "g" limits. The external store station pylons are bolted on and cannot be dropped.

ROCKET EQUIPMENT

Several types of standard rocket pods can be carried at the sponson stations, centerline pylon, and the wing pylon stations. For rocket pod capability, refer to Section XI, Part 1.

MISSILE EQUIPMENT

A missile control panel is located on the pilot's center pedestal. However, electrical wiring and provisions for

carrying AIM-9 air-to-air missiles are not provided and the missile control panel is inoperative on the OV-10D aircraft.

OPTICAL SIGHT

An illuminated, reflecting, noncomputing optical sight (figure 8-1) is installed in the pilot's cockpit. The reticle may be depressed up to 270 mils through tilting of the reflecting glass to provide proper sight angles for release slant range or lead angles for all types of weapons. The reticle image consists of a 2-mil pipper and quadrantal markings composed of divided 50- and 100-mil rings, with cardinal lines made up of alternating 10-mil marks and spaces. The gunsight may be removed and stored, if desired, in space provided in the forward left-hand side of cargo bay.

INCLINOMETER LIGHT

A post light, mounted on the optical sight inclinometer, provides improved illumination of the mil settings index and improved reticle light intensity. Illumination is controlled by the STBY COMPASS switch and intensity is controlled by the INSTRUMENTS knob.

SIGHT AND ARMAMENT CONTROLS**MASTER ARM SWITCH**

The ON position of the MASTER ARM switch (figure 8-1) applies power to the d-c armament bus when the landing gear handle is in the UP position. All armament selection, release, and firing power is provided through the master arm circuit. The ground safety provisions for the electrical armament fire, release, and emergency jettison systems may be bypassed for ground checks and maintenance through an ARMT SAFETY DISABLE switch in the left main landing gear well.

SIGHT RETICLE BRIGHTNESS KNOB

The sight reticle brightness knob (figure 8-1) allows selection of sight reticle illumination and brightness adjustment.

FILAMENT SELECT SWITCH

The filament select switch (figure 8-1) allows selection of the NO. 1 or NO. 2 sight reticle illuminator filament. Sight reticle brightness and ON/OFF selection are controlled through the sight dimmer knob.

OPTICAL SIGHT AND ARMAMENT CONTROLS

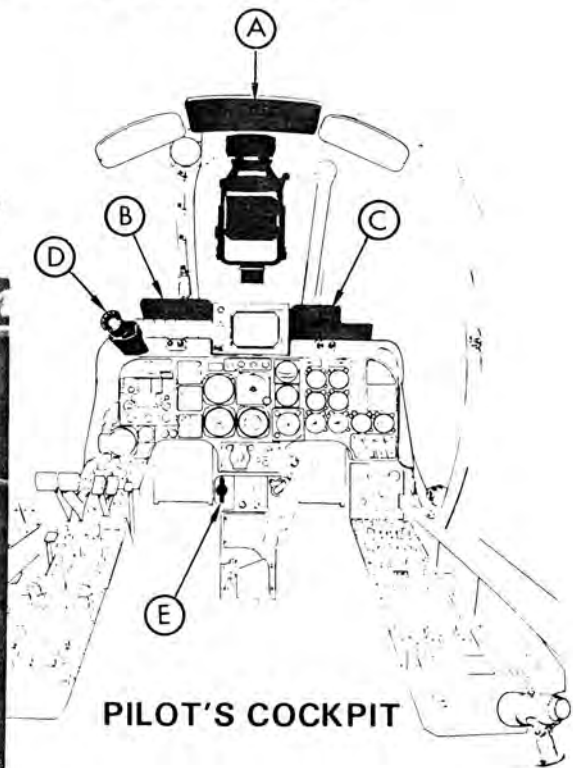
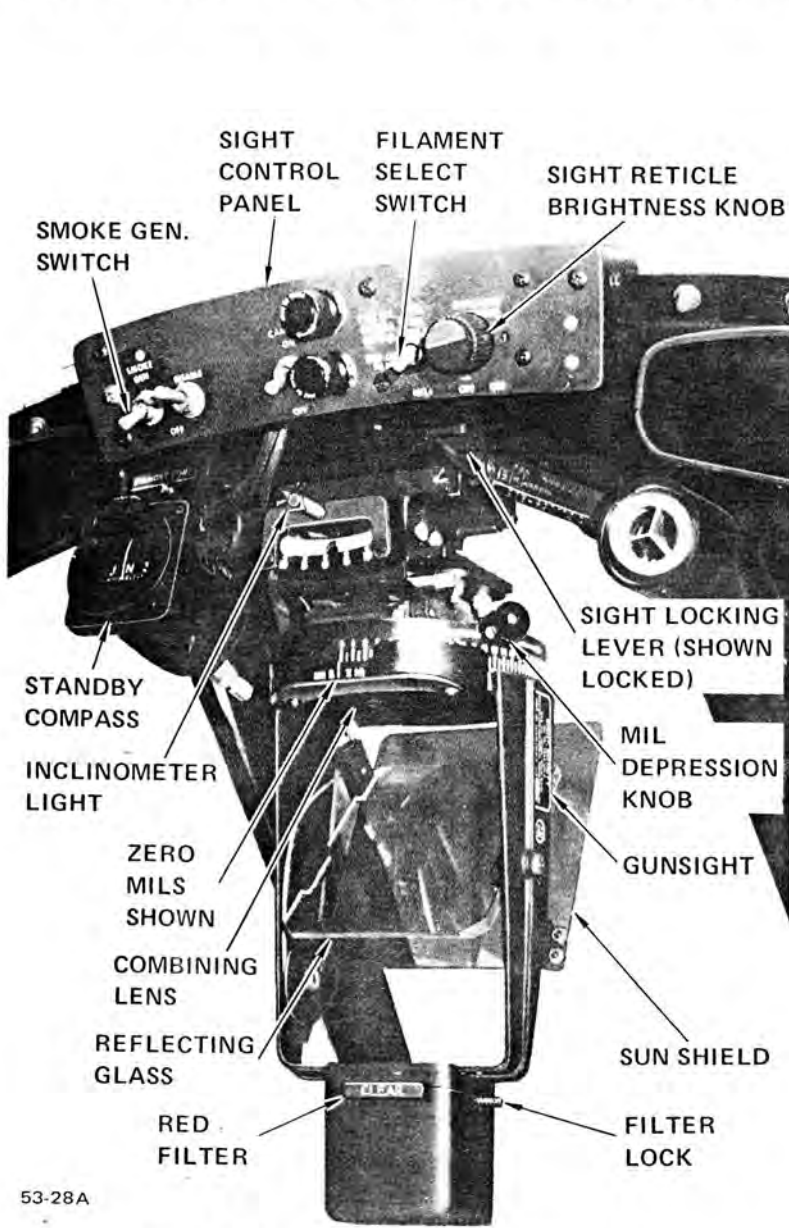

53-28A

(A) OPTICAL SIGHT AND CONTROL PANEL

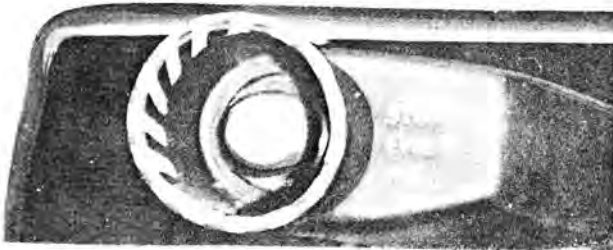

30-6B-1B

(D) STORES EMERGENCY RELEASE BUTTON



30-6B-1B

(E) EMERGENCY STORES JETTISON HANDLE

OV-10D-1-67

Figure 8-1 (Sheet 1)

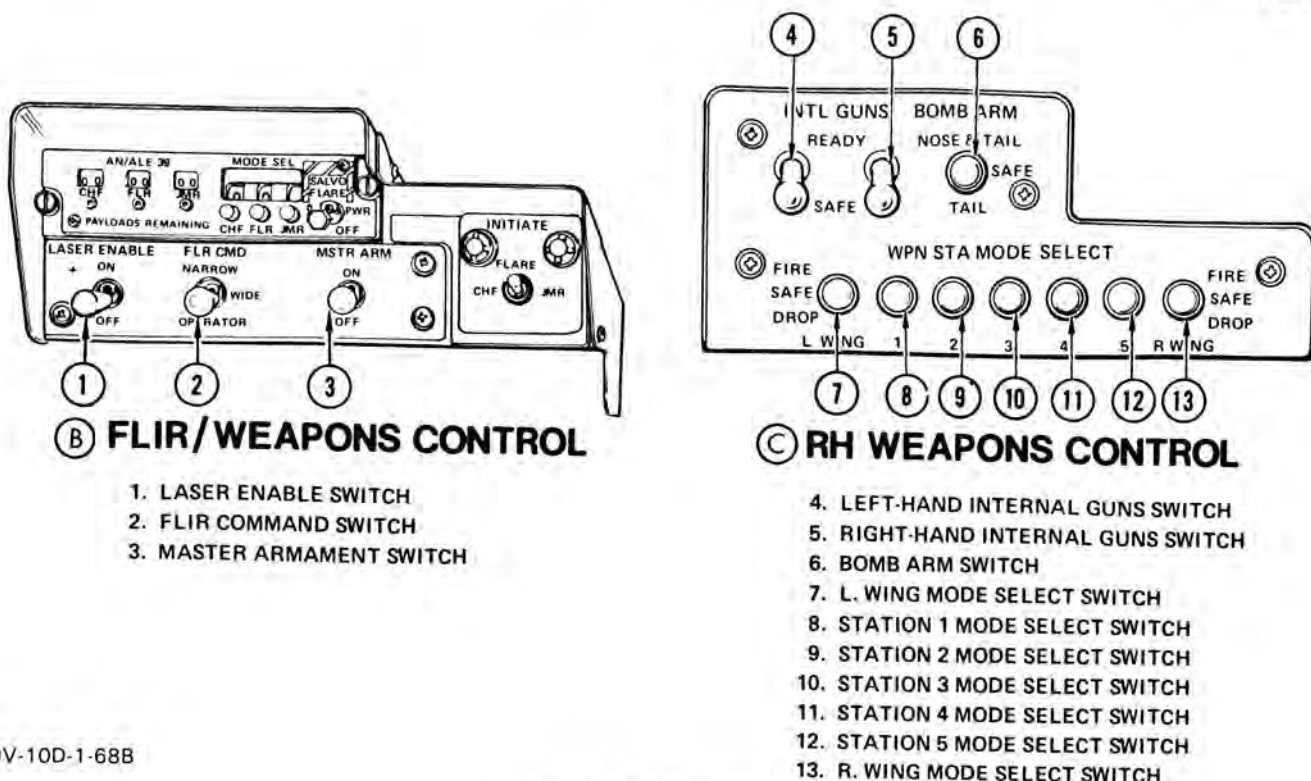

OV-10D-1-68B

Figure 8-1 (Sheet 2)

Note

Select NO. 1 filament to prevent top filament, if burned out, from shorting out bottom filament. To prolong filament life, the brightness control knob should be maintained at full low until brightness is required. Use NO. 2 filament after failure of NO. 1 filament.

SIGHT DEPRESSION LEVER

The sight depression lever (figure 8-1), mounted on the sight body, allows variable depression settings from 0 to 270 mils. The selected depression is read directly on the sight body. Depression is indicated in MILS X 10.

GUNS SWITCHES

Two guns switches are provided. The left- and right-hand pair switches (figure 8-1) are used to select READY or SAFE condition of the fixed guns, which may be fired in selected pairs or simultaneously. The fixed gun charging mechanism may be ground-checked through use of an auxiliary gun charger switch in each sponson.

STATION MODE SELECT SWITCHES

The STATION MODE SELECT switches (figure 8-1) are used to select installed external ordnance for firing or release as required. These switches are lever-loc type requiring the switch be lifted for actuation. The SAFE position is used to disable the bomb release button circuits.

The STATION MODE SELECT switches operate with the bomb release button as follows:

MODE	ORDNANCE
FIRE	Gun pods, rockets, dispensers
SAFE	Safe
DROP	Normally dropped munitions

BOMB ARM SWITCH

The BOMB ARM switch (figure 8-1) is used to arm mechanically or electrically fuze bombs. Weapons may be armed for NOSE & TAIL or TAIL fuze detonation, as required.

BOMB RELEASE BUTTON

The bomb release button (figure 1-13) is located on the pilot's stick grip. This button is used to drop any store selected through the DROP position of the STATION MODE SELECT switches and to fire any externally carried, forward-firing ordnance selected by the FIRE position.

TRIGGER

The trigger (figure 1-13) is located on the pilot's stick grip. This switch is used to fire the sponson (internal) guns only.

Part 1

STORES EMERGENCY RELEASE BUTTON

The STORES EMER REL button (figure 1-4) when depressed, releases all external stores. The stores emergency release system, powered by the battery bus, is operative only with the aircraft airborne. The emergency release system is independent of the MASTER ARM switch.

EMERGENCY STORES JETTISON HANDLE

The EMER ST JETT handle (figure 1-4) is located on the pilot's center pedestal. All stores *except* the centerline station store and wing-mounted stores may be jettisoned manually by pulling this handle outward approximately 3 inches.

Note

If desired, the centerline external fuel tank may be retained and all other external stores except wing stores released by pulling the EMER ST JETT handle.

WEAPON DELIVERY PROCEDURES**STRAFE (FIXED GUNS)**

1. Sight reticle brightness knob—AS REQUIRED.
2. FIL SEL switch—NO. 1 OR NO. 2.
3. Sight depression—AS REQUIRED.
4. INTL GUNS LH/RH switches—READY.
5. MASTER ARM switch—ON.
6. To fire—DEPRESS TRIGGER ON PILOT'S STICK GRIP.
7. To secure, INTL GUNS LH/RH switches—SAFE.
8. To secure, MASTER ARM switch—OFF, after a minimum of 5 seconds.

STRAFE [GPU-2/A (M-197) GUN POD]

1. Sight reticle brightness knob—AS REQUIRED.
2. FIL SEL switch—NO. 1 OR NO. 2.
3. Sight depression—AS REQUIRED.
4. Pod(s) STATION MODE SELECT switch(es)—FIRE.
5. MASTER ARM switch—ON.
6. To fire—DEPRESS BOMB BUTTON.
7. To secure, Pod(s) STATION MODE SELECT switch(es)—SAFE.

8. MASTER ARM switch—OFF.

STRAFE (SUU-11A/A PODS)

1. MASTER ARM switch—ON.
2. Sight reticle brightness knob—AS DESIRED.
3. FIL SEL switch—NO. 1 OR NO. 2.
4. Sight depression—AS REQUIRED.
5. Pod(s) STATION MODE SELECT switch(es)—FIRE.
6. To fire—DEPRESS BOMB BUTTON.
7. To safe bomb button, pod(s) STATION MODE SELECT switch(es)—SAFE.
8. MASTER ARM switch—OFF.

FIRING ROCKETS

1. Sight reticle brightness knob—AS REQUIRED.
2. FIL SEL switch—NO. 1 OR NO. 2.
3. Sight depression—AS REQUIRED.
4. Rocket STATION MODE SELECT switches—FIRE.
5. MASTER ARM switch—ON.
6. To fire—DEPRESS BOMB BUTTON.
7. To drop empty pods—SELECT DROP AND DEPRESS BOMB BUTTON.
8. To secure, MASTER ARM switch—OFF.

FIRING ROCKETS FROM WING STATIONS

1. Sight reticle brightness knob—AS REQUIRED.
2. FIL SEL switch—NO. 1 OR NO. 2.
3. Sight depression—AS REQUIRED.
4. L WING or R WING MODE SELECT switch—FIRE.
5. MASTER ARM switch—ON.
6. To fire—DEPRESS BOMB BUTTON.
7. To secure—MASTER ARM switch—OFF.

DROPPING BOMBS

1. Sight reticle brightness knob—AS DESIRED.
2. FIL SEL switch—NO. 1 OR NO. 2.

3. Sight depression—AS REQUIRED.
 4. BOMB ARM switch—AS BRIEFED (NOSE & TAIL or TAIL).
 5. STATION MODE SELECT switches—DROP (desired stations).
 6. MASTER ARM switch — ON.
 7. To release — DEPRESS BOMB BUTTON.
 8. To secure, MASTER ARM switch — OFF.
2. MASTER ARM switch — ON.
 3. To dispense flares — DEPRESS BOMB BUTTON.
 4. To secure, MASTER ARM switch — OFF.

DISPENSING FLARES

1. Flare pod STATION MODE SELECT switch — FIRE.

ARMAMENT SAFETY CHECK

1. INTL GUNS LH/RH switches—SAFE.
2. BOMB ARM switch—SAFE.
3. STATION MODE SELECT switches—SAFE.
4. MASTER ARM switch — OFF.
5. Sight reticle brightness knob — OFF.

PART 2—AVIONICS

**INFRARED LASER DETECTING-
RANGING SET, AN/AAS-37**

The infrared laser detecting-ranging set, AN/AAS-37 consists of a forward looking infrared detecting set (FLIR) and a laser rangefinder designator (LRD). The FLIR views the terrain in the vicinity of the aircraft. Infrared energy is converted into electrical signals and displayed on a CRT indicator in the pilot's and observer's cockpits. The displayed video enables both crewmen to recognize, identify and classify targets which would otherwise go undetected due to darkness or camouflage. The laser rangefinder designator (LRD) transmits time coded pulses to a specific target selected by the observer. Target laser reflections are processed into range information and displayed on the Laser Control Panel located on the observer's instrument panel. The FLIR/LRD controls and indicators available to the pilot are the FLIR COMD and LASER ENABLE switches, located on the top left hand side of the instrument panel shroud, and the pilot's video indicator located above the instrument panel. All other system controls and indicators are in the observer's cockpit.

WARNING

Laser radiation from Infrared Laser Detecting-Ranging Set, AN/AAS-37, is invisible and can cause permanent blindness at a range of several miles. The same degree of care should be afforded operation of the LRD as is afforded gun systems. Aircrew members shall be provided, and use, eye protection equipment to guard against reflections of LASER energy.

**FORWARD LOOKING INFRARED
DETECTING SET (FLIR)**

The forward looking infrared detecting set (FLIR) utilizes the receiver/transmitter-converter (FLIR turret), located in the nose of the aircraft, to scan the terrain and sense thermal energy differences between objects on the ground and convert those differences into voltage differences. The voltage differences are converted into visible light images for viewing by the television camera. Camera video is routed to the power supply-video converter (in the cargo bay door) where it is converted into composite video for display on the video indicators in each cockpit. Control of the FLIR turret is accomplished by mode commands, position inputs, and rate signals from the infrared detecting set control (FLIR control), the target tracking sight control, or the receiver/transmitter-converter control (all located in the observer's cockpit). The system line of sight is adjustable from 200 degrees left to 200 degrees right in azimuth and from 15 degrees up to 84 degrees down in elevation, relative to the aircraft.

In the manual track (MANTRK) mode of operation, the system line of sight is controlled by rate outputs from the

target tracking sight control, proportional to thumb pressure on the control button. In this mode, the automatic video tracker (AVT), located in the cargo bay door can provide automatic target tracking commands to the FLIR turret. Target lock-on and tracking is accomplished by squeezing and releasing the trigger of the target tracking sight control after the target has been centered within the tracking gate on the video indicator. Target offset tracking is accomplished by depressing the OFFSET COMD pushbutton on the video tracking control panel and slewing the locked-on target to desired offset distance from the center reticle with the target tracking sight control thumb button. Target lock-on will be maintained. OFFSET COMD pushbutton illumination will be blue while in the offset mode. To return to normal automatic tracking, depressing the OFFSET COMD pushbutton will automatically slew the offset locked-on target to the center reticle and the pushbutton illumination will change to white.

The FLIR detecting set also incorporates a "coast" feature. If lock-on is broken due to obstruction or loss of contrast, the turret will coast in the same direction and at the same tracking rate for approximately 5 seconds with the four gate dots blinking. Automatic relock should occur within this time interval if former tracking conditions are restored. If relock does not occur, the four dots will be replaced with the tracking gate square and the turret will cease tracking. In the computer track (CPTR TRK) mode, all advisory indications and video displays remain the same as in the MANTRK mode and the system line of sight is controlled by the thumb button, but is also responsive to aircraft altitude, acceleration, pitch, and roll angles.

In the POS mode of operation the system line of sight is controlled by the AZIMUTH and ELEVATION controls on the FLIR control panel.

When the FWD mode is selected, the FLIR turret is positioned to zero degrees azimuth. In this mode elevation can be varied between 0 and -57 degrees by rotating the FLIR GIMBAL ANGLE DEPRESSION knob on the receiver/transmitter-converter control located in the observer's cockpit, left-hand side.

When the FLIR COMD switch in the pilot's cockpit is placed to the OPERATOR position, all system control is accomplished from the observer's cockpit. When the pilot selects WIDE or NARROW on the FLIR COMD switch, the observer's controls are overridden, an advisory light (PLT CONTR) above the observer's FLIR control panel illuminates, the FLIR turret goes to zero degrees azimuth and elevation, and the field of view is wide or narrow, as selected. With the system in this condition, the pilot's video indicator can be used as a gunsight for firing the sponson guns. The reticle however is not in boresight with the aircraft.

The FLIR system is equipped with built-in test provisions which detect, isolate, and indicate system malfunctions and which inhibit operation prior to system readiness. A NOT

READY light on the FLIR control panel indicates that (1) gyros are not up to operational speed or (2) the FLIR turret has not reached operating temperature. The FLIR control panel COOLING light indicates that the infrared detectors are not cooled to the proper operating temperature.

After the NOT READY and COOLING lights have gone out, the FLIR built-in test sequence may be initiated by depressing the BIT ON button on the FLIR control panel. A BIT ON button light will come on and remain on during the test sequence. If the test is completed without a malfunction, the SYS GO light will come on and BIT ON light will go out. Pressing the SYS GO indicator will cause that light to go out. Malfunctioning of the major functions of the FLIR system will be indicated by RCVR CONV FAIL, POWER SUPPLY FAIL, or CONTROL SERVO FAIL lights. A RCVR O TEMP light, also located on the FLIR control panel will illuminate if an overtemperature condition exists in the FLIR turret. The automatic video tracker is also equipped with built-in test provisions. Test initiation and indication are accomplished on the video tracking control located on the observer's instrument panel. A BIT ABA button on the control panel initiates the test sequence and GO or NO-GO lights indicate test results. A blue back light will illuminate when the BIT ABA pushbutton is depressed to the BIT mode. Always deselect BIT ABA after test.

LASER RANGEFINDER DESIGNATOR (LRD)

The laser rangefinder designator (LRD) transmitter and receiver components are an integral part of the FLIR turret and are boresighted to the same target point. The LRD transmits time coded pulses to a specific target selected by the observer. Returning laser reflections from the selected target area are picked up by the laser receiver and compared in time with the original laser transmission. The time differential is processed into range information and displayed on the laser control panel located on the observer's instrument panel.

The Pulse Coder Generator, located in the left-hand observer's cockpit, provides the coding logic and controls that permit the observer to encode the transmitted laser pulses. The pulse coder generator generates the laser code pulse at the rate selected by the four thumbwheel CODE switches on the front panel. This laser code pulse determines the laser firing rate.

A backlighted TEST/ON/OFF/GO pushbutton and fail indicators are also located on the pulse coder generator panel, which allows the operator to enable and interpret the LRD BIT functions.

Indicator lights on the pulse coder generator illuminate if faults are detected, during test operations or during normal operation, in the pulse coder generator (CODE FAIL), and laser designator (DES FAIL), and during test operations, in the laser rangefinder (RNG FAIL). A LOW PWR indicator light comes on, if power output drops to 70 percent of normal during test or normal operation.

With the LRD coder generator test button ON light illuminated and the LRD fire button depressed, the BIT indicators on the LRD coder generator panel indicate failures and the range readout on the LASER control panel should read 9985. With the LRD coder generator test button OFF light illuminated and the LRD fire button depressed, actual laser range is displayed on the LASER control panel, and the BIT indicators and associated BIT circuits are also enabled in this mode, except the RANGE FAIL indicator.

The laser control panel (on the observer's instrument panel), the LASER switch on the fire control grip (observer's left-hand cockpit), and the LASER ENABLE switch (on the pilot's left-hand instrument panel shroud), provide the primary controls and indications required for the laser rangefinder designator. Firing of the laser is accomplished by depressing the LASER switch on the fire control grip with the LASER switch on the laser control panel in the ARM position and the LASER ENABLE switch in the pilot's cockpit in the ON position. A LASING indicator on the laser control panel illuminates to verify laser firing. Laser range is displayed in meters on the control panel.

The laser cannot be fired from the pilot's cockpit however, the LASER ENABLE switch (in the pilot's cockpit), when placed to OFF disables firing circuit control by the observer. The firing circuit is also disabled if an overtemperature condition exists in the laser resonator or if the FLIR gimbals are positioned in an inhibited region. Either of these conditions cause the LRD INHB light on the control panel to come on. The LRD FAIL light indicates a malfunction in the laser rangefinder designator.

INFRARED LASER DETECTING-RANGING SET, AN/AAS-37 CONTROLS AND INDICATORS

FLIR CONTROL PANEL

The FLIR control panel (figure 8-2) is located on the observer's instrument panel. Controls and indicators found on the FLIR control panel are as follows:

Grayscale Switch

The GRAYSCALE switch is a two-position (ON-OFF) toggle switch which, when placed to ON, presents stepped shades of gray across the bottom of the video indicators.

Mode Switch

The MODE switch is a six-position (OFF-STBY-MANTRK-CPTRTRK-POS-FWD) rotary switch. The function of each position is as follows:

- OFF – Disables all functions of the infrared detecting set.
- STBY – Establishes and maintains system operational readiness by providing air conditioning and cryogenic cooling of the detectors. Also drives receiver to stow position.

- MANTRK** — Receiver servo control and gimbals respond to slew signals from the target tracking sight control.
- CPTRTRK** — Receiver servo control and gimbals respond to slew signals from the target tracking sight control with compensation for aircraft maneuvering.
- POS** — Receiver servo control and gimbals respond to signals from AZIMUTH and ELEVATION POS CONTROL potentiometers on the FLIR control panel.
- FWD** — Receiver line of sight is slewed to zero degrees in azimuth and the elevation depression angle is selected from the FLIR GIMBAL ANGLE DEPRESSION knob on the receiver/transmitter-converter control.

Position Control Knobs

There are two POS CONTROL knobs (potentiometers); AZIMUTH and ELEVATION. The AZIMUTH potentiometer controls the receiver line-of-sight position in azimuth when the MODE switch is in the POS position. The ELEVATION potentiometer controls the receiver line-of-sight position in elevation in the POS position. Markings of each of the potentiometers are in degrees (AZIMUTH: 0° to 200° left and right; ELEVATION: 15° up to 84° down).

Polarity Switch

The polarity (POL) switch is a two-position (WHT HOT—BLK HOT) toggle switch which selects the polarity of the video signal to be displayed. Hot targets appear white on the video indicators in the WHT HOT position. In the BLK HOT position hot targets appear black.

Field-of-View Switch

The field-of-view (FOV) switch is a two-position (WIDE—NAR) toggle switch that changes lenses in and out of the receiver optical path to obtain a wide or narrow field of view.

Gain Knob

The GAIN knob (potentiometer) when rotated clockwise increases the contrast of the target displayed on the video indicators.

Level Knob

The LEVEL knob (potentiometer) controls the brightness of the background video level displayed on the video indicators.

Reticle Bright Knob

The RTCL BRT knob (potentiometer) controls the intensity of the reticle brightness. The reticle marks the center of the displayed field of view as well as the LRD line of sight.

Focus Switch

The FOCUS switch is a five-position (300'—700'—2000'—5000'—∞) rotary switch which selects focusing range. Targets within the range selected will be in focus when NAR is selected on the field-of-view FOV switch.

Built-in-Test Switch/Indicator

The BIT ON switch/indicator is a backlighted momentary pushbutton switch which is depressed, after the COOLING and NOT READY have gone out, to initiate the built-in test sequence. The BIT ON indicator will come on while the test is in progress. Satisfactory completion of the test sequence will cause the BIT ON indicator to go out and the SYS GO indicator to come on.

System Go Switch/Indicator

The SYS GO switch indicator is a backlighted momentary pushbutton switch which lights to indicate successful completion of the built-in test function. Momentarily pressing the SYS GO button will cause the light to go out.

Power Supply Fail Indicator

Illumination of the POWER SUPPLY FAIL indicator light during BIT, indicates the most probable cause for failure of the built-in-test is malfunction or failure of the power supply-video converter (WRA2).

Receiver Converter Fail Indicator

Illumination of the RCVR CONV FAIL indicator light during BIT, indicates the most probable cause for failure of the built-in-test is malfunction or failure of the FLIR turret (WRA1).

Control Servo Fail Indicator

Illumination of the CONTROL SERVO FAIL indicator light indicates the most probable cause for failure of the built-in-test is malfunction or failure of the control servo (WRA3).

Cooling Indicator

The COOLING indicator lights will come on when system is energized and will remain on until the infrared detectors have reached operating temperature.

Not Ready Indicator

The NOT READY indicator light will come on when the system is energized and will remain on until the FLIR turret reaches operating temperature and the gyros come up to speed. Built-in testing cannot be initiated until the NOT READY light goes out.

Receiver Overtemperature Indicator

The RCVR O TEMP indicator light will come on if excessive temperature is sensed within the FLIR turret.

TARGET TRACKING SIGHT CONTROL

The target tracking sight control (figure 8-3), located on the observer's right-hand forward console is equipped with an electromechanical transducer (thumb control) and a trigger switch. In the MANTRK and CPTRTRK modes of operation, the thumb control provides a slew rate signal to control the FLIR turret line of sight in azimuth and elevation. The line of sight moves in the direction pressure is applied. Line-of-sight movement stops when pressure is removed from the thumb control. Once a target has been centered within the tracking gate on the video indicator, by using the thumb control, target lock-on and automatic tracking is achieved by squeezing and releasing the trigger switch. The square box representing the gate is replaced by four dots, one at each corner of the original box. The gate size will automatically adjust to the optimum size. If lock-on is broken due to obstruction or loss of contrast, the FLIR turret will coast for several seconds, with the four dots blinking until automatic relock occurs or the four dots are replaced with the tracking gate box if relock does not occur. To break automatic tracking of an unwanted target or to update tracking of a desired target, the trigger is squeezed again and released.

RECEIVER/TRANSMITTER-CONVERTER CONTROL

The receiver/transmitter-converter control (figure 8-4), located in the observer's cockpit forward of the power control quadrant contains the following controls and indicators.

FLIR Gimbal Angle Depression Control

The FLIR GIMBAL ANGLE DEPRESSION control is a gearbox and resolver which provides a servo error signal to establish the depression angle (0 to -57 degrees) of the FLIR turret when the system is in the fwd mode.

Mils Counter

The MILS counter, located on the FLIR GIMBLE ANGLE DEPRESSION control, is a mechanical counter which is manually set to the desired FLIR turret elevation gimbal depression (from horizontal) in milliradians.

Tracking Sensitivity Control

The TRACKING SENSITIVITY control is a ten-position (0-4-5-6-7-8-9-10-11-12) rotary switch which is used to adjust the sensitivity of the target tracking sight thumb control to suit the tactical situation and the preference of the observer. The FLIR turret will move slower as the switch position numbers increase.

VIDEO TRACKING CONTROL

The video tracking control panel (figure 8-5) is located on the observer's instrument panel. Video tracking control panel controls and indicators include:

Initial Gate Size Knob

The INITIAL GATE SIZE knob (potentiometer) is used to adjust the size of the target gate displayed on the video indicator.

Offset Command Switch/Indicator

The OFFSET COMD switch/indicator is a backlighted momentary pushbutton switch which is used to initiate the target offset function. With target lock-on, in either MAN TRK or CPTR TRK modes, offset tracking is initiated by momentarily depressing the OFFSET COMD pushbutton switch. Backlighting of the pushbutton switch will change from white to blue. To return to automatic tracking, depress the OFFSET COMD pushbutton switch. Backlighting of the pushbutton will change from blue to white.

Built-in-Test Switch/Indicator

The BIT ABA switch/indicator is a backlighted momentary pushbutton switch that when depressed momentarily, initiates a built-in test sequence of the automatic video tracking computer. The BIT ABA pushbutton indicator will illuminate blue. An artificially generated video target will appear and move about on both displays. At completion of the test sequence within 3 minutes, the GO light will illuminate green if the computer is functioning in a satisfactory manner. Depressing the BIT ABA pushbutton switch will extinguish the GO light and the BIT ABA light will illuminate white.

Note

With power outage or interruption, the laser boresighting information stored in the video tracker may be dumped. BIT ABA self test must be initiated to update boresighting.

During the test sequence, 16 small dots also appear on the upper left-hand side of the video indicators in indicate the computer is functioning in a satisfactory manner. If a malfunction is detected, a dash will replace any one or several of the dots. Depressing the BIT ABA pushbutton to white will return video tracking to normal mode.

OBSERVER'S VIDEO INDICATOR

The observer's video indicator (figure 8-6), located on the observer's instrument panel, is equipped with a power switch, brightness and contrast controls, status indicator, and an elapsed time meter.

Power Switches

The PWR switch is a two-position (ON-OFF) toggle switch which, when placed to ON, applies power to the observer's video indicator.

FLIR CONTROL PANEL

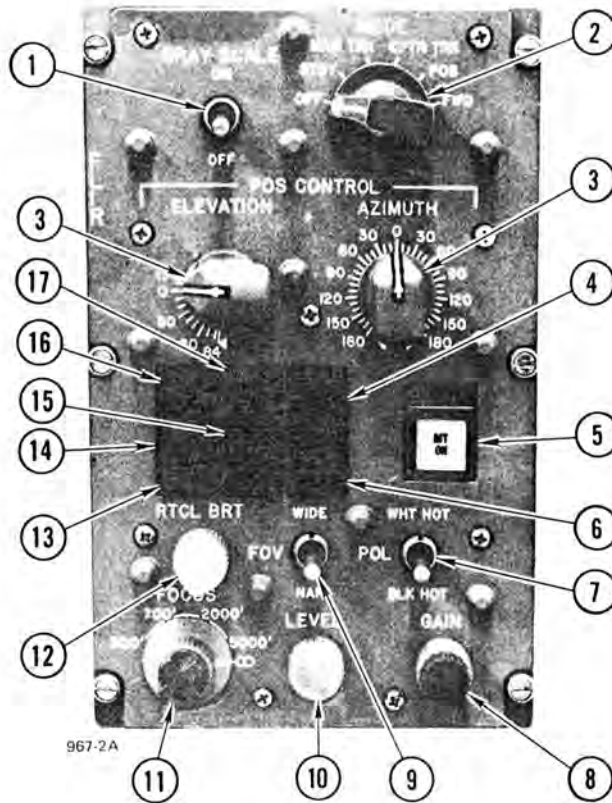

1. GRAY SCALE SWITCH
2. MODE SWITCH
3. POSITION CONTROL KNOBS
4. SYSTEM GO SWITCH/INDICATOR
5. BUILT-IN TEST SWITCH/INDICATOR
6. POWER SUPPLY FAIL INDICATOR
7. POLARITY SWITCH
8. GAIN KNOB
9. FIELD OF VIEW SWITCH
10. LEVEL KNOB
11. FOCUS SWITCH
12. RETICLE BRIGHT KNOB
13. NOT READY INDICATOR
14. COOLING INDICATOR
15. RECEIVER-CONVERTER FAIL INDICATOR
16. RECEIVER-OVERTEMPERATURE INDICATOR
17. CONTROL SERVO FAIL INDICATOR

Figure 8-2

OV-10D-1-27

TARGET TRACKING SIGHT CONTROL



967-2R

OV-10D-1-28

Figure 8-3

Brightness Control

The BRIGHTNESS control is a potentiometer used to vary the brightness of the observer's CRT display according to the preference of the observer.

Contrast Control

The CONTRAST control is a potentiometer used to vary the contrast of the observer's CRT display according to the preference of the observer.

Status Indicator

The green STATUS indicator light is illuminated whenever power and composite video are applied to the video indicator.

Elapsed Time Meter

The ETM meter indicates total time the video indicator has been operated.

RECEIVER/TRANSMITTER CONVERTER CONTROL

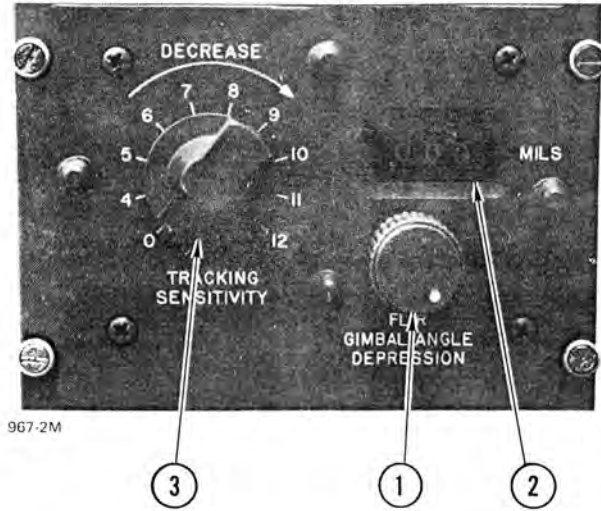

967-2M

1. FLIR GIMBAL ANGLE DEPRESSION CONTROL
2. MILS COUNTER
3. TRACKING SENSITIVITY CONTROL

OV-10D-1-29

Figure 8-4

OBSERVER'S VIDEO INDICATOR

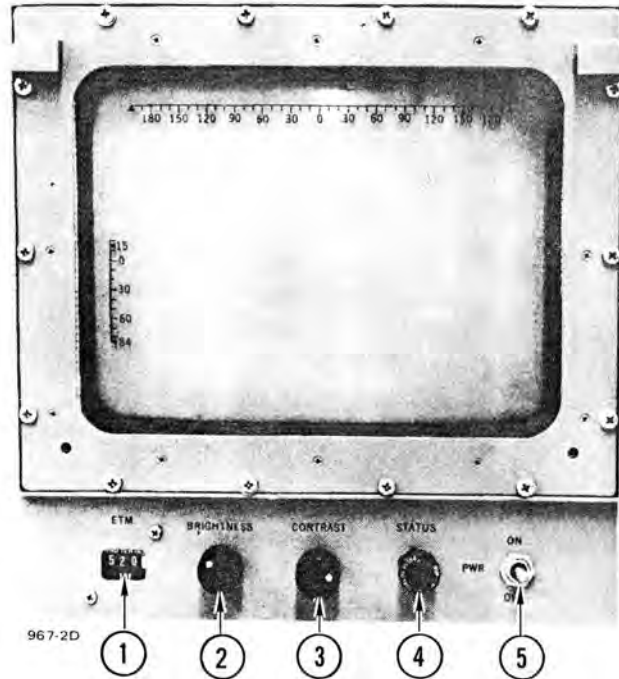

967-2D

1. ELAPSED TIME METER
2. BRIGHTNESS CONTROL
3. CONTRAST CONTROL
4. STATUS INDICATOR
5. POWER SWITCH

OV-10D-1-31

Figure 8-6

VIDEO TRACKING CONTROL PANEL

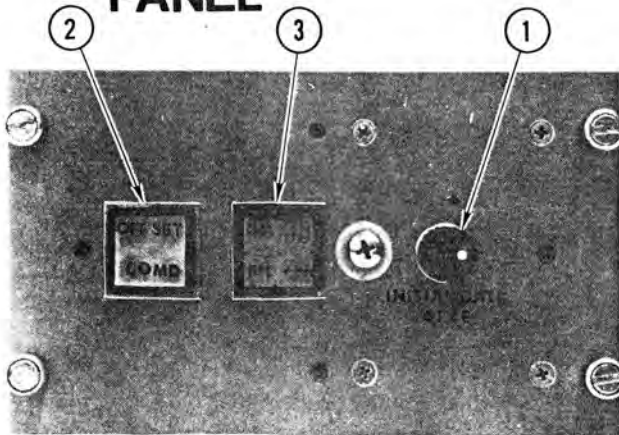

967-1G

1. INITIAL GATE SIZE KNOB
2. OFFSET COMMAND SWITCH/INDICATOR
3. BUILT-IN TEST SWITCH/INDICATOR

OV-10D-1-30

Figure 8-5

PILOT'S VIDEO INDICATOR

A brightness control, contrast control, status indicator, and elapsed time meter are found on the front of the pilot's video indicator. The indicator (figure 8-7) is located above the pilot's instrument panel.

Brightness Control

The BRT control is a potentiometer which varies the brightness of the CRT display according to the preference of the pilot.

Contrast Control

The CTRS control is a potentiometer which varies the contrast of the CRT display according to the preference of the pilot.

LASER CONTROL PANEL

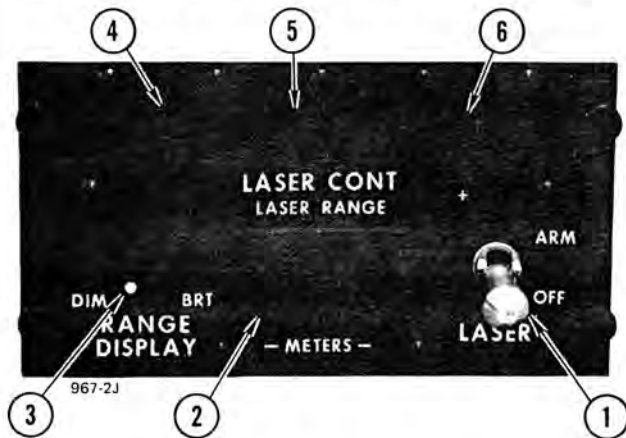

1. LASER ARMING SWITCH
2. LASER RANGE INDICATOR
3. RANGE DISPLAY BRIGHTNESS KNOB
4. LASER RANGEFINDER DESIGNATOR FAIL INDICATOR
5. LASER RANGE FINDER DESIGNATOR INHIBIT INDICATOR
6. LASING (FIRE VERIFY) INDICATOR

OV-10D-1-34

Figure 8-9

PULSE CODER-GENERATOR CONTROLS AND INDICATORS

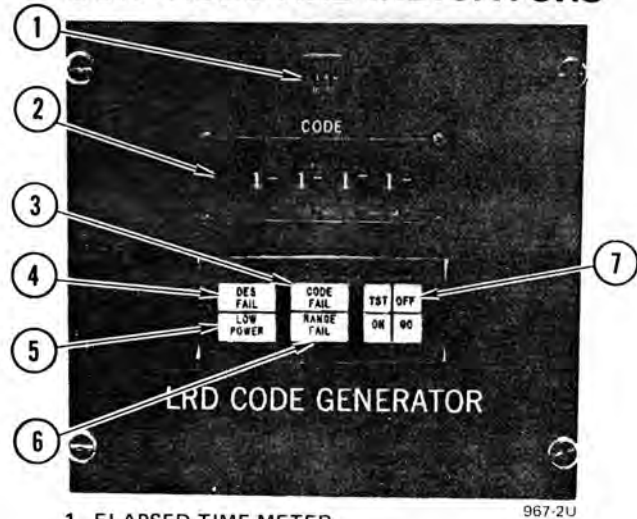

1. ELAPSED TIME METER
2. CODE SWITCHES
3. CODE FAIL INDICATOR
4. DESIGNATOR FAIL INDICATOR
5. LOW POWER INDICATOR
6. RANGE FAIL INDICATOR
7. TEST/GO/ON/OFF SWITCH—INDICATOR

967-2U

OV-10D-1-36

Figure 8-11

on the LASER RANGE indicator. With the LRD code generator TST switch in ON mode and LASER FIRE switch depressed the range will read 9985.

Range Display Knob

The RANGE DISPLAY knob (potentiometer) varies the lighting intensity of the LASER RANGE indicator between dim (DIM) and bright (BRT).

Laser Status Indicators

Three laser status indicator lights are found on the laser control panel: LRD FAIL, LRD INHIB, and LASING. The LRD FAIL indicator illuminates if a malfunction is detected in the laser rangefinder designator circuitry. The LRD INHIB indicator comes on if an overtemperature condition is detected in the laser resonator or if turret gimbal angles are outside the allowable operating envelope. Either condition will inhibit the laser fire command. The LASING indicator comes on to verify proper command is present for laser firing. The LASING indicator will come on even if the safety jumper plug is not installed on the ground airborne and actual firing missions and ground testing of the laser.

FIRE CONTROL GRIP

The fire control grip (figure 8-10), located on the left-hand, forward side of the observer's cockpit, contains the LASER fire button. The LASER button when depressed completes the laser firing circuit when all system conditions are proper.

FIRE CONTROL GRIP



967-2K1

OV-10D-1-35

Figure 8-10

PULSE CODER-GENERATOR

The pulse coder-generator (figure 8-11), located at the left-hand rear side of the observer's cockpit, provides the means of encoding the laser designator, initiating the built-in-test sequence of the laser rangefinder designator and indicating system failures in various areas.

Code Switches

A set of four self-illuminating octal thumbwheel switches (CODE) provide the means of encoding the laser designator.

Test/Go/On/Off Indicator Switches

The TST pushbutton switch has individually backlighted sections for the TST, GO, ON and OFF indications. With the ON indicator illuminated and the laser fire button depressed, the GO indicator should illuminate and the LRD control panel range readout shall read 9985, indicating a satisfactory system. Depressing the TST pushbutton with the GO indicator illuminated will extinguish the GO light and illuminate the OFF light, returning the laser to normal operating mode.

Code Fail Indicator

The CODE FAIL indicator light will come on if, during built-in testing, a malfunction is detected in the pulse coder-generator. The light will also come on to indicate a failure during normal operation.

Designator Fail Indicator

The DES FAIL indicator light will illuminate during built-in testing if a failure is noted in the laser designator. The light will also come on to indicate a malfunction during normal operation.

Range Fail Indicator

The RANGE FAIL indicator light will illuminate during built-in testing if a failure is detected in the laser rangefinder.

Low Power Indicator

The LOW POWER indicator light comes on if laser output power, during built-in test or system operation, drops below 70 percent of normal.

Elapsed Time Meter

The elapsed time meter records the total time the pulse coder-generator has been operating.

INFRARED LASER DETECTING-RANGING SET, AN/AAS-37 OPERATION

The following paragraphs provide instructions for operating the infrared detecting set (FLIR) and the laser rangefinder designator (LRD).

Note

All applicable system circuit breakers must be engaged prior to proceeding with the following paragraphs.

FLIR OPERATION

Do not operate FLIR system or fire laser at altitudes above 15,000 feet.

Before applying power to aircraft, ensure switches/controls are as follows:

LASER ENABLE to OFF
 FLIR COMD to OPERATOR
 LASER switch to OFF (O)
 FLIR MODE switch to OFF (O)
 RTCL BRT control to mid-range (O)
 LEVEL control to mid-range (O)
 GAIN control to mid-range (O)
 Video indicator PWR switch to ON (O)
 Video indicator BRIGHTNESS and CONTRAST to mid-range (P, O)

Apply external electrical power to aircraft or ensure at least one generator is providing power to aircraft bus system during ground operation of the Infrared Laser Detecting-Ranging set.

Ensure both generators are providing power to aircraft bus system during flight operations.

1. Place WARN LTS TEST switch (LIGHTS DIM/TEST panel on observer's instrument panel) to TEST and verify that all indicator lights on FLIR control panel, video tracking control panel, laser control panel, pulse-coder generator panel and the PLT CONTR light above the FLIR control panel illuminate. (O)
2. Ensure the No. 3 inverter circuit breaker is depressed. (O)
3. Set MODE switch on FLIR control panel to STBY position. (O) The NOT READY and COOLING lights on the FLIR control panel will illuminate.

Note

The NOT READY indicator light should extinguish within 2 minutes and the COOLING indicator light within 10 minutes after the MODE switch is placed in STBY.



To preclude foreign object damage, the FLIR turret should be pointing forward before taking the propellers off the start locks, and during taxi, take-off, and landing.

4. Set MODE switch on FLIR control panel to POS and rotate the turret to forward (0°) azimuth position. (O) The video green status lights will illuminate and the gimble angle indicators will appear on the top and left side of each display. FLIR video will appear on each display.

Note

On SOLO flights, engage NO. 3 INV circuit breaker and place FLIR COMD switch on pilot's left-hand instrument panel shroud to WIDE position. The FLIR turret will drive to approximately zero degrees azimuth and elevation. Placing FLIR COMD switch to OPERATOR position will turn FLIR system off with turret locked in forward pointing position.

5. Place GRAYSCALE switch to ON. (O)
6. Adjust BRIGHTNESS and CONTRAST controls on the observer's video indicator to optimize the grayscale displayed across the bottom of the indicator screen. (O)
7. Adjust BRT and CTRS controls on the pilot's video indicator to optimize the grayscale displayed across the bottom of the indicator screen.
8. Place GRAYSCALE switch OFF. (O)
9. When NOT READY indicator light extinguishes, place MODE switch to MANTRK position. (O)
10. On FLIR control panel, press BIT ON switch and verify that SYS GO indicator light comes on within 1 minute. Press SYS GO switch to extinguish light. (O)
11. Adjust RTCL BRT control on the FLIR control panel to set the desired reticle brightness level on the observer's and pilot's video indicators. (O)
12. Rotate the GAIN control to adjust contrast of the target displayed on the video indicators. (O)
13. Rotate the LEVEL control to adjust the brightness of the background of the displayed image on the video indicators. (O)
14. Select a wide or narrow field of view by placing the FOV switch to WIDE or NAR. The WIDE position of the FOV switch is best for search operations. The NAR position of the FOV switch is best for tracking a target. (O)
15. Using the FOCUS switch select the range in which a target appears in focus on the video indicators. The FOCUS control is operational only when the narrow (NAR) field of view is selected. (O)
16. Place the polarity switch (POL) to WHT HOT or BLK HOT. (O)
In the WHT HOT position, hot targets will appear white on the video indicators. In the BLK HOT position, hot targets will appear black on the video indicators.
17. With the system in the MANTRK mode of operation, the FLIR turret line of sight is controlled by applying pressure to thumb control on the target tracking sight control (right-hand forward side of observer's cockpit). (O) Sensitivity of the thumb control can be adjusted by adjusting the TRACKING SENSITIVITY control on the receiver/transmitter-converter control (observer's cockpit forward of power control quadrant).
18. Depress BIT ABA switch on video tracking control panel and observe blue background lighting on BIT ABA indicator. An artificially generated display program will appear on both video indicators. The GO light should illuminate green within 3 minutes. (O)
19. Depress BIT ABA switch and observe white background lighting on BIT ABA indicator and GO light to extinguish. (O)
20. With the system in MANTRK mode of operation, slew the turret until a target is centered at the reticle. (O) Adjust the INITIAL GATE SIZE knob on the video tracking control panel until the gate is slightly larger than the target. Squeeze and release the trigger switch on the target tracking sight control. Target lock-on and automatic tracking will be indicated by four small dots replacing the square tracking gate.
21. With the system in MANTRK mode of operation and a firm lock established on a clearly defined target, depress the OFFSET COMD pushbutton on the video tracking control panel. The pushbutton indicator will illuminate blue. (O) Use the hand sight control thumb button to slew the locked on target approximately 1-1/2 inches from the reticle. Target lock-on and offset tracking will be maintained.
22. Depress the OFFSET COMD pushbutton switch. (O) The offset target will automatically slew back to the video indicator center reticle and the pushbutton illumination will change from blue to white.
23. Squeeze and release the trigger switch on the target tracking sight control to return to manual tracking. (O)
24. Place MODE switch to CPTR TRK. Slew the FLIR turret until a target is centered at the reticle. (O) Adjust the INITIAL GATE SIZE on the AVT control panel until the gate is slightly larger than the target. Squeeze and release the trigger switch on the target tracking sight control. Target lock-on and automatic tracking will be indicated by four small dots replacing the square tracking gate.

25. With the system in CPTR TRK mode of operation and a firm lock established on a clearly defined target, depress the OFFSET COMD pushbutton on the AVT control panel. The pushbutton indicator will illuminate blue. (O) Use the hand sight control thumb button to slew the target approximately 1-1/2 inches from the reticle. Target lock-on and offset tracking will be maintained.
26. Depress the OFFSET COMD pushbutton switch. (O) The offset target will automatically slew back to the video indicator center reticle and the pushbutton illumination will change from blue to white.
27. Squeeze and release the trigger switch on the target tracking sight control to return to manual tracking. (O)
28. When the MODE switch is placed in the POS (position) mode, the observer can vary the line of sight of the FLIR turret by rotating the AZIMUTH and ELEVATION position controls on the FLIR control panel. (O) The tracking gate will disappear.
29. The forward mode of operation is selected by placing the MODE switch to the FWD position. (O) In this mode, the FLIR turret line of sight is positioned to 0 degrees in azimuth and the elevation angle (0 to -57 degrees) is selected by the FLIR GIMBLE DEPRESSION ANGLE control on the receiver/transmitter-converter control. The tracking gate will not appear.
30. Place FLIR COMD switch (pilot's left-hand instrument panel shroud) to WIDE or NARROW position. FLIR turret line of sight will go to 0 degrees azimuth and elevation in the field of view selected. The PLT CONTR light above the FLIR control panel will come on indicating that the pilot has assumed system control. The system will remain in this mode even with the system turned off on the observer's FLIR control panel.
31. Place the FLIR COMD switch to the OPERATOR position. The PLT CONT light will go out.
32. Prior to engine shutdown at completion of flight, place the MODE switch to STBY (FLIR control panel) and observe via the video indicator that the FLIR turret gimbals go to the stowed position (CCW and up limits). (O) The video image should be lost when this occurs.
33. Place MODE switch to OFF. (O)

Note

In case of emergency, place the MODE switch directly to OFF. This removes power and locks the gimbals in the operating position.

FLIGHT OPERATION

1. NO. 3 INV circuit breaker—IN. (O)
2. FLIR MODE switch —STBY (O).

Note

The NOT READY indicator light should extinguish within 2 minutes and the COOLING light within 10 minutes after the MODE switch is placed in STBY.

3. Video indicator power switch —ON. (O)
4. When the NOT READY indicator lights go out, MODE switch—Select operating position. (O)
5. GRAYSCALE switch—ON. (O)
6. Brightness and contrast controls—adjust video. (P, O) Indicators will display black, ten shades of gray and white across the bottom of indicator screen.
7. GRAYSCALE switch—OFF. (O)

LASER OPERATION

WARNING

Laser radiation from Infrared Laser Detecting-Ranging Set, AN/AAS-37, is invisible and can cause permanent blindness at a range of several miles. The same degree of care should be afforded operation of the LRD as is afforded gun systems. It is recommended that aircrew members be provided, and use eye protection equipment to guard against reflections of LASER energy.

During ground operation requiring laser operation, the LRD and FLIR window covers shall be installed.

The FLIR system must be in an operating mode in order to operate the LRD.

BUILT-IN-TEST

1. Set MODE switch on FLIR control panel to FWD. (O)
2. On the receiver/transmitter-converter control, set the FLIR GIMBAL ANGLE DEPRESSION to 400 MILS. (O)
3. Set code 1688 on LRD CODE GENERATOR. (O)
4. Set LASER ENABLE switch to ON.

5. Set LASER switch to ARM. (O) Observe that LASER RANGE indicates 0000.
6. Adjust RANGE DISPLAY lighting to desired level. (O)
7. Depress TST switch on LRD CODE GENERATOR panel and observe that ON indicator light illuminates. (O)
8. On the laser control handgrip, depress the LASER firing trigger and hold for 20 seconds minimum.
9. Observe the following if the laser fire ground safety jumper plug is installed on the ground safety panel:

Laser Control Panel	Lasing light, ON
Laser Control Panel	LASER RANGE, 9985
LRD Code Generator Panel	GO light, ON
10. Release LASER firing trigger. (O) Observe lasing light extinguishes and LASER RANGE indicates 0000.



After each laser firing, leave the FLIR system ON, the LASER ENABLE switch ON, and the LASER switch at ARM for at least 20 seconds to allow laser cooldown.

11. Push TST switch on LRD code generator panel to end test mode. (O) Observe the ON and GO indicator lights extinguish and the OFF indicator light illuminates.

Note

BIT is continuously enabled during normal laser operation with the LRD code generator panel TST switch OFF. The range display on the LRD control panel indicates actual range to target and the DES FAIL, CODE FAIL and LOW POWER indicators on the LRD CODE GENERATOR panel will indicate failures if present.

12. Secure the LRD by placing the LASER switch to OFF (O) and the LASER ENABLE switch to OFF.

Inhibited Region Test

The laser cannot be fired throughout the entire FLIR pointing envelope to prevent impingement of the laser beam on the aircraft structure (figure 8-12). A qualitative test of this function may be made during ground or flight operations as follows:

1. During ground test, ensure that the LRD and FLIR window covers are installed.

2. Set the mode switch to MANTRK and drive the turret to full up elevation and pointing aft in azimuth. (O).
3. Set the LASER ENABLE switch to ON.
4. Set the LASER switch to ARM. (O)



After laser firing, leave the FLIR system ON, the LASER ENABLE switch ON and the LASER switch at ARM for at least 20 seconds to allow laser cooldown.

5. Depress the LASER firing trigger and hold. (O). Observe:

LASING light	OFF
INHIBIT light	ON

Disregard other advisory lights.

6. Slowly decrease the elevation angle to approximately 10 degrees down and observe:

LASING light	ON
INHIBIT light	OFF

7. Release LASER firing trigger.
8. Secure the LRD by placing the LASER switch to OFF (O) and the LASER ENABLE switch to OFF.

FLIGHT OPERATION



- LRD and FLIR window covers must be removed before take-off.
- Do not operate FLIR or laser at altitudes above 15,000 feet.

1. Set assigned code on LRD CODE GENERATOR panel. (O)
2. BIT ABA—Depress.

Note

BIT ABA must be initiated prior to laser usage in order to ensure boresight. It must also be initiated after any occurrence that removes electrical power from the FLIR system, as boresight will be lost.

3. Select narrow FOV on the FLIR control panel.

LRD INHIBITED GIMBAL ANGLE ENVELOPE

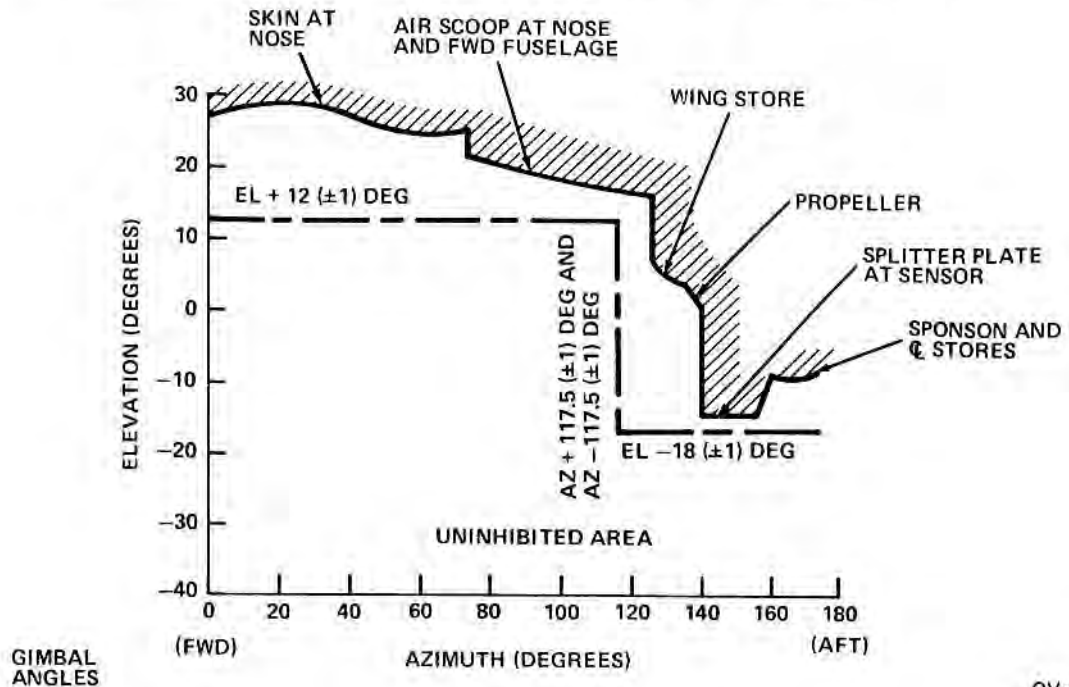

OV-10D-1-171A

Figure 8-12

Note

Ensure the laser is fired only in the narrow FOV. The laser may not be boresighted in the wide FOV.

4. Place LASER ENABLE switch to ON.
5. Place LASER switch to ARM. (O)
6. Depress LASER firing trigger. Firing continues until trigger is released or the turret is driven into the inhibited region.
7. To secure the LASER system, place LASER switch to OFF (O) and LASER ENABLE switch to OFF.

SECTION IX – FLIGHT CREW COORDINATION

TABLE OF CONTENTS

Introduction	9-1	Pretake-off	9-2
Crew Duties	9-1	Take-off/Departure	9-2
Flight Planning	9-1	In Flight	9-2
Briefing	9-1	Instrument Approach	9-2
Preflight	9-1	Landing	9-2
Prestart	9-1	Postflight	9-2
Starting	9-2	Debriefing	9-2
Poststart	9-2		

INTRODUCTION

This section provides information on pilot/observer coordination which may be required for completion of an assigned mission. The OV-10D is a single-piloted, multi-purpose aircraft designed for counterinsurgency operations. An observer is defined as any crewman occupying the rear cockpit in the performance of the assigned mission. The mission assigned to the aircraft will dictate the qualifications required for the observer.

CREW DUTIES

The duties of the pilot and observer are often integrated. Each must support and contribute to the completion of the assigned mission. Although specific responsibilities are delineated, cooperation and initiative would become paramount in the event of aircraft system malfunction, emergency or unfamiliar circumstances where assistance is desired. The pilot is the Aircraft Commander and is ultimately responsible for the safe completion of any mission assigned to his aircraft. The pilot and observer shall perform as a team in the completion of the mission. By intercommunications, the pilot and observer should anticipate rather than await developments.

FLIGHT PLANNING

- *Pilot*—The pilot will be responsible for the preparation of required charts, flight logs, navigation computation including fuel planning, checking weather and NOTAMS, and for filing required flight plans.
- *Observer* — The observer, when required by the pilot, will provide any special maps, photography, and other available information necessary for the completion of the mission.

BRIEFING

- *Pilot* — The pilot/flight leader is responsible for briefing all crew members on all aspects of the mission to be flown.
- *Observer* — The observer will assist the pilot/flight leader in preparing required flight or briefing forms and may, if applicable, brief the portion of the mission pertaining to the observer's duties.

PREFLIGHT

- *Pilot* — The pilot is responsible for accepting and preflighting the aircraft assigned in accordance with this manual and appropriate preflight checklist contained in the NATOPS Pilot's Pocket Checklist (NAVAIR 01-OV10D-1B).
- *Observer* — The observer is responsible for that portion of the exterior inspection checklist which related to the rear cockpit and security of fuel caps.

PRESTART

- *Pilot* — The pilot will execute the prestart checks described in the NATOPS Pilot's Pocket Checklist (NAVAIR 01-OV10D-1B) and will inform the observer PRESTART CHECKS COMPLETE—READY TO START.
- *Observer* — The observer will execute the prestart checks applicable to the observer's cockpit described in the NATOPS Pilot's Pocket Checklist (NAVAIR 01-OV-10D-1B) and will inform the pilot PRESTART CHECKS COMPLETE—READY FOR START.

STARTING

- *Pilot* — The pilot will start engines as described in Section III, Part 3 and will keep the observer informed of any unusual occurrences.
- *Observer* — The observer will remain alert for any emergency signals from the ground crew and will inform the pilot if such signals are observed.

POSTSTART

- *Pilot* — The pilot will complete all poststart checks described in the NATOPS Pilot's Pocket Checklist (NAVAIR 01-OV10D-1B).
- *Observer* — The observer will take command of the AN/ARC-54 when directed by the pilot and select the appropriate frequencies.

PRETAKE-OFF

- *Pilot* — The pilot will execute pretake-off, instrument, and take-off checklists described in the NATOPS Pilot's Pocket Checklist (NAVAIR 01-OV10D-1B) and as posted in the aircraft. The pilot will report completion of each of the take-off checklist items to the observer and upon completion advise the observer TAKE-OFF CHECKLIST COMPLETE—READY FOR TAKE-OFF.
- *Observer* — The observer will report READY FOR TAKE-OFF upon satisfactory completion of his checklist. The observer should be alert to challenge the pilot if any item on the take-off checklist is not reported as completed. The observer will assist in communications as directed by the pilot.

TAKE-OFF/DEPARTURE

- *Pilot* — The pilot will request, copy, and acknowledge all clearances. He should, however, afford the observer the opportunity to practice requesting and copying flight clearances in addition to his normal tactical clearances.
- *Observer* — The observer will keep a constant lookout and advise the pilot of any traffic within close proximity of the aircraft.

IN FLIGHT

- *Pilot*—The pilot will inform the observer of any unusual occurrences and will ensure that the aircraft is operated within prescribed operating limitations at all

times. The operation of the UHF radio is normally a function of pilot control and FM NO. 1 a function of observer control.

- *Observer*—The observer will assist the pilot in changing FM NO. 1 communication frequencies and will request, copy, and acknowledge flight and tactical clearances or make position reports when directed by the pilot.

INSTRUMENT APPROACH

- *Pilot*—Before commencing any penetration, the pilot will report the completion of the instrument checklist to the observer.
- *Observer*—The observer will assist the pilot as directed during the instrument approach.

LANDING

- *Pilot*—The pilot will utilize the landing checklist and will report each item to the observer. The pilot will receive a MAIN GEAR DOWN/READY TO LAND report from the observer.
- *Observer*—The observer will complete the landing checklist; visually check that main gear are down and will report MAIN GEAR DOWN / READY TO LAND to the pilot.

POSTFLIGHT

- *Pilot*—The pilot will report the ejection seat safety pins inserted and receive acknowledgement from the observer. The pilot will shut down the engines and secure the aircraft as described in Section III, Part 3. The pilot will conduct a postflight inspection of the aircraft.
- *Observer*—The observer will challenge the pilot on the insertion of the ejection seat safety pin if the report is not received. The observer should assist the pilot in conducting a postflight of the aircraft.

WARNING

The front and rear seats are interconnected so that pilot-initiated ejection will eject the rear seat even with rear seat pins installed.

DEBRIEFING

The pilot and observer will complete the yellow sheet and all required debriefing forms.

SECTION X—NATOPS EVALUATION**TABLE OF CONTENTS**

PART 1—NATOPS EVALUATION PROGRAM	10-1	Records and Reports	10-3
Concept	10-1	Flight Evaluation Grading Criteria	10-3
Implementation	10-1	PART 2—NATOPS EVALUATION QUESTION BANK	10-5
Definitions	10-1	NATOPS Evaluation Question Bank	10-5
Ground Evaluation	10-2	PART 3—NATOPS EVALUATION FORMS	10-15
Flight Evaluation	10-2	NATOPS Evaluation Forms	10-15
Final Grade Determination	10-3		

PART 1 — NATOPS EVALUATION PROGRAM**CONCEPT**

The standard operating procedures described in this manual represent the optimum method of operating the OV-10D aircraft. The NATOPS evaluation is intended to evaluate compliance with NATOPS procedures by observing and grading individuals and units. This evaluation is tailored for compatibility with various operational commitments and missions of both Navy and Marine Corps units. The prime objective of the NATOPS evaluation program is to assist the Unit Commanding Officer in improving unit readiness and safety through constructive comment. Maximum benefit from the NATOPS evaluation program is achieved only through the vigorous support of the program by commanding officers as well as flight crew members.

IMPLEMENTATION

The NATOPS evaluation program shall be carried out in every unit operating naval aircraft. The various categories of flight crew members desiring to attain/retain qualification in the OV-10D shall be evaluated initially in accordance with OPNAVINST 3510.9 series, and at least once during the 12 months following initial and subsequent evaluations. Individual and unit NATOPS evaluations will be conducted annually. However, instruction in and observation of adherence to NATOPS procedures must be on a daily basis within each unit to obtain maximum benefits from the program. The NATOPS Coordinators, Evaluators, and Instructors shall administer the program as outlined in OPNAVINST 3510.9 series. Evaluatees who receive a grade of Unqualified on a ground or flight evaluation shall be allowed 30 days in which to complete a re-evaluation. A maximum of 60 days may elapse between the date the initial ground evaluation was commenced and the date the flight evaluation is satisfactorily completed.

DEFINITIONS

The following terms, used throughout this section, are defined as to their specific meaning within the NATOPS evaluation program.

NATOPS EVALUATION

A periodic evaluation of individual flight crew member standardization consists of an open book examination, a closed book examination, an oral examination, and a flight evaluation.

NATOPS RE-EVALUATION

A partial NATOPS evaluation administered to a flight crew member who has been placed in an Unqualified status by receiving an Unqualified grade for any of his ground examinations or the flight evaluation. Only those areas in which an unsatisfactory level was noted need be observed during a re-evaluation.

QUALIFIED

That degree of standardization demonstrated by a reliable flight crew member who has a good knowledge of standard operating procedures and a thorough understanding of aircraft capabilities and limitations.

CONDITIONALLY QUALIFIED

That degree of standardization demonstrated by a flight crew member who meets the minimum acceptable standards. He is considered safe enough to fly as a pilot in command or to perform normal duties without supervision, but more practice is needed to become Qualified.

UNQUALIFIED

That degree of standardization demonstrated by a flight crew member who fails to meet minimum acceptable criteria. He should receive supervised instruction until he has achieved a grade of Qualified or Conditionally Qualified.

AREA

A routine of preflight, flight, or postflight procedures which are observed and graded during a flight evaluation.

SUBAREA

A performance subdivision within an area, which is observed and evaluated during a flight evaluation.

CRITICAL AREA/SUBAREA

Any area or subarea which covers items of significant importance to the overall mission requirements, the marginal performance of which would jeopardize safe conduct of the flight.

EMERGENCY

An aircraft component failure, system failure, or a condition which requires instantaneous recognition, analysis, and proper action.

MALFUNCTION

An aircraft component failure, system failure, or a condition which requires recognition and analysis, but which permits more deliberate action than that required for an emergency.

GROUND EVALUATION

Prior to commencing the flight evaluation, an evaluatee must achieve a minimum grade of Qualified on the open book and closed book examinations. The oral examination is also part of the ground evaluation but may be conducted as part of the flight evaluation. To assure a degree of standardization between units, the NATOPS Instructors may use the bank of questions contained in Part 2, in this section in preparing portions of the written examinations.

OPEN BOOK EXAMINATION

Up to 50 percent of the questions used may be taken from the question bank. The number of questions in the examination will not exceed 50 or be less than 25. The purpose of the open book portion of the written examination is to evaluate the crew member's knowledge of appropriate publications and the aircraft. The maximum time for this examination should not exceed 1 hour.

CLOSED BOOK EXAMINATION

Up to 50 percent of the closed book examination may be taken from the question bank and shall include questions concerning normal procedures and aircraft limitations. The number of questions in the examination will not exceed 50 or be less than 25. Questions designated critical will be so marked. An incorrect answer to any question in the critical category will result in a grade of Unqualified being assigned to the examination.

ORAL EXAMINATION

The questions may be taken from this manual and drawn from the experience of the Instructor/Evaluator. Such questions should be direct and positive and should in no way be opinionated.

OFT/WST PROCEDURES EVALUATION

An OFT may be used to assist in measuring the crew member's efficiency in the execution of normal operating procedures and his reaction to emergencies and malfunctions. In areas not served by OFT facilities, this may be done by placing the crew member in an aircraft and administering appropriate questions.

GRADING INSTRUCTIONS

Examination grades shall be computed on a 4.0 scale and converted to an adjective grade of Qualified or Unqualified.

OPEN BOOK EXAMINATION

To obtain a grade of Qualified, an evaluatee must obtain a minimum score of 3.5.

CLOSED BOOK EXAMINATION

To obtain a grade of Qualified, an evaluatee must obtain a minimum score of 3.3.

ORAL EXAMINATION AND OFT PROCEDURE CHECK (IF CONDUCTED)

A grade of Qualified or Unqualified shall be assigned by the Instructor/Evaluator.

FLIGHT EVALUATION

The number of flights required to complete the flight evaluation should be kept to a minimum, normally one flight. The areas and subareas to be observed and graded on a flight evaluation are outlined in the grading criteria with critical areas marked by an asterisk (*). Subarea grades will be assigned in accordance with the grading criteria. These subareas shall be combined to arrive at the overall grade for the flight. Area grades, if desired, shall also be determined in this manner.

FLIGHT EVALUATION GRADE DETERMINATION

The following procedure shall be used in determining the flight evaluation grade. A grade of Unqualified in any critical area/subarea will result in an overall grade of Unqualified for the flight. Otherwise, flight evaluation (or area) grades shall be determined by assigning the following numerical equivalents to the adjective grade for each subarea. Only the numeral 0, 2, or 4 will be assigned in subareas. No interpolation is allowed.

Unqualified — 0.0

Conditionally Qualified — 2.0

Qualified — 4.0

To determine the numerical grade for each area and the overall grade for the flight, add all the points assigned to the subareas and divide this sum by the number of subareas graded. The adjective grade shall then be determined on the basis of the following scale:

- Unqualified — 0.0 to 2.19
- Conditionally Qualified — 2.2 to 2.99
- Qualified — 3.0 to 4.0

Example: Add subarea numerical equivalents:

$$\frac{4 + 2 + 4 + 2 + 4}{5} = \frac{16}{5} = 3.20 \text{ Qualified}$$

FINAL GRADE DETERMINATION

The final NATOPS evaluation grade shall be the same as the grade assigned to the flight evaluation. An evaluatee who receives an Unqualified on any ground examination or the flight evaluation shall be placed in an Unqualified status until he achieves a grade of Conditionally Qualified or Qualified on a re-evaluation.

RECORDS AND REPORTS

A NATOPS Evaluation Report (OPNAV Form 3510-8) (figure 10-1) shall be completed for each evaluation and forwarded to the evaluatee's Commanding Officer. This report shall be filed in the individual flight training record and retained therein for 18 months. In addition, an entry shall be made in the crew member's flight log-book under "Qualifications and Achievements" as follows:

QUALIFICATION	DATE	SIGNATURE
NATOPS (Air- EVALUA- craft TION Model) Posi- tion)	(Date) (Authen- tication)	(Unit which Admin- istered Eval- uation)

In the case of enlisted crew members, an entry shall be made in the administrative remarks of his personnel record upon satisfactory completion of the NATOPS evaluation.

(Date) Completed a NATOPS evaluation in (aircraft designation) as (flight crew position) with an overall grade of (Qualified or Conditionally Qualified).

FLIGHT EVALUATION GRADING CRITERIA

Only those subareas provided or required will be graded. The grades assigned for a subarea shall be determined by comparing the degree of adherence to standard operating procedures with adjectival ratings. Momentary deviations from standard operating procedures should not be considered as unqualifying provided such deviations do not jeopardize flight safety and the evaluatee applies prompt corrective action.

QUALIFIED

Well standardized; evaluatee demonstrated highly professional knowledge of and compliance with NATOPS standards and procedures; momentary deviations from or minor omissions in noncritical areas are permitted if prompt and timely remedial action is initiated by the evaluatee.

CONDITIONALLY QUALIFIED

Satisfactorily standardized; one or more significant deviations from NATOPS standards and procedures, but no errors jeopardizing mission accomplishment or flight safety.

UNQUALIFIED

Not acceptably standardized; evaluatee fails to meet minimum acceptable standards regarding knowledge of and/or ability to apply NATOPS procedures; one or more significant deviations from NATOPS standards and procedures which could jeopardize mission accomplishment or flight safety.

NATOPS EVALUATION REPORT

OPNAV FORM 3510-8 (8-65) 0107-723-0000

NAME (Last, first initial)		GRADE	SERVICE NUMBER
SQUADRON/UNIT	AIRCRAFT MODEL		CREW POSITION
TOTAL PILOT/FLIGHT HOURS	TOTAL HOURS IN MODEL	DATE OF LAST EVALUATION	

NATOPS EVALUATION

REQUIREMENT	DATE COMPLETED	GRADE		
		Q	CQ	U
OPEN BOOK EXAMINATION				
CLOSED BOOK EXAMINATION				
ORAL EXAMINATION				
*EVALUATION FLIGHT				
FLIGHT DURATION	AIRCRAFT BUNO	OVERALL FINAL GRADE		

REMARKS OF EVALUATOR/INSTRUCTOR

CHECK IF CONTINUED ON REVERSE SIDE

GRADE, NAME OF EVALUATOR/INSTRUCTOR	SIGNATURE	DATE
GRADE, NAME OF EVALUEE	SIGNATURE	DATE

REMARKS OF UNIT COMMANDER

RANK, NAME OF UNIT COMMANDER	SIGNATURE	DATE
------------------------------	-----------	------

*WST, OFT, COT, or cockpit check in accordance with OPNAVINST 3510.9 (effective edition)

Figure 10-1

PART 2 — NATOPS EVALUATION QUESTION BANK

NATOPS EVALUATION QUESTION BANK

The following bank of questions is intended to assist the unit NATOPS Instructor/Evaluator in the preparation of ground examinations and to provide an abbreviated

study guide. The questions from the bank should be combined with locally originated questions as well as questions obtained from the Model Manager in the preparation of ground examinations.

1. The secondary bus is powered from the primary bus when: _____
 (a) The landing gear handle is down.
 (b) Either generator is operating.
 (c) When BATTERY switch is selected to EMERG.
 (d) All of the above.
2. The No. 2 inverter is powered by: _____
 (a) Primary bus.
 (b) Battery bus.
 (c) Monitor bus.
 (d) Secondary bus.
3. With both engines running, the voltmeter shows which voltage? _____
 (a) Battery.
 (b) Right generator.
 (c) Generator with highest output.
 (d) Left generator.
4. The ailerons are similar to the elevator in that both have aerodynamic boost provided by _____.
5. A red light glowing in the landing gear handle knob means _____

6. The procedure for setting the wheel brakes for parking is to: _____

7. Give the air start procedures: _____

8. What are the procedures in the event of engine fire in flight?

9. What are the warning and caution lights installed on both the pilot's and observer's panels?

10. How may the pilot determine if the fuel system is gravity transferring?

11. By what means is the drop tank fuel transferred? _____

12. With SUPPLY lever ON, diluter lever either NORMAL OXYGEN or 100% OXYGEN, and emergency lever NORMAL on the OXYGEN REGULATOR panel, the FLOW indicator will blink white on inhalation and black on exhalation.
 True _____; False _____

Section X
Part 2

NAVAIR 01-OV10D-1

13. With the SUPPLY lever OFF, diluter lever 100% OXYGEN, and emergency lever NORMAL on the OXYGEN REGULATOR panel, it would be impossible to breathe wearing an oxygen mask.
True _____; False _____.
14. If the FLOW indicator is blinking, it is a positive indication that oxygen is flowing to the mask.
True _____; False _____.
15. On a solo flight, the oxygen gage indicated 900 psi at 10,000 feet. With 100% oxygen selected, the pilot could expect sufficient oxygen for: _____
(a) 1 hour.
(b) 2 hours.
(c) 4.9 hours.
(d) 9.8 hours.
16. The gunsight filament switch is located: _____
(a) On right-hand instrument shroud.
(b) On left-hand instrument shroud.
(c) Top center of canopy bow.
(d) Center pedestal.
17. The stores loading limit of the centerline station is: _____
(a) 1200.
(b) 600.
(c) 2250.
(d) 500.
18. Initiation of the escape system is accomplished by a: _____
(a) "D" ring.
(b) Face curtain.
(c) Squeeze grip.
19. The seat is adjustable both vertically and fore and aft.
True _____; False _____.
20. On a parachute descent, the survival kit cannot be released.
True _____; False _____.
21. On a zero altitude and zero airspeed ejection, collision of the two seats is prevented by the time delay of the forward catapult rocket and parachute location.
True _____; False _____.
22. Failure of the seat, or seats, to eject is very remote because of the dual system to the catapult rocket.
True _____; False _____.
23. Flight at zero or negative "g" is limited to _____ seconds.
24. The INST PWR caution light illuminates on failure of primary a-c bus power regardless of inverter selection.
True _____; False _____.
25. How much time may be required to fully extend the flaps using the alternate method? _____.
26. Either MIL-L-7808 or MIL-L-23699 is acceptable oil for the OV-10D.
True _____; False _____.
27. Optimum glide gear up is _____ nautical miles for every 5000 feet of altitude.
28. When will the fuel BOOST PUMP caution light illuminate? _____.
29. In the event of runaway nose-up trim that cannot be moved by either the normal or alternate trim system, a no-flap landing is recommended.
True _____; False _____.
30. If light-off is not indicated within _____ seconds, abort start. How long must the starter cool before attempting a relight? _____.

31. When fuel quantity falls below _____ to _____ pounds in the center wing tank, the FUEL LOW caution light will illuminate. _____
 (a) 200 to 225.
 (b) 205 to 235.
 (c) 210 to 250.
 (d) 280 to 285.
32. Reverse thrust above 70 knots should be used cautiously to preclude engine rpm decay and engine overtemperature. True _____; False _____.
33. If ejector pump action should fail (wing and center tanks) fuel will continue to flow into the feed tank by: _____
 (a) Operating the wobble tank.
 (b) Engine-driven boost pump.
 (c) Gravity.
34. What are the four positions of the condition levers? _____
35. What is the total usable internal fuel quantity? JP-4 _____ and JP-5 _____.
36. Selection of full heat will reduce engine torque approximately 150 foot-pounds at Military power. True _____; False _____.
37. Operating with the temperature control full out, ram-air control full in, and cockpit air/defrost control full in may result in overheat damage to windshield panels. True _____; False _____.
38. If selection of heat (pulling temperature control out) fails to increase temperature, the pilot should _____.
39. If the temperature control failed to shut off the flow of hot air, the pilot should _____.
40. What two indications can the pilot observe to show that the elevator trim system is working? _____
41. During BEFORE TAXI check, the stick grip trim switch does not work, the first thing to check is _____.
42. The FLAP handle should be in the _____ position, when the ALT FLAPS switch is checked.
43. The emergency parachute release handle is located on the left side of the headrest on both forward and aft seats. True _____; False _____.
44. In the event of a malfunction of the hydraulic system, the landing gear can be extended and locked down by _____.
45. To arm the seats, the total safety pins to remove and stow on each seat is: _____
 (a) 1.
 (b) 2.
 (c) 3.
 (d) 4.
46. Ejection initiation by the pilot will: _____
 (a) Eject only the pilot.
 (b) Eject both pilot and observer in that sequence.
 (c) Eject both observer and pilot in that sequence.
 (d) Eject both the observer and the pilot at the same instant.
47. On a pilot-initiated ejection, the pilot should expect _____ delay.
 (a) 0.4 second.
 (b) 0.75 second.
 (c) 1.15 seconds.
 (d) 0.8 second.

Section X
Part 2

NAVAIR 01-OV10D-1

48. On an observer-initiated ejection, the pilot should expect: _____
(a) The observer to eject in approximately 1.15 seconds.
(b) The observer to eject in approximately 0.75 second.
(c) The observer to eject 0.75 second after he (pilot) ejected.
(d) No ejection for himself.
49. One capability not possible with the LW-3B ejection seat and the OV-10D is: _____
(a) Zero altitude and zero airspeed ejection.
(b) High-speed ejection.
(c) Low-speed, low-altitude ejection.
(d) Over-the-side bail-out.
50. Both the pilot and observer can eject in the shortest interval of time if: _____
(a) The pilot initiates the ejection.
(b) The observer initiates the ejection.
(c) The observer initiates his ejection and the pilot initiates his own ejection.
(d) Any of the above initiations is accomplished.
51. Ejection is always through the top glass of the cockpit enclosures.
True _____; False _____
52. On a high-altitude and/or high-speed ejection, a 2-second delay in parachute opening after ejection is normal.
True _____; False _____
53. The shoulder-harness ballistic inertia reel is actuated automatically on ejection.
True _____; False _____
54. With generators operating and external power applied, the generator caution lights will not extinguish until external power plug is disconnected.
True _____; False _____
55. The battery bus is powered: _____
(a) As long as the batteries are connected and have an adequate charge.
(b) When the BATTERY switch is positioned to ON.
(c) When the BATTERY switch is positioned to OFF.
(d) All of the above.
56. The primary d-c bus: _____
(a) Provides power to all normal mission powered equipment when a battery start is used.
(b) Supplies power directly to the No. 2 inverter.
(c) Is powered from the generators or external a-c power.
(d) May receive battery, generator, or external d-c power from the main d-c bus.
57. To dim the cockpit caution lights: _____
(a) The CONSOLES lights rheostat must be positioned away from OFF.
(b) The pilot positions the caution lights dimming switch to DIM position.
(c) The INSTRUMENTS lights rheostat is positioned away from OFF.
58. The No. 1 inverter: _____
(a) Powers the No. 1 monitor a-c bus if the INST PWR switch is at INV NO. 1 and either generator operating or utility external power is applied.
(b) Powers the primary a-c bus and TACAN when the TCN PWR switch is in NORM.
(c) Operates from the monitor d-c bus.
(d) None of the above.
59. When does the WHEELS warning light illuminate? _____

60. Manual jettison of stores will release: _____
 (a) All stations.
 (b) Stations 1 and 2.
 (c) Stations 1, 2, 3, and 4.
 (d) Stations 1, 2, 4, and 5.
61. What monitor switches on the ICS control panel must be actuated for hot-mike operations between pilot and observer?
 (a) Hot-mike.
 (b) Hot-mike (talk) and hot-mike (listen).
 (c) Transmit select to INT.
 (d) Depress CALL switch.
62. What switches must be pulled or positioned to transmit over VHF-FM and monitor UHF? _____

 (a) Selector switch to UHF and monitor switch VHF-FM pulled.
 (b) Selector switch to VHF and FM monitor switch pulled.
 (c) Selector switch to VHF and UHF monitor switch pulled.
 (d) Cannot be operated in this manner.
63. What are the engine ignition limits? _____

64. What is the maximum permissible airspeed for extending the landing gear? _____

65. Describe the procedures for unlocking the propellers. _____

66. During preflight of the ejection seat at sea level, the speed/altitude sensor window shows red. The aircraft is still up, but a yellow sheet entry must be made.
 True _____; False _____
67. When testing the fire detection warning lights systems without the inverter on, you are testing the _____ side of the system.
68. Prior to starting the second engine, rpm on the engine already running must be _____ rpm.
69. If light-off does not occur within _____ during start sequence, place the appropriate condition lever to _____ and the engine START switch to ABORT.
70. The OV-10D is currently limited to landings on _____ with sink rates of _____ maximum.
71. Use of reverse thrust on landing rollouts above 100 knots is prohibited.
 True _____; False _____
72. Minimum speed for take-off at gross weights of 12,180 pounds or less is _____ knots for 20 degrees flaps and _____ knots for no flaps.
73. Maximum allowable EGT on start is _____ transient for _____.
74. A clogged oil filter usually will not be noted by the pilot in the air, but can always be discovered during preflight.
 True _____; False _____
75. At GROUND IDLE rpm, minimum oil pressure is _____.
76. The minimum airspeed for normal landings (flaps 20 degrees) is _____ knots for gross weights up to 12,000 pounds.
77. For jettison of the external wing and C fuel tanks, maximum airspeed is _____ knots in 1.0-g level flight.

78. The OV-10D uses a closed center, intermittent duty hydraulic system. If the hydraulic pressure caution light illuminates, it indicates that system pressure is less than _____ and gear and flaps will _____.
79. Normal pressure for the hydraulic system when operating is _____ psi.
80. Sufficient d-c power is available with a single generator operational to supply all required electrical loads.
True _____; False _____.
81. In the event of a dual-generator failure, all equipment on the primary d-c bus will continue to function, and equipment on the secondary d-c bus can be used by placing the gear handle in the down position.
True _____; False _____.
82. If, during an engine air start, the START IGN ON advisory light fails to go out above 53% rpm, you should check which of the following?
(a) Condition lever on appropriate engine in NORMAL FLIGHT.
(b) AIR START switch back to the AUTO position.
(c) Battery off.
(d) Power levers forward of FLIGHT IDLE.
83. The main purpose of the NTS (negative torque system) is to prevent the propeller from driving the engine.
True _____; False _____.
84. The engine and propeller control oil is supplied from which of the following per engine: _____

(a) A single 3.0-gallon tank.
(b) Two 3.0-gallon tanks.
(c) One 1.5-gallon tank.
(d) Two 1.5 gallon tanks.
85. To fire the fixed M60 machine guns, put the MASTER ARM _____, INTL GUNS select switch to _____ and depress the _____.
86. When firing the rockets, place the MASTER ARM switch ON, WPN STA MODE SELECT switch to _____ and depress the _____.
87. In the event of a sudden and complete engine failure immediately after take-off, and altitude or terrain does not permit safe recovery, you should _____.
88. During single-engine emergencies in the dirty configuration, flaps should not be raised above 20 degrees until: _____

(a) Above 110 knots.
(b) 90 knots.
(c) Not to be raised at all.
(d) None of the above.
89. In the event an air start is unsuccessful, place the condition levers to _____ and AIR START switches to _____.
90. During aborted take-offs, jettisoning of the external stores should be considered as a last resort.
True _____; False _____.
91. If a nose tire fails on take-off and you cannot abort, the gear should be left down after becoming airborne.
True _____; False _____.
92. The normal position for the IGNITION & UNFEATHER switch on a ground start is _____.
93. The propellers should be in the _____ position prior to starting the engines.
94. The main gear oleo extension while on the ground should be: _____

(a) 3.66 inches.
(b) Three fingers.
(c) 8 inches from the oleo flange to connector nut.
(d) Approximately 5 inches.

95. The proper procedure for starting the engine with no external power, and the propellers on the start locks is power lever _____, condition levers to _____, AIR START switches in _____, START switch to _____, and at _____, condition levers to _____.
96. If light-off does not occur after 15 seconds of start cycle, the sequence may be continued with close monitor of EGT. True _____; False _____.
97. Maximum engine oil pressure at 100% rpm is: _____
 (a) 115 psi.
 (b) 50 to 120 psi.
 (c) 120 psi.
 (d) 48 psi.
98. Reverse thrust torque in the range of 0 to 2300 pounds is limited to how many seconds? _____
 (a) No limit.
 (b) 5 seconds.
 (c) 1 minute.
 (d) 5 seconds if below 98% rpm.
99. The brake systems obtain hydraulic boost pressure from the main hydraulic system during brake actuation. True _____; False _____.
100. The _____ may be used to operate the hydraulic pump at any time, to provide operation of normal hydraulic systems in the event of normal control circuit failure.
101. If the primary a-c bus power is lost, you will lose which of the following equipment? _____
 (a) IFF, instruments lights, No. 1 engine ignition, No. 1 engine T.I.T.
 (b) Attitude gyro, pilot console lights, IFF, No. 1 engine ignition.
 (c) No. 1 engine FIRE DET, No. 1 engine ignition, attitude gyro, and No. 1 engine T.I.T.
 (d) IFF, attitude gyro, No. 1 engine T.I.T., No. 1 engine FIRE DET.
102. If the No. 2 inverter is lost during straight and level flight, with the No. 1 inverter selected, the pilot will be aware of the loss through the loss of which of the following item(s) of equipment? _____
 (a) TACAN, attitude gyro, engine torque.
 (b) TACAN, IFF.
 (c) TACAN.
 (d) IFF.
103. With a "packed" centerline station external fuel tank, and auxiliary wing tanks, total fuel load is _____ using JP-4; using JP-5, it is _____.
104. When transferring external fuel, the EXT FUEL TRANS switches should be placed to OFF when external tanks are empty to prevent _____.
105. Control force trim on flight control systems is achieved by electrically operated trim _____.
106. The rudders are not tab-boosted, and are displaced by direct mechanical action through the rudder pedals. True _____; False _____.
107. In the event of a normal trim system failure, alternate power will be provided through the primary d-c bus, and the system will be operated through the alternate trim control switches. True _____; False _____.
108. The shaft horsepower rating of the T76-G-420/-421 engine is _____.
109. The T76 uses a _____ turbine _____.

Section X
Part 2

NAVAIR 01-OV10D-1

110. A function of the fuel control is: _____
(a) Modifies fuel flow for changes in engine compressor inlet temperature.
(b) Modifies fuel flow for changes in compressor inlet pressure.
(c) Provides manual fuel metering as a function of the cockpit power lever position.
(d) All of the above.
111. Placement of the power levers at the FLIGHT IDLE position provides in flight minimum fuel flow and torque, dependent on _____.
112. During starts, the TIT gage monitors EGT only below _____, then monitors _____ when the inverter is on.
113. The start ignition on light should illuminate when either engine START switch is held momentarily in START, and go out at _____.
114. In the range of 0 to 2625 pounds of torque, the time limit for this torque is: _____.
115. The maximum allowable TIT excluding start is: _____
(a) 1040°C for 1 second.
(b) 990°C, no time limit.
(c) 1108°C for 30 minutes.
(d) 1129°C for 1 minute.
116. Maximum underfuselage store loading for design "g" limits is _____.
117. The UHF has a frequency range of 225.0 to 399.95.
True _____; False _____.
118. The VHF-FM take-command switch is both a give and take switch.
True _____; False _____.
119. To transmit on a particular radio and hear yourself transmit, you must have the desired radio on, and the transmit select knob to the appropriate position.
True _____; False _____.
120. To augment weak audio signals due to distance, the UHF squelch switch should be _____.
121. The Drag Index of a LAU-3A/A rocket pod, fired, single, is: _____
(a) 9.0.
(b) 18.0
(c) 12.0
(d) 15.0.
122. Runway heading is 040 degrees. The wind is 080 degrees at 15 knots, what is the crosswind component? What is the headwind component? _____
(a) 9.5 knots; 11.5 knots.
(b) 9 knots; 7.5 knots.
(c) 10 knots; 10 knots.
(d) 15 knots; 15 knots.
123. In the event of a landing with both main gear down, but nose gear up, the brakes should not be used.
True _____; False _____.
124. During operation of the ejection seat, the speed/altitude sensor will provide a 2.0-second delay in firing the thruster above _____ altitude or at speeds in excess of _____ knots.
125. If, during ejection sequence, chute deployment fails to occur, chute deployment and seat separation can be obtained by _____.

126. A rule of thumb to rapidly determine which engine has failed is _____.
127. On engine failure immediately after take-off, after all previous steps have been taken, flaps should be raised when safely _____.
128. With a dual-engine failure, propellers feathered, clean aircraft configuration, an airspeed of 130 knots, and an altitude of 15,000 feet AGL, you can expect to have a straight-ahead glide distance of _____.
129. In the event of a complete electrical failure, including the battery, the centerline stores can be released by pulling the emergency stores jettison handle.
True _____; False _____.
130. The pilot's hydraulic light will illuminate on system demand if pressure is less than _____.
131. If primary d-c bus power is lost, you will be able to trim the aircraft by going to alternate trim control.
True _____; False _____.
132. With a failure of both No. 1 and No. 2 inverters, engine TIT will be impossible to determine.
True _____; False _____.
133. The pilot may cross-check the TIT system reading by turning the _____ switch on and reading EGT.
134. The pilot can override the yaw damper action by exerting approximately _____ force on the rudder pedals.
135. _____ minutes are required for warm-up of the AN/ARC-51 prior to _____.
136. The AN/APX-64(V) requires _____ minutes warm-up prior to interrogation-response.
137. Limit airspeed for extension of full flaps is _____.
138. Describe the flame-out approach pattern. _____

139. If the engine has been "cold-soaked" at temperatures below 0°F, a _____ warm-up at _____ is recommended.
140. Selection of frequencies below 225.00 MHz on the UHF control box may cause system malfunction.
True _____; False _____.
141. Maximum continuous TIT is _____.
142. With gross weight 13,800 pounds, what is take-off speed for normal operation with 20 degrees flaps? _____.
143. (a) For normal take-off, 0 degrees flaps, what is uncorrected take-off ground run for OAT 24°C, pressure altitude 4000 feet, gross weight 11,500 pounds, 10 knots wind? _____.
(b) What is the refusal speed? _____.
(c) What is the corrected ground run with a wind speed of 10 knots, actual torque reading 1800? _____.
(d) What will be the ground run required to clear a 50-foot obstacle on a normal take-off, flaps 0 degrees? _____.

Section X
Part 2

NAVAIR 01-OV10D-1

144. (a) What is the time required to climb to 10,000 feet, gross weight 11,500 pounds, Drag Index 60, average temperature 20°C, wind 0? _____
(b) What is distance covered? _____
(c) How much fuel is used? _____
145. Compute landing distance for gross weight 10,000 pounds, flap setting 20 degrees, 10 knots headwind, pressure altitude 3000 feet, temperature 25°C:
(a) Full reverse distance. _____
(b) Idle power distance. _____
(c) Landing at 101 knots, full reverse thrust. _____
146. Maximum TIT for start is _____
147. Maximum TIT for acceleration is _____
148. Maximum allowable torque split on the ground is _____. In the air is _____
149. Symmetrical "g" limits are minus _____ to plus _____ up to 13,142 pounds.
150. Rolling pullout "g" limits are minus _____ to plus _____
151. Maximum gross weight for take-off is _____
152. Maximum wing pylon load is _____
153. If the total ampere load per generator with all electrical equipment on is in excess of _____ amps, secure the _____ to see if it is the cause of the high load.
154. Single engine approaches should be made _____ flaps with the following minimum airspeeds:
- | Gross Weight | KIAS |
|---------------|-------|
| 12,000 pounds | _____ |
| 13,000 pounds | _____ |
155. The auxiliary fuel transfer pumps shut off automatically (illumination the respective AUX FUEL caution light) when fuel flow has stopped for 10 seconds. The transfer switch must be turned off and allow _____ seconds minimum for thermal relay reset. It will require an additional _____ seconds to reprime the pump prior to fuel transfer.
156. If the fuel boost pump caution light illuminates, _____ rpm should be maintained to ensure motive flow pressure is retained.

PART 3 — NATOPS EVALUATION FORMS

NATOPS EVALUATION FORMS

In addition to the NATOPS Evaluation Report, a NATOPS Flight Evaluation Worksheet (OPNAV FORM 3510) (figures 10-2 through 10-5) and other

forms are provided for use by the Evaluator/Instructor during the evaluation flight. All of the flight areas and subareas are listed on the worksheet with space allowed for related notes. Applicable forms in this section may be reproduced locally as required.

VT PILOT NATOPS EVALUATION WORKSHEET

Asterisk (*) denotes
a critical area

OPNAV FORM 3510/10 (11/65)

NAME	GRADE	SERVICE NUMBER
SQUADRON/UNIT	AIRCRAFT MODEL	CREW POSITION PILOT
TOTAL PILOT/FLIGHT HOURS	TOTAL HOURS IN MODEL	DATE OF LAST EVALUATION

NATOPS EVALUATION

REQUIREMENT	DATE COMPLETED	GRADE		
		Q	CQ	U
OPEN BOOK EXAMINATION				
CLOSED BOOK EXAMINATION				
ORAL EXAMINATION				
FLIGHT EVALUATION				
FLIGHT DURATION	AIRCRAFT BUONO	OVERALL FINAL GRADE		
GRADE, NAME OF EVALUATOR/INSTRUCTOR		DATE		
REMARKS				

Figure 10-2

OPNAV FORM 3510/10 (11/65)

Asterisk () denotes a critical area*

1. MISSION PLANNING		ADJECTIVE AREA GRADE			REMARKS	
SUB-AREAS	Q	CQ	U	POINTS		
A. PERSONAL FLYING EQUIP						
B. FLIGHT PREPARATION						
*C. CREW/PASSENGER BRIEFING						
*D. AIRCRAFT TAKEOFF DATA						
NUMERICAL AREA GRADE	TOTAL POINTS					
2. PREFLIGHT		ADJECTIVE AREA GRADE				
SUB-AREAS	Q	CQ	U	POINTS		
A. AIRCRAFT INSPECTION						
B. CHECKLISTS						
NUMERICAL AREA GRADE	TOTAL POINTS					
3. PRE-TAKEOFF		ADJECTIVE AREA GRADE				
SUB-AREAS	Q	CQ	U	POINTS		
A. START						
B. CHECKLISTS						
C. TAXI						
*D. ENGINE RUNUP						
NUMERICAL AREA GRADE	TOTAL POINTS					
4. TAKEOFF		ADJECTIVE AREA GRADE				
SUB-AREAS	Q	CQ	U	POINTS		
*A. TAKEOFF PROCEDURES						
*B. TRANSITION						
NUMERICAL AREA GRADE	TOTAL POINTS					

Figure 10-3

OPNAV FORM 3510/10 (11/65)

Asterisk (*) denotes critical area

5. BASIC AIRWORK		ADJECTIVE AREA GRADE			REMARKS
SUB-AREAS	Q	CQ	U	POINTS	
A.					
B.					
C.					
D.					
NUMERICAL AREA GRADE		TOTAL POINTS			
*6. EMERGENCIES		ADJECTIVE AREA GRADE			
SUB-AREAS	Q	CQ	U	POINTS	
*A. ENGINE FAILURE					
*B. FIRE INFLIGHT					
*C. SYSTEM FAILURE					
NUMERICAL AREA GRADE		TOTAL POINTS			
7. INSTRUMENT PROCEDURES		ADJECTIVE AREA GRADE			
SUB-AREAS	Q	CQ	U	POINTS	
A. HOLDING					
B. APPROACH/PENETRATION					
C. PRECISION RADAR APPROACH					
NUMERICAL AREA GRADE		TOTAL POINTS			
8. LANDING		ADJECTIVE AREA GRADE			
SUB-AREAS	Q	CQ	U	POINTS	
*A. CHECKLISTS					
*B. DESCENT					
*C. PATTERN					
*D. LANDING AND ROLLOUT					
NUMERICAL AREA GRADE		TOTAL POINTS			

Figure 10-4

OPNAV FORM 3510/10 (11/65)

Asterisk () denotes a critical area*

9. POSTFLIGHT		ADJECTIVE AREA GRADE			POINTS	REMARKS
SUB-AREAS		Q	CQ	U		
A. ENGINE SHUTDOWN						
B. CHECKLIST (NA TO JETS)						
C. POSTFLIGHT INSPECTION						
D. MISSION DEBRIEF						
NUMERICAL AREA GRADE		TOTAL POINTS				
A. TOTAL ALL SUB-AREA POINTS						
B. TOTAL NO. SUB-AREAS GRADED						
C. FLT. EVAL. NUMERICAL GRADE					A B	
*EVALUATION ADJECTIVE GRADE						

**See OPNAVINST 3510.9 Series.

Figure 10-5

SECTION XI—PERFORMANCE DATA

Note

Unless otherwise labeled, data in this section is estimated and should be treated accordingly.

TABLE OF CONTENTS

PART 1—BASIC DATA	11-1	Optimum Cruise Altitude	11-43
Aircraft Configuration Drag		Nautical Miles Per 100 Pounds Fuel	11-43
Index System	11-1		
Aircraft Configuration Stores Capability Table	11-1	PART 5—ENDURANCE DATA	11-65
Aircraft Operating Weight	11-2	Endurance Data	11-65
Example Problems	11-2	Constant-Altitude Maximum Endurance	11-65
Fuel Weight Versus Temperature	11-2	Example Problem	
Standard Data	11-2		
Airspeed Conversion	11-2	PART 6—FLIGHT CHARACTERISTICS DATA	11-69
Speed-Altitude Correction	11-2	Flight Characteristics Data	11-69
Standard Atmosphere Table	11-2	Stall Speeds	11-69
PART 2—TAKE-OFF DATA	11-9	Minimum Single-Engine Control and	
Take-off Data	11-9	Flyaway Speeds	11-69
Wind Component	11-7	Angle-of-Attack Relationship	11-70
Take-off Distance	11-9		
Minimum Torque Versus Gross Weight to Maintain		PART 7—DESCENT DATA	11-77
100 FPM Rate of Climb	11-8	Descent Data	11-77
Climb-out Flight Path	11-11	Rate-of-Descent and Descent Speed	
PART 3—CLIMB DATA	11-23	in Normal Descent	11-77
Climb Data	11-23	Distance, Time, and Fuel Used in	
Climb Charts	11-23	Normal Descent	11-77
Aircraft Ceilings	11-23		
PART 4—RANGE DATA	11-43	PART 8—LANDING DATA	11-81
Range Data	11-43	Landing Data	11-81
Constant-Altitude Cruise	11-43	Landing Distance	11-81

PART 1 — BASIC DATA

AIRCRAFT CONFIGURATION DRAG INDEX SYSTEM

Climb, range, and endurance data are presented in a drag index format to provide maximum flexibility, while requiring minimum interpolation. With this system, basic aircraft drag (with spousons and centerline pylon installed) is assigned a value of 50 and a store drag number is assigned to each external store including the wing pylons and drop tanks. By adding the individual drag numbers, a configuration drag number (called Drag Index) is obtained. This Drag Index is used with aircraft gross weight in performance data computation. The Drag Index obtained can be rounded off for convenience without losing significant accuracy. The only interpolation then required is that used to determine

data point placement between drag index reflector curves provided on the charts.

AIRCRAFT CONFIGURATION STORES CAPABILITY TABLE (FIGURE FO-5)

The Aircraft Configuration Stores Capability Table (figure FO-5) is used to determine aircraft drag index and gross weight for performance data computations. The drag number columns include data for the effects of store interference drag, or the effect of a given store by additional stores on one side (adjacent), or on both sides (multiple adjacent).

Note

Only those stores and operating limitations shown in figure 1-31 are authorized to be carried and released or fired to the limits indicated.

AIRCRAFT OPERATING WEIGHT

The operating weight of the clean aircraft is approximately 9816 pounds. Derivation of this weight and data on specific aircraft equipment are provided for planning use as required.

Weight Empty	8255 pounds
Unusable Fuel	.52
Observer's Equipment	.65
Armor Plate	.325
Sponsons (Two) with Racks	.272
Centerline Pylon	.54
Engine Oil	.34
Ballast	.117
Parachutes	.42
Survival Kits	.60
First Aid Kit	.3
Oxygen System	.63
Flooring—Cargo Bay	.58
Loose Equipment Bag	.16
(Mooring, Jacking Fittings)	
Basic Weight	9416 pounds
Pilot	.200
Observer	.200
Operating Weight	9816 pounds

Note

For gross weights of useful load items and external stores, see figure FO-5. For detailed weight data, refer to the Weight and Balance Data Manual (NAVAIR 01-1B-40).

EXAMPLE PROBLEMS

DRAG INDEX EXAMPLE

AIRCRAFT CONFIGURATION: Sponsons and centerline pylon plus one Aero 1C external fuel tank and two LAU-3A/A rocket pods.

Basic aircraft drag number	50.0
External fuel tank drag number	14.0
Two LAU-3A/A rocket pods drag	58.0
Number (cones off, single store nonadjacent)	
Drag Index (Total)	122.0

Note

If the rockets are fired and the empty pods released, Drag Index is reduced by 58.0, resulting in a return route Drag Index of 64 (122.0 minus 58.0, or 64).

GROSS WEIGHT EXAMPLE

AIRCRAFT CONFIGURATION: Sponsons and centerline pylon plus one Aero 1C external fuel tank and two LAU-3A/A rocket pods.

Operating Weight—Clean Aircraft	9816 pounds
Fuel—usable, internal (JP-5)	.1622
Aero 1C external fuel tank (full) (JP-5)	.1155
LAU-3A/A rocket pods (two)	.814
(cones off, single store, nonadjacent)	
Take-off Gross Weight	13,407 pounds

FUEL WEIGHT VERSUS TEMPERATURE

(FIGURE 11-1)

Pertinent performance data are based on the use of JP-5 fuel at a specific weight of 6.8 pounds per gallon (Standard Day). Variations in fuel weight for nonstandard temperatures and/or the use of alternate or emergency fuels can be determined by using figure 11-1.

Note

Fuel which has been stored in aircraft tanks for more than approximately 4 hours can be assumed to be at the same temperature as ambient air.

STANDARD DATA

AIRSPPEED CONVERSION

(FIGURE 11-2)

The Airspeed Conversion chart (figure 11-2) is used to determine calibrated airspeed (CAS), true airspeed (TAS), and Mach number. Indicated airspeed (IAS) must first be converted to CAS before entering the chart to determine TAS.

AIRSPPEED CONVERSION EXAMPLE PROBLEM

Determine true airspeed:

- Altitude—10,000 feet
- CAS—130 knots
- Temperature—20°C

1. True Mach number = 0.235
2. Standard Day TAS = 151 knots
3. Corrected TAS = 158 knots

SPEED-ALTITUDE CORRECTION

(FIGURE 11-3)

The Speed-Altitude Correction chart (figure 11-3) is used to determine indicated airspeed (IAS) when desired calibrated airspeed (CAS) is known, and to obtain corrections for converting indicated altitude to true pressure altitude. Airspeed corrections are generally small enough to be considered negligible. Altimeter corrections for low-altitude, high-speed flight are sufficient to warrant preplanning for low-level missions.

STANDARD ATMOSPHERE TABLE

(FIGURE 11-4)

The Standard Atmosphere Table (figure 11-4) provides various atmospheric parameters under ICAO Standard Day conditions from sea level through 39,000 feet.

FUEL WT

OV-10D-1-118

FUEL WEIGHT vs. TEMPERATURE

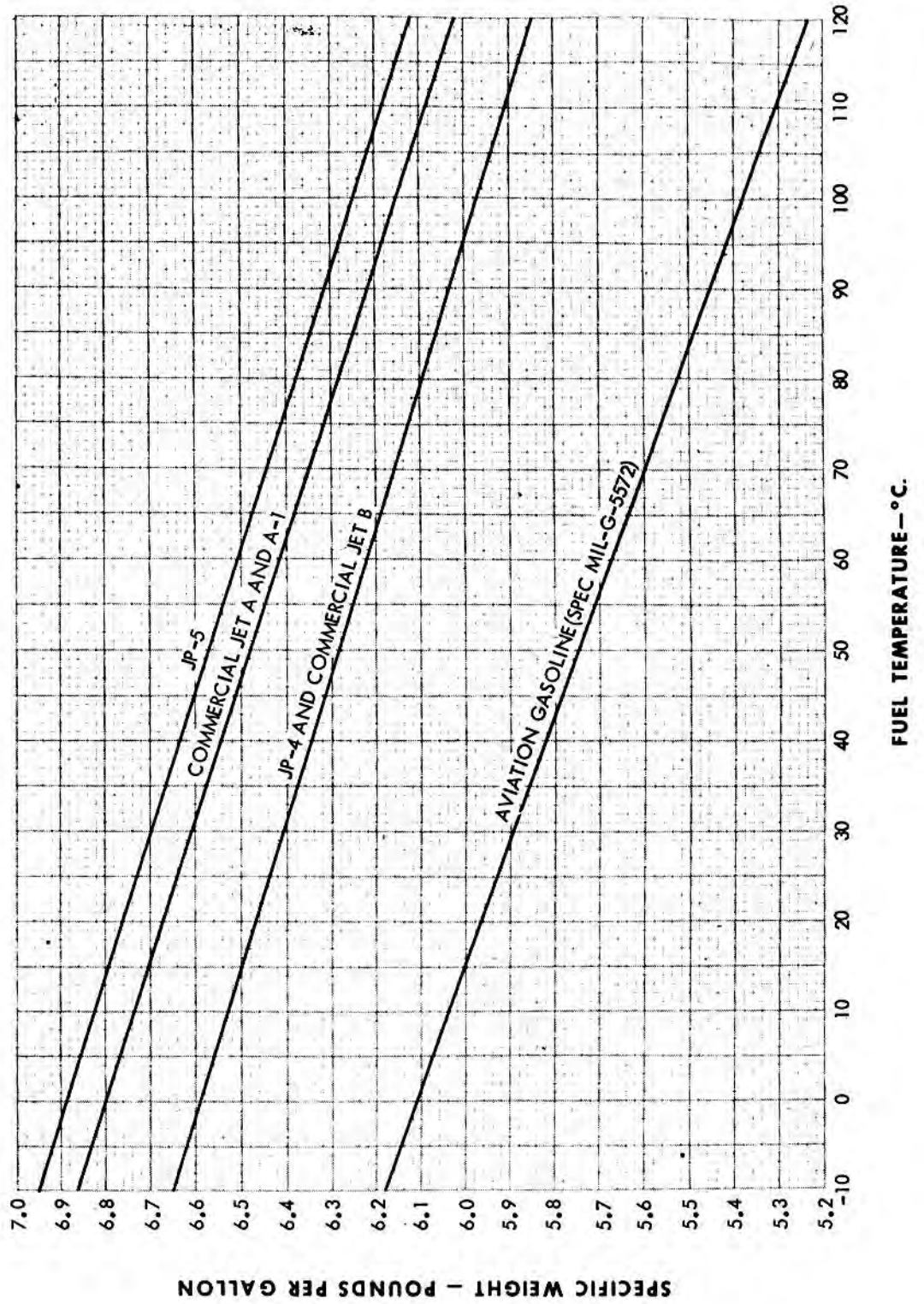
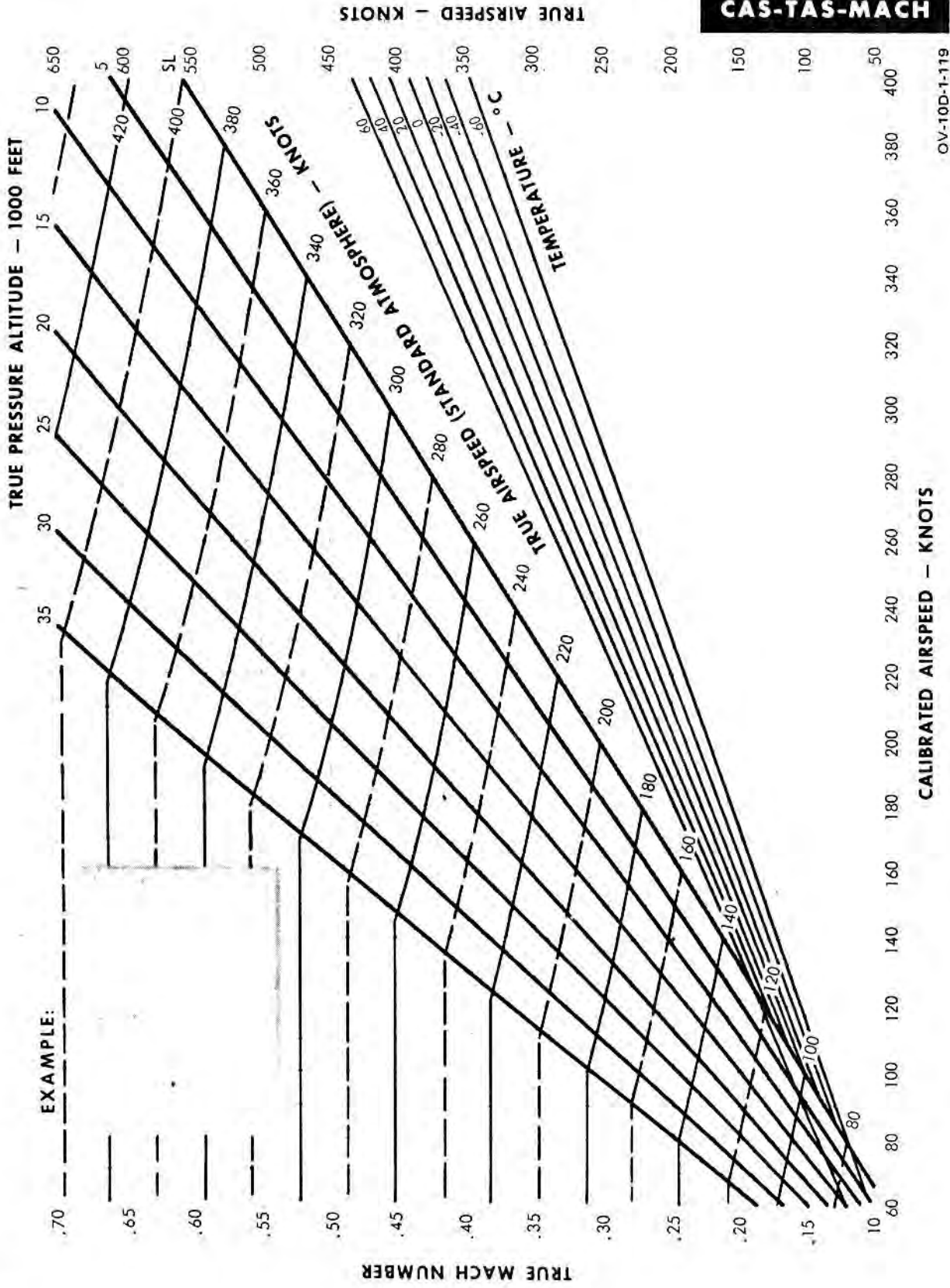

Figure 11-1

AIRSPEED CONVERSION



OV-10D-1-119

Figure 11-2

SPEED-ALTITUDE CORRECTION

BASED ON: FLIGHT TEST
DATA AS OF: 1 SEPTEMBER 1968

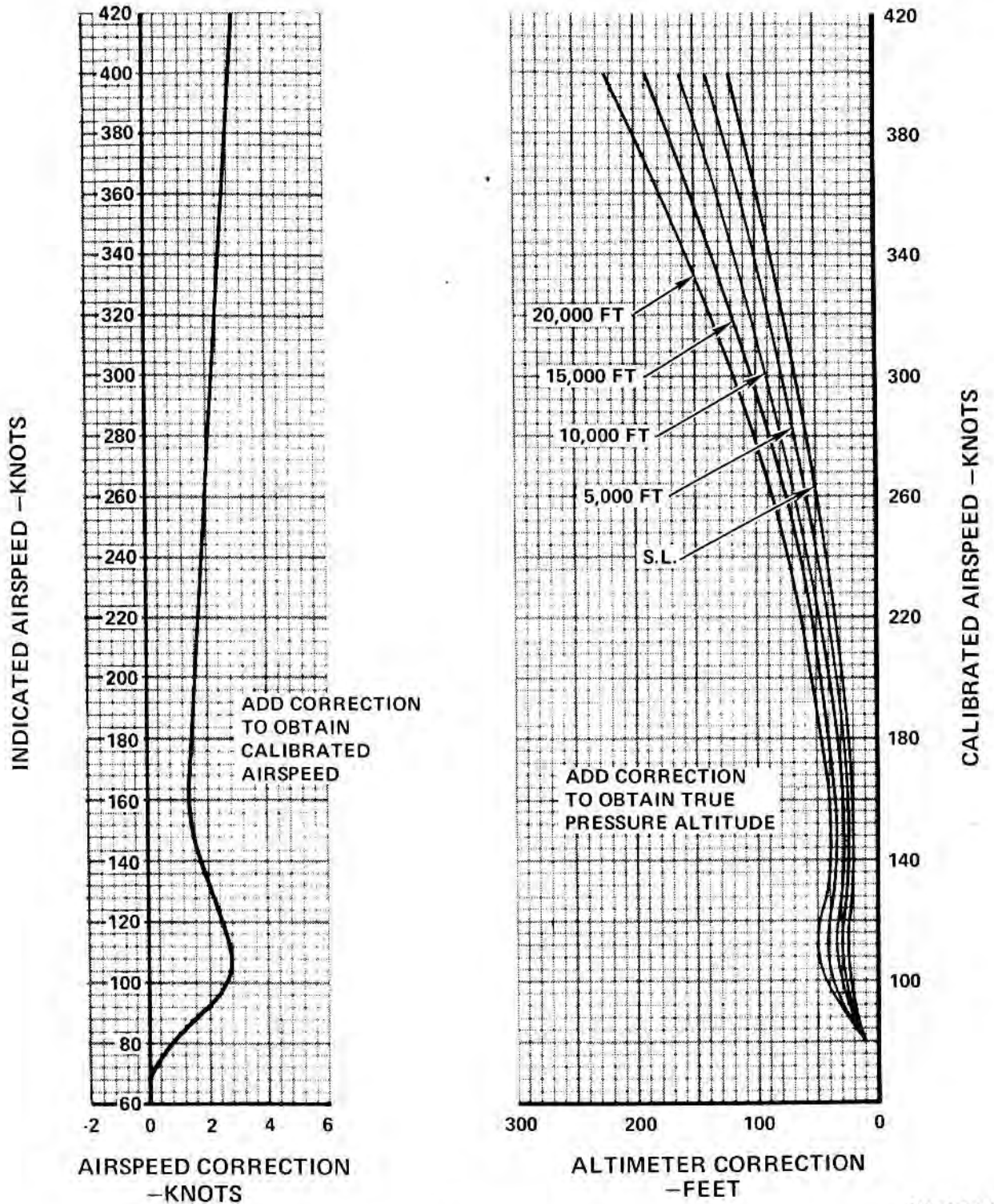

OV-10D-1-114

Figure 11-3

STANDARD ATMOSPHERE TABLE

STANDARD S L CONDITIONS:

TEMPERATURE 15°C (59°F)
 PRESSURE 29.921 IN. Hg 2116.216 LB/SQ FT
 DENSITY .0023769 SLUGS/CU FT
 SPEED OF SOUND 1116.89 FT/SEC 661.7 KNOTS

CONVERSION FACTORS:

1 IN. Hg 70.727 LB/SQ FT
 1 IN. Hg 0.49116 LB/SQ IN.
 1 KNOT 1.151 M.P.H.
 1 KNOT 1.688 FT/SEC

ALTITUDE FEET	DENSITY RATIO ρ	$\frac{1}{\sqrt{\sigma}}$	TEMPERATURE		SPEED OF SOUND (KNOTS)	PRESSURE	
			DEG. C	DEG. F		IN. OF Hg	RATIO P/PO
0	1.0000	1.000	15.0	59.0	661.7	29.92	1.0000
1000	.9711	1.015	13.0	55.4	659.5	28.86	.9644
2000	.9428	1.030	11.0	51.9	657.2	27.82	.9298
3000	.9151	1.045	9.0	48.3	654.9	26.82	.8963
4000	.8881	1.061	7.1	44.7	652.6	25.84	.8637
5000	.8617	1.077	5.1	41.2	650.3	24.90	.8321
6000	.8359	1.094	3.1	37.6	648.7	23.98	.8014
7000	.8107	1.111	1.1	34.1	645.6	23.09	.7717
8000	.7860	1.128	-0.8	30.5	643.3	22.23	.7429
9000	.7620	1.146	-2.8	26.9	640.9	21.39	.7149
10000	.7385	1.164	-4.8	23.4	638.6	20.58	.6878
11000	.7156	1.182	-6.8	19.8	636.2	19.80	.6616
12000	.6933	1.201	-8.8	16.3	633.9	19.04	.6362
13000	.6715	1.220	-10.8	12.7	631.5	18.30	.6115
14000	.6502	1.240	-12.7	9.1	629.0	17.58	.5877
15000	.6294	1.260	-14.7	5.6	626.6	16.89	.5646
16000	.6092	1.281	-16.7	2.0	624.2	16.23	.5423
17000	.5894	1.303	-18.6	-1.5	621.8	15.58	.5206
18000	.5702	1.324	-20.6	-5.1	619.4	14.95	.4997
19000	.5514	1.347	-22.6	-8.7	617.0	14.35	.4795
20000	.5331	1.370	-24.6	-12.2	614.6	13.76	.4599
21000	.5153	1.393	-26.6	-15.8	612.1	13.20	.4410
22000	.4980	1.417	-28.5	-19.3	609.6	12.65	.4228
23000	.4811	1.442	-30.5	-22.9	607.1	12.12	.4051
24000	.4646	1.467	-32.5	-26.5	604.6	11.61	.3881
25000	.4486	1.493	-34.5	-30.0	602.1	11.12	.3716
26000	.4330	1.520	-36.5	-33.6	599.6	10.64	.3557
27000	.4178	1.547	-38.4	-37.1	597.1	10.18	.3404
28000	.4031	1.575	-40.4	-40.7	594.6	9.742	.3256
29000	.3887	1.604	-42.4	-44.3	592.1	9.315	.3113
30000	.3747	1.634	-44.4	-47.8	589.5	8.904	.2976
31000	.3612	1.664	-46.4	-51.4	586.9	8.507	.2843
32000	.3480	1.695	-48.3	-54.9	584.4	8.125	.2715
33000	.3351	1.727	-50.3	-58.5	581.8	7.757	.2592
34000	.3227	1.760	-52.4	-62.1	579.2	7.402	.2474
35000	.3106	1.794	-54.3	-65.6	576.6	7.061	.2360
36000	.2989	1.829	-56.2	-69.2	574.0	6.733	.2250
37000	.2853	1.872	-56.5	-69.7	573.7	6.418	.2145
38000	.2719	1.918	-56.5	-69.7	573.7	6.118	.2045
39000	.2592	1.964	-56.5	-69.7	573.7	5.832	.1949

Figure 11-4

PART 2 — TAKE-OFF DATA

TAKE-OFF DATA

WIND COMPONENT (FIGURE 11-5)

The Wind Component chart is used to obtain headwind, tailwind, or crosswind components for winds from 0 to 60 knots at angles up to 90 degrees from aircraft heading. Tailwind components may be determined by entering the chart with wind direction taken from the reciprocal of aircraft heading. See figure 11-5.

Note

Crosswind component limit is 20 knots for take-off and landing.

WIND COMPONENT EXAMPLE PROBLEM

- Runway Heading—040 degrees
 - Reported Wind—090 degrees, 12 knots
1. Headwind component = 7.5 knots
 2. Crosswind component = 9 knots

TAKE-OFF DISTANCE (FIGURES 11-6 THROUGH 11-11)

The Take-off Distance charts provide a means of determining take-off distance under normal or STOL operating conditions. The charts present refusal speeds, take-off speeds, ground run distance with various wind conditions and total distance over a 50-foot obstacle. These data are based on two-engine operation as a function of aircraft weight, altitude and ambient temperature. The aircraft center of gravity for chart use represents a mid center-of-gravity value.

Enter Example Chart 1 with runway ambient temperature (A) and proceed up to the line corresponding to the field pressure altitude (B).

SAMPLE TAKE-OFF DISTANCE

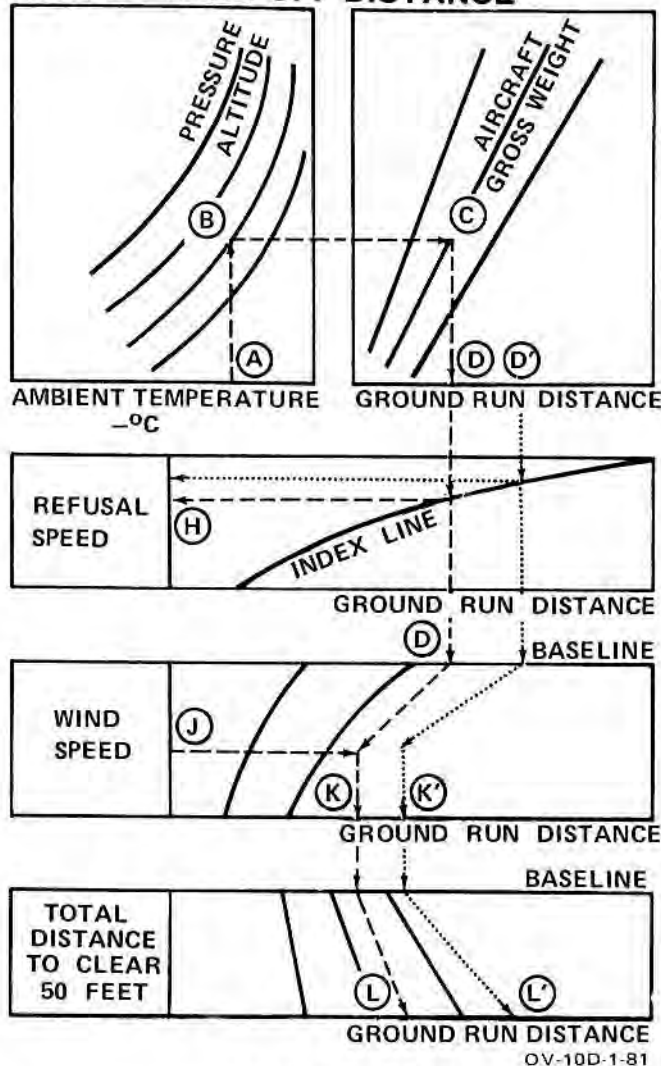

Example Chart 1

Move horizontally until intersecting the aircraft gross weight line (C).

Note

If the aircraft gross weight is other than the value shown, use linear interpolation.

Then move down to the ground run distance (D) for a dry, hard, prepared surface runway in a no-wind condition.

Continue downward intersecting the index line in the refusal speed chart and read the value of refusal speed (H) at the left side of the chart. This value of refusal speed represents the maximum speed to which the aircraft can normally accelerate and then stop in the runway length (D) using brakes only for stopping, for the no-wind condition.

Continuing vertically downward with the value D to the baseline of the wind correction chart, then left or right parallel to the guidelines for head or tail winds until the value of the wind speed (J) is intersected. Then move vertically downward to the final corrected ground run distance (K). Continue downward to the baseline of the Total Distance chart, then parallel to the guidelines for the total distance over 50 feet (L).

These data represent the capabilities of the OV-10D aircraft with the rated engine output.

SAMPLE RATED TORQUE

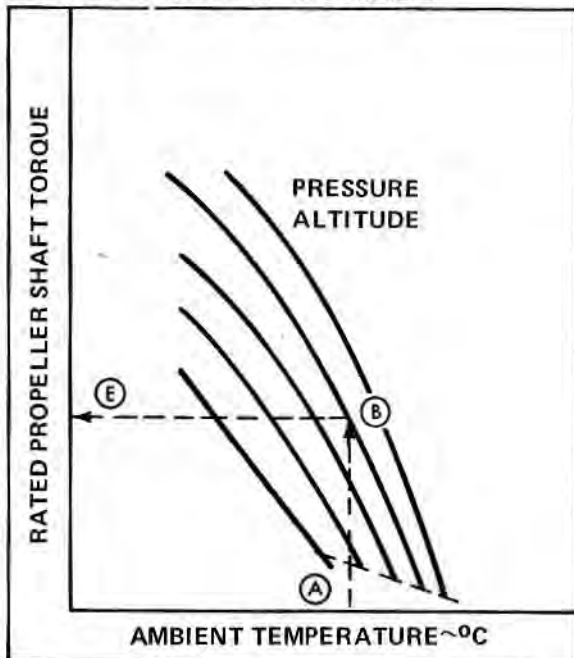

OV-10D-1-170

Example Chart 2

Enter Example Chart 2 with runway ambient temperature (A) and proceed up to the line corresponding to the field pressure altitude (B). Move horizontally to the expected torque reading (E) based on the engine manufacturer's rated engine at full throttle (MIL) power.

From previous engine run-ups, if rated torque cannot be obtained, the power correction nomogram must be used to determine corrected take-off distance requirements.

If the engine torque is below the chart value (E) for the same pressure altitude and temperature conditions, then an additional correction must be made to the ground run and air distance.

Enter the power correction nomogram (Example Chart 3) with the rated value (E) and the actual value (F) of the engine torque readings, draw a straight line through these

POWER CORRECTION NOMOGRAM

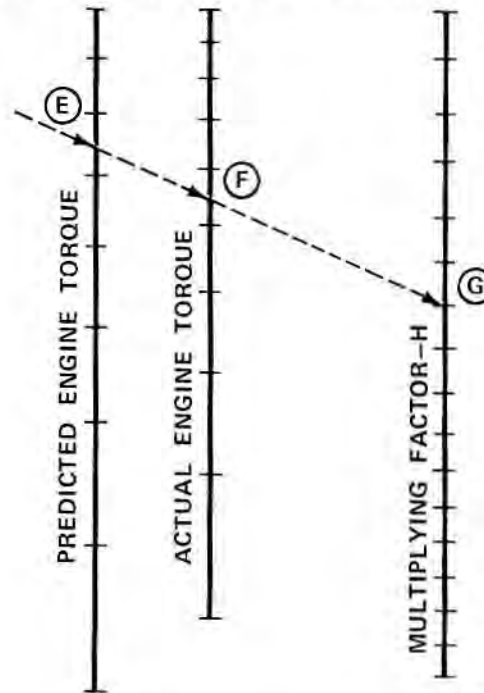

OV-10D-1-82

Example Chart 3

two points, and read the multiplying factor at the intersection of the right vertical scale (G). The product of this factor (G) and the ground run (D) will produce a new corrected ground run (D').

Re-enter Example Chart 1 with the corrected ground run (D') and determine a revised refusal speed. Continue through the chart a second time as described previously.

The total distance to clear a 50-foot obstacle (L) must be corrected if the power correction nomogram was employed to correct ground run distances for deficient torque readings. Subtract the ground run distance (K') from the total distance (L') and multiply the difference by the multiplying factor (G), then add the product to the corrected ground run distance (K') for a final corrected total take-off distance over a 50-foot obstacle.

If the actual available runway length is greater than the required ground run determined from the charts for no-wind conditions, the refusal speed may be revised upward to be compatible with the actual runway length.

Enter the refusal speed plot with the actual runway length and move up or down intersecting the index line, then read horizontally to obtain a new refusal speed.

MINIMUM TORQUE VERSUS GROSS WEIGHT TO MAINTAIN 100 FPM RATE OF CLIMB (FIGURE 11-12)

Aircraft single-engine flyaway capability after take-off with the landing gear retracted and the flaps up or flaps at 20-degree position, can be determined from the Minimum Torque vs. Gross Weight to Maintain 100 FPM Rate of Climb chart (figure 11-12).

SAMPLE MINIMUM TORQUE vs. GROSS WEIGHT TO MAINTAIN 100 FPM RATE-OF-CLIMB

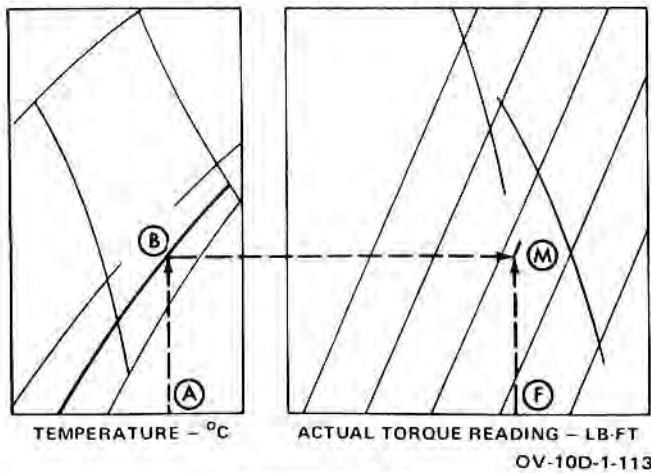

Example Chart 4

If an engine failure occurs during a take-off ground roll, the aircraft should be stopped. Safe stopping distance can be ensured if the refusal speed previously determined is observed. The single-engine fly-away chart (Example Chart 4) is entered at the lower left side with runway temperature (A), then moving vertically up to intersect the field pressure altitude (B). Then move horizontally until a vertical line is intersected from the actual engine torque reading (F) on the right, and the gross weight (M) is then interpolated linearly from the lines of constant gross weight.

If this take-off weight value (M) is less than the initial value (C), the pilot must be prepared to jettison all external stores in the event of engine failure following take-off in order to maintain level flight. If the value of the aircraft gross weight less external stores still exceeds the chart value (M), then single-engine level flight cannot be maintained and the pilot must be prepared to return the aircraft to the runway at once. If sufficient altitude is not available to return to the runway, ejection procedures should be initiated providing the terrain does not permit a satisfactory landing. Each take-off ground run chart contains a limit line reflecting single-engine fly-away capability.

TAKE-OFF DISTANCE EXAMPLE PROBLEM

Find the ground run, total distance over a 50-foot obstacle, refusal speed, and lift-off speed utilizing normal performance technique (figure 11-7) for the following conditions:

- Runway Temperature 32°C
- Pressure Altitude—Sea Level
- Flap Setting—20 degrees
- Take-off Gross Weight—13,000 pounds
- Actual Engine Torque Reading—1700 foot-pounds
- Runway—Level
- Wind Velocity—20 knots (headwind)

1. For take-off distance (D) for rated engines, read 1820 feet.
2. Refusal speed (H) is 63 knots.

3. Correct take-off distance for headwind (J) velocity of 20 knots and read total distance (K) as 1250 feet.
4. Read total distance over 50-foot obstacle (L) of 1700 feet.
5. For rated engine torque (E) of 2200 foot-pounds and actual engine torque reading (F) of 1700 foot-pounds, read power correction factor (G) of 1.30 in figure 11-11.
6. The corrected ground run (D') is 1820 feet X 1.3 = 2366 feet.
7. New refusal speed is 70 knots.
8. Correct distance for headwind (J) velocity of 20 knots and read total distance (K') as 1600 feet.
9. Read total distance over 50-foot obstacle (L') of 2200 feet.
10. Total distance over 50-foot obstacle, must be corrected for engine torque deficiency and is determined by subtracting corrected ground run distance (K') from total distance over 50-foot obstacle (L') multiplying by power correction factor (G) and adding to the corrected ground run distance (K') or $(2200 - 1600) 1.3 + 1600$
 $780 + 1600 = 2380$ feet over 50-foot obstacle.
11. With flaps and gear up and actual engine torque reading of 1700 foot-pounds, single-engine fly-away capabilities can be determined using figure 11-12. The maximum weight at which 100 feet per minute rate of climb can be maintained is 12,100 pounds. If the flaps are not retracted but the gear is up, only a 10,300-pound gross weight will permit a single-engine, 100-foot-per-minute rate of climb.

CLIMB-OUT FLIGHT PATH (FIGURES 11-13 THROUGH 11-16)

The Climb-out Flight Path charts (figures 11-13 through 11-16) may be used to determine distance required from lift-off to clear obstacles up to 200 feet high. The performance shown, is for airspeed at take-off. Increased airspeeds will provide improved performance.

CLIMB-OUT FLIGHT PATH EXAMPLE PROBLEM

Determine distance following normal take-off to clear an obstacle for the following standard day conditions:

- Landing Gear—Down
- Obstacle Height Above Runway—120 feet
- Flap Setting—20 degrees (normal take-off)
- Pressure Altitude—4000 feet
- Gross Weight—14,000 pounds

1. Distance from lift-off = 1600 feet at a climb speed of 106 knots.

Note

Assuming a take-off roll distance of 2800 feet under these conditions, a total cleared surface length of 4400 feet in front of the obstacle is required for take-off and straight-ahead climb.

WIND COMPONENT

CROSSWIND

EXAMPLE:

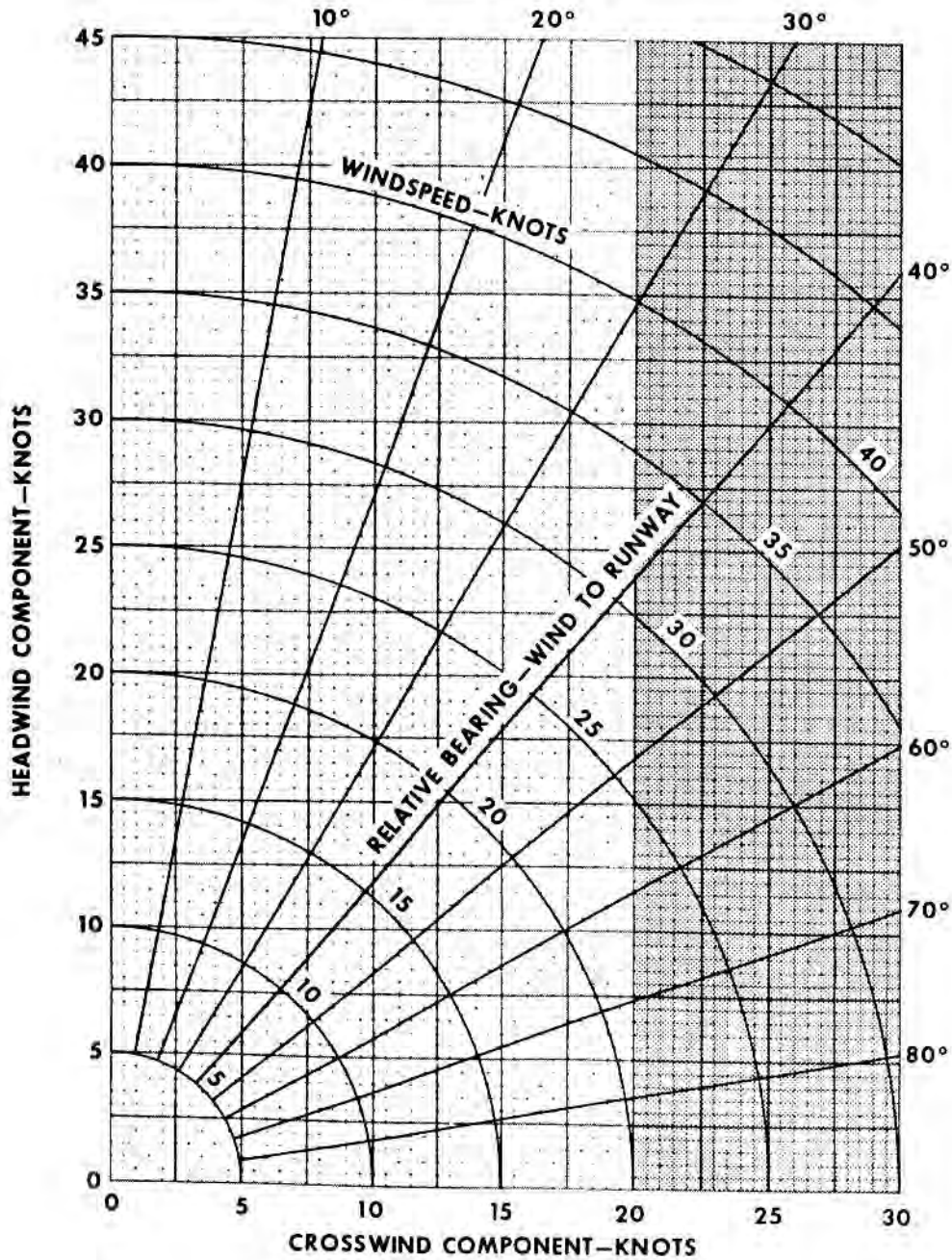
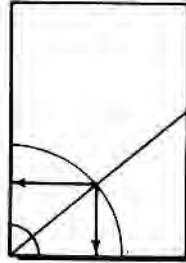

Figure 11-5

OV-10D-1-121

TAKE-OFF DISTANCE

BASED ON: FLIGHT TEST DATA
DATA AS OF: 15 NOV. 1977

NORMAL PERFORMANCE

FLAPS UP

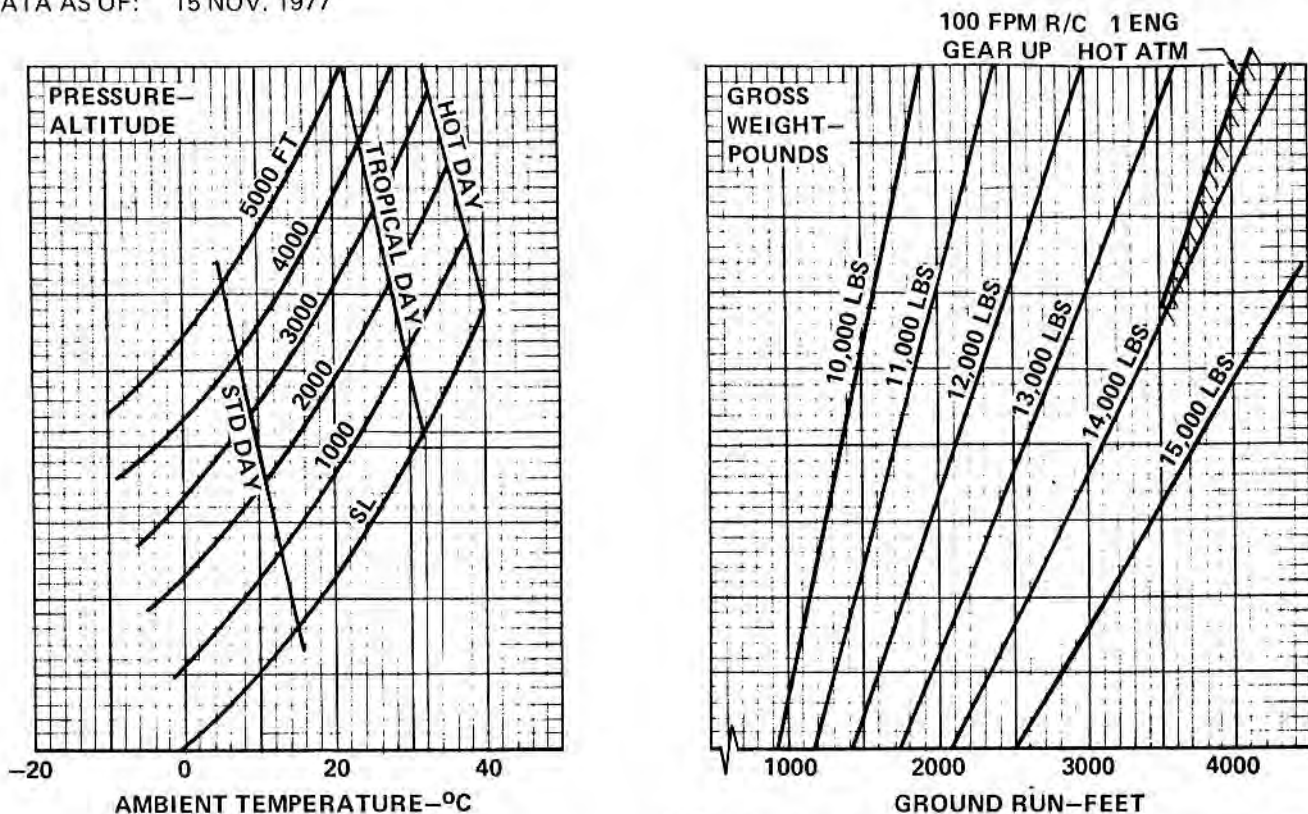

TAKE-OFF SPEED— KNOTS IAS

GROSS WEIGHT (POUNDS)	SPEED
10,000	94.5
11,000	99.0
12,000	103.5
13,000	108.0
14,000	113.0
15,000	116.5

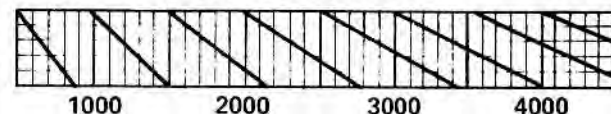
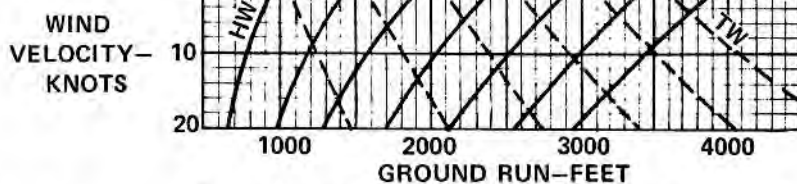
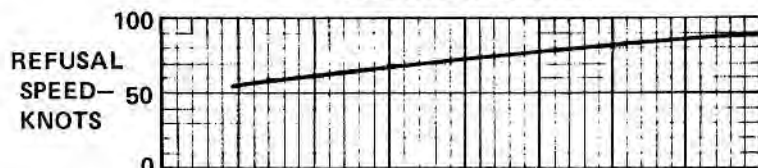

TOTAL DISTANCE TO CLEAR 50-FOOT OBSTACLE

NOTE:
INCREASE GROUND RUN DISTANCE
4% FOR EACH ONE PERCENT INCREASE
IN THE RUNWAY SLOPE

EXAMPLE

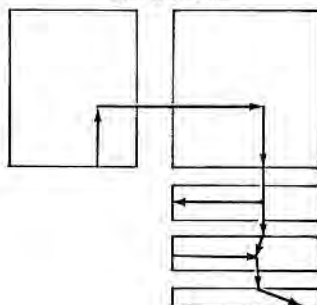

Figure 11-6

OV-10D-1-57C

TAKE-OFF DISTANCE

NORMAL PERFORMANCE

FLAPS 20°

BASED ON: FLIGHT TEST DATA
DATA AS OF: 15 NOVEMBER 1977

100 FPM R/C 1-ENGINE
GEAR UP HOT ATM

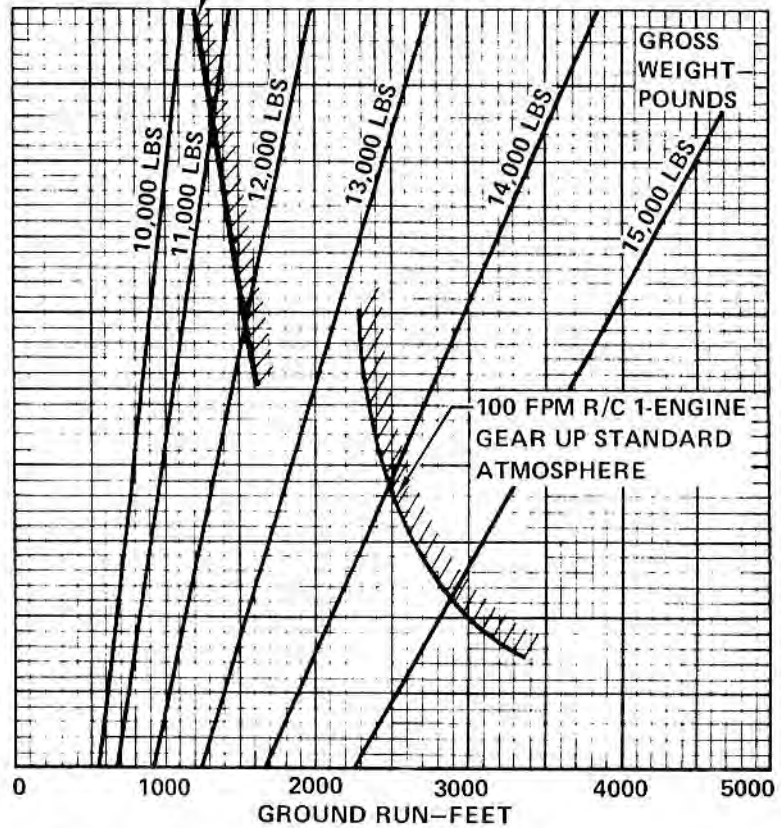
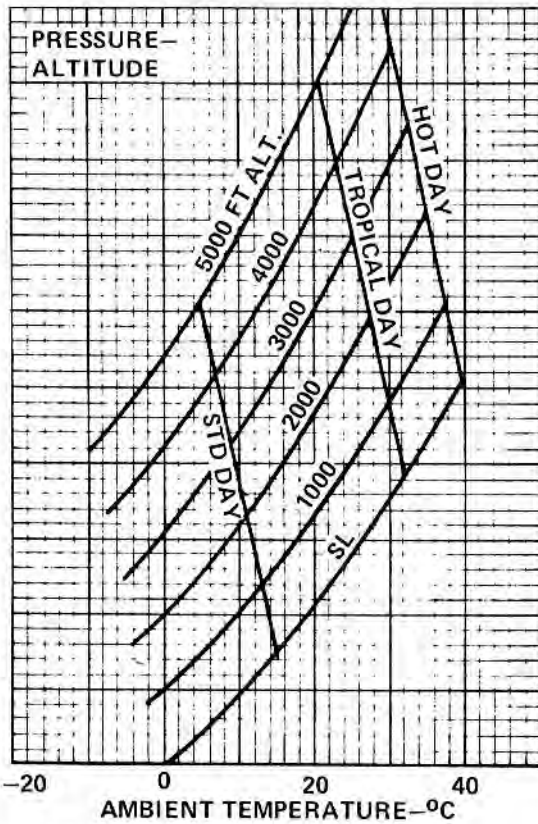

TAKE-OFF SPEED—KNOTS IAS

GROSS WEIGHT (POUNDS)	SPEED
10,000	80
11,000	85
12,000	91
13,000	98
14,000	106
15,000	114

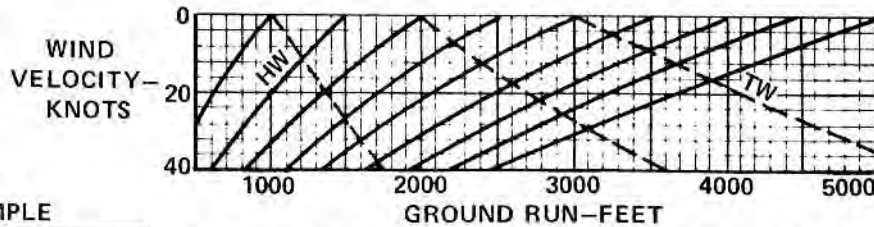
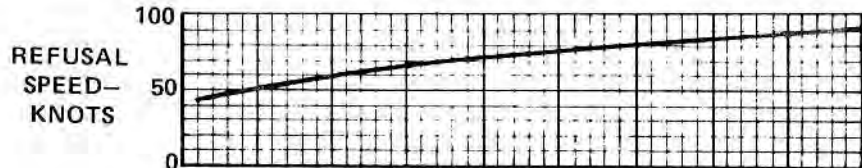

EXAMPLE

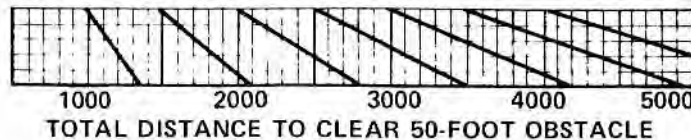
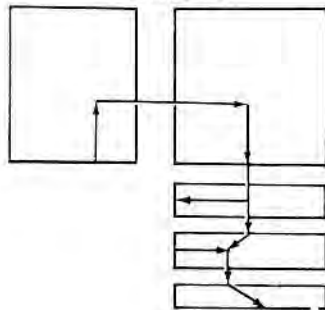

NOTE:
INCREASE GROUND RUN DISTANCE
4% FOR EACH ONE PERCENT INCREASE
IN THE RUNWAY SLOPE

OV-10D-1-58F

Figure 11-7

TAKE-OFF DISTANCE

STOL PERFORMANCE

FLAPS 20°

BASED ON: FLIGHT TEST DATA
DATA AS OF: 15 NOVEMBER 1977

NOTE:
INCREASE GROUND RUN DISTANCE
4% FOR EACH ONE PERCENT INCREASE
IN THE RUNWAY SLOPE

TAKE-OFF SPEED— KNOTS IAS

GROSS WEIGHT (LBS)	SPEED (IAS)
10,000	76
11,000	82
12,000	88
13,000	94
14,000	100
15,000	106

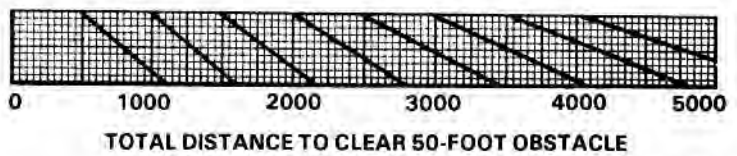
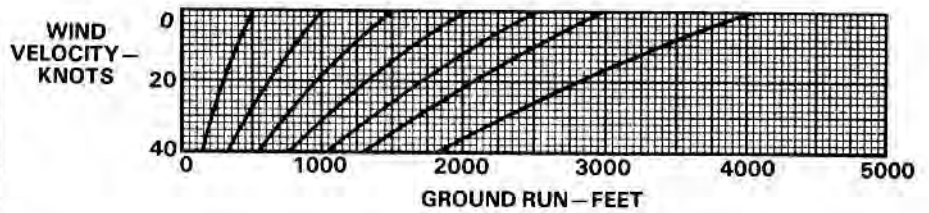
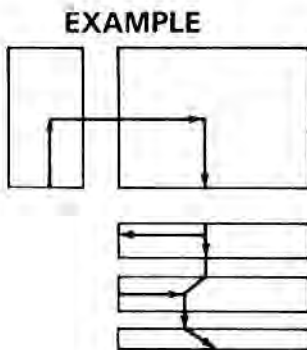
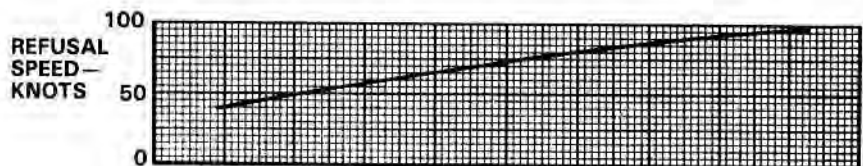
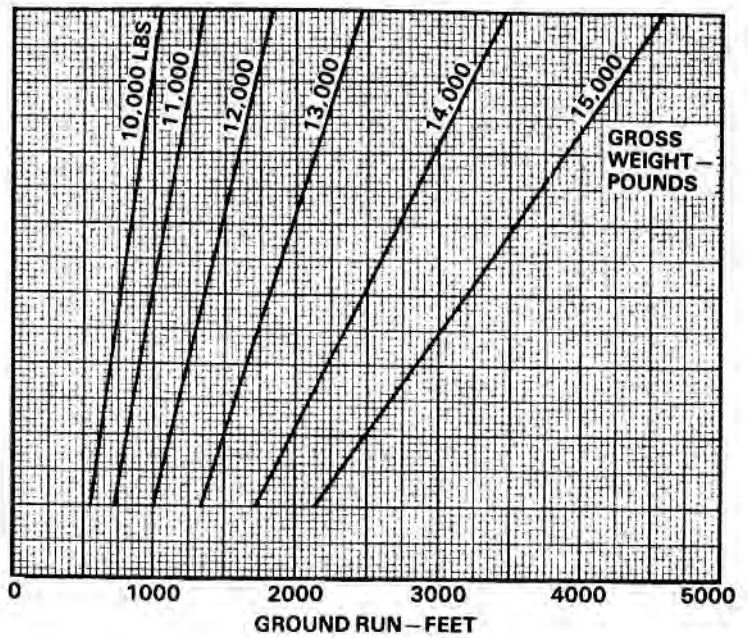
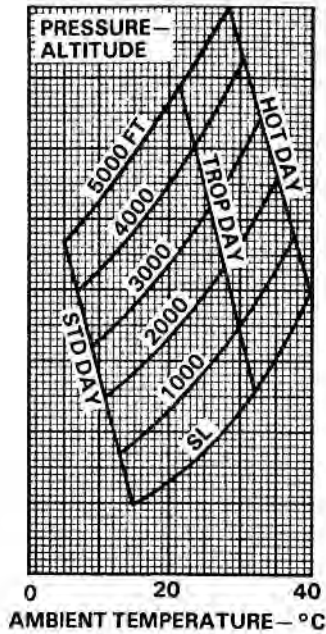

OV-10D-1-175A

Figure 11-8

TAKE-OFF DISTANCE

MAXIMUM PERFORMANCE

20° FLAPS

BASED ON: FLIGHT TEST DATA
DATA AS OF: 15 NOVEMBER 1977

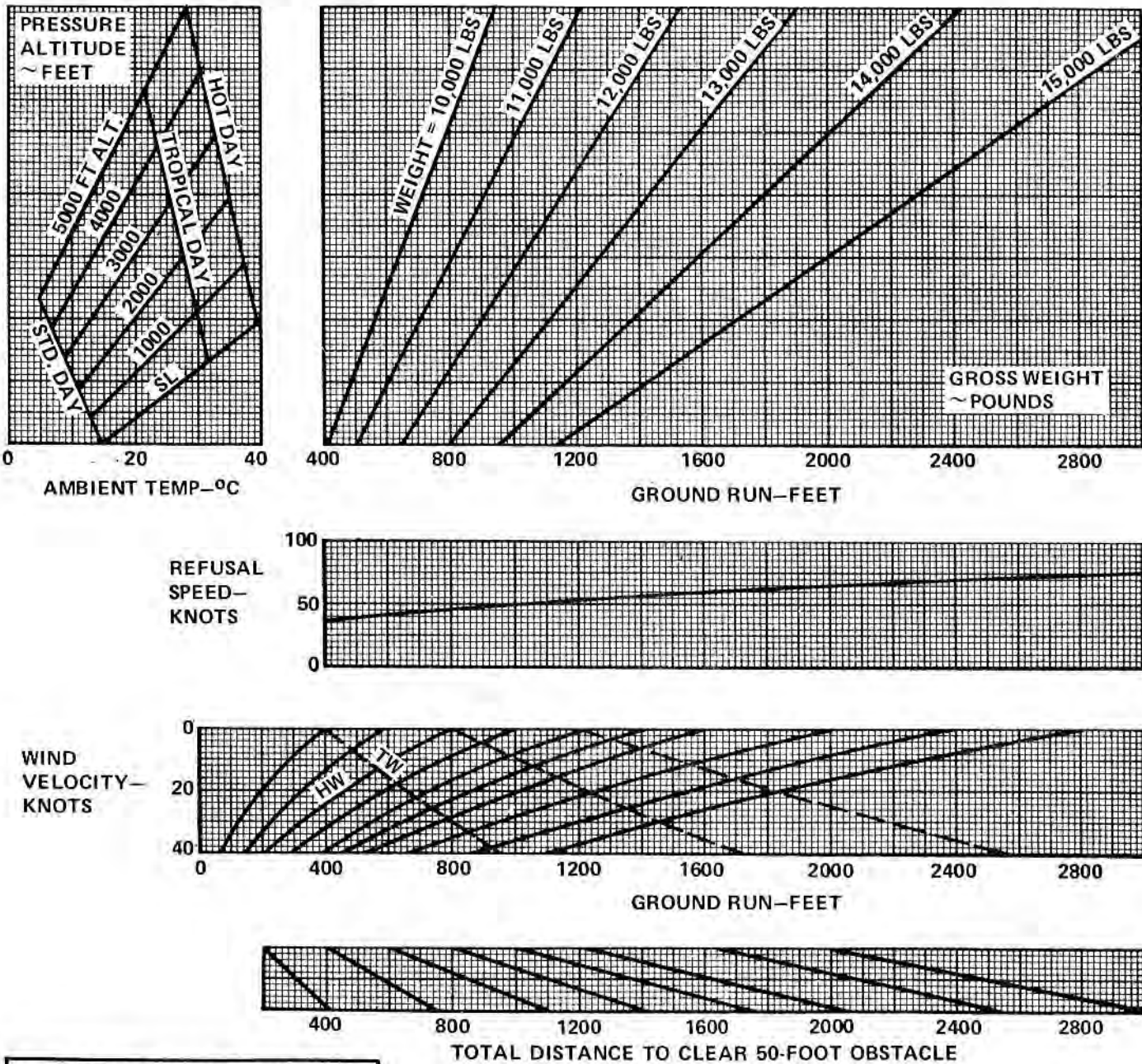

TAKE-OFF SPEED—KNOTS IAS	
GROSS WEIGHT (POUNDS)	LIFT-OFF SPEED IAS ~KNOTS
10,000	68.0
11,000	71.5
12,000	75.0
13,000	78.0
14,000	82.0
15,000	85.0

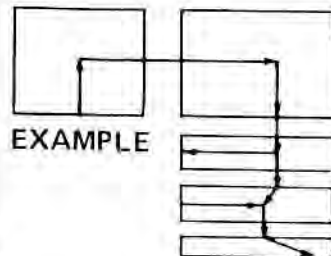

NOTE:
INCREASE GROUND RUN DISTANCE
4% FOR EACH ONE PERCENT INCREASE
IN THE RUNWAY SLOPE

Figure 11-9

OV-10D-1-102B

RATED PROPELLER SHAFT TORQUE AT MILITARY POWER (POUND-FOOT)

ENGINE: T76-G-420/421
 FUEL: JP-5 OR JP-4
 (MIL-T-5624)
 TIT: 1108°C

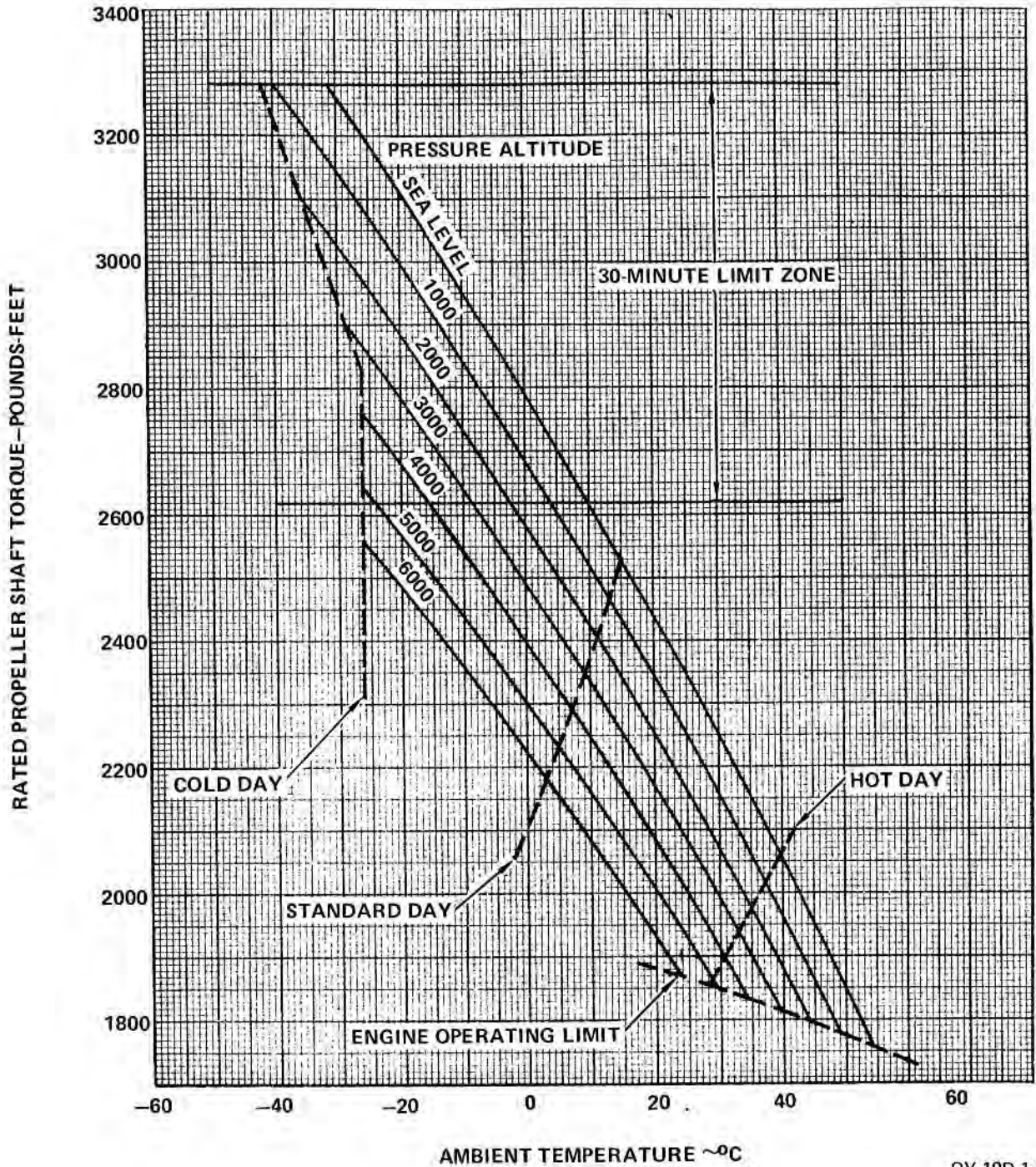
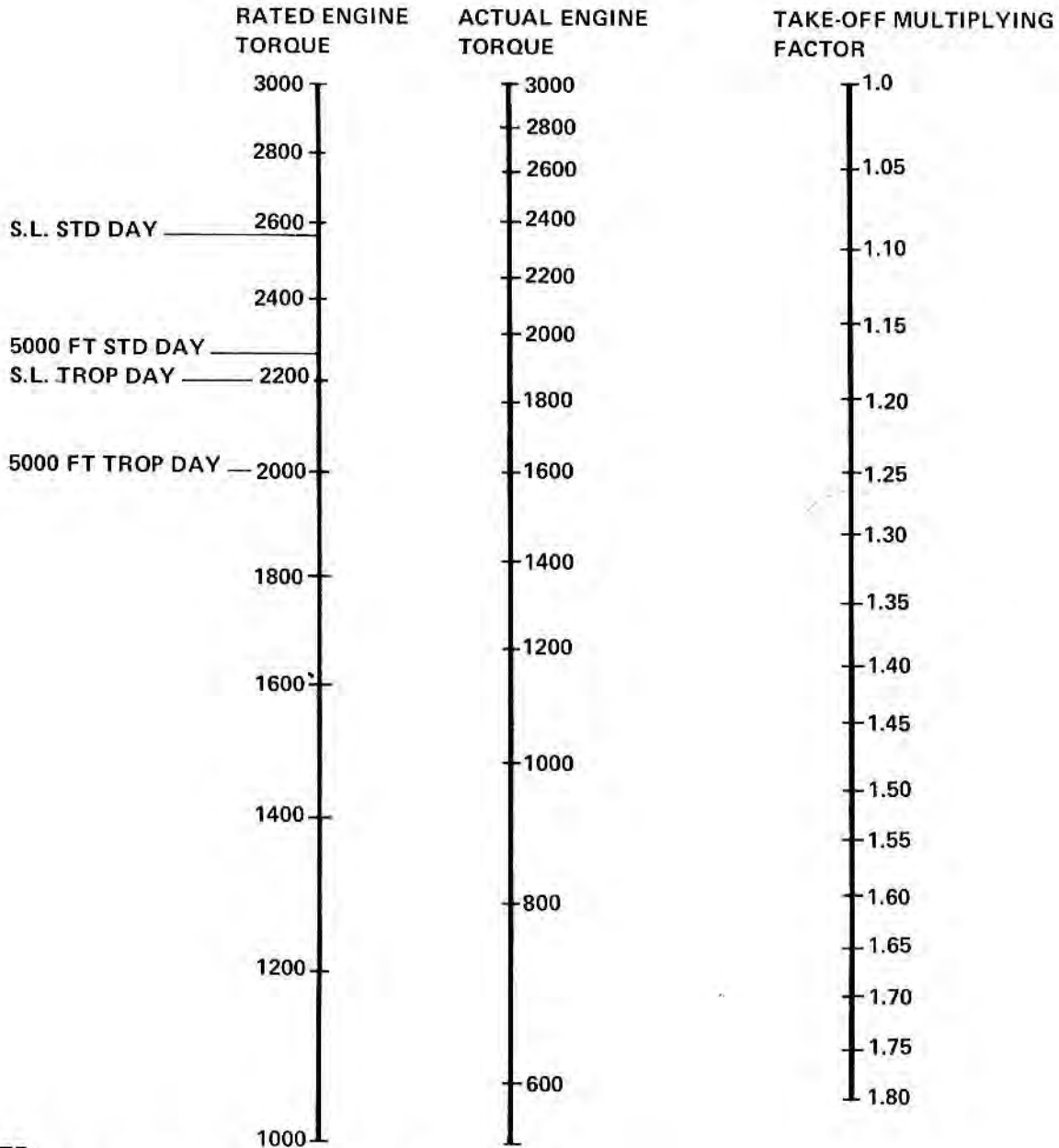
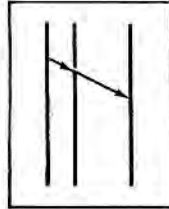

Figure 11-10

OV-10D-1-115

POWER CORRECTION

CORRECTION TO INITIAL TAKE-OFF DISTANCE DUE TO ENGINE OPERATING BELOW RATED POWER.



NOTE:
IF ENGINE TORQUE READING IS LESS THAN RATED VALUE, TAKE-OFF DISTANCE WILL INCREASE.

OV-10D-1-59A

Figure 11-11

MINIMUM TORQUE VS. GROSS WEIGHT TO MAINTAIN 100 FPM RATE OF CLIMB

BASED ON: FLIGHT TEST DATA
DATA AS OF: 15 NOVEMBER 1977

FLIGHT AT BEST CLIMB SPEED
BASIC AIRCRAFT + WING PYLONS
AND Q PYLON

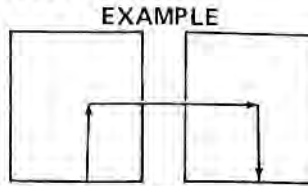

STANDARD DAY
SEA LEVEL
NO STORES OR TANKS

NOTE:
INCREASE ACTUAL TORQUE READING
BY 120 LB-FT FOR EACH 50 INCREASE
IN DRAG INDEX DUE TO STORES

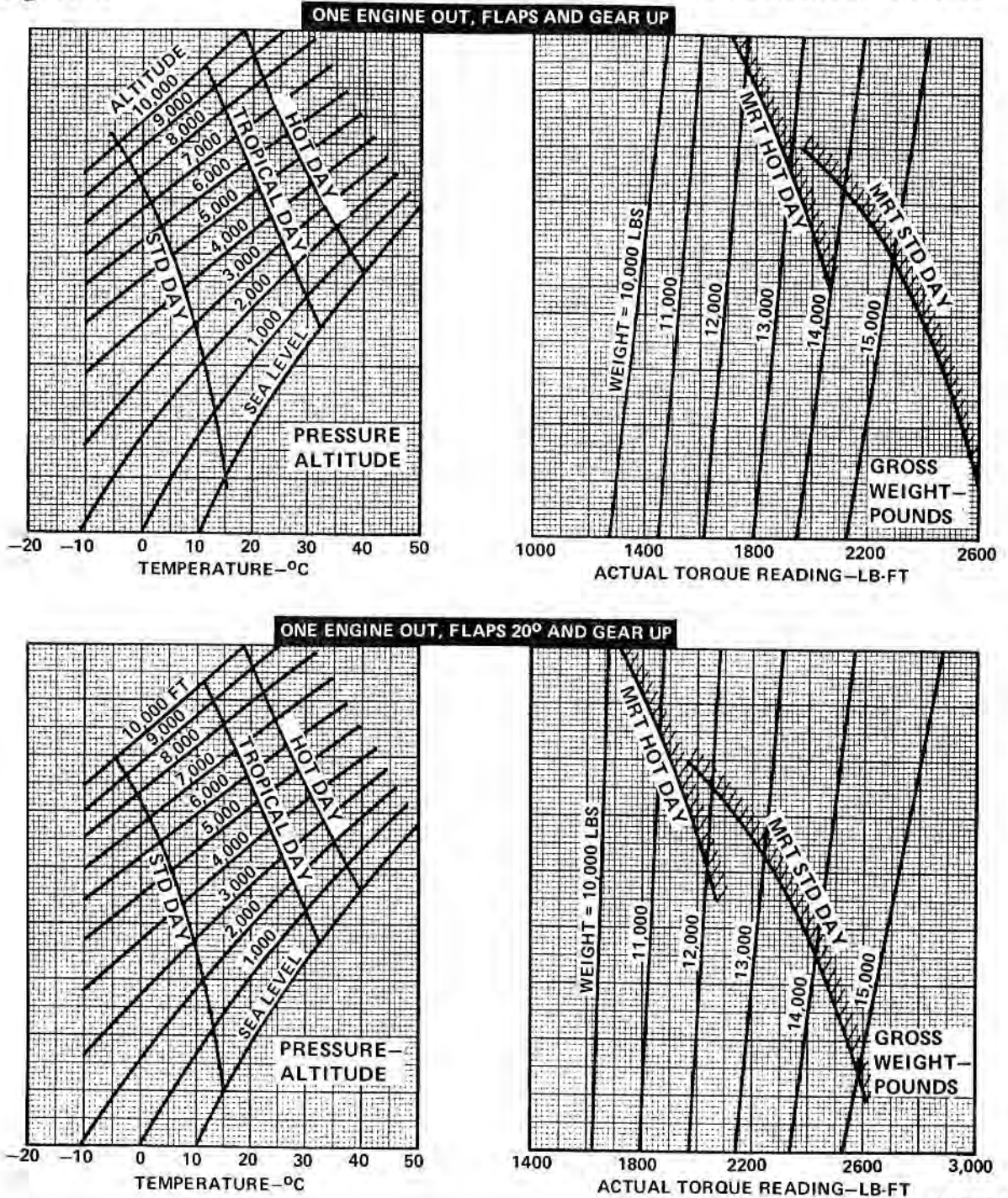

OV-10D-1-60C

Figure 11-12

CLIMB-OUT FLIGHT PATH (2 ENGINES)

FLAPS UP

BASED ON: FLIGHT TEST DATA
DATA AS OF: 15 NOVEMBER 1977

MILITARY POWER
STANDARD DAY

GEAR DOWN
CLIMB SPEED CONSTANT

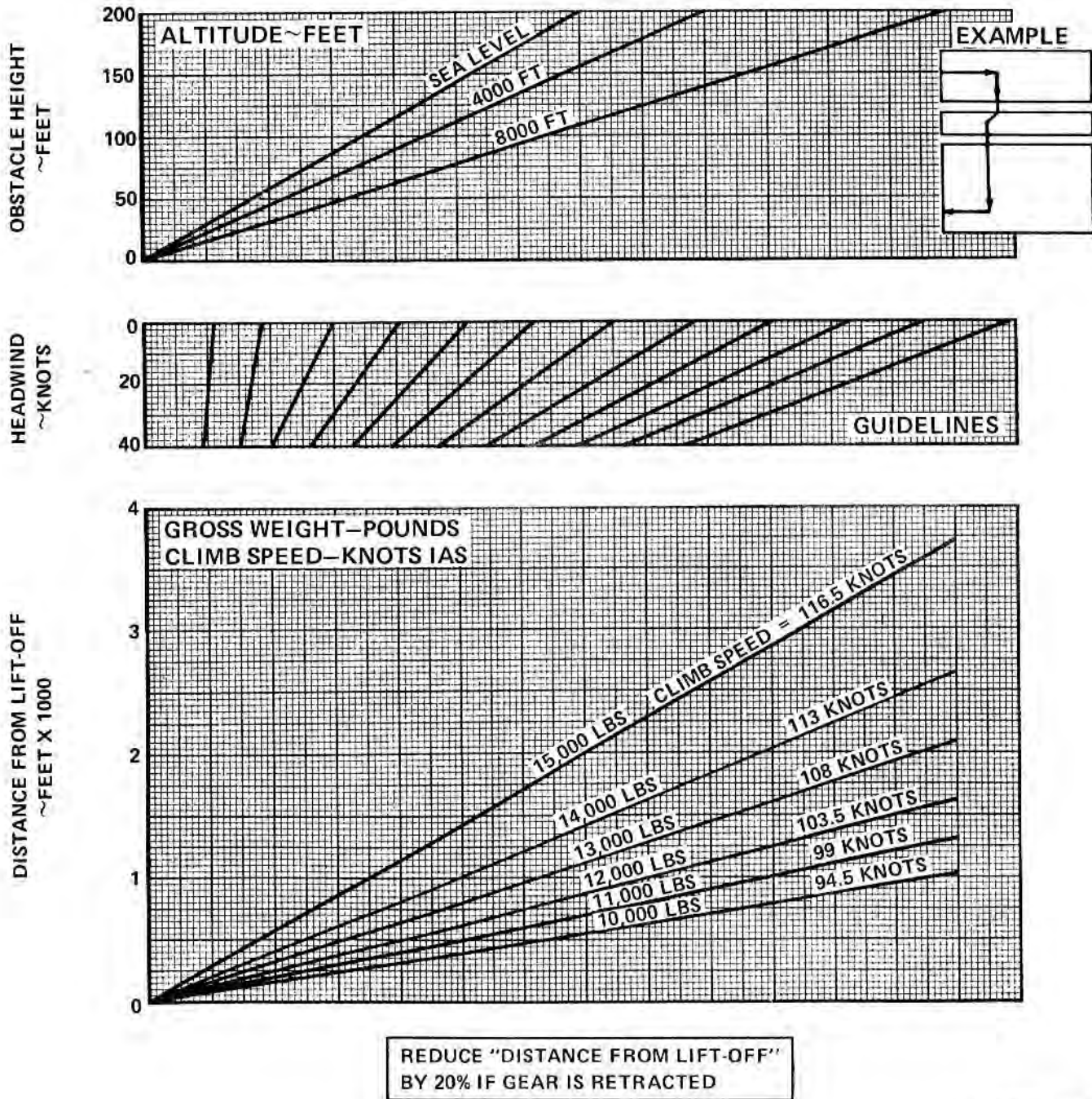

OV-10D-1-69A

Figure 11-13

CLIMB-OUT FLIGHT PATH (2 ENGINES)

FLAPS 20°

BASED ON: FLIGHT TEST DATA
DATA AS OF: 15 NOVEMBER 1977

MILITARY POWER
STANDARD DAY

GEAR DOWN
CLIMB SPEED CONSTANT

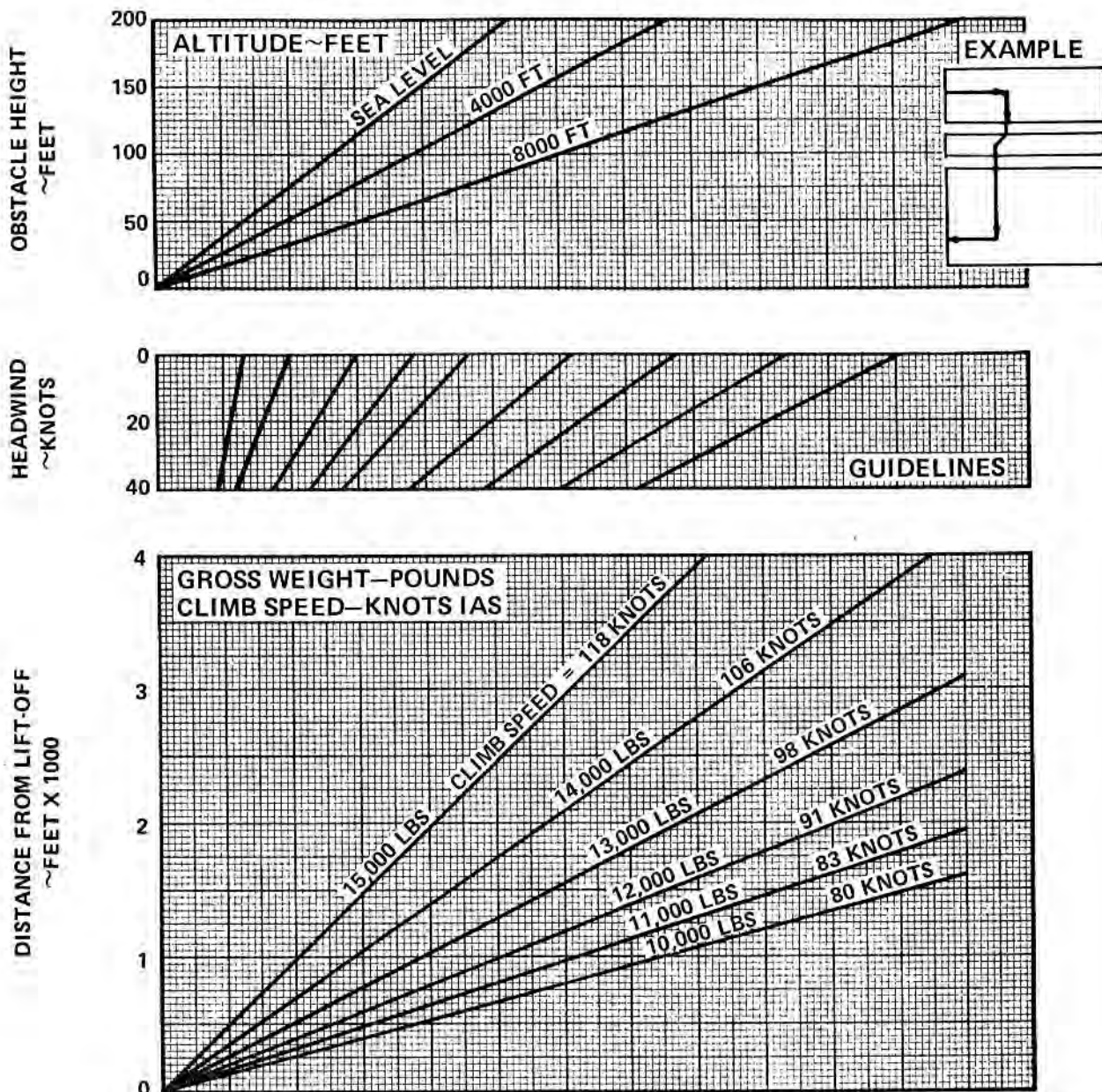

REDUCE "DISTANCE FROM LIFT-OFF"
BY 20% IF GEAR IS RETRACTED

OV-10D-1-70A

Figure 11-14

SINGLE ENGINE CLIMB-OUT FLIGHT PATH

BASED ON: FLIGHT TEST DATA
DATA AS OF: 15 NOVEMBER 1977

MILITARY POWER
STANDARD DAY

**FLAPS UP
GEAR UP
AND DOWN
CLIMB SPEED
CONSTANT**

EXAMPLE

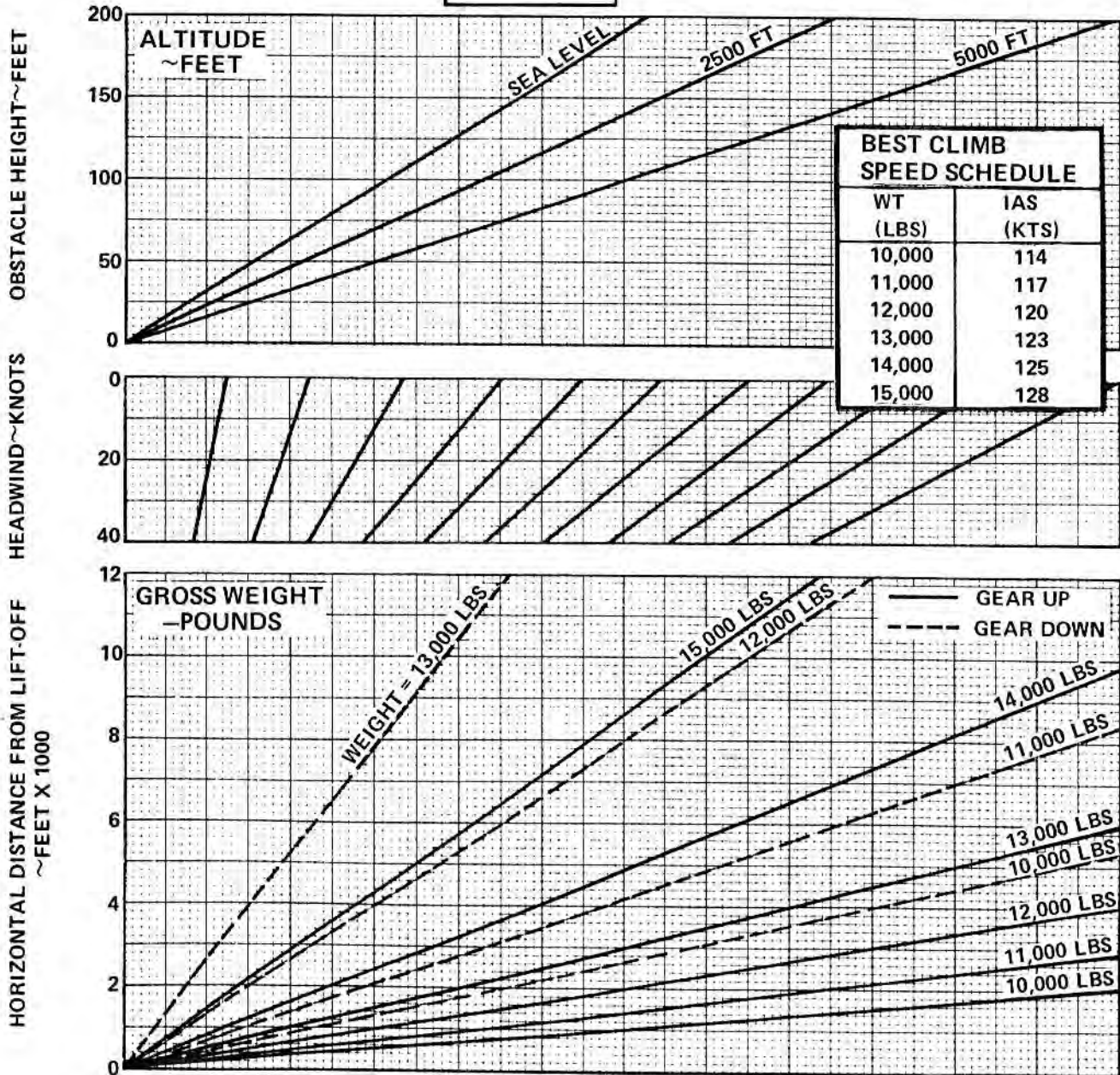
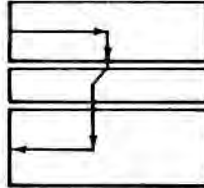

OV-10D-1-71A

Figure 11-15

SINGLE ENGINE CLIMB-OUT FLIGHT PATH

FLAPS 20°
GEAR UP
AND DOWN

BASED ON: FLIGHT TEST DATA
DATA AS OF: 15 NOVEMBER 1977

EXAMPLE

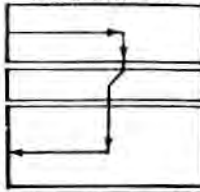

MILITARY POWER
STANDARD DAY

CLIMB SPEED
CONSTANT

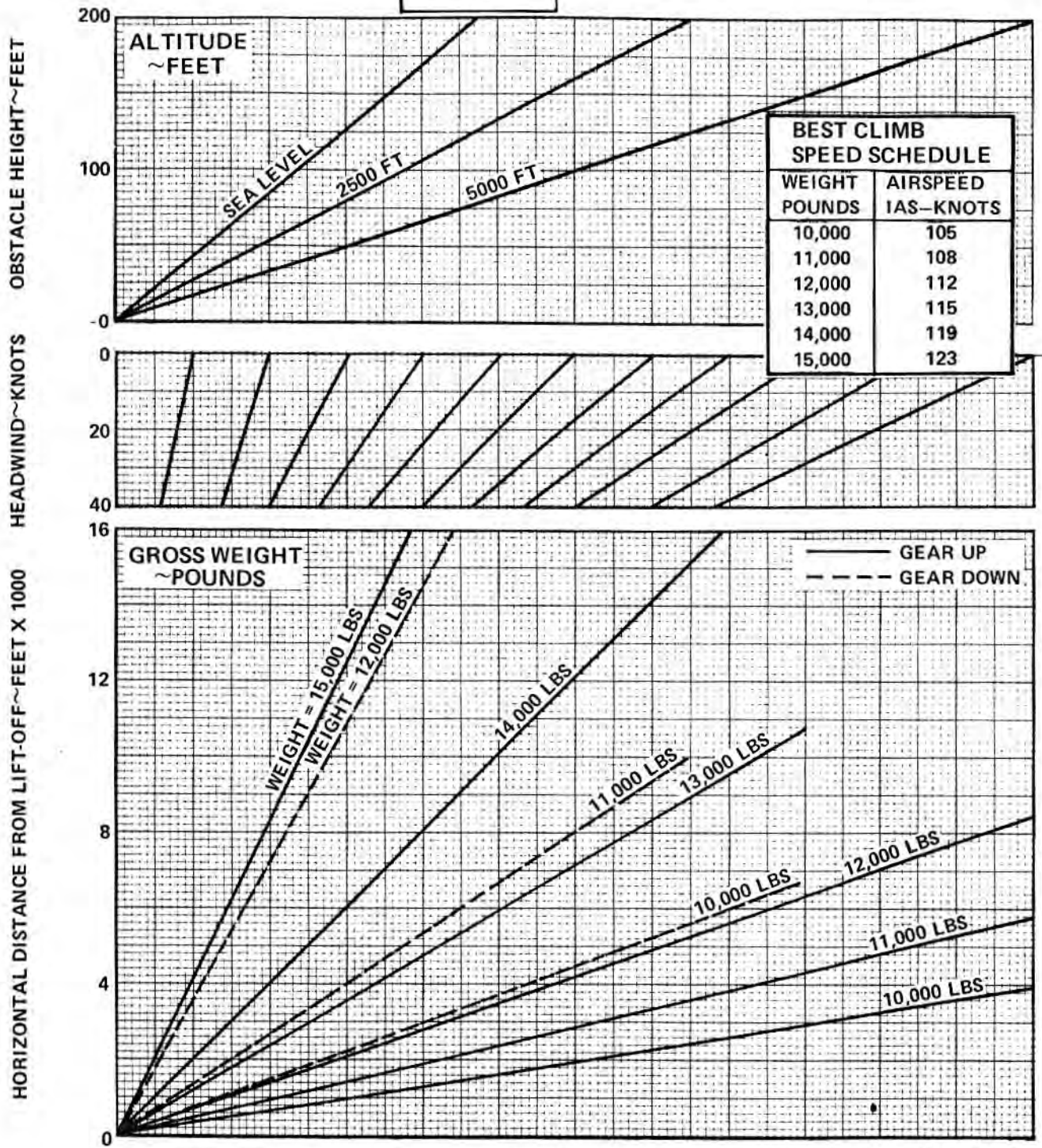

Figure 11-16

OV-10D-1-72A

PART 3 — CLIMB DATA**CLIMB DATA****CLIMB CHARTS** (FIGURES 11-17 THROUGH 11-19)

Time to climb, distance covered, and fuel required at best climb speed during Military, normal, and single-engine power climb at various gross weights, drag indexes, and ambient temperatures are shown in figures 11-17 through 11-19. Climb data assume that recommended speeds are used.

MILITARY POWER CLIMB EXAMPLE PROBLEM

Climb from sea level to 15,000 feet:

- Gross Weight—14,000 pounds
 - Drag Index—60
 - Average Temperature—20°C hot
 - Wind—Zero (average)
1. Time to climb = 12.5 minutes
 2. Distance covered = 32 nautical miles
 3. Fuel used = 175 pounds

SINGLE-ENGINE CLIMB (FIGURES 11-20 THROUGH 11-25)

Single-engine rate of climb versus airspeed curves are given in figures 11-20 through 11-25 for various ambient air temperatures, with flaps and landing gear retracted. In the event of a single-engine emergency, flaps and landing gear

should be retracted since this will provide the best climb performance.

Note

Decrease rate of climb by 85 feet per minute for each 50 increase in drag index due to stores.

AIRCRAFT CEILINGS (FIGURES 11-26 THROUGH 11-28)

Optimum cruise ceiling and Military power combat ceiling at various gross weights, drag indexes, and ambient temperatures are shown in figure 11-26. For two-engine MRP and single-engine MRP service ceilings for various configurations, see figures 11-27 and 11-28 respectively. To use these charts, estimate a gross weight at altitude by subtracting climb fuel, and determine a preliminary ceiling. Aircraft gross weight is adjusted for this weight reduction and ceiling is corrected for the new gross weight.

AIRCRAFT CEILINGS EXAMPLE PROBLEM

Find initial optimum cruise ceiling with the following conditions:

- Gross Weight—14,000 pounds
 - Drag Index—60
 - Ambient Temperature—10°C hot (average)
1. Initial cruise ceiling = 15,400 feet
 2. Correction for climb fuel = 180 pounds
 3. Corrected cruise ceiling = 15,800 feet

MILITARY POWER CLIMB

MIL CLIMB TIME

BASED ON: FLIGHT TEST DATA
DATA AS OF: 15 NOVEMBER 1977

CLIMB SPEED SCHEDULE—KNOTS IAS			
ALTITUDE—FEET	DRAG 50	100	150
SEA LEVEL	144	139	135
5,000	139	134	130
10,000	133	129	124
15,000	129	125	123
20,000	126	123	123
25,000	125	123	123
30,000	125	123	123

EXAMPLE

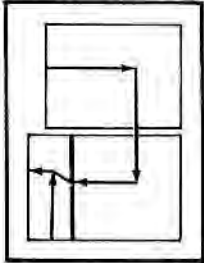

GROSS WEIGHT~POUNDS X 1000

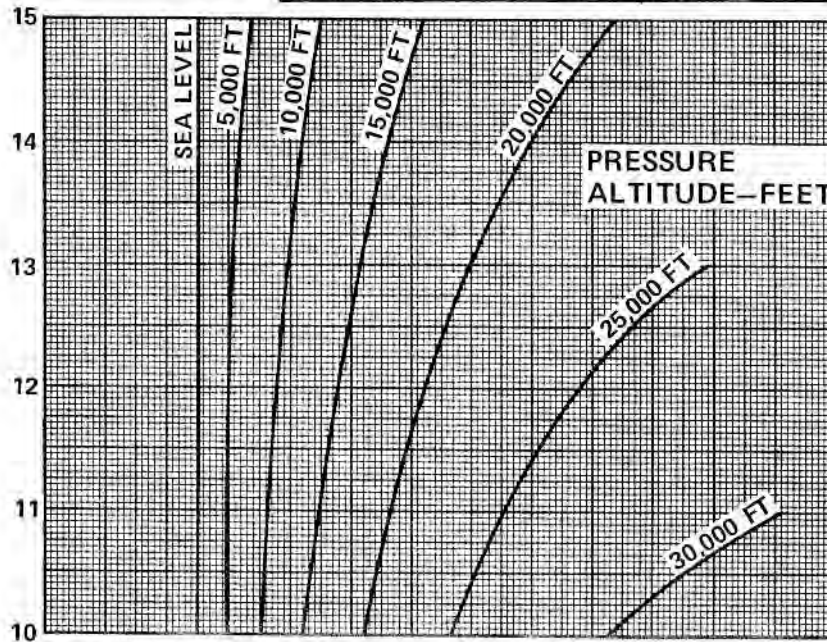

TIME TO CLIMB~MINUTES

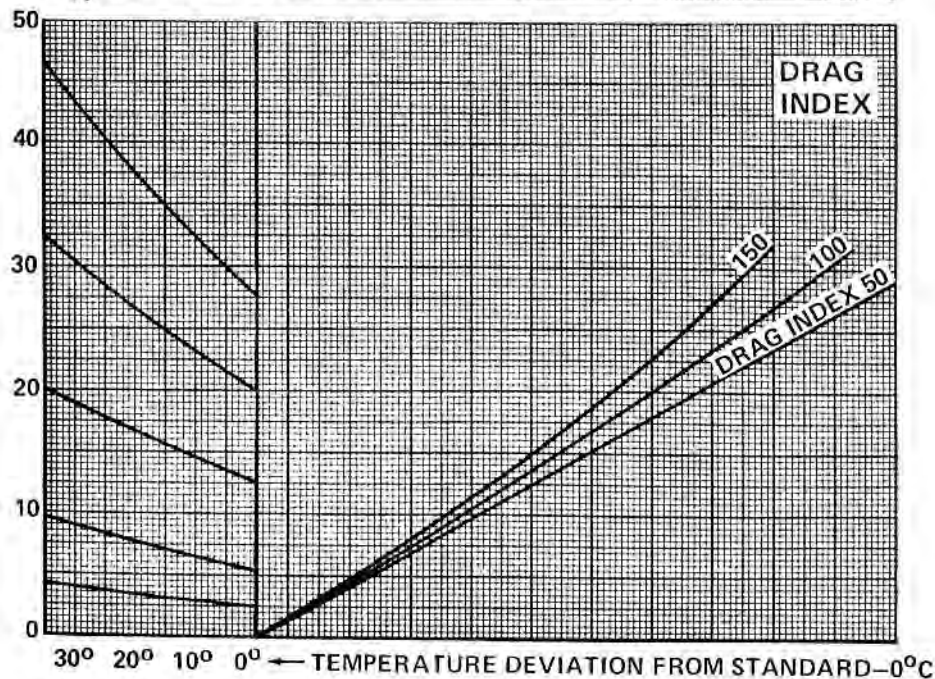

STD	TEMP
ALT	°C
SL	15
5,000	5
10,000	-5
15,000	-15
20,000	-25
25,000	-35
30,000	-44

Figure 11-17 (Sheet 1)

OV-10D-1-75B

MILITARY POWER CLIMB

BASED ON: FLIGHT TEST DATA
DATA AS OF: 15 NOVEMBER 1977

EXAMPLE

MIL CLIMB DISTANCE

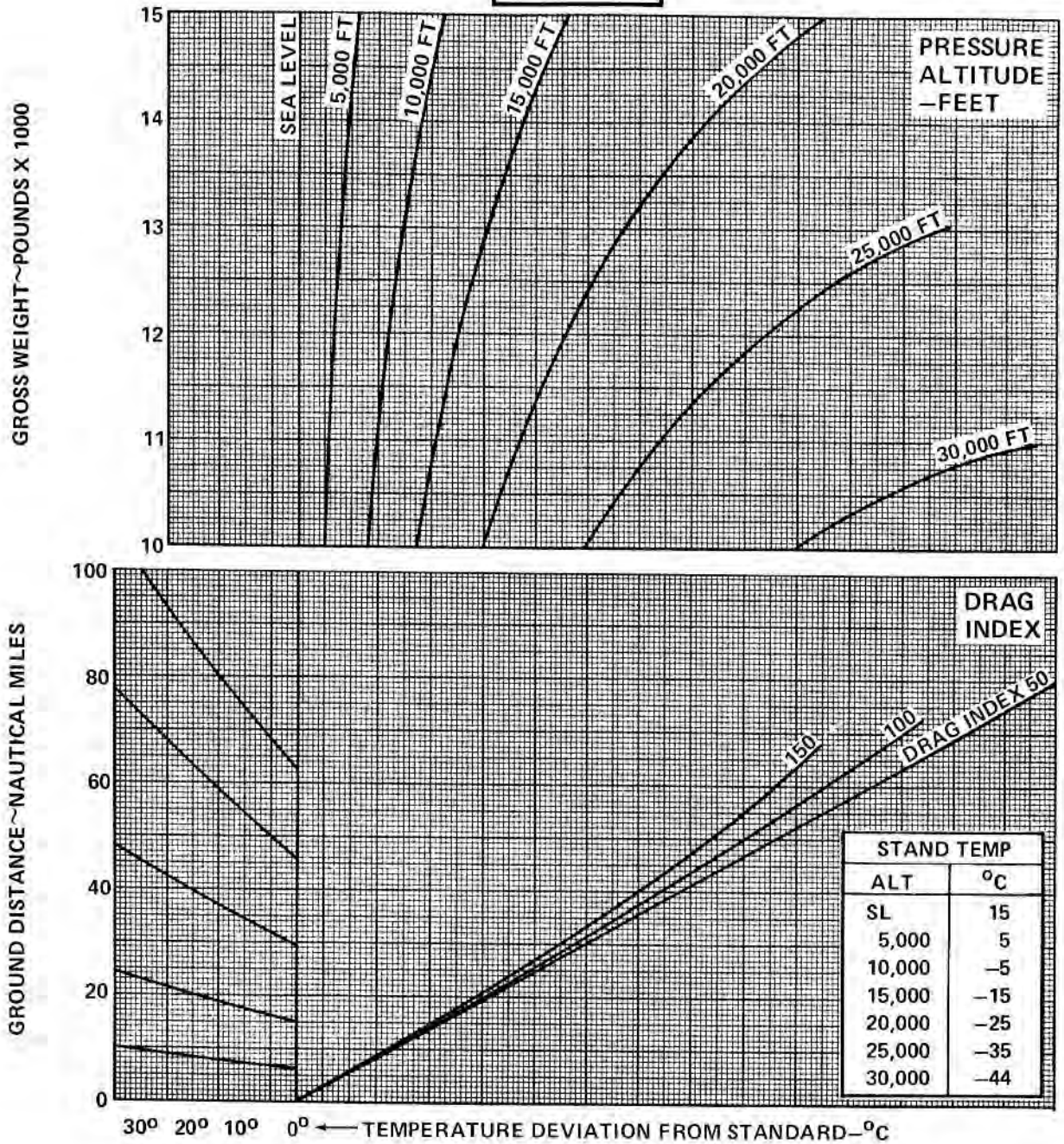
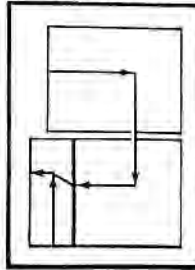

OV-10D-1-76A

Figure 11-17 (Sheet 2)

MILITARY POWER CLIMB

BASED ON: FLIGHT TEST DATA
DATA AS OF: 15 NOVEMBER 1977

EXAMPLE

MIL CLIMB FUEL

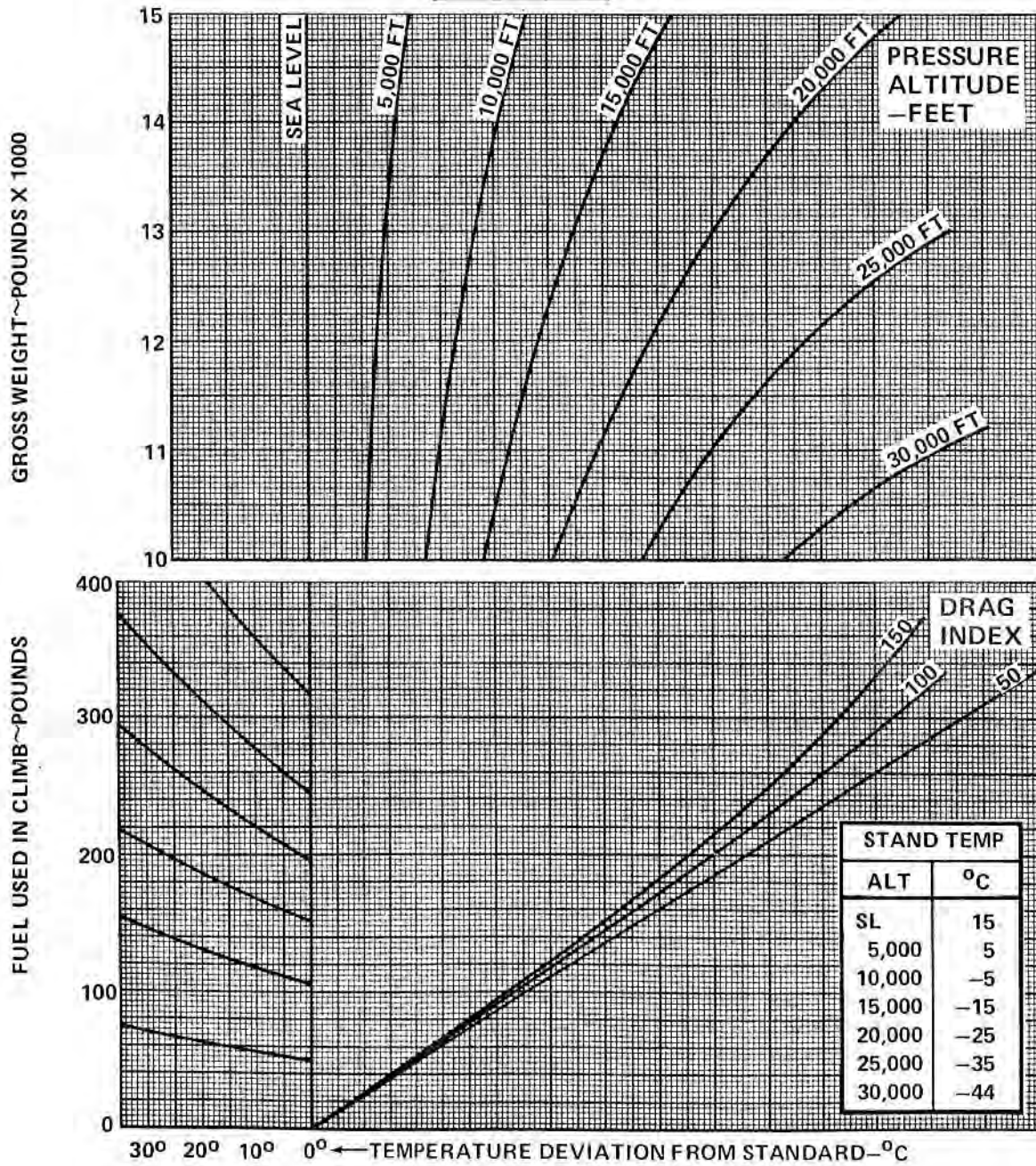
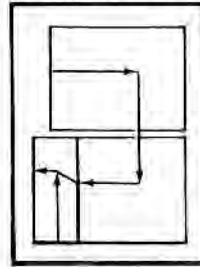

Figure 11-17 (Sheet 3)

OV-10D-1-77A

NORMAL POWER CLIMB

NORM CLIMB TIME

BASED ON: FLIGHT TEST DATA
DATA AS OF: 15 NOVEMBER 1977

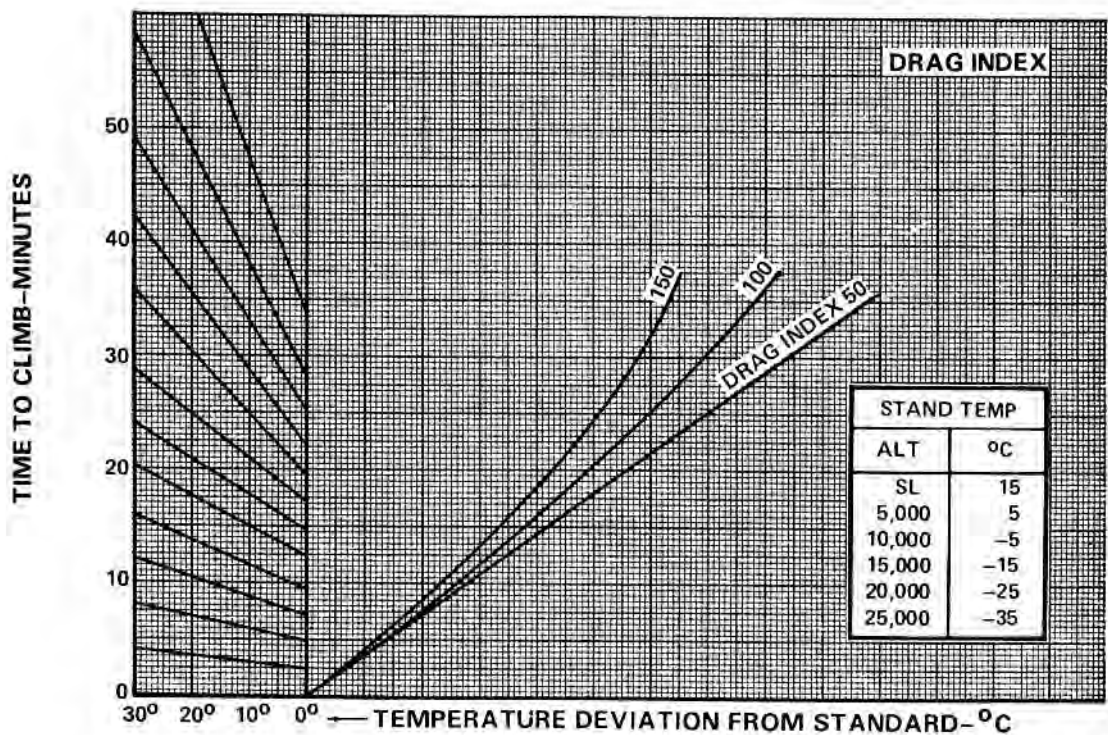
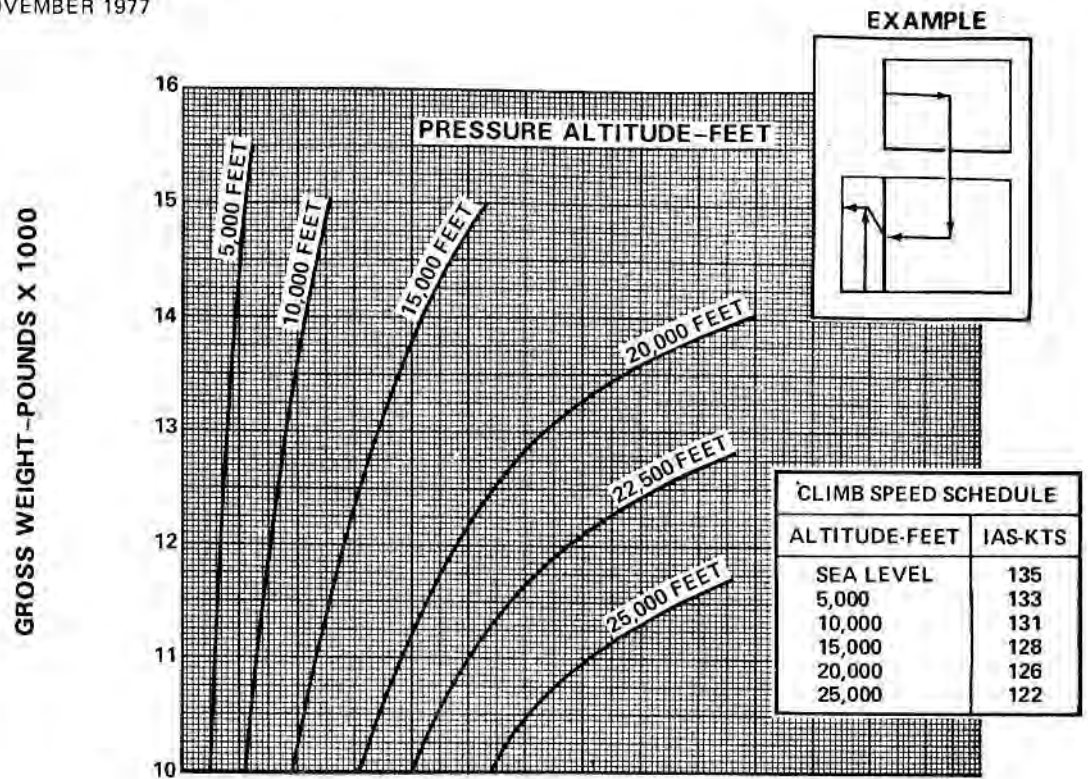

OV-10D-1-153A

Figure 11-18 (Sheet 1)

NORMAL POWER CLIMB

NORM CLIMB DISTANCE

BASED ON: FLIGHT TEST DATA
DATA AS OF: 15 NOVEMBER 1977

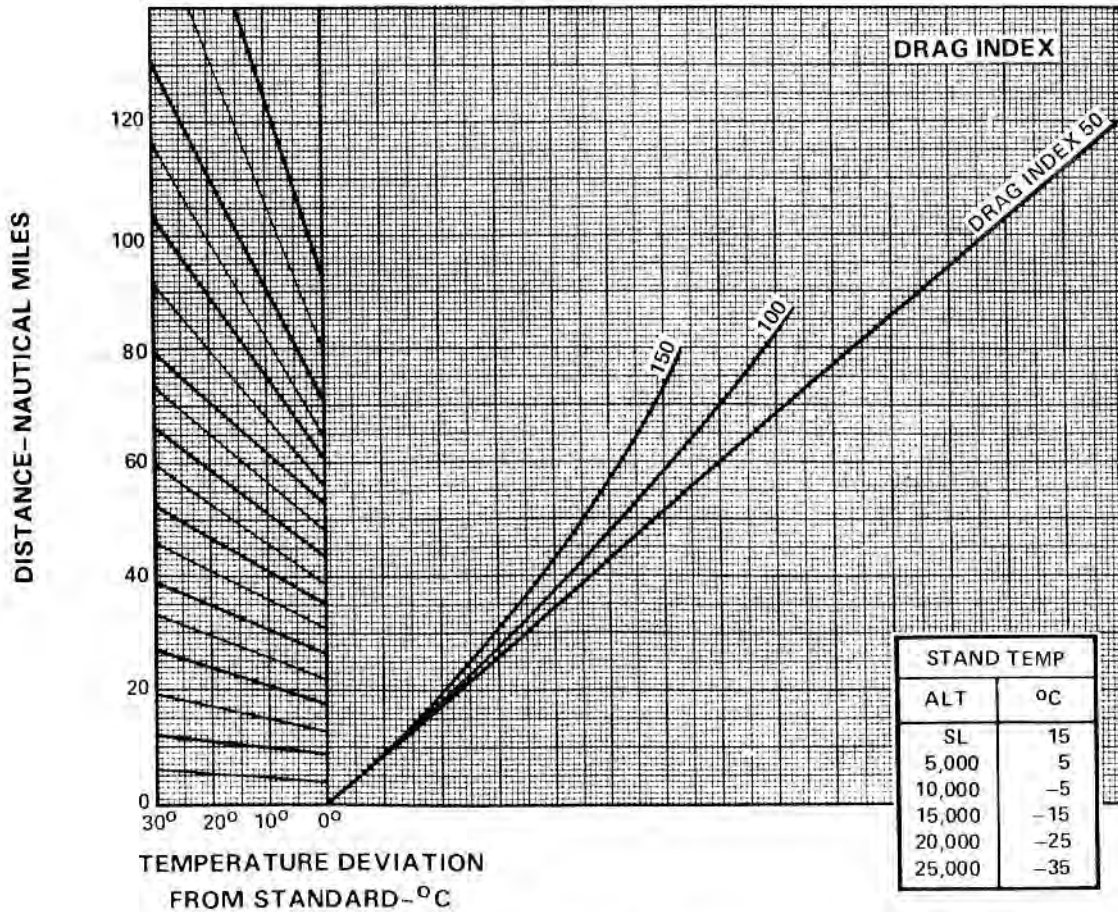
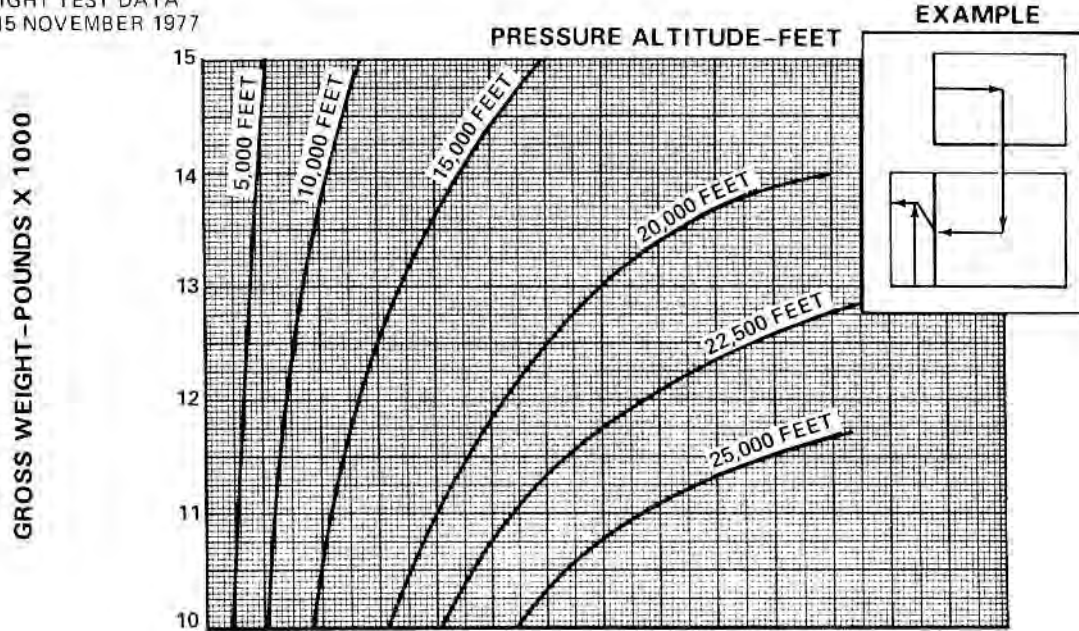

OV-10D-1-154

Figure 11-18 (Sheet 2)

NORMAL POWER CLIMB

BASED ON: FLIGHT TEST DATA
DATA AS OF: 15 NOVEMBER 1977

NORM CLIMB FUEL

EXAMPLE

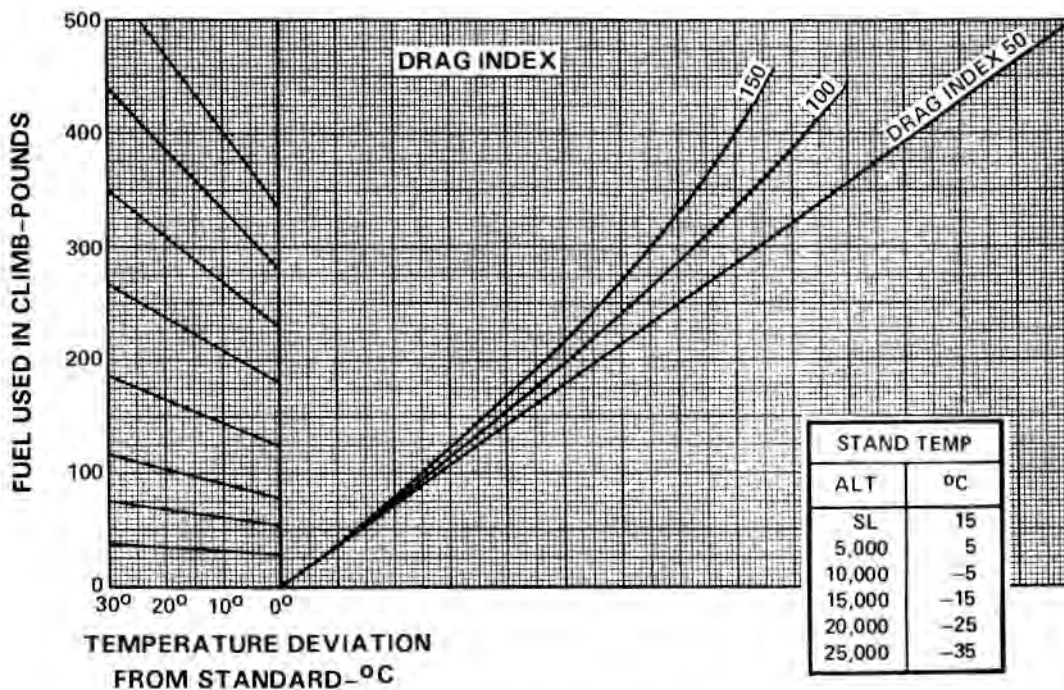
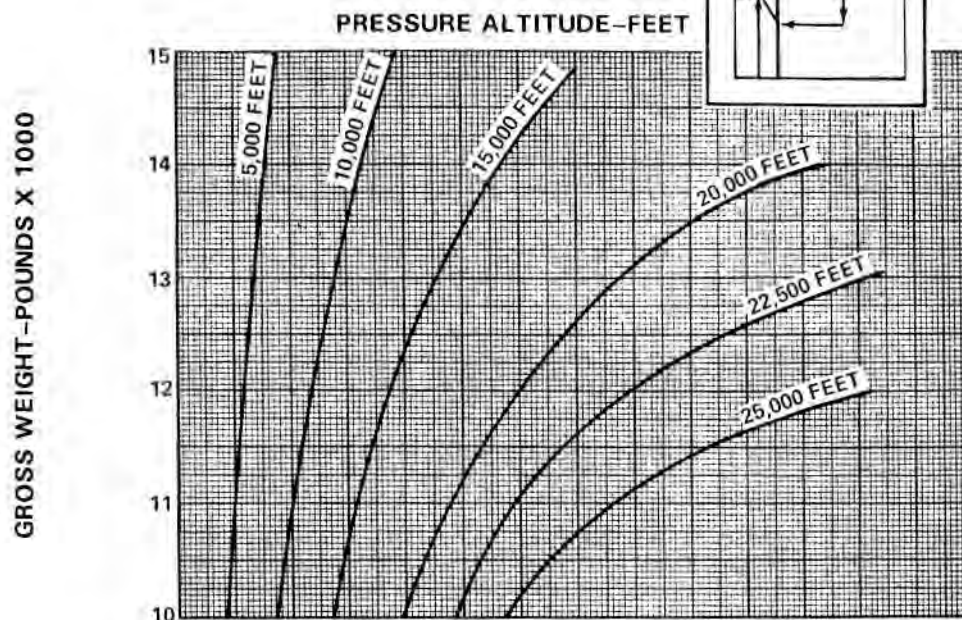
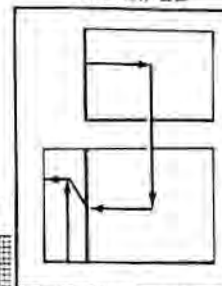

OV-10D-1-158

Figure 11-18 (Sheet 3)

SINGLE ENGINE CLIMB

**MILITARY RATED POWER
1 ENG CLIMB TIME**

BASED ON: FLIGHT TEST DATA
DATA AS OF: 15 NOVEMBER 1977

CLIMB SPEED SCHEDULE—KNOTS IAS			
ALTITUDE—FT	DRAG 50	100	150
SL	126	123	123
5,000	123	123	123
10,000	123	123	123
15,000	123	123	123

EXAMPLE

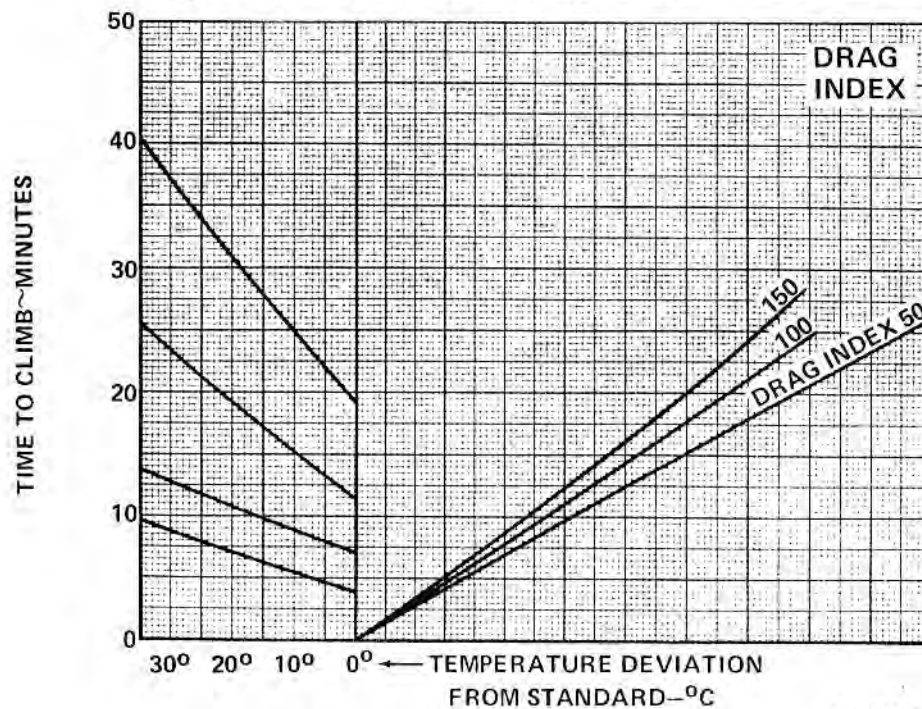
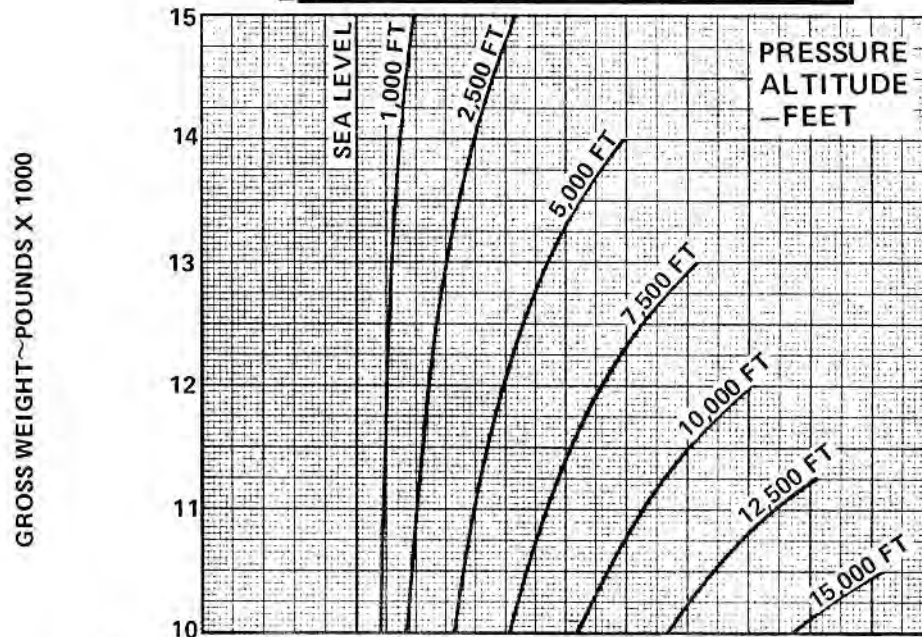
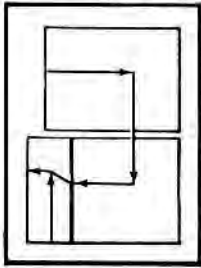

STAND TEMP	
ALT	°C
SL	15
5,000	5
10,000	-5
15,000	-15

OV-10D-1-78A

Figure 11-19 (Sheet 1)

SINGLE ENGINE CLIMB

BASED ON: FLIGHT TEST DATA
DATA AS OF: 15 NOVEMBER 1977

**MILITARY RATED POWER
1 ENG CLIMB DISTANCE**

EXAMPLE

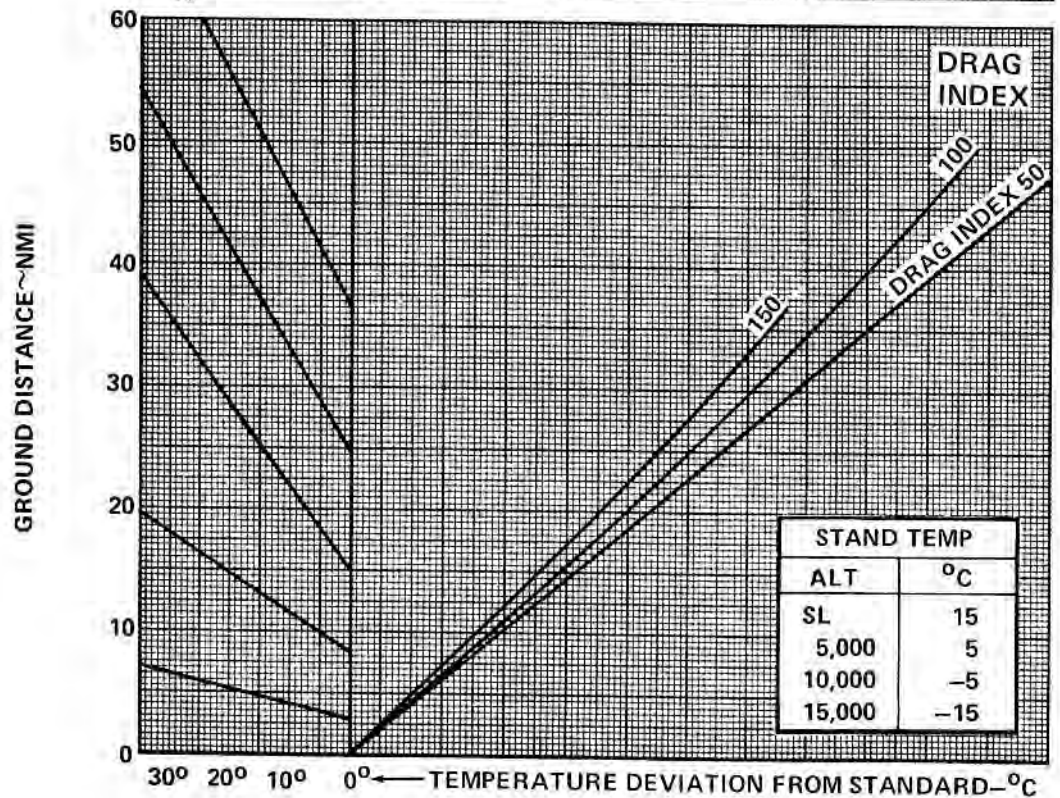
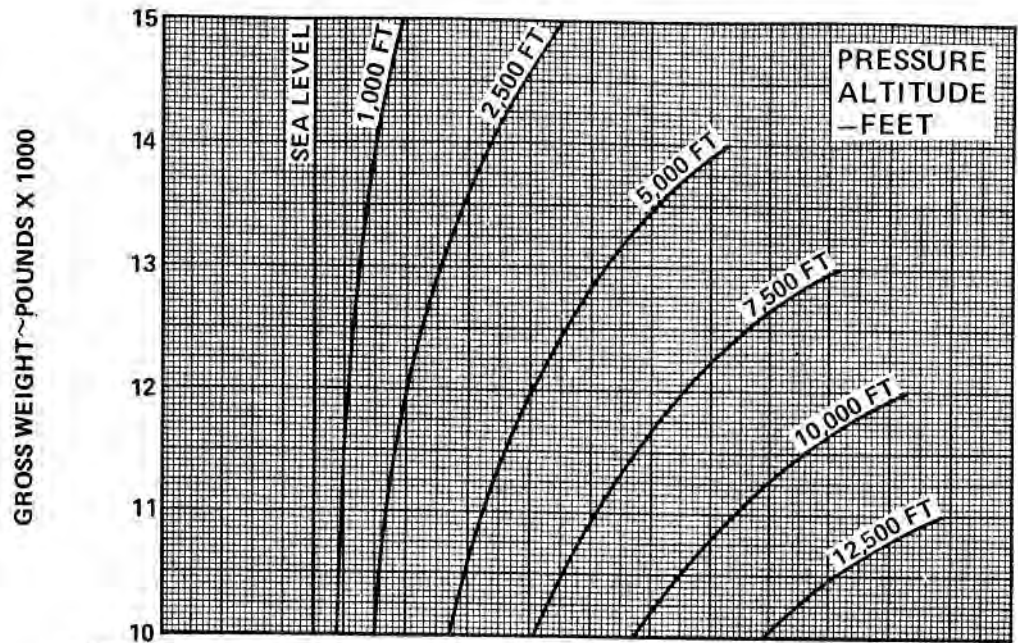
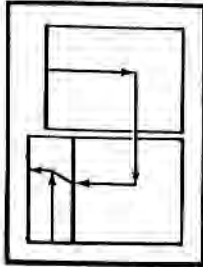

OV-10D-1-79B

Figure 11-19 (Sheet 2)

SINGLE ENGINE CLIMB

BASED ON: FLIGHT TEST DATA
DATA AS OF: 15 NOVEMBER 1977

**MILITARY RATED POWER
1 ENG CLIMB FUEL**

EXAMPLE

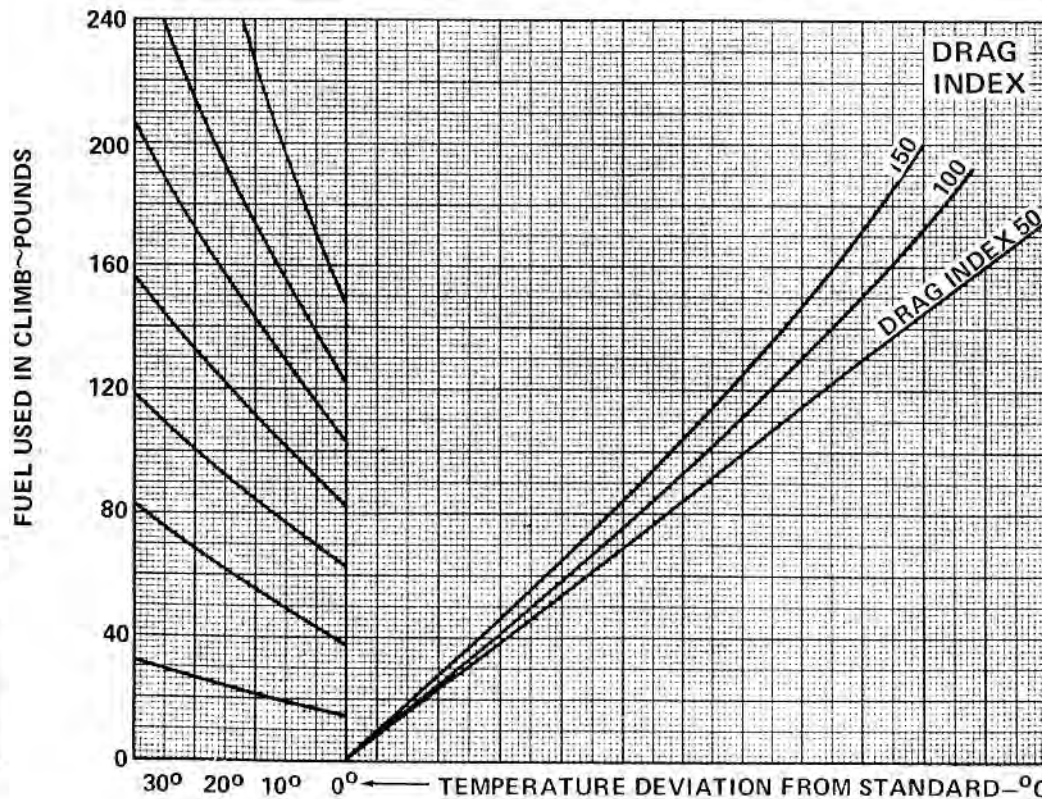
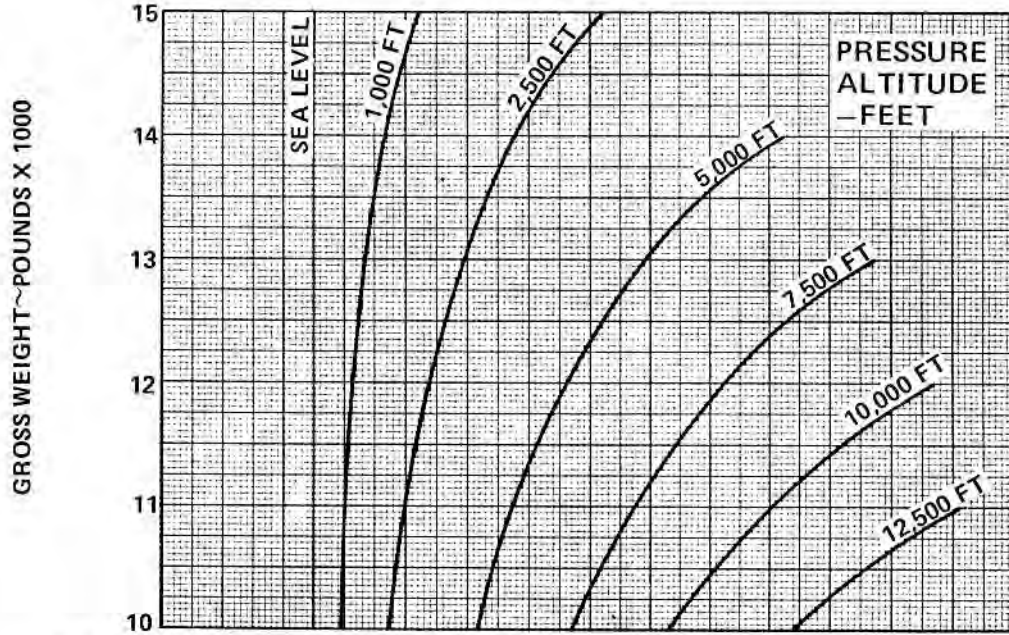
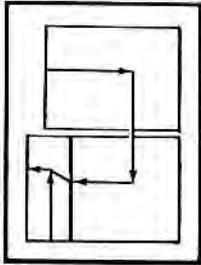

STAND TEMP	
ALT	°C
SL	15
5,000	5
10,000	-5
15,000	-15

OV-10D-1-80A

Figure 11-19 (Sheet 3)

SINGLE ENGINE CLIMB AT SEA LEVEL PRESSURE ALTITUDE

DRAG INDEX 50

FLAPS RETRACTED

LANDING GEAR RETRACTED

MILITARY POWER

DATA BASIS FLIGHT TEST

DATA AS OF: 15 NOVEMBER 1977

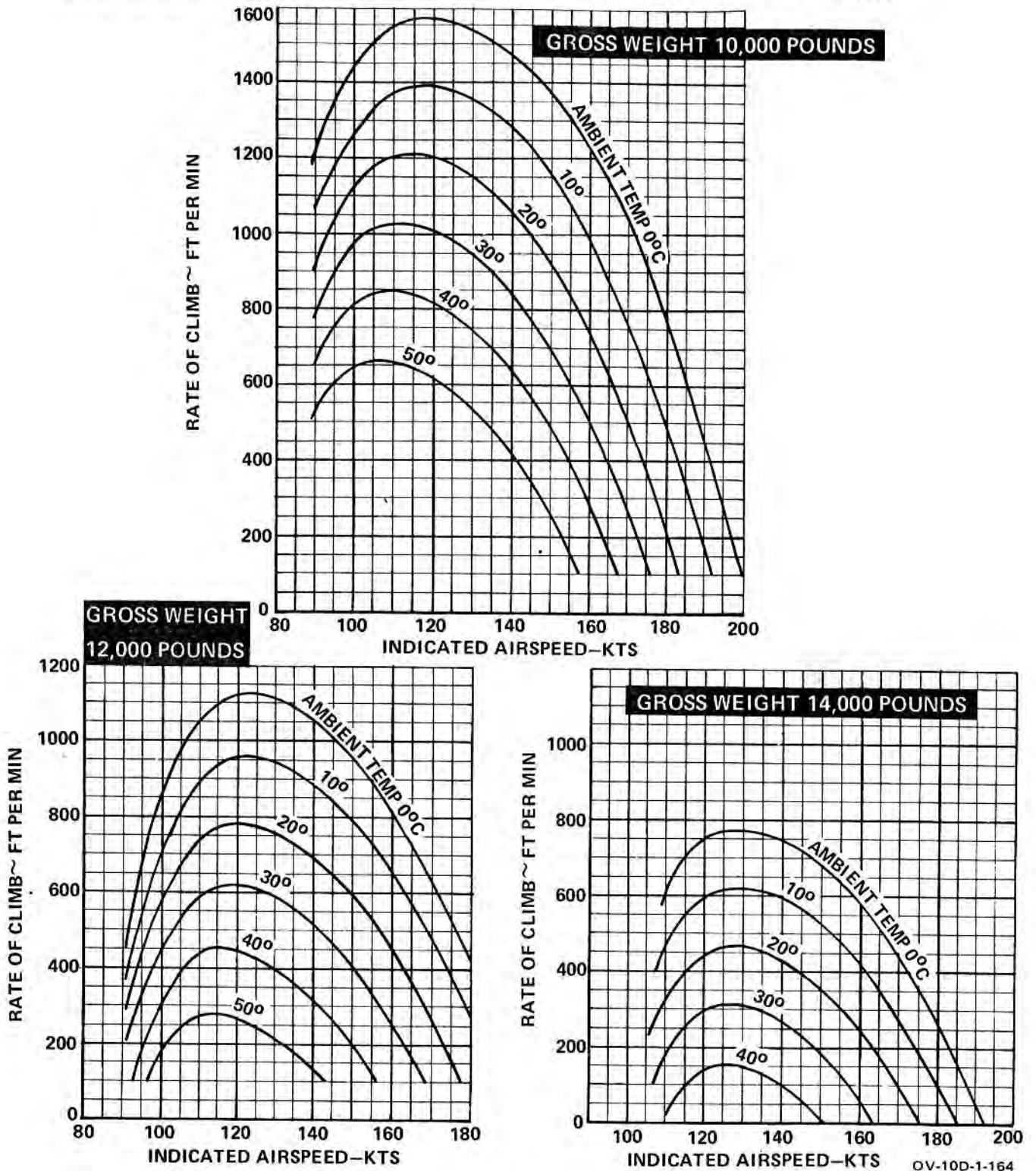

Figure 11-20

SINGLE ENGINE CLIMB AT 4,000 FEET PRESSURE ALTITUDE

DRAG INDEX 50

FLAPS RETRACTED
LANDING GEAR RETRACTED

MILITARY POWER
DATA BASIS FLIGHT TEST
DATA AS OF 15 NOV 1977

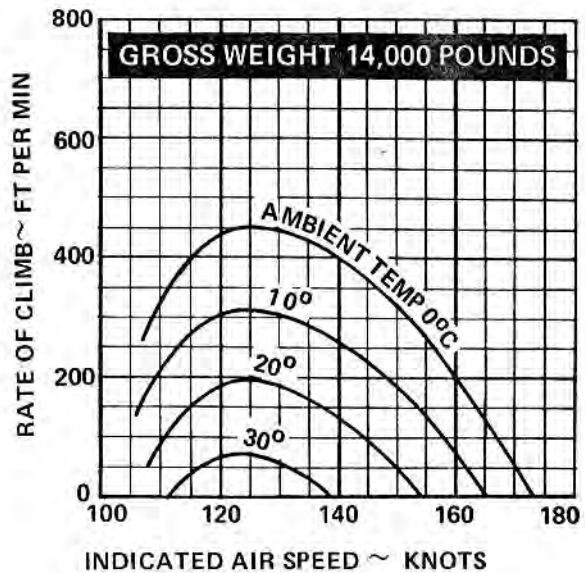
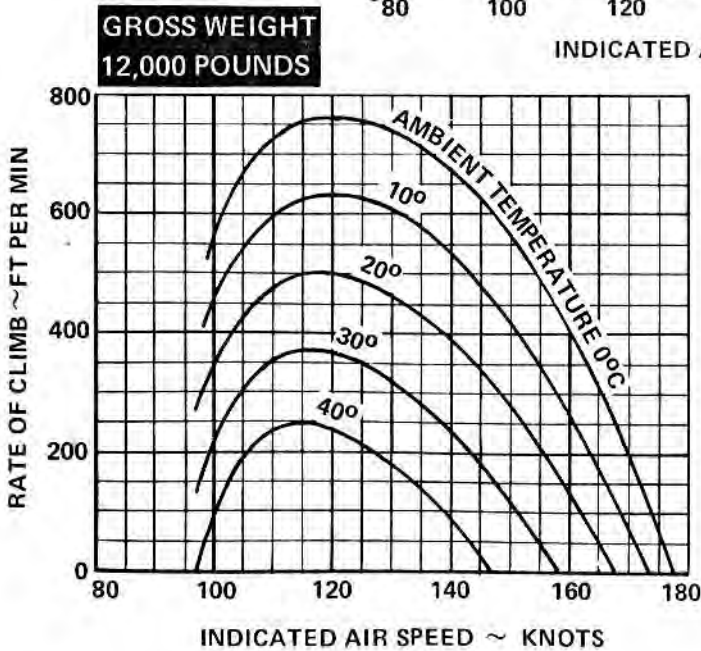
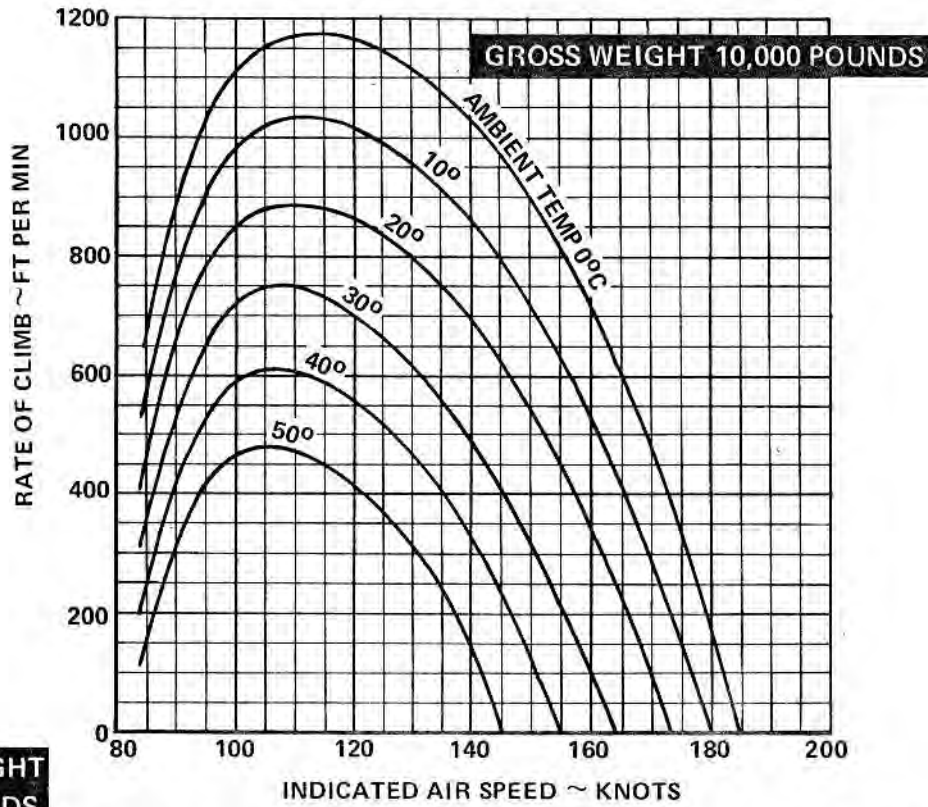

Figure 11-21

OV-10D-1-165

SINGLE ENGINE CLIMB AT 8,000 FEET PRESSURE ALTITUDE

DRAG INDEX 50

FLAPS RETRACTED
LANDING GEAR RETRACTED

MILITARY POWER
DATA BASIS FLIGHT TEST
DATA AS OF: 15 NOVEMBER 1977

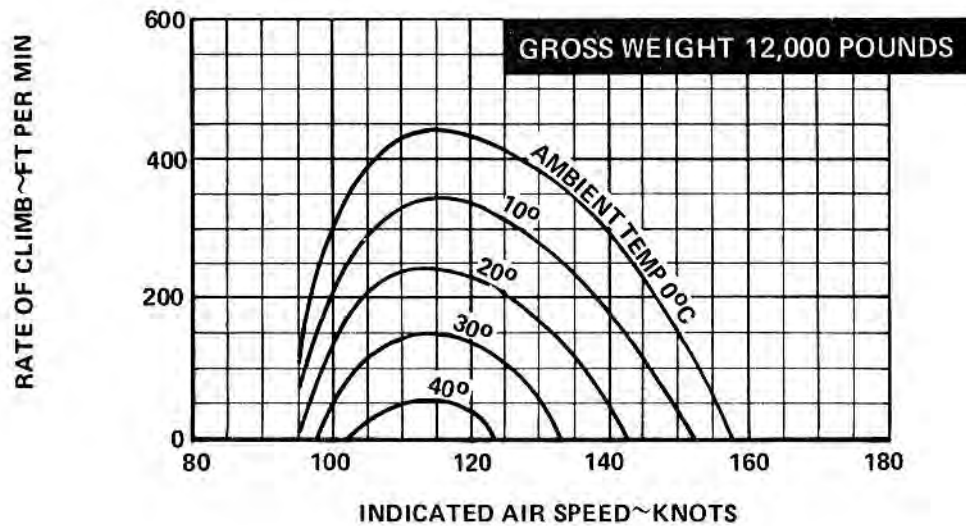
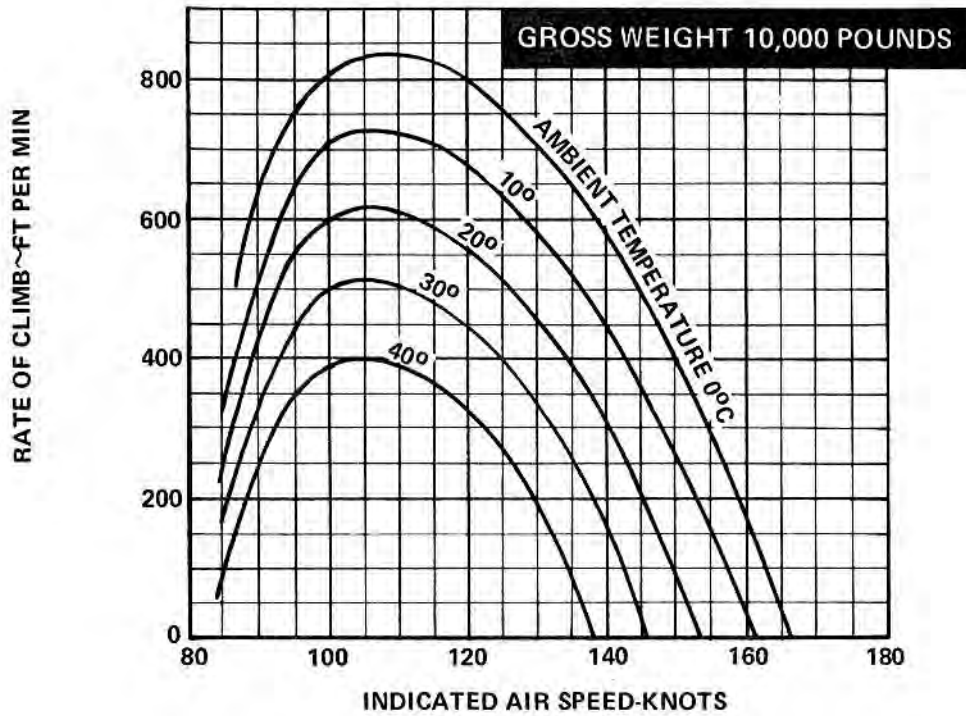

Figure 11-22

SINGLE ENGINE CLIMB AT SEA LEVEL PRESSURE ALTITUDE

DRAG INDEX 100

FLAPS RETRACTED
LANDING GEAR RETRACTED

MILITARY POWER
DATA BASIS FLIGHT TEST
DATA AS OF 15 NOVEMBER 1977

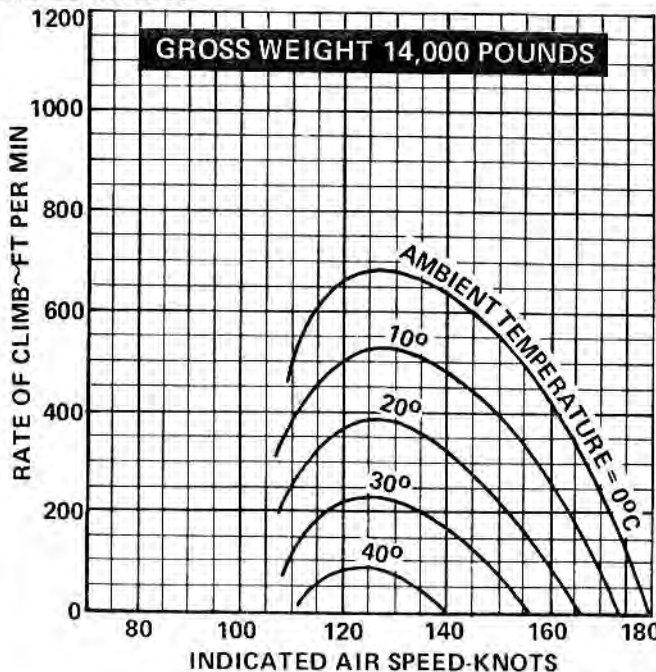
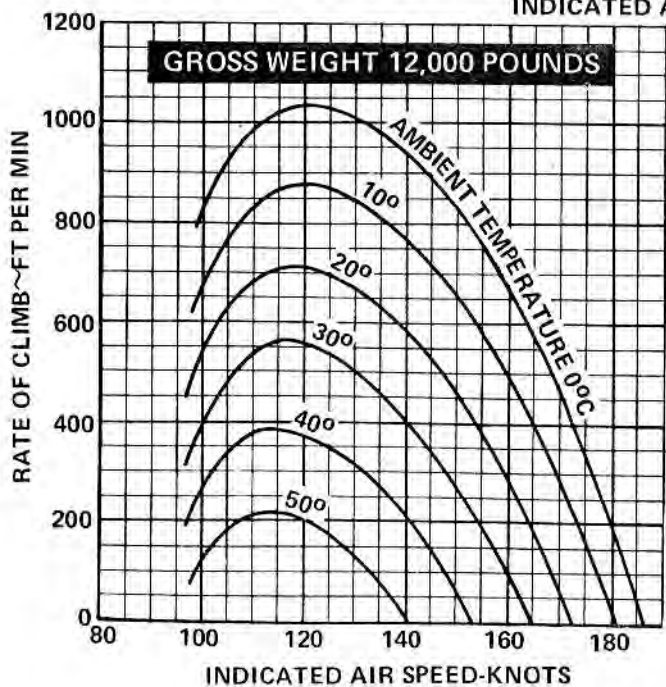
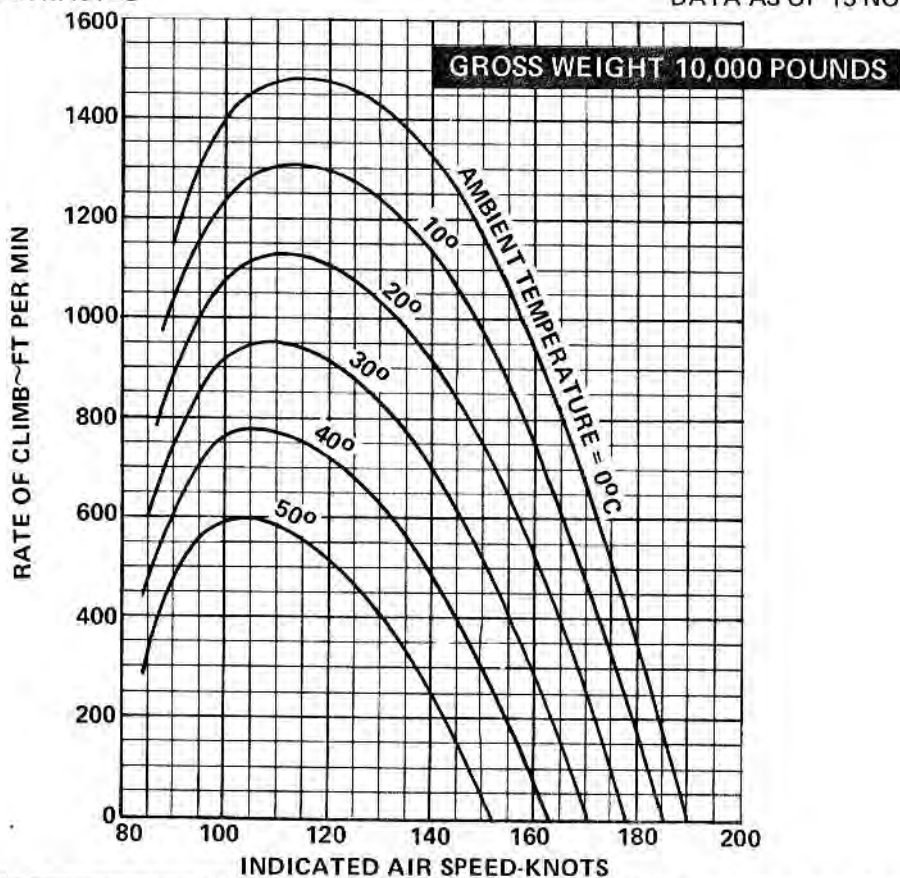

OV-10D-1-167

Figure 11-23

SINGLE ENGINE CLIMB AT 4,000 FEET PRESSURE ALTITUDE

DRAG INDEX 100

FLAPS RETRACTED
LANDING GEAR RETRACTED

MILITARY POWER
DATA BASIS FLIGHT TEST
DATA AS OF 15 NOV 1977

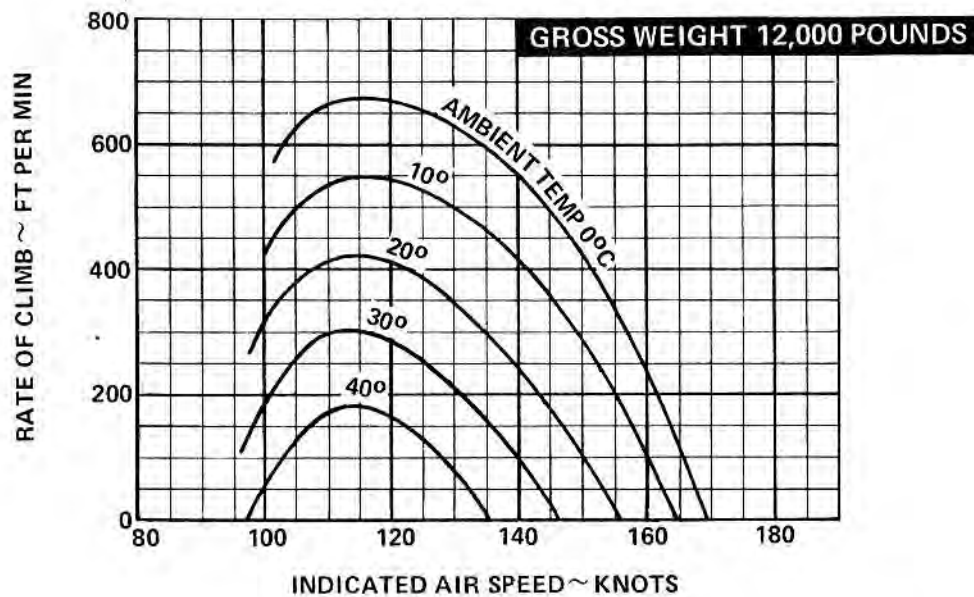
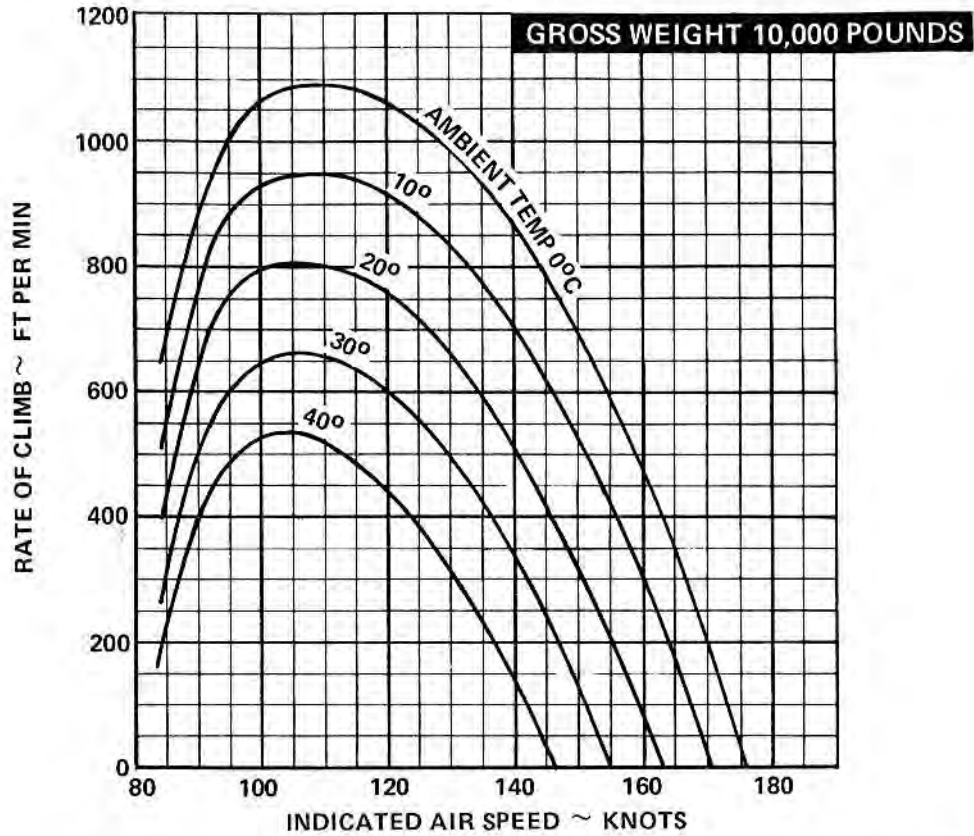

OV10D-1-168

Figure 11-24

SINGLE ENGINE CLIMB AT 8,000 FEET PRESSURE ALTITUDE

DRAG INDEX 100

FLAPS RETRACTED
LANDING GEAR RETRACTED

MILITARY POWER
DATA BASIS FLIGHT TEST
DATA AS OF 15 NOV 1977

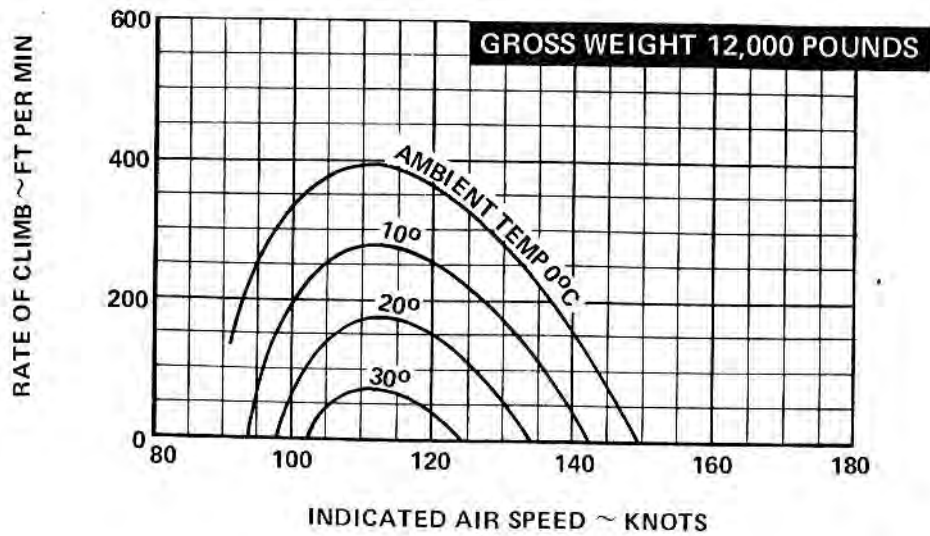
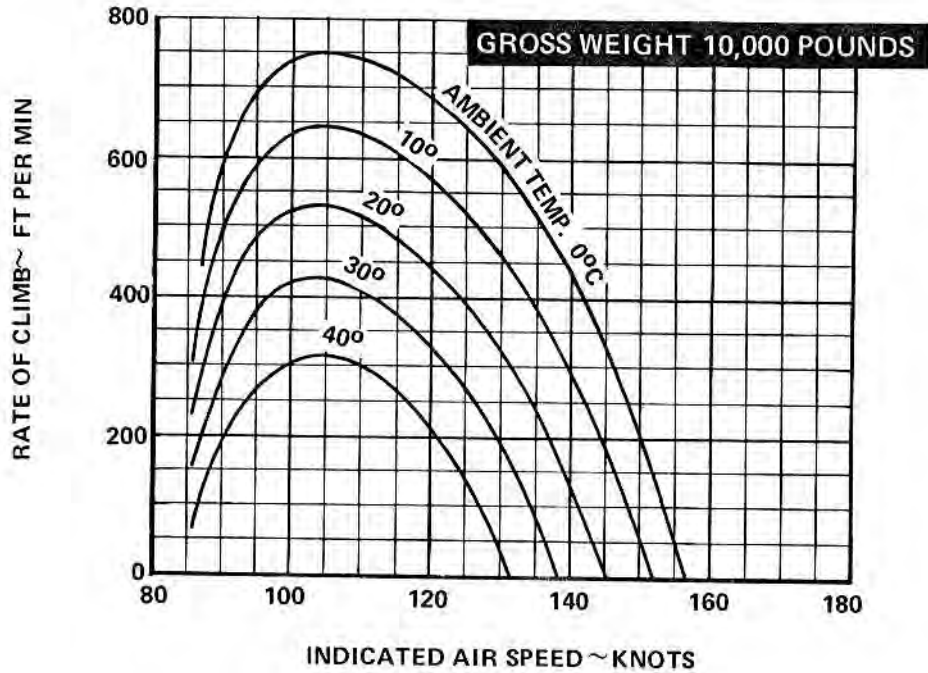

Figure 11-25

OV-10D-1-169

AIRCRAFT CEILING—2 ENGINES

BASED ON: FLIGHT TEST DATA
DATA AS OF: 15 NOVEMBER 1977

EXAMPLE

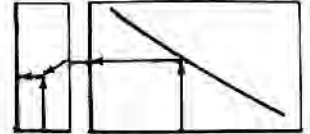

OPTIMUM CRUISE ALTITUDE

NORMAL RATED POWER
(300 FEET/MINUTE)

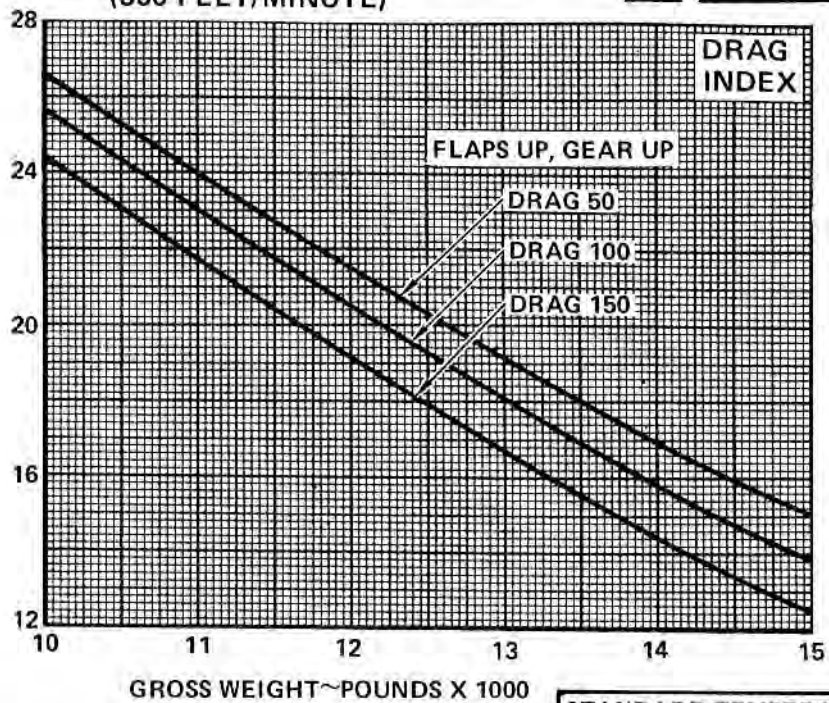
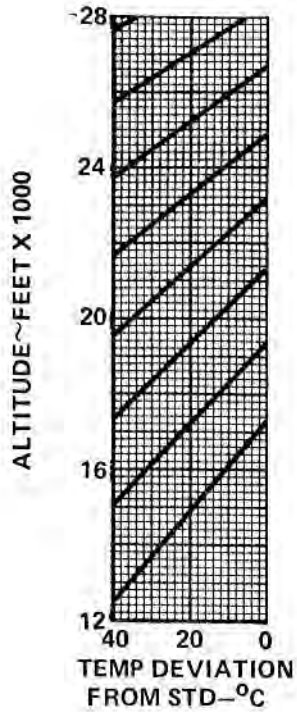

STANDARD TEMPERATURE		
ALT	°C	°F
SL	15	59
5,000	5	41
10,000	-5	23
15,000	-15	5
20,000	-25	-13

COMBAT CEILING

MILITARY POWER
(500 FEET/MINUTE)

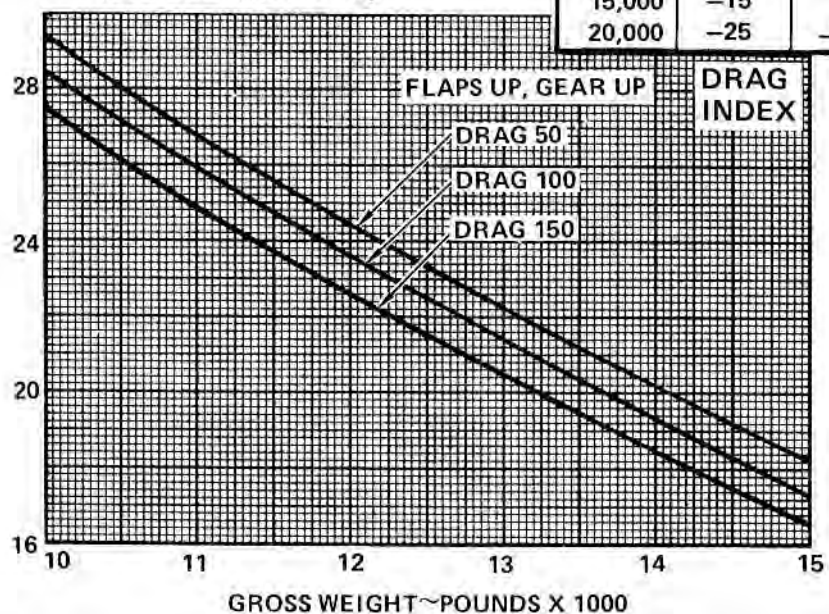
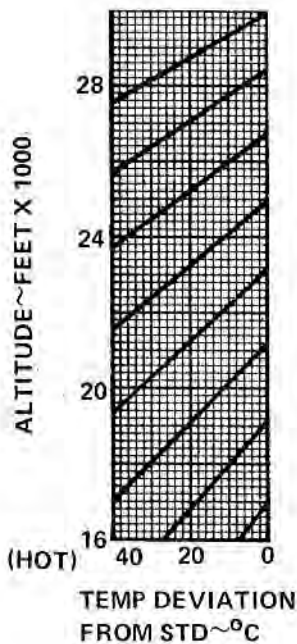

OV-10D-1-73

Figure 11-26

SERVICE CEILING-2 ENGINES

BASED ON: FLIGHT TEST DATA
DATA AS OF: 15 NOVEMBER 1977

**MILITARY RATED POWER
RATE OF CLIMB = 100 FPM**

EXAMPLE

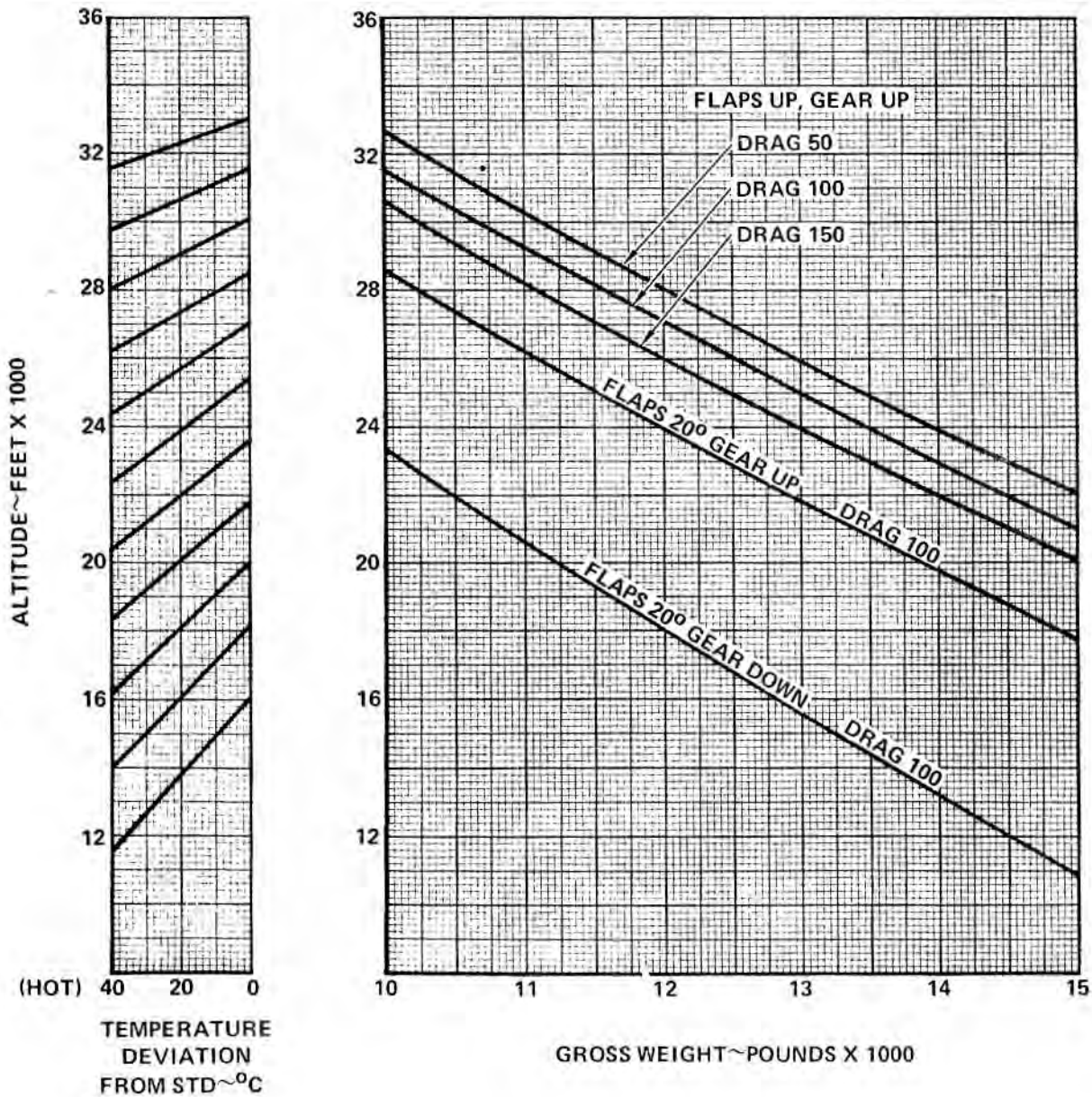
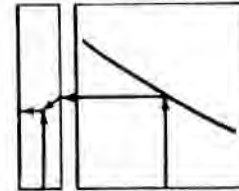

Figure 11-27

OV-10D-1-74A

SERVICE CEILING—SINGLE ENGINE

DRAG 70

BASED ON: FLIGHT TEST DATA
DATA AS OF: 15 NOVEMBER 1977

**MILITARY RATED POWER
RATE OF CLIMB = 100 FPM**

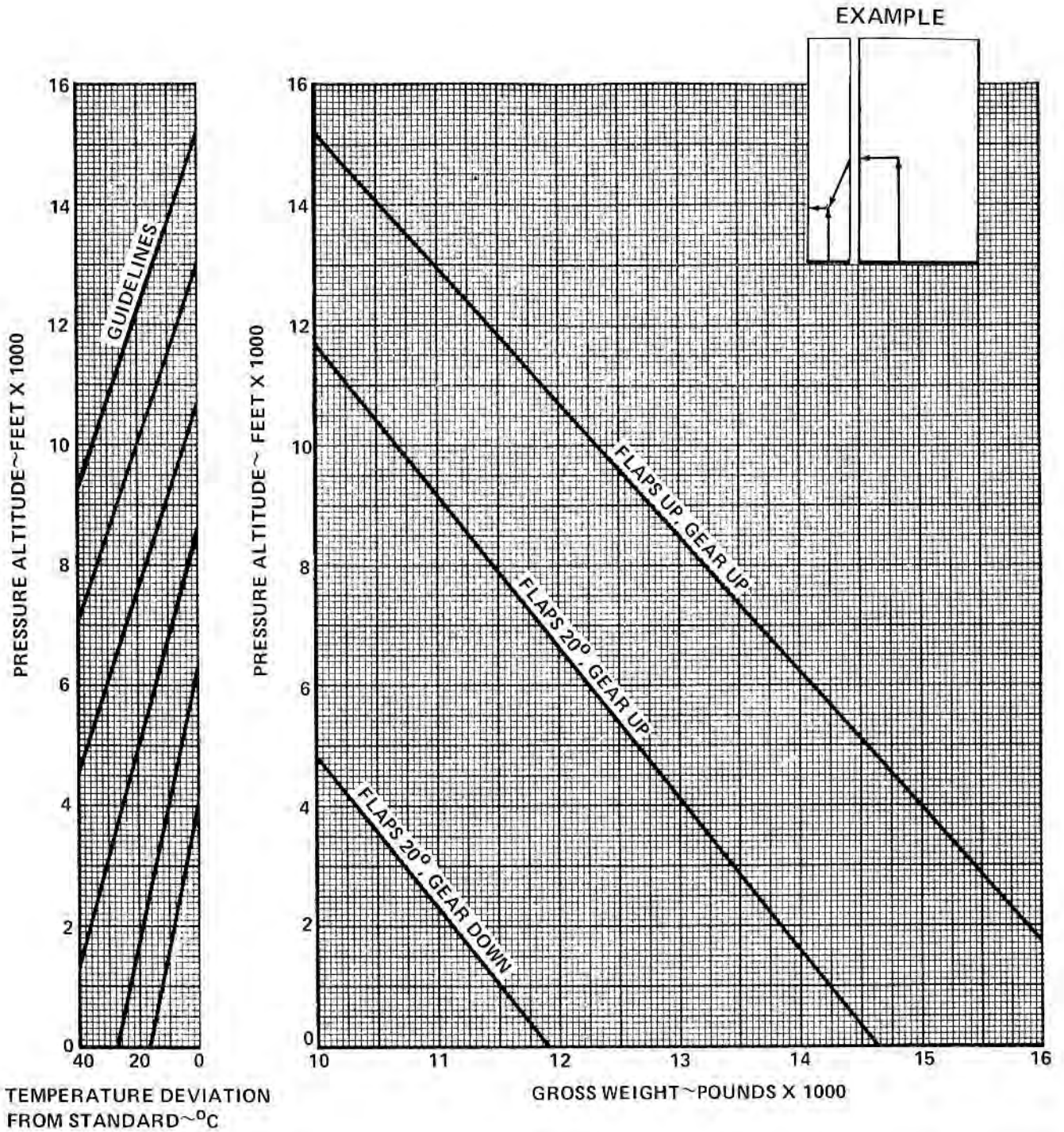

OV-10D-1-84A

Figure 11-28

PART 4 — RANGE DATA**RANGE DATA****CONSTANT-ALTITUDE CRUISE** (FIGURES 11-29 AND 11-30)

The Constant-Altitude Cruise charts (figures 11-29 and 11-30) may be used in preflight planning to determine speeds, fuel and time requirements for navigational flights, or preplanned missions. An average gross weight may be used for a given leg, or instantaneous data may be extracted. A standard temperature block is provided for use in determining deviation based on reported temperature at flight altitude.

CONSTANT-ALTITUDE CRUISE EXAMPLE PROBLEM

Find fuel and time required for a 200-nautical-mile leg:

- Gross Weight—13,000 pounds
- Cruise Altitude—10,000 feet
- Drag Index—60 (use 50 Drag Index line)
- Ambient Temperature—10°C above standard
- Wind Velocity—28 knots (head)

1. Best cruise CAS = 174 knots
2. Ground nautical miles per 100 pounds fuel = 27.4
3. Fuel quantity = 700 pounds
4. Time required = 70 minutes

OPTIMUM CRUISE ALTITUDE (FIGURE 11-31)

During preflight planning, pilots are often faced with the task of determining what altitude should be used to obtain maximum range. This requires detailed examination of reported or forecast wind information, then computation of best altitude as a function of ground speed. The Optimum Cruise Altitude chart (figure 11-31) permits rapid determination of best long-range cruise altitude for prevailing winds aloft. To use the chart, superimpose a plot of known effective headwind or tailwind values on the grid, then pick the altitude depicting maximum specific range (nautical miles per pounds fuel).

OPTIMUM CRUISE ALTITUDE EXAMPLE PROBLEM

Find best cruise altitude for the following en route wind structure:

ALTITUDE (FEET)	WIND
Surface	10 knots tail
5,000	7 knots tail
10,000	4 knots tail
15,000	4 knots head
20,000	29 knots head

By examining the wind curve, it is seen that best range will result at approximately 16,000 feet (about 34 nautical miles per 100 pounds of fuel).

NAUTICAL MILES PER 100 POUNDS FUEL (FIGURES 11-32 THROUGH 11-46)

Specific range data is provided for altitudes from sea level through 25,000 feet at Drag Indexes 50, 100, and 150. These charts may be used to determine instantaneous planning data and initial engine rpm required to obtain a specified true airspeed under Standard Day conditions. See figures 11-32 through 11-46.

NAUTICAL MILES PER 100 POUNDS FUEL EXAMPLE PROBLEM

Find the best cruise data for 5000 feet:

Gross Weight—12,000 pounds
 Drag Index—90
 (Use nearest Drag Index chart in this example, 100 Drag Index)

1. Enter Drag Index 100 chart for 5000 feet (figure 11-35).
 - (a) CAS = 168
 - (b) TAS = 182
 - (c) Fuel Flow = 635 pounds per hour
 - (d) Nautical miles per 100 pounds of fuel = 28.6
 - (e) RPM = 91%

CONSTANT ALTITUDE CRUISE

**MAXIMUM RANGE
FUEL, TIME AND
NAUTICAL MILES/POUND**

BASED ON: FLIGHT TEST DATA
DATA AS OF: 15 NOV 77

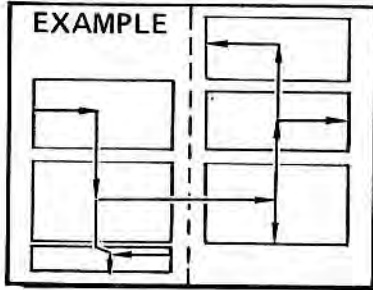

STAND TEMP	
ALT FT	°C
SL	15
5,000	5
10,000	-5
15,000	-15
20,000	-25

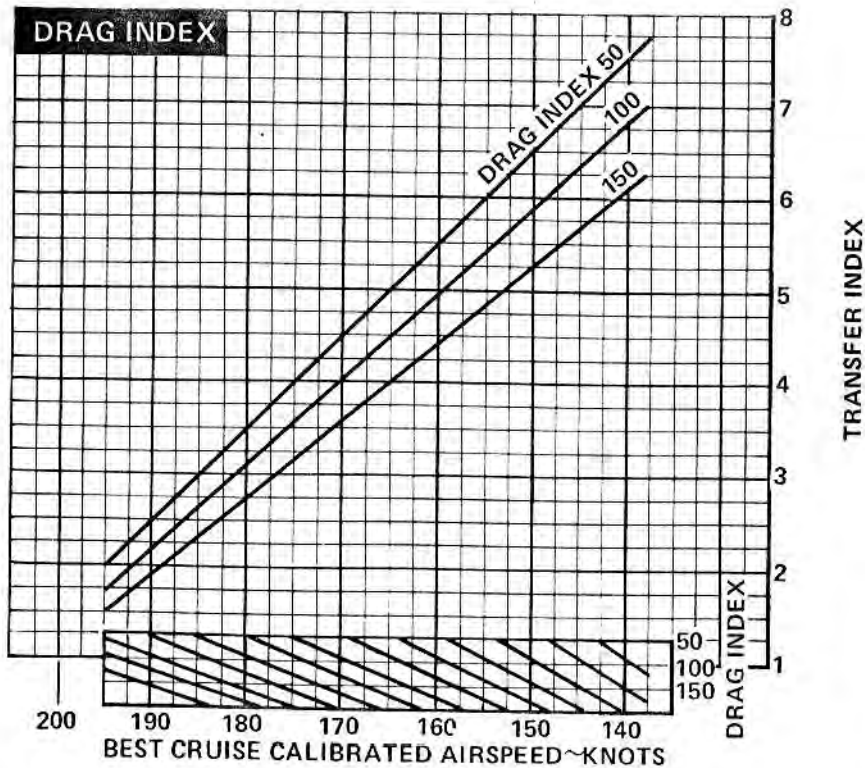
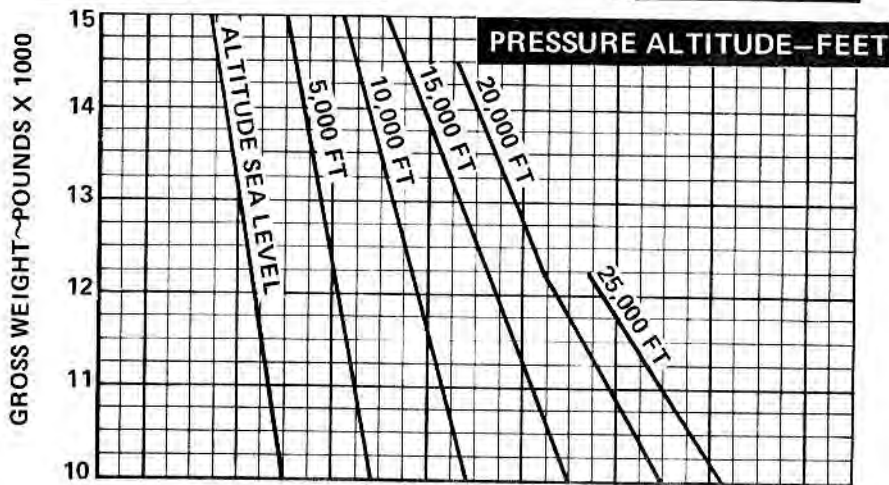
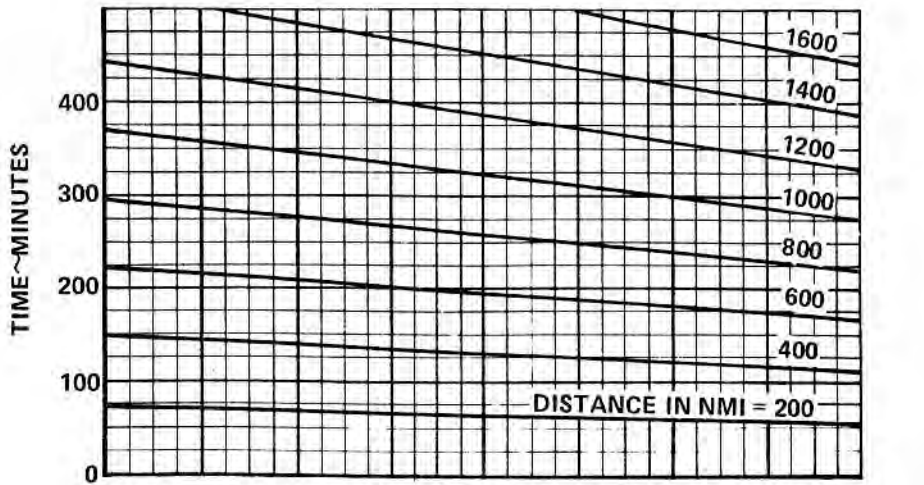
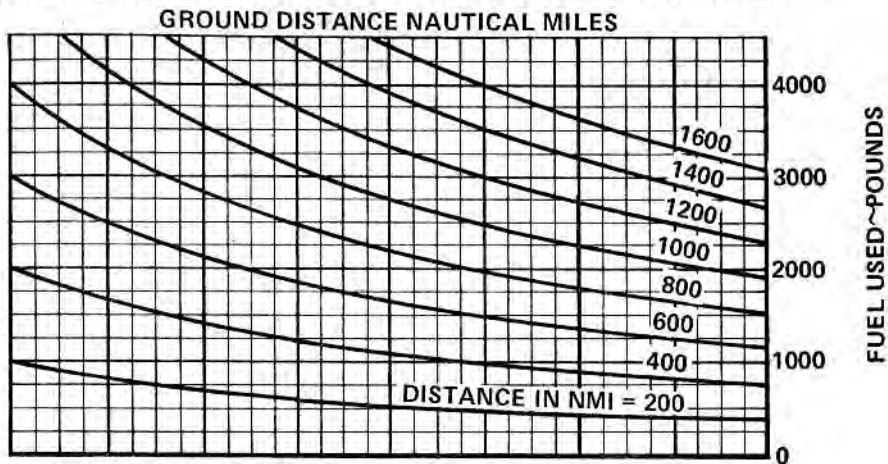

Figure 11-29 (Sheet 1)

**CONSTANT
ALT CRUISE**



TIME



FUEL

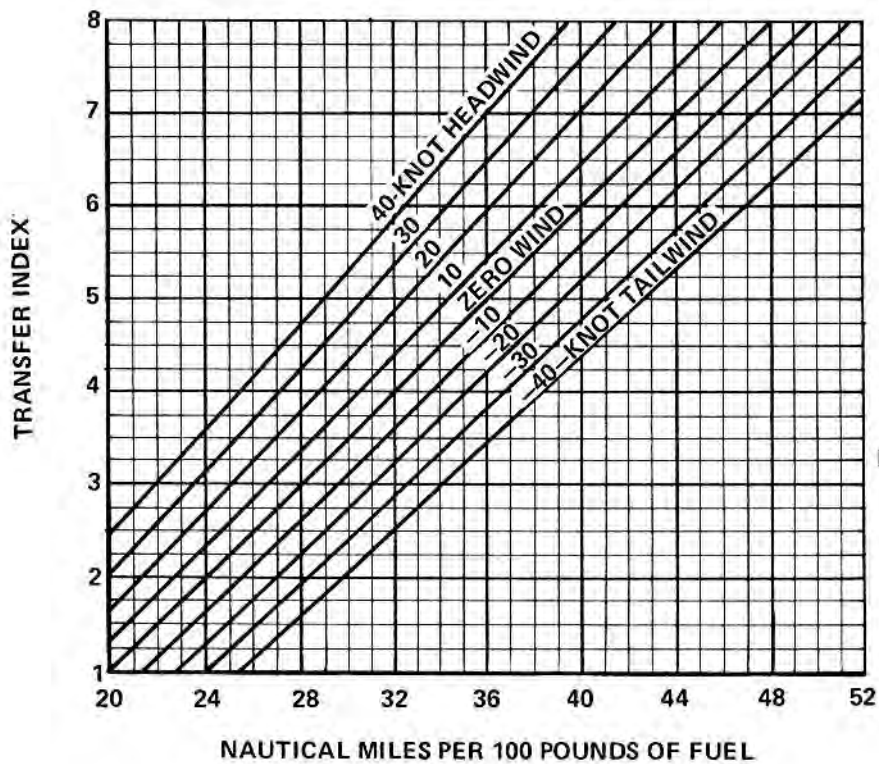

NMI/LB

NOTE: DECREASE NMI/LB 1%
FOR EACH 5°C ABOVE
STD TEMPERATURE

Figure 11-29 (Sheet 2)

SINGLE ENGINE CONSTANT ALTITUDE CRUISE

**MAXIMUM RANGE
FUEL, TIME AND
NAUTICAL MILES/POUND**

BASED ON: FLIGHT TEST DATA
DATE AS OF: 15 NOV 77

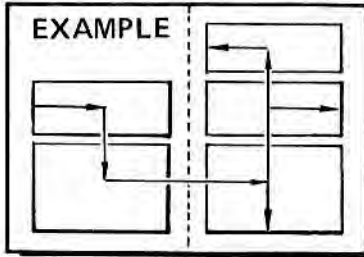

CRUISE SPEED	
WEIGHT	KNOTS-CAS
10,000 LBS	140 KTS
11,000	145
12,000	150
13,000	155
14,000	160

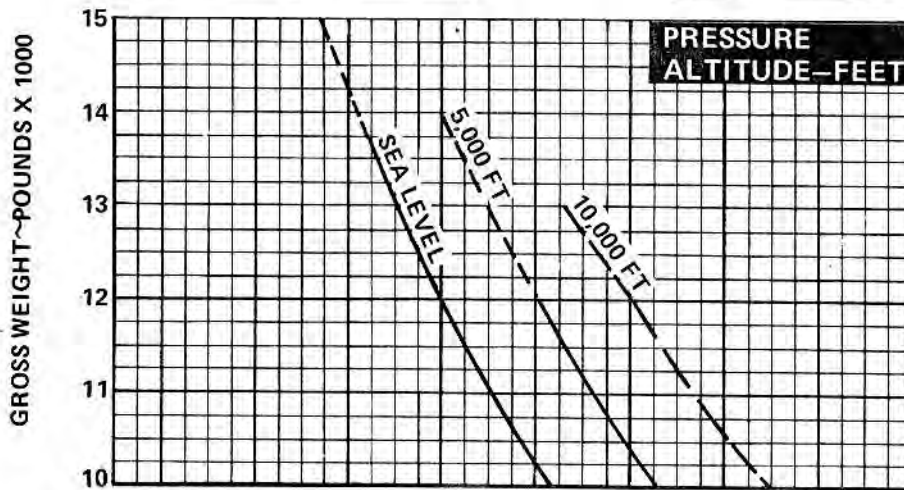

NOTE:
DASHED LINE INDICATES
POWER IN EXCESS OF
MAXIMUM CONTINUOUS

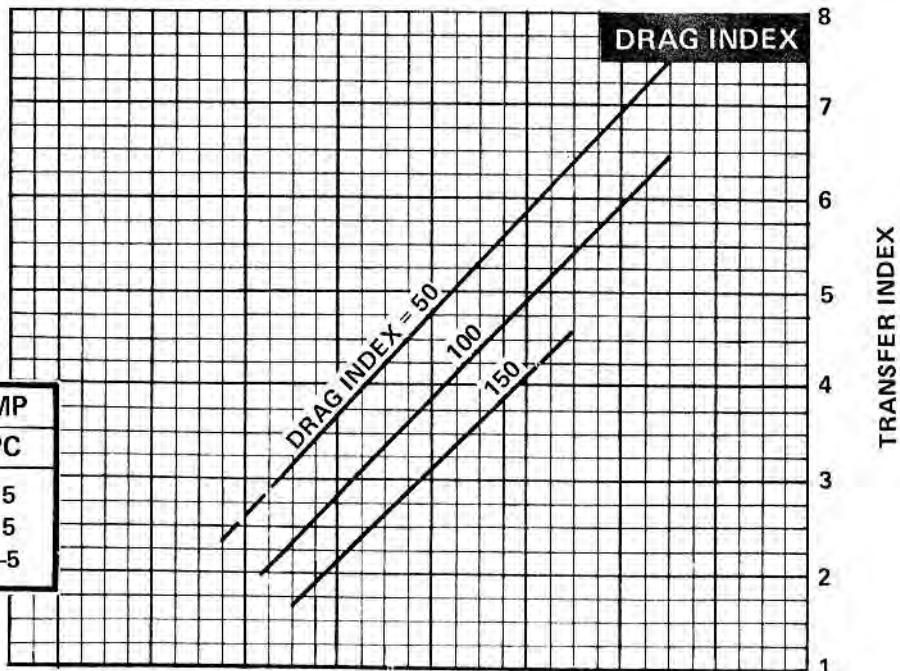

STD TEMP	
ALT	°C
SL	15
5,000	5
10,000	-5

Figure 11-30 (Sheet 1)

**1 ENGINE
CONSTANT
ALT CRUISE**

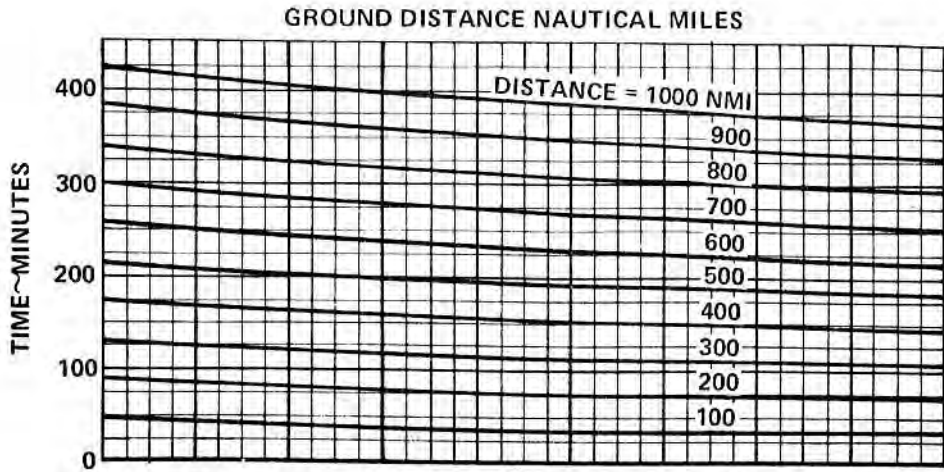

TIME

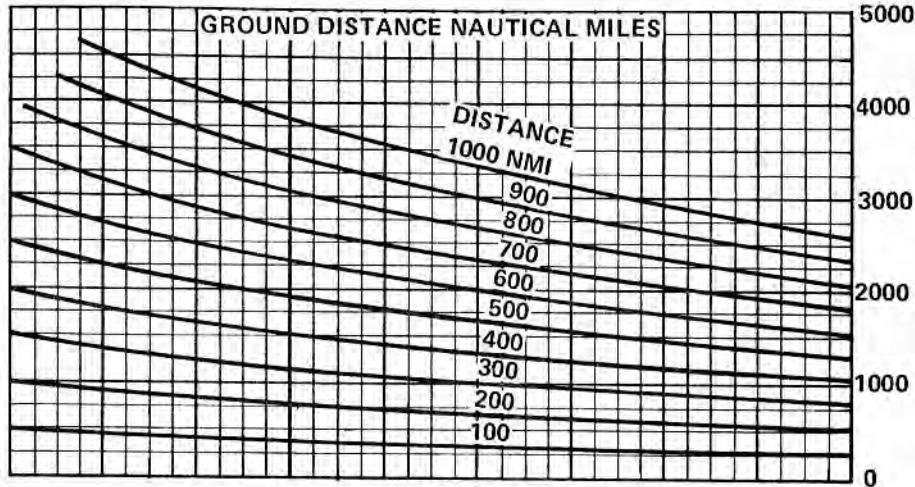

FUEL

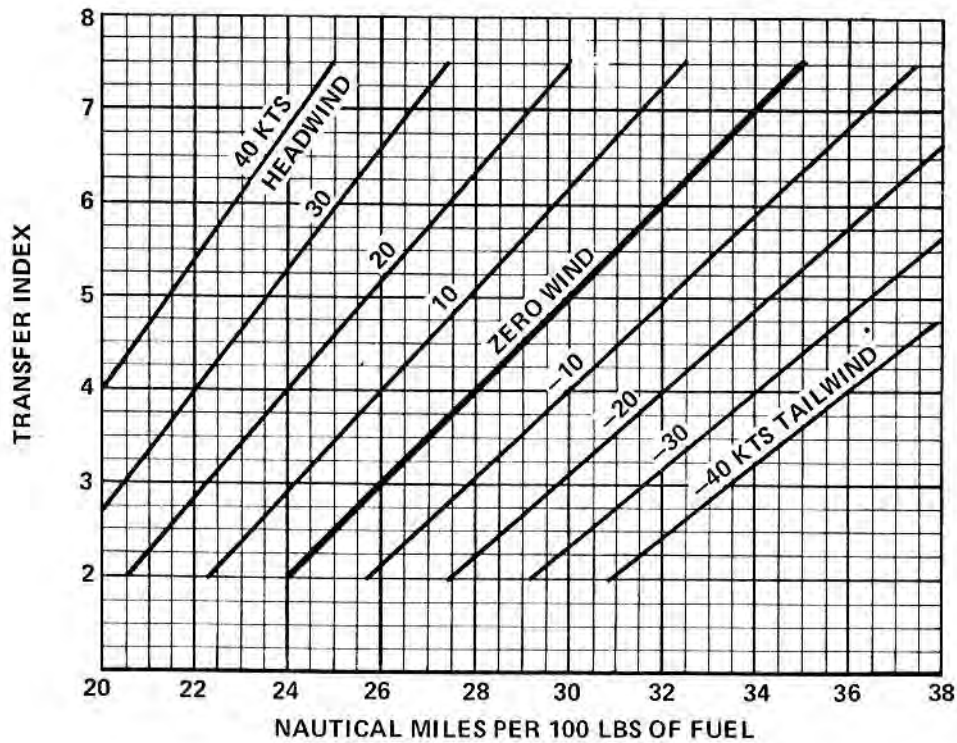

NMI/LB

Figure 11-30 (Sheet 2)

OPTIMUM CRUISE ALTITUDE

DATA BASE ON: FLIGHT TEST DATA
DATA OS OF: 15 NOVEMBER 1977

**FERRY CONFIGURATION
SPONSONS, CENTERLINE PYLON**

AVERAGE GROSS WEIGHT = 12,000 POUNDS

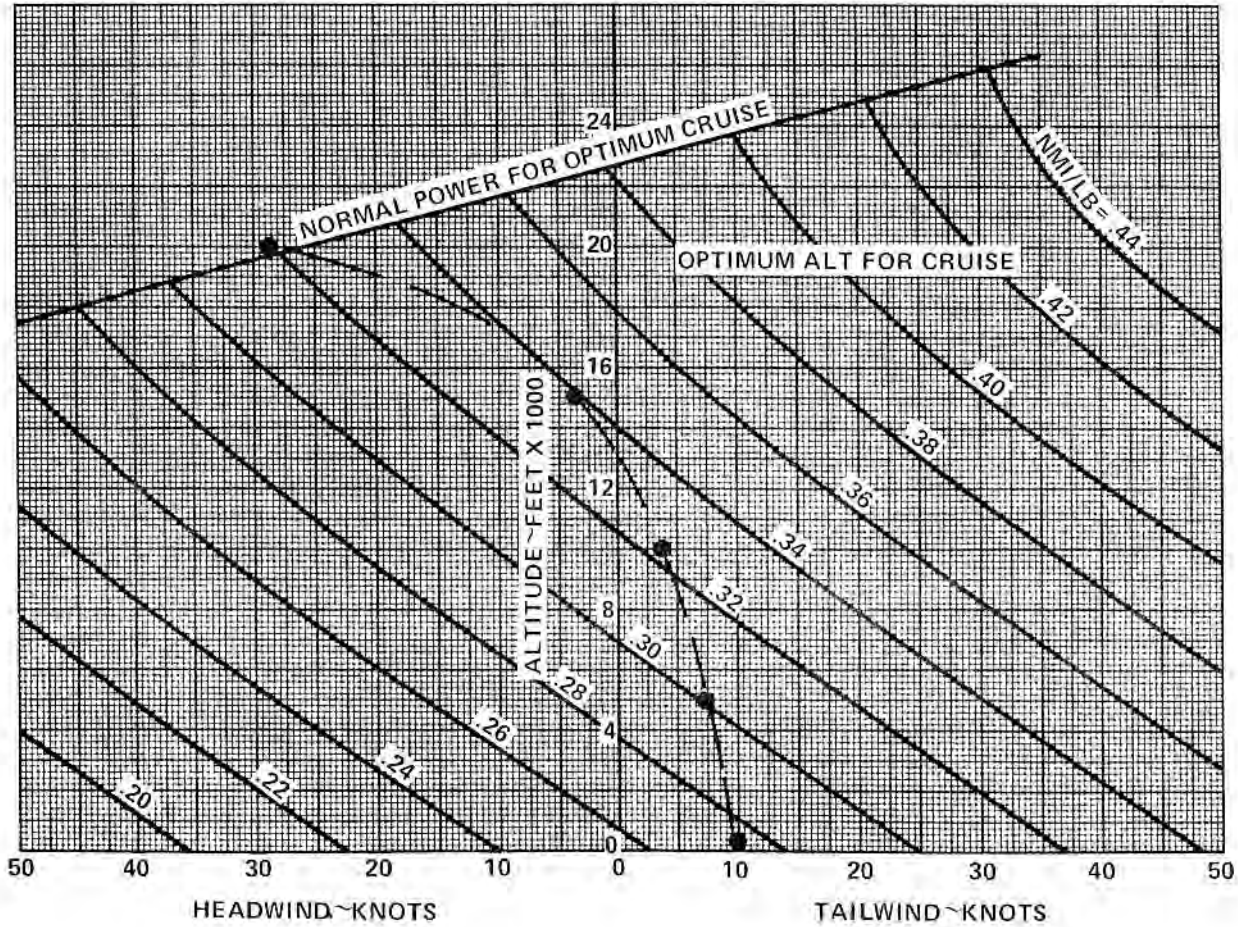

NOTE:

- FOR INCREASED WEIGHT, REDUCE NMI/LB 5% PER 1000 POUNDS
- FOR LIGHTER WEIGHT, INCREASE NMI/LB 5% PER 1000 POUNDS
- FOR OPTIMUM CRUISE AIRSPEED, INCREASE NO-WIND CRUISE SPEED 1/2 KNOT PER KNOT OF HEADWIND AND DECREASE 1/2 KNOT PER KNOT OF TAILWIND

Figure 11-31

OV 10D-1-87

NAUTICAL MILES PER 100 POUNDS FUEL

BASED ON: FLIGHT TEST DATA
DATA AS OF: 15 NOVEMBER 1977

DRAG 50
ENGINES (2) T76

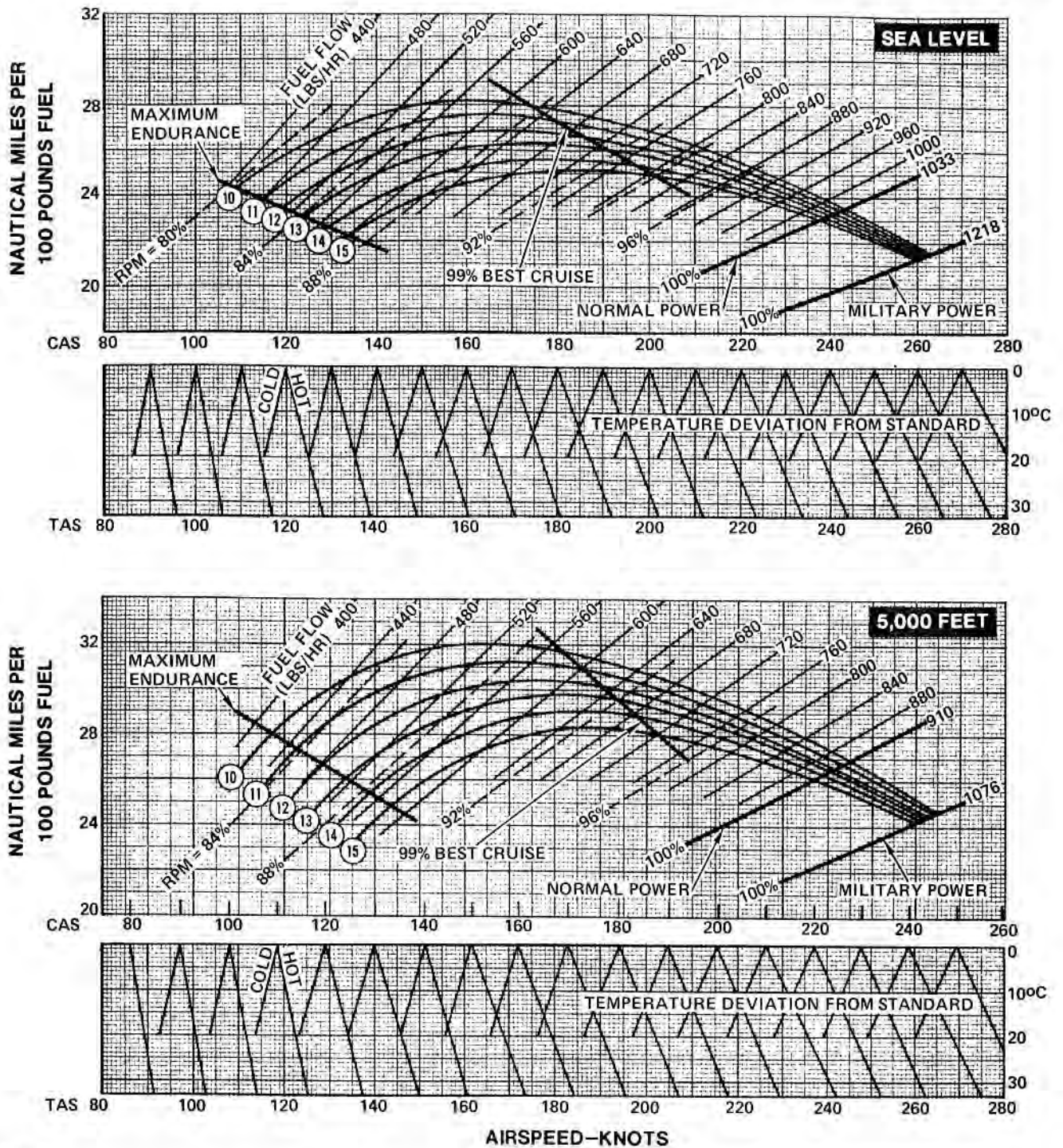

NOTE:

- CURVE VALUES FOR A NO WIND ($V_w = 0$) CONDITION
TO COMPUTE FOR WIND EFFECTS:

$$\text{NMI/100 LB} = \text{NMI/100 LB (NO WIND)} \times \frac{\text{GROUND SPEED}}{\text{TRUE AIRSPEED}}$$
- REDUCE NMI/100 LB 3% FOR EACH 10°C ABOVE STANDARD TEMP

GROSS WEIGHT	
⑩ 10,000 POUNDS	⑬ 13,000 POUNDS
⑪ 11,000 POUNDS	⑭ 14,000 POUNDS
⑫ 12,000 POUNDS	⑮ 15,000 POUNDS

OV-10D-188

Figure 11-32

NAUTICAL MILES PER 100 POUNDS FUEL

DRAG 50

ENGINES (2) T-76

BASED ON: FLIGHT TEST DATA
DATA AS OF: 15 NOVEMBER 1977

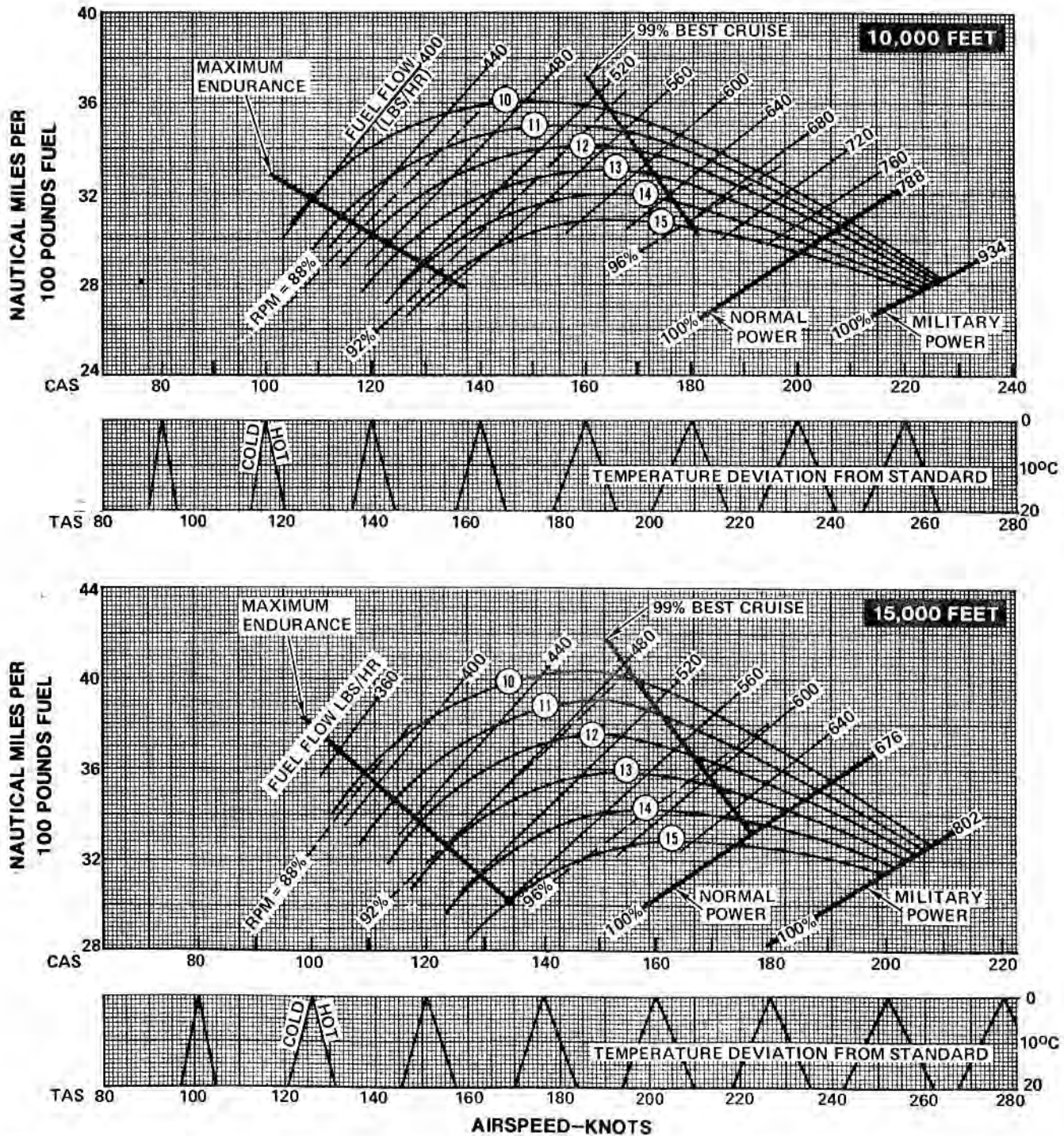

NOTE:

- CURVE VALUES FOR A NO WIND ($V_w = 0$) CONDITION
TO COMPUTE FOR WIND EFFECTS:
$$\text{NMI}/100 \text{ LB} = \text{NMI}/100 \text{ LB (NO WIND)} \times \frac{\text{GROUND SPEED}}{\text{TRUE AIRSPEED}}$$
- REDUCE NMI/100 LB 3% FOR EACH 10°C ABOVE STANDARD TEMP

GROSS WEIGHT	
⑩ 10,000 POUNDS	⑬ 13,000 POUNDS
⑪ 11,000 POUNDS	⑭ 14,000 POUNDS
⑫ 12,000 POUNDS	⑮ 15,000 POUNDS

OV-10D-1 89A

Figure 11-33

NAUTICAL MILES PER 100 POUNDS FUEL

DRAG 50

BASED ON: FLIGHT TEST DATA
DATA AS OF: 15 NOVEMBER 1977

ENGINES (2) T-76

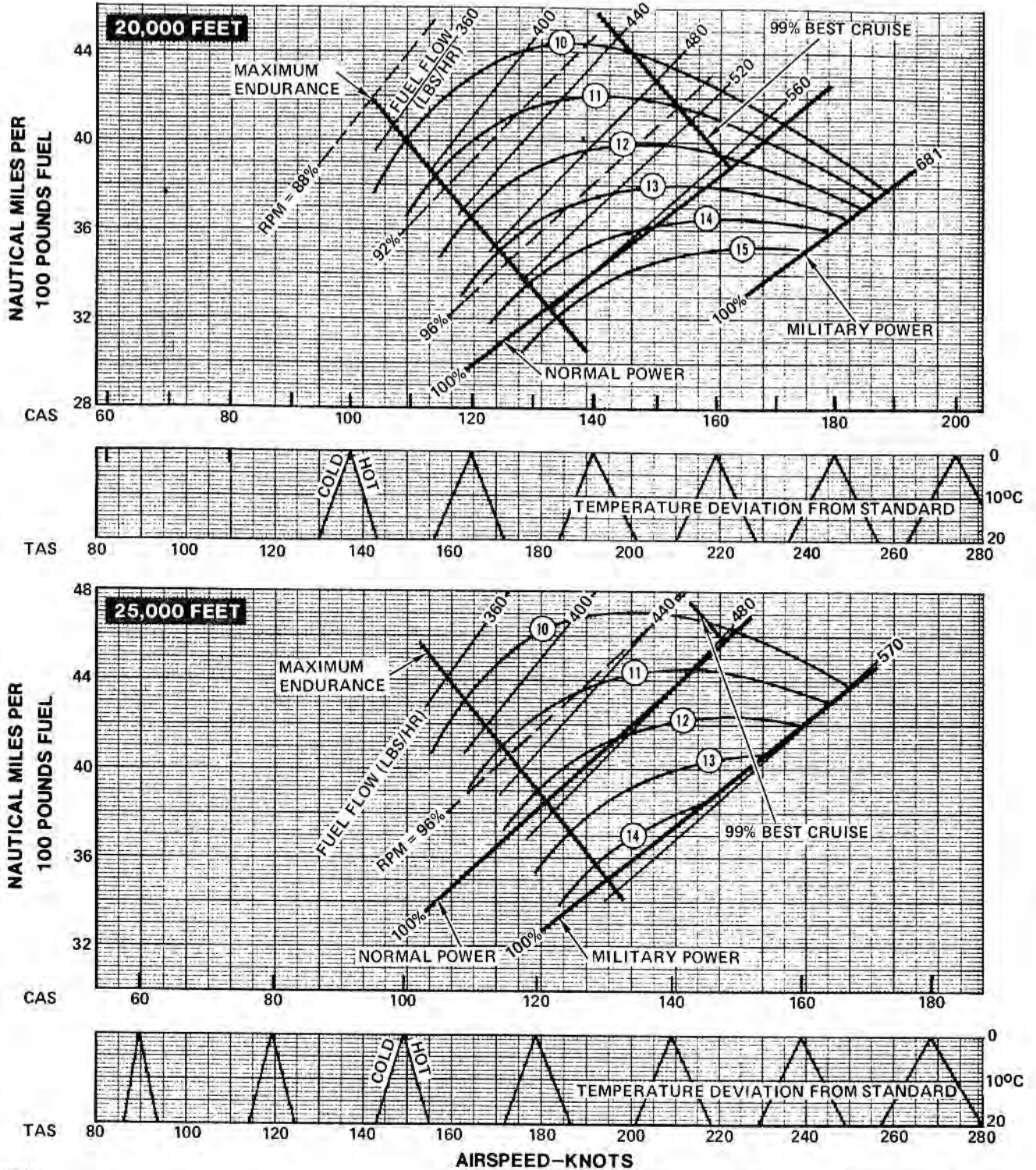

NOTE:

- CURVE VALUES FOR A NO WIND ($V_w = 0$) CONDITION
TO COMPUTE FOR WIND EFFECTS:
NMI/100 LB = NMI/100 LB (NO WIND) TIMES GROUND SPEED / TRUE AIRSPEED
- REDUCE NMI/100 LB 3% FOR EACH 10°C ABOVE STANDARD TEMP

GROSS WEIGHT	
10	10,000 POUNDS
11	11,000 POUNDS
12	12,000 POUNDS
13	13,000 POUNDS
14	14,000 POUNDS
15	15,000 POUNDS

OV-10D-1-90

Figure 11-34

NAUTICAL MILES PER 100 POUNDS FUEL

DRAG 100

BASED ON: FLIGHT TEST DATA
DATA AS OF: 15 NOVEMBER 1977

ENGINES (2) T-76

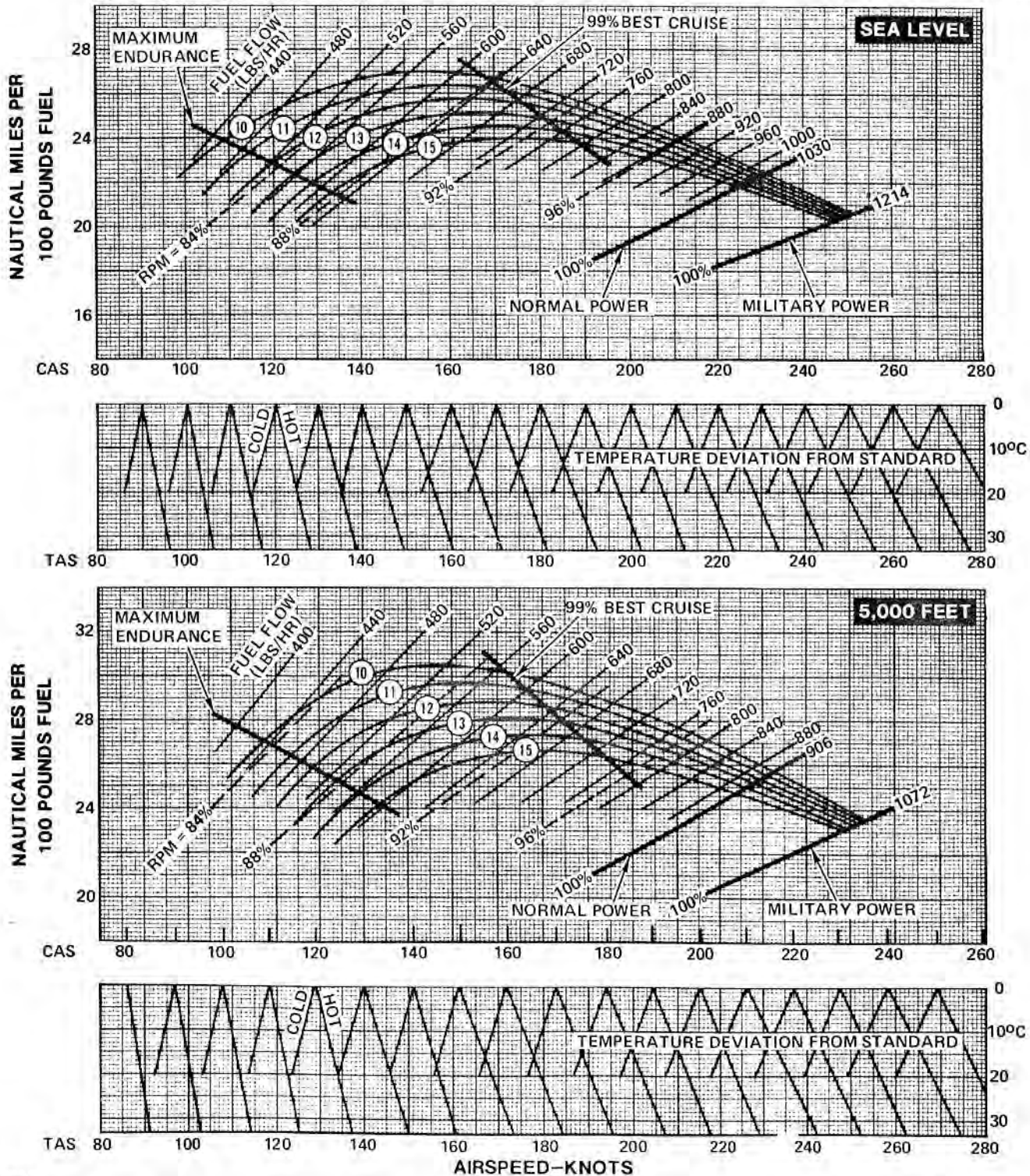

NOTE:

- CURVE VALUES FOR A NO WIND ($V_w = 0$) CONDITION
TO COMPUTE FOR WIND EFFECTS:
NMI/100 LB = NMI/100 LB (NO WIND) TIMES GROUND SPEED
TRUE AIRSPEED
- REDUCE NMI/100 LB 3% FOR EACH 10°C ABOVE STANDARD TEMP

GROSS WEIGHT	
(10) 10,000 POUNDS	(13) 13,000 POUNDS
(11) 11,000 POUNDS	(14) 14,000 POUNDS
(12) 12,000 POUNDS	(15) 15,000 POUNDS

OV-10D-1-91A

Figure 11-35

NAUTICAL MILES PER 100 POUNDS FUEL

BASED ON: FLIGHT TEST DATA
DATA AS OF: 15 NOVEMBER 1977

DRAG 100

ENGINES (2) T-76

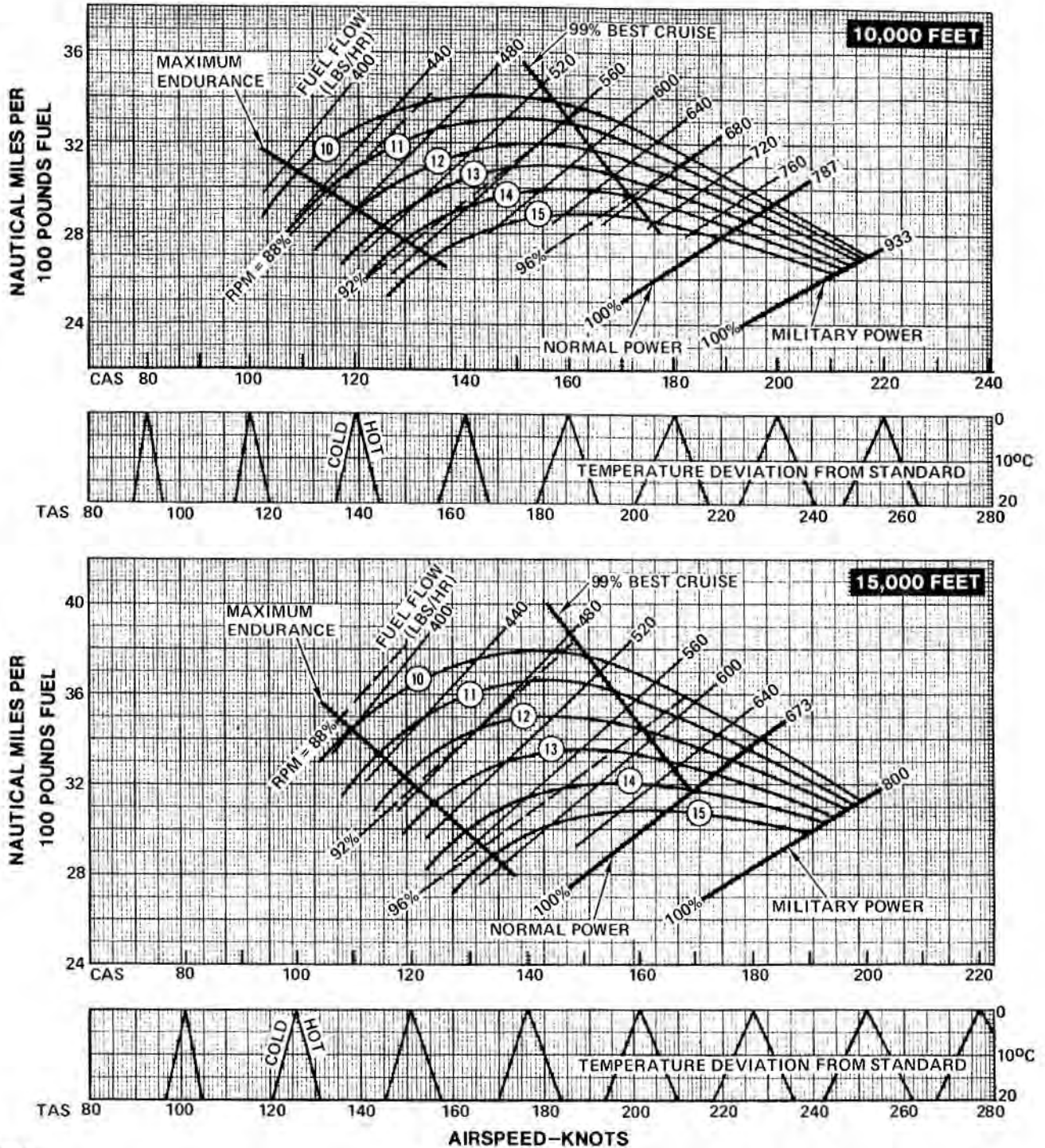

NOTE:

- CURVE VALUES FOR A NO WIND ($V_w = 0$) CONDITION
TO COMPUTE FOR WIND EFFECTS:

$$NMI/100\text{ LB} = NMI/100\text{ LB (NO WIND)} \times \frac{\text{GROUND SPEED}}{\text{TRUE AIRSPEED}}$$
- REDUCE NMI/100 LB 3% FOR EACH 10°C ABOVE STANDARD TEMP

GROSS WEIGHT	
⑩ 10,000 POUNDS	⑬ 13,000 POUNDS
⑪ 11,000 POUNDS	⑭ 14,000 POUNDS
⑫ 12,000 POUNDS	⑮ 15,000 POUNDS

OV-10D-1-82

Figure 11-36

NAUTICAL MILES PER 100 POUNDS FUEL

DRAG 100

BASED ON: FLIGHT TEST DATA
DATA AS OF: 15 NOVEMBER 1977

ENGINES (2) T-76

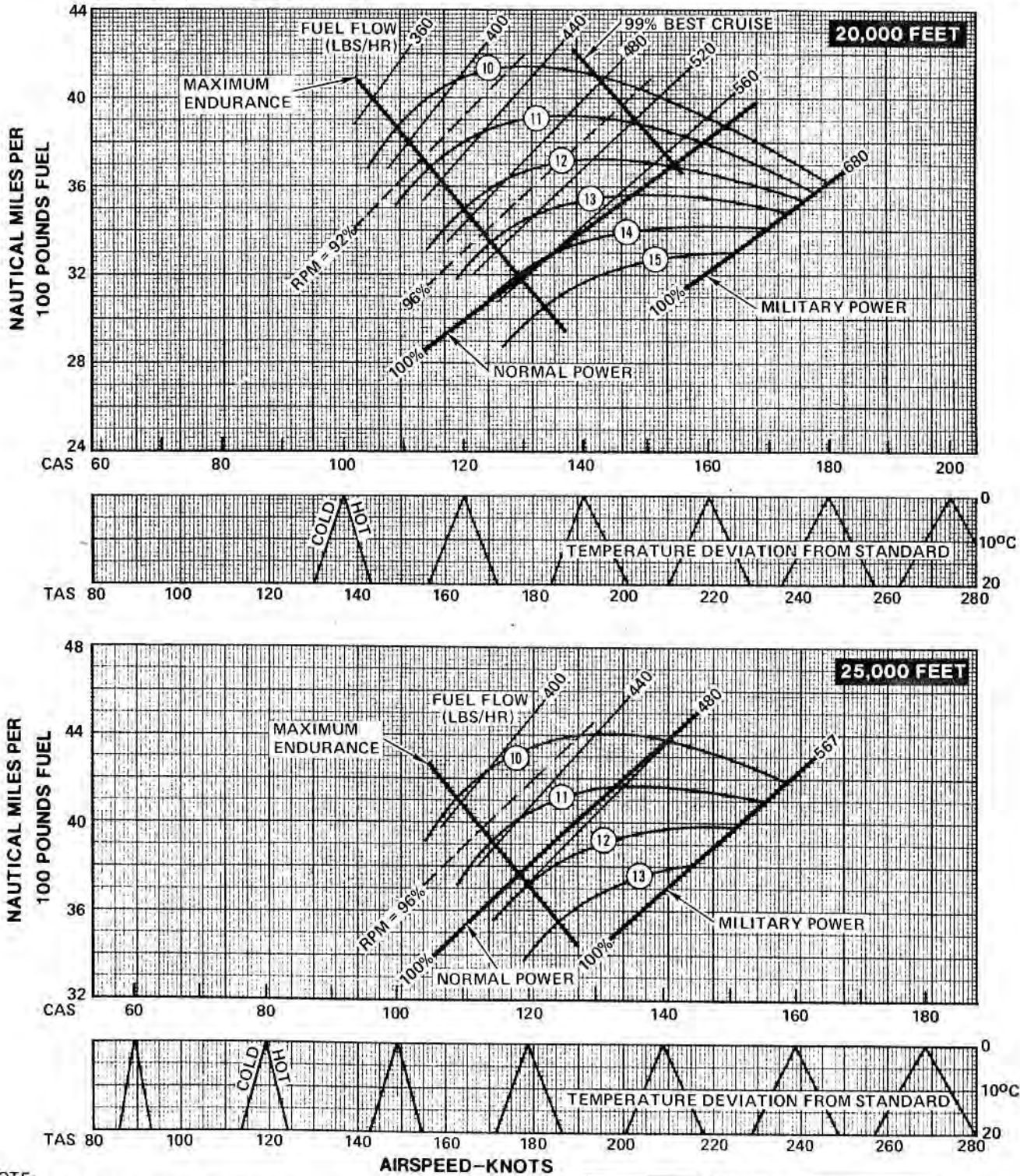

NOTE:

- CURVE VALUES FOR A NO WIND ($V_w = 0$) CONDITION
TO COMPUTE FOR WIND EFFECTS:

$$\text{NMI/100 LB} = \text{NMI/100 LB (NO WIND)} \times \frac{\text{GROUND SPEED}}{\text{TRUE AIRSPEED}}$$
- REDUCE NMI/100 LB 3% FOR EACH 10°C ABOVE STANDARD TEMP

GROSS WEIGHT	
⑩ 10,000 POUNDS	⑬ 13,000 POUNDS
⑪ 11,000 POUNDS	⑭ 14,000 POUNDS
⑫ 12,000 POUNDS	⑮ 15,000 POUNDS

OV-10D-1-93

Figure 11-37

NAUTICAL MILES PER 100 POUNDS FUEL

DRAG 150

ENGINES (2) T-76

BASED ON: FLIGHT TEST DATA
DATA AS OF: 15 NOVEMBER 1977

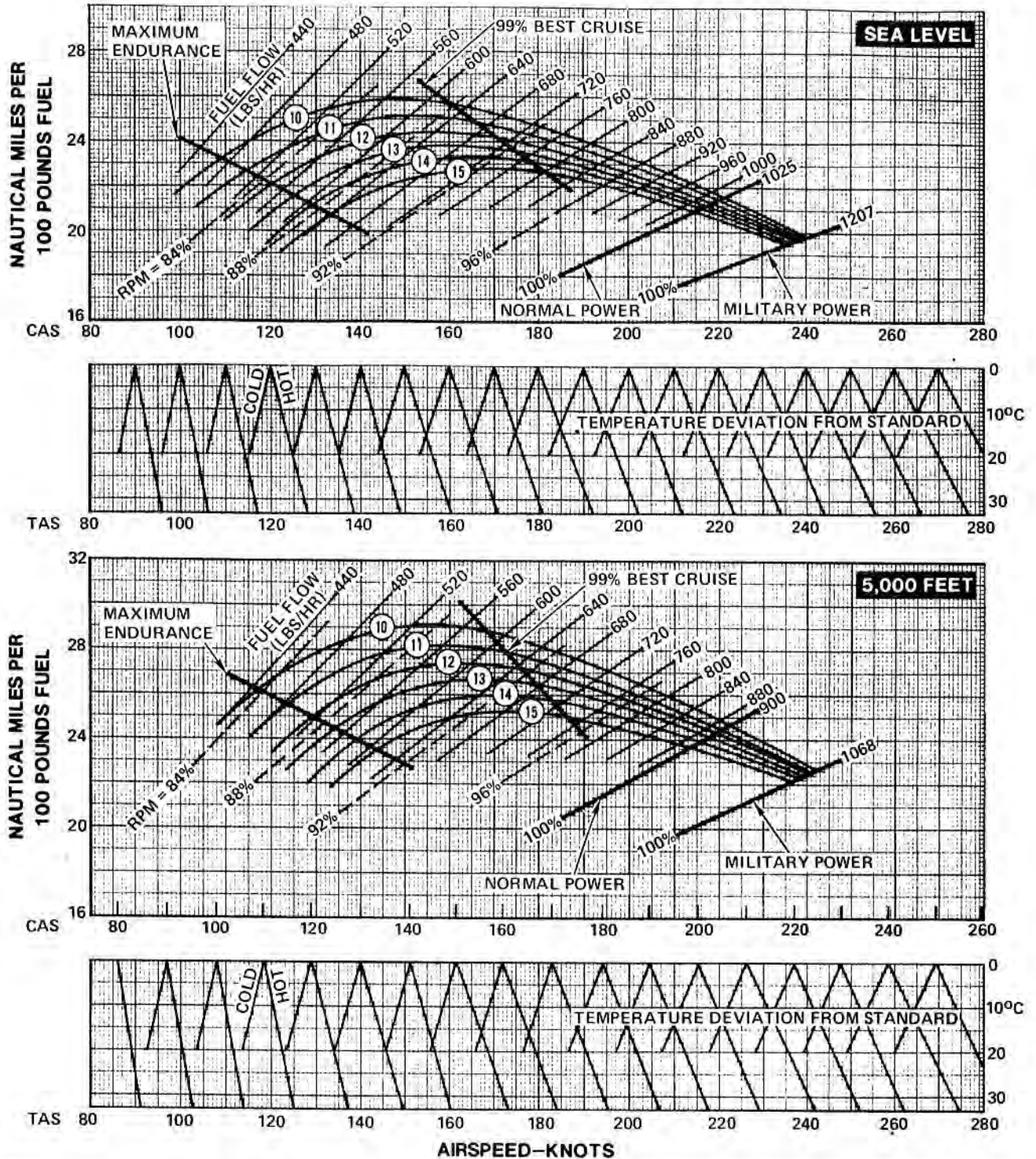

NOTE:

- CURVE VALUES FOR A NO WIND ($V_w = 0$) CONDITION
TO COMPUTE FOR WIND EFFECTS:
NMI/100 LB = NMI/100 LB (NO WIND) TIMES $\frac{\text{GROUND SPEED}}{\text{TRUE AIRSPEED}}$
- REDUCE NMI/100 LB 3% FOR EACH 10°C ABOVE STANDARD TEMP

GROSS WEIGHT	
⑩ 10,000 POUNDS	⑬ 13,000 POUNDS
⑪ 11,000 POUNDS	⑭ 14,000 POUNDS
⑫ 12,000 POUNDS	⑮ 15,000 POUNDS

OV-10D-1-94

Figure 11-38

NAUTICAL MILES PER 100 POUNDS FUEL

DRAG 150

BASED ON: FLIGHT TEST DATA
DATA AS OF: 15 NOVEMBER 1977

ENGINES (2) T-76

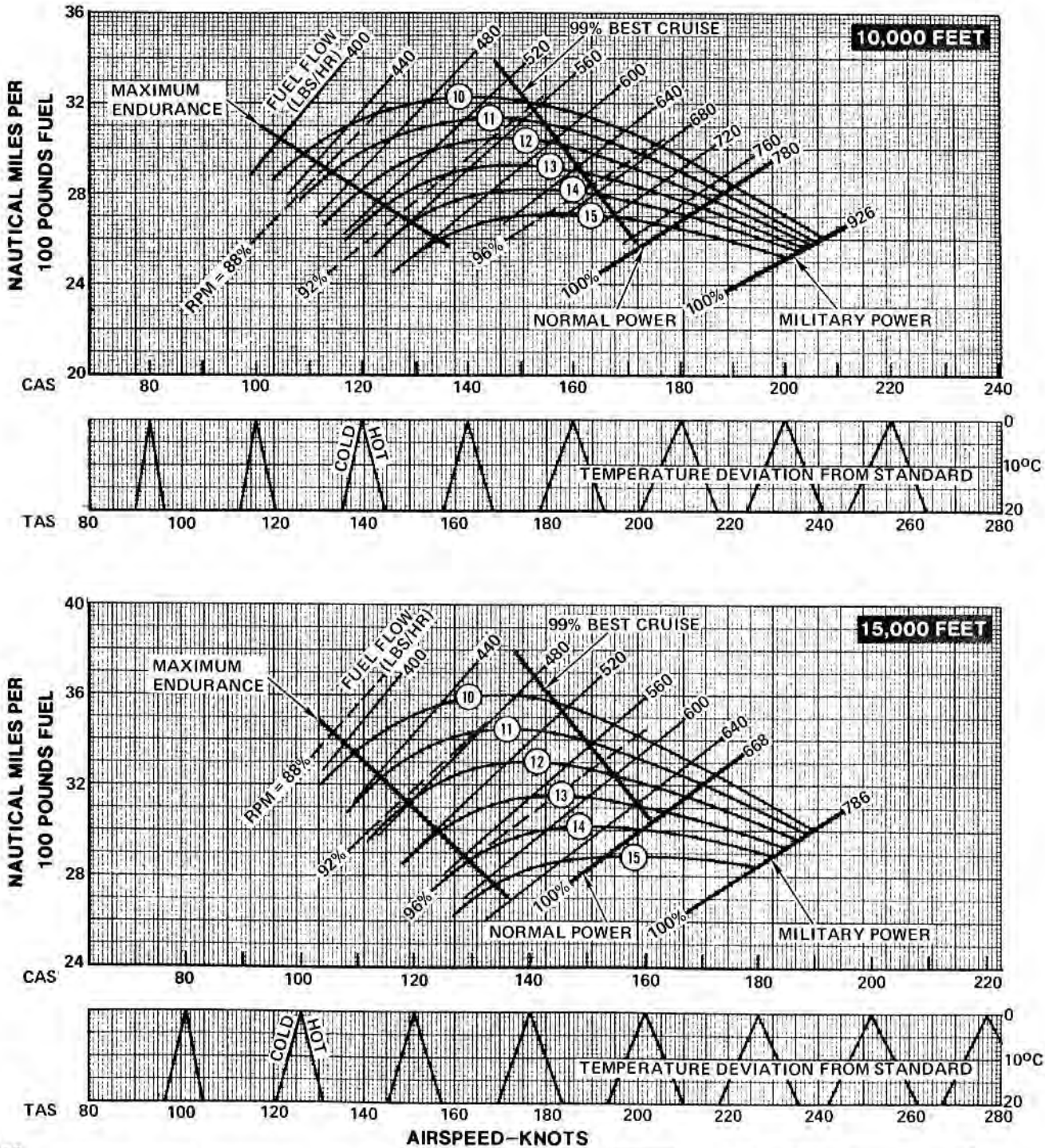

- NOTE:
- CURVE VALUES FOR A NO WIND ($V_w = 0$) CONDITION
TO COMPUTE FOR WIND EFFECTS:

$$\text{NMI}/100 \text{ LB} = \text{NMI}/100 \text{ LB (NO WIND)} \times \frac{\text{GROUND SPEED}}{\text{TRUE AIRSPEED}}$$
 - REDUCE NMI/100 LB 3% FOR EACH 10°C ABOVE STANDARD TEMP

GROSS WEIGHT	
⑩ 10,000 POUNDS	⑬ 13,000 POUNDS
⑪ 11,000 POUNDS	⑭ 14,000 POUNDS
⑫ 12,000 POUNDS	⑮ 15,000 POUNDS

OV-10D-1-95

Figure 11-39

NAUTICAL MILES PER 100 POUNDS FUEL

DRAG 150

BASED ON: FLIGHT TEST DATA
DATA AS OF: 15 NOVEMBER 1977

ENGINES (2) T-76

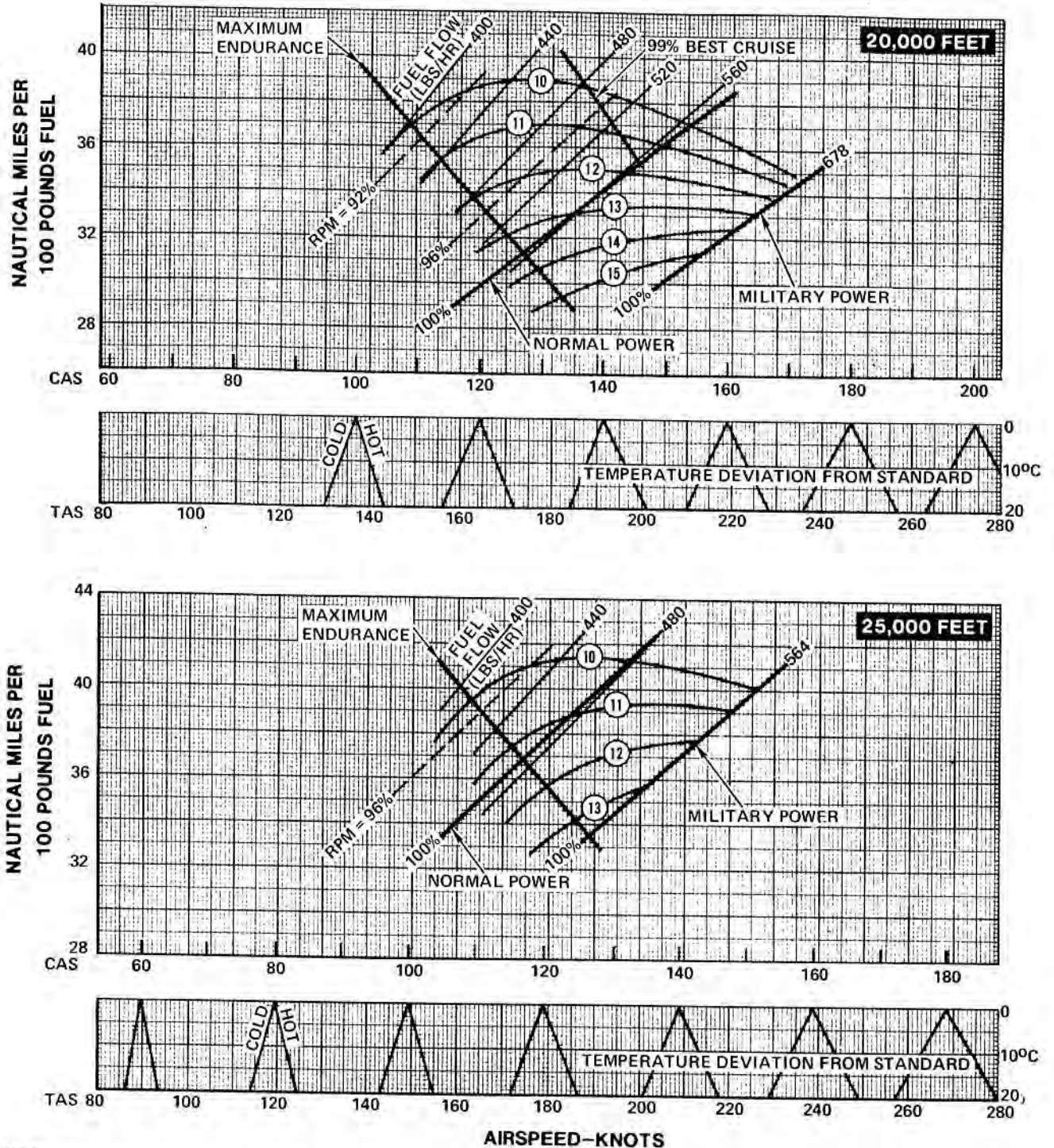

NOTE:

- CURVE VALUES FOR A NO WIND ($V_w = 0$) CONDITION TO COMPUTE FOR WIND EFFECTS:

$$\text{NMI}/100 \text{ LB} = \text{NMI}/100 \text{ LB (NO WIND)} \times \frac{\text{GROUND SPEED}}{\text{TRUE AIRSPEED}}$$
- REDUCE NMI/100 LB 3% FOR EACH 10°C ABOVE STANDARD TEMP

GROSS WEIGHT	
⑩ 10,000 POUNDS	⑬ 13,000 POUNDS
⑪ 11,000 POUNDS	⑭ 14,000 POUNDS
⑫ 12,000 POUNDS	⑮ 15,000 POUNDS

OV-10D-1-96

Figure 11-40

NAUTICAL MILES PER 100 POUNDS FUEL— SINGLE ENGINE

DRAG 50

BASED ON: FLIGHT TEST DATA
DATA AS OF: 15 NOVEMBER 1977

ENGINES (1) T-76

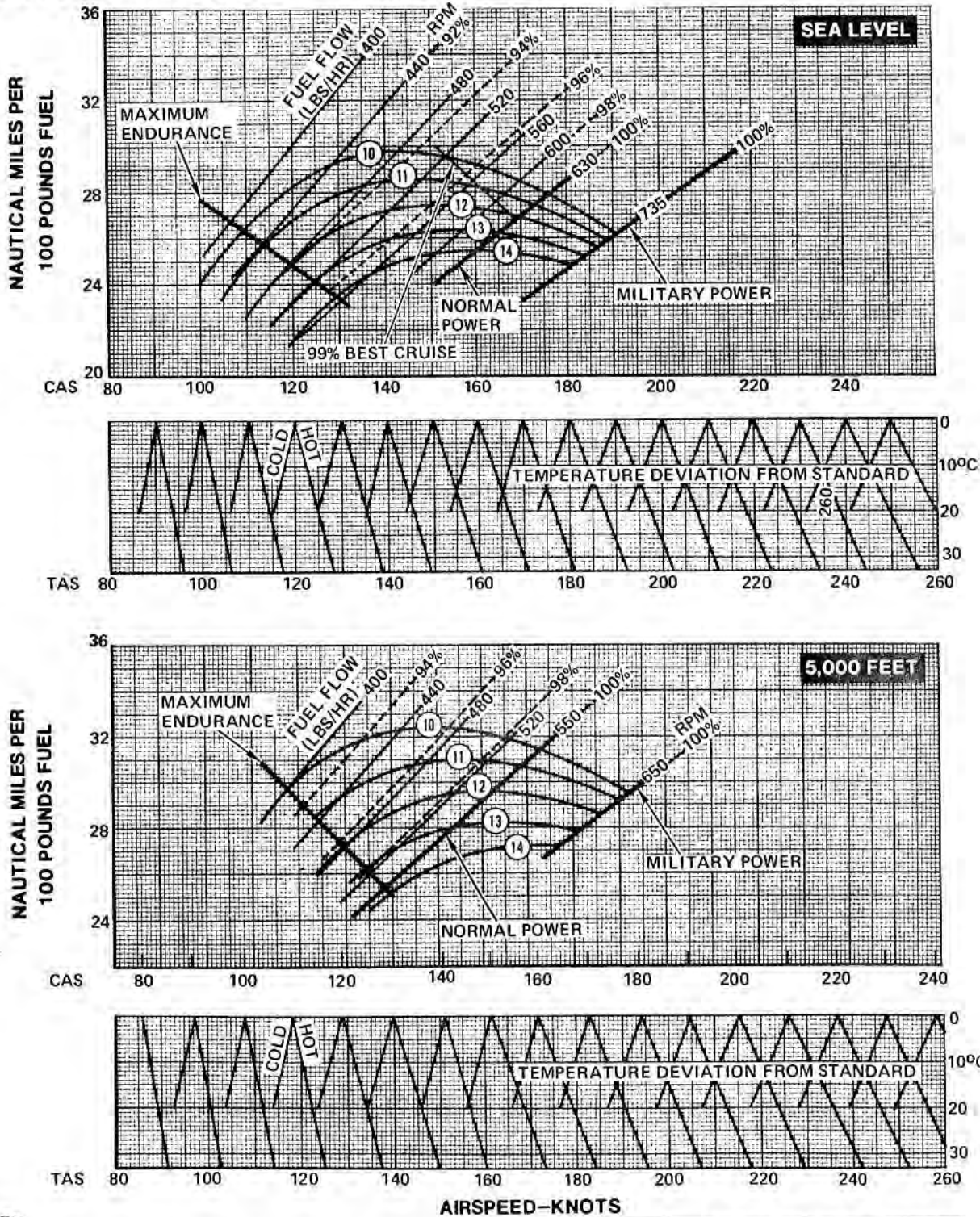

NOTE:
 • CURVE VALUES FOR A NO WIND ($V_w = 0$) CONDITION
 TO COMPUTE FOR WIND EFFECTS:
 $NMI/100 LB = NMI/100 LB (NO WIND) \times \frac{GROUND SPEED}{TRUE AIRSPEED}$
 • REDUCE NMI/100 LB 3% FOR EACH 10°C ABOVE STANDARD TEMP

GROSS WEIGHT	
⑩ 10,000 POUNDS	⑬ 13,000 POUNDS
⑪ 11,000 POUNDS	⑭ 14,000 POUNDS
⑫ 12,000 POUNDS	

OV-10D-1-97A

Figure 11-41

NAUTICAL MILES PER 100 POUNDS FUEL— SINGLE ENGINE

DRAG 50

ENGINES (1) T-76

BASED ON: FLIGHT TEST DATA
DATA AS OF: 15 NOVEMBER 1977

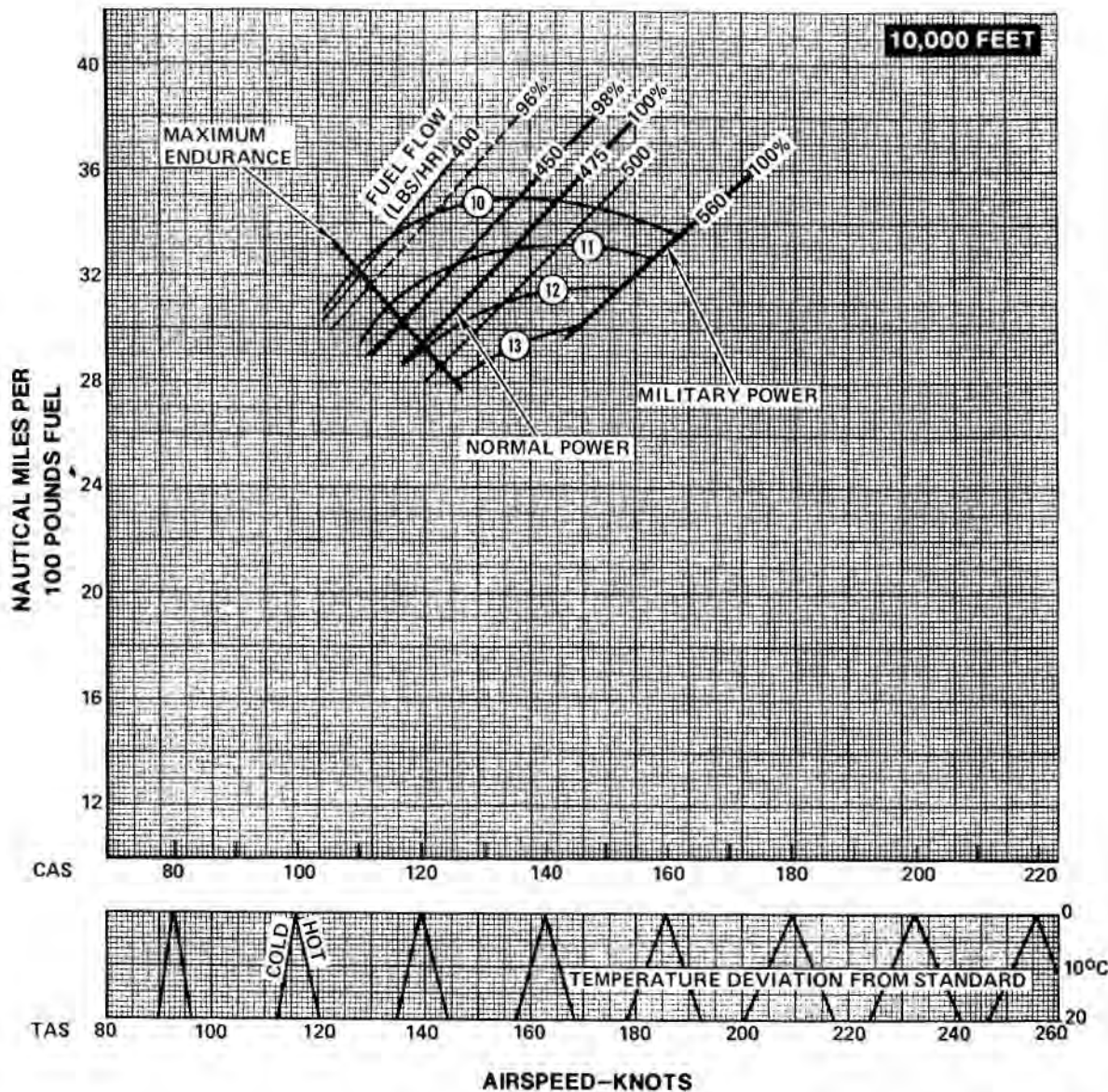

NOTE:

- CURVE VALUES FOR A NO WIND ($V_w = 0$) CONDITION
TO COMPUTE FOR WIND EFFECTS:
 $NMI/100\text{ LB} = NMI/100\text{ LB (NO WIND)} \times \frac{\text{GROUND SPEED}}{\text{TRUE AIRSPEED}}$
- REDUCE NMI/100 LB 3% FOR EACH 10°C ABOVE STANDARD TEMP

GROSS WEIGHT	
⑩	10,000 POUNDS
⑪	11,000 POUNDS
⑫	12,000 POUNDS
⑬	13,000 POUNDS

OV-10D-1-98A

Figure 11-42

NAUTICAL MILES PER 100 POUNDS FUEL— SINGLE ENGINE

DRAG 100

ENGINES (1) T-76

BASED ON: FLIGHT TEST DATA
DATA AS OF: 15 NOVEMBER 1977

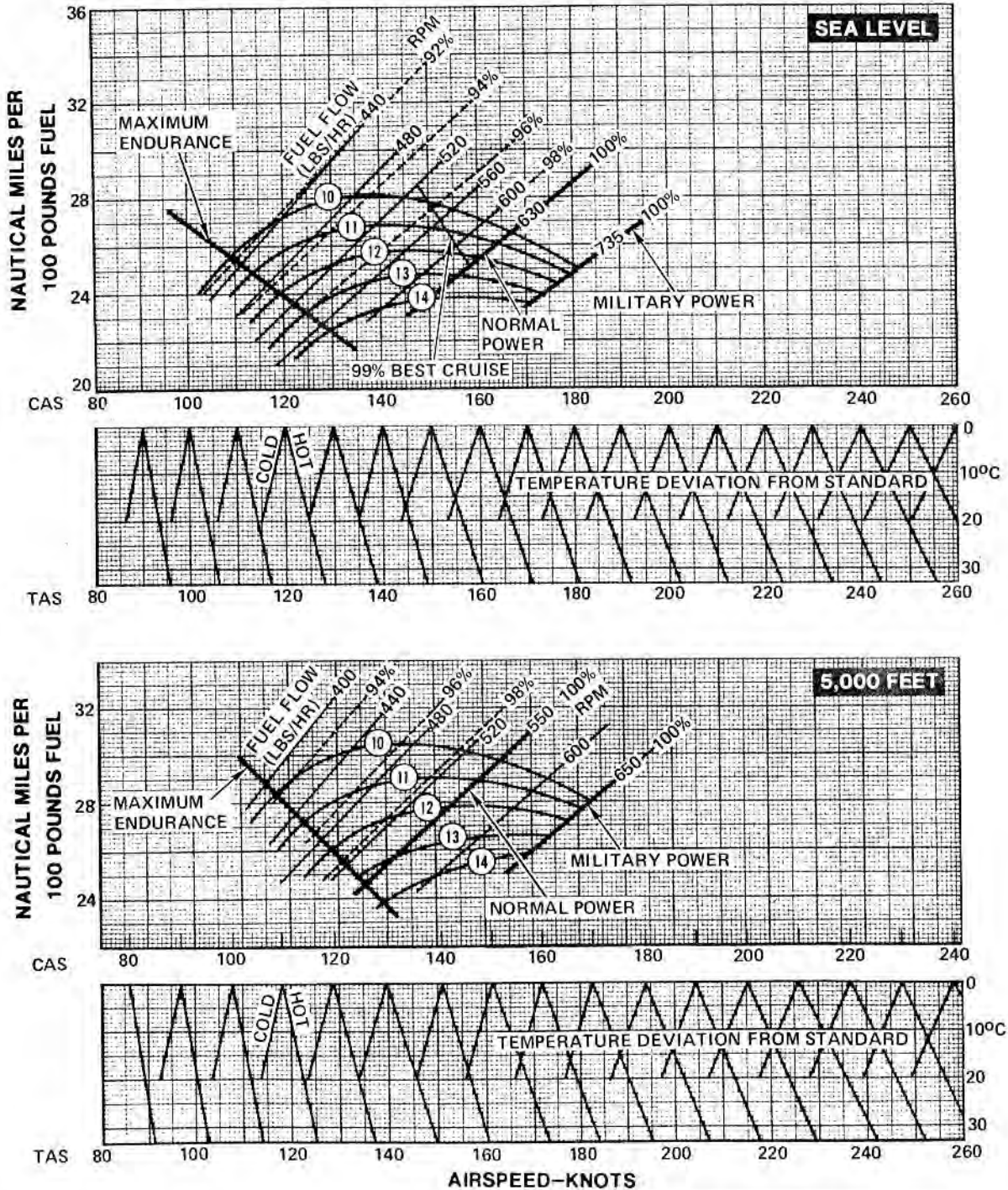

- NOTE:
- CURVE VALUES FOR A NO WIND ($V_w = 0$) CONDITION
TO COMPUTE FOR WIND EFFECTS:
NMI/100 LB = NMI/100 LB (NO WIND) TIMES $\frac{\text{GROUND SPEED}}{\text{TRUE AIRSPEED}}$
 - REDUCE NMI/100 LB 3% FOR EACH 10°C ABOVE STANDARD TEMP

GROSS WEIGHT	
⑩ 10,000 POUNDS	⑬ 13,000 POUNDS
⑪ 11,000 POUNDS	⑭ 14,000 POUNDS
⑫ 12,000 POUNDS	

OV-10D-1-99A

Figure 11-43

NAUTICAL MILES PER 100 POUNDS FUEL— SINGLE ENGINE

DRAG 100

ENGINES (1) T-76

BASED ON: FLIGHT TEST DATA
DATA AS OF: 15 NOVEMBER 1977

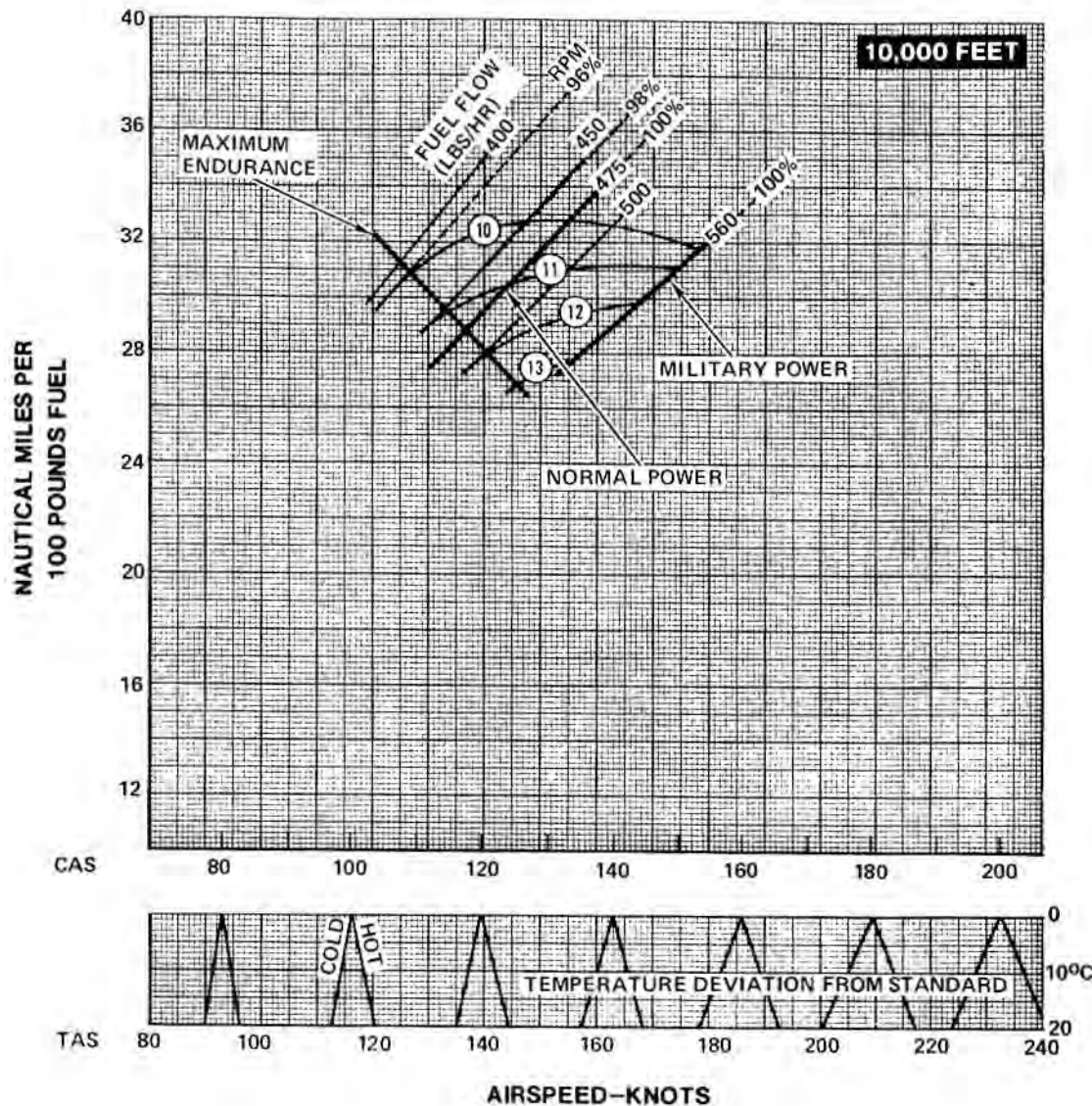

NOTE:

- CURVE VALUES FOR A NO WIND ($V_w = 0$) CONDITION
TO COMPUTE FOR WIND EFFECTS:
 $NMI/100\text{ LB} = NMI/100\text{ LB (NO WIND)} \times \frac{\text{GROUND SPEED}}{\text{TRUE AIRSPEED}}$
- REDUCE NMI/100 LB 3% FOR EACH 10°C ABOVE STANDARD TEMP

GROSS WEIGHT	
⑩	10,000 POUNDS
⑪	11,000 POUNDS
⑫	12,000 POUNDS
⑬	13,000 POUNDS

Figure 11-44

DV-10D-1-100A

NAUTICAL MILES PER 100 POUNDS FUEL— SINGLE ENGINE

DRAG 150

ENGINES (1) T-76

BASED ON: FLIGHT TEST DATA
DATA AS OF: 15 NOVEMBER 1977

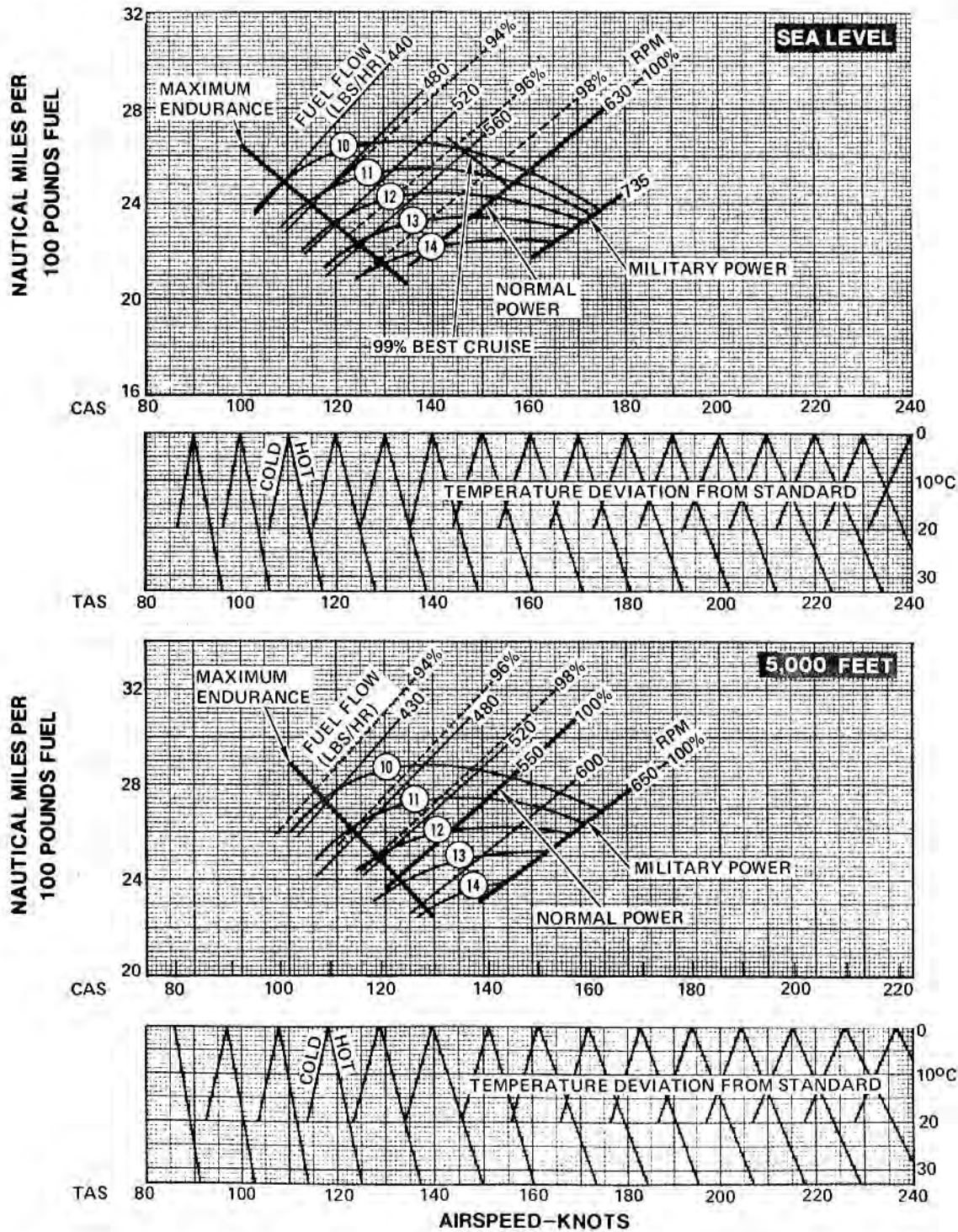

NOTE:
 ● CURVE VALUES FOR A NO WIND ($V_w = 0$) CONDITION
 TO COMPUTE FOR WIND EFFECTS:

$$NMI/100\text{ LB} = NMI/100\text{ LB (NO WIND)} \times \frac{\text{GROUND SPEED}}{\text{TRUE AIRSPEED}}$$
 ● REDUCE NMI/100 LB 3% FOR EACH 10°C ABOVE STANDARD TEMP

GROSS WEIGHT	
⑩ 10,000 POUNDS	⑫ 12,000 POUNDS
⑪ 11,000 POUNDS	⑬ 13,000 POUNDS

OV-10D-1-101A

Figure 11-45

NAUTICAL MILES PER 100 POUNDS FUEL— SINGLE ENGINE

DRAG 150

ENGINES (1) T-76

BASED ON: FLIGHT TEST DATA
DATA AS OF: 15 NOVEMBER 1977

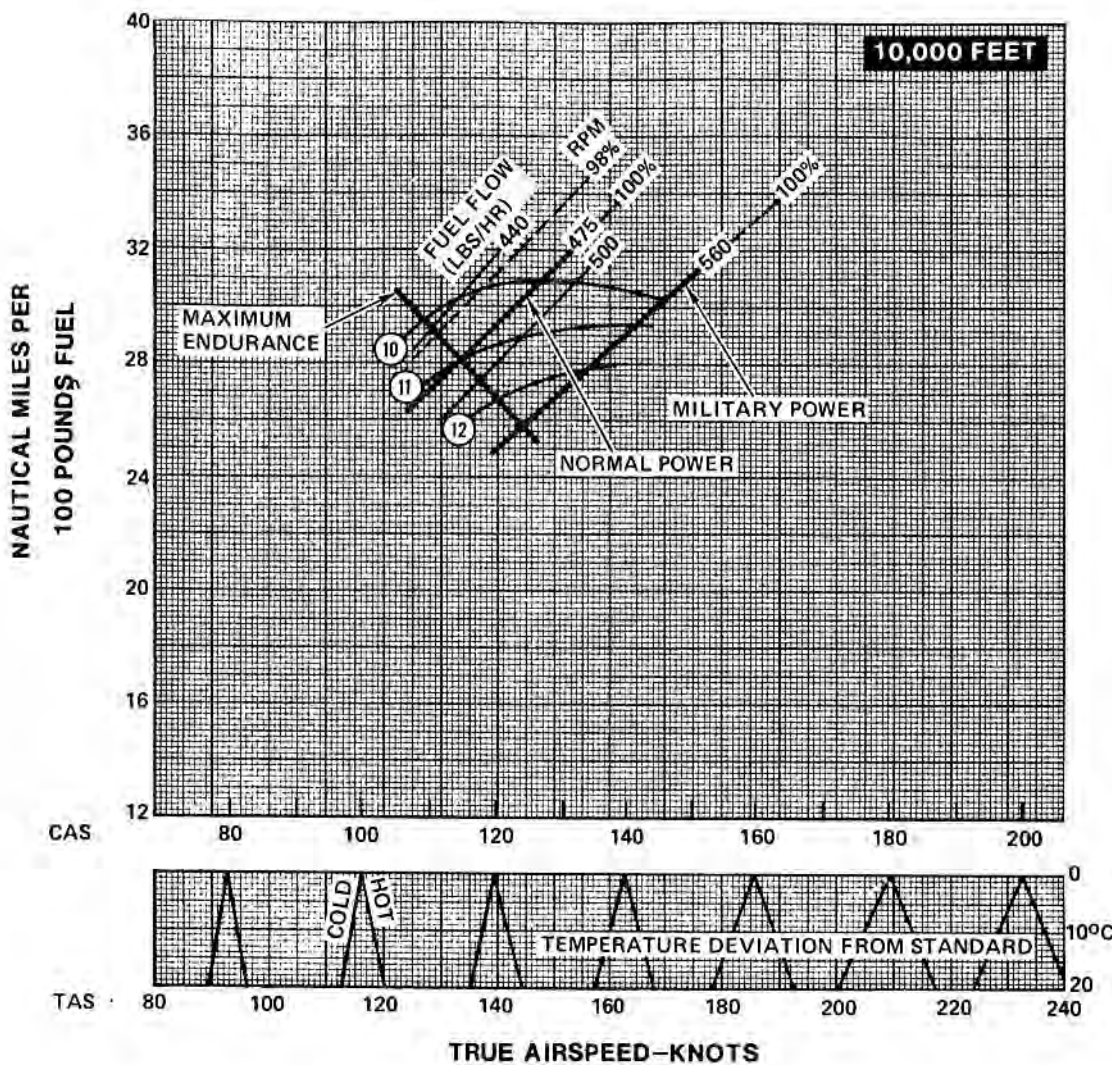

NOTE:

- CURVE VALUES FOR A NO WIND ($V_w = 0$) CONDITION
TO COMPUTE FOR WIND EFFECTS:
NMI/100 LB = NMI/100 LB (NO WIND) TIMES $\frac{\text{GROUND SPEED}}{\text{TRUE AIRSPEED}}$
- REDUCE NMI/100 LB 3% FOR EACH 10°C ABOVE STANDARD TEMP

GROSS WEIGHT	
⑩	10,000 POUNDS
⑪	11,000 POUNDS
⑫	12,000 POUNDS

OV-10D-1-137

Figure 11-46

PART 5 — ENDURANCE DATA

ENDURANCE DATA

CONSTANT-ALTITUDE MAXIMUM ENDURANCE

(FIGURES 11-47
AND 11-48)

The Constant-Altitude Maximum Endurance charts (figures 11-47 and 11-48) provide fuel required for various drag indexes, gross weights, altitudes, and times.

CONSTANT-ALTITUDE MAXIMUM ENDURANCE EXAMPLE PROBLEM

Find fuel required and best speed to loiter for 2 hours (normal two-engine operation, figure 11-47).

- Gross Weight—12,000 pounds
- Drag Index—100
- Pressure Altitude—10,000 feet
- Ambient Temperature—Standard

1. Best speed = 120 knots CAS
2. Fuel required = 960 pounds

CONSTANT ALTITUDE MAXIMUM ENDURANCE

MAX ENDURANCE

BASED ON: FLIGHT TEST DATA
DATA AS OF: 15 NOVEMBER 1977

EXAMPLE:

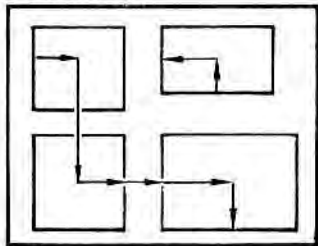

STANDARD TEMP	
ALTITUDE	°C
SL	15
5,000	5
10,000	-5
15,000	-15
20,000	-25

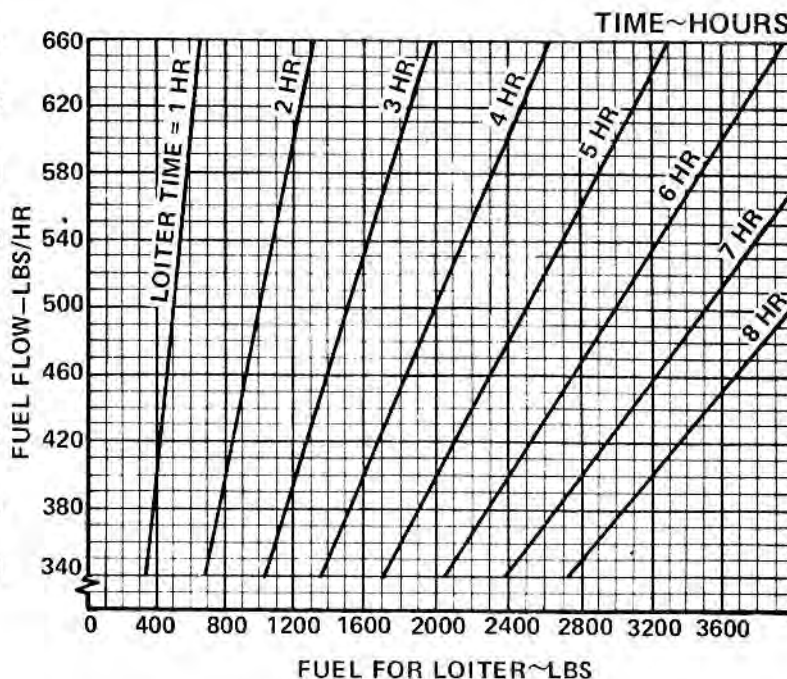
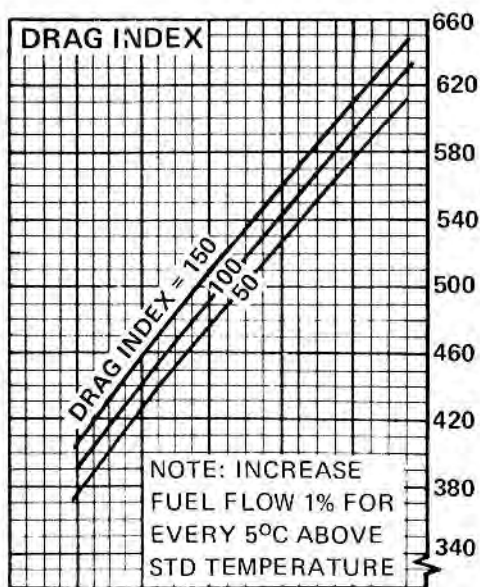
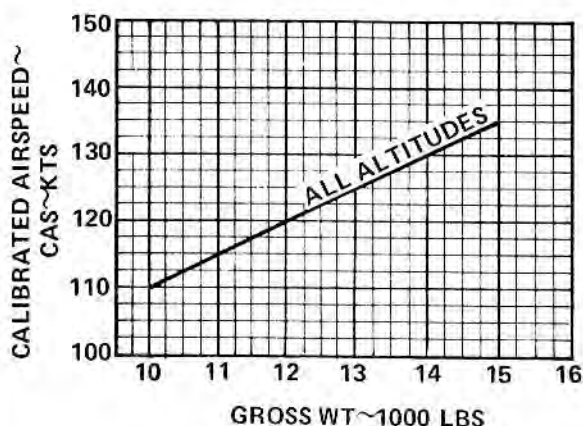
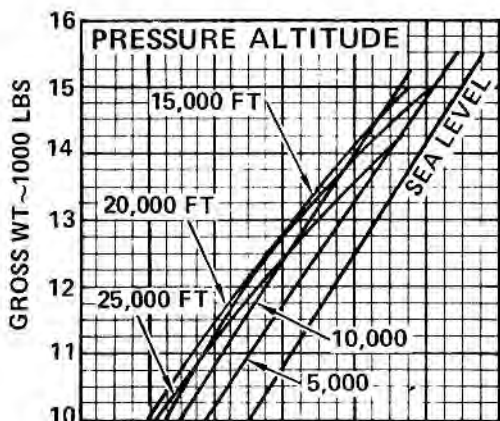

OV-10D-1-160A

Figure 11-47

CONSTANT ALTITUDE MAXIMUM ENDURANCE

SINGLE-ENGINE

MAX ENDURANCE

BASED ON: FLIGHT TEST DATA
DATA AS OF: 15 NOVEMBER 1977

EXAMPLE:

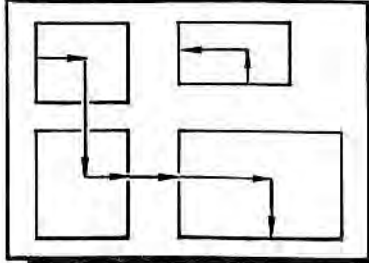

STANDARD TEMP	
ALTITUDE	°C
SL	15
5,000	5
10,000	-5
15,000	-15
20,000	-25

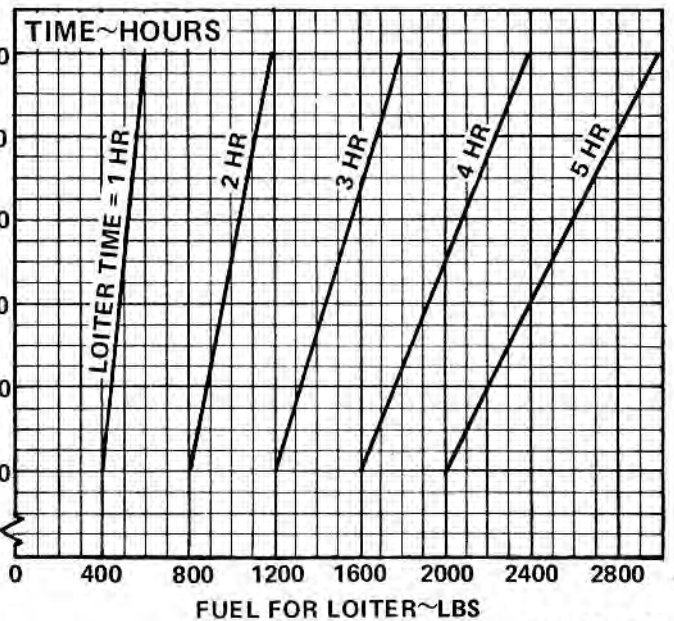
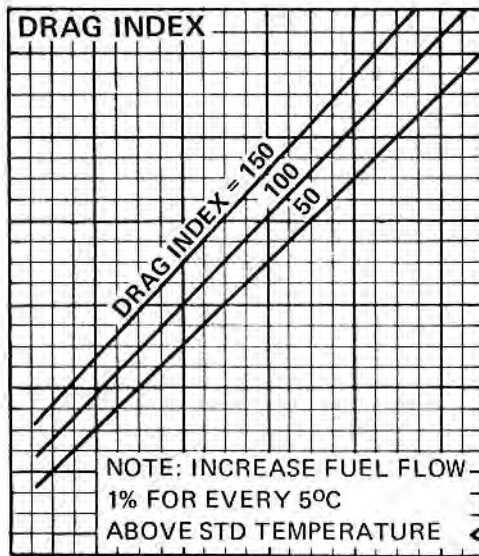
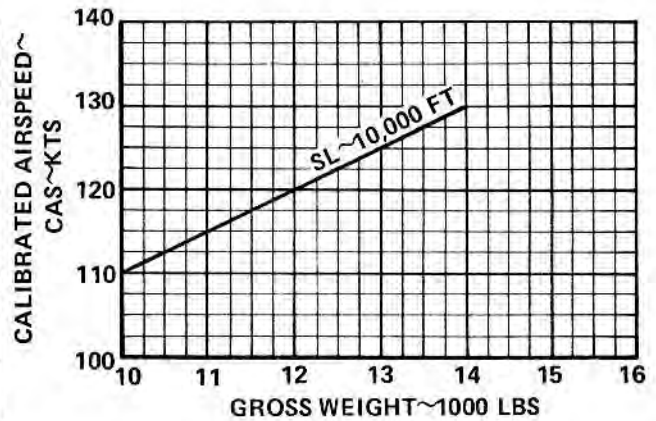
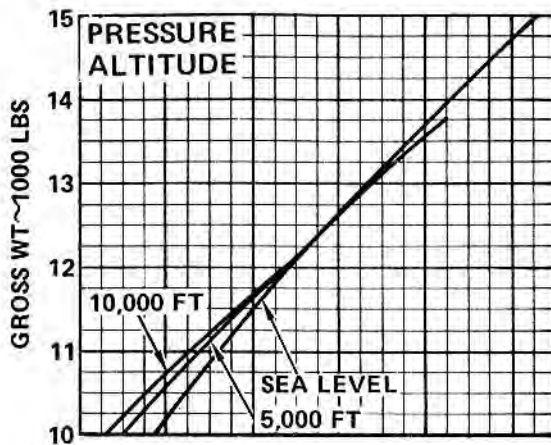

OV-10D-1-161

Figure 11-48

PART 6 — FLIGHT CHARACTERISTICS DATA**FLIGHT CHARACTERISTICS DATA****STALL SPEEDS**

(FIGURE 11-49)

The two-engine Stall Speeds chart (figure 11-49) determines minimum safe operating speeds with Military power on and power off both engines. Indicated airspeeds may be determined for any of three flap positions with gross weights up to 15,000 pounds.

STALL SPEEDS EXAMPLE PROBLEM

Find stall speed with the following conditions:

- Flaps—20 degrees
- Gross Weight—13,000 pounds
- Power Setting—Military power
- Landing Gear—down

1. Stall speed = 69 KIAS (POWER ON).
2. Stall speed = 94 KIAS (POWER OFF).

MINIMUM SINGLE-ENGINE CONTROL AND FLY-AWAY SPEEDS

(FIGURES 11-50 AND 11-51)

The minimum Single-Engine Control and Flyaway Speeds charts (figures 11-50 and 11-51) provide the pilot with the minimum single-engine control speed for various gross weights and maximum weight flyaway curves as a function of temperature and speed. If the aircraft gross weight is to the right of the appropriate temperature line, single-engine fly-away is not possible. Gross weight must be reduced to a value that falls left of the applicable temperature line. When operating on single engine, the airplane should be flown with the dead engine held high and zero sideslip. This will require approximately 2° of bank.

MINIMUM SINGLE-ENGINE SPEED EXAMPLE PROBLEM

Find minimum single-engine control speed and minimum safe (maintaining level flight) speed, gears down and up, if engine fails with following conditions:

- Flap Position—20 degrees

- Gross Weight—13,000 pounds

- Temperature—30°C

1. Enter weight scale at 13,000 pounds on 20-degree flaps (gear down) chart.
2. Move vertically to minimum single-engine control speed line and note speed of 94 KIAS (gear down).
3. Note that the gross weight is right of the temperature line. Under these conditions, wings-level climb is not possible at any airspeed.
4. Enter weight scale at 13,000 pounds on 20-degree flaps (gear up) chart.
5. Move vertically to minimum single-engine control speed line and note that speed is 79 KIAS (gear up).
6. Move vertically to applicable temperature line and note minimum flyaway speed of 104 KIAS. Level flight at 100 fpm rate of climb is possible if airspeed is not reduced below this level.

ALTITUDE LOST IN DIVE RECOVERY

(FIGURE 11-52)

Altitude lost in recovering to level flight at various dive angles, airspeeds, and load factors may be determined by using the Altitude Lost in Dive Recovery chart (figure 11-52).

ALTITUDE LOST IN DIVE RECOVERY EXAMPLE PROBLEM

Find altitude lost in dive recovery for the following conditions:

- Altitude at Start of Pullout—10,000 feet
- Airspeed—250 KIAS
- Dive Angle—50 degrees
- Load Factor—4.0 "g's"

1. Altitude lost = 980 feet

ANGLE-OF-ATTACK RELATIONSHIP (FIGURE 11-53)

The relationship of aircraft angle of attack at the fuselage reference line (in degrees) and indicated angle of attack (in units) to gross weight, dive angle, and calibrated airspeed may be determined on the Angle-of-Attack Relationship chart (figure 11-53).

ANGLE-OF-ATTACK RELATIONSHIP EXAMPLE PROBLEM

Find indicated angle of attack and fuselage reference line angle of attack for the following conditions:

- Gross Weight—13,000 pounds

- Dive Angle—30 degrees
- Power Setting—Military power
- Airspeed—240 knots CAS

1. Fuselage reference line = -1.8 degrees
2. Angle of attack = 9.2 units

STALL SPEED vs. GROSS WEIGHT

BASED ON: FLIGHT TEST DATA
DATA AS OF: 15 NOVEMBER 1977

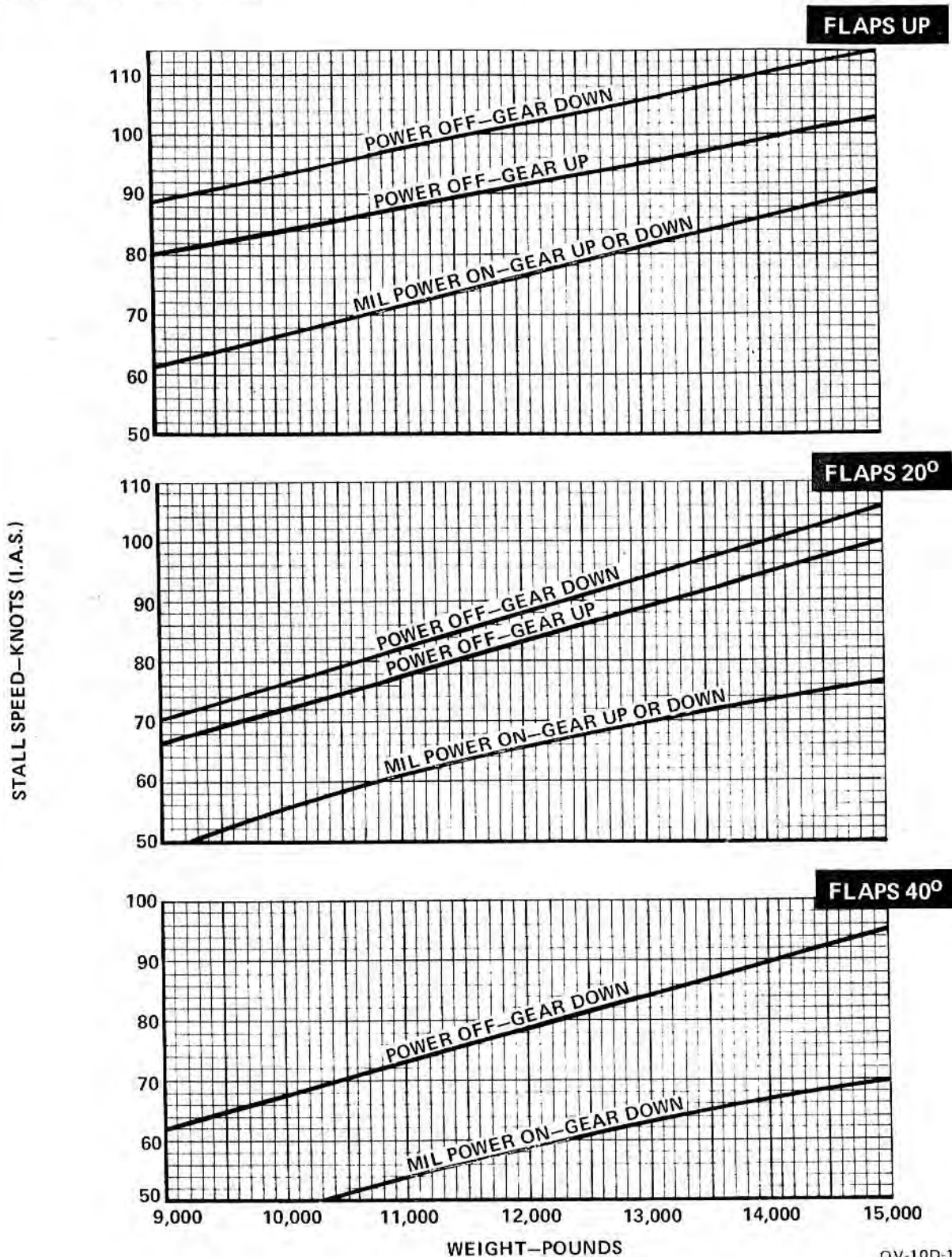

OV-10D-1-37A

Figure 11-49

MINIMUM SINGLE ENGINE CONTROL AND FLYAWAY SPEEDS

FLAPS UP

BASED ON: FLIGHT TEST DATA
DATA AS OF: 15 NOVEMBER 1977

STANDARD DAY
SEA LEVEL
NO STORES OR TANKS

NOTE: LEVEL FLIGHT NOT POSSIBLE TO THE RIGHT OF APPLICABLE TEMPERATURE LINE

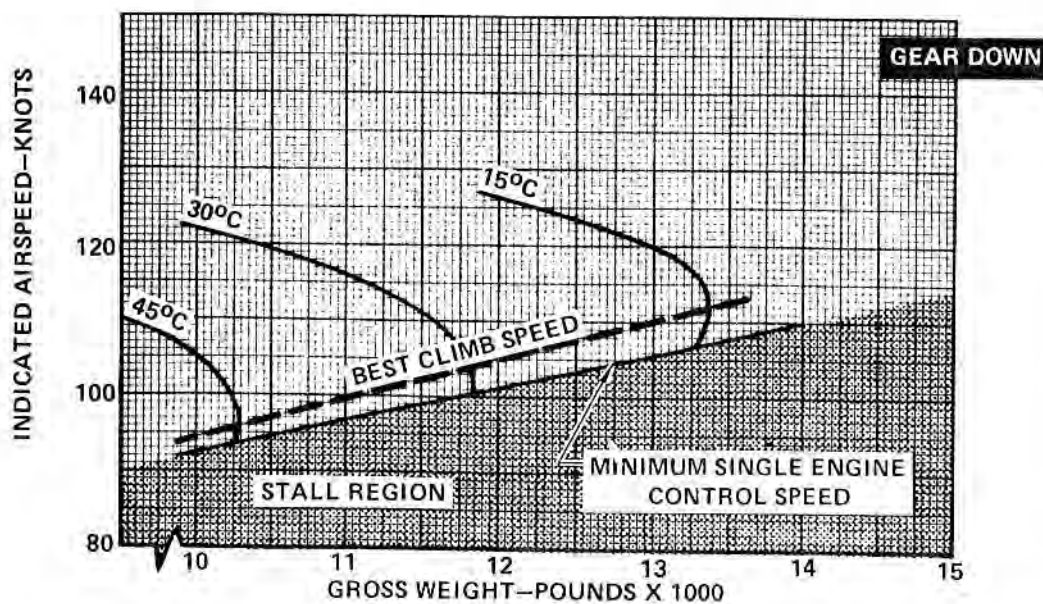
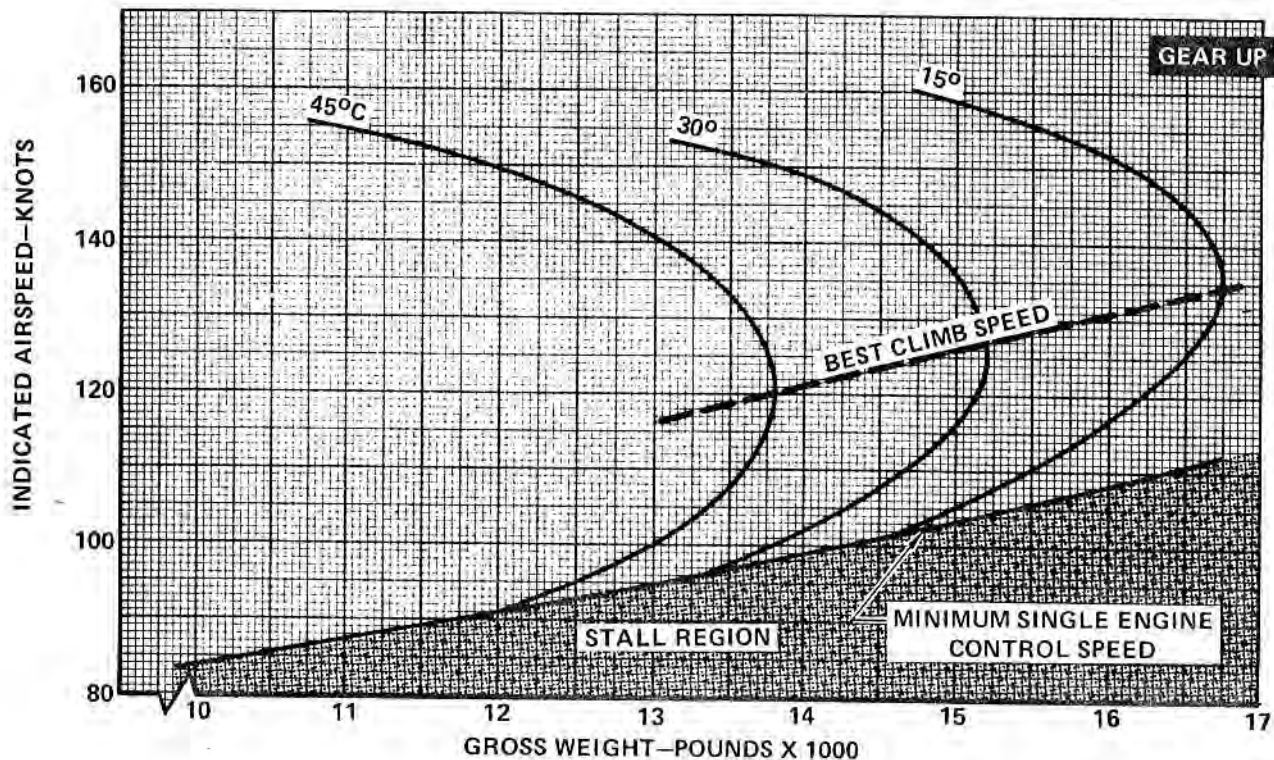

Figure 11-50

OV-10D-1-61A

MINIMUM SINGLE ENGINE CONTROL AND FLYAWAY SPEEDS

BASED ON: FLIGHT TEST DATA
DATA AS OF: 15 NOVEMBER 1977

STANDARD DAY
SEA LEVEL
NO STORES OR TANKS

FLAPS 20°

NOTE: DESCENT FLIGHT ONLY, TO THE RIGHT OF APPLICABLE TEMPERATURE LINE

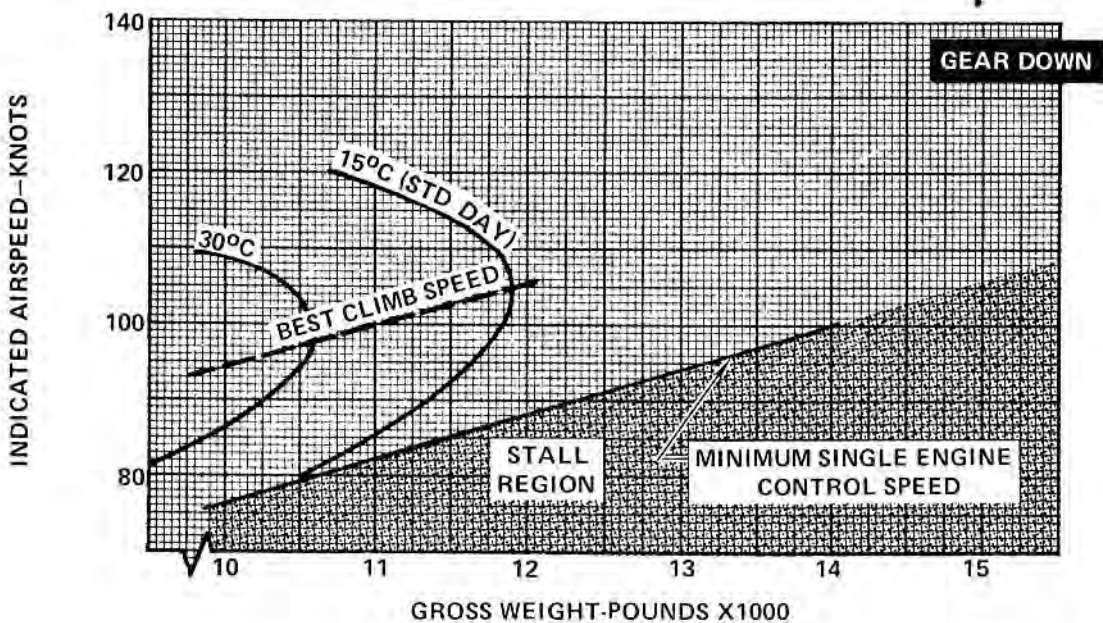
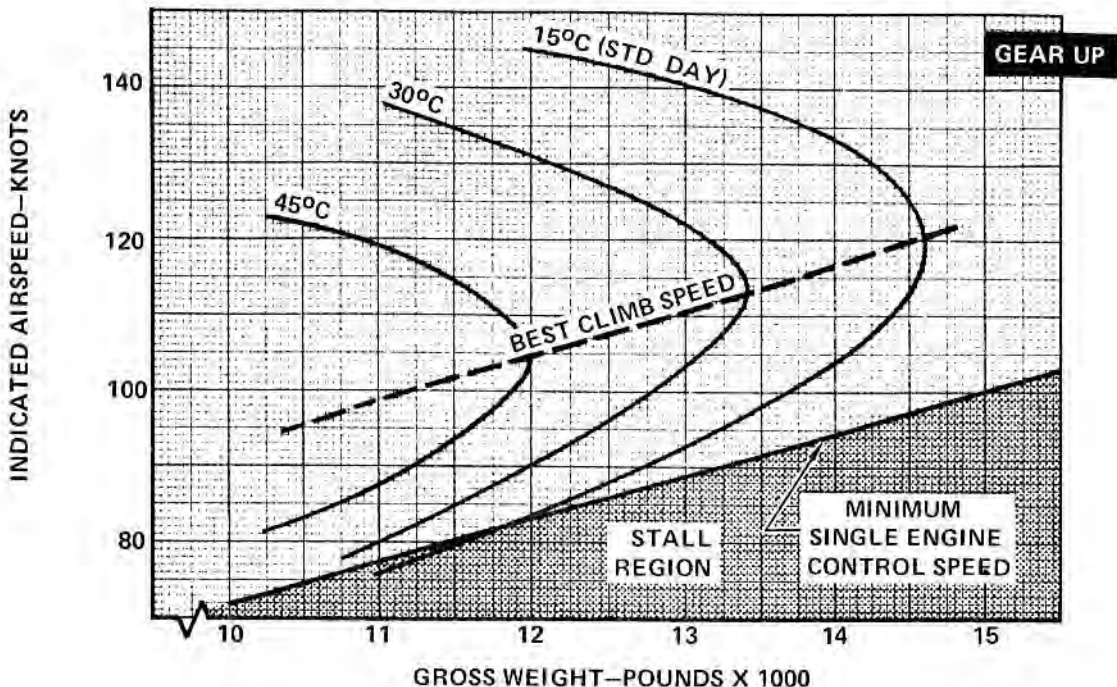

OV-10D-1-62B

Figure 11-51

ALTITUDE LOST IN DIVE RECOVERY

BASED ON ESTIMATED DATA (NA-66H-882)
DATA AS OF: 1 SEPTEMBER 1968

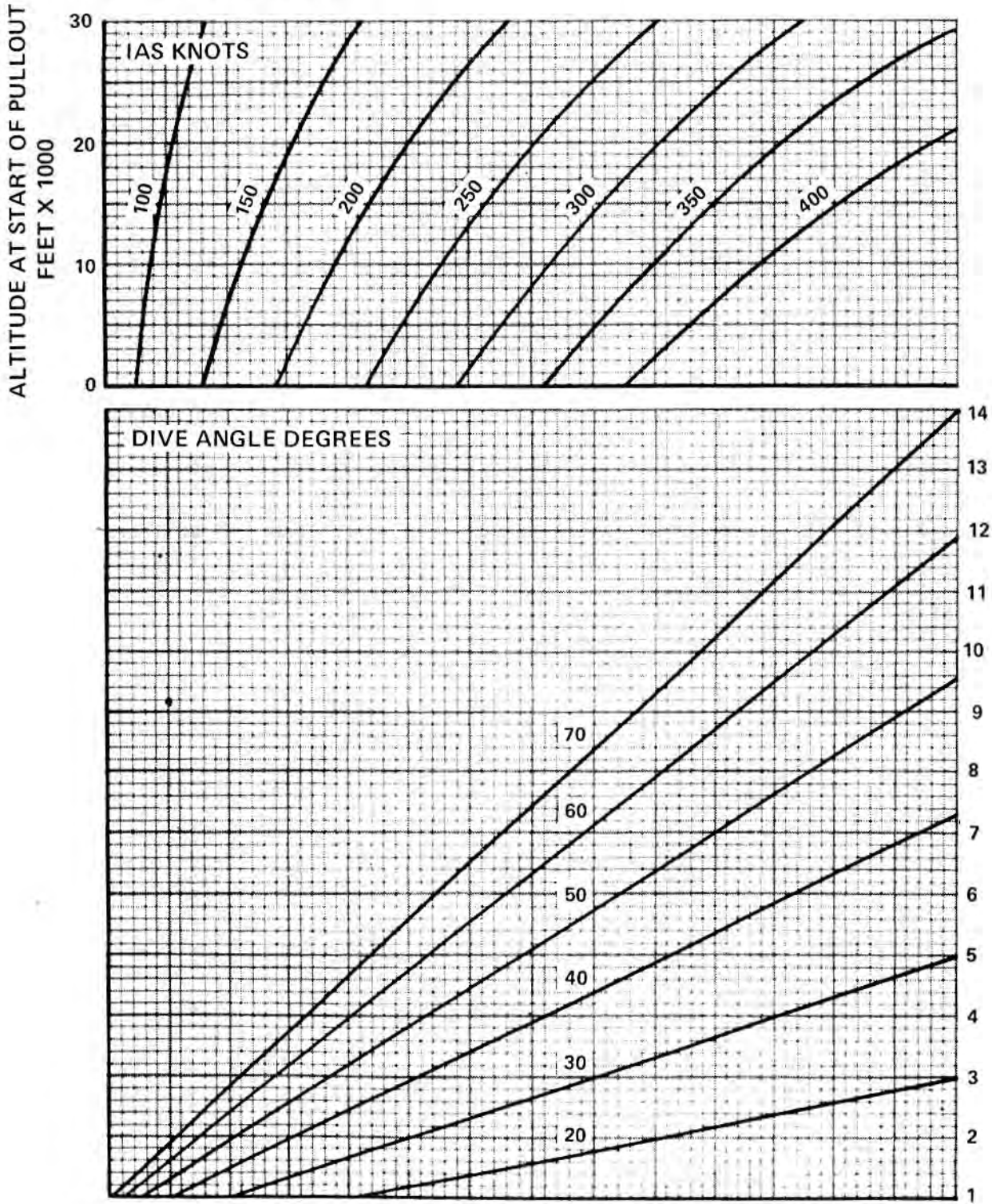

OV-10D-1-123

Figure 11-52 (Sheet 1)

**FLIGHT IDLE POWER
DIVE RECOVERY**

EXAMPLE

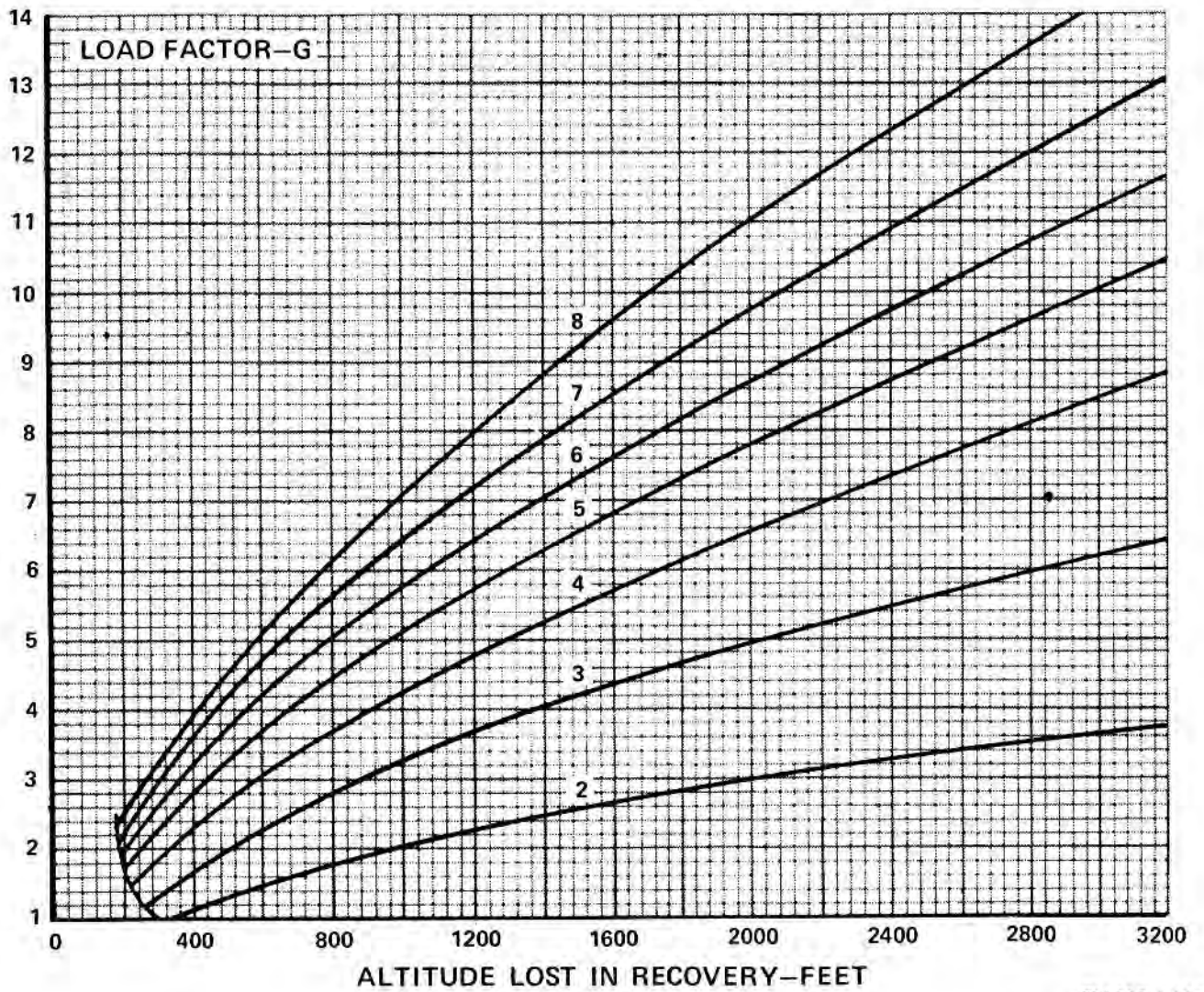
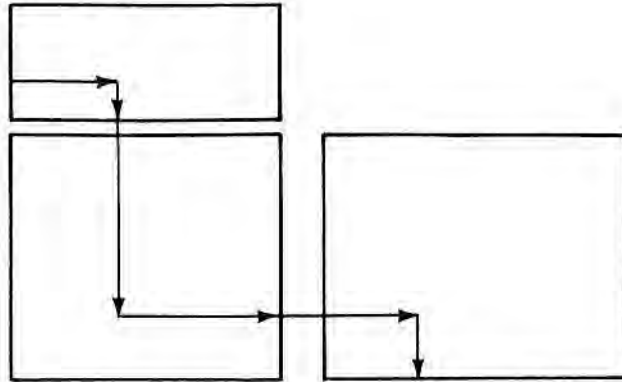

OV-10D-1-124

Figure 11-52 (Sheet 2)

ANGLE OF ATTACK RELATIONSHIP

BASED ON: ESTIMATED DATA (462-146-67)
DATA AS OF: 9 NOVEMBER 1967

A/A VS CAS

DIVE ANGLE—DEGREES

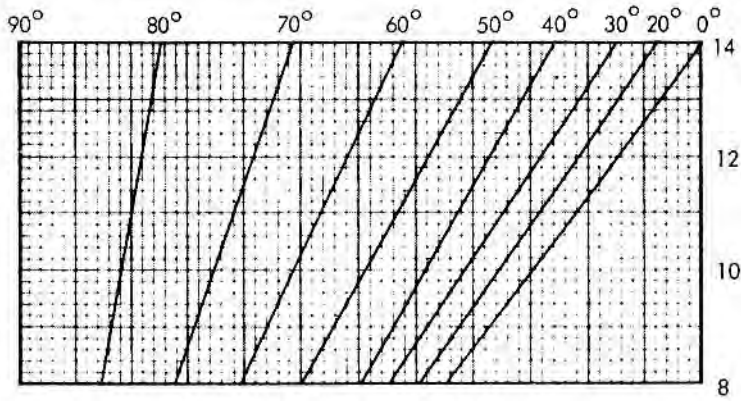

EXAMPLE

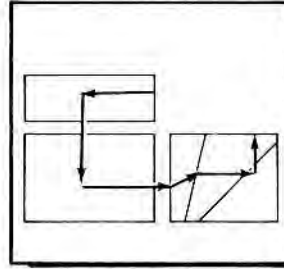

GROSS WEIGHT
POUNDS X 1000

INDICATED ANGLE OF ATTACK — UNITS

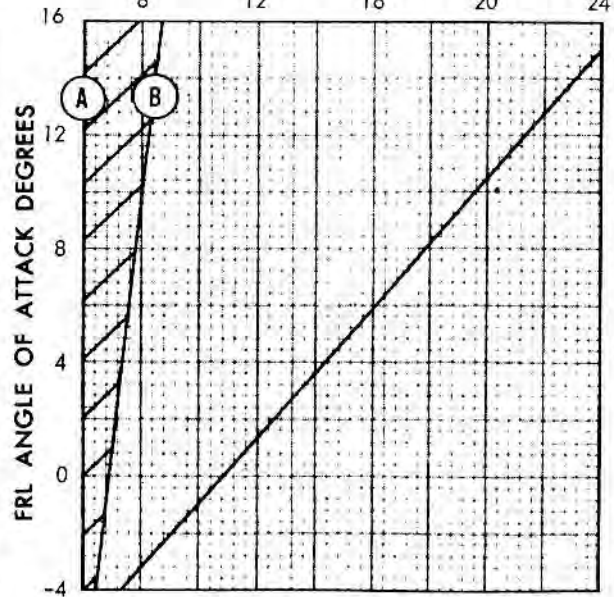
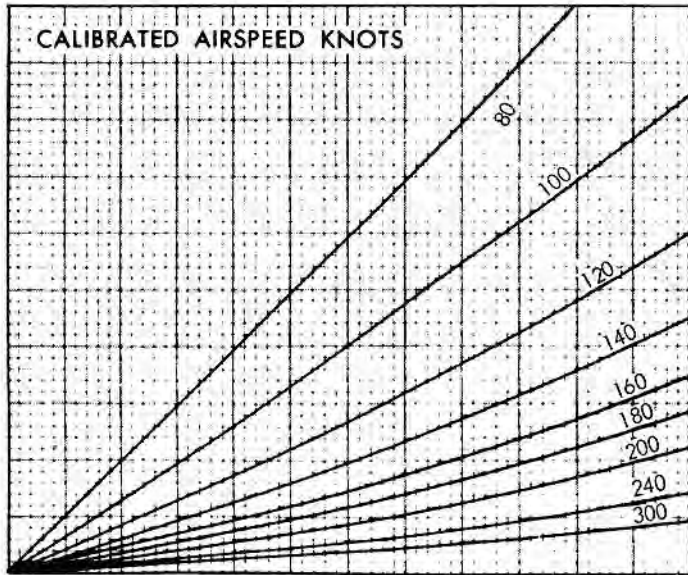

- (A) MILITARY POWER
- (B) POWER FOR LEVEL FLIGHT

OV-10D-1-122

Figure 11-53

PART 7 — DESCENT DATA

DESCENT DATA

Descent data depict the maximum nautical miles per pound of fuel obtainable during operational descents from altitude down to the landing pattern or target area.

RATE-OF-DESCENT AND DESCENT SPEED IN NORMAL DESCENT (FIGURE 11-54)

The rate-of-descent and descent speed during a normal descent (figure 11-54) can be determined for the cruise configuration with both engines at idle power for descents from 32,000 feet and weights up to 15,000 pounds.

RATE-OF-DESCENT AND DESCENT SPEED IN NORMAL DESCENT EXAMPLE PROBLEM

Determine the desired speed at idle power to establish the optimum rate of descent for maximum penetration, miles per pound of fuel, and the value of the rate of descent in cruise configuration.

- Gross Weight—12,000 pounds
- Altitude—14,000 feet
 1. Rate of descent = 1,300 feet per minute
 2. Descent speed = 136 KCAS

DISTANCE, TIME, AND FUEL USED IN NORMAL DESCENT (FIGURE 11-55)

The distance, time, and fuel requirements of a normal descent can be determined from figure 11-55 for descents from 32,000 feet and gross weights up to 14,000 pounds.

DISTANCE, TIME, AND FUEL USED IN NORMAL DESCENT EXAMPLE PROBLEM

Find the distance, time, and fuel used during a normal descent in the cruise configuration and both engines at idle power.

- Gross Weight—12,000 pounds
- Altitude—14,000 feet
 1. Distance = 35 nautical miles
 2. Time = 14 minutes
 3. Fuel used = 66 pounds

NORMAL DESCENT

BASED ON: FLIGHT TEST DATA
DATA AS OF: 15 NOVEMBER 1977

**IDLE POWER
FLAPS AND GEAR UP**

ENGINES: (2) T-76

EXAMPLE:

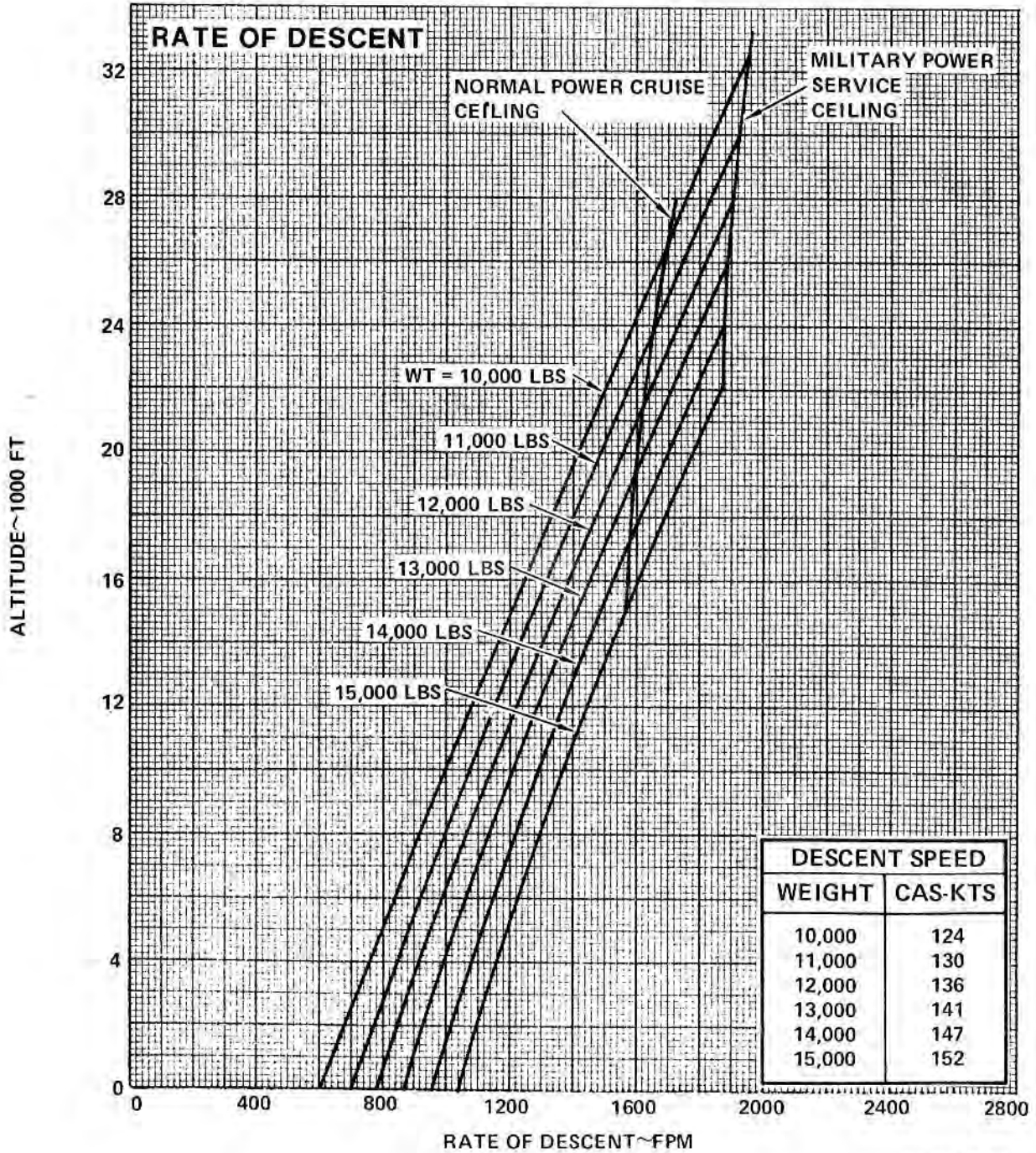
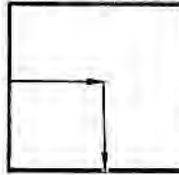

OV-10D-1-162

Figure 11-54

NORMAL DESCENT

BASED ON: FLT TEST DATA
DATA AS OF: 15 NOVEMBER 1977

**IDLE POWER
FLAPS AND GEAR UP**

ENGINES: (2) T-76

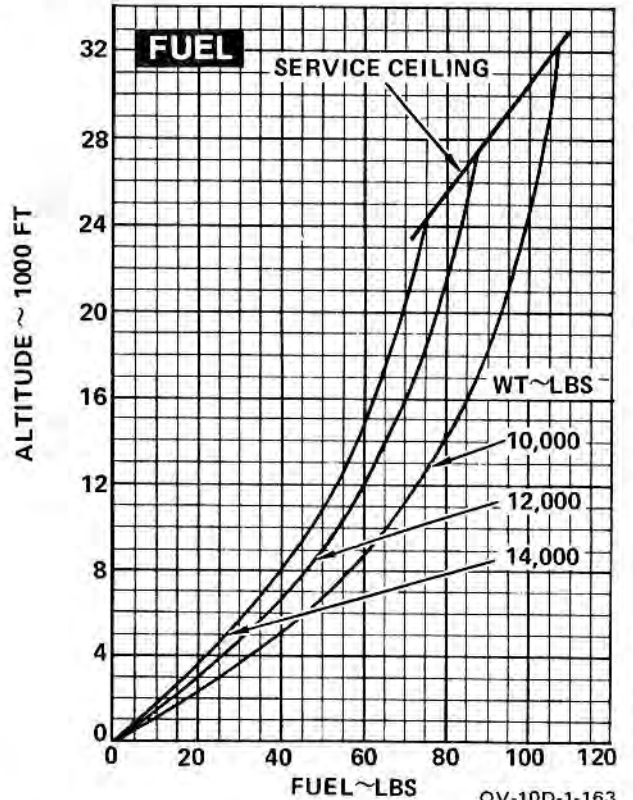
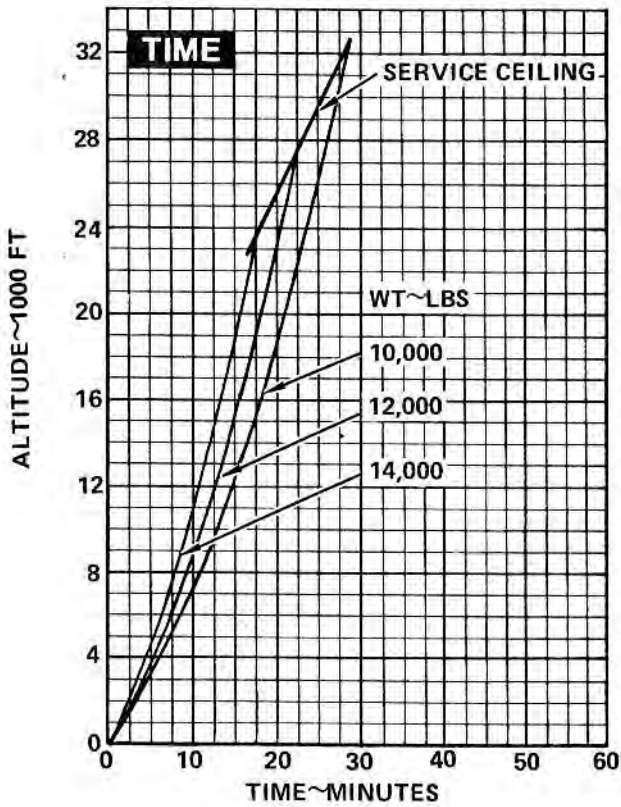
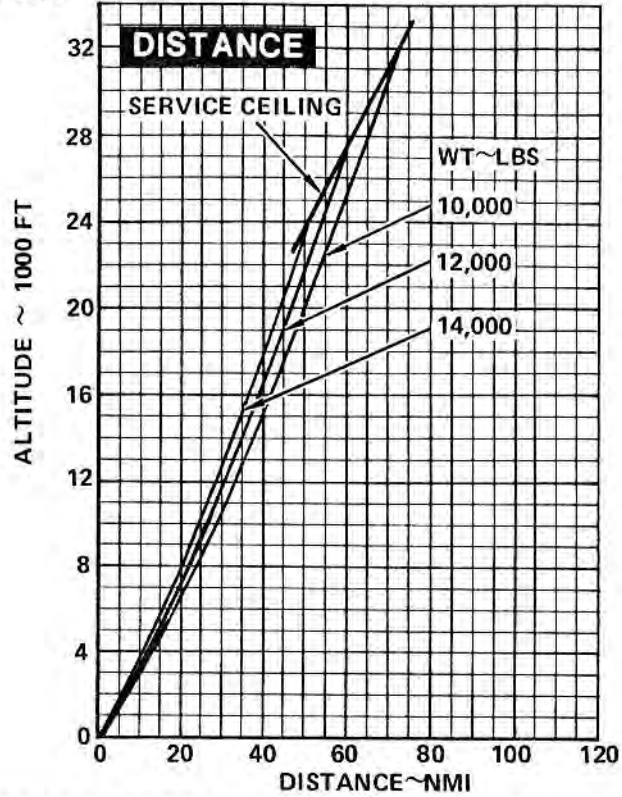
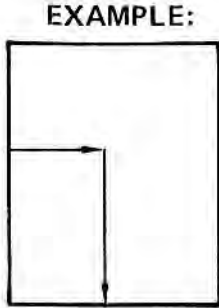

OV-10D-1-163

Figure 11-55

PART 8 LANDING DATA**LANDING DATA****LANDING DISTANCE**(FIGURES 11-56
THROUGH 11-59)

The Landing Distance chart determines landing roll for normal performance on hard-surface runways for various flap settings. Landing roll distance may be determined for idle or full-reverse power at various gross weights and ambient temperatures. See figures 11-56 through 11-59.

LANDING DISTANCE EXAMPLE PROBLEM

Find landing roll for normal performance braking and reverse thrust and for braking only (IDLE power):

- Gross Weight — 12,000 pounds
 - Flap Setting—20 degrees (normal performance)
 - Pressure Altitude — 2000 feet
 - Ambient Temperature — 30°C
 - Wind Velocity — 10 knots (head)
1. Braking and full reverse distance = 1055 feet
 2. Braking only (idle power) distance = 1899 feet (chart distance X 1.8)

LANDING DISTANCE

NORMAL PERFORMANCE

BASED ON: FLIGHT TEST DATA
DATA AS OF: 15 NOVEMBER 1977

DRY HARD RUNWAY

FLAPS UP

**MIRROR APPROACH
FULL REVERSE THRUST**

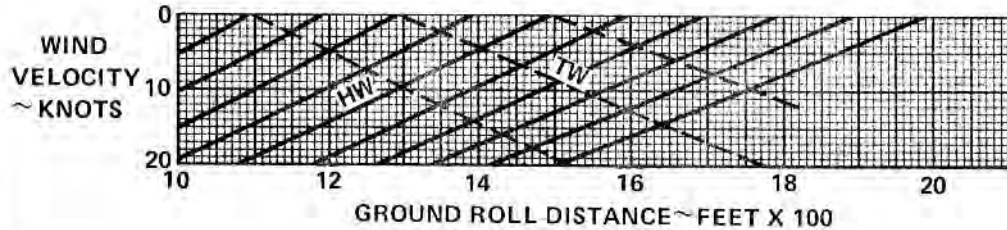
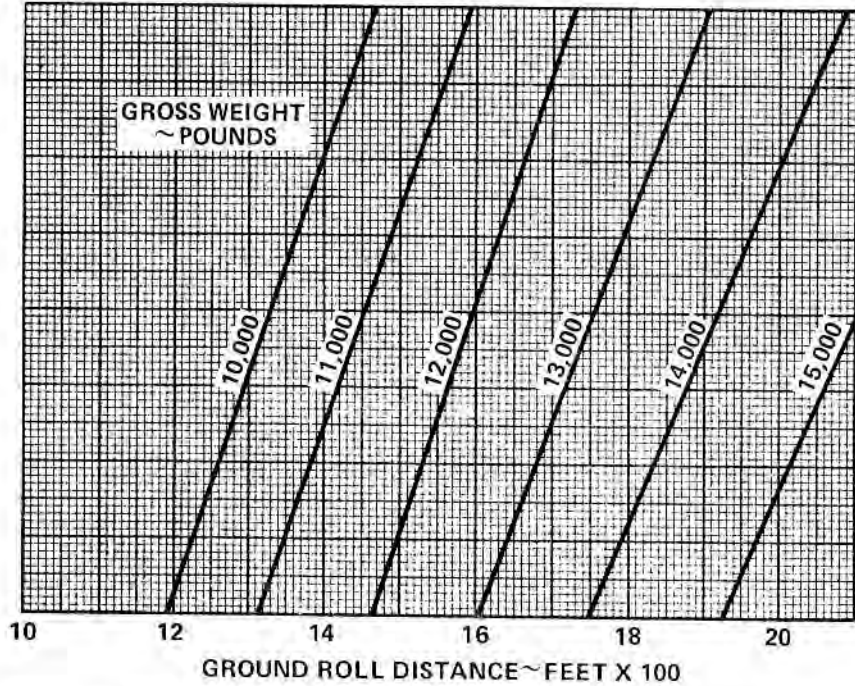
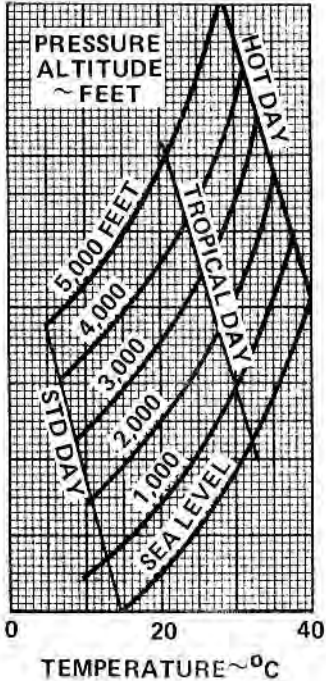

EXAMPLE

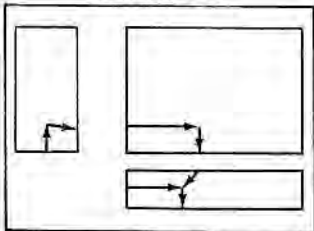

- NOTE:**
1. FOR DISTANCE TO CLEAR 50-FOOT OBSTACLE, INCREASE GROUND RUN 70%.
 2. FOR EACH KNOT ABOVE RECOMMENDED APPROACH SPEED, INCREASE GROUND RUN 25 FEET.
 3. FOR LANDING WITH NO REVERSE THRUST, INCREASE GROUND RUN 80%.
 4. REFER TO AIRSPEED LIMITS, SECTION I, PART 4.
 5. FOR LANDING WITHOUT BRAKES, INCREASE GROUND RUN 80%.

LANDING SPEEDS	
GROSS WEIGHT (POUNDS)	TOUCHDOWN SPEEDS ~ IAS ~ KNOTS
10,000	107
11,000	111
12,000	117
13,000	121
14,000	126
15,000	131

Figure 11-56

OV-10D-1-85C

LANDING DISTANCE

NORMAL PERFORMANCE

BASED ON: FLIGHT TEST DATA
DATA AS OF: 15 NOVEMBER 1977

DRY HARD RUNWAY

FLAPS 20°

**MIRROR APPROACH
FULL REVERSE THRUST**

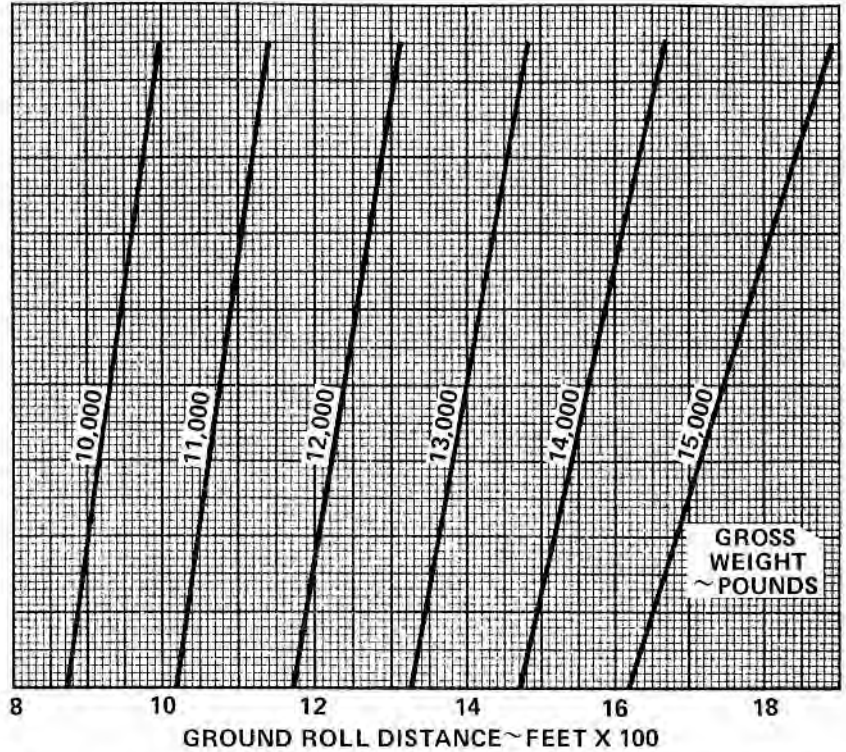
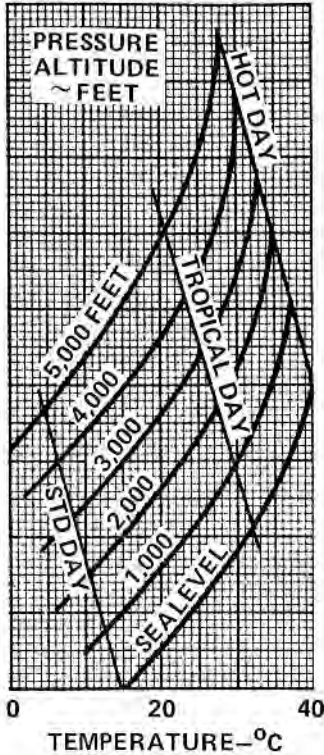

EXAMPLE

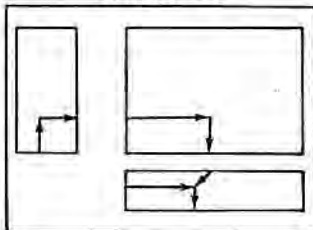

WIND VELOCITY
~ KNOTS

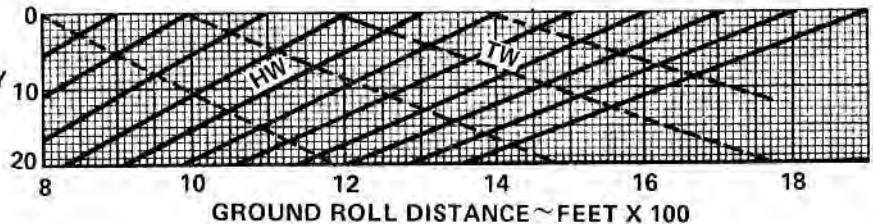

LANDING SPEEDS	
GROSS WEIGHT (POUNDS)	TOUCHDOWN SPEEDS MIRROR LANDING ~IAS~ KNOTS
10,000	87
11,000	94
12,000	101
13,000	108
14,000	115
15,000	122

- NOTE:**
- FOR DISTANCE TO CLEAR 50-FOOT OBSTACLE UTILIZING 10 FPS SINK RATE, INCREASE GROUND RUN 70%.
 - FOR DISTANCE TO CLEAR 50-FOOT OBSTACLE UTILIZING 7 FPS SINK RATE, INCREASE GROUND RUN 120%.
 - FOR EACH KNOT ABOVE RECOMMENDED APPROACH SPEED, INCREASE GROUND RUN 20 FEET.
 - FOR LANDING WITHOUT REVERSE THRUST, INCREASE GROUND RUN 80%.
 - FOR LANDING WITHOUT BRAKES, INCREASE GROUND RUN 80%.

OV-10D-1-86C

Figure 11-57

LANDING DISTANCE

BASED ON: FLIGHT TEST DATA
DATA AS OF: 15 NOVEMBER 1977

DRY HARD RUNWAY

STOL PERFORMANCE

FLAPS 20°

MIRROR APPROACH

FULL REVERSE THRUST

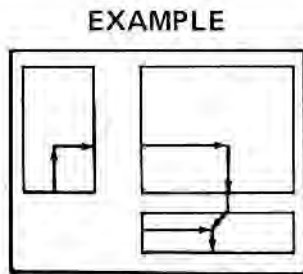
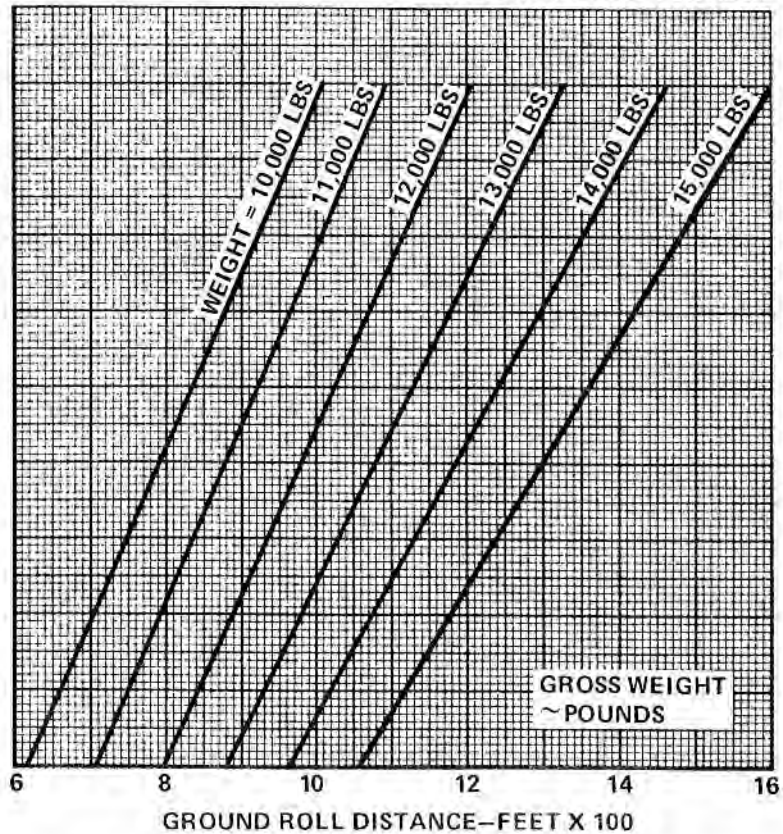
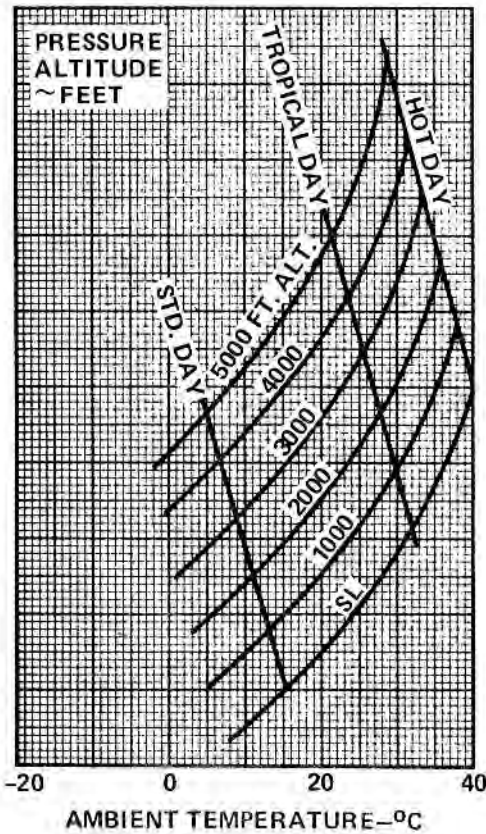

WIND
VELOCITY—
KNOTS

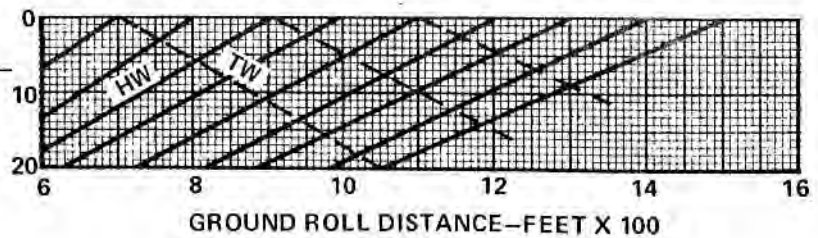

LANDING SPEEDS	
GROSS WEIGHT (POUNDS)	TOUCHDOWN SPEEDS IAS ~ KNOTS
10,000	80
11,000	84
12,000	88
13,000	92
14,000	95

NOTE:

1. FOR EACH KNOT ABOVE RECOMMENDED APPROACH SPEED, INCREASE GROUND RUN 20 FEET.
2. FOR LANDING WITHOUT REVERSE THRUST, INCREASE GROUND RUN 50%.
3. FOR LANDING WITHOUT BRAKES, INCREASE GROUND RUN 80%.

OV-10D-1-103A

Figure 11-58

LANDING DISTANCE

BASED ON: FLIGHT TEST DATA
DATA AS OF: 15 NOVEMBER 1977

STOL PERFORMANCE

FLAPS 40°

DRY HARD RUNWAY

MIRROR APPROACH
FULL REVERSE THRUST

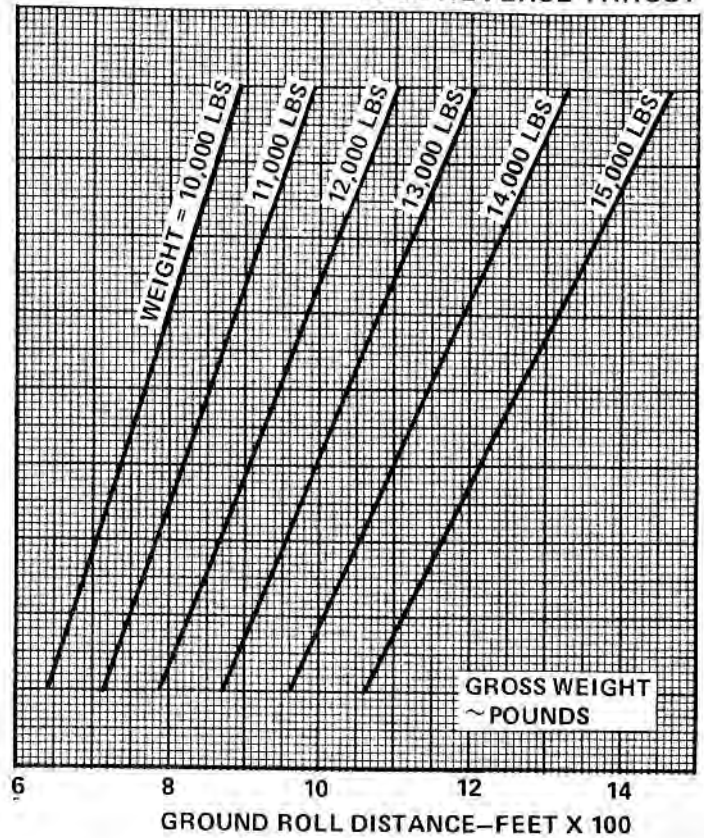
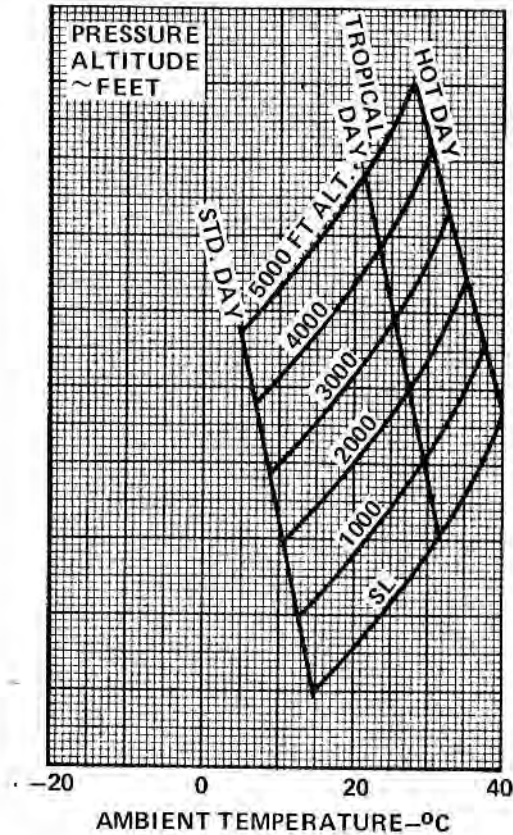

EXAMPLE

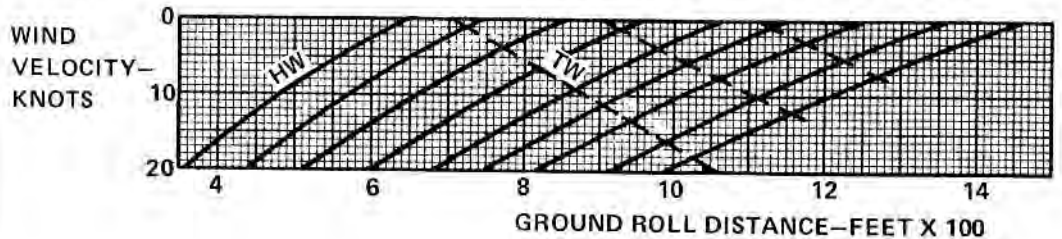
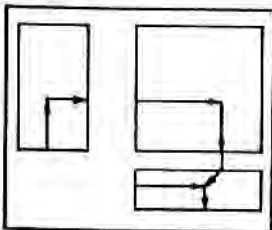

LANDING SPEEDS	
GROSS WEIGHT (POUNDS)	TOUCHDOWN SPEEDS IAS-KNOTS
10,000	74
11,000	78
12,000	82
13,000	86
14,000	89
15,000	94

NOTE :

1. FOR EACH KNOT ABOVE RECOMMENDED APPROACH SPEED, INCREASE GROUND RUN 20 FEET.
2. FOR LANDING WITHOUT REVERSE THRUST, INCREASE GROUND RUN 50%.
3. FOR LANDING WITHOUT BRAKES, INCREASE GROUND RUN 80%.

OV-10D-1-104A

Figure 11-59

AIRCRAFT FUEL SYSTEM

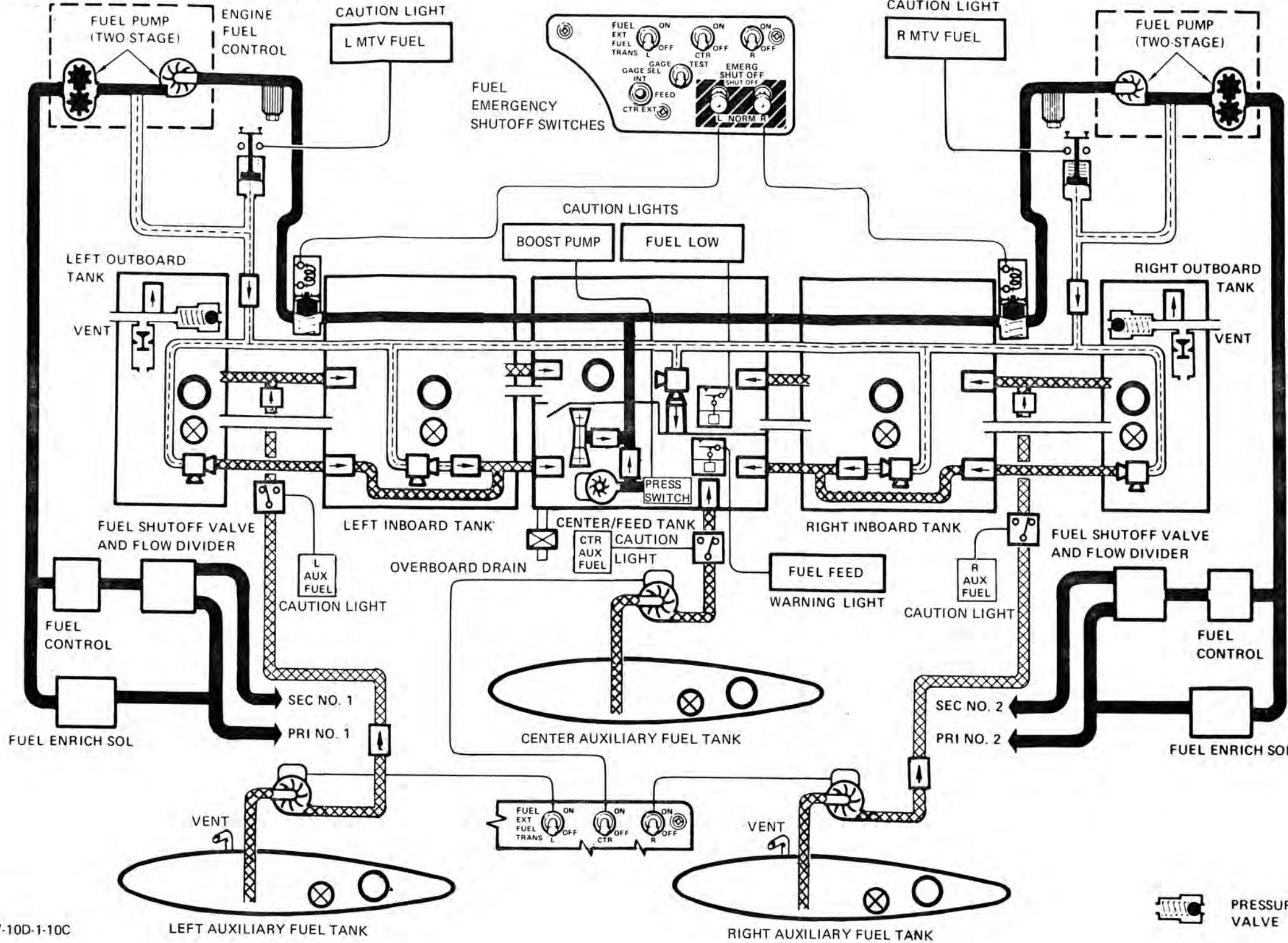

- VENT
- ENGINE FEED FLOW
- MOTIVE FLOW
- FUEL TRANSFER
- ELECTRICAL CONTROL
- CHECK VALVE
- DRAIN VALVE
- DRAIN VALVE
- FLOAT SWITCH
- PRESSURE SWITCH
- GRAVITY FILLER
- FLOW SWITCH
- ENGINE FUEL PUMP
- FUEL TRANSFER PUMP
- FUEL EMERGENCY SHUTOFF VALVE
- ENGINE BOOST PUMP
- TRANSFER EJECTOR PUMP
- OPEN IN INVERTED FLIGHT FUEL PICKUP ASSEMBLY
- OPEN IN NORMAL FLIGHT FUEL PICKUP ASSEMBLY
- VENT VALVE, FLOAT OPERATED
- FUEL FILTER
- PRESSURE RELIEF VALVE

OV-10D-1-10C

Figure FO-1

HYDRAULIC POWER SYSTEM

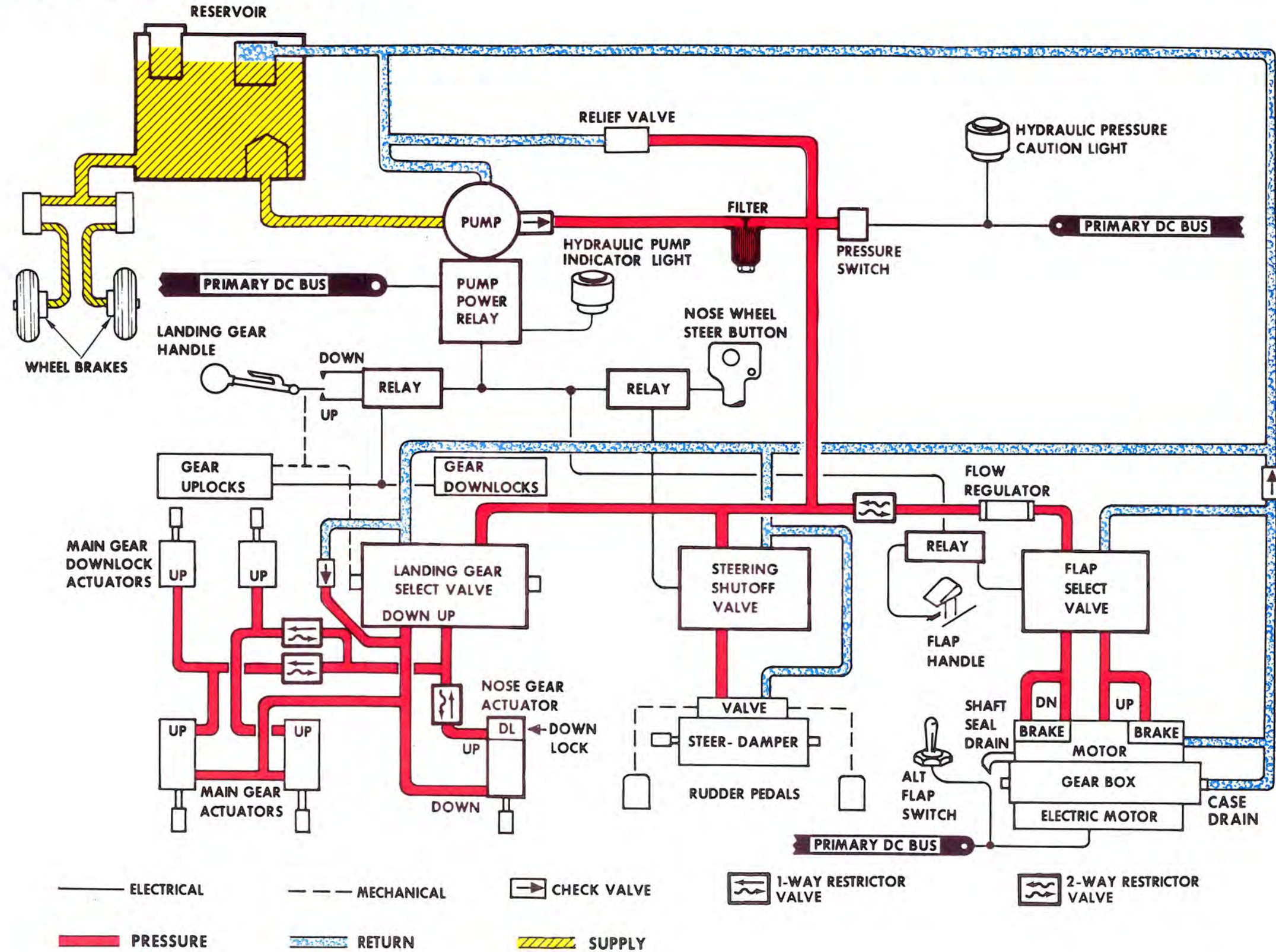
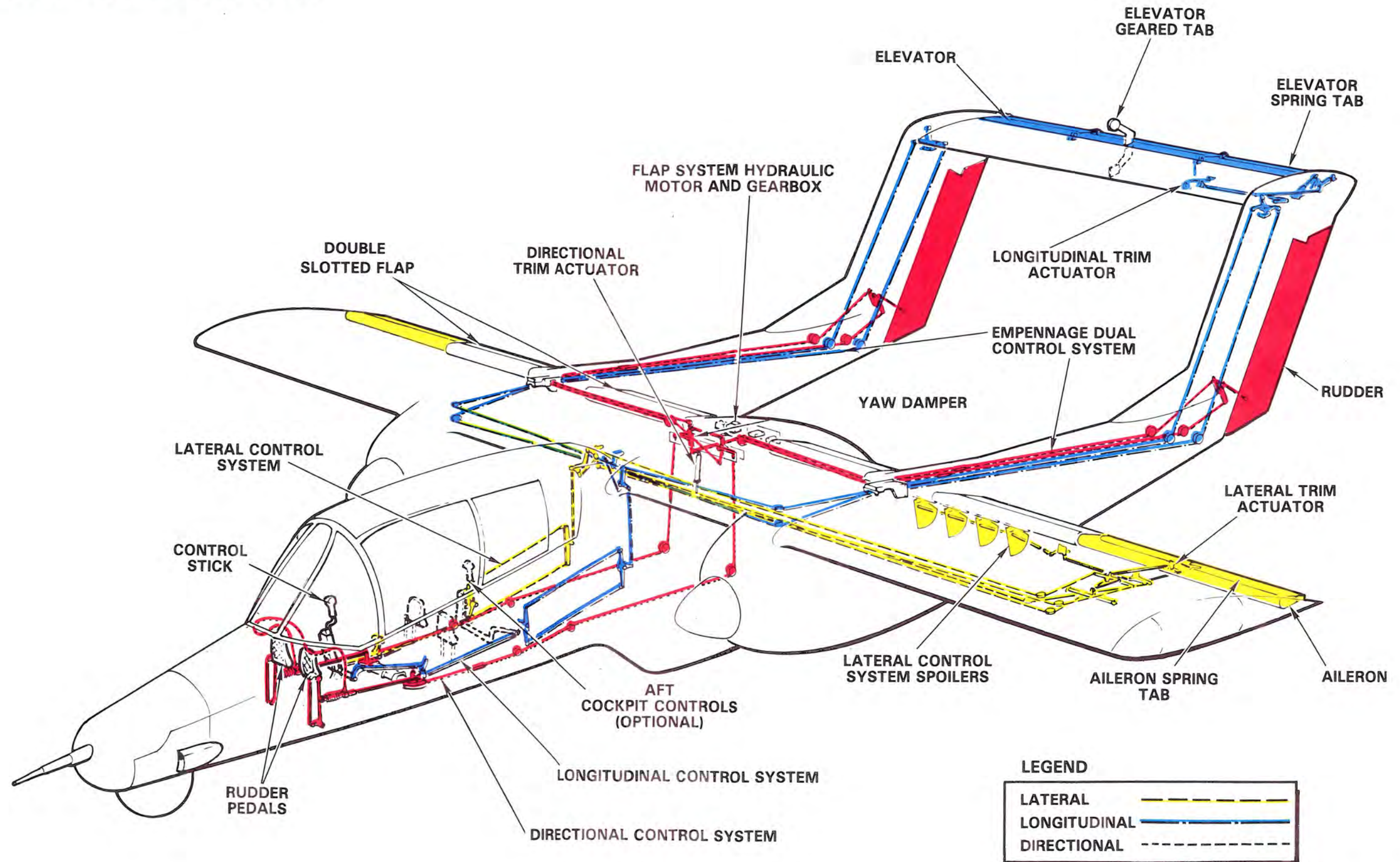

Figure FO-3

FLIGHT CONTROL SYSTEM





OV-10D-1-117A

Figure FO-4

AIRCRAFT CONFIGURATION TABLE - STORES CAPABILITY

NOTE: IN CASE OF MIXED STORES, USE HIGHEST DRAG INDEX

CLEAN AIRCRAFT (SPONSORS, C PYLON AND FLIR TURRET) DRAG = 50*

ITEM	STATION					WEIGHT-LBS		DRAG NUMBER		
	1	2	3	4	5	FULL	EMPTY	SINGLE	ADJACENT	MULTIPLE
AIRCRAFT OPERATING WEIGHT INCLUDES: SPONSORS (TWO) WITH RACKS CENTERLINE PYLON						272	9,816			
		X				52		21.0*		
								4.5*		
GENERAL ITEMS										
USABLE INTERNAL FUEL, JP-5						1,622				
WING STATION PYLONS (TWO)					WING PYLONS		132	15.0		
AUXILIARY FUEL TANKS (TWO) (JP-5)						1,538	232	27.0		
AERO 1C OR FPU-3/A FUEL TANK (JP-5)			X			1,155	135	14.0		24.0
M60C GUNS (FOUR) COMPLETE AMMUNITION 2000 ROUNDS							150			
GENERAL PURPOSE BOMBS										
MK-81 (CONICAL FINS)	X	X	X	X	X	260		4.0	5.0	6.0
MK-81 (SNAKEYE FIN)	X	X	X	X	X	305		6.5	7.5	8.0
MK-82 CONICAL FIN	X	X	X	X	X	531		5.0	6.0	7.0
MK-82 SNAKEYE (RETARDED/UNRETARDED)	X	X	X	X	X	572		9.0	10.0	11.0
MK-83 CONICAL FIN			X			985		9.0	10.5	12.0
FIRE BOMBS										
MK 77 MOD 2	X	X	X	X	X	520		6.0	8.0	10.0
MK 77 MOD 4	X	X	X	X	X	593		8.0	10.0	12.0
CLUSTER BOMBS										
CBU-55/B (FAE) OR CBU-55A/B (FAE)	X	X	X	X	X	519		13.0	20	27.0
					AND WING PYLONS					
PRACTICE BOMBS										
MK-86	X	X	X	X	X	217		4.0	5.0	6.0
A/A37B-3 (PMBR)							87.0	10.0	12.0	14.0
SIX MK-76	X	X	X	X	X	237		18.5	25.0	32.0
SIX MK-106	X	X	X	X	X	117		25.0	34.0	45.0

ITEM	STATION					WEIGHT-LBS		DRAG NUMBER		
	1	2	3	4	5	FULL	EMPTY	SINGLE	ADJACENT	MULTIPLE
ROCKET LAUNCHERS (2.75 INCH FFAR)										
LAU-3A/A (CONES ON)	X	X		X	X	427		9.0	15.0	20.0
W/O CONES (FULL)						407	79	29.0	35.0	40.0
W/O CONES (FIRED)								12.0	18.0	23.0
LAU-32A/A (CONES ON)	X	X		X	X	175		4.0	5.0	6.0
W/O CONES (FULL)						162		15.0	16.0	17.0
W/O CONES (FIRED)							51	5.0	6.0	7.0
LAU-32A/A (CONES ON)	X	X		X	X	175		4.0	5.0	6.0
W/O CONES (FULL)						162		15.0	16.0	17.0
W/O CONES (FIRED)							51	5.0	6.0	7.0
LAU-32B/A (CONES ON)	X	X		X	X	175		4.0	5.0	6.0
W/O CONES (FULL)						162		15.0	16.0	17.0
W/O CONES (FIRED)							51	5.0	6.0	7.0
LAU-59/A (CONES ON)	X	X		X	X	175		4.0	5.0	6.0
W/O CONES (FULL)						162		15.0	16.0	17.0
W/O CONES (FIRED)							51	5.0	6.0	7.0
LAU-60/A (CONES ON)	X	X		X	X	474		9.0	15.0	20.0
W/O CONES (FULL)						460		29.0	35.0	40.0
W/O CONES (FIRED)							79	12.0	18.0	23.0
LAU-61/A (CONES ON)	X	X		X	X	542		10.0	17.0	22.0
W/O CONES (FULL)						529		29.0	35.0	40.0
W/O CONES (FIRED)							133	12.0	18.0	23.0
LAU-61A/A (CONES ON)	X	X		X	X	542		10.0	17.0	22.0
W/O CONES (FULL)						529		29.0	35.0	40.0
W/O CONES (FIRED)							133	12.0	18.0	23.0
LAU-68/A (CONES ON)	X	X		X	X	217		4.0	5.0	6.0
W/O CONES (FULL)						204		15.0	16.0	17.0
W/O CONES (FIRED)							67	5.0	6.0	7.0
LAU-68B/A (CONES ON)	X	X		X	X	217		4.0	5.0	6.0
W/O CONES (FULL)						204		15.0	16.0	17.0
W/O CONES (FIRED)							67	5.0	6.0	7.0
LAU-69/A (CONES ON)	X	X		X	X	506		10.0	17.0	22.0
W/O CONES (FULL)						493		29.0	35.0	40.0
W/O CONES (FIRED)							98	12.0	18.0	23.0
ROCKET LAUNCHERS (5.0 INCH FFAR)										
LAU-10/A (CONES ON)	X	X		X	X	533		7.0	11.0	15.0
W/O CONES (FULL)						500		26.0	30.0	34.0
W/O CONES (FIRED)							105	9.0	13.0	17.0

ITEM	STATION					WEIGHT-LBS		DRAG NUMBER		
	1	2	3	4	5	FULL	EMPTY	SINGLE	ADJACENT	MULTIPLE
LAU-10A/A (CONES ON)										
W/O CONES (FULL)	X	X		X	X	533		7.0	11.0	15.0
W/O CONES (FIRED)						500	105	26.0	30.0	34.0
GUN PODS										
SUU-11A/A GPU-2/A (M-197 GUN)	X	X	X	X	X	325	245	7.0	8.0	10.0
						586	417	20.0		33.0
FLARES (PARACHUTE)										
A/A37B-3 (PMBR)								10.0	12.0	14.0
SIX MK 24, MOD 2A, 3, 4	X	X	X	X	X	249	87	32.0	43.0	55.0
SIX MK 45 MOD 0	X	X	X	X	X	249	87	32.0	43.0	55.0
DISPENSERS, FLARES (PARACHUTE)										
SUU-44/A	X	X	X	X	X					
EIGHT MK 24						350	135	8.0	13.0	17.0
EIGHT MK 45						350	135	8.0	13.0	17.0
SENSORS (SEISMIC)										
A/A37B-3 (PMBR)							87	10.0	12.0	14.0
SIX ADSID III (S)	X				X	237	-	70.0	96.0	112.0
THREE ADSID III (N)	OR	X			X	162	-	50.0	80.0	
SENSORS (ACOUSTIC)										
SUU-44/A										
FOUR GSQ-141	X	X		X	X	300	135	8.0	13.0	17.0
A/A37B-3 (PMBR)							87	10.0	12.0	14.0
THREE GSQ										
-141	OR	X		X	X	185	-	30.0	50.0	
-107	OR	X		X	X	200	-	30.0	50.0	
SIGNAL MARKERS										
A/A37B-3 (PMBR)							87	10.0	12.0	14.0
SIX MK 6 MOD 3	X	X	X	X	X	183		60.0	72.0	84.0
CHEMICAL										
SMOKE TANK MK 12, MOD 0		X				1000	340	7.0	11.0	15.0

Figure FO-5

INDEX

	Page Text	No. Illus.		Page Text	No. Illus.
A					
Aborted	3-9		fuel supply system	1-20	
hung start	3-9		external fuel tanks	1-20	
take-off, one engine	5-7		system controls and indicators	1-21	
take-off, two engines	5-7		“G” limits, aircraft		1-64
A-C			general arrangement		1-2
electrical power system	1-25		gross weight	1-1	
bus			missions	1-4	
instrument	1-25		operating limitations	1-59	
monitor	1-25		weight	11-2	
primary	1-25		servicing	1-53	1-57
fuses and circuit breakers	1-25	1-26	the aircraft	1-1	
instrument power caution light	1-25		Aircraft		
inverters and instrument power			conversion	11-2	
switch	1-25		example	11-2	
Acceleration			indicator	1-33	
limits	1-62		limits	1-62	1-63
stalls, accelerated	4-3		crosswind component	1-62	
Accelerometer	1-33		external stores	1-65	
Aerobatics	3-18		flap limit speeds	1-62	
maneuver parameters	3-19		landing gear limit speed	1-62	
Aileron and Elevator Trim Switches	1-31	1-30	maximum allowable airspeed	1-62	
AIMS System	7-14		minimum speeds—normal operations	1-62	
AAU-21/A and AAU-24/A	1-33		landing	1-62	
altimeter encoder, AAU-21A	7-14		take-off	1-62	
operation of transponder	7-16		minimum speeds—STOL operations	1-62	
radar indicator and controls	7-2	7-2	Air Start, Engine	5-10	
operation	7-2		(ignition and unfeather switches)	1-14	
transponder test set	7-16		Air-to-Air Ranging	7-12	
Air			homer	7-12	
start (ignition and unfeather)			homing	7-12	
switches	1-14		All-Weather Operation	6-1	
Aircraft			cold-weather procedures	6-6	
before leaving aircraft	3-16		hot-weather and desert procedures	6-8	
cold-weather procedures	6-6		ice and rain	6-2	
hot-weather and desert procedures	6-8		instrument flight procedures	6-1	
capability table, aircraft			night flying	6-6	
configuration stores	11-1		turbulence and thunderstorms	6-2	
ceilings	11-23		Altimeter		
configuration drag index system	11-1		AIMS system, AAU-21/A		
description	1-1		AAU-24/A	1-33	
dimensions	1-1		radar altimeter system,		
entering, cold-weather procedures	6-7		AN/APN-171(V)	7-2	7-2
exterior inspection, cold-weather	6-6		indicator and controls	7-2	7-2
hot-weather and desert procedures	6-8		low-altitude light	7-2	
			off-set—push-to-test knob	7-2	
			radar altimeter operation	7-2	

	Page Text	No. Illus.		Page Text	No. Illus.
Altitude			safety check	8-5	
lost in dive recovery	11-69		sight controls	8-1	
optimum cruise	11-43		ARU-13/A Attitude Indicator	1-34	
speed-altitude correction	11-43		Asymmetric Power	4-6	
sensor/speed	1-43	1-45	flaps	5-14	
Ammeter Select Switch	1-23		Attitude Gyro Erect Switch	1-34	1-6
AN/ASN-37, Infrared Laser Detecting- Ranging Set	8-7		Audio		
AN/AIC-18, Intercommunications Set	7-2		identifier	7-11	
AN/ALE-39 Countermeasures Dispensing Set	7-17		Automatic Emergency IFF	1-46	
AN/APN-171(V), Radar Altimeter System	7-2		Auxiliary Fuel Caution Lights	1-23	
AN/APX-64(V), IFF-SIF	7-12				
AN/AIC-51, UHF Communications Set	7-5		B		
AN/ARC-54, VHF-FM Communications	7-6		Balance, Weight and	3-5	
AN/ARC-120, HF Communications	7-8		Basic Data	11-1	
AN/ARN-52(V), TACAN	7-10		aircraft configuration drag index system	11-1	
AN/ASN-75, Compass System	7-1		fuel weight vs. temperature	11-2	11-3
Angle-of-Attack			standard	11-2	
relationship	11-70		Battery		
example	11-70		bus	1-23	
system	1-34		servicing	1-56	
indexer	1-34		switch	1-23	
indicator	1-34		Bearing Distance Heading Indicator (BDHI)	7-12	
lights, approach	1-34		Bearing, False	7-11	
test switch	1-35		Before		
stall warning	1-35		landing	3-14	
Annunciator	7-1		leaving	6-7	
Antenna Select Switch	7-13		aircraft	3-16	
Anticollision Lights Switch	1-37		starting	1-20, 3-8, 3-24	
Anti-G Suit System	1-39		engines	6-8	
Approach			take-off	3-11	
high altitude approach (typical)	6-3		taxi	3-11	
hot-weather and desert procedures	6-8		Beta		
indexer	1-34		control mode	1-17	
instrument	6-2		functional check flight procedures	3-23	
landing	6-8		valve	1-17	
lights	1-34		Bleed Air Switches	1-37	
test switch	1-35		Bomb		
low altitude approach (typical)	6-4		dropping	8-4	
missed	6-2		equipment	8-1	
precautionary	5-16	5-17	release button	8-3	
radar approach (typical)	6-5	6-5	Bombing Equipment	8-1	
section approaches	3-20		Boost Pump Caution Light, Fuel	1-22	
storm, the	6-6		failure	5-12	
turn, approach	4-5		Brakes		
Area	10-2		failure wheel brake	5-16	
Armament			hot brakes	5-20	
bus	1-24		parking brake handle	1-33	
equipment	8-1		wheel	1-32	
bombing	8-1		Briefing and Debriefing	3-1	
gunnery	8-1		flight crew coordination	9-1, 9-2	
optical sight	8-1	8-2	guide	3-1	
rocket	8-1		emergencies	3-2	

	Page Text	No. Illus.		Page Text	No. Illus.
formation.....	3-2		Charts		
general	3-1		performance data	Section XI	
mission profile.....	3-1		Check flight, Functional Procedures	3-23	
weapons.....	3-2		Chip Caution Lights, Engine	1-12	
weather.....	3-1		detector caution light illumination	5-11	
introduction.....	3-1		Circuit Breakers		
Build-in-Test	8-17		d-c	1-25	
inhibited region test.....	8-18	8-19	panels.....		1-26
Bus			Climb	3-14	
armament	1-24		climb-out flight path.....	11-9	
battery	1-23		example.....	11-9	
monitor.....	1-24		data	11-23	
main.....	1-23		aircraft ceilings	11-23	
primary.....	1-24		military climb example problem	11-23	
secondary	1-24		single engine	11-23	
Button			5000 feet (profiles ABCD).....	3-26	
bomb release.....	8-3		instrument.....	6-1	
call	7-4		level flight 5000 feet.....	3-26	
nose wheel steering.....	1-33		level flight 10,000 feet (profiles ABC)	3-27	
stores emergency release.....	8-4		military power		11-24
			single-engine	11-23	
C			Clock.....	1-34	
Call Button.....	7-4		Closed Book Examination	10-2	
Canopy			Cockpit		
doors.....	1-41	1-42	air/defrost knob.....	1-37	
handles	1-43		check, cockpit	3-6	
open in-flight.....	5-14		enclosure	1-41	
ventilators.....	1-39		canopy doors	1-41	
Capability, Recovery	1-47	1-48	handles	1-43	
Cargo			steps and handholds	1-43	
bay doors open in-flight	5-14		observers.....		1-8
bay lights	1-35		air valve	1-39	
compartment	1-47		lights	1-35	
hold open rod, cargo door.....	1-47		pilot's cockpit lights	1-35	
transport.....	1-4		Cold-Weather Procedures	6-6	
Carrier-Based Procedures	3-21		alternate fuel use.....	6-7	
field carrier landing practice	3-21		before leaving.....	6-7	
aircraft handling and launch			entering aircraft	6-7	
procedures	3-22		exterior inspection	6-6	
flight procedures	3-21		ground checks	6-7	
ground training	3-21		landing	6-7	
introduction	3-21		starting engines.....	6-7	
landing pattern and recovery			take-off	6-7	
procedures	3-22		after.....	6-7	
pilot certification.....	3-21		taxiing	6-7	
pre-carrier briefing.....	3-21		Communications.....	7-2	7-3
the FCLP pattern.....	3-21	3-22	and navigation.....	6-2	
Cases, Map and Data.....	1-51		briefing guide.....	3-1	
Caution Light, AUX FUEL.....	5-13		electronic equipment.....	7-1, 7-21	
Caution Light, Boost Pump	1-22		general.....	7-21	
Caution Light, MTV Fuel	5-12		operation.....	7-21	
Ceilings, Aircraft	11-23		systems	7-2	
Center-of-Gravity Limits	1-64		HF set, AN/ARC-120	7-8	
Characteristics			intercommunications set, AN/AIC-18.....	7-2	
flight.....	3-14, 4-1		KY-28	7-9	

	Page Text	No. Illus.		Page Text	No. Illus.
UHF set, AN/ARC-51	7-5		Cruise	3-14	
VHF-FM set, AN/ARC-54	7-7		free	3-19	
visual	7-21		instrument	6-1	
Compass System, AN/ASN-75	7-1		communications and navigation	6-2	
controls	7-1	7-1	optimum altitude	11-43	
annunciator	7-1		example	11-43	
push-to-set knob	7-1				
slaved-free switch	7-1		D		
operation	7-1		Data, Performance	11-1	
standby magnetic	1-34		basic	11-1	
Component			climb	11-23	
crosswind	1-62		descent	11-77	
Concept	10-1		endurance	11-65	
Condition			flight characteristics	11-69	
engine	1-18		landing	11-81	
levers	1-17		range	11-43	
fuel	1-21		take-off	11-7	
Conditionally Qualified	10-1		D-C Electrical Power System	1-23	
Console			ammeter select switch	1-23	
light knob	1-35		armament bus	1-24	
pilot's			batteries	1-23	
left	1-5		battery bus	1-23	
right	1-7		battery switch	1-23	
Constant Altitude Cruise	11-46		circuit breakers	1-25	1-26
Controls and Indicators			generator switches	1-23	
compass	7-1		generator-out caution lights	1-23	
ejection	1-46		monitor bus	1-24	
engine speed	1-18		main bus	1-23	
HF comm controls	7-8		primary bus	1-24	
ICS controls	7-4		secondary bus	1-24	
IFF-SIF controls and indicators	7-12		starter generators	1-23	
oxygen, control and indicators	1-39		voltammeter	1-23	
radar altimeter	7-2		Debriefing	3-2	
refueling	1-53		Definitions	10-1	
TACAN controls	7-10	7-10	area	10-2	
UHF comm controls	7-5	7-6	critical/area/subarea	10-2	
Control Sticks and Rudder Pedals	1-29	1-30	emergency	10-2	
Countermeasures Dispensing Set			malfunction	10-2	
controls and indicators	7-16		NATOPS		
dispenser control panel	7-17	7-18	evaluation	10-1	
initiate switch panel	7-19	7-18	re-evaluation	10-1	
programmer control panel	7-17		qualified	10-1	
operation	7-19		conditionally	10-1	
automatic (programmed dispensing)	7-19		subarea	10-2	
manual (single dispensing)	7-19		unqualified	10-1	
chaff	7-19		Descent	3-14	
flare	7-20		data	11-77	
jammer	7-20		functional checkflight procedures	3-29	
Crew Duties	9-1		Description, the Aircraft	1-1	
Critical Area/Subarea	10-2		dimensions	1-1	
Cross Country Flight	2-2		general arrangement	1-2	1-2
Crossunder	3-19		gross weight	1-1	
Crosswind			missions	1-4	
component	1-62		Determination		
landing	1-62		final grade	10-3	
take-off	1-62		flight evaluation grade	10-2	

	Page Text	No. Illus.		Page Text	No. Illus.
Diagram, V-N.....	1-63		instrument power caution light.....	1-25	
Dials, SIF Code.....	7-13		inverters and instrument power		
Diluter Lever.....	1-41		switch.....	1-25	
Dimensions, Principal.....	1-9		monitor a-c bus.....	1-25	
Directional System			primary a-c bus.....	1-25	
control.....	4-2		d-c electrical power system.....	1-23	
yaw damper.....	1-29		ammeter select switch.....	1-23	
Dispensing Flares.....	8-5		armament bus.....	1-24	
Distance			batteries.....	1-23	
glide.....	5-10		battery bus.....	1-23	
landing.....	11-81		battery check.....	5-13	
take-off.....	11-9		battery switch.....	1-23	
Distribution, Electrical Power.....	FO-3		circuit breakers.....	1-25	
Ditching (Water Landing).....	5-15		generator switches.....	1-23	
Doors			generator-out caution lights.....	1-23	
canopy.....	1-41	1-42	monitor bus.....	1-24	
handles.....	1-43		main bus.....	1-23	
cargo bay doors open in-flight.....	5-14		primary bus.....	1-24	
compartment, cargo.....	1-47		secondary bus.....	1-24	
hold-open rod, door.....	1-47		starter generators.....	1-23	
message drop door.....	1-51	1-52	voltammeter.....	1-23	
Drag Index System, Aircraft			failures.....	5-13	
Configuration.....	11-1		battery check.....	5-13	
example.....	11-2		both generators out.....	5-13	
“D” Ring Ejection.....	1-46		fuel system.....	5-12	
Duties, Crew.....	9-1		generator failure.....	5-13	
			instrument power failure.....	5-13	
			fire.....	5-12	
			elimination of smoke and fumes.....	5-12	
			functional checkflight procedures.....	3-23	
			Electronic Countermeasures Equipment.....	7-16	
			AN/ALE-39 dispensing set.....	7-16	
			controls and indicators.....	7-16	
			operation.....	7-19	
			Electronic Equipment.....	7-1	7-3
			communications system.....	7-2	7-3
			compass system, AN/ASN-75.....	7-1	
			controls.....	7-1	7-1
			operation.....	7-1	
			countermeasures.....	7-16	
			identification systems.....	7-12	
			navigation systems.....	7-10	
			radar altimeter system,		
			AN/APN-171(V).....	7-2	7-2
			Elevator Trim Indicator.....	1-31	1-6
			Elimination of Smoke and Fumes.....	5-12	
			Emergency Procedures.....	5-1	
			briefing guide.....	3-2	
			ejection.....	5-23	
			equipment.....	1-45	
			first aid kit.....	1-45	
			survival kit.....	1-45	
			fire.....	5-3	
			nacelle fire.....	5-4	
			on shutdown (propellers feathered).....	5-5	

	Page Text	No. Illus.		Page Text	No. Illus.
on shutdown (propellers unfeathered) ..	5-4		beta control mode	1-17	
on start/hot start.....	5-4		valve.....	1-17	
warning lights, nacelle.....	1-14		chip caution lights.....	1-12	
warning system, nacelle.....	1-14		cold-weather procedures, starting.....	6-7	
fuels, primary, alternate	1-55		conditions.....	1-18	
gear extension, landing.....	5-14		condition levers	1-17	
ground emergencies	5-1		controls and indicators.....	1-16	
egress	5-5		aileron and elevator trim		
fire	5-4		switches.....	1-31	1-30
introduction.....	5-1		control sticks and rudder pedals	1-29	1-30
IFF emergency switch	7-13		elevator trim indicator	1-31	1-6
in-flight	5-9		pedal adjust crank.....	1-29	1-6
canopy open	5-14		rudder trim switches	1-31	1-30
cargo bay door open.....	5-14		trim neutral lights	1-31	1-6
electrical fire.....	5-12		trim select switch	1-29	1-30
electrical system failures	5-13		yaw damper switch.....	1-31	1-30
emergency jettison	5-14		detection/warning lights test		
engine failure	5-7		switch	1-15	
fuel system failures.....	5-12		engine and propeller indicators.....	1-16	
landing gear emergency extension	5-14		exhaust	1-11	
structural damage/control			external view		1-13
malfunction	5-14		failure, engine	5-7	
trim systems failure	5-13		aborted take-off (one engine and		
jettison.....	5-14		two engines).....	5-7	
landing.....	5-15		both engines in flight.....	5-9	
ditching (water landing).....	5-15		fire after take-off	5-7	
emergency rescue	5-20		gross power loss during take-off		
forced landing	5-15		roll	5-7	
hydraulic system failure.....	5-19		fire	5-4	
immediate landing—low altitude	5-15		nacelle	5-4	
precautionary approach	5-16	5-17	on shutdown (propellers feathered).....	5-5	
single-engine landing pattern.....		5-18	on shutdown (propellers unfeathered) ..	5-4	
tire failures.....	5-19		on start/hot	5-4	
unsafe landing gear.....	5-19		flight		
wheel brake failure.....	5-20		NORMAL	1-19	
lever, supply	1-41		take-off (T.O./LAND)	1-19	
oil system failure	5-11		friction lever	1-17	
oxygen system operation.....	1-41		fuel	1-11	
emergency.....	1-41		enrichment.....	1-11	
normal.....	1-41		governing control mode.....	1-17	
parachute emergency release			ground operation.....	1-19	
handle.....	1-46	1-44	hot-weather and desert procedures.....	6-8	
release button, stores.....	8-4		before starting	6-8	
release handle, parachute.....	1-46		starting	6-8	
rescue	5-20	5-21	ignition systems.....	1-11	
shutoff switches, fuel.....	1-22		in-flight emergencies	5-9	
stores jettison handle.....	8-4		air start	5-10	
survival equipment.....	5-23		failure below minimum single-engine		
take-off	5-7		control speed.....	5-9	
aborted (two engines and one			failure of both engines in flight	5-9	
engine)	5-7		landing in T.O./LAND.....	1-19	
engine failure	5-7		levers, condition	1-17	
Endurance Data	11-65		nacelle, fire engine	5-11	
Engines	1-11	1-12	warning lights	1-14	
air start (ignition and unfeather			warning system	1-14	
switches).....	1-14				
before starting	6-8				

	Page Text	No. Illus.		Page Text	No. Illus.
negative torque sensing operation	1-18		emergency	1-45	
oil systems	1-12		gunnery	8-1	
chip caution lights	1-12		miscellaneous	1-51	1-52
failure	5-11		mission	1-47	1-52
pressure indicator	1-16		personal flying	2-2	
operating limitations	1-59	1-61	rocket	8-1	
ignition system	1-59		survival	5-23	
military power	1-59		Erect Spins	4-5	
normal power	1-59		Evaluation, NATOPS	10-1	
rpm limits	1-59		Examination		
starter limits	1-59		closed book	10-2	
operation	1-16		open book	10-2	
overspeed governor (OSG)	1-17		oral	10-2	
overtemperature warning lights	1-15		Example Problems	11-1	
overtorque caution lights	1-16		drag index	11-2	
pilot's warning and caution lights	1-6	1-6	gross weight	11-2	
power levers	1-16		Exterior		
power management control system			inspection	3-5	
(PMSC)	1-16		lights	1-37	
propellers	1-16		control, exterior	1-37	1-36
governor	1-17		master switch, lights	1-37	
reverse power	1-20		External		
shutdown	1-20		electrical power applied for start	5-4	
simulated engine(s)-out operations	3-18		flight with external stores	4-7	
simulated single-engine landing			fuel tanks	1-20	
pattern	5-16		power	1-25, 1-53	
single-engine, handling	4-8		store limits	1-62	1-65
landing	5-16		auxiliary fuel tanks	1-62	
speed control	1-18	1-18	tank transfer failure	5-13	
start ignition on light	1-15		transfer switch, fuel	1-22	
starter switches	1-14				
starts	1-19, 3-8		F		
tachometers	1-16		Failure		
take-off	1-19		auxiliary fuel tank transfer	5-13	
aborted take-off (one engine)	5-7		both engines in flight	5-9	
aborted take-off (two engines)	5-7		electrical systems	5-13	
temperature limits	1-59	1-61	engine	5-7	
exhaust gas temperature limits			fuel system	5-12	FO-1
(START)	1-67	1-67	generator	5-13	
hydraulic system operation limits	1-62		hydraulic	5-19	
oil pressure limits	1-61	1-60	instrument power	5-13	
reverse thrust limits	1-62		normal trim system	5-13	
torque limits	1-61	1-61	oil system	5-11	
turbine inlet temperature	1-59	1-60	tire	5-19	
torque indicators	1-16		trim systems	5-13	
turbine inlet temperature indicators	1-16		wheel brake	5-20	
inlet temperature system	1-15		yaw damper	1-29	
underspeed governor (USG)	1-17		False Bearings	7-11	
Entering Aircraft	6-7		Familiarization	2-2	
Equipment			Feed Warning Lights, Fuel	1-22	
armament	8-1		Filament Select Switch	8-1	
bombing	8-1		Final Grade Determination	10-3	
communication and navigation			Fire		
equipment	6-2		control grip	8-14	8-14
electronic	7-1	7-3	detection warning lights test switch	1-15	

	Page Text	No. Illus.		Page Text	No. Illus.
electrical fire.....	5-12		instrument approach	9-2	
engine	5-4		introduction.....	9-1	
nacelle.....	5-4, 5-11		landing	9-2	
nacelle fire warning system.....	1-14		planning	9-1	
fire warning lights.....	1-14		postflight	9-2	
First Aid Kit	1-45		poststart	9-2	
Firing			preflight.....	9-1	
rockets from wing stations.....	8-4		prestart.....	9-1	
Flap	1-31		pretake-off	9-2	
alternate flaps switch	1-31		starting	9-2	
operation.....	5-14		take-off departure	9-2	
asymmetric	5-14		crew designations, qualifications, and requirements	2-2	
controls and indicators.....	1-31		functional check pilot (FCP)	2-2	
functional checkflight procedures	3-23		pilot qualified in model (PQM)	2-2	
handles	1-31	1-30	cross country flight	2-2	
limit speeds, flap	1-62		data	11-69	
Flares, Dispensing	8-5		altitude lost in dive recovery	11-69	
Flight			angle-of-attack relationship	11-70	
canopy open	5-14		minimum single-engine control and flyaway speeds.....	11-69	
cargo bay door open	5-14		stall speeds	11-69	
characteristics, flight.....	3-14, 4-1		evaluation	10-2	
accelerated stalls	4-3		hot-weather and desert procedures.....	6-8	
control	4-1		in NORMAL FLIGHT.....	1-19	
directional	4-2		in take-off and LAND		
lateral.....	4-1		(T.O./LAND)	1-19	
longitudinal	4-1		performance data, characteristics.....	11-69	
external stores	4-7		personal flying equipment	2-2	
high speed	4-2		preflight checks	3-5	
introduction.....	4-1		exterior.....	3-5	
low speed	4-2		interior	3-5	
normal stalls	4-3		preparation for flight	3-5	
operation.....	8-17, 8-18		planning	3-5	
single engine	4-7		restrictions	3-5	
spins	4-5		weight and balance	3-5	
cold-weather procedures	6-6		night flying	2-2	
controls and indicators.....	1-29		qualifications	2-1	
aileron and elevator trim			safety	2-1	
switches.....	1-31	1-30	FLIR Command Switch	8-13	8-13
control sticks and rudder pedals	1-29	1-30	FLIR Control Panel.....	8-8	
elevator trim indicator	1-31	1-6	controls and indicators	8-8	
pedal adjust crank.....	1-29	1-6	control servo fail indicator.....	8-9	
rudder trim switches	1-31	1-30	cooling indicator	8-9	
trim neutral lights	1-31	1-6	grayscale switch	8-8	
trim select switch	1-29	1-30	mode switch.....	8-8	
yaw damper switch.....	1-31	1-30	not ready indicator	8-9	
control systems	1-28		power supply fail indicator	8-9	
controls and indicators.....	1-29		receiver converter fail indicator.....	8-9	
directional system	1-29		receiver overtemperature indicator	8-10	
lateral system.....	1-29		FLIR/LRD System Checks	3-23	
longitudinal system	1-28		FLIR Operation	8-15	
crew coordination	9-1		FLIR System.....	8-7	
briefing.....	9-1		Floodlights Switch	1-36	
debriefing.....	9-2		Flow Indicator	1-41	
duties	9-1				
in-flight	9-2				

	Page Text	No. Illus.		Page Text	No. Illus.
Flying, Night.....	2-2		G		
personal flying equipment	2-2				
FM Controls		7-7	“G” Limits, Aircraft		1-64
Formation	3-2, 3-18		Gage Select Switch Fuel.....	1-21	
crossunder	3-19		test switch, fuel	1-21	
free cruise	3-19		Gear, Landing	1-31	
lights switch	1-37		emergency extension.....	5-14	
parade	3-18		functional checkflight procedures	3-23	
rendezvous	3-19		unsafe landing gear	5-19	5-20
night flying	3-20		General.....	3-1	
running	3-20		arrangement		1-2
safety rules.....	3-20		communications	7-2	
turning.....	3-19		mission planning.....	3-3	
section approaches.....	3-20		Generator		
take-off.....	3-20		failure.....	5-13	
tail chase	3-19		both generators out	5-13	
Forward Looking Infrared Detecting			generator out	5-13	
Set (FLIR).....	8-7		oil tank, smoke generator	1-51	
Friction Lever	1-17		out caution light	1-23	
Fuel			smoke generating system	1-51	
alternate fuel use, cold weather	6-7		control switch	1-51	
control.....	1-55		oil tank	1-51	
controls and indicators.....	1-21		switches.....	1-23	
auxiliary fuel caution lights	1-23		Glide		
boost pump caution light	1-22		distance		5-10
condition levers	1-21		maximum.....	5-9	
emergency shutoff switches	1-22		Governor		
external fuel transfer switch.....	1-22		governing control mode.....	1-17	
feed warning lights	1-22		overspeed governor (OSG)	1-17	
gage select switch	1-21		propeller.....	1-17	
gage test switch	1-21		underspeed governor (USG)	1-17	
level window assembly	1-21		Grading Instructions	10-2	
low caution light.....	1-22		closed book examination	10-2	
motive flow caution lights.....	1-22		open book examination.....	10-2	
quantity indicator	1-21		oral examination and OFT		
enrichment system	1-11		procedure	10-2	
oil tank, smoke generating system	1-51		Ground		
primary alternate and emergency	1-55		cold weather procedures, check.....	6-7	
refueling.....	1-53		emergency	5-1	
servicing	1-56		egress	5-5	
smoke generator oil tank	1-56		fire	5-4	
system failure, fuel.....	5-12		introduction.....	5-1	
auxiliary fuel tank transfer	5-13		special instructions	5-1	
boost pump caution.....	5-12		evaluation.....	10-2	
fuel feed warning	5-12		operation.....	1-19, 3-10	
MTV fuel caution	5-12		safety switch.....	1-32	
weight vs. temperature	11-2		training.....	2-1	
Functional Checkflight Procedures	3-23		requirements	2-1	
conditions requiring	3-23		subjects	2-1	
introduction	3-23		Guide, Briefing.....	3-1	
procedures	3-23		Gunnery Equipment	8-1	
Function Knob.....	7-12		sponson	8-1	
Fuses			switches	8-3	
a-c	1-25	1-26			

	Page Text	No. Illus.		Page Text	No. Illus.
H					
Handle					
canopy door	1-43		pump indicating light	1-28	1-6
emergency stores jettison	8-4		servicing, hydraulic system	1-55	
flap	1-31		shutoff failure, pump	5-19	
inertia reel lock	1-46		system operation, hydraulic limits	1-62	
kit deployment	1-46		I		
landing gear	1-32		Ice and Rain	6-2	
parachute emergency release	1-46		landing	6-2	
parking brake	1-33		removal	1-56	
Handling, Single Engine	4-8		ICS Controls	7-3	7-3
Harness and Lap Belt, Parachute	1-45		Identification Systems	7-12	
Heating, Ventilation, and Defrost			AIMS	7-14	
Systems	1-37	1-38	IFF-SIF, AN/APX-64(V)	7-12	
anti-G suit systems	1-39		controls and indicators	7-12	7-14
controls	1-37	1-38	code dials	7-13	
bleed air switches	1-37		Master knob	7-12	
canopy ventilators	1-39		switch		
cockpit air/defrost knob	1-37		antenna	7-13	
observer's air ventilation valve	1-39		emergency	7-13	
observer's cockpit air valve	1-39		identification	7-13	
ram-air knob	1-37		mode select	7-13	
temperature knob	1-37		operation	7-14	
operation	1-39		Ignition Systems	1-11	
HF Comm Controls	7-8	7-8	Implementation	10-1	
operation	7-9		Indexer		
HF Communications Set,			approach	1-34	
AN/ARC-120	7-8		light switch	1-35	
controls	7-8	7-8	Indicator		
knob			airspeed	1-33	
frequency	7-8		angle-of-attack system	1-34	
mode	7-9		attitude indicator	1-34	
RF sensitivity	7-9		bearing distance heading (BDHI)	7-12	
operation	7-9		controls and indicators, landing gear	1-32	
High Altitude Approach (Typical)	6-3		elevator trim	1-31	
High-Intensity Lights Switch	1-35		engine and propeller	1-16	
High Oil Pressure (Above 120 PSI)	5-11		torque	1-16	
High Speed Flight	4-2		flap position	1-31	
Hold Open Rod, Cargo Door	1-47		fuel quantity	1-21	
Holding	6-2		oil pressure	1-16	
Hot Brakes	5-20		outside air temperature	1-33	
Hot Start/Engine Fire on Start	5-4		oxygen system, controls and	1-39	
Hot-Weather and Desert Procedures	6-8		position indicator, landing gear	1-32	
approach and landing	6-8		radar altimeter	7-2	
before leaving	6-8		turbine inlet temperature indicators	1-16	
before starting engines	6-8		turn-and-slip	1-34	
before take-off	6-8		vertical velocity	1-33	
exterior inspection	6-8		Indoctrination and Training	2-1	
starting	6-8		Inhibited Region Test	8-18	
take-off	6-8		Inertia Reel	1-45	
Hydraulic Power System	1-28		lock handle	1-46	
failure	5-19		In-Flight		
operation limits	1-62		crew coordination	9-1	
pressure caution light	1-28		emergencies	5-9	
			canopy open	5-14	
			cargo bay open	5-14	
			electrical fire	5-12	

	Page Text	No. Illus.		Page Text	No. Illus.
electrical system failures	5-13		Intercom Operation	7-5	
emergency jettison	5-14		Interior Lights	1-35	
engine failure	5-7		cargo bay lights	1-35	
fuel system failures.....	5-12		interior lights control	1-35	1-36
landing gear emergency extension	5-14		observer's cockpit	1-35	
structural damage/control			pilot's cockpit	1-35	
malfunction	5-14		Inverters and Instrument Power Switch	1-25	
trim systems failure	5-13				
Ignition System	1-11, 1-59		J		
Infrared Laser Detecting-Ranging Set,			Jack/Moor Pads	1-56	1-57
AN/AAS-37	8-7		Jettison		
controls and indicators	8-8		auxiliary fuel tanks—maximum		
FLIR command switch.....	8-13	8-13	airspeed.....	1-62	
FLIR control panel.....	8-8		emergency.....	5-14	
laser control panel.....	8-13		external stores—maximum allowable		
laser enable switch	8-13		airspeed.....	1-62	1-65
observer's video indicator.....		8-12	handle emergency stores.....	8-4	
operation.....	8-15				
pilot's video indicator.....		8-13	K		
pulse coder generator.....	8-15	8-14	Kit		
receiver/transmitter-converter			deployment handle.....	1-46	
control	8-10		first aid	1-45	
target tracking sight control.....	8-10		survival	1-45	
video tracking control	8-10		Knob		
operation.....	8-15		channel, TACAN	7-11	
Instructions, Special	5-1		cockpit air/defrost	1-37	
Instruments			console lights	1-35	
a-c bus	1-25		flight instrument light	1-35	
accelerometer	1-33		frequency	7-7, 7-8	
approach, crew coordination.....	9-2		function, TACAN	7-11	
clock	1-34		HF frequency	7-8	
flight procedures, all-weather	6-1		HF mode.....	7-9	
checklist.....	6-1		hot mike (listen)	7-4	
climb.....	6-1		talk	7-4	
cruise	6-1		ICS monitor.....	7-4	
descent	6-2		IFF-SIF master	7-12	
holding	6-2		instrument lights.....	1-35	
instrument approaches	6-2		KY-28 function.....	7-9	
missed approach	6-2		manual frequency.....	7-5	
take-off	6-1		master volume.....	7-4	
lights knob.....	1-35		mode.....	7-5	
markings	1-59	1-60	off-set—push-to-set	7-2	
navigation.....	1-34		preset channel knob	7-5	
outside air temperature indicator	1-33		push-to-set	7-1	
panel.....		1-6	ram-air knob	1-37	
pitot-static system	1-33		RF sensitivity	7-9	
power caution light	1-25		sight reticle brightness	8-1	
power failure	5-13		squelch	7-7	
requirements, prior to flight.....	2-2		TACAN volume	7-11	
standby magnetic compass	1-34		temperature.....	1-37	
take-off, instrument.....	6-1		transmit select	7-4	
training.....	2-1		UHF function	7-5	
turn-and-slip indicator	1-34		UHF volume	7-5	
vertical gyro indicating system	1-33		VHF-FM volume	7-7	
Intelligence.....	2-1		volume	7-7	

	Page Text	No. Illus.		Page Text	No. Illus.
KY-28 System.....	7-9		LASER Control Panel	8-13	8-14
controls	7-9	7-9	fire control grip	8-14	8-14
function knob	7-9		laser arming switch.....	8-13	
mode switch	7-9		laser range indicator	8-13	
zeroize switch	7-10		laser status indicators.....	8-14	
operation.....	7-10		RANGE DISPLAY knob	8-14	
control unit	7-10		LASER ENABLE Switch	8-13	
			LASER Operation	8-17	
L			LASER Rangefinder Designator (LRD).....	8-8	
Landing			Lateral		
after (when clear of runway).....	3-15		control	4-1	
airspeed, limit	1-62		directional	4-2	
approach.....	6-8		spoilers	1-29	
before	3-14		Lever		
cold-weather procedures	6-6		condition	1-17	
crosswind	3-15		diluter lever, oxygen system	1-41	
data	11-81		emergency, oxygen system	1-41	
distance	11-81		friction.....	1-17	
example	11-81		levers, condition	1-21	
emergencies.....	5-14		power	1-16	
ditching (water landing).....	5-15		sight depression	8-3	
emergency rescue.....	5-20	5-21	supply lever, oxygen system	1-41	
forced landing.....	5-15		Lighting Systems		
hydraulic system failure.....	5-19		exterior	1-37	1-36
immediate landing—low altitude	5-15		interior.....	1-35	1-37
precautionary approach	5-16	5-17	Lights		
single-engine landing pattern	5-16	5-18	approach	1-34	
tire failures.....	5-19		test switch	1-35	
unsafe landing gear	5-19		auxiliary fuel caution	1-23	
wheel brake failure.....	5-20		boost pump caution.....	1-22	
functional checkflight procedures	3-29		cargo bay.....	1-35	
gear emergency extension.....	5-14		chip caution	1-12	
gear limit speed	1-62		chip detection caution	5-11	
hot-weather and desert procedures.....	6-8		feed warning.....	1-22	
landing gear	1-31		inclinometer.....	8-1	
controls and indicators.....	1-32		instrument lights knob	1-35	
handles	1-32		instrument power caution	1-25	
position indicator	1-32		landing gear, unsafe	1-32	
unsafe light	1-32		motive flow caution.....	1-22	
wheels warning lights	1-32		observer's cockpit lights	1-35	
landing in rain	6-2		low altitude.....	7-2	
landing sink rates.....	1-64		low caution	1-22	
nose tire failure on landing	5-19		overtemperature warning.....	1-15	
performance data	11-81		overtorque caution.....	1-16	
single-engine landing	5-16		pilot's cockpit	1-35	
slippery runways.....	3-15		pilot's warning and caution.....	5-2	
T.O./LAND	1-19		pressure caution	1-28	1-6
touch-and-go pattern	3-15		pump indicating	1-28	1-6
typical landing and touch-and-go			nacelle fire warning	1-14	
pattern	3-13		start ignition on	1-15	
unsafe landing gear	5-19	5-20	system.....	1-35	
wheel brake failure.....	5-20		exterior	1-37	
hot brakes.....	5-20		interior.....	1-35	
			test switch, fire		
			detection/warning	1-15	
			trim neutral	1-31	1-6
			wheels warning.....	1-32	
			functional checkflight procedures	3-23	

	Page Text	No. Illus.		Page Text	No. Illus.
Limits			Miscellaneous Equipment	1-51	1-52
acceleration	1-62	1-65	map and data cases	1-51	
aircraft "G"		1-64	message drop door	1-51	
aircraft operating	1-59		rearview mirrors	1-51	
airspeed	1-62		relief tubes	1-51	
center-of-gravity	1-64		smoke generating system	1-51	
engine turbine inlet temperature	1-59		Missile Equipment	8-1	
exhaust gas temperature (START)		1-61	Mission		
external store	1-62	1-73	aircraft	1-4	
tank	1-62		cargo transport	1-4	
flap limit speeds	1-62		night observation surveillance		
hydraulic system operation	1-62		(NOS)	1-4	
landing gear limit speed	1-62		strike-reconnaissance or TAC(A)	1-4	
oil pressure	1-61	1-60	briefing guide	3-1	
operating limitations	1-59		cargo compartment	1-47	
ignition system	1-59		door, cargo	1-47	
military power	1-59		hold open rod	1-47	
normal power	1-59		equipment	1-47	
rpm limits	1-59		planning	3-3	
starter limits	1-59		profile	3-1	
reverse thrust	1-62		training	2-1	
rpm limits	1-59		weapon training, mission and	2-2	
STOL operation	1-62		Mode		
torque limits	1-61	1-61	beta control	1-17	
turbine inlet temperature	1-59	1-61	governing control	1-17	
weight	1-64		Monitor Bus	1-24	
Longitudinal System	1-28		a-c	1-25	
Low Caution Light, Fuel	1-22		Motive Flow Caution Lights, Fuel	1-22	
Low Speed Flight	4-2				
LRD Inhibited Gimbal Angle Envelope		8-19	N		
M			Nacelle Fire Warning System	1-14	
Main Bus	1-23		NATOPS Evaluation	10-1	
Main Tire Failure			forms	10-15—10-19	
on landing	5-19		program	10-1	
on take-off	5-8		concept	10-1	
Maneuvers, Prohibited	1-62		definitions	10-1	
Map and Data Cases	1-51		final grade determination	10-3	
Markings, Instrument	1-59		flight	10-2	
Material Specifications	1-53		grading criteria	10-3	
Maximum			ground	10-2	
allowable airspeed	1-62	1-63	implementation	10-1	
glide	5-9		records and reports	10-3	
distance		5-10	question bank	10-5	
MB-1 Attitude Indicator	1-34		re-evaluation	10-1	
Message Drop Door	1-51	1-52	Nautical Miles per 100 lbs of Fuel	11-31	
Military Power	1-59		Navigation Systems	7-10	
operation—1108°C	1-59		instruments	7-10	
Minimum Speeds			TACAN, AN/ARN-52(V)	7-10	7-10
normal operations	1-62		controls	7-10	
landing	1-62		Negative Torque Sensing Operation	1-18	
take-off	1-62		Night Flying	2-2, 6-6	
STOL operations	1-62		procedures	3-20	
Mirrors, Rearview	1-51		formation	3-20	
			rendezvous	3-20	
			Night Observation Surveillance (NOS)	1-4	

	Page Text	No. Illus.		Page Text	No. Illus.
Normal			oxygen system	1-41	
operating procedures	3-1		emergency	1-41	
power operation—1034°C	1-59		normal	1-41	
Nose			simulated engine(s)-out	3-18	
tire failure on landing	5-19		STOL	3-16	
tire failure on take-off	5-8		TACAN	7-11	
wheel steering	1-33		Optical Sight	8-1	
button	1-33		Optimum Cruise Altitude	11-43	
			example	11-43	
O			Outside Air Temperature Indicator	1-33	
Observer's			Overtemperature Warning Lights	1-15	
cockpit	1-8		Oxygen System		
fire control grip	8-14	8-14	controls and indicators	1-39	1-40
FLIR control panel	8-8		emergency operation	1-41	
interior inspection	3-5		normal operation	1-41	
laser control panel	8-13	8-14	pressure indicator	1-41	
lights, cockpit	1-35		regulator	1-39	
pulse coder generator	8-15		diluter lever	1-41	
receiver/transmitter-converter control ..	8-10		emergency lever	1-41	
target tracking sight control	8-10		flow indicator	1-41	
valve, cockpit air	1-39		pressure indicator	1-41	
ventilation valve, air	1-39		supply lever	1-41	
video indicator	8-10	8-12	servicing	1-55	
brightness control	8-11		system check	1-41	
contrast control	8-11				
elapsed time meter	8-11		P		
power switches	8-10		Pads, Jack/Moor	1-56	1-57
status indicator	8-11		Parachute		
warning and caution lights	1-8, 5-3		emergency release handle	1-46	
OFT/WST Procedures Evaluation	10-2		harness and lap belt	1-45	
Oil			recovery	1-43	
engine	1-12		Parade Formation	3-18	
high pressure (above 120 PSI)	5-11		Parking Brake Handle	1-33	
pressure indicator	1-16		Pedal		
pressure limits	1-61	1-60	adjust crank	1-29	1-6
servicing oil systems	1-55		control sticks and rudder	1-29	1-30
smoke generator oil tank, servicing	1-56		Performance Data	11-1	
system failure	5-11		basic	11-1	
systems, oil	1-12		climb	11-23	
tank, smoke generating system	1-51		descent	11-77	
Open Book Examination	10-2		endurance	11-65	
Operation			flight characteristics	11-69	
all-weather	6-1		landing	11-81	
automatic/programmed dispensing	7-19		range	11-43	
communications	7-21		take-off	11-7	
countermeasures dispensing set	7-19		Personal Flying Equipment	2-2	
engine	1-16		Pilots		
ground	1-19	3-10	check	3-23	
hydraulic system limits	1-62		instrument panel		1-6
intercom	7-5		interior inspection	3-5	
manual operation (single dispensing)	7-19		left console		1-5
minimum speeds-STOL	1-62		lights, cockpit	1-35	1-36
negative torque sensing	1-18		right console		1-7

	Page Text	No. Illus.		Page Text	No. Illus.
video indicator	8-12	8-13	Primary		
brightness control	8-12		a-c bus	1-25	
contrast control	8-12		d-c bus	1-24	
elapsed time meter	8-13		primary, alternate and emergency fuels ..	1-55	
status indicator	8-13		Principal Dimensions		1-9
warning and caution lights		1-8	Procedures		
Pitot Heat Switch	1-33		aircraft handling and launch	3-22	
Pitot-Static System	1-33		climb 5000 feet (profiles ABCD)	3-26	
airspeed indicator	1-33		climb and level flight 10,000 feet		
altimeters, AAU-21/A and			(profiles ABC)	3-27	
AAU-24/A	1-33		cold-weather	6-6	
pitot heat switch	1-33		descent	3-29	
vertical velocity indicator	1-33		ejection	5-23	
Planning, Crew Coordination	9-1		emergency	5-1	
Planning, Mission	3-3		hot-weather and desert	6-8	
Postflight	9-2		landing pattern and recovery	3-22	
Poststart	9-2		night flying	3-20	
Power			formation	3-20	
asymmetric	4-6		rendezvous	3-19	
correction nomogram	11-8	11-16	normal	3-1	
engine speed control		1-18	operating	3-1	
erect spins	4-5		shore-based	3-5	
asymmetric	4-6		stall	4-5	
symmetric	4-5		weapon delivery	8-4	
external	1-25, 1-53		Prohibited Maneuvers	1-62	
governing control mode	1-17		Propellers	1-15	
hydraulic power system	1-28, 1-55		engine fire on shutdown (propellers		
instrument power caution light	1-25		unfeathered)	5-4	
power failure	5-13		(propellers feathered)	5-5	
levers	1-16		governor	1-17	
military	1-59		indicators, engine and propeller	1-16	
normal	1-59		Pulse Coder Generator	8-15	8-14
overspeed governor (OSG)	1-17		code fail indicator	8-15	
power management control system			code switches	8-15	
(PMCS)	1-16		designator fail indicator	8-15	
propeller governor	1-17		elapsed time meter	8-15	
reverse power	1-20		low power indicator	8-15	
underspeed governor (USG)	1-17		range fail indicator	8-15	
Power Management Control System			TEST/GO/ON/OFF indicator		
(PMCS)	1-16		switches	8-15	
Preflight			Pump		
checks			hydraulic shutoff failure	5-19	
ejection seat inspection	3-6	3-7	indicating light, hydraulic	1-28	1-6
exterior inspection	3-5		Push-To-Set Knob	7-1	
interior inspection	3-5				
Preparation for Flight	3-5		Q		
planning	3-5		Qualifications, Flight	2-1	
restrictions	3-5		Qualified	10-1	
weight and balance	3-5		Question Bank, NATOPS Evaluation	10-5	
Pressure Indicator, Oil	1-16		R		
Prestart	9-1		Radar Altimeter System,		
Pretake-off	3-25, 9-2		AN/APN-171(V)	7-2	
crew coordination	9-2		indicator and controls	7-2	7-2
functional checkflight procedures	3-25		low-altitude light	7-2	
Pretaxi					
functional checkflight procedures	3-24				

	Page Text	No. Illus.		Page Text	No. Illus.
off-set—push-to-test knob.....	7-2		oil system.....	1-55	
operation	7-2		oxygen system.....	1-55	
Radar Approach (Typical).....		6-5	smoke generator oil tank	1-56	
Ram-Air Knob.....	1-37		struts	1-56	
Range Data.....	11-31		tires.....	1-56	
optimum cruise altitude	11-31		Shore-Based Procedures	3-5	
Ranging Set, Infrared Laser			aborted/hung start	3-9	
Detecting	8-7		aerobatics	3-18	
Rearview Mirrors.....	1-51		after landing (when clear of		
Recovery			runway).....	3-15	
capability.....	1-47	1-48	after take-off.....	3-12	
parachute	1-43		before		
Re-Evaluation, NATOPS	10-1		landing.....	3-14	
conditionally qualified	10-1		leaving aircraft.....	3-16	
qualified.....	10-1		start	3-8	
unqualified	10-1		take-off.....	3-11	
Refueling.....	1-53		taxi	3-11	
control.....	1-55		climb	3-14	
primary, alternate and emergency	1-55		cockpit check	3-6	
Regulator, Oxygen	1-39	1-40	crosswind take-off	3-12	
Relief Tubes	1-51		cruise.....	3-14	
Remote Site Operations.....	3-18		descent.....	3-14	
Removal, Ice	1-56		ejection seat inspection	3-6	3-7
Rendezvous			exterior inspection	3-5	
night flying	3-20		flight characteristics	3-14	
running	3-20		formation		
safety rules.....	3-20		crossunder	3-19	
turning.....	3-20		free cruise	3-19	
Requirements.....	2-1		parade	3-18	
currency.....	2-2		rendezvous.....	3-19	
Rescue, Emergency	5-20	5-21	section approaches	3-20	
Reverse Power	1-20		section take-off	3-20	
Reverse Thrust Limits.....	1-62		tail chase	3-19	
Rocket			ground operation		3-10
equipment	8-1		landing.....	3-14	
firing.....	8-4		crosswind	3-15	
RPM Limits	1-59		slippery runways.....	3-15	
Rudder Trim Switches.....	1-31	1-30	touch-and-go pattern	3-15	
Runway, Slippery	3-15		normal take-off.....	3-12	
			preflight checks	3-5	
S			exterior inspection—observer's.....	3-5	
Safety			interior inspection—pilot's.....	3-5	
flight.....	2-1		preparation for flight	3-5	
Seat			planning	3-5	
adjust switches	1-46		restrictions	3-5	
ejection	1-43	1-44	weight and balance	3-5	
inspection.....	3-6		remote site operations	3-18	
safety harness	1-46		shutdown.....	3-15	
Secondary Bus	1-24		simulated engine(s)-out operation	3-18	
Servicing			starting engines.....	3-8	
aircraft.....	1-53	1-54	STOL operations.....	3-16	
batteries	1-56		landing.....	3-17	
hydraulic system.....	1-55		take-off.....	3-16	
ice removal.....	1-56		take-off.....	3-11	
			crosswind	3-12	
			normal.....	3-12	

	Page Text	No. Illus.		Page Text	No. Illus.
taxi checks	3-11		stall speeds		4-4
typical landing and touch-and-go patterns		3-13	underspeed governor (USG)	1-17	
unfeathering (if required)	3-8		Spins.....	4-5	
wave-off.....	3-15		avoidance.....	4-5	
Shoulder Harness Manual Release	1-47		erect.....	4-5	
Shutdown			recovery.....	4-6	
engine.....	1-20		inverted	4-7	
functional checkflight procedures	3-23		recovery.....	4-7	
procedures	3-15		Spoilers.....	1-29	
Shutoff Switches, Fuel.....	1-22		Stall		
SIF Code Dials.....	7-13		accelerated	4-3	
Sight			normal	4-3	
armament controls	8-1	8-2	procedures.....	4-5	
bomb release button.....	8-3		accelerated	4-5	
depression lever	8-3		approach turn	4-5	
emergency stores jettison handle	8-4		power off	4-5	
reticle brightness knob.....	8-1		power on.....	4-5	
stores emergency release button	8-4		speeds	11-69	4-4
switches			warning system	1-35	
bomb arm	8-3		Standard Atmosphere Table		11-6
filament select	8-1		Standard Data	11-2	
guns.....	8-3		airspeed conversion.....	11-2	11-4
master arm	8-1		example.....	11-2	
station mode select	8-3		speed-altitude correction	11-2	11-5, 11-6
optical.....	8-1		standard atmosphere table	11-3	11-6
Simulated Engine(s)-Out Operation.....	3-18		Standby Compass Light Switch	1-37	
Single Engine			Standby Magnetic Compass	1-34	
characteristics	4-7		Start		
angle-of-attack relationship	4-8		air start (ignition and unfeather switches).....	1-14	
failure	4-7		before.....	3-8, 6-8	
handling	4-8		engine	1-19, 3-8	
minimum control speed	4-8		functional checkflight procedures	3-24	
minimum safe speed.....	4-8		generators.....	1-23	
climb.....	11-23		ignition on light.....	1-15	
landing.....	5-16		starter limits	1-59	
Smoke and Fumes, Elimination of	5-12		switches.....	1-14	1-24
Smoke Generating System.....	1-51		Starter-Generator Duty Cycle	1-59	
control switch	1-51		Steps and Handholds.....	1-43	
oil tank	1-51		STOL		
servicing.....	1-56	1-55	maximum performance	3-16	
Special Instructions	5-1		landing.....	3-17	
Speed			take-off	3-16, 11-14	
airspeed conversion.....	11-2	11-4	operations.....	3-16	
example.....	11-2		Stores Emergency Release Button.....	8-4	
altitude sensor.....	1-43	1-45	Strafe		
engine control	1-19	1-19	fixed guns.....	8-4	
high speed flight.....	4-2		[GPU-2/A (M-197) gun pod].....	8-4	
low speed flight.....	4-2		SUU-11A/A pods	8-4	
minimum single-engine control and flyaway speeds.....	11-69		Strike-Reconnaissance of TAC(A).....	1-4	
example	11-69		Structural Damage/Control		
overspeed governor (OSG)	1-17		Malfunction	5-14	
speed-altitude correction	11-2	11-5, 11-6	Struts.....	1-56	
			Sub-Area.....	10-2	

	Page Text	No. Illus.		Page Text	No. Illus.
Supply Lever	1-41		master arm	8-1	
Survival			microphone	7-4	
equipment	5-23		select observer	7-4	
kit	1-45		mode	7-9, 8-8	
requirements	2-1		mode select	7-13	
Surveillance, Night Observation (NOS)	1-4		mode selector control	7-17	
Switch			pitot heat	1-33	
aileron and elevator trim	1-31	1-30	polarity	8-9	
air start (ignition and unfeather)	1-14		power	8-10	
alternate flaps	1-31		POWER/FLARE SALVO	7-17	7-18
ammeter select	1-23		RESET	7-19	
antenna select	7-13		rudder trim	1-31	1-30
anticollision lights	1-37		seat adjust switches	1-46	
approach lights test	1-35		slaved-free	7-1	
attitude gyro erect	1-34	1-6	squelch disable	7-5	
battery	1-23		standby compass light	1-37	
bleed air	1-37		starter	1-14	
bomb arm	8-3		station mode	8-3	
cargo bay lights	1-37		gage	1-21	
CHAFF B INTV	7-17		test/go/on/off indicator	8-15	
CHAFF B QTY	7-17		trim select	1-29	1-30
chaff dispensing	7-17		VHF-FM take command	7-7	
CHAFF S INTV	7-17		windshield wiper, control	1-39	
CHAFF S QTY	7-17		wing and tail lights	1-37	
code	8-13		yaw damper	1-31	1-30
control switch, smoke generating system	1-51		zeroize	7-10	
emergency shutoff	1-22		Systems		
exterior light master	1-37		AIMS system	7-14	
external fuel transfer	1-22		angle-of-attack	1-34	
field-of-view	8-9		anti-G suit	1-39	
filament select	8-1		check, FLIR/LRD	3-23	
fire detection/warning lights test	1-15		communications	7-2	
FLARE INTV	7-19		compass	7-1	
flare dispensing	7-20		directional	1-29	
FLARE QTY	7-19		electrical power	1-23	
floodlights	1-35		failures	5-13	
FLR command	8-13		engines	1-11	
focus	8-9		exhaust system	1-11	
formation lights	1-37		fuel system	1-20	
gage select	1-21		failures	5-12	
generator	1-23		heating, ventilation, and defrost	1-37	
grayscale	8-8		hydraulic failure	5-19	
ground safety	1-32		hydraulic system operation limits	1-62	
guns	8-3		identification systems	7-12	
high-intensity lights	1-35		ignition	1-11, 1-59	
identification	7-13		KY-28	7-9	
IFF emergency switch	7-13		lateral control	4-1	
indexer light	1-35		nacelle fire warning	1-14	
jammer dispensing	7-20		navigation	7-10	
JAMMER INTV	7-19		oil	1-12	
JAMMER QTY	7-19		oxygen	1-39	
KY-28 mode	7-9		pitot-static	1-33	
L10, L20, R10, R20 LOAD	7-19		power management control system (PMCS)	1-16	
laser arming	8-13		radar altimeter, AN/APN-171(V)	7-1	
laser enable	8-13				

	Page Text	No. Illus.		Page Text	No. Illus.
stall warning system	1-35		pretake-off	9-2	
system, lighting	1-35		sample take-off	11-17	
exterior	1-37		section take-off	3-20	
interior	1-35		taxi, before	3-11	
systems, servicing	1-55		T.O./LAND	1-19	
trim systems failure	5-13		Tank		
vertical gyro indicating	1-33		external	1-62	
T			fuel tanks	1-20	
Table of Electronic Equipment	7-3		Target Tracking Sight Control	8-10	
TACAN, AN/ARN-52(V)	3-29, 7-10	7-10	Taxi		
air-to-air ranging	7-11		before	3-11	
audio identifier	7-11		checks	3-11	
channel knobs	7-11		functional check flight procedures	3-25	
controls	7-10		procedures, cold-weather	6-25	
false bearings	7-11		Temperature		
function knob	7-11		knob	1-37	
operation	7-11		limits	1-59	
power switch	7-11		turbine inlet	1-59	1-61
procedures	7-12		weight vs. temperature, fuel	11-2	
air-to-air ranging (Homer)	7-12		Thunderstorms, Turbulence, and	6-2	
air-to-air ranging (Homing)	7-12		Tires		
bearing-distance-heading			failures		
indicator (BDHI)	7-12		main tire failure on landing	5-19	
normal navigation	7-12		on take-off	5-8	
volume knob	7-11		nose tire failure on landing	5-19	
Tachometers	1-16		on take-off	5-8	
Tail Chase	3-19		servicing	1-56	
Take-Off			Torque		
after	3-12		indicators	1-16	
airspeed limits	1-62		limits	1-61	1-61
before	3-11		sample minimum vs. gross weight	11-18	
cold-weather procedures	6-7		Training		
crosswind	3-12		ground	2-1	
departure	9-2		indoctrination	2-1	
distance example problem	11-19		instrument	2-1	
emergencies	5-7		mission	2-2	
aborted take-off (one engine)	5-7		weapon, mission and	2-2	
aborted take-off (two engines)	5-7		Transponder Test Set	7-16	
engine failure	5-7		operation	7-16	
fire after take-off	5-7		Transport		
gross power loss during take-off	5-7		cargo	1-4	
main tire failure	5-8		Trigger	8-3	
nose tire failure	5-8		Trim		
flight characteristics	4-2		neutral lights	1-31	1-6
functional check flight procedures	3-26		select switch	1-29	1-30
hot weather and desert procedures	6-8		systems failures	5-13	
in normal	1-20		normal and alternate pitch	5-13	
instrument	6-1		normal failure	5-13	
main tire failure on take-off	5-8		Tubes, Relief	1-51	
normal	3-12		Turbine Inlet Temperature	1-59	1-61
nose tire failure	5-8		indicators	1-16	
performance data	11-7		system	1-15	
distance	11-7		Turbulence and Thunderstorms	6-2	
wind component	11-7		approaching	6-6	
			in the storm	6-6	
			Turn-and-Slip Indicator	1-34	
			Typical Landing, Touch-and-Go Pattern	3-13	

	Page Text	No. Illus.		Page Text	No. Illus.
U			W		
UHF/ADF (AN/ARA-50)			Warning, Fuel Feed.....	5-12	
functional checkflight procedures	3-28		Wave-off	3-15	
UHF Comm Controls.....	7-5	7-6	Weapons		
operation	7-6		briefing guide	3-2	
UHF Communications Set, AN/ARC-51	7-5		mission and training.....	2-2	
controls	7-5		systems	8-1	
knob			armament equipment	8-1	
function.....	7-5		delivery procedures.....	8-4	
manual frequency.....	7-5		armament safety check	8-5	
mode.....	7-5		dispensing flares	8-5	
preset channel	7-5		dropping bombs.....	8-4	
volume	7-5		firing rockets.....	8-4	
squelch disable switch.....	7-5		strafe	8-4	
operation	7-6		Weather	3-1	
UHF Radio (AN/ARC-51)			Weight		
functional checkflight procedures	3-28		aircraft operating.....	11-2	FO-9
Unfeathering (If Required)	3-8		balance, weight and	3-5	
Unqualified.....	10-1		gross weight	1-1	
Unsuccessful Air Start	5-11		limits	1-64	
			sample minimum torque vs. gross.....	11-18	
V			Wheel		
Valve			brake, failure.....	5-20	
air ventilation, observer's	1-39		brakes, wheel.....	1-32	
observer's cockpit air valve	1-39		parking brake handle	1-33	
Ventilators, Canopy	1-39	1-2	nose wheel steering.....	1-33	
Vertical Velocity Indicator	1-33		button.....	1-33	
VHF-FM Communicators Set	7-6		warning lights	1-32	
AN/ARC-54	7-7		functional checkflight procedures	3-23	
controls	7-6		Wind Component	11-7	11-10
knob			example.....	11-7	
frequency	7-7		Windshield Wiper	1-39	
mode.....	7-7		control switches.....	1-39	
squelch	7-7		Wing Flaps.....	1-31	
volume	7-7		controls and indicators.....	1-31	
take command switch.....	7-7		flaps		
operation	7-7		alternate switch	1-31	
homing	7-8		handles	1-31	
normal voice communications	7-7		position indicator	1-31	
retransmission	7-8		wing and tail light switch	1-37	
VHF-FM Radio			Worksheet, VT Pilot NATOPS		
(AN/ARC-54 and AN/ARC-131).....	3-29		Evaluation.....	10-16	
VHF-FM Take-Command Switch	7-7		Y		
Visual Communications	7-21		Yaw Damer	1-29	
V-N Diagram.....	1-63		switch	1-31	1-30
Voltammeter	1-23		Z		
Volume			Zeroize Switch	7-10	
master	7-4				
TACAN	7-12				