

MSG RYAN

T.O. 1C-121A-1

UTILITY FLIGHT MANUAL

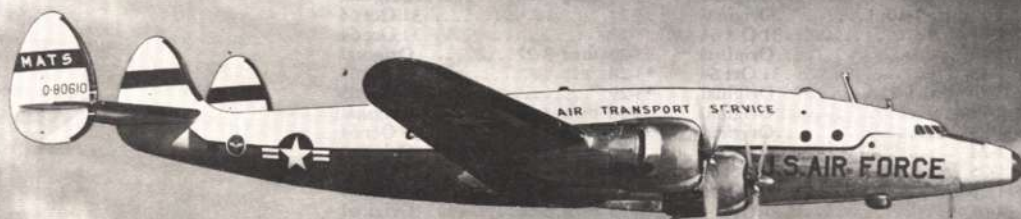

USAF SERIES **C-121A** AIRCRAFT

AF04(606)-13264

Commanders are responsible for bringing this publication to the attention of all AF personnel cleared for operation of subject aircraft.

PUBLISHED UNDER AUTHORITY OF THE SECRETARY OF THE AIR FORCE
AND THE CHIEF OF THE BUREAU OF AERONAUTICS

See Weekly Index T.O. 0-1-1A for current status of Operational and Safety Supplements.

CHANGE NOTICE

**LATEST CHANGED PAGES SUPERSEDE
THE SAME PAGES OF PREVIOUS DATE**

Insert changed pages into basic publication. Destroy superseded pages.

Reproduction for non-military use of the information or illustrations contained in this publication is not permitted without specific approval of the issuing service (BuAer or USAF). The policy for use of Classified Publications is established for the Air Force in AFR 205-1 and for the Navy in Navy Regulations, Article 1509.

LIST OF EFFECTIVE PAGES

INSERT LATEST CHANGED PAGES, DESTROY SUPERSEDED PAGES.

NOTE: The portion of the text affected by the changes is indicated by a vertical line in the outer margins of the page.

TOTAL NUMBER OF PAGES IN THIS PUBLICATION IS 484, CONSISTING OF THE FOLLOWING:

Page No.	Issue	Page No.	Issue
*Title	31 Jan 65	3-9	31 Oct 64
*A	31 Jan 65	3-10	31 Oct 64
i thru iv	Original	3-11 thru 3-20	Original
1-1 thru 1-10	Original	3-21	31 Oct 64
1-11	31 Oct 64	3-22	31 Oct 64
1-12	Original	3-23 thru 3-27	Original
1-13	31 Oct 64	*3-28	31 Jan 65
1-14 thru 1-22A	Original	*3-29	31 Jan 65
1-22B	Original	3-30 thru 3-41	Original
1-23	Original	3-42	31 Oct 64
1-24	Original	3-43 thru 3-48	Original
1-25	31 Oct 64	3-49	31 Oct 64
1-26 thru 1-30	Original	*3-50 thru 3-52B	31 Jan 65
1-31	31 Oct 64	3-53 thru 3-60	Original
1-32	31 Oct 64	4-1 thru 4-83	Original
1-33 thru 1-38A	Original	4-84 Blank	Original
1-38B Blank	Original	5-1 thru 5-8	Original
1-39 thru 1-52	Original	6-1 thru 6-4	Original
1-52A	31 Oct 64	7-1 thru 7-12	Original
1-52B Blank	31 Oct 64	8-1 thru 8-14	Original
1-53	Original	9-1 thru 9-12	Original
1-54	Original	A-1	Original
2-1 thru 2-8	Original	A-2 Blank	Original
2-9	31 Oct 64	A1-1 thru A1-17	Original
2-10	31 Oct 64	A1-18 Blank	Original
2-10A	Original	A2-1 thru A2-13	Original
2-10B Blank	Original	A2-14 Blank	Original
2-11	31 Oct 64	A3-1 thru A3-29	Original
2-12 thru 2-14	Original	A3-30 Blank	Original
2-14A	31 Oct 64	A4-1 thru A4-12	Original
2-14B Blank	31 Oct 64	A5-1 thru A5-64	Original
2-15	Original	A6-1 thru A6-4	Original
2-16	Original	A7-1 thru A7-21	Original
2-17	31 Oct 64	A7-22 Blank	Original
2-18	Original	X-1	Original
2-19	Original	X-2	Original
2-20	31 Oct 64	*X-3	31 Jan 65
2-21 thru 2-27	Original	X-4	Original
2-28	31 Oct 64	X-5	Original
2-29 thru 2-31	Original	*X-6	31 Jan 65
2-32	31 Oct 64	X-7	Original
2-33 thru 2-36	Original	X-8 Blank	Original
2-36A	31 Oct 64		
2-36B Blank	31 Oct 64		
2-37	31 Oct 64		
2-38 thru 2-42	Original		
3-1 thru 3-3	Original		
3-4	31 Oct 64		
3-5 thru 3-8	Original		

CURRENT FLIGHT CREW CHECKLISTS

1C-121A-1CL-1	2 Dec 63	Changed 31 Jan 65
1C-121A-1CL-2	2 Dec 63	Changed 31 Jan 65
1C-121A-1CL-3	2 Dec 63	
1C-121A-1CL-4	2 Dec 63	
1C-121A-1CL-5	2 Dec 63	

*The asterisk indicates pages changed, added, or deleted by the current change.

ADDITIONAL COPIES OF THIS PUBLICATION MAY BE OBTAINED AS FOLLOWS:

USAF ACTIVITIES.—In accordance with T.O. 00-5-2.

NAVY ACTIVITIES.—Submit request to nearest supply point listed below, using form NavAer 140; NASD, Philadelphia, Pa.; NAS, Alameda, Calif.; NAS, Jacksonville, Fla.; NAS, Norfolk, Va.; NAJ, San Diego, Calif.; NAS, Seattle, Wash.; ASD, NSC, Guam.

For listing of available material and details of distribution see Naval Aeronautics Publications Index NavAer 00-500.

D-2
USAF

Changed 31 January 1965

TABLE OF CONTENTS

SECTION I	DESCRIPTION	1-1
SECTION II	NORMAL PROCEDURES	2-1
SECTION III	EMERGENCY PROCEDURES	3-1
SECTION IV	AUXILIARY EQUIPMENT	4-1
SECTION V	OPERATING LIMITATIONS	5-1
SECTION VI	FLIGHT CHARACTERISTICS	6-1
SECTION VII	SYSTEMS OPERATION	7-1
SECTION VIII	CREW DUTIES	8-1
SECTION IX	ALL WEATHER OPERATION	9-1
APPENDIX I	PERFORMANCE DATA	A-1
	INDEX	X-1

READ IT HERE! THEN REMEMBER!

SCOPE. This manual contains the information necessary for safe and efficient operation of the C-121A. These instructions provide you with a general knowledge of the airplane, its characteristics, and specific normal and emergency operating procedures. Your flying experience is recognized, and therefore basic flight principles are avoided.

SOUND JUDGMENT. Instructions in this manual are for a crew inexperienced in the operation of this airplane. This manual provides the best possible operating instructions under most circumstances, but it is a poor substitute for sound judgment. Multiple emergencies, adverse weather, terrain, etc., may require modification of the procedures.

PERMISSIBLE OPERATIONS. The Flight Manual takes a "positive approach" and normally states only what you can do. Unusual operations or configurations (such as asymmetrical loading) are prohibited unless specifically covered herein. Clearance must be obtained from the C-121 Flight Manual Manager before any questionable operation is attempted which is not specifically permitted in this manual.

HOW TO BE ASSURED OF HAVING LATEST DATA. Refer to T. O. 0-1-1A which is issued weekly and provides current information regarding availability and status of Safety Supplements, recently issued Flight Manuals.

STANDARDIZATION AND ARRANGEMENT. Standardization assures that the scope and arrangement of all Flight Manuals are identical. The manual is divided into ten fairly independent sections to simplify reading it straight through or using it as a reference manual. The first three sections must be read thoroughly and fully understood before attempting to fly the airplane. The remaining sections provide important information for safe and efficient mission accomplishment.

SAFETY OF FLIGHT SUPPLEMENTS. Information involving safety will be promptly forwarded to you by Safety of Flight Supplements. Supplements covering loss of life will get to you in 48 hours by TWX, and those concerning serious damage to equipment within

10 days by mail. The title page of the Flight Manual and the title block of each Safety Supplement should be checked to determine the effect they may have on existing supplements. You must remain constantly aware of the status of all supplements—current supplements must be complied with, but there is no point in restricting your operation by complying with a replaced or rescinded supplement.

CHECKLISTS. The Flight Manual contains only amplified checklists. Condensed (abbreviated) checklists have been issued as separate technical orders—see the back of the title page for T. O. number and date of your latest checklist. Line items in the Flight Manual and checklists are identical with respect to arrangement and item number. Whenever a safety supplement affects the abbreviated checklist, write-in the applicable change on the affected checklist page. As soon as possible, a new checklist page, incorporating the supplement will be issued. This will keep hand-written entries of safety supplement information in your checklist to a minimum.

HOW TO GET PERSONAL COPIES. Each flight crew member is entitled to personal copies of the Flight Manual, safety supplements, and checklists. The required quantities should be ordered before you need them to assure their prompt receipt. Check with your supply personnel—it is their job to fulfill your Technical Order requests. Basically, you must order the required quantities on the Publication Requirement Table (T. O. 0-3-1). Technical Orders 00-5-1 and 00-5-2 give detailed information for properly ordering these publications. Make sure a system is established at your base to deliver these publications to the flight crews immediately upon receipt.

FLIGHT MANUAL AND CHECKLIST BINDERS. Loose leaf binders and sectionalized tabs are available for use with your manual.⁹ These are obtained through local purchase procedures and are listed in the Federal Supply Schedule (FSC Group 75, Office Supplies, Part 1). Binders are also available for carrying your abbreviated checklist. These binders contain plastic envelopes into which individual checklist pages are inserted. They are available in three capacities and are obtained through normal Air Force supply under the following stock list numbers: 7510-766-4268, -4269, and -4270 for 15, 25, and 40 envelope binders respectively. Check with your supply personnel for assistance in securing these items.

WARNINGS, CAUTIONS, AND NOTES. The following definitions apply to "Warnings," "Cautions," and "Notes" found throughout the manual.

WARNING

Operating procedures, techniques, etc., which will result in personal injury or loss of life if not carefully followed.

CAUTION

Operating procedures, techniques, etc., which will result in damage to equipment if not carefully followed.

Note

An operating procedure, technique, etc., which is considered essential to emphasize.

YOUR RESPONSIBILITY — TO LET US KNOW.
Every effort is made to keep the Flight Manual current. Review conferences with operating personnel and a constant review of accident and flight test reports assure inclusion of the latest data in the manual. However, we cannot correct an error unless we know of its existence. In this regard, it is essential that you do your part. Comments, corrections, and questions regarding this manual or any phase of the Flight Manual program are welcomed. These should be forwarded through your Command Headquarters to Sacramento Air Material Area (SMAMA), McClellan AFB, California, ATTN: SM NEO.

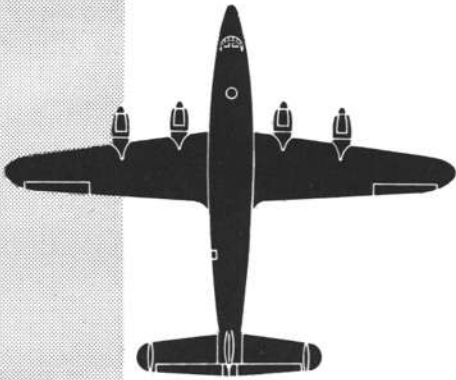

the
C-121A
AIRCRAFT



Figure 1-1

SECTION I

DESCRIPTION

TABLE OF CONTENTS

	<i>Page</i>
THE AIRCRAFT	1-1
ENGINES	1-3
PROPELLERS	1-11
ENGINE OIL SYSTEM	1-13
FUEL SYSTEM	1-14
ELECTRICAL POWER SYSTEM	1-18
HYDRAULIC POWER SYSTEM	1-25
FLIGHT CONTROL SYSTEM	1-31
WING FLAPS	1-34
LANDING GEAR	1-36
NOSE GEAR STEERING SYSTEM	1-37
BRAKE SYSTEM	1-38
INSTRUMENTS	1-38A
PITOT-STATIC SYSTEM	1-48
EMERGENCY SYSTEMS	1-48
SEATS	1-53
AUXILIARY EQUIPMENT	1-54

THE AIRCRAFT.

The C-121A is a four engine, low wing monoplane designed for high speed, long range transportation of personnel over land or water. The distinguishing external features are its three vertical fins and rudders, its dual wheel tricycle landing gear, and its characteristically shaped fuselage with the extended nose which houses AN/APS-42 radar equipment. The aircraft is powered by four R3350-75 (BD-1) engines, equipped with Curtiss Electric propellers with fluid de-icing. The flight con-

trols incorporate hydraulic boosters to assist in the movement of the control surfaces, and an automatic pilot with flight path control is provided for automatic control of the aircraft in flight and approach. The semi-monocoque fuselage is sealed for pressurization between the forward and aft bulkheads. The forward bulkhead separates the flight station from the nose radome and the aft bulkhead is the rear wall of the cabin. All doors in the lower sides and bottom of the fuselage have additional sealing to minimize water leakage if the aircraft has been ditched.

general arrangement diagram

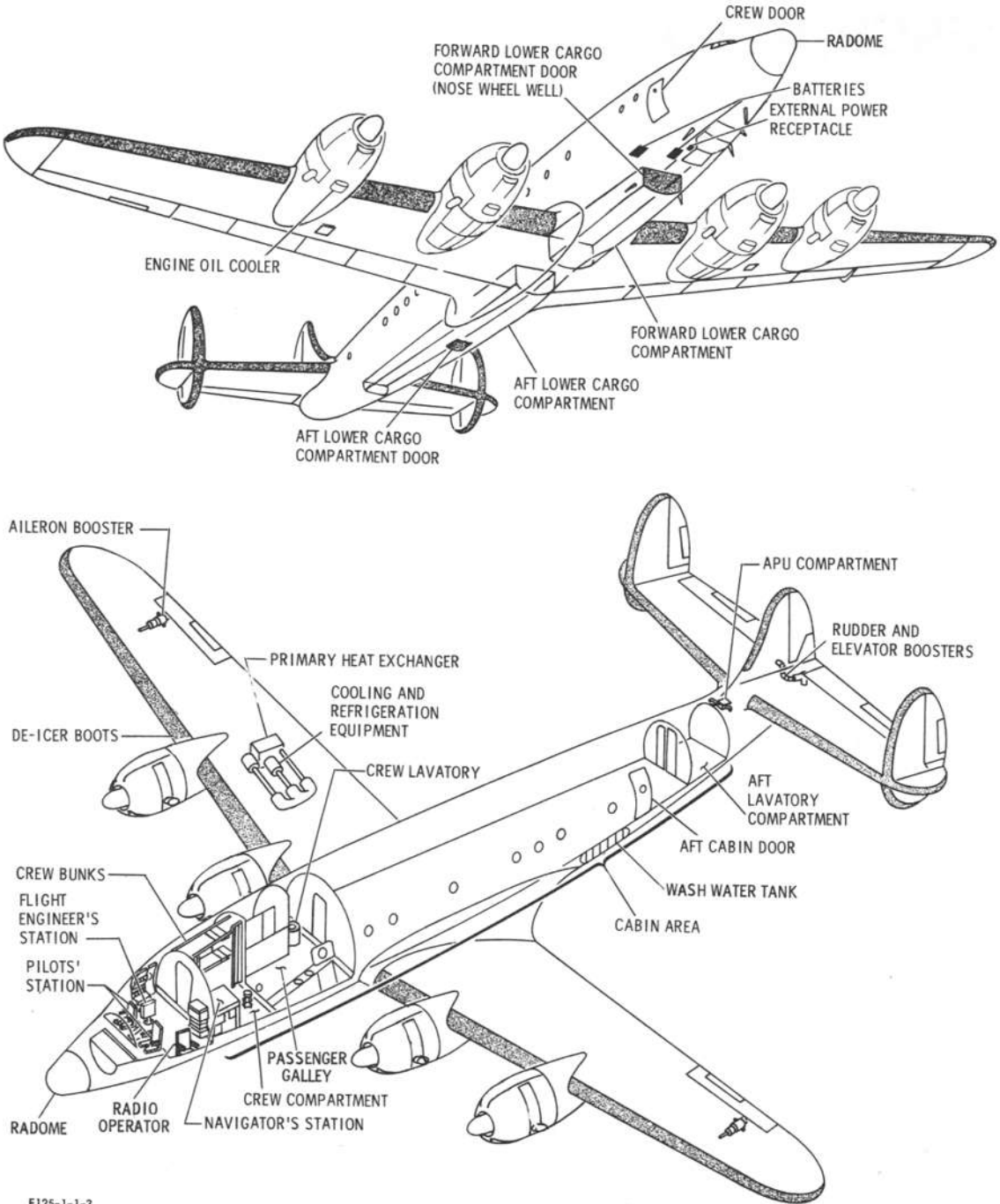

F125-1-1-3

Figure 1-2

GENERAL ARRANGEMENT.

(FIGURE 1-2)

The interior of the fuselage is divided by the 260 bulkhead into the flight compartment and the cabin. The cabin area includes a crew compartment and a galley. A personnel door is located on the left side near the aft end of the cabin. A crew door is located on the right side immediately forward of the 260 bulkhead. Below the cabin floor are two storage compartments that are separated by the wing center section.

CREW REQUIREMENTS.

Crew requirements include a pilot, copilot, flight engineer, radio operator and a navigator. Facilities for the four relief crew members are installed on the right side of the crew compartment opposite the navigator's station.

CABIN UTILITY.

The cabin area is designed for personnel transportation, for over-land or over-water service. A galley is installed aft of the crew compartment with a lavatory on the right side. An additional lavatory is installed in the aft end of the main cabin.

AIRCRAFT DIMENSIONS.

The over-all dimensions of the aircraft are as follows:

Length	97' 4"
Height (to top of fins)	23' 1"
Height (to top of fuselage)	18' 10"
Wing Span	123' 0"

DESIGN GROSS WEIGHT.

The gross take-off weight is 107,000 pounds. Refer to Section V for additional weight information.

ENGINES.

The four engines installed on the aircraft are R-3350-75 (BD-1) Wright Cyclone air-cooled radial engines. Each engine has 18 cylinders arranged radially in a double row. Each incorporates a fuel injection system, a two-speed supercharger, a low tension ignition system, and a torque meter.

THROTTLES.

One set of four throttle levers is located on the pilots' pedestal (5 figure 1-22), and another set of four throttle levers (4 figure 1-24) is located on the flight engineer's control quadrant. Both sets of throttles are labeled CLOSED (aft), and OPEN (fwd). The throttles are

numbered from left to right and corresponding levers are mechanically interconnected to the carburetor butterfly shafts by cable, pulley, and linkage systems. The throttle levers are also interconnected to the landing gear warning circuit through a four-gang switch which is actuated when one or more throttles are in the closed position. They are connected in series with the landing gear warning horn so that the horn sounds if any throttle is closed and gears are not locked down.

Reverse Pitch Throttle Levers.

The pilots' throttle levers incorporate an additional set of four reverse pitch throttle levers (4 figure 1-22) which are hinged on the main throttle arms. The reverse levers normally are folded forward and below the main throttle knobs so that they do not interfere with normal throttle operation. The reverse pitch throttle levers are connected by a linkage mechanism to the same cable system as the main throttle levers. A spring-loaded electrically-controlled mechanical lock prevents inadvertent movement of the reverse throttle levers while in flight. The reverse throttle lock is normally released by a 28-volt d.c. reverse actuator which is controlled through the landing gear switches. In addition, it can be manually released by depressing the reverse lock override lever (flag) (6 figure 1-22) located on the pilots' pedestal. When the main throttle levers are retarded to the full aft position, the reverse pitch throttle levers may be lifted upward and pulled aft, provided the reverse lock has been released. This action energizes the propeller controls that turn the blades to the fixed reverse stop position. As the reverse pitch throttle levers are moved aft they open the engine throttle valves to increase power. The maximum travel of the master control (carburetor) butterfly valves is limited in reverse pitch by the travel of the reverse pitch throttle levers.

FUEL MASTER CONTROL UNIT (CARBURETOR).

Each engine utilizes a direct fuel injection system which consists of a carburetor, two injection pumps, and a fuel injection nozzle for each cylinder. The carburetor unit senses the amount of air passing through it and meters the correct proportion of fuel from the fuel pressure chamber of the carburetor to the two injection pumps that are mounted on each side of the rear crankcase section of each engine. Each injection pump is geared to the engine and contains nine plungers which time and distribute the metered fuel to the cylinder combustion chambers. A synchronizing bar connects the fuel injection pumps to assure equal metering of fuel. Spring-

loaded poppet valves in the fuel injection nozzles, one of which is located in each cylinder head, are opened by the pressure of the fuel and the nozzle sprays the fuel into the combustion chamber.

ENGINE AIR INDUCTION SYSTEM.

Hot or cold air may be directed to each carburetor by means of a variable-position hot air door located just forward of the carburetor. When the hot air door is closed (COLD position), air entering the cold air duct flows directly to the carburetor. When the hot air door is open (HOT position), air that has been heated by flowing around the hot cylinders and around the exhaust manifold is ducted to the carburetor.

Carburetor Air Switches.

The carburetor air switches consist of four toggle switches (1 figure 1-24) located on the left side of the flight engineer's lower switch panel. Each switch has three positions, OFF, COLD and HOT, and is spring-loaded from HOT to the OFF position. By holding the switch in the HOT position, d.c. current electrically actuates the hot air door in the carburetor air intake scoop, permitting hot air from behind the engine cylinders to enter the carburetor. Moving the switch to the COLD position, closes the hot air door, permitting unheated air to enter the carburetor. The door can be stopped at any position between full open and full closed to obtain any desired degree of carburetor heat. Limit switches automatically stop the door when it reaches either the full open or the full closed position.

Mixture Levers.

Four mixture levers (6 figure 1-24) are located on the flight engineer's control quadrant and are mechanically linked to the fuel master control valves. The mixture control quadrant is marked as follows: OFF, AUTO LEAN, and AUTO RICH. The quadrant is continuously serrated to permit setting the control in an intermediate position for best economy. Manual leaning may be accomplished by moving the mixture levers inboard from the AUTO RICH position toward the OFF position. (Refer to Section VII for MANUAL LEANING procedures.)

Carburetor Air Temperature Indicators.

Two dual carburetor air temperature indicators (47 figure 1-23), located on the lower left side of the flight engineer's upper instrument panel, register the induction air temperature at the carburetor upper deck by

means of temperature resistance bulbs. D.C. power for these instruments is routed through the MJB bus. The indicators are calibrated in degrees Centigrade.

SUPERCHARGERS.

Each engine incorporates a single-stage, two speed supercharger that is mechanically controlled by levers on the flight engineer's control quadrant.

Engine Superchargers and Cabin Supercharger Disconnect Levers.

Four engine supercharger levers (4 figure 1-24) are located at the center of the flight engineer's control quadrant. All of the levers have a HIGH and a LOW position. The two outboard levers (engines No. 1 and No. 4) have a third position labeled EMERGENCY CABIN SUPERCHARGER DISCONNECT, which mechanically disconnects cabin pressurization supercharger drive shafts from the engines. Spring-loaded locks mounted adjacent to the outboard levers prevent inadvertent operation of the cabin supercharger disconnect system as they cannot be reconnected in flight.

ENGINE COWL FLAPS.

Engine temperature is controlled by air exit flaps, one on each side cowl panel. The cowl flaps are positioned by d.c. electrical actuators. The two cowl flap actuators in each power plant are interconnected by a flexible synchronizer shaft and housing assembly which maintain an equal degree of opening. The outboard actuator incorporates a transmitter for position indication at the flight engineer's station. The flaps are positioned as required and are automatically stopped at the full open or the full closed position.

Cowl Flap Switches.

The four paddle-type cowl flap switches (13 figure 1-24), located on the left side of the flight engineer's lower switch panel, have three positions: OFF, OPEN, and CLOSE. The OPEN and CLOSE positions provide electrical d.c. power to the cowl flap actuators in each nacelle.

Cowl Flap Position Indicators.

Two dual cowl flap position indicators (38 figure 1-23) are located on the flight engineer's lower instrument panel and are marked from 0 to 100%. The indicators are connected to position transmitters on the actuator housing unit and are a.c. operated.

ignition analyzer controls

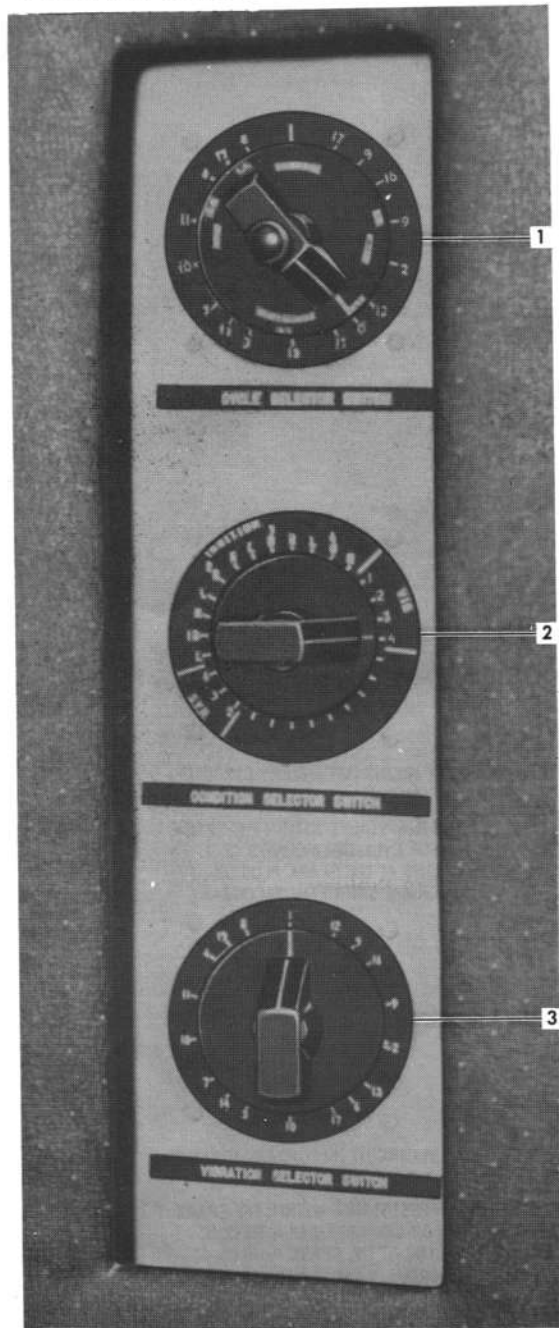

- 1 CYCLE SWITCH
- 2 CONDITION SWITCH
- 3 VIBRATION SWITCH

FB 6648
F125-1-1-49

Figure 1-3

Cylinder Head Temperature Indicators and Switches.

Two dual cylinder head temperature indicators (39 figure 1-23) and a three-position selector switch (34 figure 1-23) are located on the flight engineer's lower instrument panel. A bayonet type thermocouple on cylinders No. 1 and 18 of each engine electrically transmits the temperature by d.c. current to the indicators, which are calibrated in degrees Centigrade. The selector switch has 1, 2 and 3 positions. The 1 position selects cylinder No. 1 on each engine and position 2 selects cylinder No. 18. No. 3 position selects the cabin supercharger gear box temperature for engines No. 1 and No. 4.

IGNITION SYSTEM.

Each engine utilizes a low tension dual ignition system. The low tension magneto installed on the rear accessory section produces a low voltage spark for the right and left distributors located on the nose section case. The right distributor directs low voltage to high tension coils that fire the front plugs and the left distributor directs low voltage to the high tension coils that fire the rear plugs in each cylinder. A high tension coil is provided for each cylinder and is attached to a cylinder rocker box cover.

Ignition Switches.

Four ignition switches (4 figure 1-21) each of which has four positions, are located on the pilots' overhead panel. As the switches are rotated in a clockwise direction the positions are OFF, RIGHT, LEFT and BOTH. When the ignition switch is placed in the RIGHT position, the circuit to the left distributor is grounded and the circuit to the right distributor, which fires the front plugs in each cylinder is ungrounded. The LEFT switch position grounds the right distributor circuit and completes the circuit to the left distributor which fires the rear plugs in each cylinder. The BOTH position completes the circuits to both the left and the right distributors and the OFF position grounds both circuits.

IGNITION ANALYZER.

(Refer to Figure 1-3.)

The ignition analyzer provides a visual means of detecting, locating and identifying engine ignition abnormalities. The analyzer can be used either on the ground or during flight and will reveal ignition malfunctions at high altitude that normally are not evident on the

ignition analyzer patterns

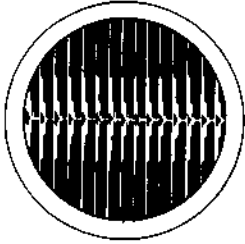

PATTERN 1 - NORMAL PATTERNS - SLOW SWEEP

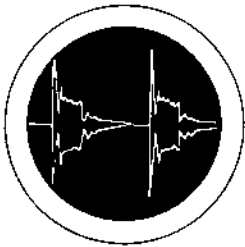

PATTERN 2 - NORMAL PATTERN - FAST SWEEP

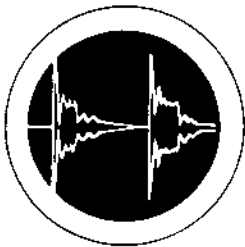

PATTERN 3 - FIRST STAGE OF HIGH-TENSION CIRCUIT (SECONDARY CIRCUIT)
HIGH-RESISTANCE PATTERN

PROBABLE CAUSES: LARGE PLUG GAP, HIGH RESISTANCE WITHIN THE SPARK PLUG, DIRTY SPARK PLUG CONTACT BUTTON OR CYLINDER MOUNTED COIL CONTACT BUTTON, DAMAGED CIGARETTE SPRING AT THE SPARK PLUG OR AT THE CYLINDER-MOUNTED COIL, OR ANY ABNORMAL GAP IN THE SECONDARY CIRCUIT.

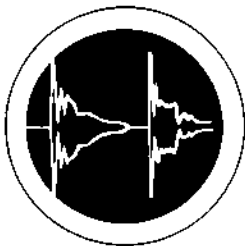

PATTERN 4 - SECOND STAGE OF HIGH-TENSION CIRCUIT (SECONDARY CIRCUIT)
HIGH-RESISTANCE PATTERN

PROBABLE CAUSES: LARGE PLUG GAP, HIGH RESISTANCE WITHIN THE SPARK PLUG, DIRTY SPARK PLUG CONTACT BUTTON OR CYLINDER-MOUNTED COIL CONTACT BUTTON, DAMAGED CIGARETTE SPRING AT THE SPARK PLUG OR AT THE CYLINDER-MOUNTED COIL, OR ANY ABNORMALLY LARGE GAP IN THE SECONDARY CIRCUIT.

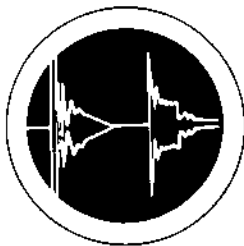

PATTERN 5 - OPEN HIGH-TENSION CIRCUIT (SECONDARY CIRCUIT) PATTERN

PROBABLE CAUSES: AN ABNORMALLY LARGE SPARK PLUG GAP, AN OPEN WITHIN THE SPARK PLUG, MISSING CIGARETTE SPRINGS AT THE SPARK PLUG OR CYLINDER-MOUNTED COIL, OR ANY OPEN IN THE HIGH-TENSION CIRCUIT.

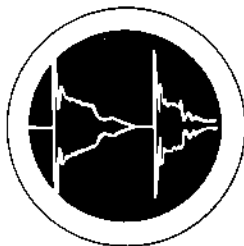

PATTERN 6 - INITIAL FOULING OF SPARK PLUG PATTERN

PROBABLE CAUSES: EARLY STAGES OF SPARK PLUG FOULING DUE TO A FOREIGN SUBSTANCE (LEAD OR CARBON) ON THE SPARK PLUG ELECTRODES. THE CONDITION CAN GENERALLY BE CLEARED UP BY PERFORMING THE RECOMMENDED PLUG DE-FOULING PROCEDURE. (REFER TO SECTION VII, TECHNIQUES, FOR PROCEDURE.)

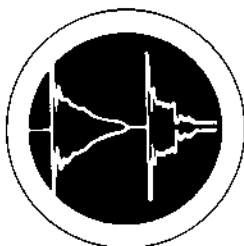

PATTERN 7 - FOULED PLUG PATTERN

PROBABLE CAUSES: SPARK PLUG FOULING DUE TO A FOREIGN SUBSTANCE (LEAD OR CARBON) ON THE SPARK PLUG ELECTRODES. THE CONDITION CAN SOMETIMES BE CLEARED UP BY PERFORMING THE RECOMMENDED PLUG DE-FOULING PROCEDURE. (REFER TO SECTION I, TECHNIQUES, FOR PROCEDURE)

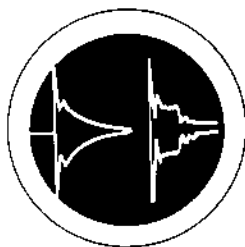

PATTERN 8 - SHORTED HIGH-TENSION CIRCUIT (SHORTED SECONDARY) PATTERN

PROBABLE CAUSES: BADLY FOULED SPARK PLUGS, A SHORT CIRCUIT WITHIN THE SPARK PLUGS, SUCH AS A CRACKED CERAMIC OR CARBON TRACKED CIGARETTE WELL, A SHORT IN THE HIGH-TENSION LEAD OR COIL, A SPARK PLUG LEAD OFF AND SHORTED TO GROUND. IF THE PATTERN APPEARS ON BOTH SPARK PLUGS OF ONE CYLINDER, EXPERIENCE HAS SHOWN THAT THIS CONDITION GENERALLY INDICATES A MECHANICAL FAILURE WITHIN THE CYLINDER. THE METAL PARTICLES FROM THE FAILED PART ARE THROWN AROUND BY ACTION OF THE PISTON, AND PEEN OVER THE ELECTRODES OF THE SPARK PLUG CAUSING A SHORT CIRCUIT.

7198.1-54(2)

Figure 1-4 (Sheet 2)

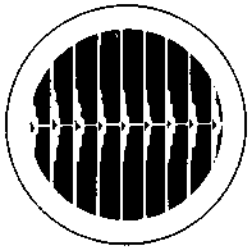

PATTERN 9 - SHORTED PRIMARY CIRCUIT PATTERN (MAGNETO TO DISTRIBUTOR)
CHARACTERISTIC: EVERY OTHER PATTERN MISSING; THAT IS, NINE NORMAL PATTERNS INSTEAD OF 18.

PROBABLE CAUSES: FAULTY MAGNETO GROUNDING SWITCH OR GROUNDING SYSTEM, THE BREAKER POINTS NOT OPENING, A GROUND PRIMARY COIL OR CONDENSER, OR A GROUND BETWEEN THE MAGNETO AND DISTRIBUTOR.

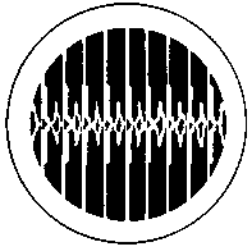

PATTERN 10 - OPEN PRIMARY CIRCUIT PATTERN (MAGNETO TO DISTRIBUTOR)

PROBABLE CAUSES: THE BREAKER POINTS ARE NOT CLOSING EITHER MECHANICALLY OR ELECTRICALLY BECAUSE OF EXCESSIVE POINT CLEARANCE, OR THE PRESENCE OF A FOREIGN SUBSTANCE INSULATING ELECTRICAL CONTACT BETWEEN THE POINTS. THE PATTERN CAN ALSO BE CAUSED BY AN OPEN IN THE PRIMARY COIL OR BY THE DISTRIBUTOR.

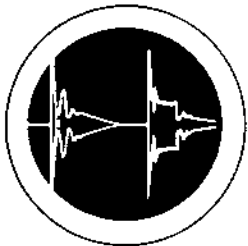

PATTERN 11 - OPEN PRIMARY CIRCUIT PATTERN (DISTRIBUTOR TO COIL)

PROBABLE CAUSES: AN OPEN IN THE LEAD FROM THE DISTRIBUTOR TO THE CYLINDER-MOUNTED COIL OR IN THE PRIMARY WINDING OF THIS COIL.

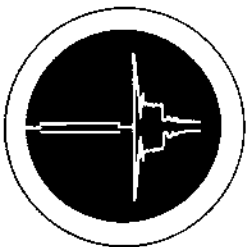

PATTERN 12 - SHORTED PRIMARY CIRCUIT PATTERN (DISTRIBUTOR TO COIL)

PROBABLE CAUSES: A GROUND IN THE PRIMARY LEAD FROM THE DISTRIBUTOR TO THE CYLINDER-MOUNTED COIL OR A SHORT IN THE PRIMARY WINDING OF THIS COIL.

FB 6645
1122 2 1 44(2)

Figure 1-4 (Sheet 3)

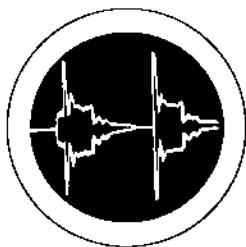

PATTERN 13 - ARCING BREAKER POINTS PATTERN

PROBABLE CAUSES: OIL ON THE BREAKER POINTS, A DEFECTIVE (OPEN) PRIMARY CONDENSER, OR THE LEAD FROM THE BREAKER POINTS TO THE CONDENSER IS DISCONNECTED.

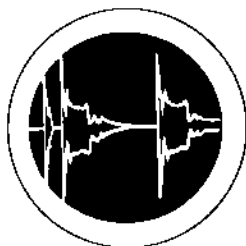

PATTERN 14 - BREAKER POINT BOUNCE PATTERN

PROBABLE CAUSES: A WEAK BREAKER POINT SPRING OR DAMAGED CAM WITH ROUGH SPOTS ON IT. A WEAK SPRING SHOULD CAUSE BOUNCE ON ALL SPARK PLUG POSITIONS OF THE AFFECTED DISTRIBUTOR, WHILE FOR A DAMAGED CAM THE BOUNCE SHOULD OCCUR ON ONLY ONE SPARK PLUG POSITION.

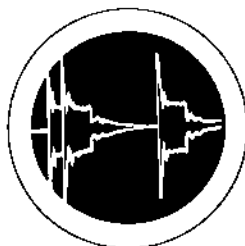

PATTERN 15 - BREAKER POINT NON-SYNCHRONIZATION PATTERN

THE CONDITION SWITCH IS SET TO "B" (BOTH MAGNETS) OF THE SELECTED ENGINE. IF THE BREAKER POINTS ARE NOT SYNCHRONIZED, THE BREAKER POINTS ASSOCIATED WITH THE PATTERNS APPEARING TO THE LEFT ARE OPENING BEFORE THOSE ASSOCIATED WITH THE PATTERNS ON THE RIGHT. BY MEASURING THE DISTANCE ON THE SCREEN BETWEEN THE POINTS OF BREAKER POINTS OPENING AND ALLOWING 1/32 INCH TO EQUAL 1 DEGREE OF CRANKSHAFT ROTATION, THE AMOUNT OF NON-SYNCHRONIZATION MAY BE DETERMINED.

NOTE

THE NON-SYNCHRONOUS CONDITION OF MAGNETO FIRING DOES NOT NECESSARILY REPRESENT AN ENGINE MALFUNCTION.

ground. Data are presented in the form of patterns on the face of the cathode ray tube indicator mounted on the flight engineer's table. The characteristic ignition patterns of each engine may be examined singly for individual cylinders or simultaneously for all cylinders. Any ignition malfunction during engine operation will alter the characteristic pattern and change its contour. Each engine pattern can be identified with the number of the cylinder, spark plug, or magneto associated with the malfunction. The basic components of the ignition analyzer system are: a synchronizing generator for each engine, a condition switch, a cycle switch, a vibration switch and an indicator (cathode ray tube). The condition switch, cycle switch and vibration switch are located on the Station 260 panel. The power supply amplifier is supplied with a.c. power and contains the electronic circuits that provide necessary voltages to operate the cathode ray tube indicator. The synchronizing generator is driven by the engine auxiliary tachometer drive at one-half engine speed, and provides 3-phase voltage for timing the patterns to the angular position of the engine crankshaft. This voltage initiates and produces the horizontal base sweep across the cathode ray tube of the indicator.

Cycle Switch.

The cycle switch (1 figure 1-3) located on the Station 260 panel consists of a fixed index ring marked off with numbers that correspond to the number of cylinders of the engine in their firing order. The inner rotatable switch dial is marked with an index line and abbreviations at specific points which indicate events occurring during a complete engine cycle. The center selector switch incorporates a push-pull knob that controls the sweep of the horizontal pattern on the cathode ray tube indicator. The IGN position is aligned with any cylinder designation on the fixed ring dial. The operator may choose the pattern presentation, the number of patterns that will be seen is contingent upon the position of the push-pull knob. In the "pushed-in" position (fast sweep), two complete patterns will appear on the indicator, beginning with the ignition diagram of the cylinder on which the cycle switch is indexed, and will conclude with that of the next cylinder in firing order. In the "pulled-out" position (slow sweep), the patterns of all cylinders will appear beginning with that of the cylinder on which the IGN is indexed. Some typical patterns are illustrated on figure 1-4, sheet 1 through 4.

Condition Switch.

The condition switch (2 figure 1-3), located on the Station 260 panel, functions as a selector for a specific

engine for either ignition analysis or for checking the speed synchronism between engines. Furthermore, it selects either left, right, or both magnetos for observation. The inner rotatable dial has a single index mark which is rotated to the desired indices engraved on the fixed outer ring. The fixed ring is divided into four general sections which are engraved as follows: SYN, 2, 3, and 4 for checking synchronization of respective engines with No. 1 engine; IGNITION, 1, 2, 3, and 4, for ignition analysis of the respective engines, B (both), L (left) and R (right) magnetos, and vibration selector positions, 1, 2, 3, and 4.

Vibration Switch.

The vibration switch, (3 figure 1-3) located on the Station 260 panel, functions as a selector switch for a specific cylinder for vibration analysis. The inner rotatable dial has a single index mark which is rotated to the desired indices engraved on the fixed outer ring. The fixed index ring is marked off with numbers that correspond to the number of the cylinders of the engine in their firing order.

Cathode Ray Tube Indicator.

The indicator assembly is a housing which encloses a 3-inch cathode ray tube. The assembly is mounted face-up in the flight engineer's table (9 figure 1-24). The power supply amplifier provides the adjustments of the indicator such as focus, length, H-centering, and intensity gain. However, when these controls are set, they should not require frequent readjustment.

PRIMING SYSTEM.

Fuel for priming is supplied by the auxiliary fuel pumps through the solenoid priming valve, mounted on the housing of each carburetor pressure chamber. The solenoid valve is electrically actuated by d.c. current through a momentary contact switch. Priming fuel is discharged from the inlet chamber of the fuel master control to the engine supercharger section.

Priming Switch.

The single priming switch (d.c.) (12 figure 1-11), located on the MJB No. 2 switch panel, is a momentary-contact push button which electrically operates a solenoid primer valve on the carburetor that discharges fuel directly into the engine induction passage. Selection of the solenoid primer valve and the engine to be primed is determined by the engine starter selector switch.

STARTING SYSTEM.

Each engine is equipped with a direct cranking d.c. electric starter mounted on the engine accessory section. The starter incorporates a disc-type clutch which is designed to slip when the engine offers abnormal resistance to cranking during starting operation, such as that caused by a hydraulic lock.

Starting Switches.

Two switches for the starting system are located on the MJB No. 2 panel. One is a rotary-type selector switch (10, figure 1-11) with five positions; Engine No. 1, No. 2, OFF, No. 3, and No. 4. This switch selects the engine starter to which d.c. current will be directed when the starter switch (11 figure 1-11) is pushed. It also selects the carburetor primer valve that will be opened by the primer switch. The second starting switch is a momentary-contact push button which energizes the selected engine starter.

Starter Selector Light.

This red push-to-test light (14 figure 1-11) will glow whenever the starter selector switch is in any position other than OFF.

Tachometer Indicators.

Engine rotational speed is transmitted to four dual electric indicators by tachometer generators, mounted on the rear case of each engine. Two are located on the pilots' instrument panel (16 figure 1-18), and two are located on the flight engineer's lower instrument panel (40 figure 1-23). The indicators are calibrated to read in revolutions per minute.

Manifold Pressure Indicators.

Two dual manifold pressure indicators (11 figure 1-18) located on the pilots' instrument panel and two dual indicators (36 figure 1-23) located on the flight engineer's lower instrument panel, electrically (26 volt a.c.) register the air induction pressure in the engine manifolds. These instruments are calibrated in inches of mercury.

Torquemeters (BMEP Gages).

Two dual torquemeter indicators (42 figure 1-23) located on the flight engineer's lower instrument panel measure the torque at the propeller shaft through an (26 volt a.c.) autosyn transmitter. The indicators are calibrated in BMEP units. A heating element is installed around the BMEP lines.

Oil Pressure Indicators.

Four dual oil pressure indicators (26, 29 figure 1-23) are located on the right side of the flight engineer's lower

instrument panel and register pressure in pounds per square inch. The oil pressure transmitters are connected to the nose section and rear engine oil pump. Immediately below the rear oil pressure indicators are four oil pressure warning lights (connected to pressure warning switches which are connected to the oil pumps). These are set to glow when pressures reach low limits.

Oil Temperature Indicators.

Four dual oil temperature indicators are located beneath the oil cooler flap indicators on the flight engineer's upper instrument panel. Two of these indicators (21 figure 1-23) register the oil outlet temperature of each engine by a bulb located at the engine oil-out port. The other two indicators (23 figure 1-23) register the oil inlet temperature of each engine. The oil-in temperature bulb is located in the outlet port of the tank sump. Signals are transmitted electrically from the bulb transmitters to the panel indicators which are calibrated in degrees Centigrade. There are no specified limits of oil-out temperature; however, these figures do give an indication of engine operating condition. An appreciable change in these figures over a short period of time from one flight to the next will signify a changed operating condition of the engine and should be used as a signal for close surveillance of the other instruments.

Fuel Pressure Indicators.

Two dual 26-volt a.c. fuel pressure indicators (31 figure 1-23) are located on the flight engineer's lower instrument panel. They indicate fuel pressure at the carburetors.

Fuel Pressure Warning Lights.

Four fuel pressure warning lights (32 figure 1-23) are located on the flight engineer's lower instrument panel below the fuel pressure indicators. They operate electrically from the 28-volt d.c. system. The lights glow red when the fuel pressure, as measured at the carburetors, drops to the allowable minimum.

Fuel Flow Meters.

Two 26-volt a.c. dual fuel flow meters (41 figure 1-23) are located on the flight engineer's lower instrument panel. They indicate the rate of fuel flow to the engine in pounds per hour. The vapor return shut-off valves should be closed when fuel flow readings are being taken.

PROPELLERS.

The aircraft is equipped with Curtiss Model C634S electric, three-bladed, full feathering, reversible pitch

propellers. The propeller control system provides constant speed operation, synchronization, and reversing. In addition to controlling engine speed, the propeller control system provides selective fixed-pitch control of the blades, feathering, and reverse thrust for aerodynamic braking. Control of engine speed is maintained by changing the blade angle through electro-mechanical means, with power supplied from the main d.c. bus. Control current is applied to the propeller through contact brushes riding on slip rings which form a part of the hub assembly. The energizing current, transferred at this point from the stationary to the rotating parts, is conducted through the hub to the power unit. This unit consists of an electric motor which drives a power through a two-stage system of planetary gearing called the speed reducer. The power gear is in continual mesh with gears at the shank of each blade. All blade angle changes are accomplished by this means. Each propeller also is provided with a fluid de-icing distribution system.

SYNCHRONIZER.

The synchronizer provides automatic constant-speed control by electrically matching engine speeds with the speed of the master motor which is part of the synchronizer unit. Any speed variations between an engine and the master motor causes a corrective action to take place, thus synchronizing all engines with the speed of the master motor. The electrical matching of speeds is accomplished by a contactor in the synchronizer unit. This contactor compares the speed of the master motor with the engine speed by means of the frequency output of a three-phase alternator driven by the engine. The selective fixed-pitch operation feature provides a convenient means for adjusting the blade angle to obtain the desired speed for various operating conditions when automatic synchronized operation is not desired, or when conditions require this auxiliary method of control.

REVERSING AND UNREVERSING.

Reverse thrust is obtained by rotating the blades through low pitch to a negative angle thus reversing the direction of thrust. The application of reverse thrust provides effective braking action. A voltage booster provides rapid pitch reversal, unreversal and feathering operations.

FEATHERING.

During feathering operation all other propeller circuits are automatically disconnected from the system. Boosted voltage is applied to the power unit electric motor which provides a quick blade angle change to the feather angle. The voltage booster is started by actuation of the feathering switch and stops automatically when the propeller blades reach the feather angle and the feather limit switch in the power unit opens.

PROPELLER SYNCHRONIZER LEVERS.

Two master propeller levers are incorporated in the system, one on the flight engineer's control quadrant (2 figure 1-24) and one on the pilot's pedestal (9 figure 1-22). The levers are mechanically interconnected and either lever will accurately control the speed of the synchronizer motor. A small movement of the lever from the DEC (full aft) position toward INC (take-off) position, switches on the synchronizer. Positioning the lever between these points controls the rpm setting of the synchronizer.

Propeller Selector Switches.

Four propeller selector switches, located on the flight engineer's lower switch panel (12 figure 1-24), provide individual propeller control and fixed-pitch operation as well as automatic governing and synchronization. Each toggle switch has four positions, AUTO, FIXED, DEC RPM, and INC RPM. The DEC RPM and INC RPM positions are momentary-contact positions and must be held. When released, the switches automatically return to the FIXED position. When the four toggle switches are placed in the AUTO position, the automatic governing and synchronizing feature is applied to the four propellers and is maintained in accordance with the setting of the master propeller lever.

Propeller Feathering Switch.

The feathering switch, located on the flight engineer's lower switch panel (5 figure 1-24), has two positions, FEATHER and NORMAL. When the switch is placed in the FEATHER position, all other propeller change circuits are opened and the feathering circuit is completed, thereby sending the propeller blades to the feather position.

Reverse Lock Override Lever.

A visible guarded lever (flag) (6 figure 1-22) when withdrawn from sight, indicates that the reverse throttle levers may be used. This lever (flag) may be pushed down to manually release the reverse throttle lock before weight of the aircraft is on the gear, allowing reverse power to be applied. The reverse lock actuator is connected by cables to the reverse throttle locking bar, which, when turned to the open position, lowers the flag (lever) and permits the reverse throttle levers to be pulled aft for reverse thrust. An automatic means of releasing the reverse throttle lock is also provided. A switch mounted on the rear of each main landing gear strut releases the reverse throttle lock when partial weight of the aircraft is on the main gear.

Reverse Pitch Throttle Levers.

The levers that control reverse thrust are discussed under ENGINE controls.

PROPELLER REVERSING INDICATOR LIGHTS.

The four amber indicator lights mounted on the Pilot's Glare Shield Panel (figure 4-10) indicate to the pilot that the propeller blades are moving past the low pitch mechanical stop towards reverse thrust. Amber lights will go on at approximately 13° propeller blade angle. The mechanical low pitch stop is set at 17° propeller blade angle and is released electrically by energizing a solenoid when reverse switches are activated.

Synchronizer Master Motor Warning Light.

The yellow master motor warning light located on the flight engineer's lower instrument panel (35 figure 1-23) will light when the synchronizer master motor is not running. When this light remains on, the propellers are in fixed pitch.

Master Motor RPM Indicator.

A tachometer located on the flight engineer's lower instrument panel (33 figure 1-23) is calibrated to show synchronizer master motor speed in terms of engine rpm. It gives an indication of the rpm at which the engines will be synchronized. The synchronizer motor tachometer is used for a reference only. Refer to the engine tachometer for actual engine rpm.

ENGINE OIL SYSTEM.

Separate oil supply systems provide lubrication for each engine. Oil flows from the engine oil tank to the engine oil pressure pump, which pumps oil through the engine oil passages. After circulating through the engine, the oil is returned by an engine scavenging pump to the oil radiator for cooling. From the radiator, the oil flows through the return line and back into the engine oil tank. Refer to the Servicing Diagram (figure 1-16) for oil grades and specifications.

OIL TANKS.

An engine oil tank with a capacity of 55 gallons is located on the right side of each nacelle immediately forward of the fire wall. The tank is vented to its engine crankcase and is equipped with an oil quantity transmitter, a filler well, an oil hopper, a dip stick, and a removable sump. A capacitance-type oil quantity indicating system is installed in the tank to indicate the usable oil. Each tank also is equipped with a dip stick which provides a convenient method of determining the amount of oil in the tank.

Oil Cooler Radiators and Control Valves.

An oil cooler unit is installed on the under side of each engine nacelle. Ram air enters a scoop, passes through the oil radiator and exits past an oil cooler flap which controls the amount of air necessary for cooling. A

control valve mounted on the oil radiator automatically routes the oil flow in one of the following ways:

1. Straight through the valve, bypassing the radiator.
2. Around the jacket of the oil cooler radiator.
3. Through the core of the radiator.

When the engine is started at low ambient temperature, the viscosity of the oil in the cooler prevents oil flow through the radiator. Oil pressure builds up in the control valve until the pressure opens the surge valve. When the surge valve is open, the oil cooler radiator is bypassed. As the temperature rises and the oil in the jacket of the radiator becomes more fluid, the pressure decreases and the surge valve closes. The bypass valve to the jacket opens and as oil circulates through the jacket, the oil in the core is heated and becomes more fluid until the rate of oil is increased and the pressure drops below the closing point of the bypass valve. When the bypass valve is completely closed, oil circulates directly through the core of the radiator and back into the control valve, then out through the exit port to the oil tank return line. Under cruise conditions, the oil temperature is further controlled by electrically actuating the oil cooler flap which regulates the amount of air passing through the radiator.

BMEP BLEEDS.

A BMEP bleed is provided for each engine torque meter system. The bleeds are controlled separately or collectively by switches located on the flight engineer's upper switch panel.

BMEP Bleed Switches.

Four 28-volt d.c. BMEP bleed switches, (3 figure 1-23) are located on the flight engineer's upper switch panel. The switches are spring-loaded to the OFF position. When a switch is held in the BMEP BLEED position, a solenoid valve is opened to admit warm engine oil into the torque meter line.

Torque meter Line Heater Switches.

Four circuit breaker-type switches, (5 figure 1-23) located on the flight engineer's overhead panel, are used to control the electrical heating elements which are wrapped around the BMEP lines.

Oil Cooler Flap Switches.

The switches that operate the oil cooler flaps (10 figure 1-24) are located on the right side of the flight engineer's lower switch panel. The switches have four positions, AUTOMATIC, OFF, OPEN, and CLOSE. In the AUTOMATIC position the oil cooler will maintain an oil temperature within allowable limits. Operating the switches to OPEN or CLOSE overrides the control unit, within the limits of the actuator limit switches, and permits manual operation of the flaps. The flaps will

remain in the last selected position when the switches are in the OFF position.

Emergency Shut-off Levers.

The levers shut off the oil supply at the oil tanks. Refer to EMERGENCY EQUIPMENT in this Section.

Oil Quantity Indicators.

Two dual, electrically-operated, oil quantity indicators (22 figure 1-23) are located on the lower side of the flight engineer's upper instrument panel. These indicators register the oil quantity in the engine tanks. All indicators are calibrated in gallons and powered by 26 volts a.c.

FUEL SYSTEM.

(Refer to figure 1-5).

Fuel is supplied to the engines from six separate integral wing tanks. All of the tanks are interconnected by a crossfeed line which allows fuel to be supplied from any tank to any engine. However, the recommended fuel consumption and fuel loading sequences given in Section VII should be followed. Check valves make it impossible to transfer fuel from one tank to another. Provisions are incorporated for dumping fuel from the integral wing tanks. The cabin heaters receive fuel from the inboard engine fuel tanks. The APU receives fuel from the No. 4 fuel tank. (Refer to figure 1-5). For fuel tank capacities, refer to the Fuel Quantity Data Table and refer to the Servicing Diagram (figure 1-16) for fuel grades and specifications.

Auxiliary Fuel System Components.

An electric auxiliary fuel pump is located in the inboard, aft corner of each integral wing tank. Each pump is remotely controlled from the flight engineer's lower switch panel and pumps fuel under pressure to the engine-driven fuel pumps in the nacelles. Fuel is fed from the auxiliary fuel pumps to the four cable-operated fuel tank selector valves. From the selector valves, fuel flows through check valves on tanks 1 and 4, through micronic filters to the engines, or to the crossfeed system on No. 1, 2, 3 and 4 engines. There are four two-way, cable-operated crossfeed valves. As long as the crossfeed valves are closed, fuel will flow directly to the engine associated with each tank, after passing through one of the four, motor-operated emergency shut-off valves, engine-driven fuel pumps, fuel flow transmitters, and carburetors. A thermal relief valve is located in the crossfeed line to relieve pressure resulting from expansion when the crossfeed valves are closed. An additional thermal relief valve is incorporated downstream of each emergency shut-off valve to relieve pressure in the fuel lines caused by fuel expansion when the emergency shut-off valves are closed. Water drain valves are located at low points in the system.

FUEL LOADING RESTRICTIONS.

Take-off.

The maximum total fuel loads and recommended fuel distribution at various take-off weights for Model 749A airplanes modified by Service Bulletin 545 are shown in figure 7-1. The following table represents the minimum fuel loading from a structural standpoint only. These values do not represent the permissible operational fuel loading.

Model	Weight	Tanks 2 & 3		Tanks 1 & 4		Tanks 2A & 3A	
		Gals.	Lbs.	Gals.	Lbs.	Gals.	Lbs.
749A with Service Bulletin	107,000	290	1697	855	5002	565	3305
545	103,060	125	731	690	4037	565	3305
	89,500	125	731	125	731	0	0

(Straight line variation between values shown.)

* Pounds of fuel is based upon standard day weight of 5.85 lbs/gal.

Note

Minimum permissible operational fuel loading for the Model 749A with Service Bulletin 545 at take-off: Take-off weight minus 86,464 pounds.

Landing.

Do not land with more than the following fuel loads.

Model	Weight	Tanks 2 & 3		Tanks 1 & 4		Tanks 2A & 3A	
		Gals.	Lbs.	Gals.	Lbs.	Gals.	Lbs.
749A with Service Bulletin	89,500	790 ea	4622	1200 ea	7020	100 ea	585
545	or less	790 ea	4622	or 1555 ea	9097	0 ea	0

* Pounds of fuel is based upon standard day weight of 5.85 lbs/gal.

FUEL TANKS.

Tanks 1, 2, 3, and 4 are located in the inner wing panels. Tanks 2A and 3A are in the outer wing panels.

Fuel Quantity Data Table (U.S. Gallons).

Tank No.	Fully Serviced Fuel		Total Usable Fuel	
	Gals.	Lbs.	Gals.	Lbs.
2A	568	3223	565	3305
1	1558	9114	1555	9097
2	806	4715	790	4622
3	806	4715	790	4622
4	1558	9114	1555	9097
3A	568	3323	565	3305
Total	5864	34,304	5820	34,047

* Pounds of fuel is based upon standard day weight of 5.85 lbs/gal.

Filler Wells and Dip Sticks.

Each integral fuel tank has a filler well located in the upper surface of the wing and is filled separately. A measuring dip stick is stowed at the outboard side of the station 260 bulkhead. The stick is calibrated for use on all of the wing tanks. The dip stick is used in the tank filler wells and because of the wing dihedral, will not record low fuel levels.

Vapor Return Lines.

The vapor return line from each fuel master control is routed to the tank corresponding with that engine. The solenoid-operated shut-off valve installed in the return line obtains power from the MJB positive bus.

Fuel Tank Vents.

Each wing tank is vented through vent openings in the lower surface of the wing panels. Separate overboard lines which incorporate pressure and suction relief valves prevent excessive pressure from building up in the tanks if icing should close the flush-type vent.

FUEL SYSTEM CONTROLS AND INDICATORS.**Fuel Tank Selector Levers.**

Four fuel tank selector levers (7 figure 1-24) that control the opening and closing of the fuel tank shut-off valves are located on the flight engineer's control quadrant. The outside levers are two-position, ON and OFF, levers that control tanks 1 and 4. The inside levers are three-position levers. The left inside lever is placarded OFF, No. 2A, and No. 2. The right inside lever is placarded OFF, No. 3A and No. 3. The quadrant indicates the tanks selected by the position of the lever.

Fuel Crossfeed Levers.

Four two-position (OPEN and CLOSED) fuel crossfeed levers (2 figure 1-7), are located on the flight engineer's auxiliary control quadrant. These levers are used to direct fuel from any tank to any engine combination by opening the selected crossfeed valves. The auxiliary fuel pump of the crossfeed system must also be turned ON.

Auxiliary Fuel Pump Switches.

The auxiliary fuel pumps are controlled by four 28-volt d.c. switches (8 figure 1-24) located on the flight engineer's lower switch panel. The switches have three positions, HIGH, OFF, and LOW.

Tanks 2A and 3A Auxiliary Fuel Pump Switches.

Two 28-volt d.c. switches, located on the flight engi-

neer's upper switch panel control the operating speed of the tanks 2A and 3A fuel boost pumps. These switches have three positions: HIGH, LOW, and OFF.

Carburetor Vapor Return Solenoid Switches.

The four momentary-contact vapor return solenoid switches (8 figure 1-11) located on the MJB panel are spring-loaded to the OPEN position. When held in the closed position, d.c. power closes the solenoid-operated valve so that fuel flow readings may be taken; this prevents fluctuations in fuel flow indications so more accurate readings may be obtained.

Emergency Shut-off Levers.

These mechanically-operated levers actuate a micro switch, which in turn operates the motor-driven valve which will shut off fuel at the firewall. (Refer to EMERGENCY EQUIPMENT in this Section for operation.)

Fuel Quantity Indicators.

Five capacitance-type fuel quantity indicators are located on the flight engineer's panels. They are electrically operated from the 28-volt d.c. and 115-volt a.c. systems. The four indicators on the upper instrument panel are for tanks 1, 2, 3, and 4, and the dual indicator on the upper switch panel is for tanks 2A and 3A. These indicators show the weight of fuel in pounds in each of the six fuel tanks.

FUEL DUMP SYSTEM.

Fuel may be dumped from tanks 1, and 2, 3 and 4 by two symmetrical systems and from tanks 2A and 3A by another system. The dump system consists of a common dump chute and individual cable-operated dump valves for each of the two tanks in each inner wing. Initial movement of the overhead dump lever extends the retractable dump chute. Further movement opens the shut-off valve in each tank as the dump chute continues to extend. The dump chute and valves are operated by pulley-operated Geneva lock mechanisms. Fuel is dumped from tanks 2A and 3A by means of hydraulically-operated fuel dump valves and a fuel dump chute for each tank. Secondary hydraulic pressure operates these valves through an actuating cylinder mounted on each valve. Flow of hydraulic fluid to the cylinders is controlled by a selector valve (figure 1-8) mounted beneath the door leading from the flight station to the cabin. Operation of the selector valve simultaneously dumps fuel from tanks 2A and 3A.

fuel system

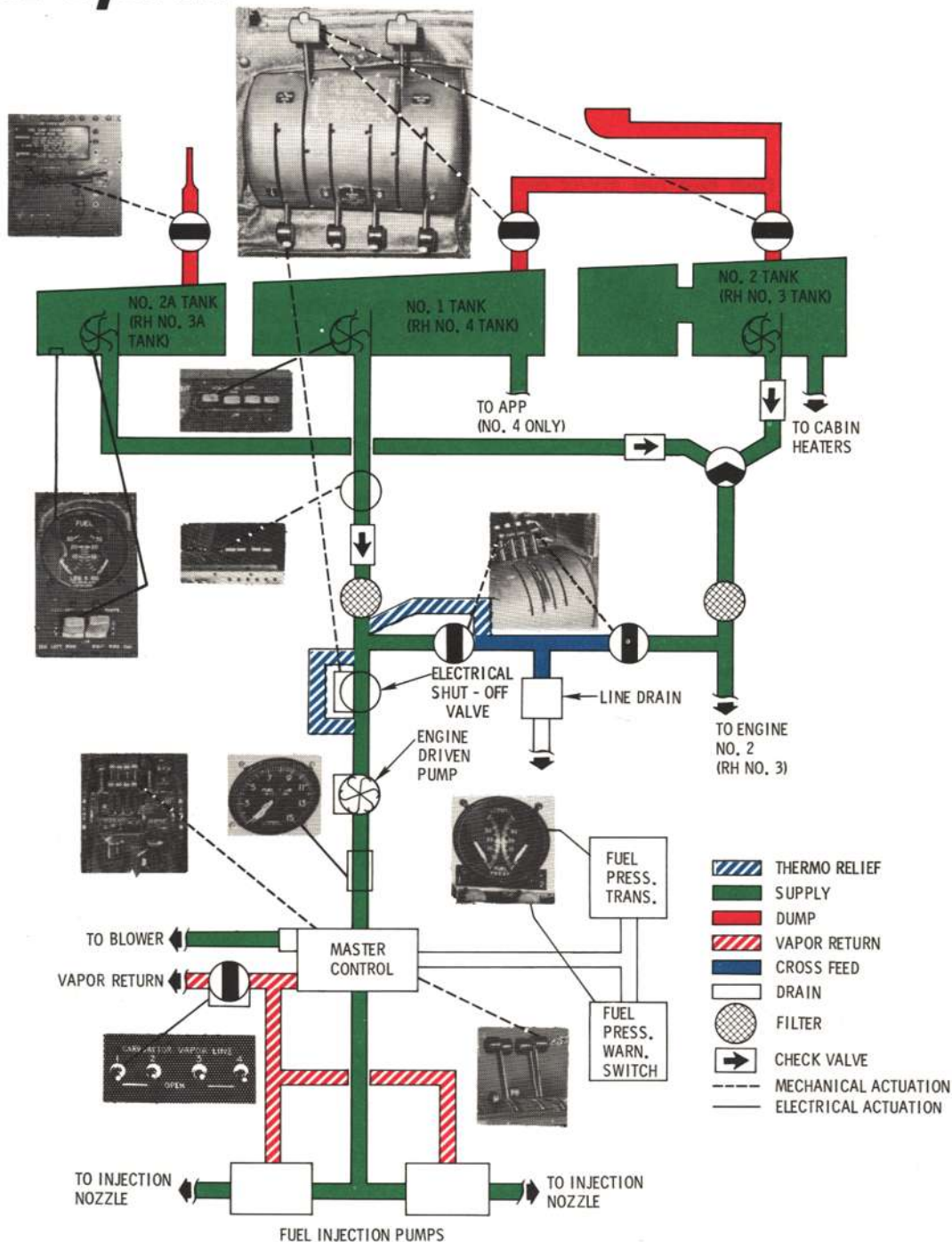

Figure 1-5 (Sheet 1)

F125-1-1-4

fuel system electrical schematic

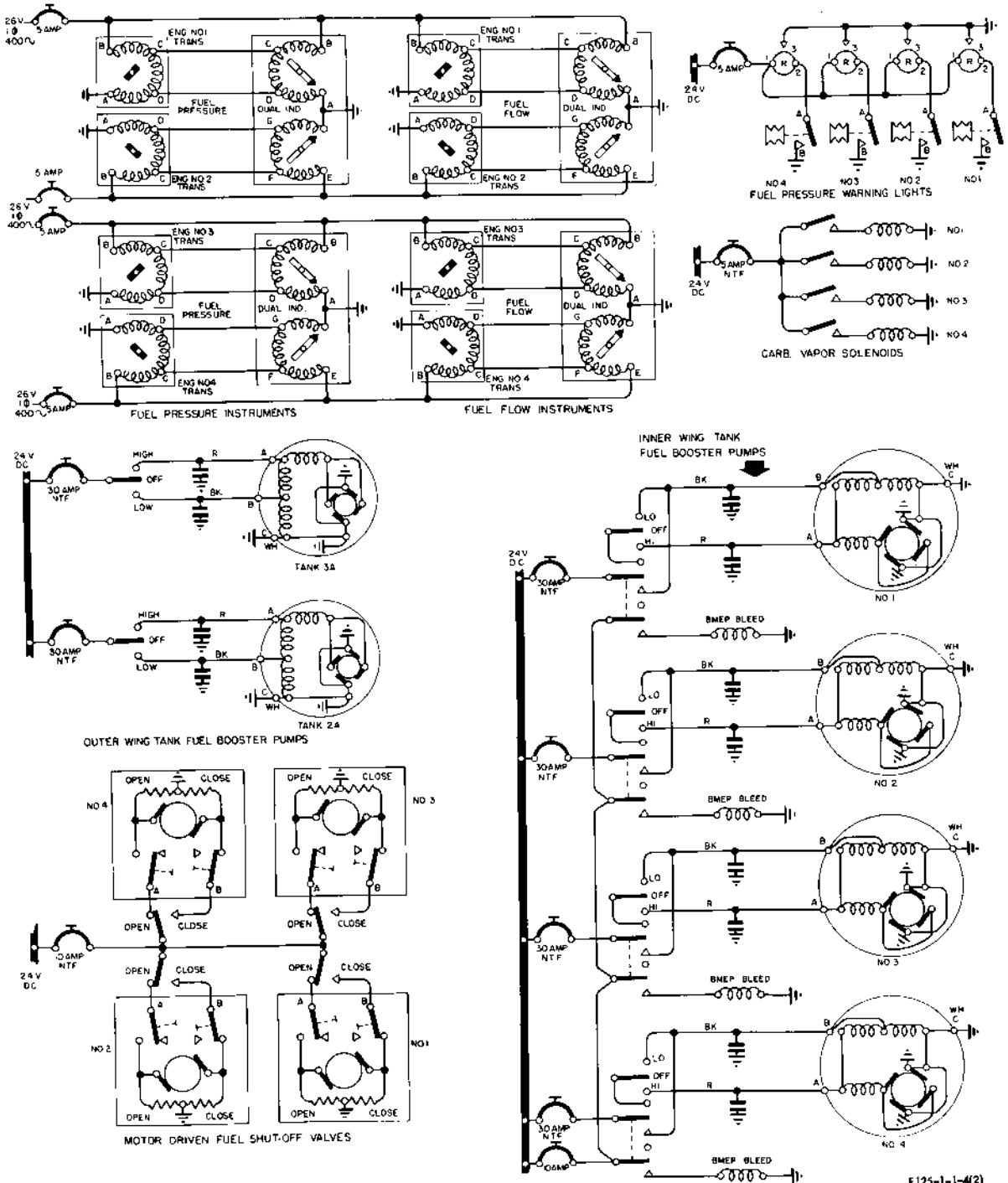

Figure 1-5 (Sheet 2)

fuel dumping system

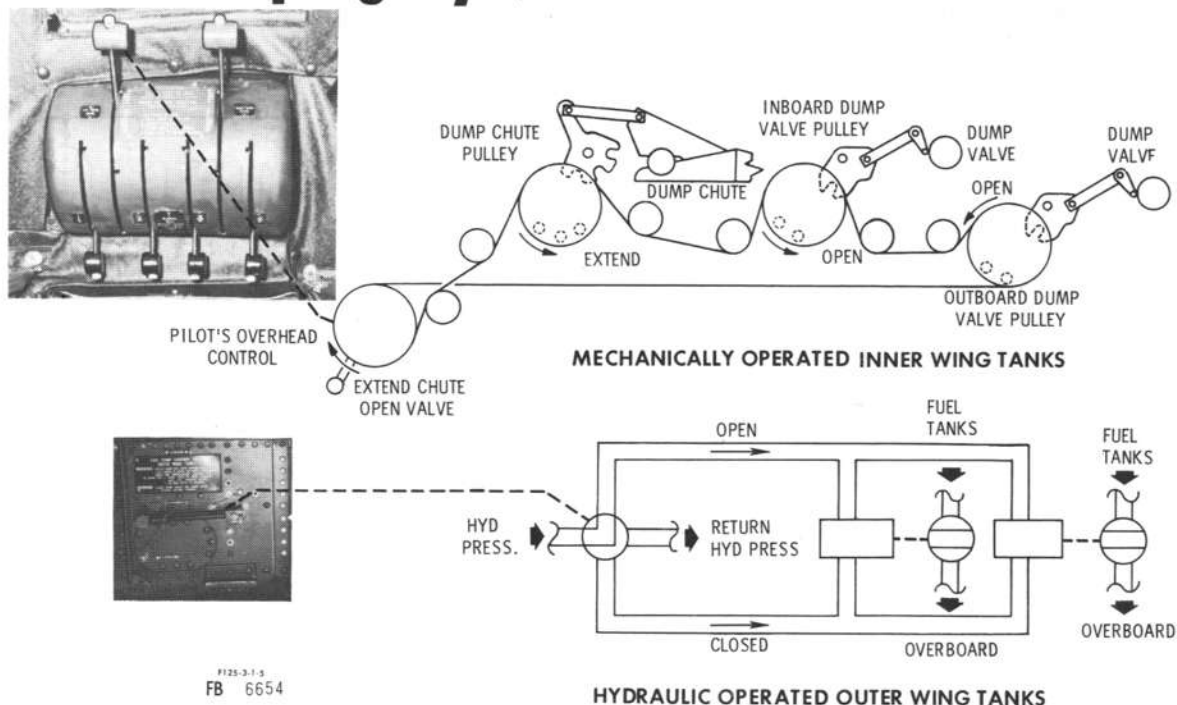

Figure 1-6

Fuel Dump Levers (Tanks 1 and 2, 3 and 4).

The fuel dump levers provide a means to dump fuel by gravity and to vent pressure during emergencies. These levers are located on the pilot's overhead control quadrant (1 figure 1-21) and are mechanically linked to the dump valves and extendable chutes. The control quadrant contains one unlabeled detent position and one unlabeled red marked position. Each aft detent represents the fuel valve closed and dump chute retracted position. Each red painted mark indicates that the fuel dump valve is closed and the dump chute is in the extended position.

Fuel Dump Lever (Tanks 2A and 3A).

The dump valves for tanks 2A and 3A are hydraulically operated by a three-position (OPEN, NEUTRAL, and CLOSED) selector lever located in the flight station beneath the door leading to the cabin. When the selector lever is in the OPEN position, secondary hydraulic pressure operates actuating cylinders which open the dump valves that allow the fuel to dump. The NEUTRAL position shuts off hydraulic pressure to the actuating cylinders and the valves remain in the last

selected position. The CLOSED position of the lever reverses the direction of hydraulic fluid flow to the actuating cylinders which move the dump valves to the closed position.

ELECTRICAL POWER SYSTEM.

The basic electrical supply system is operated by direct current power sources. Inverters provide alternating current power for some items of equipment.

Spare Fuses and Lamps.

Main cabin and cargo compartment spare lamps are stowed in a box in the crew compartment. Spare fuses are located by the No. 3 MJB panel.

D.C. ELECTRICAL POWER SYSTEM.

(Refer to figure 1-9).

The direct current electrical system is nominally a 28-volt, single-wire, (double wire forward of the 260 bulk-head) grounded circuit with power normally supplied by four engine-driven d.c. generators, and two storage batteries. The d.c. generators can be individually con-

fuel crossfeed levers

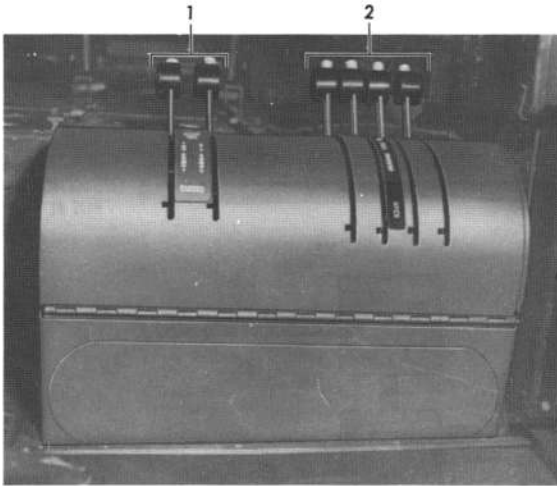

- 1 RETURN AIR SHUT-OFF VALVE LEVERS
2 FUEL CROSSFEED VALVE LEVERS

P123-3-1-21
FB 6664

Figure 1-7

trolled and connected for parallel operation. They incorporate over-voltage, reverse current and reverse polarity protection. A differential voltage reverse current relay and a voltage regulator are provided for each d.c. generator and its protective system.

BATTERIES.

The two 24-volt storage batteries are installed in the nose wheel well. A three-prong reverse polarity protected receptacle for connecting an external d.c. power supply to the aircraft power system is located in the bottom of the fuselage to the right of the nose wheel well.

Generator Switches.

Each engine mounted generator is controlled by a three-position switch (3 figure 1-11) located on the MJB No. 1 switch panel. The switch positions are labeled ON, OFF, and RESET. Each switch is spring-loaded from RESET to the OFF position. When a generator switch is placed in the ON position, output of the generator will be connected to the main d.c. bus provided loads are correct. The RESET position is a momentary-contact position, which resets the field relay in the event it was tripped by over-voltage or by reversed generator polarity or was inadvertently left in the

fuel dump controls

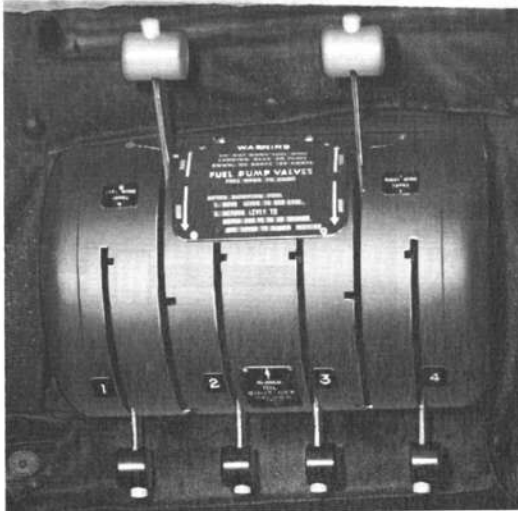

FB 6651

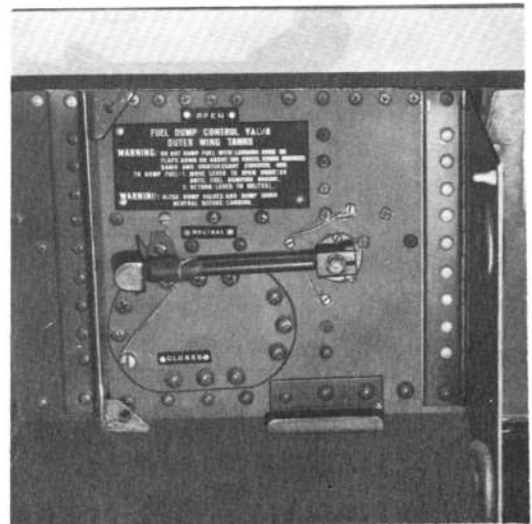
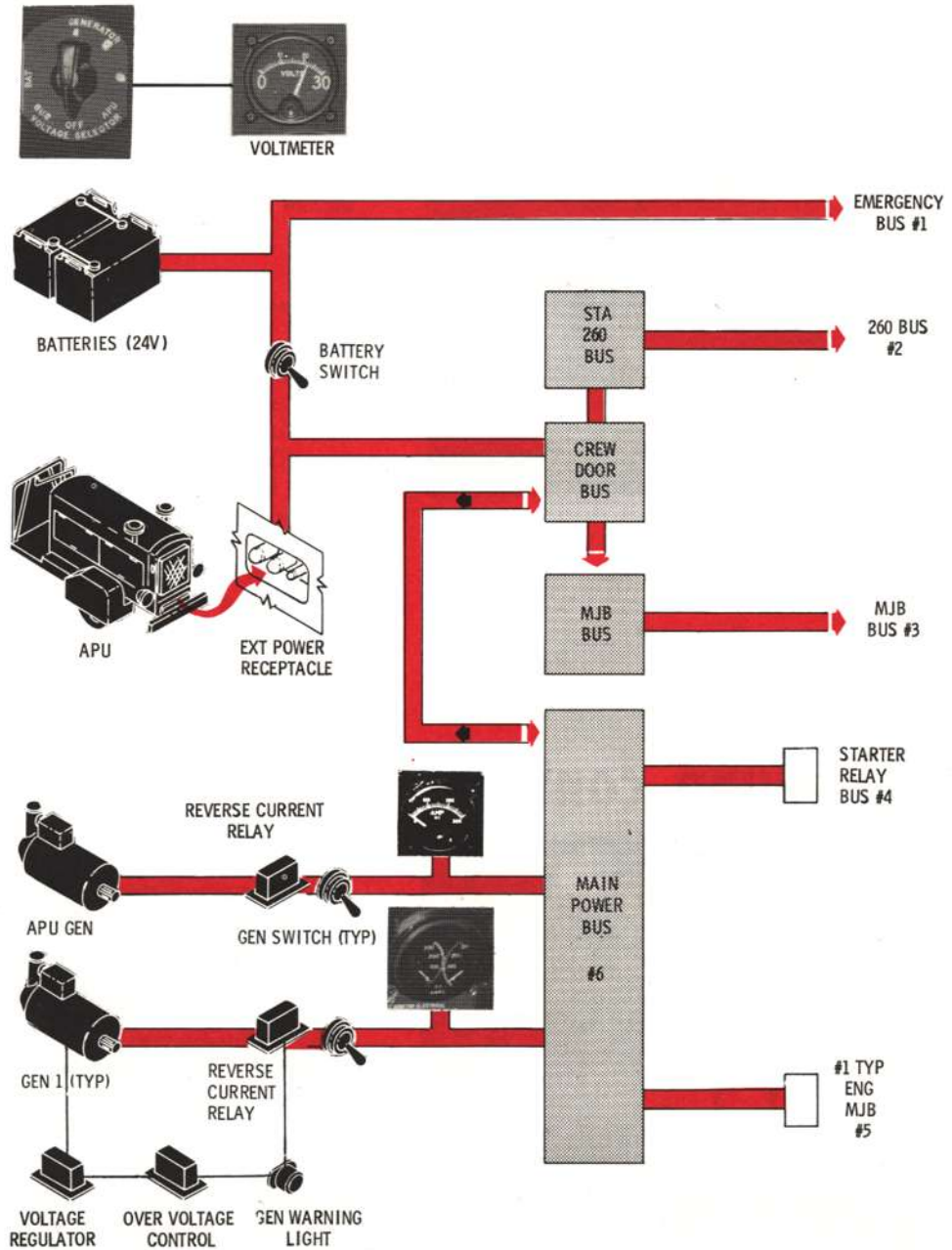

Figure 1-8

d.c. power distribution



F125-1-1-7(1)

Figure 1-9 (Sheet 1)

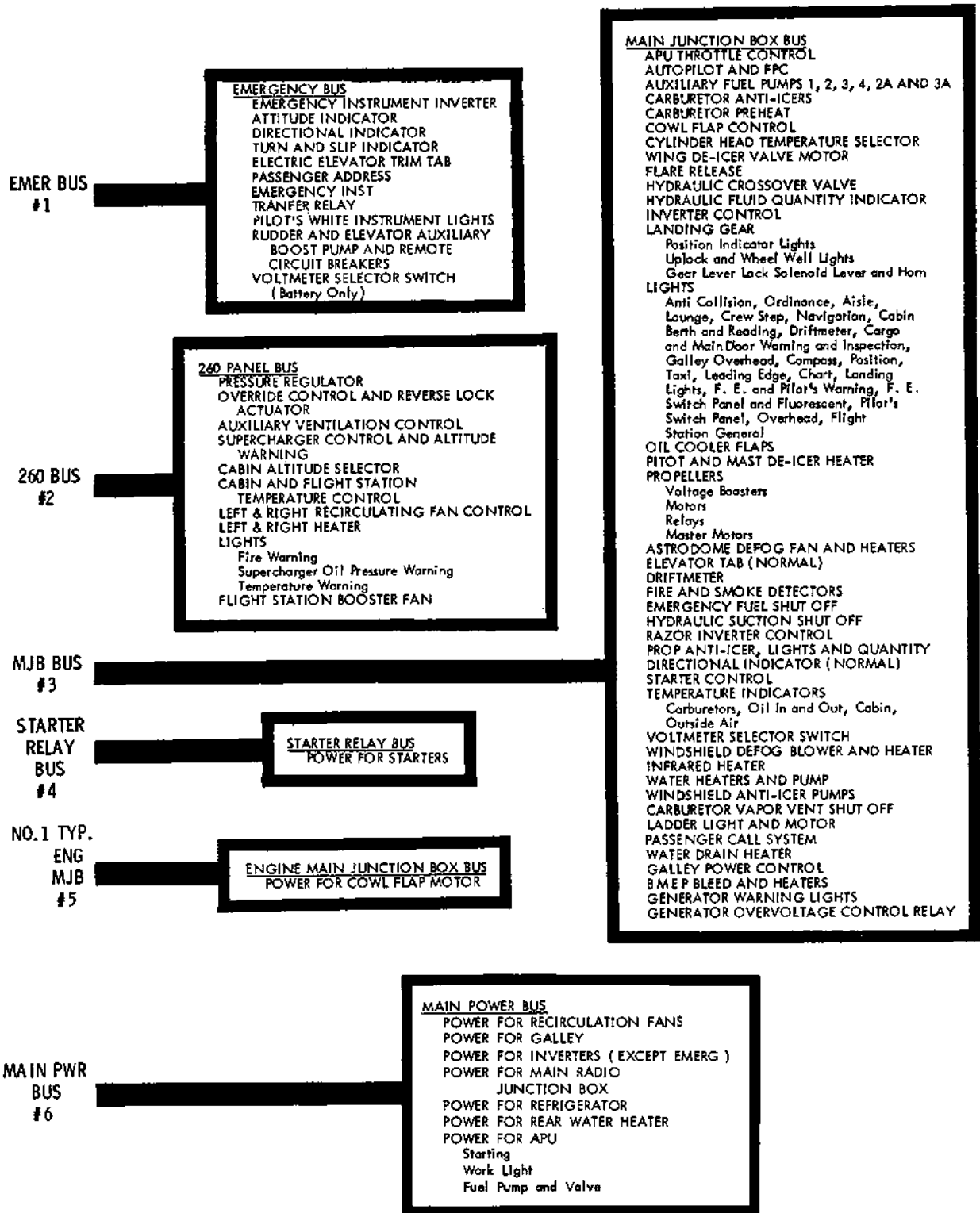

Figure 1-9 (Sheet 2)

tripped position. In the OFF position the generator is disconnected from the d.c. bus, but the field is not de-energized.

Ship's Battery Switch.

A two-position switch (23 figure 1-11) with ON and OFF positions is located on the MJB No. 1 panel. In the ON position, the aircraft batteries are connected to the main d.c. bus.

Generator Voltage Warning Lights.

Below each main generator switch is a red generator voltage warning light (4 figure 1-11). If generator switch is on and generator is not connected to main power bus, the light will glow.

D.C. Voltmeter.

A d.c. voltmeter (27 figure 1-11) located on the MJB No. 1 panel indicates the output of the generators, batteries, MJB bus voltage, and the APU.

D.C. Voltmeter Selector Switch.

An eight-position switch (27 figure 1-11) located on the MJB No. 1 switch panel provides selection of generators 1, 2, 3, 4, BAT., BUS, APU and OFF. Parallel operation of the generators and batteries necessitates that each be disconnected individually from the bus to indicate its potential.

D.C. Ammeters.

Two dual ammeters (2 figure 1-11) are installed on the MJB No. 1 switch panel. The ammeters indicate the direct load on each generator.

RADIO POWER CONTROL SWITCH.

Direct current power is normally supplied to all radio and radar equipment by means of a radio power control switch (8 figure 4-16), located on the radio operator's side panel. This switch controls the master radio power relay located in the lower forward baggage compartment which supplies d.c. power to the main radio junction box.

A.C. ELECTRICAL SYSTEM.

Two 2000 VA three-phase inverters in one system supply 400-cycle, 115-volt a.c. power for normal instruments, and two 2500 VA single-phase inverters in a separate system supply power for the radio requirements. One of these inverters in each system is used as a spare for the other. Also provided are two 26-volt a.c. transformers for operation of the hydraulic pressure

indicators and the left and right engine instruments.

MAIN INVERTERS.

(Refer to figure 1-10 Sheet 1.)

Two 2000 volt-ampere inverters deliver three-phase 115-volt, 400-cycle a.c. power for operation of the auto-pilot, driftmeter, engine analyzer, flight instruments, fuel and oil quantity, and I.F.S. The No. 1 inverter is used to supply a.c. power continuously and the No. 2 inverter functions as a standby for emergency. The circuit is so arranged that the No. 2 inverter is cut in automatically by means of the changeover relay if the No. 1 inverter fails.

RADIO INVERTER.

(Refer to figure 1-10 Sheet 3.)

The aircraft is equipped with two 2500 volt-ampere inverters that deliver single-phase a.c., at 115 volt, 400 cycles. The main inverter supplies a.c. power for all 115-volt radio requirements except the AN/APS-42 radar set which is supplied by the spare inverter. If the main inverter fails, changeover to the spare inverter is accomplished automatically or manually. Both radio inverters, a changeover relay and a transfer relay are located in the lower forward baggage compartment. Remote circuit breakers for the inverters are located on the radio junction box panel (figure 1-12). An additional inverter is installed in USAF Serials 48-610 and 48-615 to operate the ARC-58 SSB system. This 2500 volt-ampere inverter delivers three-phase a.c. at 115-volt, 400 cycles to the ARC-58 components. The inverter is located in the lower forward baggage compartment and is protected by three line fuses near the inverter, and three circuit breakers on the ARC-58 circuit breaker panel located below the radio operator's table. The inverter control switch is located on a small panel adjacent to the ARC-58 inverter warning light, above the ARC-58 control box, in the radio operator position.

EMERGENCY INVERTER.

(Refer to figure 1-10 Sheet 2.)

The emergency inverter switch and circuit breaker are located on the MJB No. 2A panel outlined in red. With the main and spare inverters inoperative, the emergency inverter will operate the pilot's and copilot's attitude indicators, and the pilot's directional indicator. These instruments are outlined in green on the pilot's

and copilot's instrument panels. The pilot's and copilot's turn and slip indicators are d.c. powered, but are wired through the emergency inverter switch. The turn and slip indicators may be operated individually by turning the emergency instrument switch ON and by tripping the instrument inverter circuit breaker. Power is derived directly from the batteries. The emergency inverter is located on the flight station radio rack.

Instrument Inverter Switch and Warning Light.

This switch (26 figure 1-11) is located on the MJB No. 1 panel and is labeled ON, OFF and TEST SPARE. Placing the switch in the ON position, permits normal operation. In the event the inverter warning light (25 figure 1-11) glows, indicating loss of power on the a.c. bus, the No. 2 inverter will be automatically cut in for an alternate power source.

60 Cycle Inverter Switch.

This inverter switch located on the MJB No. 3 panel, arms the 60-cycle, 110-volt inverter. This inverter is located in the forward cargo compartment on the right forward side. The inverter is energized when an electrical appliance plug is inserted in an outlet. Outlets are located in the galley, forward and aft lavatories, and at several locations in the cabin.

a. c. power supply

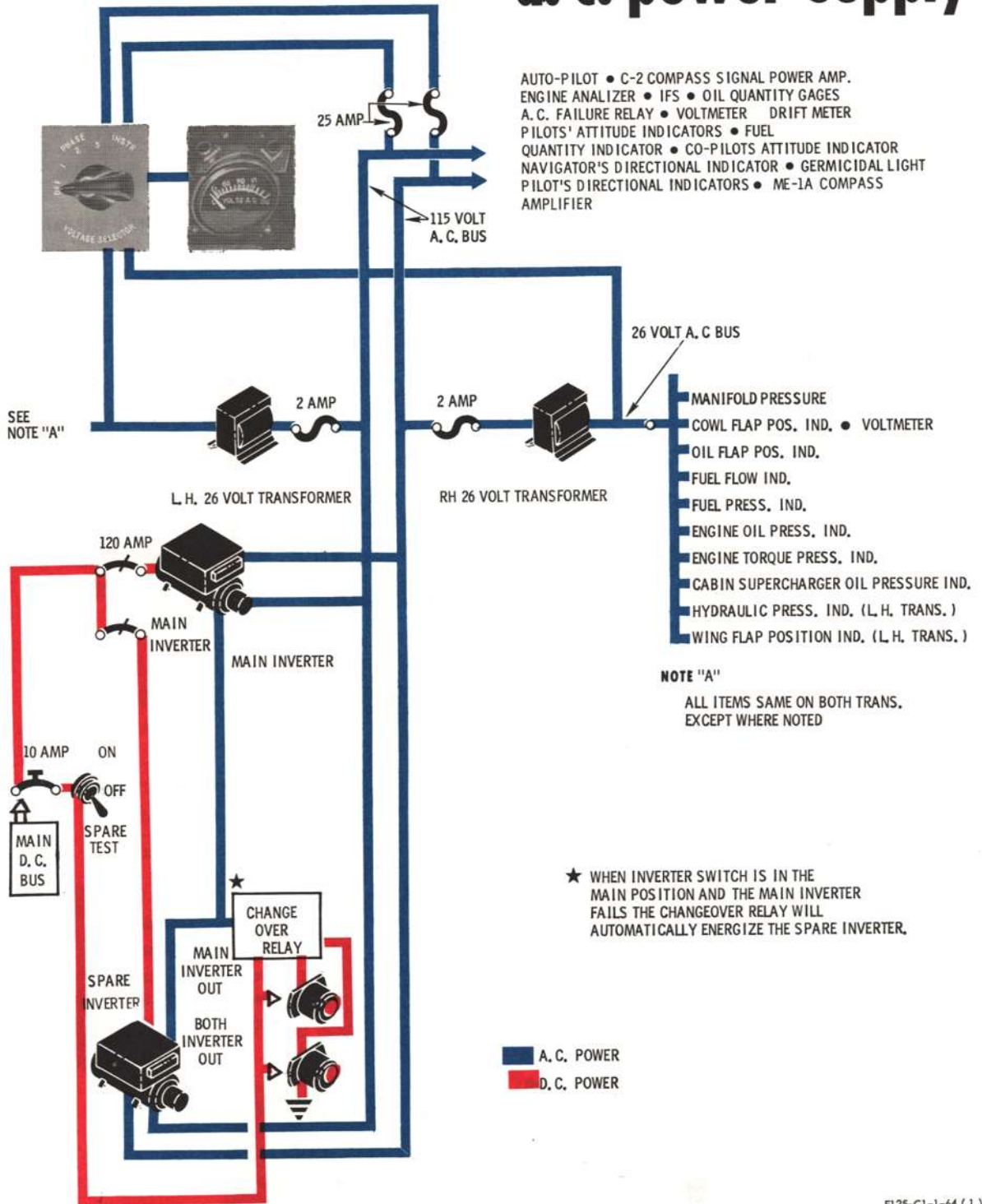

Figure 1-10 (Sheet 1)

emergency inverter power

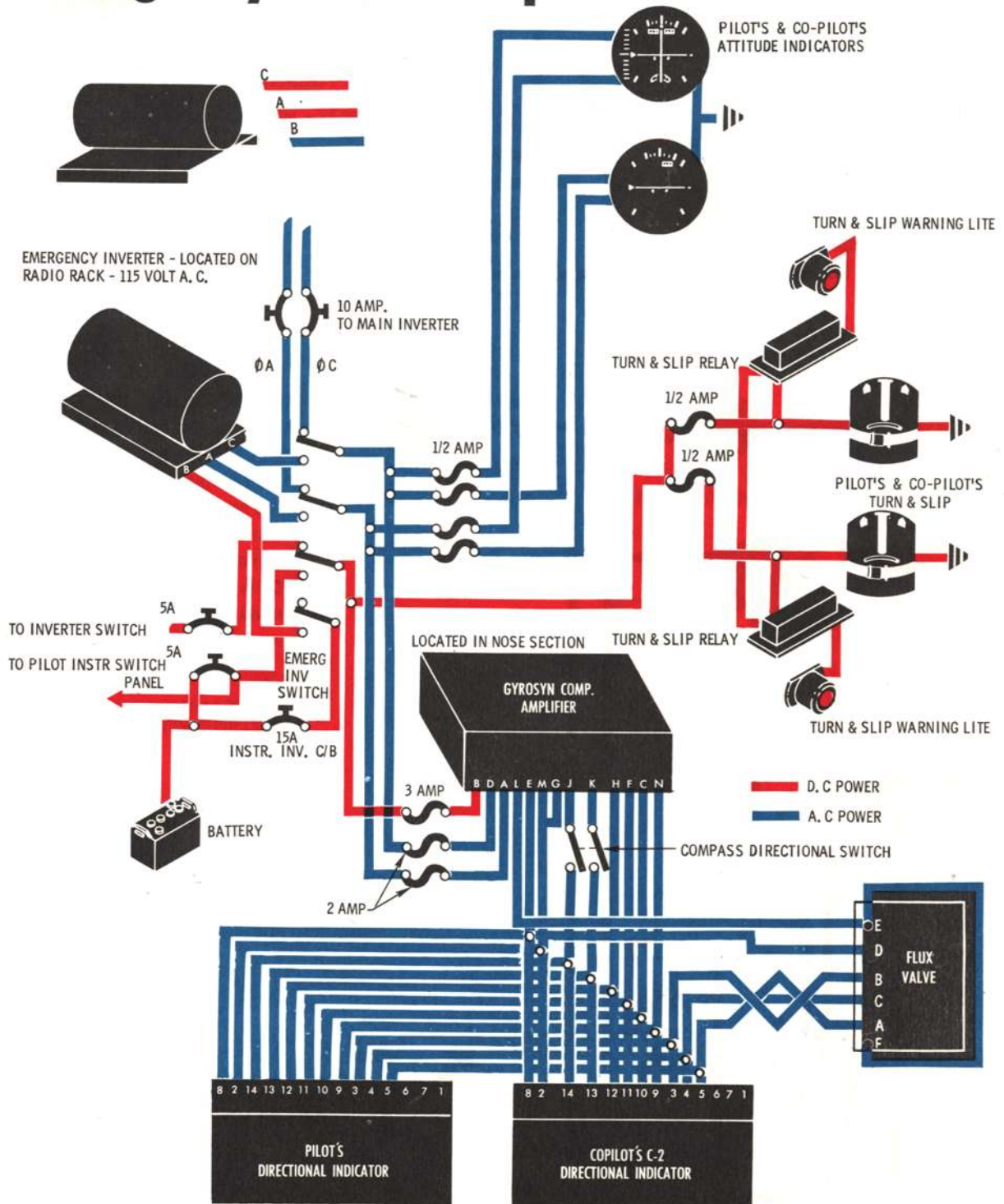
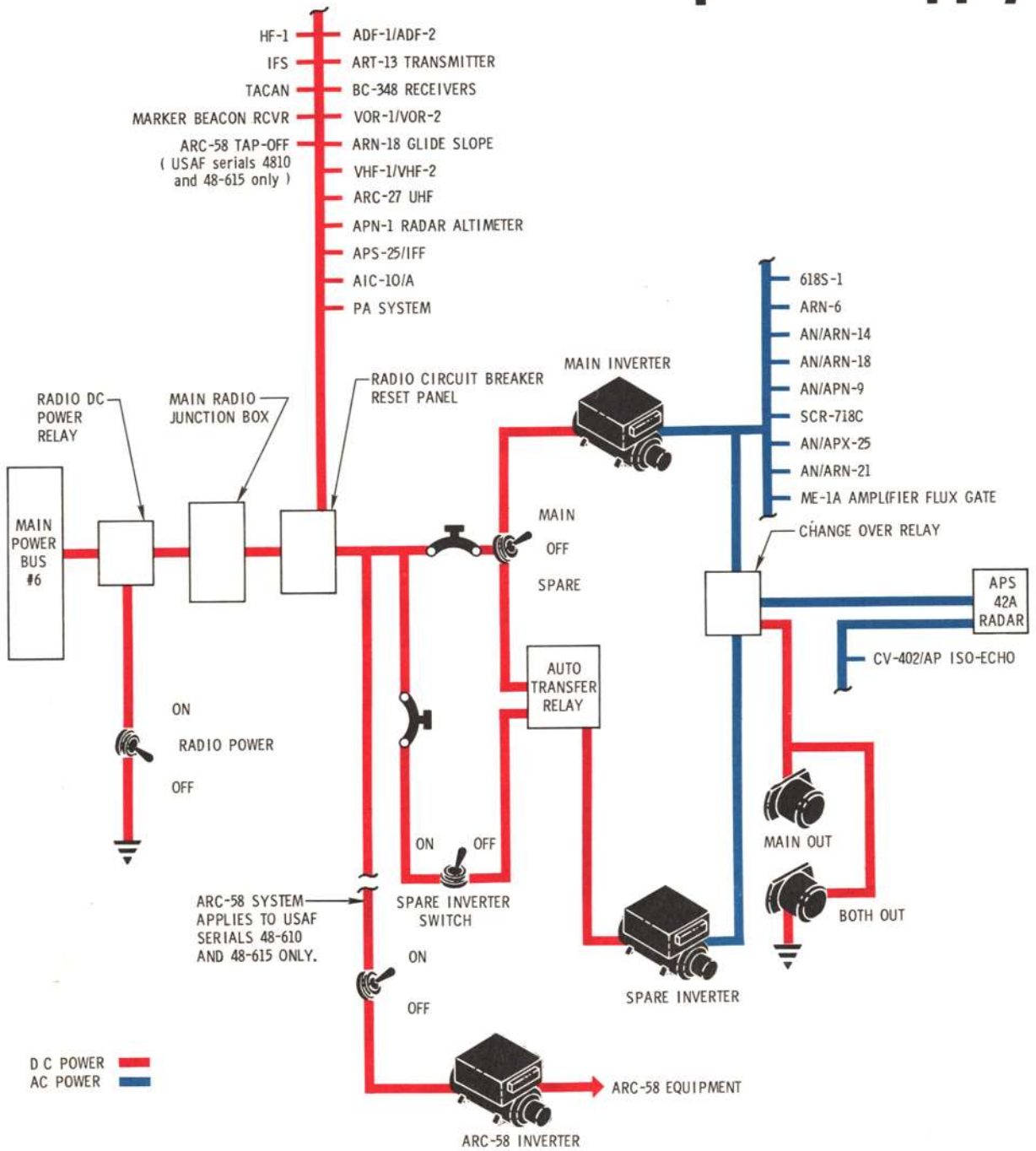

Figure 1-10 (Sheet 2)

radio power supply



F125-C1-1-64 (3)

Figure 1-10 (Sheet 3)

compass system and rmi voltage supply

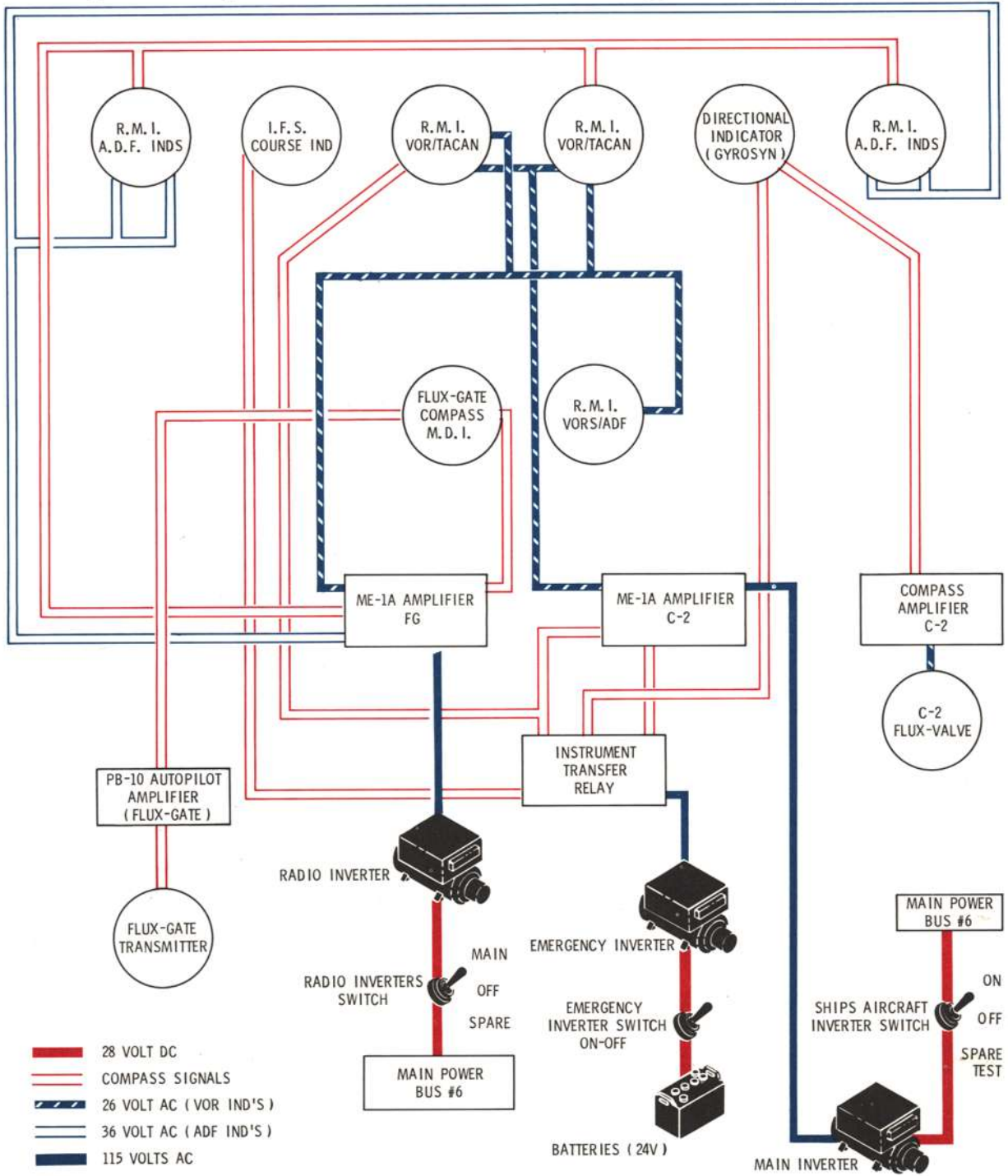

F125-C1-1-113

Figure 1-10A

Radio Inverter Switches.

The main and spare inverter control switches (11 figure 4-16), located on the radio operator's side panel, are labeled MAIN and SPARE. The main inverter switch has three positions, ON, OFF and SPARE ON. Placing the switch in the ON position permits normal operation for all a.c. operated radios except the AN/APS-42. In the SPARE ON position, the radio a.c. loads may be manually transferred to the spare inverter and the AN/APS-42 will cease to operate. The spare inverter switch has two labeled positions, ON and OFF. In the ON position, a.c. power is available for operation of the AN/APS-42 radar. The ARC-58 inverter switch (2 figure 4-17 Sheet 2), on USAF Serials 48-610 and 48-615, is located on the radio operator's console above the ARC-58 control box. The switch has two labeled positions, ON and OFF. In the ON position, a.c. power is available for operation of the ARC-58 components.

Radio Inverter Warning Lights.

The main and spare radio inverter warning lights (7 figure 4-16), are located on the radio operator's side panel, one amber and one red. The amber light will come on if the main inverter fails, indicating the automatic transfer relay has transferred the load to the spare inverter. The red warning light is located adjacent to the main inverter failed light and comes on if both inverters are inoperative. The ARC-58 inverter light (1 figure 4-17 Sheet 2), on USAF Serials 48-610 and 48-615, is located at the radio operator's control console. The red light will come on when the inverter becomes inoperative.

A.C. Voltmeter and A.C. Voltage Selector Switch.

An a.c. voltmeter and a selector switch (1 figure 1-11) are located on the MJB No. 1 panel. The selector switch is used to select any phase of the three-phase, 115-volt a.c. bus, and the L and R 26-volt instrument transformers. The selector switch also has an OFF position.

Radio Voltmeter, Frequency Meter and Selector Switch.

An a.c. voltmeter, frequency meter, and selector switch (5, 6 figure 4-16), are located on the radio operator's side panel. The selector has three positions, MAIN, SPARE and OFF. When MAIN or SPARE positions are selected, radio a.c. bus voltage and inverter frequency

are indicated on the meters. On USAF Serials 48-610 and 48-615 the selector switch, located on the same panel, has five positions, MAIN, SPARE, A, B and C phase. It is used to select the 115-volt a.c. bus of either the main or spare inverter or any phase of the ARC-58 three-phase inverter.

HYDRAULIC POWER SYSTEM.

(Refer to figure 1-13.)

Four variable-displacement hydraulic pumps, one driven by each engine, provide operating power for the various hydraulically operated units. The hydraulic power is divided into two systems, the primary and secondary, each of which obtains fluid from the main hydraulic reservoir. The reservoir is located in the leading edge of the left stub wing section. The reservoir is divided vertically into two compartments up to approximately 2/3 of its height and is pressurized with air by means of an aspirator. The reservoir partition separates secondary system fluid from primary system fluid and each system draws fluid from its respective compartment. The primary and secondary hydraulic power systems are normally kept separate but may be interconnected by means of an electrically operated crossover valve. This valve permits either the primary or secondary system to supply pressure to both systems for emergency operation. A separate and auxiliary hand pump power system, with its own reservoir, provides emergency braking or emergency landing gear extension.

Hydraulic System Crossover Valve.

An electric motor-driven valve is installed to connect the primary and secondary hydraulic systems in the event that one of the systems should fail. During normal operation, the crossover valve is closed and the primary and secondary hydraulic systems are relegated to their respective system components. The booster return bypass valves automatically direct the return hydraulic fluid from the primary and secondary hydraulic systems to their respective sides of the main hydraulic reservoir. In the event that either hydraulic system should fail, the systems can be connected by opening the crossover valve. This allows the primary hydraulic system to feed secondary system components as well as the booster systems or allows the secondary hydraulic system to feed the booster system as well as the secondary system components. The hydraulic system that is still in operation will then

master junction box panels

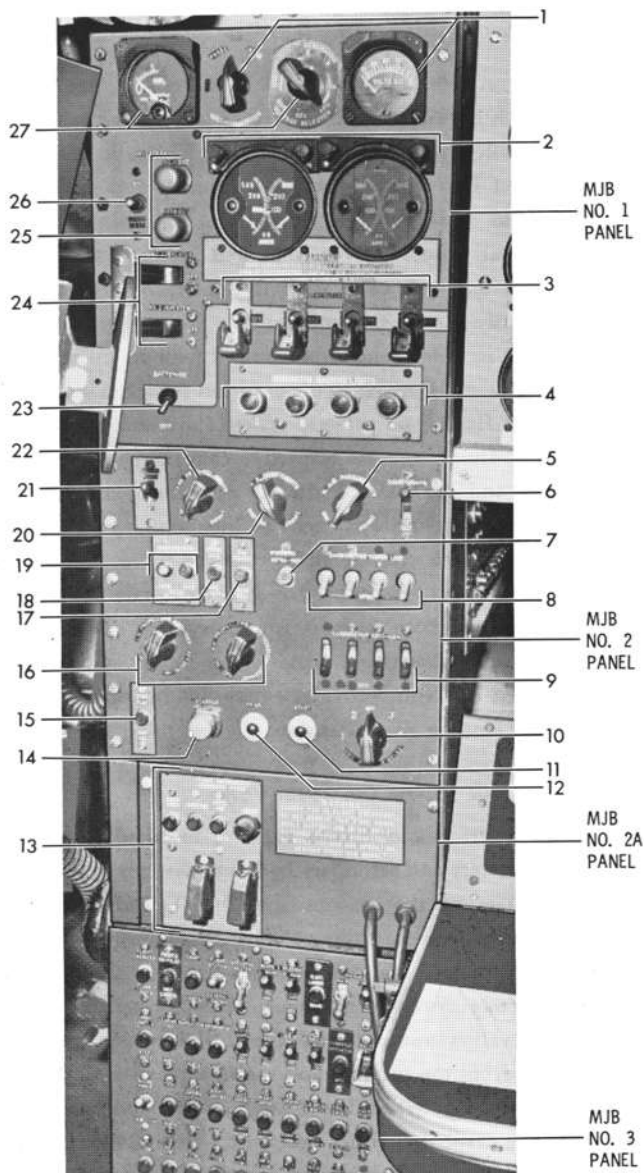

- 1 A. C. VOLTMETER AND SELECTOR SWITCH
- 2 D. C. AMMETERS
- 3 GENERATOR SWITCHES
- 4 GENERATOR WARNING LIGHTS
- 5 MJB PANEL LIGHTS RHEOSTAT
- 6 DOME LIGHT SWITCH
- 7 WINDSHIELD INFRA-RED HEATER CIRCUIT BREAKER
- 8 CARBURETOR VAPOR RETURN SOLENOID SWITCHES
- 9 CARBURETOR ANTI-ICER SWITCHES
- 10 ENGINE STARTER SELECTOR SWITCH
- 11 ENGINE STARTER SWITCH
- 12 ENGINE PRIME SWITCH
- 13 FLIGHT INSTRUMENT EMERGENCY POWER CONTROL PANEL
- 14 STARTER SELECTOR WARNING LIGHT
- 15 WING FLAP SHUT-OFF CIRCUIT BREAKER
- 16 PROPELLER ANTI-ICER CONTROL RHEOSTATS
- 17 HYDRAULIC SYSTEM CROSSOVER CIRCUIT BREAKER
- 18 PROPELLER REVERSING INDICATOR LIGHTS CIRCUIT BREAKERS
- 19 MASTER REVERSE SAFETY SWITCH CIRCUIT BREAKERS
- 20 F. E. DESK LIGHTS RHEOSTAT
- 21 GALLEY POWER SWITCH
- 22 ENGINEER'S SWITCH PANEL LIGHTS RHEOSTAT
- 23 BATTERY SWITCH
- 24 NO. 1 AND NO. 2 INVERTER CIRCUIT BREAKERS
- 25 NO. 1 OUT AND BOTH OUT INVERTER WARNING LIGHTS
- 26 INVERTER ON/SPARE-TEST SWITCH
- 27 D. C. VOLTMETER AND SELECTOR SWITCH

F125-C1-1-37

Figure 1-11

circuit breaker panels

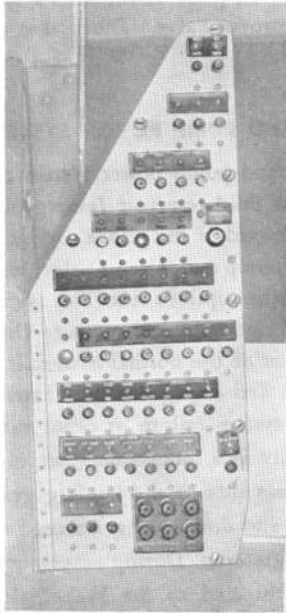

↑
RADIO JUNCTION BOX PANEL

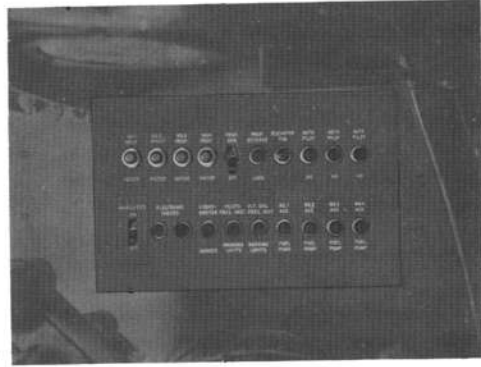

↑
UPPER 212 PANEL

LOWER 212 PANEL →

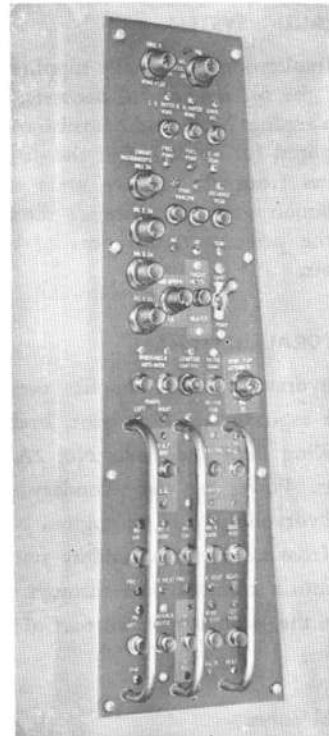

FB 6658

Figure 1-12

supply pressure for both hydraulic systems and the return hydraulic fluid will be directed automatically by the return bypass valves to the same side of the hydraulic system. The aspirator, which is the means by which the main system reservoir is pressurized, also directs brake return fluid to the main reservoir. During normal operation the aspirator return bypass valve directs the return fluid to the secondary side of the main hydraulic reservoir. The electrically controlled hydraulic system crossover valve incorporates a manual override in the valve body. To operate the crossover valve manually the crossover valve circuit breaker should be pulled prior to operating the valve lever, (located in the center aisle floor of the forward passenger compartment), from the CLOSED position to the OPEN position.

CAUTION

In the event of loss of system pressure from either the primary or secondary system, before opening the crossover valve it should be determined that loss of the remaining system pressure and fluid will not occur.

PRIMARY HYDRAULIC SYSTEM.

The primary hydraulic system normally supplies pressure for operation of the surface control boosters. The hydraulic pumps on engines No. 1 and 2 furnish the volume and pressure required for operation of the primary system. Return lines from all primary units are manifolded into a common return line through the main primary filter to the primary return port of the main hydraulic reservoir.

SECONDARY HYDRAULIC SYSTEM.

The secondary hydraulic system supplies pressure for operation of the aspirator, landing gear, brakes, nose wheel steering, wing flaps and tanks No. 2A and 3A fuel dump valves. Power for the secondary system is supplied by the hydraulic pumps on engines No. 3 and 4. Return lines from all of the secondary system units are manifolded into a common line through the main secondary filter to the secondary return port of the main hydraulic reservoir.

Restriction Control Valve.

A restriction control valve is installed in the secondary system pressure manifold to operate as a flow control valve if the hydraulic system pressure drops to a pre-set value. Extension of the landing gear and wing flaps

may be slower than normal because the restriction control valve will give priority to the pressure requirements of the flight control boosters when one of the systems is providing hydraulic pressure for both systems through the hydraulic crossover valve. The brakes and steering are not affected.

EMERGENCY HAND PUMP POWER SYSTEM.

The emergency hand pump power system consists of a separate hydraulic fluid reservoir (emergency extension tank), located forward of the pilot's rudder pedals, and a combined hand pump and selector valve, located on the floor outboard of the copilot's seat. This system provides an auxiliary source of fluid and pressure (hand pump), that is independent of the normal hydraulic system, for emergency brakes and emergency gear extension in the event of normal system failure or other existing emergencies. A separate and independent set of lines, connected to the down side of the landing gear actuating cylinder up-locks and down locks, are used only during emergency gear extension. During emergency brake operation, fluid is directed to the brake selector valve, which in turn directs fluid to the brakes when the selector is in the NORM. position, or through the accumulators to the brakes when the selector is in the EMER. position.

Additional components include provisions for replenishing the system with fluid. These components consist of a hand wobble pump with a capped inlet line (to be attached to a portable fluid container which is stowed in the forward cargo compartment) and an outlet line connecting the wobble pump to a filler selector valve which will direct replenishing fluid to the emergency extension tank or to the main system hydraulic reservoir.

Emergency Shut-off Levers.

The emergency shut-off levers (3 figure 1-21) are located on a control quadrant in the ceiling of the flight station. There is one lever for each engine, and each lever has two positions. The CLOSED position mechanically shuts off the hydraulic oil supply in each engine-driven pump suction line. The emergency shut-off levers to the hydraulic firewall shut-offs are mechanically connected by a cable and pulley system, and the hydraulic suction shut-off valves are operated electrically by 28-volt d.c. Refer to EMERGENCY EQUIPMENT in this section for operation.

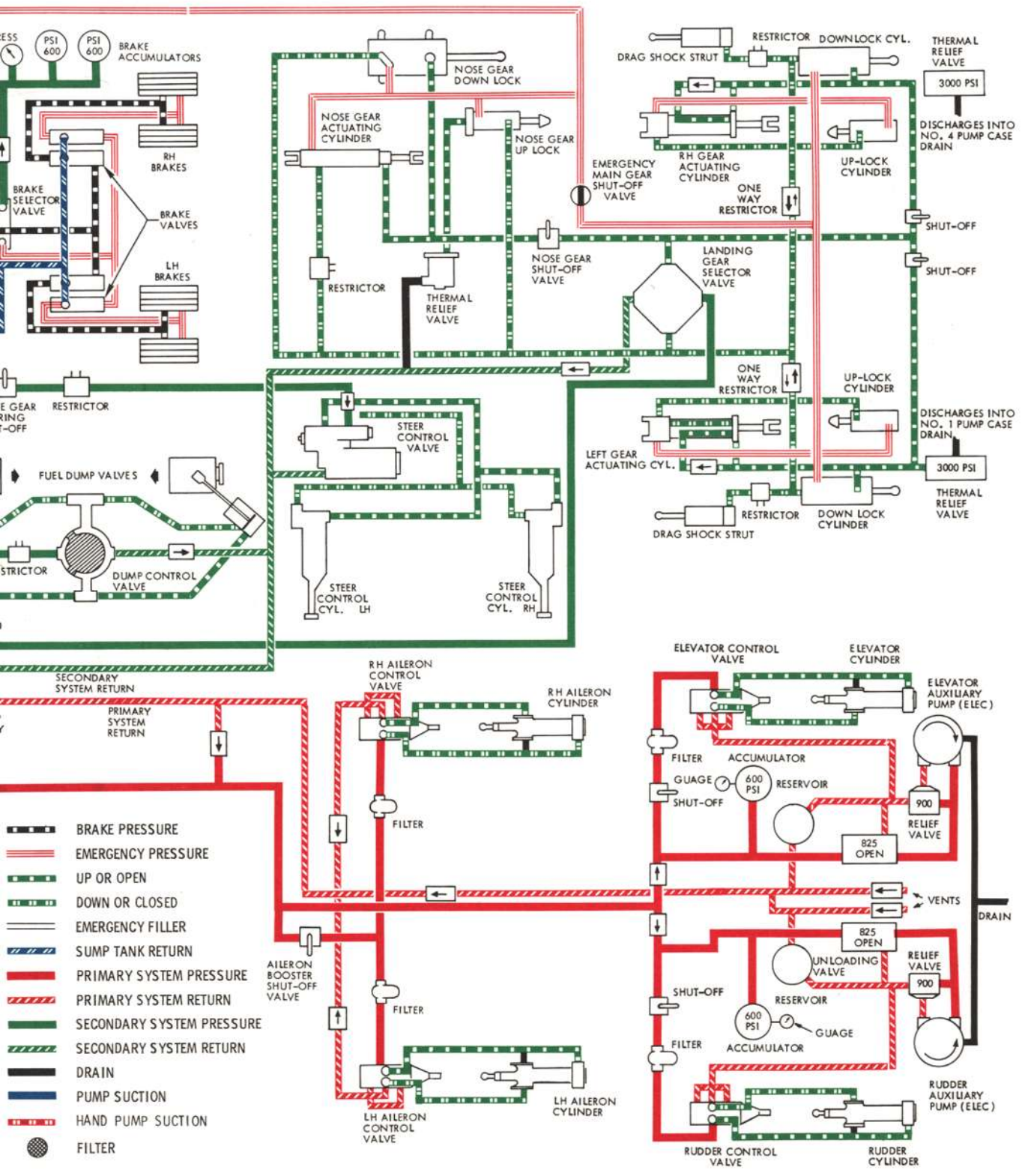
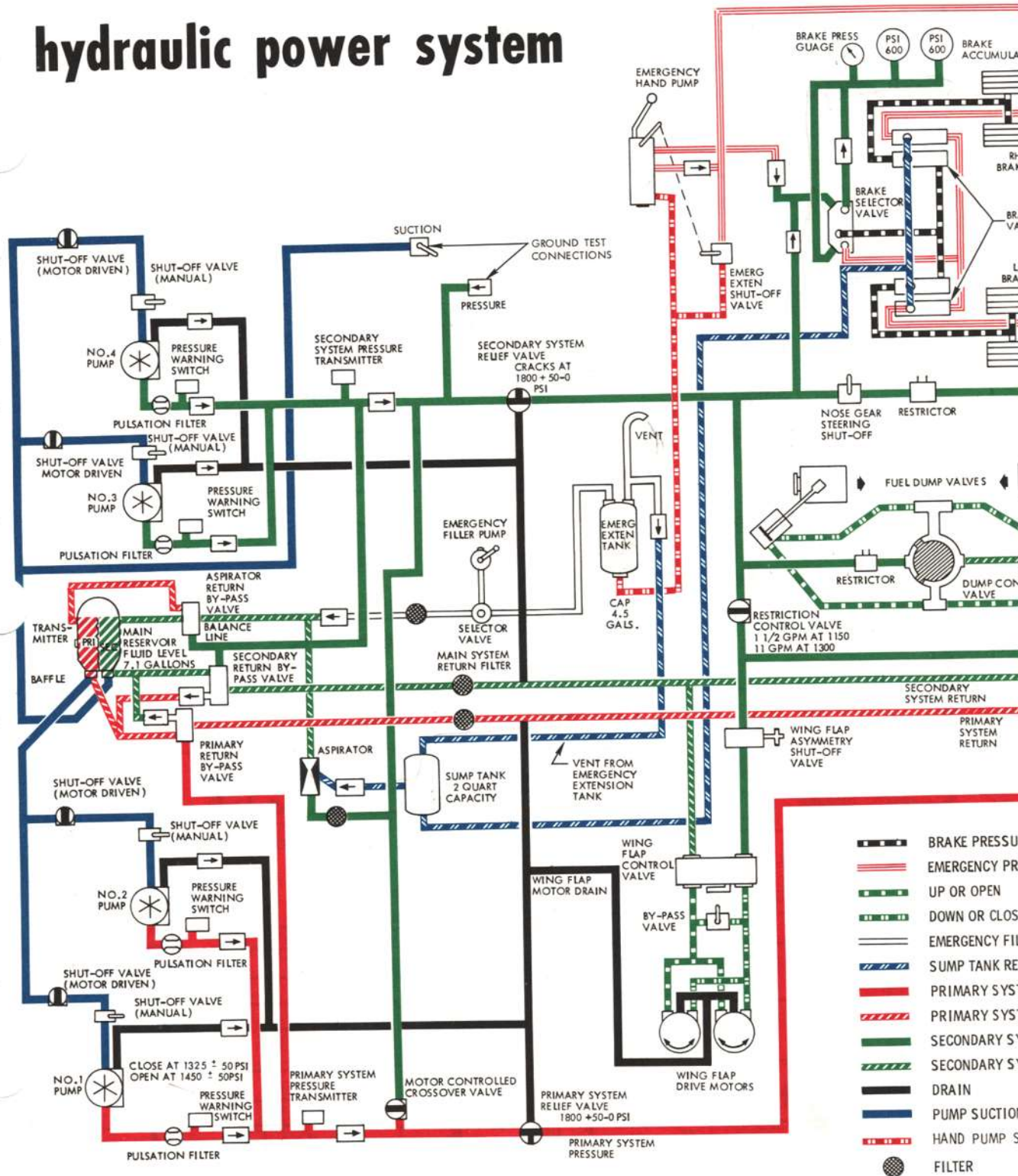

Figure 1-13 (Sheet 1)

hydraulic power system



- BRAKE PRESSURE
- EMERGENCY PRIMARY SYSTEM
- UP OR OPEN
- DOWN OR CLOSED
- EMERGENCY FILLER PUMP
- SUMP TANK RETURN
- PRIMARY SYSTEM
- PRIMARY SYSTEM RETURN
- SECONDARY SYSTEM
- SECONDARY SYSTEM RETURN
- DRAIN
- PUMP SUCTION
- HAND PUMP SUCTION
- FILTER

hydraulic system electrical circuits

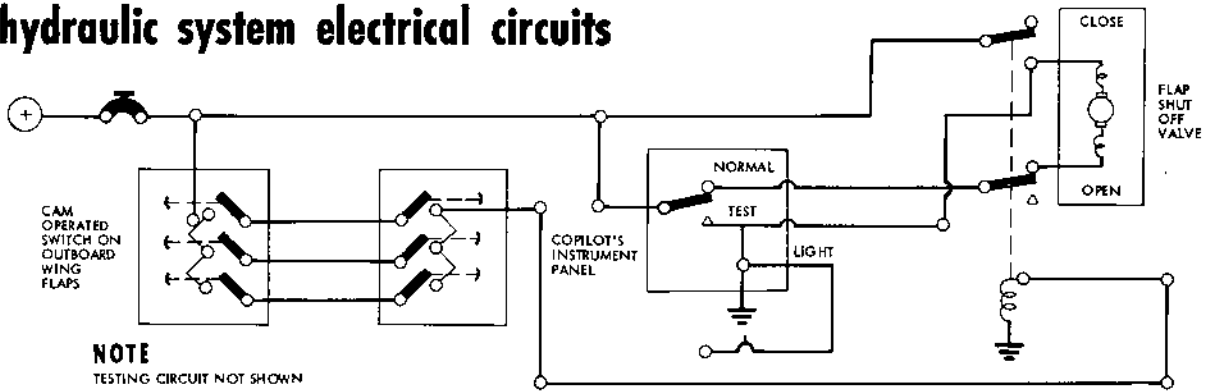

WING FLAP ASYMMETRY PROTECTION SYSTEM CIRCUIT

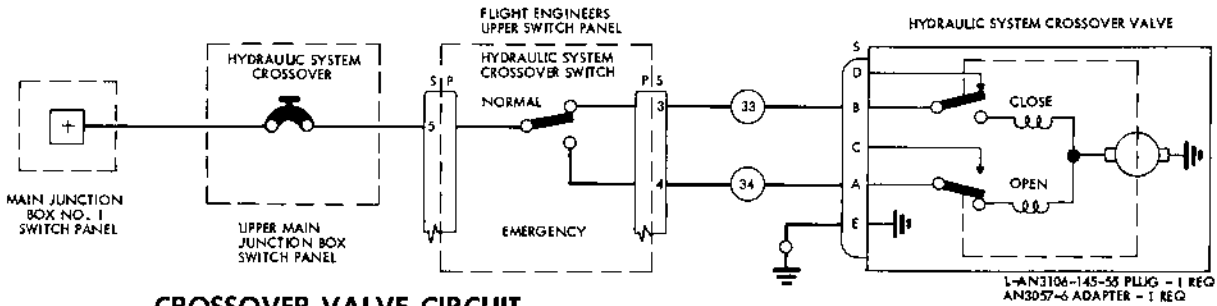

CROSSOVER VALVE CIRCUIT

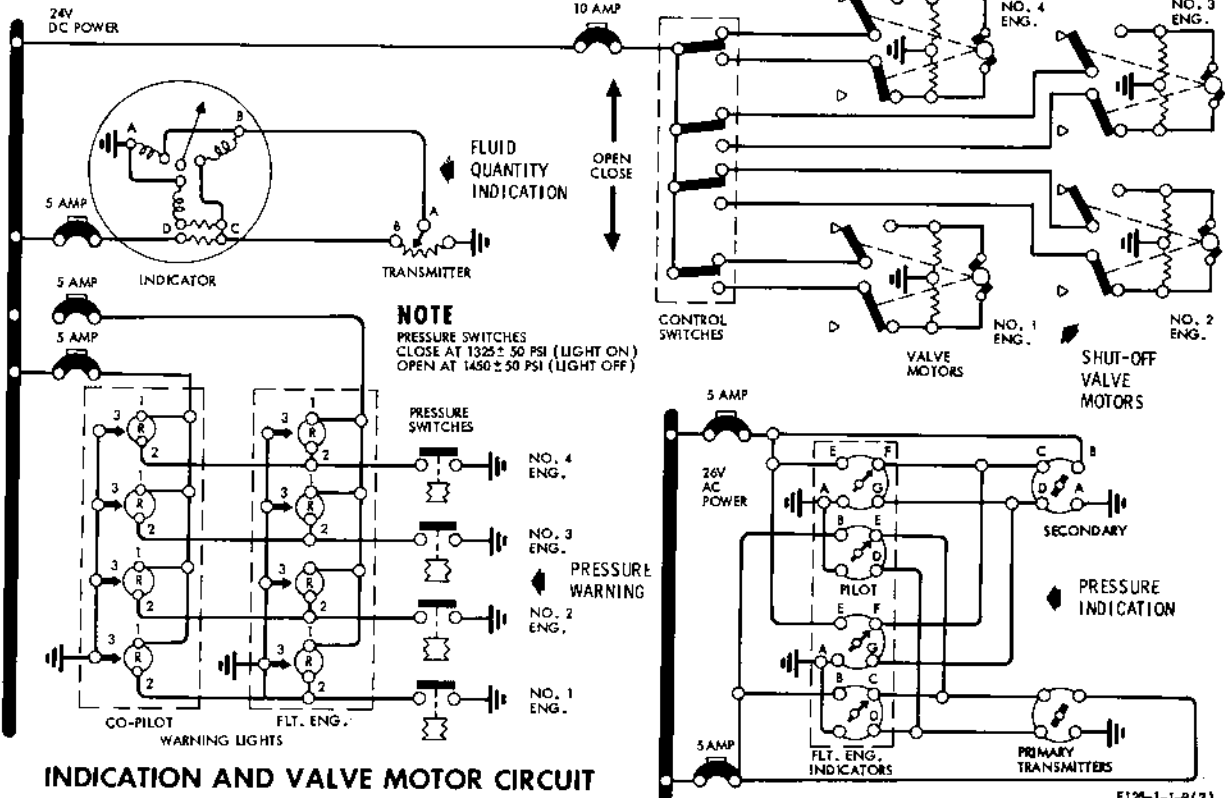

INDICATION AND VALVE MOTOR CIRCUIT

Figure 1-13 (Sheet 2)

Emergency Hand Pump and Selector Lever.

The emergency hand pump and selector lever are located on the flight station floor, outboard of the copilot's seat. The selector lever has two positions, EMER. BRAKES and EMER. GEAR. When the lever is in the EMER. BRAKES position, the hand pump may be used to direct fluid and pressure to the brake selector valve. By placing the brake selector lever in the NORM. position, hand pump pressure is directed directly to the brakes. By placing the brake selector lever in the EMER. position, hand pump pressure is directed to the brake accumulators, thus giving accumulator pressure for actuating the brakes. When the hand pump selector valve is placed in the EMER. GEAR position, the hand pump lever may be used to supply pressure, through an independent system of lines, to the downside of the landing gear actuating cylinders, and the uplocks and downlocks.

Hydraulic System Crossover Valve Switch.

The hydraulic system crossover switch (2 figure 1-23) is a guarded switch installed on the flight engineer's upper panel. It has two positions, NORMAL and EMERGENCY. The NORMAL position is the closed position. When the switch is in the EMERGENCY position, the d.c. motor-driven crossover valve is open and the primary and secondary hydraulic systems are interconnected.

Hydraulic Suction Shut-off Valve Switches.

Four two-position switches (4 figure 1-23) located on the flight engineer's upper panel, are guarded to the OPEN position. When in the CLOSED position, d.c. power runs the motor-driven valve to the closed position, shutting off the flow of fluid from the main hydraulic reservoir to the pump.

Hydraulic System Crossover Valve Lever.

This lever is located on top of the valve in the top rear area of the forward baggage compartment (figure 1-14). It may be used to manually open or close the crossover valve after the circuit breaker has been tripped or in case of electrical system malfunction.

Hydraulic Reservoir Filler Selector Valve.

This selector valve, labeled OFF, EMER. RES. and MAIN RES., is located near the hydraulic reservoir filler pump. The EMER. RES. or MAIN RES. positions permits hydraulic oil to be transferred manually from a portable container to the emergency reservoir or main reservoir respectively.

Hydraulic Reservoir Filler Pump.

A wobble pump is located on the flight station floor-offset behind the pilot's seat. This pump transfers hydraulic oil through a selector valve from a portable container to the hydraulic system.

Hydraulic Fluid Quantity Indicator.

The main hydraulic reservoir dual quantity indicator (51, figure 1-23) is located on the flight engineer's upper instrument panel. This indicator is actuated by the liquidometer transmitters in the primary and secondary sides of the main fluid reservoir. The dial is marked EMPTY^o, ONE QUARTER, ONE HALF, THREE QUARTERS, and FULL for both systems. The indicator is powered by 28 volts d.c.

Hydraulic System Pressure Indicators.

Two dual hydraulic pressure indicators are installed, one on the copilot's auxiliary instrument panel (25 figure 1-18) and one on the flight engineer's upper instrument panel (48 figure 1-23). The indicators are calibrated in psi. One needle in each instrument indicates the hydraulic pressure in the primary system and the other needle indicates the pressure in the secondary system. Each indicator is electrically connected to a pressure transmitter located in the pressure lines of each system. The indicators are powered by 26 volts a.c.

Hydraulic Pump Low Pressure Warning Lights.

Four pump low-pressure warning lights are installed on the flight engineer's upper instrument panel (46 figure 1-23), and on the copilot's auxiliary instrument panel (23 figure 1-18). The lights are numbered from left to right and are electrically connected to the hydraulic pressure warning switches.

Emergency Extension Hydraulic Reservoir Sight Gage.

A sight gage mounted on the emergency extension reservoir is visible between the pilot's rudder pedals.

FLIGHT CONTROL SYSTEM.

The elevators, rudders, and ailerons are actuated by cable and pulley systems which incorporate tension regulators that automatically maintain constant tension in the cable systems. Each outboard rudder, each elevator, and each aileron is also provided with a cable-operated trim tab controlled from the flight station. Hydraulic boosters are built into the elevator, rudder, and aileron cable systems to assist the pilot in moving

hydraulic crossover



Figure 1-14

the control surfaces. The elevator and the rudder booster systems incorporate a complete electrical power unit that will provide an auxiliary source of hydraulic power to the booster assemblies in the event of primary or secondary hydraulic system failure. Hydraulic fluid for this emergency system is provided by the primary system and stored in accumulators and reservoirs in the tail cone. There is no source of auxiliary hydraulic power for the aileron booster system.

FLIGHT CONTROL BOOSTERS.

Hydraulic pressure for the flight control boosters is supplied normally by the primary hydraulic system. In the event of failure of the primary system, hydraulic pressure can be supplied to the flight control boosters through the hydraulic system crossover valve. This will direct secondary system pressure to the boosters.

CAUTION

Do not operate the hydraulic system crossover valve until it has been determined that loss of the remaining system pressure and fluid will not occur.

Each booster assembly includes a hydraulic actuating cylinder which applies the force and a four-way control valve which regulates the speed and direction of movement of the actuating cylinder piston. Any movement of the rudder pedals or control wheel opens the control valve or valves which direct hydraulic pressure to the actuating cylinder or cylinders.

Surface Control Lock.

The effect of surface control locks is achieved by leaving the flight control boosters ON while the aircraft is parked. The boosters provide sufficient resistances in the system to absorb the impact loads caused by gusts.

AILERON CONTROL SYSTEM.

Aileron control consists of a cable and pulley system that connect the pilots' control wheels with the aileron booster assemblies, located in the wing forward of each aileron. As the control wheel is rotated, push rods mechanically force the ailerons and the aileron booster control valves which hydraulically boost the control wheel action.

Aileron Trim Tabs.

Each aileron incorporates a mechanically controlled and servo-acting trim tab. Motion of the ailerons causes the servo-acting trim tab to automatically move in the opposite direction to aid the pilot in maneuvering the aircraft. This tab is also mechanically attached to a handcrank located on the pilot's pedestal which is used for trimming the aircraft laterally.

ELEVATOR CONTROL SYSTEM.

The elevator control system consists of a cable system that connects the control columns with the booster assembly which is located in the aft end of the fuselage. As the control column is moved forward and aft, the system mechanically actuates the elevators and the elevator booster control valve which regulates the flow to the cylinder supplying hydraulic boost for the elevators. In the event of hydraulic power system failure, elevator booster operation is provided by an electrically-driven hydraulic pump which supplies hydraulic power to the elevator booster assembly.

Elevator Trim Tabs.

Elevator trim can be controlled either manually by control wheels on the pilot's pedestal, or electrically by push buttons on pilot's control wheel. The elevator trim wheel is rotated forward for nose down, and aft for nose up trim. A dial indicator is mounted inboard of the wheels

and indicates the relative position of the tabs. The elevator electric trim tab operates from the ship's electrical system, or directly from the battery in case of electrical failure. A spring loaded lever, installed on the pedestal, permits disengaging or engaging of the clutch for electrical operation of the tabs.

Note

When both buttons are depressed simultaneously the elevator trim tabs will move to give nose up trim. Releasing either button but continuing to hold the other will also give nose up trim. In case of emergency, disengaging the clutch can be accomplished by moving the clutch handle forward until the spring loaded lock falls in the detent position.

RUDDER CONTROL SYSTEM.

The rudder control system consists of a cable system that connects the pilots' rudder pedals with the rudder booster assembly. This quadrant assembly is connected to the center rudder which is interconnected with the outboard rudders. Rudder booster operation is similar in principle to the aileron and elevator boosters. In the event of hydraulic power system failure, rudder booster operation may be provided by an auxiliary electrically-driven hydraulic pump which supplies hydraulic power to the rudder booster assembly. The rudder booster control lever must be left in the boost ON position, however, in order to obtain auxiliary rudder booster operation.

Rudder Trim Tabs.

The flight station trim tab control is connected by cable to each rudder tab gear box.

Rudder Pedals.

The rudder pedals are conventional in operation and are mechanically connected to a rudder booster assembly and the center rudder which is interconnected to the outboard rudders. Each pedal has an individual position latch for alignment and adjustment located at the base of the pedal. Adjustments are made by lifting the spring-loaded position latch and moving the pedal to the desired position. Toe pedals are installed on top of each rudder pedal.

Control Wheel.

The pilot's and copilot's control wheels are also conventional in operation and are mechanically connected

to booster assemblies which in turn are connected to the ailerons and elevators.

Aileron Booster Lever.

The aileron booster control lever (3 figure 1-22) is located on the pilots' pedestal to the left of the throttle controls. When the booster lever is pulled to the OFF (aft) position, hydraulic pressure is shut off and the bypass valves in each cylinder are opened to allow the fluid to flow freely from one end of the cylinder to the other as the ailerons are moved. When the boosters are shut off, the control wheel forces are transmitted to the ailerons through the mechanical system of cables and linkage.

Aileron Trim Tab Handcrank.

The aileron trim tab handcrank (22 figure 1-22) is located on the pilots' pedestal. Tab position is shown by a needle forward of the handle and by a dial indicator below the handcrank. The needle on the lower dial gives the most sensitive indication. Direction of rotation of the handcrank matches direction of the roll of the aircraft.

Elevator Emergency Booster Shift Lever.

The elevator emergency booster shift lever (21 figure 1-22) is located on the left side of the pilots' pedestal and consists of a shaft with a push-button lock on the handle grip. Normally, the lever is in the forward and down position for boost ON operation. It is pulled upward and aft for boost off. In the event of elevator booster system failure, the elevators may be actuated manually by use of the elevator emergency booster shift lever. When this shift lever is pulled upward, it shuts off and bypasses the normal and the auxiliary booster systems and alters the leverage ratio between the control columns and the elevator. This provides the pilots with sufficient mechanical advantage to actuate the elevators manually during the boost-off operations. The amount of elevator travel in relation to control column movement is reduced approximately 3 to 1. There is approximately 1 or 2 inches of free movement in the control column before elevator movement is affected.

Elevator Auxiliary Booster Indicator Light.

The elevator auxiliary booster indicator light (5 figure 1-21) is located on the pilots' overhead panel adjacent to the elevator auxiliary booster switch. The indicator light is connected to the d.c. system and glows amber when the auxiliary boost pump is in operation.

Elevator Auxiliary Booster Switch.

The elevator auxiliary booster switch (9 figure 1-21), located on the pilots' overhead panel, has three positions, ON, OFF and EMERGENCY. It is spring-loaded to OFF from the EMERGENCY position. In the ON position, the d.c. electrically operated auxiliary hydraulic pump supplies hydraulic power to the booster. In the event of normal hydraulic power failure and electrical system failure, the switch can be held in the EMERGENCY position to energize the auxiliary booster. The EMERGENCY position is connected to the emergency d.c. power bus. The elevator emergency booster shift lever must be in the boost on (forward and down) position in order to obtain auxiliary elevator booster operation.

Elevator Trim Tab Wheels and Indicator.

The elevator trim tabs are controlled by wheels (1 figure 1-22) located on each side of the pilots' pedestal and are interconnected. The wheels are rotated forward for nose-down, and aft for nose-up trim. A dial needle indicator is mounted inboard of the wheels and indicates the relative position of the tabs.

Rudder Boost Control Lever.

The rudder boost control lever (2 figure 1-22) is located on the pilots' pedestal to the left of the throttle controls. When the booster control lever is pulled to the OFF (aft) position, the hydraulic pressure is shut off and the bypass valve is opened in the rudder actuating cylinder. This allows the fluid to flow freely from one end of the cylinder to the other as the rudders are moved. When the rudder booster is shut off the rudder pedal forces are transmitted to the rudders through the mechanical system of cables and linkage.

Rudder Auxiliary Control Booster Switch.

The rudder auxiliary control booster switch, located on the pilots' overhead switch panel (8 figure 1-21), has three positions, ON, OFF, and EMERGENCY. It is spring-loaded to OFF from the EMERGENCY position. In the ON position, the d.c. electrically operated hydraulic pump is energized which supplies auxiliary hydraulic power to the rudder booster in the event normal hydraulic power is not available, provided the rudder booster lever is in the ON position. When the switch is held in the EMERGENCY position, electrical power is supplied directly to the auxiliary motor from the emergency d.c. power bus.

Rudder Auxiliary Control Booster Indicator Light.

The rudder auxiliary control booster indicator light (6

figure 1-21) is located on the pilots' overhead panel adjacent to the rudder auxiliary booster switch. The indicator light (d.c.) glows amber whenever the auxiliary boost pump is in operation.

Rudder Trim Tab Handcrank.

The rudder trim tab handcrank (24 figure 1-22) is located on the pilots' pedestal. Tab position is shown by a dial indicator forward of the handcrank. Direction of rotation of the handcrank matches direction of the turn of the aircraft.

WING FLAPS.

The wing flaps are Fowler-type and the flap motion, during extension, is a combination of an aft and downward tilting movement. There are twelve flap sections, ten of which are located in the inner wing panels (five in each wing) and two in the center section. The flap control lever is connected by control cables to the flap control unit located in the wing center section rear beam. The flap control unit consists of a hydraulic selector valve and a follow-up mechanism that controls two hydraulically-driven motors which supply the driving force for the wing flaps. The control unit also allows pre-positioning of the flaps and changing of the flap movement at any time without completing a selected cycle. The two hydraulic motors are located on the rear wing beam in the center section, and are powered by the secondary hydraulic system.

WING FLAP ASYMMETRY PROTECTION SYSTEM.

The wing flap asymmetry protection system consists of cam-driven switches mounted on each of the extreme right outboard and extreme left outboard wing flap intermediate gear boxes. These switches are adjusted so that an open circuit exists during normal operation of the wing flaps. Should an asymmetrical wing flap condition caused by flap torque tube failure occur, the cam-driven switch on the flap will stop its rotation. The other switch assembly will continue to rotate until a circuit is completed through one of the contacts in the switch assembly that has stopped. This completed electrical circuit trips a mechanical latching relay, which in turn energizes an asymmetrical wing flap warning light, and closes an electric motor-driven hydraulic shut-off valve which shuts off the hydraulic pressure to the wing flap motors and stops the motion of the wing flaps. Two transmitters within the asymmetry switch boxes are connected electrically to two pointers in the dual asymmetry and position indicators.

Wing Flap Shut Off Test Switch and Warning Light.

A two-position wing flap shut-off test switch (17 figure 1-18) and an asymmetrical wing flap warning light (17 figure 1-18) taking their power from the d.c. system are located on the copilot's instrument panel. This test switch provides a means of testing the operation of the shut-off valve without energizing the latching relay, and testing the asymmetrical wing flap warning light. If the switch is held in the TEST position while the flaps are moving, the warning light will illuminate and the flaps will stop. This can be further checked by the indication of the wing flap indicator. When the switch is released to return to the NORMAL position, the wing flaps will resume travel.

Wing Flap Lever.

The wing flap lever (10 figure 1-22) is located on the top, right side of the pilots' pedestal. There are four placarded positions on the quadrant: FULL-UP, TAKE-OFF, APPROACH, and LANDING. The flaps are actuated by a mechanical-hydraulic system, including a cable system that is attached to the control unit. When the lever is full forward, the flaps are retracted or are in the UP position (0% extension). Moving the flap lever progressively aft permits the following flap extensions:

TAKE-OFF	(60% extension)
APPROACH	(80% extension)
LANDING	(100% extension)

A wing flap lever warning horn switch, wired in parallel with the landing gear warning horn throttle switches, is installed in the wing flap follow-up mechanism. When the wing flap lever is moved to the APPROACH or LANDING position, and the landing gear is not down and locked, the landing gear warning horn will sound.

Wing Flap Emergency Extension Handcrank.

The emergency extension handcrank is strapped in the right hand galley closet. It fits onto the emergency extension crank square drive located below the emergency extension access door (figure 1-15). Cranking counter-clockwise extends the flaps.

Wing Flap Motor By-pass Valve.

This valve (figure 1-15) is located in the aft baggage compartment, with access to it available through the floor in the second passenger compartment. It is used during emergency extension of the wing flaps, and allows

wing flaps emerg. extension

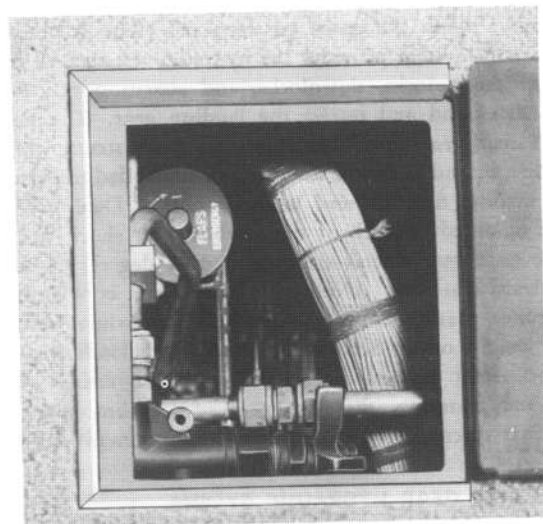

Figure 1-15

hydraulic fluid to bypass the flap motor when the valve is opened. This prevents accidental operation of the wing flaps in case the secondary pressure increases when the hand crank is being used. The valve is normally safetied in the CLOSED position. Turning the valve counterclockwise places it in the OPEN (bypass) position.

Wing Flap Asymmetry Indicator.

The wing flap asymmetry indicator (19 figure 1-18) is located on the copilot's instrument panel. The two needles are labeled L and R and the positions are marked UP, TAKE-OFF, APPROACH, and LANDING. These markings correspond to those shown on the flap lever. Under normal operating conditions with power from the 26 volt a.c. circuit, the needles are in the same position but if an asymmetrical condition occurs in the flaps, the needles will not coincide.

Wing Flap Position Indicator.

The wing flap position indicator (33 figure 1-18) is located on the pilots' center instrument panel. The DOWN position corresponds to the 100% extension.

LANDING GEAR.

The aircraft is equipped with a fully retractable, tri-cycle landing gear. When the gear retracts, the nose gear pivots aft into the underside of the fuselage, and the main gears pivot forward into the nacelle wheel wells. Landing gear doors, which are mechanically operated by the shock struts, lie flush with the airplane contour when the gears are retracted. The secondary hydraulic system provides the hydraulic pressure to operate the uplocks, downlocks, and actuating cylinders which extend and retract the landing gear. The nose and main gears also have pneumatic shock struts, which utilize air and hydraulic fluid to give controlled resistance to taxiing, take-off, and landing shocks. Dual wheels are mounted on each of the landing gear shock struts. The nose gear wheels are cambered 12 degrees to help forward castering. A centering saddle cam is built into the nose gear shock strut to align the gear when there is no weight on it. Scissors links keep the landing gear shock strut pistons and cylinders in alignment. For ground handling, the nose gear scissors link may be quickly disconnected by removing the center pivot bolt.

LANDING GEAR HYDRAULIC SYSTEM.

A cable-actuated hydraulic selector valve, located in the center of the forward cargo compartment on the left side, directs secondary hydraulic pressure to either the retracting or extending ends of the landing gear actuating cylinders and to the uplocks or downlocks. The main gear actuating cylinders, which are located on each upper drag strut assembly, have a run-around valve which allows hydraulic fluid to pass from one side of the actuating cylinder pistons to the other without returning the fluid to the hydraulic reservoir when the gears extend, thus reducing operating time.

EMERGENCY LANDING GEAR EXTENSION.

In the event that the main hydraulic system does not supply sufficient pressure, the landing gear can be extended by means of a hand pump system. Hydraulic fluid for the hand pump is taken from the emergency extension hydraulic reservoir and is directed to the uplocks, gear actuating cylinders, and downlocks through separate hydraulic lines. No emergency means is provided for gear retraction.

MAIN GEAR DRAG STRUTS.

The main gear drag strut assembly consists of an upper and lower drag strut. The upper strut is composed of two rigid triangular forgings, which are bolted together with pivot points at each end. The lower drag strut is

a hydraulic cylinder that absorbs rearward and forward shock loads of landing and taxiing by the combined action of an internal spring and a metering orifice. There is no circulation of fluid through the lower drag strut, but pressure from the secondary hydraulic system is used to maintain the hydraulic fluid in this strut when the landing gear lever is in the DOWN position.

Uplocks.

The main gear uplocks are mechanically engaged to the landing gears by tripping the uplock triggers when the gears are completely retracted. The locks are released by hydraulic pressure and are held open by springs and pressure as the gear extends. The nose gear uplock operation is similar to that of the main gear. The gears cannot be released from the uplocks by maneuvering loads.

Downlocks.

When each main gear is in the down position, a downlock strut prevents the drag strut from folding. One end of the downlock strut connects to the pivot that connects the upper and lower drag struts, and the other end hooks over a lock shaft, mounted in the wheel well. A spring-loaded latch in the hook prevents disengagement except by operation of a hydraulically-operated downlock release cylinder. The nose gear downlock is a mechanical cam that locks the drag strut in the extended position. The gear cannot retract until the cam is released by the hydraulically-operated nose gear downlock release cylinder.

Ground Safety Pins.

When the aircraft is parked, ground safety pins are supplied for insertion in the downlock mechanism. These pins will prevent accidental folding of the gears should inadvertent downlock release occur because of mispositioning of the landing gear lever when secondary hydraulic system pressure is available. These pins cannot be removed if the hydraulic forces present are on the up side of the cylinder.

Landing Gear Lever and Release Trigger.

The landing gear lever (18 figure 1-22) is located on the right, aft face of the pilots' pedestal and actuates the landing gear selector valve by control cables. It has three positions, UP, DOWN, and NEUTRAL. The lever is moved to the UP position to retract the landing gear and to the DOWN position to extend it. There is a detent in the NEUTRAL position (midway between the

UP and DOWN positions). The landing gear lever must be pulled out, then up, to pass through the NEUTRAL position to the UP position. To raise the gear the release trigger (16 figure 1-22) located to the right of the landing gear lever must be moved toward the landing gear lever and held in place before the lever can be moved to the UP position. After the landing gear has been retracted, the lever should be moved to the NEUTRAL position to decrease the possibility of leaks occurring in the landing gear system in flight. The uplocks hold the gear in the retracted position. When the landing gear is extended, the lever should be left in the DOWN position in order to keep hydraulic pressure on the down side as long as the aircraft is on the ground.

Solenoid Lock Release.

A solenoid lock is provided for the landing gear lever to prevent accidental movement of the lever into the UP position when the weight of the airplane is on the gear. The solenoid lock is operated by d.c. power through both main gear scissors switches. The solenoid lock may be manually released by depressing the landing gear solenoid lock release accessible through a hole in the right side of the pilots' pedestal.

Emergency Hand Pump and Selector Lever.

The emergency hand pump and the selector lever are located on the flight station floor outboard of the copilot's seat. The selector lever has two positions, EMER. BRAKE and EMER. GEAR. When the selector lever is in the EMER. GEAR (aft) position, the hand pump may be used to supply pressure through independent emergency extension lines to the uplocks, actuating cylinders, and downlocks. The selector lever is spring-latched in the EMER. BRAKE (forward) position.

Note

If the emergency hand pump selector valve is left in the EMER. GEAR (aft) position, and normal hydraulic pressure is applied for gear retraction, the gear will not retract. This is due to the shuttle valve on the emergency extension side being held in place by the hand pump pressure used during gear extension. If the shuttle valve is left in this position, there is a possibility of fluid returning to the emergency extension tank and overflowing.

Landing Gear Indicator Lights.

These four d.c. lights (34 figure 1-18) are located on the pilots' center instrument panel. One glows (red) whenever the landing gear is in an unlocked position. It goes out when the gear is in the retracted and locked position or in the extended and locked position. Three green lights come on when the gear is in the extended and locked position.

Landing Gear Warning Horn and Release Lever.

A landing gear warning horn is operated by four throttle switches connected in parallel with the unlock contacts of the downlock switches which also are connected in parallel. This horn will sound if one or more of the throttles is retarded beyond a critical setting and any gear is not down and locked. The landing gear warning horn can be silenced by locking the landing gear down, advancing the throttles, or raising the horn release lever located on the left side of the pilots' pedestal. When the throttles are re-advanced the warning horn circuit is reset.

NOSE GEAR STEERING SYSTEM.

The nose gear is steered by a small control wheel located on the left side of the pilots' station. This is a true steering system, having control cables running from the control wheel to a drum mounted on the shock strut. The steering valve is actuated by these cables passing through the steering valve control mechanism. This valve directs secondary hydraulic pressure to the left and to the right steering cylinders. The piston rods of these cylinders are attached to the drum mounted on the shock strut and turn the shock strut and wheels the same amount as the cable travels on the drum. Approximately $1\frac{1}{2}$ turns of the control wheel will turn the nose wheel about $68\frac{1}{2}$ degrees and the geometry of the gear will cause it to caster to the straight ahead position when the steering wheel is released. In this position the aircraft may be turned by the brakes or differential power. The cables, attached to the drum through the steer control to the steering wheel, cause the steering wheel to return to the neutral position. This position is marked by the alignment of two lines on the hub of the steering wheel and its shaft bearing. When the nose strut is turned $68\frac{1}{2}$ degrees, the inner main shock strut will turn on a radius of 12 feet. The steering cylinders also act as shimmy dampers and for this purpose they are equipped with orifices which restrict the fluid flow between the cylinders. In case of secondary hydraulic failure, a spring-loaded accumulator, which is a part of the steering control valve, supplies a differential volume of fluid for shimmy damping. The steering wheel will fold along its diameter when not in use. A shutoff valve in the hydraulic line is linked to the nose gear strut to shut off hydraulic pressure to the steering

control valve when the nose gear is approximately 36½ degrees from the fully retracted position.

BRAKE SYSTEM.

The two main landing gears are equipped with hydraulic power multiple disc brakes, that are controlled by either the pilot or copilot. One brake unit operates on each main gear wheel, making a total of four brake units on the aircraft. (The brake system is divided into two systems, the normal and the emergency systems, from the brake selector valve, to the brake control through separate plumbing to the brake assemblies). Hydraulic pressure is normally supplied by the secondary hydraulic system, taken upstream of the restriction control valve. Each brake control valve unit consists of two valves, one for normal actuation of the two brakes at each gear, and one for emergency brake actuation of both brakes at each gear. In the event of loss of secondary system pressure, actuation of the hydraulic system crossover valve permits the use of primary system pressure.

CAUTION

Do not operate the hydraulic system crossover valve until it has been determined that a loss of the remaining system pressure and fluid will not occur.

NORMAL BRAKE SYSTEM.

The normal brake system is selected by placing the brake selector valve lever in the NORM. position. When the toe pedals are pressed, pressure from the secondary hydraulic system (or when hand pump is used) is transmitted through the brake selector valve and through the normal side of the dual brake control valves to the normal side of the brake assemblies.

EMERGENCY BRAKE SYSTEM.

If the normal secondary system and primary system are inoperative the emergency system should be used. The emergency brake system is selected by placing the brake selector lever in the EMER. position. With the brake

selector lever in the EMER. position and the hand pump selector lever in the EMER. BRAKE position, hand pump pressure is directed through the brake selector valve to charge the brake accumulators. When either the pilot's or copilot's brake pedals are depressed, pressure is directed from the brake accumulators through the emergency side of the dual brake control valves, and then through separate plumbing to the emergency side of the brakes. When the brake accumulators are fully charged, a minimum of 12 applications of the brake pedals are available without actuating the hand pump. However, if the brake accumulators will not maintain pressure due to damaged diaphragms, or if the air charge is depleted, pressure will be available to the brakes by placing the brake selector lever in the NORM. position, the hand pump selector in the EMER. BRAKE position, and by actuating the hand pump. With the brake selector in the NORM. position, hand pump pressure bypasses the brake accumulators and is directed to the brakes through the normal system plumbing. This procedure is also recommended if the brake accumulators are in satisfactory condition but the emergency brake pressure is low and there is not sufficient time to re-charge accumulators with the hand pump.

Note

- When secondary system pressure is available the brake accumulators can be charged by placing the brake selector lever in the EMER. position.
- Brake accumulator pre-charge air pressure (600 psi) may be checked in flight by first turning off No. 3 and 4 hydraulic shut-off valves and placing the brake selector lever in the EMER. position. Next depress the brakes intermittently until the last big drop in pressure occurs, or the first big rise in pressure when charging the accumulators with the hand pump.

PARKING BRAKES.

The parking brake holds the brake control valves open after the toe pedals have been depressed and parking brake lever has been engaged. When the brake selector valve lever is in the EMER. position, the accumulators supply the pressure necessary to keep the brakes set

after the engines have been shut down, and normal hydraulic system pressure is no longer available. When fully charged, the brake accumulators will maintain adequate pressure to park the aircraft for approximately 24 hours. Leakage, thermal expansion and contraction causes the accumulator pressure to dissipate.

Note

The brake selector lever must be placed in the EMER. position for parking and securing the aircraft.

BRAKES.

Each of the dual wheels on the main landing gear is equipped with one hydraulically-operated multiple disc-type brake assembly. The two brake assemblies on each pair of wheels are interconnected and are supplied by normal system pressure or emergency system pressure selected by the brake selector valve.

Brake Pedals.

The brakes are controlled by the toe portion of the rudder pedals, which are connected to the brake control valves. The pilot's and copilot's brake pedals are interconnected by cables. Slack take-up springs are installed on each cable to take up the slack when the brake pedals are applied. The linkage is so arranged that the toe pedals can be depressed approximately 5° before pressure is fed to the brakes. As the pedals are depressed beyond approximately 5°, the pressure increases. The rudder pedals are hinged and geometry of the linkage is such that pedal movement for rudder control does not actuate the brake valve unless the pedals are tilted forward by toe pressure.

Parking Brake Handle.

There are two parking brake handles (23 figure 1-22), one on each side of the pilots' pedestal. They are both connected to a lever at the rear of the pedestal. With the parking brake handle in the lowered position, the parking brake is off. While the toe pedals are depressed, the mechanical linkage holds the brake valves open. Depressing the brake pedals automatically releases the parking brake.

Brake Selector Lever.

The brake selector lever is located on the aft face of the pilots' pedestal (19 figure 1-22) where it is accessible

to both pilots. It is placarded BRAKES, with its two positions, EMER. and NORM. The lever mechanically operates the brake hydraulic selector valve.

Hand Pump Selector Lever.

The hand pump selector lever is located near the base of the emergency hand pump to the right of the copilot's seat. The lever is placarded EMER. BRAKES (forward) and EMER. GEAR (aft). The lever is always in the EMER. BRAKES (forward) position and is safetied, and must be in this position whenever the hand pump is used to supply emergency brake pressure either to the normal or emergency brake system.

Parking Brake Warning Light.

There are two parking brake dc warning lights; one located on the lower right of the pilot's instrument panel (31 figure 1-18), the other located on the lower left of the copilot's instrument panel. The warning lights are actuated by the parking brake control mechanism, when the brake handle is raised.

CAUTION

The parking brake warning light only indicates that the parking brake handle is raised and does not indicate that brakes are locked sufficiently to keep the aircraft from rolling.

Emergency Brake Pressure Indicator.

The emergency brake pressure indicator is located on the copilot's auxiliary instrument panel (24 figure 1-18). It is a direct pressure instrument calibrated in psi and is actuated by hydraulic pressure in the emergency brake system accumulators.

INSTRUMENTS.

Instruments are installed on the air conditioning control panel and on the pilots', flight engineer's and the navigator's instrument panels. The instruments that are not discussed in the following paragraphs are those which are a part of a complete system. Those instruments are discussed with the appropriate system.

servicing diagram

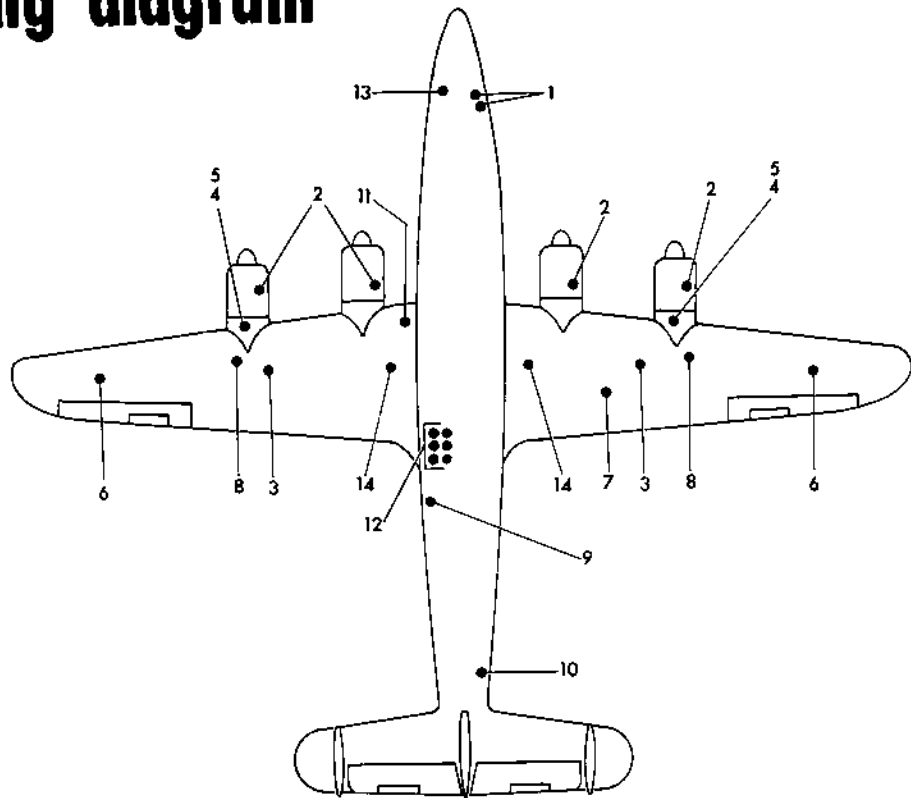

F125-4-1-12

REF.	PART	NO. OF POINTS	CAPACITY	REPLENISH WITH	REMARKS
1	BRAKE ACCUMULATORS	2	600 PSI EACH	AIR	CHARGE WITHOUT HYDRAULIC PRESSURE
2	ENGINE OIL TANKS	4	55 GALS.	GRADE 1100	INTEGRAL DIP-STICKS IN FILLER NECKS 45 GALS.
3	ANTI-ICING FLUID TANK	2	20 GALS. EA.	MIL-F-5566	FILL 200 ± 25 HOURS
4	CABIN SUPERCHARGER DRIVE SHAFT DISCONNECT HOUSING	2	690 CC EA. APPROX.		
5	CABIN SUPERCHARGER OIL TANK	2	2 GALS. EA.	S. A. E. 10	DRAIN AND REFILL AT 200 AND 400 HOURS
6	FUEL TANKS 2A AND 3A	1 EACH	565 GALS.	100/130 & 115/145	
7	REFRIGERATION UNIT	1	1 PINT	S. A. E. 20	CHECK AT 100 HR.
8	FUEL TANKS 1 AND 4	1 EACH	1555 GALS.	100/130 & 115/145	
9	WASH WATER	1	42 GALS.	WATER	
10	AUXILIARY POWER UNIT	1	3 QTS.	S. A. E. 30	
11	MAIN HYDRAULIC RESERVOIR	1	10 GALS.	MIL-O-5606	INTEG. DIPSTICK SERV. TO 7.1 GALS.
12	OXYGEN SYSTEM SUPPLY CYLINDERS	6	144 CU. FT.	OXYGEN	SERVICE TO 425 PSI
13	EMERGENCY HYDRAULIC RESERVOIR	1	4.5 GALS.	MIL-O-5606	SERVICE TO RED LINE
14	FUEL TANKS 2 AND 3	1 EACH	790 GALS.	100/130 & 115/145	

Figure 1-16

ALTIMETERS.

Five sensitive altimeters are mounted in the aircraft. One is located on the air conditioning control panel and one each is installed in the pilot's, copilot's (6 figure 1-18), flight engineer's upper (49 figure 1-23), and navigator's (8 figure 4-23) instrument panels. The altimeters include a new extended 10,000 foot pointer incorporating a notched disc warning indicator. At altitudes below 16,000 feet a striped section will appear through the notched disc. The modified altimeters improve the readability of the 10,000 foot pointer and provide a constant reminder when the aircraft altitude is less than 16,000 feet. The altimeters have a range of 50,000 feet altitude and a ground setting scale marked in inches of mercury. The static air pressure is taken from static ports on the fuselage.

Note

It is possible to set a majority of the standard altimeters in USAF use in error by 10,000 feet. This happens when the barometric set knob is continuously rotated after the baro scale is out of view. The knob can be rotated until eventually the numbers will reappear in the Kollsman window from the opposite side. If the correct altimeter setting is then established, the altimeter will read approximately 10,000 feet in error. As a preflight check, special attention should be given to the altimeter to assure that the 10,000 foot pointer is reading correctly.

AIRSPPEED INDICATORS.

Airspeed indicators (2 figure 1-18) are mounted on the pilot's, copilot's, and navigator's panels, and on the flight engineer's upper instrument panel. The airspeed indicators are calibrated in knots. Correction cards are provided.

VERTICAL VELOCITY INDICATORS.

Four instruments (21 figure 1-18) indicating vertical velocity during climb or descent are mounted on the pilot's and copilot's panels, the flight engineer's overhead instrument panel, and on the air conditioning control panel. The vertical velocity indicator on the air conditioning control panel indicates only the equivalent cabin pressure rate-of-change. The other two indicators show the aircraft rate of climb or descent.

DIRECTIONAL INDICATOR (MDI).

The directional indicator is located on the navigator's instrument panel (3 figure 4-23) and indicates the magnetic heading of the aircraft. The azimuth dial is directly connected through gears and linkage to an induction motor which operates both directionally and proportionally to changes of the magnetic heading of

the aircraft. The gyro Flux Gate transmitter, mounted in the left wing, senses the aircraft heading changes, because of its change of position in the earth's magnetic field, and transmits an electrical signal to the Flux Gate indicator. Heading information from this indicator is repeated on the copilot's ADF RMI and VOR TACAN RMI and on the pilot's ADF RMI. It also originates a course signal impulse for the automatic pilot control. (Refer to Automatic Pilot Controls, Section IV.) Power for operation of the Flux Gate direction indicator system is supplied by the d.c. and a.c. electrical systems.

C-2 COMPASS.

The C-2 compass system provides an accurate, stabilized indication of the aircraft heading. The system consists of an amplifier located in the right hand side of the nose, a flux valve and compensator located in the right wing, an indicator located on the copilot's instrument panel (27 figure 1-18) and a gyrosyn compass-directional gyro switch located on the copilot's instrument panel (20 figure 1-18). Compass information is repeated on the navigator's RMI, the pilot's VOR TACAN RMI, and on the pilot's IFS course indicator. The C-2 compass system utilizes both 400-cycle a.c. and d.c. power simultaneously.

DIRECTIONAL INDICATOR (DIRECTIONAL GYRO) C5C.

A directional indicator (C5C) is mounted on the left side of the navigator's table and is used in Polar regions. Power is supplied by the main inverter system.

COMPASS (B-16).

A standby magnetic compass (13 figure 1-21) is provided. The compass card is calibrated in degrees and indicates the direction of flight with reference to magnetic north. A compass correction card is mounted on each side of the compass.

ATTITUDE INDICATORS.

Two attitude indicators (7 figure 1-18), powered by 115-volt a.c. current, is mounted on the pilot's and copilot's instrument panels. Each indicator is an electrically-driven, vertical seeking gyro, coupled with a bank marker and a horizontal reference bar. A knob on the instrument provides adjustment of the horizontal reference bar to correspond to different pitch attitudes. An additional vacuum driven, attitude indicator is provided as standby equipment. This instrument is located on the pilot's auxiliary instrument panel (41 figure 1-18).

TURN AND SLIP INDICATORS.

Two turn and slip indicators (29 figure 1-18) are provided. They are mounted on the pilot's and copilot's instrument panels. The indicators are powered by 28-volt d.c. current supplied through the inverter switch.

pilot's station — typical

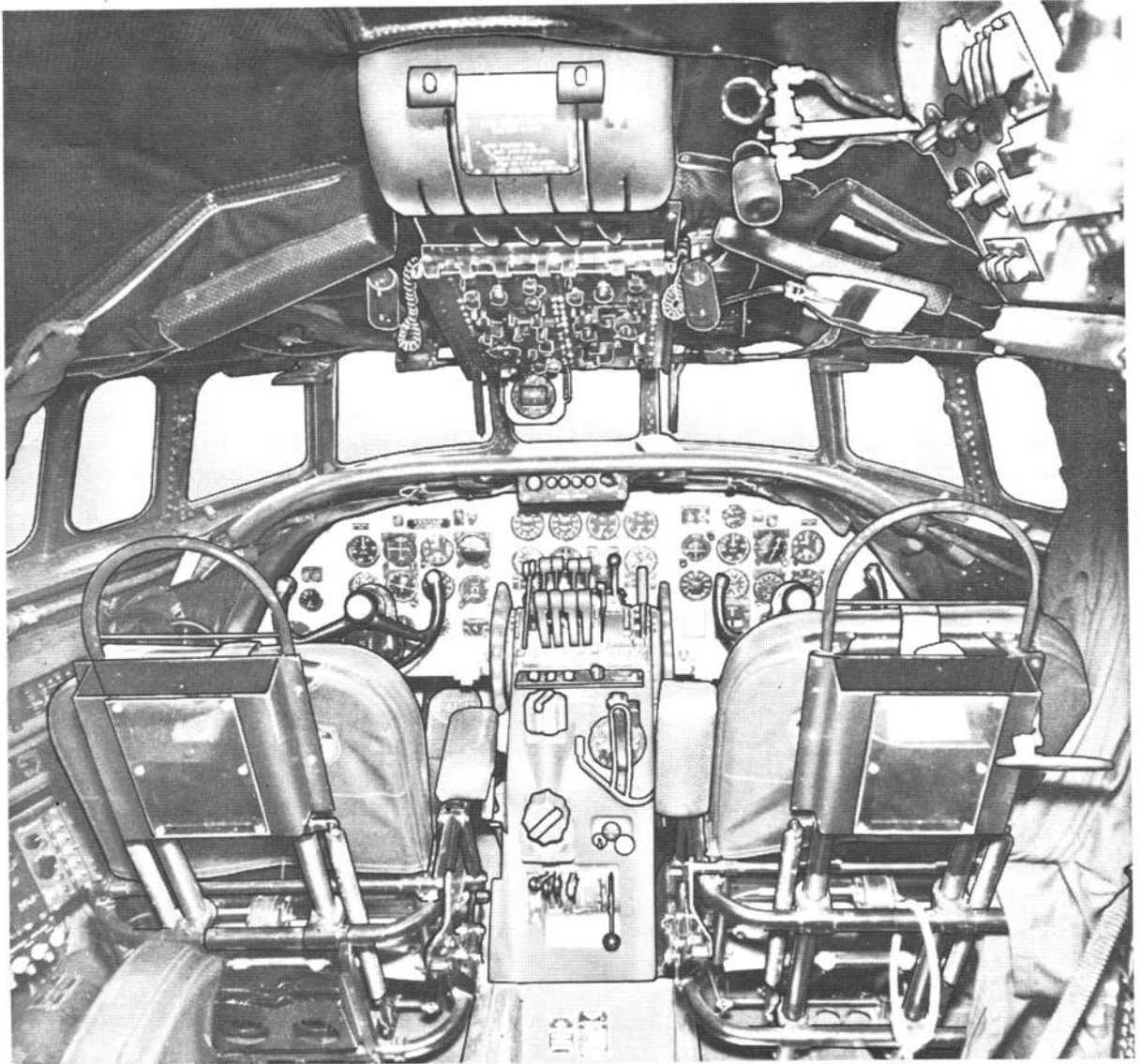
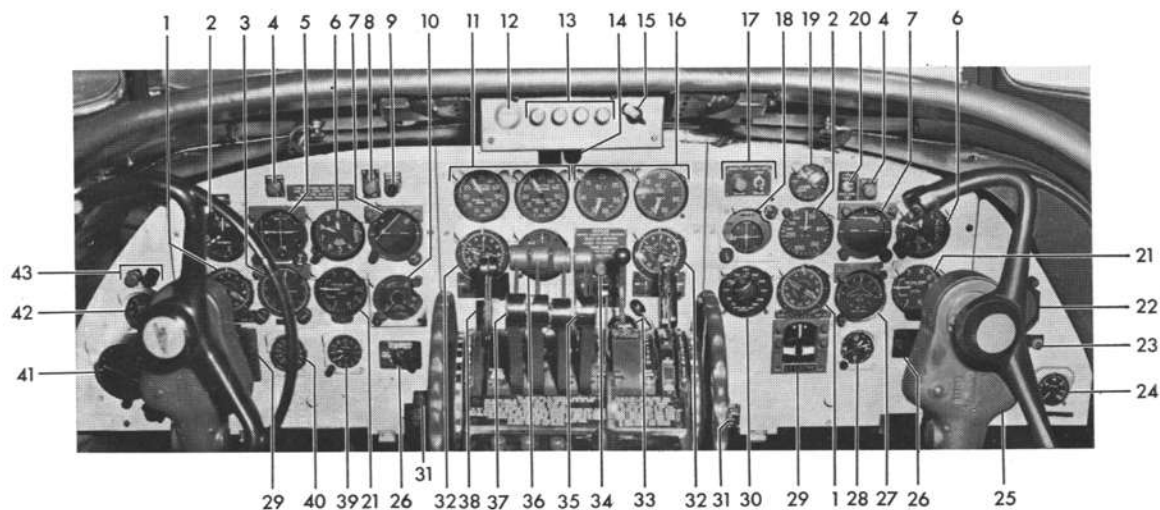

Figure 1-17

pilots' instrument panels



- | | | | |
|----|--|----|--|
| 1 | RADIO MAGNETIC INDICATOR (ADF) (2 PLACES) | 22 | (DME) RANGE INDICATOR (TACAN) |
| 2 | AIRSPPEED INDICATOR (2 PLACES) | 23 | HYDRAULIC PUMP LOW PRESSURE WARNING LIGHTS |
| 3 | IFS COURSE INDICATOR | 24 | EMERGENCY BRAKE PRESSURE INDICATOR |
| 4 | TURN AND SLIP POWER-OFF WARNING LIGHT (2 PLACES) | 25 | HYDRAULIC SYSTEMS PRESSURE INDICATOR (HIDDEN) |
| 5 | IFS APPROACH HORIZON INDICATOR | 26 | INSTRUMENT STATIC PRESSURE SELECTOR VALVE (2 PLACES) |
| 6 | ALTIMETER (2 PLACES) | 27 | DIRECTION INDICATOR (GYROSYN COMPASS) |
| 7 | ALTITUDE INDICATOR (2 PLACES) | 28 | CLOCK |
| 8 | IFS GYRO CAGED WARNING LIGHT | 29 | TURN AND SLIP INDICATOR (ELECTRIC) (2 PLACES) |
| 9 | MARKER BEACON LIGHT | 30 | RADIO ALTIMETER ALTITUDE LIMIT SWITCH |
| 10 | RADIO ALTIMETER (APN-1) | 31 | PARKING BRAKE WARNING LIGHT (2 PLACES) |
| 11 | MANIFOLD PRESSURE INDICATORS | 32 | RADIO MAGNETIC INDICATOR (VOR/TACAN) (2 PLACES) |
| 12 | VERTICAL GYRO MONITOR INDICATOR | 33 | WING FLAP POSITION INDICATOR (HIDDEN) |
| 13 | PROPELLER REVERSING LIGHTS | 34 | LANDING GEAR POSITION INDICATOR LIGHTS |
| 14 | MASTER FIRE WARNING LIGHT | 35 | OUTSIDE AIR TEMPERATURE INDICATOR (HIDDEN) |
| 15 | WINDSHIELD WIPER CONTROL SWITCH | 36 | THREE AXIS TRIM INDICATOR |
| 16 | TACHOMETERS | 37 | ADF LANDING GEAR DOWN CORRECTION PANEL (HIDDEN) |
| 17 | WING FLAP SHUT-OFF TEST SWITCH AND WARNING LIGHT | 38 | RADIO ALTIMETER LIMIT LIGHTS (HIDDEN) |
| 18 | COURSE INDICATOR | 39 | ELAPSED-TIME CLOCK |
| 19 | WING FLAP ASYMMETRY INDICATOR | 40 | DE-ICER PRESSURE INDICATOR |
| 20 | GYROSYN COMPASS/DIRECTIONAL GYRO SELECTOR SWITCH | 41 | STANDBY ALTITUDE INDICATOR (VACUUM) |
| 21 | VERTICAL VELOCITY INDICATOR (2 PLACES) | 42 | VACUUM INDICATOR |
| | | 43 | VACUUM PUMP WARNING LIGHTS |

Figure 1-18

OUTSIDE TEMPERATURE INDICATORS.

A free air temperature indicator is mounted on the pilots' center instrument panel (35 figure 1-18), the navigator's instrument panel (9 figure 4-19) and the flight engineer's upper instrument panel (53 figure 1-23). The indicators are energized by d.c. electrical resistance bulbs located in the right side of the nose wheel well.

CLOCKS.

An eight-day clock with a sweep second hand is installed on the copilot's instrument panel (28 figure 1-18), the flight engineer's lower instrument panel (27 figure 1-23), and at the radio operator's stations (figure 4-16). In addition, the pilot's instrument panel is provided with an elapsed time clock (39 figure 1-18).

INCLINOMETER.

An inclinometer (43 figure 1-23) is mounted on the flight engineer's lower instrument panel. The instrument is a ball-bank type and indicates the pitch attitude of the aircraft about the lateral axis, provided the aircraft is flying under a one G load factor.

INTEGRATED FLIGHT SYSTEM.

(Refer to Section VII.)

The integrated flight system is designed to give the pilot a clear pictorial presentation on only two navigation instruments of all information needed to:

1. Make ILS approaches.
2. Fly VOR courses.
3. Fly compass headings.
4. Maintain proper pitch and roll attitudes.

The major components of the integrated flight system are the approach horizon, the course indicator, the gyro monitor, the attitude indicator and the steering computer. The first three components are mounted on the pilot's instrument panel, and the last two components are mounted in the radio rack. Three auxiliary units are necessary to complete the system: a gyro stabilized magnetic compass, a VOR receiver, and a glide slope receiver. The integrated flight system is operated by a.c. and d.c. power. The a.c. power is supplied by the main inverter, and the d.c. power is supplied from the main d.c. bus.

APPROACH HORIZON.

The approach horizon is the pilot's source of steering information, pitch and roll reference, and aircraft displacement from the glide slope. Flag warnings are provided by the GS and LOC flags. These flags indicate that adequate signals are being received for proper

operation of the system by swinging upward to a masked position. An ILS-HDG switch, which selects enroute navigation and approach functions, and a pitch trim knob are also contained in the case. The approach horizon includes the following indicators:

1. Steering pointer.
2. Pitch bar.
3. Glide slope indicator.
4. Horizon bar and bank pointer.
5. Glide slope and localizer flags.

Steering Pointer.

Steering information is presented by the upright steering pointer. Steering indications are computed from three basic signals and their rates of changes:

1. The VOR receiver gives course deviation.
2. The compass gives heading error.
3. The vertical gyro gives bank information.

These signals are sent to the steering computer and the lateral guidance signal output of the computer is used to operate the steering pointer. Turns are always made toward the steering pointer to eliminate a deviation error. The steering pointer centers when the aircraft is holding a selected heading or when the bank angle has been correctly adjusted to turn to the heading. A bank angle of 20 to 25 degrees is the normal maximum amount needed to bring the steering pointer to center. If a steeper bank entry is made, the steering pointer will move past center on its return and thus advise the pilot to ease his bank. Holding the steering pointer at center will result in a smooth rollout from the turn. In the ILS function, the steering pointer responds to a synthetic heading signal based on the rate at which the localizer deviation signal changes. Centering the steering pointer on an ILS approach results in the alignment of the aircraft track with the localizer course, thereby correcting for crosswind.

Pitch Bar.

The pitch bar, symbolizing the wings and the vertical stabilizer of the aircraft, moves up or down from center references as the pitch of the aircraft changes. The pitch signal is produced by the vertical gyro. The pitch trim knob enables the pilot to adjust the position of the pitch bar to compensate for changes from the normal pitch attitude of the aircraft during flight. When the ILS-HDG function switch is in the ILS position, the pilot cannot adjust the normal pitch attitude indication. It is determined by a pre-set approach trim control

pilot's side panel

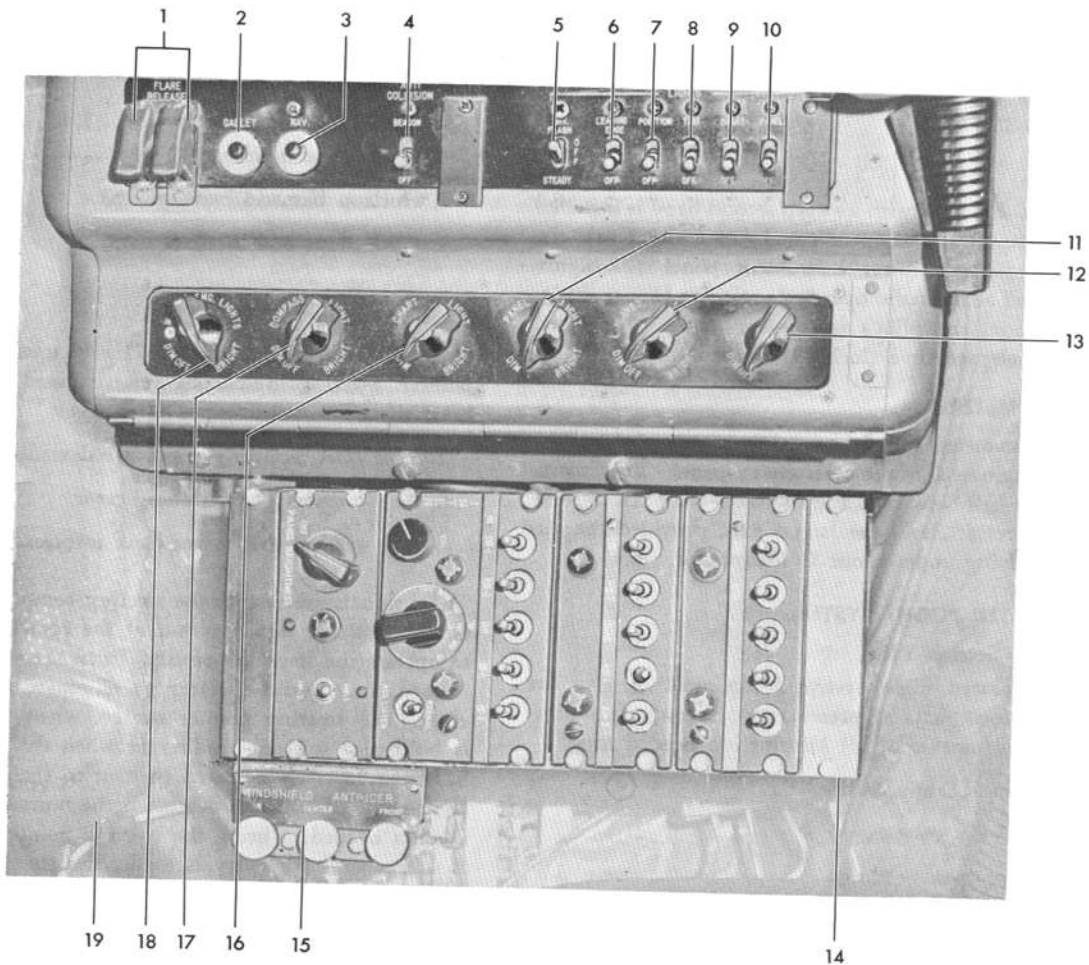

- | | | | |
|----|----------------------------------|----|---|
| 1 | FLARE RELEASE SWITCHES | 11 | PANEL LIGHT RHEOSTAT |
| 2 | GALLEY CALL BUTTON | 12 | INSTRUMENT PANEL LIGHT RHEOSTAT |
| 3 | NAVIGATOR CALL BUTTON | 13 | CENTER INSTRUMENT LIGHT RHEOSTAT |
| 4 | ANTI-COLLISION LIGHT SWITCH | 14 | INTERPHONE CONSOLE |
| 5 | NAVIGATION LIGHTS CONTROL SWITCH | 15 | WINDSHIELD ALCOHOL ANTI-ICER CONTROL VALVES |
| 6 | LEADING EDGE LIGHT SWITCH | 16 | CHART LIGHTS RHEOSTAT |
| 7 | POSITION LIGHTS SWITCH | 17 | COMPASS LIGHT RHEOSTAT |
| 8 | TAXI LIGHTS SWITCH | 18 | EMERGENCY WHITE LIGHTS RHEOSTAT |
| 9 | CHART LIGHT SWITCH | 19 | INTERPHONE SPEAKER |
| 10 | PANEL LIGHT SWITCH | | |

Figure 1-19

copilot's side panel

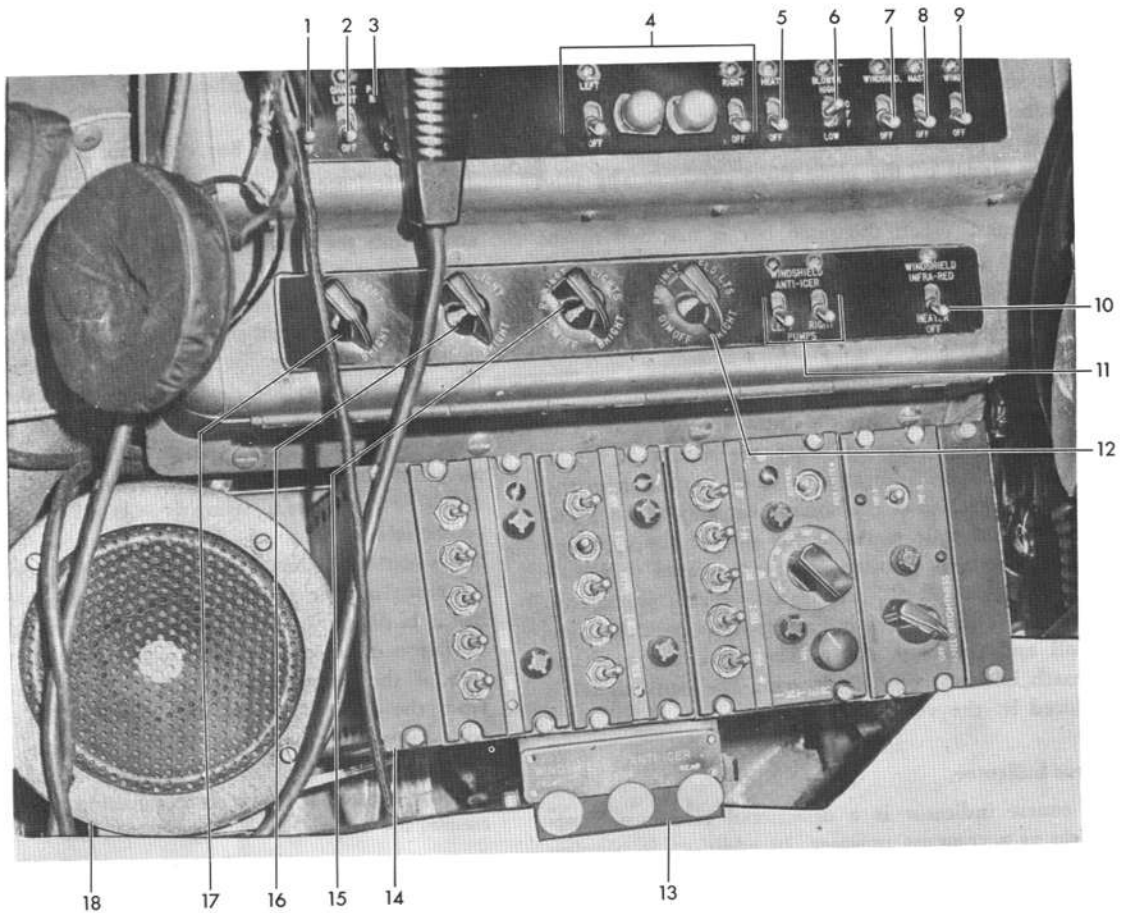

- | | | | |
|---|-----------------------------------|----|---|
| 1 | PANEL LIGHT SWITCH | 10 | WINDSHIELD INFRA-RED HEATER SWITCH |
| 2 | CHART LIGHT SWITCH | 11 | WINDSHIELD ALCOHOL ANTI-ICER PUMP SWITCHES |
| 3 | PEDESTAL REAR LIGHT SWITCH | 12 | RED INSTRUMENT LIGHTS RHEOSTAT |
| 4 | PITOT HEATERS LIGHTS AND SWITCHES | 13 | WINDSHIELD ALCOHOL ANTI-ICER CONTROL VALVES |
| 5 | WINDSHIELD DEFOG HEATER SWITCH | 14 | INTERPHONE CONSOLE |
| 6 | WINDSHIELD DEFOG BLOWER SWITCH | 15 | INSTRUMENT LIGHTS RHEOSTAT |
| 7 | WINDSHIELD DE-ICER SWITCH | 16 | CHART LIGHT RHEOSTAT |
| 8 | MAST DE-ICER SWITCH | 17 | PANEL LIGHTS RHEOSTAT |
| 9 | WING DE-ICER SWITCH | 18 | INTERPHONE SPEAKER |

Figure 1-20

located in the steering computer. The pitch range of the pitch bar in the ILS and HDG function is placarded on the face of the approach horizon.

Glide Slope Pointer.

Displacement of the aircraft, above or below the glide slope, is indicated by the glide slope pointer and a vertical scale at the left of the approach horizon face. The same scale is used as a pitch bar reference. The glide slope pointer responds to the glide slope course deviation signal of the glide slope receiver. The pilot flies the aircraft to align the pitch bar with the glide slope pointer. When the pitch bar is matched to the glide slope pointer at the center scale, the aircraft is in the correct approach attitude and holding on the glide path.

Horizon Bar and Bank Pointer.

The horizon bar and bank pointer are connected and therefore operate together. They are similar to a conventional attitude indicator in both appearance and action. The position of the horizon bar may be compared to the vertical scale marks at the side of the approach horizon. The bank pointer may be compared to a scale of ± 10 , ± 20 , ± 30 , and ± 60 degrees at the top of the case. Thus the two indicators show both direction of roll and the bank angle. The bank range of the approach horizon is ± 50 degrees. The bank signal is produced by the vertical gyro.

Course Indicator.

The course indicator is a directional reference, functioning as a compass repeater. In addition, it supplies a properly oriented pictorial presentation of the aircraft's heading and displacement with respect to a VOR or ILS course. The course indicator includes the following:

1. Azimuth ring.
2. Heading marker and selector knob.
3. Course arrow, course bar, and course selector knob.
4. To-From arrow.

Azimuth Ring.

The azimuth ring repeats the indications of the aircraft's stabilized magnetic compass and thus displays the aircraft's heading continuously at the stationary lubber line.

Heading Marker and Selector Knob.

To aid in flying on a selected heading a heading marker is provided. The heading marker is set to a desired

heading on the azimuth ring by turning the heading selector knob. After the heading marker is set, it rotates with the azimuth ring, and shows the amount and direction of heading error as a displacement between the marker and the lubber line. This heading error is relayed through the steering computer to the steering pointer of the approach horizon. The steering pointer deviates from center indicating the required correction.

Course Arrow, Course Bar, and Course Selector Knob.

The central area of the course indicator face is termed the deviation indicator section. It includes the course arrow and the course bar. All parts of the deviation indicator section rotate as a unit, turning with the azimuth ring as the aircraft's heading changes. A miniature aircraft is etched on the cover glass of the course indicator, and shows the position of the actual aircraft by its relation to the deviation indicator section. The course arrow and course bar are used in conjunction with the VOR receiver. After the correct channel for an omni-range station is chosen, a desired course or radial of the chosen station is selected by rotating the course selector knob to adjust the position of the course arrow on the azimuth ring. The course arrow is the reference marker for the course bar. Since the course bar is bi-directional in its movement, rotating with the deviation indicator section as well as moving across the face of the instrument, it indicates both displacement from the selected course and direction to the course with respect to the actual aircraft heading. The pilot then may select the heading required by adjusting the heading marker. If the aircraft is making good a selected course, the course bar is aligned with the course arrow.

To-From Arrow.

The To-From arrow is also included in the deviation indicator section of the course indicator. The VOR receiver, operating on omni-range channels, produces the signal to operate the To-From arrow. This arrow removes all ambiguity from the position picture. It indicates which end of the course bar (including the course arrow) points toward the station. Reversal of indications shows passage over the station.

Vertical Gyro Monitor.

The vertical gyro monitor (figure 4-10), indicates applications of power to the vertical gyro rotor and torque motors. It also shows when the rotor has reached operating speed and is fully erected. When the rotor reaches operating speed, the pointer drops back to the center scale from the SLO position of the scale. When full erection of the rotor is reached, the pointer flickers and holds within the center scale, the green area bordered by yellow fluorescent lines. Torque motor opera-

pilots' overhead controls

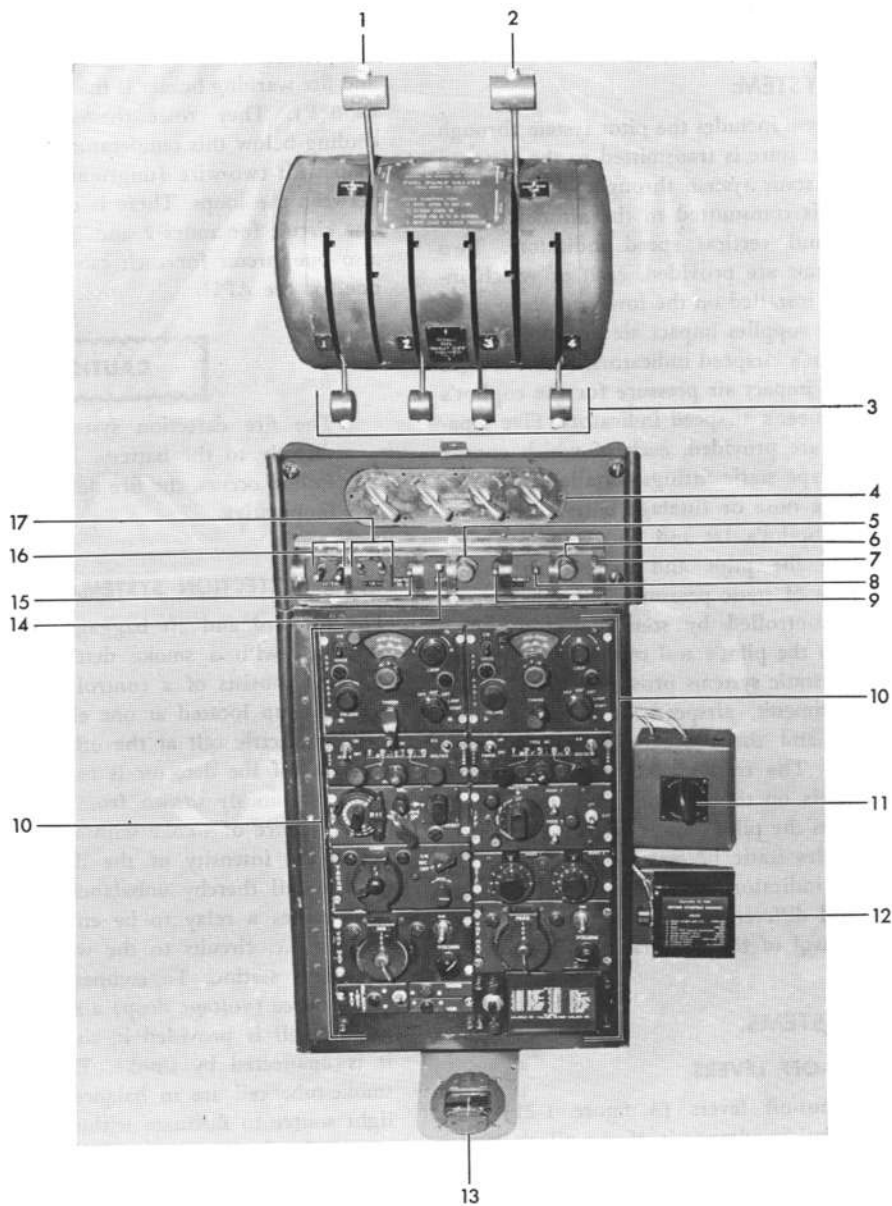

- | | |
|---|--|
| 1 FUEL DUMP LEVER - (TANKS 1 AND 2) | 9 ELEVATOR AUXILIARY BOOSTER SWITCH |
| 2 FUEL DUMP LEVER - (TANKS 3 AND 4) | 10 OVERHEAD RADIO CONTROL PANEL |
| 3 EMERGENCY SHUT-OFF LEVERS | 11 OVERHEAD PANEL LIGHTS SWITCH |
| 4 IGNITION SWITCHES | 12 CHECK LIST SCROLL |
| 5 ELEVATOR AUXILIARY BOOSTER INDICATOR LIGHT | 13 STANDBY COMPASS |
| 6 RUDDER AUXILIARY BOOSTER INDICATOR LIGHT | 14 ELEVATOR AUXILIARY BOOSTER CIRCUIT BREAKER SWITCH |
| 7 RUDDER AUXILIARY BOOSTER CIRCUIT BREAKER SWITCH | 15 FASTEN SEAT BELT/NO SMOKING LIGHT SWITCH |
| 8 RUDDER AUXILIARY BOOSTER SWITCH | 16 LANDING LIGHTS EXTEND - RETRACT SWITCHES |
| | 17 LANDING LIGHTS LAMP ON-OFF SWITCHES |

F125-C1-1-32

Figure 1-21

tion to maintain the rotor's erection causes the pointer to flicker, with initial motion toward the SLO position of the scale. Power failure immediately drops the pointer to OFF. Refer to Section VII for operating instructions.

PITOT-STATIC SYSTEM.

The pitot-static system includes the pitot system through which impact air pressure is transmitted to the airspeed indicators and the static system through which outside static air pressure is transmitted to the altimeters, airspeed indicators and vertical speed indicators. Two separate pitot systems are provided, each of which includes a pitot head installed on the lower fuselage nose. The left pitot head supplies impact air pressure for the pilot's and navigator's airspeed indicators, and the right pitot head supplies impact air pressure for the copilot's and the flight engineer's airspeed indicators. Five separate static systems are provided, each of which consist of a pair of flush-type static fittings installed on either side of the fuselage nose or fuselage barrel. Four systems, pilot's and copilot's 1st and 2nd statics, are installed to provide the pilot and copilot with two independent sources of static pressure. The selection of either system is controlled by static selector valves (26 figure 1-18) on the pilot's and copilot's instrument panels. The pilot's static systems provide static pressure for the pilot's altimeter, airspeed indicator, vertical velocity indicator, and the navigator's altimeter and airspeed indicators. The copilot's static systems serve the same instruments on the copilot's and flight engineer's panels as does the pilot's static systems. The fifth static system provides static pressure to the cabin differential pressure indicator, the differential pressure switch, altitude and differential pressure indicator, and to the altitude control of the automatic pilot.

EMERGENCY SYSTEMS.

EMERGENCY SHUT-OFF LEVERS.

Four emergency shut-off levers (3 figure 1-21) are located on the control quadrant aft of the pilot's overhead panel. The function of these levers is to shut off the hydraulic oil, fuel, engine oil supply, vacuum pump blast tube, engine electrical junction box and generator blast tubes of each engine. Each lever has two positions, the full forward position being all ON. Each lever is rigged in conjunction with a manual shut-off in each engine-driven hydraulic pump suction line and a valve in each engine oil supply line. Simultaneously an electric switch is actuated at the hydraulic shut-off valve to close an electric motor-driven fuel shut-off valve in each fuel supply line. This combination of controls is simultaneously actuated by movement of the emergency shut-off levers.

FIRE DETECTION SYSTEM.

Heat-sensitive fire detector switches are installed in each zone of all engine nacelles, at the APU, and in each cabin heater compartment. These switches close and complete the electric circuits to the fire warning lights and fire warning buzzer if the temperature rises to 232°C (450°F). They reset themselves automatically after cooling below this temperature. Each circuit is a double loop with two-wire (ungrounded) detectors in parallel between the loops. There is one circuit for zone 1 and one circuit for zones 2 and 3 of each nacelle. There is also one circuit for each cabin heater installation, and one for the APU.

CAUTION

The fire detection system is not connected directly to the battery. If complete electrical failure occurs, the fire detection system will be inoperative.

SMOKE DETECTION SYSTEM.

The forward and aft baggage compartments are each equipped with a smoke detector circuit. Each smoke detector consists of a control housing with an illuminating lamp located at one end of a smoke tube, and a photoelectric cell at the other end of the tube. The function of the detector is to analyze air samples that are continuously drawn from the cargo compartment. The presence of smoke within the smoke tube will decrease the intensity of the light reaching the photoelectric cell thereby unbalancing the photocell circuit. This causes a relay to be energized which closes the 28 volt d.c. circuits to the warning light and bell in the flight station. To compensate for changes in the light source (voltage drop) a second, or balance, photoelectric cell is provided in the control housing where it is unaffected by smoke. This second cell and the smoke-tube cell are in balance, thereby permitting the light source to fluctuate without affecting the response relay. The detector can be tested and reset electrically either at the flight station or at the detector.

Master Fire Warning Lights and Warning Bell.

A master fire warning light is located in the top center of the pilots' instrument panel (14 figure 1-18) and on the flight engineer's lower instrument panel (24 figure 1-23). The fire warning bell is located on the bulkhead behind the copilot's seat. These lights and the bell are energized simultaneously by the d.c. electrical system and are actuated when one or more fire detector switches close. Each warning light can be tested by pressing its cap and by the fire warning test switch.

pilots' pedestal

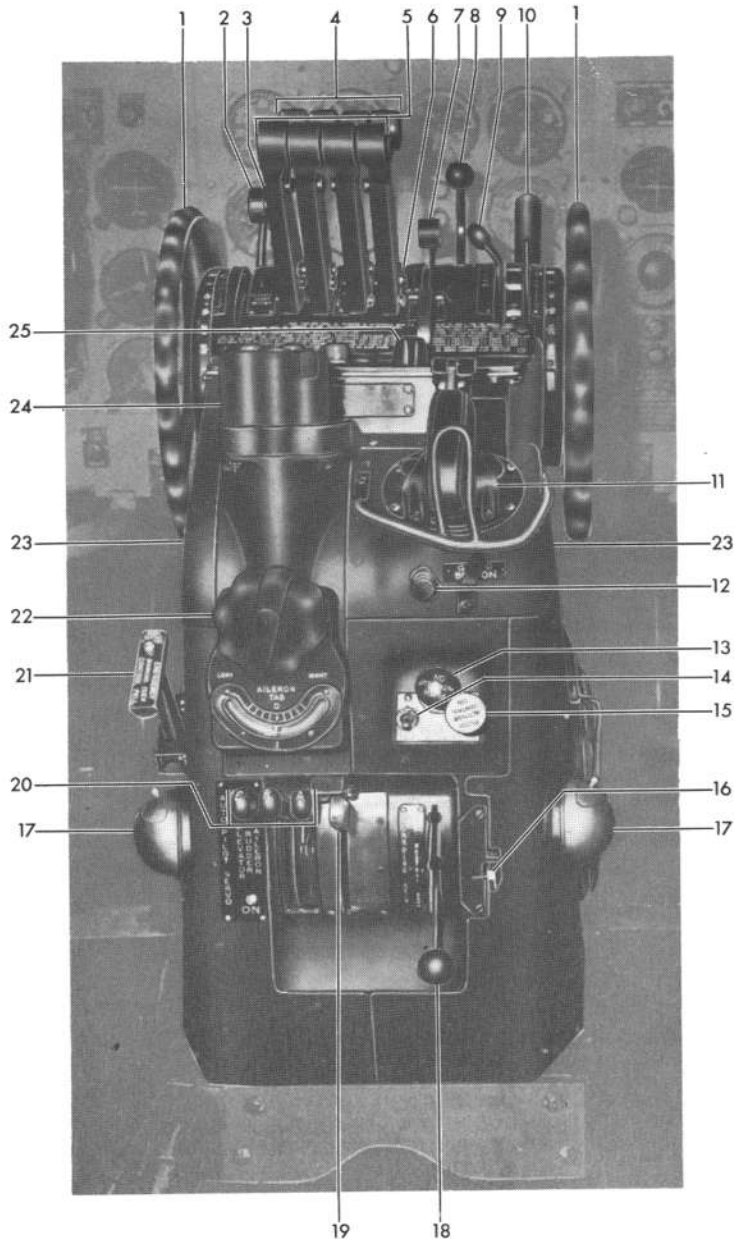

- 1 ELEVATOR TRIM TAB CONTROL WHEEL (2)
- 2 RUDDER BOOST CONTROL LEVER
- 3 AILERON BOOSTER CONTROL LEVER (HIDDEN)
- 4 REVERSE PITCH THROTTLE LEVERS (4)
- 5 THROTTLE LEVERS (4)
- 6 REVERSE LOCK OVERRIDE LEVER (HIDDEN)
- 7 THROTTLE LOCK LEVER
- 8 ELECTRIC ELEVATOR TRIM TAB CLUTCH LEVER
- 9 PROPELLER SYNCHRONIZER LEVER
- 10 WING FLAP LEVER
- 11 AUTOMATIC PILOT PISTOL GRIP TURN HANDLE
- 12 GYRO BEACON LIGHT
- 13 AUTOMATIC PILOT CLUTCH SWITCH
- 14 AUTOMATIC PILOT FLUX GATE CAGING SWITCH
- 15 AUTOMATIC PILOT ALTITUDE CONTROL SWITCH
- 16 LANDING GEAR LEVER RELEASE TRIGGER
- 17 ASH TRAYS (2)
- 18 LANDING GEAR LEVER
- 19 BRAKE SELECTOR LEVER
- 20 AUTOMATIC PILOT SERVO DISCONNECTS (3)
- 21 ELEVATOR EMERGENCY BOOSTER SHIFT LEVER
- 22 AILERON TRIM TAB HAND CRANK
- 23 PARKING BRAKE HANDLE (2) (HIDDEN)
- 24 RUDDER TRIM TAB HAND CRANK
- 25 AUTOMATIC APPROACH CONTROL SELECTOR

F125-1-1-34

Figure 1-22

flight engineer's instrument panels

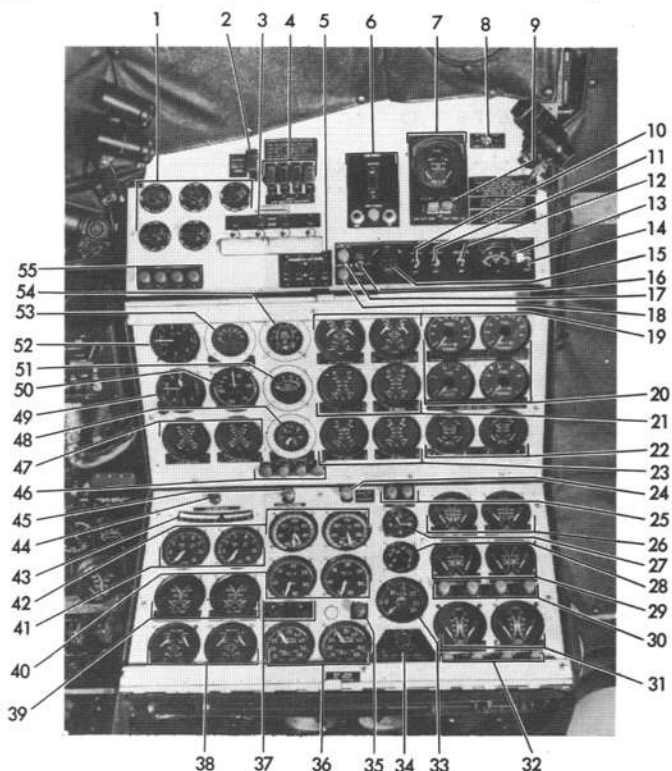

- | | | | |
|----|--|----|--|
| 1 | INSTRUMENT PANEL LIGHT RHEOSTATS | 29 | REAR PUMP OIL PRESSURE INDICATORS |
| 2 | HYDRAULIC SYSTEM CROSSOVER VALVE SWITCH | 30 | OIL PRESSURE WARNING LIGHTS |
| 3 | BMEP BLEED SWITCHES | 31 | FUEL PRESSURE INDICATORS |
| 4 | HYDRAULIC SUCTION SHUT-OFF VALVE SWITCHES | 32 | FUEL PRESSURE WARNING LIGHTS |
| 5 | TORQUEMETER LINE HEATER SWITCHES | 33 | MASTER MOTOR RPM INDICATOR |
| 6 | CARGO SPEEDPAK FIRE DETECTOR AND CONTROL | 34 | CYLINDER HEAD TEMPERATURE SELECTOR SWITCH |
| 7 | TANKS 2A AND 3A FUEL QUANTITY GAGE | 35 | SYNCHRONIZER MASTER MOTOR WARNING LIGHT |
| 8 | CARGO AND TAIL SECTION LIGHT SWITCH | 36 | MANIFOLD PRESSURE INDICATORS |
| 9 | TANKS 2A AND 3A AUXILIARY FUEL PUMP SWITCHES | 37 | PROPELLER ALCOHOL WARNING LIGHTS |
| 10 | APU IGNITION SWITCH | 38 | COWL FLAP POSITION INDICATORS |
| 11 | APU STARTER SWITCH | 39 | CYLINDER HEAD TEMPERATURE GAGES |
| 12 | APU GENERATOR SWITCH | 40 | TACHOMETERS |
| 13 | APU AMMETER | 41 | FUEL FLOWMETERS |
| 14 | APU FIRE WARNING TEST SWITCH | 42 | TORQUEMETERS |
| 15 | APU GOVERNOR CONTROL SWITCH | 43 | INCLINOMETER |
| 16 | APU FUEL PUMP SWITCH | 44 | REAR DOOR CLEAR LIGHT |
| 17 | APU OIL PRESSURE WARNING LIGHT | 45 | DOOR WARNING LIGHT |
| 18 | APU FUEL PRESSURE WARNING LIGHT | 46 | HYDRAULIC PUMP WARNING LIGHTS |
| 19 | OIL COOLER FLAP POSITION INDICATORS | 47 | CARBURETOR AIR TEMPERATURE INDICATORS |
| 20 | FUEL QUANTITY INDICATORS | 48 | HYDRAULIC SYSTEM PRESSURE INDICATOR |
| 21 | OIL OUTLET TEMPERATURE INDICATORS | 49 | ALTIMETER |
| 22 | OIL QUANTITY INDICATORS | 50 | AIRSPPEED INDICATOR |
| 23 | OIL INLET TEMPERATURE INDICATORS | 51 | HYDRAULIC RESERVOIR FLUID QUANTITY INDICATOR |
| 24 | MASTER FIRE WARNING LIGHT | 52 | VERTICAL SPEED INDICATOR |
| 25 | VACUUM PUMP WARNING LIGHTS | 53 | OUTSIDE AIR TEMPERATURE INDICATOR |
| 26 | FRONT PUMP OIL PRESSURE INDICATORS | 54 | ANTI-ICER FLUID QUANTITY INDICATOR |
| 27 | CLOCK | 55 | ENGINE FIRE WARNING LIGHTS |
| 28 | SYNCHROSCOPE | | |

Figure 1-23

Individual Area Fire Warning Lights.

Fire warning lights for each nacelle are located adjacent to the placarded zone 2 and 3 positions for the engine fire extinguisher selector handle on the station 260 bulkhead. The zone 1 engine fire warning lights are located on the flight engineer's upper switch panel. Fire warning lights for the left and right cabin heater compartments and the baggage compartment smoke detector lights are located adjacent to the cabin heater and cargo compartment fire extinguisher selector handle near the floor on the station 260 bulkhead. The fire warning light for the APU is located adjacent to the APU selector valve near the floor on the station 260 bulkhead. Each warning light may be pressed to test. The master warning lights on the flight engineer's lower instrument panel and on the pilots' center instrument panel will glow whenever one or more of the area warning lights is energized, either by test or by fire.

FIRE EXTINGUISHING SYSTEM.

(Refer to Figure 1-25.)

The airplane is equipped with a two-shot carbon dioxide fire extinguishing system. This system is used to extinguish fires in the power plant installations, the cabin heaters, the auxiliary power unit, or in the baggage compartments. In addition to this system, four hand fire extinguishers are provided in convenient locations in the passenger cabin and flight station. The fire extinguishing system consists of six 12.5-pound cylinders of carbon dioxide (three per shot), operating heads, two selector valves, cable controls, and a distribution system. The cylinders are mounted on the right-hand side of the forward baggage compartment. A safety disc is provided in the cylinder plug assembly which will break and discharge the cylinder if the pressure becomes too high because of overcharging or excessive heat. The safety discharge port is directed to the outside of the airplane and is capped with a celluloid seal. An overboard dump valve is mounted on the station 260 bulkhead. This valve exhausts the carbon dioxide overboard if the cylinders are discharged while the selector valves are in the off position. Each cylinder is equipped with an operating head. One master cylinder in each group of three is equipped with a cable-operated operating head which fractures the sealing disc in the cylinder when actuated by the cable-controlled pull handle. The remaining two cylinders in each group are equipped with pressure-operated operating heads, the sealing discs in these cylinders being actuated by pressure from the master cylinder.

Cabin Heater and Baggage Compartment Fire Extinguisher Selector Lever.

The cabin heater and baggage compartment fire ex-

tinguisher selector, located on the station 260 bulkhead, is actuated by a selector valve handle. The CO₂ can be directed to either cabin heater or to either baggage compartment.

Engine Fire Extinguisher Selector Lever.

The engine fire extinguisher selector is controlled by a selector lever located above the station 260 air conditioning panel. By moving the selector lever to the desired position, the gas can be directed to any one of the four engines. Each selector port is piped to a distributing tube mounted on the aft face of the firewall in each nacelle. Nozzles are attached to the tube to direct the carbon dioxide gas forward through the firewall into zone No. 2, and aft of the firewall into zone No. 3. An additional line is routed forward through the firewall and carries the gas into the engine blower section.

APU Fire Extinguisher Selector Lever.

The auxiliary power unit selector lever is on the station 260 bulkhead directly above the crew door aisle light. By moving the selector lever to the ON position, the CO₂ is directed to the four nozzles within the auxiliary power unit shroud.

MISCELLANEOUS EMERGENCY EQUIPMENT.

(Refer to Figure 3-2.)

Hand Fire Extinguishers.

Four fire extinguishers are provided; two are of the A-20 (bromochloromethane) type, and two are of the CO₂ (carbon dioxide) type. These extinguishers are located in each aircraft as follows:

USAF Serial 48-608.

A-20 type:

- a. One in the forward left galley area.
- b. One in the aft cabin baggage rack.

CO₂ type:

- c. One in the flight station.
- d. One in the aft cabin baggage rack.

USAF Serials 48-609 thru 48-617.

A-20 type:

- a. One in the galley coat closet.
- b. One in the aft cabin baggage rack.

CO₂ type:

- c. One in the flight station.

flight engineer's control quadrant and lower switch panel

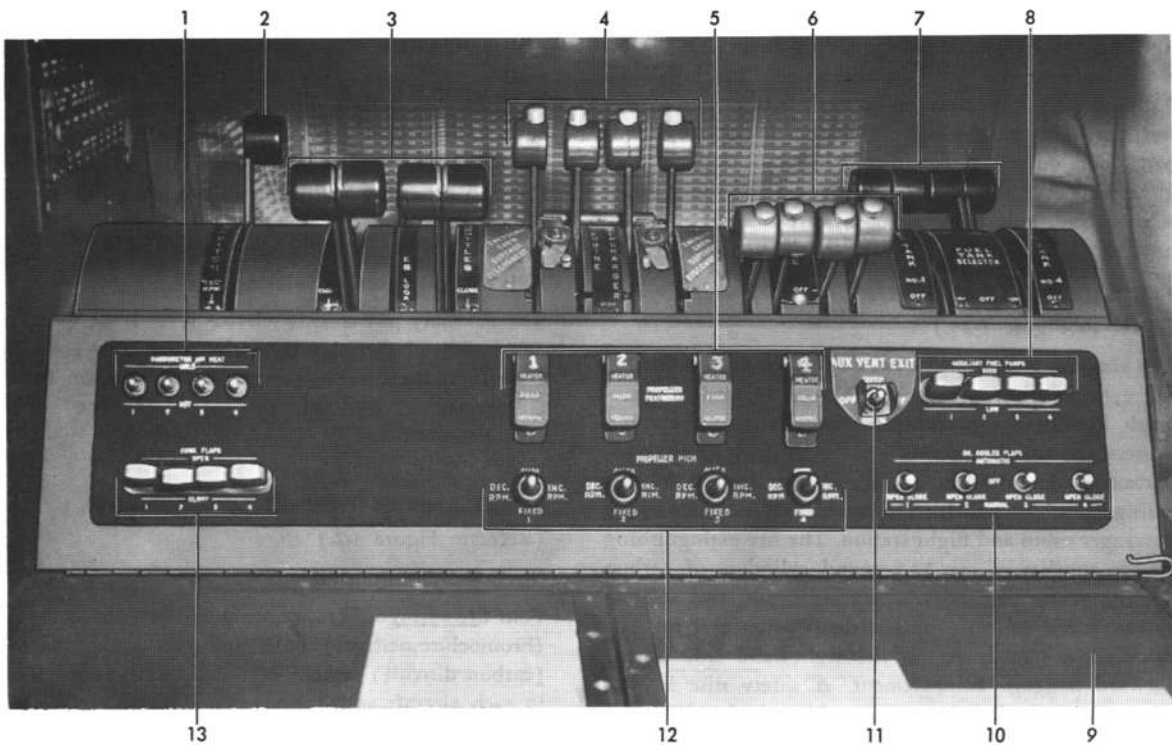

- | | | | |
|---|---|----|-----------------------------------|
| 1 | CARBURETOR AIR HEAT SWITCHES | 7 | FUEL TANK SELECTOR LEVERS |
| 2 | PROPELLER SYNCHRONIZER LEVER | 8 | AUXILIARY FUEL PUMP SWITCHES |
| 3 | THROTTLE LEVERS | 9 | ENGINE ANALYZER SCOPE (NOT SHOWN) |
| 4 | ENGINE SUPERCHARGERS AND CABIN SUPERCHARGER DISCONNECT LEVERS | 10 | OIL COOLER FLAP SWITCHES |
| 5 | PROPELLER FEATHERING SWITCHES | 11 | AUXILIARY VENT. EXIT SWITCH |
| 6 | MIXTURE LEVERS | 12 | PROPELLER SELECTOR SWITCHES |
| | | 13 | COWL FLAP SWITCHES |

F125-1-1-36

Figure 1-24

d. One on the wall forward of the left aft coat closet.

WARNING

Prolonged exposure (5 minutes or more) to high concentrations (resulting in pronounced irritation of eye and nose) of Bromochloromethane (CB) or its decomposition products should be avoided. CB is an anesthetic agent of moderate intensity. It is safer to use than previously used fire-extinguishing agents (carbon tetrachloride, methylbromide); however, in confined places especially, adequate protection (including the use of oxygen when available) of the respiratory system and eyes from excessive exposure should be sought as soon as the primary fire emergency will permit.

Fireman's Hand Axe.

Two fireman's hand axes are provided. One is located on the 260 panel and the other on the wall forward of the left aft coat closet. (On USAF Serial 48-608, the second axe is located in the aft cabin baggage rack.) These axes are especially designed for chopping emergency escape exits in the fuselage or breaking windows.

Emergency Ditching Lights.

Emergency ditching lights are installed in the overhead lighting compartments. These lights are battery operated from their own battery supply located in the navigator's closet. They may be turned on manually by a switch located on the flight attendant's aft panel (on USAF Serial 48-608 this switch is located overhead on the sidewall of the closet forward of the main cabin door) and a switch located above the navigator's closet, or by an inertia switch.

Ladders and Rope.

An escape rope is provided in the flight station on the forward right-hand bulkhead at station 260. An emergency ladder for the main cabin is located in the left-hand closet forward of the main cabin door. On most

aircraft a Jacob's ladder is located in one of the aft coat closets or in the aft cabin baggage rack.

Evacuation Chutes.

All aircraft are equipped with one inflatable evacuation chute stored in the baggage rack. A noninflatable evacuation chute is also provided and is located in the closet forward of the main cabin door.

Life Rafts.

Two 20-man life rafts are installed, one in each wing compartment. Refer to Section III for instructions on use of the rafts.

Life Vests.

Provisions are made to stow life vests in the aft cabin baggage rack.

AN/CRT-3 Emergency Transmitters.

Two AN/CRT-3 transmitters are provided. One is located under the navigator's table and one in the left aft coat closet. On USAF Serial 48-608 the second AN/CRT-3 transmitter is located in the aft cabin baggage rack. Each transmitter operates on the international frequency of 500 and 8364 kc. Operating instructions are inscribed on the equipment.

AN/URC-4 Emergency Transceiver.

Two VHF/UHF AN/URC-4 emergency transceivers are provided. Both sets are located in the crew compartment. Each set is battery powered and operates on 121.5 mc. or 243.0 mc. They are intended for emergency use only. Operating instructions are stamped on the case of each set.

First Aid Kits.

USAF Serial 48-608.

Four first aid kits are provided in the aft pullman compartment. Three are located in the left coat closet and one in the center lavatory compartment.

USAF Serials 48-609 thru 48-617.

Three first aid kits are provided. One is located in the galley coat closet and two in the left aft coat closet.

Smoke Masks.

Smoke masks are provided for the crew, and stowed at the following locations for each aircraft:

USAF Serial 48-608.

- a. One at the pilot's station.
- b. One at the flight engineer's station (260 bulkhead).
- c. Two at the radio operator's station.

USAF Serials 48-609 thru 48-613; 48-615; 48-617.

- a. One at the pilot's station.
- b. Three at the flight engineer's station (260 bulkhead).
- c. One at the navigator's station.

USAF Serials 48-614.

- a. Three at the flight engineer's station (260 bulkhead).
- b. One at the radio operator's station.
- c. One at the navigator's station.

Gloves (Asbestos).

One pair of asbestos gloves is provided, and located at the flight engineer's station (260 bulkhead).

Landing Flares.**Note**

Flare chutes are installed in all the aircraft; however, flares have been removed from 1254th ATW aircraft.

Two flares may be installed in separate chutes located in the wing leading edge, inboard of No. 3 engine. Each flare weighs 16 pounds and is provided with a parachute which allows it to descend at the rate of approximately 360 feet per minute. Burning time of the flare is 3 minutes and the light output is 300,000 to 400,000 candlepower. At 2500 feet above the terrain the light range is 1½ miles. The release and triggering provisions consist of release switches, cover latch, lanyard and dc-operated solenoids. When the release switches are actuated, the solenoid triggers the latch and the flares drop through the flare chute. A cover plate is installed over each flare chute. When the flares are released, the thin sheet of aluminum will break from the weight of the falling flares. The flare will not ignite nor will the parachute be ejected if the release switch is inadvertently closed when the aircraft is on the ground, because the lanyard is long enough to permit the flare to drop to the ground without tripping the parachute release and flare ignition mechanism. In flight, the flare falls a considerable distance below the aircraft before the parachute is ejected and the flare is ignited.

Flare Release Switches.

Flare release switches are located near the top aft end of the pilot's switch panel (1, figure 1-19). Guards cover the flare release switches and are safetied in the closed position. D.C. power is furnished through a circuit breaker, located on the MJB No. 3 panel.

Note

Flares have been ejected successfully at 217 knots (250 mph) indicated airspeed.

SEATS.**CREW SEATS.**

Seats for pilot, copilot, radio operator, and flight engineer are installed in the flight station. Four passenger-type seats are provided in the crew compartment to the right of the navigator's station for the relief crew members. Each seat is equipped with a lap-type safety belt.

PILOTS' SEATS.

The pilot's and copilot's seats are track-mounted to provide fore-and-aft positioning. They have tilting backs, and are adjustable for height. Each seat is equipped with folding arm rests, a removable head rest, and a shoulder harness connected to an inertia reel mounted on the back of each seat.

Pilots' Seat Controls.

Levers for tilting the backs and for adjusting the height of the pilots' seats are located on the inboard side of each seat. The handles for releasing the seats for fore-and-aft movement and for locking them in position are located on the inboard sides near the floor. Height adjustment is accomplished by overcoming the upspring action when the control lever is lifted to release the position lock. The inertia reel control lever is located on the inboard side of each seat near the forward end of the cushion. It has detents in two positions; LOCKED (forward) and UNLOCKED (aft). In the LOCKED position, the inertia reel holds the shoulder harness so that the pilot cannot lean forward. In the UNLOCKED position, the harness will not restrict movement but is set for inertia action so that the reel automatically restrains the shoulder harness when the aircraft encounters an impact force of from 2 to 3 G's. When the reel is locked by impact force, it must be released by moving the control lever to the LOCKED position, then to the UNLOCKED position.

FLIGHT ENGINEER'S SEAT.

The seat for the flight engineer is track-mounted to provide back-and-forth position adjustment, and is ar-

fire extinguishing system

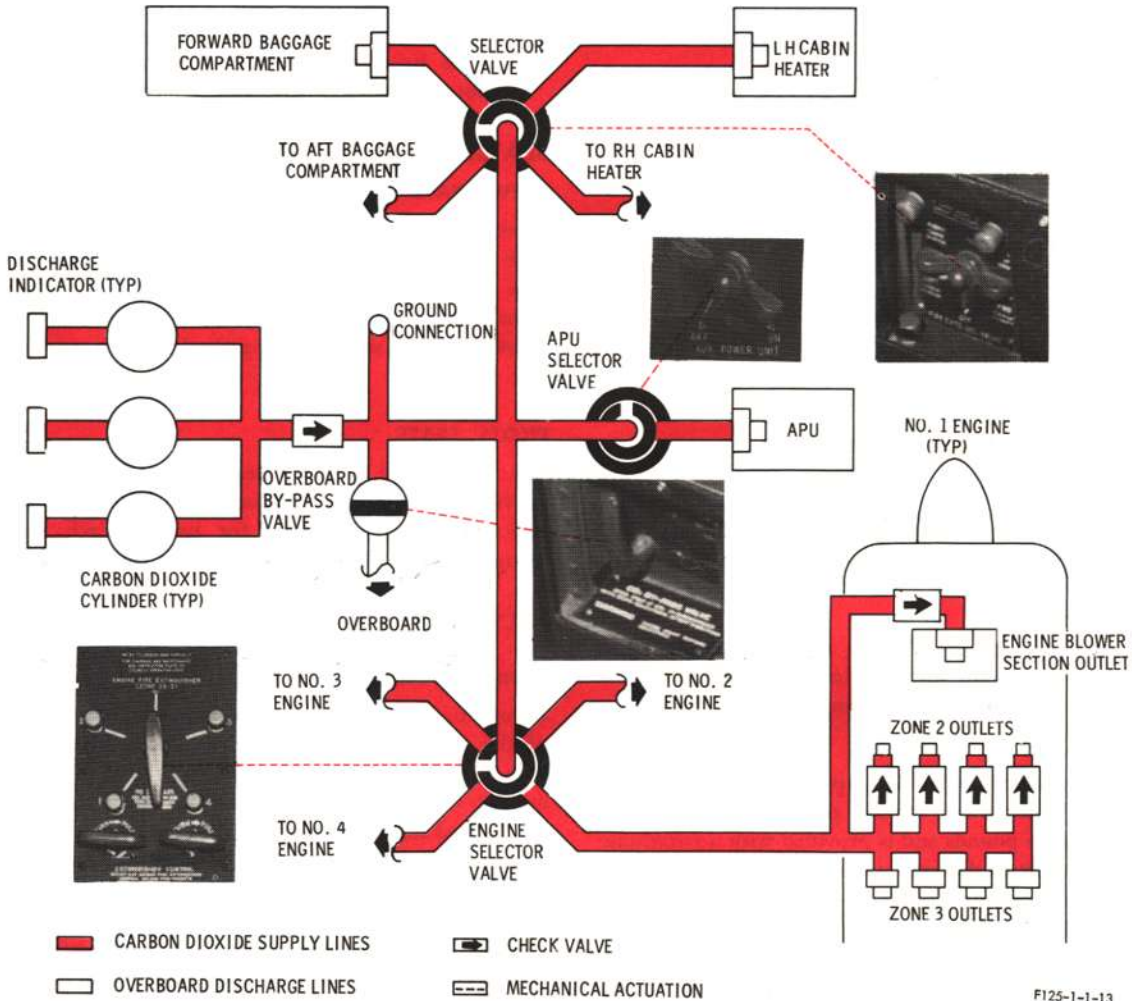

Figure 1-25

ranged to swivel. The chair may be locked in increments of 15 degrees.

Flight Engineer's Seat Controls.

The position control adjustment lever for the flight engineer's seat is a horizontal bar below the rear edge of the seat which must be reached and operated by hand. The position locking mechanism is released by raising

the bar. The swivel lock is controlled by a lever located to the left of center, below the seat.

AUXILIARY EQUIPMENT.

Auxiliary equipment, such as the air conditioning, communication, electronic, lighting, oxygen, automatic pilot, navigation equipment are discussed in Section IV of this manual.

SECTION II

NORMAL PROCEDURES

TABLE OF CONTENTS

	<i>Page</i>		<i>Page</i>
PREPARATION FOR FLIGHT	2-1	LINE UP	2-23
CHECK LISTS	2-1	TAKE-OFF	2-25
PREFLIGHT CHECK	2-7	AFTER TAKE-OFF/CLIMB	2-25
BEFORE INTERIOR INSPECTION	2-7	LEVEL-OFF PROCEDURE	2-29
INTERIOR INSPECTION	2-7	CRUISE CHECKS	2-29
EXTERIOR INSPECTION	2-7	INITIAL DESCENT PROCEDURE	2-30
BEFORE STARTING ENGINES	2-7	DESCENT	2-31
ENGINE STARTING PROCEDURE	2-11	BEFORE LANDING	2-33
ENGINE GROUND OPERATION	2-14	LANDING TECHNIQUE AND PROCEDURE	2-35
BEFORE TAXIING	2-14	GO AROUND	2-38
TAXIING	2-15	TOUCH AND GO PROCEDURE	2-38
ENGINE RUN-UP	2-18	AFTER LANDING	2-39
THRU-FLIGHT ENGINE RUN-UP	2-21	POST FLIGHT (Idle Mixture Check)	2-40
BEFORE TAKE-OFF	2-21	BEFORE LEAVING AIRCRAFT	2-40

PREPARATION FOR FLIGHT.

FLIGHT RESTRICTIONS.

Refer to Section V for information concerning operating limitations.

FLIGHT PLANNING.

For operating data necessary to plan and complete the proposed mission, refer to charts and tables in Appendix I.

TOLD (TAKE-OFF AND LANDING DATA).

The take-off and landing data must be computed and checked during determination of the data necessary for the proposed mission. The TOLD chart will be reviewed and available for ready reference. Refer to part 8 of the Appendix for an illustration of the card and sample problem.

WEIGHT AND BALANCE.

It is the responsibility of the pilot in command to ascertain that the aircraft is properly loaded and balanced and that the center of gravity limits are not exceeded. To obtain further loading information, refer to the Handbook of Weights and Balance, T. O. 1-1B-40, and the Operating Limitations in Section V. In completing Form 365F, be certain that the basic weight being used applies to the aircraft assigned for the flight. A check should be made of the take-off and anticipated landing gross weights, and that the grades and weight of fuel, oil, and special equipment carried is suited to the mission to be performed.

CHECK LISTS.

It will be the responsibility of the pilot to insure that each crew member has accomplished his individual in-

interior inspection

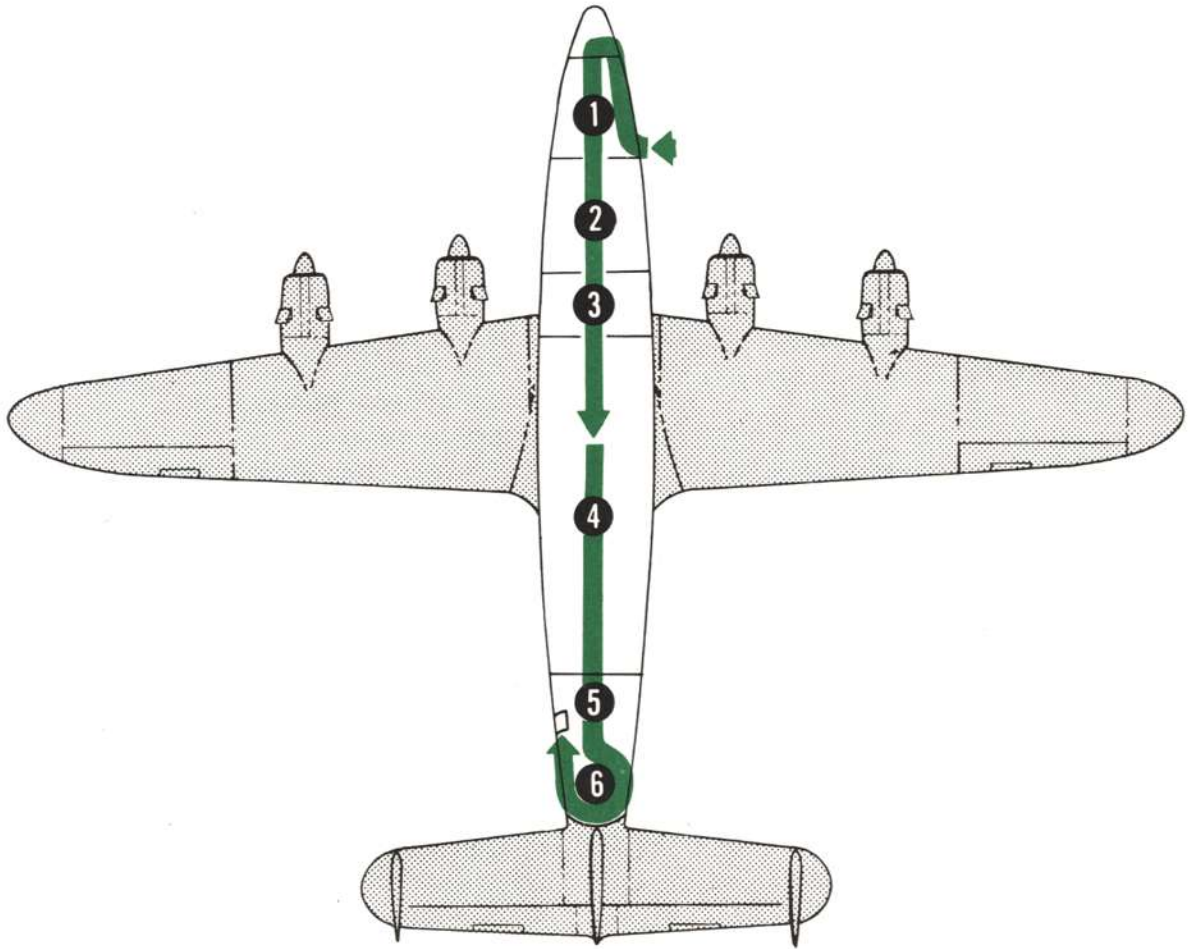

Figure 2-1 (Sheet 1)

1 COCKPIT STATION

- * 1. Flight engineers logs and forms ABOARD
- 2. Aircraft files CHECKED
- 3. Spare lamps, bulbs and fuses ABOARD
- * 4. Battery voltage CHECKED
- * 5. Circuit breakers CHECKED ON
- * 6. Brake selector EMER. POSITION
- * 7. Windshields CLEAN AND CONDITION
- * 8. Brake accumulator pressure 1000 - 1600 PSI
- 9. Pitot heaters CHECKED AND OFF
- 10. Windshield defog switches CHECKED AND OFF
- * 11. Hydraulic emergency tank supply CHECKED AND SERVICED
- 12. CO₂ fire extinguisher INSTALLED, RADIO SEAT
- 13. Ditching rope INSTALLED, 260 PANEL
- 14. Fire axe and asbestos gloves INSTALLED AND SECURED
- * 15. Oxygen supply PRESSURE AND WALK AROUND BOTTLE CHECKED
- 16. Smoke masks INSTALLED AND CHECKED
- 17. Aldis lamp INSTALLED AND OPERATING
- 18. Emergency inverter and lights OPERATION
- 19. Flashlights ABOARD
- 20. Hydraulic filler hose ABOARD
- * 21. Ignition switches OFF
- 22. Windshield alcohol CHECK FOR OPERATION
- 23. Fuel dip sticks ABOARD
- * 24. Propeller synchronizer lever CHECKED
- * 25. Throttle levers CHECKED
- 26. Hand pump selector FORWARD BRAKE POSITION
- * 27. Parking brake SET
- * 28. Cockpit instrument and general lighting CHECKED

2 CREW QUARTERS

- 1. Life vests IN PLACE
- 2. Emergency exit SECURED
- 3. CRT-3 and URC-4's STOWED
- * 4. Astral dome SECURE AND CHECKED
- 5. Emergency cabin lights CHECKED AND OFF
- * 6. Portable oxygen bottle INSTALLED AND ACCESSIBLE
- 7. Very pistol and flares ABOARD AND SECURED
- * 8. Oxygen PRESSURE

3 GALLEY — FORWARD LAVATORY — CARGO COMPARTMENT

- 1. Sink stoppers IN PLACE
- * 2. Drinking water FULL AND SECURED
- 3. All electrical equipment CHECKED AND OFF
- 4. Disposal bucket IN PLACE
- 5. Spare hydraulic fluid 5 GALLON MINIMUM
- 6. Main landing gear hydraulic shut-off OPEN AND SAFETIED
- 7. Refrigerator unit CHECKED

GALLEY CLOSET

- 1. Emergency flap handle ABOARD AND SECURED
- 2. Fire extinguisher CHECKED AND SECURED
- 3. First aid kit CHECKED AND SECURED
- 4. Berth ladder ABOARD AND SECURED

4 CABIN

- 1. Emergency exits SECURED AND SAFETIED
- 2. Windows CLEAN, CHECK FOR CRACKS AND CRAZING
- 3. Flap motor by-pass valve CLOSED AND SAFETIED
- 4. Cabin seats and doors OPERATION AND CONDITION
- 5. Ditching ropes SECURED
- 6. Berths SECURED

5 ENTRANCE AREA AND REAR LOUNGE

- 1. Electric ladder SECURED
- 2. Emergency equipment (parachutes, life vests, life raft kits, exposure suits, emergency water, first aid kits, CRT-3) ABOARD AND SECURED
- 3. Fire extinguishers CHECKED AND SECURED
- 4. Fire axe INSTALLED
- 5. Ground evacuation chute INSTALLED
- * 6. Oxygen masks ABOARD AND STOWED
- * 7. Pressure bulkhead door SECURED
- * 8. Drinking water FULL AND SECURED
- * 9. Bucket INSTALLED
- * 10. Wash water CHECKED
- 11. Emergency lights CHECKED

6 TAIL SECTION

- 1. Auxiliary Power Unit OIL, TIME AND CONDITION
- 2. General condition CABLES, WIRING, LINES AND UNITS

Figure 2-1 (Sheet 2)

exterior inspection

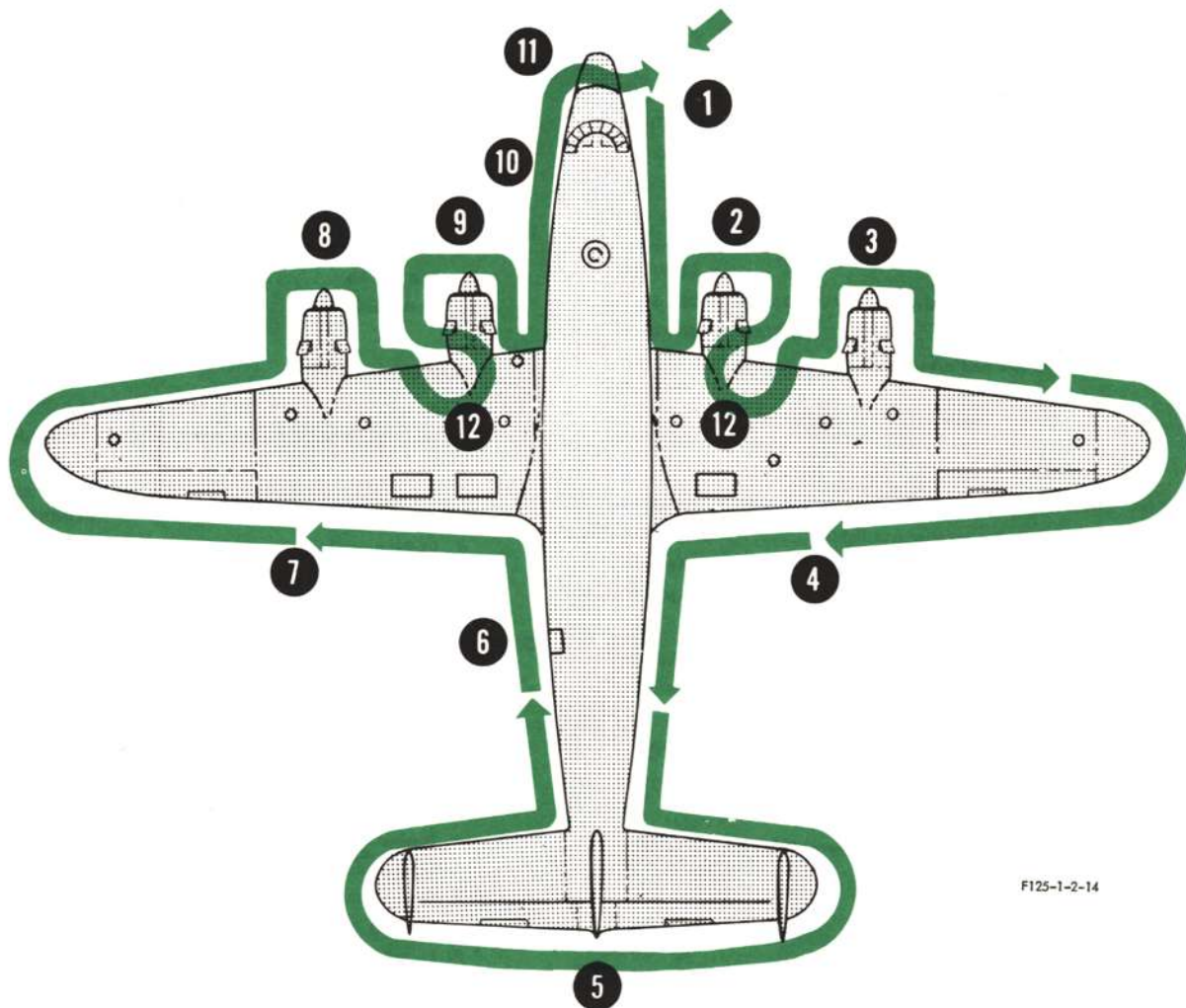

F125-1-2-14

1 FUSELAGE — RIGHT SIDE

- * 1. Fuselage skinCONDITION
- * 2. CO₂ overboard safety discharge discsINTACT
- 3. Parachute flare shieldsINTACT

2 INBOARD ENGINE AND MAIN GEAR

ENGINE

- * 1. Engine cowlingCONDITION AND SECURED
- * 2. Propeller — blades for cuts, nicks, brush block, alternator for security, cuffs, dome safetiesCONDITION
- 3. Cowl flapsSECURED

- * 4. Engine — leaks; oil and fuel, and ignition for securityCONDITION
 - a. Oil sump plugsCONDITION
- * 5. Engine breather lines and ventsOPEN
- * 6. Engine exhaust systemCONDITION AND SECURED

WHEEL WELL

- * 7. TiresCONDITION AND PROPER INFLATION
- * 8. BrakesLEAKS; FITTINGS AND BLEED PLUGS SECURED
- 9. Hydraulic shut-off valveSAFETIED OPEN
- * 10. Main gear strutsPROPER INFLATION AND CONDITION
- * 11. Main gear uplocksOPEN

Figure 2-2 (Sheet 1)

- *12. Main gear doors and attachments LATCHED AND CONDITION
- *13. Main gear safety pin INSTALLED (REMOVE PRIOR TO FLIGHT)
- *14. Wheel chock IN PLACE
- 15. Ground wire GROUNDED
- *16. General -- all lines, cables, wiring, and units in wheel well CONDITION

3**OUTBOARD ENGINE**

1. Repeat steps 1 through 6 of INBOARD ENGINE AND MAIN GEAR CHECK.

General

- a. Cabin supercharger REQUIRED OIL LEVEL AND CONDITION
- b. Engine fireseal INSTALLED
- c. Condition of lines LEAKS AND SECURITY
- d. Cables and units CONDITION
- e. Hydraulic and fuel valves LEAKS AND SECURITY
- f. Oil sump plugs CONDITION

4**UNDERSIDE WING SURFACE**

1. Scoops, access doors, and dump chutes CONDITION AND SECURITY
- * 2. Wing surface FUEL LEAKS
- * 3. De-icer boots CONDITION
4. Exterior lights LENSES CLEAN AND INTACT
- * 5. Flaps, ailerons, and aileron trim tabs (check flap tracks, cables, torque tubes and area) CONDITION
- * 6. Cabin heater area CONDITION

5**EMPENNAGE SURFACES**

- * 1. Stabilizer CONDITION
- * 2. De-icer boots CONDITION
- * 3. Elevators and trim tabs CONDITION
- * 4. Rudders and trim tabs CONDITION
- * 5. Tail cone, navigation lights HYDRAULIC LEAKAGE AND CONDITION

6**FUSELAGE UNDERSIDE**

- * 1. Fuselage (pulled rivets, dents and cracks) GENERAL CONDITION
 - * 2. Antennas and masts CONDITION AND SECURED
 - * 3. Cargo and access doors CLOSED AND SECURED
 4. Auxiliary vent exit valve POSITION AND CLEAR
- General
- a. APU drains LEAKAGE
 - b. Main cabin door CLOSED
 - c. Drain holes CHECK FOR OBSTRUCTION AND WATER
 - d. Water filler door SECURED
 - e. Heater exhaust CONDITION

7**UNDERSIDE WING SURFACE**

1. Repeat steps 1 through 6 of UNDERSIDE OF WING SURFACE CHECK.

8**OUTBOARD ENGINE**

1. Repeat steps 1 through 6 of INBOARD ENGINE AND MAIN GEAR CHECK.

9**INBOARD ENGINE AND MAIN GEAR**

1. Repeat steps 1 through 16 of INBOARD ENGINE AND MAIN GEAR CHECK.

10**FUSELAGE — LEFT SIDE FORWARD**

- * 1. Fuselage skin CONDITION
2. Cabin pressure regulator exit OBSTRUCTION
3. Driftmeter lens and shield CLEAN AND SECURED

11**NOSE GEAR AND WHEEL WELL**

- * 1. Nose gear up-lock OPENED
- * 2. Nose gear safety pin INSTALLED (REMOVE PRIOR TO FLIGHT — CHAIN STOWED)
- * 3. Batteries CONNECTED AND SECURED
4. Battery acid traps EMPTY AND SECURED
5. Hydraulic shut-off valve SAFETIED OPEN
- * 6. Nose gear strut and scissors CONDITION AND SCISSORS SAFETIED
- * 7. Nose wheel tires and dust covers CONDITION AND INFLATION
8. Nose gear steering LEAKAGE, BLEED PLUGS, TORSION LINK
- * 9. Nose well doors CONDITION AND SECURED
- *10. Pitot heads COVERS REMOVED
11. Taxi lights GLASS INTACT AND CLEAN
- *12. Forward cargo door CLOSED
- *13. General condition of all lines, wiring and units (Static wire grounded) SECURED AND NO LEAKAGE
- *14. Flush static holes NO OBSTRUCTION
15. Radar dome SECURED

12**TOP SIDE WING**

- * 1. Fuel tanks QUANTITY, SECURE CAPS AND COVERS
- * 2. Oil tanks QUANTITY, SECURE CAPS AND COVERS
3. Main hydraulic reservoir (left side) QUANTITY, SECURE CAPS AND COVERS
- * 4. Anti-icer fluid tanks SECURE CAPS AND COVERS
- * 5. De-icer boots CONDITION
- * 6. Wing and nacelle skin GENERAL CONDITION AND SECURED
7. Refrigerator oil (right side) QUANTITY
- * 8. Life raft door and access panels LOCKED AND SAFETIED

Figure 2-2 (Sheet 2)

EXTERIOR ELECTRICAL "POWER ON" ENGINEER'S PREFLIGHT

- | | |
|---|---|
| 1. Taxi light ON - OFF | 14. Preheat door HOT TO COLD (LISTEN FOR MOTOR RUNNING - BOTH POSITIONS) |
| *2. Navigation lights - Flash and steady -
Wheel well lights ON - OFF | 15. Carburetor alcohol ON - OFF |
| 3. Leading edge light ON - OFF | 16. Propeller alcohol ON - PROPELLERS VISUAL CHECK - OFF |
| 4. Landing light EXTENDED - ON
RETRACTED - OFF | 17. Fuel pressure "ON" main tanks, cross feeds
and 2A and 3A tanks ALL PUMPS TO LOW, TO HIGH.
VISUAL CHECK ALL ENGINE NACELLES, FUEL VALVES, LINES,
CROSS FEED, FUEL FILTER, FUEL BOOSTER PUMPS FOR LEAKS
AND NOISE AND VALVE OPERATION |
| *5. Rotating beacon lights ON - OFF | 18. Aftercooler scoop motor OPEN - CLOSED |
| *6. Position lights (navigation lights on) ON - OFF | 19. Auxiliary vent check |
| 7. Pitot head and mast de-icer ON - OFF
(Actuate landing gear microswitch to check mast operation) | (a) Supercharger dump valve OPEN - CLOSED |
| 8. Cowl flaps CLOSED - OPEN POSITION (CHECK
VISUALLY AND CHECK INSTRUMENT
OPERATION) - OPEN | (b) Auxiliary inlet valve OPEN - CLOSED |
| 9. Oil coolers AUTO, OPEN, CLOSED POSITION
(CHECK VISUALLY AND CHECK INSTRUMENT) | (c) Auxiliary vent exit OPEN - CLOSED |
| 10. Propeller decrease check MANUAL DECREASE,
VISUAL CHECK, MOMENTARY INCREASE | (d) Auxiliary vent position "A" |
| 11. Propeller feathered VISUAL | 20. Aileron and tab PROPER DIRECTION AND
FREEDOM OF MOVEMENT |
| 12. Propeller increase check HIGH RPM | 21. Rudder and tab AUXILIARY BOOST -
PROPER DIRECTION, FREEDOM OF MOVEMENT |
| 13. Reverse check VISUAL AND FULL INCREASE | 22. Elevator and tab AUXILIARY BOOST
PROPER DIRECTION, FREEDOM OF MOVEMENT |

Figure 2-2 (Sheet 3)

Inspection requirement as outlined in Section II and Section VIII of this manual. The air crew visual inspection procedures outlined in this section are predicated on the assumption that maintenance personnel have completed all the requirements of the -6 Inspection Requirements Manual, for PREFLIGHT or THRU FLIGHT. Additional checks may be performed at the discretion of the flight crew. Emphasis should be placed on the major components which have a marked effect on safety of flight, not on the myriad system details which must be entrusted to the ground crews if the flight crews are not to dissipate excessive hours in endless inspection. The criteria on which these checks shall be based are safety of flight, items that have previously been a problem or that are anticipated to be a problem, and ease of accomplishing the check.

AMPLIFIED AND ABBREVIATED CHECK LISTS.

This manual now contains only amplified check lists. These check lists are presented in two column form, one column listing pilot items and one listing flight engineer items. The pilots' list must be used as a challenge and reply procedure to assure that each and

every item contained therein is checked. The flight engineer's list will be read and accomplished by the flight engineer. The items marked with circled numerals are items requiring coordination with the opposite party and his list; neither list should be continued until such items are coordinated. Frequently, it is desirable to accomplish items prior to reading the checklists. All items must be completed no later than the time the checklist is read. The use of a Scroll Flight Deck Coordinator is authorized.

Abbreviated check lists, one each for the pilots, flight engineer, navigator, radio operator and flight attendants have been issued as separate Technical Orders. For the T. O. number and date of the check list applicable to the C-121A, refer to page A and to the Forward Page iii under CHECK LISTS.

Note

When an aircraft is flown by the same flight crew in regularly scheduled airline-type operations, or when assigned tactical or administrative missions require intermediate stops, it is unnecessary and wasteful of time to require the flight crew to perform all the checks required

under BEFORE INTERIOR INSPECTION, INTERIOR INSPECTION, and EXTERIOR INSPECTION. Under these conditions, only a portion of the normally required checks are necessary to assure safe operation. Accordingly, for those aircraft in which thru-flight operation will frequently occur, an asterisk (*) will immediately precede each check that must be performed during thru-flight operation. Inspection items not marked with an asterisk may be checked at the discretion of the flight crew.

PREFLIGHT CHECK.

A visual pre-flight inspection of the aircraft should be made by the flight engineer in accordance with the items noted in figures 2-1 and 2-2. On all flights requiring a navigator, the navigator will follow the pre-flight procedure set forth in Section VIII.

Note

- Replace outer windows if:
 - a. The depth of the cracked, scratched, nicked, chipped, or otherwise damaged area is such as to exceed the thickness of the vinyl shield.
 - b. Delamination of vinyl shield and basic window is more than one inch from the edge of gravel shield.
 - c. The outer tension or soft vinyl core is scratched, chipped, cracked, etc.
 - d. A window bulge exceeds one inch when a straight edge is placed along the horizontal axis.
- Flight may be dispatched non-pressurized under the above conditions.

BEFORE INTERIOR INSPECTION.

- *1. Check Form 781.
- *2. Chocks in place.

3. Gear pins installed.
4. Check cowl flap locks.

INTERIOR INSPECTION.

A visual preflight inspection of the interior of the aircraft in accordance with the items noted in figure 2-1 should be made immediately after boarding.

EXTERIOR INSPECTION.

A visual preflight inspection of the aircraft in accordance with the items noted in figure 2-2 should be made.

Note

Draining the fuel tank drains and fuel filters is the responsibility of the maintenance personnel performing the preflight and through flight inspection required by T. O. 1C-121A-6. Those items will be accomplished by the flight engineer at stations where maintenance personnel are not available and the T. O. 1C-121A-6 inspections are performed by the flight crew.

BEFORE STARTING ENGINES.

The pilot and copilot will check and position all switches, as desired, on the side, instrument and overhead panels. The pilot and copilot will check all push-to-test lights. The pilot sets the UHF or VHF to the desired channel and assures that the radio master switch is on. Both pilots will adjust rudder pedals, seats, and fasten seat belts and shoulder harness. The engineer will adjust and fasten his seat belt.

Note

To adjust the rudder pedals properly, both left and right pedals should be fully extended, then depressed through the same number of notches to insure an even setting. It is extremely important to insure that the seats are securely latched in the desired position; otherwise the seat may slide aft when maximum power is applied.

BEFORE STARTING ENGINES

Pilots

Flight Engineer

When the pilot instructs copilot to read both pilot's and flight engineer's checklist, copilot will read off items and obtain required answers.

1. Visual inspection — COMPLETED.
2. Gross Weight and CG—_____ TOLD CARD,
_____ COMPLETED.
3. Fuel and oil quantity — _____ POUNDS.
_____ GALLONS.
4. Landing gear lever—DOWN.
Lever should be down and three green lights on copilot's panel ON.
5. Autopilot servo disconnect levers—OFF.
Three levers located aft side of pedestal should be disconnected for all take-offs and landings. The up position disengages autopilot servos.
6. Brake selector lever—EMERGENCY (CP).
Located on aft face of pedestal. In emergency position, accumulator pressure is directed directly to brakes. In the normal position, brakes receive pressure from secondary hydraulic system or directly from hydraulic hand pump.
7. Hand pump selector lever—EMERGENCY BRAKE (CP).
Located near base of hand pump. Brake position supplies hand pump pressure for brakes. If selector is left in GEAR (Aft) position, landing gear cannot be retracted.
8. Emergency brake pressure—1000 to 1600 PSI (CP).
A direct pressure gage on copilot's right hand panel reads brake accumulator pressure, 1000 psi for adequate parking. Twelve minimum brake applications at 1600 psi. Air pressure (with no hydraulic pressure) in accumulator is 600 psi.
9. Parking brake lever—SET.
The brakes may be set by depressing the toe pedals and pulling up on the parking brake lever located at the forward end and on each side of the pilot's pedestal. A red light on the pilot's and copilot's instrument panel indicates that the parking brake

After completing BEFORE INTERIOR, INTERIOR AND EXTERIOR checklists the engineer will accomplish his BEFORE STARTING checklist.

1. Visual inspection — COMPLETED.
2. Gross Weight and CG—_____ TOLD CARD,
_____ COMPLETED.
Checked and recorded. Form F complete, weight and MAC checked.
3. Fuel and oil quantity (amount and recorded)—
_____ POUNDS, _____ GALLONS.
Check gages against known quantity.
4. Battery voltage—CHECKED 24-28 VOLTS.
Turn voltage selector switch to battery position.
5. Emergency instrument inverter—CHECKED AND OFF.
Turn on the emergency inverter and check its operation (should operate directly off the battery), and make sure all flight instruments are operating.
6. APU—ON.
Turn voltage selector to APU position. Engineer starts APU and switches generator on the main bus.
7. Ignition switches — OFF.
8. Circuit breakers and switches — CHECKED AND OFF.
Check all circuit breakers and switches on No. 1, 2, 2A & 3 main junction panels, 260 panel, and upper and lower 212 panels for proper position. Check radio junction box panel when there is no radio operator on the aircraft.
9. IFS and autopilot gyro switches—ON.
10. Warning lights—CHECKED.
Check all warning lights that should be on. Push-to-test warning lights that are not on. Check fire detection circuits, lights and bell.
11. Inverter switches—CHECKED.
Check main and spare inverters for voltage and frequency (if frequency meter is installed). With main inverter on, pull main inverter circuit breaker

BEFORE STARTING ENGINES

(CONTINUED)

Pilots

lever is in PARK position. Release of the brakes is accomplished by depressing and releasing the brake pedals.

10. Static selector switches—FLUSH STATIC (P, CP).
11. Flight control booster levers—ON.

Aileron and rudder boost levers located to the left of throttles. Forward position is ON. Aft position is OFF. Emergency manual elevator control located lower left hand side of pedestal. Pulled out, cuts off boost system and changes mechanical ratio between control column and elevator for manual control. Center the control column for shifting. All boost levers should be on for normal operation. Rudder and elevator levers must be on for use of auxiliary boost system. Turn all levers to OFF position to check for free movement of controls, return to ON position.

WARNING

Shifting the emergency manual elevator booster shift control lever to the OFF position with the control column in the FULL FORWARD position has caused the lever to bind and in some cases not move at all due to bending of the roller assembly attachment bolt adjacent to the bypass valve link rod in the elevator boost assembly. During ground checks and preflight, do not shift the elevator boost from ON to OFF or OFF to ON unless the control column is in the neutral position.

12. Electric elevator tab control—CHECKED and OFF.
Nose up and down switches located on pilot's control wheel. Disengaging lever located on top of pedestal. Check for up and down operation and disengaging of clutch motor. Unit operates directly from battery. Check manual operation and zero tab.
13. Flight path control cover—REMOVED.
Assure F.P.C. switch is in OFF position.
14. Landing light switches—AS DESIRED.
Switches are located on pilots' overhead switch panel. One pair of switches extend and retract lights, the other pair turns lights on and off.

Flight Engineer

to check change-over relay and warning light. Turn inverter OFF, reset main inverter circuit breaker. Check the manifold pressure indicator for barometric pressure with inverter ON, and the following items: fuel, oil, and hydraulic fluid quantities.

BEFORE STARTING ENGINES

(CONTINUED)

Pilots

15. Navigation, cockpit, no smoking and seat belt light switches—AS DESIRED.

Navigation and cockpit lighting switches are located on side switch panels. Radio panel, no smoking/seat belt switches are located on pilot's overhead switch panel.

16. Flight control auxiliary booster switches—CHECKED AND OFF.

Switches, circuit breakers, and amber lights are located on pilots' overhead switch panel. Use for take-off and landing and emergency operation without normal hydraulic pressure. EMERGENCY position bypasses circuit breaker and operates directly from battery.

17. Ignition switches—OFF.

Flight Engineer

12. Hydraulic fluid—FULL PLUS 5 GALLONS.

Check primary and secondary system quantity on the quantity gage. Check for spare hydraulic fluid in the forward baggage compartment.

13. Inverter switch—OFF (after all instruments checked).

14. Generator switches—OFF.

Generator switches and warning lights OFF.

15. De-icer and anti-icer switches—OFF.

Check the master control switches and propeller de-icer rheostats.

16. Sound trap air valve levers—OPEN.

Two levers located inboard of the crossfeed levers to be in the OPEN (up) position.

17. Fuel crossfeed levers—CLOSED.

Four levers located inboard No. 3 main junction box to be CLOSED (up) position.

18. Emergency shut-off levers—OPEN.

Four levers located in the pilots' overhead control panel should be in the full forward (OPEN) position. Engine oil, fuel, hydraulic valves, cooling air for the generator vacuum pump, and nacelle junction box are open.

19. Fuel dump levers—CLOSED AND SAFETIED.

Two red levers located on pilots' overhead control panel should be in the CLOSED (aft) position and safetied. The left lever dumps fuel from 1 and 2 main tanks, the right lever dumps fuel from 3 and 4 main tanks. Check placard for instructions.

20. Anti-icer fluid level—CHECKED — — — — —
GALLONS.

Check both anti-icer tanks (capacities 20 gals. each).

21. Fuel tank selector levers—ON MAIN.

Four levers located on the right hand side of flight engineer's quadrant. The tanks are ON in the forward (MAINS) position.

22. Mixture levers—OFF.

BEFORE STARTING ENGINES

(CONTINUED)

Pilots**Flight Engineer**

23. Engine supercharger levers — LOW.
Number 1 and 4 controls are used for cabin supercharger disconnect. Do not exceed more than two shifts in a five minute period.
24. Propeller synchronizer lever — CHECKED AND OFF.
Propeller master motor lever full forward position indicates 2800 rpm, amber warning light should be out.
25. Carburetor air switches — COLD.
26. Cowl flap switches — OPEN.
Full open position for all ground operation.
27. Feathering switches — NORMAL.
28. Propeller selector switches — AUTOMATIC.
Automatic for governing to master motor speed, decrease rpm momentarily to the *left*, increase rpm momentarily to the *right*.
29. Auxiliary fuel pump switches—OFF.
30. Oil cooler flap switches—AUTOMATIC.
31. Air conditioning (260) panel — SET.
Auxiliary ventilation knob to position A for starting engines. Recirculating fans and heater off for starting. Temperature selectors automatic. Cabin altitude selector set and light out. Rate of change selector as desired. Auxiliary ventilation exit valve cracked open as desired by means of the auxiliary ventilation override switch on the engineer's panel.

BEFORE STARTING ENGINES

(CONTINUED)

Pilots

18. Oxygen System—PRESSURE & MASKS CHECKED.
19. Pitot heater switches—OFF (CP).
20. De-icer boot switches—OFF (CP).

21. Engineer's before starting engines checklist—COMPLETED.

Flight Engineer

32. CO₂ selector and dump controls—OFF AND CLOSED.
Engine, APU, baggage compartment and heater selector controls OFF. CO₂ dump control valve closed and safetied.
33. Oxygen system — PRESSURE AND MASKS CHECKED.
Check flight engineer's and radio operator's gage pressures.
34. Auxiliary fuel dump valves—NEUTRAL AND SAFETIED.
Located at step, 260 station. Three positions: CLOSED, NEUTRAL and OPEN. Operation of the valve requires secondary hydraulic pressure.
35. Life raft handles and driftmeter shut-offs—CHECKED.
Located at step, 260 station.
36. Vacuum shut off valve—ON.
Located near hydraulic filler valve (ON when parallel with floor, pointed inboard).
37. Engineer's before starting engines checklist—COMPLETED.

ENGINE STARTING PROCEDURE*Pilots*

Upon completion of the BEFORE STARTING ENGINES checklist and after insuring that a ground signal man is ready or a ground controller is on interphone, the pilot states: START ENGINES.

Flight Engineer

After receiving orders from the pilot to start engines, the engineer will receive clearance from either the pilot or ground signal man to turn each engine.

Before starting, the engines must be turned over a minimum of six blades with the starter while the ignition switch is off to check for the presence of a liquid lock which may seriously damage the engine. If a liquid lock exists, the lower cylinder spark plugs must be removed and the propeller rotated to remove the oil from the cylinder.

WARNING

The propeller should never be moved in a direction opposite to normal rotation.

ENGINE STARTING PROCEDURE

(CONTINUED)

Pilots

Flight Engineer

The engine starting sequence is 3, 4, 2, 1. They are started in this order to provide immediate secondary hydraulic pressure. After obtaining the all-clear starting signal, complete starting procedure as follows:

1. Fire guard — POSTED.
2. CO₂ selector — SET.
3. Auxiliary fuel pump switch — ON HIGH.
4. Mixture lever — AS REQUIRED.
5. Engine starter selector switch — SET.
6. Starter switch — ENGAGE.

Note

Avoid throttle movement until engine is running smoothly. Do not exceed 1400 rpm on start.

Acknowledges: ON.

7. Ignition switch — ON.

Note

Ignition switch should be turned on after the propeller has turned six blades.

After number 3 is started, actuate the automatic caging switch.

Cold Engine. AUTO-RICH prior to engaging starter. If engine does not fire within a short period after the ignition switch is activated, place mixture lever in OFF momentarily to prevent afterburning.

Note

- Cold weather starts should be made with closed throttle using either mixture control or primer. If primer starts are made, the mixture lever should remain in OFF until a positive start with smooth operation is obtained.
- Simultaneous use of both primer and mixture control during starting often results in exhaust system fires.
- Following initial firing, and disengagement of the starter, the engine will often motor at low speed, rather than accelerate to normal idle speed. Allow the engine to run at this condition until engine speed increases to normal idle speed. Premature application of throttle or attempts to vary the mixture will stop the engine. Such a false start results in iced spark plugs, preventing successful starting on the following attempts.

ENGINE STARTING PROCEDURE

(CONTINUED)

Pilots**Flight Engineer**

Warm Engine. AUTO-RICH prior to activating ignition. (Optimum point depends on engine temperature.) If engine does not fire within two revolutions after ignition, or if engine loads up, move mixture lever to OFF momentarily.

Hot Engine. OFF until engine fires or two revolutions after ignition, then advance mixture lever to AUTO-RICH. If engine does not fire within a short period in AUTO-RICH, return lever to OFF.

Note

If engine fails to start within 30 seconds, discontinue starting attempt and allow starter to cool for 1 minute before repeating starting procedure.

CAUTION

Observe the oil pressure gages. Stop the engine if the oil pressure does not register within 10 seconds or reach 40 psi within 20 seconds.

Note

When it is necessary to start the engine on the ship batteries, minimize the electrical load.

8. Generator switch — ON.
Check voltage, amps, and overvoltage warning light.
9. Inverter switch — ON.
10. Hydraulic system crossover switch — EMERGENCY, CHECKED AND NORMAL.

Note

After engines No. 3 and No. 4 have been started, check the secondary hydraulic system for pressure. Place hydraulic system crossover switch in EMERGENCY, check operation of the aileron controls and for zero primary gage pressure. This check is made to insure that the crossover valve is functioning satisfactorily. The hydraulic system crossover switch must then be returned to the NORMAL position, checking for no crossover action.

11. Pressures and temperatures — NORMAL.
12. Auxiliary fuel pump switch — OFF after engine has started.
13. Engine starter selector switch — OFF after all engines have been started.
14. CO₂ selector — OFF.

Note

Signal ground crew to remove gear pins after secondary hydraulic pressure has been established.

ENGINE GROUND OPERATION

*Operate the engine at 1000-1400 rpm until the oil inlet temperature has risen at least 6° C above the pre-starting temperature and the oil pressure is stabilized.

BEFORE TAXIING

Pilots

Call for: BEFORE TAXIING CHECKLIST.

1. Radio inverter ON.
Master radio switch ON. Have radio operator check voltage and cycles.
2. Radio equipment—ON (P, CP).
3. IFF: STANDBY.
4. Hydraulic pressure—CHECKED. ssure.
Check pri., sec. and emergency brake pressure.
Reset brakes.

Flight Engineer

Insure engines and systems are functioning properly, states: **READY FOR BEFORE TAXIING CHECKLIST.**

1. Radio inverter ON.
2. Propeller synchronizer lever — 2800 RPM — ON.
3. Hydraulic systems—CHECKED.
Check primary and secondary pressures and quantity.

Note

If a pressure check of each hydraulic pump is desired, place the hydraulic suction shut-off switch that controls the other shut-off valve on the same side of the aircraft, in the OFF position. However, the pumps should not be operated for an extended period on the ground in this condition because they will overheat. An extended pressure check can be made by operating each engine individually.

CAUTION

If the hydraulic pump on either engine 3 or 4 is shut down to test the other pump for suspected failure, have pilot place brake selector lever in EMER.

minimum turning radius

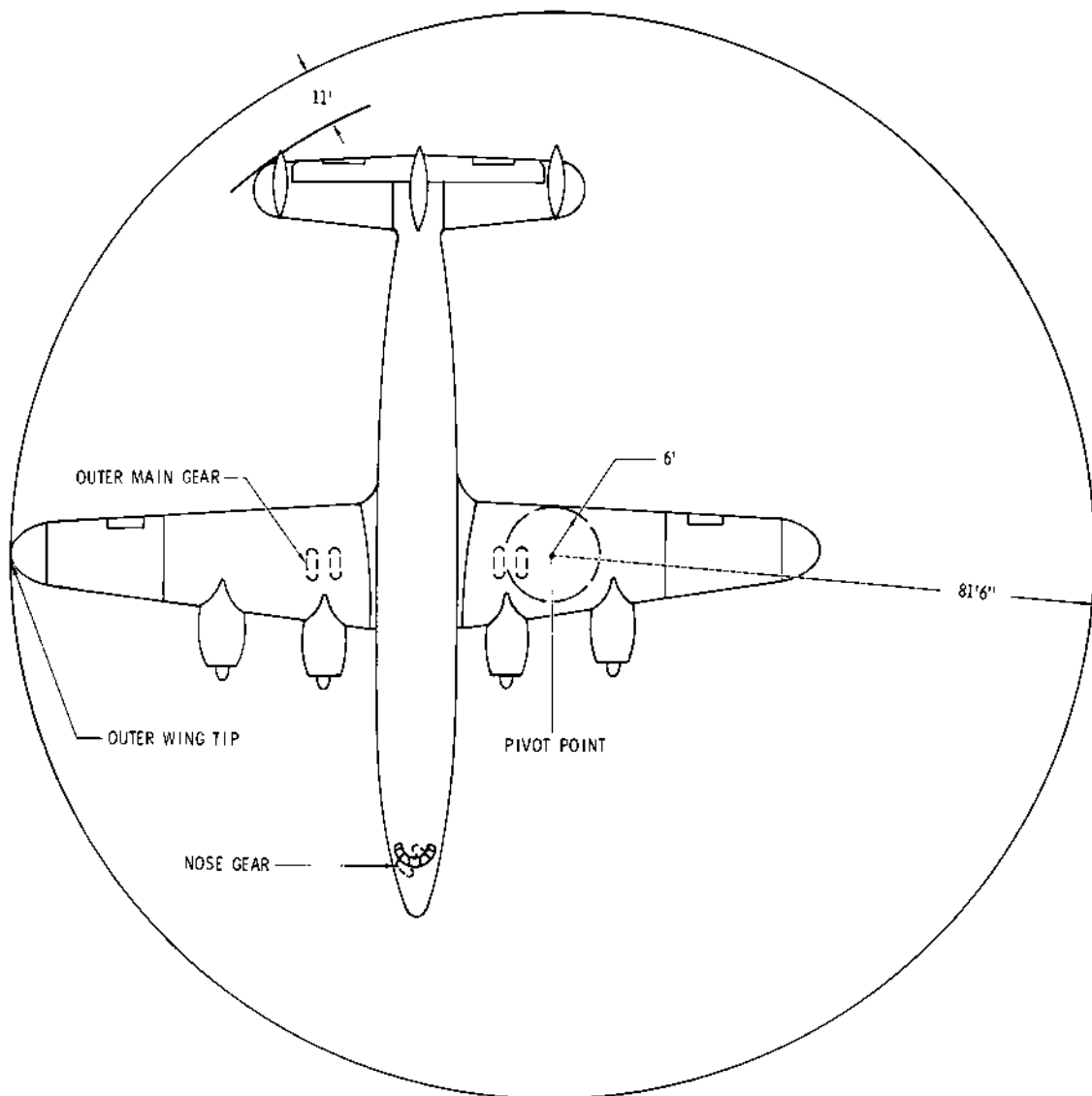

NOTE

THE TURNING RADIUS DEPICTED HERE ARE BASED ON STOPS BEING INSTALLED ON THE NOSE STEERING ASSEMBLY WHICH LIMIT NOSEWHEEL TURNING TO 58 1/2 DEGREES ON EITHER SIDE OF STRAIGHT AHEAD.

F125-01-2-1

Figure 2-2A

Changed 31 October 1964

2-14A/2-14B

BEFORE TAXIING

(CONTINUED)

Pilots

5. Altimeters—SET (P, CP).

Cross-check pilot's and copilot's altimeters for tolerance, also navigator's, if navigator aboard (plus or minus 75 feet from field elevation).

Flight Engineer

4. Altimeter—SET 29.92" HG.

WARNING

Make certain that the 10,000 foot pointer is correctly set on all standard altimeters.
(Refer to Section 1 under INSTRUMENTS.)

- ⑥ Pitot covers and gear pins—ABOARD.

- ⑦ Ground units and chocks—REMOVED.

APU—ON.

Signal ground crew to remove wheel chocks.
Release parking brake — (light out).

5. Doors— CLOSED AND LIGHT OUT.

6. Air conditioning panel—SET.

7. Engine instruments—CHECKED.

8. Ignition analyzer—ON.

9. Vacuum warning lights—OUT.

- ⑩ Pitot covers and gear pins—ABOARD.

- ⑧ Engineer's before taxiing checklist — COMPLETED.

- ⑪ Engineer's before taxiing checklist — COMPLETED.

TAXIING.

During normal taxiing, turns shall be controlled solely with the nose wheel. High taxi speeds and excessive movement of the nose wheel must be avoided. The brakes must be applied gently.

Turns should be started with a slight change in direction of the nose wheel which is gradually increased until the desired amount of turn is established. The same technique should be used in straightening out the turn. Sharp turns at high speeds impose excessive forces on the inside nose wheel tire, strut components, and aircraft structure. Side loads may prove sufficient in high speed turns to pull the inside tire off the wheel.

Note

Power should be applied until the aircraft starts rolling before using the steering wheel. The pilot shall handle the throttle during all phases of taxiing, as it is his responsibility to control the speed of the aircraft and avoid collision.

It is advisable to apply minimum power, when moving away from the ramp to avoid blowing dust on personnel and equipment. After leaving the ramp, the use of power shall be as follows:

- a. If the APU is not operating, 1000 rpm should be maintained on engines 1 and 4 to

insure ample dc output from the generators to support the electrical load on the main dc bus. This will prevent undue drain on the battery. When refrigeration is desired, 1200 rpm on engines number 1 and 4 will provide optimum supercharger output for ground refrigeration.

- b. Before testing propeller reversing, the flight engineer should be notified, in order that he may monitor the air conditioning system to prevent exhaust fumes from being drawn into the cabin. The flight engineer should monitor the electrical load.

TAXIING

Pilots

After the aircraft has been taxied away from the ramp and is clear of ALL obstructions, call for: TAXIING CHECKLIST. Note: At night the landing lights will be used for all taxiing because taxi lights are inadequate.

1. Brake selector level — NORMAL PRESSURE CHECKED (CP).

During the operation of the brake selector lever, from EMER. to NORM. brakes, there must be no pressure on the pedals. After the brake selector is in the NORM. position depress toe pedals and note pedal reaction.

CAUTION

Avoid taxiing for extended periods of time in the EMER. BRAKES position or operating the wing flaps while in that position. It is possible to deplete available emergency system pressure and in the event of a secondary hydraulic failure be without brakes.

2. Turn indicators and compasses — CHECKED (P, CP).
3. Wing flap UP test switch—CHECKED.
Copilot will extend the wing flap handle to the 100% (landing) flap position momentarily to check proper operation when performing flap warning system check. Place flap test switch in test position. Red light should come on and flaps should stop. Place flap lever in UP position.

Note

Care should be exercised when retracting flaps. A drop in system pressure while flaps are being operated may cause the nose wheel steering to be sluggish or bind when attempting to turn.

4. Vacuum—LIGHTS and PRESSURE CHECKED.
5. Propeller reversing—CHECKED.

Flight Engineer

1. Mixture levers — AS REQUIRED.
Auto-rich for initial warm-up, manual leaning to obtain 25 rpm drop from best power for prolonged idling and extended taxiing.
2. Fuel crossfeed levers — CHECKED.
Place crossfeed levers on (down position) and check operation of each individual main tank and auxiliary tanks for crossfeed operation.
3. Carburetor heat switches—CHECKED AND OFF.
 - a. Toggle carburetor air doors to HOT position until a positive increase in carburetor air temperature is indicated.
 - b. Return switches to the COLD position and note a positive drop in carburetor air temperature.
4. Magneto ground check—COMPLETED.
With engines in idle speed, momentarily turn off each ignition switch individually to check for grounding of magneto.

TAXIING

Pilots**Note**

Upon reaching a clear stretch of taxi way order: **STAND BY FOR PROP REVERSING.**

Propeller reversing check:

- a. Retarding the reverse pitch throttle levers of numbers 2 and 3 engines sufficiently to energize the reversing circuit (reversing lights should come on).
- b. Continue retarding the reverse pitch throttle levers of number 2 and number 3 engines, increasing the reverse thrust sufficiently to insure that the propeller reversing mechanisms is operating satisfactorily. Only a small amount of reverse power should be applied after which the reverse pitch throttle levers should be returned quickly to their **NORMAL** position. Observe that propellers return to normal low blade angles at an accelerated rate.
- c. Steps a and b, above, shall be repeated to check numbers 1 and 4 propeller reversing.

Note

- Care should be taken to have at least two engines at 1,000 rpm or better at all times during the reversing check.
- The **TAXIING** check lists should not be executed until the aircraft is clear of congested areas.
- The flight engineer should monitor engine operation closely during taxiing to prevent loading up, engine stoppage, or plug fouling.
- In the event an engine dies after leaving the ramp, no attempt should be made to restart the engine until either the aircraft is returned to the ramp or a fire guard is posted. An engine which has so died must be observed closely while being restarted. Any hesitancy to start immediately by normal starting procedure is cause for investigation.
- Reverse thrust should never be used to taxi the aircraft backward.
- Individual items on the **TAXIING** checklist may be accomplished prior to calling for the checklist, if the pilot so desires.

⑥ Engineer's taxiing checklist—COMPLETED.

POWER-ON AND POWER-OFF STOPS.

Because of the hydraulic drag shock struts on the main gear, two basic methods are recommended for coming to a stop after taxiing to prevent a rocking motion—with power-on and power-off. The power-on stop should be

Flight Engineer

Acknowledges: **STANDING BY FOR PROP REVERSING.**

Insure that the aux. vent knob is in position **A** to prevent exhaust fumes from being drawn into the cabin. Monitor throttles not being reversed to 1000 rpm.

Accomplish the following during the reversing check:

- a. Propeller selector switches—engines 2 and 3—hold to **INC. RPM** and then to **DEC. RPM** positions. Note that no change in blade angles occurs.

Note

If blade angle change occurs, it is an indication of miswiring and the system should be checked immediately.

- b. Propeller switches—**AUTO RPM.**
- c. Steps a and b, above, shall be repeated to check numbers 1 and 4 propeller reversing.

⑤ Engineer's taxiing checklist—COMPLETED.

used when run-up is to be made, and the power-off stop upon station arrival, or when it is desirable to stop with the engines idling. The aircraft should be parked with the nose wheel straight, in order to avoid side loads and strains on the nose wheel and struts.

Power-On Stops.

Ease the aircraft to a normal stop as approximately 1600 rpm is applied to all four engines. This is ample power to prevent rocking rearward. If it is necessary to hold before take-off, and it is desired to reduce power to idle rpm, release the brakes as throttles are retarded, thereby allowing the gear to move forward, then re-apply the brakes.

Power-Off Stops.

For a power-off stop, apply the brakes in the normal manner, but release and re-apply them as the aircraft stops, thus allowing the gear to move forward instead of the aircraft rocking rearward. If it is desired to run-up after a power-off stop, allow the aircraft to roll forward slightly and then stop in the power-on manner as described above.

CAUTION

Sharp turns at high speeds impose excessive forces on the inside nose wheel tire, strut components and aircraft structure. Side loads may prove sufficient at high speeds to pull the inside tire off the wheel.

Note

- Ground operations is more detrimental than any other type of engine operation. This is due to inadequate cooling air flow which affects the temperature of the cylinder heads, lubricating oil, accessories and wiring. The aircraft should be headed into the wind as closely as practicable.
- Ground operation should be conducted at the lowest power settings required to correct maintenance discrepancies and check out the engine prior to take-off. Normally, fouled spark plugs can be cleared at low rpm's and lean mixture settings. Refer to Section VII for spark plug clean out procedure. There should be a specific purpose for each instance wherein an engine is operated on the ground, and in no case should the engine be operated by other than fully qualified personnel.
- At night the run-up will be made with landing lights OFF and taxi lights ON. One of the pilots will keep a careful lookout outside during run-up, in case the brakes are not properly set.

ENGINE RUN-UP

Pilots

As the aircraft is taxied into position for run-up, the pilot calls for mixtures rich, makes a power on stop and sets the parking brake. States: ENGINEER'S THROTTLES, ENGINE RUN-UP CHECKLIST.

1. De-icer boots—CHECKED and OFF (CP).
2. Autopilot and servo disconnect levers—CHECKED and OFF.

Check pilot's and copilot's disconnects.

Note

The aileron servo is spring loaded, and care must be taken to prevent it from snapping into the ON position.

Flight Engineer

Acknowledges: ENGINE RUN-UP CHECKLIST.

CAUTION

Have pilot turn airplane into wind before running engines over 2400 rpm on ground.

1. Mixture levers—AUTO RICH.
2. Throttle levers—1600 RPM.

ENGINE RUN-UP

(CONTINUED)

Pilots

3. Flight instruments—CHECKED (P, CP).

Note

Insure that gyro compasses and RMI's are operating and aligned. The attitude indicators should be checked and the index airplanes set.

Flight Engineer

3. Master control de-icer — CHECKED AND OFF.
- a. 1600 rpm on all engines.
 - b. Place switch in the up (ON) position, observe a decrease in engine rpm and BMEP.
 - c. Return switch to OFF position — observe that rpm and BMEP return to previous setting.
 - d. Repeat the above steps on the other 3 engines.
4. Engine supercharger levers — HIGH BLOWER.
Shift supercharger into high blower.
5. Throttle levers — 1700 RPM.
6. Propeller synchronizer lever — CHECKED.
Retard slowly until a 200 to 300 rpm drop is noted on each engine, then rapidly return to full INC. RPM position.
- Synchronizer warning light — CHECKED.

Note

- The synchronizer warning light should go off when synchronizer motor regains selected speed followed by an even rise in rpm on each engine.
- This check indicates proper operation of the synchronizer protective circuit.

7. Propeller operation — CHECKED.
Check propellers manually.
- a. With gang bar installed, select DEC RPM and reduce engine to 1500 RPM then return to FIXED position.
 - b. Select INC RPM until 1700 RPM is reached then return to FIXED position.
 - c. Propeller selector switch — FIXED position.
 - d. Feathering switch — FEATHER.

ENGINE RUN-UP

(CONTINUED)

Pilots

Flight Engineer

- e. Feathering switch—NORMAL after 200 to 300 rpm drop; after a momentary pause, move the propeller selector switch to AUTO position.

Note

The momentary pause in step (e) above must be accomplished to allow the pitch change motor to come to a complete stop before being energized in the opposite direction.

- f. Generator voltage and amperage checked.
8. Throttle levers—ADVANCED.
Advance throttles on two symmetrical engines at a time to 2 in. Hg above field barometric pressure.
9. Engine supercharger levers—LOW.
Shift superchargers to LOW, observe approximately 2 in. Hg drop in MAP.
10. Engine Power and ignition check—COMPLETED.
Throttle levers—open to obtain field barometric pressure and observe corresponding BMEP, fuel flow, rpm and all pressures and temperatures. Advise the pilot: READY FOR IGNITION CHECK.

Acknowledges: CHECKING. Place the engine ignition switch in the LEFT position, states: LEFT.

Return the engine ignition switch to the BOTH position, states: BOTH.

Place the engine ignition switch in the RIGHT position, states: RIGHT.

Return the engine ignition switch to the BOTH position, states: BOTH.

During the check the ignition switch should be left on each position long enough for the rpm to stabilize.

Repeat procedure for ignition check on the remaining engines.

Note

Atmospheric conditions will influence the readings obtained. Normally engine readings will be approximately the same for all engines. A difference of 100 rpm between any two engines should be investigated. When checking the magneto, a drop of up to 75 rpm maximum or 12 BMEP is considered satisfactory provided no engine roughness is encountered.

CAUTION

A variation of more than 100 rpm between symmetrical engines should be investigated immediately. A crosswind may cause a variation in rpm.

Note

Check engine ignition analyzer for any malfunctions.

ENGINE RUN-UP

(CONTINUED)

*Pilots**Flight Engineer*

④ Engineer's engine run-up checklist — COMPLETED.

11. Throttle levers — RETARD TO 1500 RPM.
This is ample power to prevent the aircraft from rocking forward.

⑫ Engineer's engine run-up checklist — COMPLETED.

THRU FLIGHT ENGINE RUN-UP

*Pilots**Flight Engineer*

If the same crew takes the aircraft through an intermediate stop where no layover is involved, at the pilot's discretion, the flight engineer may accomplish the THRU-FLIGHT ENGINE RUN-UP checklist in lieu of the ENGINE RUN-UP checklist. The THRU-FLIGHT ENGINE RUN-UP checklist contains the minimum items to which an operation check must be performed.

1. Propellers — CHECKED.
 - a. Automatic operation — CHECK.
 - b. Manual operation — CHECK.
 - c. Feathering — CHECK.
2. Engine power and ignition—CHECKED.
- ③ Engineer's run-up checklist — COMPLETED.

BEFORE TAKE-OFF

*Pilots**Flight Engineer*

When the engine run-up checklists are completed, call: PILOTS' THROTTLES. Retard throttles, taking the aircraft off the step and direct copilot to extend flaps to TAKE-OFF (60%) position. The copilot will keep his hand on the control handle until the flaps are at the TAKE-OFF position.

Call for: BEFORE TAKE-OFF CHECKLIST.

- ① Doors and windows — CLOSED, LIGHT OUT (P, CP, E).
Insure that sliding windows are closed and locked.
2. Wing flap lever—TAKE-OFF (CP).
Check asymmetric flap indicator for proper positioning.
3. Trim tabs — SET.

Acknowledges: BEFORE TAKE-OFF CHECKLIST.

- ① Doors and windows — CLOSED, LIGHT OUT.
Make a push-to-test check to insure that light is good. Make visual check on crew door.

BEFORE TAKE-OFF

(CONTINUED)

Pilots

Note

- The trim tab check must follow the auto-pilot check because operation of the auto-pilot will change the elevator tab setting.
 - Keep the rudder trim tab crank unfolded at all times during all take-offs and landings. This will facilitate the immediate application of rudder trim in the event of an engine failure.
4. Flight controls booster levers — ON.
Aileron and rudder — forward, elevator — down and latched.
 5. Compasses and RMI's—CHECKED (P, CP).
Check fluxgate and C-2 compasses for correct heading.
 6. Approach horizon function knob—HEADING.
Check for correct position.
 7. Taxi lights—OFF.
 8. Anti-collision lights switch—ON.

Note

- Anti-collision light operation on the ground should be kept to a minimum. Excessive heat on the ground shortens bulb life. Also during ground emergencies the operating light could confuse rescue operations since emergency ground vehicles use a similar light.
 - During night operation, navigation lights must be on STEADY while anti-collision lights are operating.
9. Flight controls—FREE.
Move rudders, elevators, and aileron through full travel, insuring free movement.

Note

Rudder and elevator boosters are bled by holding full throw position momentarily. Avoid slamming controls against stops.

Flight Engineer

2. Propeller selector switches — AUTOMATIC.
3. Propeller synchronizer lever — 2800 RPM.
4. Pressures and temperatures — CHECKED.
5. Emergency cabin lights — AS REQUIRED.

Switches located on navigator's storage closet and flight attendant's aft panel. ON USAF serial 48-608 this switch is located overhead on the sidewall of the closet forward of the aft cabin door. Impact switch and battery located in navigator's storage closet.

BEFORE TAKE-OFF
(CONTINUED)

*Pilots**Flight Engineer*

10. Radios and radio altimeter—SET.

Insure that all desired radios are on, tuned, and checked. The Omni can be used as a spare VHF receiver.

WARNING

The AN/APN-1 and SCR-718 radio altimeters are unreliable in areas covered by large depths of snow and ice such as encountered over polar regions. An apparent terrain clearance 1600 feet greater than actual clearance has been recorded. Do not rely on your APN-1 or SCR-718 radio equipment to provide terrain clearance when flying over areas covered by large depth of snow and ice.

11. IFF/SIF—AS REQUIRED.

Set mode and code on IFF, if required.

12. Pitot heaters—AS REQUIRED (CP).

13. Wing flap visual check—SET FOR TAKE-OFF. Visual check on all wing flap segments for take-off. Position marked with red line.

14. Crew take-off briefing — COMPLETED.

The copilot and flight engineer should require no special briefing on standard take-off procedures. However, the aircraft commander should brief them on unusual requirements to be observed for a particular take-off.

Critical engine failure speed Go No-Go and Take-Off Speed will have been calculated previously from the Flight Performance Data Charts. They shall be repeated at this time, and it shall be the copilot's responsibility to call out GO or NO-GO at the Go No-Go speed when applicable, and LIFT-OFF at take-off speed.

15. Engineer's before take-off checklist — COMPLETED.

6. Wing flap visual check—SET FOR TAKE-OFF.

7. Engineer's before take-off checklist — COMPLETED.

Note

If extended holding prior to take-off is required, refer to Section VII for proper engine ground operating procedures.

LINE UP

*Pilots**Flight Engineer*

Insure all temperatures and pressures are normal.

When cleared for take-off, call for: LINE UP CHECK LIST.

1. Light switches: AS REQUIRED.

Acknowledges: LINE UP CHECKLIST.

LINE UP

(CONTINUED)

Pilots

2. Flight control auxiliary booster switches — ON (CP).
Check amber lights ON.
3. Windshield blower switches—AS DESIRED (CP).

Flight Engineer

1. Air conditioning panel — SET.

Note

If the runway length is critical, the aux-vent knob should be placed in the OPEN position.

2. Auxiliary fuel pump switches — HIGH.
Check fuel pressure indicators.
3. Mixture levers — AUTO-RICH.
4. Cowl flap switches — SET 50%.

5. Cruising altitude — . FEET.

NIGHT AND WEATHER TAKE-OFFS.

4. Windshield alcohol anti-icer pump switches and control valves — AS REQUIRED.
5. Windshield wiper control — AS REQUIRED.

6. Propeller alcohol anti-icer switches — AS REQUIRED.

6. Air conditioning panel — SET.

7. Auxiliary fuel pump switches — HIGH.

8. Mixture levers — AUTO-RICH.

9. Cowl flap switches — SET 50%.

Note

Set the cowl flaps just prior to take-off. Approximately 200° C is maximum desired cylinder head temperature prior to starting take-off run.

10. Engineer's line up checklist—COMPLETED.

7. Engineer's line up checklist—COMPLETED.

TAKE-OFF.
(Refer to figure 2-3.)**NORMAL TAKE-OFF PROCEDURES.**

Taxi the aircraft into position for take-off, lining up in the center of the runway. After completing the LINE-UP check list advance the throttles to approximately 35 in. MAP and call for: MAX POWER. The flight engineer acknowledges: MAX POWER and the copilot holds the reverse throttle lock flag down until refusal speed is reached. The flight engineer advances throttles to MAXIMUM POWER.

Note

- Maximum power should be smoothly applied in approximately five seconds to meet charted take-off performance.
- Pilot does not take his hand from throttles until reaching V_1 or Go No-Go speed. Avoid restricting throttle movement in either direction as this would make it difficult for the engineer to maintain proper BMEP.
- Pilot uses nose wheel steering until the rudders become effective at about 50-55 knots. In the event an outboard engine fails between 70 knots and decision speed, the rudders are the primary means of control, not the nose wheel steering. However, nose wheel steering should be used during reversing in addition to the rudders.

Visually check the flight instruments in order to note any irregularity or malfunction. The flight engineer maintains a constant maximum power setting and checks all instruments for any indication of malfunction, and keeps an alert watch for an engine overspeed indication.

Note

- The difference between a surging propeller or an overspeeding or runaway propeller must be recognized and treated accordingly. Surging conditions are not necessarily abnormal and will stabilize back to proper conditions, usually without corrective measures. Smooth application of throttles at beginning of take-off run normally will eliminate any tendency toward undue surging.
- An overspeed in take-off rpm between 2800 and 2885 is considered within safe operating limits. However, all cases of deviation from 2800 except minor surges should be recorded in the Form 781. Overspeeds between 2885 and 3100 rpm necessitates a special ground inspection of the engine. Engines which have exceeded 3100 rpm will be removed for overhaul.

The copilot calls out GO or NO-GO if refusal speed (V_r or V_d) is less than take-off speed. Start to take weight off nose gear so that a smooth transition can be made at take-off speed. Continue take-off run, leaving nose wheel on the runway until speed is 10 knots less than take-off speed. The copilot calls LIFT-OFF at take-off speed.

Ease nose wheel off the runway gradually as take-off speed is reached.

Lift off at take-off speed. Make smooth transition. After becoming airborne, maintain a constant climbing attitude. Do not lower the nose to gain speed until the height of immediate obstructions has been attained.

CROSSWIND TAKE-OFF PROCEDURES.

The procedures for crosswind take-offs which are different or in addition to normal take-off are as follows:

- a. During the initial take-off run, allow the aircraft to accelerate to take-off speed in the three point position.
- b. Hold upwind wing down with aileron, as necessary.
- c. Hold the yoke forward until take-off speed is attained. Make a definite pull off at take-off speed, and crab into wind, in order to make good a track in alignment with the runway.

REJECTED TAKE-OFF.

If, at any time prior to V_1 or Go No-Go, the pilot, copilot or flight engineer has any indication of a malfunction affecting flight safety, the take-off will be rejected. Refer to Section III.

Note

If a take-off is rejected because of an engine fire warning light, another take-off will not be attempted until that engine has been inspected.

AFTER TAKE-OFF/CLIMB.

When well established in the climb, call for: GEAR UP with a visual and oral signal. The copilot acknowledges GEAR COMING UP and raises landing gear. When the gear is up the copilot states: GEAR IS UP (giving a visual and oral report).

CAUTION

Do not apply the brakes while the landing gear is being retracted. This can damage the main landing gear retraction linkage crosshead. If it is necessary to stop wheel rotation after breaking ground, the brakes must be applied while the gear is still in the down and locked position.

Note

If the landing gear lever will not go past the neutral position, insert a pencil or equivalent through the hole on the right side of the control pedestal and push the solenoid pin out of the way. If handle movement is O.K. and secondary system pressure is up, but gear does not retract, check the hand pump selector valve at the base of the hand pump. If this valve is in the emergency gear (aft) position, the gear return fluid may be trapped, hydraulically locking the gear in the extended position. If this condition exists, the following procedure must be rigidly adhered to: Move the gear handle full DOWN, move the hand pump selector valve to the EMER. BRAKE (forward) position, and then place the gear handle back to the UP position. Failure to follow this sequence may rupture the emergency extension tank.

Call for: METO POWER as soon as a safe altitude and airspeed (120 kts) has been attained. The engineer acknowledges: METO POWER and sets.

When gear is up and the airspeed is 130 knots or better and a positive rate of climb is established, call for:

FLAPS UP. Normally not below 500 feet. Allow airspeed to increase to 150 knots.

Copilot acknowledges: FLAPS COMING UP, places wing flap control lever in the UP position, and insures that the flaps are fully retracted before removing his hand from handle. When wing flaps are retracted, states: FLAPS UP.

Note

- Flap retraction time from take-off flap setting (60%) is approximately fifteen seconds. Maintain positive climb during flap retraction and allow airspeed to increase to 150 knots.
- On night take-offs the landing lights may be turned off at pilot's discretion.
- METO power is to be used as the first power reduction after take-off in transition from TAKE-OFF to CLIMB power. Otherwise its use is reserved for operation as required under emergency conditions.

After climb airspeed (150 knots) has been attained, call for: CLIMB POWER.

The engineer acknowledges: CLIMB POWER, and sets. When set, states: CLIMB POWER SET.

AFTER TAKE-OFF/CLIMB

Pilots

After being advised climb power has been set, call for: AFTER TAKE-OFF CLIMB CHECK LIST.

1. Landing gear lever — UP.

Landing gear lever on pilots' pedestal (aft side) should be placed in the UP position on command from the pilot. It is necessary to pull the knob out and to release a thumb latch to raise the lever. In the event landing gear lever will not come up, a hole in the right hand side of the pedestal is provided to manually release the lock. Red light out indicates gear up and locked.

CAUTION

- Do not apply the brakes to stop wheel rotation during or after gear retraction.
- Do not turn nose gear steering wheel when gear is retracted.

Flight Engineer

Acknowledges: AFTER TAKE-OFF CLIMB CHECK LIST.

take-off pattern

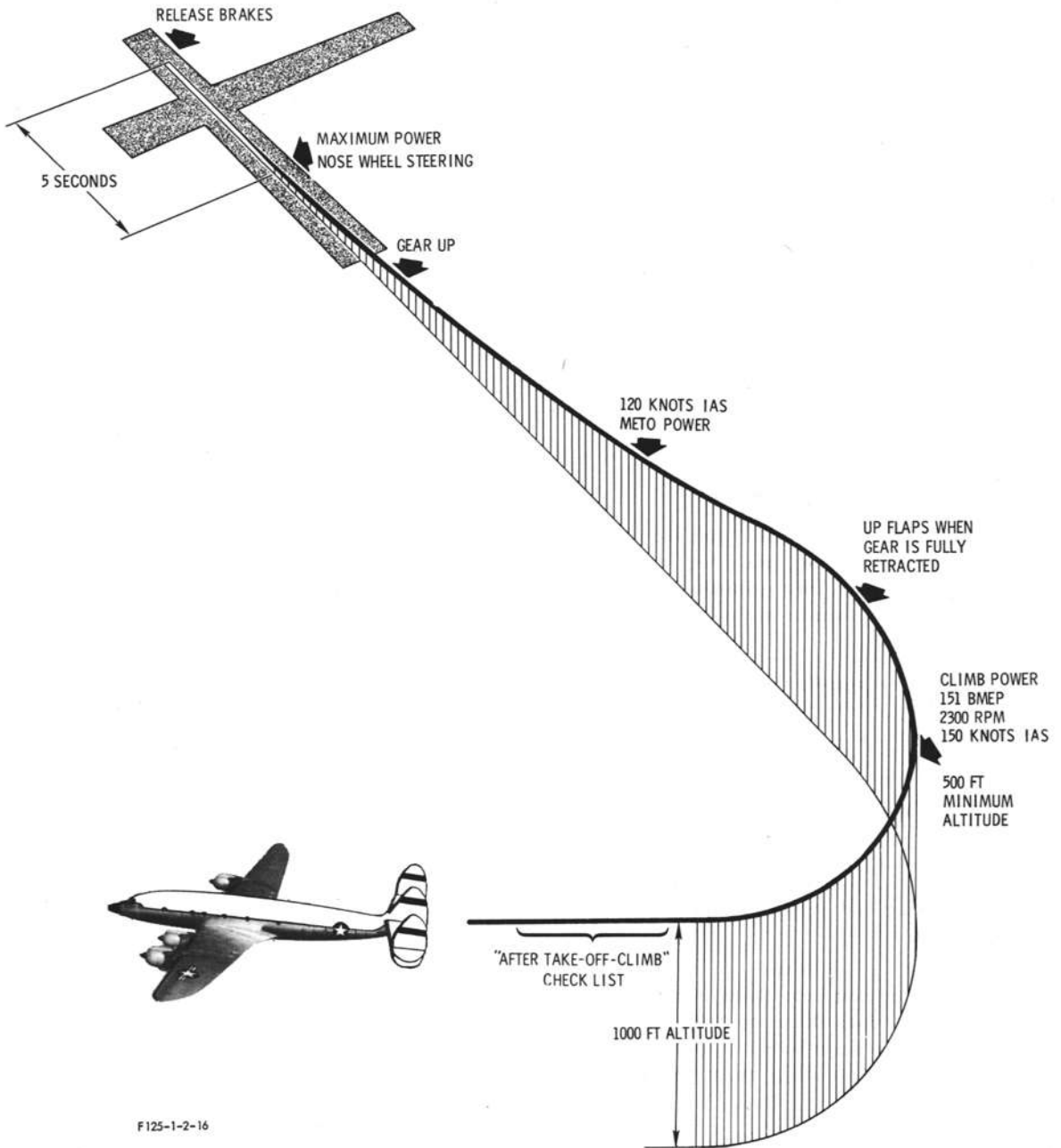

Figure 2-3

AFTER TAKE-OFF/CLIMB

(CONTINUED)

Pilots

2. Power—METO POWER.
3. Wing flap lever—UP (at 130 knots after gear is retracted).
4. Landing lights—RETRACTED AND OFF.

Check for downward deflection of beam as lights are retracted. An unretracted light will cause damage to trailing edge of aileron. After retraction return switches of OFF (neutral).

CAUTION

For maximum allowable speed for lights extended refer to OPERATING LIMITATIONS, Section V.

5. Power—CLIMB POWER.
6. Landing gear lever—NEUTRAL.
Return lever to NEUTRAL after red light is out. In NEUTRAL position gear is held up by mechanical up-locks. Hydraulic pressure to the actuating and uplock cylinders is relieved to prevent leakage from the system.
7. Flight control auxiliary booster switches—OFF.
8. Wing scan—COMPLETED.
9. No smoking and seat belt light switch—AS REQUIRED.

Note

Smoking and seat belts lights may be turned off at the pilot's discretion. The pilots' and flight engineer's seat belts will remain fastened at all times during flight when these seats are occupied.

10. Engineer's after take-off/climb checklist—COMPLETED.

Flight Engineer

1. Power—METO POWER (at pilot's command).
2. Pressurization—SET.
Close auxiliary vent knob, toggle aux. vent override switch to closed position, set cabin altitude selector to desired altitude.

3. Power—CLIMB POWER (at pilot's command).
Climb power: low blower—2300 RPM—151 BMEP.
high blower —2300 RPM—145 BMEP.
4. Auxiliary fuel pump switches—LOW.
Auxiliary fuel pumps to remain on LOW during remainder of flight (unless HIGH is required).
5. Cowl flap switches—AS REQUIRED.
6. Pressures and temperatures—NORMAL.
7. Emergency cabin lights—OFF.
8. APU—OFF.
Return voltage selector to BUS position.
9. Wing scan—COMPLETED.

10. Engineer's after take-off/climb checklist—COMPLETED.

Refer to Section VII for additional information regarding operation of the various systems. Refer to Appendix I for cruise control information.

ENGINE SUPERCHARGER SHIFT PROCEDURE DURING CLIMB.

If a climb is to be made to a high cruising altitude and an engine supercharger shift is required to maintain adequate climb power the engineer will advise pilot: **READY TO SHIFT TO HIGH BLOWER.**

The pilot states: **SHIFT TO HIGH BLOWER.**

The passengers shall be forewarned before shifting from low to high blower.

The engineer executes shift as follows:

- a. Reduce manifold pressure to 20 in. Hg.
- b. Reduce engine speed to 1600 rpm.
- c. Shift supercharger lever to HIGH position. (Make all shifts as smoothly and rapidly as possible.)
- d. After manifold pressure increases, indicating the shift has been made, reset throttles and propellers to obtain the required climb power.
- e. Advise pilot: **CLIMB POWER SET IN HIGH BLOWER.**

Note

The shift to HIGH position during climb-cruise power should be made at the altitude at which the low-blower, full-throttle BMEP has decreased to the high-blower, part-throttle BMEP value.

WARNING

Do not exceed low blower limits (See appendix I) and do not make more than two shifts within a five minute interval or the engine may be damaged. A shift from high to low blower may be done at any engine speed.

LEVEL-OFF PROCEDURE.

Upon reaching cruising altitude, the pilot insures that the pressure altimeter is properly set, levels the aircraft off and allows airspeed to increase to desired cruise speed. When this speed is attained, he calls for **CRUISE POWER.**

The flight engineer acknowledges: **CRUISE POWER**, closes the cowl flaps and oil cooler flaps to the desired position and proceeds with the manual lean procedure. Refer to Section VII.

Reset cowl flaps to retain the desired cylinder head temperature. Reset the oil cooler flaps to retain the desired **OIL IN** temperature. Shift fuel tanks and/or crossfeed as necessary, in accordance with proposed usage.

Note

Minimum in-flight **OIL-IN** temperature for continuous operation is 70° C. The desired oil temperature for all flight operation is 80-85° C. The maximum safe **OIL-IN** temperature is 104° C. The engine should be feathered if a sudden or uncontrollable rise in oil temperature occurs.

CRUISE CHECKS.**STEP AND OPTIMUM CG IN RELATION TO CRUISING AIR SPEED.**

Many pilots and flight engineers believe that CG location has a marked effect on cruising air speed. Some also seem to believe that an aft reading on the inclinometer indicates an aft CG location, and that this has an adverse effect on air speed. These ideas are incorrect. During level flight the inclinometer indicates angle of attack; this in turn is directly related to airspeed. If the airspeed is slow for the gross weight, the ball in the inclinometer will be towards the rear regardless of CG location. The only CG indicator is the elevator trim tab when the aircraft is trimmed up in cruising flight. If the inclinometer reads more than four degrees aft after cruising power is set, the flight engineer should recheck his gross weight, density altitude, and power setting and stop worrying about CG location. In the interest of passenger comfort, passenger movement in the main cabin should not be restricted except during turbulent flight conditions, take-offs, landings and emergencies.

FLIGHT CHARACTERISTICS.

Refer to Section VI for flight characteristics.

CRUISE

Pilots

Flight Engineer

The pilot acknowledges: CRUISE CHECK LIST COMPLETED.

After the aircraft is established in the cruise configuration, proceed aft and inspect the cabin for security of passengers and cargo and/or comfort of passengers.

1. Cruise power — SET.
2. Cowl flap switches — SET.
3. Oil cooler flap switches — SET.
Set flaps for desired oil temperature, then place switches in the OFF position to prevent the oil cooler flaps motor from continually hunting.
4. Mixture levers — 10% LEAN.
Manually lean the engines. Refer to Section VII.
5. Fuel tank selector levers — AS DESIRED.
Shift fuel tanks and/or crossfeeds as necessary in accordance with recommended usage outlined in Section VII.
6. Air conditioning panel — SET.
Pressurization checked, heaters as required.
7. Engineer's cruise checklist (notify pilot)—CRUISE CHECKLIST COMPLETED.

INITIAL DESCENT PROCEDURE.

Note

Before initial descent, the engineer should give the engines a thorough analyzer check and enter any pertinent findings in the discrepancy section of Form 781.

Refer to charts in Appendix I for optimum descent.

CAUTION

Turbulence, structural icing, and carburetor icing must be considered in descent; refer to Sections V and VII.

Prior to starting descent, pilot states: STARTING DESCENT TO _____ FEET, and states power desired. Engineer acknowledges: DESCENDING TO ___ FEET.

Adjust pressurization controls to insure a comfortable rate of depressurization (usually 300 feet per minute) so that cabin altitude will reach 1,000 to 1,500 feet above the pressure altitude of the field by the time the aircraft reaches that level.

Adjust cowl and oil cooler flaps to maintain desired temperatures.

A cruising descent normally is desirable on line flights when descending from cruising altitude to a lower altitude preliminary to an approach at destination. During these descents the last cruising rpm may be used. The pilot should plan his descent a sufficient distance from destination so as to reach desired altitude at the proper time. If a fixed manual lean setting is used during a prolonged descent, the mixture may tend to get slightly leaner as the aircraft descends. Consequently, if an attempt is made to level off and apply cruise power after a long descent, without resetting the mixture, there may be some slight engine instability due to leanness. This is easily remedied by resetting the mixture. Fuel injection engines will not backfire when the mixture gets lean. If power is reduced in the descent while retaining the fixed manual lean position that was used for cruise power, very little change in mixture strength will occur during the descent.

Note

During normal descent a minimum of 100 BMEP should be maintained. If this is not practical, a good rule of thumb procedure is to

maintain one inch of manifold pressure for each 100 rpm. This does not apply during final approach for landing.

As power is reduced, observe fuel flow in order to determine average consumption during descent.

Note

If HIGH blower has been used, the shift to LOW blower should be made prior to descending below 10,000 feet.

Proceed to desired air speed and rate of descent. The flight engineer retards the throttles as necessary to prevent over-boosting. If the pilot desires to take control in the cockpit, he calls for: PILOT'S THROTTLES.

Note

Notify the flight attendant of the ETA and issue instructions to awaken and secure passengers, and police the aircraft. The flight attendant will report immediately any discomfort or acute reaction shown by passengers while changing cabin altitude.

Prior to entering the traffic pattern, slow the aircraft to desired speed. (See Section IX for use of checklist during instrument approach.)

DESCENT

Pilots

Calls for: DESCENT CHECKLIST.

Normally the descent checklist will be accomplished immediately prior to entering downwind leg; or, in the event of an instrument approach immediately after passing high cone or high cone altitude, whichever comes later.

1. Altimeter setting—SET (P, CP).
2. RPM — AS DESIRED.

3. Brake selector lever—EMERGENCY CHECKED, SELECTOR NORMAL.
Depress toe pedals to assure pressure in each position.

4. Emergency brake pressure (1500 - 1700 PSI) — CHECKED (CP).

Flight Engineer

Acknowledges: DESCENT CHECKLIST.

1. Fuel tank selector levers — ON MAINS.
2. Fuel crossfeed levers — OFF.
3. Engine supercharger levers—AS REQUIRED.
Shift from high to low at 10,000 feet altitude.

Acknowledges: RPM _____ and sets the propeller controls as the pilot directs.

Note

If nature of flying conditions in descent requires a large reduction in power, reduce rpm as well as manifold pressure. For descents or other low power maneuvers, or perhaps a simulated engine failure, it is important to cushion the high inertia loads on the master rod bearings which occur at conditions of high rpm and low manifold pressure. As a rule of thumb, it is well to remember that each hundred rpm requires at least 1 inch Hg. manifold pressure. Operation at high rpm and low manifold pressure should be kept to a minimum.

4. Oil cooler flap switches — AUTOMATIC.

Note

If the brake system is checked in accordance with this procedure, a potential brake failure may be detected, and the necessary emergency action taken. The Brake check is made on the DESCENT checklist rather than during the BEFORE LANDING checklist to permit greater pilot vigilance outside the cockpit. Although there is a possibility of a brake line developing a leak or breaking as the gear comes down, it is felt that this slight possibility can be easily coped with by shifting the EMER. during the landing roll, and thus, does not warrant the greater hazard of a pilot distraction occasioned by a brake check after the gear is down.

5. Cabin altitude — SET FOR LANDING.

Set at 500 feet above field elevation. Depressurize cabin with auxiliary exit valve prior to ground contact. Move auxiliary vent knob to position A.

DESCENT

(CONTINUED)

Pilots

5. De-icer and anti-icer switches—AS REQUIRED (CP).
6. Windshield defogging switches—AS DESIRED.
Infra-red defogger and cockpit blower with heat may be used.
7. Radio altimeter—SET.



The AN/APN-1 and SCR-718 radio altimeters unreliable in areas covered by large depths of snow and ice such as encountered over polar regions. An apparent terrain clearance 1600 feet greater than actual clearance has been recorded. Do not rely on your APN-1 or SCR-718 radio equipment to provide terrain clearance when flying over areas covered by a large depth of snow and ice.

8. Autopilot servo disconnect levers—OFF.
9. Flight path control cover—REMOVED.
10. No smoking and seat belt light switches—AS REQUIRED.
11. Wing flap lever—AS REQUIRED.
Check dual flap indicator for synchronization.
Takeoff (60%)—150 Recommended
170 Maximum

12. Landing weight, CG and speeds—
POUNDS % MAC KNOTS.
After the flight engineer computes the landing gross weight and CG, determine the minimum approach and flare out speeds. Refer to Appendix I.
13. Crew briefing—COMPLETED.
Pilot should brief crew on type of approach, go around procedure, use of reverse thrust, minimums for approach being used, field elevation or any unusual conditions that may exist.

14. Engineer's descent checklist—COMPLETED.

RAPID DESCENT PROCEDURE.

There are two procedures for rapid descent; one with the aircraft clean and the other with the gear and flaps down. For discussion, these will be known as procedure A and procedure B, respectively.

PROCEDURE A.

- a. Gear—UP.

Flight Engineer

6. Emergency cabin lights—AS REQUIRED.
7. De-icer and anti-icer switches—AS REQUIRED.

8. Landing weight and CG— POUNDS
 % MAC.
After the cruise section of the engineer's log has been closed out, he computes the landing weight and CG.

9. Engineer's descent checklist—COMPLETED.

PROCEDURE B.

- a. Gear—DOWN.
- b. Wing flaps—LANDING POSITION.
- c. Propellers—2400 RPM.
- d. Throttles—CLOSED.
- e. Airspeed—122 KNOTS.
- f. Mixtures—RICH.

- b. Wing flaps - UP
 - c. Propellers AS REQUIRED.
 - d. Throttles AS REQUIRED.
 - e. Mixtures AS REQUIRED.
- Procedure A will be used mainly when a high airspeed is needed to cover a long distance from start of letdown

to the point of intended landing. Caution should be used to govern airspeed so that penetration speed is not exceeded during turbulent conditions. Procedure B is used when the distance from start of letdown to the point of landing is short and when landing is to be effected immediately. Maximum rpm provides maximum propeller drag; however, high rpm should not be used during training.

BEFORE LANDING

Pilots

Flight Engineer

After the wing flaps have been extended to the take-off (60%) position, and the downwind portion of the traffic pattern entered, the aircraft should be slowed to 150 knots. Maintain 150 knots for level flight in the traffic pattern.

When the pilot desires to handle the power, he states: PILOT'S THROTTLES.

Turning base leg, calls for: BEFORE LANDING CHECKLIST.

1. RPM — 2400.

Insure that throttles are open to at least 25" MAP so that the flight engineer can get a governed rpm. Call for: 2400 RPM.

Note

- For normal landing 2400 RPM is adequate. RPM should be increased under abnormal conditions. Refer to Section III.
 - A sample landing and approach pattern is shown in figure 2-4.
2. Landing gear lever—DOWN (P, CP).
Maximum speed for lowering gear or while extended is 145 knots. Check three green lights and secondary pressure up.

Note

The nose gear steering wheel turns through more than 360 degrees to obtain full deflection of the nose gear. Therefore, it is possible for the steering wheel in the flight station to appear to be centered for landing when the nose gear is actually turned approximately 50 degrees from forward. This condition will occur only in cases of malfunction since the nose wheel is automatically centered when the strut is extended and there is no torque on the steering wheel. If, however, there is any doubt about the position of the nose wheel, a thorough check may be made as follows after the gear has been extended:

Acknowledges: BEFORE LANDING CHECKLIST.

1. Mixture levers - AUTO-RICH.

BEFORE LANDING

(CONTINUED)

Pilots

- a. Turn the steering wheel to the left position and release.
- b. Turn to the full right position and release.
- c. If the proper centering action does not occur, locate the center as being half-way between the full left and full right positions and hold the wheel in the centered position during landing. Hold the nose wheel off the ground as long as possible after landing.

3. Flight control auxiliary booster switches — ON.
Check amber lights on.

Flight Engineer

2. Auxiliary fuel pump switches — HIGH.

③ RPM — 2400.

4. Carburetor air switches — COLD.

Normally, the carburetor air switches should be in the COLD position. However, if icing conditions are present on the final approach apply heat as required. Do not exceed 38° C CAT when heat is applied.

CAUTION

Sudden removal of carburetor heat may dislodge ice from in front of preheat door. This could cause a dangerous loss of power at low altitude. In the event of a go-around, carburetor air temperature should be monitored so as not to exceed 38° C.

5. Cowl flaps - SET
6. Oil cooler flap switches - AUTOMATIC.
7. APU — ON.
8. Cabin heater and fan switches - OFF.
9. Pressurization — DEPRESSURIZE.
Depressurize by means of the aux. vent override switch. Then when the differential is almost zero, crack the aux. vent to position A.

BEFORE LANDING

(CONTINUED)

Pilots

- ④. Engineer's before landing checklist — COMPLETED.

After touchdown, reverse as necessary.

Flight Engineer

- ⑩. Engineer's before landing checklist — COMPLETED.

Prior to touchdown, recirculating and flight station fans OFF. Turn auxiliary vent knob to position A to prevent dust and fumes from entering cabin when reverse power is applied.

After touchdown, monitor reversing and when it is evident that the landing will be completed as indicated by the completion of reversing or braking, move propeller synchronizer to 2800, open the cowl flaps, set the oil cooler flaps, and turn auxiliary fuel pump switches OFF. Then turn recirculating flight station fans ON and turn auxiliary vent knob to desired position.

LANDING TECHNIQUE AND PROCEDURE.

(Refer to figure 2-4.)

Before landing the pilot should assure that all passengers and crew are in their seats with safety belts secured. Shoulder harnesses should be worn if unusual conditions make it advisable.

During gusty wind conditions, increase the normal approach air speed by 10 knots.

The touchdown should be made in a slightly nose high attitude at not below 1.1 times the stall speed in the landing configuration (refer to Appendix I). After touchdown, retard all power and ease the nose wheel to the runway as soon as possible without allowing it to hit too hard. When the nose wheel touches, inform the copilot: You have the yoke, and place left hand on the nose wheel steering wheel. (Remember that the rudder is a more effective means of directional control than nose wheel steering at speeds above seventy knots. Premature reliance on nose wheel steering may only

cause it to skip sideways.) The copilot will monitor the reversing flag in.

Note

The reverse throttle lock will rarely release immediately after touchdown, therefore the flag must be depressed to allow immediate reversing.

Reversing is most effective at speeds above eighty knots and should therefore, be initiated as soon as possible after the nose wheel touches. Pull the reversing throttles on for a small amount of power, then apply power evenly and positively. Don't be too slow in applying reverse power; an engine may die. Under normal circumstances, applying reverse power at about 2000 rpm should be sufficient. 1200 to 1500 rpm will give approximately sixty percent of full braking effectiveness provided the power is applied at relatively high ground speed. When the aircraft has slowed to approximately forty-five (45) knots, take the throttles out of reverse so as to have all propellers back in positive pitch at

landing pattern

(TYPICAL FOR GROSS WEIGHT OF 84,500 LBS.)
SEE PERFORMANCE DATA FOR OTHER WEIGHTS,
CONDITIONS, AND RECOMMENDED APPROACH SPEEDS.

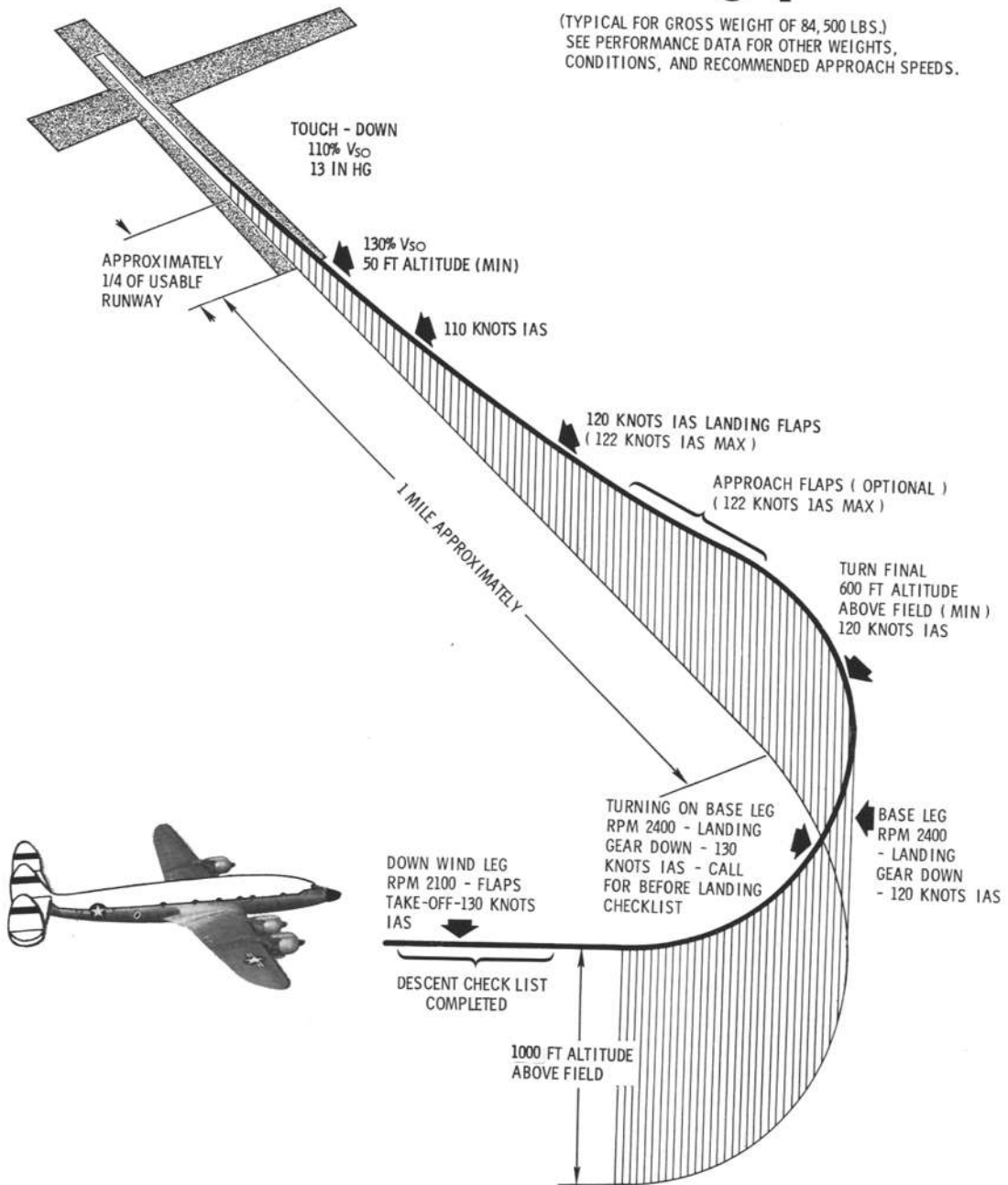

F125-C1-2-17

Figure 2-4

lower speeds to prevent overheating. Should circumstances require it, full reversing throttle may be utilized.

CAUTION

Continued use of reverse pitch may have detrimental effects on engine cooling as well as causing damage to the propellers and other parts of the airplane due to loose gravel, etc., which may be present on the runway.

WARNING

- If a propeller fails to go into reverse, forward thrust will be applied when the reverse throttle is pulled back.
- If the APU is not used the flight control auxiliary boosters should be turned off as soon as possible after touchdown to reduce the electrical load.

CROSSWIND LANDINGS.

Except in an emergency, thirty knots is the maximum allowable perpendicular wind component. In making crosswind landings, the following variables must be taken into consideration:

- a. Velocity of the wind.
- b. Condition and length of the runway.
- c. Wind component.
- d. Gustiness of the wind.

The three approved methods of making crosswind approaches are:

- a. Lower the upwind wing.
- b. Crab into the wind.
- c. Combinations of the first two methods.

Landings in crosswind conditions require careful attention and skillful handling on the part of the pilot. Make the approach slightly longer and lower than usual. This will aid in establishing a definite ground track in line with the runway center line. Keep a safe margin of speed. Extend wing flaps as desired. In strong or gusty crosswinds it may be desirable to use less than 100 percent flaps. Remove crab just before contact with the runway. Pilots must be careful not to overcontrol on the rudder when straightening out from the heading used to correct for drift. It is preferable to set the aircraft down on the upwind gear rather than allowing it to strike the runway in a crab. Place the nose wheel on and exert forward pressure on the yoke. Keep sufficient aileron rolled in to hold the upwind wing down. If gusty winds are encountered, 2400 rpm tends to stabilize the aircraft.

Note

The high angle dihedral in the wing exposes the windward wing to lifting which imposes the possibility of dragging the opposite wing. Prior to landing, the copilot should be briefed on holding the ailerons during the roll out so that the upwind wing will not be lifted by the wind. Flaps should be raised as soon as the wheels are on the ground.

Refer to Appendix I for crosswind components.

SHORT FIELD LANDINGS.

The following procedure shall be used for short field landings:

- a. The approach airspeed will be 1.3 times the stalling speed of the aircraft.
- b. Make a lower approach than normal with power on (minimum of 2400 rpm) and 100% flaps.
- c. Aim for a spot slightly short of the runway, so that the flare out will carry the aircraft over the end of the runway. This will result in a point of touchdown in the first available part of the runway instead of the first third part as in a normal landing.
- d. Get the nose wheel on the runway and reverse as soon as possible.
- e. To obtain maximum braking, first apply reverse thrust (this increases weight on the wheels), then apply brakes by first partly depressing the brake

pedals, then gradually increasing braking pressure up to the maximum possible without sliding tires.

- f. For minimum landing distance over a fifty foot obstacle, refer to Appendix I.

LANDING ON SLIPPERY RUNWAYS.

When other than dry conditions exist on active runways, base operation officers are responsible for determining and relaying to the base weather station the type of runway covering and the relative slickness of the runway as determined by the James brake decelerometer. This information will be transmitted as part of the teletype weather sequence. The relative slickness of the runway is determined as outlined in T.O. 33-1-23. This number will either be a one or two digit number and is referred to as the runway condition reading. This number will be followed by the letter "P" if the runway is patchy. A report of SLR14P would indicate slush on the runway, RCR of 14, and patchy conditions.

Explanation of Terms

RCR	Runway condition reading
P	Patchy
WR	Wet runway
SLR	Slush on runway
LSR	Loose snow on runway
PSR	Packed snow on runway
IR	Ice on runway

Instructions:

- a. Using the latest reported RCR, determine the stopping distance factor.
- b. Multiply the dry runway roll by the stopping distance factor to determine the ground roll on the slippery runway.

Note

If no RCR is available, use 12 for wet runways and 5 for icy runways.

Wet Runway.

When landing on wet runways, apply the brakes lightly and intermittently during the initial phase of the landing run. After most of the weight is on the landing gear, more braking pressure may be used, but the applications must continue to be intermittent. Flaps shall be raised

as soon as the wheels are definitely on the ground. It should be remembered that braking efficiency increases as greater weight is put on the wheels. Also, as the weight increases the tires tend to flatten out and force the water out from under them, greatly increasing their traction. The copilot shall note the hydraulic system and brake accumulator gage readings immediately after the first brake application on landing and be prepared to operate the hand pump immediately for brake pressure in the event of loss of braking action. In the event of loss of braking or of secondary system pressure or fluid, the brake selector lever should immediately be placed to EMER so the accumulator pressure can be utilized. Additional pressure should be supplied with the hand pump. The auxiliary control boosters should be turned OFF as soon as possible after touchdown to reduce the electrical load.

Snow Covered Runways.

Since brakes are relatively ineffective on slippery runways, it is recommended that reverse thrust be used during landing under such conditions. Differential reverse thrust can be used to advantage on slippery runways, or in emergency conditions such as failure of the hydraulic system, or other situations in which nose wheel steering may not be available.

Note

If loose snow is present on the airport, the use of high power in reverse pitch at low speed will result in a cloud of snow ahead of the aircraft, tending to obscure the pilot's vision. High power should be used in reverse pitch only while the aircraft speed is above 50 knots.

In order to avoid damage to the wing trailing edge and the flap retraction mechanism, it is recommended that after landing on snow or slush covered runways, the wing flaps should not be retracted beyond the 30% extended position before arriving at the ramp and shutting down the engines. This setting places the flaps in a position sufficiently high to protect them from flying debris and affords adequate clearance in the wing flap well so that damage due to accumulation of snow or slush will be avoided.

OVERGROSS LANDING PROCEDURES.

Refer to landing roll distance charts in the appendix and fuel dumping procedure in Section III.

GO AROUND.

The go-around procedure with four engines operating and control boosters ON is outlined as follows:

- a. Request power as desired — (MAXIMUM or METO POWER. Lower power may be used if applicable.)
- b. Wing flaps — TAKE-OFF (60%) POSITION.

Note

The purpose of retracting the wing flaps to the 60% position before raising the landing gear is to reduce the drag which is greater when the wing flaps are extended beyond the 60% position.

- c. Landing gear — UP (after flaps are at 60% position).

Note

If obstacle clearance is required, maintain take-off speed (1.15 of the zero thrust stall speed) for above configuration during initial climb out.

- d. Cowl flap switches — SET.
- e. Oil cooler flap switches — SET.
- f. Proceed as outlined in normal take-off procedure.

TOUCH AND GO PROCEDURES.

- a. The landing approach will be continued as if a full stop landing were to be made. After touchdown, the nose wheel will be lowered to the runway in the normal manner. Call: FLAPS TAKE-OFF. The copilot places the wing flap selector handle in the TAKE-OFF position.
- b. Trim tab neutral.
- c. Advance the throttles as soon as flaps start retracting, and set METO POWER OR MAX. POWER.
- d. Continue with normal take-off and climb procedures, unless an emergency is simulated; refer to Section III.

AFTER LANDING**Pilots**

After turning off the runway, call for: AFTER LANDING CHECKLIST.

1. Wing flap lever—UP (CP).

Note

Operation of wing flaps at low rpm may tend to starve nose steering when turns are made.

CAUTION

When landing on gravel runways, it is possible for rocks and gravel to be carried into the wing flap well where they may jam the flap mechanism upon retraction. Under these conditions, the flaps should be left in whatever position used for landings until the flap tracks and chains can be inspected and cleaned if necessary.

2. Flight control auxiliary booster switches — OFF (CP).
3. Pitot heater switches —OFF (CP).
4. Antenna mast de-icer switch —OFF (CP).
Mast de-icer is inoperative on the ground because of the action of a microswitch on landing gear shock strut.
5. Radios and lights— AS REQUIRED.
After final landing all unnecessary radio equipment, lights and switches may be turned off to conserve electrical power.
6. IFF —OFF.
Turn IFF OFF as soon after landing as possible. This will eliminate signals from taxiing or parked aircraft, which would otherwise block the controller's scope and interfere with the control of airborne aircraft.
7. Anti-collision lights —OFF (P).
8. Out of reverse check — COMPLETED.
9. Engineer's after landing checklist —COMPLETED.

If practicable, start scavenging prior to reaching the blocks.

Approaching the line, move the brake selector handle to the EMERGENCY position.

Flight Engineer

Acknowledges: AFTER LANDING CHECKLIST.

1. Auxiliary fuel pump switches — OFF. (Check engine fuel pressure when fuel pumps are off.)
2. Cowl flap switches - 100% OPEN.
3. Oil cooler flap switches - - 100% OPEN.
4. Propeller synchronizer lever - - 2800 RPM.
Set take-off rpm for ground operation or immediate take-off.
5. Ignition analyzer — OFF.

6. Out of reverse check — COMPLETED.
Bring the throttles up to around, 1000 rpm, put the props into manual decrease and check drop in rpm, then put into manual increase.
7. Emergency cabin lights switch - OFF.
8. Engineer's after landing checklist—COMPLETED

To scavenge:

In order to insure a maximum of engine oil scavenging and a minimum of residual oil which can lead to liquid lock, plug fouling, and smoky starts, it is recommended that the engine be operated below 1000 rpm for a minimum period of 30 seconds before shut-down.

AFTER LANDING (CONTINUED)

Pilots

Note

The brakes should be shifted to the EMERGENCY position just before entering congested areas.

CAUTION

Avoid taxiing for extended periods of time in the EMER. BRAKES position or operating the wing flaps while in that position. It is possible to deplete available emergency system pressure and in the event of a secondary hydraulic failure be without brakes.

After the aircraft is stopped in the parking spot with the brakes set on EMER., the pilot will state: ENGINEER'S THROTTLES - CUT ENGINES WHEN READY.

Flight Engineer

Acknowledges: ENGINEER'S THROTTLES.

This authorizes the engineer to complete any scavenging that remains to be done and cut the engines.

POST-FLIGHT.

Following the final flight of the day before engine shut-down, perform the following checks for the purpose of determining and reporting any malfunctioning system or unit. These checks should be made with the aircraft headed into the wind.

a. Idle mixture — CHECKED.

Perform the idle mixture check as follows:

- (1) Master rpm control lever—FULL INCREASE RPM.
- (2) Cylinder head temperature — NORMAL.
- (3) Oil temperature — NORMAL.
- (4) Mixture lever — AUTO-RICH.
- (5) Throttle lever — move to obtain IDLE RPM.
- (6) Mixture lever — move SLOWLY and evenly toward OFF.

Note

SLOWLY may be defined as the rate of movement which would require 12 to 15 seconds to move the mixture lever from AUTO-RICH to

OFF position. This slow movement of the lever is necessary so that the engine can respond to the change in fuel-air ratio and an accurate reading can be obtained as the BEST POWER mixture is reached.

- (7) If a rise of more than 10 rpm or a drop in manifold pressure exceeding $\frac{1}{4}$ inch Hg. is noted, the idle rpm mixture fuel/air ratio is too rich. After maximum rise has been obtained and rpm starts to decrease with further movement of the mixture lever, return the mixture lever to AUTO-RICH. If no rise in rpm occurs, the mixture may be at Best Power which is desired, or it may be too lean. Momentary operation of the primer solenoid will determine if the mixture is too lean. A rise in rpm will then indicate a Best Power ratio.

b. Equipment and power plant — CHECK.

If conditions warrant, check engines as outlined in ENGINE RUN-UP paragraph in this Section.

BEFORE LEAVING AIRCRAFT

Pilots

Call for: BEFORE LEAVING AIRCRAFT CHECK LIST.

1. Brake selector lever — EMER.

Flight Engineer

Acknowledges: BEFORE LEAVING AIRCRAFT CHECKLIST.

1. Mixture levers — OFF.

Do not shut-down engines with high cylinder head temperature.

BEFORE LEAVING AIRCRAFT

(CONTINUED)

Pilots**CAUTION**

Never move brake selector lever while the toe pedals are depressed or while the parking brakes are engaged.

2. Parking brake—SET.
Check accumulator pressure and warning light.
3. Ignition switches — OFF (after engines have stopped turning).
4. Radio switches — OFF.
Insure that master radio power switches are OFF.
5. IFF—CODES REMOVED.
If classified codes have been inserted, they must be removed or properly protected.
6. Unnecessary lights and switches — OFF.
7. Brakes (after chocks are in place) — OFF.

8. Engineer's before leaving aircraft checklist — COMPLETED.

Flight Engineer

2. Ignition switches — OFF.
3. Generator switches — OFF.
4. Inverter switch — OFF.
5. IFS and autopilot gyro switches—OFF.
6. Radio inverter and power switches — OFF.
7. Propeller synchronizer lever—2800 RPM and OFF.
8. BMEP heater line switches — OFF.
9. Cowl flap switches—OFF.
10. Oil cooler flap switches — OFF.
11. Propeller switches — FIXED PITCH.
12. Air conditioning — OFF.
All switches off and auxiliary ventilation knob to position A.
13. Galley Power circuit breaker — OFF.
14. Hot water heater switches — OFF.
15. Wash water pump switch — OFF.
16. APU — OFF.
17. Battery switch — OFF.
18. Unnecessary switches — OFF.
19. Chocks and gear pins — IN PLACE.
Toss landing gear pins and pitot covers out. Insure that wheel chocks and gear pins are installed.
20. Doors and windows — CLOSED.

21. Engineer's before leaving aircraft checklist — COMPLETED.

Note

Close crew doors and windows to prevent rain from entering the flight station. Rain water can cause malfunctioning in electrical circuits.

WARNING

There is some tendency for a hot fuel injection engine to fire when being pulled through with ignition switch OFF. Unfortunately, there are several cases on record where serious injury to ground crew has resulted from attempts to manually position a propeller following shut down of fuel injection engines. There is extreme hazard in this practice. The positioning of a propeller following shut down should be accomplished with engine starter only.

Leave the flight control booster levers on. This will dampen movement of the surfaces during wind gusts.

Do not close cowl flaps regardless of the weather until engines have cooled. Closing cowl flaps immediately after shut down may cause damage from excessive soak temperatures. If the engine is to be idle for an extended period of time or if dusty conditions exist, cover all openings after the engine has cooled.

BEFORE LEAVING AIRCRAFT

(CONTINUED)

Pilots

Flight Engineer

Make complete walkaround inspection of aircraft and enter any pertinent information in Form 781.

CAUTION

- In addition to established requirements for reporting any system defects, unusual and excessive operations, the flight crew will also make entries in Form 781 to indicate when any limits in the Flight Manual have been exceeded.
 - When use of military power is required for longer than 30 minutes, a notation must be made in the Form 781. (Military Power for reciprocating engine aircraft is the same as maximum (take-off) power, wet or dry, except that it is limited to 30 minutes duration instead of five minutes).
-

NOTE

The abbreviated normal check list for each crew member is now contained in the T. O. listed below:

Pilots	— T. O. 1C-121A-(CL)1-1
Flight Engineer	— T. O. 1C-121A-(CL)1-2
Navigator	— T. O. 1C-121A-(CL)1-3
Radio Operator	— T. O. 1C-121A-(CL)1-4
Flight Attendant	— T. O. 1C-121A-(CL)1-5

SECTION III

EMERGENCY PROCEDURES

TABLE OF CONTENTS

	<i>Page</i>		<i>Page</i>
ENGINE FAILURE	3-2	BAIL OUT	3-24
FLIGHT CHARACTERISTICS UNDER PARTIAL POWER CONDITIONS	3-2	EXPLOSIVE DECOMPRESSION	3-24A
ENGINE FAILURE UNDER SPECIFIC CONDITIONS	3-3	EMERGENCY DESCENT PROCEDURE	3-24A
ENGINE RESTART DURING FLIGHT	3-8	TAKE-OFF AND LANDING EMERGENCIES	3-24A
FUEL PRESSURE DROP	3-9	GROUND EVACUATION	3-30
LANDING WITH ONE OR MORE ENGINES INOPERATIVE	3-10	EMERGENCY ENTRANCE	3-31
GO-AROUND PROCEDURE	3-12	DITCHING AND SURVIVAL	3-31
PRACTICE MANEUVERS WITH ONE OR MORE ENGINES INOPERATIVE	3-12	Ditching Procedures	3-40
PROPELLER OVERSPEED	3-12A	EMERGENCY JETTISONING	3-45
FIRE	3-12B	ELECTRICAL POWER SYSTEM FAILURE	3-48
Engine Fire	3-12B	HYDRAULIC POWER SYSTEM FAILURE	3-49
Cabin Fire	3-13	FLIGHT CONTROL SYSTEM	3-50
Cargo Compartment Fire	3-16	WING FLAP MALFUNCTION	3-53
Cabin Heater Fire	3-19	LANDING GEAR SYSTEM MALFUNCTION	3-56
Brake Fire	3-19	EMERGENCY BRAKE OPERATION	3-58
APU Fire	3-21	HYDRAULIC ACCESS DOOR UNLATCHED IN FLIGHT	3-59
Electrical Fire	3-22	DISCONNECTING THE CABIN SUPER- CHARGER DRIVESHAFTS	3-59
Smoke Fume Elimination	3-23		

INTRODUCTION.

The various emergencies that may be encountered during take-off, flight and landing may each present a different problem; however, a complete knowledge of the procedures set forth in this section will enable a flight crew to better cope with these emergencies. After it has been determined that an emergency exists, communications should be immediately established with surface craft or stations so that the Air Rescue Service can be advised

of the flight progress. Accurate position reporting is essential.

Pilot and flight engineer procedures requiring a checklist are covered by dual checklists, one for the pilots and one for the flight engineer, unless the procedure requires action by only one or the other. The items marked with a circled numeral require coordination with the opposite party and his checklist. Items in **BOLD PRINT** will be accomplished prior to reading the checklist.

ENGINE FAILURE.

The corrective actions required after an engine failure occurs, consist of shutting down the failed engine, feathering the propeller, and then retrimming the aircraft to continue flight. The longer the delay between detection of a malfunction and the actual feathering, the more severe the damage will be.

Feather propeller and stop the engine when:

- a. An extreme or abnormal engine vibration occurs.
- b. An excessive or uncontrollable power loss occurs.
- c. A sudden or uncontrollable rise in oil temperature occurs.
- d. A sudden or uncontrollable drop in oil pressure occurs.
- e. A sudden and uncontrollable rise of cylinder head temperature occurs.
- f. A heavy discharge of oil emits from the engine breather or exhaust system.
- g. An engine fire occurs.
- h. Minimum fuel pressure cannot be maintained with the fuel pumps operating in the HIGH position.
- i. Any other condition warranting feathering.

In the event of extreme engine malfunctioning, it is possible for the Curtis Electric propeller, Model C634S-C460-830-26C4-0, to exceed the maximum allowable stress, unless the propeller is feathered or the engine rpm is restricted. When engine roughness or power loss indicates that two or more engine cylinders are inoperative (indicated by BMEP drop in excess of 1/18 of normal value for a given rpm and manifold pressure), the following is recommended.

- a. The engine be shut down and the propeller feathered.
- b. If continued engine operation is imperative, engine speeds of 1700, 2050 or 2600 rpm must be used.

Engine roughness may occur without indication of power loss, as would be the case with a damaged propeller. In such a case the propeller must be feathered without delay in order to avoid possible destructive failure of the propeller and/or engine.

FLIGHT CHARACTERISTICS UNDER PARTIAL POWER CONDITIONS.

Flight characteristics will change very little with the loss of either inboard engine and will not require the immediate use of trim. With the loss of either outboard engine, a definite yawing will take place which will require the use of trim.

Note

The minimum control speed in the air is 85 knots IAS, flush static system. (Minimum control speed is that speed required to provide sufficient control to enable the airplane to fly a straight flight path over the ground when an outboard engine has failed. This minimum control speed is based on take-off configuration, propeller on dead engine windmilling, maximum power on remaining three engines, wing flaps TAKE-OFF position, landing gear either retracted or extended, and no more than 5 degrees of bank angle away from the failed engine.)

SAFE ENGINE-OUT SPEED.

Configuration and Power	Three engine climb speed (Flush Static)	Rate of Climb
First Take-Off Segment—Max. Power	107 knots IAS (SL to 7950')	100'/min or better
Fourth Take-Off Segment—METO Power	107 knots IAS (SL to 13,000')	100'/min or better
Clean—METO Power	147 knots IAS (SL to 17,300')	100'/min or better

Refer to performance data in the Appendix for specific operating information.

Note

(The safe one-engine-out speed is that speed that will permit the airplane to maintain 100' / minute rate of climb after clean configuration has been established and the propeller on the inoperative engine is feathered.) The climb speeds in the table are based on standard day operation at 107,000 pound gross weight using the flush static system.

ENGINE FAILURE UNDER SPECIFIC CONDITIONS.**ENGINE FAILURE DURING TAKE-OFF.**

If engine failure occurs before airplane leaves the ground:

a. ABORT TAKE-OFF.

Refer to ABORT TAKE-OFF PROCEDURE under TAKE-OFF AND LANDING EMERGENCIES in this section.

— ENGINE FAILURE AND/OR FIRE DURING FLIGHT —**Pilots****Flight Engineer****Note**

Pilots and flight engineers should thoroughly familiarize themselves with the recommended fire extinguishing procedure. The procedure should be mastered so that the individual steps are carried out in quick succession (but not rushed) and the fire extinguished with a minimum of delay.

At the first indication or report of engine malfunction, failure or fire, advises the pilot of conditions. If applicable, states: FIRE IN NUMBER _____ ENGINE. RECOMMEND FEATHERING.

Depending upon conditions and the flight engineer's recommendation, states: FEATHER NO. _____ CO-PILOT'S POWER.

Direct copilot to adjust power as necessary on remaining engines.

Note

Gear and wing flaps should be set at pilot's discretion.

Acknowledges: FEATHERING NO. _____

* These steps may be omitted if fire is not evident.

1. Power — AS REQUIRED.**CAUTION**

If the emergency occurs while in cruise with mixtures in manual lean, it will be necessary for the copilot to request the engineer to place the mixtures in RICH before increasing power above maximum cruise power. When the mixtures are in rich the BMEP will increase approximately 18 and a serious overboost condition could exist unless the copilot either increases the rpm or decreases the MAP at this time.

ENGINE FAILURE AND/OR FIRE DURING FLIGHT

(CONTINUED)

Pilots

2. Landing Gear Lever—AS DESIRED.
3. Wing Flap Lever—AS DESIRED.
- * 4. Smoke Masks—ON & OXYGEN SET TO 100%.
5. EMERGENCY SHUT-OFF LEVER
ENGINE NO. ___ ___ (CP VERIFY) FULL OFF
(FE)
- * 6. CO₂—AS NECESSARY.

Flight Engineer

1. THROTTLE LEVER—CLOSED.
2. FEATHERING SWITCH—FEATHER.
3. MIXTURE LEVER—OFF.
4. EMERGENCY SHUT-OFF LEVER
ENGINE NO. ___ ___ (AT CP VERIFICATION)—
FULL OFF.
5. HYDRAULIC PUMP SUCTION SHUT-OFF SWITCH
—OFF.
- * 6. SMOKE MASK—ON & OXYGEN SET TO 100%.
- * 7. ENGINE FIRE SELECTOR—SET—ALL OTHER
FIRE SELECTORS OFF. ADVISE PILOT: CO₂ IS
REQUIRED OR NOT REQUIRED.
- * 8. CO₂ (Pull one handle at pilot's command)—
DISCHARGE.

WARNING

The second CO₂ charge must not be released until it is definitely determined that the initial charge has not smothered the fire and the check list has been completed.







9. Cowl Flap Switch—OPEN (if no fire—Faired).
Opening the cowl flaps in the case of an engine fire effects some cooling and minimizes flame damage to the nacelle.
10. Fuel tank selector levers (operating engines)—
ON MAINS.
11. Fuel tank selector lever (inoperative engine)—
OFF.
12. Auxiliary fuel pump switch (inoperative engine)—
OFF.
13. Oil cooler flap switch—OFF (after fire).
14. Fuel crossfeed levers—ALL OFF.
15. Anti-icer switches—OFF.
16. Cowl flaps—FAIRED (after fire).
17. Generator switch—OFF.

After fire out, if electrical system checked OK:

7. Ignition switch—OFF.

18. Propeller selector switch—FIXED.

engine fire and smoke

CAUSE	ACTION	
<p>SMOKE: OIL LEAKING ONTO EXHAUST STACKS AND VAPORIZING. NOT A DANGEROUS CONDITION PROVIDING OIL LEAK IS NOT EXCESSIVE. NO INSTRUMENT INDICATIONS EXCEPT FOR POSSIBLE DROP IN OIL QUANTITY.</p>	<p>NORMALLY, NO ACTION IS NECESSARY UNLESS FIRE DEVELOPS. IF FIRE OCCURS, FOLLOW EMERGENCY ENGINE FIRE PROCEDURE.</p>	 <p>THIN WISPS OF BLUISH-GREY SMOKE FROM EXHAUST AND COWL FLAP AREA</p>
<p>SMOKE: ON GROUND AT IDLING SPEEDS, INDICATES MIXTURE TOO RICH. IN FLIGHT, USUALLY AT HIGH POWER SETTINGS, THIS CAN OCCUR AND INDICATES TOO RICH MIXTURE. THERE WILL BE NO INSTRUMENT INDICATIONS.</p>	<p>ON GROUND, INCREASE THROTTLE. IN FLIGHT, LEAN MIXTURE ACCORDING TO THE APPROVED MANUAL LEANING PROCEDURE.</p>	 <p>GREY-BLACK SMOKE COMING FROM EXHAUST</p>
<p>SMOKE: DAMAGED OR WORN-OUT PISTON RINGS PERMITTING CYLINDER TO PUMP OIL. AT NIGHT, THIS CONDITION APPEARS AS FIRE, HOWEVER, IT IS ONLY HOT OIL BURNING IN EXHAUST STACK AND EXHAUST STREAM. NO INSTRUMENT INDICATION.</p>	<p>MONITOR CONDITION AND RECORD IN DD FORM 781</p>	 <p>BLACK SMOKE COMING FROM EXHAUST</p>
<p>SMOKE AND FIRE: FIRE CAUSED BY OIL LEAK IN ACCESSORY SECTION. FIRE DETECTOR LIGHTS FOR ZONE 2 AND 3 WILL COME ON IF FIRE OCCURS.</p>	<p>FOLLOW EMERGENCY ENGINE FIRE PROCEDURE.</p>	 <p>BLACK SMOKE COMING FROM ACCESSORY SECTION</p>
<p>SMOKE AND FIRE: FUEL FIRE IN ACCESSORY SECTION GENERALLY CAUSED BY BROKEN FUEL LINE. LOW FUEL PRESSURE MAY BE INDICATED. FIRE WARNING LIGHTS, ZONE 2 AND 3 WILL COME ON.</p>	<p>FOLLOW EMERGENCY ENGINE SHUT-DOWN PROCEDURE. PREPARE TO ABANDON AIRCRAFT IF FIRE DOES NOT GO OUT.</p>	 <p>BLACK SMOKE WITH ORANGE-YELLOW COMING FROM ACCESSORY SECTION</p>
<p>SMOKE AND FIRE: DETONATION, FOULED SPARK PLUGS OR FOULED FUEL INJECTION NOZZLE. IF DETONATION CONTINUES, ENGINE FAILURE MAY BE IMMINENT.</p>	<p>ENRICH MIXTURE. INCREASE COWL FLAP SETTING IF CHT IS HIGH. IF ENGINE CONTINUES TO BE ROUGH AND LOW ON POWER SHUT-DOWN ACCORDING TO APPROVED SHUT-DOWN PROCEDURE.</p>	 <p>BLUE-BLACK SMOKE WITH FLASHES OF ORANGE COMING FROM EXHAUST</p>

F125-C1-3-65

Figure 3-1

ENGINE FAILURE AND/OR FIRE DURING FLIGHT

(CONTINUED)

Pilots

Flight Engineer

8. Engineer's engine failure and or fire checklist COMPLETED.

19. Propeller feathering switch FEATHER.
20. Engine fire selector -- OFF.
21. Ignition switch — OFF.

22. Engineer's engine failure and or fire checklist COMPLETED.

Note

- When there is an engine failure on each side of the aircraft, it is not recommended that the hydraulic system crossover valve switch be moved to the EMERGENCY position until approaching the airport. This will preclude loss of the complete hydraulic system through a hydraulic leak while in cruising flight.
- If either No. 1 or No. 4 engine is feathered at high altitude, a close check on the cabin pressurization must be made. One cabin supercharger will usually hold the cabin altitude within normal limits; however, at any altitude above 17,000 feet, the cabin altitude will usually climb 1,000 to 2,000 feet higher than normal limits. If either or both the galley and radio sonic venturis are open, only approximately 4 inches of mercury differential pressure may be obtained.

FAILURE OF TWO ENGINES IN FLIGHT.

Because of the manner in which associated systems are integrated with different engines, the effects of losing various combinations of engines must be understood and anticipated. In all combinations of two engine failures, generator loading must be watched. If it is too high, shut off galley hot plates and other electrical equipment as may be required to keep loading within the range of available output. Refer to the performance information in Appendix I.

Note

At a gross weight of 85,000 pounds, the aircraft will climb to approximately 9,600 feet with two engines operating at METO power. If cruising at an altitude of 17,000 feet or above, the aircraft will maintain an altitude of 15,000 feet with METO power, provided the gross weight of the aircraft is less than 85,000 pounds.

Engines No. 1 and No. 4 Inoperative.

- a. Shut down the engines as described in ENGINE FAILURE OR FIRE IN FLIGHT.

- b. Descend to safe altitude, if necessary.

- c. When at a safe altitude, place the aux. vent knob in the OPEN position.

Note

- Engines No. 1 and No. 4 drive the cabin superchargers, therefore, without them pressurization is not available. It may be necessary to descend to a lower altitude.
- The hydraulic pump driven by engine No. 2 will supply hydraulic pressure to operate the flight control boosters. The hydraulic pump driven by engine No. 3 will supply hydraulic pressure to operate the aspirator, landing gear, wing flaps, brakes, tanks 2A and 3A fuel dump actuation, and nose wheel steering. The restriction control valve may slow the operation of the wing flaps and landing gear while giving priority to the other systems.

Engines No. 2 and No. 3 Inoperative.

- a. Shut down the engines as described in ENGINE FAILURE OR FIRE IN FLIGHT.

Note

- The vacuum systems for the de-icer will be inoperative. Turn the vacuum shut-off valve and the drift-meter vacuum shut-off valves to the OFF position to avoid back pressure through these lines, causing partial inflation of the boots. Operate the boots through one complete cycle. De-icer boots may still be operated. Avoid high air speeds during emergency descents.
- The hydraulic pump driven by engine No. 4 will supply hydraulic pressure to operate the aspirator, landing gear, wing flaps, brakes, tanks 2A and 3A fuel dump actuation, and nose wheel steering. (The restriction control valve may slow operation of the wing flaps and landing gear while giving priority to the other systems.)

The hydraulic pump driven by engine No. 1 will supply hydraulic pressure to operate the flight control boosters.

Engines No. 3 and No. 4 Inoperative.

- a. Shut down the engines as described in ENGINE FAILURE OR FIRE IN FLIGHT.
- b. Hydraulic system crossover switch — EMERGENCY.

CAUTION

Do not move the hydraulic system crossover switch to the EMERGENCY position until it has been determined that a complete loss of hydraulic pressure will not occur.

Note

With engines No. 3 and No. 4 inoperative, secondary system hydraulic pressure will not be available. Placing the hydraulic system crossover switch in the EMERGENCY position will allow the primary system to provide the secondary system with normal hydraulic pressure.

Engines No. 1 and No. 2 Inoperative.

- a. Shut down the engines as described in ENGINE FAILURE OR FIRE IN FLIGHT.
- b. Hydraulic system crossover switch — EMERGENCY position.

CAUTION

Do not move the hydraulic system crossover switch to the EMERGENCY position until it has been determined that a complete loss of hydraulic pressure will not occur.

Note

- With engines No. 1 and No. 2 inoperative, primary hydraulic system pressure for the flight control boosters will be supplied by the secondary hydraulic system through the electrically actuated hydraulic system crossover valve. Landing gear extension and wing flap operation may be slower than normal because the restriction control valve will give priority to the pressure requirements of the flight control boosters.
- With propellers No. 1 and No. 2 feathered, the aircraft may be trimmed for hands-off flight, using auxiliary flight control boosters, down to an IAS of 140 knots.

Engines No. 1 and No. 3 Inoperative, or Engines No. 2 and No. 4 Inoperative.

- a. Shut down the engines as described in ENGINE FAILURE OR FIRE IN FLIGHT.

Note

With these combinations of inoperative engines, hydraulic power will be available, but flow rates will be reduced. One air pressure and one vacuum pump in the wing and empennage de-icing system will be inoperative.

ENGINE RESTART DURING FLIGHT

Pilots

Flight Engineer

CAUTION

If propeller has been feathered because of a malfunction, do not attempt to unfeather propeller and restart engine unless a greater emergency exists.

Note

The ENGINE RESTART DURING FLIGHT checklist will be accomplished step by step as each item is read.

When the decision has been reached to unfeather and restart an engine, the pilot states: ENGINE RESTART DURING FLIGHT CHECKLIST.

Acknowledges: ENGINE RESTART DURING FLIGHT CHECKLIST.

1. Airspeed - 135 KNOTS MAXIMUM.

1. Propeller selector switch - FIXED position.
2. Propeller feathering switch - NORMAL position.
3. Oil cooler flap switch - AUTOMATIC position.
4. Cowl flaps - FAIRED.
5. Fuel tank selector lever - ON.
6. Auxiliary fuel pump switch for engine to be started - LOW.
7. Hydraulic pump suction shut-off switch - ON.
8. Emergency shut-off lever - OPEN.
9. Throttle lever - CLOSED.
10. Engine supercharger lever - LOW.
11. Mixture lever - OFF.
12. Ignition switch - OFF.
13. Engine fire extinguisher selector - SET; advise pilot: READY TO TURN PROPELLER.

2. Starter switch - TURN PROPELLER SIX BLADES.
After being advised by engineer ready to turn propeller.

14. Starter switch - TURN PROPELLER SIX BLADES, CHECKED FOR LIQUID LOCK.

Pilot turns ignition switch to BOTH.

15. Ignition switch - NO. BOTH.

ENGINE RESTART DURING FLIGHT

(CONTINUED)

*Pilots**Flight Engineer*

16. Propeller selector switch (Position intermittently until 800 rpm is reached)—INC RPM.

CAUTION

During unfeathering operation the propeller should be under observation by a crew member. If unfeathering an outboard propeller, cabin refrigerator OFF. Low rpm and high torque on supercharger drive can cause engine drive failure and subsequent engine failure. Broken parts will contaminate oil.

17. Mixture lever (at 800 rpm)—AUTO RICH.
 18. Generator switch—ON.
 19. Propeller selector switch—1200 to 1400 RPM.
 20. Throttle lever—SET 18 INCHES HG. MAP.
 Operate the engine at 1200 to 1400 rpm. When engine oil inlet temperature has risen to 6° C (11° F) above the unfeathering temperature, increase rpm and power to corresponding engines.
 21. Cowl flaps switch—SET.
 22. Oil cooler flap switch—SET.
 23. Engine fire extinguisher selector—OFF.
 24. Engineer's engine restart during flight checklist—COMPLETED.

3. Engineer's engine restart during flight checklist—COMPLETED.

FUEL PRESSURE DROP.**ENGINE OPERATING NORMALLY.****During Ground Operation.**

If fuel pressure drops below the operating limits during ground operation, but the engine continues to operate normally:

- Stop the aircraft.
- Set the fire extinguisher selector to the affected engine.
- Shut down engine IMMEDIATELY.
- DO NOT TAKE OFF.
- Investigate the cause and correct.

During Flight.

If fuel pressure drops below the operating limits during flight, but the engine continues to operate normally, the cause may be one or more of the following:

- Primer leakage.
- Oil dilution solenoid leakage.
- Engine-driven fuel pump bypass valve leakage.
- Clogged pressure line.
- Instrument failure.
- Line leakage.

Possible courses of action, depending on the cause of

the pressure drop, are as follows:

WARNING

Whenever fuel pressure drops and the engine continues operating normally, the first concern of the crew must be to guard against the outbreak of an engine fire. The greatest danger lies in the fact that the crew develops a false sense of security because no fire exists at the time the fuel pressure drops is noticed nor after several hours of flight. However, when the throttle lever is retarded (as in preparation for a landing), an engine fire develops and the results are usually disastrous. What has happened is that a fuel leak existed, but the cooling and dispersing effect of the airflow through the engine nacelle at cruising speed has prevented the start of a fire. When the throttle lever was retarded, the airspeed dropped and the airflow was reduced sufficiently to permit ignition of the leaking fuel. Any change in the airflow pattern, such as feathering the propeller or entering a climb, can start a fire if a fuel leak exists. Increasing the power is less likely to start a fire since airspeed will be increased, but even here there is a possibility of fire since the exhaust heat and flame pattern may change sufficiently to outweigh the increase in cooling airflow. Accordingly, it must be the objective of the crew to eliminate the fuel before any change is made to the airflow or exhaust pattern. The most effective means of accomplishing this is by moving the *MIXTURE LEVER TO OFF* before any throttle reduction, propeller feathering, or any other engine shut down procedure is initiated. An additional advantage of moving the *MIXTURE LEVER TO OFF* is that it provides the most rapid means of eliminating exhaust stack flames and reducing exhaust heat.

- a. *Shut down the engine immediately by means of the mixture lever. Do this if the power is not*

necessary to sustain flight or to reach a safe destination. Refer to *ENGINE FAILURE AND/OR FIRE* this section for shut down procedure.

- b. *Keep the affected engine in operation at or above cruising speed while maintaining watch for fire. This can be done if it cannot be determined whether or not an actual leak exists and the engine is required to either sustain flight or to maintain the required altitude for a safe arrival at destination. However, prior to power reduction for entrance to the landing pattern, shut down the affected engine completely (by means of the mixture lever—not by retarding the throttle lever) and accomplish a partial power landing. Unless the added power is absolutely essential to effect a safe landing, do not reduce airspeed until affected engine is shut down.*
- c. *Continue operating the engine normally. This may be done if it can be reasonably ascertained that the indicated fuel pressure drop has not resulted from a fuel leak.*

Note

All other factors being equal, course "a" is generally the best. However, action to be taken depends entirely upon the circumstances existing at the time. Such factors as the known condition of the airplane and the remaining engines, stage and requirements of the mission, and power requirements of the aircraft should all be considered.

LANDING WITH ONE OR MORE ENGINES INOPERATIVE.

Refer to Section V for limits imposed on the aircraft when landing with one or more engine inoperative.

Note

- The following notes and procedures are in

addition to the normal landing procedures. It is assumed that the landing area is within range and that the feathering procedure has been completed.

- On aircraft that have either propeller No. 1 or No. 2 feathered:
 - a. Hydraulic crossover switch — EMERGENCY position during preparation for landing.
 - b. All unnecessary electrical equipment switches — OFF. Turn off all unnecessary electrical equipment due to high amperage loads imposed on remaining generators.

Landing with only one engine inoperative will not seriously affect the normal flight characteristics of the aircraft. In this event the use of 2400 rpm is recommended. However, with engine No. 3 or No. 4 inoperative, the reduction in output to the secondary hydraulic system may cause the landing gear and wing flap operation to be slower than normal. After landing, the wing flaps should not be raised until after the full use of nose wheel steering and full use of the brakes is not critical. When landing with any two engines feathered, the windmilling drag is reduced by half and the deceleration with closed throttles is less than normal. Hence, excessive speed on approach should be anticipated and avoided. However, a slightly high final approach with low power is considered good practice.

Landing With Engines No. 1 and No. 2 Inoperative.

The primary hydraulic system will be inoperative unless the hydraulic cross-over switch is moved from NORMAL position to EMERGENCY position. This switch-over allows pressure from the secondary system to take over the functions of the primary system.

CAUTION

- Do not move the hydraulic system cross-over switch to the EMERGENCY position until it has been determined that a complete loss of hydraulic system pressure will not occur. If it is not advisable to operate the hydraulic

cross-over valve, the flight control boosters will be inoperative. To restore operation of the flight control boosters, proceed as described UNDER LOSS OF FLIGHT CONTROL BOOSTERS IN FLIGHT, this section.

- Use propeller reversing with caution.

Landing With Engines No. 2 and No. 3 Inoperative.

Note

The hydraulic pump driven by engine No. 4 will supply hydraulic pressure for operation of the landing gear, wing flaps, brakes, tanks 2A and 3A fuel dump actuation, and nose-wheel steering. The restriction control valve may slow operation of the wing flaps and landing gear while giving priority to the other systems. The hydraulic pump, driven by engine No. 1, will supply hydraulic pressure for operation of the flight control boosters.

Landing With Engines No. 3 and No. 4 Inoperative.

The secondary hydraulic system will be inoperative unless the hydraulic crossover switch is moved from NORMAL position to EMERGENCY position. This switch-over allows the primary system to take over the functions of the secondary system.

CAUTION

- Do not move the hydraulic system crossover switch to the EMERGENCY position until it has been determined that a complete loss of hydraulic system pressure will not occur. If it is inadvisable to use the hydraulic system cross-over valve, it will be necessary to power the brakes with emergency brake system, extend the landing gear by means of the emergency gear extension, and operate the wing flaps by means of the hand crank. Nose gear steering and tanks 2A and 3A fuel dump valves will be inoperative.
- Use propeller reversing with caution.

Landing With Engines No. 1 and No. 4 Inoperative.

Note

The hydraulic pump driven by engine No. 3 will supply hydraulic pressure for operation of the landing gear, wing flaps, brakes, tanks 2A and 3A fuel dump actuation, and nose wheel steering. The restriction control valve may slow operation of the wing flaps and landing gear while giving priority to the other systems. The hydraulic pump driven by engine No. 2 will supply hydraulic pressure for operation of the flight control boosters. D.C. generators 1 and 4 will be inoperative.

GO-AROUND PROCEDURE.

THREE ENGINES OPERATING, FLIGHT CONTROL BOOSTERS ON.

Use procedure given in Section II, GO-AROUND PROCEDURE, — FOUR ENGINES OPERATING.

TWO ENGINES OPERATING, FLIGHT CONTROL BOOSTERS ON.

In general, a two-engine go-around is not recommended, however, it can be accomplished if altitude is not less than 50 feet and the airspeed is not less than 125 knots. Use the procedure given in the following paragraphs.

Note

- If engines No. 1 and No. 2 are inoperative, the hydraulic system crossover switch must be in the EMERGENCY position for boost on operation.
- If engines No. 3 and No. 4 are inoperative, the hydraulic system crossover switch must be in the EMERGENCY position to retract the landing gear and wing flaps.

WARNING

If it is inadvisable to use the hydraulic system crossover switch, and engines No. 3 and No. 4 are inoperative, a go-around would be difficult because the landing gear cannot be retracted.

- a. Airspeed (indicated) — 125 knots.

- b. Engines — apply take-off power as rapidly as directional control will permit.
- c. Wing flap lever — TAKE-OFF.
- d. Landing gear lever — UP.
- e. Wing flap lever — raise flaps slowly.
- f. Reduce to METO power when safe altitude is reached.

PRACTICE MANEUVERS WITH ONE OR MORE ENGINES INOPERATIVE.

It should be understood that during practice maneuvers the simulating of engine failures and various systems failures requires thorough knowledge of resulting conditions. Therefore, cognizance of applicable regulations and other sections of this manual is essential.

Practice maneuvers involving more than one engine inoperative should be accomplished by feathering only one engine and simulating zero thrust with the second engine (set 20 inches Hg. and 2000 rpm).

Note

During descent or simulated engine failure conditions, when a large reduction of power is desired, it is important to cushion the high inertia loads on the master rod bearings which occur when a high-rpm and low-manifold pressure power combination is used. Each hundred rpm requires at least 1 inch Hg. manifold pressure. Operation at high rpm and low manifold pressure should be kept to a minimum.

Practice maneuvers involving the actual feathering of one engine and the throttling (zero thrust) of an additional engine should be confined to altitudes which comply with Service Regulations. The following information is based on a gross weight of 86,500 pounds.

CAUTION

Turns should not exceed 45 degrees of bank during simulated two engine failure.

WARNING

During practice maneuvers, the simulated failure of more than two engines is prohibited. There are no restrictions on combinations of two engine failures.

Typical two engine failure procedures are as follows:

- a. Feather propeller on engine No. 1.
- b. Simulate No. 2 engine failure by reducing rpm to 2000 and M.A.P. to 20 inches. This will represent a zero thrust condition.
- c. Use normal rated power or the power necessary to maintain minimum pattern airspeed (130 knots) on operating engines.
- d. Resume four engine flight. Do not exceed 135 knots during unfeathering operation.

PRACTICE WITH BOOST-OUT.

If boost-out and engine-out operation is to be practiced, the following is recommended:

- a. Follow recommended procedures for boost-out operation as described in this section.
- b. Throttle engine or engines to simulate zero thrust conditions.
- c. Turns of over 15 degrees of bank are not recommended.

PROPELLER OVERSPEED

Pilots

States: EXECUTE EMERGENCY PROCEDURE, COPILOTS POWER. Direct copilot to adjust power as necessary on remaining engines.

1. Power — AS REQUIRED.
2. Landing Gear Lever — AS DESIRED.
3. Wing Flap Lever — AS DESIRED.
4. Airspeed — 130 KNOTS MAXIMUM.

Flight Engineer

At the first indication or report of propeller malfunction calls: PROPELLER OVERSPEED NUMBER__ ENGINE.

Acknowledges: EXECUTING EMERGENCY PROCEDURE.

1. Throttle Lever — PARTIALLY RETARDED.
2. Propeller Selector Switch — FIXED POSITION. Control rpm with feathering switch. If control cannot be obtained, inform pilot.

Note

If rpm cannot be controlled — feather propeller.

5. Propeller feathering switch (inop. engine) — FEATHER.

3. Propeller Feathering Switch (inop. engine) — FEATHER.

Note

Complete ENGINE FAILURE AND OR FIRE DURING FLIGHT checklist.

6. Engineer's propeller overspeed checklist — COMPLETED.

4. Engineer's propeller overspeed checklist — COMPLETED.

CAUTION

If voltage boosters do not operate, check voltage booster circuit breakers — (Circuit breakers located copilot's side, forward section of engineer's M J B panel).

INADVERTENT REVERSING IN FLIGHT.

If a propeller accidentally reverse in flight, proceed as follows:

- a. Throttle lever — retard on reversed engine and reduce airspeed.
- b. Propeller reverse circuit breaker — pull out.
- c. Feathering switch — FEATHER and complete feathering procedure.

FEATHERING PROCEDURE WITH FEATHER SWITCH INOPERATIVE.

Note

A propeller may be feathered at normal voltage by placing the feathering switch to NORMAL and holding the respective selector switch in DEC. RPM position. This will allow feathering in the event of voltage booster failure.

FIRE.

(Refer to figure 3-2.)

ENGINE FIRE IN FLIGHT.

Refer to paragraph titled ENGINE FAILURE AND/OR FIRE DURING FLIGHT in this section.

ENGINE FIRE ON THE GROUND.

Judgment and precision are equally as important as speed when putting out an engine fire. Closing a wrong valve can cause more trouble than a few seconds delay in controlling the fire. The procedures vary for fires which occur during starting and after starting.

Engine Fire During Starting.

If a fire occurs before the engine takes hold during starting, proceed as follows:

- a. With an indication or report of an engine fire, the pilot states: EXECUTE EMERGENCY PROCEDURE.
- b. The flight engineer acknowledges: EXECUTING EMERGENCY PROCEDURE and proceeds as follows:
 - (1) Continue cranking to draw the fire through the engine.
 - (2) Discontinue priming.
 - (3) Mixture lever — OFF.
 - (4) Auxiliary fuel boost pump switch — OFF.
 - (5) If fire continues or spreads, stop cranking the engine.
 - (6) Emergency shut-off lever — FULL OFF.
 - (7) Fuel tank selector — OFF.
- c. The copilot calls for ground fire-fighting equipment.
- d. Smother fire with CO₂ from a ground source and/or aircraft fire extinguishing system if required.
- e. Shut down other engines.
- f. Evacuate passengers and crew members as necessary.

Engine Fire After Starting.

If a fire occurs after the engine has started, proceed as follows:

- a. With an indication or report of an engine fire the pilot heads aircraft downwind, if conditions permit, and states: EXECUTE EMERGENCY PROCEDURE.
- b. The flight engineer acknowledges: EXECUTING EMERGENCY PROCEDURE and proceeds as follows:
 - (1) Throttle lever — CLOSED.
 - (2) Mixture lever — OFF.
 - (3) Emergency shut-off lever — FULL OFF.
 - (4) Fuel tank selector — OFF.

- (5) Auxiliary fuel boost pump switch — OFF.
- (6) Cowl flap switch — OPEN.
- c. Place the brake selector in the EMERGENCY position, set the parking brakes and call for ground fire-fighting equipment.
- d. Ignition switch — OFF.
- e. Smother the fire with CO₂ from a ground source and/or aircraft fire extinguishing system if required.
- f. Shut down the other engines.
- g. Evacuate passengers and crew members as necessary.

CAUTION

Do not attempt to restart engine until cause of the fire has been determined and corrected.

CABIN FIRE.**Miscellaneous Cabin or Flight Compartment Fire.**

Hand fire extinguishers are located in the cabin and flight compartment to be used at the crew's discretion on localized fires (figure 3-2). Operating instructions are attached to each extinguisher.

WARNING

Prolonged exposure (5 minutes or more) to high concentrations (pronounced irritation of eye and nose) of Bromochloromethane (CB) or its decomposition products should be avoided. CB is an anesthetic agent of moderate intensity. It is safer to use than previous fire extinguishing agents (carbon tetrachloride, methylbromide). However, especially in confined spaces, adequate respiratory and eye protection from excessive exposure, including the use of oxygen when available, should be sought as soon as the primary fire emergency will permit.

Note

- In the event of heavy smoke concentrations in the cabin or cockpit, refer to SMOKE/FUME ELIMINATION PROCEDURE in this section.
- If a rapid descent is necessary, refer to EMERGENCY DESCENT PROCEDURES in this section.

emergency equipment location

(USAF SERIAL 48-608 ONLY)

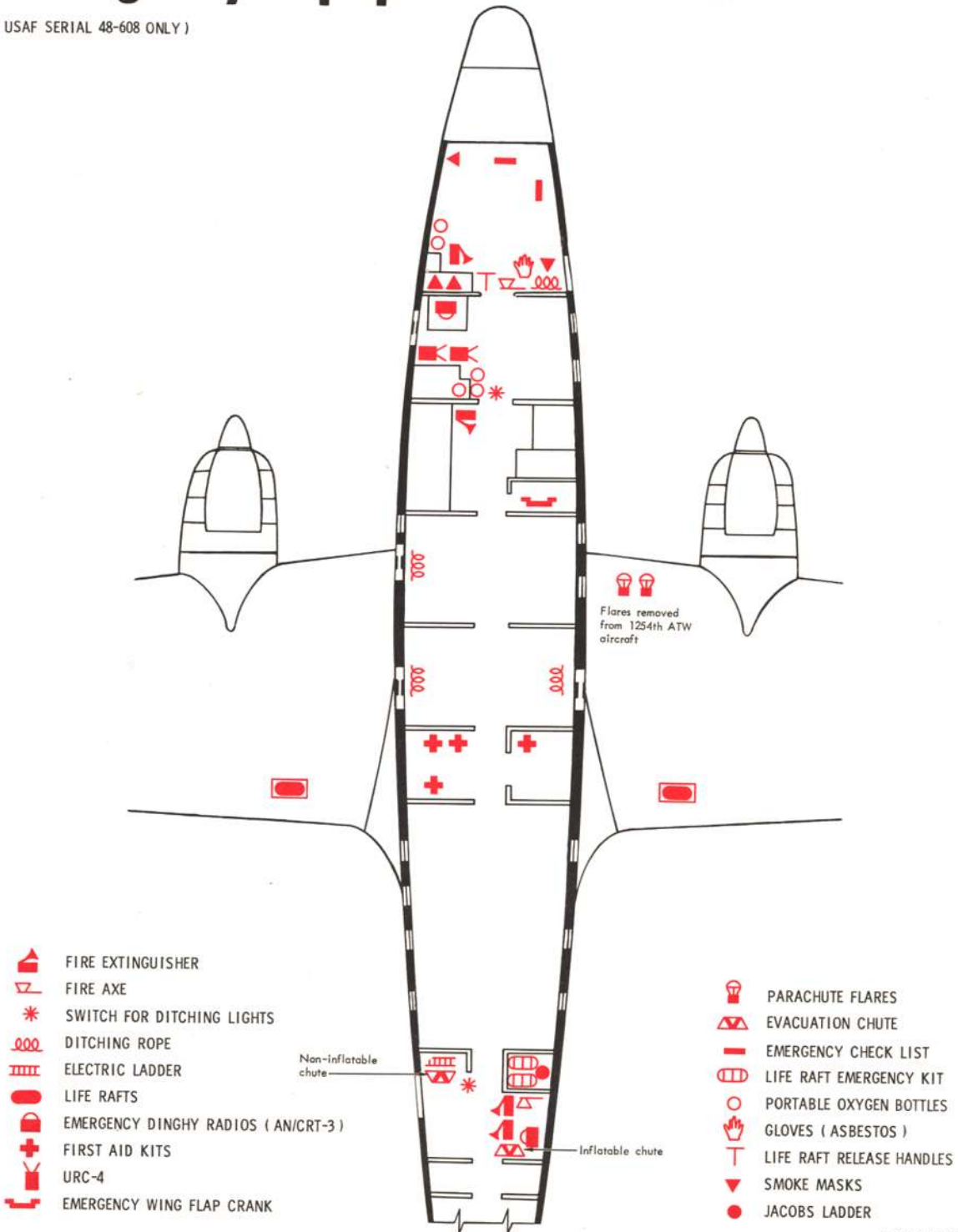

Figure 3-2 (Sheet 1)

F125-C1-3-111 (1)

emergency equipment location

(USAF SERIALS 48-609 THRU 48-617)

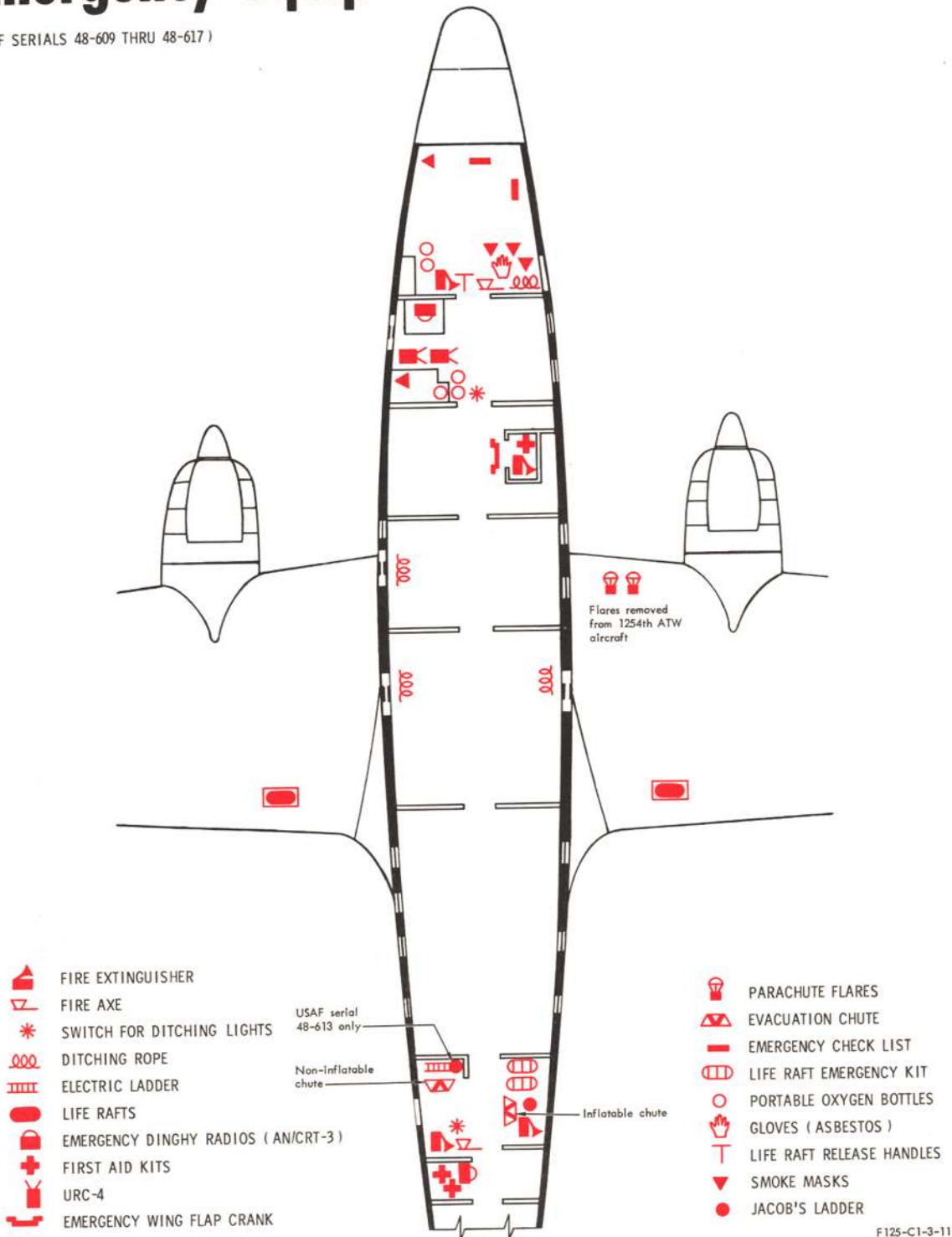

Figure 3-2 (Sheet 2)

F125-C1-3-111 (2)

CABIN FIRE

Pilots

Flight Engineer

If smoke is noticed or a fire occurs in the cabin, the crew should breathe 100% oxygen, shut off the recirculating fans, and block open the curtain and/or door between the cabin and flight station. These steps will protect the flight crew, help to prevent spread of fire, and prepare the aircraft for smoke removal. If smoke should become dense, follow the smoke removal procedure given in this section. If an open fire should occur in the cabin or flight station, it may be controlled by one of the portable fire extinguishers. When smoke or fire is noticed or reported in the cabin, pilot states: EXECUTE CABIN FIRE EMERGENCY PROCEDURES.

Acknowledges: EXECUTING EMERGENCY PROCEDURE.

1. Smoke masks — ON & OXYGEN SET TO 100%.

1. Smoke mask — ON & OXYGEN SET TO 100%.

② Emergency descent — AS NECESSARY.

② Emergency descent — AS NECESSARY.

3. Cabin heaters & all fan switches — OFF.

4. Cabin and flight station temp switches — COOL.

③ Pressurization — AS NECESSARY.

⑤ Pressurization — AS NECESSARY.

④ Portable fire extinguisher — AS NECESSARY.

⑥ Portable fire extinguisher — AS NECESSARY.

⑤ Engineer's cabin fire checklist — COMPLETED.

⑦ Engineer's cabin fire checklist — COMPLETED.

CARGO COMPARTMENT FIRE

Pilots

Flight Engineer

If a fire should occur in the forward or aft cargo compartment, the smoke detector will energize the warning lights and bell. Cargo compartment fires can be extinguished with the aircraft fire extinguishing system.

If the warning light comes on, calls: ENGINEER'S REPORT.

At the first indication or report of cargo compartment fire, calls: FIRE SMOKE IN FORWARD/AFT CARGO COMPARTMENT.

States: EXECUTE EMERGENCY PROCEDURE, — COPILOT'S POWER.

Acknowledges: EXECUTING EMERGENCY PROCEDURE.

Attempt to isolate the cause of the fire by shutting off any fluids that may be feeding the fire. Start emergency descent and advise all crew members to don smoke mask and select 100% oxygen. When cabin is depressurized discharge CO₂ at pilot's command. If it is known that the hydraulic and electrical systems are not involved in the fire, they will remain on.

1. Smoke mask — ON & OXYGEN SET TO 100%.

1. Smoke detector—RESET.

CARGO COMPARTMENT FIRE
(CONTINUED)*Pilots**Flight Engineer*

2. Flight control auxiliary booster switches — ON.

CAUTION

Auxiliary control boosters will still be available for the rudders and elevators and should be turned on. If the hydraulic system has been turned off, aileron boost system should be by-passed to reduce forces. The auxiliary control booster motors will deplete the battery power very rapidly and, since the batteries may be the only power available for operation of the propellers, instruments, and etc., the auxiliary control boost motors should be turned off as soon as safety permits. To reduce control forces, the rudder boost system should then be by-passed and the emergency elevator booster shift lever pulled out and locked.

3. Aileron booster lever — OFF.

Note

If it is definitely known the hydraulic system is not involved in the fire steps 2 and 3 may be omitted.

If Fire is Present:

4. Emergency descent — AS NECESSARY.

2. Recirculating fans and cabin heaters—OFF.
3. Return air shut-off levers—CLOSED.
4. Smoke mask —ON & OXYGEN SET TO 100%.
5. Cargo compartment—CHECKED.

CAUTION

Check cargo compartment for fire or smoke. Do not open hatches in cabin floor; the resulting draft could cause a smoldering fire to burst into flame.

If Fire Is Present:

6. Fuel tank selector levers — ON MAINS.
7. Fuel crossfeed levers — OFF.
8. Cabin and flight station temp. switches—COOL.
9. Emergency descent —AS NECESSARY.
10. Pressure regulator valve override switch — OPEN POSITION (until 2" cabin differential pressure is reached).
11. Auxiliary ventilation control knob (at 2" differential) — POSITION B, THEN POSITION A.
Select position B to dump cabin pressure, then turn auxiliary ventilation control knob to position A to prevent partial pressurization of cabin.

CARGO COMPARTMENT FIRE

(CONTINUED)

Pilots

- 5. Hydraulic pump suction shut-off switches — OFF.
- 6. Propeller synchronizer lever—AS REQUIRED.

Flight Engineer

- 12. Hydraulic pump suction shut-off switches—OFF.
- 13. Propeller synchronizer lever—AS REQUIRED.

Note

In fixed pitch there will be approximately a 50 rpm decrease for every 1000' of altitude lost.

14. Generator switches—OFF.

15. Battery switch—OFF.

Note

If it is definitely known the fire is not violent and hydraulic and electrical systems are not involved, steps, 12, 13, 14 and 15 may be omitted.

16. Cargo compartment fire extinguisher selector — SET, ALL OTHER FIRE SELECTORS OFF.

17. Emergency inverter switch—ON.

Advise pilot: CABIN DIFFERENTIAL ZERO, CO₂ IS REQUIRED, or IS NOT REQUIRED.

7. CO₂ — AS NECESSARY.

18. CO₂ (pull one handle at pilot's command) — AS NECESSARY.

WARNING

- Extremely high concentrations of CO₂ are dangerous, therefore, not more than one charge of CO₂ can be discharged at once into the compartment without producing a dangerous quantity of CO₂ in the flight station. Do not use a second charge of CO₂ unless absolutely necessary and in any case not sooner than fifteen minutes after the first charge has been released.
- Never discharge CO₂ while pressurized because it increases the possibility of contaminating the pressurized areas of the fuselage.
- Never discharge CO₂ while in a nose-down attitude because the CO₂ will flow to the lowest level.

8. Engineer's cargo compartment fire checklist — COMPLETED.

19. Engineer's cargo compartment fire checklist — COMPLETED.

CABIN HEATER FIRE*Pilots**Flight Engineer*

If a fire should occur in the cabin heaters or cabin heater compartments, the fire detectors will energize the warning lights and bell. Heater fires can be extinguished with the aircraft fire extinguishing system.

If fire warning light comes on, calls: ENGINEER'S REPORT.

States: EXECUTE EMERGENCY PROCEDURE, — COPILOT'S POWER.

Flight engineer will turn cabin heaters and all recirculating fans off. The pilot advises all crew members to don smoke masks and select 100% oxygen. Discharge CO₂ at pilot's command.

1. Smoke mask — ON & OXYGEN SET TO 100%.

2. CO₂ — AS NECESSARY.

At the first indication or report of heater fire, calls: FIRE IN LEFT/RIGHT HEATER.

Acknowledges: EXECUTING EMERGENCY PROCEDURE.

1. Cabin heater switches — OFF.

2. All recirculating fan switches — OFF.

3. Smoke mask — ON & OXYGEN SET TO 100%.

4. Cabin heater fire extinguisher selector — SET.

Check engine & APU fire extinguisher selectors OFF, and overboard discharge valve CLOSED. Advise pilot: CO₂ IS REQUIRED or NOT REQUIRED.

5. CO₂ (pull one handle at pilot's command) — AS NECESSARY.

WARNING

Do not release second charge until it is obvious that the first charge has not smothered the fire.

3. Engineer's cabin heater fire checklist — COMPLETED.

6. Engineer's cabin heater fire checklist — COMPLETED.

BRAKE FIRE*Pilots**Flight Engineer*

During flights where frequent landings are made or when excessive brake usage is required, it is possible to overheat the brake system and cause a fire. To avoid the possibility of retracting the gear with hot brakes, it is desirable to obtain a visual brake check before take-off. At the first indication or report of a brake fire, the pilot states: BRAKE FIRE, EXECUTING EMERGENCY PROCEDURE.

1. Brake selector lever — EMER. position.

2. Stop aircraft.

1. Throttle levers (except engine over burning wheel) — CLOSED.

BRAKE FIRE

(CONTINUED)

Pilots

3. Wing flap lever—LANDING FLAPS (100%) (to facilitate evacuation of passengers).
4. Ground fire fighting equipment—REQUESTED.
5. Nose wheel — TURNED FULL THROW TOWARD BURNING OR SMOKING WHEEL.
6. Brake on burning wheel—RELEASED, OPPOSITE BRAKE ON, PARKING BRAKE SET.
7. RPM on engine over burning wheel— 2400 RPM.
Increase rpm to 2400 or as required to attempt to extinguish fire.
8. All engines (except engine over burning wheel)— SHUT DOWN.

If ground fire equipment is available, shut down engine over burning wheel and evacuate passengers.

If Ground Fire Fighting Equipment is Not Available, Proceed as Follows:

9. RPM on engine over burning wheel — MAINTAINED.
Maintain sufficient rpm to keep fire clear of nacelle.
10. Passengers — EVACUATED AND CLEAR OF AIRCRAFT.
Evacuate passengers using available exits, normally those on side opposite fire. Direct all passengers to a safe distance from the aircraft.

WARNING

- Stay clear of spanwise path of wheel fragments, in event the wheel disintegrates.
- Do not use CO₂ directly on the wheel as this may cause it to shatter.

Upon Arrival of Fire Fighting Equipment Proceed as Follows:

11. Engine over burning wheel— SHUT DOWN.
12. Throttle lever on engine over burning wheel — CLOSED.
13. Mixture lever on engine over burning wheel— OFF.

BRAKE FIRE
(CONTINUED)*Pilots**Flight Engineer*⑫ CO₂—DISCHARGED.

5. Emergency shut-off lever—CLOSED.

6. Fuel tank selector lever—OFF.

⑬ Engineer's brake fire checklist—COMPLETED.

7. Engine fire selector—SET, ALL OTHER FIRE SELECTORS OFF.

⑧ CO₂—DISCHARGED.

⑨ Engineer's brake fire checklist—COMPLETED.

APU FIRE*Pilots**Flight Engineer*

If a fire occurs in the auxiliary power unit, the fire detectors will energize the warning lights and bell. APU fires can be extinguished with the aircraft fire extinguishing system.

If fire warning light comes on, calls: ENGINEER'S REPORT.

At the first indication or report of a APU fire, calls: APU FIRE.

States: EXECUTE EMERGENCY PROCEDURE. (CO-PILOT'S POWER.)

Acknowledges: EXECUTING EMERGENCY PROCEDURE.

The flight engineer will turn off APU fuel pump, ignition and generator switches. The pilot advises all crew members to don smoke masks and select 100% oxygen. Discharge CO₂ at pilot's command.

1. Smoke masks—ON & OXYGEN SET TO 100%.

1. APU fuel pump switch—OFF.

2. APU ignition switch—OFF.

3. APU generator switch—OFF.

4. Smoke mask—ON & OXYGEN SET TO 100%.

5. APU fire extinguisher selector—SET.

Check engine & cabin heater/cargo compartment fire extinguisher selector OFF, and overboard discharge valve CLOSED.

Advise pilot: CO₂ IS REQUIRED or NOT REQUIRED.

② CO₂—AS NECESSARY.⑥ CO₂ (pull one handle at pilot's command)—AS NECESSARY.**WARNING**

Do not release the second CO₂ charge unless it is obvious that the first discharge failed to extinguish the fire.

③ Engineer's APU fire checklist—COMPLETED.

⑦ Engineer's APU fire checklist—COMPLETED.

ELECTRICAL FIRE

Pilots

Flight Engineer

Fires caused by an active short circuit cannot be extinguished until the circuit involved is dead. It is essential, therefore, to locate the fire source and interrupt any circuits involved as quickly as possible.

Isolate the affected circuit if possible, the pilot states: EXECUTE EMERGENCY PROCEDURE. COPILOT'S POWER.

Acknowledges: EXECUTING EMERGENCY PROCEDURE.

1. Smoke masks—ON & OXYGEN SET TO 100%.
2. Electrical equipment—OFF.

1. Emergency inverter switch—ON.

Note

If operation of emergency inverter is not required at time of emergency, it may be turned off, only after concurrence of the Pilot.

3. Portable fire extinguisher—AS NECESSARY.

5. Portable fire extinguisher—AS NECESSARY.

WARNING

Do not use liquid fire extinguisher on electrical fires.

4. Engineer's electrical fire checklist—COMPLETED.

6. Affected circuit—LOCATE AND ISOLATE.

7. Engineer's electrical fire checklist—COMPLETED.

CAUTION

Before turning the battery switch ON, it is imperative that the source of the trouble be located and the affected circuit isolated from the main bus.

Note

Heavy load items such as inverters, recirculating fans, etc., should be shut off prior to restoring d.c. power after affected circuit has been located and isolated.

SMOKE/FUME ELIMINATION.

If the cabin must be cleared of noxious fumes or gases of any kind, the following smoke elimination procedure should be used:

WARNING

Sound judgment is required to measure the

relative danger involved in fanning the fire with fresh air and subjecting the passengers and crew to high altitude as against the alternate danger of asphyxiation. If immediate smoke elimination is felt to be necessary, the following procedure may be initiated:

- a. Crew don smoke masks and set air valve lever at 100% oxygen.
- b. Close throttles and make descent. Refer to RAPID DESCENT PROCEDURES (A or B), Section II.
- c. If pressurized, depressurize cabin by dumping cabin superchargers. This is done by placing the pressure regulator valve override switch to the OPEN position. When cabin differential reaches 2", then place auxiliary ventilation knob to position B. After dumping return to position A.
- d. Turn recirculating and flight station fans OFF.
- e. When depressurized, remove smoke as follows:
 - (1) Block open connecting doors to provide a clear path for the air.
 - (2) Reduce speed to 175 knots or less to facilitate opening of emergency exits.
 - (3) First step: Open one or more of the emergency exits over the wing.

Note

If unable to open emergency exit, break window with an axe or heavy object. Personnel should stay clear of the opening, particularly if the window must be broken at full cabin pressure differential.

- (4) Second step: Open the flight station windows.

WARNING

Never open a vent in the flight station before there is an opening in the cabin over the wing. Never open an emergency exit in front of the propeller plane. The pressure outside of the cockpit is low and a vent in this area will suck air forward into the flight station. By first opening a vent over the wing, where the pressure is even lower, the air will be sucked aft from the flight station and out over the wing.

SMOKE/FUME ELIMINATION

Pilots**Flight Engineer**

In the event it becomes necessary to clear the cabin of noxious fumes or gases of any kind, depressurize the cabin by setting rate of change to maximum and raising cabin altitude with the altitude selector until the cabin differential drops to 1" Hg. If immediate removal is felt to be necessary, the pilot calls: SMOKE/FUME ELIMINATION CHECKLIST.

WARNING

Sound judgment is required to measure the relative danger involved in fanning the fire with fresh air and subjecting the passengers and crew to high altitude as against the alternate danger of asphyxiation. If immediate smoke removal is believed to be necessary, the following procedures may be initiated:

1. Smoke masks — ON & OXYGEN SET TO 100%.
2. Emergency descent — AS NECESSARY.

Acknowledges: SMOKE/FUME ELIMINATION CHECKLIST.

1. Smoke mask — ON & OXYGEN SET TO 100%.
2. Emergency descent — AS NECESSARY.
3. Cabin heaters, recirculating and flight station fan switches—OFF.

SMOKE/FUME ELIMINATION

(CONTINUED)

Pilots

Flight Engineer

4. Pressure regulator override switch—OPEN.

When cabin differential reaches 2", place auxiliary ventilation knob to position B, then position A. For rapid depressurization open auxiliary ventilation knob to position B until depressurized, then return to position A.

5. Auxiliary ventilation control knob POSITION B, THEN POSITION A.

Do not turn auxiliary ventilation knob to position B until 2" of cabin differential pressure is reached unless rapid depressurization is required.

6. Passageway doors—BLOCKED OPEN.

7. Airspeed—175 KNOTS MAXIMUM.

8. Rear emergency wing exits -- OPEN.

3. Airspeed—175 KNOTS MAXIMUM.

4. Rear emergency wing exits -- OPEN.

5. Flight station window — OPEN.

WARNING

Never open an exterior vent in the flight station before there is an opening in the cabin over the wing. Never open an emergency exit in front of the propeller plane. The pressure outside of the cockpit is low and a vent in this area will suck air forward into the flight station. By first opening a vent over the wing, where the pressure is even lower, air will be sucked aft from the flight station and out over the wing.

6. Engineer's smoke/fume elimination checklist — COMPLETED.

9. Engineer's smoke/fume elimination checklist — COMPLETED.

BAIL OUT.

When the decision is made to abandon aircraft in flight:

- Depressurize the cabin.
- Give the signal for bail out preparation over interphone.
- Receive acknowledgment from each crew member.
- If possible, reduce airspeed.
- Trim aircraft slightly nose down.

- f. Head toward an uninhabited area.

Note

The automatic pilot may be engaged to maintain course and stability for crew abandonment.

- Give warning for bail-out over interphone.
- Receive acknowledgment from each crew member.
- All crew members bail out aft cabin door.

EXPLOSIVE DECOMPRESSION.

When an explosive decompression occurs, the cabin pressure is reduced to the outside pressure in less than a second. The fog caused by explosive decompression should not be confused with smoke. Any explosive decompression affects all crew members and can be extremely dangerous if occurring at high altitude. Rush of air from lungs, a momentary dazed sensation that passes immediately, possible gas pains, and anoxia if oxygen equipment is not immediately available are some of the effects accompanying explosive decompression. Maintaining a safe pressure differential, and having oxygen equipment immediately available are precautions that should be observed in pressurized compartments. If an explosive decompression occurs, the pilot should try to ascertain the cause of the trouble and if it cannot be fixed in flight, he should decide whether to continue on his mission or to descend to a safe altitude immediately.

EMERGENCY DESCENT PROCEDURE.

Emergency descent from high altitudes may be made in either of two configurations: clean, or with landing gear DOWN and wing flaps in the LANDING (100%) position. Under emergency conditions, the choice of configuration should be governed by such factors as: desired rate of descent, glide angle, and maximum airspeed that can be used under prevailing conditions.

EMERGENCY DESCENT PROCEDURE.**(Clean Configuration).**

Descent in clean configuration can be made at speeds up to placard limits. The most rapid rate of descent can be made in this configuration. To make a rapid descent in the clean configuration, proceed as follows:

- a. The pilot states: EMERGENCY DESCENT and proceeds as follows:
 - (1) Automatic pilot — DISENGAGE.
 - (2) Throttle levers — CLOSE SMOOTHLY.
 - (3) Flight control auxiliary booster switches — ON.
 - (4) Descend at speeds up to placarded airspeeds.
- b. The flight engineer acknowledges: EMERGENCY DESCENT, and proceeds as follows:
 - (1) Mixture levers — AUTO RICH.
 - (2) Engine supercharger levers — LOW.
 - (3) Propeller switches — set to 2800 rpm.
 - (4) Cowl flap switches — 100% open.
 - (5) Oil cooler flap switches — 100% open.

- (6) Depressurize — AS NECESSARY.

EMERGENCY DESCENT PROCEDURE (Landing Gear Down and Wing Flaps in Down Position).

Descent with landing gear lowered and wing flaps in down position may be made at speeds up to the placarded airspeeds. This configuration produces a steeper angle than the clean configuration, but the rate of descent is slightly less. To make an emergency descent with landing gear and wing flaps in the down position, proceed as follows:

Note

If rough air, or the possibility of structural damage indicates the advisability of descending at low airspeed, rapid loss of altitude can be achieved at relatively low airspeeds in this configuration. These lower airspeeds also permit earlier execution of smoke removal procedures.

- a. The pilot states: EMERGENCY DESCENT PROCEDURE.
 - (1) Automatic pilot — DISENGAGE.
 - (2) Throttle levers — CLOSE SMOOTHLY.
 - (3) Wing flap lever — LANDING (100%) POSITION.
 - (4) Landing gear lever — DOWN.
 - (5) Flight control auxiliary booster switches — ON.
 - (6) Descend at airspeeds up to flaps extended placarded speed (with 60% flaps use gear extended placard speed).
- b. The flight engineer acknowledges: EMERGENCY DESCENT and proceeds as follows:
 - (1) Mixture levers — AUTO RICH.
 - (2) Engine supercharger levers — LOW.
 - (3) Propeller switches — set to 2800 rpm.
 - (4) Cowl flap switches — 100% OPEN.
 - (5) Oil cooler flap switches — 100% OPEN.
 - (6) Depressurize — AS NECESSARY.

Note

Refer to Section V for placarded airspeeds.

**TAKE-OFF AND LANDING EMERGENCIES.
ABORT TAKE-OFF PROCEDURE.**

If at any time prior to V_d or GO-NO-GO, the pilot,

copilot or flight engineer has any indication of a malfunction affecting flight safety, he will call: REJECT.

- a. If it becomes necessary to refuse a take-off before reaching V_d or GO-NO-GO speed, the pilot states or acknowledges: REJECT.
- b. Close throttles, reverse propellers as needed to decelerate, apply brakes as necessary.
- c. The copilot holds the yoke and depresses reversing flag down.

After the reversing cycle has been completed the engineer will accomplish the following:

- d. Open cowl flaps.
- e. Open oil cooler flaps.
- f. Place fuel pump switches in the OFF position.

When a malfunction occurs and a reject has been accomplished, determine cause and take appropriate action. After everything is under control, the pilot calls for: AFTER LANDING CHECK LIST.

ENGINE FAILURE DURING TAKE-OFF.

If an engine should fail during take-off prior to V_d or GO-NO-GO speed, stop the aircraft using procedures outlined under TAKE-OFF REJECTED. If an engine fails after the aircraft has proceeded too far down the runway to be stopped, take-off should be continued, climbing at three-engine climb speed. Raise the landing gear, feather propeller on inoperative engine and add extra power if necessary. The engine should be shut down as described in ENGINE FAILURE AND/OR FIRE CHECK LIST. Consider fuel dumping and/or immediate landing. If an immediate landing is desirable, there will probably be time for only the BEFORE LANDING check list.

Note

- After the landing gear is reported up, the wing flaps may be raised as desired. This depends upon the circumstances existing at the time engine failure or fire occurs. If an immediate landing can be accomplished, it is desirable to leave the wing flaps in TAKE-OFF position. Furthermore, with TAKE-OFF flaps the aircraft can be climbed at take-off speed, if necessary. If further climb is to be made, the flaps should be retracted when the aircraft is well clear of all obstructions and a high angle of climb is no longer necessary. (The flaps should not be retracted below 130 knots.)

- The minimum controllability speed in the air, with one outboard engine inoperative, propeller windmilling in low pitch, maximum power on the remaining three engines, wing flaps TAKE-OFF and the landing gear either retracted or extended, is 85 knots IAS, flush static system.
- If an engine failure occurs during cruise at higher altitudes, it may be necessary to descend to a lower altitude at which favorable three-engine cruise performance can be accomplished. Continuance of flight on three engines should be conducted in accordance with three-engine cruise control.

CAUTION

Visually check propeller position after feathering operation and at frequent intervals to see that propeller remains feathered.

LANDING GEAR TIRE FAILURE.

- a. If a tire is blown during take-off and the remaining runway is sufficient to stop the aircraft, close the throttles and maintain directional control by using brakes and nose wheel steering. Use reverse thrust as necessary. If the remaining runway is not sufficient to accomplish a safe stop, continue the take-off, but do not retract the landing gear, since the blown tire may jam the gear in the wheel well.
- b. If the nose wheel tire is flat at time of landing, keep this wheel off the ground as long as possible, with aft CG at 30%. (Moving two passengers from the center cabin area to the rear cabin area will shift the CG approximately 1%.) Use a minimum of braking.
- c. If one or both tires are flat on one main gear, make the nose gear contact as quickly as possible. There is very little actual danger in landing with one flat tire on one main gear. The landing should be made smoothly and taxiing should be done slowly.
- d. If both tires are flat on one main gear as a result of striking some object on the runway, damage in addition to the flat tires may have occurred. For example, a hydraulic hose may have been torn loose, a wheel may have been broken, or the landing gear itself may have been damaged.

A forward CG will place more weight on the nose wheel and provide positive steering after touchdown. Make a

normal approach and landing. After touchdown, the aircraft will tend to swerve in the direction of the blown tires; therefore, land the aircraft on the side of the runway away from the blown tires to allow space for possible swerve during deceleration. The use of aileron on the flat tire side will ease the weight on the blown tires. When the aircraft has slowed, reverse thrust may be used on the outboard engine opposite the side of the blown tires to aid in maintaining directional control. Do not apply brakes to the wheels with the blown tires during the landing roll nor attempt to taxi after the aircraft has stopped.

LANDING ON SOFT GROUND OR UNPREPARED RUNWAYS.

If it is necessary to land on soft ground or unprepared runway, the landing should be made with the landing gear retracted.

LANDING WITHOUT ALL GEARS EXTENDED AND LOCKED.

In the event that all gears can neither be extended nor retracted, land with the aircraft level and hold it that way as long as possible after the extended gear contacts the runway.

Landing With Gear Unlocked Indication.

If any one of the landing gears should extend fully without the downlock engaging, as evidenced by glowing of the unsafe warning light and unlocked indication of one of the gear position indicators, the gear can be held in the extended position by hydraulic pressure as long as sufficient hydraulic pressure is maintained in the landing gear actuating cylinder. If any of the landing gear warning devices indicates an unsafe condition of the gear when the gear is extended, it should be considered that the gear is unsafe for landing and not that there is a malfunction of the warning system unless definitely proved otherwise. These warnings consist of illumination of the gear "unlocked" warning light, unlocked indication of any of the gear "down and locked" lights or indicators, and sounding of the landing gear warning horn.

Landing with a Main Gear Fully Extended But Not Locked.

If the procedures outlined in the preceding paragraph fail to lock the gear down and a landing must be made, it is still possible to land safely while holding the gear in the extended position by normal hydraulic system pressure. To maintain sufficient pressure, it is essential

to keep engines at an adequate rpm and to refrain from activating other hydraulically-operated units that might cause pressure to drop in the landing gear hydraulic lines. The following procedure is recommended:

- a. Brake selector lever — EMER.
- b. Hand pump selector lever — EMER. GEAR.
- c. If certain that both hydraulic systems are operating normally, place hydraulic system crossover valve switch in EMERGENCY (open).
- d. Make a normal landing, or slightly flatter than normal if runway length is adequate. Do not make an extremely slow, nose-high landing. If the airplane should drop in a stalled condition, the impact forces could cause the gear to collapse.
- e. Do not use propeller reversing.

Note

Due to the geometry of the gear, the inertia of the airplane being opposed by the wheel brakes will tend to hold the gear in the DOWN position. This may not be true if propeller reversing is used for braking action.

- f. Do not use nose gear steering unless unable to steer aircraft by braking. Do not turn off runway.
- g. Do not raise the flaps. Operation of the flaps will reduce hydraulic pressure and may allow the gear to collapse.
- h. Maintain 1000 to 1200 rpm on all four engines and gradually apply brakes. Just before the aircraft comes to a complete stop, release the brakes momentarily to allow the lower drag shock struts to retract, then bring aircraft to a smooth stop. Hold position with brakes.

Note

An rpm of 1000 to 1200 will give full hydraulic pressure as long as no other hydraulic system units are operated. This is considerably more pressure than is required to keep the gear extended. Also, at this rpm the lower drag shock strut normally will remain retracted as the aircraft stops. It is recognized that at times the aircraft will rock backward as it stops in spite of the pilot's best efforts to stop with the lower drag shock struts retracted; however, this condition is not critical as long as full hydraulic pressure is maintained and rpm is in the recommended range. Stopping with the

crew crash landing stations

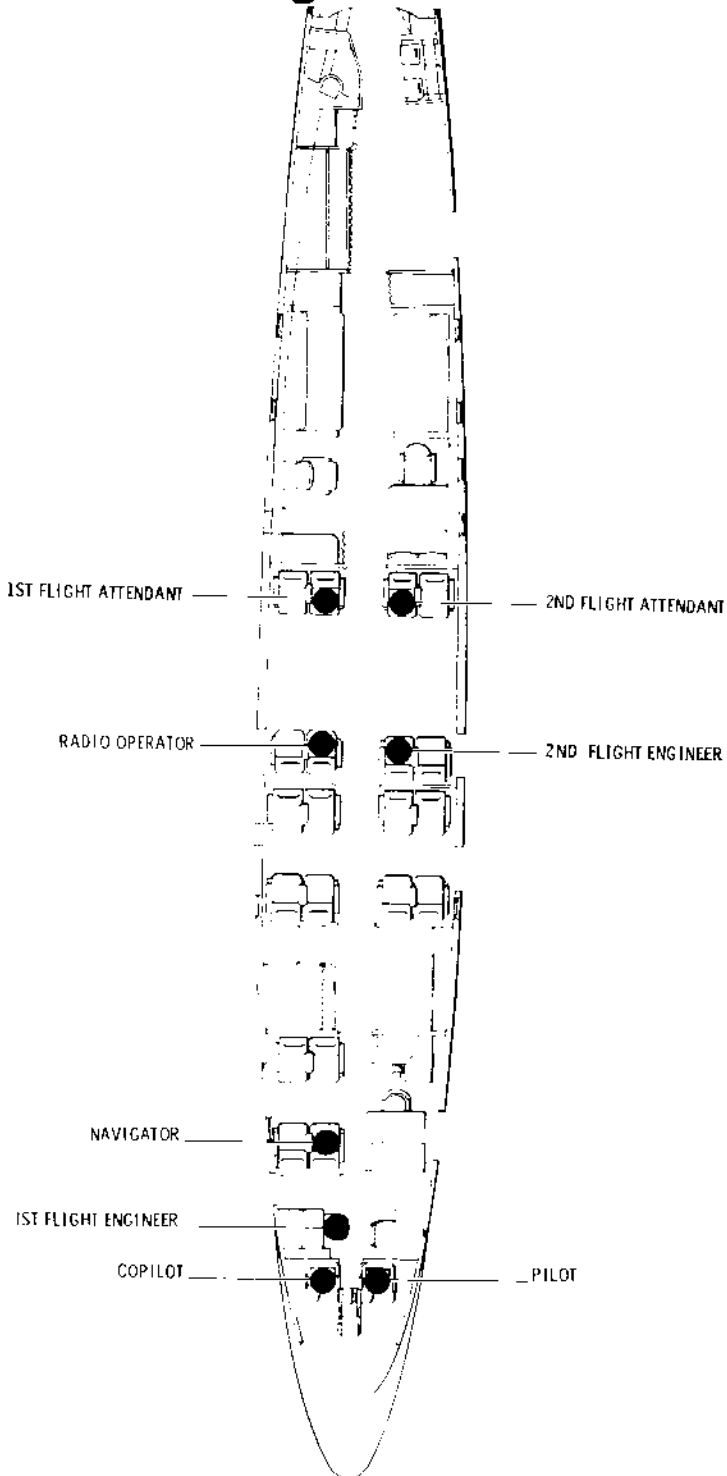
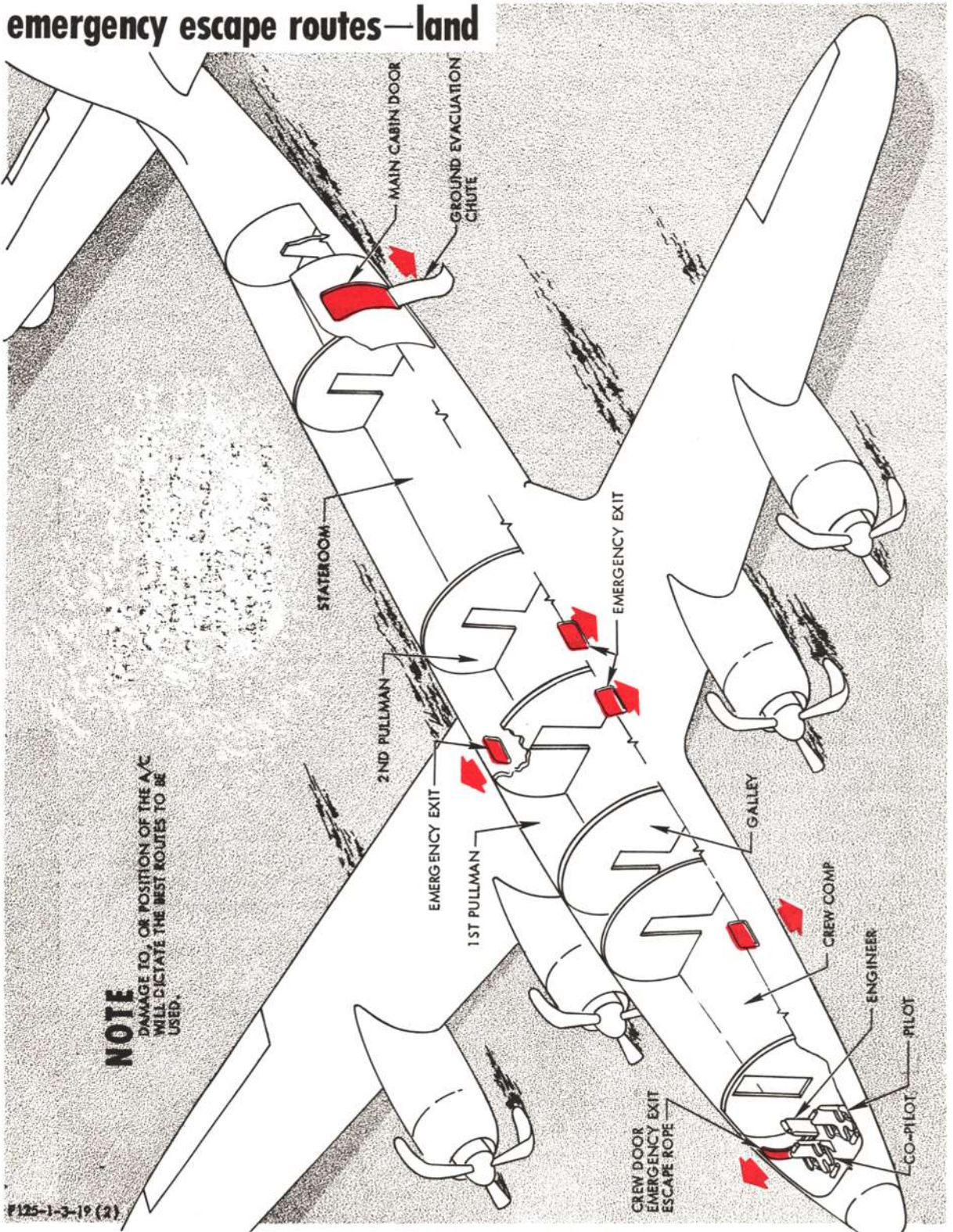

Figure 3-3

F125-1-3-19(1)

emergency escape routes—land



F125-1-3-19 (2)

Figure 3-4

Note

drag shock struts retracted is recommended since it facilitates ground action in making the gear safe, as explained below.

- (1) The hydraulic force imposed by the landing gear cylinder acts to pull the downlock hook onto the shaft. If the lower drag shock strut is extended, the tension in the drag shock strut opposes the force exerted by the landing gear hydraulic cylinder and tends to raise the downlock hook off the shaft. This may make it difficult or impossible to move the latch to the locked position in order to insert the ground safety pin.
 - (2) If the downlock strut is broken, the landing gear hydraulic cylinder will extend until it bottoms, putting the upper and lower drag struts in an over-center (stable) condition. If the lower drag shock strut is extended, the tension produced opposes the force exerted by the landing gear hydraulic cylinder and tends to pull the upper and lower drag struts back into a straight line, or on-center position, making it more difficult to insert bracing to hold the gear extended.
- i. Have the landing gear safety pins inserted. It may be necessary to move the downlock latch to the locked position manually. If a main gear downlock or downlock latching mechanism is damaged, thus preventing the insertion of the safety pin or making its insertion ineffective; block the nose wheels and jack the aircraft with a wing jack. Blocking the nose wheels will prevent the aircraft from rocking off the jack when engine power is reduced should the lower drag shock struts retract at that time.

WARNING

Ground personnel should be alerted to the possibility of the landing gear collapsing while the ground pins are being inserted or while the aircraft is being jacked. It may be considered desirable to back a heavy truck under the wing box beam; however, to be of any help, the truck must have sufficient bearing area and strength

to support the aircraft. Use of small equipment is not recommended since it will not protect personnel and will increase the damage to the aircraft if the gear does collapse.

- j. Do not reduce engine rpm until either the landing gear is safely locked down or the aircraft is on jacks. When safe to do so, reduce rpm gradually to idle prior to stopping engines. Do not move the aircraft until the landing gear is safely locked.

LANDING WITH UNLOCKED NOSE GEAR INDICATION.

The following procedure will allow the aircraft to be landed in this configuration with minimum damage:

- a. Reduce landing weight by burning or dumping excess fuel.

Note

If the nose gear is to be inspected through the nosewheel well access door, leaking hydraulic fluid can spray back into the lower compartment.

- b. Make a flat approach using 60 per cent flaps.
- c. Place brake selector in EMERGENCY.
- d. After touchdown, shut down engines 2 and 3.

CAUTION

Minimum damage should occur by shutting down the engines with the mixture controls. Feathering may result in the engines being torn loose from the mounts when the stopped propellers strike the runway surface.

- e. After stopping the aircraft using brakes, shut down engines 1 and 4.
- f. Secure all switches and controls and evacuate promptly.

Landing With Gear Retracted.

It is possible in an emergency to land this aircraft with the landing gear retracted without serious damage. With the exception of those procedures which are obviously peculiar to ditching, the procedures for a gear-up landing are very similar to those recommended for ditching. Escape routes are shown on Figures 3-4 and 3-6. Crash landing stations are shown on Figure 3-3.

The recommended procedure is given in the following steps:

Note

The pilot will delegate duties to the crew members.

- a. Notify crew of intention to make a gear-up landing.
- b. Notify ground stations of position.
- c. Reduce gross weight of aircraft by dumping fuel.

Note

Cabin heaters should be OFF.

- d. If possible, move center of gravity to approximately 25% to 30% MAC.
- e. Passenger seat belts fastened.
- f. Secure or stow loose equipment.
- g. Open all necessary doors; remove and stow securely all emergency exit hatches or doors.
- h. When approach speed and final approach is satisfactory give flight engineer command to feather inboard engines.
- i. Emergency shut-off levers (for feathered engines)—all OFF.
- j. Ignition switches (of feathered engines)—OFF.
- k. All auxiliary fuel pump switches—OFF.
- l. Auxiliary flight control booster switches—ON.
- m. Wing flaps lever—extend to LAND position as soon as it is certain landing area can be reached.
- n. Give order to brace 30 seconds before contact.
- o. Hold nose fairly high for landing.
- p. After touchdown, shut down engines No. 2 and No. 3.

CAUTION

Minimum damage should occur by shutting down the engines with the mixture controls. Feathering may result in the engines being torn loose from the mounts when the stopped propellers strike the runway surface.

- q. Mixture levers—Engines No. 1 and No. 4—OFF (on pilot's command).
- r. Fuel tank selector levers—OFF.
- s. Ignition switches—OFF.
- t. All electrical power (batteries, generators, and generator field circuit breakers)—OFF, as soon as possible after contact with ground.
- u. Emergency shut-off levers, engines No. 1 and No. 4—FULL OFF position.
- v. Evacuate aircraft promptly.

NO FLAP LANDING.

When making a no flap approach and landing, the air-speed downwind should be maintained at 140 to 145 knots. Make the turn to base leg so that the final approach will be longer than for normal landing and use 2400 rpm. Speed throughout the base leg and on the final should be maintained at 130 to 140 knots depending upon the gross weight. (Do not exceed maximum gear speed of 145 knots). Flare using power as necessary. Do not allow the plane to float. Fly it on and commence reversing as soon as possible while the speed is high.

FLIGHT CONTROL BOOST-OFF LANDING.**Note**

Arrange the aircraft loading to give a "gear down" CG between 23% and 30% MAC. The forward CG position is limited by inability to flare for landing because of reduced elevator travel (elevator shift lever pulled out to EMER. position). The aft CG position is limited by the possibility of the lack of down elevator in case it is necessary to use full power at low airspeed in rough air.

- a. When possible, reduce aircraft weight as much as practicable.
- b. Propellers—2400 rpm.
- c. Wing flaps to TAKE-OFF position.
- d. Approach at slightly greater speed (130 knots)

than that normally used for boost-on landings. This must be done to counteract the effect of the higher stalling speed with the reduced flap setting, as well as to provide sufficient elevator effectiveness for the flare with the reduced elevator travel. A longer, flatter approach with more power is desirable since a lesser amount of flare and attitude change will be required than with a higher, steeper approach. If difficulty is encountered in flaring, power may be used to pull the nose up.

Note

Ailerons or differential power may be used to raise the wings. Rudders and or differential power may be used for direction control. Turns may be made either with rudder, ailerons, or differential power.

GROUND EVACUATION.

(Refer to Figures 3-3, 3-4.)

Note

On aircraft, serial number 48608 crew ditching positions and emergency landing positions will be assigned prior to flight by pilot in command as aft pullman compartment has inadequate seating for ditching and crash landing procedures as outlined in this section.

PILOT

First Action:

1. Order use of ground evacuation chute following landing.
 - a. Advise personnel of probable attitude of aircraft, nature of landing surface, and possibility of unusual circumstances.
 - b. Remind crew that rear door will be approximately 15 feet above ground if nose wheel has collapsed and forward door will be approximately 17 feet above the ground if tail is on the ground.
 - c. Advise immediate departure of personnel from vicinity of aircraft.

After Landing:

1. Leave wing flaps extended.
2. Proceed to rear of aircraft ensuring prior to leaving aircraft that all passengers and crew have evacuated.
3. Last to exit via rear door. Follow radio operator down evacuation chute.
 - a. Advise crew members that aircraft is empty and that all personnel will remain clear of aircraft.

CO-PILOT

First Action (Following Pilot's Orders):

1. Aid pilot.
2. Insure that evacuation preparations are complete.
 - a. Insure that all crew safety belts and shoulder straps are properly secured.
 - b. Report to pilot that crew is in position and ready for landing.

After Landing:

1. Place all switches in proper position.
2. Proceed to rear of aircraft, follow first engineer down evacuation chute.
3. Proceed clear of aircraft immediately.

FIRST FLIGHT ENGINEER

First Action:

1. Remain in assigned position following instructions of pilot.
 - a. Discuss with pilot the nature of immediate action during the landing.

After Landing:

1. Place all switches in proper position.
2. Proceed to rear of aircraft, follow navigator down evacuation chute. If no navigator aboard aircraft follow last passenger down chute.
3. Proceed clear of aircraft immediately.

SECOND FLIGHT ENGINEER

First Action:

1. Assist flight attendants in stowing all loose equipment.
2. Open and secure all interior doors.
3. Proceed to aft pullman compartment, take aisle seat, on left side of aircraft facing aft.

After Landing:

1. Assist passengers and crew to exit via evacuation chute making certain personnel enter chute in a sitting position and female passengers remove high heel shoes.
2. Follow the copilot down evacuation chute.
3. Proceed clear of aircraft immediately.

NAVIGATOR

First Action:

1. Inspect aircraft and supervise the securing of all

loose equipment where necessary.

2. Report to pilot that aircraft is ready for landing.
3. Take seat in crew compartment, facing aft.

After Landing:

1. Proceed to rear of aircraft and assist any passengers requiring help.
2. Follow last passenger down evacuation chute.
3. Supervise the immediate clearing of the area by non-participating passengers and crew members as they evacuate the aircraft.

RADIO OPERATOR

First Action:

1. Proceed to the aft pullman compartment, take aisle seat on right side of aircraft facing aft.

After Landing:

1. Assist passenger and crew as necessary.
2. Follow second engineer down evacuation chute.
3. Proceed clear of aircraft immediately.

FIRST FLIGHT ATTENDANT

First Action:

1. Brief passengers regarding evacuation procedure and use of evacuation chute. (Pass out blankets and pillows if necessary).
 - a. Passengers to remain seated until instructed to proceed to door.
 - b. Remove high healed shoes, glasses, and all sharp objects from pockets.
 - c. Make orderly exit from cabin. Assume sitting position at chute, feet extended, push themselves into chute.
 - d. Leave vicinity of aircraft immediately.
2. Turn emergency lighting switch on if necessary.
3. Proceed to aft pullman compartment, take aisle seat on right side of aircraft, facing forward.

After Landing:

1. Open passenger door.
2. With help of second flight attendant install and inflate ground evacuation chute according to placard instructions.
3. First to exit from aircraft after evacuation chute is inflated.
4. Assume position on ground at end of chute to assist passengers as they evacuate aircraft.
5. Remain at position until pilot exits from aircraft.

6. Proceed clear of aircraft upon command of pilot.

SECOND FLIGHT ATTENDANT

First Action:

1. Select two able bodied male passengers to follow the flight attendants down evacuation chute; these are the first two passengers to exit aircraft. Brief selected passengers that they will assist at the bottom of the evacuation chute in order to expedite evacuation. Assign selected passengers to seats at rear of aircraft.
2. Check and stow all loose equipment. Remove emergency exits and stow in a safe area.
3. Turn emergency lighting switch on if necessary.
4. Proceed to aft pullman compartment, take aisle seat on left side of aircraft, facing forward.

After Landing:

1. Assist first flight attendant with installation and inflation of ground evacuation chute.
2. Follow first flight attendant down the evacuation chute.
3. Assume position on ground at end of chute to assist passengers as they evacuate the aircraft.
4. Remain at position until pilot exits from aircraft.
5. Proceed clear of aircraft upon command of pilot.

EMERGENCY ENTRANCE.

If it is necessary to enter the aircraft to rescue trapped personnel, open the emergency exits or the aft cabin door, all of which are operable from inside and outside. Otherwise, it is necessary to chop through the fuselage at one of the marked cut-in-areas.

DITCHING AND SURVIVAL.

Note

On aircraft, serial number 48608 crew ditching positions and emergency landing positions will be assigned prior to flight by pilot in command as aft pullman compartment has inadequate seating for ditching and crash landing procedures as outlined in this section.

GENERAL.

The procedures and instructions given herein are based on the results of tests conducted on a scale model of the airplane by the NACA in the Langley Aeronautical Laboratory, and on the experiences of military personnel who have successfully ditched large four-engine airplanes.

In order to insure an orderly operation in case of an emergency requiring ditching, periodic drills should be held with all crew members participating. Knowledge

of all equipment locations and the duties of the other crew members is essential for each person, so that in case of injury to one, his duties may be re-assigned to another.

Ditching cards outlining specific duties will be posted near each crew member's duty station. This card serves as a check list, provided time permits. It will allow each crew member to review his duties on the ground or in the air. It may be used by supervisory personnel to check on the knowledge of crew members during ditching drills. It should be pointed out to all crew members that ditching cards list the most essential duties, in the sequence of importance and in consideration of the time element. The responsibilities of the crew member do not end with the completion of the duties specified on the ditching card. The measures to be taken after ditching to ensure survival until rescue vary considerably depending upon the nature of the emergency which necessitated the ditching and the success of the ditching itself.

The utilization of 20-man life rafts provides a number of advantages. There is a definite reduction in overall weight when compared to the number of small rafts which must be carried to accommodate the same passenger load. There is an overall reduction in space required for stowage. The size of the raft, its construction, and its emergency equipment content are definite advantages in the open sea. The general acceptance of the 20-man life raft places it in the category of standard equipment. Ditching procedures are therefore based upon the 20-man raft. In the event that life rafts with a capacity other than 20 men are utilized, the unit concerned will be responsible for the proper assignment of crew personnel and duties. These assignments will be consistent with the procedure specified herein and will be governed, basically, by the number and types of rafts installed.

Additional crew members may be handled as passengers; however, it is recommended that they be assigned to a crew member to assist in performing duties designated by the pilot or crew member concerned. Additional crew members who are familiar with or qualified in any crew position can be particularly useful.

Prior to each overwater flight, the pilot or his designated crew member representative will determine that the following equipment is on board and is properly stowed:

- a. Life rafts — Adequate to accommodate the maximum cabin capacity plus maximum crew complement.
- b. Life vests — A minimum of one life vest will be aboard for each person.

Note

For aeromedical evacuation requirements, consult directives in effect.

Basic emergency equipment, other than life rafts and life vests, will be placed aboard in the quantities specified in the directives of the major air command concerned. Additional equipment will be placed aboard in consideration of the areas involved and at the discretion of lowest echelon of command to which such authority is delegated.

COMMUNICATION.

A ditching may be highly successful; however, the possibility of surviving until rescued will be greatly reduced unless it is known that you are in distress. *It should be remembered that the necessity for ditching an aircraft is usually the result of more than one difficulty or emergency condition. Therefore, whenever you are in trouble, the most intelligent thing to do is to advise a station, ship, or other aircraft of your problems and intentions. Any message may be amplified or cancelled by another message.* This should be done on the same frequency to insure that the stations originally intercepting a message may take necessary action to continue or discontinue their efforts in your behalf.

The first transmission of a distress message should be on the assigned air-ground frequency. This is applicable on VHF, UHF, HF, Voice or CW, and when flying on airways, advisory routes, or uncontrolled routes over land or water. If acknowledgment is received, do not change frequency until directed to do so or unless a change in condition warrants such action.

In aircraft equipped with dual HF equipment, one set can be shifted to another frequency, preferably 8364 kilocycles. If contact is not established on the assigned air-ground frequency, utilize 8364 and call any ship, station, or aircraft. Should this prove unsuccessful, shift to 500 kilocycles and transmit in the blind to any or all stations. After the first call on 500 kilocycles, precede all subsequent calls with the automatic alarm signal of twelve 4-second dashes with intervals of 1 second between dashes, i.e., 4 sec 1 sec, 4 sec 1 sec, 4 sec 1 sec, etc. This signal will automatically sound an alarm on all ships at sea. This system is employed on ships when the complement of radio operators does not allow continuous 24-hour coverage. The radio operator is berthed near the alarm and is therefore alerted when the alarm is activated by the above signal. The frequencies referred to above are a few of the many frequencies which can be employed in establish-

crew ditching stations

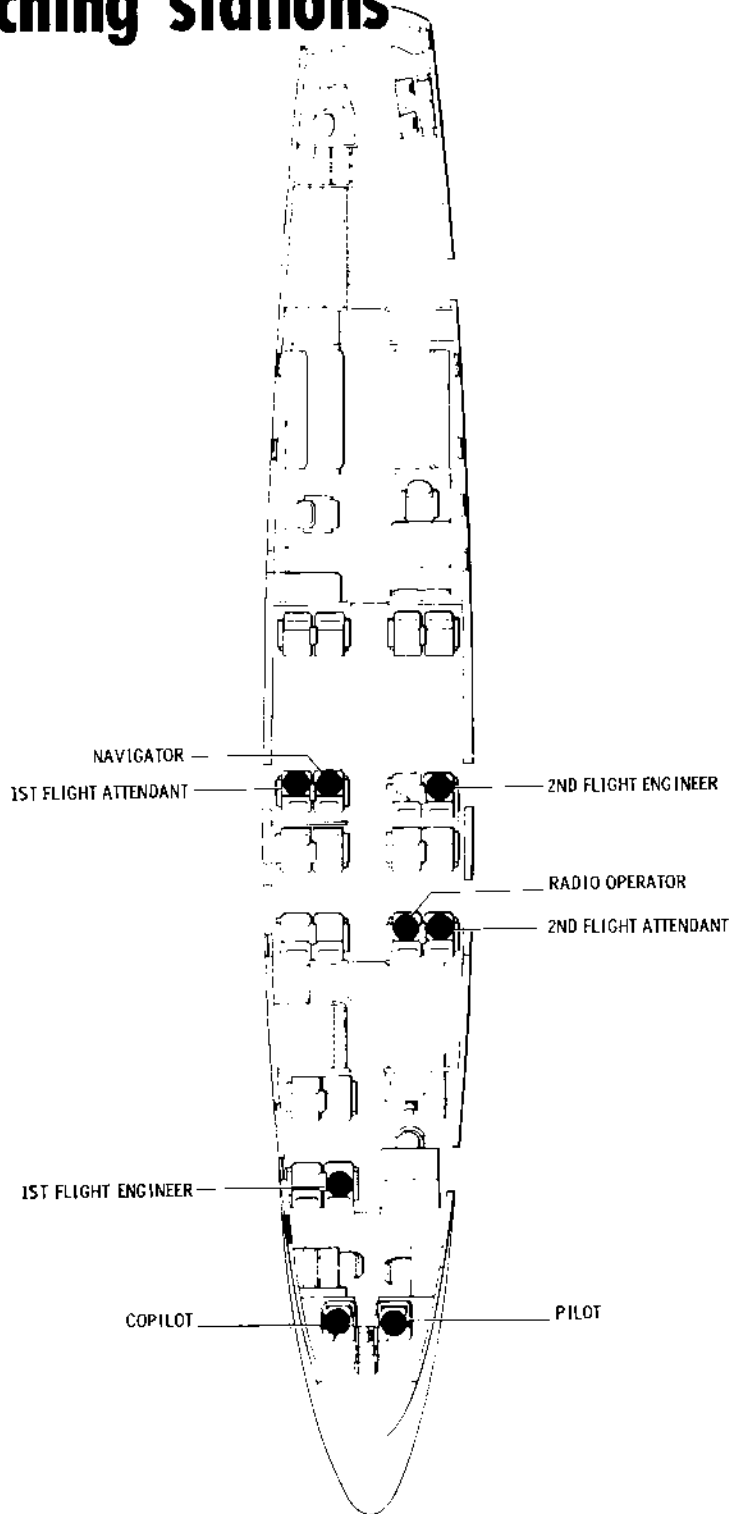

Figure 3-5

F125-1-3-18

emergency escape routes—water

NOTE

DAMAGE TO, OR POSITION OF AIRCRAFT WILL DICTATE BEST ROUTES TO BE USED.

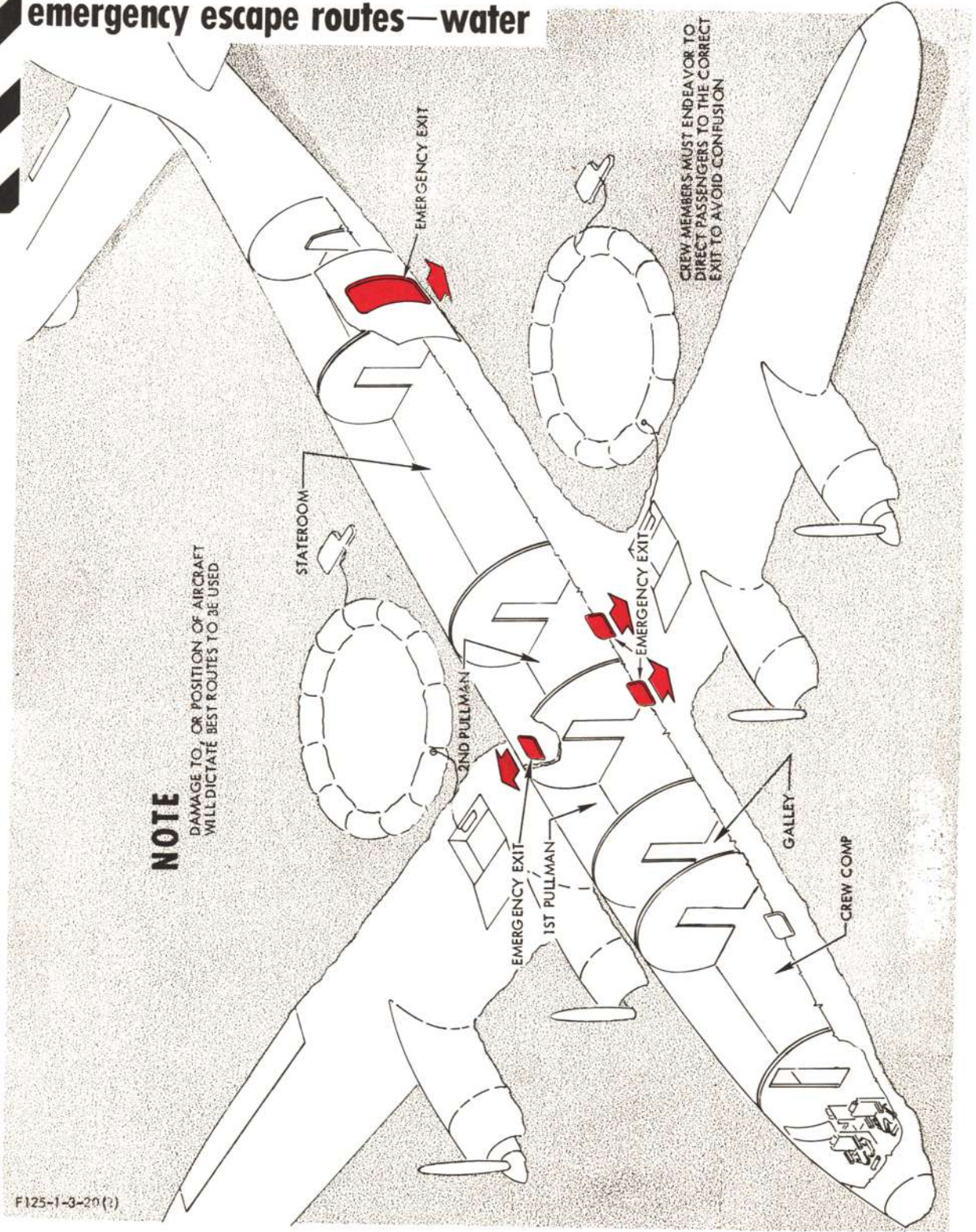

F125-1-3-20 (?)

Figure 3-6

ing contact with rescue facilities. *Current procedures and frequencies are listed in the Supplementary Flight Information Document and Radio Facility Charts for the area concerned.*

Serious consideration should be given to establishing communications with the nearest ocean station vessel at the earliest opportunity. These vessels guard 8364 kilocycles and 500 kilocycles in addition to a number of other frequencies, including UHF. Provided the aircraft can establish contact and reach the ocean station vessel, the possibility of a successful ditching is excellent. This course of action is highly recommended. Ocean station vessels are equipped to provide a modified radar approach, bearing and distance information, illumination of the ditching area, the conditions of the sea, distance between swells, the recommended ditching heading, weather conditions, and rescue boats. These vessels will take immediate action to close the distance between the aircraft and the vessel when a distress message is received or intercepted.

When an airfield or ocean station vessel cannot be reached, the heading should be altered to intercept the nearest surface ship. In this regard it is recommended that ship positions be obtained prior to an overwater flight. By plotting the ship's position, course, and speed, an intercept heading can be computed to the nearest ship.

Consult the Supplementary Flight Information Document and Radio Facility Chart for current procedures for alerting rescue facilities with partial or complete loss of communications.

PREPARATION FOR DITCHING. (Figures 3-5 and 3-6.)

When a decision has been reached, *immediate steps will be taken to transmit the distress message and to advise all crew members and passengers of the pilot's intentions.*

Instructions will be issued to appropriate crew members concerning methods for jettisoning cargo equipment and fuel. This matter can normally be covered prior to a flight. When the aircraft is used as a personnel transport, the gross weight cannot be greatly reduced, except for the possible jettisoning of fuel. In case cargo is to be jettisoned, the crew members concerned will be securely fastened to the aircraft. The length of the securing line should allow movement, but not beyond the cabin door. It will probably be advisable to station one man on each side of the door.

In jettisoning cargo or equipment, serious consideration must be given to the possibility of the loss in structural

strength incurred by jettisoning the door.

By dumping or consuming fuel, buoyancy will be improved. A reduction in weight will reduce the forward momentum after touchdown. This will provide for a shorter deceleration period and a reduction in impact force. A short runout or deceleration distance is particularly important in the Atlantic, since the distance between swells is usually less than that in other waters.

The initial stowage and subsequent relocation of equipment for ditching may have a profound effect on the possibility of survival. Emergency equipment and life rafts in particular should be dispersed throughout the cabin. The importance of this matter has been proven in aircraft wherein the rear section parted upon ditching and the emergency equipment was lost. When a particular configuration does not lend itself to a stowage plan which provides for adequate dispersal, a plan should be developed for relocation in flight. *All loose equipment should be securely fastened to prevent injury to personnel by flying objects. This is particularly true of food and water containers, portable lights, stores, temporary tables, and navigator tables.*

Do not conduct an evaluation of sea conditions at extremely low altitudes, except at night when flares are not available or information cannot be obtained from surface vessels, etc. This is important since there are usually two or more swell systems in the open sea. Combined with the height of the swell, currents, and wind conditions, the sea will appear confused at low altitude. The primary swell is more apparent at altitudes between 1000 and 1200 feet, depending upon light conditions, etc. After selecting a ditching heading based upon a reasonable sea evaluation, the heading should not be altered more than 10 degrees. Serious consideration should be given to the relationship between swell and wind direction. There are times when a landing parallel to the swell may be accomplished in a crosswind of more than 30 knots. An actual ditching of a C-54 alongside an ocean station vessel was accomplished in a crosswind of approximately 40 knots. In this instance, the swell and wind movement were in the same direction. It is interesting to note that in this ditching, a second impact did not occur. The following information should be carefully studied in order to conduct a sea evaluation prior to ditching.

Definitions.

Sea—A wave, or undulating motion, caused by local disturbance.

Swell—A wave, or undulating motion, caused by a remote disturbance.

Length of swell—The horizontal distance from the crest of one wave to the crest of the adjoining wave.

Height of swell—The vertical distance between the trough and the crest of a wave.

Period—The time in seconds for the crest of two adjacent waves to pass a given point.

When the probability of a ditching exists, every effort should be made to determine the direction of the swell, the length and height of the swell, the period and velocity of the swell, and the wind direction and velocity. The swell is the primary factor in evaluating the sea for ditching since it normally is the greatest force or factor. In the event that essential information is not available through a ship or station, the sea may be evaluated through the use of smoke or light flares. By timing the rise of the flare to the crest of two adjacent swells, a period is determined. Usually the period is determined as an average of the time over five swells. *When a period has been determined, the length and velocity can be calculated from the formula L equals $5P^2$ and V equals $3P$, when L equals length in feet, P equals period in seconds, and V equals velocity in knots.* The height of the sea will be very difficult to estimate from the aircraft. The following information will be helpful in the Atlantic Ocean. The average swell has a slope of 1 to 14 and runs 6 to 8 feet in height. The maximum height seldom exceeds 10 to 12 feet. The length of the swell will average about 125 feet. It should be emphasized that the sea must be evaluated at 1000 to 1200 feet in order to determine the direction of primary swell. At higher or lower altitudes, it is almost impossible to observe the primary swell system. The wind can be determined by flying parallel to the wind streaks on the surface and solving the 180-degree ambiguity by watching the white caps. The white caps will break into the wind; however, the spray will be carried downwind.

The following is noted as an aid to determining surface wind velocity:

No white caps—0 to 9 knots.

Few white caps—9 to 18 knots.

Many white caps—25 to 35 knots.

Many white caps with spray—35 knots.

When the sea evaluation has been completed, the pilot is in a position to decide upon a ditching heading. There are three major ditching possibilities. Given the following conditions, we can then further evaluate ditching possibilities: P (period) equals 10 seconds; L equals 500 feet; velocity equals 30 knots; then the

runout average is 600 feet in 8 seconds (determining period mathematically, L equals $5P^2$ and V equals $3P$, as previously explained).

Ditching Into Swell.

In this instance, the swell moves toward the aircraft at the rate of 30 knots or approximately 260 feet in 8 seconds, so that the effective distance between swells would be only 240 feet (L equals 500 feet—260 feet, or 240 feet) and the aircraft tends to nose into the swell. This course of action is not recommended and should be avoided when possible.

Ditching Down Swell.

In this instance, the swell moves with a velocity of 30 knots in the same direction as the aircraft. The aircraft is touched down with the receding swell and realizes an effective distance of 760 feet to come to rest. This is practical where the swells are far apart. This approach is not normally recommended in the Atlantic with its short swells.

Ditching Cross Swell.

The third major condition is to ditch cross-swell. This is a practical and recommended procedure. This procedure will usually provide a crosswind so that crabbing is necessary. Do not lower the wing more than is necessary. Ditching crosswind can be made in the trough, parallel to the swell or on the receding (back) side of the crest, parallel with the swell. The sun should be kept at the pilot's back when practical and altitude should be maintained by reference to the swell rather than the horizon. Do not attempt to land on the face of a rising swell. The existence of a wind may create a sea condition, as well as a swell system. If a wind and swell oppose each other long enough, the swell will decrease. If the wind and swell are at right angles, a normal trough is provided, and ditching can be made into the wind as well as parallel to the swells. In the average condition, the wind and swells are moving in the same direction, so that ditching parallel to the swell provides a crosswind. The following criteria have been established to aid the pilot in determining the effect of wind on the ditching pattern:

- a. Winds from 0 to 20 knots — Land parallel with the major swell and down swell to the secondary swell system.
- b. Winds from 20 to 35 knots — This is a difficult area for decision, wherein the best choice appears to be a heading at an angle to the wind line and slightly cross swell.
- c. Winds over 35 knots — Head into the wind. The reduction in ground speed due to a high wind will improve the overall ditching problem.

Landing Technique.

Landings should be made parallel to the swell and near the crest, unless there is a very strong crosswind. If the wind is above 25 knots, the landing should be made into the wind and contact should be made on the upslope of the swell, near the top. The optimum configuration for landing a Constellation on water is: flaps fully extended, landing gears retracted, with a medium nose-high attitude. (corresponding to about 83 knots at 84,500 pounds gross weight). If available, power should be used to flatten the approach and control the point of contact. In case the airplane bounces on first contact, the nose should be held up by using full-up elevator.

Aircraft weight should be reduced as much as possible by dumping fuel, if practicable. This not only serves to reduce the stalling speed, but also aids in flotation. The dump valves must be closed after fuel is dumped.

The cabin should be depressurized to facilitate the opening of hatches after landing; however, after pressure is dissipated, all openings in the bottom of the fuselage should be closed, if possible, including the auxiliary ventilating exit valve. Further pressurization can be prevented by opening the astrodome, the cockpit door scanning disk, and the emergency exit hatches over the wings.

Because of the probability of landing with tail low, it is recommended that the cabin door be kept closed during the landing. The emergency exit windows over the wings may be removed prior to impact. All other emergency exit locks should be released, but the hatches left in place. The astrodome may be removed for use as an additional escape opening.

Shoulder straps will greatly reduce the possibility of personal injury to crew members. When installed, these straps must be worn during ditching. Although rearward and forward-facing seats are designed for the same stress (6 to 9 g's), there are advantages in the rearward-facing seats. A normal sitting position with the back and head against the seat, in an upright position, eliminates the seat belt and bracing problems common to forward-facing seats. When seats are not available, personnel should be seated in rows of three, bobsled fashion facing the rear of the aircraft, with the back of the forward man braced against a bulkhead (wall). Where forward-facing seats are utilized, the seat belt should be fastened tight and low on the hip bones and with the head down and braced on the knees. An alternate position would be with the head braced on the back of the seat immediately in front.

The average transport aircraft should stay afloat at least 3 minutes. Ditching drills and procedures should therefore be designed to evacuate the aircraft in 3 minutes. The average floating time of aircraft has been between 5 and 12 minutes. The floating time is basically influenced by the amount of fuel in the tanks, amount of fuselage damage, and the amount of cargo on board.

SURVIVAL. (Figure 3-6.)

Survival action begins when the aircraft comes to rest. The first engineer is responsible for preparing the two twenty-man life rafts for launching. He accomplishes this by pulling the raft handles located on the 260 bulkhead under the step at entrance to crew compartment. By pulling the raft handles, the wing well doors will unlock and the rafts will inflate, causing them to be forced out of the well onto the wing surface. In event the rafts do not inflate, the personnel responsible for securing raft to aircraft by rope, will manually inflate rafts by pulling the inflating cord.

The rafts must be launched over the wing, so great care should be taken when sliding the raft into the water. The flaps may be carried away upon ditching. This would leave jagged metal edges which may cause considerable damage to the rafts. It may be necessary to launch rafts outboard of the flap area. When rafts are loaded, a check should be made to ascertain that all personnel are accounted for.

At night, display lights to enable any missing persons to locate the rafts. As soon as possible, check survivors for injuries and administer necessary first aid.

An important item aboard the raft is the Gibson girl transmitter. As soon as practical, the antenna should be raised and the unit placed in operation. Do not rush the period of inflation for the balloon utilized to raise the antenna. It will normally require 30 minutes to fully inflate this antenna balloon. When fully inflated, the balloon is capable of sustaining the full length of the antenna in reasonably high wind. The minimum recommended diameter of the balloon is 40 inches. Do not kink the antenna. Use the instructions and check-off list which accompany this equipment. Prepare distress signal messages for immediate use. It is recommended that the first signal be used for actuating the automatic alarm on surface ships on 500 kilocycles. Shift the transmitter to manual and transmit twelve 4-second dashes with 1-second intervals between dashes. This signal may be repeated between messages transmitted on other frequencies. Remember that the Gibson girl is energized by hand cranking and may therefore be

used continuously. Rotate this duty among personnel aboard the raft.

An effort should be made to insure that spare portable URC-4 radios are carried into the raft. This equipment is battery operated and is limited in range to line of sight. Conserve this equipment until rescue parties are in the vicinity or aircraft are observed in the vicinity.

Remove other distress signals from the accessories kit for ready use. Distribute signals among personnel aboard the raft and assign responsibility. After removing equipment from the accessory kit at any time, insure that it is closed and remains attached to the raft. In this manner, equipment will not be lost should the raft overturn. The signalling mirror can be effectively used even though aircraft are not in sight. It is possible to attract the attention of aircraft at a distance of 30 to 40 miles. In order to establish the sighting point, flash the light onto the raft and align. Next sweep the horizon for maximum distance to signal an aircraft or ship in the vicinity, establish the sighting point as outlined above, and aim directly at aircraft or ship. Conserve flashlight batteries and smoke flares.

Carry exposure suits into the raft if not worn at the time of ditching. Put the suit on over wet clothes if necessary. The exposure suit can be useful for many purposes other than protection from exposure; e.g., it may be cut into strips to fashion slit goggles, to bind splints, etc.

As early as practicable, equipment should be set up to collect and manufacture water. The equipment aboard the raft includes solar stills which require some time to make water. Chemical desalting kits are also included. The kits are a positive means of obtaining drinking water and should not be used until all other means for obtaining water are exhausted. The taste of water can be improved by utilizing the purification tablets contained in the ration kits. The canopy should be used to trap water during periods of rain. The canopy cover should be installed to provide exposure protection from extremes of cold and heat and to attract attention. One side of the canopy is fluorescent red in color and is visible at considerable distance, depending upon sea and light conditions. Other important means of exposure protection from the cold are the wearing of the anti-exposure suit over all possible clothing and keeping as dry as possible. Protection from the sun can be accomplished by keeping the body covered and applying protective ointment to exposed areas. The opposite side of the canopy is blue in color, and is used primarily for camouflage purposes.

20-Man Raft.

The following information concerns the operation of the 20-man raft.

All inflation valves and other appurtenances attached to the raft are identified by placards so that their functions may be easily understood.

CO₂ Inflation.

Only the main tubes of the raft are inflated by carbon dioxide equipment. The boarding section of both the upper and lower tubes is not inflated by CO₂.

Manual Inflation.

The uninflated chambers, one in each main tube, and the blister in the center of the floor, must be inflated manually. Placards adjacent to the valves indicate the chambers or sections to which they lead.

Sea Anchor.

The sea anchor is tied to the raft and, when trailing in the water, retards the drift of the raft. The position of the raft relative to the direction of the wind can be changed by moving the sea anchor attachment to another position of the raft. The raft is always downwind from the sea anchor.

Operating Instructions For 20-Man Raft.

The rafts are circular in shape and consist of twin tubes assembled one above the other. The round shape gives the most room for the least weight and span and is also most stable. The deck is placed between the two tubes and insures the raft's being right side up no matter how it comes out of the aircraft, it being the same on either side. The reason for this construction is the impracticability of righting a large capsizable raft.

Deck.

The deck, which is between the two tubes, traps air underneath it and makes a warmer and more comfortable seat for passengers. In order to prevent sagging of the deck, there is an inflatable section in the center which is inflated by the hand pump furnished with the raft.

Buoyancy.

The flotation is more than double that normally required. With a full load, only 80 per cent of one tube is submerged. The tubes are independently airtight with the equalizer in place. If by accident the raft should be punctured, it can be quickly repaired by a Schrader leak plug, several of which are available in the accessories container.

Inflation.

A steel cylinder of carbon dioxide gas inflates both tubes in a few seconds. Jerking on the PULL handle actuates the valve on the cylinder, releasing the gas into the raft. The raft gets very cold, because of the expansion of gas, and in some spots may freeze hard and deposit snow which will soon thaw out. The raft will also grow more firm as it warms the gases. A small section of each tube remains uninflated and is blocked off by bulkheads. These sections are called boarding stations, and make it necessary to climb over the upper tube.

Operation After Boarding Raft.

Two accessory containers are stowed in the rear of aircraft opposite the main entrance and are placed in each raft by the responsible personnel. Each container carries the following items:

- 1 Pump
- 1 Repair Kit with Pliers
- 5 Plastic Water Containers
- 1 Fishing Kit
- 1 Knife Assembly
- 1 Survival Manual
- 1 Nonliquid Compass
- 2 Sunburn-Preventive Cream
- 4 Chapping Lipsticks
- 1 Nylon Cord, 30 feet
- 4 Distress Signals
- 1 URC-4 Emergency Radio
- 1 Canopy Plus Mast and Poles
- 1 Bailing Bucket
- 2 Cellulose Sponges
- 2 Mattress Valve Washers
- 1 Emergency Signaling Mirror

- 6 First Aid Kits, Individual
- 12 Seawater Desalting Kits
- 2 Seawater Distilling Kits
- 8 Survival Rations

Remove the pump from the accessories container. To use the pump, screw the hose into the valve caps, open the valve caps two turns, then pump up the raft and close the valves. Ten valves are located in the raft, five on either side. These valves service the upper and lower tubes, the upper and submerged boarding stations, and the submerged deck compartment. The valves for submerged parts of the raft are accessible through sleeves in the deck. The boarding station should be inflated to gain added buoyancy and to close the gap in the tube. The submerged deck support in the middle of the raft should then be inflated. Main tubes should not be allowed to become too taut (remedy this situation by letting air escape from the valves). The action of cold water on the tubes at night may cause the tubes to become flabby, but additional air can be pumped in by means of the hand pump. Leak repair clamps are available in the accessories container, if leaks become apparent. The raft is equipped with an equalizer tube to equalize the pressure in both tubes. The equalizer tube has a shutoff valve, which is open at initial inflation. *This valve should be shut off after CO₂ has penetrated the tubes to prevent loss of CO₂ in case of a leak in either tube.*

The canopy carried in the accessories container is designed to protect occupants from sun and weather exposure. The canopy has 12 supporting rods and a canopy mast. The lower edge of the spray shield has an elastic cord threaded through it, the two ends of which can be snapped together. After snapping the cords together, the canopy should be stretched over the sides of the raft until the cord rests in the hollow between the top and bottom tubes. Next, erect the canopy mast on the center support from which to hang the canopy. Two sockets are provided for this purpose, one at the top of the canopy, and one in the center support of the raft, which is folded down on the deck. The shield can then be supported by the 12 tube supports which fit into small sockets on the deck and into sockets at its upper side. The canopy and spray shield are then snapped together. Either the spray shield or the canopy can be opened for ventilation. The canopy and spray shield fits either side of the raft. After the canopy is erected, the sea anchor should be put out to hold the raft steady and decrease drift.

DITCHING PROCEDURES

PILOT

First Action

1. INITIATE DISTRESS CALL

The pilot will evaluate the situation and order the radio operator and copilot to start emergency radio procedures.

2. ALERT ALL PERSONNEL ON BOARD

The PA system will be used and a briefing will be given to the passengers and the crew as to what type of action you are contemplating. Briefing should include approximate time remaining.

3. PERSONAL PREPARATION

Don a life vest. Fasten the shoulder harness and lock it in a position so that the shoulders are tight against the back of the seat. Loosen tie and collar. Remove glasses and any sharp objects from your clothing. Insure possession of adequate flashlight.

4. AIRCRAFT PREPARATION

Order fuel dumping and jettisoning of excess baggage as necessary to increase flotation. Assign additional crew members or passengers to assist as required. Order depressurization when practicable.

Ditching Imminent.

1. ORDER CREW TO STATION

When it is determined that you must ditch and crew assistance is required, you will issue the order for all crew members to take their ditching positions. Order copilot to send final distress message.

2. FINAL WARNING

A final warning will be given over the PA system just before impact

After Ditching.

1. CHECK CABIN—LAST OUT

When aircraft comes to rest, proceed to the rear of the aircraft. Check that no personnel are left on board the aircraft and exit out the forward left emergency exit. You will take command and assume responsibilities for survival discipline.

CO-PILOT

First Action

1. SET IFF ON EMERGENCY

Red button on IFF control must be depressed to rotate the master switch to EMER position which activates automatic Emergency transmissions. Following instructions of the pilot you will transmit on either 121.5 mcs (VHF) or 243 mcs (UHF) emergency message containing — coordinates and time of position, magnetic course, altitude, true airspeed, nature of emergency and pilot's intentions.

2. PERSONAL PREPARATION

Don a life vest, loosen tie and collar, remove glasses and sharp objects from clothing. Fasten shoulder harness and lock it in a position so that the shoulders are tight against the back of the seat. Take control of aircraft while the pilot prepare for ditching.

Ditching Imminent.

1. ASSIST PILOT

During the final few moments prior to landing it will be your duty to assist the pilot as necessary. Have a suitable flashlight readily available.

Ditching station:

1. CO-PILOT'S SEAT

After Ditching.

1. ASSIST PILOT

Assist pilot if necessary, assist passengers out emergency exits.

2. EMERGENCY EXIT

Exit out the aft left emergency exit, following last passenger.

NAVIGATOR

First Action.

1. GIVE POSITION TO FIRST PILOT AND RADIO OPERATOR

The navigator's first concern is to get pertinent information to the first pilot and radio operator for immediate transmission. This information will include:

- a. Coordinates and time of position
- b. Magnetic Course
- c. Altitude
- d. True Air Speed
- e. Nature of Emergency

2. SWEEP WITH RADAR

- a. Ascertain APS-42 is on and operating.
- b. Search on 30, 100, and 200 mile sweeps respectively.
- c. Note the course and distance to any island or surface vessel spotted.

3. GIVE THE PILOT THE COURSE AND TIME TO NEAREST AID

The nearest aid may be a ship, an island, or the original destination. Give the following information to the pilot in clear, concise form so that he can make a prompt decision:

- a. Course
- b. Elapsed Time
- c. Sea Condition
- d. Surface Wind

4. DON ONE URC-4 RADIO

The URC-4 radio is located in the metal cabinet on the wall to the left of the navigator's seat. The URC-4 radio *must* be put on before the life vest.

5. PERSONAL PREPARATION

- a. Don life vest over URC-4 radio vest. The life vest will be distributed by the second engineer as his first action after the pilot's declaration of an emergency.
- b. Loosen tie and collar.
- c. Remove sharp objects from clothing.

It is not advisable to take the sextant or bulky navigation equipment from the aircraft for aid will reach you more quickly if you stay near the place of ditching.

Ditching Imminent.

1. REMOVE ASTRALDOME AND STORE IN FORWARD LAVATORY

- a. Be sure the cabin is depressurized.

The astraldome is removed by breaking the safety wire and pulling in on the handles. The dome comes down into the cabin after it has broken loose from the seal.

2. ASSURE ESCAPE HATCHES ARE REMOVED AND STOWED

The second engineer should have removed and stowed the escape hatches while the navigator was removing the astraldome. Upon reaching his ditching station the navigator will check to insure that this action has been accomplished.

3. Select an able bodied male passenger to assist in passing emergency equipment to the raft. Brief selected passenger and assign him a seat near the emergency exit.

Ditching Station.

1. AFT PULLMAN COMPARTMENT RIGHT SIDE—AISLE SEAT—FACING AFT

Assume ditching position—fasten seat belt—brace for impact.

After Ditching.

1. HAND OUT EMERGENCY EQUIPMENT

After the first flight attendant is out on the wing, pass the ditching rope to him. Pass the CRT-3 (Gibson girl) emergency radio and other emergency equipment to the flight attendant or passenger after the ditching rope has been secured. Check that emergency water, first aid kits, etc. have been passed through the emergency exit. Assist passengers as necessary.

2. ASSURE CABIN EVACUATED OF PASSENGERS

Check the main cabin to make sure all passengers have left the aircraft.

3. EXIT OUT—RIGHT EMERGENCY EXIT

Follow the last passenger from the aircraft and assume command of the raft. As soon as it is practicable he will attempt to tie to the other life raft.

RADIO OPERATOR

First Action.

1. PLACE IFF ON EMERGENCY POSITION
2. MAKE INITIAL DISTRESS CALL
 - a. On voice MAYDAY, on CW SOS (3 times).
To be used as applicable.
 - b. Airplane call and sign (3 times.)
 - c. Type of airplane.
 - d. Position and time.
 - e. Magnetic Heading.
 - f. True airspeed.
 - g. Altitude.
 - h. Nature of emergency.
 - i. Pilot's intentions.
 - j. Two ten second periods with microphone button or key depressed.
 - k. Call sign of airplane (once).
 1. On voice OVER, on CW K.
Continue sending position and other pertinent traffic information until ditching is imminent.
3. DON URC-4 RADIO
The URC-4 radio is located in the metal cabinet on the wall to the left of the navigator's seat. The URC-4 radio *must* be put on before the life vest.
4. PERSONAL PREPARATION
 - a. Don life vest over URC-4 radio.
The life vest will be passed to you by the second engineer as his first action, after the emergency has been declared.
 - b. Loosen tie and collar.
 - c. Remove sharp objects from clothing.

Ditching Imminent.

1. Lock key on frequency in use.
2. Select an able bodied male passenger to assist in passing emergency equipment to the raft. Brief selected passenger and assign him a seat near the emergency exit.

Ditching Station.

3. FORWARD PULLMAN COMPARTMENT LEFT AISLE SEAT—FACING AFT

Before assuming ditching position assure that the two CRT-3 emergency radios (Gibson girl) are in position; one near the left forward emergency exit and one near the right emergency exit.

After Ditching.

1. HAND OUT EMERGENCY EQUIPMENT

After the second flight attendant is out on the wing, pass the ditching rope to him. Pass the CRT-3 (Gibson girl) emergency radio and other emergency equipment to the flight attendant or passenger after the ditching rope has been secured. Check that emergency water, first aid kits, etc., have been passed through the emergency exit. Assist passengers as necessary.

2. EXIT OUT—LEFT FORWARD EMERGENCY EXIT

Follow the last passenger out the exit and assure that CRT-3 (Gibson girl) is put aboard life raft and board raft.

FIRST ENGINEER

First Action.

1. PERSONAL PREPARATION
Loosen necktie and don life vest.
2. DEPRESSURIZE—DISCONNECT CABIN SUPERCHARGER
 - a. Depressurize cabin using pressure regulator override switch to open regulators.
 - b. Open auxiliary vent knob, when cabin pressure is down to 2" Hg differential pressure.
 - c. Disconnect cabin superchargers when cabin differential pressure is 0" Hg.
3. INFORM PILOT OF CONFIGURATION
 - a. Fuel dumping time.
 - b. Weight of airplane.
 - c. Stall speed for ditching configuration (gear up, flaps down).

Ditching Imminent.

1. SET PANEL FOR DITCHING
 - a. Mixtures—RICH
 - b. Fuel pumps—HIGH
 - c. Prop sync lever—2400 rpm
 - d. Throttle lock—OFF
 - e. Cowl flaps and oil cooler flaps—AS REQUIRED
 - f. Set remainder of panel as required by pilot.

Ditching Station.

1. Flight engineer's seat facing aft. Slide seat up against desk and secure. Assume ditching position. Fasten seat belt. Brace for impact.

After Ditching.

1. PULL RAFT HANDLES
2. ASSIST PILOTS
Assist the pilots as necessary.
3. EXIT OUT—RIGHT EMERGENCY EXIT
Follow the navigator.

SECOND ENGINEER**First Action.**

1. **DISTRIBUTE LIFE VESTS TO CREW AND URC-4 RADIO TO RADIO OPERATOR**
 - a. Distribute vests to both pilots, radio operator, engineer at panel and navigator.
 - b. Take URC-4 radio from rack on navigator's wall and give to radio operator.
2. **STOW ALL LOOSE EQUIPMENT — SECURE DOORS**
 - a. Stow and secure all loose equipment throughout the aircraft.
 - b. Secure all doors by jamming them open so they will not close on impact.
3. **STOW EMERGENCY EQUIPMENT NEAR EMERGENCY EXITS**
 - a. Pick up CRT-3 (Gibson girl) and stow one radio between the seats by the forward left emergency exit and one by the right emergency exit.
 - b. Stow emergency kits at right and left exits.
 - c. Secure equipment for impact.
4. **EMERGENCY CABIN LIGHTS ON**
 - a. Turn lights ON and check for operation.
5. **PERSONAL PREPARATION**
 - a. Loosen necktie.
 - b. Don life vest.

Ditching Imminent.

1. **REMOVE AND STOW EMERGENCY HATCHES**
 - a. Stow hatches in forward lavatory.

Ditching Station.

1. **AFT PULLMAN COMPARTMENT LEFT SIDE — WINDOW SEAT — FACING AFT**
 - a. Assume ditching position. Fasten seat belt—brace for impact.

After Ditching.

1. **FIRST MAN OUT—SECURE ROPE TO GAS TANK CAP**
 - a. Remove ditching rope from container (making sure one end is secured to aircraft).
 - b. Take other end of rope out and secure to inboard main fuel tank cap.
2. **ASSURE LIFE RAFT IS READY FOR BOARDING**
 - a. Make sure raft is inflating properly, and is secured to the aircraft by a rope.
 - b. Receive emergency equipment from flight attendant and put in raft.
 - c. Help passengers into raft.
 - d. Last man into raft.

FIRST FLIGHT ATTENDANT**First Action.**

1. **ASSIST PASSENGERS WITH PREPARATION**
 - a. Assist passengers to don life vests.
 - b. Advise passengers as to ditching position. Remove sharp articles from pockets such as pens and pencils, remove spectacles, remove tie and loosen collar. Show passengers how to protect head with hands and arms.
2. **PREPARE CABIN FOR DITCHING**
 - a. Prepare cabin by securing all loose equipment. Remove all loose equipment from cabin such as baggage, dispatch cases, tables, serving equipment or

Ditching Station.

1. **AFT PULLMAN COMPARTMENT, RIGHT SIDE—WINDOW SEAT—FACING AFT**
 - a. Assume ditching position. Fasten seat belt—brace for impact.

After Ditching.

1. **FIRST OUT—ASSURES RAFT IS READY FOR BOARDING**
 - a. Remove assist rope from pouch beneath emergency exit, pass the rope through the handle of the inboard main fuel tank and secure it.
 - b. Determine that raft has been released and inflated. If raft has not released pry open raft well with tool attached to assist rope, and inflate raft by pulling lanyard on raft bottle.
 - c. Position raft for boarding by passengers, maintaining raft in position with assist rope. Avoid contact between raft and any portion of aircraft which may have been torn or damaged in landing.

CONTINUED

FIRST FLIGHT ATTENDANT

(Continued)

anything that may cause injury. Stow in rear lavatory or closed cabinets and compartments or jettison as directed.

3. STOW EMERGENCY EQUIPMENT

- a. Collect equipment needed on raft and stow at ditching station. Remove one raft kit from stowage and place on floor at your ditching station. Secure kit to seat legs. Stow emergency water and food as space permits at your ditching station.
- b. Be prepared to jettison unnecessary equipment, if instructed, such as parcels, baggage, hooks, ladders or anything which may obstruct aisles, doors or escape routes or may cause injury.

4. PERSONAL PREPARATION

- a. Prepare your person for ditching, don life vest, and remove articles as specified for passengers.

- d. Assist passengers and crew in boarding raft.
- e. Assist others in loading raft kit, emergency water, rations, blankets, etc., on raft.
- f. Release or cut life raft lanyard from aircraft structure.
- g. Assist in moving raft to opposite side of aircraft and give aid as required.
- h. Tie rafts together.

SECOND FLIGHT ATTENDANT

First Action.

1. ASSIST PASSENGERS WITH PREPARATION

- a. Assist passengers to don life vests.
- b. Advise passengers as to ditching position. Remove sharp articles from pockets such as pens and pencils, remove spectacles, remove tie and loosen collar. Show passengers how to protect head with hands and arms.

2. PREPARE CABIN FOR DITCHING

- a. Prepare cabin by securing all loose equipment. Remove all loose equipment from cabin such as baggage, dispatch cases, tables, serving equipment or anything that may cause injury. Stow in rear lavatory or closed cabinets and compartments or jettison as directed.

3. STOW EMERGENCY EQUIPMENT

- a. Collect equipment needed on raft and stow at ditching station. Remove one raft kit

Ditching Station.

1. FORWARD PULLMAN COMPARTMENT, LEFT SIDE WINDOW SEAT— FACING AFT

- a. Assume ditching position. Fasten seat belt -brace for impact.

After Ditching.

1. FIRST OUT— SECURE ROPE TO GAS TANK CAP

- a. Remove assist rope from pouch beneath emergency exit, pass the rope through the handle of the inboard main fuel tank and secure it.
- b. Determine that raft has been released and inflated. If raft has not released pry open raft well with tool attached to assist rope, and inflate raft by pulling lanyard on raft bottle.
- c. Position raft for boarding by passengers, maintaining raft in position with assist rope. Avoid contact between raft and any portion of aircraft which may have been torn or damaged in landing.
- d. Assist passengers and crew in boarding raft.
- e. Assist others in loading raft kit, emergency water, rations, blankets, etc., on raft.
- f. Release or cut life raft lanyard from aircraft structure.

CONTINUED

SECOND FLIGHT ATTENDANT

(Continued)

from stowage and place on floor at your ditching station. Secure kit to seat legs. Stow emergency water and food as space permits at your ditching station.

- b. Be prepared to jettison unnecessary equipment, if instructed, such as parcels, baggage, books, ladders or anything which may obstruct aisles, doors or escape routes or may cause injury.

4. PERSONAL PREPARATION

- a. Prepare your person for ditching, don life vest, and remove articles as specified for passengers.

- g. Assist in moving raft to opposite side of aircraft and give aid as required.
- h. Tie rafts together.

179
14

EMERGENCY JETTISONING.

FUEL DUMPING.

Fuel dumping will not normally be accomplished under the following conditions.

- a. When there is evidence of a fire.
- b. When landing gear and flaps cannot be fully retracted.
- c. When moderate or severe turbulence exists.
- d. When heavy static, lightning, and Saint Elmo's fire exists.
- e. When less than one thousand feet above the terrain.

Note

After the dump valves are opened fuel will be discharged at approximately 179 gallons per minute from each side of the aircraft; however, tanks will not be completely drained due to the position of the outlet ports and standpipes in the main tanks.

Total fuel capacity 5864 US Gallons.

Total usable fuel 5820 US Gallons.

Total undumpable fuel including unusable fuel, 550 US Gallons. 139 US Gallons each outboard tank, 132

US Gallons each inboard tank, and 4 US Gallons each auxiliary tank.

Total undumpable but usable fuel, 506 US Gallons. 136 US Gallons each outboard tank, 116 US Gallons each inboard tank, and 1 US Gallon each auxiliary tank.

Total dumpable fuel 5314 US Gallons.

CAUTION

After desired amount of fuel has been dumped, the dump valve controls for tanks No. 1 and 2, and tanks No. 3 and 4, should be moved back to the red lines on the quadrant and then back to the INTERMEDIATE position for 15 to 30 seconds until the chutes have stopped draining. (This should be determined by visual inspection). It is essential that the controls not be moved past the red lines as this would start retraction of the dump valves into the wing before they are drained completely. The dump valve controls are then placed in closed position. The dump valve control for 2A and 3A should not be moved to the closed position until the dump chutes have been drained and the dump valve is closed, then return to the Neutral position.

fuel dumping rates

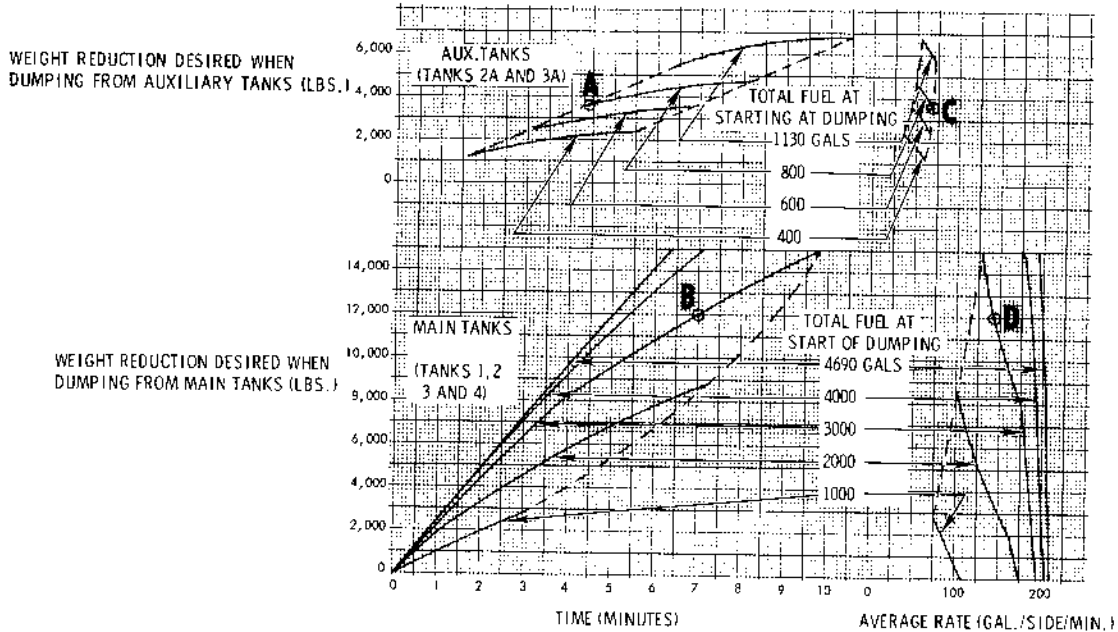

TIME AND RATE OF FUEL DUMPING

1. RAM VENTS ON ALL TANKS.
2. PROPORTIONAL FUEL LOADING BETWEEN TANKS 1, 2, 3 AND 4 (PROPORTIONAL TO TANK CAPACITIES).
3. I. A. S. = 170 M. P. H.
4. DUMP RATE WILL INCREASE WITH INCREASE IN AIRSPEED.
5. DUMP RATE WILL INCREASE SLIGHTLY IF AIRPLANE IS FLOWN LEVEL INSTEAD OF IN THE GLIDE ATTITUDE.

EXAMPLE

AIRPLANE WEIGHT: 100,000 LBS.
 LANDING WEIGHT: 84,500 LBS.
 FUEL TO BE DUMPED: 15,500 LBS.
 TOTAL FUEL LOAD: 3,800 GALS.
 FUEL IN TANKS 2A & 3A (TOTAL): 800 GALS.
 FUEL IN TANKS 1, 2, 3, & 4 (TOTAL): 3,000 GALS.
 WEIGHT OF FUEL (TANKS 2A & 3A): 4,800 LBS.
 WEIGHT OF FUEL (TANKS 1, 2, 3, & 4): 18,000 LBS.

FUEL TO BE DUMPED FROM:
 TANKS 2A & 3A (TOTAL): 3,600 LBS. (600 GALS.)
 REMAINING FUEL TO BE DUMPED FROM TANKS 1, 2, 3, & 4: 15,500 LBS. - 3,600 LBS. OR 11,900 LBS.
 DUMPING TIME, TANKS 2A & 3A: **A** 4.4 MIN.
 DUMPING TIME, TANKS 1, 2, 3, & 4: **B** 6.95 MIN.
 DUMPING RATE, TANKS 2A & 3A: **C** 68 G. P. M./SIDE
 DUMPING RATE, TANKS 1, 2, 3, & 4: **D** 142 G. P. M./SIDE

F-125-0-3-61

Figure 3-7

FUEL DUMPING**Pilots**

The pilot calls for: FUEL DUMPING CHECK LIST.

1. Advise ground station (if practical)—ADVISED.
2. Landing gear and flap levers — UP.
3. Airspeed (135 min. - 185 max.) — 150 - 165 DE-SIRED.

Note

The maximum permissible airspeed during fuel dumping is 185 knots; the minimum 135 knots. However, since airspeed will build up as fuel is dumped, it is desirable to start dumping at a speed of 150 knots. (Speeds below 165 knots will make dump chute actuation easier for the engineer.) The aircraft should be flown straight with wings level to avoid the possibility of flight through fuel vapors. Engine powers should be kept constant. Shallow turns, climb and descent are permissible.

4. Flight control auxiliary booster switches - OFF.
5. Unnecessary radios and electrical equipment- OFF.
6. Smoking switch — NO SMOKING.
7. Exterior light switches — AS NECESSARY.
(Anti-collision lights — OFF and wing lights STEADY).
8. Ready to dump fuel — DUMP FUEL.

Note

Keep account of dumping time by using elapsed time clock.

Flight Engineer

Acknowledges: FUEL DUMPING CHECK LIST.

1. Cabin heaters and all fan switches -- OFF.
2. APU — OFF.

3. Unnecessary radios and electrical equipment- OFF.

4. Ready to dump fuel — DUMP FUEL (at pilot's command).

5. Fuel dump levers (1 & 2, 3 & 4) — OPEN.
6. Fuel dump lever (2A & 3A) — OPEN and NEUTRAL.

When tanks 2A, 3A start to dump, RETURN LEVER to NEUTRAL.

AFTER DUMPING.

7. Fuel dump levers (1, 2, 3 and 4) — CLOSED POSITIONS.

Note

After dumping return levers to Red Line, then to Intermediate for 15 to 30 seconds. Check that fuel stops dumping, then CLOSED positions.

CAUTION

Use care not to inadvertently pull an emergency shut-off lever.

FUEL DUMPING (CONTINUED)

Pilots

9. Fuel dumping — COMPLETED.
10. Radios and electrical equipment — AS NECESSARY.
11. Engineer's fuel dumping checklist—COMPLETED.

Flight Engineer

8. Fuel dump lever (2A & 3A) — CLOSED AND NEUTRAL.
9. Fuel dumping — COMPLETED.
Engineer not at the panel will make visual check to insure that fuel dumping is completely stopped.
10. Engineer's fuel dumping checklist—COMPLETED.

JETTISONING OF BAGGAGE AND/OR CARGO.

If it becomes necessary to reduce weight in flight, consideration should be given to the peculiarities of the cargo load and to time available for load reduction.

Careful consideration should be given to the following:

- a. Jettisoning the heaviest cargo that can be pushed out of the lower aft cargo compartment door, (access to this compartment can only be made by cutting through floor in stateroom), or the passenger door. This would reduce weight in less time as opposed to jettisoning lighter items because of better accessibility and ease of handling.
- b. Maintaining the airplane center of gravity within limits to preclude inadvertent loss of altitude.
- c. If carrying passengers, all unneeded baggage, seats, gear and radio equipment may be jettisoned, but if possibility of ditching exists, seats should be retained.

The trajectory of objects thrown overboard would be straight back; therefore, it is recommended that the lower aft cargo compartment door and the passenger door be used as the primary means of jettisoning cargo.

Proceed as follows:

- a. Depressurize, and at 1" Hg turn auxiliary ventilation control knob to position A.
- b. Airspeed — 150 to 160 knots.
- c. Wing flaps — may be used to change the longitudinal axis of the aircraft to facilitate movement of the cargo fore or aft for jettisoning.

- d. Passenger entrance door and lower aft cargo compartment door — OPEN.

WARNING

- Crew member who is jettisoning cargo must be safety-strapped to aircraft structure so that maximum length of strap will prevent his falling through the opening.
- The cargo doors must never be opened in flight.

ELECTRICAL POWER SYSTEM FAILURE.

GENERAL.

It is extremely difficult to anticipate all of the possible failures and plan corrective action for each individual failure. Tachometers, airspeed indicators, altimeters, rate of climb indicators, brake accumulator pressure gauge, and the magnetic compass are not directly affected by the electrical systems and will continue to operate. The cable controlled firewall shutoff valves can still be used to shut off engine oil, and hydraulic fluid. A broad analysis of the situation indicates that electrical failures fall into four possible categories as follows:

LOSS OF ONE OR MORE PRIMARY SOURCES.

- a. If the field control relay trips (with over-voltage light on) turn affected generator switch OFF,

check no load voltage, set voltage regulator to proper voltage, reset, then return generator switch to ON position.

- b. If the field control relay trips again, turn the generator off. Do not reset until the source of trouble is located and corrected. (In flight remedies are limited to checking the circuit breakers, reset button an field control relay, or replacing voltage regulators).
- c. If the generator malfunction cannot be corrected and power returned to main bus, open the field circuit breaker and/or remove voltage regulator for further protection.

GENERATOR MALFUNCTION OR FAILURE.

In event that the ammeter starts to fluctuate and voltage is erratic, or a generator light comes on indicating a possible generator system malfunction, immediate corrective action will be taken as outlined in the following steps:

- a. Check operating loads to determine that ratings will not be exceeded. If load is excessive turn off all unnecessary electrical equipment.
- b. Generator Switch (of malfunctioning or failed generator)—OFF.
- c. If the no load voltage is normal, but the ammeter does not indicate a load, the reverse current relay is malfunctioning. Leave the generator switch OFF. (Replace the reverse current relay after the flight.)

This page intentionally left blank

- d. If there is a no-voltage condition, then either the generator or voltage regulator is malfunctioning. The field ammeter and voltage circuit breakers should be checked to see if they are tripped. Replace voltage regulator. If resetting the circuit breakers and replacing the voltage regulator does not bring the generator back on the bus, turn the generator switch to OFF and remove voltage regulator. Trip field circuit breakers for further protection.

CAUTION

Before replacing a voltage regulator pull the field circuit breaker to prevent arcing of the regulator base.

COMPLETE GENERATOR FAILURE.

Loss of all generators leaves the batteries as the only source of power.

- a. Battery switch—OFF.
- b. Generator switches—OFF.

Note

The following items are operated from the batteries through the emergency bus:

- (1) Pilot's emergency white lights and instrument lights.
- (2) Auxiliary flight control boosters.
- (3) Emergency flight instrument inverter.
- (4) Electric elevator trim tab.
- (5) Voltmeter.
- (6) Passenger address system.
- (7) Integrated flight system gyro and IFS instrument channels.
- (8) VHF No. 1 and PA system.

INSTRUMENT OR RADIO INVERTER FAILURE.

In the event the radio inverter fails, the changeover relay will switch to the spare inverter.

Note

The APS-42 will be inoperative until the main inverter switch is moved to the OFF position and the spare inverter switch is moved to the ON position.

Changed 31 October 1964

FAULTS WITHIN EQUIPMENT ITEMS.

This will normally concern the loss of one or more items of electrical or electronic equipment. Isolate the faulty item by removing the fuse or opening the circuit breaker, if not already open, and shut-down the equipment.

FAULTS ON THE BUS AND DISTRIBUTION SYSTEMS.

Faults on the distribution system should clear through the action of circuit breakers, fuses, limiters, and generator protective systems. This may result in smoke and require some emergency corrective action on the part of the flight engineer and other crew members.

Note

If smoke or fire is evident, refer to ELECTRICAL FIRE in this section.

Faults on the bus or complete loss of D.C. system from other causes are extremely unlikely. Loss of one or more of the primary sources will require the flight engineer to take action in the nature of monitoring electrical loads so that the remaining power sources will not be overloaded.

HYDRAULIC POWER SYSTEM FAILURE.

In the event of continuous and/or repeated flashing of a pump low pressure warning light which is not caused by operating a hydraulic system component at low engine rpm, the pump should be shut down by placing the hydraulic pump suction shut-off valve switch in the OFF position.

CAUTION

When a hydraulic pump fails, turn both pumps in the affected system OFF and deplete pressure. Then turn on the good pump. Repeat this procedure if the warning light on the failed pump starts to flicker; this prevents contamination of the hydraulic system by metal particles from the failed pump.

If pressure in either the primary or secondary system is lost, the operating system may supply pressure to the

inoperative system. This can be done by moving the hydraulic system crossover switch to the emergency position. The automatic repositioning of valves in an inoperative system requires zero pressure for effective crossover operation.

WARNING

Do not move the hydraulic system crossover switch to the EMERGENCY position until it has been determined that a complete loss of the remaining hydraulic system pressure will not occur.

FAILURE OF PRIMARY HYDRAULIC SYSTEM.

Failure of the primary hydraulic system will cause loss of the flight control boosters. To restore operation of the flight control boosters, proceed as described under LOSS OF FLIGHT CONTROL BOOSTERS IN FLIGHT DUE TO HYDRAULIC SYSTEM FAILURE, this section.

FAILURE OF SECONDARY HYDRAULIC SYSTEM.

Failure of the secondary hydraulic system will leave the items operated by that system inoperative. Trouble shoot the secondary hydraulic system if time permits. If the cause is a leak in the secondary hydraulic system and it can be isolated or if the system is intact, the hydraulic system crossover switch may be moved to the EMERGENCY position and the primary pumps will furnish pressure to operate the secondary hydraulic system components. If it is not advisable to operate the hydraulic system crossover valve it will be necessary to power the brakes with the emergency brake system, extend the landing gear by means of the emergency gear extension system, and operate the wing flaps by means of the hand crank. The nose gear steering, tanks 2A and 3A fuel dump valves and aspirator will be inoperative.

FAILURE OF THE PRIMARY AND SECONDARY HYDRAULIC SYSTEMS.

Failure of both the primary and secondary hydraulic systems makes it necessary to power the brakes with the emergency brake system, extend the landing gear by means of the emergency gear extension system, and operate the wing flaps by means of the hand crank. The nose gear steering, the normal flight control boosters, tanks 2A and 3A fuel dump valves and aspirator will become inoperative. Under these circumstances, auxiliary elevator and rudder boost may be available. Refer to LOSS OF FLIGHT CONTROL BOOSTERS IN FLIGHT DUE TO HYDRAULIC SYSTEM FAILURE.

Note

Brakes will be available only if the brake accumulators are charged and the brake selector is in the EMER. position. If the accumulators are discharged, the brakes may be powered by the hand pump with the selector lever in the BRAKE position and the brake selector lever in the NORM. position.

FLIGHT CONTROL SYSTEM.

LOSS OF FLIGHT CONTROL BOOSTERS IN FLIGHT DUE TO HYDRAULIC SYSTEM FAILURE.

In the event of complete loss of primary hydraulic system pressure to the boosters in flight, proceed as follows if the electrical system is functioning normally:

- a. Automatic pilot OFF.
- b. Flight control auxiliary booster switches ON.

Note

If both auxiliary control boosters operate normally, continue to operate on auxiliary boost while troubleshooting the primary system. Loss of one auxiliary control booster indicates leak area.

- c. Reduce airspeed to 150 knots and turn aileron flight control booster off.

Note

With the loss of boost in flight, auxiliary flight control boost will still be available for rudders and elevators and should be turned ON to maintain hydraulic pressure for the surface control boosters. In case of emergency, the flight control boosters may be turned off at any airspeed. Monitor electrical load if necessary to determine cause of trouble.

- d. Trouble shoot hydraulic system to determine cause of trouble.
- e. Hydraulic system crossover switch — EMERGENCY upon pilot's discretion.

WARNING

Do not move the hydraulic system crossover switch to the EMERGENCY position until it has been determined that a complete loss of the remaining hydraulic fluid will not occur.

- f. Flight control auxiliary booster switches—OFF.
Aileron flight control booster lever—ON if primary hydraulic system pressure is restored.

CAUTION

- Airspeed should be reduced to 150 knots before re-engaging aileron flight control booster lever.
- Auxiliary flight control electrical boost switches should be turned on only when required as the hydraulic fluid and the electric booster motors have a tendency to overheat.

Note

If trouble shooting should disclose that actuation of the hydraulic system crossover switch would result in complete loss of the secondary hydraulic system, the airplane should be operated at the pilot's discretion with either the auxiliary flight control booster control switches ON and the aileron flight control lever OFF, or all flight control boosters OFF.

TURNING FLIGHT CONTROL BOOSTERS OFF IN FLIGHT BECAUSE OF MALFUNCTIONING BOOSTER SYSTEM.

Although the booster control system is designed to be on at all times, it can be turned off in the event of malfunctioning.

- a. Reduce airspeed—to between 130 and 156 knots. Although the boosters can be turned off in an emergency at any airspeed it is desirable to be in this speed range, since an abrupt control surface deflection is not likely to cause as serious a change in attitude and therefore, would not put as large loads on the aircraft structure as might be done at higher airspeeds.
- b. Maintain sufficient altitude to permit recovery from any inadvertent attitude change.
- c. Automatic pilot—OFF.
- d. Trim the aircraft longitudinally, laterally, and directionally for hands-off, straight and level flight. This is important because if the aircraft is being held in trim manually by the pilot when the booster is turned off, the sudden increase in control force may go beyond the strength of the pilot and may, therefore, result in an abrupt change in attitude. For example, a condition critical for the rudder boost would be a situation in which one or

more engines was inoperative at very low airspeed, with the pilot already applying high forces; then, if the boost were turned off, force beyond the pilot's strength would be required to maintain directional control. Under these conditions it would be better to increase the airspeed and maintain directional trim before turning off the boost.

- e. Booster control levers—turn off slowly, one at a time, without applying any force to the controls.

Note

Electric elevator trim tab may be used during all flight control boost-out operations.

LOSS OF FLIGHT CONTROL BOOSTERS IN FLIGHT—USE OF AUTOMATIC PILOT.

In the event that a hydraulic system failure should disable both the primary and secondary hydraulic systems, the automatic pilot may be used with boost off in cruising, in preference to the auxiliary (electrically driven) booster system with boost levers on, particularly for a long flight. Use of the automatic pilot in preference to manual flying of the aircraft with boost off also presents an obvious advantage to the pilot. However, he should monitor the controls very closely, especially in rough air conditions because the automatic pilot may not be able to control the aircraft properly.

The automatic pilot should never be used under conditions wherein the boosters are being shifted OFF and ON. It is very important to make certain that the automatic pilot is disconnected and that the aircraft is trimmed before shifting the boosters either from OFF to ON or ON to OFF.

No automatic pilot malfunction tests have been conducted with the surface control boosters OFF. In the event of an automatic pilot malfunction, the forces applied to the surface controls by the automatic pilot are not great enough to cause a quick attitude change of the aircraft. However, it is possible that an automatic pilot malfunction could cause a very slow and gradual maneuver, such as a diving spiral. Boost-off recovery from such a maneuver, should it become well developed before corrective action is initiated, could become very difficult. Therefore, the pilot should be prepared at all times to take corrective action immediately should a malfunction occur.

Use of the automatic pilot with the surface control boosters off is approved; however, it is not necessarily recommended for all conditions. When using the auto-

matic pilot with boosters off, the various limitations described in these paragraphs should be clearly understood.

TURNING FLIGHT CONTROL BOOSTERS ON IN FLIGHT.

Once the boosters have been turned off, they should not be turned on again unless it is known that the cause of the malfunction no longer exists. If the decision is made to turn the boosters on in flight, use the following procedure:

- a. Maintain airspeed between 130 and 156 knots. With the airspeed in this range, an abrupt control surface deflection is not likely to cause a serious change in attitude and consequently will not subject the aircraft structure to as large loads as would be the case at higher airspeeds.
- b. Maintain sufficient altitude to permit recovery from any inadvertent attitude change.
- c. Automatic pilot—OFF.
- d. Trim the aircraft longitudinally, laterally, and directionally for hands-off, straight and level flight. Even though the aircraft is trimmed for hands-off flight with boost off, it is possible that a boost control valve may be slightly open and if the boost is turned on, it may cause an abrupt change in control surface position. For this reason, the airspeed should be held within the range noted above.
- e. Do not apply any force to the rudders, elevators, or ailerons, but merely hold the controls lightly. This is important since the application of pressure to any of the controls will open the booster control valve and may cause a sudden change in control surface positions when the boosters are turned on.
- f. Move the booster control levers individually to ON very slowly. Positioning the controls slowly has the effect of turning on the hydraulic pressure slowly, which, if a booster control valve is slightly open, will preclude the possibility of an abrupt control surface deflection.

Note

- In the event that there is some misrigging between the two aileron booster units, turning the aileron booster on slowly may cause the aircraft to rock laterally slightly.

- When the elevator booster is turned on, the control column may assume a new position, depending on the original elevator position.

SHIFTING FLIGHT CONTROL SYSTEMS FROM BOOST-ON TO BOOST-OFF OPERATION.

The need to shift a booster surface control system from boost-on to boost-off could be created by a loss of hydraulic pressure or by a discrepancy in the mechanical portion of the affected booster system.

Most control system difficulties should be recognized by one or more of the following conditions:

- a. Aircraft does not respond to pilot force on cockpit control.
- b. Cockpit control seems to be immovable or requires abnormally high force.
- c. Aircraft starts nosing up or down, rolling or yawing and application of pilot force on the cockpit control to correct or stop the condition is ineffective. (If the changing attitude is being caused by an autopilot malfunction, corrective action on the cockpit control *will be* effective, since malfunctions of the autopilot can be overpowered.)
- d. Application of trim tab has no effect on trimming the aircraft. (If this is a *tab system problem* the airplane will respond to the pilot force on the primary control.)

An important consideration in shifting a boosted control system to boost-off is the position of the trim tabs; they should be at or near normal trim position prior to shifting. If the trim tabs are displaced several degrees out-of-trim (by pilot or the autopilot), the airplane may be expected to lurch when the transition to boost-off operation is made. If time does not permit retrimming prior to shifting to boost-off, the next best thing is to retrim as soon as possible after achieving boost-off operation.

Although the procedure of shifting to boost-off usually will not help if the control system is rigidly jammed by a foreign object or other serious interference, it is recommended that the shift to boost-off be made regardless, because it is possible that the problem will be overcome by doing so.

EMERGENCY CONTROL BOOST SHUTOFF

*Pilots**Flight Engineer*

Items in **BOLD PRINT** will be accomplished prior to reading checklist.

1. **AUTOPILOT DISCONNECT LEVERS—OFF.**
2. **TRIM TAB—NORMAL** (if time permits).

If time does not permit, retrim airplane after booster shift is accomplished.

WARNING

A sudden and pronounced lurch of the airplane should be anticipated as the shift is made if the tab setting is more than 2 or 3 degrees from the normal trim position.

Note

If the pilot or automatic pilot has unsuccessfully attempted to counteract an attitude change by moving the tabs, the tabs can be out-of-trim by several degrees. That is why it is important to check the setting of the tab and to return it to a normal trim setting before or immediately after shifting—preferably before.

3. **AFFECTED CONTROL BOOST—PULL OFF.**

WARNING

When shifting the *elevator system* to boost-off, a force on the control column will increase the force required to pull the shift handle. A heavy force could make it difficult to pull the shift handle. *Do not apply force on the elevator control column during operation of the elevator shift handle.*

If Unable to Shift Affected System For Any Reason
(Such as Malfunction of Shift Mechanism):

4. **OPERATIVE CONTROL BOOST SYSTEMS—PULL OFF.**

Changed 31 January 1965

EMERGENCY CONTROL BOOST SHUTOFF

(CONTINUED)

Pilots

Flight Engineer

5. NO. 1 AND NO. 2 EMERGENCY SHUTOFF LEVERS—HYD OIL OFF.

① NO. 1 AND NO. 2 EMERGENCY SHUTOFF LEVERS —HYD OIL OFF.

6. AUX BOOST—OFF.

7. AFFECTED CONTROL BOOST—PULL OFF*

WARNING

If the shift cannot be completed, leave primary hydraulic pressure off for the remainder of the flight.

8. OPERATIVE BOOST SYSTEMS—ON.

Note

- If the shift is completed on the malfunctioning system, reestablish airplane hydraulic pressure and return the other two control systems to boost-on operation.
- Auxiliary boost or other system pressure can be reestablished provided it does not supply pressure to the malfunctioning system.

- d. Elevator booster shutoff lever — Pull OFF.
DO NOT APPLY ELEVATOR FORCE TO THE CONTROL WHEEL WHILE SHIFTING.

CAUTION

Once a stable attitude is regained, remain in the boost-off condition for the remainder of the flight.

- e. Rudder auxiliary booster switch — ON, if needed.
f. Land boost-off at nearest airport.

Note

In either of the above procedures, the elevator booster shutoff lever can more readily be shifted to OFF at airspeeds above stall speeds.

SPECIAL CASE FOR NOT SHIFTING TO BOOST-OFF

If any primary control (elevator, rudder or aileron) should become free—that is, cockpit control moves freely with no effect on aircraft attitude—the following is recommended:

1. Leave automatic pilot ON if already on.
2. Turn automatic pilot ON if not on.
3. Do not shift to boost off.
4. Land airplane with automatic pilot by using automatic pilot controller.

WING FLAP MALFUNCTION.

The aircraft is equipped with an asymmetric flap shutoff system to prevent wing flap malfunctioning by stopping all flap movement any time the flap splits three to five percent. However, a malfunction within the asymmetric shutoff itself or an electrical power failure will render the asymmetric shutoff inoperative and a split flap could result. Furthermore, the automatic shutoff will operate only if the torque tube breaks or otherwise becomes separated. Therefore, if the drive chains or cable to individual flap sections should fail, those sections would become fixed whereas the other flap panels with intact drive mechanisms would continue to operate. In this way, it is possible to have a partial asymmetric flap condition with no indication in the cockpit except a rolling tendency. For this reason the flaps should not normally be raised after take-off until an altitude of 500 feet is attained, and the copilot should keep his hand on the flap control lever whenever the flaps are operated and keep his right hand available for the flap test switch for use in emergency stopping of flaps until the flaps have reached the selected position.

The only type of wing flap malfunction which will cause a serious malfunction is one resulting in an asymmetric wing flap condition. Asymmetric wing flaps will be indicated by a rolling motion of the aircraft (not created by the ailerons as evidenced by displacement of the yoke) following any movement of the wing flap selector handle. The roll will be away from the extended flap. The time required for the wing flaps to extend to the sixty percent position is approximately fifteen seconds. This allows a reasonable time for detection of the malfunction, and initiation of corrective action before loss of control of the aircraft occurs. Wind tunnel analysis indicates that it is possible to control the aircraft at speeds below 165 knots with an asymmetric wing flap deflection of 60%. With wing flap on one side extended to the 100% position and the other retracted, it will be impossible to control the aircraft laterally at any speed. In the event of a wing flap malfunction, immediate action must be taken to stop the flaps as quickly as possible after the roll is noticed. Proceed as follows:

- a. At the first indication of wing flap malfunction, the pilot states: WING FLAP FAILURE, STOP FLAPS.
- b. Reduce air speed to 165 knots. If possible, place the aircraft in a level flight attitude.
- c. The copilot acknowledges: WING FLAP FAILURE and depresses the flap control lever handle button, and moves the handle toward the position shown by the wing flap position indicator. When slight resistance is felt selector valve has been repositioned to hydraulic neutral, releases the handle. At the same time actuate the flap test switch to stop the flaps as a back-up procedure.

Note

After the flaps have been stopped, further movement of the flap handle in the wrong direction will cause additional asymmetric flap travel which may result in total loss of control of the aircraft.

- d. Prepare to land the aircraft as soon as possible.

Note

- Successful landings have been made with all the wing flaps on one side of 60% and all the wing flaps on the opposite side retracted. Asymmetric travel in excess of 60% will permit only partial control of the aircraft, and at 100% the aircraft will be uncontrollable.
- If the asymmetric condition is critical it is recommended that the secondary hydraulic system be shut off and the flaps handcranked to symmetry.

CAUTION

Reposition the flap control lever to hydraulic neutral by feel prior to repressurizing the secondary system.

Note

Depending on the type of failure, it is possible to equalize the flaps with the flap handle. However, if the flap system is not fully understood, or if lateral control is marginal, it is safer to use procedure given in the above note.

EMERGENCY WING FLAP OPERATION

Pilots

Flight Engineer

The wing flaps may be extended or retracted manually in the event of failure of the primary and secondary hydraulic system. However, movement of the wing flaps is very slow when powered by the emergency hand crank. Since 60% flap extension is recommended for go-around procedure, do not manually extend flaps beyond TAKE-OFF (60%) position because manual retraction would be impractical. When it is desired to use the emergency procedure to operate the wing flaps, pilot calls for: EMERGENCY WING FLAP OPERATION CHECKLIST.

Acknowledges: EMERGENCY WING FLAP OPERATION CHECKLIST.

① Hydraulic pump suction shut-off switches for engines 3 & 4—OFF POSITION.

① Hydraulic pump suction shut-off switches for hydraulic pumps 3 & 4—OFF POSITION.

2. Hydraulic system crossover switch—NORMAL.

WARNING

Do not direct pressure to the secondary hydraulic system or attempt to operate any other equipment powered by the secondary hydraulic system while extending the wing flaps manually.

2. Wing flap lever—TAKE-OFF (60%).

5. Flap motor bypass valve—FULL OPEN.

CAUTION

- Placing the flap control lever in this position permits the flap control valve to remain open to bypass the fluid, thus keeping hand crank torque to a minimum.
- Should hydraulic pressure become available to the secondary hydraulic system, the flaps will go to the position selected by the wing flap lever. Therefore, the wing flap lever should be placed in the TAKE-OFF (60%) position.

EMERGENCY WING FLAP OPERATION

(CONTINUED)

*Pilots**Flight Engineer*

4. Flap hand crank — TAKE-OFF (60%).

Engage hand crank in drive unit and crank counter-clockwise to the 60% position. Approximately 360 turns (approximately 5 minutes) are required to lower the flaps to the 60% position.

WARNING

- Never engage hand crank unless the No. 3 and No. 4 hydraulic pump suction shut-off switches are OFF and the hydraulic system crossover switch is placed in the NORMAL position. If the hydraulic flap motors become activated while the hand crank is engaged, action will be fast enough and powerful enough to whirl the hand crank too fast and may cause serious injury to personnel.
- Never engage hand crank unless the flap motor bypass valve is FULL OPEN.

5. Hand crank — REMOVED.

When TAKE-OFF (60%) flap position (as indicated by the flap position indicator) has been achieved, remove hand crank.

③ Engineer's emergency wing flap operation check list — COMPLETED.

⑥ Engineer's emergency wing flap operation check list — COMPLETED.

WING FLAP OPERATION AFTER MANUAL EXTENSION

*Pilots**Flight Engineer*

To restore the secondary hydraulic system after shut-down for manual extension or retraction of the wing flaps the procedure is as follows:

Note

In the event of a wing flap failure that causes an asymmetric flap condition, the wing flap travel will be stopped automatically by the wing flap asymmetry protection system. This action will be initiated by the illumination of the wing flap shut-off warning light and by indication of the wing flap position indicator. No further movement of the wing flaps should be attempted.

Calls for: WING FLAP OPERATION AFTER MANUAL EXTENSION CHECK LIST.

Acknowledges: WING FLAP OPERATION AFTER MANUAL EXTENSION CHECK LIST.

1. Wing flap lever — SET TO POSITION OF WING FLAPS.

1. Flap motor bypass valve — CLOSED.

2. Hydraulic pump suction shut-off switches for hydraulic pumps 3 & 4 — ON (open position).

② Engineer's wing flap operation after manual extension check list — COMPLETED.

③ Engineer's wing flap operation after manual extension check list — COMPLETED.

LANDING GEAR SYSTEM MALFUNCTION.

When the landing gear is extended, if any of the landing gear warning devices indicate an unsafe condition of the gear, it should be considered that the gear is unsafe for landing and not that there is a malfunction of the warning system unless definitely proven otherwise. These warnings would be:

- a. Glowing of the gear UNLOCKED warning light.
- b. Unlocked indication of any of the GEAR DOWN AND LOCKED lights or indicators.
- c. The sounding of the landing gear warning horn.

The following procedures are based upon the assumption that normal hydraulic system pressure is available; however, certain portions of these procedures will still apply if only the emergency extension system is operating. The procedures apply to malfunctioning nose or main gear unless specified otherwise.

- a. Check if gear is on uplock or down but not locked.
- b. If affected gear is up and locked:
 - (1) Retract and extend gear several times.
 - (2) (Malfunctioning main gear) — with gear extended operate flaps several full cycles.
 - (3) Retract gear and extend with emergency extension system (Nos. 3 and 4 hydraulic suction shut-off switches — OFF).
 - (4) (Malfunctioning main gear) — Nos. 3 and 4 hydraulic suction shut-off switches) — ON and operate flaps several full cycles. Maintain hand pump pressure.
 - (5) Make alternate push-overs and pull-ups holding hand pump and system pressure.
 - (6) Repeat steps (1) through (5) as necessary.
- c. If the affected gear is down but not locked:
 - (1) Retract and extend gear several times.
 - (2) Make alternate push-overs and pull-ups with gear handle in DOWN position.
 - (3) Retract gear and extend with emergency extension system. (Nos. 3 and 4 hydraulic suction shut-off switches — OFF).
 - (4) Repeat steps (1) through (3) as necessary.
- d. Landing with gear fully extended but not locked:
 - (1) Brake selector lever — EMER.
 - (2) Hydraulic system crossover switch — EMERGENCY.

CAUTION

Do not pump the toe pedals or you will be unnecessarily displacing additional hydraulic fluid from the brake lines.

- (3) Make a flat landing if runway length is adequate.
- (4) Do not use propeller reversing.

Note

Due to the geometry of the gear, the inertia of the airplane being opposed by the wheel brakes will tend to hold the gear in the DOWN position. This will not be true if propeller reversing is used for braking action.

- (5) Do not use nose gear steering unless unable to steer aircraft by braking. Do not turn off runway.
- (6) Do not raise the flaps.
- (7) Maintain 1000 to 1200 rpm on all four engines and bring aircraft to a smooth stop. Hold position with the brakes.

Note

This rpm should be maintained to keep the maximum hydraulic system pressure, which will keep the landing gear struts extended. A higher rpm should not be used or the lower drag strut hydraulic cylinder may extend making it impossible to insert the landing gear safety pins.

- (8) Have the landing gear safety pins inserted.

CAUTION

Some means of preventing the aircraft from dropping to the runway should be provided as protection to the ground personnel while the landing gear safety pins are inserted. It may be necessary to move the down lock latch to the locked position manually.

- (9) Do not move the aircraft and do not reduce the engine rpm until the landing gear safety pins are inserted.

EMERGENCY LANDING GEAR EXTENSION**Pilots**

When it is desired to extend the landing gear using the emergency system, pilot calls for: EMERGENCY LANDING GEAR EXTENSION CHECK LIST.

1. Landing gear lever — DOWN.
2. Hand pump selector lever — EMER GEAR.
3. Emergency hand pump — OPERATE UNTIL GEAR IS DOWN AND LOCKED.

Note

- About 245 strokes are required over 3 to 4 minutes to extend and lock all gears. The design of the gears is such that the uplocks and downlocks must be operated by hydraulic pressure.
- When the landing gear control lever is placed in the DOWN position, the main gear may fall of its own weight but may not lock. Therefore, the emergency extension system must be used to assure locking in the down position.
- Opening of the Hydraulic System Crossover Valve may permit operation of the landing gear.

4. Hand pump selector lever — EMER BRAKE.

5. Engineer's emergency gear extension check list — COMPLETED.

Flight Engineer

Acknowledges: EMERGENCY LANDING GEAR EXTENSION CHECK LIST.

1. Hydraulic system crossover valve switch — NORMAL.
2. Emergency extension tank quantity — CHECKED.

3. Engineer's emergency gear extension check list — COMPLETED.

CAUTION

If a landing must be made with an unlocked gear indication refer to the procedure under LANDING GEAR SYSTEM MALFUNCTION.

NOSE GEAR EMERGENCY EXTENSION PROCEDURES.

In cases of an emergency, such as failure in the emergency hydraulic line to the main gear accompanied by some other malfunction which prevents the extension of the nose gear with the normal hydraulic pressure, emergency pressure can be concentrated in the nose gear line by closing the M.L.G. SHUT-OFF VALVE. If the main gears can be extended and locked successfully by free fall, the main gears can be isolated from the emergency gear extension system, and emergency pressure directed to the nose gear with the emergency extension procedure.

Note

The emergency main landing gear hydraulic shut-off valve is located on the left side of the forward baggage compartment. The valve is marked M.L.G. SHUT-OFF VALVE.

EMERGENCY LANDING GEAR RETRACTION.

If the landing gear lever will not go past the neutral position, insert a finger in the hole on the right side of the control pedestal and push the solenoid pin out of the way. If handle movement is satisfactory and secondary system pressure is up, but gear does not retract, check the hand pump selector valve at the base of the pump. If this valve is in the emergency (aft) position, the gear return fluid may be trapped, hydraulically locking the gear in the extended position. If this condition exists, the following procedure must be rigidly adhered to: Move the gear handle full down, move the hand pump selector valve to the brake (forward) position, and then place the gear handle back up to the position. Failure to follow this sequence may rupture the emergency extension tank.

EMERGENCY BRAKE OPERATION.

Note

If a brake emergency occurs after touchdown, in which little or no braking action can be developed by any of the following emergency procedures, propeller reversing is available for aerodynamic braking. However, reversing should be used judiciously if the secondary hydraulic system is inoperative, because nose wheel steering will not be available.

WITH PRESSURE IN THE SECONDARY HYDRAULIC SYSTEM.

If there is no braking action with the brake selector valve lever in the NORMAL position:

- Brake selector valve lever — EMER.
- Hand pump selector lever—check EMER BRAKES position.
- Stand by to operate the hand pump.

WITHOUT PRESSURE IN THE SECONDARY HYDRAULIC SYSTEM PRIOR TO LANDING.

Note

After landing gear has been locked down by means of the emergency extension procedure:

- Emergency extension tank — check fluid level.
- Hand pump selector lever—check EMER BRAKES position.
- Brake selector valve lever - - EMER.

- Emergency brake pressure indicator — check. If less than 1250 psi, raise pressure to 1250 psi with hand pump.
- Depress toe pedals once, and observe emergency brake pressure indicator.

Note

A slight pressure drop with one application of the brakes is normal. If the pressure drop is excessive (more than 100 psi) a reduction in the number of brake applications available may be anticipated.

- Restore emergency brake pressure to not less than 1250 psi with the hand pump.

CAUTION

During maneuvers requiring extreme movement of the rudder pedals, it is possible that the toe pedals may be depressed inadvertently, thus depleting the accumulator charge. Utmost care should be exercised to avoid this.

After landing:

- Operate the emergency hand pump continuously during the landing roll.

Note

Avoid pumping the toe pedals because this will reduce the number of useful brake applications available.

EMERGENCY BRAKE CHECK (IN FLIGHT)

Pilots

Flight Engineer

Prior to landing, but after landing gear has been locked down by means of the emergency extension procedure, the pilot calls for: EMERGENCY BRAKE CHECK LIST.

- Emergency extension tank — CHECKED (at least ½ full).
- Hand pump selector lever — EMER. BRAKES.
- Brake selector valve lever — EMER.
- Emergency brake pressure indicator — CHECKED.
If less than 1250 psi, raise pressure to 1250 psi with hand pump.

EMERGENCY BRAKE CHECK (IN FLIGHT)

(CONTINUED)

Pilots**Flight Engineer**

5. Emergency hand pump — **STANDING BY.**
Operate the emergency hand pump continuously during the landing roll.

Note

- Avoid pumping the toe pedals because this will reduce the number of useful brake applications available.
- Use propeller reversing with caution. Nose wheel steering will be inoperative.

HYDRAULIC ACCESS DOOR UNLATCHED IN FLIGHT.

In the event the hydraulic oil tank access door latches should inadvertently be left open or should come open in flight, severe buffeting will result. The aft portion of the door is in a region of reduced pressure which causes the door to lift under certain flight conditions. This causes a discontinuity over the upper wing surface and thus creates turbulence in the wing-to-fuselage fillet area. The condition under which this buffeting occurs is, therefore, related to the airspeed and weight of the airplane. Thus, for each weight and airspeed combination, there is a critical airspeed above which buffeting will be minimized or may not occur. Extension of the wing flaps changes the air flow over the wing in such a way that the critical airspeed for buffeting with the access door unlatched is reduced. With 60% flaps, no buffeting should be experienced in the normal speed range. It is possible that during landings at landing gross weights, some buffeting may occur at approximately touchdown speed.

If buffeting is experienced and unlatched hydraulic access door is suspected, proceed as follows:

- a. If possible, increase airspeed to the value where buffeting does not occur.

CAUTION

This should be done only if it is necessary to continue cruising flight for a protracted period. It should not be done in turbulent air conditions.

Note

If buffeting is first noticed during take-off, after the wing flaps have been retracted, it is possible the access door has come open. In this event, re-extend the wing flaps to 60%.

- b. If it is necessary or desirable for other reasons to maintain lower airspeed, extend the wing flaps as far as necessary to stop the buffeting (approx. 60%).
- c. Land at the nearest suitable airport and secure access door.
- d. During landing, if buffeting is experienced, maintain airspeed above that at which the buffeting begins.

PROCEDURE FOR DISCONNECTING THE CABIN SUPERCHARGER DRIVE SHAFTS.

In the event of malfunction, the cabin superchargers may be disconnected by compressing a spring loaded lock, mounted adjacent to the Number 1 and 4 engine blower control levers, and by pushing the levers through and beyond the **LOW BLOWER** position. The minimum rpm for disconnecting the supercharger on the ground is 1200 rpm.

The procedure for disconnecting a cabin supercharger in flight is as follows:

- a. At the first indication of a cabin supercharger malfunction, the engineer advises the pilot:—
(Left or Right Hand) **CABIN SUPERCHARGER MALFUNCTIONING. RECOMMEND DISCONNECTING.**

- b. The pilot states: DISCONNECT—CABIN SUPERCHARGER.
- c. The engineer acknowledges: DISCONNECTING — SUPERCHARGER.

Note

If the cabin supercharger being disconnected is the only source of pressurization remaining, a descent to safe altitude must be accomplished immediately, the engineer:

- (1) Releases hook type lock on the engine blower control lever quadrant.
- (2) Moves corresponding control lever forward past the low position of the limit of travel.
- (3) After noting indications that the cabin supercharger has disconnected, returns lever to the desired engine blower position (HIGH or LOW).

Caution should be taken that proper blower shift procedure is used, if returning to HIGH blower.

- d. The following are indications that the cabin supercharger has disconnected:

- (1) A sharp decrease in the needle spread on the cabin supercharger differential air pressure indicator.
- (2) If not already lighted, the cabin supercharger low oil pressure warning light should light.
- (3) In the event of inability to disconnect the cabin supercharger, advise the pilot.
- (4) If the cabin supercharger fails to disconnect, the propeller of the engine driving that supercharger should be feathered immediately, provided all other engines are operating normally.
- (5) If the cabin supercharger being disconnected is the only remaining source of pressurization, place the auxiliary vent control knob in the FULL OPEN position, after cabin altitude is equal to flight altitude.

NOTE

The abbreviated emergency check list for each crew member is now contained in the T. O. listed below:

- Pilots — T. O. 1C-121A-(CL)1-1
- Flight Engineer — T. O. 1C-121A-(CL)1-2
- Navigator — T. O. 1C-121A-(CL)1-3
- Radio Operator — T. O. 1C-121A-(CL)1-4
- Flight Attendant — T. O. 1C-121A-(CL)1-5

SECTION IV

AUXILIARY EQUIPMENT

TABLE OF CONTENTS

	<i>Page</i>
AIR CONDITIONING SYSTEM	4-1
ANTI-ICING, DE-ICING, DEFOGGING AND VACUUM SYSTEMS	4-30
COMMUNICATIONS AND ASSOCIATED ELECTRONIC EQUIPMENT	4-36
LIGHTING SYSTEM	4-65
OXYGEN SYSTEM	4-69
AUTOMATIC PILOT	4-70
AUXILIARY POWER UNIT	4-76
FUSELAGE FURNISHINGS AND MISCELLANEOUS EQUIPMENT	4-79

AIR CONDITIONING SYSTEM.

The heating, ventilating, cooling and pressurization systems on this aircraft are so united and controlled that they will be considered as one system.

HEATING.

Heated air for the cabin is supplied by two 100,000 btu combustion heaters located in each wing fillet. Each heater package, or assembly, contains its own ignition system and individual units for supplying the combustion fuel/air mixture. Fuel is supplied to the heaters from the No. 2 and No. 3 engine fuel tanks. The heaters, during auxiliary ventilation operation, heat outside ram air. During pressurized operation, cabin air that is obtained through the recirculation dampers from the area around the outside of the aft cargo compartment liner is heated. A mixture of heated and unheated air from the output side of the heaters is then mixed with fresh air from the cabin superchargers before entering the cabin distribution system. Heated air for the flight station may be recirculated cabin air

or, by positioning the flight station temperature switch, a mixture of fresh air and recirculated air or all fresh air.

VENTILATION.

Ambient air for ventilation is provided by circulating ram air from inlets in the leading edges of the left and right stub wing sections. The ram air is directed from the inlet to the cabin distribution system. The air from the cabin is exhausted overboard through the auxiliary ventilation exit valve and the cabin pressure regulators. Ventilation on the ground is furnished by the recirculation fans which draw air through the auxiliary ventilation inlet valves and distribute it to the cabin in the same manner as during flight operation.

REFRIGERATION.

Cooled or refrigerated air is supplied to the cabin and flight station from equipment in the right wing panel. Partial cooling may be accomplished by positioning the primary aftercooler and refrigerator switch toward the cool position which cools supercharged air. Heat transfer from the supercharged air within the tubes is

auxiliary ventilation in flight without heating

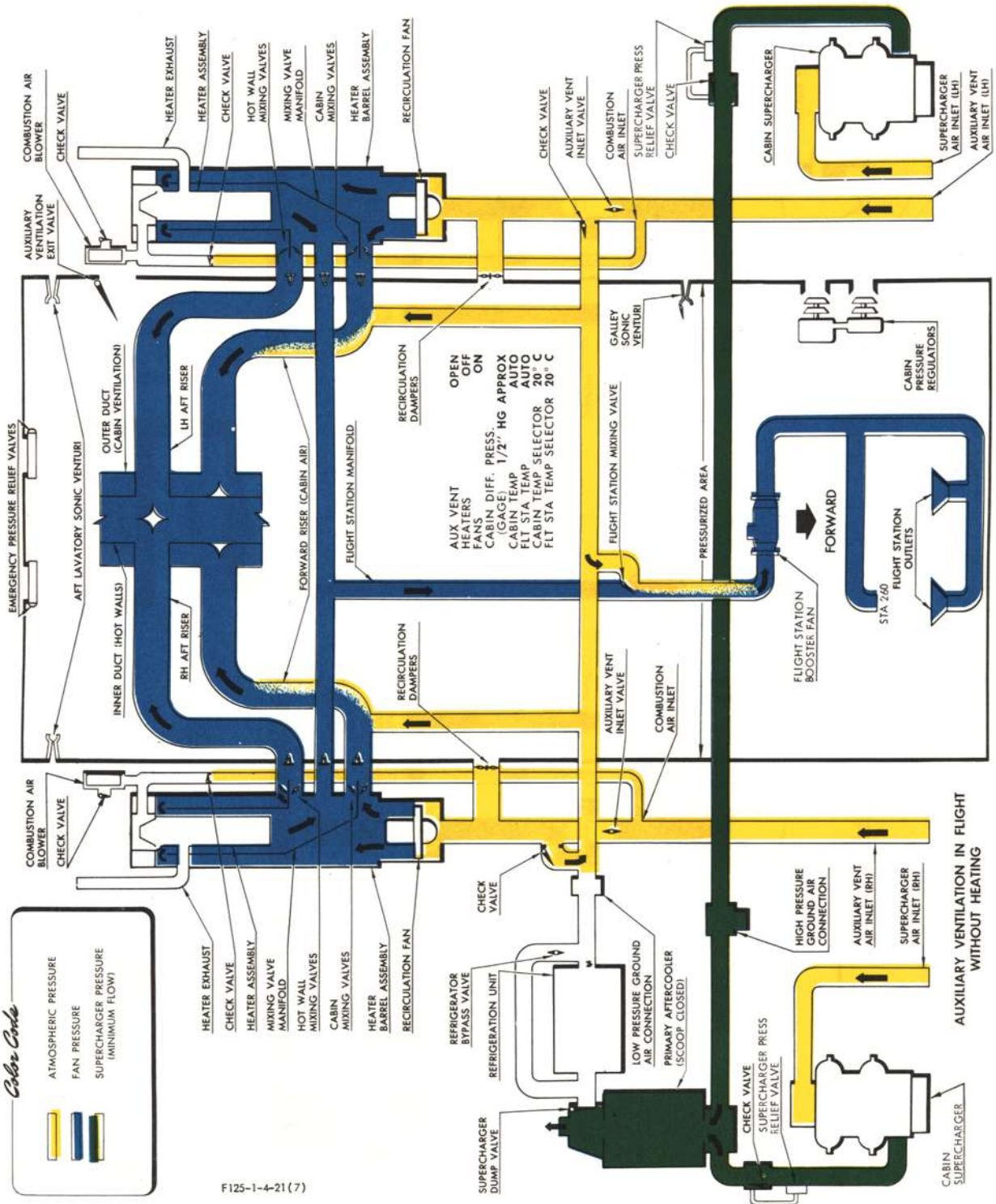

cabin heater ducting

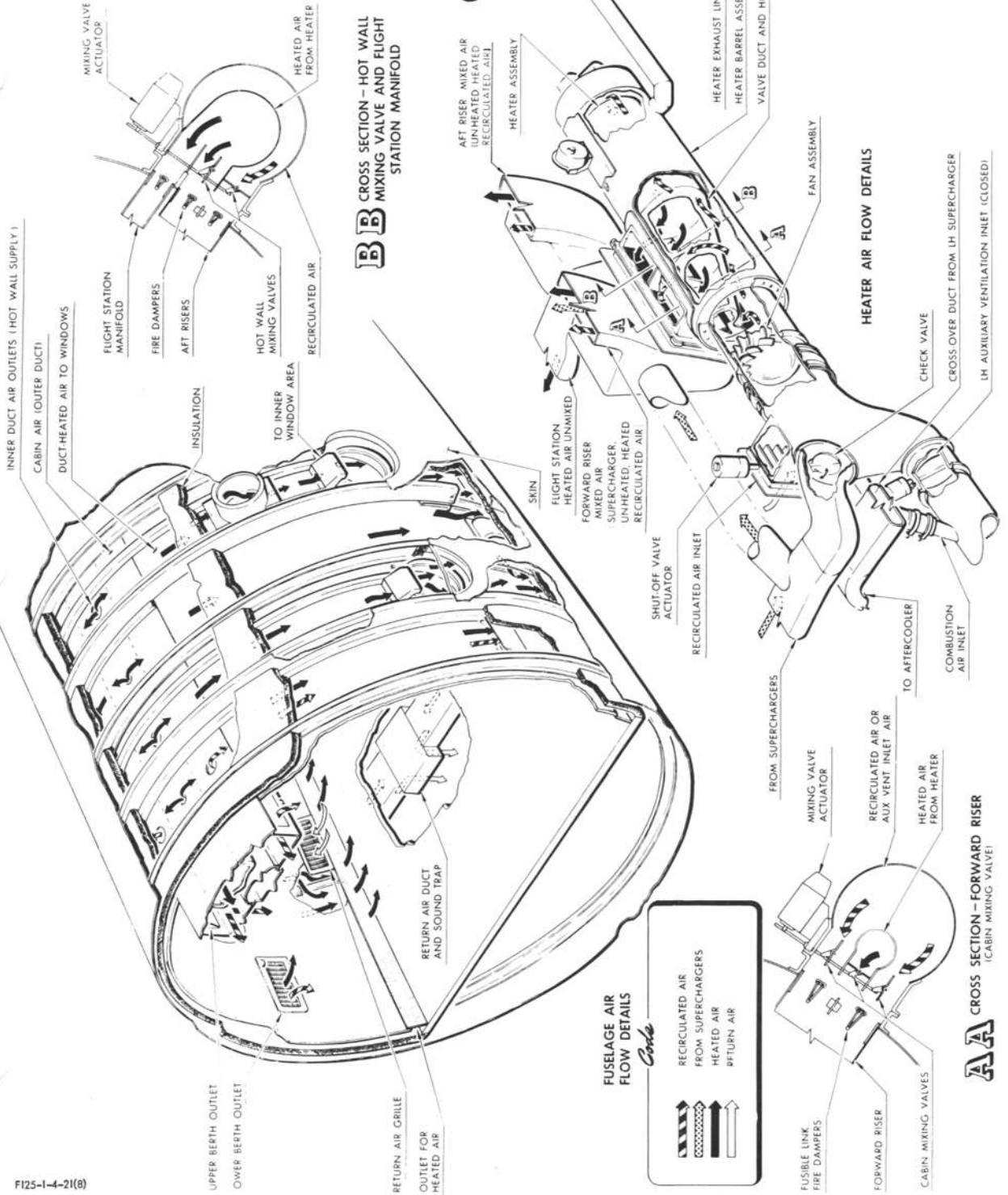

Figure 4-1 (Sheet 8)

pressure regulator valve

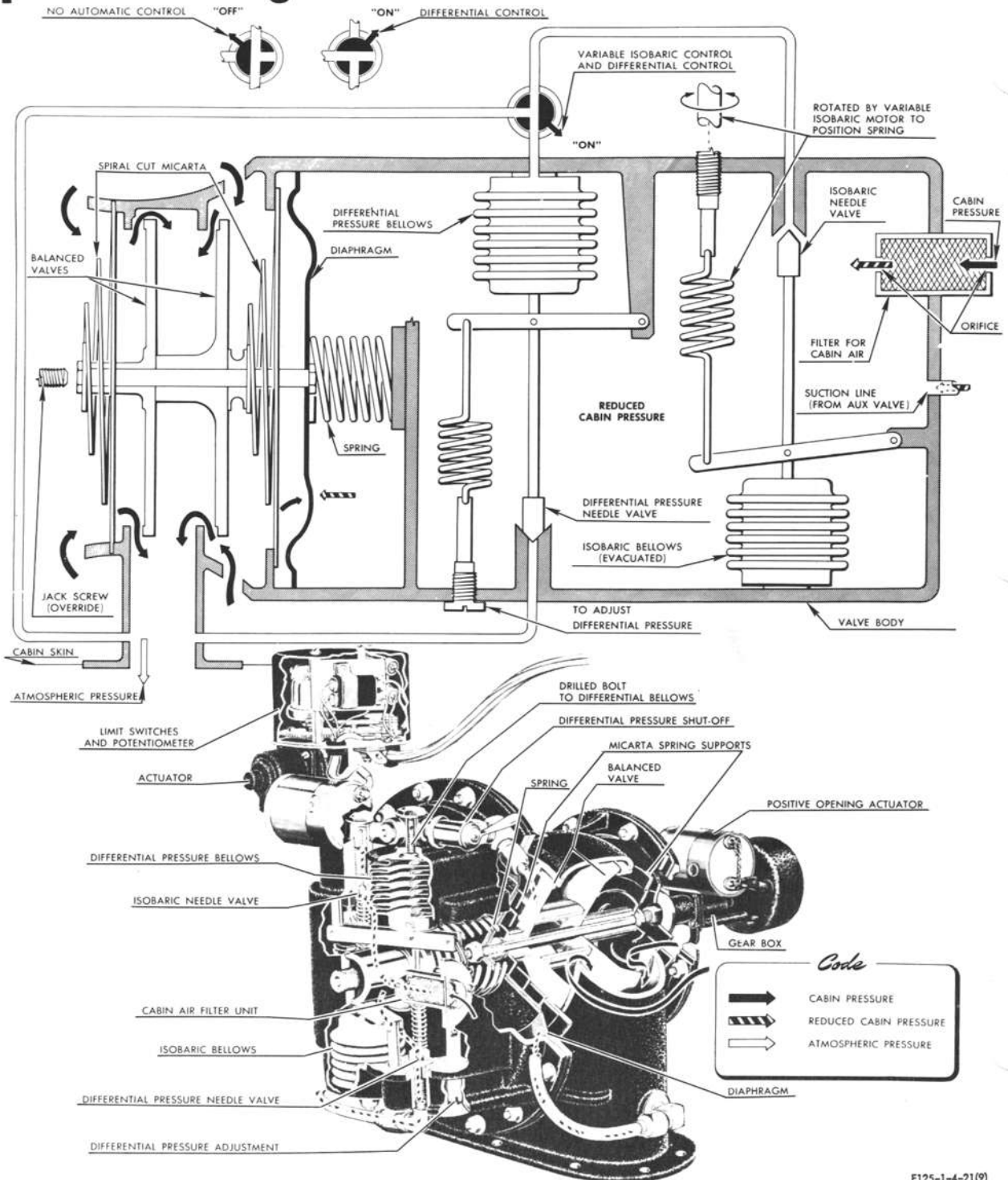
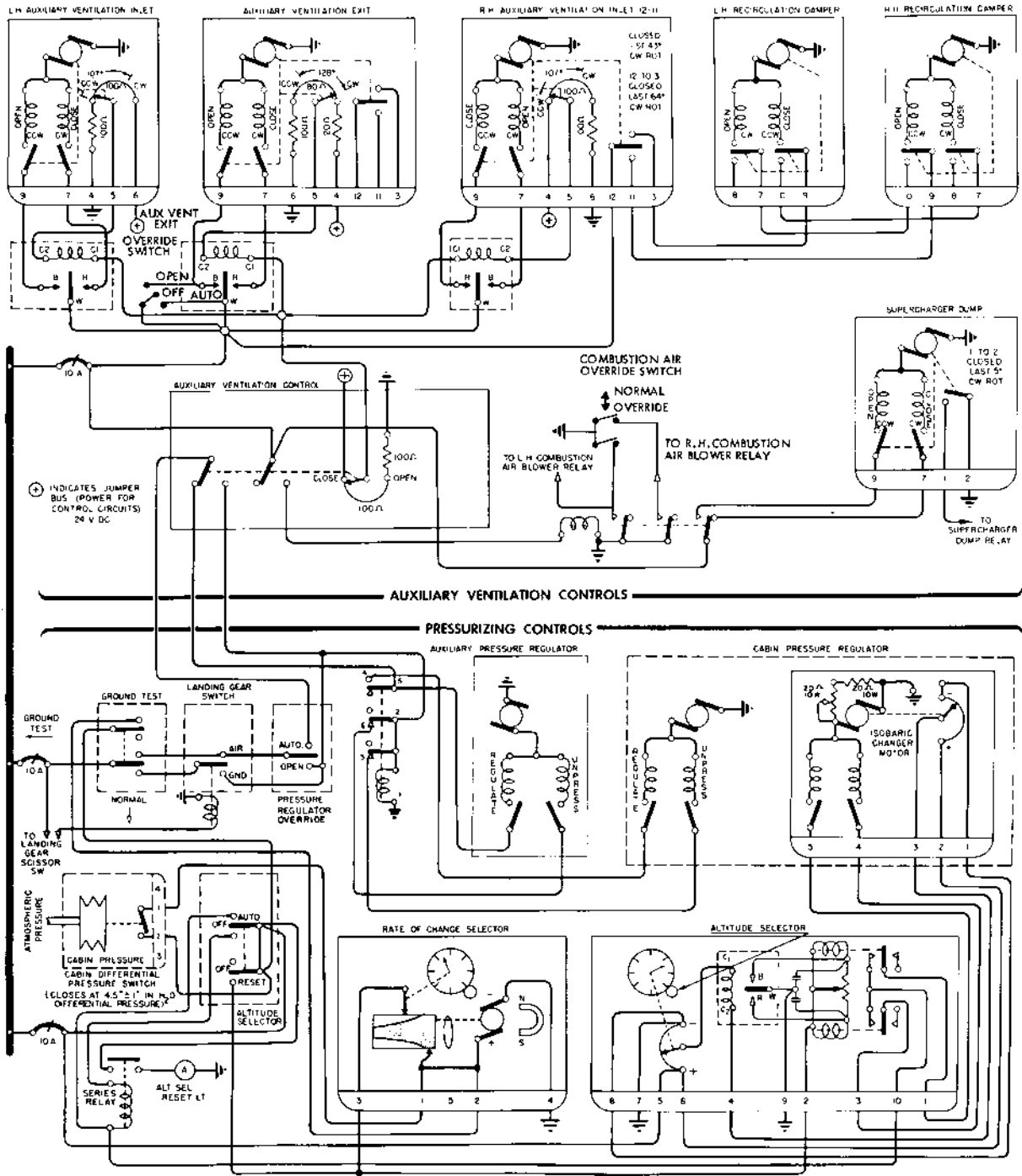

Figure 4-1 (Sheet 9)

F125-1-4-21(9)

auxiliary ventilation and pressurization control—wiring diagram



F125-4-4-21 (11)

Figure 4-1 (Sheet 11)

aftercooler scoop and refrigerator control

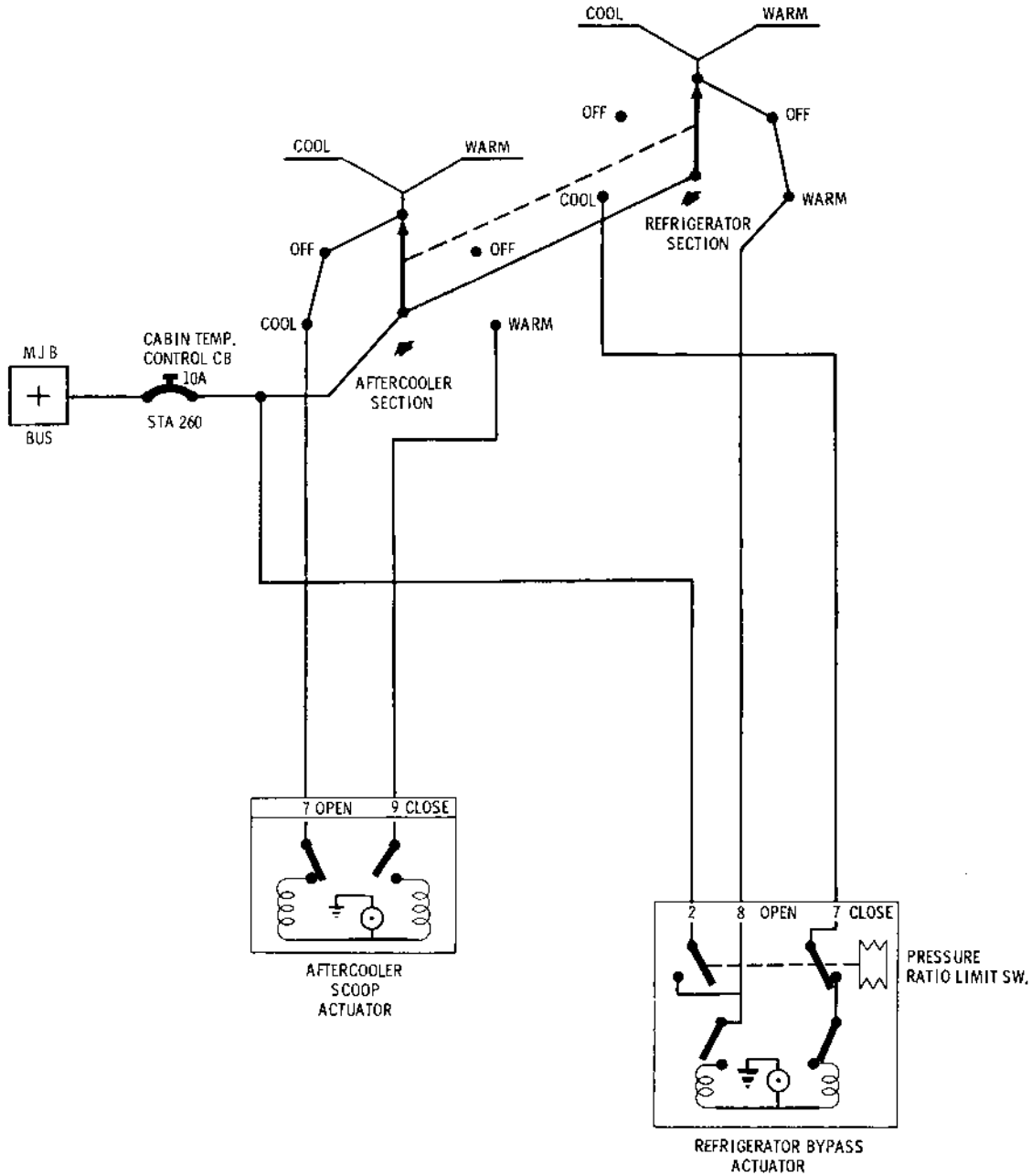

Figure 4-1 (Sheet 13)

F125-1-4-21(13)

cabin temperature control

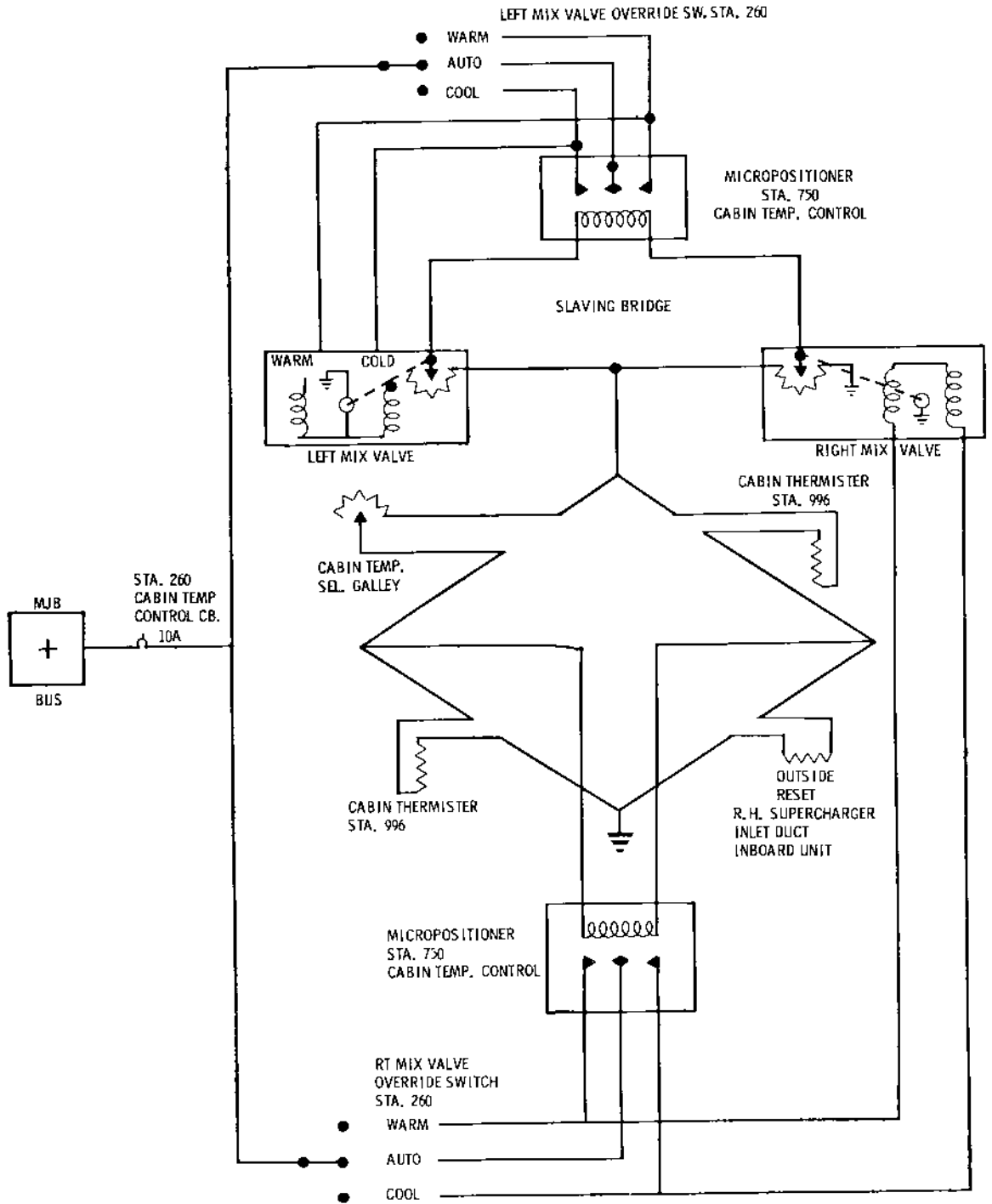

Figure 4-1 (Sheet 14)

F125-1-4-21(SM.14)

made to the cooling ram air around the tubes. The cooling ram air is carried away through the exit door in the upper surface of the wing panel. Modulation of the amount of cooling is then determined by the position of the primary aftercooler scoop. Full cooling and refrigeration may be accomplished by positioning the primary aftercooler and refrigerator switch to the full COOL position. From the outlet side of the primary aftercooler, the air flows into the compressor turbine of the cooling unit. From this turbine, the air passes through the secondary heat exchanger, then back into the expansion turbine of the cooling unit. From this turbine the air flows through the water separator into the fuselage duct.

PRESSURIZATION.

Ambient air is ducted through inlets on the wing leading edges to the cabin superchargers located in the outboard nacelles. It is then compressed and passed through the refrigeration and cooling equipment located in the right wing and then introduced into the fuselage structure to pressurize and ventilate this area when the auxiliary ventilation system is closed. The amount and rate at which the cabin air is exhausted overboard to maintain selected cabin pressure are determined by the auxiliary pressure regulator valve, the master pressure regulator control valve, the altitude selector, and the rate-of-change selector. The auxiliary pressure regulator valve automatically meters the outflow of cabin air in response to variable pneumatic control forces from the master pressure regulator control valve. The valve varies the pneumatic control forces in response to the manually selected positions of the altitude and rate-of-change selectors. These instruments provide for remote positioning of the isobaric section of the valve, permitting selective automatic operation up to a maximum pressure differential of 8.25 inches of mercury. Two cabin pressure safety relief and vacuum dump valves are installed on the aft pressure bulkhead. These valves act as a safety pressure relief valve and a vacuum dump valve. The housing (in which these valves are installed) is hinge-mounted from the top to permit it to swing inward if outside pressure is greater than inside pressure.

AIR CONDITIONING CONTROLS.

Heater Switches (Left and Right).

The heater switches (33 figure 4-7) are two-position switches labeled ON and OFF. The ON positions permit operation of the cabin heaters provided the recirculating fan switches are ON and the cabin temperature selector switch is set above a specified temperature. This automatic type electrical system is

protected by left and right heater circuit breakers located on the 260 switch panel.

Emergency Heater Switch.

This guarded switch (6 figure 4-7) will cause the heaters to cycle at a temperature (140°C) in excess of the normal cycling range by over-riding the outside compensators of the left and right hand cycling control circuits.

Heater Emergency Ignition Switches (Left and Right).

These two-position switches (1 figure 4-7) are labeled EMERGENCY and NORMAL. The EMERGENCY position permits selection of an alternate set of ignition points if the first set of ignition points malfunctions. The NORMAL position selects the first set of ignition points. The cabin heater circuit breakers, located on the 260 upper switch panel, protect the emergency ignition switches.

Note

Operate the emergency ignition switch first and then the heater switch to prevent possible damage to the ignition unit transfer relay.

Fan Switches (Left and Right).

The fan switches (30 figure 4-7) are two-position switches labeled ON and OFF. The fans are located on the forward end of each heater. These switches must be on for heater operation, and at all times to provide recirculated air and combustion air during auxiliary ventilation. The recirculating dampers are connected to the fan switches and auxiliary ventilation control, which provides means of shutting off or allowing recirculated air to enter the cabin. When the fan switches are turned off, or when the auxiliary ventilation knob is approximately 40% open, the recirculation dampers are closed.

Cabin Temperature Selector Rheostat.

This switch is a rheostat-type switch located on the galley control panel and is labeled in degrees from 15.5 to 27.7° C with the word DECREASE pointing to the low number. Cabin thermistors automatically control selected temperatures. A bridge circuit breaker, located on the 260 switch panel, protects this phase of the cabin heater electrical system.

Cabin Temperature Switch.

The cabin temperature switch is a four-position switch (5 figure 4-7) with the following positions: AUTOMATIC, OFF, COOL and WARM. The AUTOMATIC position controls the temperature of the cabin according to the setting of the cabin temperature selector rheostat. The COOL and WARM positions are used to override automatic operation to obtain a desired temperature.

heater system

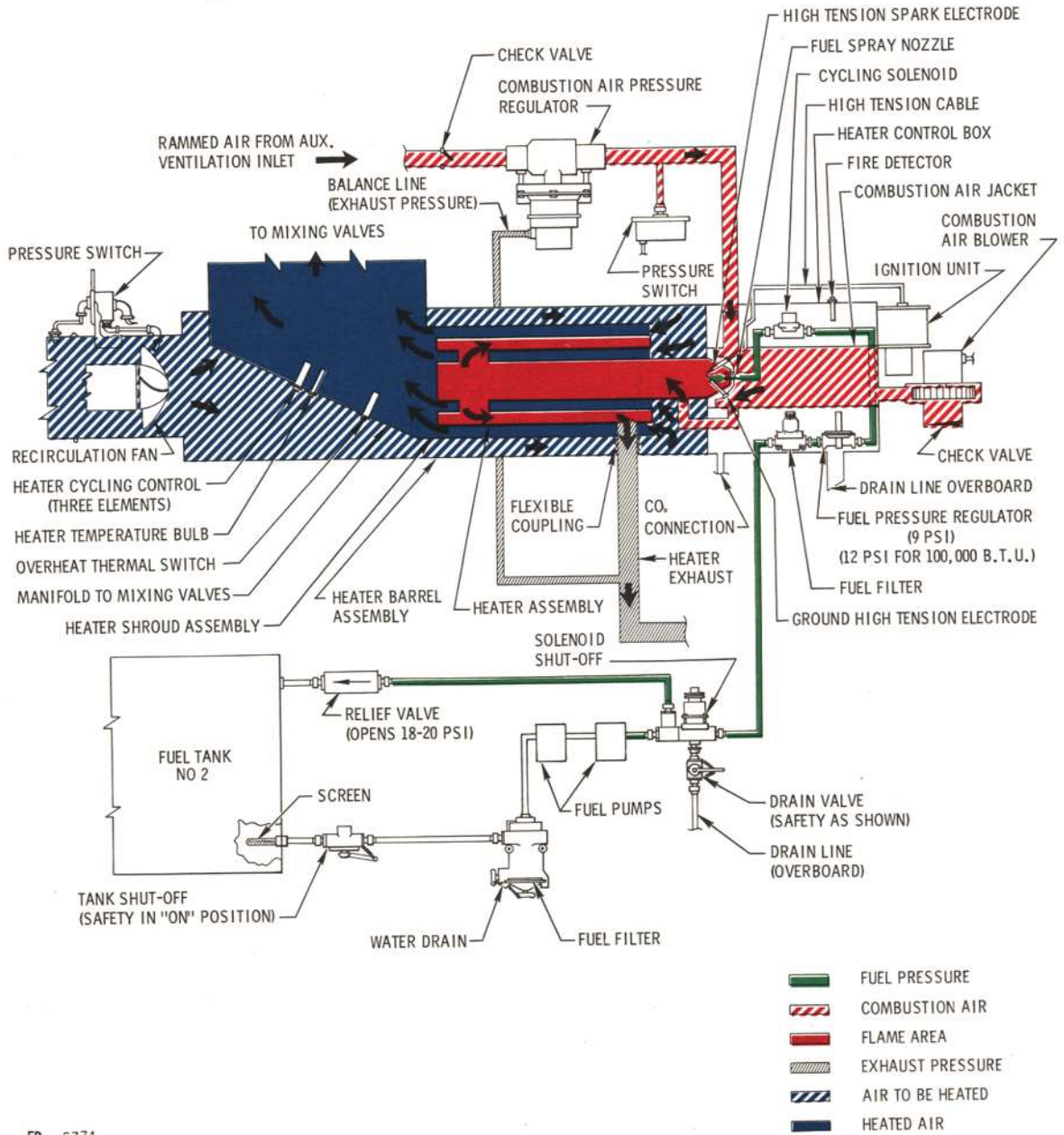

FB 6771
F125-4-4-22

Figure 4-2

aftercooler and refrigerator schematic

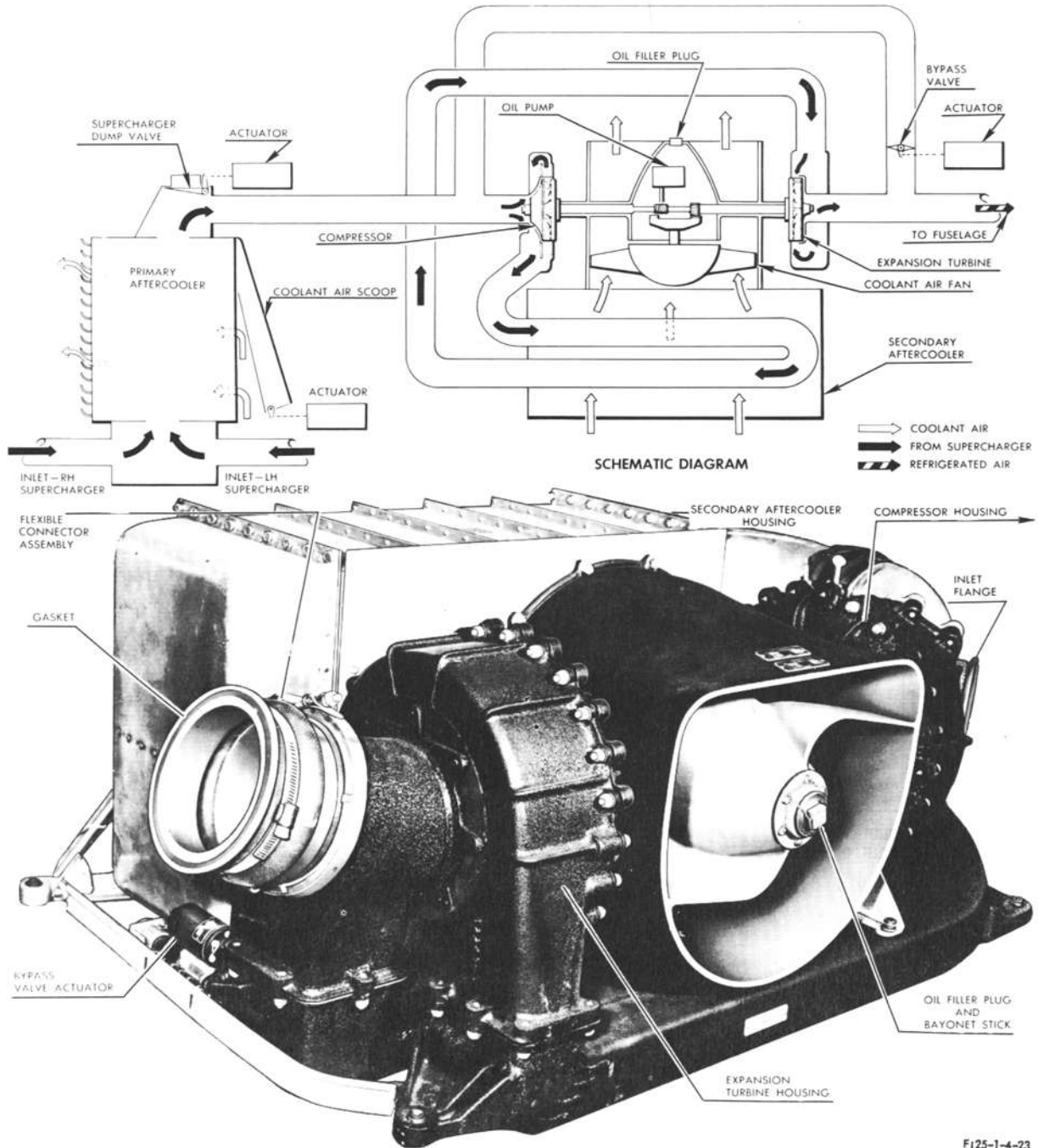

F125-1-4-23

Figure 4-3

The OFF position prevents the cabin control circuit from effecting any further temperature change.

Flight Station Fan Switch.

The flight station fan switch (11 figure 4-7) is an electrically-actuated, two-position, ON and OFF switch that controls the flight station fan. Air circulation in the flight station is increased when the switch is in the ON position.

Flight Station Temperature Switch.

This is a four-position switch (32 figure 4-7) with the following positions: AUTOMATIC, OFF, COOL and WARM. The AUTOMATIC position controls the temperature of the flight station according to the setting of the flight station temperature selector rheostat. The COOL and WARM positions are used to override automatic operation to obtain a desired temperature. The OFF position prevents the flight station control circuit from effecting any further temperature change.

Flight Station Temperature Selector Rheostat.

The flight station temperature selector (2 figure 4-7) is a rheostat-type switch and is labeled in degrees from 15.5 to 27.7° C with the word DECREASE pointing to the low number. Flight station thermistors automatically control selected temperatures. A bridge circuit breaker, located on the 260 switch panel, protects this phase of the heater circuit.

Left-Hand Mix Valve Switch.

This control is a four-position switch (14 figure 4-7) labeled AUTO, OFF, WARM and COOL. The AUTOMATIC position provides normal operation of the left-hand cabin mixing valve through the slaving control bridge. The WARM, COOL or OFF positions provide manual control of the left-hand mixing valve, overriding the right-hand mixing valve and slaving control system. The mixing valve moves to provide a mixture of recirculated cabin air and heated air while the heater is operating during pressurized operation. During auxiliary ventilation operation, the mixing valve moves to provide a mixture of fresh auxiliary ventilation air and heated fresh air (if desired) from the cabin heaters. The mixing valve ceases to change position when the switch is returned to OFF position. The full-warm position supplies no fresh air, but recirculated heated air only. This circuit is protected by a circuit breaker on the 260 switch panel.

Auxiliary Ventilation Knob.

The auxiliary ventilation knob (4 figure 4-7) is a rheostat switch circularly labeled CLOSED, A and B. This

switch is mechanically interconnected with the supercharger control (which also completes an electrical circuit to the combustion air blowers); the pressurization control switch which in turn controls the left and right auxiliary ventilation inlets, and the auxiliary ventilation exit. The switch in the A position dumps cabin supercharger discharge air and adjusts supercharger air to minimum flow; arms the combustion air blowers circuit (which will operate if the cabin heater control calls for heat), and opens the cabin pressure regulator valves. Clockwise movement of the auxiliary ventilation control knob switch past the A position progressively opens the auxiliary ventilation inlet and exit valves. However, the inlet valves open 20% prior to the initial opening of the exit valves. Any degree of opening of the auxiliary ventilation inlet and exit valves is obtainable according to the positioning of the switch. Position B of the switch provides moderate cabin and flight station ventilation without excessive air circulation. Complete clockwise movement of the switch provides maximum auxiliary ventilation (auxiliary ventilation inlets and exit fully open and recirculation valves closed). The CLOSED position of the switch provides cabin supercharger discharge air to the fuselage according to flow requirements; closes the pressure regulator valve; de-energizes the combustion air blower, and closes the auxiliary ventilation inlet valves and exit valve. The circuits are protected by an auxiliary ventilation control circuit breaker, a supercharger control and altitude warning circuit breaker, a cabin altitude control circuit breaker, and a pressure regulator valve control circuit breaker. All current breakers are located on the 260 upper switch panel.

Cabin Altitude Selector.

The cabin altitude selector (25 figure 4-7) operates a needle type indicator mounted on a dial that is calibrated both in inches-of-mercury and in thousands-of-feet. The knob (and needle) is mechanically connected to a potentiometer in such a manner that selection of an altitude on the dial mechanically positions the arm of the potentiometer so that each selected altitude is equal to a certain resistance value on the potentiometer. An isobaric changer potentiometer is connected to the selector potentiometer relay coil so that when an altitude is selected, and the selector potentiometer moves to put the circuit in an unbalanced condition, the micro-positioner moves the isobaric changer potentiometer, which actuates the isobaric spring-tension motor to correspond to the altitude selected. This results in an increase or a decrease in the sensing head valve release pressure, until the circuit is again in balance. This circuit is protected by the cabin altitude control circuit breaker located on the 260 switch panel.

auxiliary vent control knob

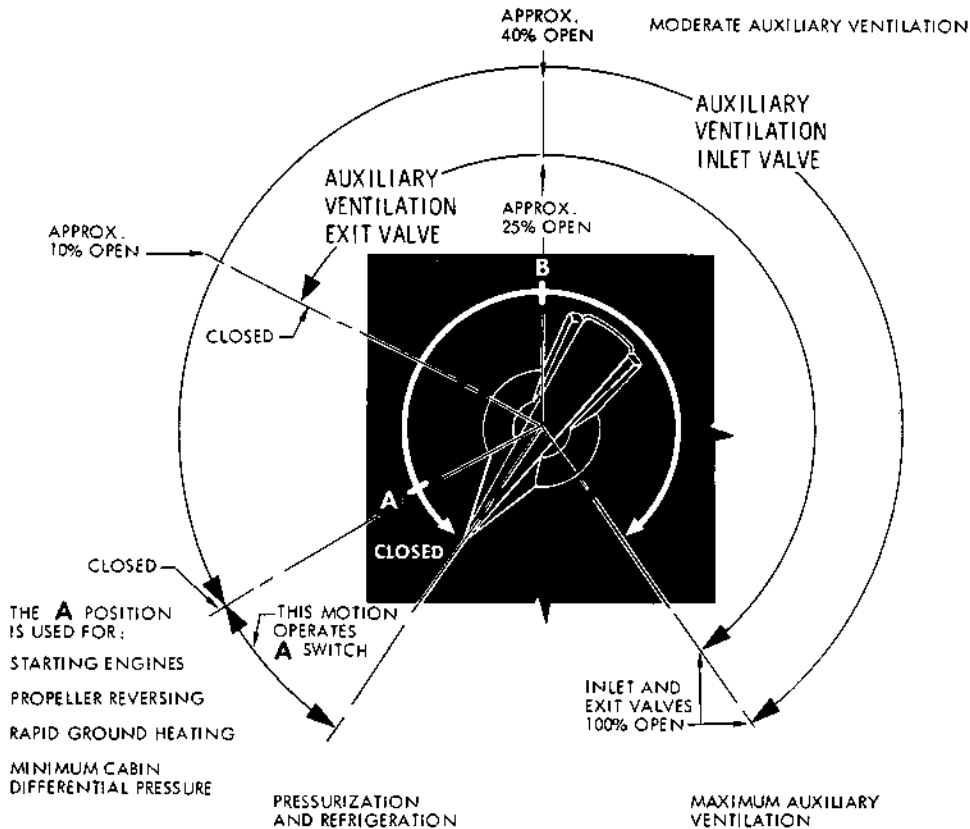

The auxiliary ventilation control knob is a rheostat-type switch placarded CLOSED, A and B. In the A position, the aux. vent. control knob dumps the cabin superchargers and puts them on minimum flow; completes an electrical circuit to the combustion air blowers (they will operate if the flight station or cabin thermostatic controls call for heat); and opens the cabin pressure regulator valves. Clockwise movement of the aux. vent. control knob, past the A position, progressively opens the auxiliary ventilation inlet and exit valves. When the inlet valves are 10% open (approximately the 10:00 o'clock position on the control

knob) the aux. vent. exit valves start to open. The last 80% travel of the control knob completes the opening of both inlet and exit valves. Any degree of open is obtainable by positioning the control knob. The position B of the aux. vent. control system is a recommended position for moderate cabin and flight station ventilation without excessive air circulation. The OPEN position provides maximum auxiliary ventilation (the aux. vent. inlets and exits are fully open). In the CLOSED position the cabin superchargers are supplying air to the fuselage according to flow requirements; the combustion air blower is de-energized; and the aux. vent. inlets and exits are closed.

F125-1-4-24

Figure 4-4

auxiliary vent control knob (emergency operation)

FUSELAGE FIRE PROCEDURE

The cabin superchargers are dumped and put on minimum flow; arms the combustion air blowers, opens the cabin pressure regulator valves, and the auxiliary ventilation inlet and exit valves are closed.

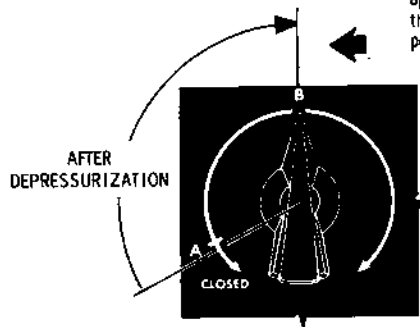

Auxiliary ventilation inlet valves are approximately 40% open; the auxiliary ventilation exit valve is approximately 25% open; the air recirculation dampers are closed.

After depressurizing to approximately 2" of Hg cabin differential pressure, move the Auxiliary Ventilation Control Knob to position "B" if the cabin is occupied. This affords moderate auxiliary ventilation without excessive air circulation. If the cabin is not occupied and there is oxygen available for the crew, position "A" may be used to shut off the auxiliary ventilation system completely and minimize air circulation.

SMOKE REMOVAL

Override pressure regulators to 2" of Hg. cabin differential pressure then move the Auxiliary Ventilation Control Knob to the full open position for approximately 15 seconds. Then return the Auxiliary Ventilation Control Knob to position "A" to prevent the partial pressurization of the cabin, which interferes with the opening of windows and doors.

The cabin superchargers are dumped and put on minimum flow; arms the combustion air blowers, opens the cabin pressure regulator valves, and the auxiliary ventilation inlet and exit valves are closed.

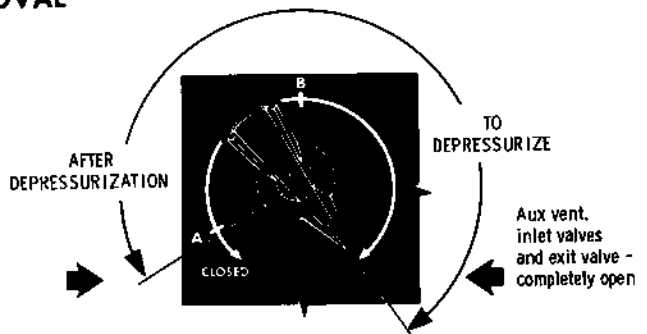

EMERGENCY DEPRESSURIZATION

The cabin superchargers are dumped and put on minimum flow; arms the combustion air blowers, opens the cabin pressure regulator valves, and the auxiliary ventilation inlet and exit valves are closed.

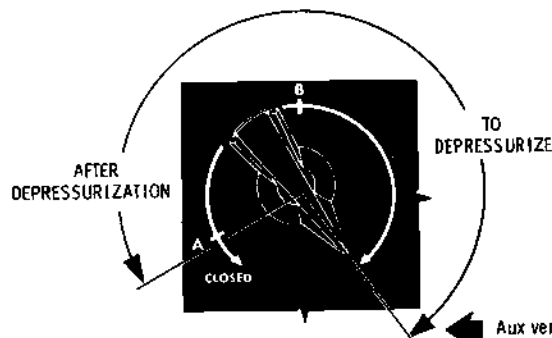

Override pressure regulators to 2" of Hg cabin differential pressure then move the Auxiliary Ventilation Control Knob to the full open position for approximately 15 seconds. Then, if windows or doors are to be opened, move the Auxiliary Ventilation Control Knob to position "A" to prevent partial pressurization. If no windows or doors are to be opened the Auxiliary Ventilation Control Knob may be moved to any position to afford the desired amount of ventilation.

F125-1-4-25

Figure 4-5

Vertical Velocity (Rate-of-Change) Selector.

The rate-of-change selector (27 figure 4-7) operates a needle-type indicator mounted on a dial that is calibrated in hundreds-of-ft. per min. The knob (and needle) is mechanically connected to a movable brush that makes electrical contact with a plastic cylinder which has a wedge-shaped contact inlay in its outer surface. This contact completes the circuit to the sensing head valve. A constant-speed electric motor causes the contact-cylinder to revolve, resulting in the interruption of this circuit. Rate-of-change in cabin pressure varies directly with the width of the contact-inlay which is determined by selection on the instrument (and, as a result, on the movable brush). This circuit is protected by the cabin altitude control circuit breaker located on the 260 switch panel.

Altitude Selector Reset Switch and Light.

The altitude selector reset switch (7 figure 4-7) is a three-position switch labeled AUTO, OFF and ALT. SEL. RESET. This switch should be in the AUTO position for all normal flight conditions. The OFF position will stop the changer assembly at the existing condition, and the ALT. SEL. RESET position will bypass the cabin rate-of-change selector for an approximate 2500 ft. rate of change. The reset light (26 figure 4-7) will glow when the switch is in the ALT. SEL. RESET position until the cabin altitude selector setting has been obtained. This switch and light are part of the cabin rate-of-change selector circuit. Power for the switch and light are derived from the 260 d.c. bus.

Pressure Regulator Valve Override Switch.

The pressure regulator valve override switch (8 figure 4-7) is a three-position switch with AUTOMATIC, OFF and OPEN positions. The AUTOMATIC position is used during normal flight. The OPEN position opens the pressure regulator valves by electrically overriding the automatic position, and opening the valves electrically by positioning the jackscrews to the desired position. The OFF position is used to select cabin altitude manually during flight. Power for this switch is derived from the 260 d.c. bus.

Ground Test Switch.

This switch (22 figure 4-7) is guarded and is labeled ON FOR GROUND CHECK-PRES. INSTR. In the ON position it permits pressurization tests on the ground by overriding the differential pressure switch, which in turn allows the rate-of-change selector to function. With this switch in the ON position, the pressure regulators will function because the landing gear scissors switch is bypassed.

Auxiliary Ventilation Exit Switch.

The aux. vent. exit switch (11 figure 1-24) is a three-position switch located on the flight engineer's lower switch panel. This switch is placarded AUTO, OFF, and OPEN. In the OPEN position, the aux. vent. exit door is opened. In the AUTO position, the aux. vent. exit door is positioned by the aux. vent. control knob. In the OFF position, the door remains where it was previously positioned.

Cabin Supercharger Disconnect Levers.

The cabin supercharger disconnect levers (4 figure 1-24), (same as No. 1 and No. 4 engine supercharger levers), are labeled EMERGENCY CABIN SUPCHGR. DISCONNECT with an arrow pointing outboard and are located on the flight engineer's control quadrant. The full outboard, or quadrant-stop position, is the drive shaft disconnect position. The spring-loaded gate lever prevents inadvertent disconnection of the supercharger drive shaft when operating the supercharger levers.

Heater Cycling Lights (Left and Right).

The heater cycling lights (3 figure 4-7) flicker amber whenever the cycling control solenoid closes. The cycling control solenoid operates the fuel cycling solenoid, ignition and the amber light for the heater.

Heater Temperature Indicators.

The heater temperature indicators (13 figure 4-7) are two gages that provide a continuous indication of cabin heater discharge air temperatures in degrees Centigrade. A resistance bulb in the discharge duct electrically transmits temperature by d.c. current to the indicators.

Heater Overheat Warning Lights (Left and Right).

The heater overheat warning lights (3 figure 4-7) glow red whenever the cabin heaters reach an unsafe temperature. When one of these lights glows, it also indicates that the cabin heater is in a "locked-out" off condition.

Supercharger Pressure Indicators (Left and Right).

The supercharger pressure indicators (20 figure 4-7) provide a continuous indication of the pressure differential, in inches-of-mercury (absolute), that exists between the inlet and outlet ducts of the cabin superchargers. Needle No. 1 reads inlet pressure and needle No. 2 reads outlet pressure.

Cabin Supercharger High Oil Temperature Lights (Left and Right).

The cabin supercharger high oil temperature lights (19, 21 figure 4-7) glow red whenever "oil-in" tem-

air conditioning duct system

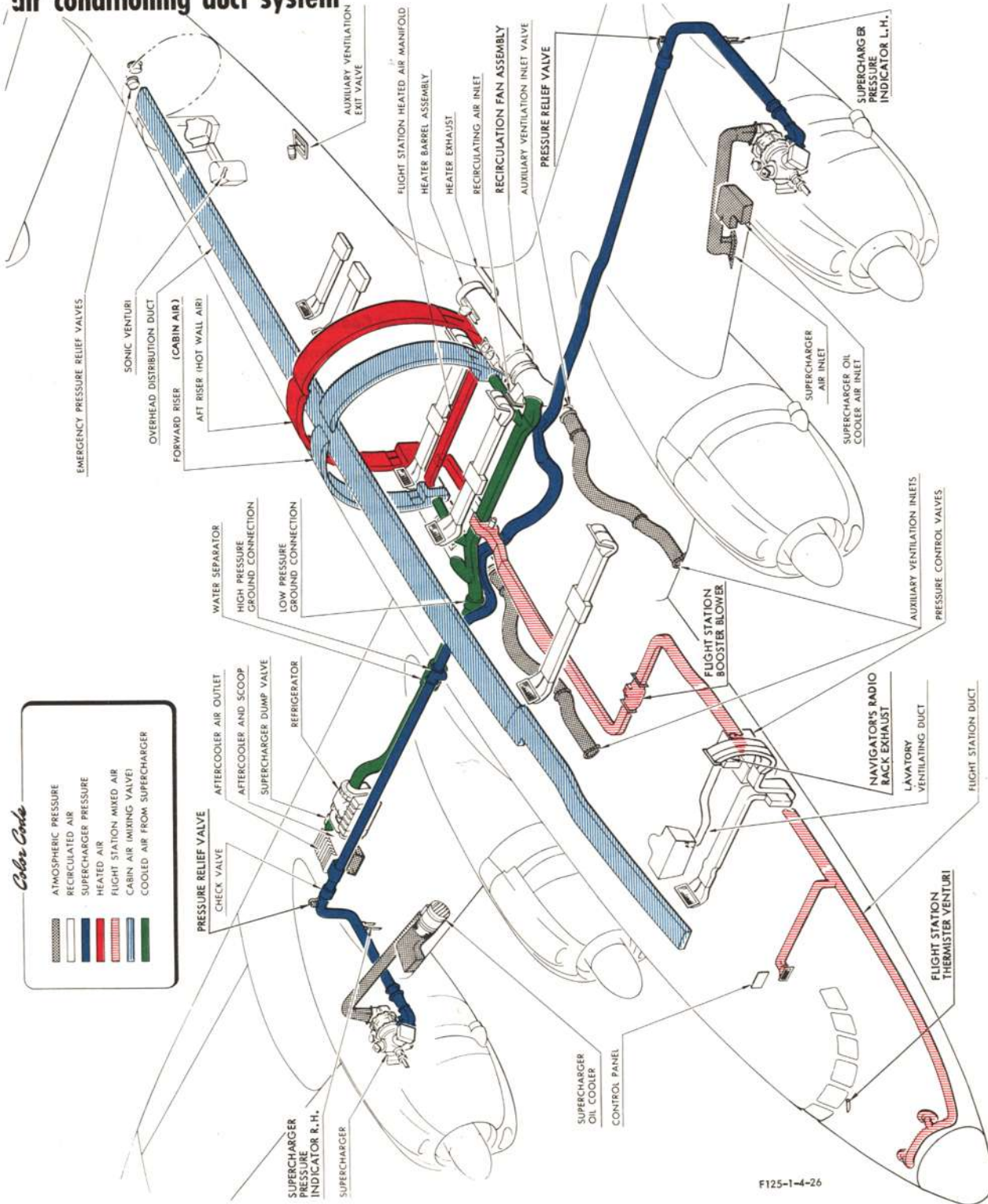

F125-1-4-26

Figure 4-6

perature exceeds a safe (225° F) value. When one of these lights glows, the associated cabin supercharger should be disconnected. Power is derived from the 260 d.c. bus.

Supercharger Sump Oil Pressure Indicator.

The supercharger sump oil pressure indicator (10 figure 4-7) is a dual gage that provides a continuous indication of supercharger sump oil pressure in pounds per square inch.

Supercharger Low Oil Pressure Warning Lights (Left and Right).

The supercharger low oil pressure warning lights (9 figure 4-7) glow red whenever sump oil pressure is below a safe (32±5 psi) value. The affected supercharger should be disconnected when a light glows.

Cabin Differential Pressure Indicator.

The cabin differential pressure indicator (23 figure 4-7) provides a continuous indication, in inches-of-mercury, of the differential pressure between cabin and atmospheric pressures.

Cabin Low Pressure Warning Light.

The cabin low pressure warning light (31 figure 4-7) glows red whenever the cabin altitude is 10,000 feet or above.

Cabin Altitude and Differential Pressure Gage.

The cabin altitude and differential pressure gage (29 figure 4-7) is located on the 260 air conditioning panel. The A-pointer provides a continuous indication of the airplane pressure altitude and the C-pointer indicates the equivalent cabin pressure in feet. The dial quadrant indicates differential pressure in pounds per square inch.

Cabin Vertical Velocity Indicator.

The cabin vertical velocity (rate-of-climb) indicator (28 figure 4-7) provides a continuous indication of changes of cabin pressure. Cabin rate of ascent and descent is indicated in feet per minute.

Altitude Selector Reset Light.

Refer to rate selector override switch under Air Conditioning Controls (26 figure 4-7).

Cabin Temperature Indicator.

The cabin temperature indicator (24 figure 4-7) provides a continuous indication of cabin air temperature derived from a resistance bulb. It is calibrated in degrees Centigrade.

NORMAL OPERATING PROCEDURES.

Ground Truck Heating or Cooling.

The flight compartment and cabin areas may be heated or cooled on the ground without the engines operating by performing the following steps:

1. Attach low-pressure truck to the ground-air connection.
2. Fan switches—OFF.
3. Aux. vent knob—POSITION A.
4. Heater switches—OFF.
5. Flight station fan switch—as required.
6. Flight station temperature switch — position as required.

Heating and Cooling During Ground Operation.

The flight compartment and cabin areas may be heated or cooled on the ground with the engines operating by performing the following steps:

1. Fan switches—ON.
2. Flight station fan switch—as desired.
3. All windows and doors—closed.

If ground heating is required:

1. Aux. vent knob—OPEN.
2. Cabin temp. switch—WARM.
3. Heater switches—ON.
4. If additional flight compartment heat is required:
 - a. Flight station temperature switch—WARM.
 - b. Flight station fan switch—ON.

If ground cooling or refrigeration is required:

Note

When refrigeration is necessary during taxiing, operate the outboard engines at 1200 rpm and idle the inboard engines. This will provide the necessary rpm for the cabin superchargers without resulting in high taxi speed.

1. Auxiliary vent. exit switch—OPEN.
2. Primary aftercooler and refrigerator knob—COOL.
3. Aux. vent knob—CLOSED.
4. Cabin temperature switch—Set for desired cooling.
5. Flight station temperature switch—Position as required.

Heating and Cooling During Flight Operation.

The flight compartment and cabin areas may be heated or cooled during flight as follows:

1. Fan switches—ON.

air conditioning control panel

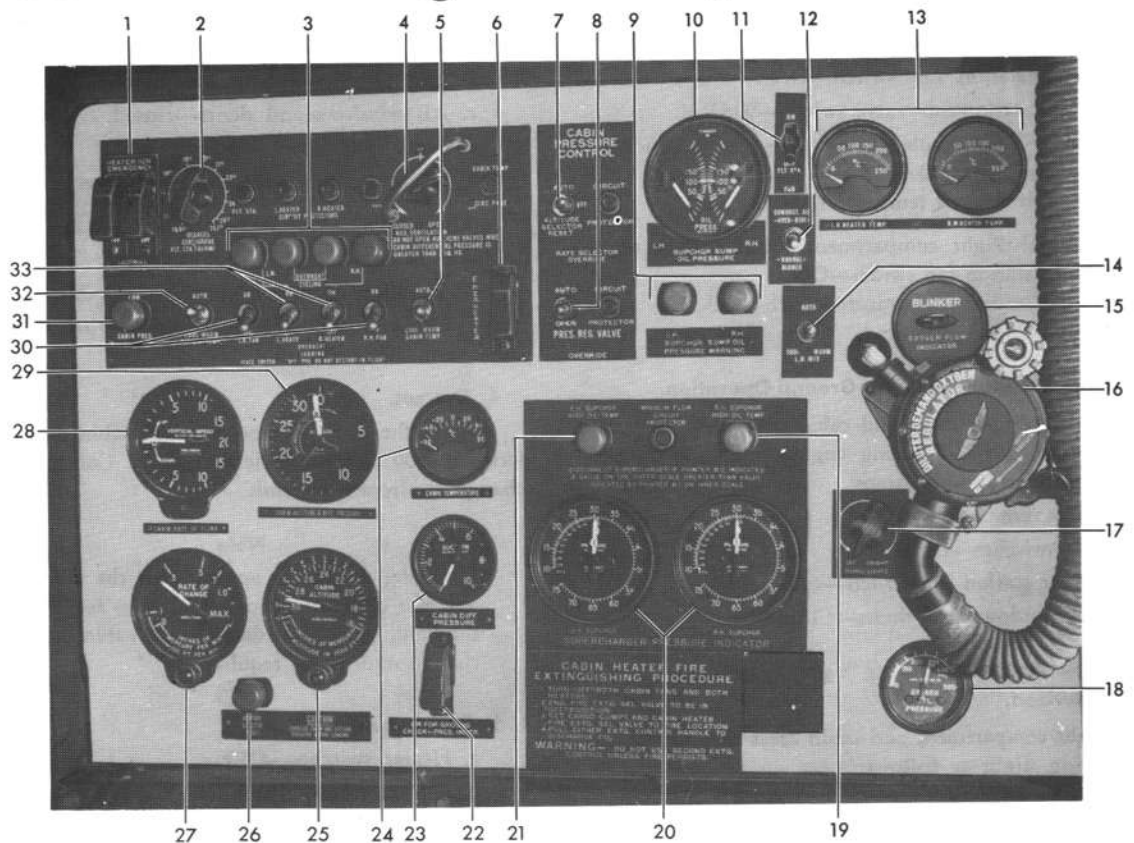

- 1 LEFT AND RIGHT HAND EMERGENCY IGNITION SWITCHES
- 2 FLIGHT STATION TEMPERATURE SELECTOR RHEOSTAT
- 3 LEFT AND RIGHT HAND OVERHEAT WARNING AND CYCLING LIGHTS
- 4 AUXILIARY VENTILATION KNOB
- 5 CABIN TEMPERATURE SWITCH
- 6 EMERGENCY HEATER SWITCH
- 7 ALTITUDE SELECTOR RESET SWITCH
- 8 PRESSURE REGULATOR VALVE OVERRIDE SWITCH
- 9 RIGHT AND LEFT HAND SUPERCHARGER LOW OIL PRESSURE WARNING LIGHTS
- 10 SUPERCHARGER SUMP OIL PRESSURE INDICATOR
- 11 FLIGHT STATION FAN SWITCH
- 12 COMBUSTION AIR OVERRIDE SWITCH
- 13 LEFT AND RIGHT HAND HEATER TEMPERATURE INDICATORS
- 14 LEFT HAND MIX VALVE SWITCH
- 15 FLIGHT ENGINEER'S OXYGEN BLINKER GAGE
- 16 FLIGHT ENGINEER'S OXYGEN REGULATOR

- 17 STATION 260 PANEL LIGHTS
- 18 CO-PILOT'S AND ENGINEER'S OXYGEN PRESSURE GAGE
- 19 RIGHT HAND SUPERCHARGER HIGH OIL TEMPERATURE LIGHT
- 20 LEFT AND RIGHT SUPERCHARGER PRESSURE INDICATORS
- 21 LEFT HAND SUPERCHARGER HIGH OIL TEMPERATURE LIGHT
- 22 GROUND TEST SWITCH
- 23 CABIN DIFFERENTIAL PRESSURE INDICATOR
- 24 CABIN TEMPERATURE INDICATOR
- 25 CABIN ALTITUDE SELECTOR
- 26 ALTITUDE SELECTOR RESET LIGHT
- 27 VERTICAL VELOCITY (RATE OF CHANGE) SELECTOR
- 28 CABIN VERTICAL VELOCITY INDICATOR
- 29 CABIN ALTITUDE AND DIFFERENTIAL PRESSURE GAGE
- 30 LEFT AND RIGHT HAND FAN SWITCHES
- 31 CABIN LOW PRESSURE WARNING LIGHT
- 32 FLIGHT STATION TEMPERATURE SWITCH
- 33 LEFT AND RIGHT HAND HEATER SWITCHES

F125-1-1-51

Figure 4-7

Section IV
Auxiliary Equipment

T. O. 1C-121A-1

If heating is required:

1. Cabin temperature selector rheostat—Set to temperature required.
2. Heater switches—ON.

If additional flight compartment heat is required:

1. Flight station fan switch—ON.
2. Flight station mix valve switch—WARM.
3. Primary aftercooler and refrigeration knob — WARM position for desired temperature, then to OFF position after desired temperature is reached.

If additional flight compartment cooling is required:

1. Flight station fan switch—ON.
2. Flight station temperature switch—COOL.
3. Aftercooler—as desired.

Auxiliary Ventilation During Ground Operation.

The flight compartment and cabin areas may be ventilated on the ground during engine operation by performing the following steps:

1. Aux. vent. knob—OPEN.
2. Fan switches—ON
3. Flight station fan switch—as required.
4. All windows and doors—Closed.

Auxiliary Ventilation During Flight Operation — Unpressurized.

The flight compartment and cabin areas may be ventilated during flight as follows:

1. Before take-off.
 - a. Fan switches—ON.
 - b. Aux. vent. knob—OPEN.
2. During flight.
 - a. Aux. vent. knob—as required to maintain adequate ventilation.
 - b. Flight station temperature switch—as desired.
 - c. Flight station fan switch—ON.
3. Before landing.
 - a. Aux. vent. knob—position A.

Pressurization Control.

The flight compartment and cabin areas may be pressurized for flight operation by performing the following steps:

1. Before starting engines.
 - a. Ground rest switch—OFF (down).
 - b. Cabin altitude selector—set to 500 feet above field altitude.
 - c. Altitude selector reset switch—ALT. SEL. RESET until cabin altitude selector reset light goes out, then move switch to AUTO position.
 - d. Aux. vent. knob—position A.
 - e. Rate-of-change selector—300 feet per minute.

f. Pressure regulator valve override switch—AUTOMATIC.

g. Auxiliary vent. exit switch—OPEN.

2. During engine ground operation (before taxiing).
 - a. Fan switches—ON.
 - b. Flight station fan switch—as required.
 - c. All windows and doors—closed.
 - d. Aux. vent knob—Position A.
 - e. Close auxiliary exit valve for 15 seconds.
3. During second segment climb.
 - a. Aux. vent knob—CLOSED.
 - b. Auxiliary vent. exit switch—CLOSED.
 - c. Cabin altitude selector—during climb select desired vent. cabin altitude.
4. Descent.
 - a. At the start of descent, reset cabin altitude selector to 500 feet above field altitude. Control rate-of-change as aircraft descends.

Note

If during descent, it appears that the altitudes will not meet at approximately 500 feet above the field, increase or decrease the cabin rate-of-change settings, as required.

5. Before landing.
 - a. Heater switches—OFF.
 - b. Fan switches—OFF.
 - c. Auxiliary vent exit switch—OPEN.
 - d. Aux. vent. knob—position A for propeller reversing.

Note

Refer to paragraphs on heating, cooling and refrigeration for procedure to be followed to maintain required cabin and flight station temperatures.

AIR CONDITIONING SYSTEM EMERGENCY PROCEDURES.

Cabin Heater Malfunction.

If the heater does not operate properly, as indicated by the cycling light glowing but no heater temperature, accomplish the following:

- a. Switch to HEATER IGNITION EMERGENCY in flight. (If heater malfunction still exists, the following items should be investigated on the ground; heater fuel pump, heater fuel shut-off solenoid, induction vibrator, and the fuel cycling solenoid.)

If the heater does not operate properly, as indicated by

no heater temperature and failure of the cycling light to glow, accomplish the following in flight:

- a. Position mix valves to the WARM position.
- b. Turn the combustion air override switch to OVERRIDE position. Cause could be that the air inlet valve is restricted or iced up.

Note

If this condition still exists in flight, the following units could be inoperative; the combustion air pressure switch and differential pressure switch. These items are not accessible during flight and must be checked on the ground.

If the heater is cycling normally, but with an indication of low cabin temperatures:

- a. Turn the cabin temperature rheostat to a higher setting.
- b. Check cabin mix by positioning to WARM.
- c. Check to see that cabin thermister is not clogged.
- d. Use EMERGENCY HEATER switch to cycle heater to a higher temperature.

Each cabin heater is protected by a fenwall overheat switch. Should the normal or overheat cycling control fail or some other units malfunction, which would cause the heater to overheat, the fenwall overheat switch will electrically lockout the heater at a temperature of approximately 180°C. Occasionally, under extreme conditions of airflow, a rapid rise of the combustion chamber temperature may cause a heater to lockout with an indicated temperature which does not seem excessive. To re-energize the heater circuit after the lockout, place heater switches off, leave recirculation fans on to cool heaters, then place heater switch in the ON position. If the fenwall thermal switch has cooled, the heater will start.

CAUTION

If the heater circuit locks out a second time, it should not be reset until the cause has been determined.

Cabin Heater Fire Control Procedure.

For procedures, refer to Section III.

Emergency Smoke Removal.

For aux. vent. control knob operation refer to figure 4-5. For emergency procedure, refer to Section III.

Fuselage and Cargo Emergency Fire Procedures.

For aux. vent. control knob operation refer to figure 4-5. For emergency procedure, refer to Section III.

Emergency Depressurization.

(Refer to figure 4-5).

1. Override pressure regulators to 2" differential then aux. vent. to position B.
2. Place the aux. vent. control knob in the full OPEN position for approximately 15 seconds, then return the knob to position A. The aux. vent. control knob must be returned to position A to prevent partial pressurization of the cabin by the auxiliary ventilation system, which is sufficient to interfere with the opening of windows and doors.

CAUTION

Electrical power must be available for emergency depressurization with the aux. vent. control knob.

3. Heater switches — AS DESIRED.
4. Fan switches—AS DESIRED.
5. Descend to a low, safe altitude.

Pressurization With One Cabin Supercharger.

If it is necessary to maintain cabin pressurization on one cabin supercharger, it should be understood that operation with cabin pressurized at full differential from the output of one cabin supercharger is marginal and depends upon the cabin differential required and the rate of leakage from the cabin through normal deterioration of seals with service use. Therefore, if operation with only one cabin supercharger connected, and

anti-icing system (airplanes with windshield anti-icing)

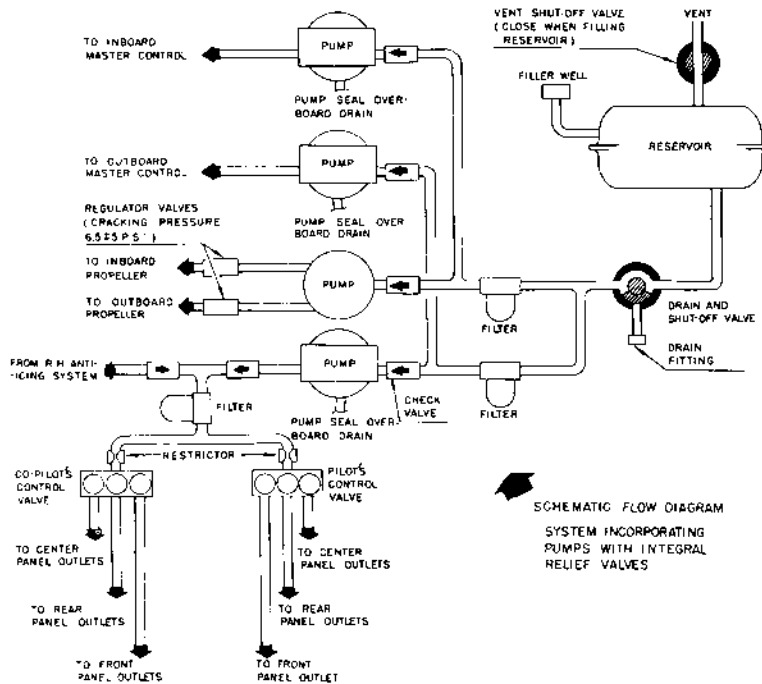
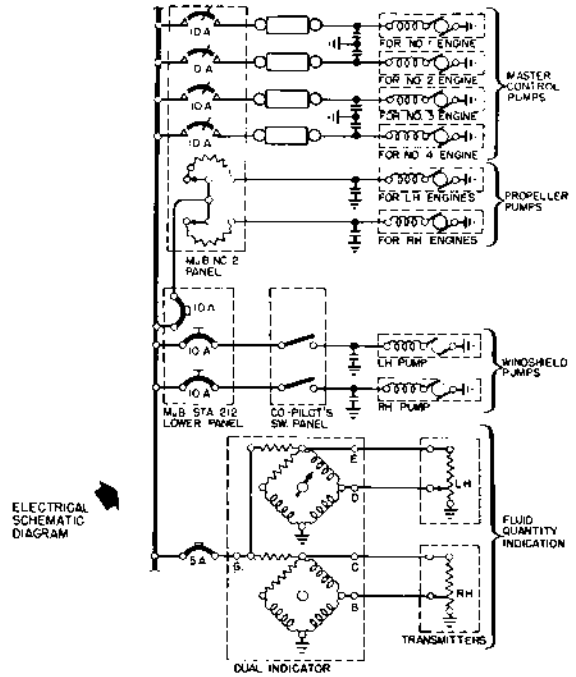
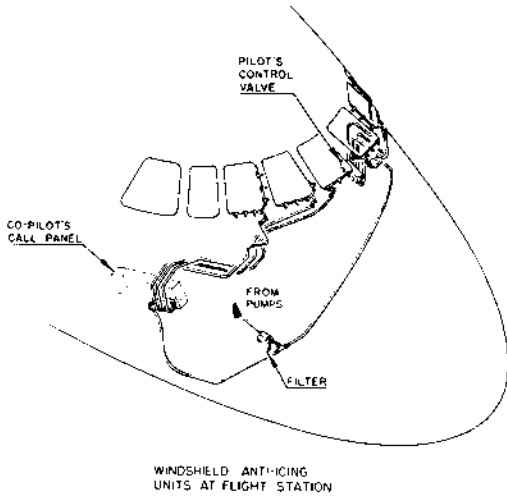

F125-1-4-27 (1)

Figure 4-8 (Sheet 1)

anti-icing system (airplanes with windshield anti-icing)

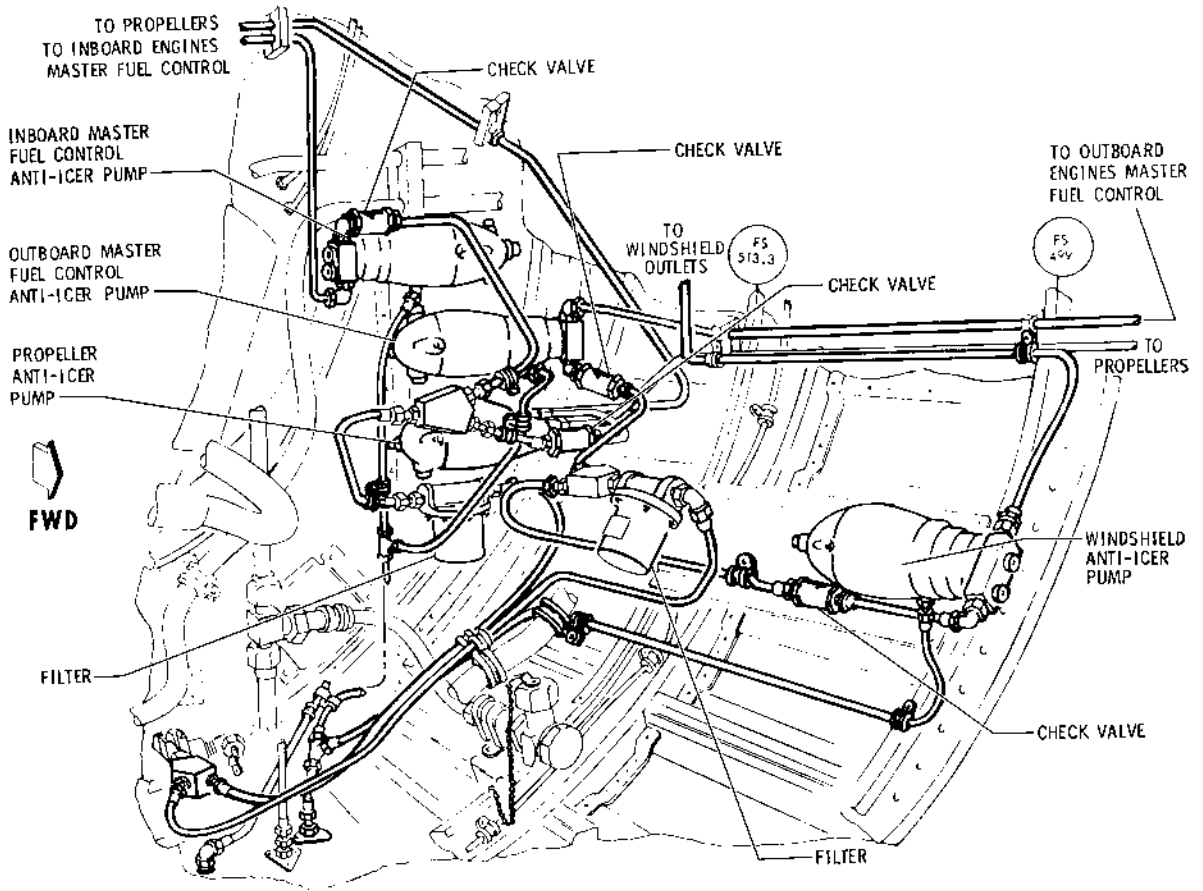

INSTALLATION OF MASTER CONTROL PROPELLER AND WINDSHIELD ANTI-ICER PUMPS

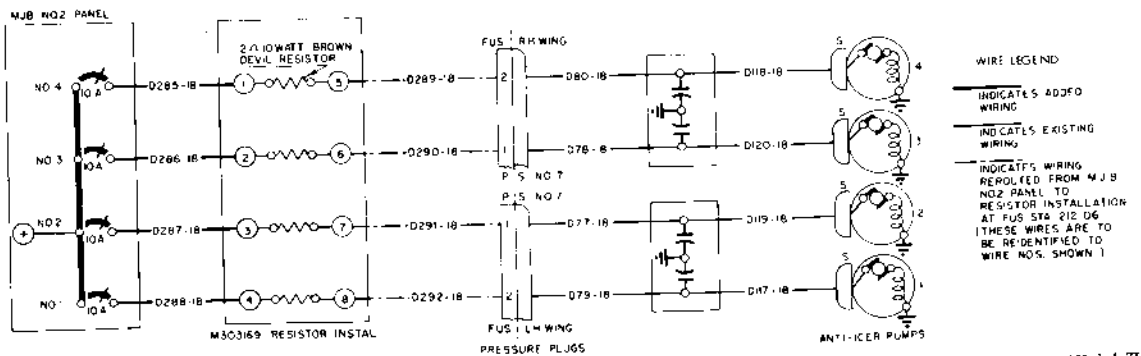

CARBURETOR ANTI-ICER PUMP RESISTORS CIRCUITRY

F125-1-4-27 (2)

Figure 4-8 (Sheet 2)

full differential is required, it is recommended that the following step be performed:

1. Galley and radio rack venturi — CLOSED.

CAUTION

If difficulty is experienced in maintaining cabin pressure up to the maximum differential with the galley venturi closed, descend to a cruising altitude where the cabin altitude can be maintained at 10,000 feet or less.

Cabin Supercharger Drive Shaft Disconnect.

Note

- The cabin supercharger disconnect may be actuated with the engine operating at any RPM within the normal operating range.
- Observe normal blower shift procedures if high blower engine operation is to be resumed after disconnecting cabin superchargers.

CAUTION

Disconnect cabin supercharger when a definite malfunction is indicated, such as low sump oil pressure, high oil temperature, low air flow, or when 150°C temperature is indicated on disconnect gear box.

1. Release hook-type lock on No. 1 and/or No. 4 engine supercharger control lever.
2. Move control lever past the LOW position to the end of its travel.
3. Return lever to desired engine supercharger position.

When the cabin supercharger drive shaft is completely disconnected, either one of the following indications will be noted:

1. Oil pressure warning light, if not already on, will come on as soon as the drive shaft is disengaged from the engine.
2. No pressure differential will be indicated on the dual pressure gage.

CAUTION

The propeller of the affected engine should be feathered immediately if the cabin supercharger does not disconnect.

ANTI-ICING, DE-ICING, DEFOGGING AND VACUUM SYSTEMS.

Anti-icing or de-icing facilities are provided for the leading edges of the wing and empennage, windshield, carburetors, propellers, pitot heads and masts, and antenna mast. Defogging facilities are provided for the windshield panels, astral dome and the cabin windows. The pilot's and copilot's forward windshield panels are equipped with wipers powered by 28-volt d.c. The wiper is controlled by a five position rheostat switch labeled, LOW, MED, HIGH, OFF and PARK.

WING AND EMPENNAGE LEADING EDGE DE-ICING SYSTEM.

Ice may be removed after it has formed on the leading edges of the wing and empennage by electrically-timed pneumatically inflated and deflated rubber boots. Pressure and vacuum for the pneumatic system are supplied by four engine-driven air pumps. Refer to figure 4-9.

De-Icer Boots.

The de-icer boots are made in segments that are firmly bonded to the leading edges of the wing and empennage. Each segment incorporates two separate systems of tubes with independent connections to their respective distributor valves except those segments that are attached to the tips of the stabilizer and to the fins, each of which has one system of cells. The boots are surfaced with a conductive coating to prevent the accumulation of static electricity which, when discharged, would interfere with radio reception.

De-Icer Boot Pumps.

Four rotary, four-vane, positive-displacement, engine-driven air pumps, one mounted on each engine, supply air pressure and vacuum for the pneumatic de-icer system. The two outboard pumps supply pressure; the two inboard pumps supply both pressure and suction.

De-Icer Boot Vacuum System.

The two inboard pumps supply suction for the de-icer boots. The output from the pressure side of the two pumps which supply vacuum is also used as a source of pressure.

De-Icer Boot Pressure System.

Pneumatic pressure from the four pumps is directed through oil separators to relief valves. These relief valves maintain 10 pounds per square inch at the outlet ports which protects the system from pressure surges in excess of 10 pounds by discharging excess air overboard. Check

instrument vacuum system

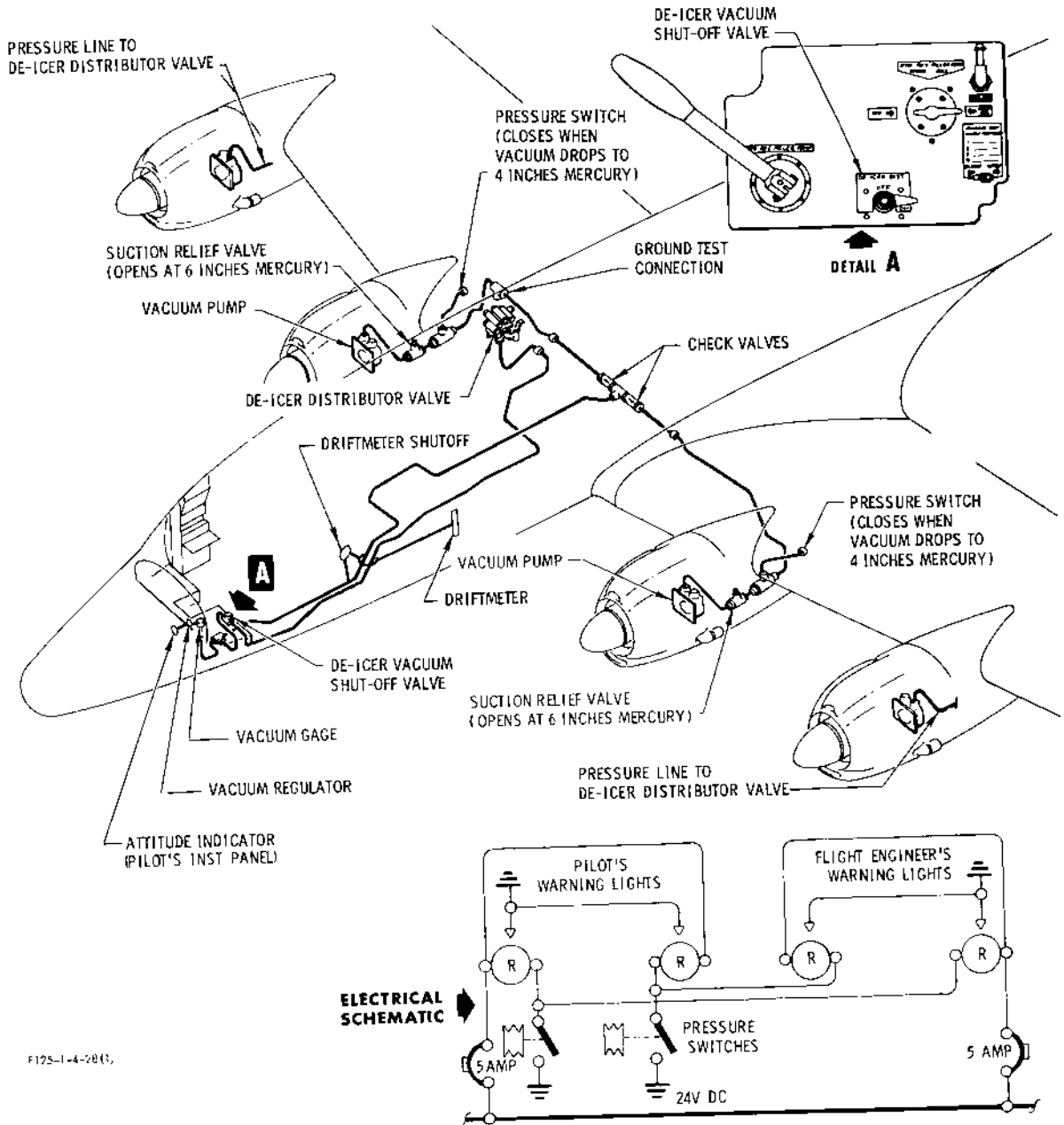

F125-1-4-28 (3)

Figure 4-9 (Sheet 1)

de-icing system

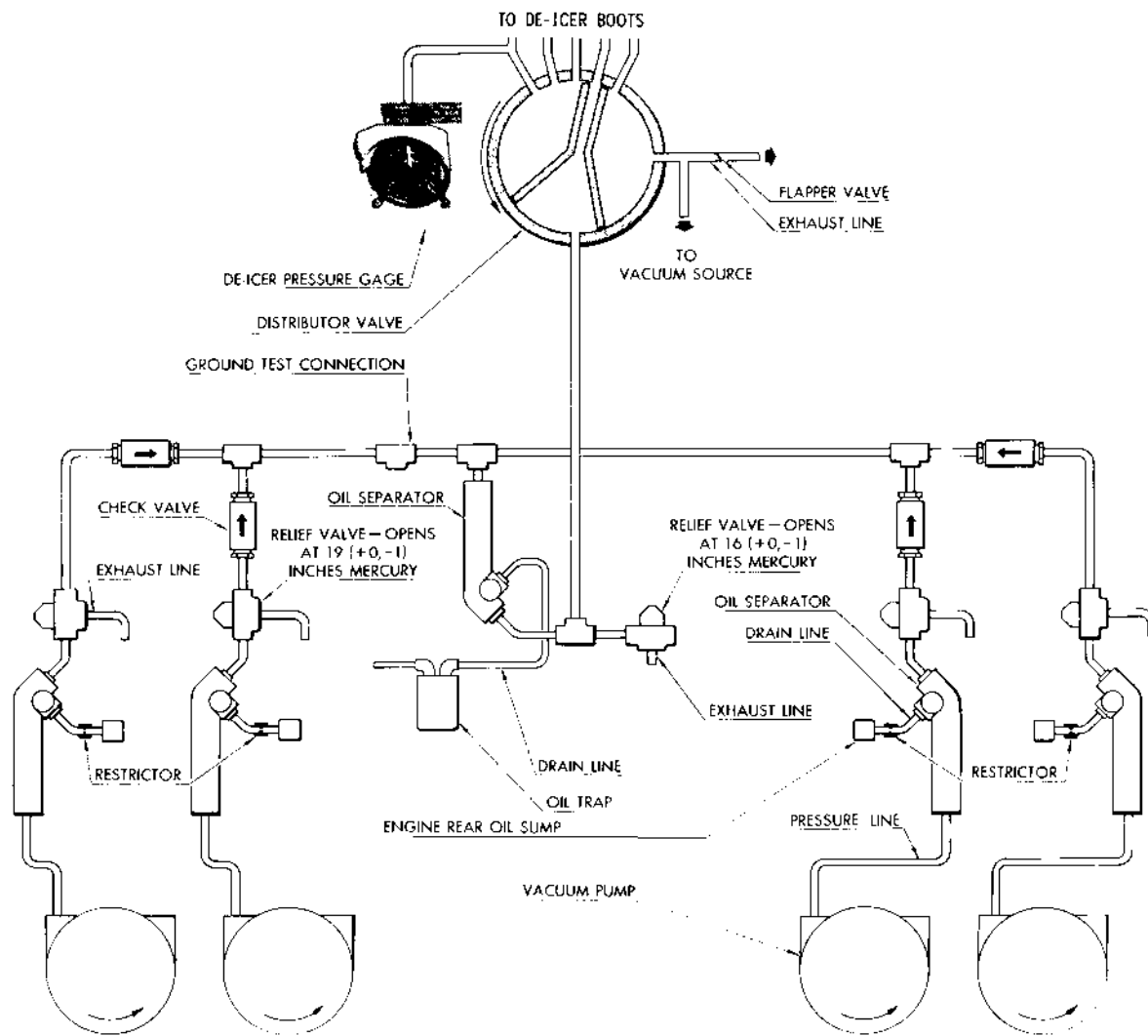

Figure 4-9 (Sheet 2)

F125-1-4-28 (2)

valves downstream from the main oil separator prevent loss of system pressure in the event of failure of any pump. From the main oil separator, the compressed air passes to the main pressure line, then to the distributor valve from which pressure is delivered to the de-icer boot segments in metered pulsations.

Distributor Valve.

The de-icer boots are operated cyclically through the action of the distributor valve. The valve consists of a 24-volt d.c. motor, a reduction gear train, an integral Geneva movement, and a valve rotor operating in a distribution housing. The valve provides a de-icing cycle consisting of a five-second inflation period, a five-second deflation period (air in the boots discharging to the atmosphere), and a 30-second dormant period. During the dormant period the boots remain deflated and the distributor valve connects the boots to the vacuum system to prevent possible inflation of the boots caused by high lift conditions above the leading edges of the surfaces. When the system is turned off the de-icer boots will continue to operate until the cycle is completed.

Wing De-Icer Switch.

This switch (9 figure 1-20), located on the co-pilot's side switch panel, routes 28-volt d.c. power from the main d.c. bus to the electrically operated de-icer distributor valve. This switch has two positions, WING (up) and OFF (down).

De-Icer System Indicator.

One direct reading vacuum-pressure indicator (40 figure 1-18) is mounted on the pilot's instrument panel. With de-icer boots off, the instrument indicates vacuum pressure to the boots. With de-icer boots on, the instrument indicates the pressure and vacuum going to the empennage boots.

Vacuum Pressure Indicator.

One direct reading vacuum pressure indicator (42 figure 1-18) is mounted on the pilot's auxiliary instrument panel. It registers the vacuum in the system in inches of mercury.

Vacuum Pump Warning Lights.

A warning light for Number 2 and 3 vacuum pump is located on the pilot's auxiliary panel (43 figure 1-18) and on the flight engineer's lower instrument panel (25 figure 1-23). They are energized by vacuum warning units located in the suction line of Number 2 and 3 vacuum pump. Power is derived from the main d.c. bus.

NORMAL OPERATING PROCEDURE FOR DE-ICER BOOTS.

Ice may be eliminated more effectively from the leading edges of the wing and empennage if it is permitted to build up to $\frac{3}{8}$ inch for clear ice and $\frac{3}{4}$ inch in thickness for rime ice before the de-icer boots are turned on. A thin film of ice may be flexible, but when it thickens, the expansion and contraction of the boots will crack it and permit it to be blown off. The method of operation of boots depends largely upon the type and severity of icing conditions. However, intermittent operation, allowing the ice to build up slightly in between operations, has generally been found to be the most effective.

1. Wing de-icer switch—ON.

Note

Wing and empennage de-icer boots must be turned OFF prior to landing.

WINDOW DEFOGGING SYSTEM.

The five front windshield panels are equipped with distributor manifolds through which heated air may be directed against the inner surface of the panels to prevent fogging. An electrically-energized heater-blower assembly, mounted forward of the pilot's instrument panels, supplies warm air for the system. The heater is protected by a special overheat thermostat which will open the relay circuit if the heater becomes overheated. In addition, the heater circuit is protected by a push-to-reset circuit breaker on the MJB No. 3 circuit breaker panel. The blower circuit is protected by a push-pull circuit breaker. The circuit is designed so that the heater will function only when the blower is operating. However, the blower may be operated without the heater. In addition the airplane is equipped with two infra-red heaters. The two heaters are connected in series with a control switch mounted on the co-pilot's switch panel. The purpose of the infra-red heaters is to de-fog the inner surface of the windshield panels just forward of the pilot and copilot.

The space between the inner and outer panes of the cabin windows is ventilated by warm air from the air conditioning system of the aircraft to prevent fogging and icing. Operation is automatic, and air circulates between the double window panes whenever the air conditioning system is operating.

Windshield Defog Blower Switch.

A three-position toggle switch on the copilot's switch panel (6 figure 1-20) controls the blower and arms the

pitot heaters circuit

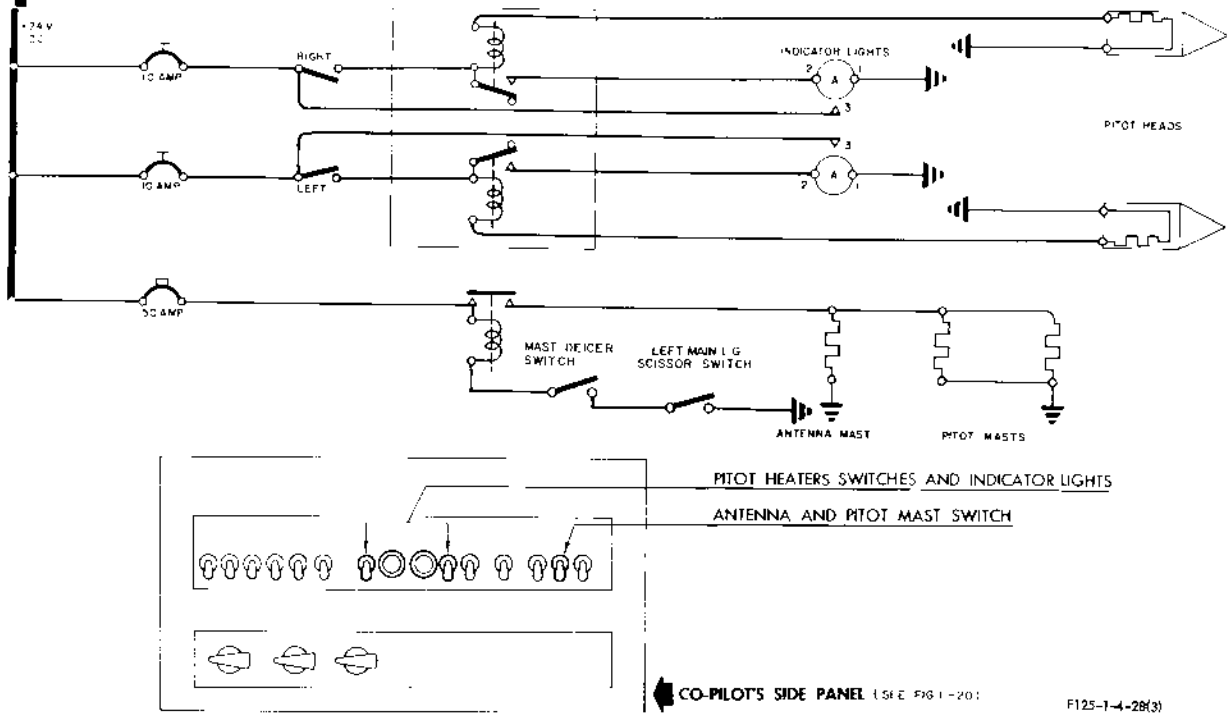

Figure 4-9 (Sheet 3)

heater circuit so that the heater may be turned on if required. The blower switch is placarded HIGH, OFF, and LOW. Power is derived from the main d.c. bus.

Windshield Defog Heater Switch.

A two-position, HEAT and OFF, windshield defogging heater switch (5 figure 1-20) is located on the copilot's side panel. Power is derived from the main d.c. bus.

Windshield Infra-Red Heater Switch.

A two-position switch (10 figure 1-20), located on the copilot's side panel and labeled WINDSHIELD INFRA-RED and OFF, controls operation of the windshield infra-red heaters. Power is derived from the main d.c. bus.

CAUTION

Remove cover before operating heater.

NORMAL OPERATING PROCEDURES FOR THE WINDSHIELD DEFOGGING SYSTEM.

When fogging occurs on the windshield panels, place the system in operation as follows:

1. To start, move the blower switch to HIGH or LOW, as required.
2. If heat is necessary, move the heater switch to HEAT.
3. When defogging is no longer necessary, turn heater switch OFF. After 30 seconds, turn blower switch OFF.

CAUTION

Leave the windshield defogging blower switch on at least 30 seconds after turning off the heater switch to cool the heating element.

ALCOHOL ANTI-ICING SYSTEMS.

The alcohol anti-icing systems provide a means for removing ice from the carburetors, windshields, and propellers. With the exception of the alcohol tanks, the systems are independent. (Refer to figure 4-8).

Alcohol Tanks.

One 20-gallon alcohol tank is mounted in the aft end of each outboard engine nacelle. The filler wells are located in the upper surface of the wing and are equipped with drains leading overboard. The carburetors and propellers are supplied from the tank located on their respective sides of the aircraft. The five windshield panels are supplied from either or both alcohol tanks. There is no interconnection between the two tanks.

Alcohol Pumps.

Four electrically-driven anti-icing pumps are mounted in the left hand side of each outboard nacelle. One pump supplies alcohol to the propellers on its respective side; the second pump supplies alcohol to the windshield anti-icing system; and the third and fourth pumps serve the inboard and outboard engine carburetors. The pump serving the propellers delivers a minimum of five gallons of alcohol per hour (2.5 gallons per propeller); each pump serving the carburetors is capable of delivering 30 gallons per hour; each or both pumps serving the windshield panels afford a maximum flow of 11 gallons per hour.

Alcohol Anti-Icer Fluid Quantity Indicator.

Each alcohol tank is equipped with a d.c. electrically operated liquidometer-type, fluid quantity transmitter which registers alcohol quantity in gallons on a dual indicator mounted on the flight engineer's upper instrument panel (54 figure 1-23).

CARBURETOR ALCOHOL ANTI-ICING SYSTEM.

Alcohol may be used to dislodge ice after it has formed in the carburetors. The carburetor alcohol anti-icing system (figure 4-8) delivers alcohol to the carburetors through three dual outlets in each upper deck, each positioned to provide adequate coverage of the critical carburetor icing area.

Carburetor Anti-Icer Switches.

The four carburetor anti-icing system alcohol pumps are individually controlled by momentary-contact, switch-type circuit breakers (9 figure 1-11) which are spring-loaded to OFF. The switches are mounted on the MJB No. 2 switch panel.

pilot's glare-shield panel

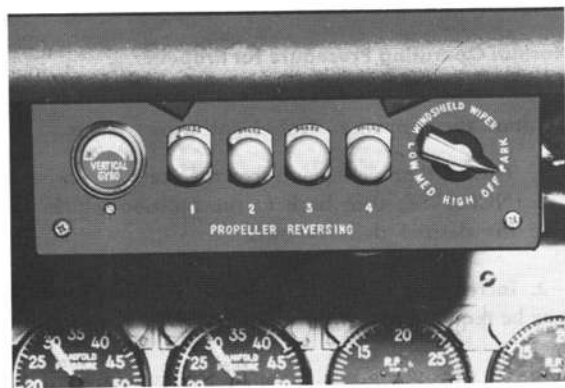

F125-C1-4-62

Figure 4-10

Normal Operating Procedure for the Carburetor Alcohol Anti-Icing System.

When alcohol injection is necessary to combat carburetor icing, momentary application (from 3 to 5 seconds) is usually sufficient. If more alcohol is necessary to control heavy or continued icing, it should be injected intermittently. Refer to Section VII, Carburetor Icing, for further discussion of this procedure.

PROPELLER ALCOHOL ANTI-ICING SYSTEM.

One of the two outlets of each propeller anti-icing pump supplies the outboard propeller, and the other supplies the inboard propeller. Alcohol is delivered by the pumps to the propeller slinger rings. Centrifugal force propels the alcohol to the outside of the slinger ring and through feeder tubes to the grooved boots mounted on the leading edges of the propeller blades. The regulator check valve in the alcohol line prevents the alcohol from escaping except when the pumps are operating.

Propeller Anti-Icer Rheostats and Indicator Lights (Left and Right).

The alcohol pumps are controlled by two rheostat switches (16 figure 1-11) located on the MJB No. 2 panel. One switch controls alcohol delivery to the two left propellers, the other controls delivery to the two

right propellers. The switches are labeled OFF, ON and, at the extreme clockwise limit of the arc, INCREASE. The ON position energizes the pumps; the positions clockwise from ON control the delivery rate of the alcohol. At the full ON position, rate of delivery will be 2.5 gal./hr for each propeller. Two lights (37 figure 1-23) on the flight engineer's instrument panel indicate when the switches are ON.

Normal Operating Procedure for Propeller Anti-Icing System.

To start the propeller alcohol anti-icing system:

1. Turn the propeller anti-icer rheostats clockwise to full INCREASE, then back to the position which will give the desired delivery rate.
2. Increase or decrease the alcohol delivery rate as may be required by icing conditions.
3. To stop the propeller anti-icing system, turn the rheostat switches counterclockwise to OFF.
4. Cross check with the indicator lights intensity. Lowest intensity desired for prolonged use.

WINDSHIELD ALCOHOL ANTI-ICING SYSTEM.

The windshield alcohol anti-icing system (figure 4-8) can be served from either or both right and left side supply and delivery units. One system in each outboard nacelle delivers fluid to the manifolds mounted outside and below each of the five forward panels. With all windshields being de-iced the rate of flow will be 11 gal./hr. Either or both pumps can be used as a pressure source. Delivery of alcohol to the individual windshield panels is controlled by valves forward of and below the pilot's (15 figure 1-19) and copilot's (13 figure 1-20) side panels.

Windshield Alcohol Anti-Icer Pump Switches.

A two-position toggle switch (11 figure 1-20) for each windshield anti-icer pump is mounted on the copilot's side panel. These two switches, placarded ON and OFF, direct d.c. power to the pumps from the main d.c. bus when placed in the ON position.

PITOT HEAD DE-ICING SYSTEM.

(Figure 4-9 sheet 3).

Electrically energized resistance elements mounted inside of the two pitot heads provide heat to prevent the accumulation of moisture or the formation of ice in the impact tubes. The heating elements operate from the d.c. electrical system and are energized, as required, through the pitot heat switches.

Pitot Heat Switches and Indicator Lights.

A two-position toggle switch (4 figure 1-20) for each pitot heater is mounted on the copilot's side panel. These two switches are placarded LEFT or RIGHT, ON and OFF. The heaters are energized when the switches are in the up position. Two indicator lights, mounted between the switches, glow when the pitot heaters are energized. The lights will go out if an open circuit occurs.

Antenna Mast De-Icer Switch.

A two-position toggle switch located on the copilot's switch panel (8 figure 1-20), turns on power from the main d.c. bus to the antenna mast de-icer when it is placed in the MAST (up) position. Power is available to the de-icer switch through the left MLG scissor switch (figure 4-9 Sheet 3).

COMMUNICATIONS AND ASSOCIATED ELECTRONIC EQUIPMENT.

Electronic equipment is installed in the aircraft for radio communications, navigation, search, identification, and intercommunication among crew members. Most of the radio equipment is located on the forward radio rack in the flight station and the navigator's radio equipment rack. Other equipment is located in the clothes closet just aft of the rear passenger door and in the aft baggage compartment. A functional breakdown of equipment in the aircraft is listed in the Table of Communications and Associated Electronic Equipment in this section, with the following information tabulated for each unit: type of unit, function, frequency band or range, and location of controls. The location of antennas associated with the communications and electronics equipment is shown on figure 4-13. Certain C-121A aircraft have equipment changes or minor variations. These are noted in the list of Communications and Associated Electronic Equipment.

Note

No transmission will be made on emergency (distress) frequency channels except for emergency purposes. For test, demonstration, or drill purposes, the radio equipment will be operated in a shielded room to prevent transmission of messages that could be construed as actual emergency messages.

POWER DISTRIBUTION SYSTEM.

Power for radio and other electronic equipment is obtained from the 28-volt d.c. bus. Two 115-VA, 400-cycle single-phase inverters furnish fixed-frequency alternating current. One of these inverters is used as a main inverter with the other as a spare. Changeover to the spare inverter may be accomplished automatically or manually. The operating spare system is arranged so that the main inverter supplies 115-volt radio power to all a.c. loads except radar set AN/APS-42, which is supplied by the spare inverter. The spare inverter may be energized by operating the spare inverter selector switch located to the right of the main inverter switch on the radio operator's side panel. If the main inverter fails, the amber warning light will go on, indicating that the automatic transfer relay has transferred the load to the spare inverter. Since radar set AN/APS-42 receives its power from the spare inverter it will be automatically disconnected when the spare inverter takes the load from the main inverter. Each inverter circuit is protected against sustained overload by remote control thermal circuit breakers mounted above the inverters.

Main Radio Junction Box.

A main radio junction box (figure 4-11) which includes all relays, terminal strips, circuit breakers and fuses required for operation of the radio and radar equipment, is mounted on the aft face of the station 260 bulkhead and is accessible by removing the cover under the navigator's table. Fuses and circuit breakers are plainly visible on a reset panel to the right of the junction box. The emergency radio d.c. bus, located in the radio junction box, supplies d.c. power to the following equipment: VHF-1, Pilot's and Copilot's AIC-10 control boxes, P. A. system, and portions of the IFS system. This is accomplished by placing the emergency a.c. inverter switch on the engineer's side panel to ON. This switch closes a relay labeled, INSTRUMENT TRANSFER and also a relay labeled, VHF EMERG, located on the main radio J box, which applies d.c. power to the equipment listed above.

ANTENNA SYSTEM.

The antenna system is installed as shown on figure 4-13.

(AN/AIC-10A) INTERPHONE COMMUNICATION SYSTEM.

The AIC-10A is a transistorized version of the AIC-10 intercommunications system. This equipment provides for the following:

a. Voice communications between any or all interphone stations.

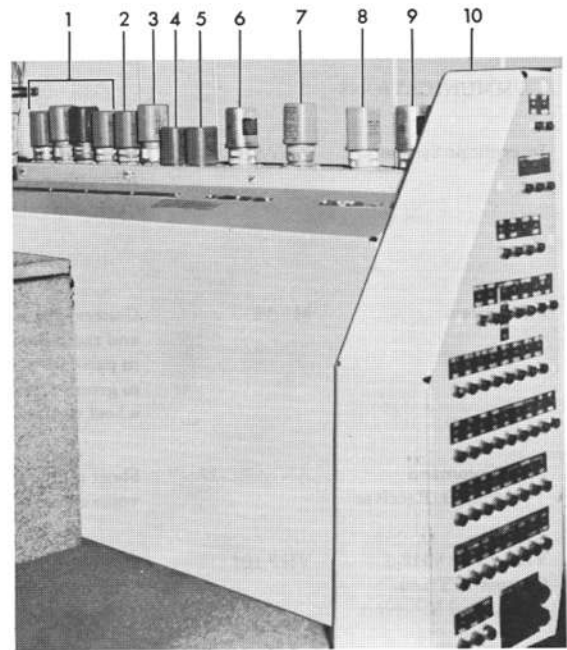
main radio junction box

F125-C1-4-112

- 1 VOR-TACAN RELAYS
- 2 TACAN RELAY
- 3 INSTRUMENT - TRANSFER RELAY
- 4 IFF/IP RELAY
- 5 VOR DAMPING RELAY
- 6 HF-2 ISOLATION RELAY
- 7 HF-1 ISOLATION RELAY
- 8 VHF EMERGENCY RELAY
- 9 P. A. VOICE/PROGRAM RELAY
- 10 RADIO JUNCTION BOX CIRCUIT BREAKER PANEL

Figure 4-11

b. A means of switching the microphone to any radio transmitter or to the interphone system.

c. Individual selection at each crew station of the audio output of any radio receiver or the interphone system.

d. A call facility whereby all positions of the flight crew may be called by interphone regardless of the setting of the microphone or facility switches at any of the called stations.

TABLE OF COMMUNICATIONS AND ASSOCIATED ELECTRONIC EQUIPMENT

<i>Type</i>	<i>Designation</i>	<i>Function</i>	<i>Range</i>	<i>Location of Controls</i>
COMMUNICATIONS				
Interphone System	AN/AIC-10A	Inter-crew audio and microphones	Crew stations, baggage compartments, tail cone, engine nacelles, nose wheel	Crew stations, galley, stateroom, rear passenger door, engine nacelles, nose wheel and baggage compartments, and tail cone
P.A. System	M1-36	General announcements and radio broadcasts to passengers. Cockpit to ground through nose wheel well speaker	Speakers in cabin and stateroom or nose wheel well speaker	Handsets for copilot, galley, rear passenger door. P. A. selector (radio operator)
UHF Command Transmitter/Receiver	AN/ARC-27	Short range, two-way voice communication	Line of sight, 225.0 to 339.9 mc's	Pilots' overhead radio control panel
VHF-1 and VHF-2 Command Transmitters and Receivers	VHF 101	Short range, two-way voice communication	Line of sight, 116.0 to 149.95 mc's	Pilots' overhead radio control panel
HF-1 Transceiver	Collins 618S-1	Transmits or receives voice (PH) or radio telegraph (CW)	Long range, 2 to 25 mc's	Radio operator's console
HF-2 Transmitter	AN/ART-13A (Part of ARC-8 System)	Transmits voice MCW or CW signals	Long range, 2 to 18.1 mc's	Radio operator's position
HF-2 Liaison Receiver	BC-348. (Part of ARC-8 System HF-2)	Receives voice MCW or CW signals	Dual range, 1.5 to 18 mc's, 200-500 kc's	Radio operator's table
Liaison Spare Receiver	BC-348. (Part of ARC-8 System)	Receives voice MCW or CW signals	Dual range, 1.5 to 18 mc's, 200-500 kc's	Radio operator's table
SSB Transceiver Note: Installed on all A/C except USAF serials 48-610 and 48-615	KWM-1	Transmits or receives SSB or CW signals	Long range, 14.0 to 30.0 mc's	Radio operator's table
HF-2 Transceiver Note: Installed only in USAF serials 48-610 and 48-615	ARC-58	Transmits or receives SSB voice or amplitude modulated voice signals	Long range, 2.0 to 29.999 mc's	Radio operator's console
AM-FM Receiver Note: Installed only in USAF serials 48-608 and 48-610		Receives AM-FM signals in broadcast or short wave		Stateroom

TABLE OF COMMUNICATIONS AND ASSOCIATED ELECTRONIC EQUIPMENT

<i>Type</i>	<i>Designation</i>	<i>Function</i>	<i>Range</i>	<i>Location of Controls</i>
NAVIGATION				
ADF-1 and ADF-2 Radio Compass Sets	AN/ARN-6	Reception of voice and code signals for direction finding and bearings	20 to 200 miles depending on frequency and time of day	Pilots' overhead radio control panel and navigator's station
VOR-1 and VOR-2 Receivers	AN/ARN-14	Reception of VOR, VAR and Localizer signals	Line of sight, 108 to 135.9 mc's	Pilots' overhead radio control panel
Glide Slope Receiver	AN/ARN-18	Reception of glide slope signals from ILS stations	15 miles, 329.3 to 335 mc's	Automatically tuned by VOR-1 control pilots' overhead radio control panel
Marker Beacon Receiver	AN/ARN-32	Reception of location marker and marker beacon signals	Fixed tuned 75 mc's	Indicator lights on pilots' and copilot's instrument panels
TACAN Transmitter/Receiver	AN/ARN-21	TACAN omni and TACAN distance measuring	Line of sight	Pilots' overhead radio control panel
Radio Altimeter	AN/APN-1	Indicates altitude above terrain	Dual range, 0-400 feet and 0-4000 feet	Pilot's instrument panel
Radio Altimeter (High Alt)	SCR-718C	Indicates altitude above terrain	40,000 feet	Navigator's station
LORAN Receiver	AN/APN-9	Indicates mapping fixes for distance location and courses	Day—700 miles Night—1400 miles	Navigator's station
Identification IFF	AN/APX-25	Reception and transmission of identification signals	Line of sight	Pilots' overhead radio control panel
Search Radar	AN/APS-42A ISO/ECHO Attachment	Navigation, weather observance, anti-collision warning, weather inverted signal	5, 10, 30, 100 and 200 miles, TD range of 30 miles	Master control-ISO/ECHO control at navigator's station, scopes at pilot's and navigator's stations
Integrated Flight System	FD-103	Gathers information from both localizer and glide slope receivers, stabilized magnetic compass, and bank information from gyroscope and passes it to steering computer, which then passes information to approach horizon and course indicators giving pilot continuous steering information and clear, concise picture of his position	Line of sight	Pilot's instrument panel

interphone control panels

pilot's and navigator's

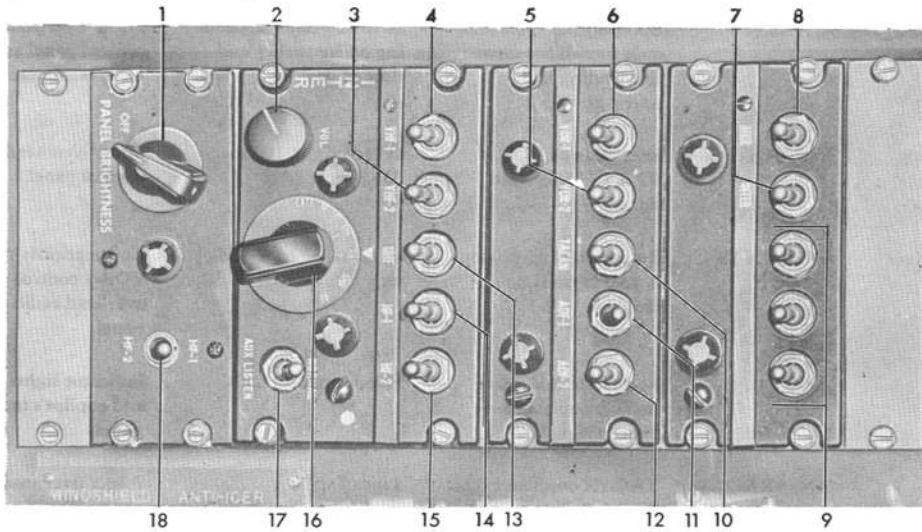

flight engineer's

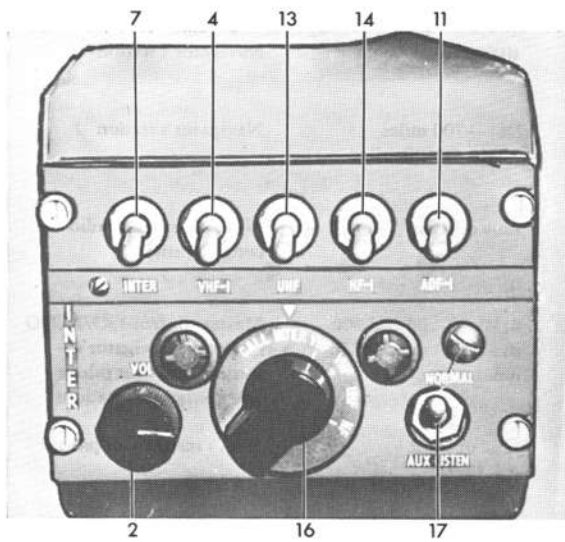

- 1 PANEL LIGHT BRIGHTNESS RHEOSTAT
- 2 VOLUME CONTROL KNOB
- 3 VHF-2 AUDIO SWITCH
- 4 VHF-1 AUDIO SWITCH
- 5 VOR-2 AUDIO SWITCH
- 6 VOR-1 AUDIO SWITCH
- 7 INTERPHONE AUDIO SWITCH
- 8 MARKER BEACON AUDIO SWITCH
- 9 SPARE SWITCHES
- 10 TACAN AUDIO SWITCH

stateroom

(ALL EXCEPT USAF SERIAL 48-617)

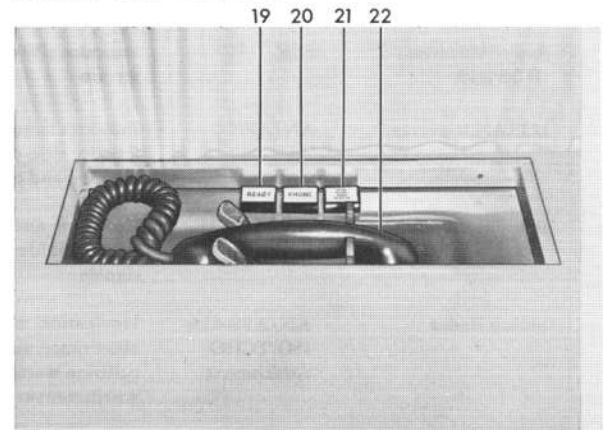

- 11 ADF-1 AUDIO SWITCH
- 12 ADF-2 AUDIO SWITCH
- 13 UHF AUDIO SWITCH
- 14 HF-1 AUDIO SWITCH
- 15 HF-2 AUDIO SWITCH
- 16 MICROPHONE SELECTOR SWITCH
- 17 NORMAL/AUX LISTEN SELECTOR SWITCH
- 18 HF-1/HF-2 MICROPHONE SELECTOR SWITCH
- 19 READY LIGHT
- 20 PHONE LIGHT
- 21 RADIO OPERATOR CALL SWITCH
- 22 HANDSET

F125-C1-4-113 (1)

Figure 4-12 (Sheet 1)

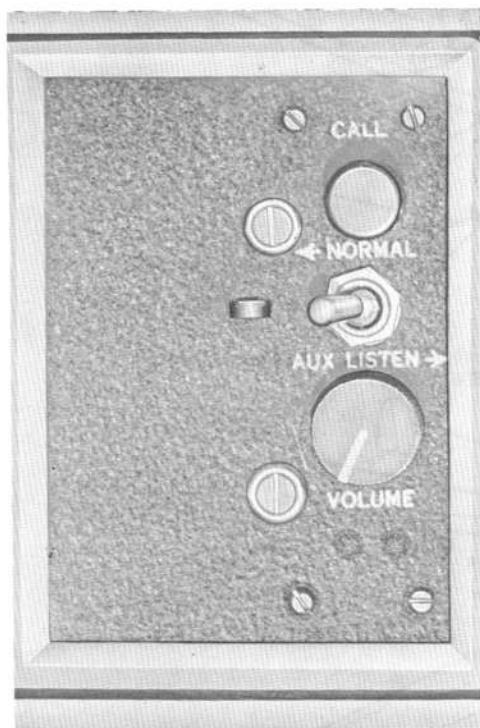
**crew interphone control
panel (typical)****passenger address control
— copilot's station**

F125-C1-4-113 (2)

- 1 HANDSET
- 2 INTERNAL/EXTERNAL SPEAKER SWITCH

Figure 4-12 (Sheet 2)

Primary power for operating this equipment is supplied from the 28 volt d.c. radio circuit. The AIC-10A provides intercommunications at the following stations: pilot, copilot, radio operator, flight engineer, navigator, galley, stateroom conference table, rear passenger door, tail cone, No. 2 and 3 engine nacelles, baggage compartment and nose wheel strut. Speakers with ON/OFF switches are located at the pilot, copilot and navigator positions.

Interphone Consoles.

(Refer to figures 4-12 and 4-17.)

Interphone consoles providing crew intercommunication and radio operation are located at the pilot's, copilot's, navigator's, flight engineer's (figure 4-12), and the radio operator's (figure 4-17) positions. An interphone console providing intercommunication and radio operation from the stateroom is also located and controlled at the radio

operator's position. All interphone consoles are identical except for the number of monitoring switches available on the flight engineer and stateroom controls. Interphone facilities only are available at the galley, rear passenger door No. 2 and 3 engine nacelles, tail cone, baggage compartment and nose wheel strut (figure 4-12). The functions and controls for the interphone consoles are as follows:

Microphone Selector Switch. This rotary-type switch is located at the lower center of the selector box panel. The switch provides positions which connect the microphone to a selected transmitter or interphone. The CALL position is used to alert any or all stations in the intercommunications system. The microphone selector switch is spring-loaded to rotate to INTER position from the CALL position when the switch is released. The INTER position is used for interphone communication between the various stations in the aircraft. The remaining posi-

antenna diagram

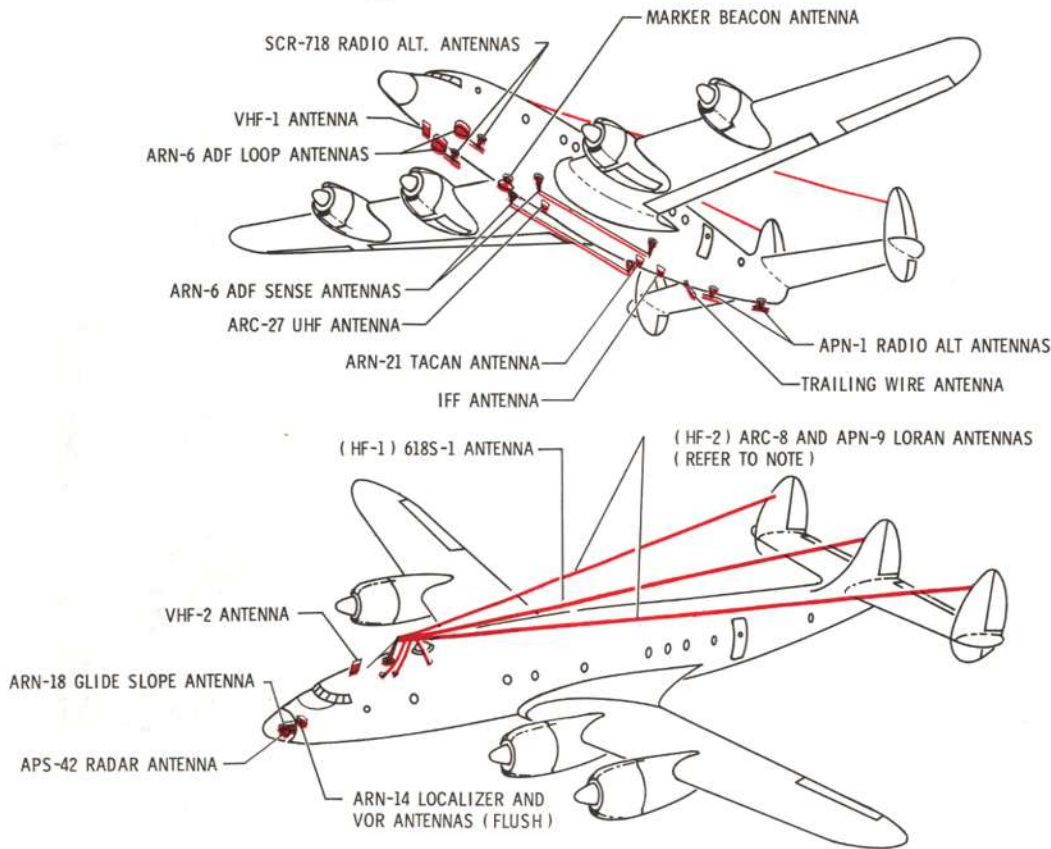

NOTE

- ON USAF SERIALS 48-610 AND 48-615, THE RIGHT ANTENNA IS USED BY THE ARC-58 SSB SYSTEM AND THE LEFT ANTENNA IS USED BY THE BC-348 AND APN-9 LORAN.
- ON AIRCRAFT HAVING A SEMI-PERMANENT INSTALLATION OF SSB MOBILE EQUIPMENT, ONE ANTENNA LEG IS USED BY THE SSB MOBILE EQUIPMENT AND THE OTHER LEG IS USED BY THE ARC-8 AND APN-9 LORAN.

F125-C1-4-58

Figure 4-13

tions are labeled according to the function provided at the various stations. When the microphone output is to be directed through a radio transmitter, it is necessary to set up the desired frequency on the control panel for the individual radio.

Audio Switches. Toggle switches are arranged horizontally across each individual panel, above the microphone selector switch. These switches control the choice of aural reception coming through the headphones. Placing any switch in the down position cuts off audible sound from the related circuit. Placing any switch in the up position connects the audio output from the related

receiver or interphone circuit to the headphones. Any combination of circuits may be monitored simultaneously.

Volume Control. This control is located to the left of the microphone selector switch and regulates the audio level of the signal heard in the headphones. This control does not regulate volume when the CALL facility is being used.

Note

The normal position for the selector box volume control knob is in the straight up (12 o'clock) position. This is the position for max-

imum undistorted volume for normal signals. Increased rotation will increase by only a small amount the normal audio level, but will greatly increase crosstalk, etc. To reduce the possibility of undesirable background interference, when it is necessary to rotate the volume control beyond the normal position, the volume controls for the unmonitored receivers should be checked to determine that they are not higher than their normal listening level.

Normal/Aux Listen Selector Switch. The NORMAL/AUX LISTEN selector switch located to the right of the microphone selector switch enables interphone and radio reception to be maintained if the internal amplifier of the control panel fails. The AUX LISTEN position bypasses the internal amplifier in case of failure, and connects the headphones directly to audio output of any one radio selected. The microphone cannot be used in this position, and only one of the channels may be monitored at a time. A definite switching priority controls the selection. First priority is held by the first (left) monitoring switch on the first row of switches above the microphone selector. While the switch is ON (up) no other circuit is connected, regardless of any other switching. When it is off priority passes to the next monitoring switch to the right. When all the monitoring switches on the microphone selector panel above the microphone selector switch are set to off position, priority passes to the first (left) switch on the next panel and continues to the right along the line of monitoring switches, etc. A safety wire holds the toggle switch in the NORMAL position during normal operation.

Panel Brightness Switch. This switch is used to control panel lighting.

HF-1/HF-2 Microphone Selector Switch (Pilot, Copilot and Navigator Control Panels Only). This switch is used to select either the HF-1 or HF-2 system for operation when the microphone selector is in the HF position.

VHF-1/VHF-2 Microphone Selector Switch (Radio Operator's Control Panel Only). This switch is used to select either the VHF-1 or VHF-2 system for operation when the microphone selector is in the VHF position.

Stateroom Inter Control Panel (USAF Serials 48-608 thru 48-615).

The stateroom inter control panel (figure 4-14), Sheet 2), identical to other selector panels, is located on the radio operator's console. It includes facilities for passengers in the stateroom to transmit and receive through certain radio sets or the interphone system. A telephone handset which is connected to the selector box control panel and located on the stateroom conference table, is connected to certain radios or interphone selected by the radio operator. The functions and controls for the stateroom inter control panel are as follows:

Stateroom Handset Microphone Selector Switch. This rotary type switch is located at the lower center of the selector box panel. The switch provides five positions which connect the handset to a selected transmitter or interphone. The positions are labeled, INTER, HF-1 and HF-2. The remaining two positions are not used.

Stateroom Handset Audio Switches. Five toggle switches are arranged horizontally across the panel, above the microphone selector switch. These switches control the choice of aural reception going through the handset. Placing any switch in the down position cuts off audible sound from the related circuit. Placing any switch in the up position connects the audio output from the related receiver or interphone circuit to the handset. The switches are labeled, from left to right, INTER, HF-1, HF-2, BC-348. The remaining switch is not used.

Note

The BC-348 is referred to as the Liaison Spare BC-348.

Stateroom Handset Volume Control. This control is located to the left of the microphone selector switch and regulates the audio level of the signal heard in the handset. The radio operator has no aural means of determining the actual listening level in the handset. It is recommended that this volume control be set to the straight-up (12 o'clock) position, or to the same approximate position of the radio operator's selector panel volume control. Audio signals to the handset will then be at approximately the same listening level as those received through the radio operator's headphones.

flight station radio rack — typical

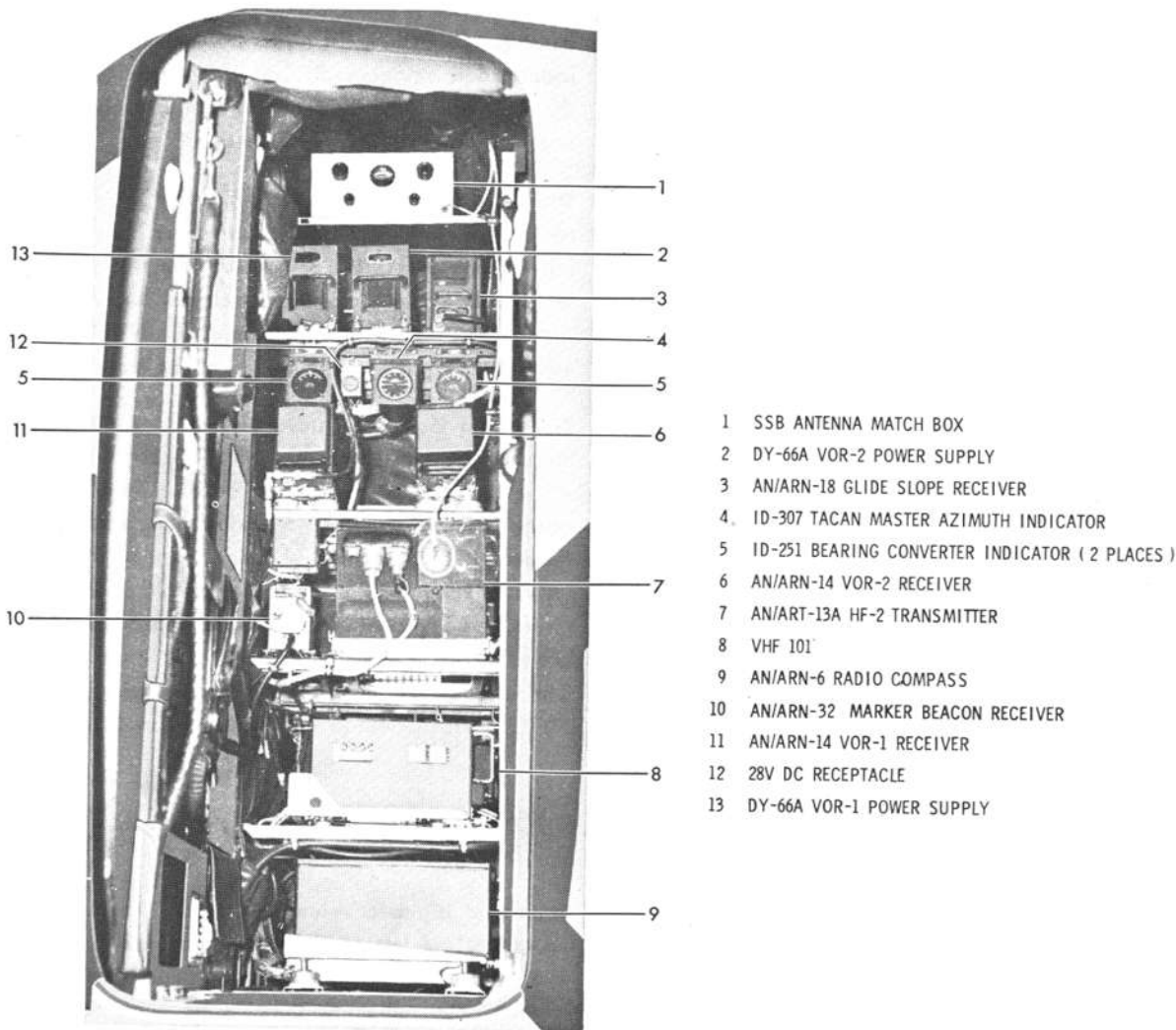

- 1 SSB ANTENNA MATCH BOX
- 2 DY-66A VOR-2 POWER SUPPLY
- 3 AN/ARN-18 GLIDE SLOPE RECEIVER
- 4 ID-307 TACAN MASTER AZIMUTH INDICATOR
- 5 ID-251 BEARING CONVERTER INDICATOR (2 PLACES)
- 6 AN/ARN-14 VOR-2 RECEIVER
- 7 AN/ART-13A HF-2 TRANSMITTER
- 8 VHF 101
- 9 AN/ARN-6 RADIO COMPASS
- 10 AN/ARN-32 MARKER BEACON RECEIVER
- 11 AN/ARN-14 VOR-1 RECEIVER
- 12 28V DC RECEPTACLE
- 13 DY-66A VOR-1 POWER SUPPLY

F125-C1-4-43 (1)

Figure 4-14 (Sheet 1)

flight station radio rack

(USAF SERIALS 48-610 AND 48-615)

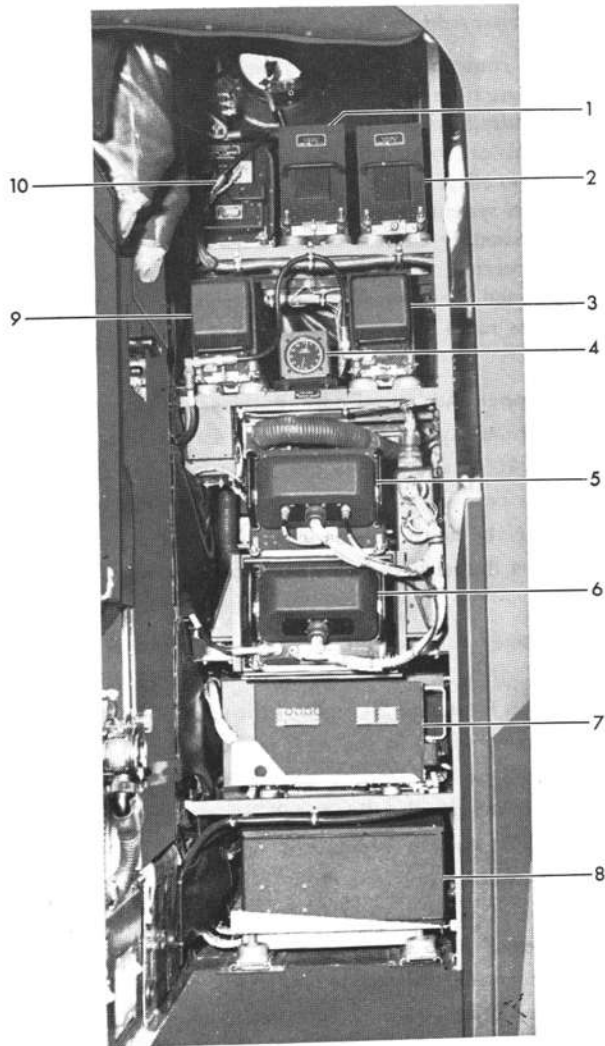

- 1 DY-66A VOR-1 POWER SUPPLY
- 2 DY-66A VOR-2 POWER SUPPLY
- 3 AN/ARN-14 VOR-2 RECEIVER
- 4 ID-307 TACAN MASTER AZIMUTH INDICATOR
- 5 ARC-58 RECEIVER/EXCITER
- 6 ARC-58 TRANSMITTER
- 7 VHF 101
- 8 AN/ARN-6 RADIO COMPASS
- 9 AN/ARN-14 VOR-1 RECEIVER
- 10 ARC-58 ANTENNA COUPLER

F125-C1-4-43 (2)

Figure 4-14 (Sheet 2)

Stateroom and Radio Operator's Call Lights and Switches. A system of call lights and switches is used at the radio operator and stateroom locations to alert either station of a calling party. On the stateroom conference table the lights are labeled, PHONE, READY, and are controlled by a switch on the radio operator's console. The PHONE light, when on, indicates to a passenger that he is being called on the interphone. The READY light, when on, indicates to a passenger that his party is on the line (radiotelephone only). A switch labeled, PRESS TO CALL RADIO OPERATOR, is used by a passenger to call the radio operator. A light located on the radio operator's console comes on any time this switch is pressed. The switch on the radio operator's console labeled, CALL/READY, activates either the phone or ready lights on the stateroom table. The CALL light on the radio operator's console has a reset switch below it to turn off the light after call has been answered.

PASSENGER ADDRESS SYSTEM MI-36.

The passenger address system is used to make general announcements to the passengers from the copilot's station (figure 4-12), galley (figure 4-25), and flight attendant's aft panel (figure 4-26). In addition, the output of most of the radio receivers may be connected to the passenger address system as selected by the radio operator (figure 4-17). Loudspeakers are located at various points in the compartments and an external loudspeaker is located in the nose wheel well. A switch (2 figure 4-12 Sheet 2) labeled, INTERNAL/EXTERNAL, is used to connect the passenger address system to all speakers within the airplane or to the external speaker in the nose wheel well. This switch is located near the copilot's handset and would normally be in the INTERNAL position for flight operation. The copilot's handset would then always be connected to all speakers for announcements and for emergency use in case of ditching, etc. Handsets located at the galley and rear passenger door are selected for operation of either the passenger address system or interphone. This is accomplished by means of a switch labeled, INTERPHONE/PUBLIC ADDRESS, located near the handset at each station. The handset in the copilot's position is located above his right shoulder and can be easily reached by the engineer for operation, if necessary.

Passenger Address Amplifier MI-36A.

The MI-36A amplifier is an audio amplifier with a self-contained power supply. It is designed for use in making announcements or for passenger entertainment. The

amplifier has no operating controls. Two potentiometers, which are adjustable from the front panel, are labeled HI and LO. These potentiometers are volume controls which regulate the amount of gain to the internal speakers or external speaker. HI, controls gain on the internal speakers, LO, controls gain on the external speaker. The amplifier is located in the aft clothes closet and is operated from the 28 volt d.c. radio circuit.

Passenger Address Radio Broadcast Selector Controls.

These controls (figure 4-17) enable the radio operator to connect the output of certain receivers to the passenger address system for broadcast to the passengers. The controls are located on the radio operator's console and have no effect on the normal operation of the passenger address system. If a radio broadcast is being made over the passenger address system and any of the handsets are operated, the radio broadcast is automatically disconnected. The functions and controls for the passenger address radio broadcast panel are as follows:

Passenger Address Radio Receiver Selector Switch.

This rotary type switch, labeled, OFF, ADF-1, ADF-2, HF-1, HF-2, and BC-348 (34, 37 figure 4-17), is located on the radio operator's console. Rotating this switch to any of the above mentioned radios will automatically connect the set to the passenger address system.

Passenger Address Radio Broadcast Speaker Switch.

This switch, labeled, ALL/PASS SPKRS (32, 35 figure 4-17), is located to the right of the selector input switch. With this switch in the ALL position the radio broadcast will be heard on all compartment speakers. With this switch in the PASS SPKRS position the radio broadcast will be heard on speakers in the passenger compartments only.

Passenger Address Radio Broadcast Volume Control.

This control, located to the right of the broadcast speaker switch, (28, 31 figure 4-17) is used to regulate the audio output of the radio selected for broadcast.

To place equipment in operation:

1. Aircraft power supply—ON.
2. Radio power switch—ON.
3. Internal/External switch—AS DESIRED.

To turn equipment OFF:

1. Radio power switch—OFF.

pilots' overhead radio control panel

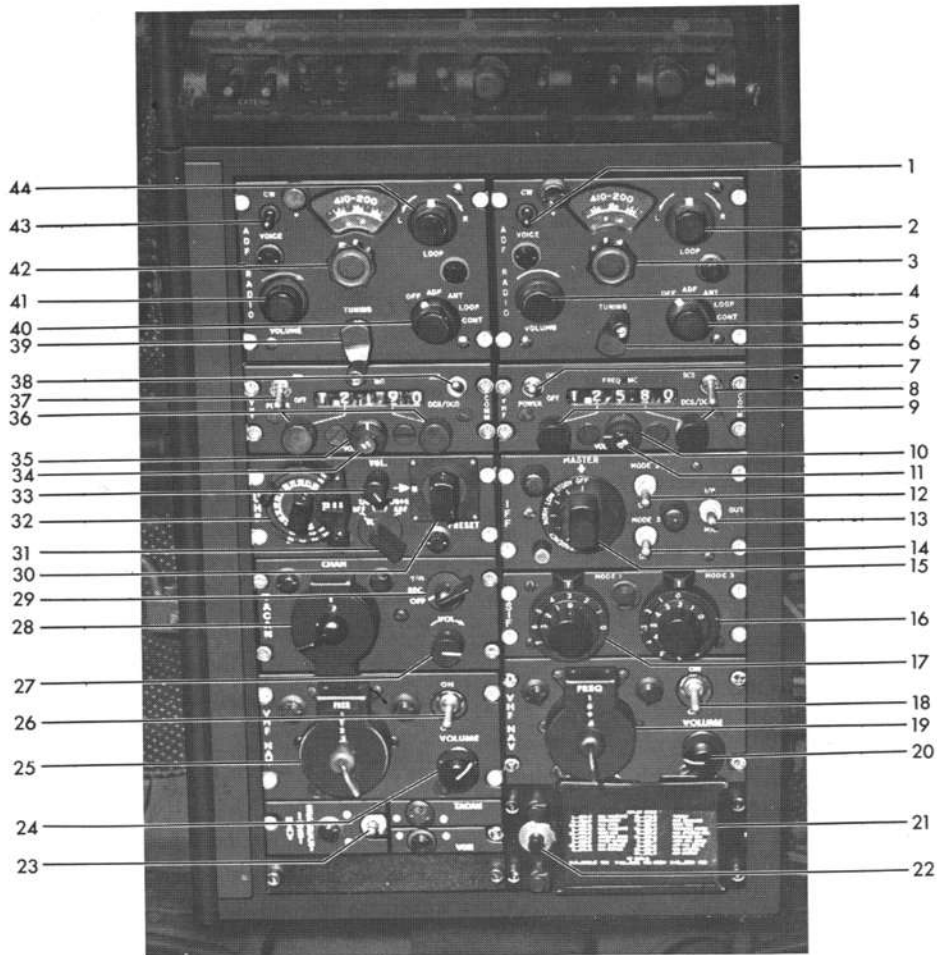

- | | | | |
|----|-----------------------------------|----|------------------------------------|
| 1 | ADF-2 CW/VOICE SWITCH | 23 | VOR-2/TACAN NAV INST SELECT SWITCH |
| 2 | ADF-2 LOOP ROTATOR SWITCH | 24 | VOR-1 VOLUME CONTROL KNOB |
| 3 | ADF-2 BAND SELECTOR | 25 | VOR-1 FREQUENCY SELECTOR |
| 4 | ADF-2 VOLUME CONTROL KNOB | 26 | VOR-1 ON/OFF SWITCH |
| 5 | ADF-2 FUNCTION SELECTOR SWITCH | 27 | TACAN VOLUME CONTROL KNOB |
| 6 | ADF-2 TUNING CRANK | 28 | TACAN CHANNEL SELECTOR |
| 7 | VHF-2 ON/OFF SWITCH | 29 | TACAN FUNCTION SELECTOR SWITCH |
| 8 | VHF-2 SCS/DCS/DCD SELECTOR SWITCH | 30 | UHF PRESET CHANNEL SELECTOR SWITCH |
| 9 | VHF-2 FREQUENCY SELECTOR KNOBS | 31 | UHF FUNCTION SELECTOR SWITCH |
| 10 | VHF-2 VOLUME CONTROL KNOB | 32 | UHF FREQUENCY SELECTOR |
| 11 | VHF-2 SQUELCH CONTROL KNOB | 33 | UHF VOLUME CONTROL KNOB |
| 12 | IFF MODE 2/OUT SWITCH | 34 | VHF-1 SQUELCH CONTROL KNOB |
| 13 | IFF 1/P-MIC-OFF SELECTOR SWITCH | 35 | VHF-1 VOLUME CONTROL KNOB |
| 14 | IFF MODE 3/OUT SWITCH | 36 | VHF-1 FREQUENCY SELECTOR KNOBS |
| 15 | IFF FUNCTION SELECTOR SWITCH | 37 | VHF-1 ON/OFF SWITCH |
| 16 | IFF MODE 3 CODER SELECTOR | 38 | VHF-1 SCS/DCS/DCD SELECTOR SWITCH |
| 17 | IFF MODE 1 CODER SELECTOR | 39 | ADF-1 TUNING CRANK |
| 18 | VOR-2 ON/OFF SWITCH | 40 | ADF-1 FUNCTION SELECTOR SWITCH |
| 19 | VOR-2 FREQUENCY SELECTOR | 41 | ADF-1 VOLUME CONTROL KNOB |
| 20 | VOR-2 VOLUME CONTROL KNOB | 42 | ADF-1 BAND SELECTOR |
| 21 | UHF FREQUENCY CARD | 43 | ADF-1 CW/VOICE SWITCH |
| 22 | UHF FREQUENCY CARD LIGHT SWITCH | 44 | ADF-1 LOOP ROTATOR SWITCH |

F125-C1-4-40

Figure 4-15

AN/ARC-27 UHF TRANSMITTER/RECEIVER SET.

The AN/ARC-27 UHF provides short range communication in the frequency range of 225.0 to 399.9 mc's with a transmitter output of 9 watts. A control box, located on the pilots' overhead radio control panel (figure 4-15), provides operation of any one of 20 preset channels or manual operation. Manual operation permits direct selection of 1750 frequencies by means of three rotary-type frequency selector knobs. The transmitter-receiver (10 figure 4-21) is located in the navigator's radio rack and receives power from the 28 volt d.c. radio circuit.

Note

- An automatic time delay of at least one minute is allowed for the equipment to warm up to preclude damage.
- No transmission will be made on the emergency (distress) frequency channels except for emergency purposes, in order to prevent transmission of messages that could be construed as actual emergency messages.

To place equipment in operation:

1. Aircraft power supply—ON.
2. Radio power switch—ON.
3. Function switch—T/R (If you wish to monitor guard receiver 243.0 mc's, in addition to main receiver, place function switch to: T/R + G-REC.)
4. Receiver toggle switch (on intercommunication panel)—UHF.
5. Microphone selector switch—UHF.
6. Channel selector switch—ROTATE to the desired channel (1 through 20). (If manual operation is desired, rotate channel selector to M, and turn frequency selector switches to frequency desired.)
7. Volume control—ADJUST AS REQUIRED.

To turn equipment OFF:

1. Function switch—OFF.

VHF 101 COMMUNICATION SYSTEMS.

(Refer to Figure 4-16)

The Collins VHF 101 communication systems operate in the frequency range from 116.0 to 149.95 mc's in increments of 50 kc's. Propagation in the VHF frequency range limits communication to essentially line-of-sight distances under normal operating conditions.

Two completely independent VHF 101 systems are installed in the airplane. Each of the two systems consists of a receiver, a transmitter, a low drag antenna, and remote controls. Transmitters and receivers are located in the flight station radio rack (8, 7, figure 4-14), and the remote control boxes are on the pilot's overhead radio control panel (figure 4-15). The transmitter has a power output of 25 watts, and a frequency selection change time of less than 6 seconds. Operation of both systems is from 28 volt d.c. radio circuits.

VHF Communications Controls and Control Circuits.

Controls for the VHF radios are on the pilot's overhead radio control panel. Two control boxes are used since each of the VHF systems is completely independent of the other. The control box on the left is VHF-1 and the control box on the right is VHF-2 (figure 4-15). Specific controls for each of the control boxes consist of an ON/OFF switch, a squelch control, a volume control, a switch to select SCS (single channel simplex) or DCS/DCD (double channel simplex, and two frequency selector knobs. A window above these knobs indicates directly, in megacycles, the operating frequency selected.

The SCS/DCS switch (8, 38 figure 4-15) is provided so that either single channel simplex or double channel simplex modes may be used. When the switch is positioned to SCS transmissions are made on the same frequency as selected in the window. When the switch is positioned to DCS transmissions are made on a frequency 6 megacycles above that frequency selected in the window. Normal operation is with the switch in the SCS position.

VHF Communication Antennas No. 1 and 2.

(Refer to Figure 4-13)

An antenna for VHF communication system No. 1 is located on the bottom of the airplane, just forward of the nose wheel. A second antenna, for system No. 2, is located on the top centerline of the airplane, forward of the navigator's astradome.

Note

- Reception on VHF-1 may be erratic at times during the ground operations due to shielding

effects of the nose wheel well doors.

- No transmission will be made on emergency (distress) frequency channels except for emergency purposes, in order to prevent transmission of messages that could be construed as actual emergency messages.

To place equipment in operation:

1. Aircraft power supply—ON.
2. Radio power switch—ON.
3. Function ON/OFF switch—ON.
4. Receiver toggle switch (on intercommunication control console—VHF-1 or VHF-2).
5. Microphone selector switch—VHF-1 or VHF-2.
6. Frequency knobs—rotate to desired frequency as indicated in window.
7. Volume control—adjust as required.
8. Squelch control—adjust to a point where noise just disappears.

To turn equipment OFF:

1. Function ON/OFF switch—OFF.

COLLINS 618S-1 HF COMMUNICATION SYSTEM.

The COLLINS 618S-1 HF transceiver provides transmitting and receiving facilities through 144 crystal controlled channels in the frequency range 2.0 to 25.0 megacycles. This equipment is controlled from the radio operator's console (figure 4-17). The antenna tuning network is an 180L-3 mounting near the transceiver and automatically tunes the final and antenna circuits. This is accomplished approximately 20 seconds after the frequency has been set up by pushing the microphone button momentarily. 115 volt 400 cycle a.c., and 28 volt d.c. power is supplied to the transceiver and antenna tuning unit through the main radio inverter and radio power switch. The antenna and transceiver are located on the navigator's radio rack (1, 15 figure 4-21).

To place equipment in operation:

1. Aircraft power supply—ON.
2. Radio power switch—ON.
3. Main radio inverter switch—ON.
4. OFF-PH-CW switch—PH position.
5. BFO control—As required.
6. Receiver toggle switch (on intercommunication panel)—HF-1.

7. Microphone selector switch—HF-1 (if operated from the pilot, copilot or navigator positions, HF selector switch should be placed in the HF-1 position).

8. Channel selector controls (on 618S-1 HF-1 control box)—rotate to desired channel as indicated on a frequency card placed on the radio operator's table.

9. Microphone button — Push microphone button momentarily. When red light on control box goes out, equipment is ready for operation.

10. Volume control—adjust as required.

To turn equipment OFF:

1. OFF—PH—CW switch—OFF.

AN/ARC-8 HF-2 COMMUNICATION SYSTEM.

(USAF Serials 48-608, 48-609, 48-611 thru 48-614, 48-617).

(Refer to figure 4-16)

The AN/ARC-8 is an HF communication system which consists of one AN/ART-13A HF transmitter and a BC-348 HF receiver. Both components are in the radio operator station with the operating controls located on each unit. The following is a description of the components used with the ARC-8 HF system.

AN/ART-13A.

The AN/ART-13A is a HF transmitting set arranged for local operation and manual tuning by the radio operator. The transmitter has 11 preset channels and provides a frequency range of 2.0 to 18.1 mc's. When using CW or MCW, keying speeds up to 30 words a minute may be used. The power output is approximately 90 watts. 28 volt d.c. input is required for operation.

To place equipment in operation.

1. Aircraft power supply—ON.
2. Radio power switch—ON.
3. Emission switch—VOICE position, or for desired type of emission.
4. Local/Remote switch—LOCAL.
5. Channel selector switch—Rotate for desired channel.
6. When the red indicator light located on transmitter panel comes on, check to make sure that proper frequency is set up on the controls and that the antenna circuit is in resonance.
7. Key/Transfer switch—LIAISON position if CW or MCW is to be used.

radio operator's station — typical

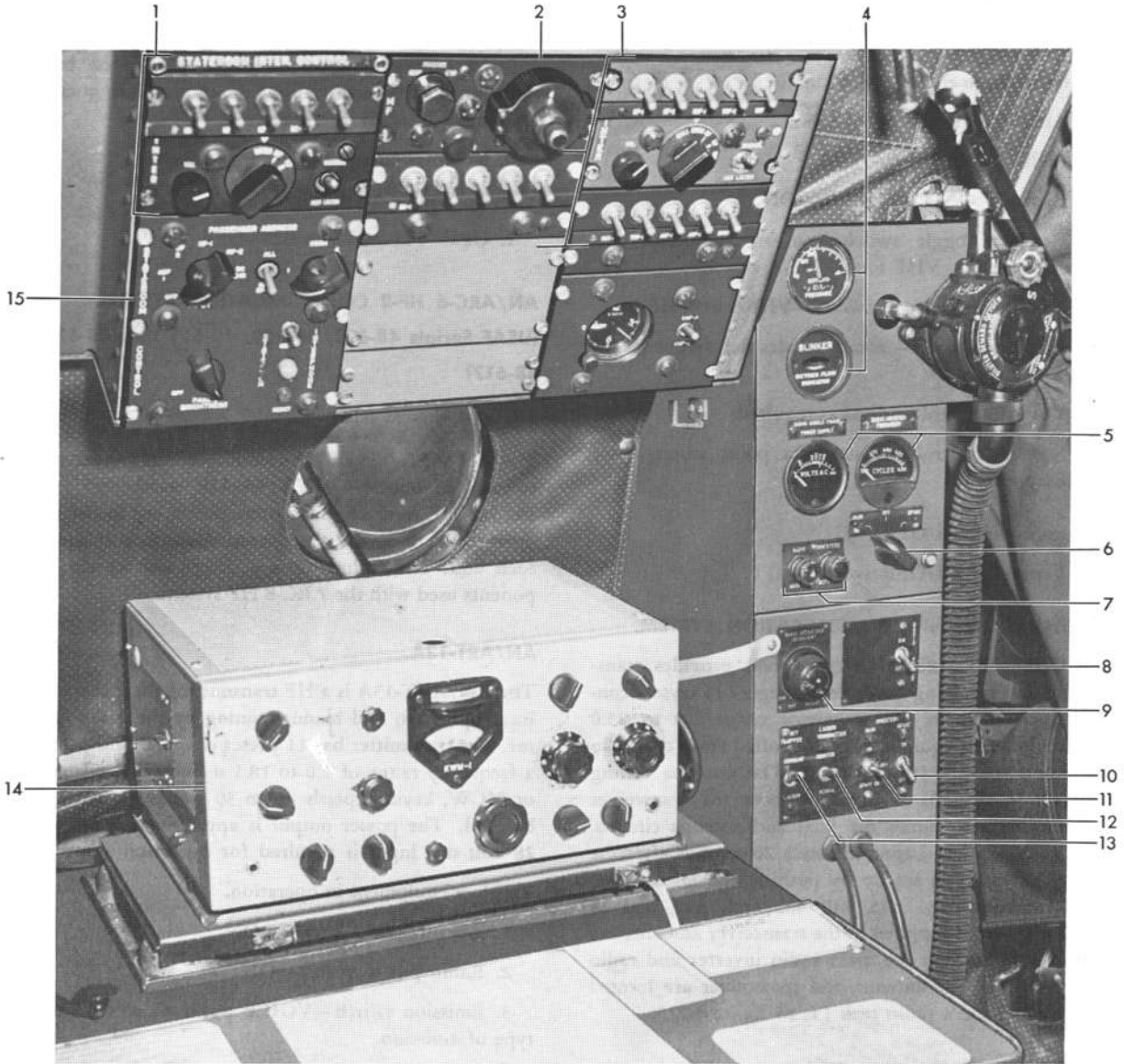

- | | | | |
|---|--|----|--|
| 1 | STATEROOM HANDSET SELECTOR PANEL | 9 | RADIO OPERATOR'S DESKLIGHT RHEOSTAT |
| 2 | HF-1 CONTROL PANEL | 10 | SPARE RADIO INVERTER SWITCH |
| 3 | RADIO OPERATOR'S INTERPHONE CONSOLE | 11 | MAIN RADIO INVERTER SWITCH |
| 4 | OXYGEN FLOW AND CYLINDER PRESSURE INDICATORS | 12 | LIAISON TRANSMITTER MONITOR/NORMAL SWITCH |
| 5 | RADIO VOLTMETER AND FREQUENCY METER | 13 | KEY TRANSFER SWITCH (COMMAND/LIAISON) |
| 6 | RADIO VOLT/FREQUENCY METER SELECTOR SWITCH | 14 | KWM-1 TRANSCIVER |
| 7 | RADIO INVERTER WARNING LIGHTS | 15 | PASSENGER ADDRESS RADIO BROADCAST/STATEROOM CONTROL SELECTOR PANEL |
| 8 | RADIO POWER SWITCH | | |

F125-C1-4-57 (1)

Figure 4-16 (Sheet 1)

radio operator's station

(USAF SERIALS 48-610 AND 48-615)

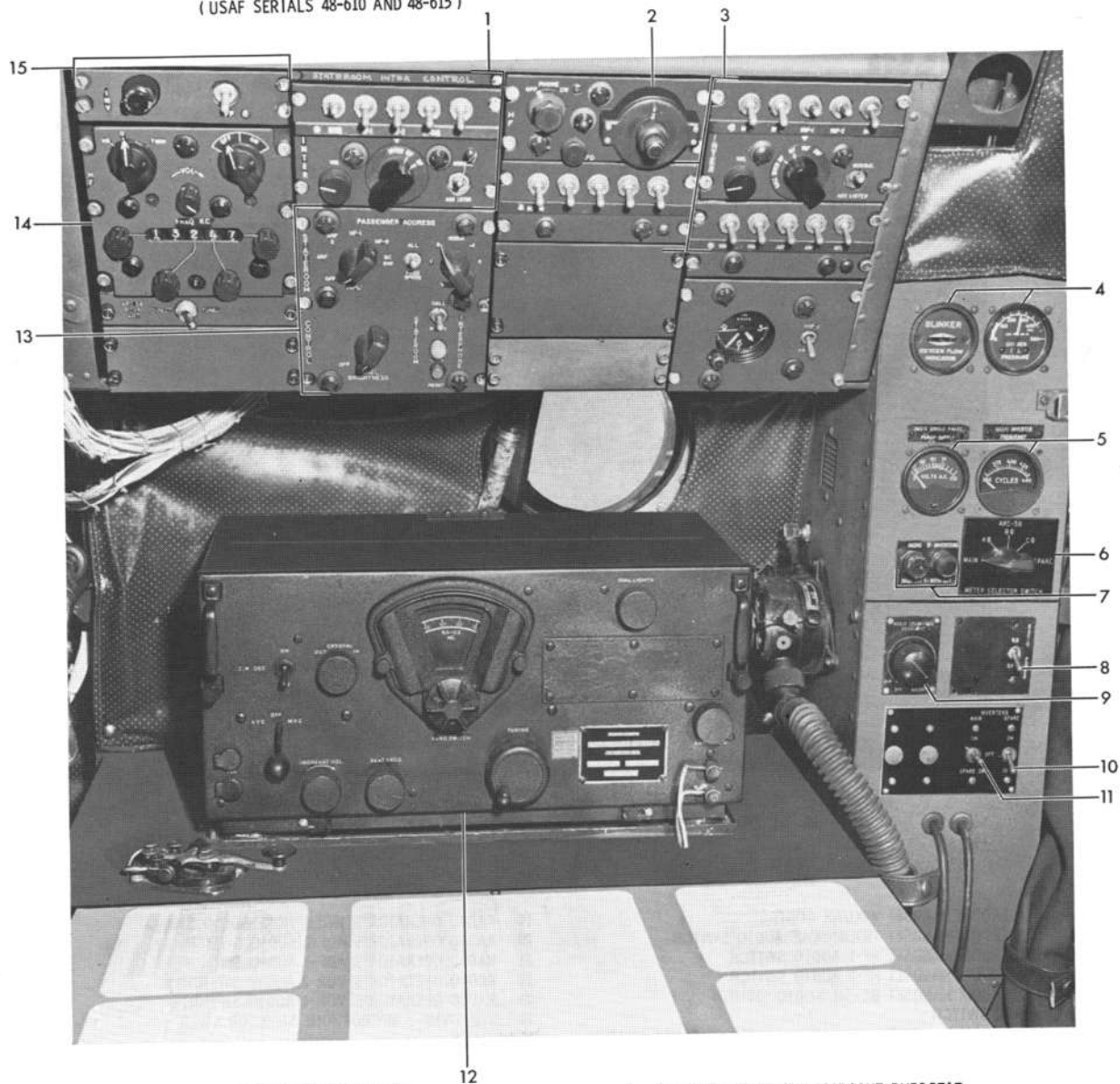

- | | | | |
|---|--|----|--|
| 1 | STATEROOM HANDSET SELECTOR PANEL | 9 | RADIO OPERATOR'S DESKLIGHT RHEOSTAT |
| 2 | HF-1 CONTROL PANEL | 10 | SPARE RADIO INVERTER SWITCH |
| 3 | RADIO OPERATOR'S INTERPHONE CONSOLE | 11 | MAIN RADIO INVERTER SWITCH |
| 4 | OXYGEN FLOW AND CYLINDER PRESSURE INDICATORS | 12 | BC-348 RECEIVER |
| 5 | RADIO VOLTMETER AND FREQUENCY METER | 13 | PASSENGER ADDRESS RADIO BROADCAST/STATEROOM CONTROL SELECTOR PANEL |
| 6 | RADIO VOLT/FREQUENCY METER SELECTOR SWITCH | 14 | ARC-58 CONTROL PANEL |
| 7 | RADIO INVERTER WARNING LIGHTS | 15 | ARC-58 INVERTER CONTROL PANEL |
| 8 | RADIO POWER SWITCH | | |

F125-C1-4-57 (2)

Figure 4-16 (Sheet 2)

radio operator's control console — typical

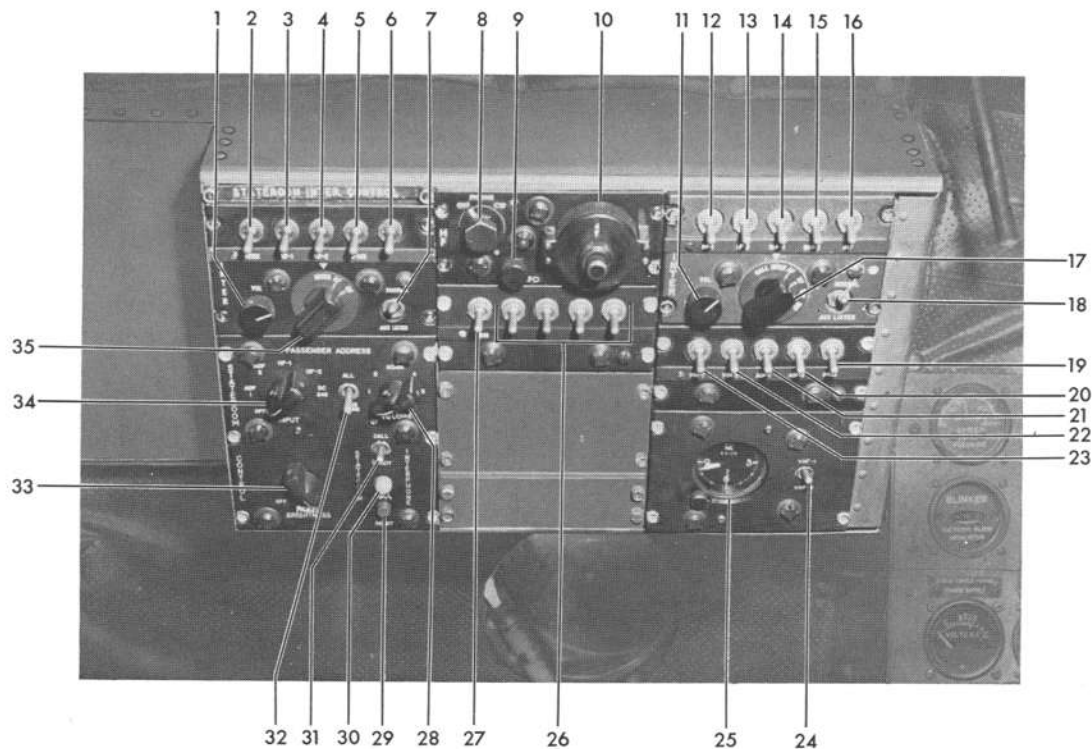

- | | | | |
|----|---|----|--|
| 1 | STATEROOM HANDSET VOLUME CONTROL | 19 | RADIO OPERATOR'S INTERPHONE AUDIO SWITCH |
| 2 | STATEROOM HANDSET INTERPHONE AUDIO SWITCH | 20 | RADIO OPERATOR'S ADF-2 AUDIO SWITCH |
| 3 | STATEROOM HANDSET HF-1 AUDIO SWITCH | 21 | RADIO OPERATOR'S ADF-1 AUDIO SWITCH |
| 4 | STATEROOM HANDSET HF-2 AUDIO SWITCH | 22 | RADIO OPERATOR'S VOR-2 AUDIO SWITCH |
| 5 | STATEROOM HANDSET BC-348 AUDIO SWITCH | 23 | RADIO OPERATOR'S VOR-1 AUDIO SWITCH |
| 6 | SPARE SWITCH | 24 | VHF-1/VHF-2 MICROPHONE SELECTOR SWITCH |
| 7 | STATEROOM HANDSET NORMAL/AUX LISTEN SELECTOR SWITCH | 25 | CLOCK |
| 8 | HF-1 OFF/PHONE/CW SELECTOR SWITCH | 26 | SPARE AUDIO SWITCHES |
| 9 | HF-1 BFO CONTROL | 27 | BC-348 AUDIO SWITCH |
| 10 | HF-1 CHANNEL SELECTOR | 28 | PASSENGER ADDRESS RADIO BROADCAST VOLUME CONTROL |
| 11 | RADIO OPERATOR'S INTERPHONE CONSOLE VOLUME CONTROL | 29 | RADIO OPERATOR'S CALL LIGHT RESET SWITCH |
| 12 | RADIO OPERATOR'S HF-1 AUDIO SWITCH | 30 | RADIO OPERATOR'S CALL LIGHT |
| 13 | RADIO OPERATOR'S HF-2 AUDIO SWITCH | 31 | STATEROOM CALL/READY SWITCH |
| 14 | RADIO OPERATOR'S VHF-1 AUDIO SWITCH | 32 | PASSENGER ADDRESS RADIO BROADCAST SPEAKER SWITCH |
| 15 | RADIO OPERATOR'S VHF-2 AUDIO SWITCH | 33 | CONSOLE LIGHTS BRIGHT/DIM RHEOSTAT |
| 16 | RADIO OPERATOR'S UHF AUDIO SWITCH | 34 | PASSENGER ADDRESS RADIO RECEIVER SELECTOR SWITCH |
| 17 | RADIO OPERATOR'S MICROPHONE SELECTOR SWITCH | 35 | STATEROOM HANDSET MICROPHONE SELECTOR SWITCH |
| 18 | RADIO OPERATOR'S NORMAL/AUX LISTEN SELECTOR SWITCH | | |

F125-C1-4-41 (1)

Figure 4-17 (Sheet 1)

radio operator's control console

(USAF SERIALS 48-610 AND 48-615)

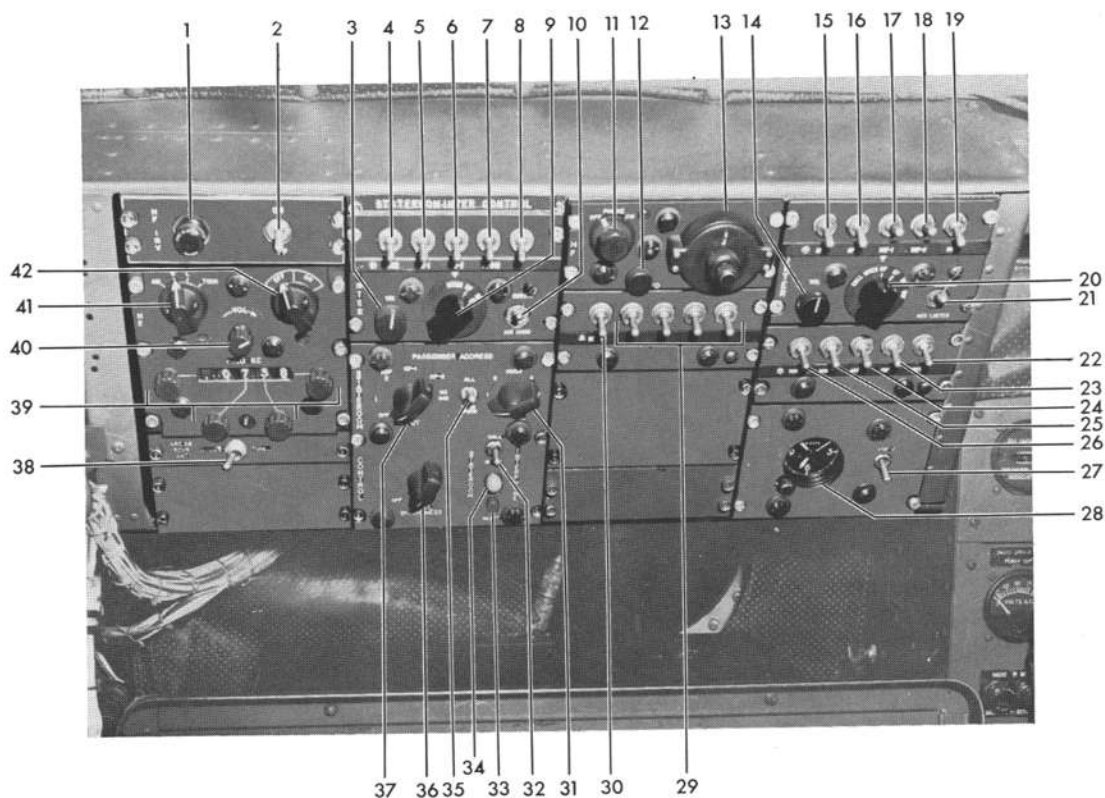

- | | | | |
|----|---|----|--|
| 1 | ARC-58 INVERTER WARNING LIGHT | 22 | RADIO OPERATOR'S INTERPHONE AUDIO SWITCH |
| 2 | ARC-58 INVERTER ON/OFF SWITCH | 23 | RADIO OPERATOR'S ADF-2 AUDIO SWITCH |
| 3 | STATEROOM HANDSET VOLUME CONTROL | 24 | RADIO OPERATOR'S ADF-1 AUDIO SWITCH |
| 4 | STATEROOM HANDSET INTERPHONE AUDIO SWITCH | 25 | RADIO OPERATOR'S VOR-2 AUDIO SWITCH |
| 5 | STATEROOM HANDSET HF-1 AUDIO SWITCH | 26 | RADIO OPERATOR'S VOR-1 AUDIO SWITCH |
| 6 | STATEROOM HANDSET HF-2 AUDIO SWITCH | 27 | VHF-1/VHF-2 MICROPHONE SELECTOR SWITCH |
| 7 | STATEROOM HANDSET BC-348 AUDIO SWITCH | 28 | CLOCK |
| 8 | SPARE SWITCH | 29 | SPARE AUDIO SWITCH |
| 9 | STATEROOM HANDSET MICROPHONE SELECTOR SWITCH | 30 | BC-348 AUDIO SWITCH |
| 10 | STATEROOM HANDSET NORMAL/AUX LISTEN SELECTOR SWITCH | 31 | PASSENGER ADDRESS RADIO BROADCAST VOLUME CONTROL |
| 11 | HF-1 OFF/PHONE/CW SELECTOR SWITCH | 32 | STATEROOM CALL/READY SWITCH |
| 12 | HF-1 BFO CONTROL | 33 | RADIO OPERATOR'S CALL LIGHT RESET SWITCH |
| 13 | HF-1 CHANNEL SELECTOR | 34 | RADIO OPERATOR'S CALL LIGHT |
| 14 | RADIO OPERATOR'S INTERPHONE CONSOLE VOLUME CONTROL | 35 | PASSENGER ADDRESS RADIO BROADCAST SPEAKER SWITCH |
| 15 | RADIO OPERATOR'S HF-1 AUDIO SWITCH | 36 | CONSOLE LIGHTS BRIGHT/DIM RHEOSTAT |
| 16 | RADIO OPERATOR'S HF-2 AUDIO SWITCH | 37 | PASSENGER ADDRESS RADIO RECEIVER SELECTOR SWITCH |
| 17 | RADIO OPERATOR'S VHF-1 AUDIO SWITCH | 38 | ARC-58 DIRECT/TUNED SWITCH |
| 18 | RADIO OPERATOR'S VHF-2 AUDIO SWITCH | 39 | FREQUENCY SELECTOR CONTROLS |
| 19 | RADIO OPERATOR'S UHF AUDIO SWITCH | 40 | ARC-58 VOLUME CONTROL |
| 20 | RADIO OPERATOR'S MICROPHONE SELECTOR SWITCH | 41 | ARC-58 FUNCTION SELECTOR SWITCH |
| 21 | RADIO OPERATOR'S NORMAL/AUX LISTEN SELECTOR SWITCH | 42 | ARC-58 ON/OFF SWITCH |

F125-C1-4-41 (2)

Figure 4-17 (Sheet 2)

liaison transceiver an/arc-58

(USAF SERIALS 48-610 AND 48-615)

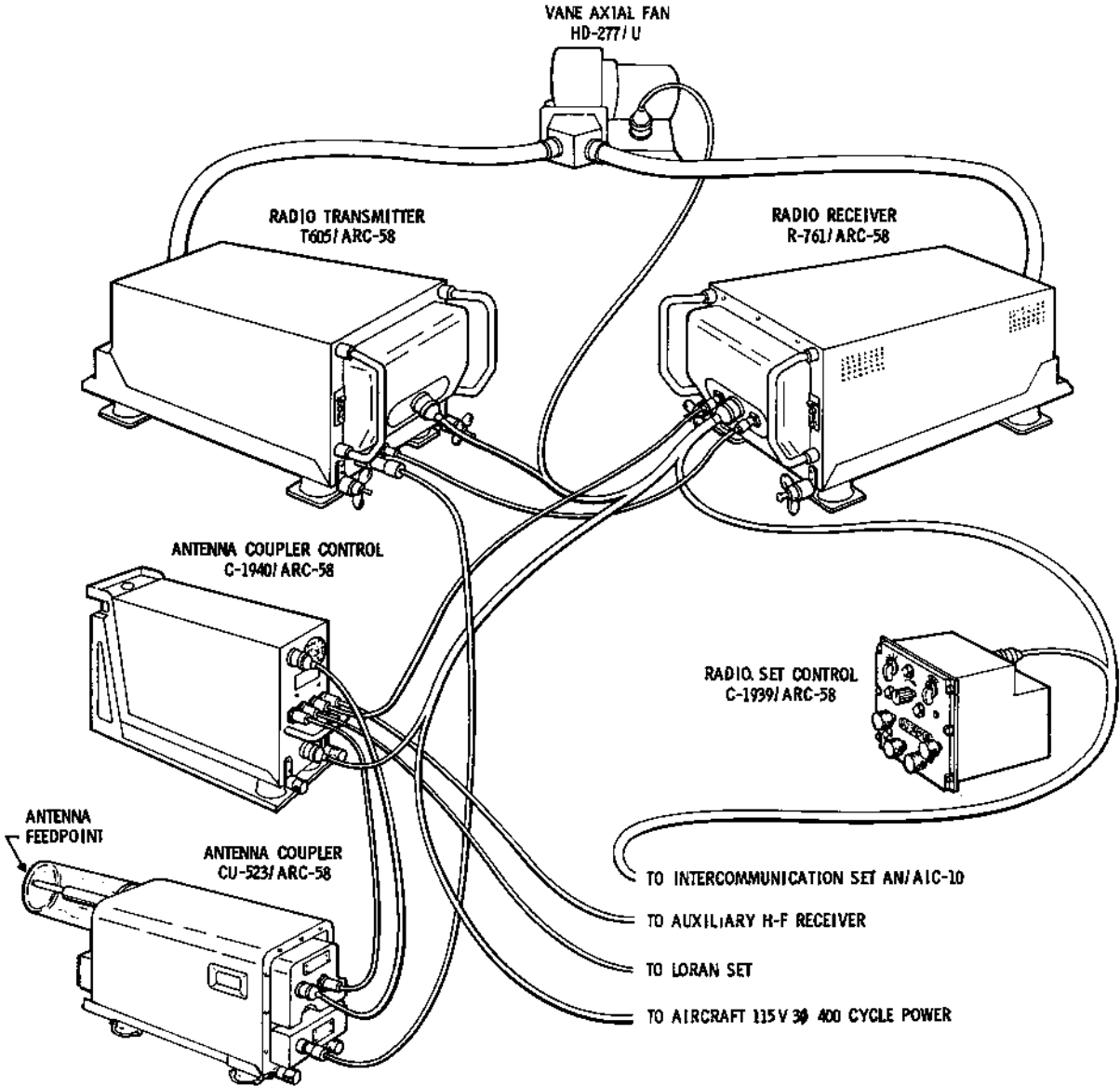

Radio Set AN/ARC-58, For Use in Areas Maintained
at an Environment Below 20,000 Feet of Altitude

F125-C1-4-103

Figure 4-18

8. Microphone selector switch—HF-2.
9. Receiver toggle switch (on intercommunication set)—HF-2.
10. Normal/Monitor switch—NORMAL.

To turn equipment OFF:

1. Emission switch—OFF.

BC-348 HF Receiver.

(Refer to Note)

The BC-348 receiver is locally tuned, six band super-heterodyne, covering a frequency range from 200 to 500 kc's and 1.5 to 18.0 mc's. It is designed for CW, MCW, and voice reception with manual or automatic volume control. The receiver is located on the radio operator's table (12 figure 4-16) and obtains power from the 28 volt d.c. radio circuit. High voltage is supplied by a dynamotor within the receiver. A 5 amp fuse is located within the receiver. All operating controls are on the front panel of the receiver. Audio output is in the HF-2 position of all selector panels.

Note

HF-2 Systems on USAF Serials 48-608, 48-609, 48-611, 48-612 and 48-617, the BC-348 receiver was removed from its mounting rack to provide room for the installation of a KWM-1 SSB transceiver. This is the BC-348 normally used with the ARC-8 HF-2 system. For aircraft having this semi-permanent installation, a switch is provided enabling the radio operator to select either ART-13 or KWM-1 for operation in the HF-2 position of all selector panels. On USAF Serials 48-610 and 48-615, an ARC-58 airborne SSB system is installed in place of the ARC-8 systems.

To place equipment in operation:

1. Aircraft power supply—ON.
2. Radio power switch—ON.
3. AVC-OFF-MVC switch—Place in AVC for voice; MVC for CW.
4. Band switch—rotate until required frequency band appears.
5. Tuning control—rotate until desired frequency appears opposite the marker on the face of the frequency dial.
6. CW-OSC-ON-OFF switch—OFF for voice; ON for CW.
7. Crystal IN/OUT switch—OUT for voice; IN for CW as desired.

8. BEAT FREQ control—adjust as desired (CW operation only).

9. Volume control—adjust as required.

10. Receiver toggle switch (intercommunication console)—HF-2.

To turn equipment OFF:

1. AVC-OFF-MVC switch—OFF (Refer to Note.)

Spare BC-348 HF Receiver.

The receiver is identical to the BC-348 just described and is used primarily to pick-up weather broadcast, time hacks, VOA-AFRS programs, and to provide entertainment to the passengers through the P.A. system. This receiver is also used in conjunction with the AN/ART-13A transmitter if the normal receiver fails or is removed (refer to Note under BC-348 HF RECEIVER). The audio output of this receiver is connected to toggle switches labeled BC-348, on the radio operator and stateroom intercommunication consoles only. The output is also connected to the passenger address radio broadcast selector switch.

AN/ARC-58 SSB-AM HF EQUIPMENT

(USAF Serials 48-610 and 48-615).

(Refer to figure 4-18.)

Radio set AN/ARC-58 is designed primarily to provide reliable long distance, two-way communication in the HF frequency band. Design features include improved communicating ability through the use of increased power and single-sideband techniques, 28,000 directly selectable frequency channels, automatic tuning, and retention of compatibility with existing AM stations. One thousand watts of transmitting power is available throughout the frequency of 2.0 to 29.999 megacycles when operating SSB and 400 watts when operating AM. All components of the system are located in the flight station radio rack (figure 4-14 sheet 2). The operating controls are on the radio operator's console (figure 4-17 sheet 2). A.C. power is supplied by an independent 115-volt, 3-phase, 400 cycle a.c. inverter located in the forward baggage compartment. 28 volt d.c. is supplied from the main radio d.c. bus. The main ARC-58 circuit breaker panel is located under the radio operator's panel. Additional a.c. circuit breaker fuses are located near the ARC-58 inverter in the forward baggage compartment.

To place equipment in operation:

1. Aircraft power—ON.

an/arc-58 control panel

(USAF SERIALS 48-610 AND 48-615)



F125-C1-4-105

Figure 4-19

2. Radio power switch—ON.
3. ARC-58 inverter switch—ON.
4. ARC-58 OFF/ON switch—ON (Check voltage and frequency).
5. Function switch—AM-U-L-TWIN as desired.
6. Allow at least 10 minutes for equipment to warm up.
7. Frequency selectors—Select desired frequency as indicated in window.
8. Microphone selector switch—HF-2.
9. Receiver toggle switch (on intercommunication console)—HF-2.
10. Microphone button—Push microphone button momentarily; wait until tune tone is no longer heard. Equipment is ready for operation.

11. Volume control—Adjust as desired.
To turn equipment OFF:

1. ARC-58 OFF/ON switch—OFF.

AN/ARN-6 ADF SYSTEMS.

The AN/ARN-6 ADF systems operate in the frequency range from 100 to 1750 kc's. Two completely independent AN/ARN-6 systems are installed in the airplane. Each of the two systems consists of a receiver, a non-directional (sense) antenna, a rotatable loop antenna, and remote controls. Receivers (figure 4-14) are located on the flight station radio rack and the loop and sense antennas (figure 4-13) are on the under side of the fuselage. Each of the two systems operate from a 28 volt d.c. radio circuit supplied through input relays, labeled, ADF-1 and ADF-2. These relays are located in the main radio junction box. A. C. voltage is required for instrumentation and loop operation. This a. c. power is 36 volt, 400 cycle, and comes from the power supply section of the fluxgate ME-1A amplifier.

ADF System Controls.

Control for the ADF systems are on the pilots' overhead radio control panel (figure 4-15). The control box on the left is ADF-1 and the control box on the right is ADF-2. A control box is also located at the navigator's position (3 figure 4-22) which enables operation of the ADF-2 system only. Specific controls for each of the control boxes consist of a function switch labeled OFF-ADF-ANT-LOOP-CONT, a band change control, a loop rotating switch, a tuning control, and a CW-VOICE switch.

ADF-1 and ADF-2 Instrumentation.

Bearing information from the ADF-1 and ADF-2 systems are displayed on RMI's located on the pilot's, copilot's (1 figure 1-18) and navigator's (4 figure 4-23) instrument panels.

To place equipment in operation:

1. Aircraft power supply—ON.
2. Radio power switch—ON.
3. Main radio inverter switch—ON.
4. Function switch—ANT position.
5. Receiver toggle switch (intercommunication console)—ADF-1 or ADF-2 as desired.
6. Tune in desired station and then place function switch to ADF for bearing information.

To turn equipment OFF:

1. Function switch—OFF.

ADF LANDING GEAR DOWN CORRECTION**CIRCUIT AND PANEL.**

The operation of the ADF system is corrected for interference from the nose landing gear (in the extended position) by the correction loop circuit. Controls for the circuit are on the pilots' center instrument panel (37 figure 1-18). The controls consist of a circuit on indicator light, an emergency switch and a push button test switch. Each correction loop consists of a single turn of heavy wire contained within the ADF loop housings. The relays are mounted above the loops. The circuit functions as follows: As the nose gear extends, it automatically closes a micro switch to energize two correction loop relays and lights the indicator light. The relay contacts close, thereby making a closed circuit of each of the two correction loops, thus rendering the loops active. The energy switch on the panel is used if the automatic switch fails. When the gear is extended, the functioning of the correction loops may be checked by momentarily pressing the test switch. This will cause a fluctuation of the indicator needles if the correction loops are operating.

AN/ARN-14 VOR SYSTEMS.

Two completely independent AN/ARN-14 receivers (figure 4-14) are installed on the airplane. Controls for the VOR systems are located on the pilot's overhead radio control panel (figure 4-15). The control box on the left is VOR-1, and the control box on the right is VOR-2. The navigation information is visual and observed on RMI indicator units at the pilots' center instrument panel (32 figure 1-18), and the navigator station (4 figure 4-23). VOR-1 selected bearing deviation is observed on the IFS Course Indicator (3 figure 1-18). VOR-2 selected bearing deviation is observed on the ID-249 course indicator (18 figure 1-18). Power is supplied to both systems from the 28 volt d.c. radio circuit and the 115 volt a.c. radio inverter system.

To place equipment in operation:

1. Aircraft power supply—ON.
2. Radio power switch—ON.
3. Main radio inverter switch—ON.
4. VOR ON/OFF switch—ON.
5. Receiver toggle switch (on intercommunications console)—VOR-1 or VOR-2 as desired.
6. Frequency selectors—Rotate to desired frequency.
7. Volume control—As desired.
8. NAV INST SEL switch—If operating VOR-2, place the NAV INST SEL switch, located on pilots' overhead radio control panel (23 figure 4-15) to VOR

an/arc-58 circuit breaker panel

(USAF SERIALS 48-610 AND 48-615)



Figure 4-20

position. This connects the No. 2 needles on the center panel RMI's and the ID 249 indicator to the VOR-2 system.

To turn equipment OFF:

1. VOR ON/OFF switch—OFF.

AN/ARN-21 TACAN SYSTEM.

The AN/ARN-21 TACAN system is operated from its control box located on the pilots' overhead radio control panel (figure 4-15). The system is used to provide automatic azimuth and range indications with respect to a selected beacon. Power is supplied to the equipment from the 28 volt d.c. radio circuit and the 115 volt a.c. radio inverter system.

To place equipment in operation:

1. Aircraft power supply—ON.

navigator's radio rack

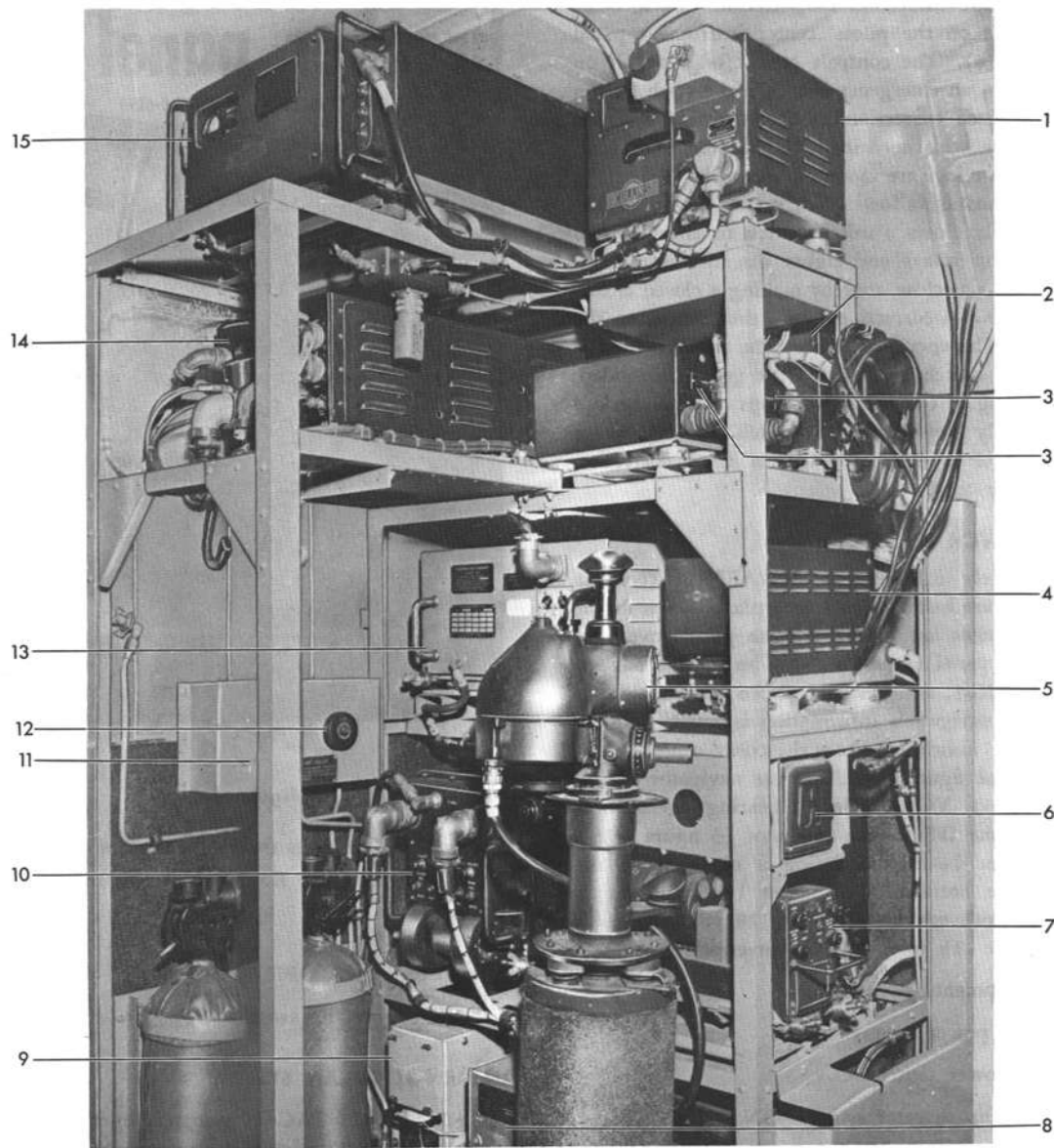

- 1 180L-3 ANTENNA TUNER
- 2 CV402/AP WAVE FORM CONVERTER
- 3 ME-1A COMPASS AMPLIFIER
- 4 FPC STEERING COMPUTER
- 5 DRIFTMETER
- 6 1FS VERTICAL GYRO
- 7 416W-1 HF POWER SUPPLY

- 8 THROTTLE SERVO AMPLIFIER
- 9 FLIGHT PATH COMPUTER
- 10 AN/ARC-27 UHF TRANSMITTER/RECEIVER
- 11 PASSENGER OXYGEN SYSTEM PRESSURE INDICATOR
- 12 PASSENGER OXYGEN SYSTEM SHUT-OFF VALVE
- 13 PB-10 AUTO-PILOT
- 14 APS-42 SYNCHRONIZER
- 15 618S-1 HF TRANSMITTER/RECEIVER

F125-4-4-44

Figure 4-21

2. Radio power switch—ON.
 3. Main radio inverter switch—ON.
 4. NAV INST SEL switch—TACAN.
 5. OFF-REC-T/R switch—T/R (if only bearing information is desired, place switch in REC).
 6. Receiver toggle switch (on intercommunication console)—TACAN.
 7. Channel selector switch—Desired channel.
- To turn equipment OFF:
1. Set OFF-REC-T/R switch—OFF.

RADIO MAGNETIC INDICATORS (RMI).

RMI's are located at the Pilot's, Copilot's (1, 32 figure 1-18), and navigator's (4 figure 4-23) positions in the aircraft, providing compass and radio information. Voltage for operation of the RMI's is derived from the power supply sections (figure 1-10A) of two ME-1A amplifiers. The ME-1A amplifier used with the fluxgate system provides the following:

- a. 26 volt 400 cycle a.c. for operation of all fluxgate RMI's.
- b. 26 volt 400 cycle a.c. for operation of all VOR-2 and TACAN indicators.
- c. 36 volt cycle a.c. for operation of all ADF-1 and ADF-2 indicators.

The ME-1A amplifier used with the C-2 system provides the following:

- a. 26 volt 400 cycle a.c. for operation of all C-2 system RMI's.
- b. 26 volt 400 cycle for operation of all VOR-2 indicators.

The ME-1A amplifiers are located on the navigators radio rack (3 figure 4-21).

AN/ARN-18 GLIDE SLOPE RECEIVER.

The AN/ARN-18 glide slope system is a navigational aid used during instrument landings. The system consists of one receiver (3 figure 4-14), connected to an antenna mounted in the nose radar dome. Only one glide slope receiver is installed in the airplane. It is paired with the VOR-1 receiver in localizer operation to form an Instrument Landing System (ILS). The receiver is turned on by a switch on the VOR-1 control box and automatically tunes to the correct glide slope frequency when a localizer frequency is selected. Glide slope indication is visual and displayed on the pilot's approach

horizon indicator (5 figure 1-18), and copilot's ID-249 course indicator (18 figure 1-18). The power is derived from the 28 volt d.c. radio circuit and the 115 volt a.c. radio inverter system.

AN/ARN-32 MARKER BEACON RECEIVER.

The AN/ARN-32 marker beacon receiver (10 figure 4-14) has no controls but comes on automatically when power is supplied to the radio d.c. bus. A marker beacon indicator light is located on the pilot's instrument panel (9 figure 1-18) and on the copilot's course indicator (18 figure 1-18). An aural signal may be heard when the aircraft is within the radiation pattern of a 75-megacycle marker beacon transmitter and the MKR switch on the intercommunication control panel is in the ON (up) position.

CAUTION

There is a possibility of erroneous marker beacon indications by the marker beacon receiver because of its broad band characteristics. The possibility of erroneous indications are increased when operating in the vicinity of television channel No. 5 which transmits on a frequency of 76-82 megacycles. The radio receiver can be keyed by signals from approximately 73.75 to 76.25 megacycles.

AN/APN-9 LORAN RECEIVER.

The AN/APN-9 Loran receiver (5 figure 4-22) is operated from the navigator's station and is used for long-range navigation. Power is supplied to the equipment from the 115-volt a.c. radio inverter system.

To place equipment in operation:

1. Aircraft power supply—ON.
2. Radio power switch—ON.
3. Radio main inverter switch—ON.
4. AMPLITUDE BALANCE control—set to center position of rotation.
5. FINE DELAY control—set to center position of rotation.
6. RECEIVER GAIN-POWER-OFF control—turn clockwise until the STATION rate identification (pilot light) comes on. Wait at least five minutes to allow equipment to warm up.

To turn equipment OFF:

1. RECEIVER GAIN-POWER-OFF control—turn counterclockwise to POWER-OFF position.

navigator's station

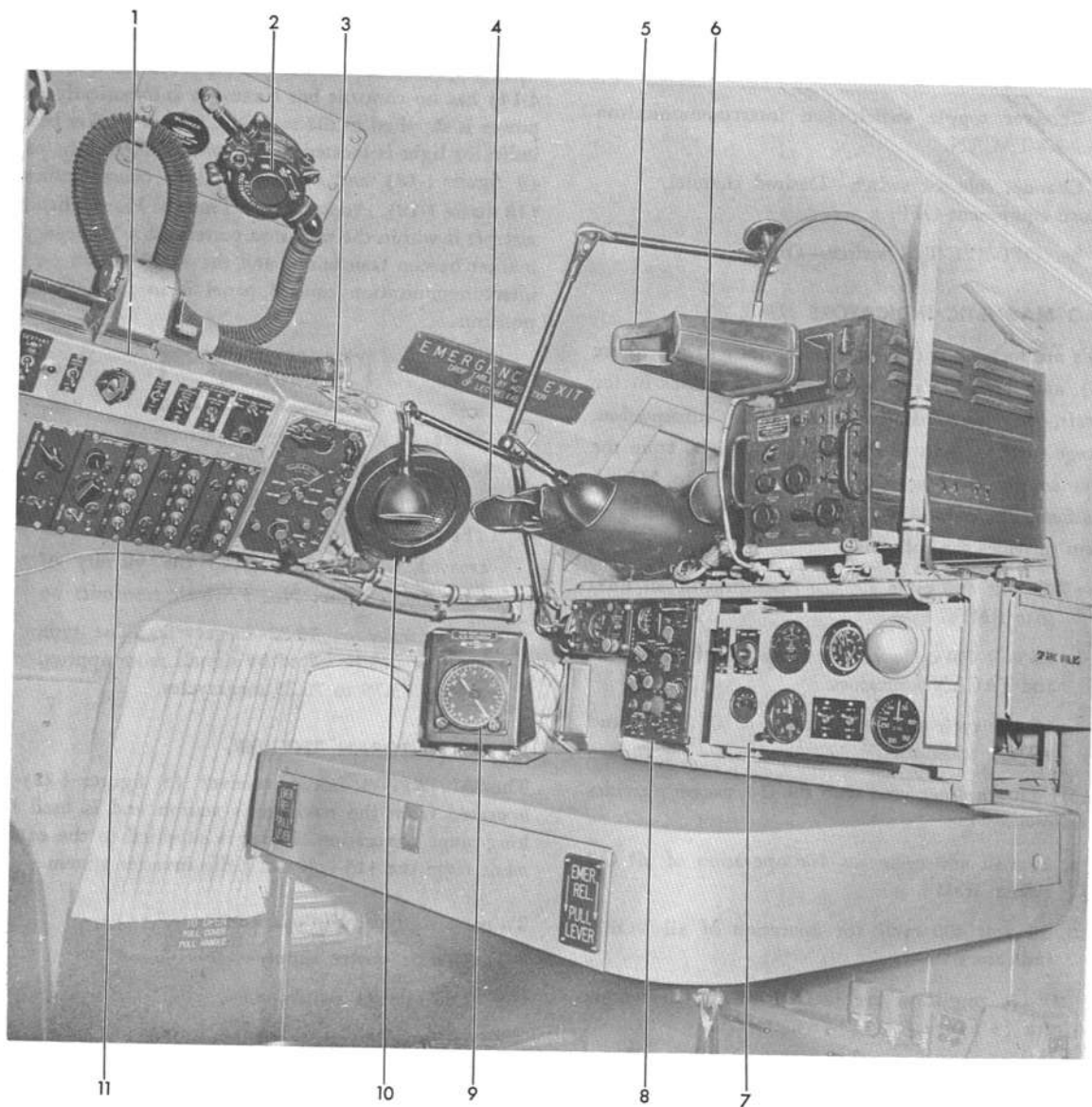

- | | | | |
|---|--------------------------------|----|------------------------------|
| 1 | LIGHT AND HEATER CONTROL PANEL | 6 | SCR-718C RADIO ALTIMETER |
| 2 | OXYGEN REGULATOR | 7 | NAVIGATOR'S INSTRUMENT PANEL |
| 3 | ADF CONTROL PANEL | 8 | AN/APS-42 CONTROL PANEL |
| 4 | AN/APS-42 SCOPE | 9 | DIRECTIONAL INDICATOR |
| 5 | AN/APN-9 LORAN | 10 | INTERPHONE SPEAKER |
| | | 11 | INTERPHONE CONSOLE |

F125-4-4-46

Figure 4-22

navigator's instrument panel

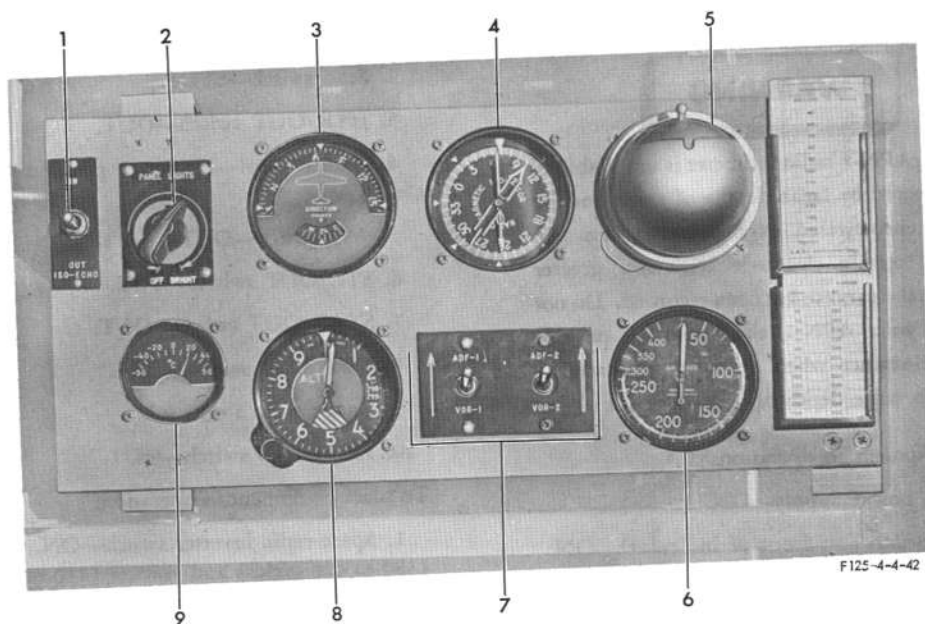

- | | | | |
|---|-------------------------------------|---|---------------------------------------|
| 1 | ISO-ECHO IN-OUT SWITCH | 6 | AIRSPD INDICATOR |
| 2 | PANEL LIGHT RHEOSTAT | 7 | ADF/VOR RML POINTER SELECTOR SWITCHES |
| 3 | FLUX GATE COMPASS (MD1) | 8 | ALTIMETER |
| 4 | DUAL RADIO MAGNETIC INDICATOR (RML) | 9 | OUTSIDE AIR TEMPERATURE INDICATOR |
| 5 | ASH TRAY | | |

Figure 4-23

SCR-718C RADIO ALTIMETER.

The SCR-718C radio altimeter indicator (6 figure 4-22) is operated from the navigator's station. The equipment indicates the aircraft altitude above the terrain. The measurement is graphically exhibited by the appearance of a lobe on the face of a cathode ray-indicator tube. Power is supplied to the equipment from the 115-volt a.c. inverter system.

WARNING

The SCR-718 radio altimeter is unreliable in areas covered by large depths of snow and ice such as encountered over polar regions. An apparent terrain clearance 1600 feet greater than actual clearance has been recorded. Do not rely on your SCR-718 equipment to provide terrain clearance when flying over areas covered by a large depth of snow and ice.

To place equipment in operation:

1. Aircraft power supply—ON.
2. Radio power switch—ON.
3. Radio main inverter switch—ON.
4. OFF-ON REC. GAIN switch—ON and turn clockwise to adjust height of lobes.

To turn equipment OFF:

1. OFF-ON REC. GAIN switch—OFF.

AN/APN-1 RADIO ALTIMETER.

The AN/APN-1 radio altimeter gives indication of the altitude above terrain and has a nominal range of zero to 4,000 feet. Altitude measurement is exhibited on an indicator (10 figure 1-18) of the dual-range type incorporating a two-position range switch. The low range will operate from zero to 400 feet, the high range will operate from zero to 4,000 feet. An interlocking

relay is incorporated which prevents operation of the SCR-718C radio altimeter when the AN/APN-1 altimeter is energized. Power is supplied from the 28-volt d.c. radio bus.

WARNING

The AN/APN-1 radio altimeter is unreliable in areas covered by large depths of snow and ice such as encountered over polar regions. An apparent terrain clearance 1600 feet greater than actual clearance has been recorded. Do not rely on your APN-1 equipment to provide terrain clearance when flying over areas covered by a large depth of snow and ice.

To place equipment in operation:

1. Aircraft power supply—ON.
2. Power switch (on front of indicator)—ON.
3. Range switch (on front of indicator)—HIGH or LOW, as required.

To turn equipment OFF:

1. Power switch (on front of indicator)—OFF.

**AN/APX-25 RADAR IDENTIFICATION
TRANSPONDER.**

The purpose of the AN APX-25 is to identify the aircraft as friendly when correctly challenged by friendly shore, shipboard and airborne radars, and to permit surface tracking and control of aircraft in which it is installed. The AN APX-25 control panel is located on the pilot's overhead radio control panel (figure 4-15).

AN/APS-42A RADAR SYSTEM.

The AN APS-42A equipment is mounted in the nose radome and the navigator's radio rack (14 figure 4-21). Two scopes are provided, one for the pilot (figure 4-24) and one for the navigator (4 figure 4-22). 115 volt 400 cycle a.c. power is supplied by the spare radio inverter and 28 volt d.c. power is supplied from the d.c. radio circuit. The equipment is used as a navigational, weather observance and anti-collision warning device. An ISO-ECHO attachment is used to invert strong return signals for better weather presentation. An IN/OUT switch (1 figure 4-23), at the navigator's station, is used as desired.

The AN/APS-42A equipment is operated as follows:
Pre-Operation Check:

(Refer to 8 figure 4-22)

1. Function switch—OFF.
2. Scan switch—STOP.
3. HTR/OUT switch—OUT.
4. Gain control—Minimum position (Fully Counter-clockwise).
5. A/J switch—OUT.
6. STC/OUT switch—OUT.
7. STAB/OUT switch—OUT.
8. OBS/MAP switch—OBS.
9. Range switch—30 mi.
10. ISO/ECHO switch—OUT.

To place equipment in operation:

1. Spare radio inverter switch—ON. Check frequency (380 to 420 cycles) and voltage (110 to 120 volts).

Note

When the function switch is turned to any position from the OFF position, there is a 3-minute delay before the equipment will operate. When the HTR/OUT switch is in HTR position, Radar Set, AN/APS-42A does not function. The HTR/OUT switch should be positioned to OUT. Antenna AS-428A does not employ heaters.

2. Function switch — STANDBY. Turn function switch to STANDBY and wait at least 3 minutes. This is added precaution for there is an automatic 3-minute delay any time the function switch is switched from the OFF position.

Note

The antenna will respond to the tilt meter control as soon as the power is turned on; however, the tilt motor indicator will not register antenna position until the set has warmed up completely. The tilt control should not be deflected for more than 4 seconds prior to complete warm-up to avoid damaging the antenna tilt stops.

3. Intensity control — Adjust intensity control on radar scope so that the sweep line appears plainly on the screen.

4. Focus control—Adjust focus control on radar scope so that the sweep line appears sharp and clear.

5. Intensity control—Rotate intensity control slowly counterclockwise until the sweep line is barely visible.

6. Function switch—Set function switch to SEARCH position.

7. Scan switch—Set SCAN switch to FULL or SECTOR position.

8. Gain control—Rotate gain control clockwise, until the target appears, then turn intensity down so that the sweep trace is just barely visible again. There is an optimum position for the clearest viewing and the highest degree of definition.

9. Tune control—As necessary. If no signal appears after turning up the GAIN a reasonable amount, or in the event that the sweep starts spoking, move the tune control from the AFC position and attempt to tune and set manually. This is a critical adjustment requiring extreme care. Use the MANUAL tuning only when absolutely necessary. The AFC position is more advantageous.

10. A/J switch—As necessary. When it is desired to materially reduce the returns from heavy masses of targets, better definition may be had by setting the A/J switch to the FTC position. Further sharpening may be obtained by placing the A/J switch in the IAGC position. Use the setting that gives the clearest results and readjust GAIN if necessary.

CAUTION

The A/J switch should not be used unless definite improvements are noted. The overall sensitivity is reduced, making small targets more difficult to detect on the longer range.

11. STC/OUT switch—As necessary. At times, the returns from large cities or a rough sea may appear too bright on the scope. Setting the STC/OUT switch to STC position will reduce the return from targets up to 10 miles. Increase the GAIN to compensate for the reduction in intensity.

12. OBS/MAP switch—As desired. Use the MAP position on the OBS/MAP switch for low ranges (5, 10

pilots' APS 42 scope



Figure 4-24

and 30) with the antenna tilt meter approximately -2. In this position, the radiation pattern of the antenna is such that the distant targets will return as much energy as nearby targets; hence, a good mapping presentation. In the OBS position, all of the energy is concentrated into a narrow beam of approximately 5 degrees. Operate antenna TILT switch to experiment for the best results. With zero tilt and OBS position employed, one can observe objects at approximately the same altitude for collision prevention.

13. Range switch—As desired. On the first five positions of the range switch, the scope represents the number of nautical miles, as indicated by the range switch. Range marks will appear on the scope with intervals corresponding to the number illuminated at the top of the scope (5 and 10 miles range will have 2 mile intervals, 30 mile range will have 5 mile intervals, 100 and 200 mile range will have 25 mile intervals). The sixth position of the range switch, TD (target discrimination), enables the operator to pick out any 30 mile sector

within range of the set and use the entire scope to present it. This is accomplished with the use of the DELAY control.

Note

- On the TD position of the range switch, the start of the sweep is delayed from 5 to 175 miles as indicated by the DELAY control. On any other position of the range switch, a variable delay marker will appear on the scope a distance from the start of the sweep as indicated by the DELAY control setting.
- There are two screwdriver adjustment screws on the front of synchronizer SN-59A/APS-42A for adjusting the intensity of the fixed range marks and variable delay marker.

14. Sector scan—Use sector scan any time it is desired. Observation of specific targets in the direction of the aircraft heading is slightly improved by using sector scan.

15. Cursor, azimuth and range lights—As desired. The control on top of the indicator housing varies the brightness of illuminating lights for observing cursor line and azimuth scale. It also varies the brightness of the range marker indicator lights on upper rim of the indicator.

16. Cursor lines — Rotate to desired azimuth. The knurled knob on the lower edge of indicator housing rotates cursor lines to the desired azimuth position.

17. Function switch—BEACON. For beacon operation, place the function switch on BEACON, and the A-J and STC switches in the OUT position. In beacon operation, the MAP beam is automatically selected; therefore, operate antenna TILT switch to zero tilt, as indicated on the antenna tilt meter, then proceed as for SEARCH operation.

Note

There are no ground returns when utilizing BEACON. The exact range of the station will be ½ mile less than the distance to the first arc line from the start of the sweep. The bearing may be obtained by placing the cursor line through the center of the arcs and reading the bearing from the azimuth scale. To read the beacon station code, interpret long intervals be-

tween arcs as dashes and short intervals as dots. Read identification of radar station from start of sweep outward.

18. Function switch—WEATHER. When it is desired to view surrounding weather conditions, place function switch in the WEATHER position and proceed as in search. Energy returns from clouds are proportional to the amount of precipitation contained in them. Hence, the denser the cloud formation, the brighter the return will appear on the scope. Use OBS and operate TILT switch to zero for best indications.

Note

Place function switch on STANDBY, scan switch on STOP, and STAB switch on OUT, every time set is not being used. Then there will be no delay when set is used again.

To turn equipment OFF:

1. STAB switch—OUT position.
2. SCAN switch—STOP position.
3. Intensity control—Rotate the INTENSITY (on both scopes) full counterclockwise.
4. Gain control—Rotate GAIN control full counterclockwise.
5. Function switch—OFF position.

Note

If spoking is noticed on the scopes during the weather operation or long range search operation, use set on low range search operation only.

NOSE RADOME PRESSURIZATION SYSTEM.

The radar pressurization system maintains an air pressure approximately equal to that of the atmosphere at sea level in the AN/APS-42 radar transmitter-receiver and associated wave guides. A pressure switch automatically energizes the air compressor when the line pressure drops below 28 inches of mercury (absolute) and stops the air compressor at about 32 inches. A check valve at the air compressor outlet retains pressure in the line after the compressor is stopped. The system is capable of pressurizing the radar system at any altitude within the limits of the aircraft.

CAUTION

Do not operate the radar when the radar pressure indicator shows pressure below 26 inches of mercury.

A silica-gel dehydrator (located at the navigator's station) is installed in the radar pressurization lines to remove moisture from the cabin air that is used to pressurize the radar components. Radar operating controls (8 figure 4-22) are located at the navigator's station.

Radar Pressurization Switch.

This switch has three positions: NORMAL ON, OFF and is spring-loaded from the MOMENTARY ON to the OFF position. In the NORMAL ON position, the pressure switch controls the air compressor. When the switch is held in the MOMENTARY ON position, the pressure switch is bypassed and the compressor is energized.

Bleed Button.

This button is used to bleed pressure from the lines so that the pressure indicator can be calibrated.

Radar Pressure Indicator.

This indicator shows the air pressure in the radar pressurization lines.

Radar Pressure Indicator Light.

This indicator glows whenever the radar pressurization pump is operating.

Calibration of Radar Pressure Indicator.

1. Radar pressurization switch—OFF.
2. Dial shield—turn to point the calibration arrow at approximately sea level pressure (29.92 on the instrument).
3. Bleed button—depress and hold until any existing pressure differential is equalized. The pressure gage should then indicate the barometric pressure of the station at which the aircraft is located. If this barometric pressure is unknown, the average reading of the supercharger pressure ratio indicators may be used as the true barometric reading while the aircraft is on the ground.

LIGHTING SYSTEM.

EXTERIOR LIGHTS.

The exterior lights include the landing lights, leading edge lights, position lights, wheel well lights, taxi light, navigation lights, and anti-collision light. All of these lights are operated by the d.c. electrical system, and the control systems incorporate the necessary switches and relays.

Landing Lights Switch.

A 600-watt landing light is installed in the lower surface of each outer wing panel. The lights are powered from the 28-volt d.c. circuit. A switch for each light, (17 figure 1-21) labeled LAMP ON and OFF, turns the lights on or off and another switch (16 figure 1-21) for each light, labeled EXTEND, OFF and RETRACT, controls the motors which extend or retract the lights independently of the exterior light master switch. It is possible to turn the lights on while they are extended, retracted, or in any intermediate position.

Leading Edge Lights Switch.

The leading edge lights switch (6 figure 1-19) controls the two white 28-volt d.c. lights mounted on the outboard side of each outboard nacelle. These lights are used to illuminate the wing leading edge for detection of ice, etc.

Navigation Lights Switch.

This switch (5 figure 1-19) controls 28-volt d.c. power to the navigation lights. It has FLASH, OFF and STEADY positions. When the switch is placed in the FLASH position, the wing tip lights and the white tail cone light will flash alternately with the red tail light. When the switch is placed in the STEADY position, the wing tip lights and the white tail light burn steadily. The wheel well lights, which illuminate the wheel wells when the gear is in the extended position, are also wired through this switch.

Position Lights Switch.

The position lights switch (7 figure 1-19) is used to turn the position and wheel well lights on. The position lights switch and the navigation lights switch must be ON to operate the position lights. Power is supplied from the 28-volt d.c. circuit.

Anti-Collision Light Switch.

A two-position switch (4 figure 1-19) is used to turn the anti-collision lights on. Power is supplied from the 28-volt d.c. circuit.

Note

The rotating anti-collision light should be turned OFF during flight through conditions

galley switch panel

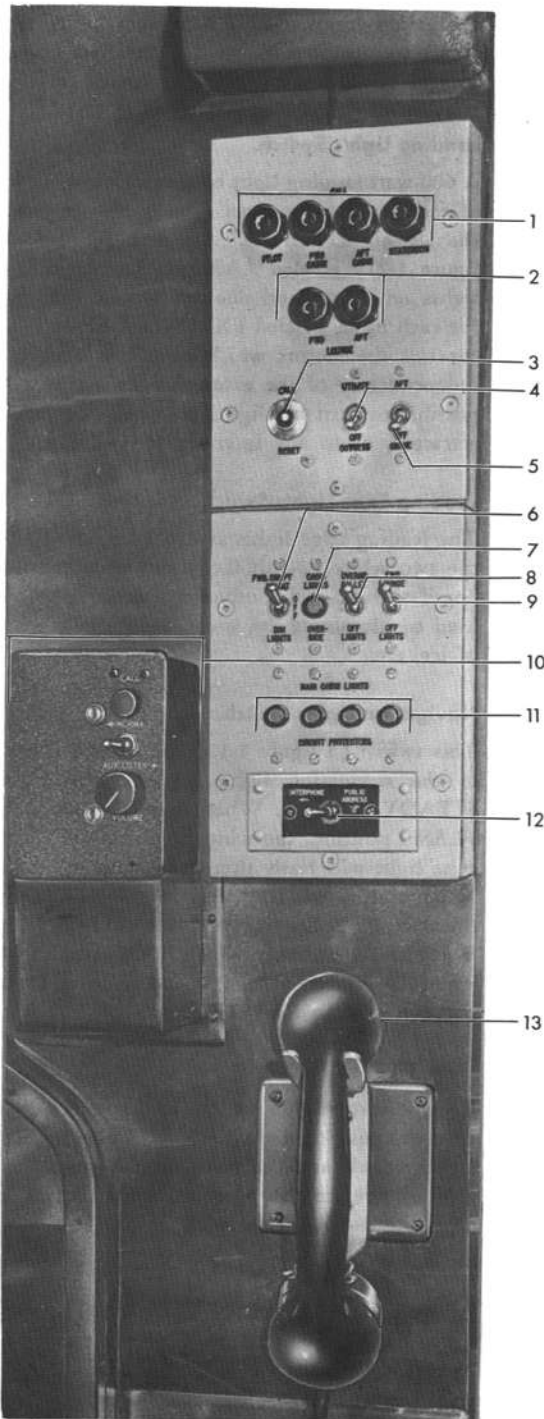

- 1 CALL LIGHTS (PILOT, FWD AND AFT CABIN, STATEROOM)
- 2 CALL LIGHTS (FWD AND AFT LOUNGE)
- 3 CALL RESET BUTTON
- 4 UTILITY OUTLETS SWITCH
- 5 AFT CHIME SWITCH
- 6 FORWARD COMPARTMENT LIGHTS BRIGHT-DIM-OFF SWITCH
- 7 CABIN LIGHTS OVERRIDE BUTTON
- 8 OVERHEAD GALLEY LIGHT SWITCH
- 9 FORWARD LOUNGE LIGHTS SWITCH
- 10 INTERPHONE CONTROL PANEL
- 11 MAIN CABIN LIGHTS CIRCUIT BREAKERS
- 12 INTERPHONE/PUBLIC ADDRESS SELECTOR SWITCH
- 13 HANDSET

F125-4-4-60

Figure 4-25

of reduced visibility where the pilot could experience vertigo as a result of the rotating reflections of the light against the clouds. In addition, the light would be ineffective as an anti-collision light during these conditions since it could not be observed by pilots of other aircraft.

Taxi Lights Switch.

This switch (8 figure 1-19) is used to control the two 50-watt nose taxi lights. Power is supplied from the 28-volt d.c. circuit.

INTERIOR LIGHTS.

Interior lighting provides general illumination for the cabin, flight station, cargo compartments, tail section and illumination for the controls and control panels provided for the flight crew. Dimming of cabin overhead lights is possible for night lighting in addition to regular night lights. Reading lights, lavatory lights, germicidal lights and berth lights are also provided.

Main Cabin Lights Circuit Breaker Switch.

This two-position circuit breaker switch placarded MAIN and OFF is located on the MJB No. 3 panel. Power is derived from the 28-volt d.c. circuit through a sustained overload 90 ampere remote controlled circuit breaker and is divided into four groups, each group individually protected by a circuit breaker on the galley switch panel (11 figure 4-25).

Note

Overhead light control switches are located on the flight stewards aft panel and also in each compartment.

Forward Compartment Overhead Lights Switch.

This switch (6 figure 4-25) has three positions: BRIGHT, OFF and DIM. It is located on the galley switch panel, and is used to control the eight overhead lights in the crew compartment. Power is supplied through a 20-ampere circuit breaker located on the MJB No. 3 panel from the 28-volt d.c. circuit.

Berth and Reading Light Switches.

These two-position ON-OFF switches are provided for each berth and reading light. Power for these circuits is derived from the 28-volt d.c. circuit and protected by a circuit breaker located on the MJB No. 3 panel.

Fasten Seat Belt/No Smoking Light Switch.

This three-position switch (15 figure 1-21) located on

flight attendant's aft panel

(USAF SERIAL 48-608 ONLY)

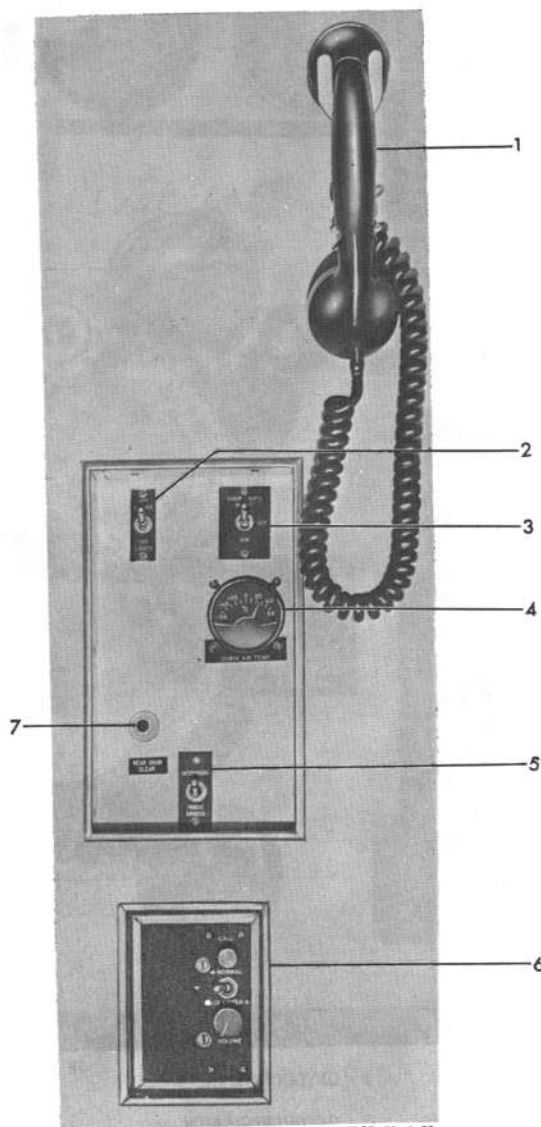

F125-C1-4-59

- 1 FLIGHT STEWARD'S HANDSET
- 2 AFT LOUNGE LIGHTS SWITCH
- 3 CABIN LIGHTS BRIGHT-DIM-OFF SWITCH
- 4 CABIN AIR TEMPERATURE INDICATOR
- 5 INTERPHONE PUBLIC ADDRESS SELECTOR SWITCH
- 6 INTERPHONE CONTROL PANEL
- 7 REAR DOOR CLEAR BUTTON

Figure 4-26

oxygen regulator



- FB 6673
- 1 OXYGEN FLOW INDICATOR
 - 2 OXYGEN REGULATOR
 - 3 OXYGEN PRESSURE GAGE

Figure 4-27

the pilots' overhead control panel, is used to turn on either the Fasten Seat Belt or No Smoking-Fasten Seat Belt ordinance lights. Power is supplied from the 28-volt d.c. circuit.

Germicidal Lamp Switch.

This circuit-breaker type switch is located on the MJB No. 3 panel and is used to control the 115-volt a.c. single-phase circuit for the two germicidal lamps located in the lavatories.

Pilots' Switch Panel Light Switches.

A two-position toggle switch and a rheostat-type switch (10, 11 figure 1-19 and 1, 17, figure 1-20) are located on each pilots' side panel. They control the operation and the intensity of the panel lights. The toggle switches are labeled PANEL ON and OFF. The rheostat switches are labeled PANEL LIGHT, DIM, and BRIGHT. Power is supplied from the 28-volt d.c. circuit.

Chart Light Switches.

A two-position toggle switch labeled CHART ON and OFF, and a rheostat (9, 16 figure 1-19 and 2, 16 figure 1-20) labeled CHART LIGHT, DIM, BRIGHT, are installed on each pilot's side panel. They are used to control the chart lights on each side of the overhead panel. Each light has a removable red lens and the light can be removed from its base for hand use as a flashlight. Power is supplied from the 28-volt d.c. circuit.

Compass Light Switch.

A rheostat on the pilot's side panel, (17 figure 1-19) labeled COMPASS LIGHT, DIM, OFF, BRIGHT may be used to turn on the light in the magnetic compass and to control its intensity. Power is supplied from the 28-volt d.c. circuit.

Pilots' Overhead Panel Lights Switches.

Red edge lighting is provided for the pilots' overhead panel. A rheostat (11 figure 1-21) switch controls power that is supplied from the 28-volt d.c. circuit.

Flight Station Lights Switch.

A white dome light is provided in the flight station for general illumination. The control switch located on the MJB panel, (6 figure 1-11) is labeled ON and OFF. Power is supplied from the 28-volt d.c. circuit.

Flight Engineer's Instrument Panel Lights Switches.

Four rheostats (1 figure 1-23) control the fluorescent lighting of the flight engineer's center and lower instrument panels. An independent rheostat switch controls the lighting for No. 2A and 3A fuel tank quantity indicators. Power is supplied from the 28-volt d.c. circuit. Red lights for the upper and lower instrument panels

are controlled by two rheostat switches located above the control quadrant.

Station 260 Instrument Panel Lights Switch.

A rheostat (1 figure 1-23) controls the fluorescent lighting of the station 260 instrument panel. Power is supplied from the 28-volt d.c. circuit. Additional lighting is controlled by a rheostat (17 figure 4-7) located on the 260 panel.

Flight Engineer's Desk Light Switch.

A rheostat-type switch (20 figure 1-11) controls the lights for the flight engineer's desk. This switch has DIM, OFF, and BRIGHT positions. Power is supplied from the 28-volt d.c. circuit.

Master Junction Box Panel Lights Switch.

A rheostat (5 figure 1-11), with positions labeled DIM, OFF and BRIGHT, controls the lights that illuminate the MJB panels.

OXYGEN SYSTEM.

FIXED OXYGEN SYSTEM.

A diluter-demand gaseous oxygen system is installed for the crew and passengers for emergency use in case of failure of the cabin pressurizing system. The complete oxygen system may be filled through a common filler valve located in the lower leading edge of the right stub wing. A line valve is provided in the filler line between the passenger and crew sections of the oxygen system. The line valve should be opened for charging the complete oxygen system. The line valve should remain closed at all other times to prevent any possible flow of oxygen from the crew section to the passengers' section of the oxygen system. The crew members are supplied by two oxygen cylinders. Check valves for safety are installed between the pilot, radio operator and navigator's section and the copilot and flight engineer's section. Space provisions have been allowed for the installation of two additional oxygen cylinders. A diluter-demand oxygen regulator is installed at each crew station. A pressure gage is located at the flight engineer's, radio operator's and navigator's stations. Some aircraft have three oxygen cylinders installed for the passenger oxygen system. Provisions are made to allow installation of additional cylinders if necessary. A pressure gage (11 figure 4-17 and figure 4-28) for the passengers' oxygen system is installed on the navigator's radio rack. Oxygen flow is automatic when a continuous flow mask is attached and cabin altitude is above 10,000 feet. Refer to figure 4-29 for oxygen duration.

Note

As an airplane ascends to high altitudes where the temperature is normally quite low, the oxygen cylinders become chilled. As the cylinders grow colder, the oxygen gage pressure is reduced, sometimes rather rapidly. With a 100° F decrease in temperature in the cylinders, the gage pressure can be expected to drop 20%. This rapid fall in pressure is occasionally a cause for unnecessary alarm. All of the oxygen is still there, and as the airplane descends to warmer altitudes, the pressure will tend to rise again, so that the rate of oxygen usage may appear to be slower than normal. A rapid fall in oxygen pressure while the airplane is in level flight, or while it is descending, is not ordinarily due to falling temperature, of course. When this happens, leakage or loss of oxygen must be suspected.

PORTABLE OXYGEN EQUIPMENT.

Two portable oxygen units are provided at the radio operator's station and three at the navigator's station. A recharging station is located on each side of the flight compartment and at the navigator's station.

Diluter-Demand Regulator.

A diluter-demand regulator (figure 4-27) is provided for each crew oxygen station. This regulator automatically mixes varying quantities of air and oxygen, the ratio depending on the altitude and setting of the air valve lever to NORMAL OXYGEN, and delivers the quantity demanded upon inhalation. The 100% OXYGEN position delivers only 100% oxygen upon inhalation.

Passenger Oxygen System Continuous-Flow Regulators.

Three type A-11 regulators are installed in parallel between the passenger system cylinders and the passenger system distribution plumbing lines. They operate automatically at cabin altitudes from 10,000 to 30,000 feet and at pressures between 50 psi and 450 psi. A total of six A-11 regulators may be used at one time.

Passenger Oxygen System Line Valve.

This shut-off valve is installed on the oxygen panel in the navigator's station (figure 4-28), just below the pressure gage. It is used to isolate the crew oxygen system from the passenger oxygen system. It must be in the OPEN position before the passenger oxygen system may be charged.

WARNING

oxygen system control

When the use of 100% OXYGEN or the emergency valve becomes necessary, the pilot should be informed of this action. Use of 100% OXYGEN or opening of the emergency valve will reduce oxygen duration. After the emergency is over, set air valve lever to NORMAL OXYGEN.

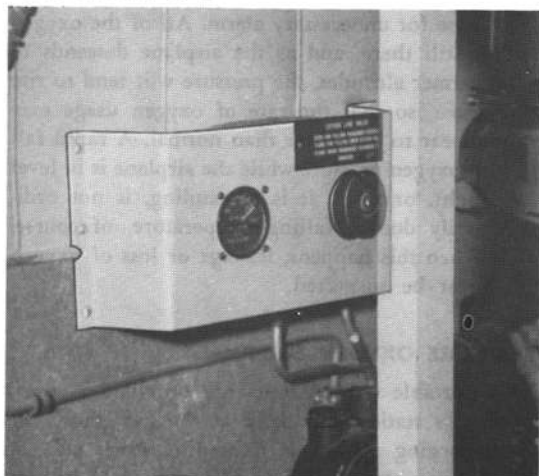

FB 6665

Figure 4-28

Passenger System Pressure Gage.

A pressure gage, installed upstream of the passenger system oxygen bottles, is located in the navigator's oxygen station (figure 4-28). This gage gives a continuous indication of the pressure in the passenger oxygen system.

NORMAL OPERATING PROCEDURE — CREW.

1. Connect mask to diluter-demand regulator.
2. Check mask for leakage.
3. Check flow indicator.

NORMAL OPERATING PROCEDURE — PASSENGERS.

1. Connect continuous-flow mask to individual passenger outlets.
2. Check pressure gage for proper pressure above 50 psi.

EMERGENCY OPERATING PROCEDURE — CREW.

1. Passenger oxygen system line valve OPEN for additional oxygen from passenger system.

AUTOMATIC PILOT.

(Refer to figure 4-30.)

The PB-10 automatic pilot is an electrically operated system that requires alternating current which is supplied by the inverters, and direct current which is supplied by the main bus. The automatic pilot establishes references for automatic control of the aircraft. Whenever there are any deviations in the attitude of the aircraft from these flight references, the system senses these deviations electronically and operates the rudders, ailerons, and elevators through the normal flight control system, accordingly.

Fundamentally, the automatic pilot is made up of nine components. Of these the gyro Flux Gate transmitter, the amplifier signal generator, the three main servos, and the elevator trim tab servo comprise the working units of the system. The remaining three components, the master direction indicator, the three-axis trim indicator, and the controller provide indications and operating controls for the pilots. In addition, switches are provided to control the various functions of the equipment. An elevator trim tab servo eliminates the need for manual nose-up or nose-down trimming when the automatic pilot is being used because the elevator trim tab servo is controlled directly by the elevator servo signal. When the elevator servo is required to sustain a force for a period of time to hold an elevator position, the elevator trim tab servo will be actuated automatically and will position the trim tab to provide aerodynamic balance. The manual trim tab wheel will move very slowly and the tab position indicator will show the position of the tab. A safety circuit in the amplifier causes disengagement of the automatic pilot in case of a.c. power failure. The automatic pilot clutches are also automatically disengaged in case of d.c. power failure.

Circuit Breakers.

Three circuit breakers (figure 1-12), two labeled PB-10 AUTO PILOT A and C and one labeled D.C., are located on the upper 212 panel. When these circuit

oxygen duration

PASSENGER SUPPLEMENTAL OXYGEN DURATION - HOURS

CABIN ALTITUDE - FEET	GAGE PRESSURE PSI							50
	400	350	300	250	200	150	100	
25,000	0.72	0.72	0.51	0.41	0.31	0.21	0.10	EMERGENCY DESCEND TO ALTITUDE NOT REQUIRING OXYGEN
20,000	0.79	0.78	0.56	0.45	0.34	0.23	0.11	
15,000	0.88	0.75	0.63	0.50	0.38	0.25	0.13	
10,000	0.98	0.84	0.70	0.56	0.42	0.28	0.14	

*BASED ON 3 TYPE G-1 OXYGEN CYLINDER AND 26 PASSENGERS ON CONTINUOUS FLOW. PASSENGER OXYGEN REQUIREMENTS BASED ON TABLE IV PAGE 18 OF MIL-1-585A.

CREW SUPPLEMENTAL OXYGEN DURATION - HOURS

CABIN ALTITUDE - FEET	PILOT, RADIO OPERATOR AND NAVIGATOR GAGE PRESSURE PSI							50
	400	350	300	250	200	150	100	
25,000	0.59 0.33	0.50 0.29	0.42 0.24	0.34 0.19	0.25 0.14	0.17 0.10	0.08 0.05	EMERGENCY DESCEND TO ALTITUDE NOT REQUIRING OXYGEN
20,000	0.99 0.26	0.85 0.23	0.71 0.19	0.56 0.15	0.42 0.11	0.28 0.08	0.14 0.04	
15,000	1.21 0.21	1.04 0.18	0.86 0.15	0.59 0.12	0.52 0.09	0.35 0.06	0.17 0.03	
10,000	1.28 0.17	1.10 0.14	0.91 0.12	0.73 0.09	0.55 0.07	0.37 0.05	0.18 0.02	

BASED ON 1 TYPE F-1 OXYGEN CYLINDER

CABIN ALTITUDE - FEET	CO-PILOT AND FLIGHT ENGINEER GAGE PRESSURE PSI							50
	400	350	300	250	200	150	100	
25,000	0.88 0.50	0.76 0.43	0.63 0.36	0.50 0.29	0.38 0.22	0.25 0.14	0.13 0.07	EMERGENCY DESCEND TO ALTITUDE NOT REQUIRING OXYGEN
20,000	1.48 0.39	1.27 0.34	1.06 0.28	0.85 0.23	0.64 0.17	0.42 0.11	0.21 0.06	
15,000	1.81 0.31	1.55 0.27	1.29 0.22	1.03 0.18	0.78 0.13	0.52 0.09	0.26 0.04	
10,000	1.92 0.25	1.64 0.21	1.37 0.18	1.10 0.14	0.82 0.11	0.55 0.07	0.27 0.04	

BASED ON 1 TYPE F-1 OXYGEN CYLINDER

RED FIGURES INDICATE 100% OXYGEN

Figure 4-29

auto pilot controls

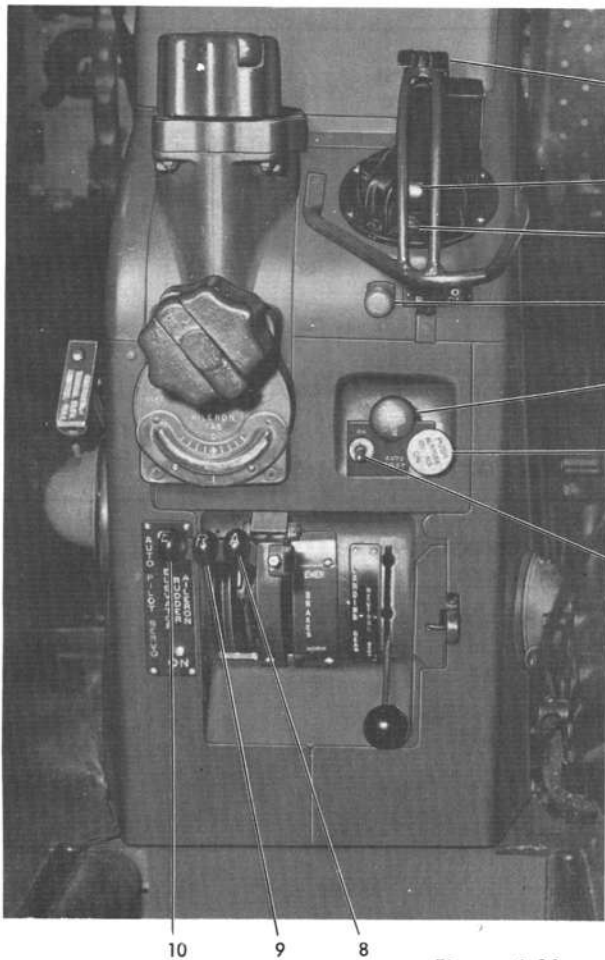

- 1 PITCH TRIM KNOB
- 2 PISTOL GRIP TURN HANDLE AND TRIGGER SWITCH
- 3 BANK TRIM KNOB
- 4 GYRO BEACON LIGHT
- 5 CLUTCH SWITCH
- 6 ALTITUDE CONTROL SWITCH
- 7 FLUX GATE CAGING SWITCH
- 8 AILERON SERVO DISCONNECT LEVER
- 9 RUDDER SERVO DISCONNECT LEVER
- 10 ELEVATOR SERVO DISCONNECT LEVER

Figure 4-30

F-125-0-4-48

breakers are pushed in, both a.c. and d.c. power are directed to the system.

Servo Disconnect Levers.

These three levers (8, 9, 10 figure 4-30), located on the lower aft side of the pilot's pedestal, operate mechanical clutches in each of the servos. Raising any one lever completely disengages the corresponding servo pulley from the servo drive shaft so that the pulley is free to turn with cable control movement. The servo disconnect levers also operate interlock switches at the beginning of their travel which interrupt the d.c. power to the clutch switch and prohibit engagement before the actual mechanical engagement.

Flux Gate Caging Switch.

This momentary-contact switch (7 figure 4-30), located on the pilots' pedestal to the left of the clutch switch, provides a means for expediting the erection of the gyro in the gyro Flux Gate transmitter and the automatic pilot vertical flight gyro. When the caging switch is placed in the CAGE (up) position and then released, the caging motors are energized to drive and lock the gimbal rings of the gyros so that the gyros are caged; then the gyros are automatically released (uncaged) and the caging motors are stopped. The caging circuit to the automatic pilot and Flux Gate compass also includes an interlock so that in case the caging switch is closed while the automatic pilot is engaged, the clutch switch holding solenoid is de-energized. This releases the clutch

switch, allowing it to pop out, disengaging the automatic pilot.

Clutch Switch.

This switch (5 figure 4-30) is located on the pilots' pedestal directly above the caging switch, and when pressed in, operates an electric clutch in each of the servos and the direction indicator to engage the automatic pilot, provided a.c. and d.c. power have been on approximately two minutes, the servo disconnect levers are in the ON position, and gyros are uncaged. A clutch time delay relay prevents engagement of the clutch for approximately two minutes after the automatic pilot is turned on. The delay set in by the relay allows time for the amplifier tubes to warm up, the gyros to reach operating speed, and the servos to turn to cancel the net channel signal before the automatic pilot takes control of the aircraft. During this delay period, the clutch switch, when pressed, will not hold and will not operate the servo clutches. The trim tab functions with the automatic pilot clutch switch. With the clutch switch out and the automatic pilot not engaged, a clutch inside the trim tab servo disengages to free the servo. A pulley friction release, mounted on the servo shaft, permits overpowering the trim tab servo.

Altitude Control Switch.

This switch (6 figure 4-30) is mounted on top of the controller and energizes a clutch which connects the altitude control autosyn to its sensing aneroid. Any deviation from the altitude at which this clutch is engaged will cause a signal to be generated for automatic control of the elevator, which will hold the aircraft at any pressure altitude up to 35,000 feet, provided airspeed and altitude are stabilized at the time it is turned on. Regardless of the amount the aircraft is displaced in altitude, the maximum pitch change that the unit can set in to return the aircraft to its original altitude is limited. The switch is electrically interlocked with the clutch switch to prevent engagement of the automatic pilot while the altitude control switch is ON. Also, when the altitude control switch is ON, a guard protects the pitch trim knob. The altitude control is inoperative with the guard pushed down. It must be reset after the guard is released.

Controller.

The controller mounted on the pilots' pedestal permits maneuvering the aircraft through the automatic pilot to make coordinated turns, climbs, descents, climbing turns, or descending turns. The three controls and their functions are:

1. The pistol grip turn handle (2 figure 4-30) incorporates two cut-out switches; one operated automati-

cally whenever the handle is displaced 4 degrees maximum in either direction from the center position and the other operated manually by a trigger switch on the pistol grip. The switches are normally closed and are connected in series with the clutch solenoid in the master direction indicator. When either switch is opened, the course autosyn is disengaged, thus allowing the selection of a new heading by use of the turn handle. If neither of these switches is opened while maneuvering the aircraft with the controller, the aircraft will return to its original heading when the turn handle is returned to the detent.

2. The bank trim knob (3 figure 4-30) may be used to adjust bank attitude after squeezing the pistol grip trigger switch. (See paragraph on CRUISE procedure.)

3. The pitch trim knob (1 figure 4-30) may be used to bias the elevator channel for any desired angle of climb or descent. This control is not accessible when the altitude control switch is ON.

Pilots' Clutch Disconnect Switches.

These switches, mounted on the right hand grip of each pilot's control wheel, provide a means of disengaging the automatic pilot. When pressed, either of these switches will electrically disconnect the automatic pilot system and the clutch switch will pop out. When this occurs, the clutches in the servos and in the direction indicator are disengaged, preventing automatic control from being applied to the aircraft control surfaces.

Flux Gate Sensitivity Control.

This control, located under a removable cover on the lower right corner of the automatic pilot amplifier-signal generator, is used for adjusting Flux Gate compass sensitivity. For latitudes approximating that of the Continental United States, this adjustment can be fully counter-clockwise. For those latitudes nearer the poles where the horizontal component of the earth's flux is weaker, increased sensitivity will probably be preferred. A setting which is too high results in oscillation of the master direction indicator and of the aileron servo. Sluggish movement of the direction indicator occurs when the setting is too low.

Gyro Beacon Light.

The gyro beacon light (4 figure 4-30), located on the pilots' pedestal directly above the automatic pilot clutch switch. If connected, it indicates the erect position and the approximate rotating speed of the flight gyro. This beacon light is energized through a photo-electric tube positioned so that the light reflected from a mirror surface at the top of the flight gyro strikes the photo-electric tube and causes the neon bulb to glow. When the gyro is properly erected and running at correct speed, and the

airplane is not in a bank or steep climb, the neon bulb flashes approximately 35 to 45 times per minute.

Flux Gate Compass Master Direction Indicator.

The Flux Gate compass master direction indicator (3 figure 4-23), located on the navigator's instrument panel, indicates the magnetic heading of the aircraft whether the automatic pilot is engaged or disengaged. The dial is directly connected through gears and linkages to an induction motor which operates both directionally and proportionally to changes of the magnetic heading of the aircraft. When the heading changes, the gyro Flux Gate transmitter mounted in the wing electrically senses this change due to its range of position in the earth's magnetic field, and transmits a signal to the Flux Gate direction indicator. This signal serves two purposes: it is used to drive the dial of the Flux Gate direction indicator, and to originate a course signal for automatic control. The course signal is then transmitted to the amplifier where it is amplified and modified to become a working signal with the characteristics necessary for application of power to the servo motor. When this working signal energizes the servo motor, which is tied to the aileron control system of the aircraft, it drives in the proper direction to apply corrective force for holding the aircraft on a desired magnetic heading.

Three-Axis Trim Indicator.

The three-axis trim indicator (36 figure 1-18), mounted on the pilots' center instrument panel, is connected across all three amplifier channels and indicates trim condition in all three axes. A sustained displacement of the indicator hand indicates a servo is putting out torque and the direction indicated. This out-of-trim condition requires manual correction by use of the trim tab controls in the same direction.

NORMAL OPERATING PROCEDURE.

To engage the automatic pilot for ground check.

1. Circuit breakers—IN.
2. Servo disconnect levers—ON.
3. Gyros—caged (after the inverter has been operating at least two minutes). Allow about 30 seconds for completion of the caging cycle.

Note

The gyro beacon light indicates that the flight gyro is erect and up to speed when it flashes at a rate of 35 to 45 times per minute. This light is disconnected in some aircraft.

4. Center all controls.
5. Altitude control switch—OFF.
6. Clutch switch—press.

Ground Check.

1. With the engines running and with boost on, operate the surface controls several times.
2. Neutralize (center) surface controls.
3. Engage the automatic pilot.
4. By use of the pitch and turn controller, move the surface controls each way.
5. Operate the turn controller and determine that the rotation of the control wheel can be stopped with moderate effort of one hand.
6. Operate the pitch controller forward and aft and determine that the control column movement can be stopped with moderate effort of one hand.
7. Operate the turn controller and determine that the rudder motion can be stopped with moderate effort. (The rudder will move only a few inches.)

To check the overpowering forces, proceed as follows:

1. With the turn and pitch controller in the neutral position, operate each of the surface controls against the power of the automatic pilot.
2. Using two hands on the wheel, the pilot should be able to turn or move it forward and aft.
3. By applying considerable effort on the rudders, the pilot should be able to move the pedals each way.

Note

The above checks can be performed in flight as well as on the ground.

The above checks give the pilot an approximation of the forces that the automatic pilot can produce. If it requires maximum effort with two hands to stall the elevator, the pilot is sure that the automatic pilot is capable of producing excessive force. If the pilot can overpower the ailerons easily with one hand, he knows that the aileron servo is not putting out sufficient force.

Note

Wind blowing directly on the tail may affect required force on the controls.

Before Take-off.

1. Pilot's (or copilot's) clutch disconnect switch—press.
2. Servo disconnect levers—OFF.

Climb.

1. After climb power is set, the aircraft should be trimmed before the automatic pilot is used.
2. Altitude control switch—OFF.

CAUTION

Never turn the altitude control switch ON during a climb. If it is accidentally turned ON, trim the aircraft and disengage the automatic pilot before turning it OFF.

3. Servo disconnect levers—ON.
4. Clutch switch—push.

Cruise.

When the desired cruising altitude has been attained, proceed as follows:

1. Disengage the automatic pilot.
2. Trim the aircraft manually for straight and level cruising flight at the desired altitude with desired cruising power.
3. Set the automatic pilot trim knobs to neutral.
4. Check that the altitude control switch is OFF.
5. Engage the automatic pilot.
6. Altitude control switch—ON, if desired.
7. If the altitude control fails to hold a steady altitude, it is possible that the aircraft was slightly out of trim when the altitude control was turned ON. To correct this, repeat the steps in this paragraph.

Note

If a major change in trim occurs, such as a power change, while using the altitude control, it will be necessary to disengage the automatic pilot, turn OFF the altitude control, and repeat the above steps. For minor changes in trim as noted on the three axis trim indicator, adjustments can be made to the aircraft trim tabs in the normal manner while on altitude control.

8. The automatic pilot now has control of all three axes of the aircraft. With the altitude control OFF, the aircraft can be maneuvered by moving various components of the controller. It is possible to adjust bank attitude by squeezing the trigger switch and using the bank trim knob, however, since the inclusion of the directional signal in the aileron channel the bank knob is of no practical use. The automatic pilot should be engaged with the aircraft trimmed for wings-level flight. If changes in bank attitude become necessary, disengage the automatic pilot and re-trim the aircraft again for level flight. Rotating the pitch trim knob aft (toward the pistol grip) will move the elevator to raise the nose.

Any desired angle of descent may be obtained by rotating the pitch trim knob forward. To make a coordinated turn, move the pistol grip in the direction it is desired to turn. This operation gives the proper amount of "up" elevator to maintain altitude and the correct amount of aileron and rudder for a coordinated turn. When the turn control grip is rotated to make greater changes in heading, a switch is automatically tripped to disconnect the automatic pilot from the Flux Gate compass so that when the handle is returned to the central detent position, the aircraft will maintain the new heading. If very slight changes in heading are desired, squeeze the trigger switch under the pistol grip, which cuts out compass heading signals, and rotate the grip a small amount in the desired direction, and then return it to the detent. The aircraft will hold the new course.

Descent.

1. Automatic pilot—disengage.
2. Altitude control switch—OFF.

Note

The automatic pilot may be engaged and used for descents when the altitude control is turned OFF, by adjusting the pitch trim knob.

PRE-TRAFFIC PATTERN.

To disengage the automatic pilot, proceed as follows:

1. Pilot's (or copilot's) clutch disconnect switch—press.
2. Servo disconnect levers—OFF.

EMERGENCY OPERATING PROCEDURES.

When using the automatic pilot, the pilot or copilot must be in his seat, with his safety belt fastened so that if any malfunction of the automatic pilot should occur, he can recover immediately.

Automatic Pilot Failures.

Automatic pilot failures generally will fall into one of the following categories; continuous hard-over signals or oscillating signals. The continuous hard-over type of malfunction can result from shorting or grounding of certain circuits, and/or the failure of certain tubes. The result will be that the automatic pilot servo will develop full torque on one of the surfaces (not necessarily full deflection) and the maneuver that results will depend upon the speed, CG position, gross weight, and to a certain extent upon the type of failure that has occurred, as it is possible to get erroneous signals that do not develop full torque from the servo unit.

Elevator Hard Nose-Down.

Should the automatic pilot malfunction give an elevator hard nose-down signal, the aircraft will pitch over quite rapidly to almost zero G, which is the critical condition. In combination with turbulence, this hard nose-down signal may produce an acceleration below zero G's which could unseat the pilot. Therefore, the pilot must have his safety belt fastened at all times.

Aileron Hard-Over.

Another type of failure is an aileron hard-over signal which produces a smooth movement of the ailerons and the aircraft will roll at a maximum rate of about six degrees per second. This is so smooth that it is quite possible that the pilot will not detect the motion at night or when on instruments, unless he is actually observing the attitude indicator or the control wheel at the time. It is possible that the aircraft can reach a very steep bank angle before the pilot detects the motion, particularly if the air is slightly turbulent, making the pilot relatively insensitive to the small acceleration produced by the aileron roll.

Oscillating Signals.

Oscillating signals can occur due to a failure in the automatic pilot follow-up circuit and will be evident by the oscillating movement of the controls. Should the automatic pilot malfunction, it should be disengaged immediately by one of the following methods:

1. Operate either the pilot's or copilot's clutch disconnect switches.
2. Pull out the clutch switch.
3. Move the servo disconnect levers to OFF (up) position.
4. Move the Flux Gate caging switch to the ON (up) position and then release.

If a malfunction occurs, the pilot must restrain the controls while disconnecting the automatic pilot to prevent a sudden jerk when it disengages. The automatic pilot will be disengaged automatically by any momentary interruption of either a.c. or d.c. current.

Note

The automatic pilot may be over-powered; however, the control forces required will be higher than when the automatic pilot is disengaged.

AUXILIARY POWER UNIT.

(Refer to figure 4-31)

The auxiliary power unit is an Air Force Type D-2,

self-contained gasoline engine that drives a direct current generator of 200 ampere, 28 volt capacity. It furnishes auxiliary power that can be used for ground operation of the airplane electrical system and can be used as a standby generator in case of inflight emergency. The unit receives electrical energy for starting from the main power circuit, and takes its fuel from the number 4 fuel tank. Fuel from the tank comes thru a manual shut-off valve, strainer, electric power fuel pump, and solenoid which is located in the lower section of number 5 nacelle. The power unit is encased in a metal housing that is shock mounted in the fuselage area aft of the rear pressure bulkhead. A removable door in the aft pressure bulkhead provides access to the unit. The APU assembly contains the throttle actuator, altitude compensator, tachometer, oil pressure, fuel pressure instruments, and the hour time meter. The APU remote controls (figure 1-23) are located on the flight engineer's upper panel and consist of the low oil pressure warning light, high fuel pressure warning light, throttle selector, fuel pump switch, ignition switch, starter switch, generator switch, ammeter, and fire detector switch for testing the fire warning system.

Fuel Pump Switch.

This three position switch (16 figure 1-23) labeled, FUEL PRIME, OFF and NORMAL, is located on engineers overhead panel. When the switch is placed in the FUEL PRIME position, the fuel pump and fuel valve solenoid is energized directly from the reverse current bus, filling the carburetor float chamber for starting in cold operation. The NORMAL position places the fuel pump in operation only when the APU fuel pump relay is energized by means of the starter switch.

Governor Control and Choke Selector Switch.

This rotary-type selector switch (15 figure 1-23) has three positions: CHOKE, IDLE and RUN. The CHOKE position is used to start engine at lower temperatures. The IDLE position is used during initial warm-up period. The RUN position is used after initial warm-up and during all normal operation.

Note

The APU will not start with the selector in the RUN position.

Ignition Switch.

This two-position, ON and OFF, switch (10 figure 1-23) is provided for magneto control. In the OFF position the magneto is grounded, and it is also grounded when the battery switch is in the OFF position.

auxiliary power unit installation

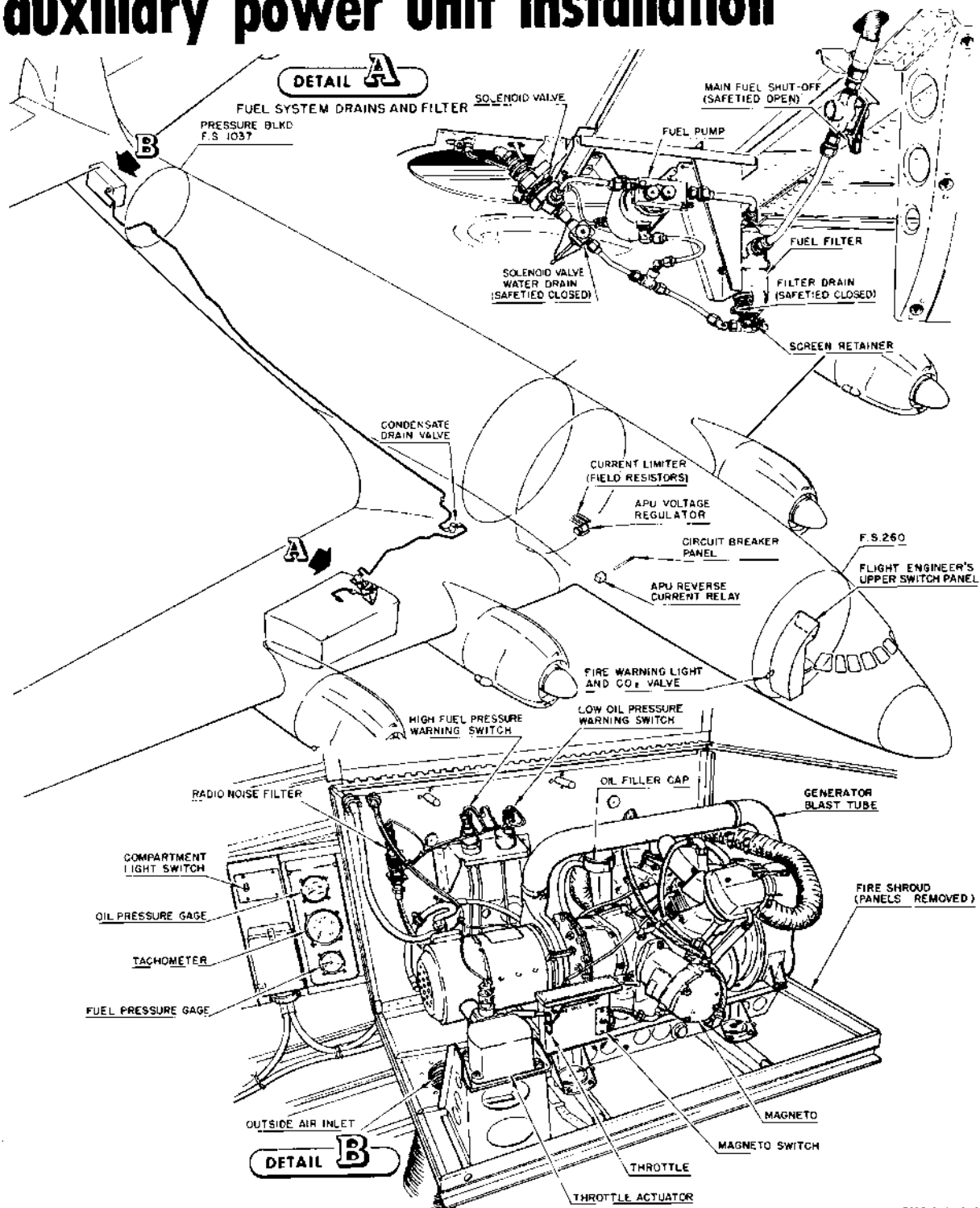

F125-1-4-701(2)

Figure 4-31 (Sheet 1)

auxiliary power unit wiring and controls

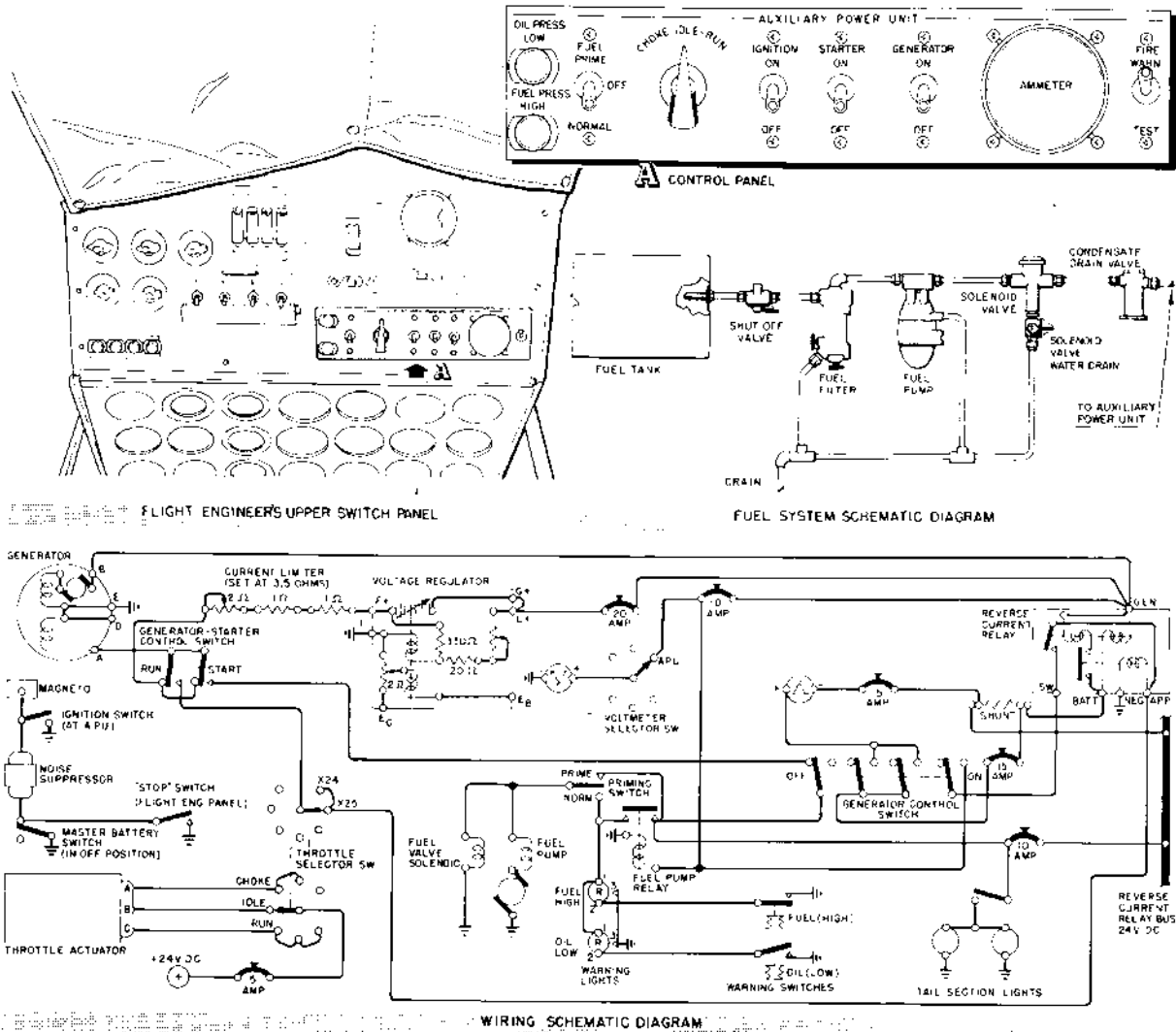

F125-1-4-101(1)

Figure 4-31 (Sheet 2)

Starter Switch.

This two-position, ON and OFF, switch (11 figure 1-23) provides power from the aircraft 28-volt d.c. circuit for cranking the APU engine. In the ON position power is applied to the APU fuel pump relay and to the starting motor; however, the governor control switch must be in either the CHOKE or IDLE position and the generator switch must be in the OFF position.

Generator Switch.

A two-position, ON and OFF, switch (12 figure 1-23) is provided for APU generator control. In the ON position, generator output from the APU is connected to the aircraft d.c. reverse current relay bus.

Fire Warning Test Switch.

A two-position, WARN and TEST, switch (14 figure 1-23) is provided for testing the fire warning lights and circuit. In the TEST position, the circuit is completed and the fire warning light comes on.

Oil Pressure Warning Light.

This d.c. warning light (17 figure 1-23) will be turned on by a pressure switch within the unit when oil pressure is below the minimum.

Fuel Pressure Warning Light.

This d.c. warning light (18 figure 1-23) will glow whenever fuel pressure exceeds 3 psi.

Ammeter.

A 300-ampere ammeter (13 figure 1-23) is installed for constant indication of the ampere output of the APU during its operation.

Circuit Breakers.

The circuit breakers for the APU are located in the forward baggage compartment on the overhead panel.

STARTING PROCEDURE.

1. Voltage selector switch—APU.
2. Generator switch—OFF.
3. Aircraft battery switch—ON.
4. Fuel pump switch—hold in PRIME position for few moments then return to NORMAL (if APU is cold).
5. Ignition switch—ON.
6. Starter switch—ON (spring loaded to OFF position).

Note

Engine start will be indicated when the engine oil pressure warning light goes out. Release of

the starter switch will result in the indication of generator voltage. Since the engine low idle speed is 1700 to 1800 rpm, the indicated voltage will drop to approximately 2-5 volts.

7. Choke selector switch—move to CHOKE until engine begins to fire, then return to IDLE.
8. Starter switch—release.

CAUTION

If the voltmeter indicates that the engine is in operation and the engine oil low-pressure warning light does not go out within 30 seconds, move ignition switch to OFF position to stop engine.

9. Operate the engine at idle rpm until warm (approximately 5 minutes).
10. Governor control switch—RUN.
11. Generator switch—ON.

To Stop APU:

1. Generator switch—OFF.
2. Governor control switch—IDLE. Operate in idle position approximately 1 minute.
3. Ignition switch—OFF.

Emergency Stop.

In the event of fire or a mechanical failure, the magneto can be grounded through the APU ignition switch at the flight engineer's station, or by placing the airplane battery master switch in the OFF position.

FUSELAGE FURNISHINGS AND MISCELLANEOUS EQUIPMENT.**NAVIGATOR'S STATION.**

The navigator's station (figure 4-22) is located on the left forward side of the cabin and is equipped with a chair, table, instrument panel, book locker, and a driftmeter.

Driftmeter.

A gyro-stabilizer driftmeter (5 figure 4-21) is installed to aid the navigator in determining terrestrial bearings of objects relative to the heading of the aircraft, ground speed, and wind velocity. The driftmeter is mounted on the floor of the navigator's station. A toggle switch mounted on the lower gyro housing controls gyro power. A rheostat installed on top of the upper gyro housing controls illumination of the reticle optical system. A

lever, mounted on the filter housing marked SHADE GLASS, controls a shade glass filter. By operation of the lever, the shade glass may be interposed in the optical system to reduce the intensity of light when the ground image is too bright. A one-power eyepiece and a three-power eyepiece are secured in an ocular housing. The eyepieces are equipped with rubber guard buffers and the unused eyepiece is stowed in a holder on the side of the driftmeter. The driftmeter telescope tube extends downward through the fuselage floor and projects through a hole in the lower fuselage skin.

WASH WATER SYSTEM.

A wash water system provides water to the lavatory basins and to the galley sink. (Refer to figure 4-32.) The water supply is stored in two 21-gallon tanks located on the left side of the rear cargo compartment. Installed at the tank outlet is a 28-volt d.c. electrically-driven water pump which is automatically controlled by a pressure switch. The pressure switch turns the pump on if water pressure drops to 4 psi and turns the pump off when the pressure reaches 7 psi. A surge tank is installed in the water pressure line to absorb line surges and to reduce the number of pump operating cycles. If the pressure switch should fail to shut off the pump, a pressure relief valve directs the excess water back to the supply tank. A fitting is installed in the bottom of the fuselage to which a water hose can be connected to refill the water tank. A direct reading sight gage and float control valve are installed. When the tanks are being filled, the water is routed to the top of one tank and enters the other tank through a connecting line. When the aircraft is parked where the temperature is below freezing, the water system must be drained.

CAUTION

Do not exceed 50 psi water pressure when replenishing wash water system.

Wash Basins.

All of the water taps and basin drains in the lavatories are spring-loaded. The basin drains should normally be in the closed positions to prevent loss of cabin pressure.

Wash Water Drain Tank.

A 10-gallon drain tank is placed between the wash basin drain lines and the system outlet. The tank is installed for use as a sump in case conditions are encountered which would cause water to freeze in the outlet.

Hot Water Tanks.

The wash basins are supplied from hot water tanks. The water enters the bottom of the tanks and is heated by thermostically controlled electric immersion heaters. The heaters derive their power from the 28-volt d.c. system which operates from a switch-type circuit breaker on the MJB No. 3 panel. A time delay relay is installed in the heating circuit of the aft hot water tank as a secondary source of protection if the tank thermal switch should not turn the heater off at 135°F.

Note

An additional hot water tank is installed in USAF Serials 48-608 and 48-610.

Drain Valves.

These two valves are on the left side of the aft cargo compartment and are beneath an access cover located across from the aft cargo compartment door. The valve has two positions: DRAIN and CLOSE. The DRAIN position is used to drain the water supply tanks and system.

INTERIOR CONFIGURATIONS.

Any one of several interiors providing for convertible sleeper arrangements, day seats, and for either over-land or over-water flying are installed. The aircraft incorporates a stateroom, two cabins, and a galley. All configurations have accommodations for a crew of nine consisting of a pilot, copilot, flight engineer, radio operator, navigator, and four relief crew members.

Passenger Seats.

Seats are reclining type and are berthable. Retaining fittings are installed in the cabin floor into which chair legs are snapped. Ash receivers, safety belts, and individual air sickness container brackets are provided.

Radio Operator's Seat.

The seat for the radio operator is track-mounted to provide back-and-forth position adjustment, and is arranged to swivel. The chair may be locked in increments of 15 degrees.

Relief Crew Seat-Bunk.

A crew bunk is installed on the right side of the crew compartment opposite the navigator's station. The upper bunk may be lowered into position by disengaging the keylock and allowing the bunk to pivot downward on the outboard supports. The four seats can be made into bunks as desired and the forward seats can be used for emergency landing if necessary.

wash water system

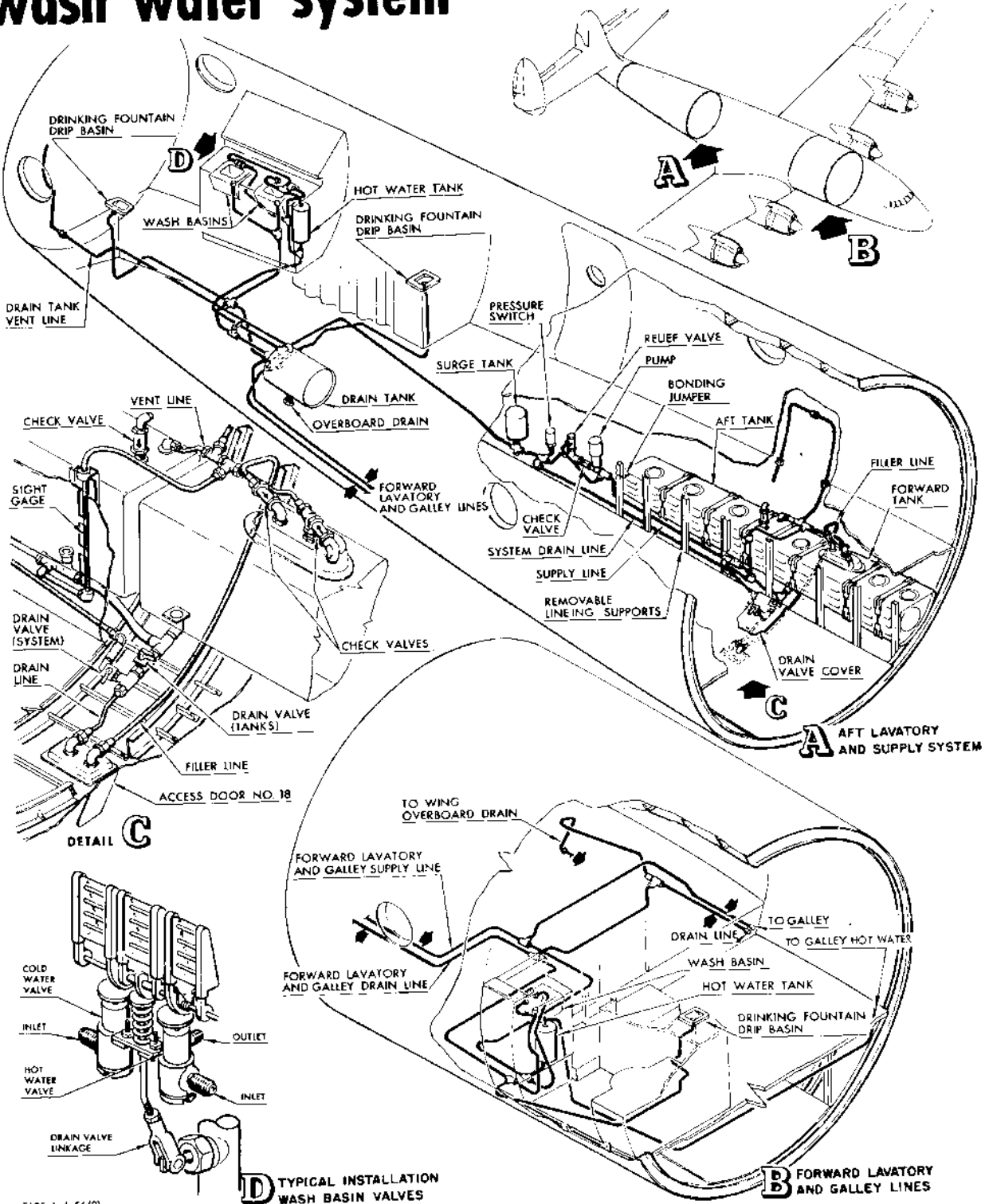

F125-1-4-56 (2)

Figure 4-32 (Sheet 1)

wash water system (schematic)

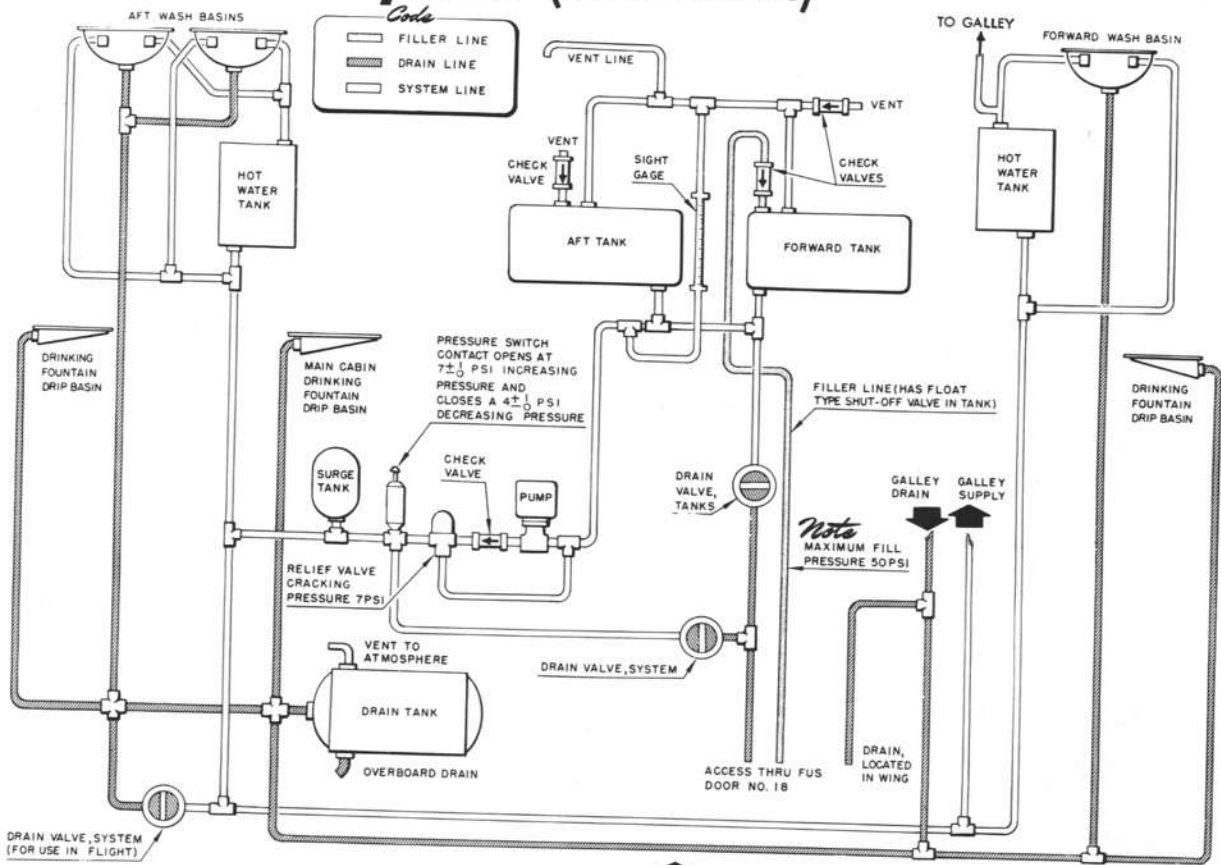

SYSTEM SCHEMATIC

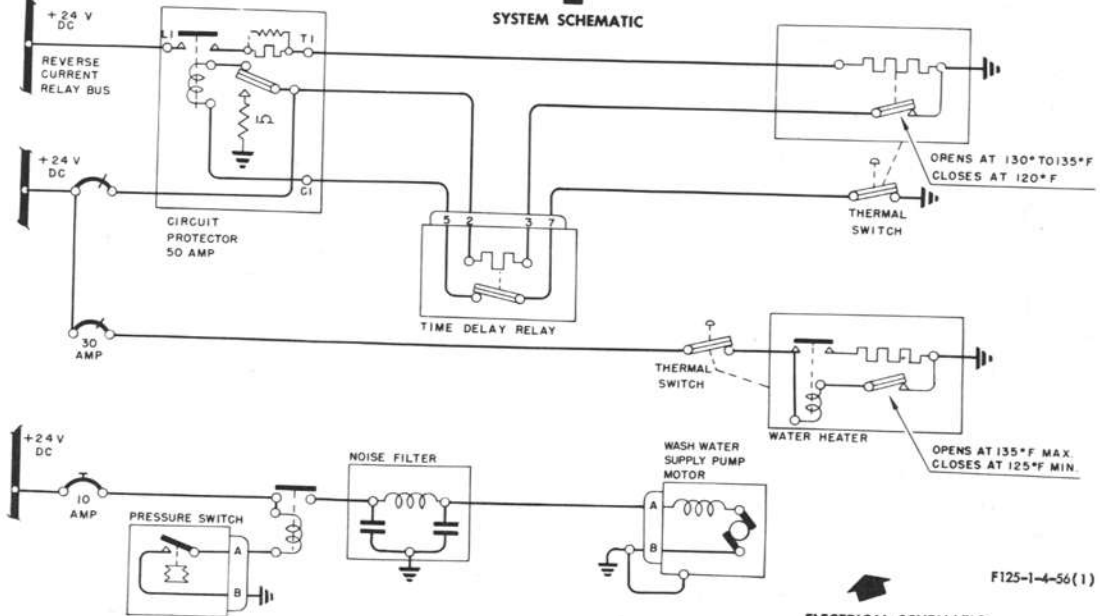

F125-1-4-56(1)

ELECTRICAL SCHEMATIC

Figure 4-32 (Sheet 2)

Upper Berths.

Berth sections are provided that fold down from the side of the fuselage. When they are down they are supported by fittings in the side wall of the fuselage and by rods attached to the ceiling.

Food Locker and Galley.

A food locker and galley is installed forward of the main cabin.

Lavatories and Toilets.

One forward and one aft lavatory compartment is provided. The forward compartment may vary in position depending upon configuration. The aft compartment is equipped with a seat located against the pressure bulkhead. Each lavatory is equipped with mirrors, towel dispensers, holder for air sickness containers, and waste containers.

Drinking Water.

Three six-quart water containers and cup dispensers are located as follows: one in the aft lounge, one in the left hand coat closet, and one in the galley coat closet.

MISCELLANEOUS EQUIPMENT.**Windshield Wipers.**

Electric windshield wipers, controlled by a switch on the glare shield panel (figure 1-18), are provided for the pilot's and copilot's forward windshield panels. Both

wipers are driven through a flexible shaft by a d.c. electric motor mounted on the flight station canopy above the MJB switch panels. Power is derived from the main d.c. bus.

CAUTION

Do not operate windshield wipers on dry glass.

Windshield Wiper Switch.

This five-position switch (figure 4-10) with LOW, MED., HIGH, OFF and PARK., provides d.c. power control from the main d.c. bus to the windshield wiper motor.

ELECTRIC LADDER.

An electric ladder and controls are installed at the main cabin door on some aircraft. Power is derived from the 28-volt d.c. circuit.

ASH TRAY.

An ash tray is provided for each crew member.

LOOSE EQUIPMENT.

The following items are stowed in the navigator's compartment: Maintenance Instruction Manual, miscellaneous Service and Operating Instruction Handbooks.

Note

Jack pads and enroute kits are located in the aft cargo compartment.

SECTION V

OPERATING LIMITATIONS

TABLE OF CONTENTS

	<i>Page</i>
INTRODUCTION	5-1
MINIMUM CREW REQUIREMENTS	5-1
INSTRUMENT MARKINGS	5-1
ENGINE LIMITATIONS	5-1
PROPELLER LIMITATIONS	5-4
AIRSPPEED LIMITATIONS	5-4
PROHIBITED MANEUVERS	5-4
CENTER-OF-GRAVITY LIMITATIONS	5-4
STRUCTURAL LOAD LIMITATIONS	5-4
OTHER LIMITATIONS	5-4
CONFIGURATION AND PERFORMANCE	5-7

INTRODUCTION.

The limitations imposed on the aircraft must be observed during normal operation. Cognizance must be taken of the instrument markings (figure 5-1) since they represent limitations that are not necessarily repeated in the text. Further explanation of the instrument markings is covered in the text under pertinent headings.

Note

Attention is directed to the fact that the airspeeds shown in this flight manual are Indicated Air Speeds (IAS) using the flush-static system, unless otherwise noted. Previous issues of this flight manual contained airspeed limitations in terms of Equivalent Air Speed (EAS), formerly called True Indicated Air Speed (TIAS). Corrections were required to these values in order to obtain IAS. It is considered more desirable to provide the flight crew with airspeeds directly in terms of IAS, so that no mental correction need be made. The limit airspeeds now appearing in Section V have been corrected to IAS and so labeled. It should be clearly understood that the values shown in this issue have not changed the limitations

or airplane capabilities previously shown, but have only corrected these values for position error and adiabatic compressibility. Instrument error, if known, should be applied to obtain exact IAS. (See Part I of the Appendix.)

MINIMUM CREW REQUIREMENTS.

The minimum crew required to operate this aircraft comprises the pilot, copilot, and flight engineer. Additional crew members may be added at the discretion of the commander.

INSTRUMENT MARKINGS.

The limits and interpretation of the markings on the aircraft instruments are shown on figure 5-1.

ENGINE LIMITATIONS.

In addition to the limitations shown on the Instrument Markings Diagram (figure 5-1) and on the Engine Limits and Characteristics Curve (figures A2-1 and A2-2), the following limitations must be observed:

1. Do not make more than two engine supercharger shifts within a 5-minute interval. Reduce engine speed to 1600 rpm and MAP to 20 in. Hg before shifting from low to high blower.

instrument markings

TACHOMETER



- 1400-2400 RPM AUTO/MANUAL LEAN PERMITTED
- 2400 RPM MAX CONTINUOUS (operation above this rpm limited to 2 min.)
- 2800 RPM MAXIMUM

NOTE

REFER TO T.O. 5-1-2
SECTION II FOR METHOD
OF MARKING INSTRUMENTS

CYLINDER HEAD



- 150°-232° C AUTO/MANUAL LEAN PERMITTED
- 232°-246° C AUTO RICH REQUIRED
- 246° C MAX CONTINUOUS (operation above this temperature limited to 2 min.)
- 260° C MAXIMUM

MANIFOLD PRESSURE



- 20-38" HG AUTO/MANUAL LEAN PERMITTED (LO-BLO)
- 38-44" HG AUTO RICH REQUIRED
- 44" HG MAX CONTINUOUS (operation above this pressure limited to 2 min.)
- 51.5" HG TAKE-OFF

FUEL PRESSURE



- 18 PSI MINIMUM FOR FLIGHT
- 24-26 PSI NORMAL
- 35 PSI MAXIMUM

OIL INLET



- 70-85° C CONTINUOUS OPERATION
- 104° C MAXIMUM

ENGINE OIL PRESSURE
(REAR PUMPS)



- 65 PSI MINIMUM FOR FLIGHT
- 65-75 PSI CONTINUOUS OPERATION
- 75 PSI MAXIMUM
- 15 PSI IDLE

NOTE

REFER TO T. O. 5-1-2
SECTION II FOR METHOD
OF MARKING INSTRUMENTS

ENGINE OIL PRESSURE
(FRONT PUMPS)



- 35 PSI MINIMUM FOR FLIGHT
- 35-50 PSI CONTINUOUS OPERATION
- 50 PSI MAXIMUM
- 15 PSI IDLE

CARBURETOR AIR



- 15° TO 38° C CONTINUOUS OPERATION
- 10° TO +15° C DANGER OF ICING
- 38° C MAXIMUM - (danger of detonation)

AIRSPEED



- 275 KTS IAS MAXIMUM GLIDE OR DIVE SPEED
- 230-275 KTS IAS CAUTION (230 KTS IAS MAXIMUM LEVEL FLIGHT SPEED)
- 122 KTS IAS MAXIMUM -WING FLAPS EXTENDED TO APPROACH OR LANDING (LANDING GEAR 145 KTS IAS)

VACUUM



- 3.75" HG MINIMUM
- 3.75-4.25" HG NORMAL
- 4.25" HG MAXIMUM

DE-ICER PRESSURE



- 4-6" HG NORMAL
- 5.5-8 PSI NORMAL
- 10 PSI MAXIMUM

HYDRAULIC PRESSURE



- 1500-1700 PSI NORMAL
- 1850 PSI MAXIMUM

EMERGENCY BRAKE PRESSURE



- 700 PSI ONE BRAKE APPLICATION REMAINING
- 1500-1700 PSI NORMAL
- 1850 PSI MAXIMUM

F125-C1-5-53 (2)

Figure 5-1 (Sheet 2)

2. Do not use HIGH blower for take-off at altitudes below 10,700 feet.

3. The maximum power for auto-lean operation is 1470 BHP in low blower, and 1400 BHP in high blower. Refer to Standard Day Power Available Table in Appendix I.

4. Use manifold pressure required to maintain 1470 BHP in low blower auto-lean, but do not exceed 38 in. Hg. In high blower auto-lean, use manifold pressure required to maintain 1400 BHP but do not exceed 37 in. Hg.

5. Operation at speeds between 2885 and 3100 rpm represents limited overspeed which must be followed by inspection.

6. Operation at speeds greater than maximum permissible power-off diving speed of 3100 rpm must be followed by engine removal.

PROPELLER LIMITATIONS.

There are no limitations or restrictions on the Curtiss C-634S-C460 830-26C4-0 propellers.

AIRSPED LIMITATIONS.

1. Maximum glide or dive speed with de-icer boots installed:

a. Sea level to 17,000 feet:

(1) De-icer boots not operating—275 knots IAS.

(2) De-icer boots operating—255 knots IAS.

b. Reduce airspeed 5 knots for each 1000 feet above 17,000 feet.

2. Design Maneuvering Speed (V_p) — 165 knots IAS.

3. Maximum Level Flight Speed:

a. Sea Level to 16,000 feet — 230 knots IAS.

b. Reduce airspeed 4 knots for each 1000 feet above 16,000 feet.

4. Maximum speed while lowering the landing gear or with the landing gear extended — 145 knots IAS.

5. Maximum speed while lowering the wing flaps or with the wing flaps extended:

a. Take-off flaps 170 knots IAS

b. Approach flaps 122 knots IAS

c. Landing flaps 122 knots IAS

6. Minimum control speed in the air with failure of one outboard engine, with take-off power on the remaining three engines, with wing flaps in the TAKE-OFF position, and with landing gear retracted or extended—85 knots IAS, flush-static system.

7. Minimum take-off climb speed at 80,000 pounds—94 knots IAS, flush-static system.

8. Maximum speed with landing light extended—130 knots IAS, flush-static system.

PROHIBITED MANEUVERS.

The aircraft is restricted to normal flight maneuvers. No aerobatics are permitted.

CENTER OF GRAVITY LIMITATIONS.

Refer to the Airplane Handbook of Weight and Balance, T.O.-01-1B-40.

STRUCTURAL LOAD LIMITATIONS.

FUEL MANAGEMENT CONSIDERATIONS.

Recommended fuel loading and management procedures must be used if the restrictions imposed by use of the Weight Limitations Chart are to reflect true structural capabilities. The fuel loading and management procedures shown in Section VII take maximum advantage of fuel weight and distribution to relieve wing bending moments. Minimum fuel requirements must be observed. Improper fuel management procedures which violate this restriction, at best cause an increase in the wing operating stress level. At worst, structural damage of the wing in flight may occur at load factors which would be permissible under the proper fuel management.

FLIGHT CONTROL PRECAUTIONS.

Although the control forces for transport aircraft are, in general, heavier than in some other types, it is still possible to apply severe structural loads by rapid and violent application, or sudden release or reversal of forces on any of the three control systems. It is within the pilot's physical power to cause failure of some components of the airframe structure, particularly when flying at high speeds. A rapid release or reversal of rudder force can result in heavy loads on the vertical fins and aft fuselage and should, therefore, be avoided.

OTHER LIMITATIONS.

CABIN PRESSURIZATION LIMITATION.

Cabin pressurization is not permitted during take-off and landing. Maximum cabin differential is 8.25 in. Hg.

FUEL DUMPING LIMITATIONS.

Do not dump fuel with the gear or flaps down, or at speeds below 135 knots IAS or above 185 knots IAS, flush-static system. Do not fire pyrotechnic pistol while dumping fuel. Turn off auxiliary power plant.

WEIGHT LIMITATIONS.

Weight limits have been provided here to show operational capabilities and restrictions which must be observed due to structural and performance considerations. Their proper use will assure maximum utilization of the aircraft as well as extend the life of its structural components. Overloading or improper weight distribution results in penalties in performance and can result in structural damage or failure. Factors which govern weight limitations, as applied to this aircraft, are discussed in the succeeding paragraphs.

Weight and Loads.

The total weight an aircraft must sustain is composed of the basic operating weight of the aircraft plus the crew, fuel, oil, cargo and any additional equipment. Additional loads are frequently imposed on the structure during flight which result from operation in turbulent air or from maneuvering of the aircraft. These loads have been considered in the design of the aircraft and will not exceed the limit strength of the structure in normal operation. However, if these loads were imposed with the aircraft in an overweight condition, the limit strength of the supporting structure might be exceeded and damage or failure could result. The maximum weight which the aircraft can safely carry depends upon the distribution of the weight throughout the aircraft, its capacity to sustain airloads in accelerated flight, and its available performance under the existing flight conditions. Fuel and cargo must be carried in accordance with recommended procedures if maximum structural capability is to be maintained.

Load Factors.

A load factor is the ratio of the load imposed on the aircraft (when accelerated in any direction) relative to the weight of the aircraft. The load factor is indicative of the magnitude of the forces acting on the aircraft due to such accelerations, and may occur because of sudden changes in air currents or by manipulation of the controls or due to loads imposed during ground handling. The load resulting from these forces is expressed in terms of "g's" and is the ratio of forces acting on the structure to the airplane weight. For example, if a 100,000 pound airplane underwent an acceleration of 3.0 g's at some given moment, the wings would have to sustain approximately three times the load on the wings in 1 "g" level flight, or 300,000 pounds.

Margin of Safety.

The margin of safety of an airplane part in a given design condition is defined as the amount by which its strength exceeds its design loading in that condition. In actual operation of the aircraft, the margin of safety becomes the difference between the load carried by the airplane structure at a particular instant and the load at which structural damage would occur.

Explanation of Weight Limitations Chart.

The gross weight limitation chart (figure 5-2), is intended to represent graphically the weight carrying capabilities of all C-121A aircraft. Use of the chart will aid the flight planner in recognizing the weight limitations within which he can conduct a specific mission.

Note

Although the chart indicates the limitations applicable to a specific loading of the aircraft, the authority for operating the aircraft at a given gross weight remains the responsibility of the commander.

Gross Weights.

The data in this chart are referenced to a basic operating weight, exclusive of fuel and cargo, of 70,000 pounds. This value is an arbitrary weight which approximates the aircraft basic weight shown on Chart "C" of T.O. 1-1B-40, Handbook of Weight and Balance Data, plus standard crew and full oil capacities. Individual aircraft weights vary because of differences in equipment weights. Therefore it may be necessary to adjust the chart for variations in basic operating weight before use.

The basic operating weight is represented on the chart by the intersection of the vertical and horizontal axes where the fuel load and cargo load are zero. The diagonal gross weight lines show combinations of fuel load and cargo load that can be used to make up a given permissible gross weight. Normal take-off and landing gross weights are listed, as are weights where performance or structural considerations may limit operations. The load factor lines represent the combinations of fuel and cargo load at which the "limit" wing strength allows a given load factor when *FUEL AND CARGO ARE LOADED ACCORDING TO RECOMMENDED PROCEDURE*.

Design Load Factors.

The design load factor is 2.5 g's. The airplane will normally be loaded and flown so that maneuvering or gusts or combinations of both will not cause load factors in excess of 2.5 g's to be experienced. The strength capabilities of the airplane in flight can support limit loads due to a 2.5 g maneuver without detrimental or permanent deformation. Any deformation which might occur will not interfere with safe operation of the airplane. The structure is also designed to ultimate loads obtained by applying a 1.5 factor of safety to limit loads, and is capable of supporting ultimate loads without failure of the primary structure.

Wing Fuel Load.

The ability of the wing to safely withstand the imposed airloads is allied not only with the weight of the wing fuel present, but also with the distribution of the fuel along the span. Therefore, it is important to adhere to fuel loading and consumption schedules recommended in Section VII.

GROSS WEIGHT LIMITATIONS

MODEL: C-121A

ENGINES: (4) R3350-75

PROPS: CURTISS C460/830-26C4-0

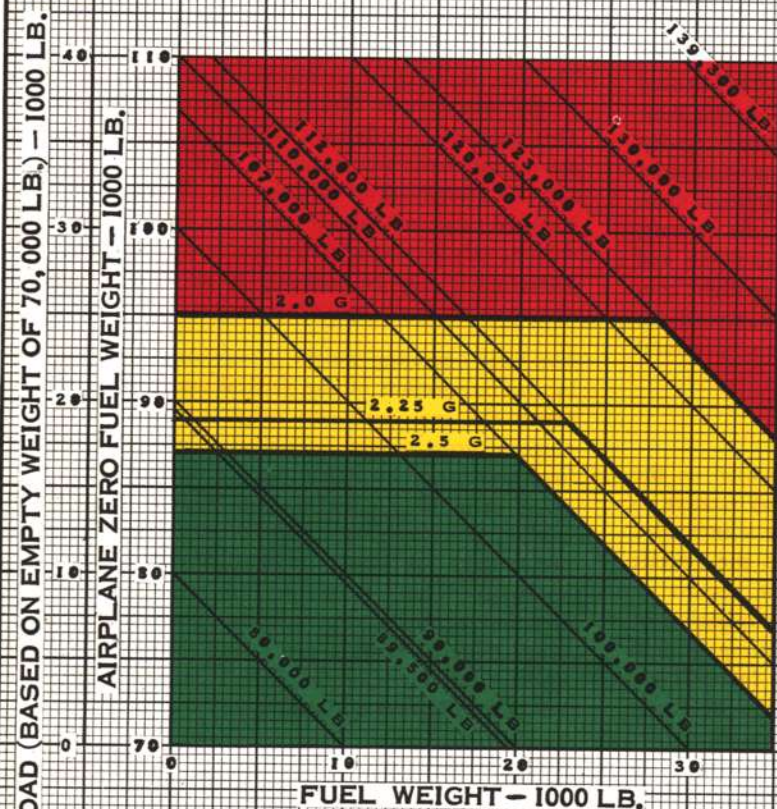

- 70,000 LB.**
BASIC OPERATING WEIGHT.
- 89,500 LB.**
DESIGN LANDING WEIGHT FOR 10 FT./SEC. SINKING SPEED.
- 107,000 LB.**
DESIGN GROSS WEIGHT FOR LOAD FACTOR OF 2.5 G.
- 112,000 LB.**
MAXIMUM GROSS WEIGHT FOR LOAD FACTOR OF 2.25 G.
- 139,300 LB.**
10,000 FT. TAKE-OFF DISTANCE TO A 50 FT. HEIGHT AT SEA LEVEL, HOT DAY.
- 149,000 LB.**
500 FT./MIN. RATE OF CLIMB, SEA LEVEL, STD. DAY, GEAR UP, FLAPS UP, METO POWER ON FOUR ENGINES.
- 151,000 LB.**
8,000 FT. TAKE-OFF GROUND RUN DISTANCE AT SEA LEVEL, STANDARD DAY.
- 158,000 LB.**
100 FT./MIN. RATE OF CLIMB, SEA LEVEL, HOT DAY, ONE PROP FEATHERED, GEAR UP, WING FLAPS 60%, MAXIMUM POWER.
- 164,500 LB.**
100 FT./MIN. RATE OF CLIMB, AT SEA LEVEL, STD. DAY, CLEAN CONFIGURATION, MAX. POWER ON THREE ENGINES, NO. 1 PROP FEATHERED.

NOTE: INCREASED CARE SHOULD BE EXERCISED IN TAXIING, BRAKING, TURNING AND OTHER GROUND HANDLING OPERATIONS, AT GROSS WEIGHTS IN EXCESS OF 107,000 POUNDS, TO AVOID EXCEEDING GEAR STRENGTH.

SINKING SPEED MUST BE LESS THAN 10 FT. PER SEC. WHEN OPERATING IN THE CAUTIONARY RANGE, WHERE ZERO FUEL WEIGHTS SHOWN WILL LEAD TO LANDING WEIGHTS IN EXCESS OF 89,500 POUNDS.

CAREFUL ADHERENCE TO ROUGH AIR PENETRATION SPEEDS IS RECOMMENDED WHEN OPERATING AT AIRPLANE WEIGHTS IN THE CAUTIONARY RANGE.

THESE CAPABILITIES ARE BASED ON FUEL USAGE CONFORMING TO THE MINIMUM FUEL FOR FLIGHT REQUIREMENTS SHOWN IN SECTION V.

Figure 5-2

Cargo Load.

Range and rate of fuel consumption determine the quantity of fuel which must be carried for any mission, and indirectly, the amount of cargo which can be transported. Cargo loading is variable within the limits established by the strength and performance of the aircraft with the necessary fuel for the mission established. Since empty equipped weight varies, it may be necessary to adjust cargo load values read from the curve before application.

Wing Limitations.

Lines showing wing strength in terms of aircraft flight load factors for combinations of fuel and payload are shown for 2.0, 2.25, and 2.5 g's. Aircraft utilizing combinations of payload and fuel which reduce the allowable load factor to less than 2.5 g's should be flown with caution, especially when making turns and pull-outs and when operating in turbulent air. In addition to the instructions noted under the paragraph titled "LOADING NOT RECOMMENDED", *THE AIRCRAFT SHOULD NEVER BE LOADED WITH ANY COMBINATION OF PAYLOAD AND FUEL WHICH REDUCES THE LOAD FACTOR BELOW 2.0 G's, BECAUSE OF THE HIGH PROBABILITY OF INCURRING STRUCTURAL DAMAGE TO THE WING.*

Landing Gear and Braking Limitations.

The airplane design landing weight is 89,500 pounds for a design limit sinking speed of 10 feet per second. The landing gear and associated structure are of required strength for normal taxiing and ground handling at take-off weights up to 107,000 pounds. Increased care should be exercised during taxiing, braking, turning and other ground handling operations at heavier weights. Braking capability meets specification performance requirements. It should be possible to make at least 100 normal stops without reverse thrust at an 89,500 pound landing weight without brake difficulty (provided brakes are cooled properly on the ground or in the air between landings). Brake wear at heavier landing weights will be increased unless the assistance of reverse thrust is used properly. The Bendix brakes are capable of bringing the airplane to an emergency stop from normal take-off speed at a weight of 107,000 pounds without the assistance of reverse propeller thrust. The maximum permissible take-off weight of the C-121A, as limited by brake capacity, is estimated to be as follows: without reverse thrust 129,400 lbs.; with two propellers in full reverse 138,000 lbs.

Performance Limitations.

Structural limitations rather than performance requirements generally limit the weight carrying capabilities

of a four engine airplane. The most severe normal performance requirement is met at a weight of 139,300 lb. At this weight, the airplane will take off and climb fifty feet within a distance of 10,000 feet at sea level on a hot day. Higher weights are listed on the Weight Limitations chart for less severe performance requirements. However, this chart is to be used only as a guide with respect to performance available. Refer to the appendix for detailed performance information. Local operating conditions may limit allowable weights more severely than is indicated by the Weight Limitations Chart.

CONFIGURATION AND PERFORMANCE.

The configuration of the airplane may impose a penalty on performance. An increase in drag over that for the cruise configuration decreases the rate of climb available, increases the power required and may require a readjustment of the permissible operating gross weight. As with power losses, increases in drag are most critical at take-off when, of necessity, the landing gear is extended, the cowl flaps are 50% and the wing flaps are 60% extended. The effect of the drag produced is indicated on the Weight Limitations Chart by the gross weights at which minimum performance requirements are met with various airplane configurations.

Recommended Loading Area.

The green area of the chart represents the loading conditions that present no particular problem in regard to strength or performance of the airplane. Operation of the airplane at weights outside of this recommended loading area should be avoided unless the mission requires it.

Cautionary Loading Area.

The yellow area on the chart represents loadings of progressively decreasing margin of safety as the red area is approached. An aircraft may reasonably be expected to encounter a load factor of 2.5 g's at times because of either maneuvering or turbulence. Also, performance may become critical in the upper region of this area depending upon aircraft configurations and atmospheric conditions. Careful adherence to rough air penetration speeds is recommended when operating at airplane weights in the cautionary range. In a particular emergency, landings at airplane weights in excess of normal landing weights are practicable on the condition that the pilot exercise ordinary care and precaution during the approach and landing. The glide path should be planned for decremental power changes from the start of the final approach to the landing. Rapid power changes should be held to a minimum during the approach and a small amount of engine power should

be kept in reserve until after the landing flare. Every effort should be made to achieve minimum rate of descent on landing.

Loading Not Recommended.

Note

Whenever flights are conducted at weights shown in the red area of the chart, entry of this fact in AF Form 781 is required.

The red area represents loadings which are not recommended because of the reduced margin of safety available from the standpoint of both performance and structural limitations. Under conditions of extreme emergency, the commander will determine if the degree of risk warrants operation of the airplane at gross weights appearing in the red zone.

Sample Use of Weight Limitations Chart.

Example 1.

Assume a mission requires a 12,500 pound payload and a 24,000 pound fuel load (of which 2,000 pounds is the reserve allowance). Calculate the gross weight to be:

Basic Operating Weight	— 70,500 lbs.
Payload	— 12,500 lbs.
Fuel Load	— 24,000 lbs.
	Total—107,000 lbs.

The weight limitations curve can only be used directly for a basic operating weight of 70,000 lbs. since its entire construction is based on this value. Any other value (as in example 1) must be adjusted to 70,000 pounds before entering the curve. This step may be accomplished by subtracting 70,000 lbs. from the basic operating weight for the problem and adding the difference to the problem payload value. The solution for example 1 would be as follows:

Example 1 Basic Operating Weight	— 70,500 lbs.
Curve Basic Operating Weight	— 70,000 lbs.
	Difference— 500 lbs.

The problem payload now becomes 12,500 plus 500, or 13,000 pounds.

Recalculate the loaded gross weight.

Adjusted Basic Operating Weight	— 70,000 lbs.
Payload + Weight Adjustment	— 13,000 lbs.
Fuel Load	— 24,000 lbs.
	Total—107,000 lbs.

Enter the weight limitations curve at "0", which represents the basic operating weight of 70,000 pounds, and proceed horizontally along the fuel load line of

24,000 pounds. Move vertically along this line to 13,000 pounds payload. Find the loaded gross weight by interpolation to be 107,000 pounds; which checks the initial calculation. This initial operating point falls in the green area and the planned landing weight (with reserve fuel included) is less than 89,500 pounds.

Example 2.

Using the same conditions as example 1, assume the basic operating weight is found to be 71,000 pounds rather than 70,500 pounds. Also, weather information indicates a headwind will be encountered which will increase the fuel load by 1,000 pounds. The following conditions are now present:

Basic Operating Weight	— 71,000 lbs.
Payload	— 13,000 lbs.
Fuel Load	— 25,000 lbs.
	Total—109,000 lbs.

As in example 1, the basic operating weight for the problem must be adjusted to 70,000 pounds before entering the weight limitations curve. This adjustment is made, as before, by adding the difference of the two basic operating weights to the payload value as follows:

Example 2 Basic Operating Weight	— 71,000 lbs.
Adjusted Basic Operating Weight	— 70,000 lbs.
	Difference— 1,000 lbs.

The payload plus weight adjustment value now becomes $13,000 + 1,000$ or 14,000 pounds. Enter the curve as in the previous example with the 25,000 pound fuel load value and the 14,000 pound payload value. Read the loaded weight to be 109,000 pounds, which checks the initial calculation. The point falls in the cautionary area. Since an overload flight has not been authorized, and a fuel load of 25,000 pounds is mandatory for the flight, the payload must be reduced. Drop vertically from the point for the initial weight (109,000 lbs.) to intersection of the 2.5 g line. Proceed to the left to the payload scale and read the maximum payload plus weight adjustment value for the flight to be 12,000 pounds. (It must be remembered at this time that 1,000 pounds of alternate load, $(71,000 - 70,000 = 1,000)$, had been considered as payload.) The payload now becomes $12,000 - 1,000 = 11,000$ pounds. A final check should now be made.

Basic Operating Weight	— 71,000 lbs.
Payload	— 11,000 lbs.
Fuel Load	— 25,000 lbs.
	Total—107,000 lbs.

The point now falls in the green area and the planned landing weight (reserve included) is less than 89,500 pounds.

SECTION VI

FLIGHT CHARACTERISTICS

TABLE OF CONTENTS

	<i>Page</i>
FLIGHT CHARACTERISTICS	6-1
STALL CHARACTERISTICS	6-1
SPIN CHARACTERISTICS	6-3
FLIGHT CONTROLS	6-3
LEVEL FLIGHT CHARACTERISTICS	6-4
MANEUVERING FLIGHT	6-4
DIVING	6-4

FLIGHT CHARACTERISTICS.

In order to perform their primary mission efficiently, aircraft in the transport category are designed to withstand lower load factors than are some other types, such as attack bombers and fighters which require greater maneuverability. To reduce the possibility of inadvertently applying structural loads greater than those for which they are designed, transports have a very high degree of stability. Because of this stability, the control forces necessary to perform maneuvers are somewhat greater than those required on other types. This aircraft exhibits no flight characteristics that would tend to place the pilot in a difficult situation. It has been flown during various weather conditions including thunderstorms, gusty crosswind landings, and severe icing.

General performance and flight characteristics under such conditions have been described as good by operating service personnel. Its handling qualities are normal in every respect. Control response under typical flight conditions and with asymmetrical power is considered excellent.

STALL CHARACTERISTICS.

The stall characteristics of this aircraft, with any combination of wing flap or landing gear positions, are excellent and the stall is preceded by adequate warning in the form of mild buffeting. There is no abnormal tendency for a wing to drop and aileron and rudder controls are effective up to and into the actual stall. With a forward center of gravity, the control forces

STALL SPEED CURVE

MODEL: C-121A

ENGINES: (4) R3350-75

PROPS: CURTISS C460/830-26C4-0

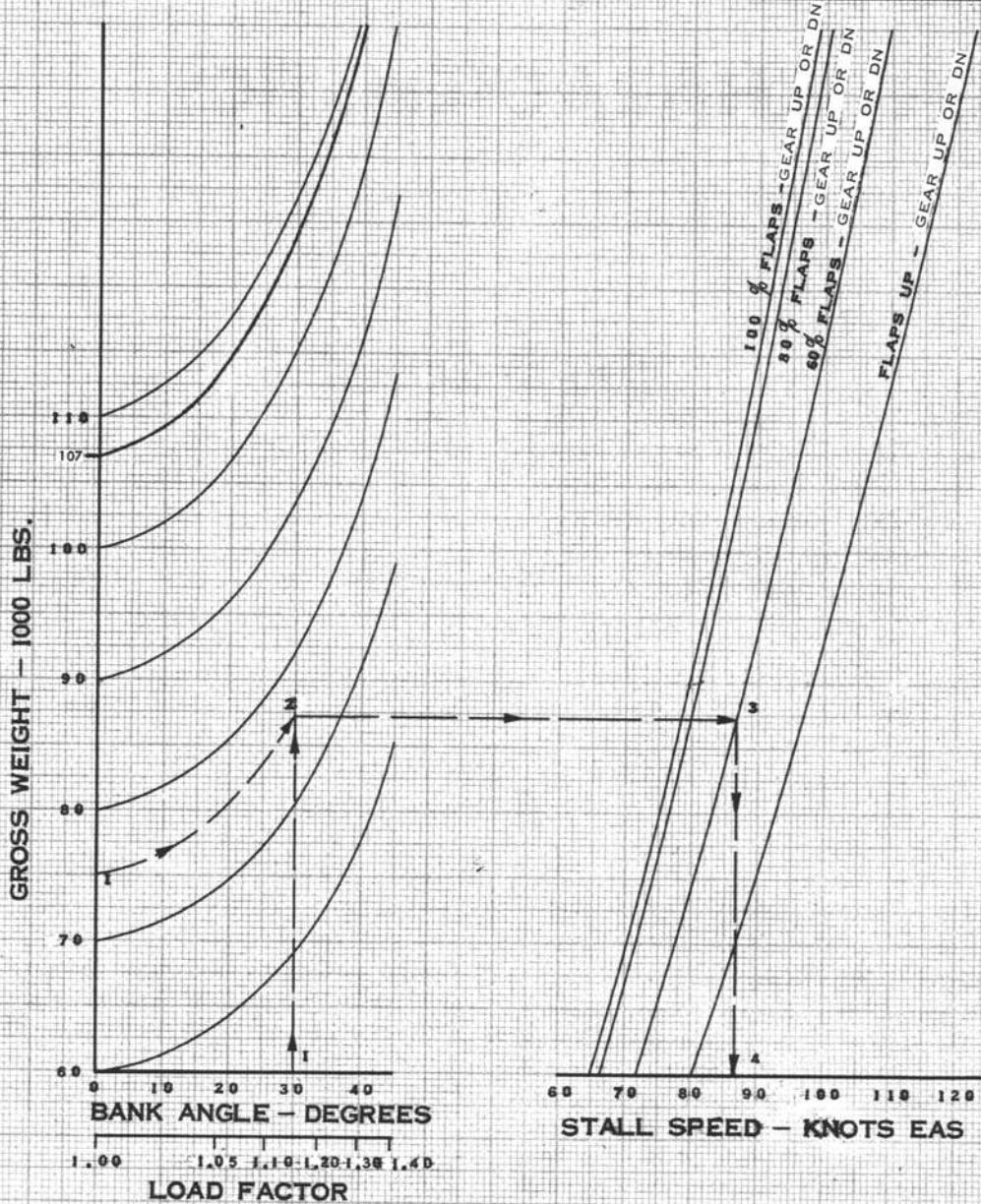

NOTE:

1. LOAD FACTORS ARE FOR COORDINATED TURNS AT CONSTANT ALTITUDES WITH BANK ANGLE NOTED.
2. STALL SPEEDS ARE THOSE WITH PROPS SET AT LOW PITCH, ENGINE POWER AT ZERO THRUST AT 118% V - STALL, DECELERATION = -1 KNOT / SEC. FROM CONTRATORS 749A FLIGHT TESTS.

Figure 6-1

that are necessary to slow the aircraft down to the stall speed will be fairly heavy and will increase as speed is reduced. At the stall a pronounced nose-down pitch will occur; however, if the center of gravity is moved near the aft limit, the forces that are necessary to accomplish the stall will be greatly reduced and this nose-down pitching tendency at the stall will also be reduced. With increased power the stall occurs at a more pronounced nose-up attitude, at a lower speed, with a slight increase in rolling tendency and with a reduction in stall warning. The stall speeds for three gross weights and angles of bank, with the airplane in three configurations are given on figure 6-1. Accelerated stalls are similar to the level flight unaccelerated stalls, except that the warning margin, normally 3 to 5 knots above the stall, is somewhat reduced. During progressive stalls (one stall immediately following another), no change occurs in the stall characteristics with each succeeding stall. However, if only a partial recovery is effected between stalls, a considerable increase in rolling tendency and buffeting will result. The technique for recovering from stalls of any nature is to move the control column forward and apply power and whatever aileron and rudder control is necessary to keep the wings level.

SPIN CHARACTERISTICS.

WARNING

Intentional spins with this aircraft are prohibited.

No spin tests have been conducted with Constellation aircraft. If a spin is inadvertently entered, it is felt that a normal spin recovery method consisting of the application of opposite rudder followed by the forward movement of the wheel, would accomplish recovery. However, it is recommended that the control column not to be pushed forward of its neutral position, as excessive build-up in speed might result. Avoid excessive back pressure on the wheel during the pull-out after recovery.

FLIGHT CONTROLS.

The aileron, elevator, and rudder control systems are conventional in every respect except that they are partially powered by means of hydraulic booster units. Since these booster units do not completely accomplish the movement of the surfaces but merely assist in this movement, "feel" of the controls is retained by the pilot. To maintain this "feel" and to prevent overcontrolling,

the booster units are designed to provide low boost ratios for small control force applications, and to increase boost ratios as the applied control force is increased. The possibility of the booster units becoming inoperative is rather remote because the boosters can be operated by either the primary or secondary hydraulic system. If both of these systems fail, the auxiliary booster systems will still provide hydraulic pressure to the rudder and elevator booster units. In the event that all boosters are inoperative, which is highly unlikely, the aircraft still can be adequately controlled, provided that the center of gravity is between 23 and 30% MAC. The control forces will, of course, be quite heavy and the emergency manual elevator shift control should be pulled out to reduce the forces on the control wheel. This reduction in force is accomplished by a change in mechanical ratio and results in a corresponding reduction in the available elevator travel. Rudder and aileron boost should also be turned off.

TRIM DEVICES.

All control systems are equipped with conventional trim tabs which are mechanically operated. The elevator tabs can also be operated electrically by means of the control button on the pilot's control wheel. The electric elevator trim system is particularly useful during boost-out landings because trim corrections can be applied rapidly, if necessary, without releasing the control wheel with either hand. The electric tab, however, should never be used during high speed flight, because its rapid movement applies rather severe loads on the structure in this flight condition.

FLIGHT CONTROL PRECAUTIONS.

Although the control forces in transport aircraft are, in general, heavier than in some other types, it is still possible to apply severe structural loads by a rapid and violent application, sudden release, or reversal of force on any of the three control systems. It is within the pilot's physical power to cause failure of some components of the airframe structure, particularly when flying at high speeds. A rapid release or reversal of rudder force can result in heavy loads on the vertical fins and aft fuselage, and should, therefore, be avoided. Boosters should never be turned on at high speeds, or at any speed if the aircraft is out of trim. This will result in a rapid and severe application or release of forces on any system in which the boost is turned either off or on. In an emergency, the boost may be turned off at any airspeed. If conditions permit, however, airspeed should be maintained between 130 and 156 knots during the change-over. Normal cruising speed schedules may be re-established with boost off; however, an increase in control forces should be expected.

If the auto-pilot is engaged during boost-off operation, the flight crew should monitor airplane attitude continually and more carefully than during normal operation, particularly during flight through turbulent areas. If gusts cause deviations from the trimmed attitude, the auto-pilot might become stalled due to increased air loads on the controls, so that action by the crew may be required to effect recovery. Cross wind landing characteristics are excellent; however, airspeeds above 115 knots may be desirable in the approach if gusty conditions exist in order to maintain desired margins of aileron control response rate.

LEVEL FLIGHT CHARACTERISTICS.

SLOW FLYING.

Extensive test flights of civilian and military versions of the Constellation aircraft indicate that the C-121A is stable throughout its speed range and, therefore, can be flown from its maximum placard speed to the stall speed without reversals or abnormal variations of control force. However, as is true of any aircraft, excellent piloting technique and smooth air are required to maintain steady speeds when power is reduced approximately to the minimum for level flight. Wing flaps may be lowered to TAKE-OFF position for slow flight in order to improve maneuverability and lower the stall speed. Before retracting the flaps, altitude and airspeed should be considered: if low, apply power and increase airspeed in order to prevent a stall or loss of altitude.

CRUISING FLIGHT.

The basic mission of this type aircraft involves long periods of flying at cruise power settings; it is for these conditions that the aircraft was designed and is most effective. Patience and skill on the part of the flight crew will result in optimum aircraft performance. Adequate data are presented in Appendix I of this handbook to permit preparation of a wide variety of flight plans. It is suggested, however, that the pilot consider the use of the following techniques in order to obtain optimum performance from the aircraft.

1. When entering a cruise condition from a climb speed which is below that desired for level flight, main-

tain climb power after leveling off until the desired cruise speed is attained, then reduce to the desired cruising power. Airspeed will tend to increase thereafter as fuel is consumed if cruising power is held constant. The increase in speed relative to the decrease in weight lessens as light weights are approached.

2. Flight characteristics in turbulent air are favorable although, as would be expected, the average airspeed will tend to be less than for the same power setting in calm air. Some loss of range results. If the particular mission during this period involves remaining in flight for a maximum period of time, no change of power setting is necessary as duration is not affected by turbulence. If range is the primary consideration, the pilot will find that a slight increase in power will result in a more stable speed. The increase should be determined for the specific conditions existing by inspection of fuel economy data in Appendix I.

HIGH SPEED FLIGHT.

In general, high speed flight will be normal in all respects: that is, no compressibility effects will be noted at speeds up to the placard dive speed.

MANEUVERING FLIGHT.

The maneuvering flight characteristics are normal in every respect. No reversals or abnormal variations of control forces will be encountered.

DIVING.

In general, it is not necessary to observe any special precautions when diving other than to observe the limit speeds and structural load factors described in Section V of this handbook. Under these conditions, no high-speed compressibility effects will be encountered. The aircraft should be retrimmed manually with speed changes in the normal manner. Use of the electric elevator trim system is not recommended while diving. When recovering from a dive attitude, the aircraft should be pulled out manually without changing trim. Excessive or rapid application of control forces in the recovery should be avoided to preclude structural damage to the aircraft.

SECTION VII

SYSTEMS OPERATION

TABLE OF CONTENTS

	<i>Page</i>
ENGINES	7-1
ENGINE SUPERCHARGER SHIFT	7-2
IGNITION ANALYZER OPERATION	7-2
FUEL SYSTEM	7-4
FILLING HYDRAULIC RESERVOIR IN FLIGHT	7-5
USE OF LANDING WHEEL BRAKES	7-6
INTEGRATED FLIGHT SYSTEM	7-7
FLIGHT PLANNING FUEL CONSUMPTION TABLES	7-12

ENGINES.

RPM AND MANIFOLD SETTINGS FOR LOW POWER CONDITIONS.

During descents and other low-power maneuvers, including simulated engine failures, operation at high rpm and low manifold pressure should be kept to a minimum. High inertia loads on the master rod bearings will occur during these conditions. Each hundred rpm requires at least one inch Hg. manifold pressure.

PROCEDURE IN THE EVENT THE RUN-UP INDICATES PLUG FOULING.

Spark plug fouling is an ever present problem. Importance of this subject has multiplied as engine power and allowable manifold pressure have increased. When modern engines are operated at high power settings, spark plugs with a heat transfer rating capable of con-

ducting the heat away from the electrodes fast enough to prevent pre-ignition must be used. This good heat transfer rating makes the spark plug run cold when the engine is operated at low power, allowing the plug to foul easily. An excessively rich idle mixture aggravates this situation during ground operation. The majority of fouled plugs are caused by an improperly set idle mixture which allows a gummy residue to form on the plugs. During the run-up and magneto check, this deposit prevents the spark from jumping across the air gap in the plug and the plug does not fire, causing excessive rpm drop during the magneto check. Whenever excessive rpm drop is encountered during magneto check, the following clean-out procedure should be used.

NORMAL PLUG CLEAN-OUT PROCEDURE.

In the event of prolonged ground operation, the following procedures are recommended to clear out fouled spark plugs:

1. Cowl flap switches—OPEN.
2. Propeller synchronizer lever—Full INC RPM.
3. RPM—800 to 1200.
4. Mixture levers—lean until best-power is obtained. There is no time limit for this operation; however, it is recommended that the cylinder head temperature not exceed 200° C.

Note

At 800 rpm the spark is about as hot or strong as when using 30 in. Hg manifold pressure, but the pressure in the cylinder is much less, due to the lower manifold pressure. Therefore, the spark can more easily jump the air gap. As the plug begins to fire, it will tend to remove the deposit already formed and thereby clean itself. The engine should be run in this condition for one to three minutes. A magneto check can now be made and no excessive rpm drop due to plug fouling should occur.

ENGINE SUPERCHARGER SHIFT.

If a climb is to be made to a high cruising altitude and an engine supercharger shift is required to maintain adequate climb power, shift to high blower in the following manner:

1. Reduce manifold pressure to 20 in. Hg.
2. Reduce engine speed to 1600 rpm.
3. Shift supercharger lever to HIGH position. (Make all shifts as smoothly and rapidly as possible.)
4. After manifold pressure increases, indicating the shift has been made, reset throttles and propellers to obtain the required climb power.

Note

The shift to HIGH position during climb-cruise power should be made at the altitude at which the low-blower, full-throttle BMEP has decreased to the high-blower, part-throttle BMEP value.

WARNING

Do not exceed low blower limits, Append. I, and do not make more than two shifts within a five minute interval or the engine may be damaged. A shift from high to low blower may be done at any engine speed.

IGNITION ANALYZER OPERATION.

(Figure 1-3).

Note

Ignition analysis is recommended prior to take-off. This analysis should be made after the magneto check and with engine speed at the magneto check rpm. The cycle switch should be set on slow sweep position.

1. Turn on the amplifier power supply and allow the amplifier and the cathode-ray tube to warm up.

2. Set the index on the inner dial of the condition switch to the L index near the number 1 engine beneath the general caption IGNITION on the fixed ring.

3. Set the index labeled IGN on the inner dial of the cycle switch against the number 1 on the fixed ring. This setting, supplementing that of the condition switch, will present the pattern of the No. 1 cylinder, left magneto, of the No. 1 engine on the indicator, followed by the pattern of the No. 12 cylinder, which is next in firing order.

Note

With the push-pull knob in the "pulled-out" position and with the switches set as indicated above, the indicator will portray all the ignition patterns associated with the left magneto, beginning with No. 1 cylinder.

4. Push the push-pull knob in and set the dial index of the condition switch to B, near the number 1 beneath the general caption IGNITION. Maintain IGN against 1 on the cycle switch. The pattern on the indicator will portray the functioning of both magnetos and both spark plugs for cylinders 1 and 12. This setting is used for checking magneto synchronization. Number 2 ignition points are timed to number 2 cylinder. For an accurate synchronization check, use cylinders number 1 and 2.

5. For study of the individual ignition patterns or all the ignition patterns of engines No. 2, 3, or 4, the same settings of the cycle switch as for engine No. 1 are used, but the condition switch must be switched to L, B, and R adjacent to the numerals 2, 3, and 4, respectively.

6. For engine speed synchronization check, set the dial index of the condition switch against the index 2 under the caption SYN on the fixed ring. This setting establishes the electrical connection for the comparison of speed of engine No. 2 to that of engine No. 1. The push-pull knob should preferably be in the "pushed-in" position. To compare the speeds of engines No. 3 and 4 to engine No. 1, set the dial index on the condition switch to 3 and 4 within the captioned SYN segment of the outer ring.

required operational minimum fuel loading

MAXIMUM TAKE-OFF 107,000 LBS.
MAXIMUM LANDING 89,500 LBS.
MAXIMUM ZERO FUEL 86,464 LBS.
BASED ON CHR REQUIREMENTS
MODEL 749A WITH SB545

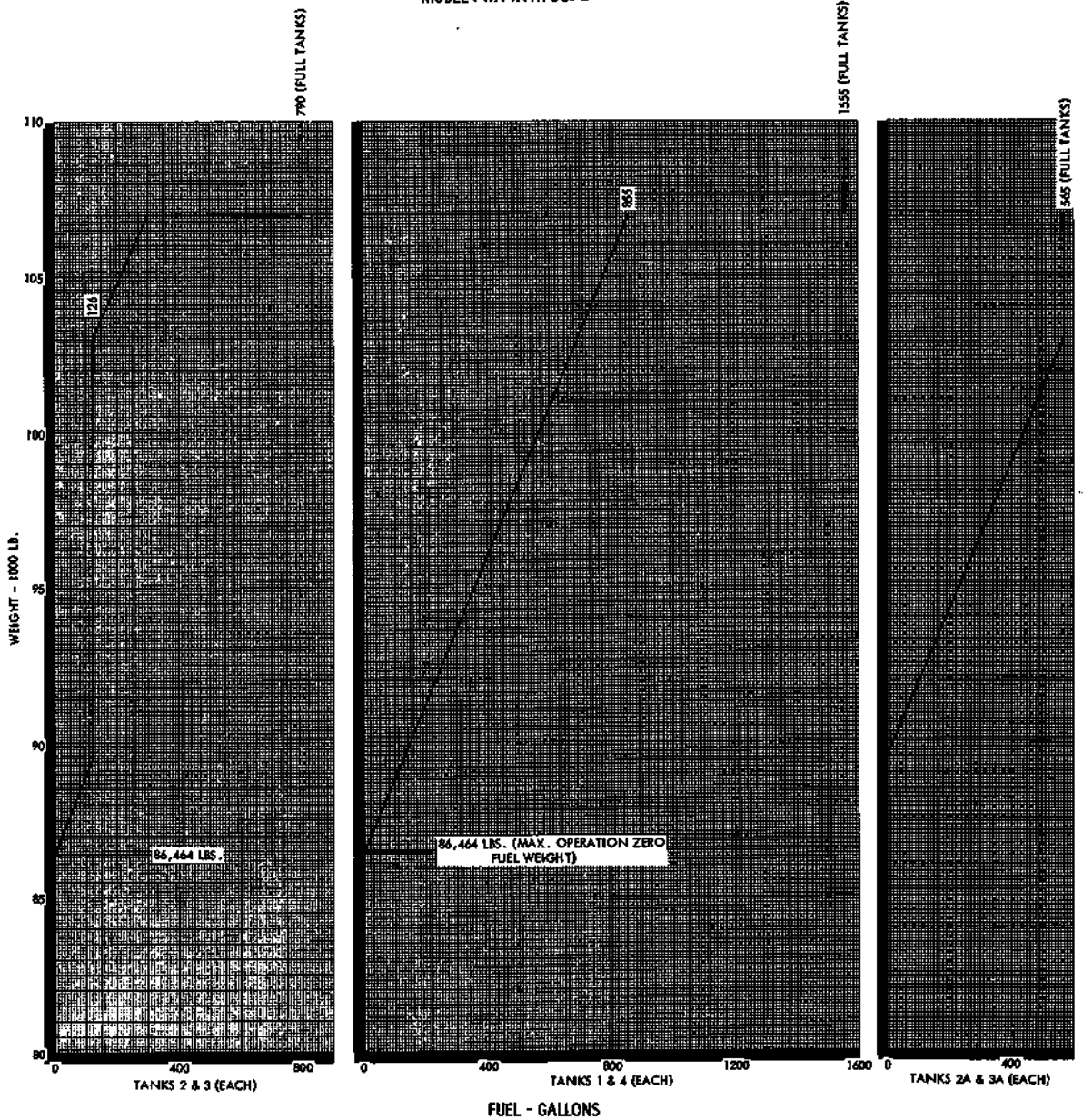

H19-67-44

Figure 7-1

Note

When making the engine synchronization check, the position of the cycle switch is of no importance.

FUEL SYSTEM.

FUEL SYSTEM MANAGEMENT.

At a maximum gross operating weight of 107,000 pounds, this aircraft uses tanks 1, 2, 3, and 4 for take-off and landing. When no fuel is carried in the auxiliary tanks and the fuel in the inboard and outboard tanks is equally distributed, operate the engines from their respective tanks. When fuel is carried in the auxiliary tanks and/or there is more fuel in the outboard tanks than there is in the inboard tanks, the auxiliary tanks must be emptied and the inboard and outboard tanks equalized. The following procedure is recommended for fuel system operation:

1. Use fuel from tanks 1, 2, 3, and 4 direct to engine until the gross weight is reduced to 103,000 pounds.
2. Use fuel from tanks 1, 2A, 3A, and 4 direct to engine until tanks 2A and 3A are empty.
3. If fuel quantities in tanks 1, 2, 3, and 4 are not now equal, crossfeed from 1 and 4 until quantities are equalized.
4. Then use fuel from tanks 1, 2, 3, and 4 direct to engine.

Although it is desirable to reduce the fuel load in tanks 2A and 3A as quickly as possible because of structural landing restrictions with fuel in these tanks, care must be used to assure that the flight structural requirements of fuel distribution are met at all times. The fuel load in tanks 2A and 3A should never exceed 600 pounds per tank for landing, and should be empty if tanks 1 and 4 exceed 7,200 pounds per tank during landing. The amount of fuel in main tanks 2 and 3 should never exceed the amount of fuel in main tanks 1 and 4, respectively.

REFUELING WITH PASSENGERS ABOARD.

During refueling operations with passengers aboard, the following precautionary measures must be taken:

1. A crew member must be assigned to prevent passengers from smoking in the aircraft or in the vicinity until refueling is completed.
2. Passenger loading stairways must be in position at the entrances and the doors must be kept open.
3. During daytime refueling, the APU and the ship battery switches must be turned off.
4. During night refueling, the ship battery switch may be left on to provide cabin lighting. The exterior

lights switch may either be turned off or left at the STEADY position, if required by the airport. All radio equipment, inverters, motors and similar electrical equipment must be turned off. No switches are to be operated after refueling is started.

5. The auxiliary ground power source must be shut down and moved clear of the aircraft unless it is explosion-proof.

FUEL STABILIZING TIME.

A fuel stabilizing time is required before accurate fuel quantity indications can be obtained for tanks 2 and 3. During that time, dip stick and fuel quantity indicator readings will be high.

AUXILIARY FUEL PUMP OPERATION.

Each fuel tank contains an electrically-operated, submerged fuel boost pump. These pumps supply relatively vapor-free fuel under pressure to the engine-driven fuel pumps so that engine operation is not affected by vapor and entrained air. The HIGH position of the pump switches is used during take-off and landing and to supply fuel under pressure in the event of engine-driven fuel pump failures or when the LOW position cannot maintain sufficient pressure. The LOW positions are used during climb, cruise and descent. When going to cross-feed operation, it is recommended that the switch for the fuel boost pump in the tank to supply the fuel be turned to HIGH. After cross-feed operation has been established, the fuel boost pump in this tank may be returned to LOW operation provided fuel pressure is maintained within limits. When the engines are not operating, the fuel boost pump switches should be turned on LOW before going to the HIGH position.

CARBURETOR ICING.

Ice can form in the air induction system or in the fuel metering side of the carburetor. The symptoms of both types of icing are nearly identical, namely, loss of automatic mixture control, rising, falling, or fluctuating fuel flow, and engine instability. However, the carburetor is more susceptible to metering disturbances resulting from air induction system icing. The aircraft is equipped with the following provisions to combat carburetor icing:

1. A heated air source to facilitate removal of induction ice to maintain induction air temperatures up to 38° C maximum.
2. Three alcohol spray nozzles installed at the carburetor top deck to remove ice from air induction components.

The application of carburetor heat is not permissible during take-off. Carburetor heat may be used before take-off to insure that any ice accumulation has been

dislodged, but the switch must be in the COLD position and carburetor temperature normal before take-off. After the first power reduction is made, carburetor heat may be applied to maintain a minimum temperature indication within limits. Anticipation of impending icing conditions is of primary importance in avoiding fuel metering disturbances. Visible moisture in the air with free air temperature below 10° C may be an indication of impending fuel flow disturbances. Intermittent fluctuations of fuel flow and BMEP, or gradual decrease or increase in fuel flow, under these conditions usually indicate a fuel metering disturbance which may be followed by a loss of power.

Note

If fuel flow indicates that the mixture is excessively rich, which has happened upon very rare occasions, manually lean with the mixture control to maintain smooth operation, then apply pre-heat to remedy.

If icing conditions are anticipated, or if any atmospheric icing is encountered which could cause a radical metering disturbance, the following procedures should be followed:

1. Mixture levers—AUTO RICH.
2. Carburetor heat switches—raise temperature to 20 to 30° C—38° C maximum.
3. Reset cruise power and monitor fuel flow and BMEP for evidence of instability.
4. Continue to monitor all instruments for any icing symptoms.
5. Leave carburetor heat on for approximately five minutes after passing through icing conditions to insure that ice is melted, then remove heat slowly in small increments, one engine at a time.

When a metering disturbance (caused by atmospheric conditions) occurs suddenly and unexpectedly, apply the same procedure as outlined above with special attention to resetting power and fuel flows plus:

1. Carburetor alcohol—as required to stabilize power.

Note

When alcohol is used, it should be applied for a period of 3 to 5 seconds, then released and an observation made to determine whether or not stable power has been regained.

It is possible that conditions conducive to carburetor icing will be aggravated by lower power, lean mixture, and part-throttle operation, especially during long steep descents. If trouble is encountered under these circumstances, the icing conditions should be controlled by use

of carburetor heat. The use of carburetor heat has been effective under all normal conditions where ice is likely to be encountered at altitudes below 20,000 feet and at temperatures between +10 and -25° C. At ambient temperatures below -25° C the amount of visible moisture in the air is extremely small and is not likely to cause induction system icing trouble; however, the temperature in clouds may be considerably different than the temperature outside of the cloud. Therefore, it should be anticipated that icing conditions will be prevalent when entering a condition of visible moisture, and preventative measures should be taken. Generally, after a given configuration has been established, whether or not any anti-icing technique is used, it may be better not to change the configuration while in icing as long as no difficulties are encountered.

MANUAL LEANING.

Manual mixture control should be used to obtain best economy fuel flows in accordance with the following procedures:

CAUTION

Manual mixture control should not be used outside the normal AUTO LEAN cruise power settings as outlined in the operating instructions.

1. Set desired rpm.
2. Set mixture lever at AUTO RICH.
3. Set desired BMEP.
4. Manually lean with mixture lever to obtain best power.

Note

The rise for best power will normally be from 1 to 5 BMEP when moving the mixture lever from AUTO RICH.

5. Throttle lever—reset to obtain desired BMEP.
6. Lean mixture manually for 10% BMEP drop from the desired value.
7. Throttle lever—open to originally desired BMEP.

Note

The manual lean mixture setting should be rechecked following any change in cruise altitude greater than 2,000 feet.

FILLING HYDRAULIC RESERVOIR IN FLIGHT.

Emergency hydraulic fluid may be used to replenish either the main hydraulic reservoir or the emergency

extension and brake reservoir by the following method:

1. Attach the emergency fluid container to the capped line.
2. Set hydraulic reservoir selector to reservoir to which fluid is to be transferred.
3. Operate hydraulic reservoir filler wobble pump handle.

Note

If fluid fails to flow from the pump, the pump requires bleeding. Proceed as follows:

- a. Pump bleed valve — OPEN.
- b. Disperse air in the pump, by operating handle until fluid flows from the bleed port.
- c. Pump bleed valve — CLOSED.
4. Tank selector valve — OFF.

USE OF LANDING WHEEL BRAKES.

It is absolutely necessary that airplane brakes be treated with respect. It is generally known that operating personnel stop the aircraft as quickly as possible regardless of the length of the runway, use the brakes consistently for speeding up turns, and drag the brakes while taxiing. To minimize brake wear, the following precautions should be observed insofar as is practicable:

1. Use extreme care when applying brakes immediately after touchdown or whenever there is considerable lift on the wings to prevent skidding the tires and causing flat spots. A heavy brake pressure can result in locking of the brakes more easily if brakes are applied immediately after touchdown than if the same pressure is applied after the full weight of the aircraft is on the wheels. A wheel once locked in this manner immediately after touchdown will not become unlocked as the load on the wheel is increased as long as brake pressure is maintained. Proper braking action cannot be expected until the tires are carrying heavy loads.

a. Brakes, themselves, can merely stop the wheel from turning, but stopping the airplane depends upon the friction of the tires on the runway. For this purpose it is easiest to think in terms of coefficient of friction which is equal to the frictional force divided by the load on the wheel. It has been found that optimum braking occurs with a rolling skid at approximately 15 to 20 percent; i.e. the wheel continues to rotate but has approximately 15 to 20 percent slippage on the surface so that the rotational speed is 80 to 85 percent of the speed which the wheel would have were it in free roll. As the amount of skid increases beyond this amount, the coefficient of friction decreases rapidly so that with a 75 percent skid the friction is approximately 60 percent of the optimum and, with a full skid, becomes even lower.

b. There are two reasons for this loss in braking effectiveness with skidding. First, the immediate action is to scuff the rubber, tearing off little pieces which act almost like rollers under the tire. Second, the heat generated starts to melt the rubber and the molten rubber acts as a lubricant.

c. NACA figures have shown that for an incipient skid with an approximate load of 10,000 lbs per wheel, the coefficient of friction on dry concrete is as high as .8, whereas the coefficient is of the order of .5 or less with a 75 percent skid. Therefore, if one wheel is locked during application of brakes there is a very definite tendency for the airplane to turn away from that wheel and further application of brake pressure will offer no corrective action. Since the coefficient of friction goes down when the wheel begins to skid, it is apparent that a wheel, once locked, will never free itself until the brake pressure is reduced so that the braking effect on the wheel is less than the turning moment remaining with the reduced frictional force.

2. If maximum braking is required after touchdown, lift should first be decreased as much as possible by raising the flaps and dropping the nose (on tricycle gear aircraft) before applying brakes. This procedure will improve braking action by increasing the frictional force between the tires and the runway. Reverse pitch should be used whenever possible to reduce the braking action required.

3. For short landing rolls, a single, smooth application of the brakes with constantly increasing pedal pressure is most desirable. This procedure applies equally well for operation on emergency braking systems.

4. It is recommended that a minimum of 15 minutes elapse between landings where the landing gear remains extended in the slip stream, and a minimum of 30 minutes where the landing gear has been retracted to allow sufficient time for cooling between brake applications. Additional time should be allowed for cooling if brakes are used for steering, cross-wind, taxiing operation, or if a series of landings are performed.

5. The full landing roll should be utilized to take advantage of aerodynamic braking and to use the brakes as little and as lightly as possible.

6. After the brakes have been used excessively for an emergency stop and are in the heated condition, the aircraft should not be taxied into a crowded area or the parking brakes set. Peak temperatures occur in the wheel and brake assembly from 5 to 15 minutes after a maximum braking operation. To prevent brake fire and possible wheel assembly explosion, the specified procedures for cooling brakes should be followed.

7. The brakes should not be dragged when taxiing, and should be used as little as possible for turning the aircraft on the ground.

INTEGRATED FLIGHT SYSTEM.
(Figure 7-2).**NORMAL OPERATING PROCEDURE:**

Flying magnetic headings:

1. ILS-HDG switch — HDG.
2. Heading marker — set to selected course.
3. Steering pointer — centered.

Flying omni-courses:

1. ILS-HDG switch — HDG.
2. VOR (AN/ARN-14) receiver — set.

Note

LOC flag warning should swing upward to the masked position.

3. Course arrow — set to selected course.
4. Heading marker — set to heading that will approach or hold selected course.
5. Steering pointer — centered.
6. Course indicator — cross check for oriented picture of position relative to omni-radial: Compare position of course bar, course arrow, and miniature aircraft.

Note

To-from arrow establishes direction and indicates, by reversal, station passage.

7. Plot omni-range stations, if necessary, by setting the VOR (AN/ARN-14) receiver to proper channels and adjusting the course selector knob to align the course bar with course arrow.

FLYING ILS APPROACHES.

1. Heading marker — adjust to heading which will intercept localizer course at desired location.
2. Steering pointer — centered.
3. VOR (AN/ARN-14) and glide slope (AN/ARN-18) receivers — set.

Note

CS and LOC flag warnings should move to the masked position.

4. Course arrow — set to inbound localizer course.

Note

Course bar now represents the localizer course.

5. When course bar is intercepted, fly out bound localizer course and complete procedure turn.

Note

- Course bar and miniature aircraft provide a constant position-picture with reference to the localizer beam. Actual headings are displayed under the lubber line.
 - If the steering pointer is to be used, the heading marker must be advanced through a series of headings which make good the requirements of the procedure turn. Advance the heading marker into the turn, less than 90 degrees at a time, during the turn around.
6. Heading marker — set to same heading as head of course arrow.
 7. ILS-HDG switch — ILS, when the course bar moves from the full five-dot deflection to a four-dot deflection.
 8. Fly by reference to the steering pointer and the altimeter until the glide slope pointer is centered.
 9. Adjust power settings or pitch attitude as necessary to match the glide slope pointer and pitch bar.

Note

In unusual circumstances such as down wind approaches or extreme C.G. location, it is difficult to hold the two pointers together at the center of the scale. Fly the pitch bar to maintain the glide slope pointer centered.

MISSED APPROACH.

1. ILS-HDG knob — HDG.

Note

An immediate change to the HDG function is required to remove the synthetic heading signal response of the steering pointer and to remove the pre-set approach trim of the pitch bar.

2. Heading marker — set and fly by reference to the steering pointer.

integrated flight system

COURSE INDICATOR

APPROACH HORIZON ★

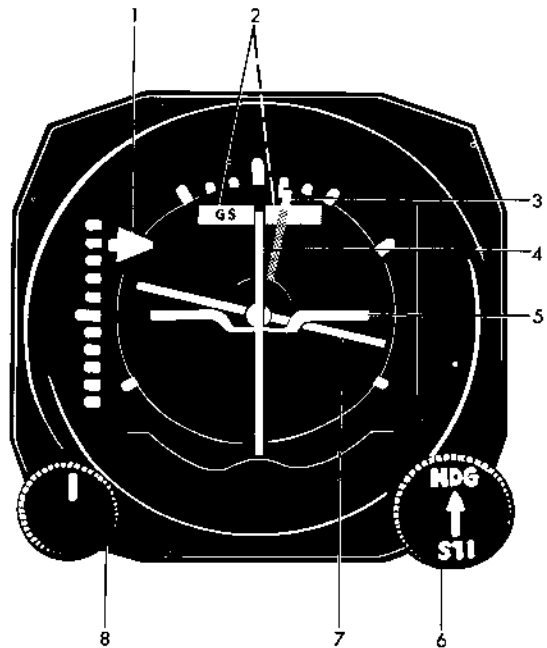
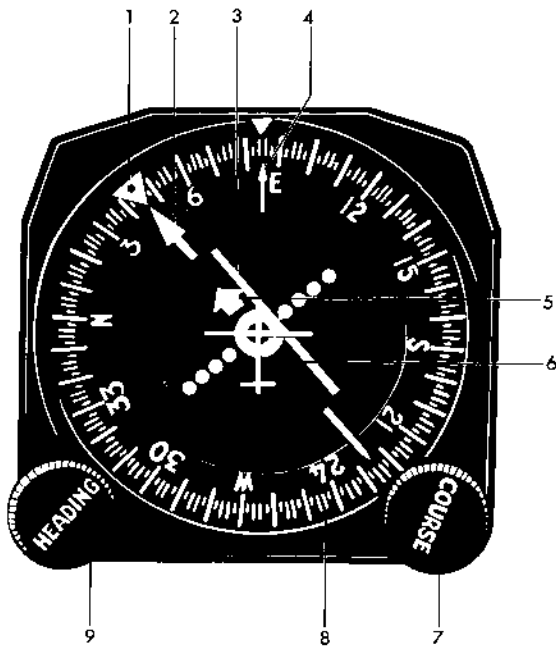

★ Flight Director Horizon

- | | |
|------------------|-------------------------|
| 1 HEADING MARKER | 6 MINIATURE AIRPLANE |
| 2 COURSE ARROW | 7 COURSE SELECTOR KNOB |
| 3 COURSE BAR | 8 AZIMUTH RING |
| 4 LUBBER LINE | 9 HEADING SELECTOR KNOB |
| 5 TO-FROM ARROW | |

- | | |
|-----------------------|--------------------------|
| 1 GLIDE SLOPE POINTER | 5 PITCH BAR |
| 2 WARNING FLAGS | 6 FUNCTION SELECTOR KNOB |
| 3 BANK POINTER | 7 HORIZON BAR |
| 4 STEERING NEEDLE | 8 PITCH TRIM KNOB |

The Course Indicator combines compass heading and radio position indications to form a plan view or map-like display of the aircraft with respect to a selected course. The Course Bar simulates the selected course while other indications show the direction of the omnirange station and the position of the aircraft. The picture is equal to that which would be presented if the selected course were marked on the ground with the shadow of the aircraft moving along or toward it and the To-From arrow pointing out the direction of the VOR station. The Course Indicator contains two meter movements in a standard three- or five- inch instrument case.

The Approach Horizon is a primary attitude and steering instrument. It is a forward view instrument with glide slope position and computed steering information superimposed on a pitch and roll reference. Steering information for precise ILS let-down and cross country flying is given by the Steering Needle. Other Approach horizon indications show pitch and bank attitude, give vertical guidance on the glide slope, and show when external signals are present. The Approach Horizon contains six meter movements in a standard three-inch instrument case. Resistance and sensitivity characteristics of all meter movements are standard.

Figure 7-2 (Sheet 1)

F125-1-7-106(1)

COURSE INDICATOR

AZIMUTH RING

Driven by the aircraft compass system, the Azimuth Ring rotates as aircraft heading changes. It always shows heading of aircraft beneath Lubber Line at top of instrument.

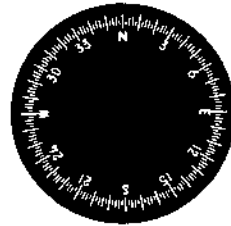

COURSE BAR AND ARROW

Course bar simulates selected course. Deflection represents deviation from selected course, measured against the standard five-dot scale. Course Arrow indicates selected VOR radial or localizer inbound track. Knob at lower right sets Course Arrow to any desired course. Course Bar and Arrow ride with Azimuth Ring as aircraft heading changes.

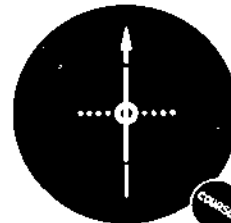

TO - FROM ARROW

To-From omni range indication is provided by a large arrow which appears beneath Course Bar on appropriate side of center. To-From Arrow is not displayed when IFS is working on localizer or VAR signals.

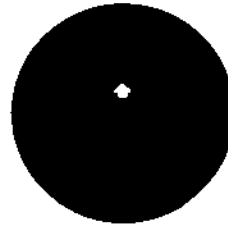

HEADING MARKER

Knob at lower left turns Heading Marker to magnetic heading desired. Marker rides with Azimuth Ring as aircraft heading changes. Heading error is shown in degrees by displacement of marker from Lubber Line.

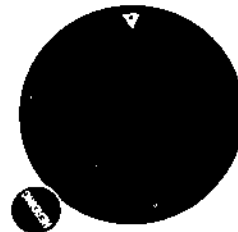

MINIATURE AIRPLANE AND LUBBER LINE

Etched on instrument's glass, the Miniature Airplane simulates aircraft. Lubber Line indicates aircraft heading. Picture is comparable to shadow of aircraft on ground. When Miniature Airplane is pointed toward Course Bar, aircraft is approaching selected course.

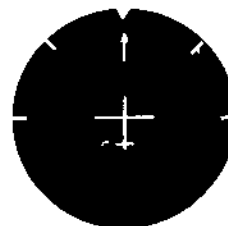

F125-1-7-104(2)

Figure 7-2 (Sheet 2)

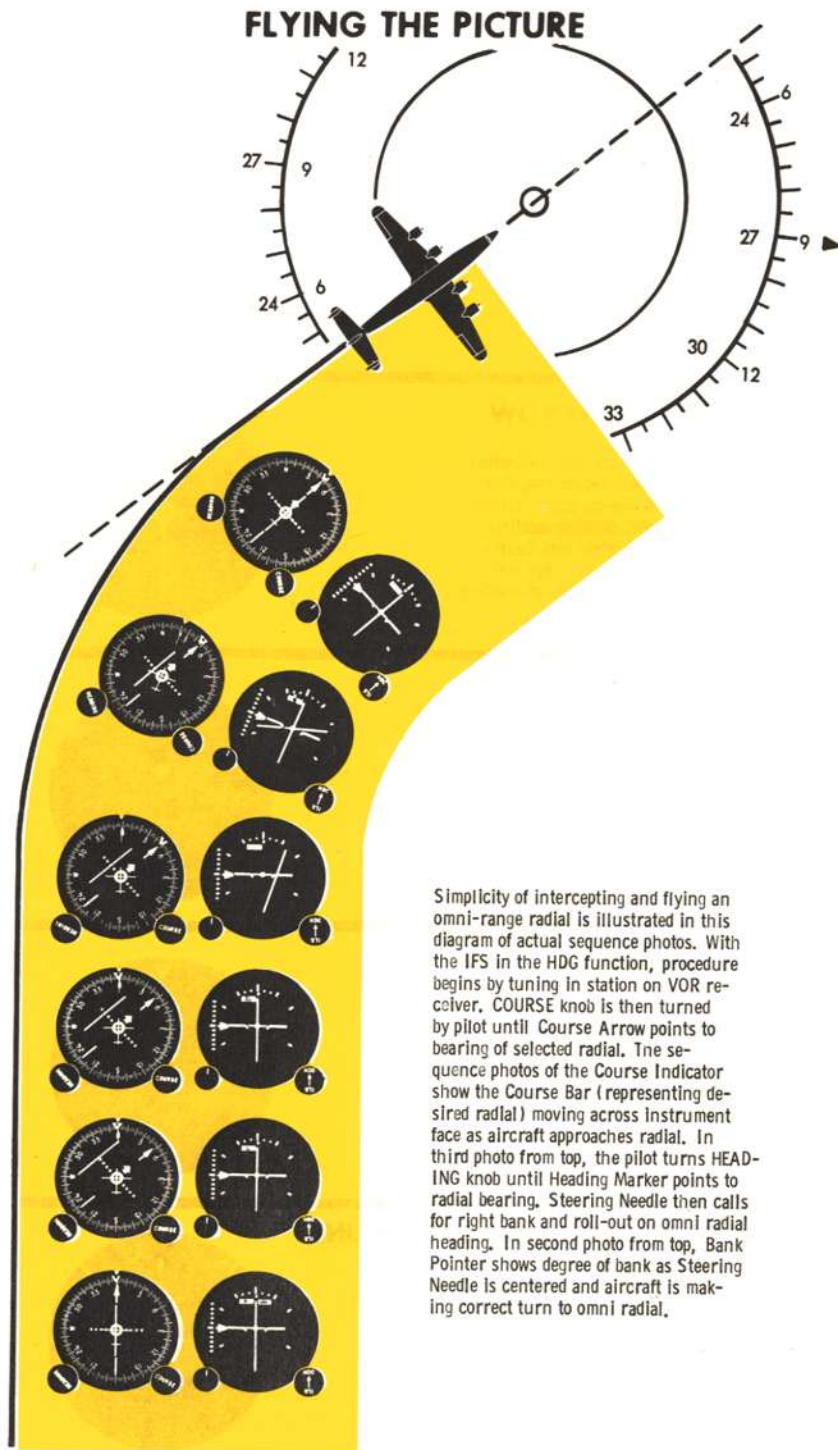

F125-1-7-106(3)

Figure 7-2 (Sheet 3)

IFS ON ILS

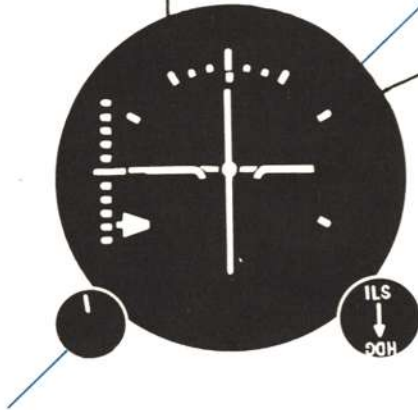

VERTICAL GUIDANCE

IN DRAWING ABOVE, THE GLIDE SLOPE POINTER OF THE APPROACH HORIZON SHOWS AIRCRAFT IS ABOVE THE GLIDE SLOPE. MAKE CORRECTION BY NOSING DOWN TO POSITION PITCH BAR OPPOSITE POINTER. KEEP PITCH BAR AND GLIDE SLOPE POINTER MATCHED AT CENTER SCALE TO FOLLOW GLIDE SLOPE TO BREAK-OUT IN CORRECT VERTICAL APPROACH ATTITUDE. ABSENCE OF WARNING FLAGS SHOWS GLIDE SLOPE AND LOCALIZER RECEIVERS ARE IN OPERATION.



LATERAL GUIDANCE

IN THIS DRAWING, AIRCRAFT IS TO THE LEFT OF LOCALIZER. DEFLECTION OF THE STEERING NEEDLE TO THE RIGHT INDICATES THAT RIGHT BANK CORRECTION IS REQUIRED. BANKING TOWARD THE NEEDLE WILL CENTER IT. KEEPING IT CENTERED IN THE TURN INSURES AN ASYMPTOTIC APPROACH WHICH ELIMINATES BRACKETING.

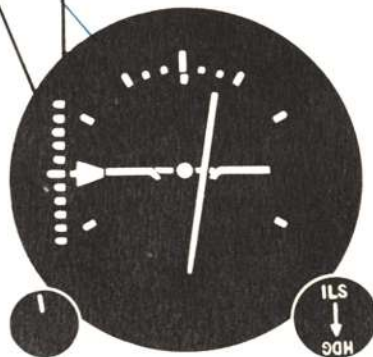

F125-1-7-10(4)

Figure 7-2 (Sheet 4)

PAGES 7-13 THROUGH 7-24 DELETED.
FLIGHT PLANNING FUEL CONSUMPTION TABLES C-121A (H-1)
NOW INCORPORATED IN APPENDIX I, PART 5.

SECTION VIII

CREW DUTIES

TABLE OF CONTENTS

	<i>Page</i>
INTRODUCTION	8-1
PILOT	8-1
COPILOT	8-1
FLIGHT ENGINEER	8-1
NAVIGATOR	8-1
RADIO OPERATOR	8-3
FLIGHT ATTENDANT	8-4

INTRODUCTION.

This section contains those functions which are in addition to the primary responsibilities of a crew member. It is assumed that each individual crew member is fully aware of the primary responsibilities of his job.

PILOT.

It will be the responsibility of the pilot to insure that a thorough inspection of the aircraft and all equipment be conducted in sufficient time prior to departure to permit correction of discrepancies without incurring delays. The responsibilities for conducting the inspection may be assigned to any other crew member that may be assigned by the pilot.

Your normal and emergency abbreviated check lists are now contained in T. O. 1C-121A-(CL)1-1.

COPILOT.

Aid the pilot as directed to accomplish the assigned mission.

Your normal and emergency abbreviated check lists are now contained in T. O. 1C-121A-(CL)1-1.

FLIGHT ENGINEER.

Perform pre-flight inspection prior to departure to determine the condition of the aircraft. See Section II.

Your normal and emergency abbreviated check lists are now contained in T. O. 1C-121A-(CL)1-2.

NAVIGATOR – NORMAL PROCEDURES.

The navigator will aid the pilot in all matters pertaining to flight planning and will perform any other duties assigned.

PREFLIGHT.

Exterior Inspection.

1. Driftmeter lens and housing — CHECKED AND HOUSING SECURED.

Check lens and lens housing for cleanliness, general condition, and housing secured.

2. Flare chute — CHECK FOR GENERAL CONDITION.

Interior Inspection.

1. Navigator's personal equipment — ABOARD AND STOWED.
 2. Sextant — ABOARD AND STOWED.
 3. Astral compass and mount — ABOARD AND STOWED.
 4. Navigation tables and almanac — ABOARD AND STOWED.
 5. URC-4 radio — ABOARD AND STOWED.
 6. Oxygen regulator — OPERATIONAL.
 7. Desk lights — OPERATIONAL.
 8. Dome light — OPERATIONAL.
 9. Astral dome de-fog switch — OFF.
 10. Astral dome heater switch — OFF.
 11. Trailing antenna — IN.
 12. Radio compass — OPERATIONAL.
 13. Magnetic compass — OPERATIONAL.
 14. Electric gyro — CAGED AND OFF.
 15. APS-42
 - a. Antenna heater switch — OUT.
 - b. ISO-ECHO switch — OUT.
 - c. Function switch — OFF.
 - d. Scan switch — STOP.
 - e. Gain control — FULLY COUNTERCLOCKWISE.
 - f. A-J switch — OUT.
 - g. STC switch — OUT.
 - h. Antenna stab switch — OUT.
 - i. OBS map switch — OBS.
 - j. Range switch — 10 MILES.
 - k. Delay control — 175 MILES.
 - l. Time switch — AFC.
 - m. Intensity, focus and light control on both pilots' and navigator's scope — FULLY COUNTERCLOCKWISE.
 16. Radio altimeter — OPERATIONAL.
 17. LORAN — OPERATIONAL.
 18. Pressure altimeter — SET AS REQUIRED.
 19. VOR-ADF switch — AS REQUIRED.
 20. Driftmeter — CAGED AND OFF.
 21. Watches and clocks — SET.
- On all overwater flights, the navigator should make the following preflight inspection.
1. Astral Dome — CLEAN AND LOCKED.
 2. Forms, logs, and handbooks — ABOARD.
 3. Oxygen masks and equipment — CHECK SUPPLY AND FLOW.

4. Spare fuses and bulbs — STOWED.
5. Pyrotechnic pistol and cartridges — ABOARD.
6. Driftmeter — CAGED.
7. Navigator's watch and equipment — STOWED.

BEFORE STARTING ENGINES.

1. Oxygen system—PRESSURE & MASK CHECKED.

BEFORE TAXIING.

1. Altimeter — SET.

BEFORE TAKE-OFF.

1. Fluxgate compass heading — CHECKED.

DESCENT.

1. Driftmeter — CAGED & OFF.
2. Navigator's radar — AS REQUIRED.

NAVIGATOR — EMERGENCY PROCEDURES.

CABIN FIRE.

1. Smoke mask — ON & OXYGEN SET TO 100%.
2. Radio rack venturi — CLOSED.
3. Standby to assist.

CARGO COMPARTMENT FIRE.

1. Smoke mask — ON & OXYGEN SET TO 100%.

CABIN HEATER FIRE.

1. Smoke mask — ON & OXYGEN SET TO 100%.

APU FIRE.

1. Smoke mask — ON & OXYGEN SET TO 100%.

ELECTRICAL FIRE.

1. Electrical equipment — OFF.
2. Radio rack venturi — CLOSED.
3. Smoke mask — ON & OXYGEN SET TO 100%.
4. Standby to assist.

CAUTION

Do not use liquid fire extinguishers on electrical fires.

SMOKE/FUME ELIMINATION.

1. Smoke mask — ON & OXYGEN SET TO 100%.
2. Standby to assist.

BAIL OUT.

- a. Refer to Section III.

GROUND EVACUATION.

- a. Refer to Section III.

DITCHING PROCEDURES.

- a. Navigator's amplified ditching procedures contained in Section III.
- b. Navigator's abbreviated ditching checklist contained in T. O. 1C-121A-(CL)1-3.

FUEL DUMPING.

1. Unnecessary radios and electrical equipment—OFF.

After Dumping.

1. Radios and electrical equipment — AS NECESSARY.

Your normal and emergency abbreviated checklists are now contained in T. O. 1C-121A-(CL)1-3.

RADIO OPERATOR — NORMAL PROCEDURES. PREFLIGHT.**Note**

On aircraft without the services of a radio operator, these items will be checked by a pilot crew member.

Exterior Inspection.

1. Antennas, antenna masts and insulators — CHECKED FOR TENSION AND PROPER MOUNTING.
2. Loops and radomes — CHECKED FOR CHIPS AND CLEANLINESS.

Interior Inspection — Power Off.

1. All plugs and cables — CHECKED FOR TIGHTNESS AND SAFETY WIRING.
2. Mikes, headsets and plugs — CHECKED FOR OPERATION, LOCATION AND MOUNTING.
3. Current facility charts — ABOARD.
4. CRT-3 and URC-4s — ABOARD AND STOWED.
5. All radio and radar equipment — ABOARD AND PROPERLY MOUNTED.

Power and Inverters On.

6. APN-1 limit lights and range switch — OPERATIONAL.
Check APN-1 to see if limit lights operate when range switch is operated.
7. ADFs — OPERATIONAL.
Check both ADFs on all antenna positions and for CW operation. Check both loops for a null.
8. VHF (171-4 and ARC-36) — OPERATIONAL.
9. UHF — OPERATIONAL.
10. ARC-58 — OPERATIONAL.
11. VHF omni receivers — OPERATIONAL.
12. TACAN (AN ARN-21) — OPERATIONAL.
13. IFS — OPERATIONAL.
Check IFS for power by gyro monitor indication in green. Tune in appropriate station for audio check. Check visual action of needle indication.
14. HF (618S-1) — OPERATIONAL.
15. ART-13 and BC 348 — OPERATIONAL.
16. SCR-718 altimeter — OPERATIONAL.
Check SCR-718 altimeter for circle shape, size, and altitude indication.
17. PA system — OPERATIONAL.
Turn PA system on, and with another crew member's aid check for clarity and tone of speakers in rear of aircraft and check external operation.

BEFORE STARTING ENGINES.

1. Oxygen system—PRESSURE & MASK CHECKED.

BEFORE TAXIING.

1. Radio inverter switch — ON.
2. Master radio switch — ON.
Check voltage and cycles.
3. Radios — CHECKED.

BEFORE TAKE-OFF.

1. IFF/SIF — AS REQUIRED.

DESCENT.

1. Trailing antenna — IN.

AFTER LANDING.

1. IFF — OFF.

BEFORE LEAVING AIRCRAFT.

1. Radios — OFF.
2. IFF — CODES REMOVED.
3. RADIO inverter switch — OFF.
4. All switches — OFF.
All unnecessary switches OFF before leaving flight station.

RADIO OPERATOR — EMERGENCY PROCEDURES.**CABIN FIRE.**

1. Smoke mask — ON & OXYGEN SET TO 100%.
2. Standby to assist.

CARGO COMPARTMENT FIRE.

1. Smoke mask — ON & OXYGEN SET TO 100%.

CABIN HEATER FIRE.

1. Smoke mask — ON & OXYGEN SET TO 100%.

APU FIRE.

1. Smoke mask — ON & OXYGEN SET TO 100%.

ELECTRICAL FIRE.

1. Electrical equipment — OFF.
2. Smoke mask — ON & OXYGEN SET TO 100%.
3. Standby to assist.

CAUTION

Do not use liquid fire extinguisher on electrical fires.

SMOKE/FUME ELIMINATION.

1. Smoke mask — ON & OXYGEN SET TO 100%.
2. Standby to assist.

BAIL OUT.

- a. Refer to Section III.

GROUND EVACUATION.

- a. Refer to Section III.

DITCHING.

- a. Radio operator's amplified ditching procedures contained in Section III.
- b. Radio operator's abbreviated ditching checklist contained in T. O. 1C-121A-(CL)1-4.

FUEL DUMPING.

1. Unnecessary radios and electrical equipment—OFF.

After Dumping.

1. Radios and electrical equipment — AS NECESSARY.

Your normal and emergency abbreviated checklists are now contained in T. O. 1C-121A-(CL)1-4.

FLIGHT ATTENDANT — NORMAL PROCEDURES.

PREFLIGHT.

Main Cargo Compartment.

1. Lavatories — INSPECTED.
Inspect both lavatories for neatness and cleanliness. Check water flow from lavatory faucets.
2. Cabin — INSPECTED.
Inspect cabin for cleanliness, and all necessary equipment for passenger comfort.
3. First aid kits — CHECKED.
Check first aid kits for proper amount, seals unbroken and mounting.
4. Emergency equipment — ABOARD AND STOWED.
Check all emergency equipment required for proper storage and correct amount: Mae Wests, life raft kits, oxygen masks, ditching placards for proper location, fire extinguishers (one CO₂ and one chlorobromomethane type) and fire axe.
5. Evacuation chute — ABOARD AND STOWED.
6. Ditching ropes — CHECKED FOR MOUNTING.
7. Jacob's ladder — ABOARD AND STOWED.
8. Seats, safety belts and head rest covers—CHECKED FOR SECURITY.
9. Baggage and cargo loading — CHECKED.
Check distribution and secureness of baggage and cargo. Cargo shall be loaded to provide unobstructed and operable emergency exits.
10. Water tank quantity — CHECKED.
11. Lower rear cargo compartment — DOOR CLOSED.
12. All lighting including emergency lights — CHECKED.
13. Steward's call system — OPERATIONAL.

Galley.

1. Galley cleanliness — CHECKED.
2. Electrical equipment — OPERATIONAL.
3. First aid kit, water jug and chlorobromomethane fire extinguisher — ABOARD AND STOWED IN WING FLAP CRANK CLOSURE.

4. Water system — CHECKED.
5. Cooking and eating equipment — ABOARD AND STOWED.

BEFORE STARTING.

1. Portable oxygen cylinders — PRESSURE AND MASK CHECKED.

FLIGHT ATTENDANT — EMERGENCY PROCEDURES.

CABIN FIRE.

1. Passenger oxygen system or portable oxygen cylinder — MASK ON.
2. Galley sonic venturi — CLOSED.
3. Standby to assist.

CARGO COMPARTMENT FIRE.

1. Passenger oxygen system or portable oxygen cylinder — MASK ON.

CABIN HEATER FIRE.

1. Passenger oxygen system or portable oxygen bottle — MASK ON.

APU FIRE.

1. Passenger oxygen system or portable oxygen cylinder — MASK ON.

ELECTRICAL FIRE.

1. Passenger oxygen system or portable oxygen cylinder — MASK ON.
2. Galley sonic venturi — CLOSED.
3. Standby to assist.

CAUTION

Do not use liquid fire extinguisher on electrical fire.

SMOKE/FUME ELIMINATION.

1. Passenger oxygen system or portable oxygen cylinder — MASK ON.
2. Standby to assist.

BAIL OUT.

- a. Refer to Section III.

GROUND EVACUATION.

- a. Refer to Section III.

DITCHING PROCEDURES.

- a. First and second flight attendants amplified ditching procedures contained in Section III.
- b. First and second flight attendants abbreviated ditching checklist contained in T. O. 1C-121A-(CL)1-5.

Your normal and emergency abbreviated checklists are now contained in T. O. 1C-121A-(CL)1-5.

SECTION IX

ALL WEATHER

TABLE OF CONTENTS

	<i>Page</i>
INTRODUCTION	9-1
NIGHT FLYING	9-1
OPERATION UNDER INSTRUMENT FLIGHT CONDITIONS	9-1
SNOW, RAIN, ICE, CYRSTAL, OR CORONA RADIO STATIC	9-2
FLIGHT IN TURBULENCE AND THUNDERSTORMS	9-2
DESCENT	9-3
HOLDING PROCEDURES	9-3
APPROACH PROCEDURES	9-3
COLD WEATHER PROCEDURES	9-9

INTRODUCTION.

This section contains those procedures which differ from, or are in addition to, the normal operating instructions previously covered in this manual, except where repetition is necessary for emphasis, clarity, or continuity of thought.

NIGHT FLYING.

Night flying procedure is conventional and there is no special technique required in the use of any of the aircraft equipment.

OPERATION UNDER INSTRUMENT FLIGHT CONDITIONS.

The aircraft has excellent qualities in regard to instrument flying. Take-off characteristics are satisfactory. Maneuverability on GCA and ILS is excellent. Before attempting an instrument flight, check that all radios and flight instruments are operating properly.

WARNING

In cold weather, make sure all instruments have warmed up sufficiently to insure normal operation. Check for sluggish instruments during taxiing.

TAKE-OFF.

WARNING

Do not attempt to take off with ice or snow on the wings. Even loose snow may not blow off. Loss of lift and treacherous stalling characteristics may result. Depending on the weight of snow and ice accumulated, take-off distances and climb-out performance can be seriously

affected. The roughness and distribution of the ice and snow could vary stall speeds and characteristics to an extremely dangerous degree. Loss of an engine shortly after take-off is a serious enough problem without the added, and avoidable, hazard of snow and ice on the wings. In view of the unpredictable and unsafe effects of such a practice, the ice and snow must be removed before flight is attempted.

INSTRUMENT TAKE-OFF.

Use the following procedure when making an instrument take-off.

1. Check all radios and flight instruments for proper operation.
2. Make certain that the controls are free and auxiliary flight control boosters are turned on.
3. Set the altimeters for correct barometric pressure.
4. When take-off clearance is received, align the aircraft on the centerline of the runway and proceed with a normal take-off.
5. Raise the landing gear as soon as the aircraft is definitely airborne and a positive climb is established.
6. Climb until clear of obstacles, and accelerate to enroute climb speed.

INSTRUMENT CLIMB.

Climbing airspeed and attitude are easily maintained and the aircraft handles satisfactorily up to and during maximum rate of climb. Climbing turns should not exceed bank angles of 30 degrees.

During freezing rain, climb above the condition *AS RAPIDLY* as possible to the warmer air that may lie above. Continue climbing as long as the temperature increases to reach the warmest portion of the inversion. Level off when the temperature stops rising because additional icing conditions may be present at higher altitudes.

Remember to use caution in climbing at high angles of attack, because large quantities of ice can form on the lower surface of the wings. Such ice is hazardous because of the weight, and the fact that it forms out of reach of the de-icer boots, and because it cannot be seen. Make every effort to place ice on your plane where you want it, not where the ice wants to form. Do this by increasing the horsepower and decreasing the angle of attack, and using correct anti-icing and ice removal procedures.

CRUISING UNDER INSTRUMENT CONDITIONS.

The aircraft should be handled in the same manner as during VFR flight. In addition, the following checks should be made periodically:

1. Check directional indicators and attitude indicators for proper indication, cross-checking all flight instruments.
2. Check pitot heaters and surface de-icing equipment for proper operation during icing conditions.

Another major item to consider in regard to icing is that the large indicated air speed loss when carrying a load of wing ice may range as high as 40 knots. This condition can be controlled, and somewhat overcome, by placing the ridge of ice as nearly across the leading edge as possible and not allowing it to build up underneath the wing, i.e., by presenting the smallest frontal area to absolutely minimize the collection of moisture. If the airspeed is kept at 170 knots or over, only a very small amount of ice, if any, can form on the underside of the wing.

SNOW, RAIN, ICE, CRYSTAL, OR CORONA RADIO STATIC.

When radio static is encountered en route, turn the radio volume down until conditions improve. When nearing the destination, the following may improve reception:

1. Reduce airspeed.
2. Lower radio volume.
3. Keying the transmitter.
4. Radio compass in LOOP (wing tip position).
5. Changing RPM.

FLIGHT IN TURBULENCE AND THUNDERSTORMS.

Avoid penetrating a thunderstorm if it is at all possible. Thunderstorm flying demands considerable instrument experience and technique.

CAUTION

Remember the G units increase in proportion to increased angles of bank.

It is imperative that the aircraft be prepared prior to entering a zone of turbulent air. Normal preparatory procedures should be employed when there is a possibility of encountering thunderstorm activity. Prepare the aircraft as follows:

1. Adjust power to obtain optimum penetration speed and altitude.
2. Turn on pitot heat.
3. Check gyro instrument for proper settings.
4. Fasten all safety belts (check crew).
5. Turn off radio equipment rendered useless by static.
6. If turbulence is light, engage autopilot, and turn altitude control off.
7. Maintain pitch attitude with autopilot pitch control. Once in the storm, devote full attention to the aircraft.

A power setting should be made prior to entering a turbulent zone to provide a flight speed 60 knots above stall speed for the weight, altitude and configuration being flown. Refer to the stall speed curve, Figure 6-1, for stall speed data.

PENETRATING THE THUNDERSTORM.

1. Maintain power and propeller pitch settings established before entry. Hold these and the attitude constant, and the airspeed will be constant regardless of erratic airspeed indicator readings.
2. Attention should be devoted to flying the aircraft by reference to the attitude indicator, holding a level attitude.
3. The altimeter is unreliable in severe turbulence because of differential barometric pressures.
4. Use as little elevator control as possible in maintaining attitude in order to minimize the stresses imposed on the aircraft.

CAUTION

Do not attempt to alter the aircraft attitude by reference to the airspeed indicator. Heavy rain may partially block the pitot heads and cause erratic readings.

DESCENT.

To descend from altitude, use the same procedure as prescribed for VFR flight down to the minimum safe altitude for the range being used and in accordance with instructions received from the airway traffic controller.

HOLDING PROCEDURES.

Holding is normally accomplished by using the traffic pattern configuration (rpm 2100, flaps take-off, and 130 knots).

However, if prolonged holding is expected or if fuel supply is critical, fly the aircraft clean in accordance

with the data on Maximum Endurance Power charts found in Appendix I.

APPROACH PROCEDURES.

CIRCLING APPROACH PROCEDURES.

For circling approach procedures, see figure 9-1, Sheets 1 and 2.

CIRCLING APPROACHES.

If it is necessary to make a circling approach to align the aircraft with the runway, one of the following methods may be used:

Note

Circling approaches should be conducted in strict observance of circling approach minimums.

270-Degree Method.

This approach (figure 9-1) may be used when it is practical to cross the runway at 90 degrees from the low approach course of the aircraft. The runway is crossed at a 90-degree angle. Fly this heading straight ahead for approximately 13 seconds; then make a standard rate turn to the runway heading.

45-Degree Method.

This approach (figure 9-1) consists of a standard rate turn to a heading 45 degrees from the downwind heading, continuing the heading in accordance with existing visibility conditions, and making a standard rate turn to the landing heading.

80- to 260-Degree Method.

This approach (figure 9-1) consists of a standard rate turn of 80-degrees, rolling out of this turn and into a standard rate turn to the runway heading.

Boxing Runway.

Boxing the runway (figure 9-1) is basically a close-in traffic pattern made by flying down the runway, making a standard rate 180-degree turn, paralleling the runway, and making another 180-degree turn.

RANGE AND ADF PROCEDURES.

For range and ADF procedures, see figure 9-2.

GCA PROCEDURES.

For GCA procedures, see figure 9-3.

ILS PROCEDURES.

For ILS procedures, see figure 9-4.

circling approaches

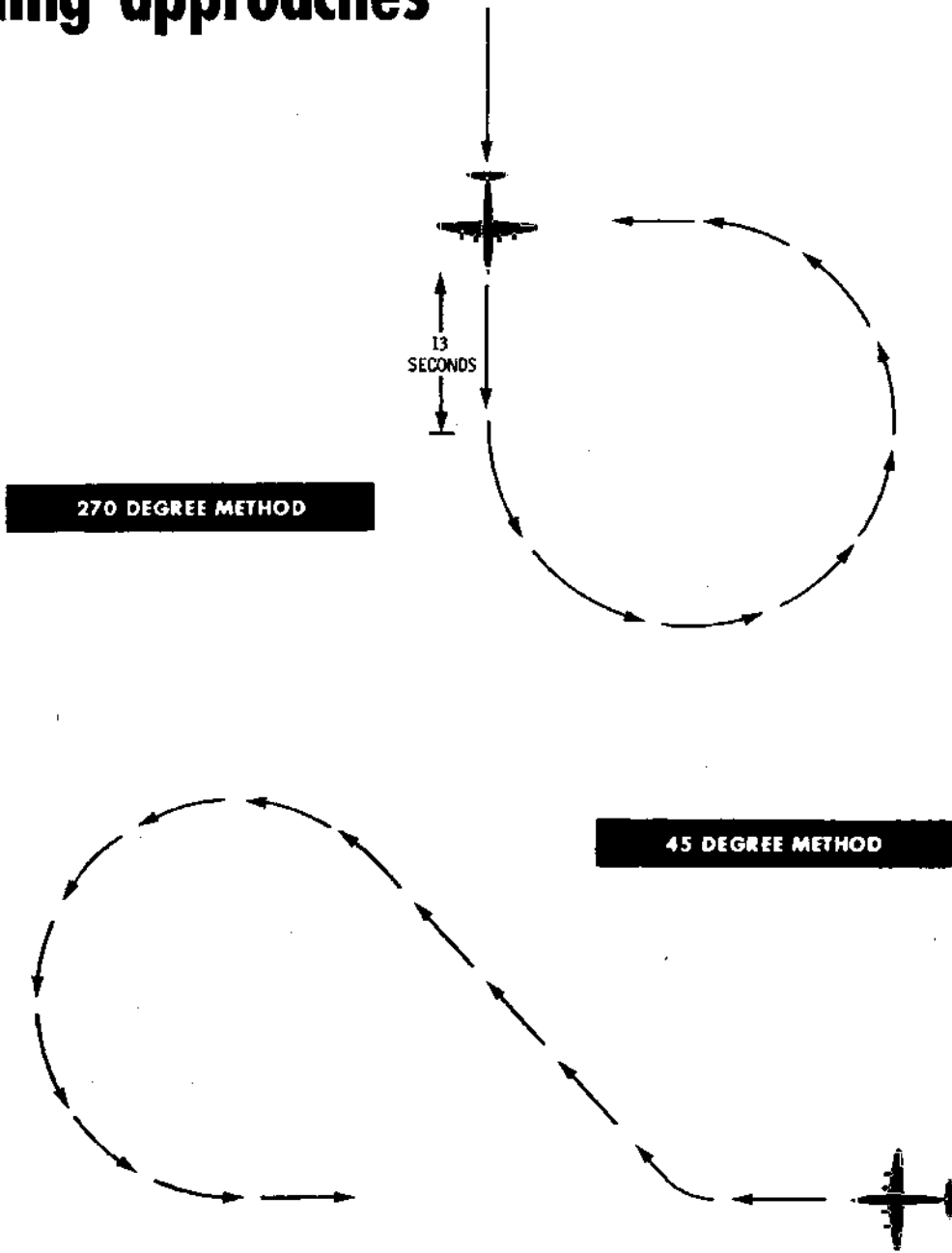

Figure 9-1 (Sheet 1)

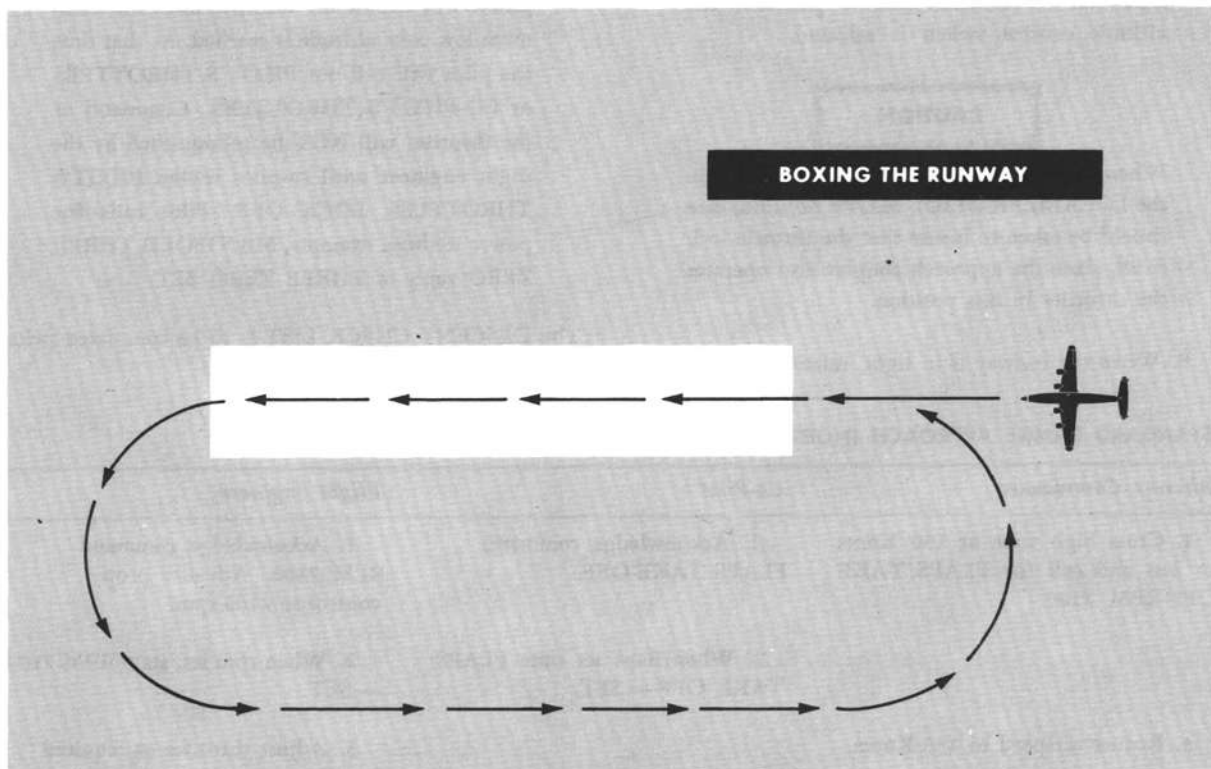
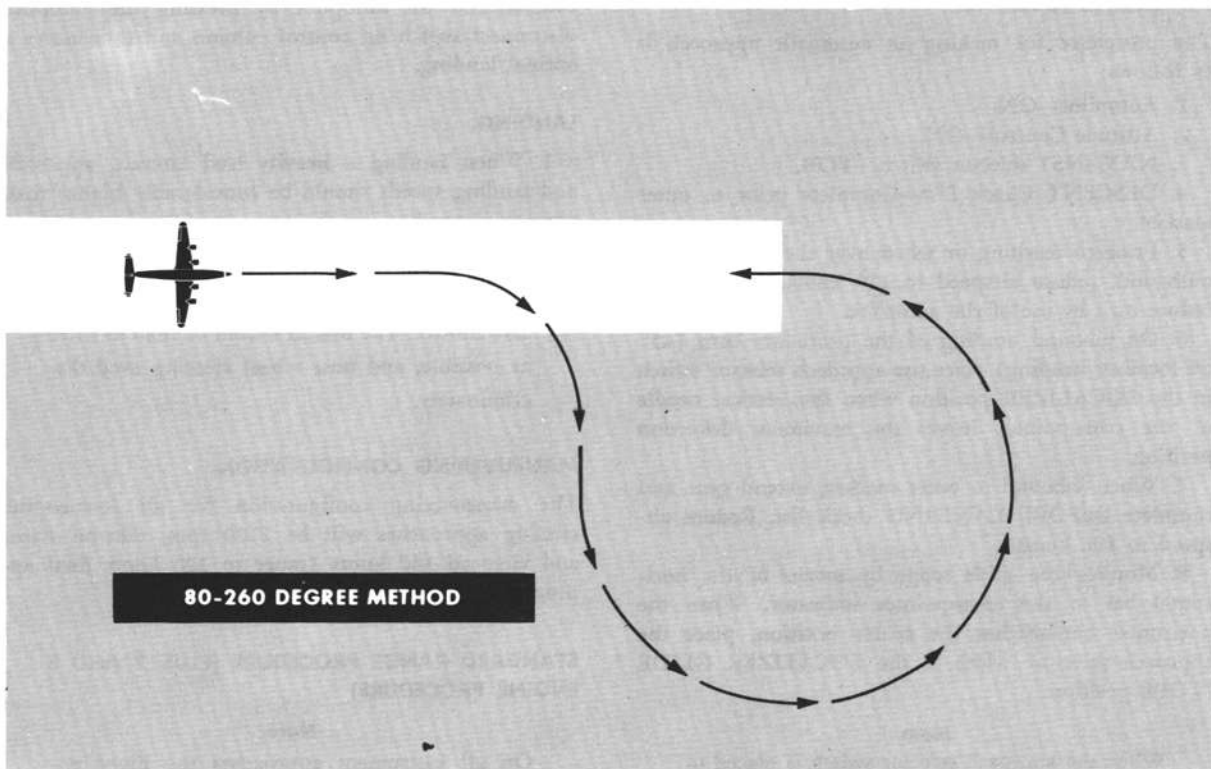

Figure 9-1 (Sheet 2)

AUTOMATIC APPROACH.

The procedure for making an automatic approach is as follows:

1. Autopilot—ON.
2. Altitude Control—ON.
3. NAV INST selector switch—VOR.
4. DESCENT Check List—Complete prior to outer marker.
5. Prior to reaching or when over the outer marker outbound, reduce airspeed to 130 knots. Execute procedure turn by use of the autopilot.
6. On inbound heading of the procedure turn (45° off localizer heading) place the approach selector switch in the LOCALIZER position when the vertical needle of the cross-pointer leaves the maximum deflection position.
7. When inbound to outer marker, extend gear and complete BEFORE LANDING check list. Reduce airspeed to 120 knots.
8. Monitor the glide scope by means of the horizontal bar of the cross-pointer indicator. When the horizontal bar reaches the center position, place the approach selector switch in the LOCALIZER GLIDE SLOPE position.

Note

When the approach selector switch is placed in LOCALIZER GLIDE SLOPE position, the altitude control switch is released.



When placing the approach selector switch in the LOCALIZER GLIDE SLOPE position, care should be taken to insure that the throttle lock is off, since the approach coupler also operates the throttles in this position.

9. When the runway is in sight, release the approach

coupler and the autopilot by pressing the autopilot disconnect switch on control column and then make a normal landing.

LANDING.

1. When landing a heavily iced aircraft, approach and landing speeds should be considerably higher than normal, depending on the amount of icing.

Note

A slow touchdown is desirable, consistent with safe control. The brakes should be used as little as possible, and nose wheel steering used discriminately.

MANEUVERING CONFIGURATION.

The maneuvering configuration for all four-engine circling approaches will be 2100 rpm, take-off flaps, and airspeed 130 knots (taper to 120 knots final approach speed).

STANDARD RANGE PROCEDURE (PLUS 2 AND 3 ENGINE PROCEDURE)

Note

On all instrument approaches the flight engineer will handle the throttles until the minimum low cone altitude is reached. At that time the pilot will call out PILOT'S THROTTLES or CO-PILOT'S THROTTLES. Command of the throttles will NOT be relinquished by the flight engineer until co-pilot replies PILOT'S THROTTLES, LOCK OFF. Pilot calls for power settings; example, MANIFOLD THREE ZERO reply is THREE ZERO SET.

The DESCENT CHECK LIST is to be completed prior to reaching the high cone.

STANDARD RANGE APPROACH (NORMAL) (STRAIGHT-IN):

<i>Aircraft Commander</i>	<i>Co-Pilot</i>	<i>Flight Engineer</i>
1. Cross high cone at 150 Knots or less and call for FLAPS TAKE OFF-RPM 2100.	1. Acknowledge command FLAPS TAKE-OFF.	1. Acknowledge command RPM 2100. Advance prop control to 2100 rpm.
	2. When flaps set state FLAPS TAKE OFF — SET.	2. When rpm set, state RPM 2100 — SET.
3. Reduce airspeed to 130 Knots.		3. Adjust throttles as required by pilot.

range and adf procedures (straight in)

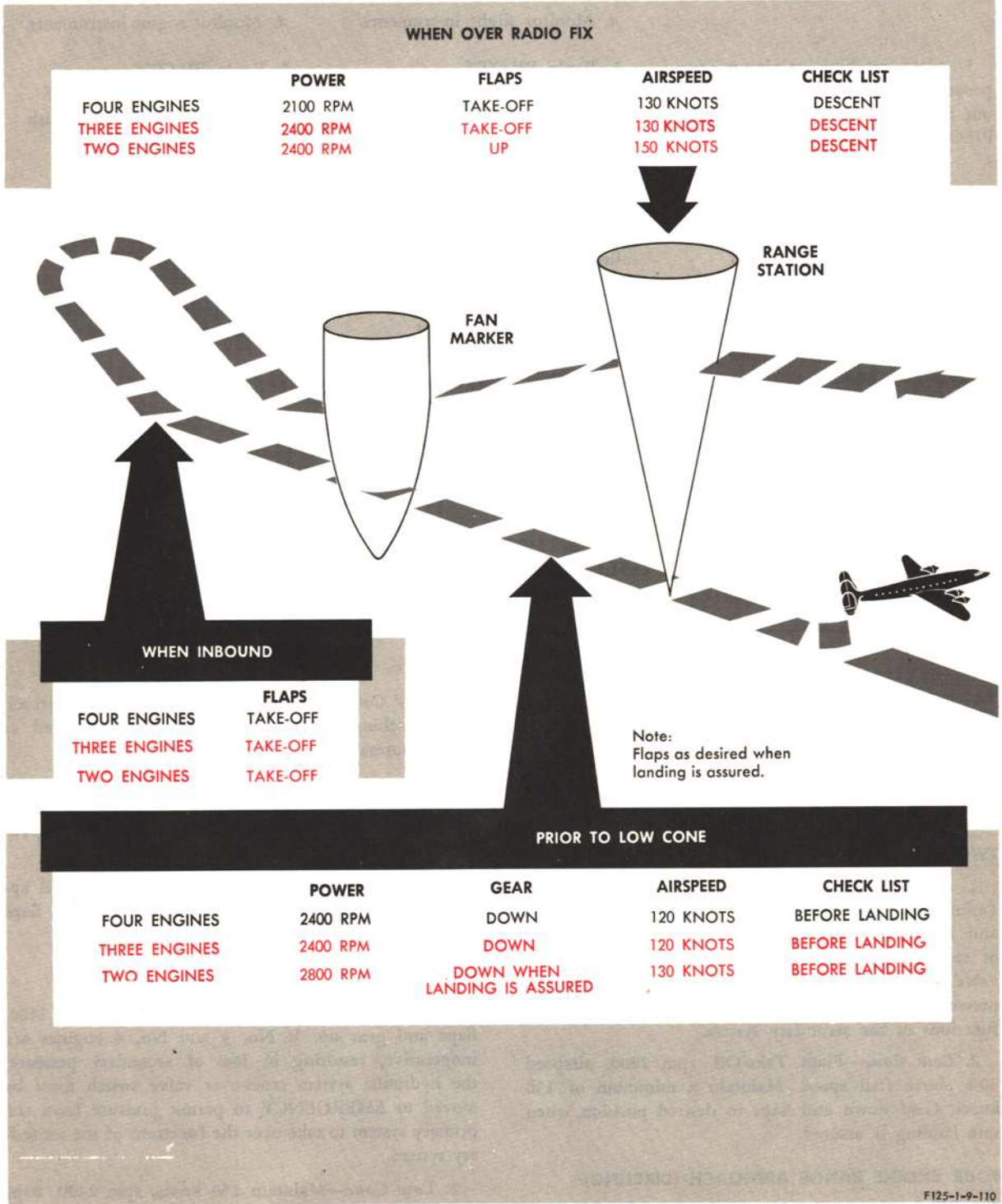

Figure 9-2

STANDARD RANGE APPROACH (NORMAL) (STRAIGHT-IN) (Continued)

<i>Aircraft Commander</i>	<i>Co-Pilot</i>	<i>Flight Engineer</i>
	4. Monitor flight instruments.	4. Monitor engine instruments.
5. After reaching minimum approach altitude for low cone call out PILOT'S THROTTLES or CO-PILOT'S THROTTLES".	5. Reply PILOT'S THROTTLES, LOCK OFF, or CO-PILOT'S THROTTLES, LOCK OFF.	5. Reply PILOT'S THROTTLES or CO-PILOT'S THROTTLES. Do not relinquish command of throttles until Co-Pilot replies.
6. State power settings. Example: MANIFOLD THREE ZERO.	6. If Co-Pilot's throttles, adjust power and repeat each setting called for by pilot.	6. Monitor power adjustments made by pilots; monitor engine instruments.
7. Over low cone call for GEAR DOWN, RPM 2400 (flaps required for final landing) and reduce air-speed to 120 knots.	7. Acknowledge command GEAR COMING DOWN. Gear down, 3 lights. When flaps are set, state FLAPS SET. (As desired).	7. Monitor engine instruments. Acknowledge: RPM 2400.
8. Call for BEFORE LANDING CHECK LIST.	8. BEFORE LANDING CHECK LIST COMPLETE.	8. BEFORE LANDING CHECK LIST COMPLETE.
9. Take throttles and state PILOT'S THROTTLES, instruct Co-Pilot to make adjustments if desired.	9. Acknowledge command PILOT'S THROTTLES, place left hand on throttles to adjust power if so instructed.	9. Monitor power adjustments by pilots.

THREE ENGINE RANGE APPROACH (STRAIGHT-IN):

1. *High Cone to Low Cone*—Same as four (4) engine approach except 2400 rpm over high cone.
2. *Low Cone*—Gear down and rpm 2400. Landing flaps as desired.

TWO ENGINE RANGE APPROACH (STRAIGHT-IN):

1. *High Cone to Low Cone*—Maintain 150 knots (minimum), rpm 2400, gear and flaps UP. If No. 3 and No. 4 engines are inoperative, resulting in loss of secondary pressure, the hydraulic system cross-over valve switch must be moved to EMERGENCY to permit pressure from the primary system to take over the functions of the secondary system.
2. *Low Cone*—Flaps Take-Off, rpm 2800, airspeed 30% above stall speed. Maintain a minimum of 130 knots. Gear down and flaps to desired position when safe landing is assured.

FOUR ENGINE RANGE APPROACH (CIRCLING):

1. *High Cone to Low Cone*—Same as four (4) engine range approach (straight-in).

2. *Low Cone*—Keep gear up and continue approach until reaching opposite end of runway. Proceed as during normal traffic pattern.

THREE ENGINE APPROACH (CIRCLING):

1. *High Cone to Low Cone*—Same as three (3) engine range approach (straight-in).
2. *Low Cone*—Keep gear up until turning final approach, then put gear down. Lower balance of flaps as required.

TWO ENGINE RANGE APPROACH (CIRCLING):

1. *High Cone to Low Cone*—150 knots, rpm 2400, flaps and gear up. If No. 3 and No. 4 engines are inoperative, resulting in loss of secondary pressure, the hydraulic system cross-over valve switch must be moved to EMERGENCY to permit pressure from the primary system to take over the functions of the secondary system.
2. *Low Cone*—Maintain 150 knots, rpm 2400, flaps and gear up while circling. Entering final, same as two-engine range approach (straight-in).

**STANDARD GCA AND ILS PROCEDURE
(PLUS 2 AND 3 ENGINE PROCEDURE)**

1. Prior to reaching the radio fix used in conjunction with GCA or ILS the pilot reduces airspeed to 150 knots and calls for **FLAPS TAKE OFF, RPM 2100, DESCENT CHECK LIST.**

2. Co-Pilot and Flight Engineer acknowledge and repeat command when accomplished.

3. Maintain 130 knots on GCA down wind leg and ILS outbound course.

4. When ILS glide path needle starts to deflect downward or when informed by GCA to begin rate of descent, pilot calls for **GEAR DOWN, RPM 2400, BEFORE LANDING CHECK LIST.** Pilot then adjusts power to maintain airspeed and glide path angle - 120 knots - final flaps when contact.

Three (3) Engine GCA or ILS Approach.

The three (3) engine approach is same as four (4) engine except pilot calls for rpm 2400 over radio fix.

Two (2) Engine GCA or ILS.

1. The two engine approach is same as three engine except that airspeed is 150 knots, and gear and flaps remain up.

2. When intercepting GCA or ILS glide slope, rpm 2800, flaps take-off, and maintain 130 knots. If No. 3 and No. 4 engines are inoperative, resulting in loss of secondary pressure, the hydraulic system cross-over valve switch must be moved to **EMERGENCY** to permit pressure from the primary system to take over the functions of the secondary system.

3. Pilot calls for **GEAR DOWN** when safe landing assured. Complete **BEFORE LANDING CHECK LIST.**

COLD WEATHER PROCEDURES.

Most cold weather operating difficulties are encountered on the ground. The most critical periods in the operation of the aircraft are the postflight and preflight periods. Proper diligence on the part of crew members concerning ground operations is the most important factor in successful arctic operations. The following should be noted when temperatures reach freezing or below.

1. The oil dilution system has been disconnected on all C-121A aircraft.

2. Since all Air Force C-121A aircraft are equipped with electric propellers there are no instructions or special steps necessary to assure proper operation of the propellers under extreme cold conditions. Proper propeller feathering is assured as long as there is adequate electrical power.

3. Arctic Operating Technique:

a. Check Y-drains and oil tank sumps to be sure the oil is not congealed. If necessary, warm oil until it flows freely, and remove any ice that may have collected in Y-drains or sumps.

b. Check that the alcohol de-icing tanks are full, and that all alcohol pumps for propeller, windshield, and carburetors are working properly.

c. Check that the pitot heaters are working.

d. For starting engines, make sure there is auxiliary power available (either the ship's A.P.U. or an external battery cart). Pull propellers through twelve blades with the starter before placing magneto switch to the ON position. Start engine by normal procedure, remembering that when the engine is cold it will probably require extra priming.

e. After engines have been started, there is no minimum oil temperature specified before take off. It is necessary to assure proper circulation of the oil before using maximum power. When oil temperature has risen a minimum of 6° C (10° F) above prestarting temperature, and oil pressure has stabilized, it is permissible to take-off. Do not take-off with an oil temperature higher than 104° C (219° F).

f. There is no minimum cylinder head temperature specified for take-off.

CAUTION

If engines do not start after a reasonable number of attempts, it is recommended that the engines be prewarmed, either by the use of outside heaters, or by putting the aircraft in the hangar.

4. All C-121A aircraft are equipped with electrically-driven instruments which will operate if cockpit temperature is above -65° C. The instruments may be prewarmed, if necessary, by directing the heat from the aldis lamp against the instruments.

CAUTION

Electrical instruments are sometimes slow in becoming properly erect in extreme cold; however, a maximum of 15 minutes should allow them to stabilize properly.

5. Take-Off:

If deep, heavy snow interferes with the take-off run, but permits taxiing, the aircraft may be taxied

gca procedures

WHEN OVER RADIO FIX

	POWER	FLAPS	AIRSPEED	CHECK LIST
FOUR ENGINES	2100 RPM	TAKE-OFF	130 KNOTS	DESCENT
THREE ENGINES	2400 RPM	TAKE-OFF	130 KNOTS	DESCENT
TWO ENGINES	2400 RPM	UP	150 KNOTS	DESCENT

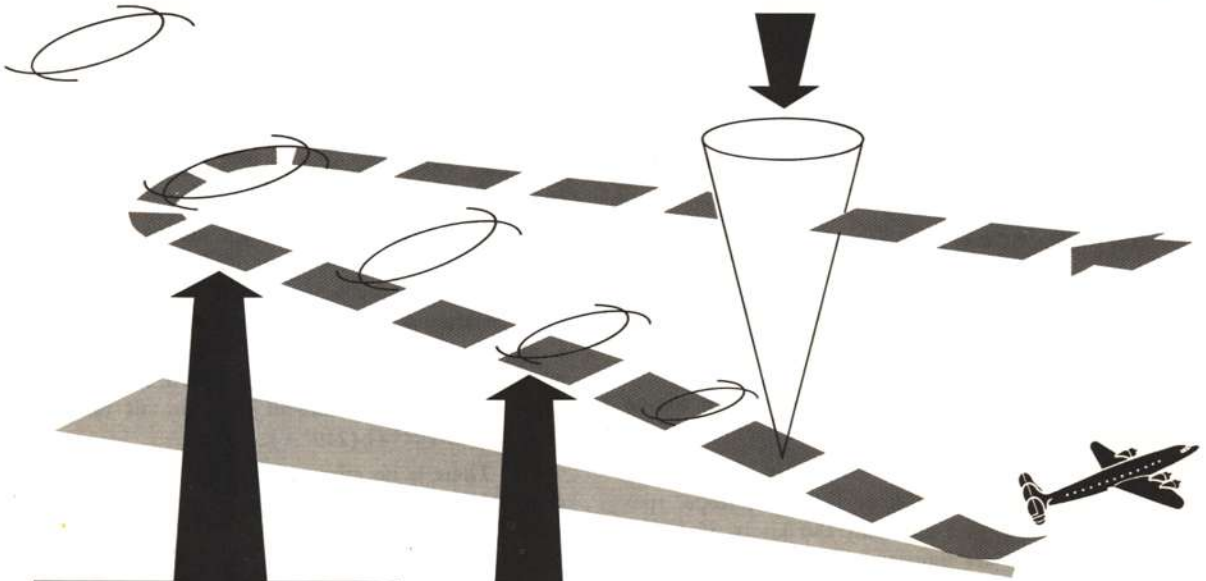

WHEN INBOUND

FOUR ENGINES	FLAPS
THREE ENGINES	TAKE-OFF
TWO ENGINES	TAKE-OFF

Note:
Flaps as desired when
landing is assured.

PRIOR TO INTERCEPTING GLIDE PATH

	POWER	GEAR	AIRSPEED	CHECK LIST
FOUR ENGINES	2400 RPM	DOWN	120 KNOTS	BEFORE LANDING
THREE ENGINES	2400 RPM	DOWN	120 KNOTS	BEFORE LANDING
TWO ENGINES	2800 RPM	DOWN WHEN LANDING IS ASSURED	130 KNOTS (MIN)	BEFORE LANDING

Note: The pilot will advise GCA of the rate of turn to be used throughout the procedure. Request a 10-second gear warning before intercepting glide path.

F125-4-9-109

Figure 9-3

ils procedures

WHEN OVER RADIO FIX

FOUR ENGINES
THREE ENGINES
TWO ENGINES

POWER
2100 RPM
2400 RPM
2400 RPM

FLAPS
TAKE-OFF
TAKE-OFF
UP

AIRSPEED
130 KNOTS
130 KNOTS
150 KNOTS

CHECK LIST
DESCENT
DESCENT
DESCENT

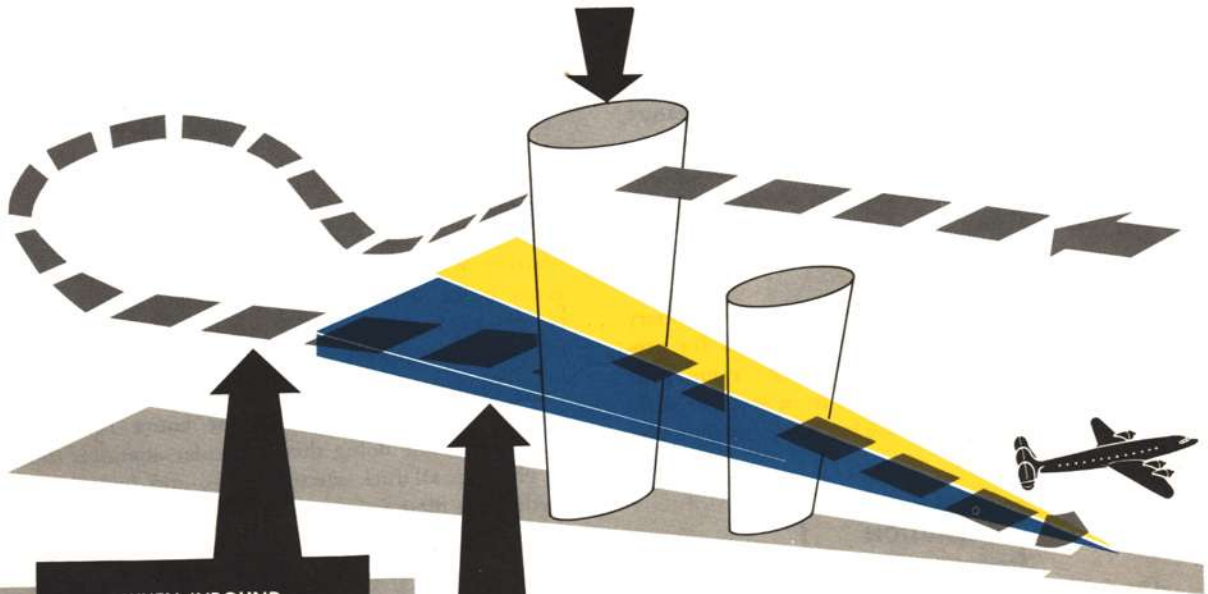

WHEN INBOUND

FOUR ENGINES
THREE ENGINES
TWO ENGINES

FLAPS
TAKE-OFF
TAKE-OFF
TAKE-OFF

Note:
Flaps as desired when
landing is assured.

PRIOR TO INTERCEPTING GLIDE PATH

FOUR ENGINES
THREE ENGINES
TWO ENGINES

POWER
2400 RPM
2400 RPM
2800 RPM

GEAR
DOWN
DOWN
DOWN WHEN
LANDING IS ASSURED

AIRSPEED
120 KNOTS
120 KNOTS
130 KNOTS

CHECK LIST
BEFORE LANDING
BEFORE LANDING
BEFORE LANDING

Figure 9-4

up and down the runway to pack down the snow. Never take-off with snow or ice on the wings or tail surfaces. Particular attention should be given to all movable surfaces to see that hinges and trim tabs have free and full movement.

6. In Flight:

Following take off from a snow or slush covered field, the landing gear should remain down long enough for the moisture to either freeze or dry, if terrain and flight conditions permit. However, if it is night or if instrument conditions prevail and it is necessary to climb, the gear must be retracted as soon as possible to aid in a faster climb.

a. When operating at cruise power under icing conditions and in extreme cold outside air temperature, it is recommended that sufficient carburetor heat be applied to prevent ice; this will also aid in fuel vaporization under extreme cold condition, giving better fuel consumption and smoother engine performance.

7. Landing:

Before landing, it is advisable to start the auxiliary power unit to insure sufficient electrical power for propeller reversing, when the generators are running at slow speed. This allows the aircraft to be stopped without the use of brakes. Always use brakes sparingly under extreme cold conditions.

CAUTION

On fields that are covered with loose snow, it is necessary to be careful to avoid blowing

snow up in front of aircraft when propellers are reversed, thereby reducing visibility to zero momentarily.

8. Sump Drainage:

It is necessary to drain the sumps on the fuel and oil systems frequently to remove ice and water that may have collected in these systems. It is also necessary to drain the sumps on the heater fuel system in order to assure proper fuel flow for heater operation. This may be accomplished by lowering the flaps and opening the heater inspection plates on the under side of the wing root.

9. Parking:

When aircraft is parked for the night, it is advisable to leave a window, door, or some other hatch open to allow air circulation. This will greatly reduce the frosting of windows. Furthermore, when parking be sure that the brake selector is placed in the EMER. position while parking brakes are on, as the emergency brake system has an accumulator which allows for any expansion or contraction of hydraulic fluid due to change in temperature.

10. Under extreme cold conditions it is necessary to make frequent inspections of the entire fuel system for leaks. While doing this, particular attention should be given to all fuel selector valves, and fuel line connections, as these units are more likely to develop leaks.

11. It is also necessary to give the landing gear struts particular attention under extreme cold conditions, as the strut packing glands often develop leaks, and require frequent tightening and inflation of struts.

APPENDIX I

PERFORMANCE DATA

TABLE OF CONTENTS

<i>Part</i>		<i>Page</i>
1	INTRODUCTION	A1-1
2	ENGINE OPERATING DATA	A2-1
3	TAKE-OFF	A3-1
4	CLIMB	A4-1
5	CRUISE	A5-1
6	LANDING AND GO-AROUND	A6-1
7	MISSION PLANNING WITH SAMPLE PROBLEM	A7-1

PART 1— INTRODUCTION

TABLE OF CONTENTS

	<i>Page</i>
Summary	A1-2
Aircraft Configurations	A1-2
Engines	A1-2
Propellers	A1-2
Carburetor Air Scoops	A1-2
Data Basis	A1-2
Fuel and Fuel Density	A1-2
Airspeed and Altimeter Correction Charts	A1-2
Temperature Correction and Conversion Charts	A1-3
Standard Atmosphere Table	A1-3
Density Altitude Chart	A1-3
Psychrometric Chart	A1-3
Symbols and Definitions	A1-3
Sample Problems — Use of Standard Charts	A1-3
Speed Relationship	A1-4
Temperature Relationship	A1-4
Altitude Relationship	A1-5
Use of Psychrometric Chart	A1-5

LIST OF ILLUSTRATIONS

<i>Title</i>	<i>Page</i>
Airspeed Installation Error Correction	A1-6
Altimeter Installation Error Correction	A1-8
Compressibility Correction Table	A1-10
Airspeed Compressibility Correction Graph	A1-11
Temperature Compressibility Correction	A1-12
Temperature Conversion Chart	A1-13
Standard Atmosphere Table	A1-14
Density Altitude Table	A1-15
Density Altitude Chart	A1-16
Psychrometric Chart	A1-17

SUMMARY.

The purpose of this appendix is two-fold. It provides aircraft performance information needed for flight planning under standard and various non-standard conditions. It also provides those types of information needed to check aircraft and engine performance in flight. An arrangement of seven parts is used to do this. Each part either relates to a particular phase of flight, or summarizes a particular type of information. For example, Part Two presents engine operating data applying to all phases of operation. Power available, fuel flow characteristics, and detailed engine limits are given there. Part Three contains data needed for take-off planning such as critical field lengths and speed schedules. In addition, check data are given in Part Three so that aircraft speed can be compared with predicted performance at a selected distance during the run. The procedures to be followed in using the charts are given with discussions of the data. Numerical examples and solutions are also provided.

AIRCRAFT CONFIGURATIONS.

The performance charts which follow are directly applicable to C-121A and VC-121B aircraft operating with undercowl-type carburetor air scoops, without tip tanks, with R-3350-75 engines, and Curtiss 830-26C4-0 propeller blades. Minor differences in external antenna types or locations should not have any appreciable effect upon performance.

ENGINES.

Aircraft performance is for operation with the R3350-75 engines with exhaust collector rings installed. Power ratings, operating limits, and the altitude performance of this engine are the same as for the commercial counterpart, the WAD-749C18BD-1, except for effects due to jet exhaust stacks which are standard on most commercial installations.

PROPELLERS.

The performance data contained in this appendix are applicable to aircraft equipped with Curtiss C634S-C460 830-26C4-0 full-feathering, reversible electric propellers with spinners and modified cuffs. Aircraft performance is not changed for those equipped with 830-21C4-0 blades.

CARBURETOR AIR SCOOPS.

All performance data shown in this appendix reflects operation with undercowl air scoops.

DATA BASIS.

Performance data given here are based on Contractor's flight tests and operator's performance reports for C-121A and commercial model 749 aircraft. Receipt of this material has extended over a period of several years. The release date on the performance charts represents the approximate time of its re-evaluation for applicability to this flight manual.

FUEL AND FUEL DENSITY.

Aircraft and engine performance shown in this appendix are representative of normal operation with 100/130 grade fuel. This fuel has a nominal density of six pounds per U.S. gallon, a value which may be used to determine aircraft gross weight or to convert fuel flow readings from pounds per hour to gallons per hour. However, to determine the fuel weight accurately, density of the loaded fuel should be measured with a hydrometer.

AIRSPPEED AND ALTIMETER CORRECTION CHARTS.

Airspeed and altitude readings obtained directly from flight instruments should be corrected prior to use to account for the mechanical errors in individual instruments and the position errors due to pitot-static and static hole locations. An additional correction to airspeed readings should be made to account for altitude compressibility effects. Position and compressibility error correction charts are provided for this purpose in this part of the appendix. Note that they give the correction to be applied, not the error. Individual instrument corrections cannot be supplied here, but should be made available by periodic bench calibrations and supplied on calibration cards for the instruments in use.

Note

The physical condition of the flush static and pitot static pressure sources is quite important as it affects the accuracy of the position error corrections. These items should be inspected frequently, kept in alignment, and free of water, dirt, leaks, metal burrs, etc., which might result in serious malfunction of the airspeed system.

The pitot-static corrections (Fig. A1-1 and A1-3) are applicable to the Pig Nose head, Part No. 373E-012. No correction charts are presented for the Blunt Nose head, Part No. 372E-012, since there were no flight tests conducted.

TEMPERATURE CORRECTION AND CONVERSION CHARTS.

At normal flight speeds, outside air temperature is less than the value indicated by the flight instruments. This is due to the temperature rise which occurs when ram air surrounds the sensing element. The air is heated by compression to nearly 100% of adiabatic rise possible. Figure A1-7 provides the correction which should be made to the indicated value to obtain correct true ambient air temperature. Corrections for individual instrument errors should be applied first, of course. Figure A1-8 is provided as a convenience for converting from Centigrade to Fahrenheit.

STANDARD ATMOSPHERE TABLE.

The Standard Atmosphere Table presented as Figure A1-9 shows the standard variation of temperature, pressure, and density with altitude. It is based on definitions adopted by the ICAO, and supersedes data previously issued by the NACA.

DENSITY ALTITUDE CHART.

The Density Altitude Chart shown on Figure A1-11 is based on the ICAO definition of standard atmosphere. It can be used to find density altitude (H_d) and density ratio when pressure altitude (H_p) and ambient air temperature (FAT) are shown. Note the accuracy with which air temperature should be known. An error of 5° C will give an error in H_d of about 550 feet. The resultant error in $1/\sqrt{\sigma}$ will be about 1%, an error which would be reflected in computing true airspeed. Pressure altitude should be read from an instrument set at 29.92 in Hg., the standard pressure at sea level.

PSYCHROMETRIC CHART.

A Psychrometric Chart is included as Figure A1-12. This chart may be used to determine the dew point temperature value which is used in the prediction of maximum power available. The dew point may be determined with wet and dry bulb temperatures, vapor pressure, or specific humidity combined with the pressure altitude.

SYMBOLS AND DEFINITIONS.

- *IAS Indicated Airspeed—The airspeed value read from an airspeed indicator.
- BAS Basic Airspeed—The indicated airspeed reading corrected for instrument mechanical error.
- *CAS Calibrated Airspeed—The airspeed obtained by applying the position error correction to indicated airspeed.

- *EAS Equivalent Airspeed—The airspeed obtained by applying the altitude compressibility correction to calibrated airspeed. Also obtained by multiplying true airspeed by $\sigma^{1/2}$.
- *TAS True Airspeed—Speed of aircraft relative to the air through which it is flying. ($EAS \times \sigma^{-1/2}$)
- V_G Ground Speed—Speed of the aircraft relative to the ground over which it flies.
- H_p Pressure Altitude—That value obtained after correcting an altimeter reading for instrument and position errors.
- H_d Density Altitude—That value obtained from the Density Altitude Chart at which air density at the existing pressure altitude and temperature equals air density as defined by the ICAO for standard atmospheric conditions.
- OAT Observed Air Temperature—Value read from air temperature gage.
- BAT Basic Air Temperature—Observed air temperature corrected for instrument mechanical error.
- FAT Free (Ambient) Air Temperature—Air Temperature obtained by correcting BAT for the temperature rise which accompanies adiabatic compression.
- ICAO International Civil Aviation Organization.
- RPM Revolutions Per Minute—Engine rotational speed.
- BMEP Brake Mean Effective Pressure—BMEP gage reading corrected for instrument error.
- BHP Brake Horsepower—Engine power delivered for propulsion. By definition, $BHP = RPM \times BMEP / 236$ for R3350-75 engines.

*Prefix K with these symbols indicate airspeed in knots: KTAS — true airspeed in knots.

SAMPLE PROBLEMS — USE OF STANDARD CHARTS.

The examples illustrate the use of the standard correction charts and the sequence to be followed. The cases are for level flight conditions that provide the stabilized instrument readings shown. Instrument calibrations used are *assumed* values. The instrument calibration cards should be employed when available; otherwise, assume zero error.

SAMPLE PROBLEM.

SPEED RELATIONSHIP

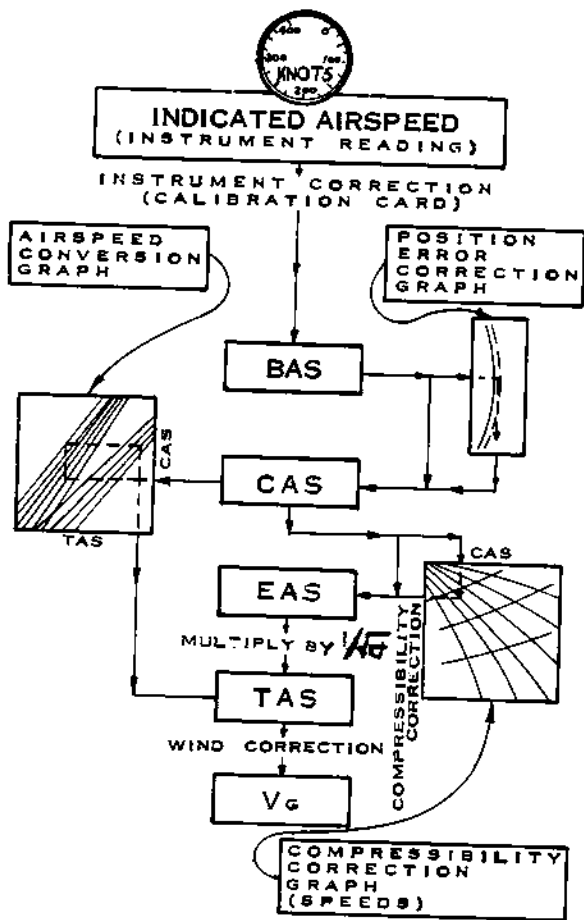

Static System Used Flush
Instrument Panel Pilot
Wing Flaps and Gear Up

Problem: to find calibrated airspeed (CAS)

Indicated Airspeed (IAS) 189.0 Kts
(Instrument reading)
Instrument Correction (assumed) -2.5
(Obtain from calibration card)
Basic Airspeed (BAS) 186.5
(IAS + calibration correction)
Position Error Correction +5.5
(Use Figure A1-2, find ΔV_{II})
Calibrated Airspeed (CAS) 192.0
(BAS + ΔV_{II})

Problem: to find equivalent airspeed (EAS)

Altimeter Reading 19,850'
(From instrument set at 29.92)
Instrument Correction +60
(Obtain from calibration card)
Indicated Pressure Altitude 19,910
(Instrument reading + correction)
Position Error Correction +90
(Figure A1-4 [ΔH_{II}])
Pressure Altitude (H_p) 20,000
(Indicated pressure altitude + ΔH_{II})
Airspeed Compressibility Correction -2.5
(Use Figure A1-6, find ΔV_c)
Equivalent Airspeed (EAS) 189.5
(CAS + ΔV_c)

Problem: to find true airspeed (TAS)

Equivalent Airspeed 189.5
(From problem above)
 $1/\sqrt{\sigma}$ (H_{II} of 21,050) 1.394
(Use Figure A1-9)
True Airspeed (TAS) 264.0
(EAS $\times 1/\sqrt{\sigma}$)

SAMPLE PROBLEM.

TEMPERATURE RELATIONSHIP

Uncorrected Air Temperature -4° C
(From OAT instrument)
Instrument Correction (assumed) -3° C
(Obtained from calibration card)
BAT -7° C
(Instrument reading + correction)
Compressibility Correction +8.5° C
(Use Figure A1-7, read ΔT)
Ambient Temperature (FAT) -15.5° C
(Basic air temperature - ΔT)
Temperature Conversion +4° F
(Use Figure A1-8, read FAT)

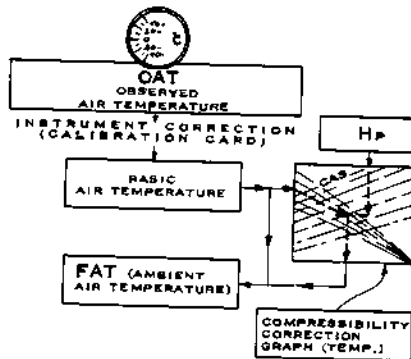

SAMPLE PROBLEM.

ALTITUDE RELATIONSHIP

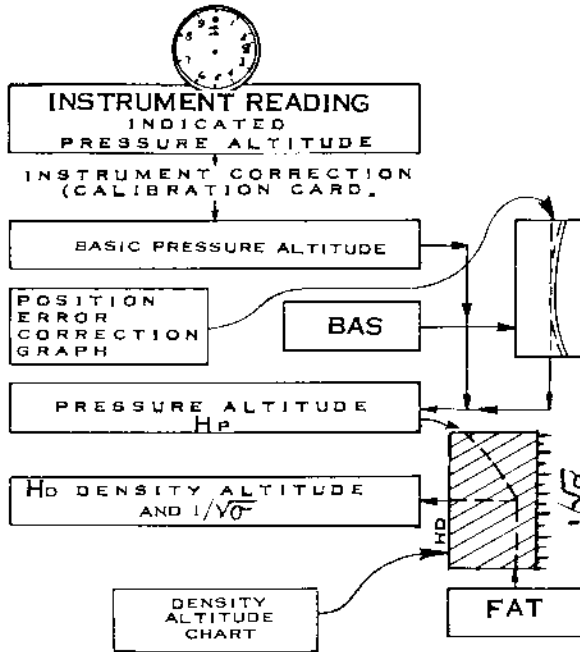

- Static System Used Flush
- Instrument Panel Pilot
- Wing Flaps and Gear Up

Problem: to find pressure altitude (H_p)

Altimeter Reading	19,850
(From instrument set at 29.92)	
Instrument Correction (assumed)	+60
(Obtain from calibration card)	
Indicated Pressure Altitude	19,910
(Instrument reading + correction)	
Position Error Correction	+90
(From Figure A1-4 [ΔH_p])	
Pressure Altitude (H_p)	20,000
(Indicated pressure altitude + position error correction)	

Problem: to find density altitude (H_0) and $1/\sqrt{\sigma}$

Density Altitude (H_0)	21,050
(From Figure A1-12, Read H_0 at the intersection of Pressure Altitude [20,000] and FAT [15.5° C])	
$1/\sqrt{\sigma}$	1.394
(From Figure A1-12, read $1/\sqrt{\sigma}$ Opposite Density Altitude [21,050] Value)	

SAMPLE PROBLEM.

USE OF THE PSYCHROMETRIC CHART

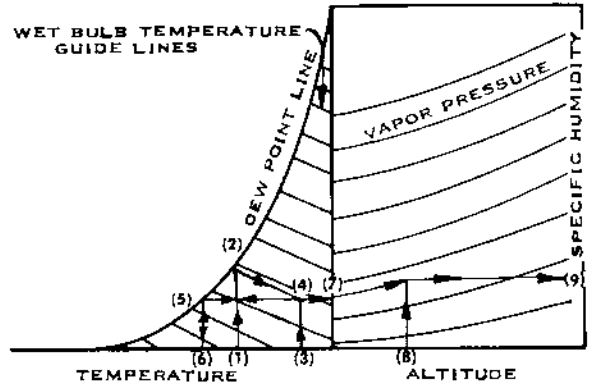

The psychrometric chart provides dew point values for prediction of maximum power for take-off. The chart can also be used to find vapor pressure, specific humidity, or relative humidity if desired.

If wet and dry bulb temperatures are given, find dew point by steps (1)-(6) in the following sequence. Enter the chart with wet bulb temperature (1) and move to the dew point base line (2). Proceed diagonally parallel to a wet bulb guide line to point (4) located above the dry bulb temperature (3). Move left horizontally to the dew point line (5) and read the dew point below at position (6). If wet bulb temperature is 70° F, and dry bulb temperature is 95° F, the dew point is 57.7° F.

If vapor pressure only is given, enter the chart with vapor pressure at (7) and follow the step sequence (7), (5), (6). Dew point is 57.7° F. when vapor pressure is 0.495.

Follow step sequence (9), (8), (7), (5), (6) when specific humidity and pressure altitude are given. Proceed horizontally from specific humidity (9) to pressure altitude (8), then parallel to a vapor pressure guide line to the vapor pressure base line (7). Then continue horizontally to the dew point line (5) and vertically to dew point at (6). Dew point is 57.7° F for a specific humidity of 0.012 and 3000 ft. pressure altitude.

Relative humidity can be used with dry bulb temperature to find dew point. For 80% r.h. and 64° F. dry bulb temperature, locate a position 80% of the vertical distance from the temperature line to the dew point line. Proceed horizontally to the dew point line (5) and read dew point below at (6), 57.7° F. or 14° C. Wet bulb temperature would be 60° F. for these conditions, since this is the intersection of a wet bulb guide line drawn from (5) to the 80% r.h. line.

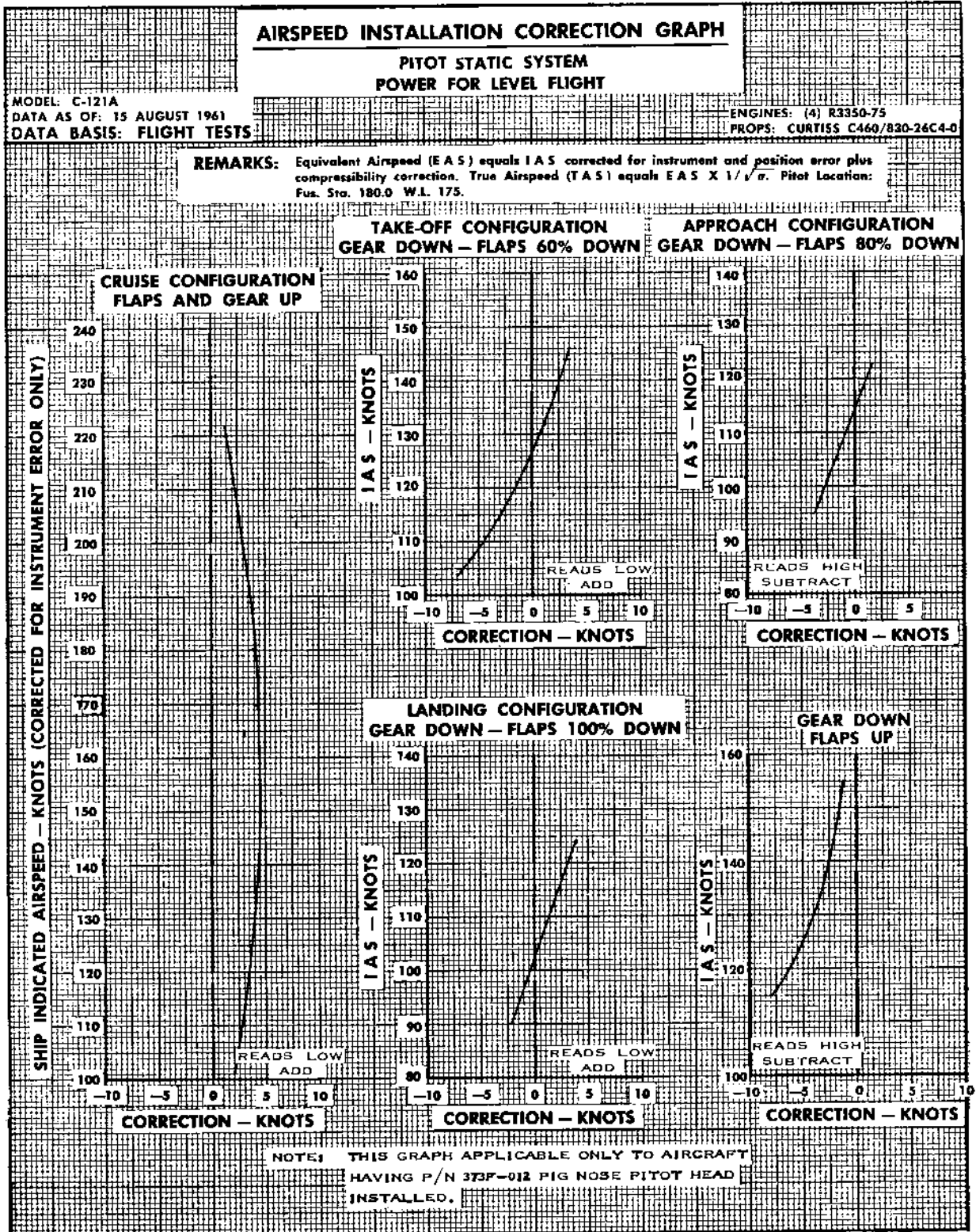
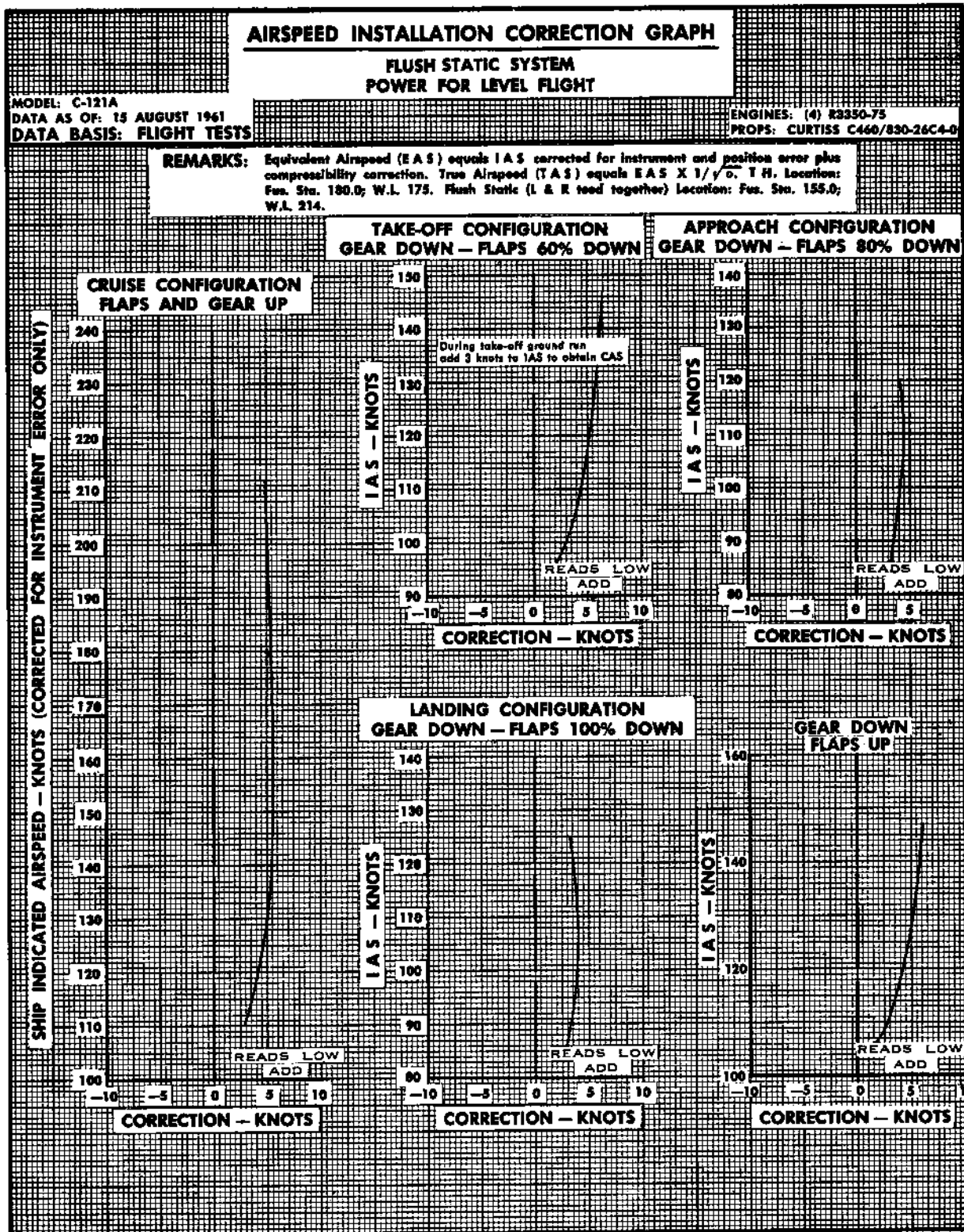

Figure A1-1



SHIP INDICATED AIRSPEED - KNOTS (CORRECTED FOR INSTRUMENT ERROR ONLY)

Figure A1-2

ALTIMETER INSTALLATION CORRECTION GRAPH

**PITOT STATIC SYSTEM
POWER FOR LEVEL FLIGHT**

MODEL: C-121A
DATA AS OF: 15 AUGUST 1961
DATA BASIS: FLIGHT TESTS

ENGINES: (4) R3350-75
PROPS: CURTISS C460/830-26C4-0

REMARKS: Correct pressure altitude equals indicated pressure altitude corrected for instrument and position error. Pitot Static (L & R feed together) Location: Fus. Sta. 180.0; W.L. 175.0.

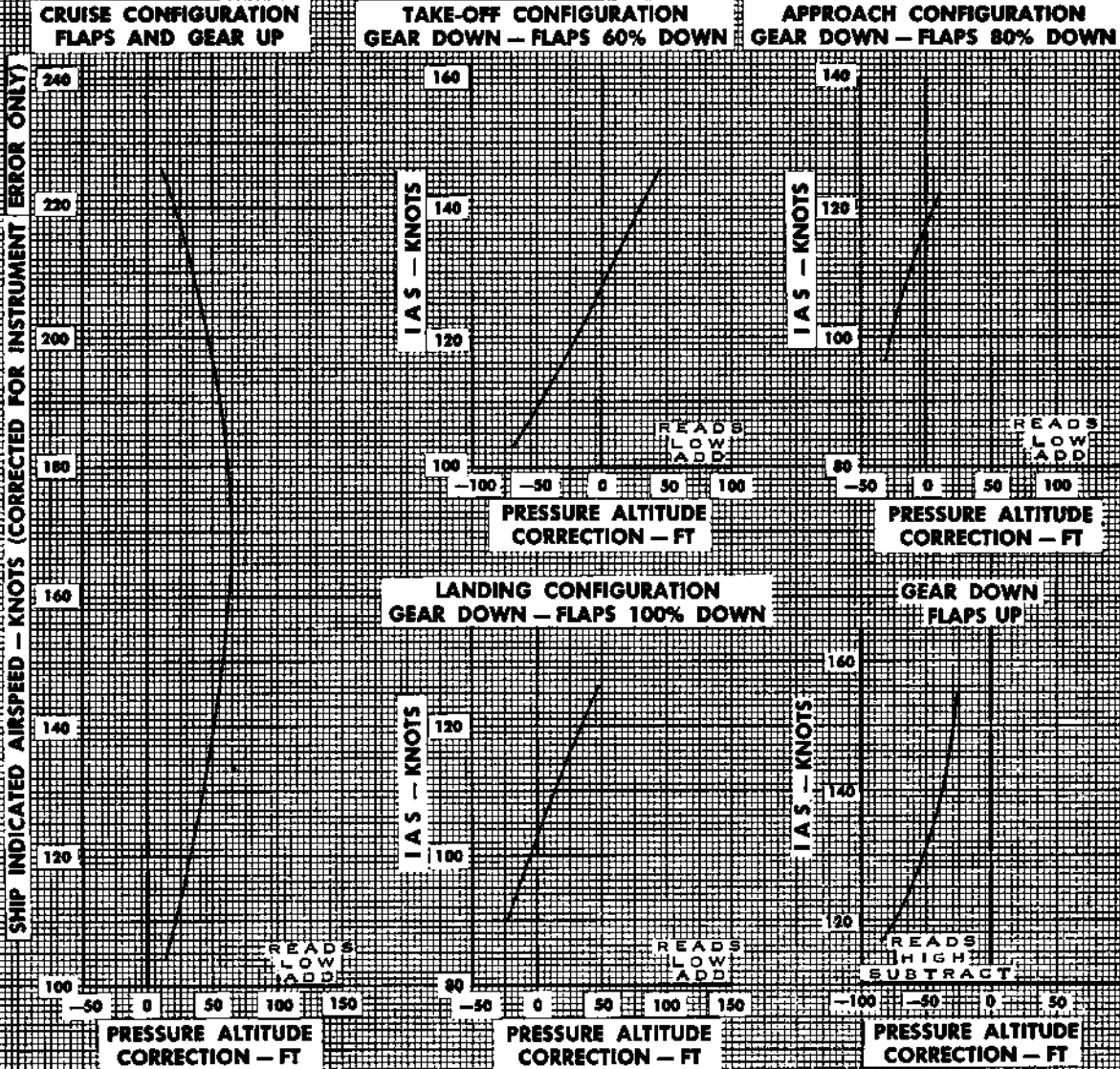

NOTE: THIS GRAPH APPLICABLE ONLY TO AIRCRAFT HAVING P/N 373F-012 PIG NOSE PITOT HEAD INSTALLED.

Figure A1-3

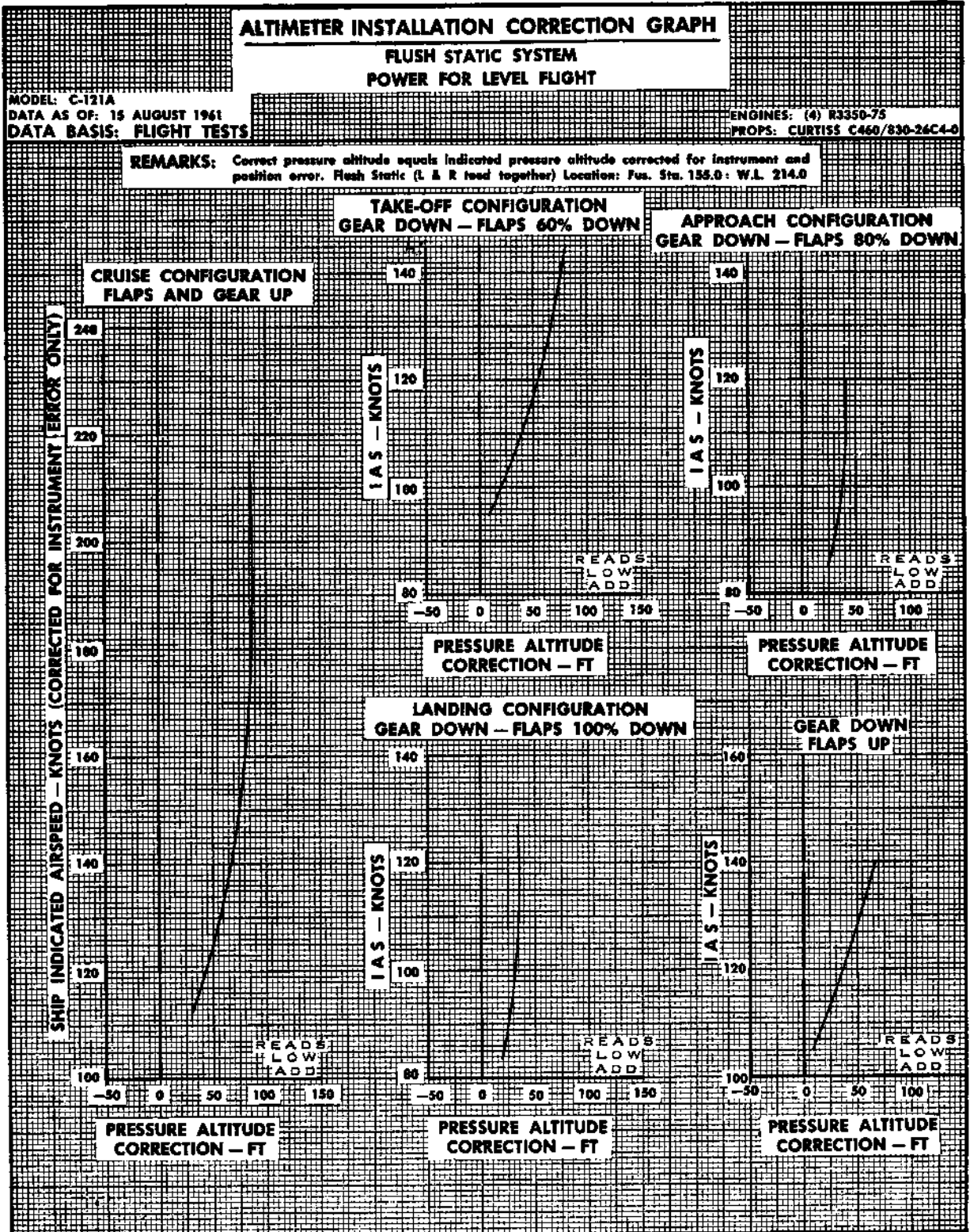

Figure A1-4

COMPRESSIBILITY CORRECTION TABLE

PRESSURE ALTITUDE FEET	CALIBRATED AIRSPEED—C A S —KNOTS			
	150	200	250	300
	TEMPERATURE COMPRESSIBILITY CORRECTION—°C			
SEA LEVEL	- 3	- 5	- 8	- 12
5,000	- 3	- 6	- 9	- 14
10,000	- 4	- 7	- 11	- 16
15,000	- 5	- 8	- 13	- 19
20,000	- 6	- 10	- 15	- 22
25,000	- 7	- 12	- 18	- 26
30,000	- 8	- 14	- 22	- 31

REMARKS:

1. 100% adiabatic temperature rise assumed.
2. Indicated temperature reads high.
3. Data based on I.C.A.O. standard day conditions.
4. Sensing element: Resistance bulb located in externally ventilated box at fus. sta. 220.65; W.L. 179.71.

PRESSURE ALTITUDE FEET	CALIBRATED AIRSPEED—C A S —KNOTS			
	150	200	250	300
	AIRSPEED COMPRESSIBILITY CORRECTION—KNOTS			
SEA LEVEL	0	0	0	0
2,000	0	0	0	- 0.5
4,000	0	- 0.5	- 0.5	- 1.0
6,000	- 0.5	- 0.5	- 1.0	- 1.5
8,000	- 0.5	- 1.0	- 1.5	- 2.5
10,000	- 0.5	- 1.0	- 2.0	- 3.5
12,000	- 0.5	- 1.0	- 2.5	- 4.0
14,000	- 1.0	- 1.5	- 3.0	- 5.0
16,000	- 1.0	- 2.0	- 3.5	- 6.0
18,000	- 1.0	- 2.5	- 4.0	- 7.0
20,000	- 1.5	- 2.5	- 5.0	- 8.0
22,000	- 1.5	- 3.0	- 5.5	- 9.0
24,000	- 1.5	- 3.5	- 6.5	
26,000	- 2.0	- 4.0	- 7.5	
28,000	- 2.0	- 4.5	- 8.0	
30,000	- 2.5	- 5.0	- 9.0	

REMARKS:

1. Equivalent airspeed (EAS) equals airspeed instrument reading corrected for instrument and position errors and the altitude compressibility correction shown above.
2. True speed through the air (TAS) equals $EAS \times 1/\sqrt{\sigma}$.

Figure A1-5

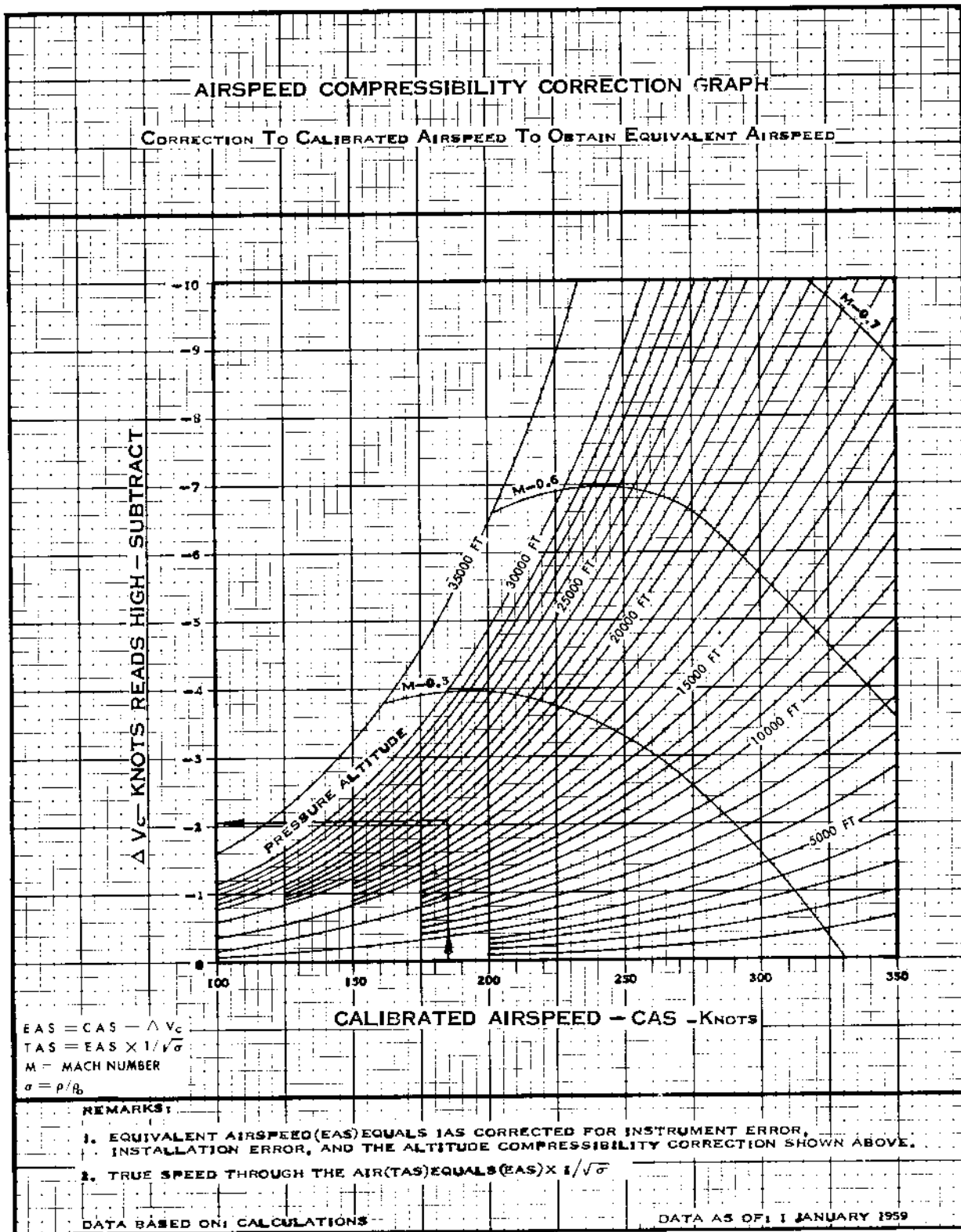

Figure A1-6

TEMPERATURE COMPRESSIBILITY CORRECTION CHART

CORRECTION TO INDICATED AMBIENT AIR TEMPERATURE
TO OBTAIN APPROXIMATE FREE AIR TEMPERATURE

Press. Alt.	IAS Knots	OBSERVED AIR TEMPERATURE — OAT — °C																
		-40	-35	-30	-25	-20	-15	-10	-5	0	5	10	15	20	25	30	35	40
5,000	150						3.0	3.0	3.0	3.0	3.5	3.5	3.5	3.5	3.5	3.5	3.5	3.5
	160						3.5	3.5	3.5	3.5	3.5	4.0	4.0	4.0	4.0	4.0	4.0	4.0
	170						4.0	4.0	4.0	4.0	4.0	4.5	4.5	4.5	4.5	4.5	4.5	5.0
	180						4.5	4.5	4.5	4.5	4.5	5.0	5.0	5.0	5.0	5.0	5.5	5.5
	190						5.0	5.0	5.0	5.0	5.5	5.5	5.5	5.5	5.5	6.0	6.0	6.0
	200						5.5	5.5	5.5	5.5	6.0	6.0	6.0	6.0	6.0	6.5	6.5	6.5
10,000	150				3.5	3.5	3.5	3.5	4.0	4.0	4.0	4.0	4.0	4.0	4.5	4.5		
	160				4.0	4.0	4.0	4.0	4.5	4.5	4.5	4.5	4.5	5.0	5.0	5.0		
	170				4.5	4.5	4.5	5.0	5.0	5.0	5.0	5.0	5.5	5.5	5.5	5.5		
	180				5.0	5.0	5.5	5.5	5.5	5.5	5.5	6.0	6.0	6.0	6.0	6.0		
	190				5.5	6.0	6.0	6.0	6.0	6.0	6.5	6.5	6.5	7.0	7.0	7.0		
	200				6.0	6.5	6.5	6.5	7.0	7.0	7.0	7.0	7.5	7.5	7.5	7.5		
15,000	150		4.0	4.0	4.5	4.5	4.5	4.5	4.5	5.0	5.0	5.0	5.0	5.0				
	160		4.5	4.5	5.0	5.0	5.0	5.0	5.5	5.5	5.5	5.5	5.5	5.5				
	170		5.0	5.5	5.5	5.5	6.0	6.0	6.0	6.0	6.0	6.5	6.5	6.5				
	180		6.0	6.0	6.0	6.5	6.5	6.5	6.5	7.0	7.0	7.0	7.0	7.0				
	190		6.5	6.5	7.0	7.0	7.0	7.5	7.5	7.5	7.5	8.0	8.0	8.0				
	200		7.5	7.5	7.5	7.5	8.0	8.0	8.0	8.5	8.5	8.5	9.0	9.0				
20,000	150	5.0	5.0	5.0	5.0	5.5	5.5	5.5	5.5	6.0	6.0	6.0	6.0					
	160	5.5	5.5	6.0	6.0	6.0	6.0	6.5	6.5	6.5	6.5	7.0	7.0					
	170	6.5	6.5	6.5	7.0	7.0	7.0	7.0	7.5	7.5	7.5	7.5	8.0					
	180	7.0	7.0	7.5	7.5	7.5	8.0	8.0	8.0	8.0	8.5	8.5	8.5					
	190	8.0	8.0	8.0	8.5	8.5	8.5	9.0	9.0	9.0	9.5	9.5	9.5					
	200	8.5	9.0	9.0	9.0	9.5	9.5	10.0	10.0	10.0	10.5	10.5	10.5					

Δ TEMPERATURE — °C

SUBTRACT Δ TEMP. FROM INDICATED AIR TEMP. TO OBTAIN AMBIENT AIR TEMP. (FAT)

* IAS - KNOTS — FLUSH STATIC SYSTEM.

- REMARKS:
1. 100% adiabatic temperature rise assumed.
 2. Indicated temperatures read high.
 3. Data based on NACA standard day conditions.
 4. Sensing element: Resistance bulb located in externally ventilated box at fus. sta. 220.65, W.L. 179.71.

Figure A1-7

TEMPERATURE CONVERSION GRAPH

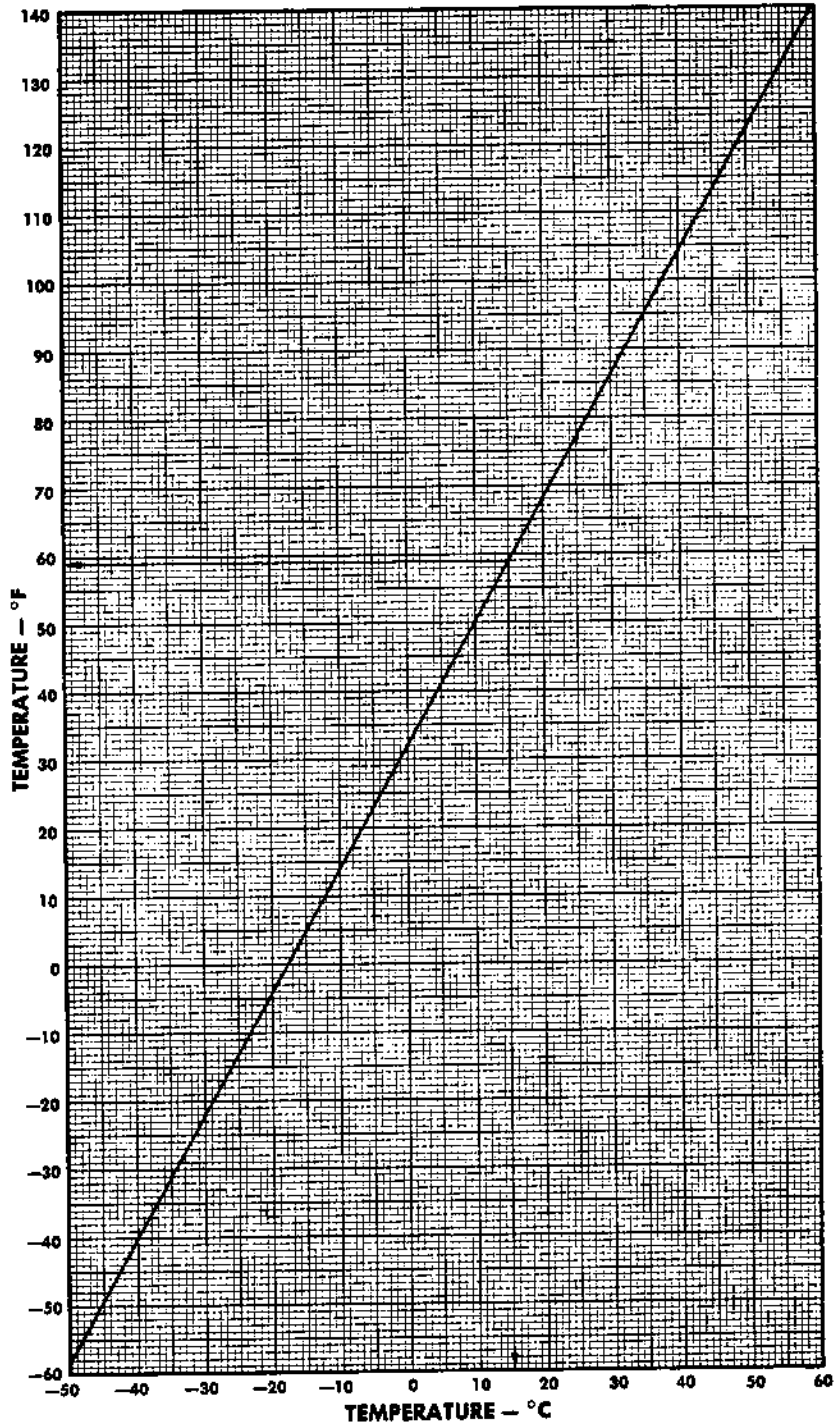

Figure A1-8

STANDARD ATMOSPHERE TABLE

STANDARD S L CONDITIONS:

TEMPERATURE 15°C (59°F)

PRESSURE 29.921 IN HG 2116.216 LB/SQ FT

DENSITY .0023769 SLUGS/CU FT

SPEED OF SOUND 1116.39 FT/SEC 661.7 KNOTS

CONVERSION FACTORS:

1 IN HG 70.727 LB/SQ FT

1 IN HG 0.49116 LB/SQ IN

1 KNOT 1.151 M.P.H.

1 KNOT 1.688 FT/SEC

ALTITUDE FEET	DENSITY RATIO σ	$\frac{\sigma - \frac{1}{2}}{\sqrt{\sigma}}$	TEMPERATURE		SPEED OF SOUND KNOTS	PRESSURE	
			DEG. C	DEG. F		IN. OF HG.	RATIO δ
-4000	1.1224	0.94390	22.925	73.265	670.7	34.5072	1.15327
-3000	1.0908	0.95748	20.943	69.698	668.5	33.3107	1.11328
-2000	1.0598	0.97136	18.962	66.132	666.2	32.1481	1.07442
-1000	1.0296	0.98552	16.981	62.566	664.0	31.0185	1.03667
0	1.0000	1.00000	15.000	59.000	661.7	29.9213	1.00000
1000	0.97106	1.0148	13.019	55.434	659.4	28.8557	0.96439
2000	0.94277	1.0299	11.038	51.868	657.1	27.8210	0.92981
3000	0.91512	1.0454	9.056	48.302	654.8	26.8167	0.89624
4000	0.88808	1.0611	7.075	44.735	652.5	25.8418	0.86366
5000	0.86167	1.0773	5.094	41.169	650.2	24.8959	0.83205
6000	0.83586	1.0938	3.113	37.603	647.9	23.9782	0.80138
7000	0.81064	1.1107	1.132	34.037	645.6	23.0881	0.77163
8000	0.78601	1.1279	-0.850	30.471	643.2	22.2249	0.74278
9000	0.76196	1.1456	-2.831	26.905	640.9	21.3881	0.71481
10000	0.73848	1.1637	-4.812	23.338	638.5	20.5769	0.68770
11000	0.71555	1.1822	-6.793	19.772	636.2	19.7909	0.66143
12000	0.69317	1.2011	-8.774	16.206	633.8	19.0293	0.63598
13000	0.67133	1.2205	-10.756	12.640	631.4	18.2917	0.61133
14000	0.65002	1.2403	-12.737	9.074	629.0	17.5773	0.58745
15000	0.62923	1.2606	-14.718	5.508	626.7	16.8858	0.56434
16000	0.60896	1.2815	-16.699	1.941	624.2	16.2164	0.54197
17000	0.58919	1.3028	-18.680	-1.625	621.8	15.5687	0.52032
18000	0.56991	1.3246	-20.662	-5.191	619.4	14.9421	0.49938
19000	0.55112	1.3470	-22.643	-8.757	617.0	14.3360	0.47913
20000	0.53281	1.3700	-24.624	-12.323	614.5	13.7501	0.45954
21000	0.51496	1.3935	-26.605	-15.889	612.1	13.1836	0.44061
22000	0.49758	1.4176	-28.586	-19.456	609.6	12.6363	0.42232
23000	0.48065	1.4424	-30.568	-23.022	607.1	12.1074	0.40464
24000	0.46416	1.4678	-32.549	-26.588	604.6	11.5967	0.38757
25000	0.44811	1.4938	-34.530	-30.154	602.2	11.1035	0.37109
26000	0.43249	1.5206	-36.511	-33.720	599.6	10.6274	0.35518
27000	0.41729	1.5480	-38.493	-37.286	597.1	10.1681	0.33983
28000	0.40250	1.5762	-40.474	-40.852	594.6	9.7249	0.32502
29000	0.38812	1.6052	-42.455	-44.419	592.1	9.2975	0.31073
30000	0.37413	1.6349	-44.436	-47.985	589.5	8.8854	0.29696

Figure A1-9

DENSITY ALTITUDE AND $1/\sqrt{\sigma}$

ALTITUDE FEET	$1/\sqrt{\sigma}$	ALTITUDE FEET	$1/\sqrt{\sigma}$	ALTITUDE FEET	$1/\sqrt{\sigma}$	ALTITUDE FEET	$1/\sqrt{\sigma}$	ALTITUDE FEET	$1/\sqrt{\sigma}$
0	1.000	6000	1.0938	12000	1.2011	18000	1.3246	24000	1.4678
100	1.0015	6100	1.0955	12100	1.2030	18100	1.3269	24100	1.4704
200	1.0029	6200	1.0971	12200	1.2049	18200	1.3291	24200	1.4729
300	1.0044	6300	1.0988	12300	1.2069	18300	1.3313	24300	1.4755
400	1.0059	6400	1.1005	12400	1.2088	18400	1.3335	24400	1.4781
500	1.0074	6500	1.1022	12500	1.2107	18500	1.3358	24500	1.4807
600	1.0088	6600	1.1039	12600	1.2127	18600	1.3380	24600	1.4833
700	1.0103	6700	1.1056	12700	1.2146	18700	1.3403	24700	1.4860
800	1.0118	6800	1.1073	12800	1.2166	18800	1.3425	24800	1.4886
900	1.0133	6900	1.1090	12900	1.2185	18900	1.3448	24900	1.4912
1000	1.0148	7000	1.1107	13000	1.2205	19000	1.3470	25000	1.4938
1100	1.0163	7100	1.1124	13100	1.2224	19100	1.3493	25100	1.4965
1200	1.0178	7200	1.1141	13200	1.2244	19200	1.3516	25200	1.4991
1300	1.0193	7300	1.1158	13300	1.2264	19300	1.3539	25300	1.5018
1400	1.0208	7400	1.1175	13400	1.2284	19400	1.3561	25400	1.5045
1500	1.0223	7500	1.1193	13500	1.2303	19500	1.3584	25500	1.5071
1600	1.0238	7600	1.1210	13600	1.2323	19600	1.3607	25600	1.5098
1700	1.0253	7700	1.1227	13700	1.2343	19700	1.3630	25700	1.5125
1800	1.0269	7800	1.1245	13800	1.2363	19800	1.3653	25800	1.5152
1900	1.0284	7900	1.1262	13900	1.2383	19900	1.3677	25900	1.5174
2000	1.0299	8000	1.1279	14000	1.2403	20000	1.3700	26000	1.5206
2100	1.0314	8100	1.1297	14100	1.2423	20100	1.3723	26100	1.5233
2200	1.0330	8200	1.1314	14200	1.2444	20200	1.3746	26200	1.5260
2300	1.0345	8300	1.1332	14300	1.2464	20300	1.3770	26300	1.5287
2400	1.0360	8400	1.1350	14400	1.2484	20400	1.3793	26400	1.5315
2500	1.0376	8500	1.1367	14500	1.2504	20500	1.3817	26500	1.5342
2600	1.0391	8600	1.1385	14600	1.2526	20600	1.3840	26600	1.5370
2700	1.0407	8700	1.1403	14700	1.2545	20700	1.3864	26700	1.5397
2800	1.0422	8800	1.1420	14800	1.2565	20800	1.3888	26800	1.5425
2900	1.0438	8900	1.1438	14900	1.2586	20900	1.3911	26900	1.5453
3000	1.0454	9000	1.1456	15000	1.2606	21000	1.3935	27000	1.5480
3100	1.0469	9100	1.1474	15100	1.2627	21100	1.3959	27100	1.5508
3200	1.0485	9200	1.1492	15200	1.2648	21200	1.3983	27200	1.5536
3300	1.0501	9300	1.1510	15300	1.2668	21300	1.4007	27300	1.5564
3400	1.0516	9400	1.1528	15400	1.2689	21400	1.4031	27400	1.5592
3500	1.0532	9500	1.1546	15500	1.2710	21500	1.4055	27500	1.5620
3600	1.0548	9600	1.1564	15600	1.2731	21600	1.4079	27600	1.5649
3700	1.0564	9700	1.1582	15700	1.2752	21700	1.4103	27700	1.5677
3800	1.0580	9800	1.1600	15800	1.2773	21800	1.4128	27800	1.5705
3900	1.0595	9900	1.1618	15900	1.2794	21900	1.4152	27900	1.5734
4000	1.0611	10000	1.1637	16000	1.2815	22000	1.4176	28000	1.5762
4100	1.0627	10100	1.1655	16100	1.2836	22100	1.4201	28100	1.5791
4200	1.0643	10200	1.1673	16200	1.2857	22200	1.4225	28200	1.5819
4300	1.0659	10300	1.1692	16300	1.2878	22300	1.4250	28300	1.5848
4400	1.0676	10400	1.1710	16400	1.2899	22400	1.4275	28400	1.5877
4500	1.0692	10500	1.1729	16500	1.2921	22500	1.4299	28500	1.5906
4600	1.0708	10600	1.1747	16600	1.2942	22600	1.4324	28600	1.5935
4700	1.0724	10700	1.1766	16700	1.2963	22700	1.4349	28700	1.5964
4800	1.0740	10800	1.1784	16800	1.2985	22800	1.4374	28800	1.5993
4900	1.0757	10900	1.1803	16900	1.3006	22900	1.4399	28900	1.6022
5000	1.0773	11000	1.1822	17000	1.3028	23000	1.4424	29000	1.6052
5100	1.0789	11100	1.1840	17100	1.3049	23100	1.4449	29100	1.6081
5200	1.0806	11200	1.1859	17200	1.3071	23200	1.4474	29200	1.6110
5300	1.0822	11300	1.1878	17300	1.3093	23300	1.4499	29300	1.6140
5400	1.0838	11400	1.1897	17400	1.3115	23400	1.4525	29400	1.6170
5500	1.0855	11500	1.1916	17500	1.3136	23500	1.4550	29500	1.6199
5600	1.0871	11600	1.1935	17600	1.3158	23600	1.4576	29600	1.6229
5700	1.0888	11700	1.1954	17700	1.3180	23700	1.4601	29700	1.6259
5800	1.0905	11800	1.1973	17800	1.3203	23800	1.4627	29800	1.6289
5900	1.0921	11900	1.1992	17900	1.3224	23900	1.4652	29900	1.6319

Figure AI-10

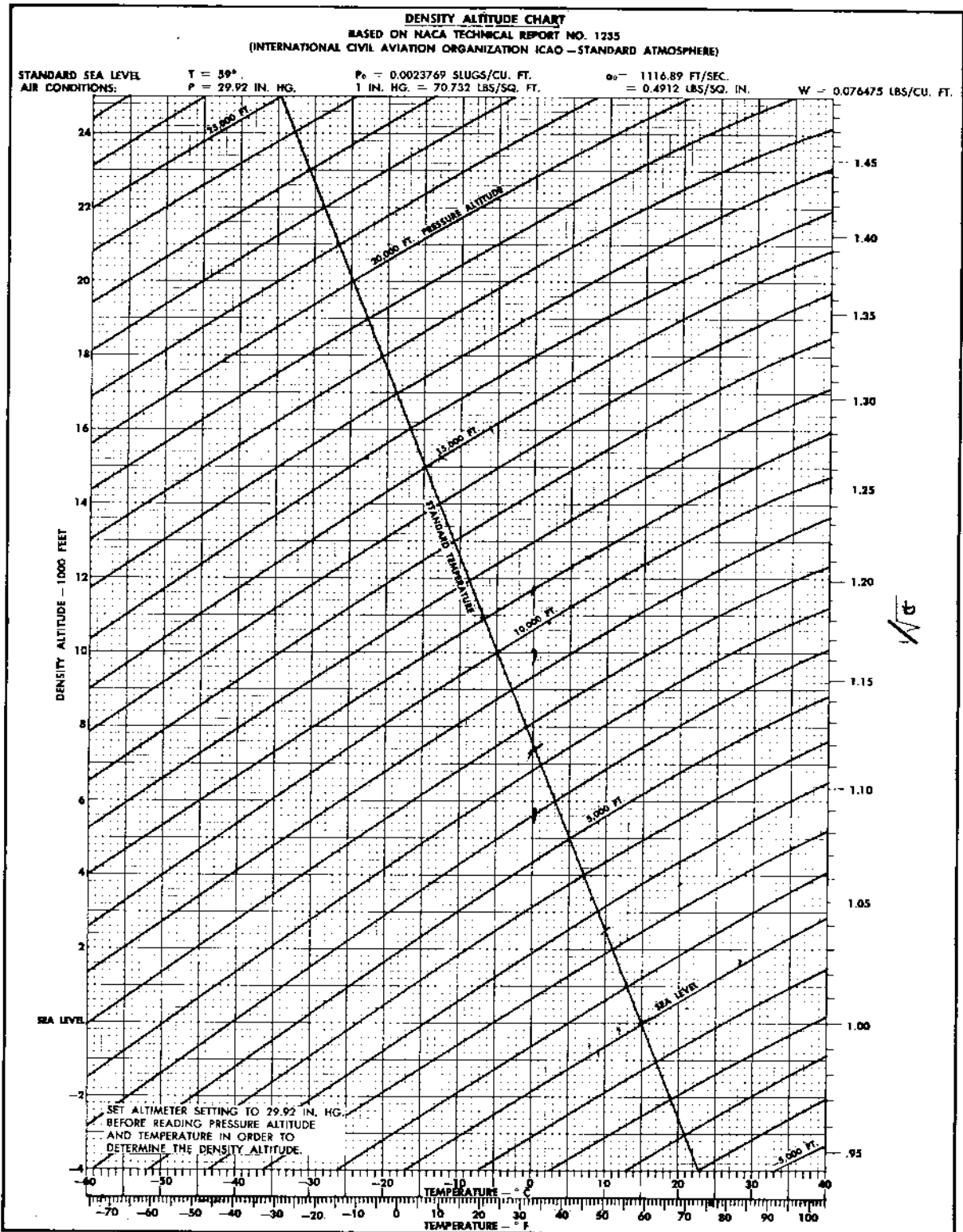

Figure A1-11

PSYCHROMETRIC CHART

VAPOR PRESSURE AND SPECIFIC HUMIDITY DETERMINATION

WHEN WET AND DRY BULB TEMPERATURES ARE GIVEN:
FIND DEW POINT:
ENTER AT WET BULB TEMPERATURE (1)
PROCEED VERTICALLY TO THE DRY BULB TEMPERATURE (2)
PROCEED VERTICALLY THROUGH DRY BULB TEMPERATURE (3)
PROCEED PARALLEL TO THE WET BULB TEMPERATURE GUIDE
LINE TO THE VERTICAL LINE THROUGH THE DRY BULB
TEMPERATURE (4)
FROM THIS INTERSECTION (4) PROCEED HORIZONTALLY TO
THE DRY BULB TEMPERATURE (5)
PROCEED VERTICALLY AND READ THE DEW POINT TEMPERATURE
AT (6)

WHEN SPECIFIC HUMIDITY AND PRESSURE ALTITUDE ARE GIVEN:
FIND WET BULB AND DEW POINT:
ENTER AT THE SPECIFIC HUMIDITY (1)
PROCEED HORIZONTALLY TO THE PRESSURE ALTITUDE (2)
FOLLOW THE VAPOR PRESSURE GUIDE LINES TO THE BASE LINE (3)
AND READ THE VAPOR PRESSURE (4)
PROCEED VERTICALLY TO THE DEW POINT LINE (5)
AND READ THE DEW POINT AT (6)

WHEN DEW POINT IS GIVEN:
FIND WET BULB TEMPERATURE AND PRESSURE:
ENTER AT THE DEW POINT (1)
PROCEED VERTICALLY TO THE DEW POINT LINE (2)
PROCEED HORIZONTALLY TO THE BASE LINE (3) AND READ VAPOR
PRESSURE

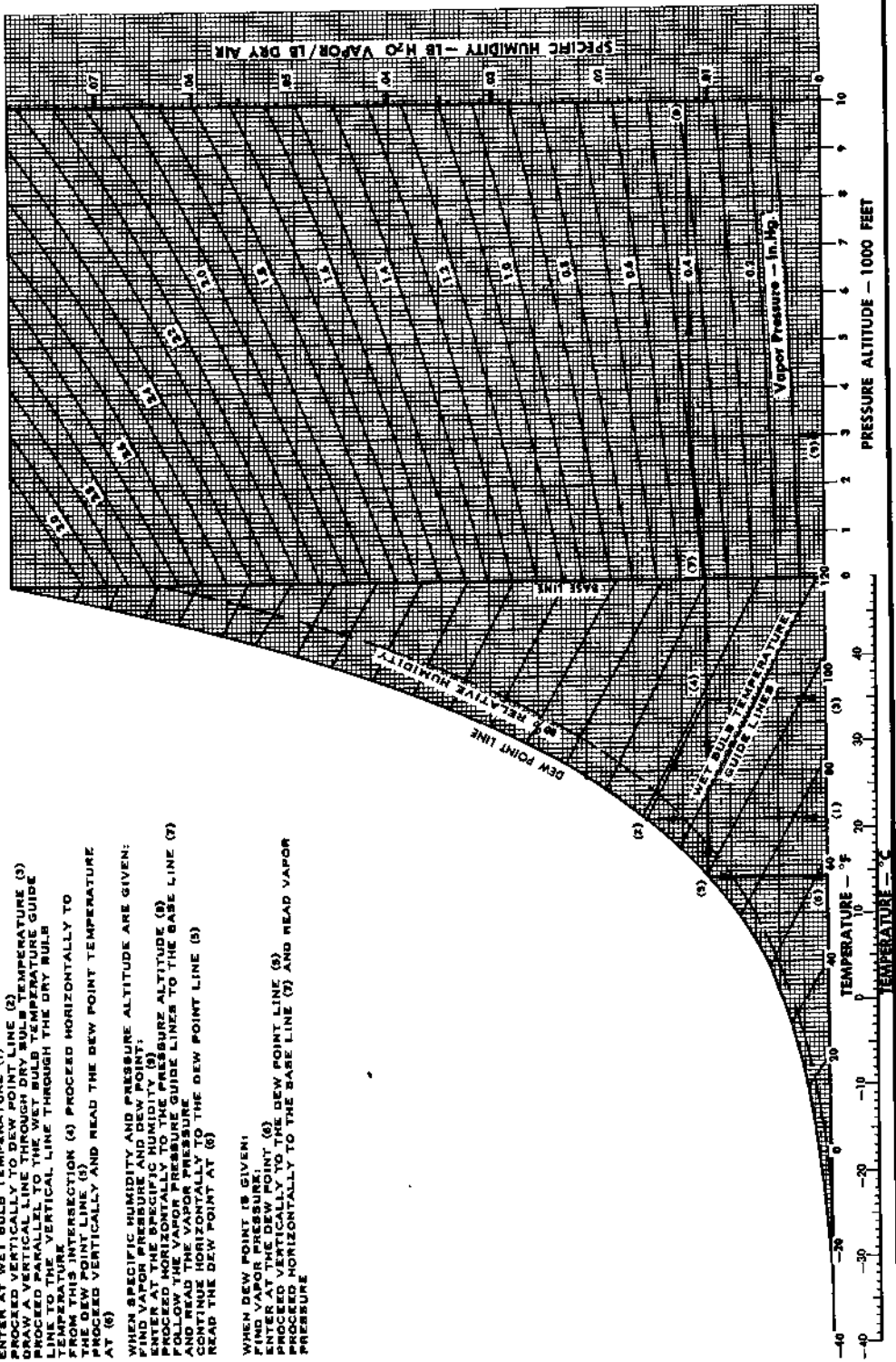

Figure A1-12

PART 2— ENGINE OPERATING DATA

TABLE OF CONTENTS

	<i>Page</i>
Summary	A2-2
Engine Limits and Characteristics Curves	A2-2
BMEP Limit Considerations	A2-2
Accessory Section Load Considerations	A2-2
Maximum Power Manifold Pressure Limits — 100/130 Fuel	A2-3
Climb Power Manifold Pressure Limits — 100/130 Fuel	A2-3
Cruise Power Manifold Pressure Limits — 100/130 Fuel	A2-3
Effects of Ram on Power Available	A2-3
Standard Day Power Available	A2-3
Operating Allowances for Full Throttle Cruise Power	A2-4
Engine Power Schedule Tables	A2-4
Fuel Flow Curves	A2-4
Use of Engine Limits and Characteristics Curves	A2-5

LIST OF ILLUSTRATIONS

<i>Figure</i>	<i>Title</i>	<i>Page</i>
A2-1	Engine Limits and Characteristics — Low Blower — 100/130 Fuel	A2-6
A2-2	Engine Limits and Characteristics — High Blower — 100/130 Fuel	A2-7
A2-3	Standard Day Power Available — 100/130 Fuel	A2-8
A2-4	Engine Power Schedule Table — Auto Rich Mixture — 100/130 Fuel	A2-9
A2-5	Engine Power Schedule — 10% Lean Mixture — 100/130 Fuel	A2-10
A2-6	Fuel Flow Curve — Auto Rich Mixture	A2-11
A2-7	Fuel Flow Curve — 10% Lean Mixture — Low Blower	A2-12
A2-8	Fuel Flow Curve — 10% Lean Mixture — High Blower	A2-13

SUMMARY.

Three types of data are provided in this part.

(1) The Engine Manufacturer's Operating Data are given on the Engine Limits and Characteristics curves, Figures A2-1 and A2-3. These show the part throttle operating limits in detail along with the full throttle calibration characteristics for the zero ram condition. The effects of mixture variation from best power are included, as are the effects of carburetor air temperature variation from standard.

(2) The results of contractor's flight tests are provided on Figure A2-3. These show the in-flight power available characteristics which include installation effects. Graphs show the performance with standard air temperatures and ram at appropriate airspeeds for take-off, climb, and cruise power settings. The installed power available data are also tabulated on Figures A2-4 and A2-5 for a convenient reference in making power settings. The tables are based on the same data as the graphical material, but a 50 rpm *pad* has been included in the full throttle 10% lean data. This allows uniform power setting schedules to be maintained at non-standard air temperatures and with variations in engine condition in service.

(3) Fuel flow calibrations are included for engine speeds ranging from the low cruise to METO power settings. The data are based on Contractor's flight tests and service records.

ENGINE LIMITS AND CHARACTERISTICS CURVES.

Briefly described each engine limits curve is divided into two major parts; the basic calibration for a reference altitude, and the altitude calibration for the noted blower setting. Two subdivisions of the altitude calibration are provided to show engine performance at part and full throttle conditions. *The altitude calibration portions of Figures A2-1 and A2-2 give detailed part throttle power limits for 100/130 grade fuel.* The engine manufacturer's calibration showing full throttle characteristics is provided for reference. (See Figure A2-3 for curves of full throttle power available in flight which include adjustments for installation effects.) In addition to providing information on operating limits, the limits and characteristics curves form the

basis for prediction of power output with any combination of control settings within allowable values. The curves are based on operation in Auto Rich or best power mixture settings. They are directly applicable only under conditions of zero relative humidity, with standard day temperatures and pressures at the carburetor top deck. Corrections for other mixture setting and non-standard air temperatures are provided on the curves.

BMEP LIMIT CONSIDERATIONS.

The near horizontal lines on the altitude calibration curves show the variation of limit brake horsepower with altitude. Corresponding limit BMEP settings are defined by the following relationship:

$$\text{BMEP} = 236 \times \text{BHP/RPM}$$

Limit power values read from the curves at various part throttle engine speeds represent the highest power which the engines may be allowed to develop at those altitudes and rpm's. In addition, limit BMEP cannot be used if conditions of either high temperature or high humidity (or both) result in limit manifold pressure being reached at a lower BMEP setting.

ACCESSORY SECTION LOAD CONSIDERATIONS.

The effect of power absorbed by the cabin superchargers (not indicated by the BMEP gages) may be neglected at cruise power settings. Observance of Maximum and METO (Maximum Continuous) manifold pressure limits during take-off and climb provides the accounting required at these high power settings.

MAXIMUM POWER MANIFOLD PRESSURE LIMITS - 100/130 FUEL.

The limit manifold pressure varies with altitude, decreasing from 51.5" Hg. at sea level to 51.0" Hg. at 3000' pressure altitude. This limitation governs when it is reached before 211 BMEP. While it is not allowable to adjust limit manifold pressures because of unusual temperature conditions, it is allowed in the event that humidity is excessive. Therefore if conditions of extreme humidity do exist, the maximum power limit manifold pressure may be increased by two times the existing vapor pressure. There is a further limit pro-

51 " 211 VENT 2500
44 287 2000
35 MIN 151 / 151 2200

vision to this — the limit MAP may not be increased more than 1" Hg., and 211 BMEP must not be exceeded.

This is illustrated by the following example:

Given: Pressure altitude sea level
Vapor Pressure 0.420
Limit MAP at sea level 51.0" Hg.

Find: Allowable MAP limit, Maximum Power

Solution: $2 \times 0.420 = 0.840'' \text{ Hg } \Delta \text{ MAP}$
 $51.0'' \text{ Hg.} + 0.84'' \text{ Hg.} = 51.84'' \text{ Hg. MAP}$

The allowable MAP limit is 51.84 Hg since the Δ MAP did not exceed 1.0" Hg.

Dew point is directly related to vapor pressure, as illustrated by the Psychrometric Chart at the end of Part 1, and most meteorological offices provide dew point rather than vapor pressure. Therefore, the conversion from vapor pressure to dew point has been incorporated in the Maximum Power prediction chart in Part 3. This allowed power available for take-off to be predicted directly from altitude, temperature, and dew point (rather than vapor pressure). Maximum Power MAP limits which have been adjusted for vapor pressure can also be read directly from the power prediction curves.

CLIMB POWER MANIFOLD PRESSURE LIMITS — 100/130 FUEL.

The limit manifold pressure for low blower METO (Maximum Continuous) power varies from 44.0" Hg. at sea level to 42.5" Hg. at 4750 feet. The corresponding high blower limits vary from 42.3" Hg. at 10,000 feet to 41.0" Hg. at 16,000 feet.

CRUISE POWER MANIFOLD PRESSURE LIMITS — 100/130 FUEL.

Manifold pressure limits for 10% lean operation are 38" Hg. for 1470 BHP in low blower and 37" Hg. for 1400 BHP in high blower. Manifold pressure settings greater than these should not be made under normal

operating conditions, even if this results in an inability to obtain limit BMEP settings.

EFFECTS OF RAM ON POWER AVAILABLE.

Each Operating Limits Graph is based on a zero ram calibration, that is, the calibration is made with ambient static pressure and temperature existing at the carburetor top deck and crankcase breather vents. Ducting necessary for installation of the engine on the aircraft alters the pressures and temperatures from these conditions during flight operation. This deviation from the standard calibration condition affects the altitude-power characteristics of the engine. The difference in performance is commonly referred to as *ram*, since normal flight speed usually results in an increase in carburetor deck pressure over ambient static and thereby increases the altitude at which full throttle occurs for particular rpm settings.

Standard manifold pressure for this higher critical altitude may be obtained by the method described in the sample problem. For example, if *ram* permitted 2100 rpm part throttle operation up to 15,000 feet altitude the maximum obtainable (and limit) power would be 1410 BHP. The 1410 BHP value is determined by extending the 2100 rpm part throttle line from the standard day full throttle limiting power line through the 15,000 foot altitude point. At the intersection of the point (15,000 feet and 2300 RPM) read the BHP on the vertical scale. The standard day manifold pressure predicted for this power is found to be 29.8" Hg. This is determined by passing a slope line, parallel to the constant RPM-MAP line previously found, through the 15,000 foot 1410 BHP point and downward to the left to the 2100 RPM zero ram full throttle calibration line. The 29.8" Hg. value is found by interpolation between 29.0" Hg. and 30.10" Hg. MAP along the 2100 RPM line.

STANDARD DAY POWER AVAILABLE.

Figure A2-3 shows the standard day variation of low and high blower power available with altitude for the complete engine installation with zero humidity, under-cowl scoops and the following flight conditions; in climb, with maximum, METO and alternate climb powers, and in level flight with normal cruising powers. It will

be noted that maximum power deviates somewhat from the limit values shown on the Limits and Characteristics Charts. This is due in installation effects discussed in the previous section. Standard day take-off, climb and part throttle cruise performance shown in this Appendix are based on the standard day powers shown to be available by this chart. Full throttle cruise performance allows for a "50 rpm" pad. That is, it is based on the power that would be obtained if critical altitude were reduced from the values shown by an amount corresponding to a 50 rpm reduction in engine speed.

OPERATING ALLOWANCES FOR FULL THROTTLE CRUISE POWER.

Full throttle cruise powers available are based on fuel-air ratios obtained with 10% lean mixture settings (using the 10% manual leaning method as recommended in Section VII).

ENGINE POWER SCHEDULE TABLES.

A tabulation of engine power settings likely to be used most frequently for operations from sea level to 25,000 feet density altitude is shown on Figures A2-4 and A2-5. Data are supplied for Auto Rich and for 10% Lean mixture settings for 100/130 grade fuel. Interpolation between altitudes and engine speeds is permitted within limits discussed under description of the Engine Limits and Characteristics Charts.

Figure A2-6 provides RPM, BMEP, and limit MAP settings for maximum, MFTO, alternate climb, and maximum cruise powers with Auto Rich mixture. Stated values of inboard power and BMEP are maximum settings to be expected at standard temperatures with ram air when limited either by power or manifold pressure considerations. Figure A2-7 lists recommended power settings for level flight cruise conditions.

FUEL FLOW CURVES.

The charts on Figures A2-6, A2-7 and A2-8 show fuel flow in pounds per hour per engine versus inboard engine power for various engine speeds. Figure A2-6 shows auto rich fuel flow during low and high blower operation for Metro and maximum cruise power; Figure

SAMPLE PROBLEM.

The sea level calibration is used together with a portion of the altitude curve to determine constant MAP-RPM lines for varying altitudes.

Problem: to find the Standard Power vs. Altitude line for 2300 RPM and 29" MAP in low blower and Best Power Mixture.

Solution: (See sketch and Figure A2-1)

1. Using the Sea Level Calibration, determine the RPM (2300) and MAP (29") intersection (A).
2. Project this point horizontally to the BHP axis and locate (B).
3. Locate (C), defined as the intersection of the full throttle constant RPM line and the full throttle constant MAP line corresponding to the given RPM (2300) and MAP (29").
4. Join (B) and (C) with a straight line.

This line (B-C) will define the altitude and power combination which will exist at 2300 RPM and 29" MAP on a standard day with Best Power Mixture. For example, at an altitude of 6000 ft., the BHP equals 1285 (intersection of line B-C with the 6000 ft. altitude).

The use of the correction grids for deviations of temperature from standard and fuel-air mixtures from Best Power is as follows:

Problem: find MAP necessary to produce 1300 BHP at 9000 ft. using 2300 RPM, an 8% lean mixture with a CAT of 18°C (15° below standard).

Solution: (See sketch and Figure A2-1)

1. Determine the altitude power intersection (1).
2. As in the previous problem, draw constant MAP, RPM lines near the power in question. (28/2300; line 2-3).

A2-6 and A2-7 shows 10% lean fuel flows for low and high blower cruise operating respectively.

USE OF ENGINE LIMITS AND CHARACTERISTIC CURVE

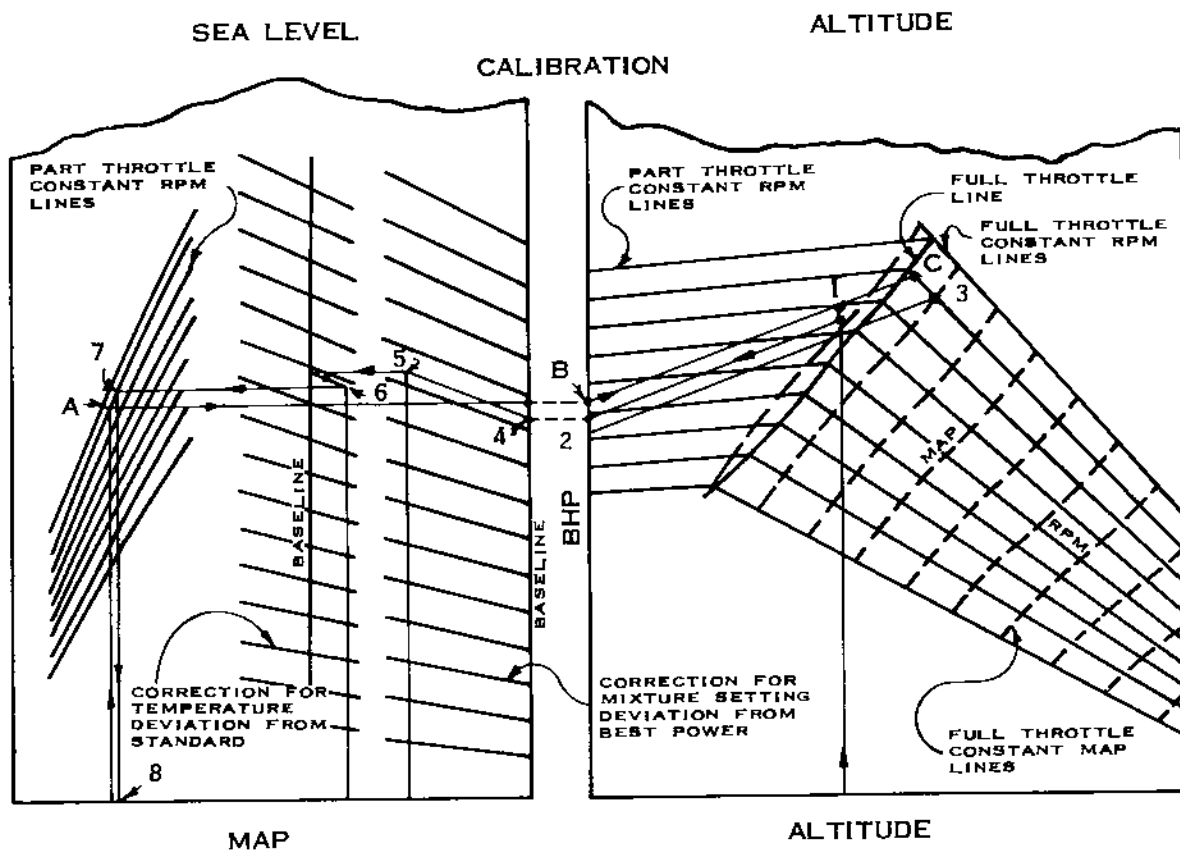

3. Draw line from (1) parallel to the constant MAP/RPM line (line 2-3). This results in a sea level BHP of 1115 at the same MAP/RPM combination.
4. Correct this MAP for the 8% BMEP drop by paralleling the nearest MAP correction slope line (line 4-5).
5. Proceed horizontally to the standard CAT line. With the temperature below stand-

ard, move parallel to the CAT slope line to the right to the -15°C variation (6).

6. Then move horizontally to the left to 2300 RPM (7) and read down to 29.2" MAP (8).

Note that the CAT correction is solely for part throttle operation and cannot be used to determine a change in critical altitude with temperature. Such a variation in CAT at full throttle would result in a double correction; the normal change of 2% power per 10°C at constant MAP and a change in MAP and power due to the change in supercharger rise with temperature.

ENGINE LIMITS AND CHARACTERISTICS
100/130

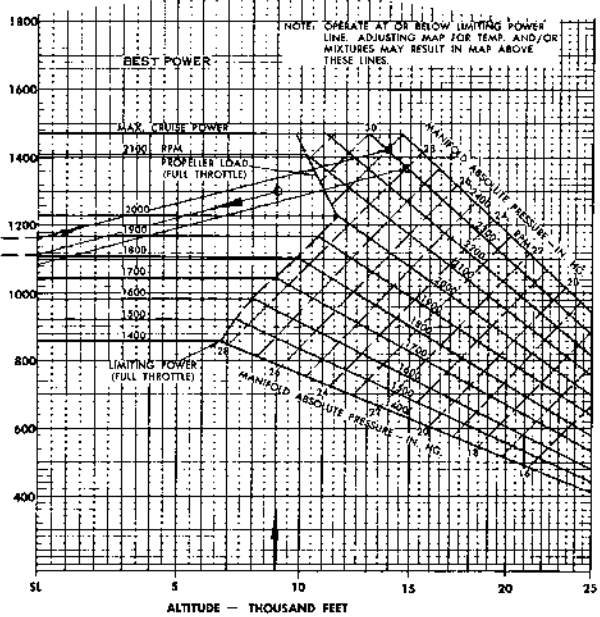
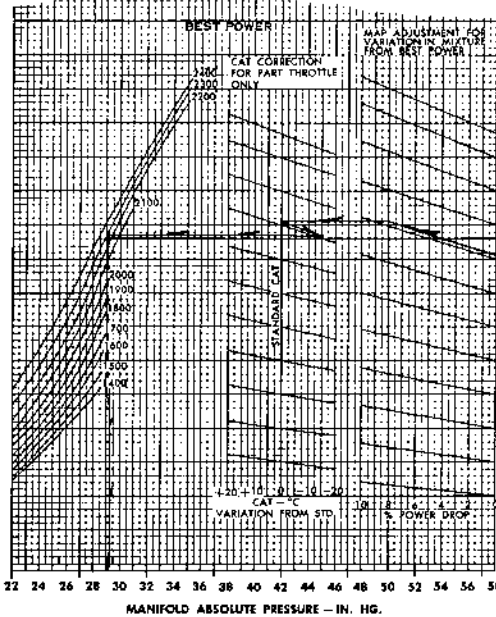
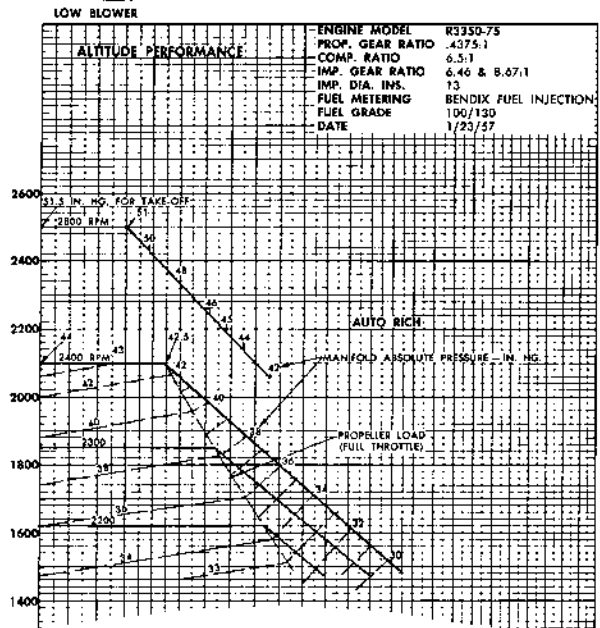
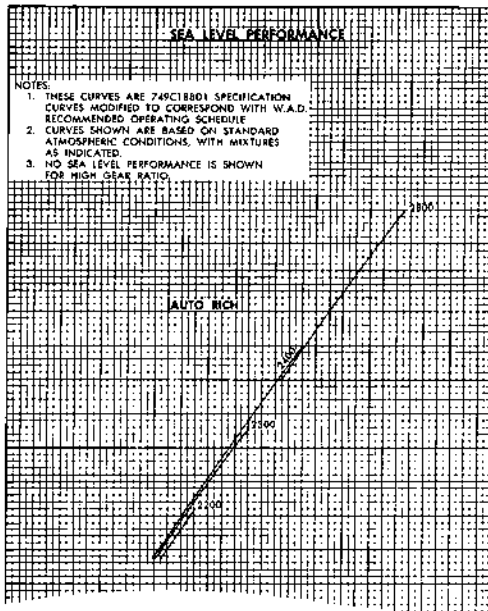

Figure A2-1

ENGINE LIMITS AND CHARACTERISTICS

100/130

HIGH BLOWER

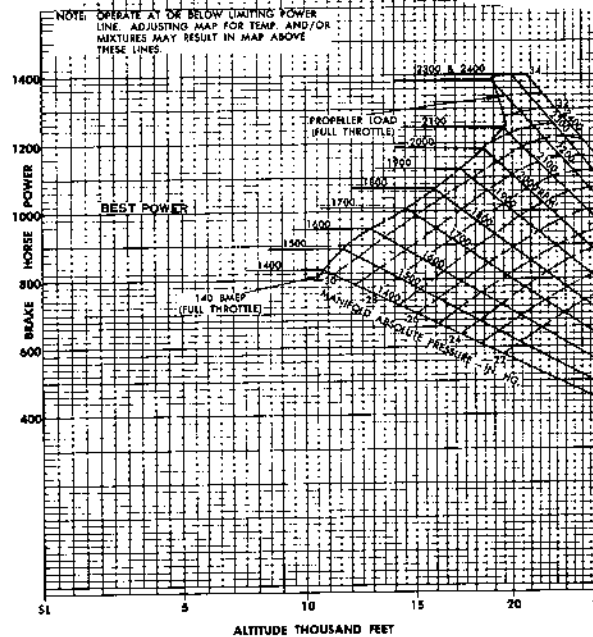
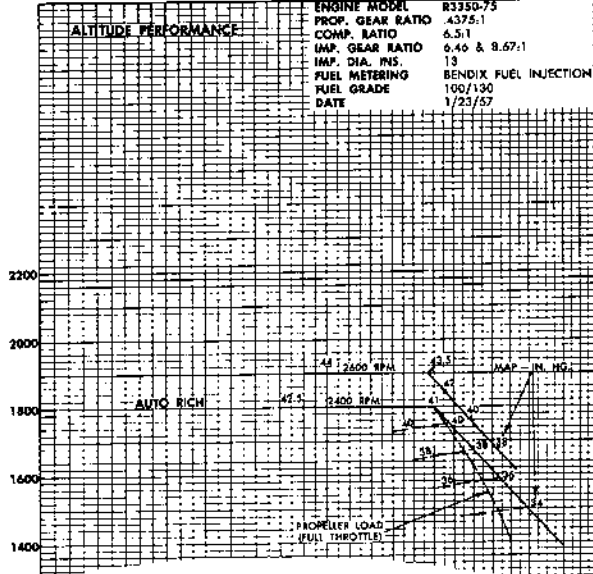
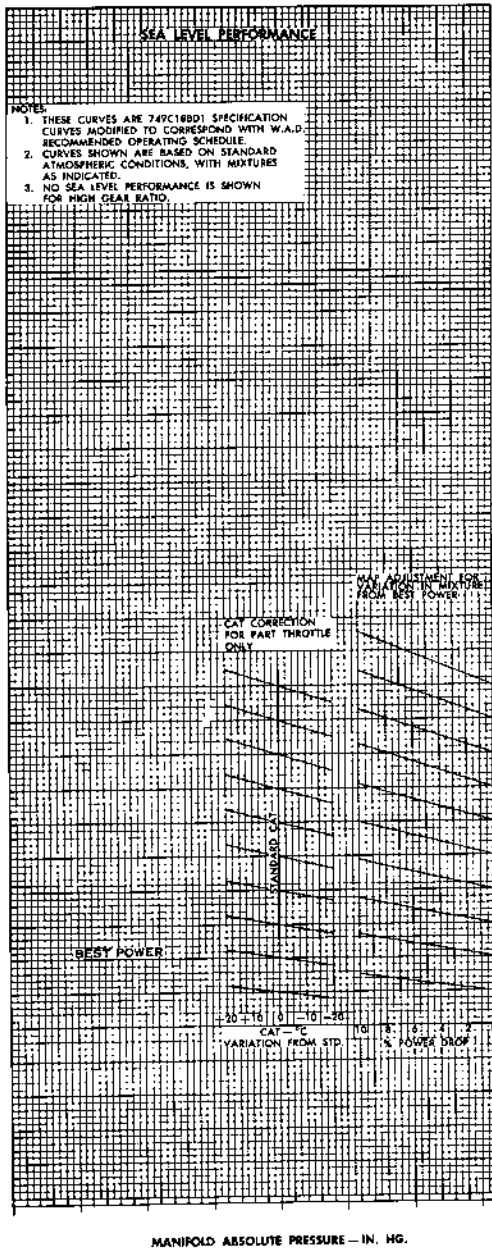

Figure A2-2

STANDARD DAY POWER AVAILABLE
ZERO HUMIDITY CALIBRATION
UNDERCOWL CARBURETOR AIRSCOOPS

MODEL: C-121A
DATA AS OF: 15 AUGUST 1961
DATA BASED ON: FLIGHT TESTS

ENGINES: (4) R3350.75

PROPS: CURTISS C460/830-26C4-0

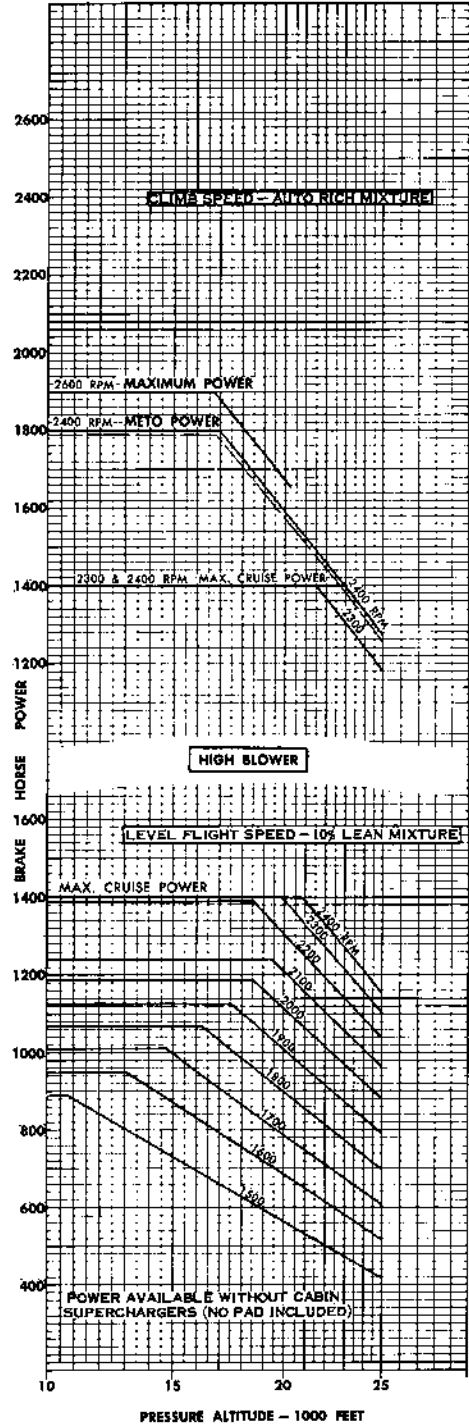
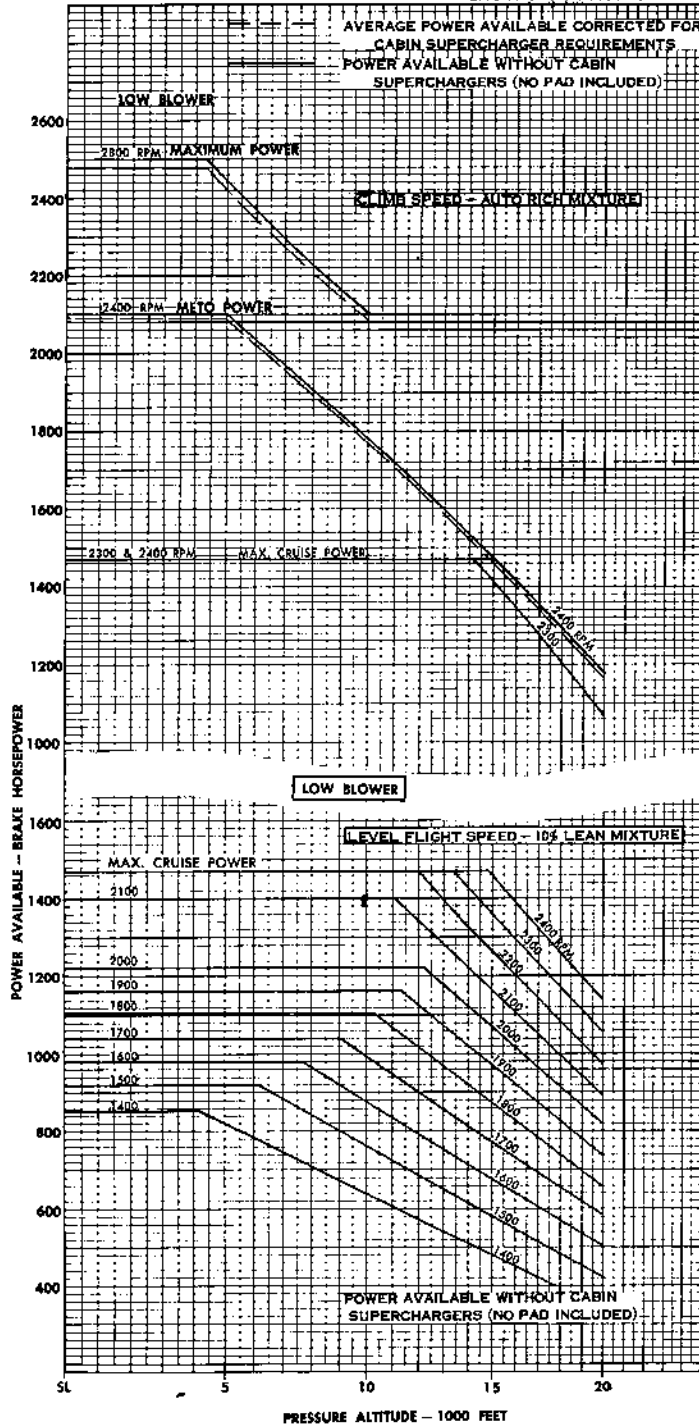

Figure A2-3

R3350-75 ENGINE POWER SCHEDULE TABLE
AUTO RICH MIXTURE

100/130 GRADE FUEL

STANDARD DAY

ZERO HUMIDITY AT STANDARD TEMPERATURE

MODEL: C-121A

DATA AS OF: 15 AUGUST 1961

DATA BASIS: FLIGHT TESTS

PROPS: CURTISS C460/830-26C4-0

ENGINE SPEED RPM	POWER SETTINGS													
	10,000	12,000	14,000	16,000	18,000	20,000	22,000	24,000	10,000	12,000	14,000	16,000	18,000	20,000
	HIGH BLOWER							LOW BLOWER						
	MAXIMUM POWER: MAXIMUM ALLOWABLE CYLINDER HEAD TEMPERATURE 260° C, LIMIT BMEP 211, TIME LIMIT 5 MINUTES.													
2800	INBOARD BHP	2500	2490 F.T.	2340 F.T.	2195 F.T.									
	INBOARD BMEP	211	211	197	185									
	LIMIT MAP	51.5	51.0											
	MAXIMUM POWER: MAXIMUM ALLOWABLE CYLINDER HEAD TEMPERATURE 260° C, LIMIT BMEP 172, TIME LIMIT 5 MINUTES.													
2600	INBOARD BHP													
	INBOARD BMEP													
	LIMIT MAP													
	METO POWER: MAXIMUM ALLOWABLE CYLINDER HEAD TEMPERATURE 245° C, TIME LIMIT NONE.													
2400	INBOARD BHP	2100	2100	2035 F.T.	1900 F.T.	1775 F.T.	1655 F.T.	1535 F.T.	1410 F.T.	1800	1800	1800	1800	1800
	INBOARD BMEP	207	207	200	187	174	163	151	139	177	177	177	177	177
	LIMIT MAP	44.0	43.5	42.5						42.5	42.0	41.5	41.0	41.0
	CRUISE CLIMB POWER: MAXIMUM ALLOWABLE CYLINDER HEAD TEMPERATURE 230° C, TIME LIMIT NONE. LIMIT MAP 35.0 IN. HG.													
2400	INBOARD BHP	1470	1470	1470	1470	1470	1470	1470	1470	1400	1400	1400	1400	1400
	INBOARD BMEP	145*	145*	145*	145*	145*	145*	145*	145*	138*	138*	138*	138*	138*
	CRUISE CLIMB POWER: MAXIMUM ALLOWABLE CYLINDER HEAD TEMPERATURE 230° C, TIME LIMIT NONE. LIMIT MAP 35.0 IN. HG.													
2300	INBOARD BHP	1470	1470	1470	1470	1470	1470	1470	1470	1400	1400	1400	1400	1400
	INBOARD BMEP	151	151	151	151	151	151	151	138	144	144	144	144	144

CAUTION - HIGH BLOWER NOT PERMITTED AT 2800 RPM

- NOTES: 1. Set power by RPM and BMEP unless limit MAP is obtained first. Set outboard engine 5 BMEP less at maximum and METO power to allow for cabin supercharger power requirements.
 2. Inboard engine BMEP settings are those expected to be available with standard day temperature and ram air. Values shown are limits unless full throttle performance is shown, noted by (F.T.), or unless settings less than limit values are recommended, denoted by (*).
 3. No more than 2 in. hg. difference in MAP between engines is allowable for a given power setting after accounting for cabin supercharger power requirements. If a greater difference is observed, reduce power 2 in. hg. or less.

Figure A2-4

R3350-75 ENGINE POWER SCHEDULE TABLE
10% LEAN MIXTURE
ZERO HUMIDITY AT STANDARD TEMPERATURE

100/130 GRADE FUEL

PROPS: CURTISS C-460/830-26C4-0

STANDARD DAY

MODEL: C-121A
DATA AS OF: 15 AUGUST 1961
DATA BASIS: FLIGHT TESTS

ENGINE SPEED RPM	PRESS. ALT.-FT.	POWER SETTINGS												
		LOW BLOWER					HIGH BLOWER							
Blower Setting		5, 1.	2,000	4,000	6,000	6,000	10,000	12,000	14,000	16,000	18,000	20,000	22,000	24,000
Blower Setting		S. L.	2,000	4,000	6,000	6,000	10,000	12,000	14,000	16,000	18,000	20,000	22,000	24,000
MAXIMUM CRUISE POWER. MAXIMUM ALLOWABLE CYLINDER HEAD TEMPERATURE 230° C. LIMIT MAP 38.0 (L.B.) 37.0 (H.B.). TIME LIMIT NONE.														
2400	INBD BHP	1470	1470	1470	1470	1470	1470	1470	1470	1470	1400	1400	1400	1300 F.T.
	INBD BMEP	145	145	145	145	145	145	145	145	145	138	138	138	128
2300	INBD BHP	1470	1470	1470	1470	1470	1470	1470	1470	1470	1400	1400	1400	1345 F.T.
	INBD BMEP	151	151	151	151	151	151	151	151	151	144	144	144	138
2200	INBD BHP	1470	1470	1470	1470	1470	1470	1470	1470	1470	1390	1390	1390	1390 F.T.
	INBD BMEP	158	158	158	158	158	158	158	158	158	149	149	149	144
2130	INBD BHP	1470	1470	1470	1470	1470	1470	1470	1470	1470	1400	1400	1400	1390 F.T.
	INBD BMEP	162	162	162	162	162	162	162	162	162	155	155	155	150 F.T.
2000	INBD BHP	1230	1230	1230	1230	1230	1230	1230	1230	1230	1185	1185	1185	1160 F.T.
	INBD BMEP	145	145	145	145	145	145	145	145	145	140	140	140	137
1900	INBD BHP	1170	1170	1170	1170	1170	1170	1170	1170	1170	1130	1130	1130	1045 F.T.
	INBD BMEP	145	145	145	145	145	145	145	145	145	140	140	140	137
1800	INBD BHP	1105	1105	1105	1105	1105	1105	1105	1105	1105	1070	1070	1070	1025 F.T.
	INBD BMEP	145	145	145	145	145	145	145	145	145	140	140	140	137
1700	INBD BHP	1045	1045	1045	1045	1045	1045	1045	1045	1045	1010	1010	1010	975 F.T.
	INBD BMEP	145	145	145	145	145	145	145	145	145	140	140	140	137
1600	INBD BHP	985	985	985	985	985	985	985	985	985	950	950	950	915 F.T.
	INBD BMEP	145	145	145	145	145	145	145	145	145	140	140	140	137
1500	INBD BHP	920	920	920	920	920	920	920	920	920	885	885	885	850 F.T.
	INBD BMEP	145	145	145	145	145	145	145	145	145	140	140	140	137
1400	INBD BHP	860	860	860	860	860	860	860	860	860	825	825	825	790 F.T.
	INBD BMEP	145	145	145	145	145	145	145	145	145	140	140	140	137
1400	INBD BHP	800	800	800	800	800	800	800	800	800	765	765	765	730 F.T.
	INBD BMEP	135*	135*	135*	135*	135*	135*	135*	135*	135*	130*	130*	130*	127
1400	INBD BHP	700	700	700	700	700	700	700	700	700	665	665	665	630 F.T.
	INBD BMEP	118*	118*	118*	118*	118*	118*	118*	118*	118*	113*	113*	113*	110
1400	INBD BHP	600	600	600	600	600	600	600	600	600	565	565	565	530 F.T.
	INBD BMEP	101*	101*	101*	101*	101*	101*	101*	101*	101*	96*	96*	96*	93
1400	INBD BHP	500	500	500	500	500	500	500	500	500	465	465	465	430 F.T.
	INBD BMEP	84*	84*	84*	84*	84*	84*	84*	84*	84*	79*	79*	79*	76

NOTES: 1. Set power by RPM and BMEP unless limit MAP is obtained first.
2. Engine BMEP settings are those to be available with standard day temperatures and ram air. Values shown are limits unless full throttle performance is shown, noted by (F.T.), or unless settings less than limit values are recommended, noted by (*). An arbitrary "pod" of 50 RPM has been included in these full throttle power settings.
3. No more than 2 in. hg. difference in MAP between engines is allowable for a given power setting after accounting for cabin supercharger requirements. If a greater difference is observed, reduce power on engine with the highest MAP until the difference is 2 in. hg. or less.

Figure A2-5

AUTO RICH FUEL FLOWS
2300 AND 2400 RPM

MODEL: C-121A
DATA AS OF: 15 AUGUST 1961
DATA BASIS: FLIGHT TESTS

ENGINES: (4) R3350-75
PROPS: CURTISS C460/830-26C4-0

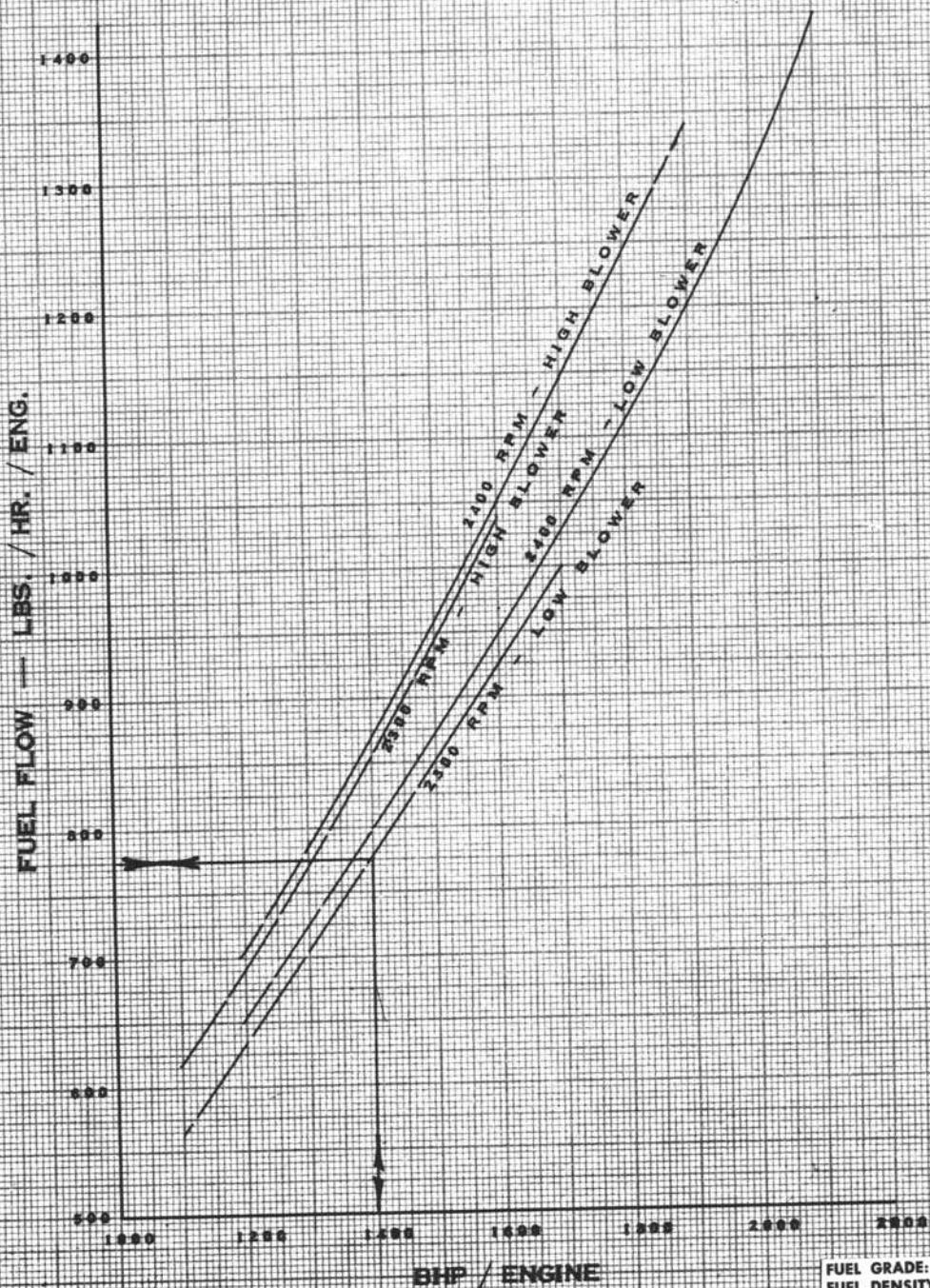

FUEL GRADE: 100/130
FUEL DENSITY: 6.0 LB/U.S. GAL.

Figure A2-6

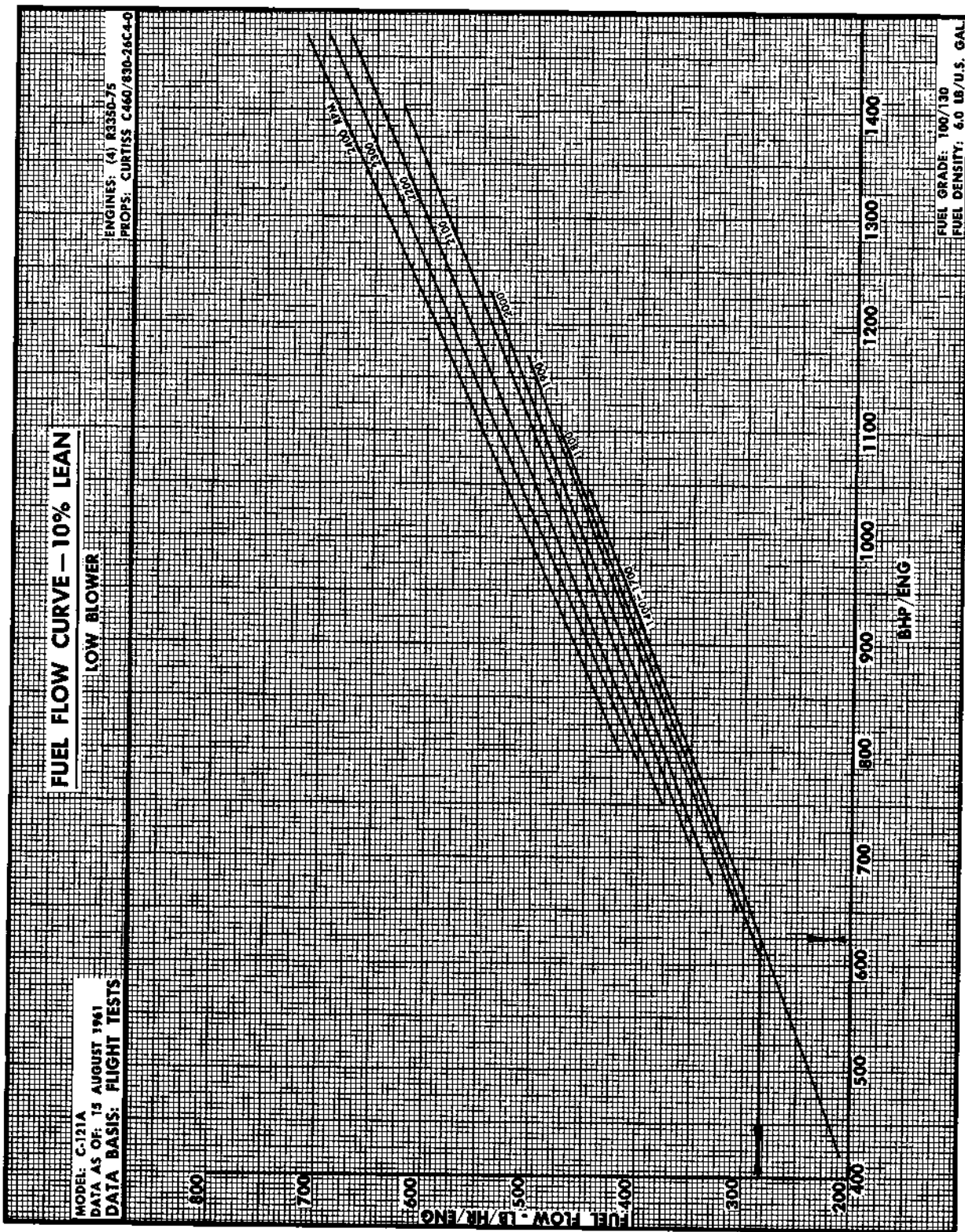

Figure A2-7

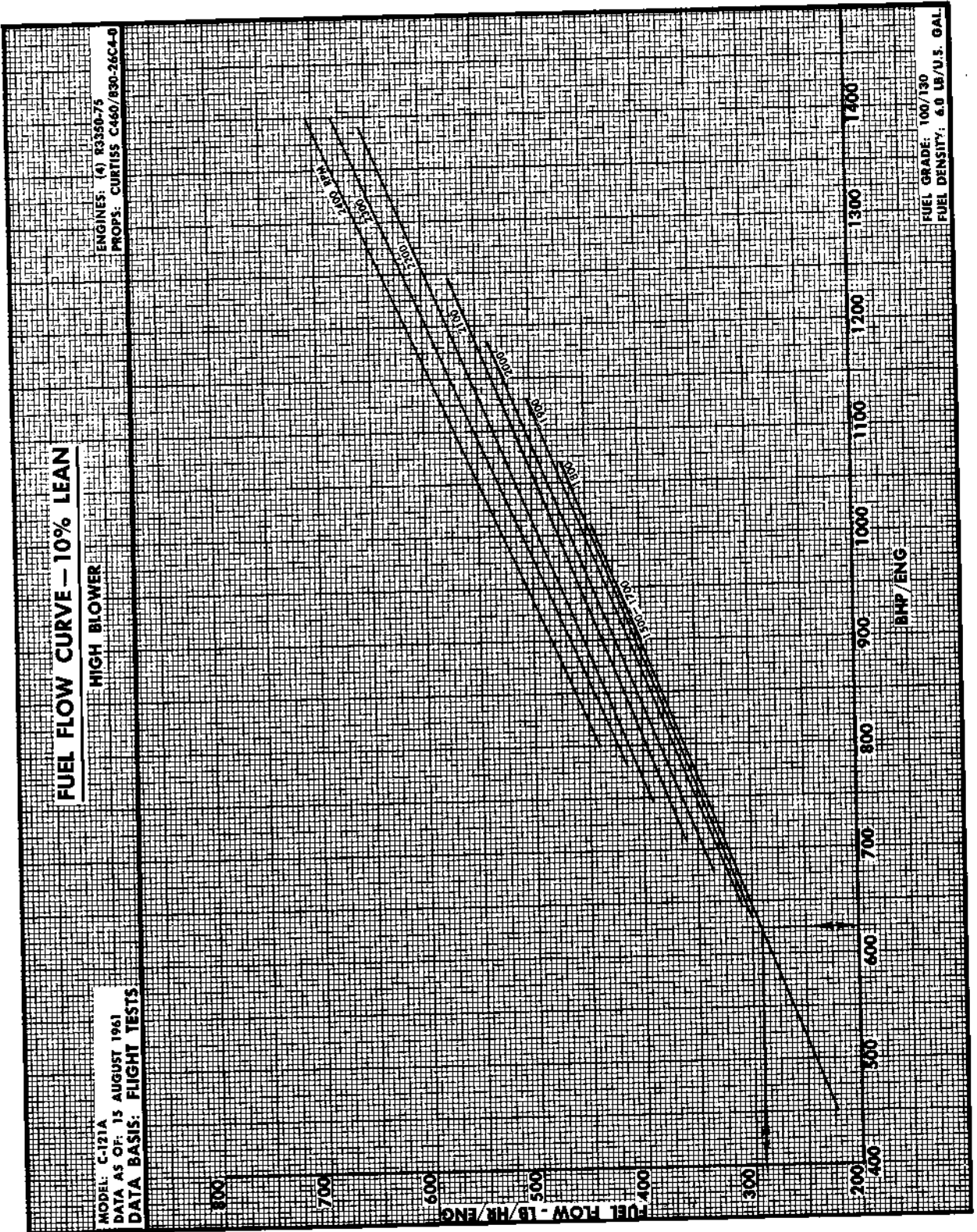

Figure A2-8

PART 3— TAKE-OFF

TABLE OF CONTENTS

	<i>Page</i>
Summary	A3-2
Basis for Take-Off Performance	A3-2
Temperature Accountability	A3-2
Effect of Humidity	A3-2
Prediction of Maximum Power Available	A3-2
Normal Take-Off Performance -- Four Engine Operation	A3-2
Wind Component Chart	A3-3
Ground Run Distances	A3-3
Take-Off Criteria Definitions	A3-3
Refusal Speed	A3-4
Velocity During Take-Off Ground Run	A3-6
Emergency Take-Off Performance	A3-7
Three Engine Climb-Out Flight Paths	A3-7
Three Engine Take-Off Rates of Climb	A3-7
Take-Off Weight as Limited by Runway Slope	A3-7
Stopping Distances	A3-7
Critical Field Length	A3-8
Three Engine Ferry Configuration Take-Off Performance	A3-9

LIST OF ILLUSTRATIONS

<i>Figure</i>	<i>Title</i>	<i>Page</i>
A3-1	Maximum Power Prediction Graph -- 100, 130 Grade Fuel	A3-10
A3-2	Wind Component Chart	A3-11
A3-3	Normal Take-Off Performance — Ground Run Distance to Take-Off	A3-12
A3-4	Normal Take-Off Performance — Distance to Take-Off and Climb 50 Ft.	A3-13
A3-5	Normal Take-Off Performance Refusal Speed	A3-14
A3-6	Normal Take-Off Performance Velocity During Take-Off Ground Run	A3-15
A3-7	Emergency Take-Off Performance Military Critical Field Length Zero Obstacle Clearance	A3-16
A3-8	Emergency Take-Off Performance Critical Engine Failure Speed Military Field Length Zero Obstacle Clearance	A3-17
A3-9	Emergency Take-Off Performance — Critical Field Length 50 Ft. Obstacle Clearance	A3-18
A3-10	Emergency Take-Off Performance - Critical Engine Failure Speed — 50 Ft. Obstacle Clearance	A3-19
A3-11	Three Engine Take-Off Flight Path — 85,000 Lbs.	A3-20
A3-12	Three Engine Take-Off Flight Path — 90,000 Lbs.	A3-21
A3-13	Three Engine Take-Off Flight Path — 95,000 Lbs.	A3-22
A3-14	Three Engine Take-Off Flight Path — 100,000 Lbs.	A3-23
A3-15	Three Engine Take-Off Flight Path — 107,000 Lbs.	A3-24
A3-16	Three Engine Rates of Climb — Various Configurations	A3-25
A3-17	Maximum Take-Off Weight Permitted by Runway Slope	A3-26
A3-18	Stopping Distance — Brakes only	A3-27
A3-19	Three Engine Ferry Configuration -- Minimum Effective Take-Off Runway Distances	A3-28
A3-20	Three Engine Ferry Configuration - Take-Off Climb - Initial Segment	A3-29, A3-30

SUMMARY.

Data included in this part of the appendix permits evaluation of take-off performance and field length requirements for three types of operation: normal operation on four engines, operation in the event of take-off emergency, and intentional three-engine operation. Data needed for prediction of maximum power are presented first. Normal four-engine take-off performance is shown next which includes take-off ground run distances, refusal speeds, and velocities during ground run. Critical field lengths follow, with take-off flight paths for three-engine operation. Three-engine take-off rates of climb and take-off weight limitations existing because of runway slope conditions are also shown. Ferrying configuration take-off performance is shown in conclusion.

BASIS FOR TAKE-OFF PERFORMANCE.

Take-off distances shown in this part are based on flight tests and reflect performance with power available under standard and non-standard day conditions. Correction grids provide accountability for the effects of wind and runway slope.

TEMPERATURE ACCOUNTABILITY.

Air temperature affects air density and power available and consequently influences take-off performance. For a particular field elevation, take-off performance will improve with lower-than-standard air temperature. That is, the aircraft can take-off at a lower true airspeed and the take-off distance will be shorter. Power available is increased if the field elevation is such that full throttle would be required at the standard air temperature condition. The converse is true at temperatures higher than standard. The true airspeed necessary for take-off will be higher and the take-off distances will be longer. It is also possible that higher-than-standard temperature may prevent the use of standard day power because of manifold pressure limitations. This decreases the aircraft's ability to accelerate and, consequently, also increases take-off distance.

EFFECT OF HUMIDITY.

The existence of water vapor in the air affects the maximum power available for a given manifold pressure and temperature. If water vapor is present, the available power is reduced. This power loss occurs because a

portion of the oxygen necessary for combustion in the cylinder is displaced by water vapor. This results in an increasingly rich mixture. The thermal efficiency of the engine is decreased, less power is developed, and longer take-off distances result.

Power loss due to excessive water vapor cannot be regained if operating at full throttle. However, in the part-throttle region, power loss due to humidity may be partially regained. This is possible through an allowable increase in the limit MAP.

PREDICTION OF MAXIMUM POWER AVAILABLE.

The maximum power prediction graphs show the power that can be expected for take-off. Minimum acceptable take-off power is defined as 95% of predicted power. Lower power readings indicate substandard engine condition.

NORMAL TAKE-OFF PERFORMANCE — FOUR ENGINE OPERATION.

Four-engine ground run distances to take-off and distances to take-off and climb fifty feet are shown in figures A3-3 and A3-4 for normal take-off procedures. Correction grids are supplied which account for the effects of true wind existing at the runway and runway slope. The distances shown apply to operation from hard-surface dry runways when 60% (Take-off) wing flap setting and 2800 RPM are used. The speed schedule recommended for normal take-offs is the faster of either 1.10 times the minimum air control speed or 1.15 times the zero thrust stall speed. Normal climb-out speeds recommended are five to seven knots faster. Their use places the aircraft in an advantageous position for three-engine operation should an emergency arise.

It is most important that the nose wheel be kept on or close to the runway until within approximately 10 knots of the take-off speed. Start a smooth rotation to take-off attitude at this point so as to leave the ground at the illustrated take-off speed schedule. This results in maximum acceleration being achieved during the run and minimizes the possibility of overshooting the take-off speed prior to leaving the ground. Gear retraction should be initiated as soon as the aircraft is clear of the ground in order to decrease aerodynamic drag as quickly as possible. The climb-out should be made at the speeds noted on the charts until above the height of obstructions.

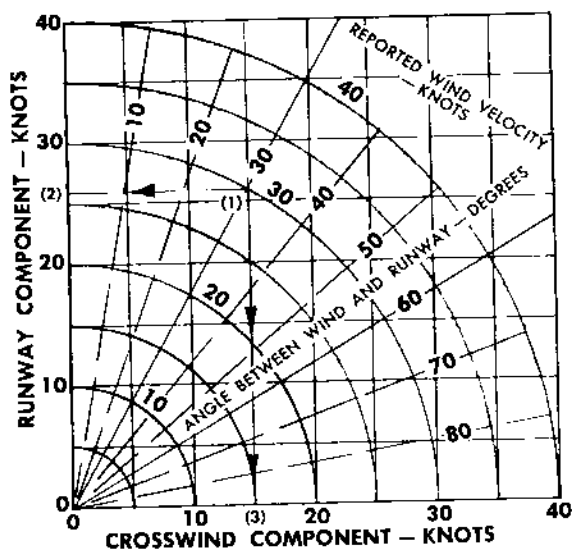

SAMPLE PROBLEM.

The wind component chart, figure A3-4, is used to determine the wind component parallel to the runway. The runway heading is always the left hand scale labelled: Runway Component—Knots. Enter the chart with ground level wind velocity and the angle between runway heading and reported wind direction. From this intersection, proceed horizontally to the left to read the wind component parallel to the runway. The crosswind component can be noted by proceeding vertically downward from the intersection to the crosswind component scale. The example shown is for a reported headwind of 30 knots at an angle of 30 degrees off the runway heading. This determines the intersection (1). Proceeding to the left the runway component (2) is 26 knots. The crosswind component, proceeding from (1) vertically, is 15 knots (3).

Wind correction grids in this part, except for climb-out flight paths, correct for the wind actually at the runway. Multiply tower reported headwinds by 0.4, tailwinds by 1.2, to obtain runway wind velocity.

GROUND RUN DISTANCES.

The following example illustrates the use of the Ground Run Distance to Take-off curve, figure A3-3.

Given conditions:

- Predicted INBD BMEP, 204 BMEP.

- Runway density altitude, 500 ft.
- Take-off weight, 107,000 lb.
- Wind, 20 kts. headwind
- Runway slope, 2% uphill

To find the distance to take-off, enter at 204 INBD BMEP (1) proceed vertically at 500 ft. density altitude (2). Proceed horizontally to the line representing the take-off weight of 107,000 lb. (3), then vertically to the zero wind line (4). Follow the wind guide lines to 20 kts. headwind (5), and continue vertically to the zero runway slope line (6). Follow the runway slope guide lines to 2% uphill slope (7). Continue vertically to (8) and read the take-off distance of 2500 ft.

The distance to take-off and climb 50 ft. curve, figure A3-4, is used in the same manner. For the same initial conditions as used in distance to take-off, the distance to take-off and climb 50 ft. is 3600 ft.

TAKE-OFF CRITERIA DEFINITIONS.

The following definitions have been promulgated by the USAF, and are supplied here for informational purposes. Performance data in this appendix are in agreement with these definitions.

Refusal Speed — Maximum speed to which the aircraft can accelerate and then stop in the available runway length.

Refusal Distance — The distance required to accelerate to the refusal speed under normal conditions.

Critical Airspeed for Engine Failure — The speed at which engine failure permits acceleration to take-off speed in the same distance the aircraft may be decelerated to a stop.

Critical Field Length — The total length of runway required to accelerate on all engines to the critical airspeed for engine failure, experience an engine failure, then continue to take-off or stop.

Acceleration Check Distance — Distance from start of take-off to an acceleration check point.

Acceleration Check Speed — Minimum speed that is allowable at the acceleration check marker.

Take-off Speed — Speed at which the main gear leaves the ground or lifts off.

Take-off Distance — Ground run in feet to take-off speed.

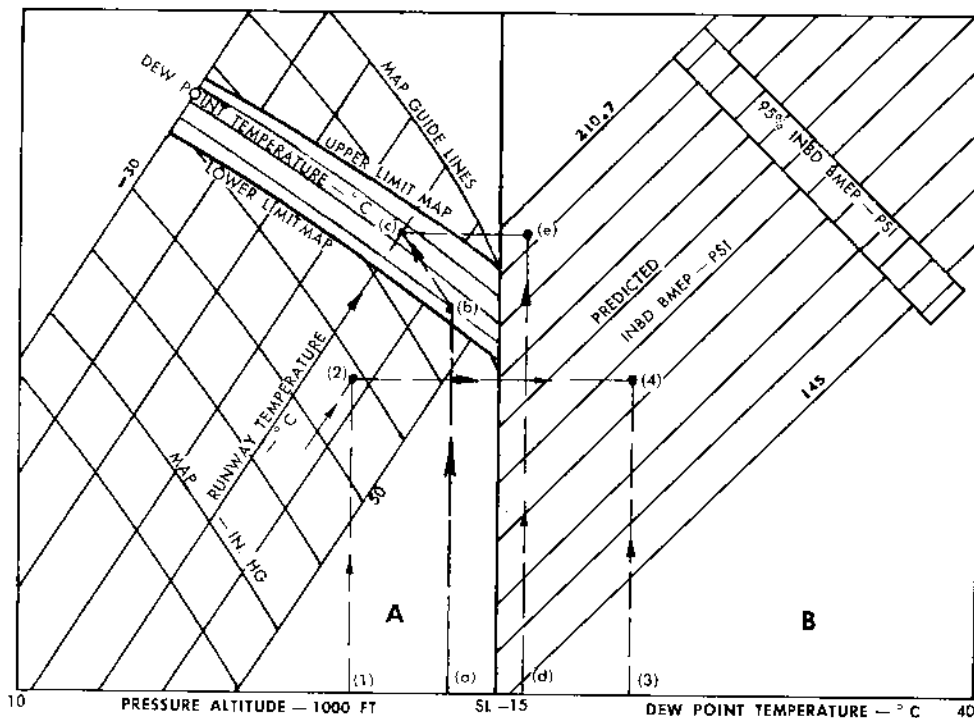

SAMPLE PROBLEM.

Figure A3-1 is a general curve that provides data for the prediction of maximum power available for pressure altitudes from sea level to 10,000 ft. with various conditions of temperature and humidity and when using 100/130 grade fuel.

To predict maximum power, obtain dew point, runway air temperature and field pressure altitude.

For purposes of explanation the chart has been divided into two parts. Part A at the left side of the chart is used for the determination of MAP and maximum BMEP available without correction for power loss due to humidity. A band crosses the upper portion of Part A which consists of upper and lower allowable MAP limit lines. Constant dew point temperature lines are drawn between these limit lines which permit direct reading of the adjusted limit MAP for given humidity conditions. The upper MAP limit constitutes the maximum MAP for high humidity condition. The lower MAP limit establishes maxi-

imum MAP for dry day and low humidity conditions. The dashed power guide lines above the band account for change in BHP due to effect of back pressure.

The loss of BMEP due to humidity is shown in Part B. This grid is direct reading and shows two BMEP scales versus dew point temperature. One scale is read to obtain predicted BMEP, and the other is read to obtain 95% predicted BMEP. Both scales are continuous through the range of dew point temperatures. The apparent break is provided only to emphasize the difference in the two scales.

Examples of chart usage are shown for two cases, one for full throttle, and another for part throttle.

Given conditions for full throttle example:

- a) Field elevation (pressure altitude)
4,300 ft.

SAMPLE PROBLEM - (Continued)

- b) Runway temperature, 26° C.
c) Dew point temperature, 20° C.

Enter Part A at 4,300 ft. (1) and proceed vertically until reaching runway temperature of 26° C (2). Read MAP of 46.7 inches Hg. Proceed horizontally into Part B and intersect dew point temperature of 20° C entered at (3). At this intersection (4), read directly 181 predicted BMEP. 95% predicted BMEP can also be read directly using the imposed 95% predicted BMEP scale. This is 172 BMEP.

An intersection of altitude and dew point temperature might have been established on entering Part A, but the point would lie higher than the altitude and runway temperature intersection for this problem thus it could not be considered, as such a condition could not be expected to exist. The **lower** intersection determines MAP limit in all cases.

Given conditions for part throttle example:

- a) Field elevation (pressure altitude).
1,200 ft.
b) Runway temperature, 20° C.
c) Dew point temperature, 10° C.

Enter Part A at 1200 ft. (A) and proceed vertically to intersect the runway temperature or dew point temperature line, whichever is lower. If the runway temperature is lower, proceed horizontally into Part B. In this case the dew point temperature of 10° C is lower and the intersection (B) is established. At (B) read a MAP of 51.9 inches Hg. and proceed along this constant MAP line (51.9 inches Hg. in this case) to intersect the runway temperature lines for 20° C (C). From (C) proceed horizontally into Part B to the dew point temperature line for 10° C, entered at (D), and locate the intersection of these lines at (E). Read predicted BMEP, directly at (E) to be 208. 95% predicted BMEP can also be read directly by the imposed 95% scale and this is 198 BMEP.

If predicted BMEP is greater than the limit BMEP of 210.7, reverse the procedure by starting at the intersection of the 21 BMEP and dew point temperature line in Part B and enter into Part A to predict MAP.

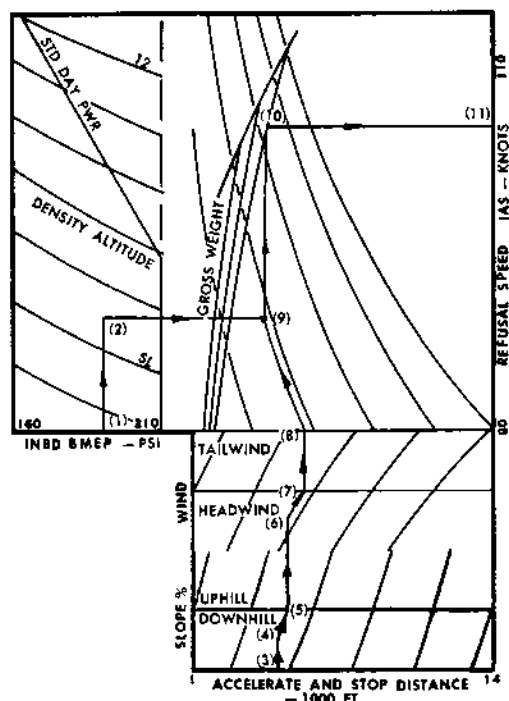

SAMPLE PROBLEM.

The following example illustrates the use of the Refusal Speed curve, figure A3-5.

Given conditions:

- a) Predicted BMEP, 204 BMEP.
b) Runway elevation (500 ft. H_{01}).
c) Runway length available, 4000 ft.
d) Runway slope, 2% uphill.
e) Wind, 20 kts. headwind.
f) Take-off weight, 107,000 lbs.

To find the refusal speed enter figure A3-5 at 204 INBD BMEP (1) and proceed vertically to 500 ft. density altitude (2). Draw a horizontal line through this point (2). Enter the bottom of the chart at 4000 ft., the distance to accelerate and stop (runway length available) (3) and proceed vertically to 2% uphill runway slope (4). Continue along the runway slope guide lines to the zero runway slope line (5) and proceed vertically to 20 kts. headwind (6). Follow the wind guide lines to the zero wind line (7) and continue vertically to the top of the wind correction grid (8). Follow the guide lines to the horizontal line through point (2). From this intersection (9), proceed vertically to the take-off weight of 107,000 lbs. (10) and continue horizontally to (11) and read the refusal speed of 101.1 kts. IAS.

It is possible to introduce a factor of conservatism by entering this curve at a distance less than the full runway length actually available.

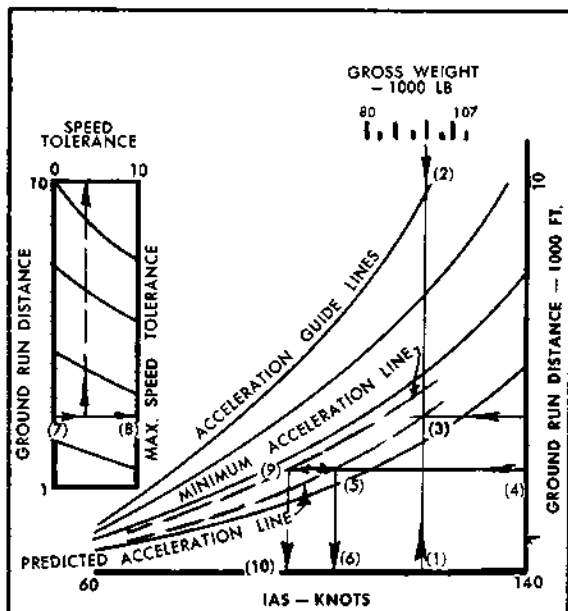

These entries intersect at (3). From (3) draw a line following the acceleration guide lines. To check the aircraft's progress follow this normal acceleration line down to a known runway distance (runway marker) and read the corresponding speed that should be reached at this distance. As shown on the curve, a distance of 2,000 ft. (4) intersects the normal acceleration line at (5). The corresponding IAS is read below at (6) as 97.0 knots, flush static system.

The distance along the runway at the refusal speed (refusal distance) can be found using this curve. Enter at the refusal speed and proceed vertically to the normal acceleration line drawn from initial conditions. Then proceed horizontally to note the refusal distance that corresponds to this refusal speed.

An allowable speed tolerance grid is shown on the left hand side of the curve. This is used to predict the minimum allowable four engine acceleration line that will permit a take-off in the runway length available. Enter the grid at the ground run distance (7). Proceed horizontally to the runway length available or until the maximum 10 knot speed tolerance is reached (8). If the runway length is reached first read the speed tolerance by proceeding vertically upwards to the speed scale. In this case the runway length available is greater than 3400 ft. so the 10 knot maximum speed tolerance will be used to find the minimum allowable acceleration line. From point (5), in the example problem, proceed horizontally to the left by an amount equal to the speed tolerance. In this case the tolerance is 10 knots. Locate (9) at (106.5) or 96.5 knots IAS. At this new point (9) draw an acceleration line following the guide lines. This line is the minimum allowable acceleration line that is permitted during a take-off. At a known runway distance (runway marker) along this minimum acceleration line, establish an acceleration check distance. The corresponding speed is the acceleration check speed (87.2 knots).

SAMPLE PROBLEM.

The velocity during take-off ground run can be checked using figure A3-6. This curve is used to check the progress of the aircraft proceeding down the runway by predicting the velocity that should be obtained at given distances along the runway. Enter the curve vertically at the take-off weight and horizontally at the take-off ground run distance predicted from figure A3-3. The intersection of these entries determines a point from which a line can be drawn following the acceleration guide lines. This is the normal line that the aircraft should follow.

Example:

Given conditions:

- Take-off ground run, 2500 ft.
- Take-off weight, 107,000 lbs.

Enter horizontally at (1) the take-off ground distance. Enter vertically at (2) the take-off weight.

EMERGENCY TAKE-OFF PERFORMANCE.

A take-off emergency occurs if an engine or propeller fails at some point along the runway during take-off. Although the probability of experiencing such a failure during take-off is small, the decrease in performance resulting from the drop in power available is sufficiently important to warrant consideration. Refusal speeds, critical airspeeds for engine failure, critical field lengths, and maximum power climb performance should be determined prior to each take-off as a standard practice. When these are known, two general rules can be applied which are summarized as follows:

1. The take-off should be rejected and the aircraft brought to a stop if a take-off emergency develops before or upon reaching the critical airspeed for engine failure.

2. The take-off should be continued and the aircraft flown out on three engines if the emergency develops after the refusal speed is reached, unless the nature of the emergency or three engine performance is such that safe completion of the take-off is impossible.

The critical airspeed for engine failure will never be greater and may be less than the refusal speed, depending on the runway length and take-off conditions. The decision to reject or continue the take-off is optional when power failure occurs between the critical speed and refusal speed, however, a stop is recommended.

If the take-off is continued and a climb-out is made on three engines, take-off speed (1.15 times the zero thrust stall speed) should be maintained until all obstacles are cleared. Unless otherwise specified, this speed schedule is used in the three engine take-off presentations.

Minimum ground control speed is the slowest airspeed for engine failure considered on the critical field length charts. A stop must be made if engine failure should occur before this speed is reached. In the event of an engine failure, primary aerodynamics controls alone are not sufficient to maintain directional control below this speed. Minimum ground control speed is 85 knots IAS flush static.

THREE ENGINE CLIMB-OUT FLIGHT PATHS.

Take-off flight path curves are provided to determine the ability of the aircraft to clear obstacles beyond the runway with an engine inoperative. They are presented on Figures A3-11 through A3-15.

The procedure used is as follows:

Given conditions:

- a) Density altitude, 6000 ft.
- b) Predicted BMEP, 189 psi
- c) Wind, 10 knots headwind
- d) Take-off weight, 107,000 lbs.

To find the obstacle that may be cleared 5,000 feet from the take-off point for the conditions stated, enter Figure A3-15 and follow the sequence shown. Results show that a 155 foot obstacle could be cleared. For weights other than those presented on the charts, a straight interpolation between obtained values is permitted.

THREE ENGINE TAKE-OFF RATES OF CLIMB.

Figure A3-16 presents three engine rates of climb for various aircraft configurations. The charts are based on a constant weight rate of climb with no power deviation on the operating engines.

TAKE-OFF WEIGHT AS LIMITED BY RUNWAY SLOPE.

Under certain conditions it is possible to reach take-off speed on three engines, within a reasonable distance, and still be unable to take-off. This situation can occur when the runway slope (or gradient) is greater than the aircraft's initial climb gradient with the gear extended.

The maximum take-off weight as limited by runway slope is shown in figure A3-17. The limit weight is that take-off weight where the gear down climb gradient is equal to the runway slope (or gradient). At greater than this limit weight the aircraft's climb gradient, with gear down, is not enough to permit lift-off from the runway.

STOPPING DISTANCE.

Flight tested distances to stop, using wheel brakes only, are shown in figure A3-18 for operation in the take-off configuration.

These data can be used to determine the accelerate and stop distances for the normal take-off speeds given on the take-off chart by adding the take-off and stopping distance plus an allowance for the time required to

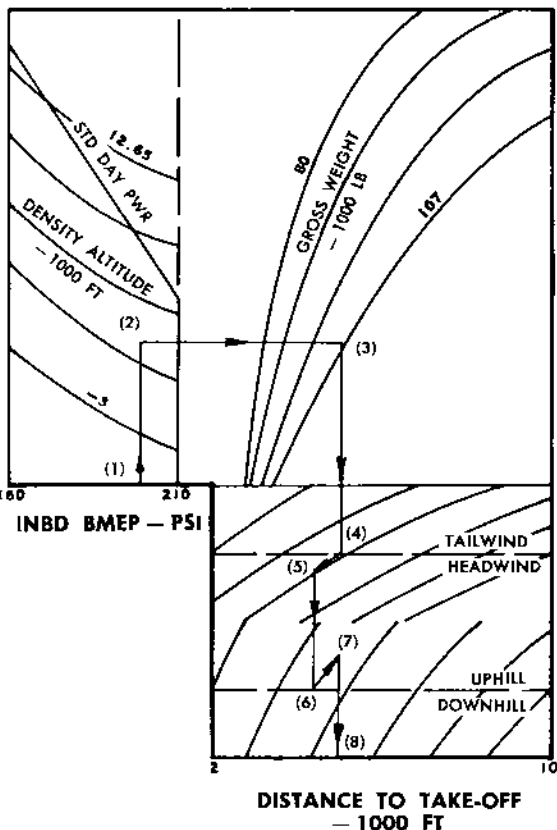

SAMPLE PROBLEM.

The critical airspeeds for engine failure for zero obstacle clearance and 50 ft. obstacle clearance may be determined from figures A3-8 and A3-10. These represent the speeds from which a take-off can either be continued and a zero or

a 50 ft. obstruction cleared at the critical field length distance, or the take-off rejected and the aircraft brought to a stop (without use of reverse thrust) within the same total runway length. Corresponding critical field lengths for zero obstacle clearance and 50 ft. obstacle clearance are provided in figures A3-7 and A3-9.

The following example shows the use of critical field length for zero obstacle clearance, figure A3-7.

Given conditions:

- a) Density altitude, 500 ft.
- b) Runway length available, 4,000 ft.
- c) Desired take-off weight, 107,000 lbs.
- d) Predicted BMEP, 204 BMEP. (95% BMEP could be used, introducing a slight margin in the performance data).
- e) Wind, 20 kts. headwind.
- f) Runway slope, 2% uphill.

Enter at INBD BMEP of 204 BMEP (1) and proceed vertically to density altitude of 1500 ft. (2). Proceed horizontally to the desired take-off weight of 107,000 lb. (3). Proceed vertically downward to the zero wind line (4) and correct for wind by following parallel to one of the guide lines to the 20 knot headwind condition line and establish point (5). Proceed vertically to the zero slope line (6). Follow parallel to one of the guide lines to correct for 2% uphill slope (7). Proceed vertically downward to read critical field length of 3,150 ft. (8).

The critical airspeed for engine failure for these conditions is 97.9 knots, IAS flush static. A chase-around illustrates the procedure for use of this curve, figure A3-8.

Since the runway length available is greater than the critical field length, the refusal speed

curve should be used to determine a greater speed at which the take-off can safely be rejected.

The critical field length curves for 50 ft. obstacle clearance, figures A3-9 and A3-10 are used in the same manner as shown for the zero obstacle clearance presentation.

The use of predicted BMEP or reject BMEP and either zero obstacle clearance critical field length or 50 ft. obstacle clearance critical field length, depends on field obstacle conditions or the level of safety preferred.

For certain conditions of runway length, predicted BMEP, altitude and a desired take-off weight, the aircraft's performance is such that if an engine fails the take-off cannot be accomplished. In these instances, the take-off weight would have to be reduced to permit a safe take-off in case of an engine failure. The following example illustrates the case when take-off weight is limited by critical field length:

Given conditions:

- a) Predicted BMEP, 190 BMEP.
- b) Field elevation (density altitude), 1500 ft.
- c) Runway available, 6,000 ft.
- d) Wind, 20 kts. tailwind.
- e) Runway slope, 1% uphill.
- f) Desired take-off weight, 107,000 lbs.

The critical field length for zero obstacle clearance, using figure A3-7 is 6,700 ft. Therefore the take-off weight would have to be reduced to 103,500 to take-off on three engines at exactly 6,000 ft. with no obstacle clearance and the engine failure occurring at the critical airspeed for engine failure. To clear a 50 ft. obstacle at the end of the runway, the take-off weight, using figure A3-9, would have to be reduced to 94,000 lbs.

recognize an engine failure and apply the brakes. Experience has shown that the allowance of 3 seconds at the airspeed for engine failure accounts satisfactorily for the distance traveled after engine failure prior to brake application. If the distance obtained is less than the runway length available, a safe stop can be made.

Stopping distances shown are based on operation from dry runways having zero slope and no wind.

THREE ENGINE FERRY CONFIGURATION PERFORMANCE.

Occasions may arise where it becomes necessary to ferry an aircraft from a base where engine or propeller repair facilities are not available. Figures A3-19 and A3-20 show the take-off distances and take-off climb performance of the airplane with the propeller of the inoperative engine feathered or removed.

The performance shown is applicable if the aircraft is operated with normal take-off trim and wing flaps 60% extended. Take-off speed schedule used is 1.3 times the zero thrust stall speed. Take-off power should be applied to two symmetrical engines, (No. 1 and 4 or No. 2 and 3). Gradual application of power to the asymmetrical engine as rudder effectiveness is gained insures directional control and should result in the predicted take-off distances with standard power. Full application of power can be obtained at 85 knots IAS flush static without assistance of nose wheel steering and with full application of rudder. Nose wheel steering will allow slightly more rapid application of power during the first portion of take-off run. However, it is recommended that nose wheel steering not be employed to an excessive degree. Skipping may be encountered which is undesirable from a structural standpoint. After maximum power is attained on the asymmetrical engine, acceleration should be continued to the take-off speeds shown.

MAXIMUM POWER PREDICTION GRAPH

MODEL: C-121A
DATA BASED ON: CALCULATIONS
DATE AS OF: 1 January 1959

100/130 FUEL

ENGINE: R3350-75
PROPS: CURTISS 830-21C4-0

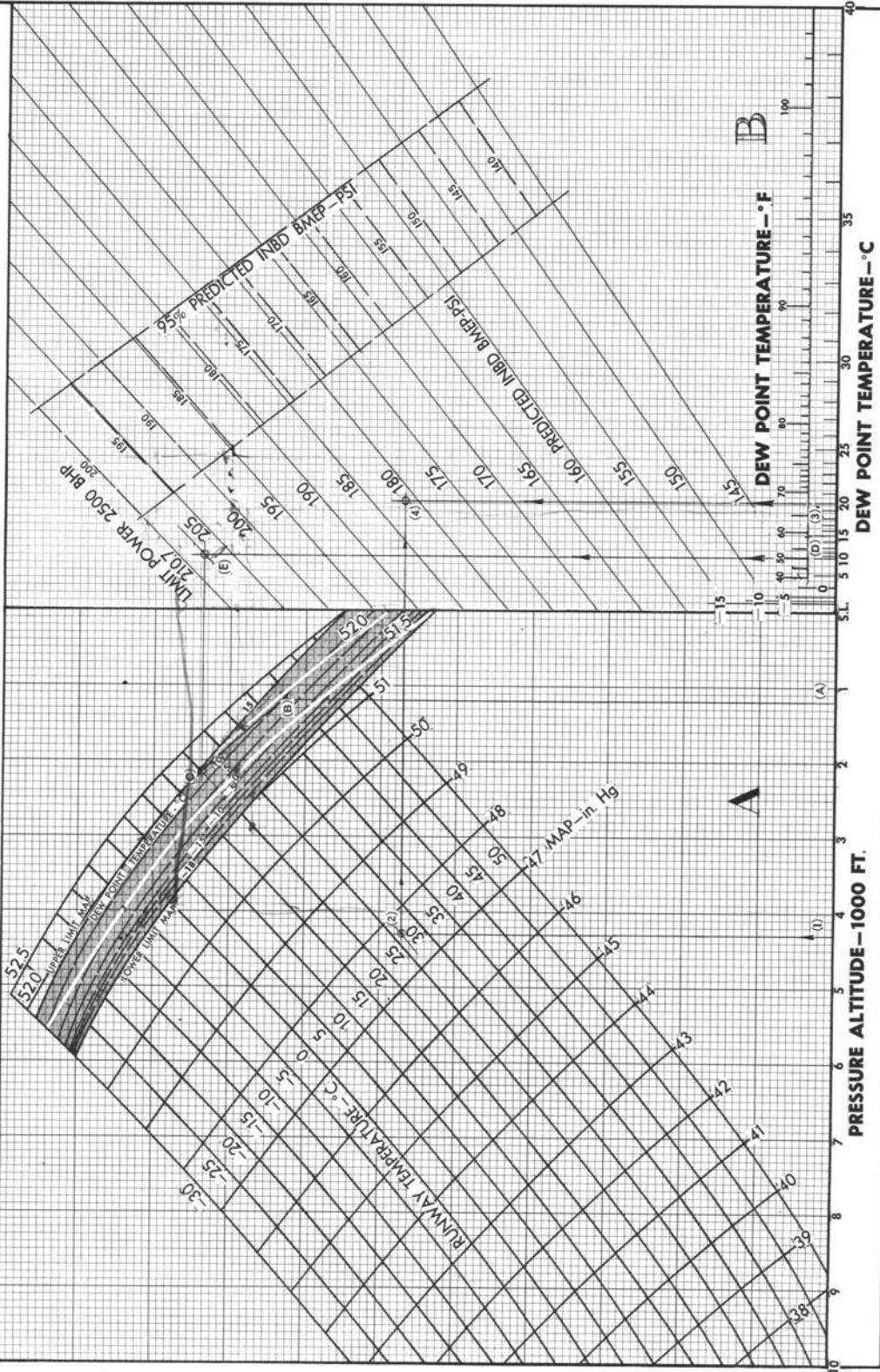

Figure A3-1

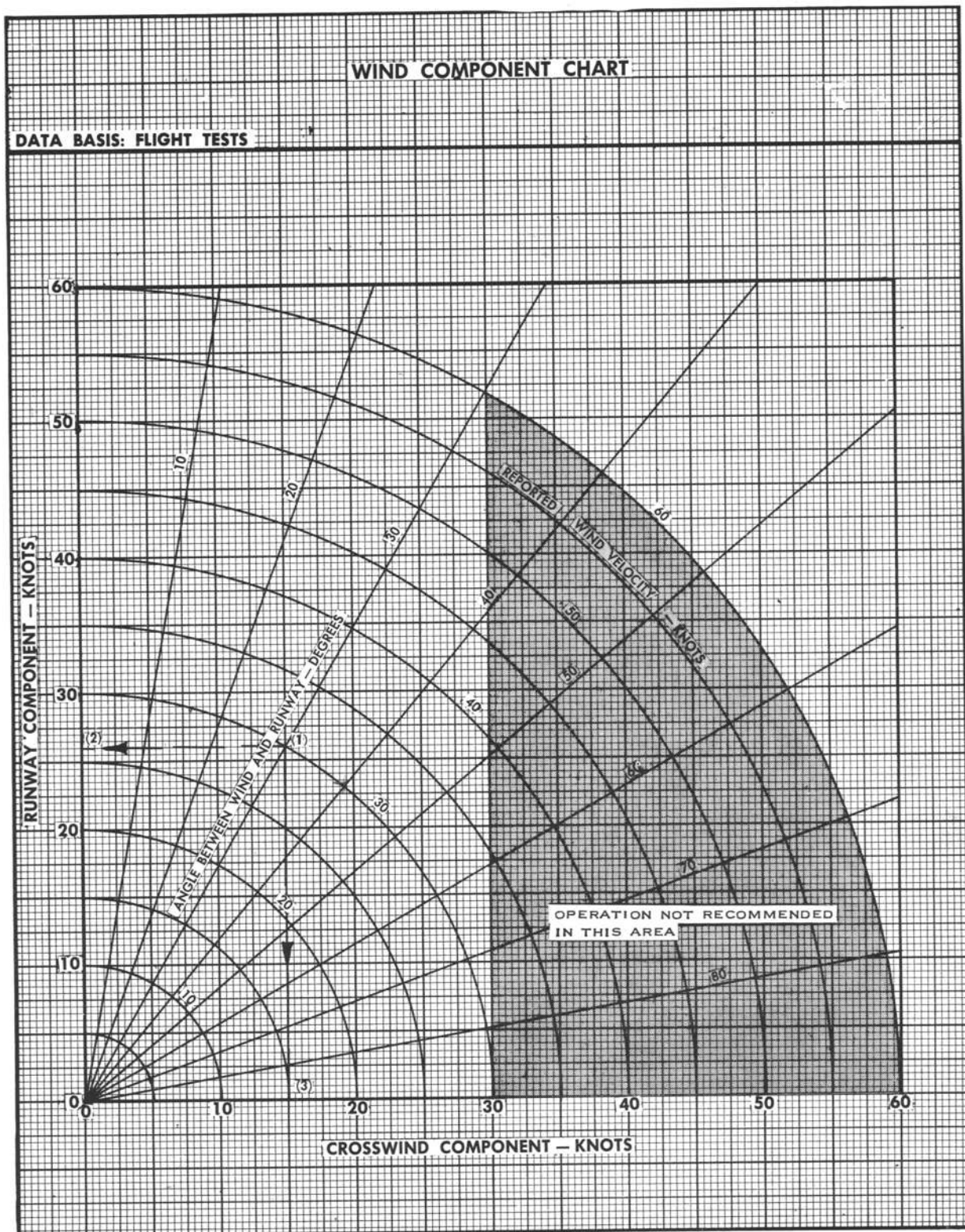

Figure A3-2

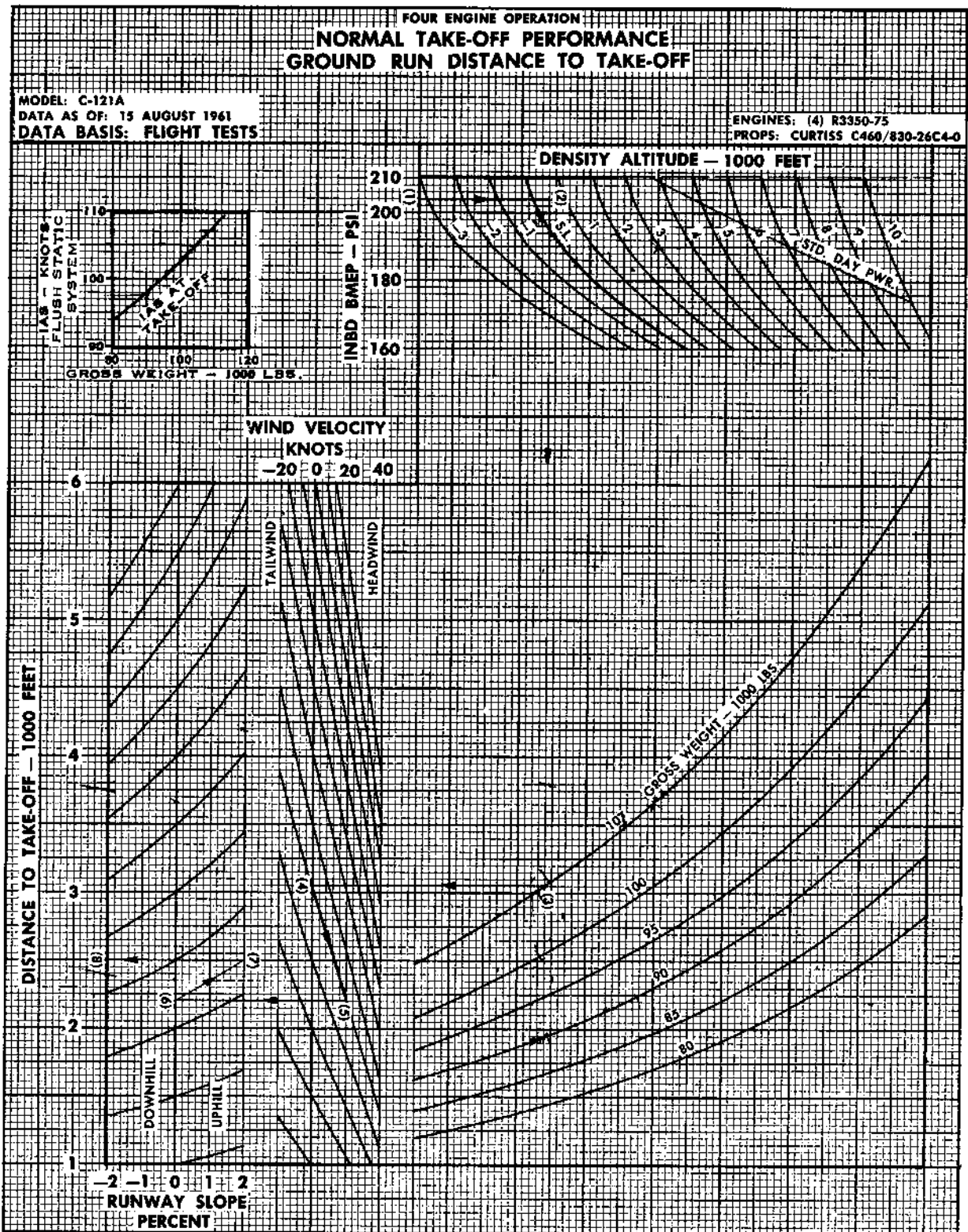

Figure A3-3

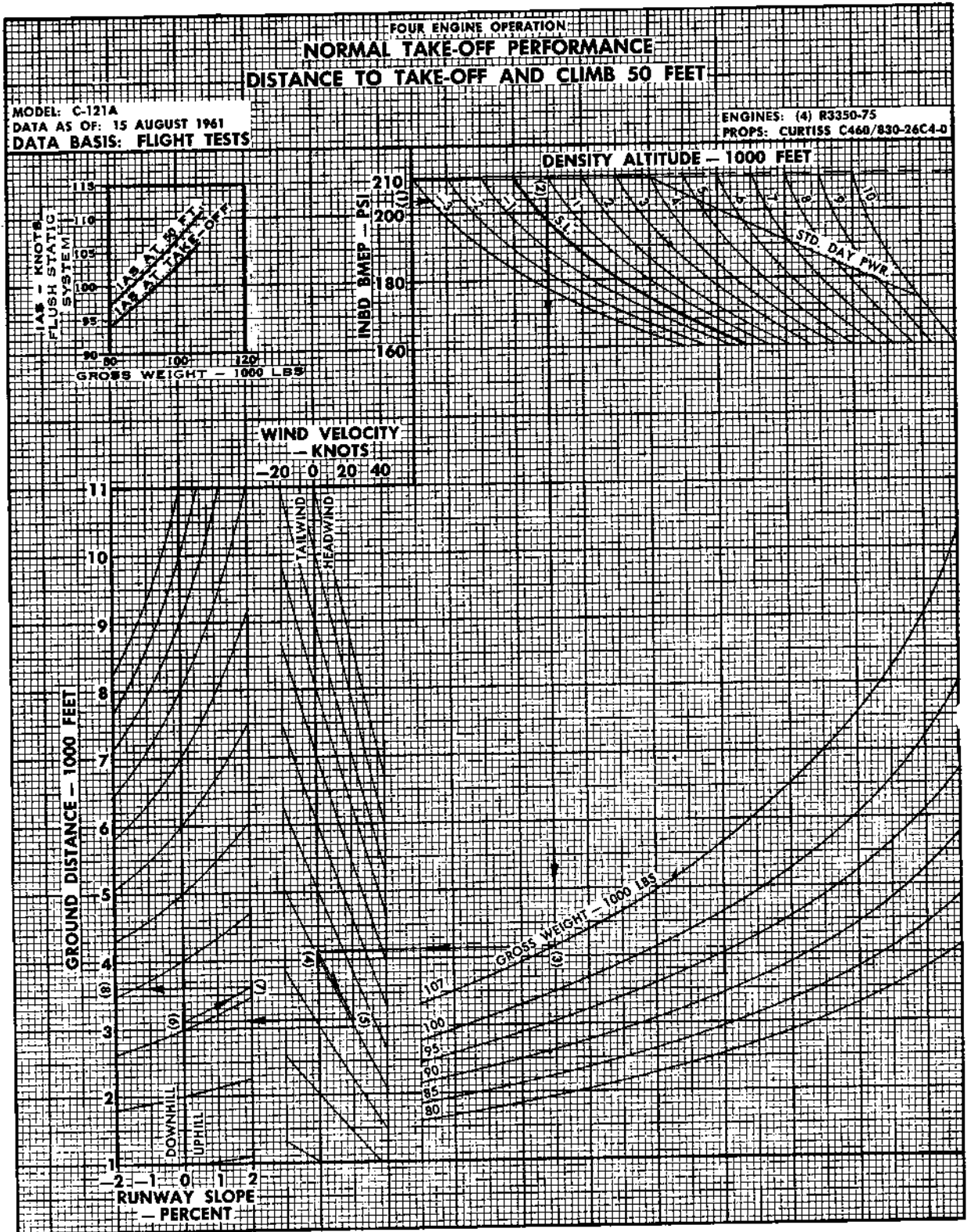

Figure A3-4

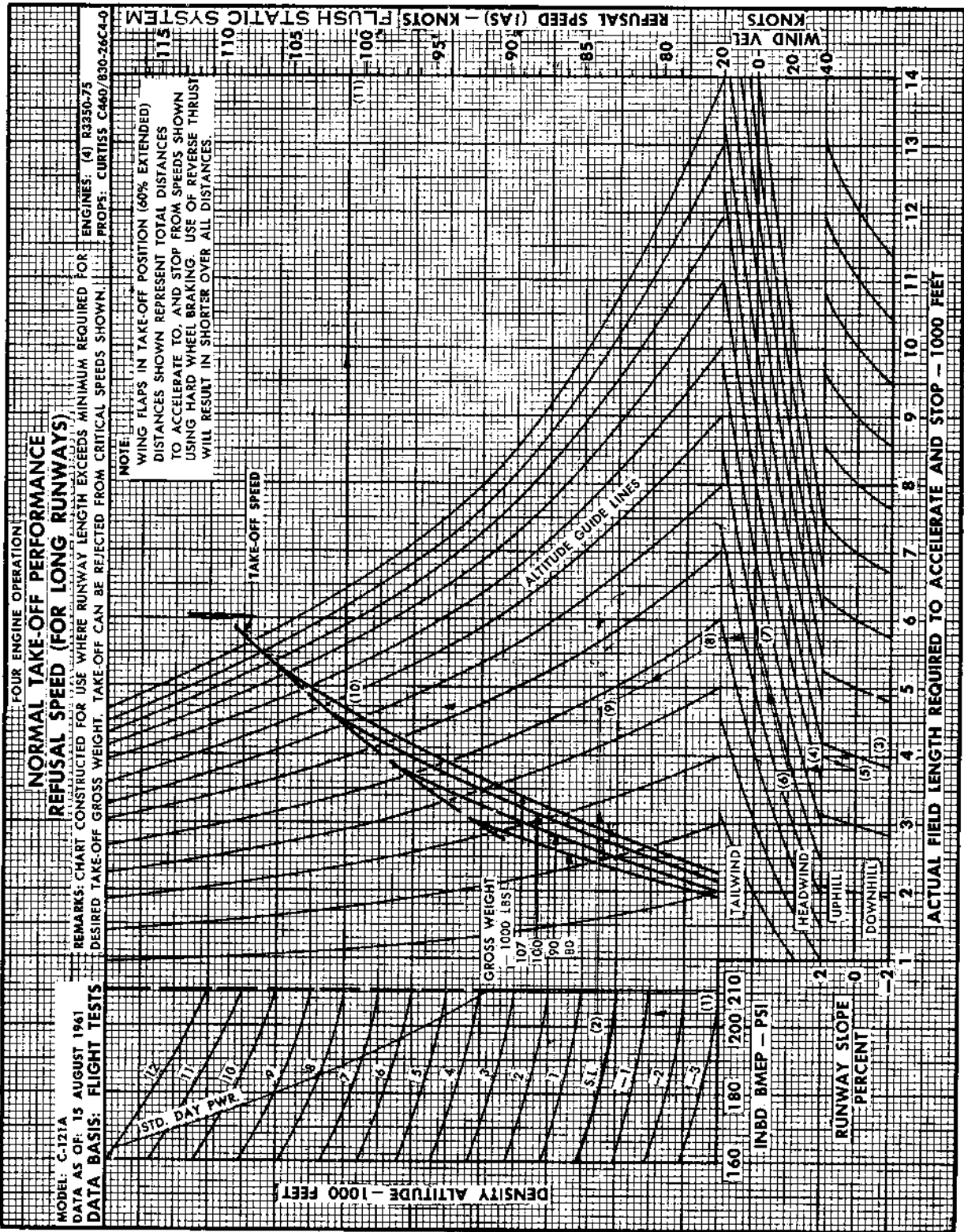

Figure A3-5

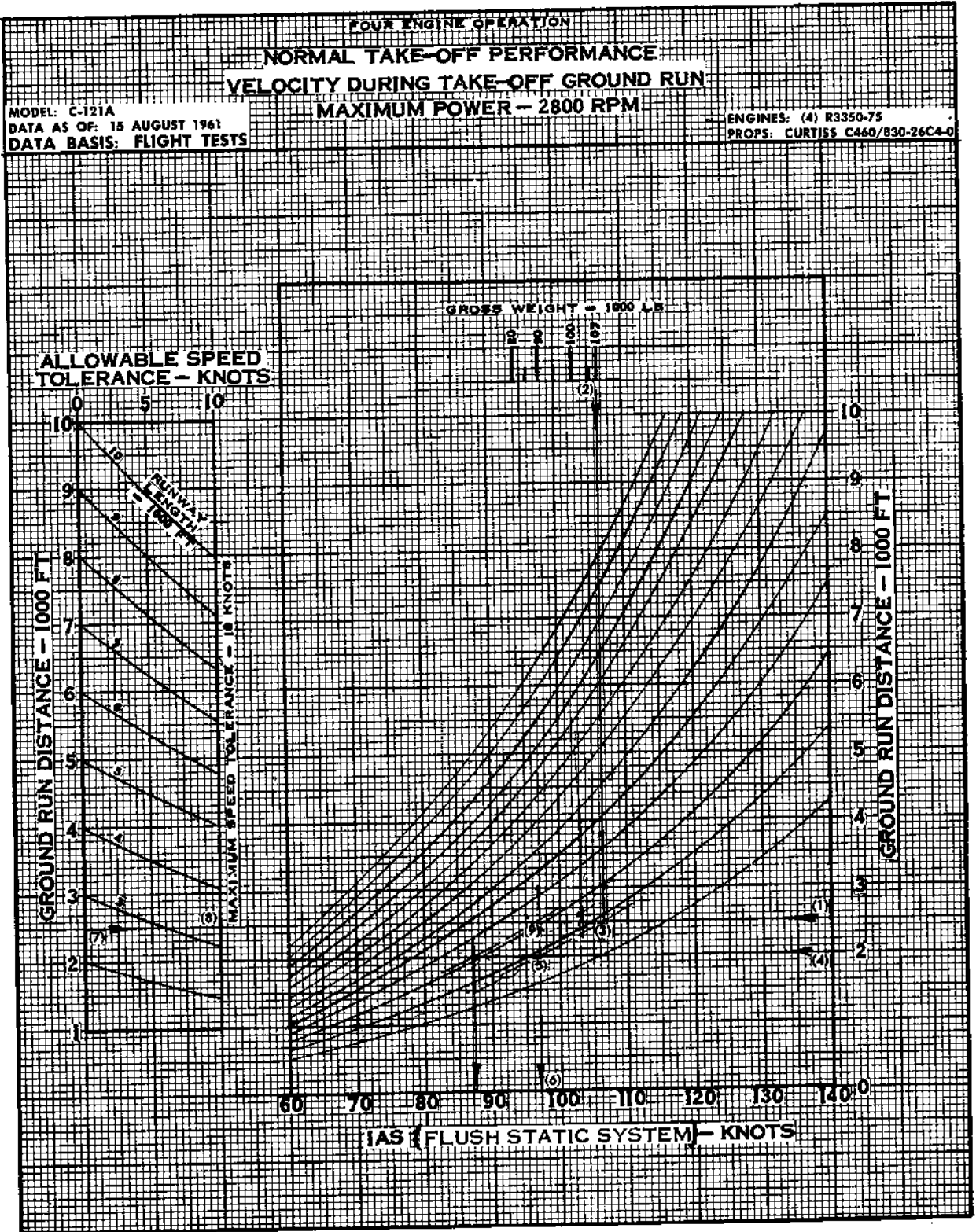

Figure A3-6

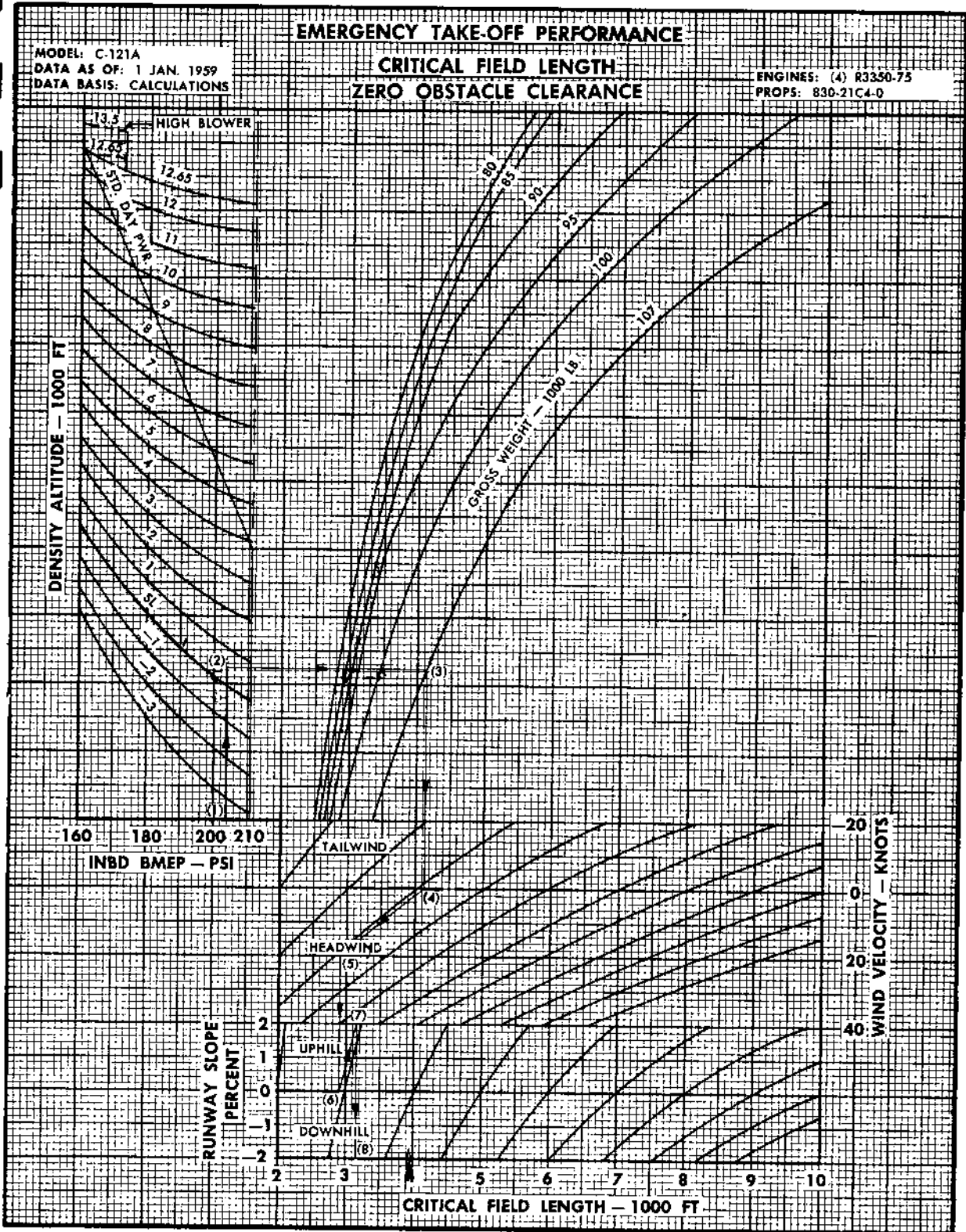

Figure A3-7

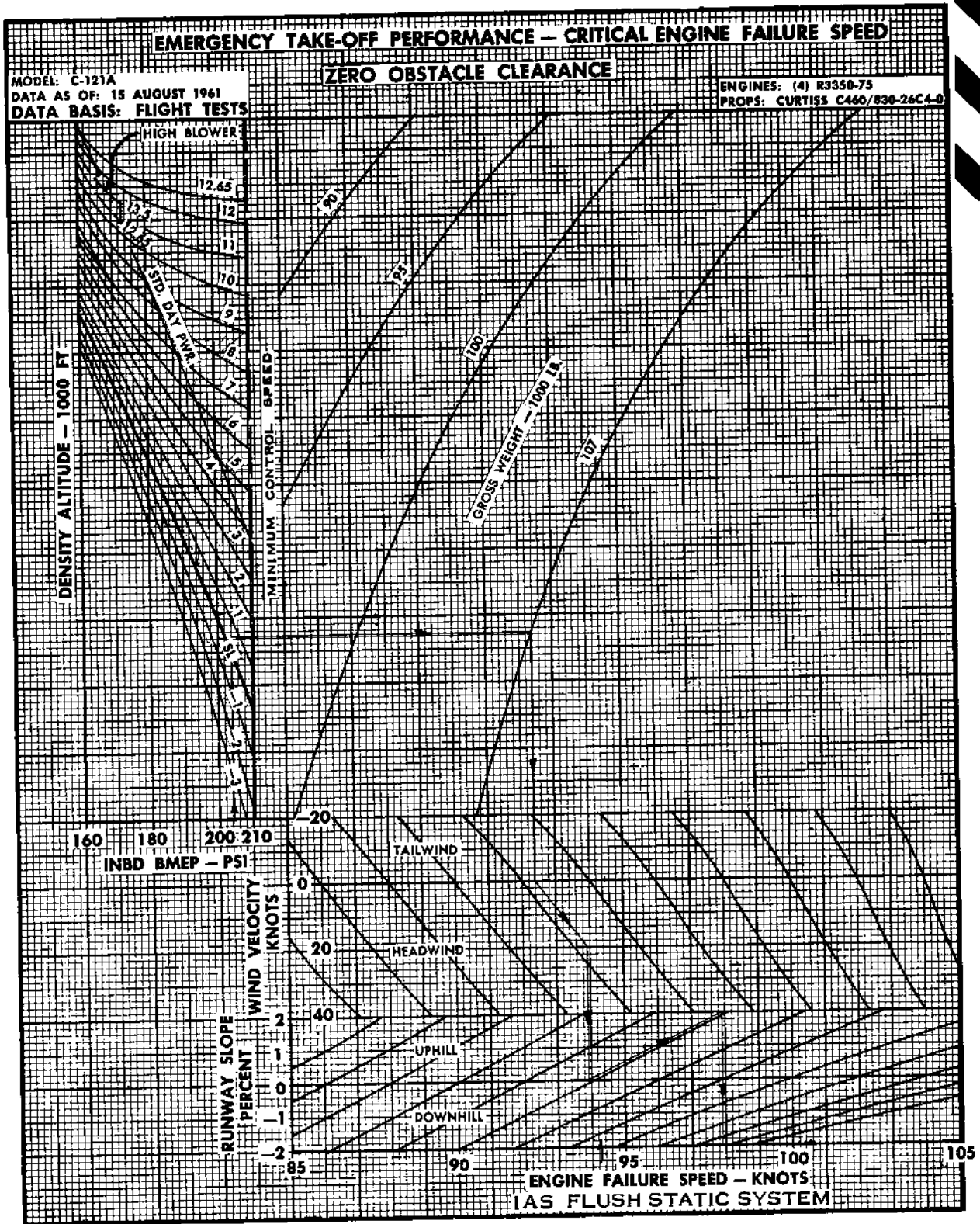

Figure A3-8

EMERGENCY TAKE-OFF PERFORMANCE

CRITICAL FIELD LENGTH

50 FT OBSTACLE CLEARANCE

MODEL: C-121A
DATA AS OF: 1 JAN. 1959
DATA BASIS: CALCULATIONS

ENGINES: (4) R3350-75
PROPS: 830-21C4-0

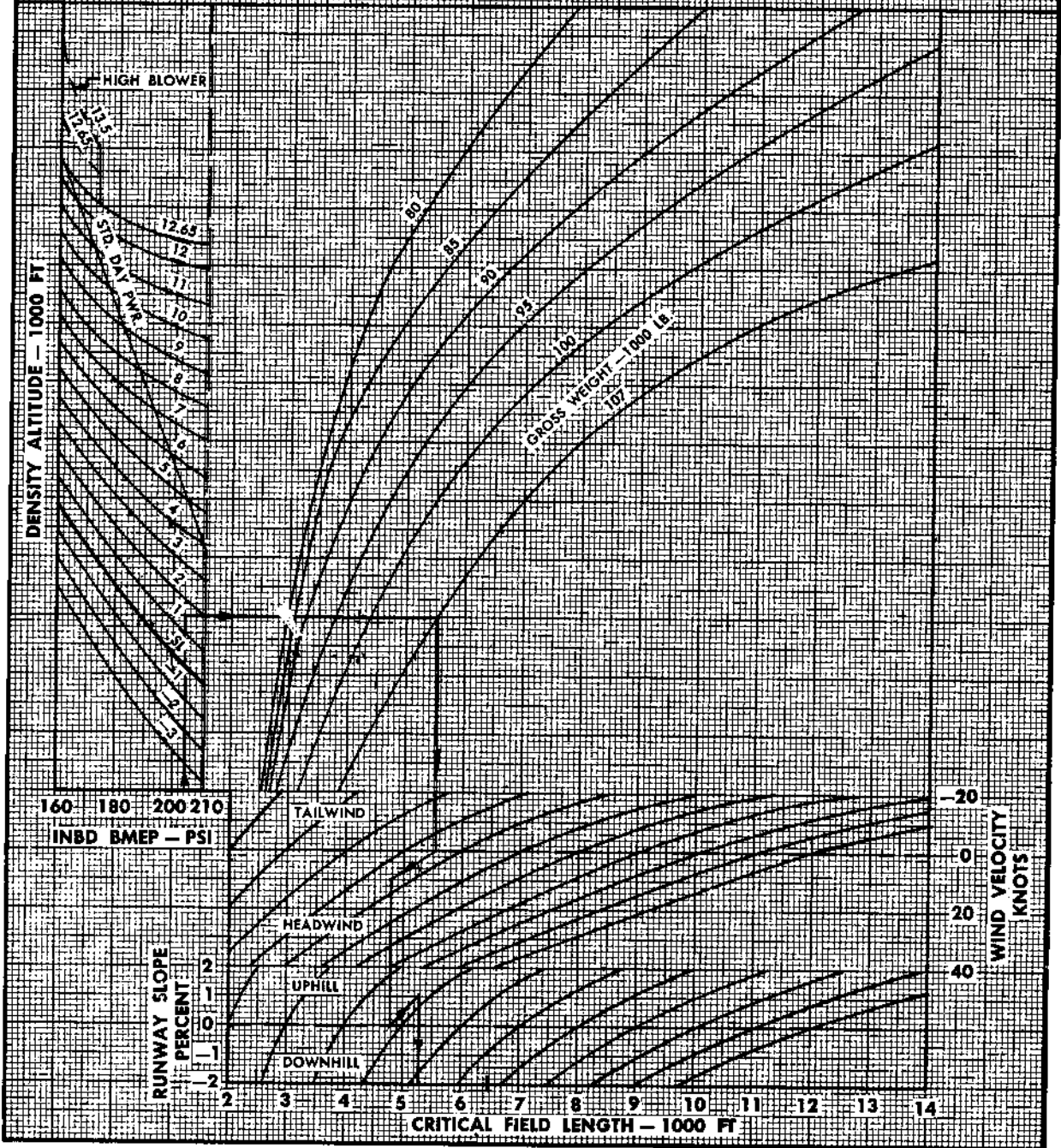

Figure A3-9

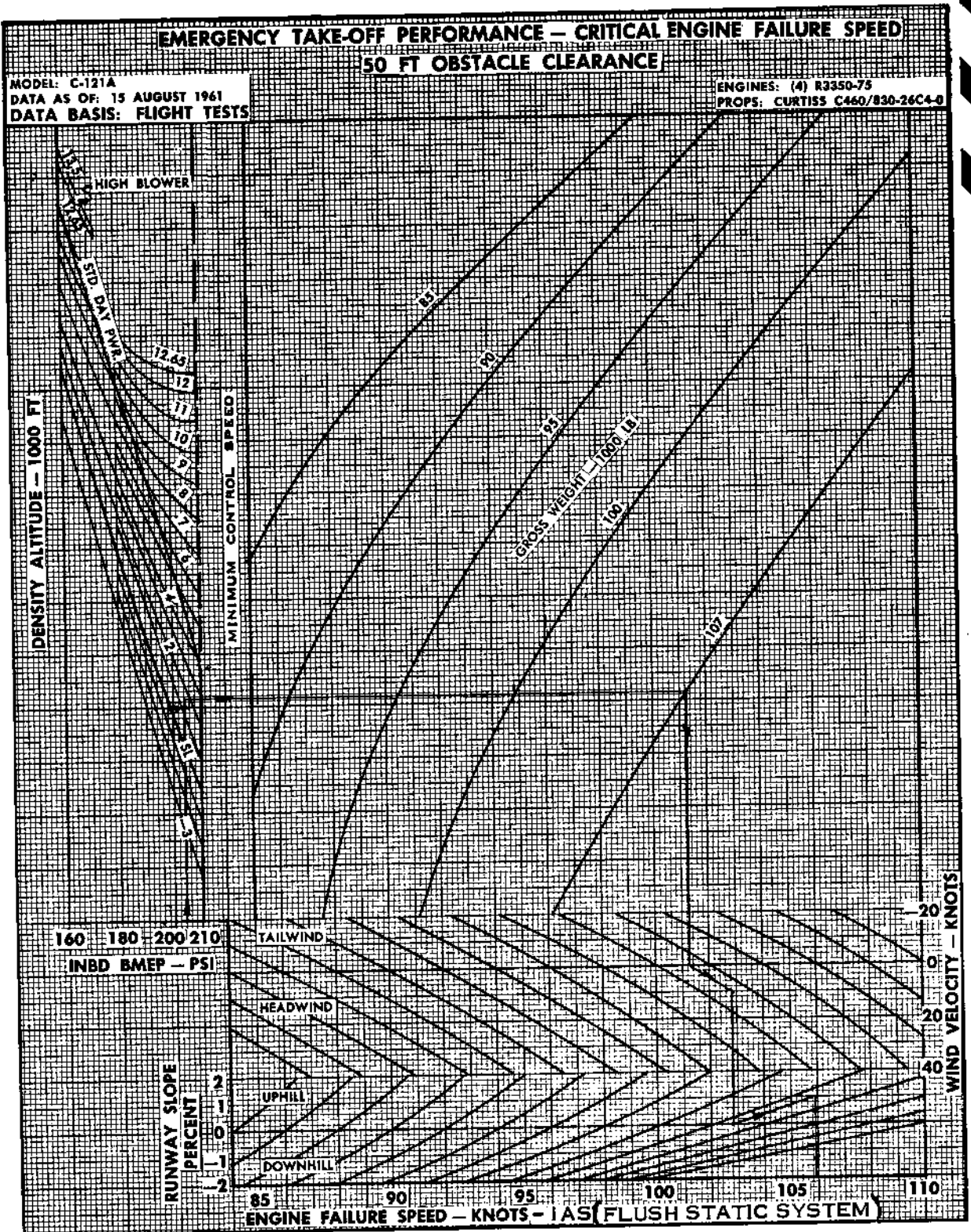

Figure A3-10

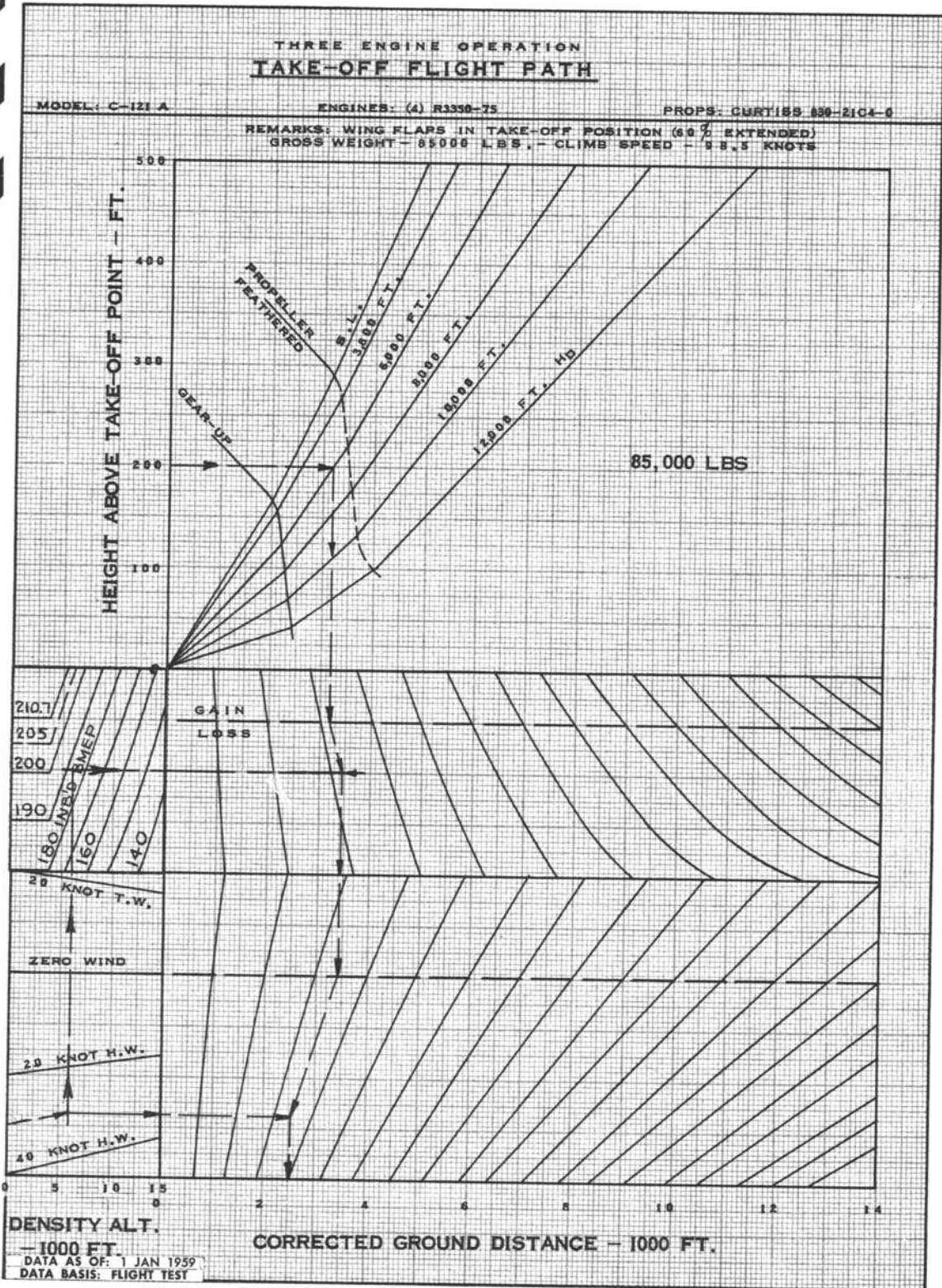

Figure A3-11

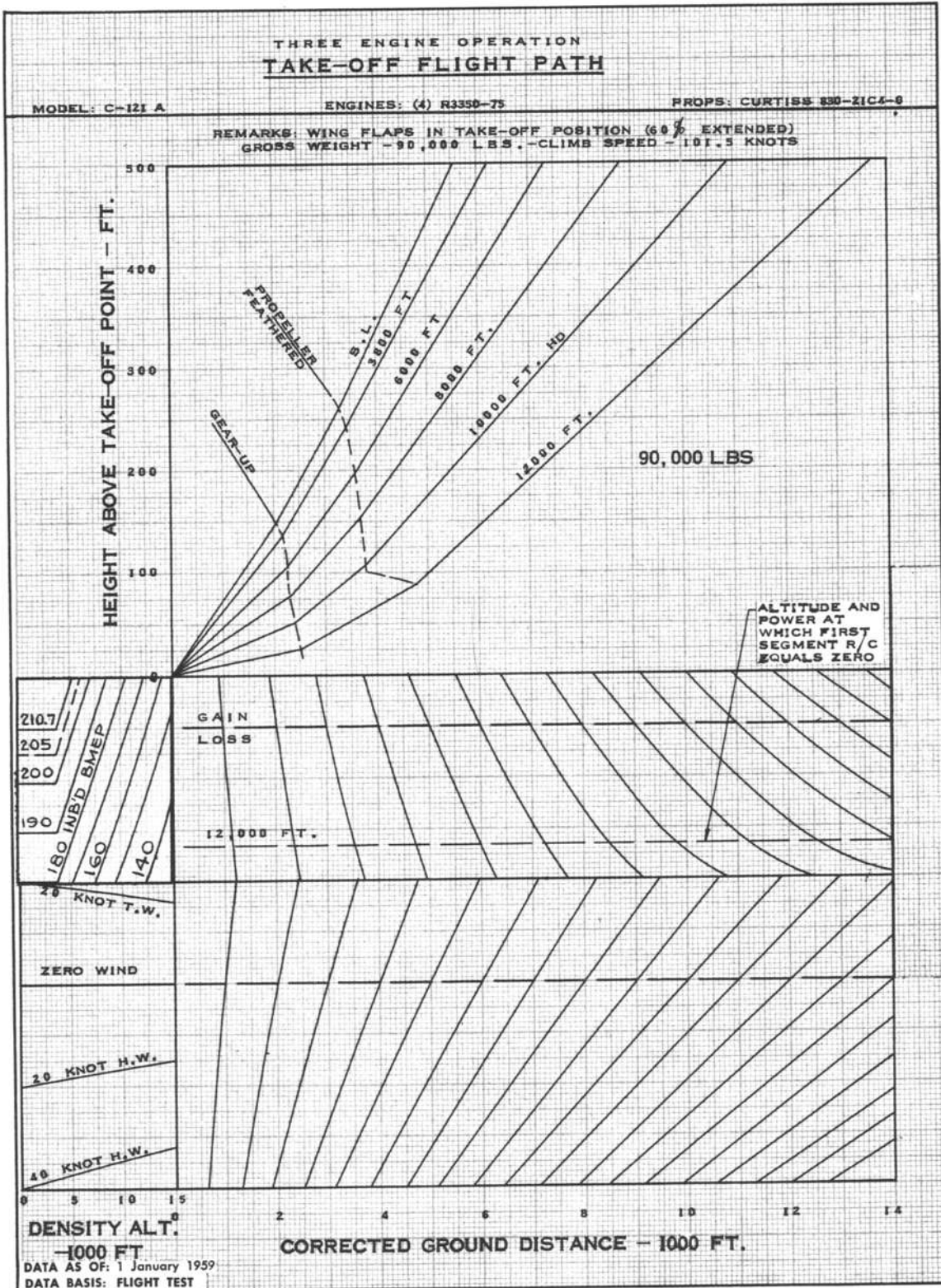

Figure A3-12

THREE ENGINE OPERATION

TAKE-OFF FLIGHT PATH

MODEL: C-121 A

ENGINES: (4) R3350-75

PROPS: CURTISS 636-21C4-6

REMARKS: WING FLAPS IN TAKE-OFF POSITION (60% EXTENDED)
GROSS WEIGHT - 95,000 LBS. - CLIMB SPEED 104.5 KNOTS.

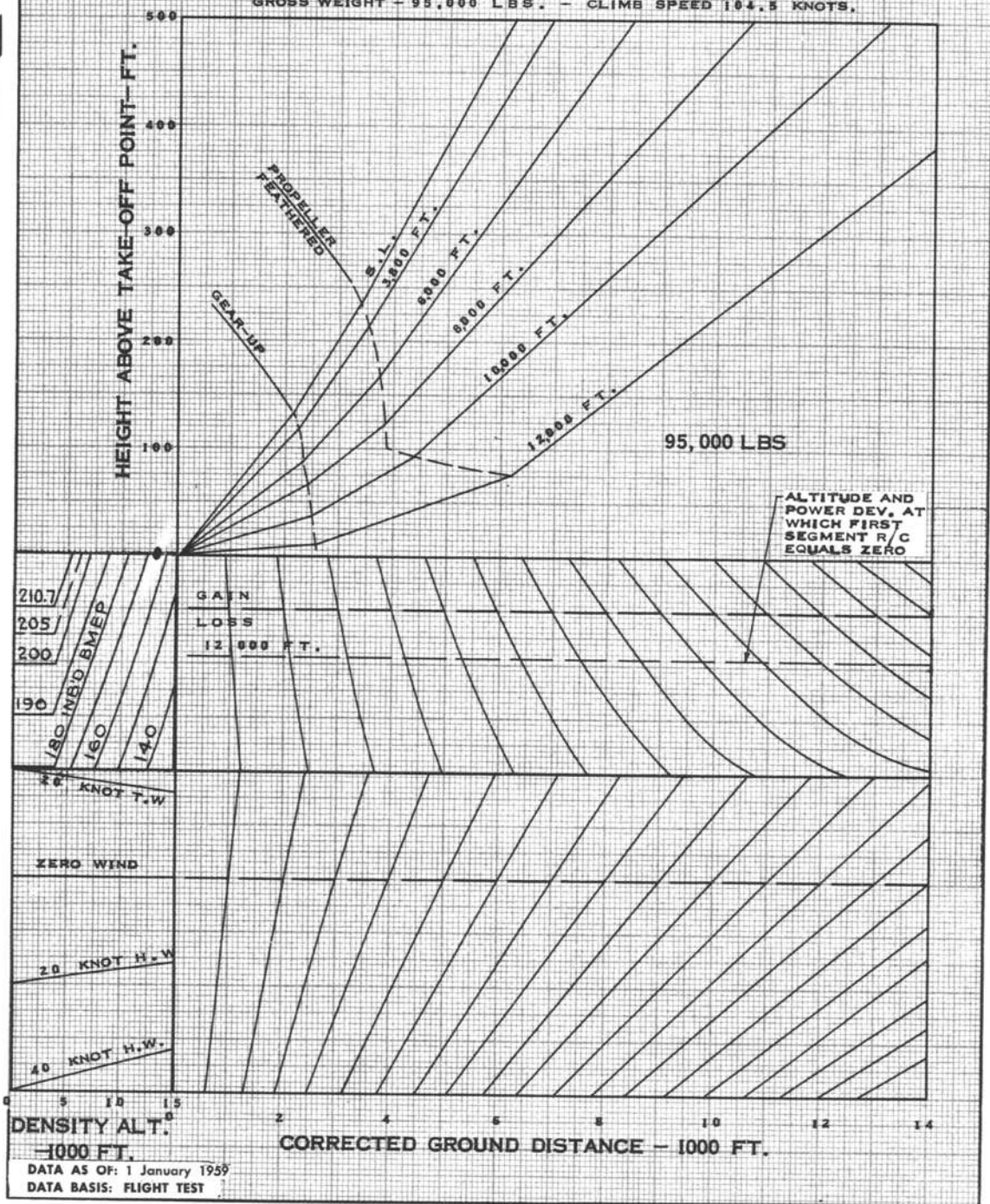

Figure A3-13

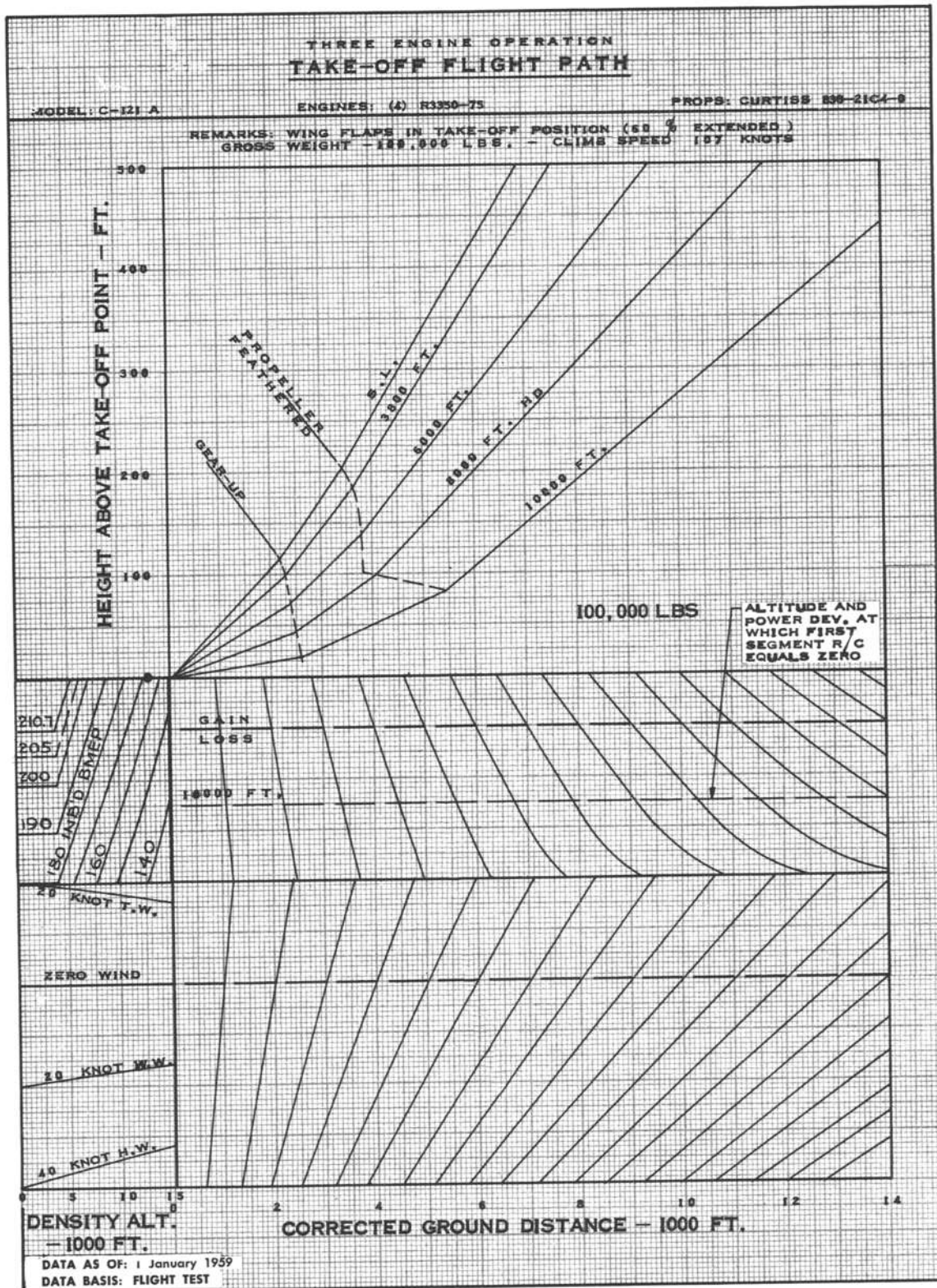

Figure A3-14

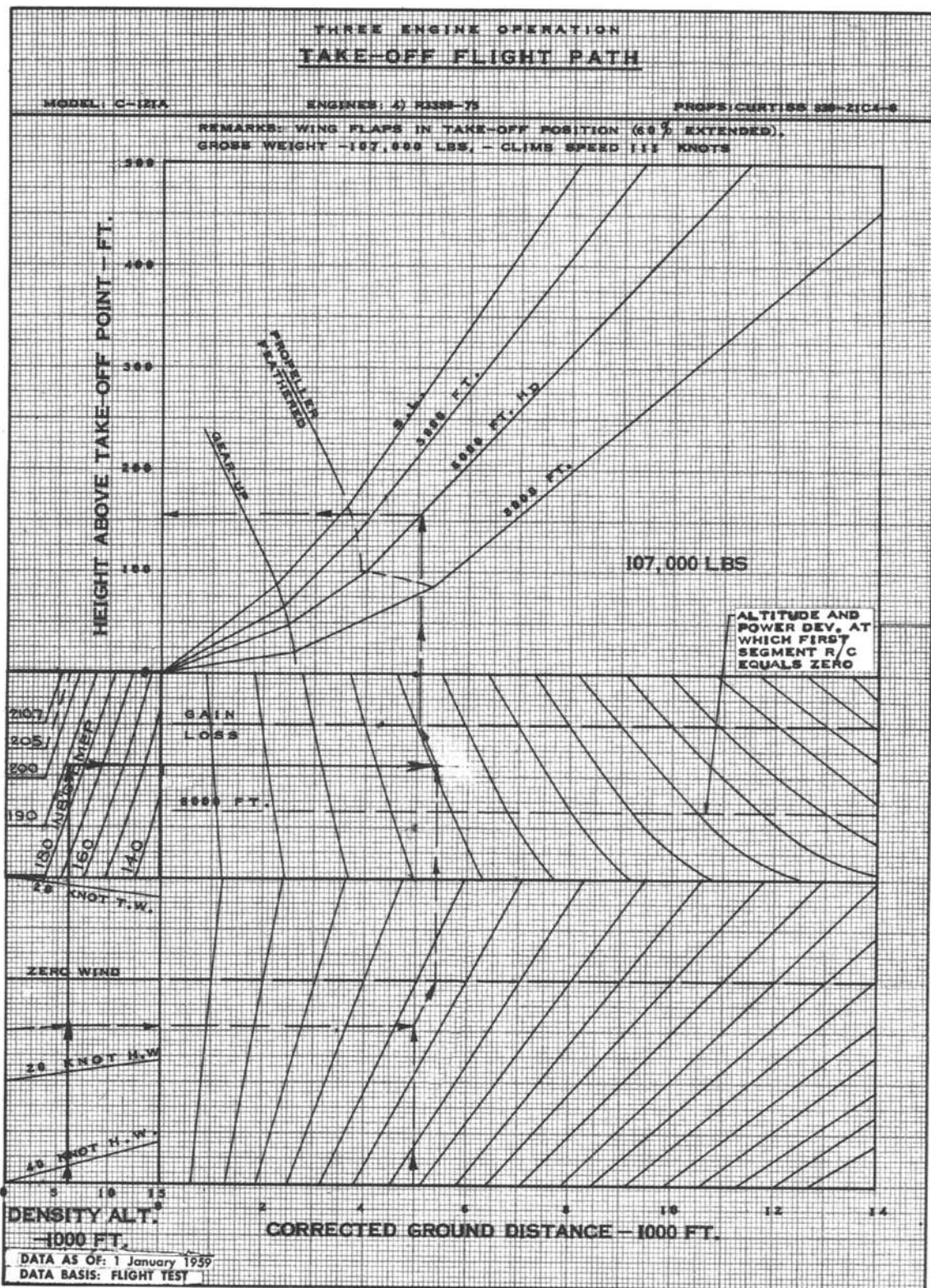

Figure A3-15

THREE ENGINE OPERATION
TAKE-OFF RATES OF CLIMB
VARIOUS CONFIGURATIONS

MODEL: C-121A
DATA AS OF: 15 AUGUST 1961
DATA BASIS: FLIGHT TESTS

ENGINES: (4) R3350-75
PROPS: CURTISS C460/830-26C4-0

MAX. POWER NOTE: HIGH BLOWER - 2600 RPM
LOW BLOWER - 2800 RPM

INITIAL SEGMENT
PROP WINDMILLING
GEAR DOWN - FLAPS 60%

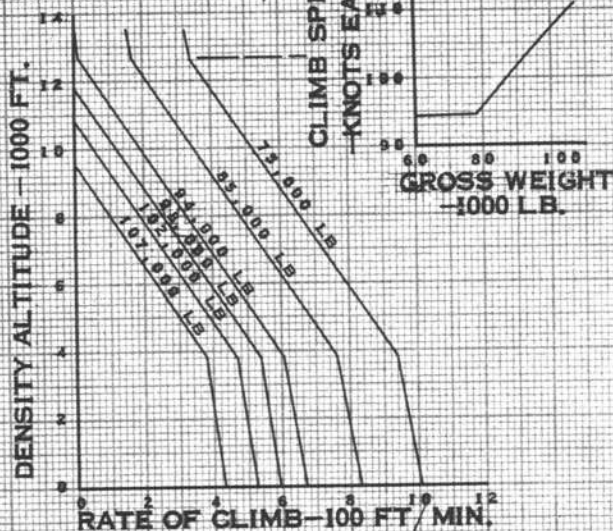

SECOND SEGMENT
PROP WINDMILLING
GEAR UP - FLAPS 60%

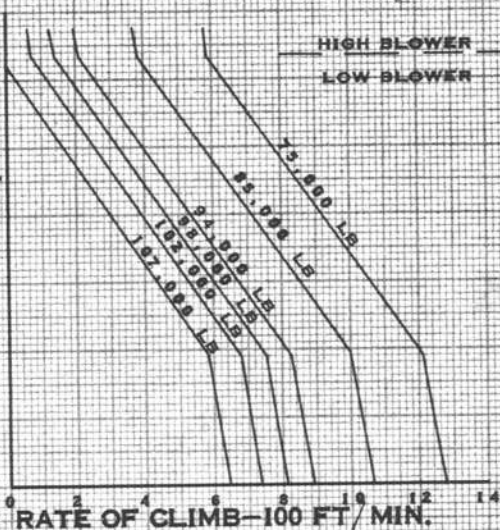

THIRD SEGMENT
PROP FEATHERED
GEAR UP - FLAPS 60%

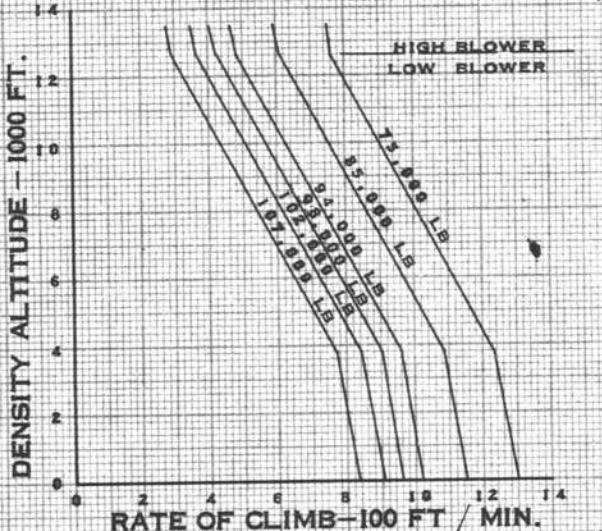

FOURTH SEGMENT
PROP FEATHERED
GEAR UP - FLAPS 60%

- CONDITIONS:
1. COWL FLAPS 50% OPEN ON ALL OPERATIVE ENGINES.
2. OIL RADIATOR FLAPS AUTOMATIC ON ALL ENGINES.
3. METO POWER ON ALL OPERATIVE ENGINES.
4. COWL AND OIL FLAPS CLOSED ON INOPERATIVE ENGINE

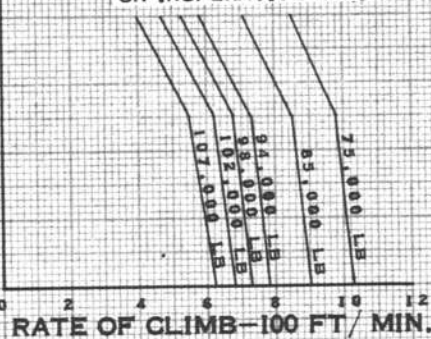

- CONDITIONS FOR INITIAL, SECOND AND THIRD SEGMENTS:
1. COWL FLAPS 50% OPEN ON ALL ENGINES.
2. OIL RADIATOR FLAPS AUTOMATIC ON ALL ENGINES.
3. MAXIMUM POWER ON ALL OPERATING ENGINES.

FUEL GRADE: 100/130
FUEL DENSITY: 6.0 LB/U.S. GAL

Figure A3-16

**MAXIMUM TAKE-OFF WEIGHT PERMITTED
BY RUNWAY SLOPE**

MODEL: C-121A

ENGINE: (4) R330-75

PROPS: CURTISS X30-21CA-B

NOTE:
HARD SURFACE RUNWAY - WING FLAPS IN TAKE-OFF POSITION (40% EXTENDED)

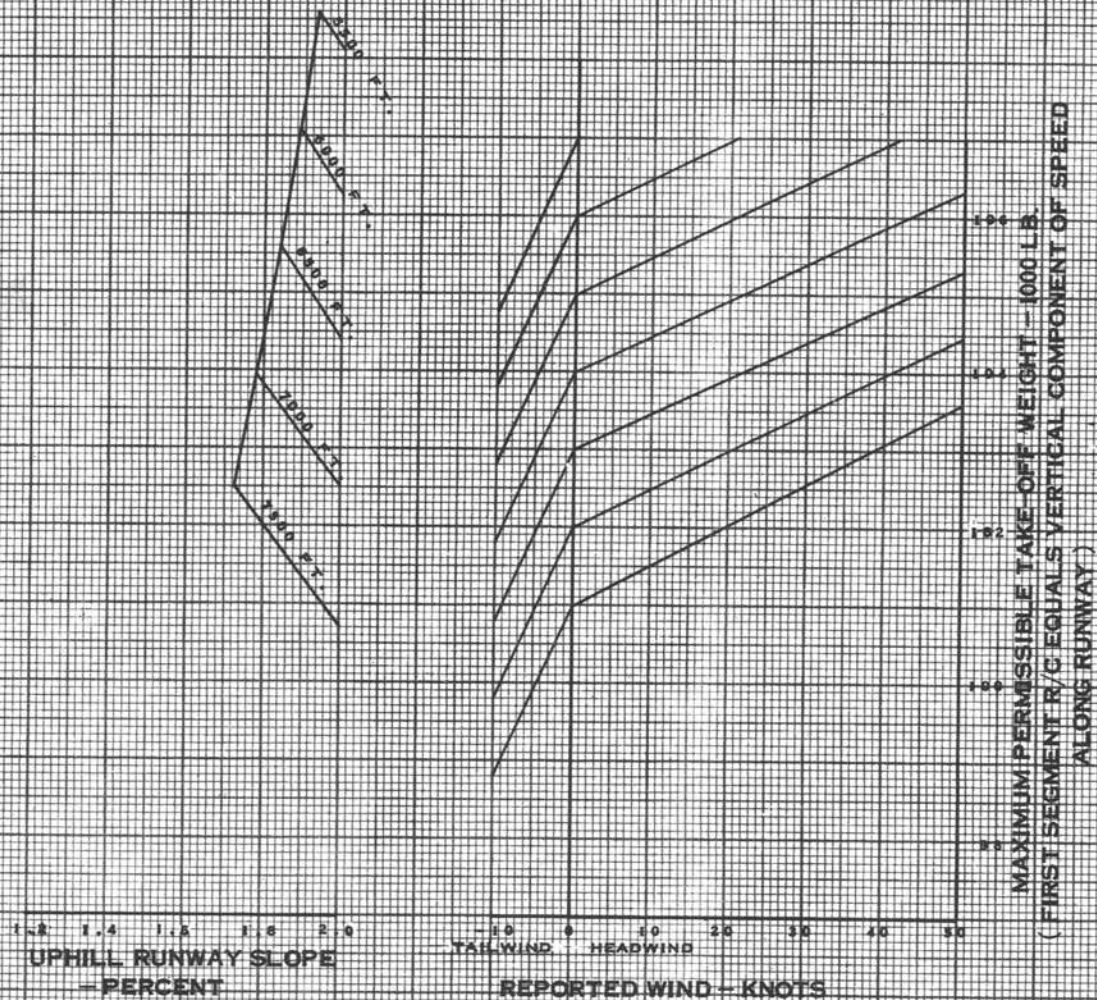

DATA AS OF: 1 FEB. 1957

DATA BASIS: FLIGHT TEST

Figure A3-17

STOPPING DISTANCE

WHEEL BRAKES ONLY

MODEL: C-121 A

ENGINES: (4) R3350-75

PROPS: CURTISS 830-21C4-0

CONDITIONS:

1. WING FLAPS IN TAKE-OFF POSITION (50 PERCENT EXTENDED)
2. HARD SURFACE - LEVEL RUNWAY.
3. ZERO WIND

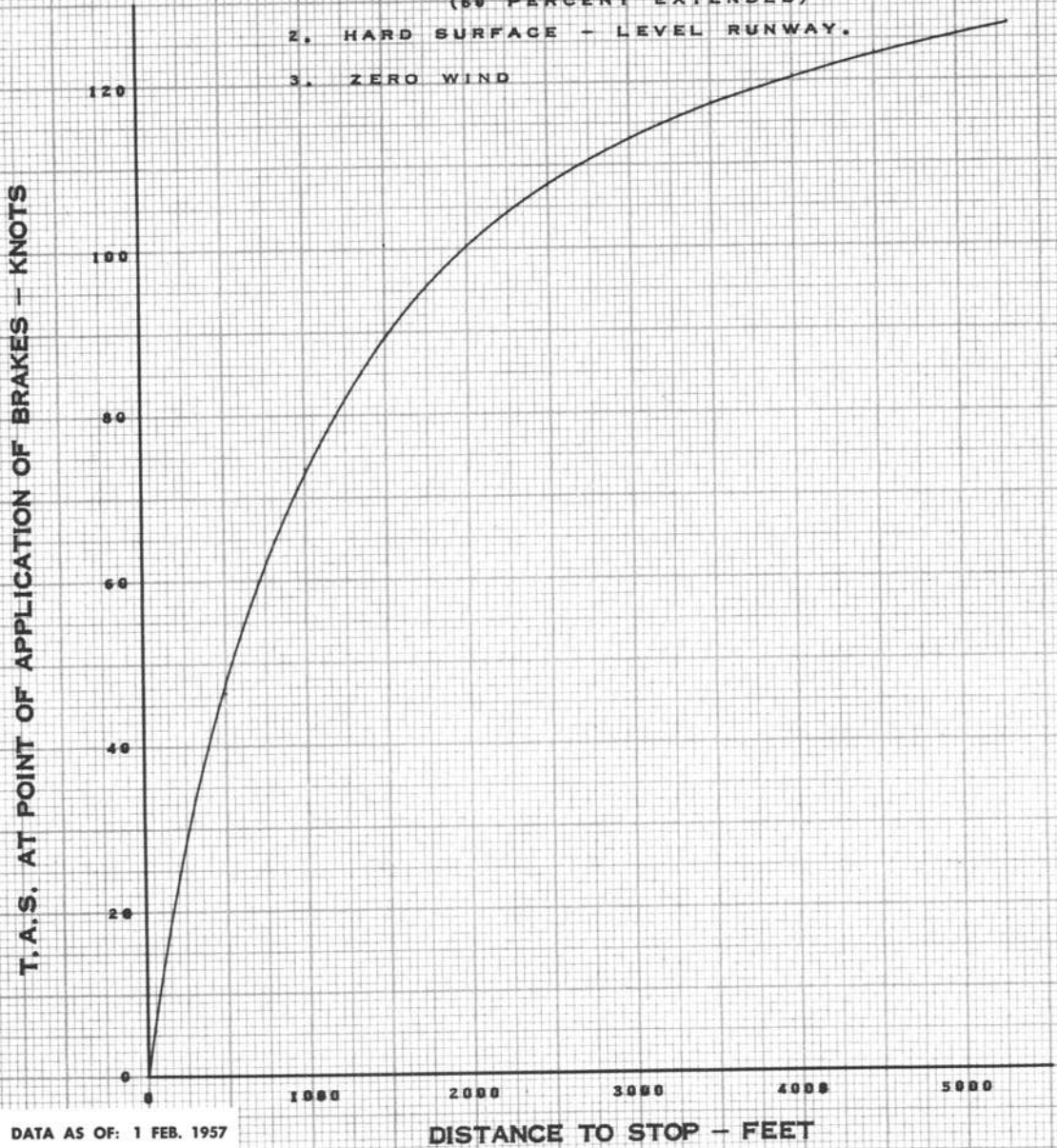

DATA AS OF: 1 FEB. 1957

DATA BASIS: FLIGHT TEST

Figure A3-18

THREE ENGINE FERRYING

**MINIMUM EFFECTIVE TAKE-OFF RUNWAY DISTANCES
FOR VARIOUS GROSS WEIGHTS, ALTITUDES, AND HEADWINDS**

MODEL: C-121 A

ENGINES: (4) R3350-75

PROPS: CURTIS 830-21C4-0

DENSITY ALTITUDE - FT.

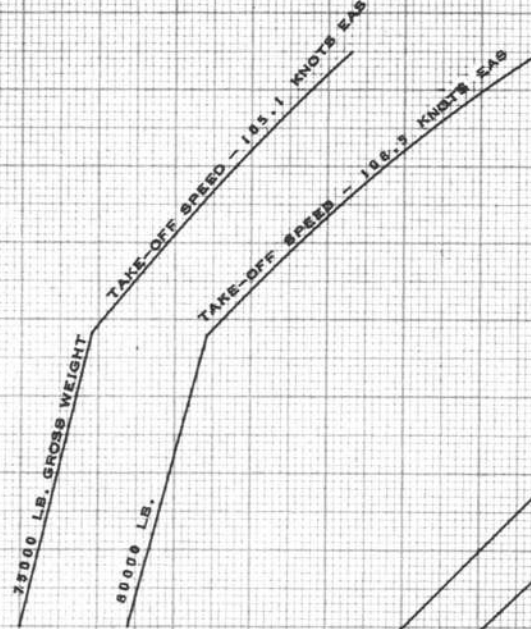

HARD SURFACED RUNWAY - WING
FLAPS IN TAKE-OFF POSITION (60%)
R3350 - 75 ENGINES
INOPERATIVE PROPELLER
FEATHERED OR REMOVED

NOTE:
THESE DISTANCES DO NOT
INCLUDE A MARGIN GRADIENT,
TEMPERATURE VARIATION, OR
OBSTACLES BEYOND THE END OF THE
RUNWAY.

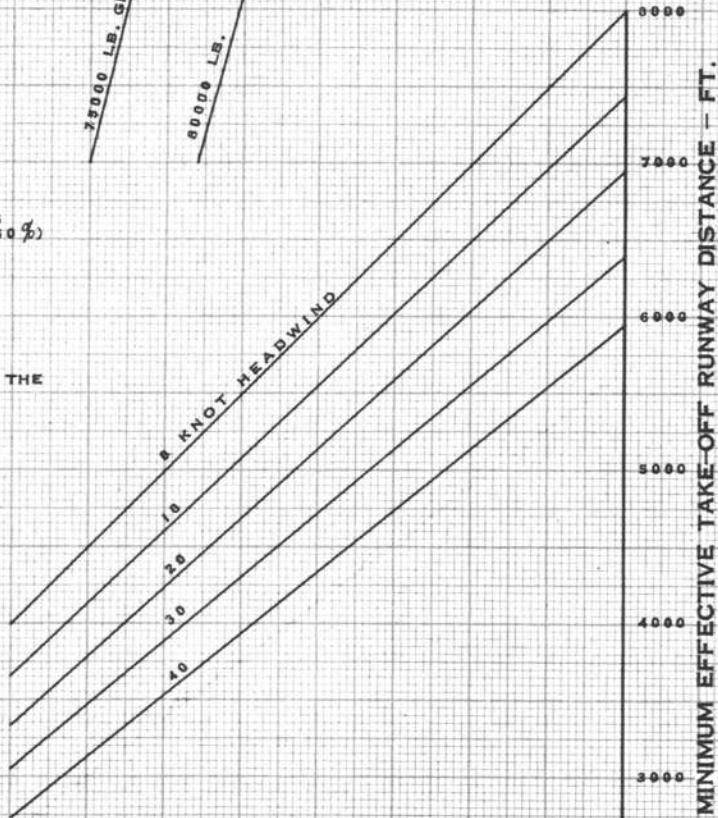

DATA AS OF: 1 FEB. 1957

DATA BASIS: FLIGHT TEST

Figure A3-19

THREE ENGINE FERRYING
TAKE-OFF CLIMB - INITIAL SEGMENT

MODEL: C-121 A

ENGINES: (4) R3358-75

PROPS: CURTISS 850-21CA-8

GEAR DOWN

R3358-75 ENGINES
 COWL FLAPS 50% OPEN ON OPERATIVE ENGINES
 OIL RAD. FLAPS IN AUTOMATIC POSITION
 WING FLAPS IN TAKE-OFF POSITION (50%)
 THREE ENGINES AT TAKE-OFF POWER
 INOPERATIVE PROPELLER FEATHERED OR REMOVED

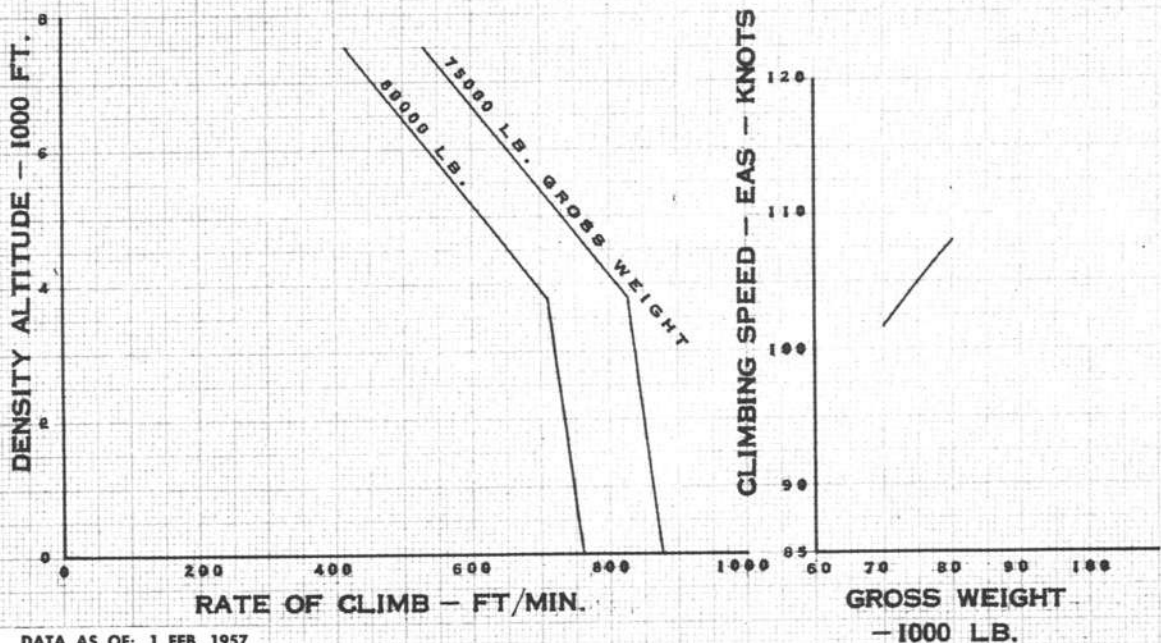

DATA AS OF: 1 FEB. 1957
 DATA BASIS: FLIGHT TEST

Figure A3-20

PART 4— CLIMB

TABLE OF CONTENTS

	<i>Page</i>
Summary	A4-2
Climb Power Settings	A4-2
METO Power Climb Performance	A4-2
Cruise Power Climb Performance	A4-2
Service Ceiling	A4-2
Allowances for Flight Planning	A4-2
Sample Problems	A4-2

LIST OF ILLUSTRATIONS

<i>Figure</i>	<i>Title</i>	<i>Page</i>
A4-1	Four Engine Enroute Climb - METO Power	A4-3
A4-2	Four Engine Climb Performance —METO Power Climb Chart	A4-4
A4-3	Four Engine Maximum Cruise Power Climb	A4-5
A4-4	Four Engine Climb Performance — Max. Cruise Power Climb Chart	A4-6
A4-5	Three Engine Enroute Climb — METO Power	A4-7
A4-6	Three Engine Climb Performance — METO Power Climb Chart	A4-8
A4-7	Two Engine Enroute Climb —METO Power	A4-9
A4-8	Two Engine Climb Performance -- METO Power Climb Chart	A4-10
A4-9	Service Ceiling	A4-11
A4-10	Allowable Altitude of Terrain	A4-12

SUMMARY.

All climb performance data are included in this part. Normal climb performance is shown first with METO power and reduced climb power settings. Performance follows for three and two engine operation with maximum continuous power (METO power) on the operating engines, and the propellers feathered on the inoperative engines. The part concludes with a graph summarizing service ceilings for two, three and four engine operation and a recommended minimum altitude of terrain which can be used for trip planning purposes.

Climb performance presented is based on maximum rates of climb which can be obtained for the speed schedules shown with standard power available and the configurations noted. A deviation of 5 knots from the recommended airspeeds will not result in any appreciable decrease in the rate of climb, provided a steady speed is maintained.

All climb speeds listed in Part 4—Climb are in equivalent airspeeds, knots (KEAS).

CLIMB POWER SETTINGS.

Evaluation of climb power settings to be used is generally based on considerations of engine wear and reliability factors in addition to resultant performance. The METO setting provides maximum performance with respect to rate of climb. Lower power settings result in less engine wear and less rate of climb, but better over-all performance may be obtained under some conditions due to reduced fuel flow during the climb. The point at which one setting becomes superior to another is generally a function of gross weight during climb, cruise altitude desired, and the cruise speed schedule to be used.

METO power requires the largest fuel flow during the climb, but allows the earliest reduction to cruise power settings. METO power is generally best when operating at high or overload weights, or when operating with one or more engines inoperative.

Maximum cruise power is the recommended climb power setting. It requires less fuel flow, and a reasonable rate of climb is maintained at normal operating weight.

METO POWER CLIMB PERFORMANCE.

Graphical climb performance is shown on figures A4-1, 2, 5, 6, 7 and 8, for four, three and two engine operation respectively.

CRUISE POWER CLIMB PERFORMANCE.

Figures A4-3 and A4-4 present climb performance with maximum cruise power in four engine operation. Maximum cruise power climbs may be conducted with mixtures manually leaned to 860 lb/hr fuel flow if engine

operation is normal. Flight with one or more engines inoperative is considered to be an emergency operating condition although three-engine operation is not marginal in the cruise configuration. The effect of non-standard temperatures on climb performance may be approximated by entering the charts at density altitude (as determined from the standard atmospheric chart) rather than pressure altitude.

SERVICE CEILING.

The altitude at which a rate of climb of 100 ft./min. can be obtained is plotted vs. gross weight on Figure A4-9. Curves are shown for two, three and four engine operation at METO power.

If engine failure should occur at an altitude greater than the three-engine emergency ceiling, a minimum rate of descent may be obtained by flying at climb speed with METO power set on the operative engines.

ALLOWANCES FOR FLIGHT PLANNING.

No allowances have been included in the climb performance charts for fuel used during warm-up, taxi and take-off, time to reach climb speed after take-off, time to shift blowers, or for time required to accelerate to cruise speed at the end of the climb. It is felt that operating personnel can determine allowances which should be made for these items to reflect normal operation procedures. The following factors are provided only as a guide:

- Warm-up, taxi and take-off — 700 lbs.
- Time to accelerate to climb speed — 2½ min.
- Time to shift blowers — 1 min. (low to high).
- Time to accelerate to cruise speed and set cruise power — 3½ min.

SAMPLE PROBLEM.

The following sample is provided to illustrate use of the climb performance data. From the Climb Performance Charts, Figure A4-1, a rate of climb at a standard altitude for a given gross weight may be determined.

- Initial Density Altitude — Sea level
- Gross Weight — 100,000 lb.
- Rate of Climb — 1330 fpm.

From the companion Climb Performance Chart, Figure A4-2, the air distance flown, time and fuel used to climb to altitude is determined.

- Take-off Gr. Wt. — 100,000 lbs.
- Climb to 12,000 ft., density altitude
- Distance — 26.5 Nautical Air Miles
- Time — 10.0 minutes
- Fuel Used — 910 pounds

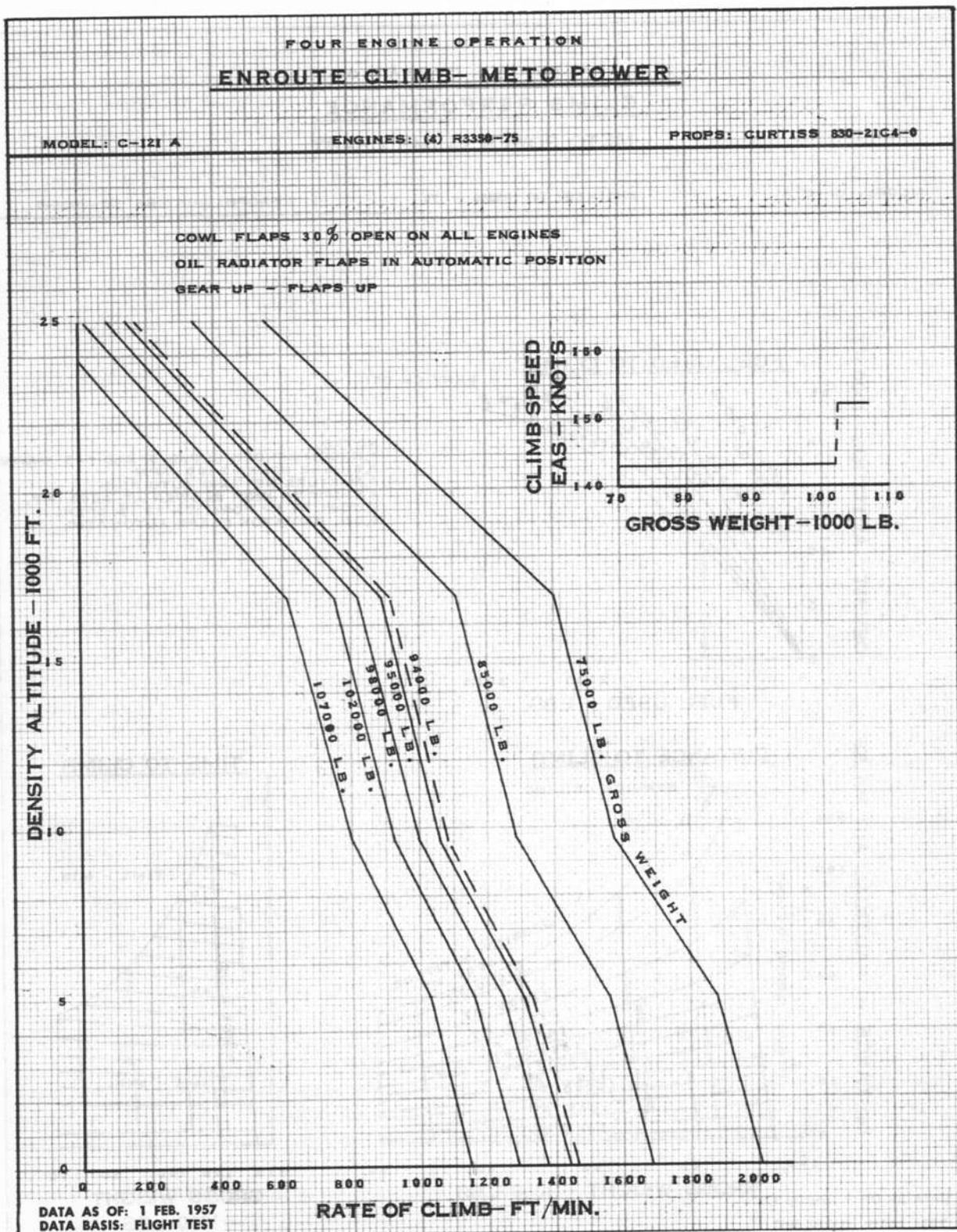

Figure A4-1

FOUR ENGINE OPERATION
CLIMB PERFORMANCE
METO POWER CLIMB CHART

MODEL: C-121 A

ENGINES: (4) R3350 - 75

PROPS: CURTISS 830-21C4-0

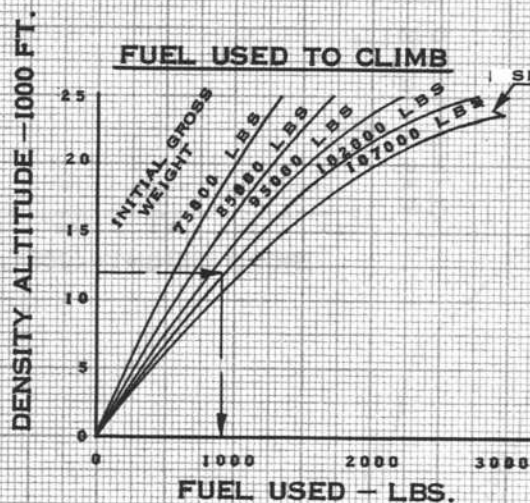

- NOTES:
1. RECOMMENDED CLIMB SPEED 143 KNOTS
 2. ENGINE SPEED 2400 RPM
 3. MIXTURE SETTING AUTO RICH
 4. SHIFT TO HIGH BLOWER AT 9600 FT.
 5. COWL FLAP POSITION 30% OPEN.
 6. OIL RADIATOR FLAPS AUTOMATIC

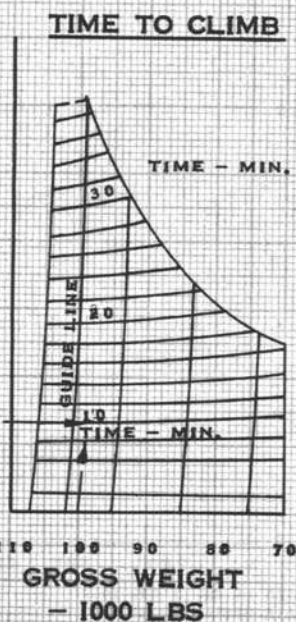
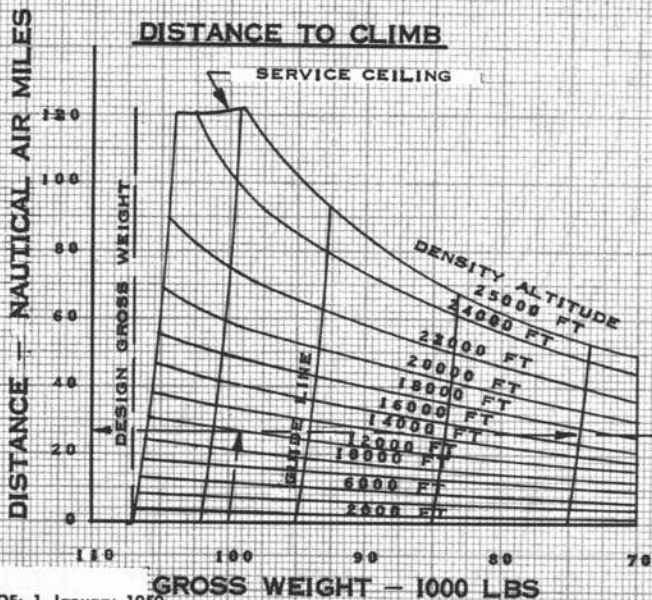

DATA AS OF: 1 January 1959

DATA BASIS: FLIGHT TEST

Figure A4-2

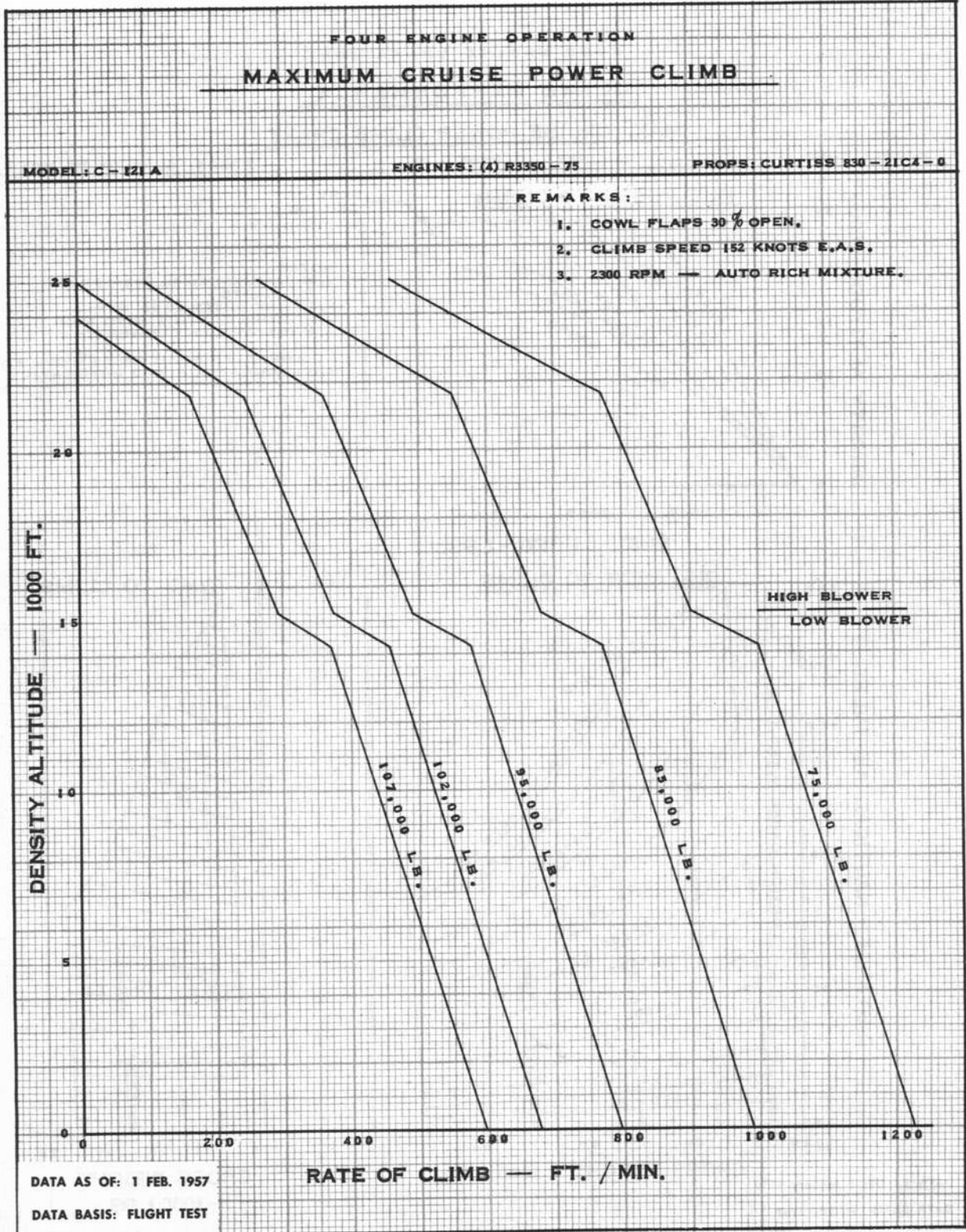

Figure A4-3

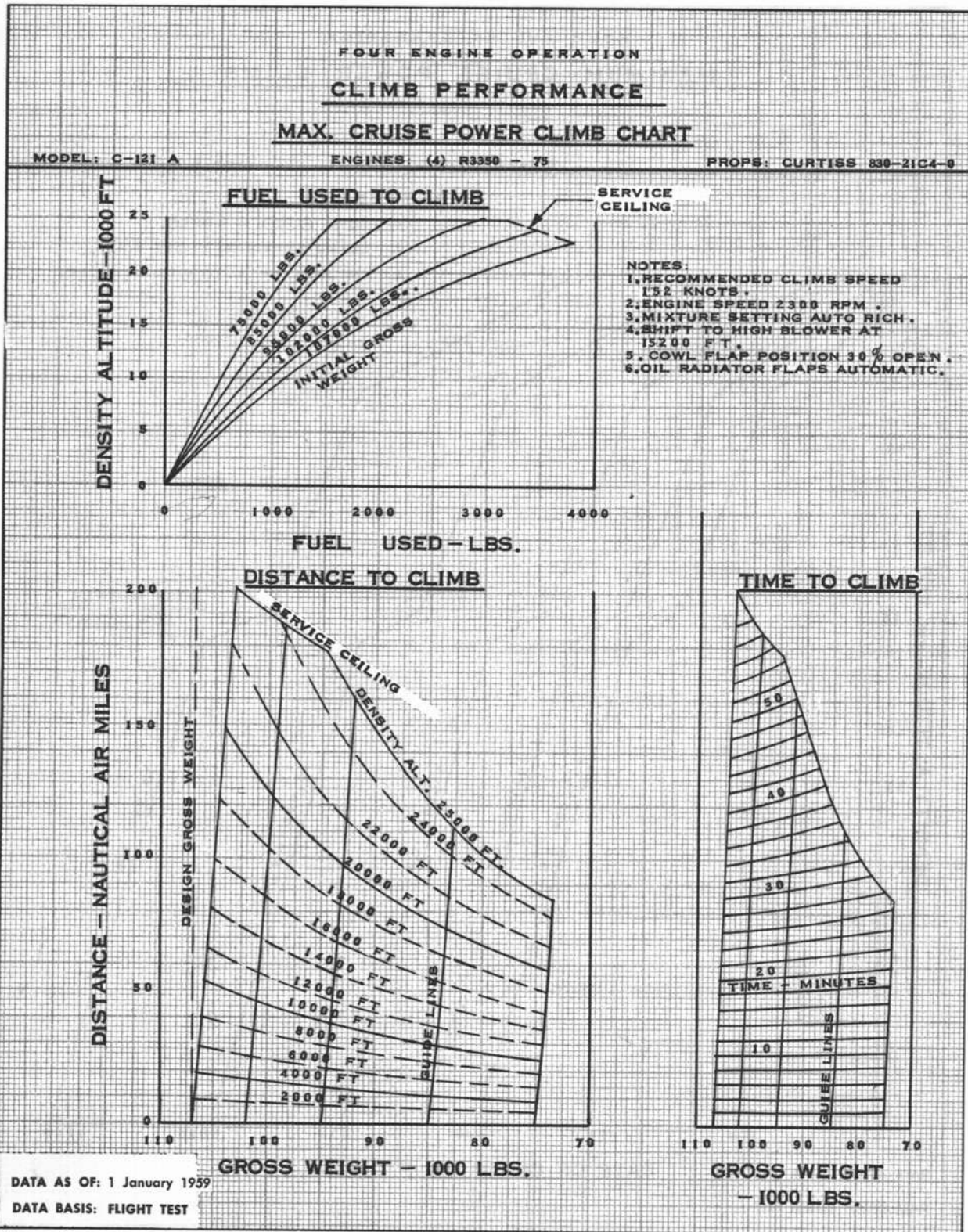

Figure A4-4

THREE ENGINE OPERATION
CLIMB PERFORMANCE

METO POWER CLIMB CHART

MODEL: C-121 A

ENGINES: (4) R3358 - 75

PROPS: CURTISS 838-21CA-9

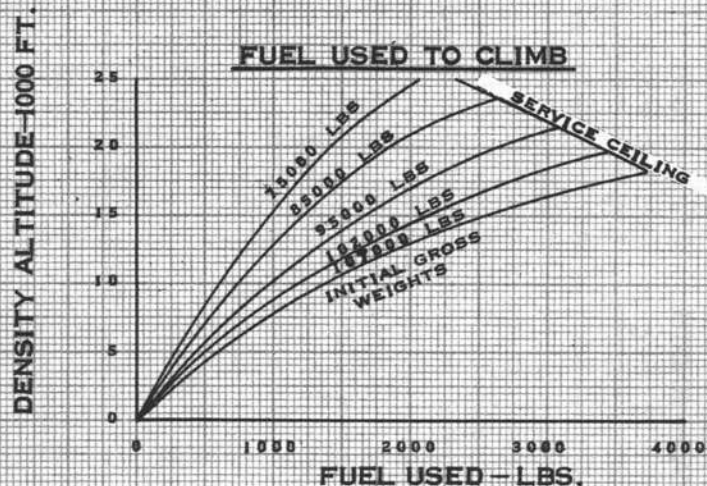

- NOTES:
1. RECOMMENDED CLIMB SPEED 143 KNOTS.
 2. ENGINE SPEED 2400 RPM.
 3. MIXTURE SETTING AUTO RICH.
 4. SHIFT TO HIGH BLOWER AT 9000 FT.
 5. COWL FLAP POSITION 30% OPEN.
 6. OIL RADIATOR FLAPS AUTOMATIC.
 7. OIL FLAPS CLOSED AND PROPELLER FEATHERED ON INOPERATIVE ENGINE.

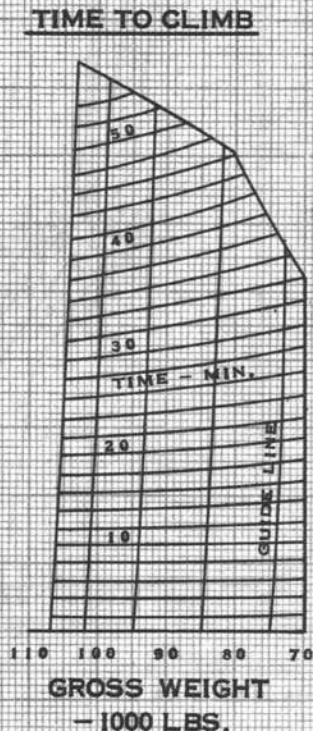
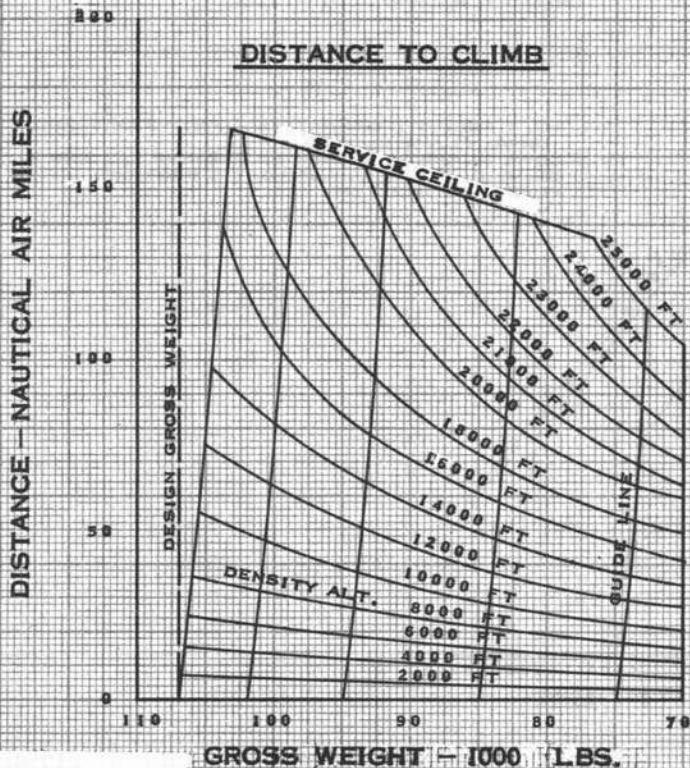

DATA AS OF: 1 January 1959

DATA BASIS: FLIGHT TEST

Figure A4-6

**TWO ENGINE OPERATION
ENROUTE CLIMB - METO POWER**

MODEL: C-121A
DATA AS OF: 15 AUGUST 1961
DATA BASIS: FLIGHT TESTS

ENGINES: (4) R3350-75
PROPS: CURTISS C460/830-26C4-0

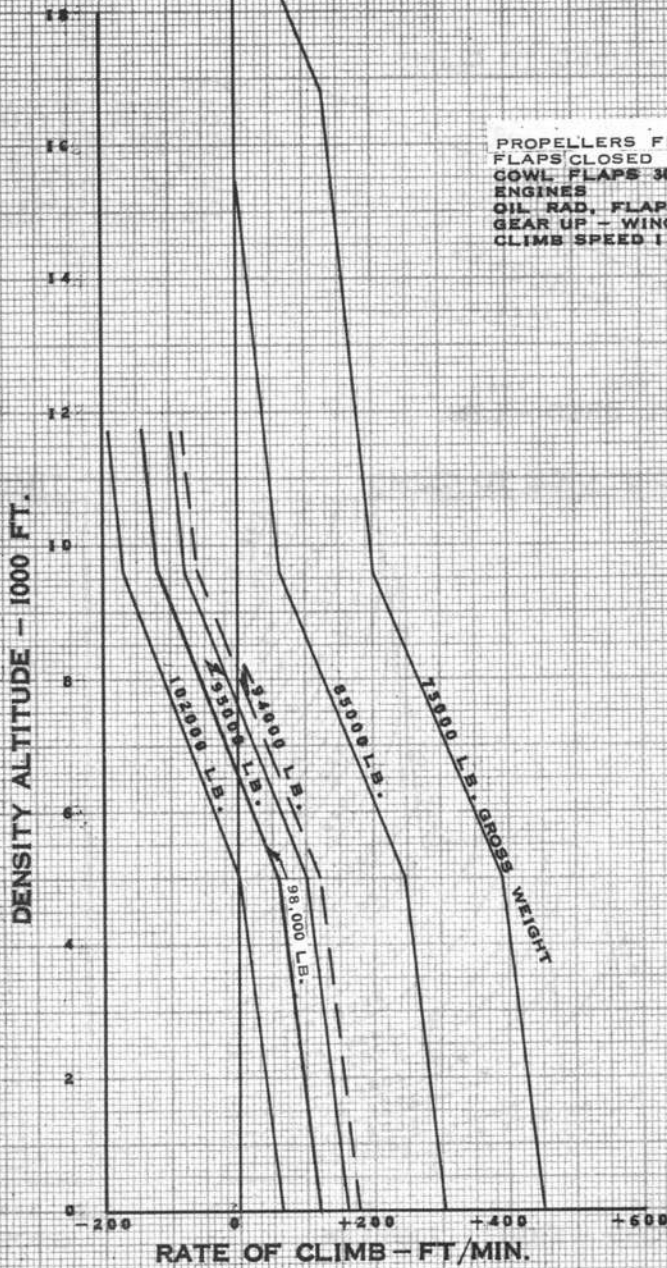

PROPELLERS FEATHERED AND COWL
FLAPS CLOSED ON INOPERATIVE ENGINES
COWL FLAPS 35% OPEN ON OPERATIVE
ENGINES
OIL RAD, FLAPS IN AUTO POSITION
GEAR UP - WING FLAPS UP
CLIMB SPEED 143 KNOTS EAS.

FUEL GRADE: 100/130
FUEL DENSITY: 6.0 LB./U.S. GAL.

Figure A4-7

TWO ENGINE OPERATION
CLIMB PERFORMANCE
METO POWER CLIMB CHART

MODEL: C-121 A

ENGINES: (4) R3390 - 75

PROPS: CURTISS 830-21C4-0

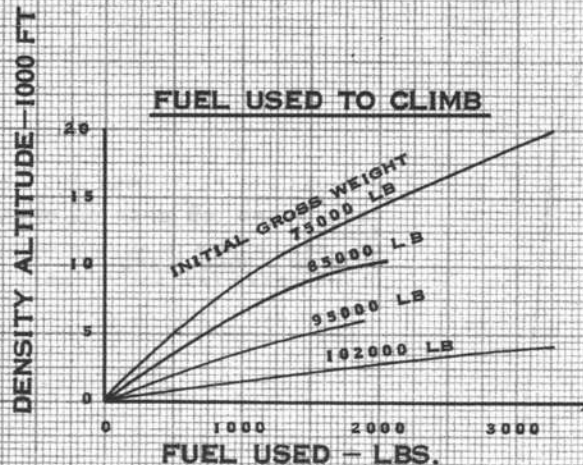

- NOTES:
1. RECOMMENDED CLIMB SPEED 143 KNOTS.
 2. ENGINE SPEED 2400 RPM.
 3. MIXTURE SETTING AUTO RICH.
 4. SHIFT TO HIGH BLOWER AT 9600 FT.
 5. COWL FLAP POSITION 30 % OPEN.
 6. OIL RADIATOR FLAPS AUTOMATIC.
- ALL FLAPS CLOSED AND PROPELLERS FEATHERED ON INOPERATIVE ENGINES.

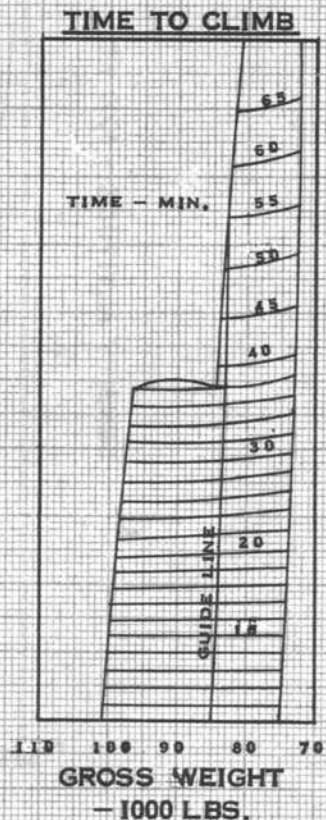
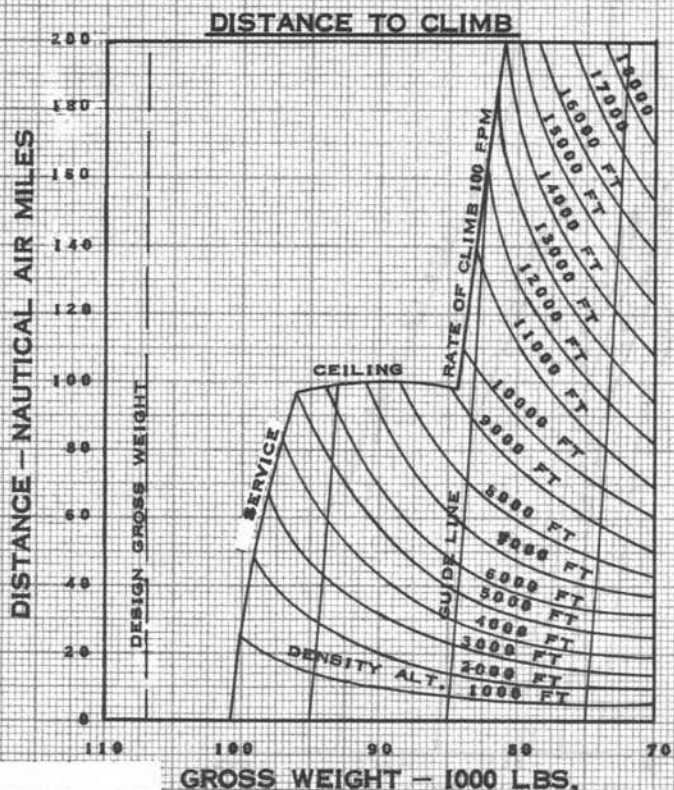

DATA AS OF: 1 January 1959
DATA BASIS: FLIGHT TEST

Figure A4-8

SERVICE CEILING

STANDARD DAY

CLEAN CONFIGURATION

MODEL: C-121A
DATA AS OF: 15 AUGUST 1961
DATA BASIS: FLIGHT TESTS

ENGINES: (4) R3350-75
PROPS: CURTISS C460/830-26C4-0

REMARKS : RATE OF CLIMB AT SERVICE CEILING - 100 FT. / MIN.
PROP(S) FEATHERED AND COWL FLAPS CLOSED ON INOPERATIVE ENGINE(S).
COWL FLAPS 30% OPEN ON OPERATIVE ENGINE(S).
OIL COOLER FLAPS IN AUTOMATIC POSITION.

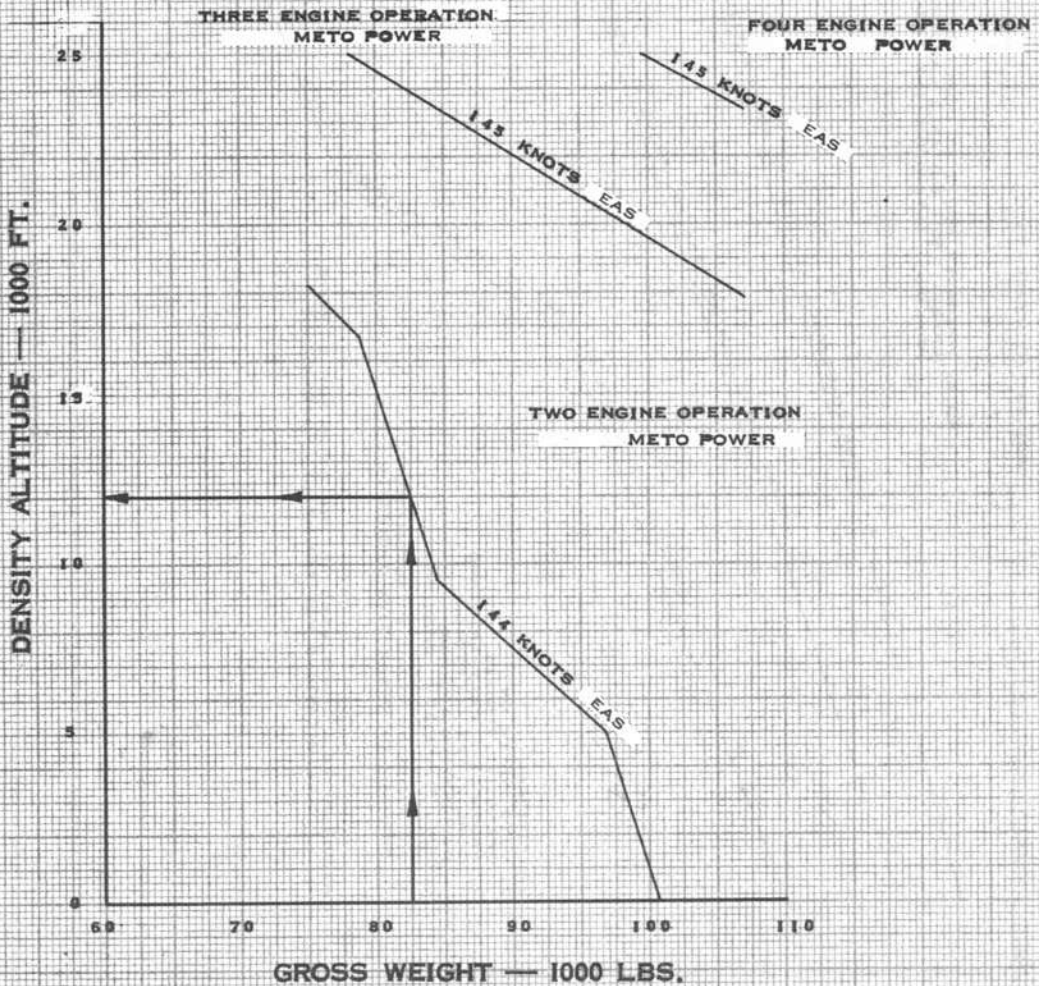

Figure A4-9

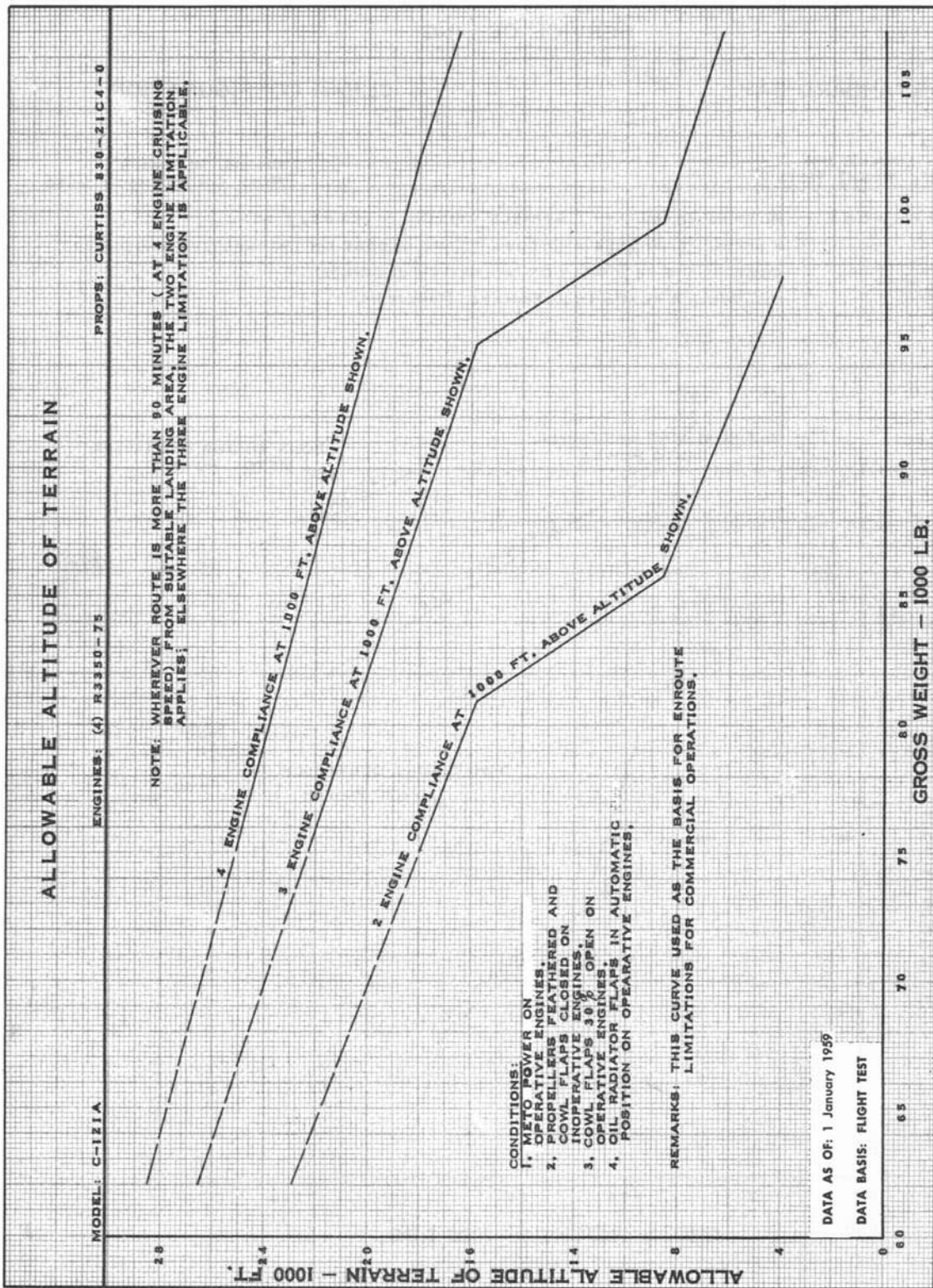

Figure A4-10

PART 5— CRUISE

TABLE OF CONTENTS

	<i>Page</i>
Summary	A5-2
Drag Conversion	A5-2
Composite Cruising Charts	A5-2
Holding Ceilings	A5-4
Cruising Ceilings	A5-4
Specific Range Data	A5-4
Time and Distance Prediction Charts	A5-4
Operating Tables	A5-5
Basis for Range Predictions	A5-5
Cruise Control	A5-6
Cruise Control Schedules	A5-9

LIST OF ILLUSTRATIONS

<i>Title</i>	<i>Page</i>
Composite Cruise Control Chart	
— Four Engine Operation	A5-12
— Three Engine Operation	A5-15
— Two Engine Operation	A5-18
Holding Ceilings	A5-19
Cruising Ceilings	A5-20
Nautical Miles Per Pound of Fuel	
— Four Engine Operation	A5-21
— Three Engine Operation	A5-30
— Two Engine Operation	A5-37
Time-Distance Predictions	
— H-1 Cruise	A5-40
— 1300 BHP	A5-42
— Holding	A5-44
Operating Tables	
— H-1 Cruise	A5-47
— 1300 BHP	A5-59
— Holding	A5-63

SUMMARY.

The charts and tables provided here are aids to efficient flight planning which permit evaluation and selection of specific methods of operation most suited to assigned missions. Text material following the discussion of the charts provides background information needed to understand cruise control.

Composite cruising charts are discussed and shown first. These allow a rapid survey of the combinations of operating weight, speed and altitude combinations available. The accompanying fuel flow data allow a quick evaluation of the economy of any proposed type of operation. Moreover, the composite charts can be used prior to or during flight for any type of cruise control schedule.

The specific range curves included next can be used directly in the computation of all types of flight plans. Miles-per-pound data are included for altitudes from sea level to 25,000 feet in 5000-foot increments and for weights from 68,000 pounds to 107,000 pounds. Power settings shown will result in maximum over-all operating economy from a standpoint of combined engine and propeller efficiencies.

Time and distance prediction charts included at the end of this part summarize performance for several types of range and endurance speed schedules. A 10% lean mixture setting results in the most economical operation of the engines. The procedure for manual leaning is given in the System Operation Section.

DRAG CONVERSION.

The cruise performance data presented in Part 5 is based on operation with cowl flaps faired (23% open). If other settings are used, deviation in airspeeds is as follows:

Full closed	3 KEAS increase
30% open	2 KEAS decrease
40% open	5 KEAS decrease
50% open	9 KEAS decrease
60% open	13 KEAS decrease
70% open	17 KEAS decrease

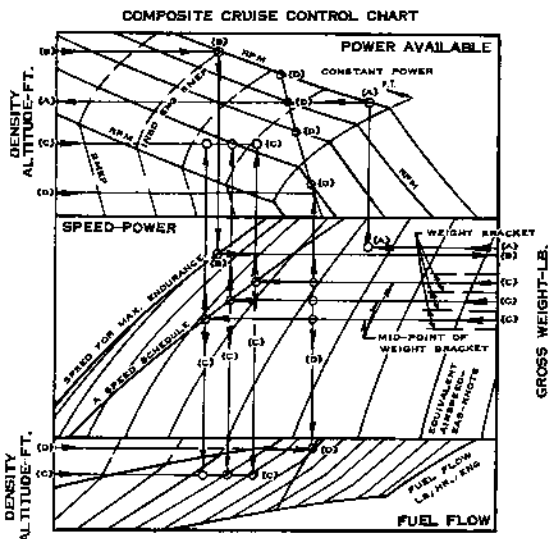

COMPOSITE CRUISING CHARTS.

Composite Cruising Charts are included as Figures A5-1 through A5-7, which cover four, three, and two-engine operation, respectively. Use of these charts permits rapid determination of level-flight speeds, power settings, and fuel flows for any given weight and density altitude.

Power settings required for various cruising speed schedules may be determined rapidly by superimposing the desired cruising speed schedule on the center portion of the chart. Required power schedules and resultant fuel flows may be read directly above and below the speed schedule line opposite the desired flight altitude.

Separate charts are furnished for either low or high blower. High blower operation is presented with Auto-Rich (shaded area) and 10% Lean on one chart.

Power settings obtained from these charts apply directly to all engines and include the 50 RPM pad in full throttle.

DETERMINATION OF CRUISING CEILING FROM COMPOSITE CHARTS.

Use Figure A5-1 to determine the low-blower cruising ceiling with maximum cruise power and 10% Lean mixture. Enter the chart at the expected gross weight, move horizontally to the desired cruise speed (shown as equivalent airspeed, EAS), then vertically into the power section to the 2400 RPM line in 10% Lean. The altitude is found by moving horizontally to the left.

This is indicated by steps marked (A) on the sample chart. Should this altitude be lower than desired, re-enter the chart at the desired altitude, move horizontally to the right to the 2400 RPM line, proceed vertically downward to the minimum acceptable cruising speed, and again move horizontally to the right. The gross weight that is read is the maximum weight that may be used for flight planning at the conditions stated (illustrated by steps B on the same chart). Should a higher cruising altitude still be desired, a shift to Auto-Rich Mixture or high blower may be necessary. Corresponding cruise ceilings can be determined from Figures A5-2 or A5-3 using the procedure described above.

USE OF COMPOSITE CHARTS TO CONSTRUCT CRUISING TABLES.

The composite charts may also be used to develop cruising tables for any desired cruise schedule such as long range, high-speed, constant power, etc., or combination schedules such as long-range and constant power.

For a specified speed schedule, the cruising speed is plotted in the speed-power section (center) in EAS values. The cruising gross weight is divided into weight brackets of 1, 2, 3 or 4,000 pounds, depending on the variation of speed that can be tolerated. Weight increments of 4,000 lbs. are used for the C-121A. Enter at the midpoint of each weight bracket and move horizontally to the scheduled equivalent airspeed. Draw a vertical line from the speed to the power available and fuel flow sections (upper and lower). The BMEP, RPM and fuel flow values may be read by entering the upper and lower sections at the desired cruise altitudes and moving horizontally to the intersection with the vertical line. This procedure is outlined by steps (C). BMEP values are read at the lowest whole value. All fractions are dropped so as not to overboost the engine, i.e., the 181.8 BMEP position on the chart would be read as 181.

A constant power schedule would require a power line superimposed in the upper and lower portions. This is accomplished by calculating the BMEP values for the BHP in question and plotting them on the RPM-BMEP grid. This is shown as steps (D). The extraction of the RPM, BMEP, fuel flow and speeds for the desired altitudes and weight brackets is the same as previously described.

The following example is from Figure A5-1.

- a) Four-engine operation.
- b) Low Blower, 10% lean mixture.

- c) Speed of 177 knots, EAS
- d) Weight bracket, 88,000 to 84,000 lbs.
- e) Density Altitude, 10,000 ft.

The mid-point of the weight bracket is 86,000 pounds. Entering the chart at 86,000 lb. gross weight, proceed to 190 knots and then vertically to the power and fuel flow sections. Read the following values at 10,000 ft.

RPM	1755
BMEP	134
BHP	996
Fuel Flow (lbs hr engine)	435

The average equivalent airspeed is converted to true airspeed by $TAS = (EAS \times 1.1 \sqrt{\sigma})$. The time is found by dividing the weight increment by the fuel flow (four engines). The air distance flown is found by multiplying the true airspeed by the time.

Average TAS	206
Time, hrs:min.	2:18 (2.3 Hrs.)
Distance, Naut. Miles	474

ADJUSTMENT FOR DRAG EFFECTS.

To find the BHP required to compensate for additional drag effects, or speed loss, read the chart at a faster speed than desired by an amount equal to the speed which would otherwise be lost due to the drag.

Example: A 177-knot EAS long-range cruise speed is desired at 86,000 pounds. Flap settings indicate 3-knot EAS drag increase over conditions stated on the Composite Chart. Enter Composite Chart at 86,000 lbs., proceed to 180 knots and read the power and fuel flow above and below this point.

WIND CORRECTIONS TO RANGE VALUES.

Wind corrections may also be made to the range values calculated from Composite Chart readings. The distance for the weight bracket is adjusted by the amount equal to the time increment for the bracket multiplied by the true wind component speed.

- Example:
- a) Zero wind conditions; 474 nautical miles, 2.3 hours and 206 KTAS
 - b) 40-knot true headwind component
 $(40) (2.3) = 92 \text{ N.Mi.}$
 $474 - 92 = 382 \text{ Nautical Ground Miles}$

HOLDING CEILINGS.

Holding ceilings for four engine operation are shown in Figure A5-8. Operation at the holding ceiling and the corresponding speed schedule is a cruise control method used to keep the aircraft in the air for a long period of time without regard to range. It is similar to maximum endurance cruise except the speed schedule is slightly faster and therefore more comfortable. The speed schedule shows the speed for level flight and allows gentle turns to be made without undue speed loss.

To obtain the power necessary to hold a desired altitude on four engines, enter Figure A5-8 at the gross weight (1). Proceed vertically to intersect the desired altitude, entered at (2). At the intersection of altitude and gross weight (3), read the power necessary to remain at this altitude. To find the corresponding speed, follow the gross weight entry until it intersects the speed schedule (4). Continue horizontally to the right and read the airspeed (5).

CRUISING CEILINGS.

Cruise ceilings for four engine operation are presented in Figure A5-9. At a given gross weight and altitude the power and speed necessary to obtain maximum range are shown. Use this curve with the same procedure described for the Holding Ceiling curve.

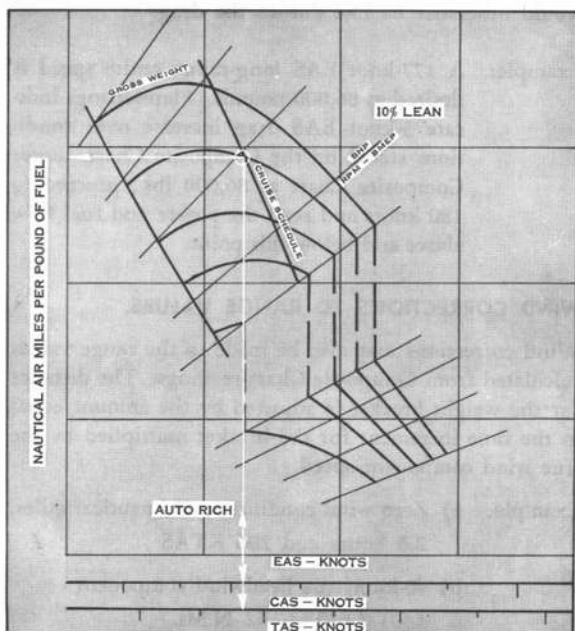

SPECIFIC RANGE DATA.

Miles per pound curves are included in this section on Figures A5-10 through A5-28. Data are included for four, three, and two-engine operation. Performance is shown for weights from 68,000 pounds to 107,000 pounds except where limited by power available, and for altitudes from sea level to the operating ceiling for the configuration noted.

The use of the specific range curves is straight-forward. Again, the initial entry is determined by the type of schedule desired. For example, from Figure A5-12:

BMEP	160
Gross Weight	86,000 lbs.
EAS	177 knots
CAS	177.5 knots
TAS	206 knots
Specific Range	0.1195 Nautical Air Miles per Pound of Fuel

Thus, with 4000 pounds of fuel, the range would be $4000 \times 0.1195 = 478$ nautical air miles.

The fuel flow at this power may be found by:

$$F. F. = \frac{TAS}{MI./LB.}$$

F. F. = $206/0.1195 = 1725$ LB/HR. (TOTAL OF FOUR ENGINES).

TIME AND DISTANCE PREDICTION CHARTS.

The time and distance charts summarize range available and flight time for operation at airspeed schedules and configurations shown on the miles per pound curves.

Note

The data shown do not include any allowance for time, distance or fuel used during the climb.

They are as illustrated by the following examples:

Starting Gross Weight	92,000 lb.
End Gross Weight	80,000 lb.
Cruise Density Altitude	10,000 ft.
	Low Blower
Time	16.40 — 9.50 or 6.90 hrs. (Fig. A5-29)
Distance	3240 — 1820 or 1420 N. Air Miles (Fig. A5-30)

Time and distance prediction curves recommended for H-1 cruise operation with three engines operative are given in Figures A5-36 and A5-37. While this type of operation represents an abnormal flight condition, ample performance is available so long as high altitude flight is not required. Auto Rich power settings are required at heavy gross weights. If prolonged flight is necessary, a cruising altitude should be selected which allows use of a lean mixture power settings as soon as possible. Three engine specific range values are 90% to 95% of four engine range values at lower altitudes and intermediate weights, and approach 100% of the four-engine values at light weights.

OPERATING TABLES.

The operating tables and graphs in this section are designed specifically for use in flight, but may also be used for detailed planning in conjunction with the general flight planning graphs in this part.

Use of the operating tables to supplement the flight planning graphs is distinctly advantageous in several ways. The planning graphs show performance graphically to maintain flexibility and to allow quick comparisons to be made between various operating procedures. The tables are not generally as flexible; however they show detailed power settings, fuel flow data, airspeeds, and incremental distances for altitude intervals of 1000 feet.

Several rule-of-thumb type adjustments can be made to the tabulated data in flight or during flight planning.

Correction of air miles to be flown for component wind effects is very easy. Note the air miles to be flown during a weight bracket and the time required to consume this amount of fuel. Round off the minute time value to a convenient fraction of an hour. Multiply the wind velocity by time and adjust the air miles entries by the amount obtained. For example: if headwind is 40 knots, air miles for a weight bracket is 345 miles, and time required is 1 hour 25 minutes; wind set-back is 1.4×40 or 56 miles, and ground miles traveled is 289.

Predicted airspeeds may not be realized in turbulent air. If the value predicted for the above example averages 197 knots CAS and only 190 knots is attained for some reason, the loss is 3½%. 3½% of 289 is 10 miles, so only 279 ground miles would be traveled during the hour and 25 minutes.

The example is based on using 4,000 pounds of fuel in 1 hr. 25 min. or 85 minutes. If fuel consumption is excessive, this period will be reduced. If predicted fuel flow for the period is 705 lb/hr/engine and fuel flow is actually 725 lb/engine (after allowing for flow-meter instrument calibration correction), the excess amounts to 20 lb/hr or a fuel flow increase of approximately 3%. The 85 minute period will be reduced approximately 3%, therefore, and become 82 minutes. Distance traveled is reduced by the same percentage (if corrections for wind and airspeed are not large) and becomes 270 nautical miles.

Most of the above corrections can be made mentally with fair accuracy. Use of a computer will aid materially, of course.

One other factor should be noted which accounts for small differences between the time and distance prediction data given in the flight planning section and that shown in this section. The flight planning charts show predictions based on operation at a given altitude with a constant blower setting. The power setting tables schedule blower shifts where necessary to maintain optimum settings for the flight weight and altitude.

BASIS FOR RANGE PREDICTIONS.

The performance which can be obtained with any power schedule is a function of many variables. These include airspeed, gross weight, mixture setting, cowl flap position, power schedule, altitude, temperature, and number of engines operating. Each has an effect on over-all performance which can be expressed in terms of distance flown per unit of fuel used, or fuel economy, which is a direct measure of the efficiency with which the aircraft is being operated.

Power schedules presented in Part 2 are shown in terms of engine speed (RPM), inboard engine torque (BMEP), and inboard engine Brake Horse Power. Use of the tachometers and BMEP gages will allow a uniform type of cruise control to be used based on density altitude. It will be independent of ambient air conditions and differences between individual engines as long as the engines are not operated at limit manifold pressure.

Manifold pressure gage readings should be used as checks to insure that engine operating limits are not exceeded. Manifold pressure limits must be observed if

they are reached before BMEP limits are reached. In addition, no more than 2" Hg difference in manifold pressure is allowable between engines set at the same power. A greater difference is indicative of engine or BMEP gage malfunction, and power on the engine with the higher BMEP reading should be reduced until the variation between engines is 2" Hg. or less.

The effect of using high blower when it is not required for a given power setting is to increase the amount of fuel consumed by the engines and decrease range. This is due to the higher internal horsepower required to drive the blowers at the greater speed. Miles per pound curves are shown for both high and low blower operation for some altitudes, and a rapid comparison can be made between the two operating conditions to determine the optimum blower setting.

Auto Rich and 10% Lean mixture cruise performance is given for airspeeds ranging from maximum endurance to maximum continuous power operation. Power schedules are shown on the miles per pound curves in terms of inboard engine power, RPM and inboard BMEP. Limit manifold pressures are included.

Power available schedules were derived from the Standard Day Power Available curve and the Engine Power Schedule table. Full throttle cruising power settings have been adjusted by a 50 rpm *pad* to allow for possible decrease in full throttle power available due to engine wear or operation with air temperature above standard. Fuel consumption values were obtained from the Fuel Flow Curves for operation with Auto Rich and ten percent Lean mixture settings (see Part 2). If power required for full throttle cruise can be obtained at less than charted values, a lower rpm should be used to conserve fuel.

CRUISE CONTROL.

Large airplanes, such as the Model C-121A are of such size and complexity as to demand the application of proper *Cruise Control* techniques if maximum utility of the aircraft is to be realized. The term *Cruise Control* means the intelligent flight planning and operation of an aircraft to accomplish the assigned mission most efficiently. These missions will be of such a variety that

it is impractical to present detailed performance data for all types which might be anticipated. Basic information is provided which permits the evaluation of a wide selection of operational techniques. However, before discussing the various types in detail, an understanding of a few basic principles is necessary.

Consideration should be given the performance of the aircraft-engine-propeller combination. These primary items determine the area of operation within which the aircraft can accomplish the specific mission. Since most missions can be accomplished in several ways, consideration should also be given to aircraft utilization factors which may govern from an overall point of view. These factors include, among others, total flight time per trip and number of trips possible per time period, weight of cargo, fuel expense per trip and crew relief requirements for long and short haul operations. In many cases, the final selection may be a compromise based on these several requirements.

When considering performance only, maximum efficiency of propeller driven aircraft occurs when the maximum combined efficiencies of the propeller, engine and aircraft-wing combinations are so perfectly matched that all components maintain maximum efficiency at the same airspeed for each possible flight condition. However, since compromises were made in the selection and design of these components, these compromises must be reflected in the selection of cruise control procedures.

Wing efficiency is the primary factor affecting cruising characteristics, although engine performance may control under some conditions. Properly selected constant speed propellers usually maintain near-maximum levels of efficiency if normal engine and aircraft operating procedures are used.

Every aircraft has an angle of attack of the wing at which the least amount of drag is created for the lift produced. This is usually expressed as the angle for maximum lift:drag or (L/D) ratio, and operation at this angle results in maximum efficiency as far as the wing alone is concerned.

Powered aircraft cannot cruise at a given altitude for long periods at both a constant value of (L/D) ratio and constant indicated airspeed. Gross weight changes in flight as fuel is consumed. Therefore, airspeed must be progressively reduced to fly level at constant (L/D).

The speed reduction schedule can be represented by the equation: $EAS_2 = EAS_1 \times (W_2/W_1)^{1/2}$ where W_1 and W_2 refer to initial cruise and enroute weights respectively. This speed variation maintains wing lift equal to gross weight at constant angle of attack.

A maximum (L/D) ratio speed schedule seldom achieves maximum range for modern transport aircraft. From a practical point of view, effects of airspeed variations with turbulence, inaccurate altitude control, etc., are greater and of longer duration at or below the speed for maximum (L/D) than they are for somewhat faster speeds. In addition, the combined efficiencies of the engine and propeller may be such that maximum overall efficiency is not maintained.

Engine life and brake specific fuel consumption (BSFC) are the measures of engine operating efficiency to be considered. Engine reliability and time between overhauls is self explanatory. A power plant which continually needs attention and repair does not contribute its full share or serve its intended purpose. However, with proper use, a long and efficient time between removals for overhaul can be obtained.

Cruise power occupies the largest percentage of an engine's total operating time, and is the outstanding factor affecting its life, performance, and operating economy. This is substantiated by extended service history of identical engines in identical aircraft installations over a period of years. Lower cruising powers extend engine life and result in better engine performance.

The brake horsepower taken from the engine is not the only operating factor which influences engine life. The manner in which this power is taken is of equal importance. It is readily apparent by reference to the engine calibration curves that a pilot or engineer can obtain a desired power output by an infinite number of RPM and BMEP settings. It has been shown conclusively by endurance tests, that, of two engines delivering equal powers, the engine which operates at the lower RPM will have the longer life if the allowable BMEP is not exceeded. The engine operating at lower speed will respond with better durability, as evidenced by having higher compression and lower oil consumption. The build-up of *piston ring miles* along the cylinder walls is a major factor in premature engine wear.

While engine wear is important from the over-all point of view, BSFC is the item of immediate concern to a crew in flight. This term is defined as the number of pounds of fuel consumed by the engine per hour divided by the brake horsepower delivered. Normal values to be expected vary from 0.4 to 0.5 pounds per BHP per hour, depending on power delivered, RPM, BMEP, altitude and blower setting. Minimum BSFC and greatest efficiency is normally obtained in low blower, between 1900 and 2300 RPM, with limit BMEP settings and 10% lean mixture strength. The BSFC increases rapidly if less than limit BMEP is used to obtain a given power since this requires a higher RPM. Other items which detract from engine efficiency are improper mixture, poor or incomplete combustion, friction of moving parts, and heat losses through exhaust and cooling systems.

The flight crew has some control over the losses which affect engine performance. Combustion efficiency can be changed with power settings and mixture control. Manually leaning to 10% lean mixture, using the 10% BMEP method, gives the best practical mixture for cruise. The largest engine losses controllable by the flight crew are those due to friction of the engine's moving parts. The simplest way to reduce friction is to reduce rpm. However, there is a limit to this reduction due to allowable cylinder BMEP, propeller design, possible vibration difficulties, and accessory minimum speeds.

There is one other factor which should be kept in mind — the portion of engine power which is delivered to accessory equipment but not indicated by the BMEP gages. This includes the generator and cabin supercharger power requirements. While the loads imposed by this equipment are normally allowed for, they should not be permitted to become excessive without reason. For example, maintaining high cabin differential pressures when not needed can be wasteful of engine power. This is particularly true in hot weather when refrigerating the cabin air. Besides pumping more air into the cabin than is needed, cooling requirements are such that the aftercooler scoop is full open. Extra fuel is required to pump more pressurized air so more drag is created in cooling it for use.

The efficiency of the propellers is the last item to be discussed here which affects performance. Operation outside the region for near maximum propeller efficiency

can penalize aircraft performance severely. For example, if 85% efficiency is a normal value attainable in cruise and only 80% is realized because of an improper combination of airspeed and power setting, the power wasted is $(85 - 80)/85$ or almost 6% of the engine power being delivered.

There is an optimum power setting for maximum propeller efficiency at each altitude and airspeed. The reactions on a propeller are much the same as the reactions on a wing. As with a wing, power must be expended to overcome drag as well as to create lift or thrust. For a given propeller, the amount of power lost is largely a function of true airspeed and propeller rpm. Maximum efficiency occurs when the most engine torque is converted to propulsive thrust, or the most horsepower is transmitted to the air as thrust horsepower. (This is something like operating at the point of maximum [L/D] for a wing.) Efficiency drops off rapidly as the tip speed approaches the speed of sound. Therefore, propeller efficiency must be taken into careful consideration and balanced with efficient engine power settings. This has been done in setting up the cruise power schedules. Flight test data have been used wherever possible.

There are five general rules which should be followed in all types of planning. The first is concerned with gross weight. *Know it.* Know your empty weight, operational weight, loaded weight, take-off weight, in-flight weight, landing weight, and zero fuel weight. The performance of the aircraft depends primarily on weight, power, and altitude.

The effect of excess weight on cruise performance must be stressed. It takes more power to fly at an efficient speed when your aircraft is heavy than when it is light. The difference in fuel consumed per mile can amount to over thirty percent as shown by the miles per pound curves.

Further, don't carry "pocket" fuel. The effects of this procedure are insidious. The aircraft demonstrates the effect of carrying the extra weight by its performance during take-off, climb and cruise. If you need the extra fuel, or think you may need it, load it, show it in your weight log, and plan your flight to allow for the additional weight. The cruise charts do not include any allowances for icing, turbulence, navigation tolerances,

and items which detract from normal performance. You are in the best position to judge what your needs might be. But unnecessary reserves increase operating costs due to higher fuel usage and reduced cargo loads.

In all cases, use actual gross weight as the basis for power settings. Keep a log of fuel used in order to determine gross weight variation in flight. The frequency with which power settings should be changed as weight decreases depends on the accuracy with which a cruise control procedure is to be followed. It is recommended that weight increments of no more than 4,000 pounds be used. Reduce power for every 4,000 pounds reduction in aircraft gross weight whenever practical. When the weight increments have been selected for a particular operation, it is desirable to set powers at the mid-points of the weight brackets.

The second rule is to operate by *density altitude*. The density of the air is the governing factor. That is what the engines, propellers, and wings are interested in. Density varies directly with pressure and inversely with temperature. Local barometric pressure and temperature are varying quantities, and the density of the air for a given geometric altitude at any one place will vary from day to day. Cruise control power settings have been established in terms of density altitudes rather than pressure altitudes and air temperatures. If flight plans are prepared in terms of density altitude, the effects of variation of air temperature from standard is minimized. Do not forget to use an altimeter set to 29.92" Hg reference pressure when reading pressure altitude to obtain density altitude.

The C-121A operates most efficiently at density altitudes from 10,000 to 15,000 feet, depending on gross weight. As gross weights decrease, the best operating *density* altitude increases. High blower power settings may be used with good economy in some cases. However, if fuel consumption per nautical mile is of primary concern, operate at the altitude where the required power setting can be obtained with full throttle in low blower without increasing engine speed. A density altitude just under the altitude for blower shift will be most efficient for that gross weight.

The effect of wind on cruise range and fuel required is very real and must be considered in flight planning. However, the effect of wind on cruise *procedure* is another problem. In theory you should speed up in a headwind, and slow down in a tailwind. A headwind

decreases the ground speed and increases the time of flight or the time during which fuel will be consumed. Therefore, for slower type aircraft, it is generally profitable to increase speed and fuel flow in a headwind in order to achieve a saving in trip fuel by reducing flight time. For similar reasons it may be profitable to reduce speed and fuel flow in a tailwind and allow it to give you more help. The C-121A, however, is a relatively high speed aircraft. Such winds are *normally* of little importance when planning speed schedules. In addition, the airspeed schedule recommended for long range cruise is already above the speed for theoretical maximum range. *Normal* headwinds of up to forty knots are automatically taken care of. However, an occasion may arise when the absolute maximum miles per pound is necessary. Refer to the miles per pound curves (Figures A5-10 through A5-28). The following rule of thumb may be used if a greater wind exists:

a. Note the true airspeed for maximum air miles per pound of fuel shown on the miles per pound curves (Figures A5-10 through A5-28) for the appropriate flight weight and altitude conditions.

b. If a headwind exists, add twenty-five percent of the headwind to this true airspeed schedule, note power settings and calibrated airspeeds to be flown.

c. If a tailwind exists *subtract* twenty-five percent of the reported tailwind from this true airspeed schedule. Note power settings and calibrated airspeeds to be flown. However, do not schedule speeds slower than those recommended for holding.

d. Compute miles per pound at the modified cruising speed schedule. Miles per pound = (air miles per pound at modified flight speed) \times (ground speed/modified true airspeed).

The third rule is not to climb higher than necessary. The fuel saved during a let-down is never equal to the additional fuel used for climb. It is therefore, never worthwhile to climb in hopes of regaining the extra fuel expenditure in a later descent. Of course, operation at higher levels may be desirable from a standpoint of decreased flight time or to decrease weather turbulence. It may also be desirable to use a step-climb procedure, particularly if operating at heavy initial weights. Start at a relatively low cruising altitude in order to avoid using high power settings. Then, as fuel is used and weight decreased, climb to a higher level where the initial power settings provide increased true airspeeds.

The fourth rule is to maintain level flight at the selected cruising altitude. This is the only way in which stabilized speed performance shown in the cruising charts can be realized. The reason is quite simple. Aside from effects of drag items, which can be accounted for, turbulence and small rates of climb are the major factors causing speed loss. The speed loss in climb will be greater, and gain in descent decreased if scoops and flaps are not set to the minimum drag positions. The speed loss will be reduced when operating at higher than long range cruising speeds. However, speed increase may not be possible at heavy initial cruising weights if maximum cruise power schedules are required for long range speeds.

The fifth rule is fairly obvious. Use a minimum drag configuration whenever possible to maintain maximum speed. Small deviations are not serious, but the effect of setting beyond faired positions is large.

Try to maintain comfortable cabin temperatures with the least opening of aftercooler scoop door. In particular, avoid full opening of aftercooler door whenever possible because of possible drag. Consider using a slightly higher cabin altitude and check cabin temperature versus temperature at the flight engineer's station before using full refrigeration.

CRUISE CONTROL SCHEDULES.

The introduction has covered the basic principles involved in cruise control and the general rules which are applicable. The main types of cruise control procedures in use can now be covered.

There are several basic types of cruise control procedures that can be used with considerable success. Some of the most common are listed below. Each has its advantages and disadvantages, which depend on airspeed desired, distance to be flown, cargo required, and other considerations. The basic types are:

- a. Maximum Range Cruise
- b. Long Range Cruise
- c. Modified Long Range Cruise
- d. Constant Power Cruise
- e. Constant Airspeed Cruise
- f. High Speed Cruise
- g. Maximum Endurance, or Holding Speed Cruise

Maximum Range Cruise Control should be considered first. It forms the general basis for all long distance types of operating schedules. But you should realize at once that it is very seldom used in actual practice, being one of the most difficult cruise procedures to apply successfully. Its use requires exact knowledge of airplane performance as related to wind and weather conditions, precise piloting technique, and fine control of all engines in order to obtain the most miles per pound of fuel used. Maximum range speed and power schedules can be obtained from the peak values shown on the miles per pound curves. However, use of such a schedule may not be sufficiently rewarding to justify its use. Effects of turbulence, inaccurate altitude control, etc., are greater and of longer duration at maximum range speeds than at higher speeds. The long range cruise schedule is approximately ten percent faster and increases theoretical fuel requirements only about one percent.

Long Range Cruise is the most economical and practical type of cruising procedure for long flights. It requires less trip fuel than any faster schedule, and may be more economical in the long run than a maximum range schedule. It is suggested that this schedule be used whenever maximum loads are to be carried over long distances and/or where fuel consumption must be kept at a minimum.

While the indicated airspeeds for long range schedules are rather low, it will be found that operation at high altitudes will result in relatively high true airspeeds. Fuel economy is not unduly reduced unless Rich mixture power settings are used. However, additional climb fuel allowances must be made.

Note

Refer to the Miles Per Pound Curves for a comparison of long range schedule specific range and true airspeed values with those for other speed schedules.

While it is true that flying at the optimum IAS for long range would result in more range, it is impractical to do so. An infinite number of very small power reductions would be required. Long range cruise is actually a series of constant power cruising segments, or brackets based on aircraft weight. The average airspeed obtained will approximate the optimum IAS for the best practical combination of wing, engine and propeller efficiencies.

Modified Long Range Cruise procedure is a variation in long range procedure which may be made in flight. Plan the flight in accordance with long range cruise. Then, if the fuel remaining after the equi-time point is reached is sufficient and if there will be no other need for reserve fuel, such as to reach an alternate destination, the cruise power being used at that time may be maintained for the remainder of the flight.

Constant Power Cruise is probably the easiest and simplest method of cruise control. One power setting is used continuously for cruise throughout the entire flight. The airspeed increases as the flight progresses, and the average airspeed is usually higher than that recommended for long range. No advantage is taken of the increased range or payload which could be obtained by reducing power as the weight of the aircraft decreases. It is less economical, fuel wise, than some other types of cruise control. However, for short range operation, constant power is often desirable since cruise power will be in the medium power range and fuel requirements are not high enough to affect the maximum payload of the airplane. This method of operation is really worthwhile when the time saved can be used profitably, for example, to obtain extra flights between engine and/or airplane overhaul times.

Constant Airspeed Cruise is a method whereby power is reduced as gross weight is reduced to maintain constant airspeed. This method simplifies flight planning and in-flight navigation. Power reductions are made at convenient intervals so that the airspeed will average a desired figure for a given distance. The composite cruise charts can be used to advantage in predicting necessary power settings. Although this type of cruising schedule can be more efficient and economical than constant power cruise, it will normally require more fuel per trip than long range cruise.

High Speed Cruise is a type of cruise control schedule which utilizes the maximum cruising power available in mixture. It results in the shortest flight time per trip. It also decreases engine life somewhat due to the engine speeds used. This type of cruise control is usually used for missions where speed is vital, and for operations which require each aircraft to be available for a maximum number of flights within a limited time. Under these conditions this type of cruise can be economical to the operator.

Use of maximum cruise power allows the airplane to develop a higher continuous speed with reasonably economical fuel consumption and a minimum of cruise control management complexity. The schedule is particularly effective for operations at moderately short ranges when an increase in the fuel load does not require flight at overload weights or restriction of cargo loads.

The high speed cruise schedule requires expenditure of more fuel than would be necessary if long range or intermediate speed procedures were followed. The difference in fuel required becomes greater at lower altitudes. Therefore, use of maximum cruise power may require a limitation of cargo to be carried.

Maximum endurance cruising performance which can be obtained is a function of the same variables as those

which affect maximum range performance, except that the time flown per unit of fuel used is the measure of efficiency for this type of operation. In order to obtain maximum endurance, low airspeeds and the lowest practical altitude should be used so that the engine power requirements and fuel flow may be reduced to a minimum. The recommended maximum endurance power settings are based on operation at speeds 10% greater than those for absolute minimum power required. This speed schedule results in slightly higher than absolute minimum fuel flows, but it represents a practical flight condition which permits operation in mild to moderate turbulence. Extension of the wing flaps *decreases* the speed necessary for level flight. The deck angle is also decreased, and this lessens the difficulty of maintaining a low airspeed. However, the extension of the wing flaps *increases* the minimum power required and *decreases* the *endurance* time available.

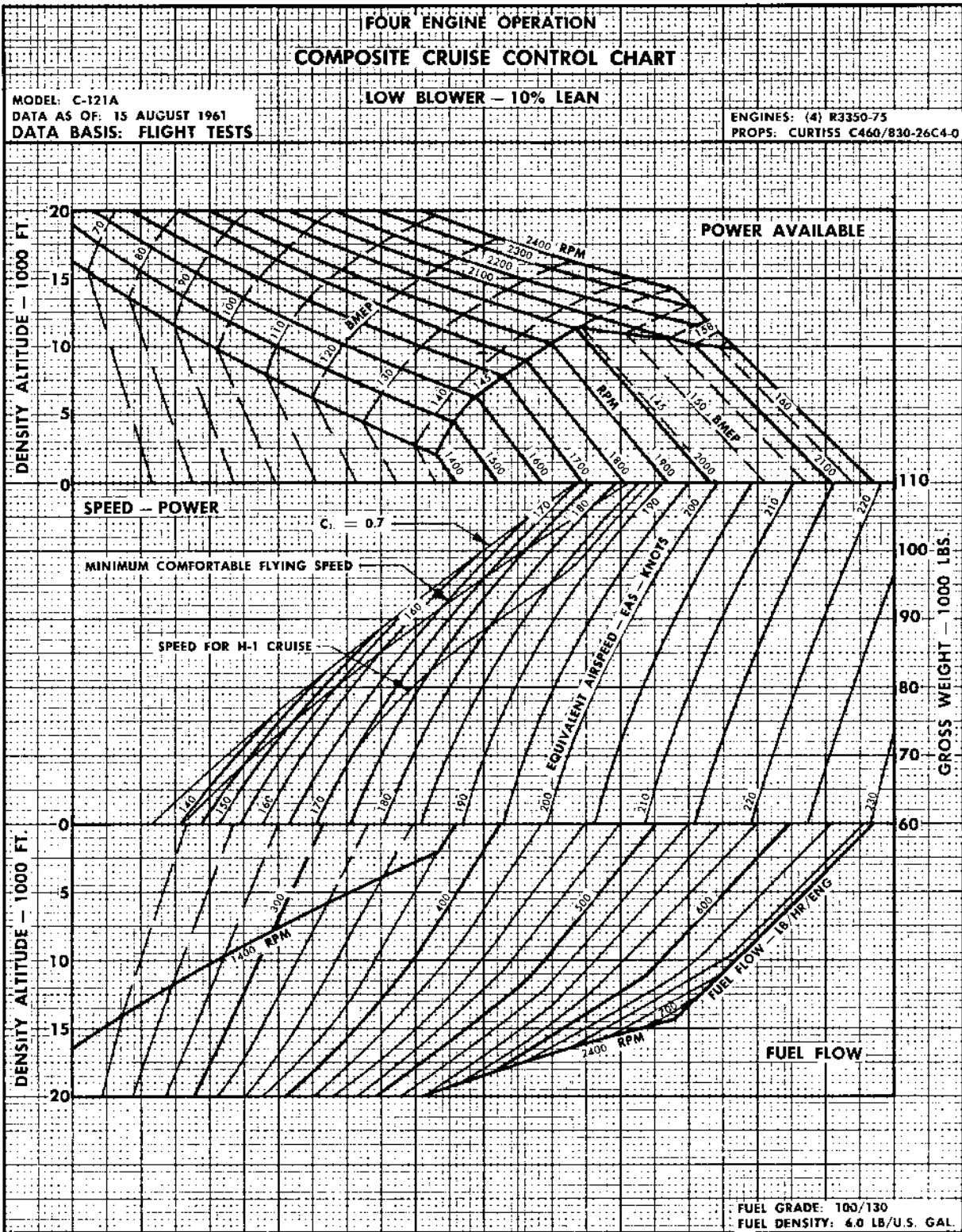

Figure A5-1

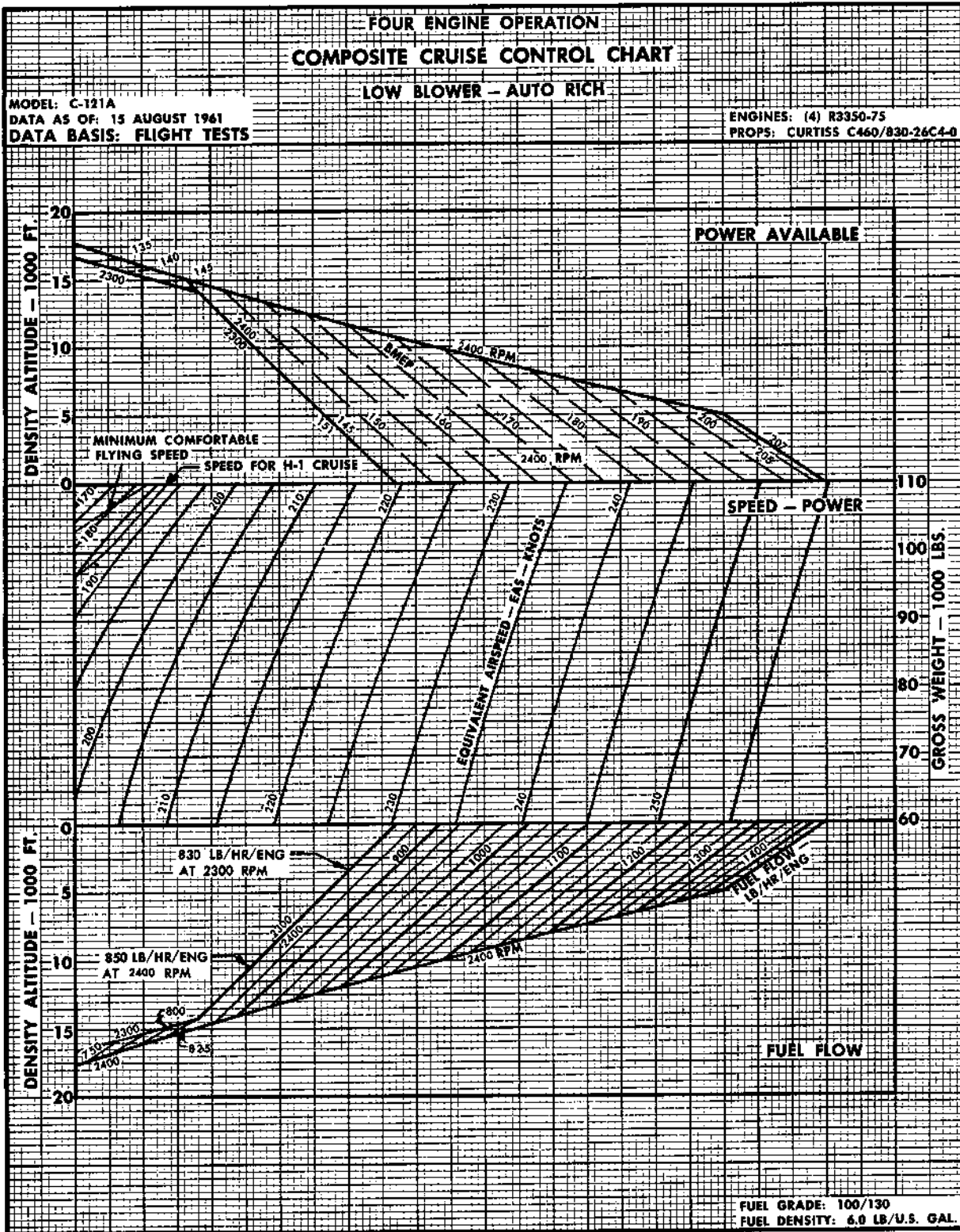

Figure A5-2

FOUR ENGINE OPERATION
COMPOSITE CRUISE CONTROL CHART

HIGH BLOWER

10% LEAN

AUTO RICH

MODEL: C-121A
DATA AS OF: 15 AUGUST 1961
DATA BASIS: FLIGHT TESTS

ENGINES: (4) R3350-75
PROPS: CURTISS C460/830-26C4-0

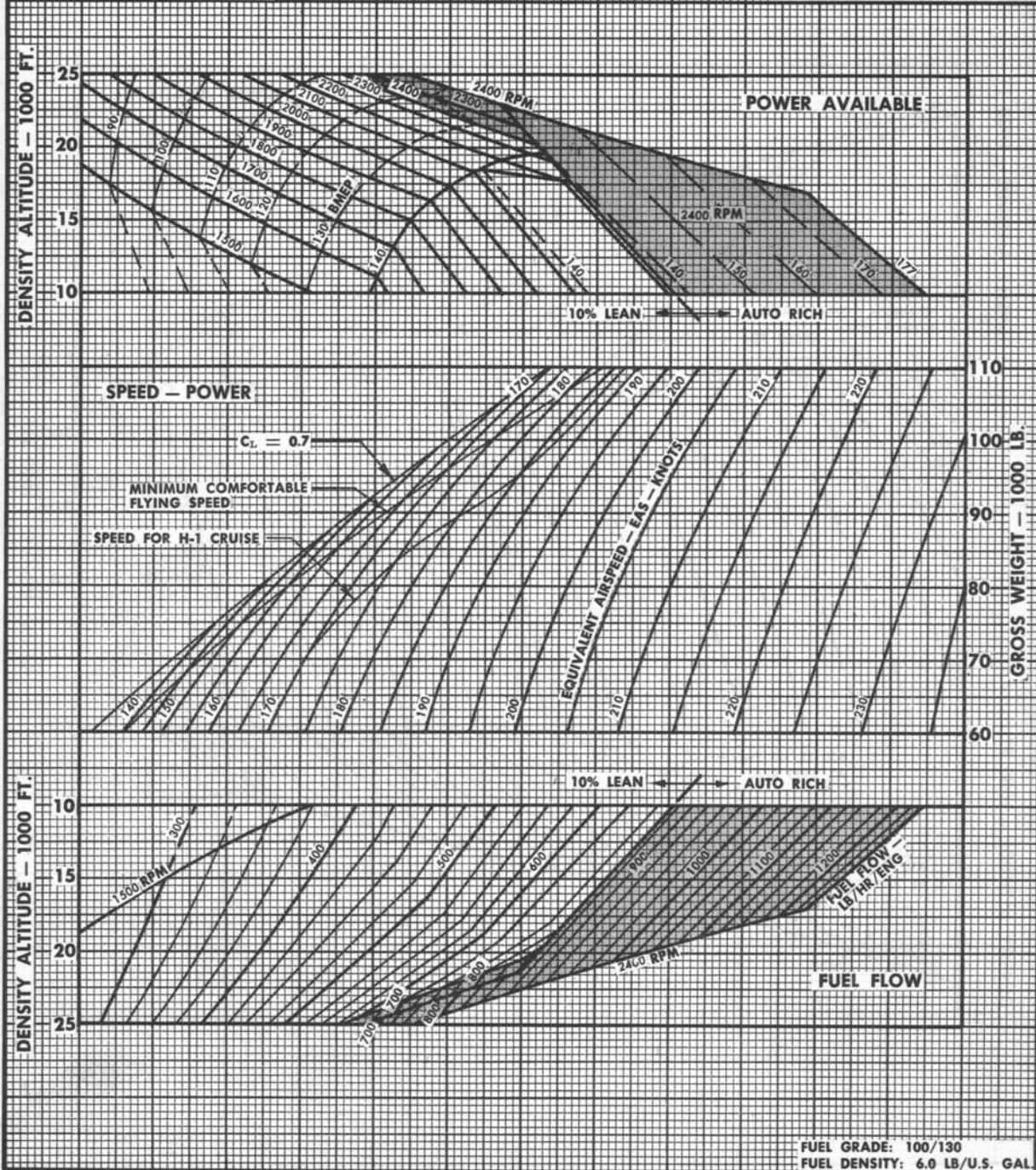

Figure A5-3

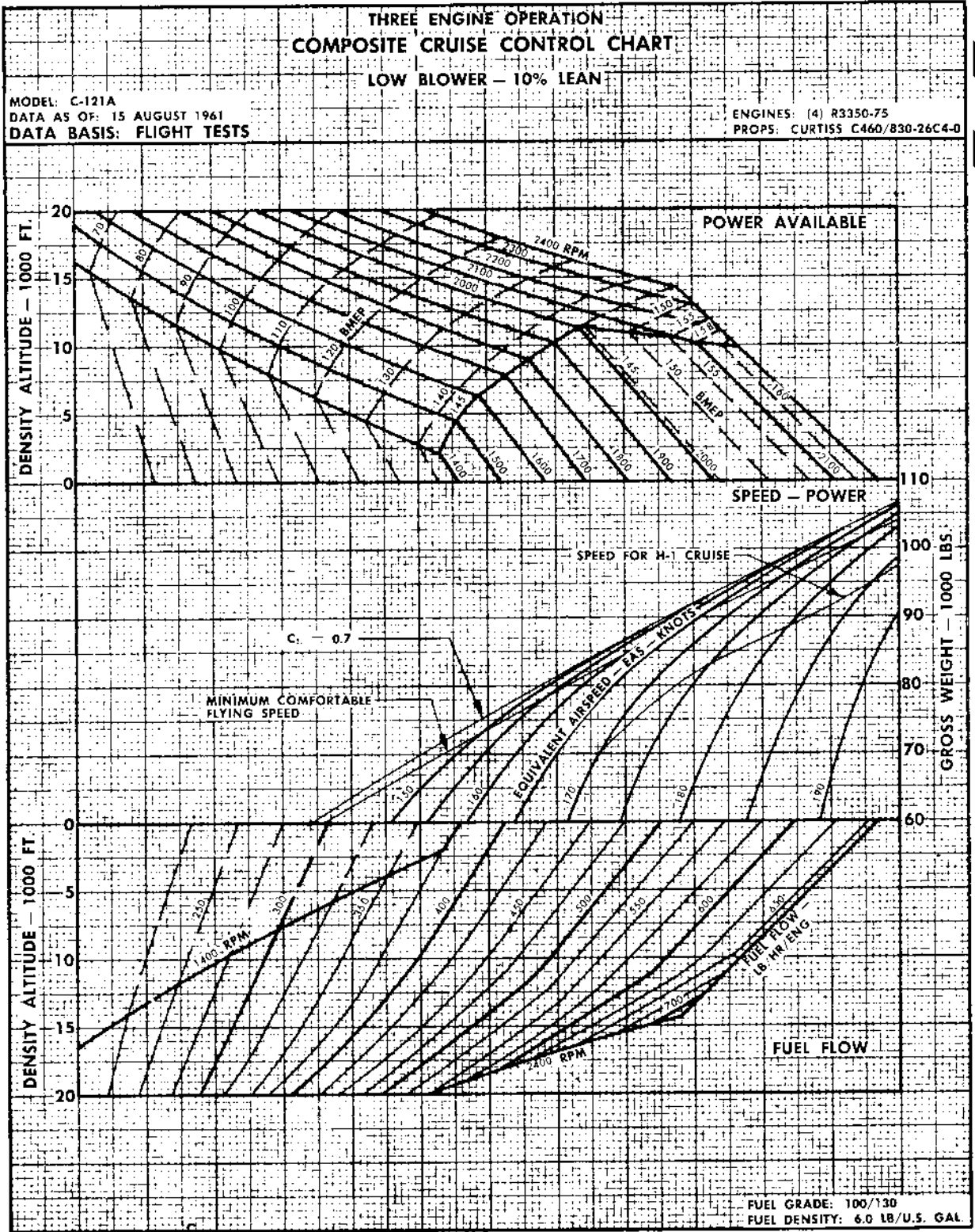

Figure A5-4

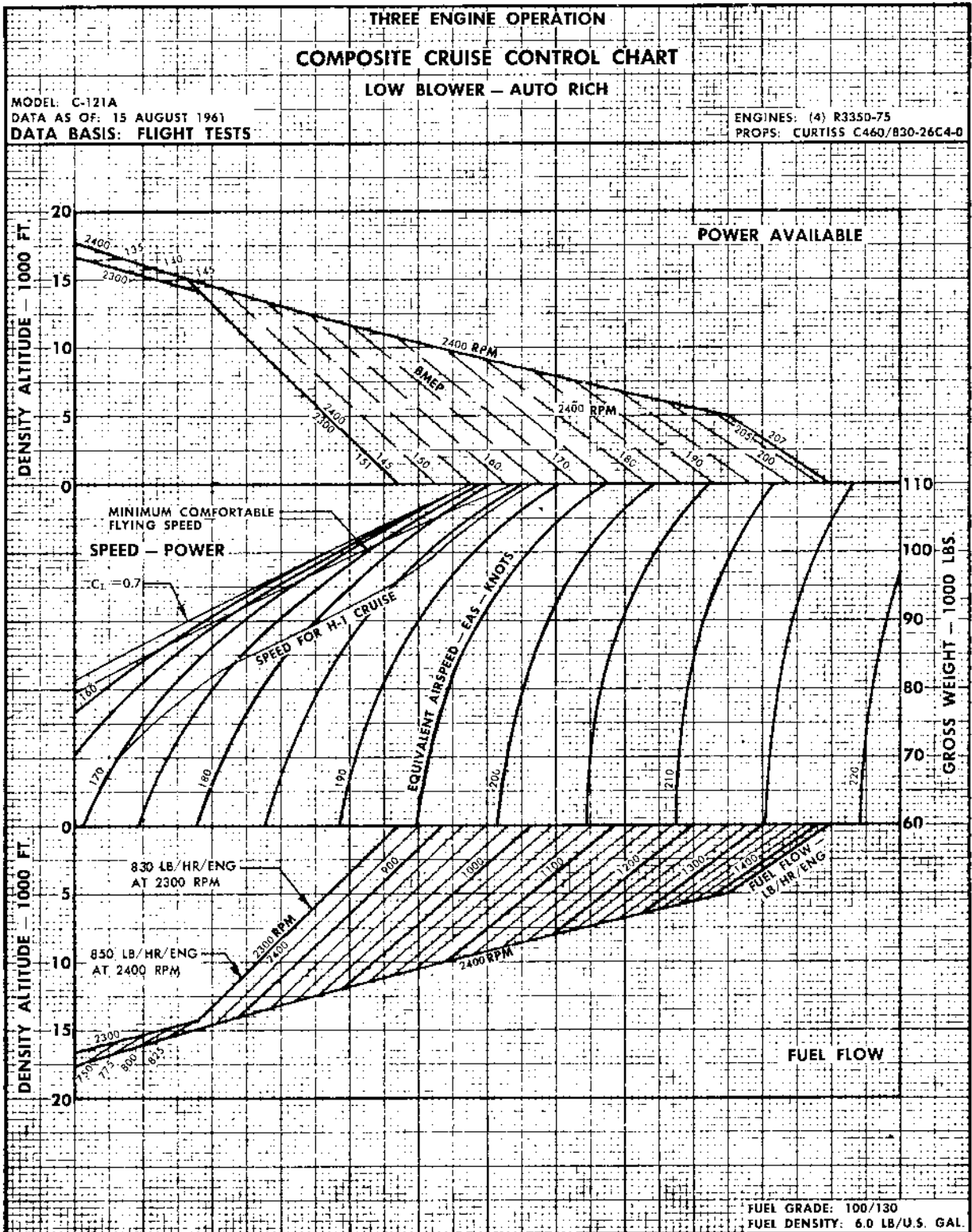

Figure A5-5

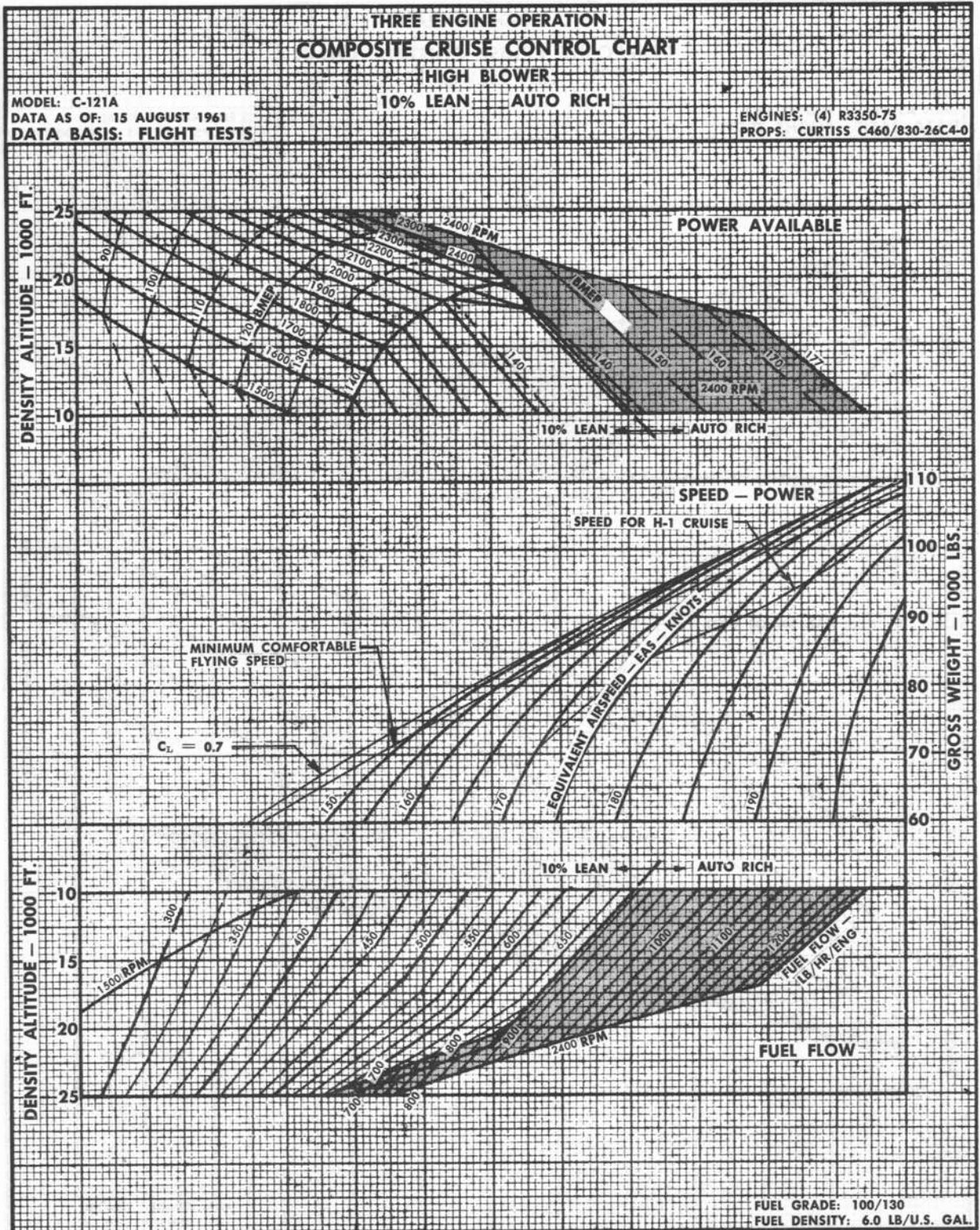

Figure A5-6

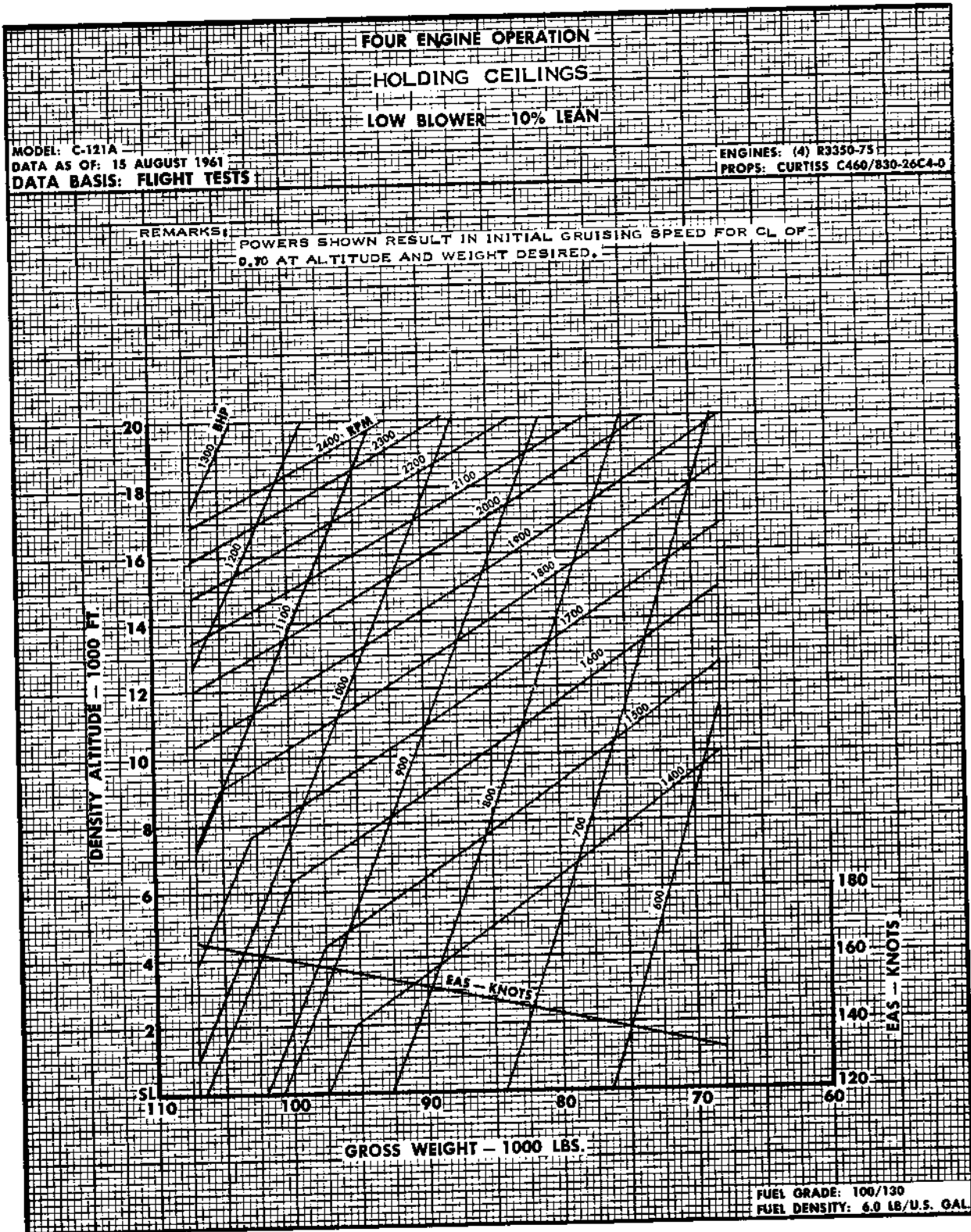

Figure A5-8

**FOUR ENGINE OPERATION
CRUISING CEILINGS**

10% LEAN

MODEL: C-121A
DATA AS OF: 15 AUGUST 1961
DATA BASIS: FLIGHT TESTS

ENGINES: (4) R3350-75
PROPS: CURTISS C460/830-26C4-0

REMARKS: POWERS SHOWN RESULT IN INITIAL CRUISING SPEED FOR MINIMUM COMFORTABLE FLYING SPEED AT ALTITUDE AND WEIGHT DESIRED.

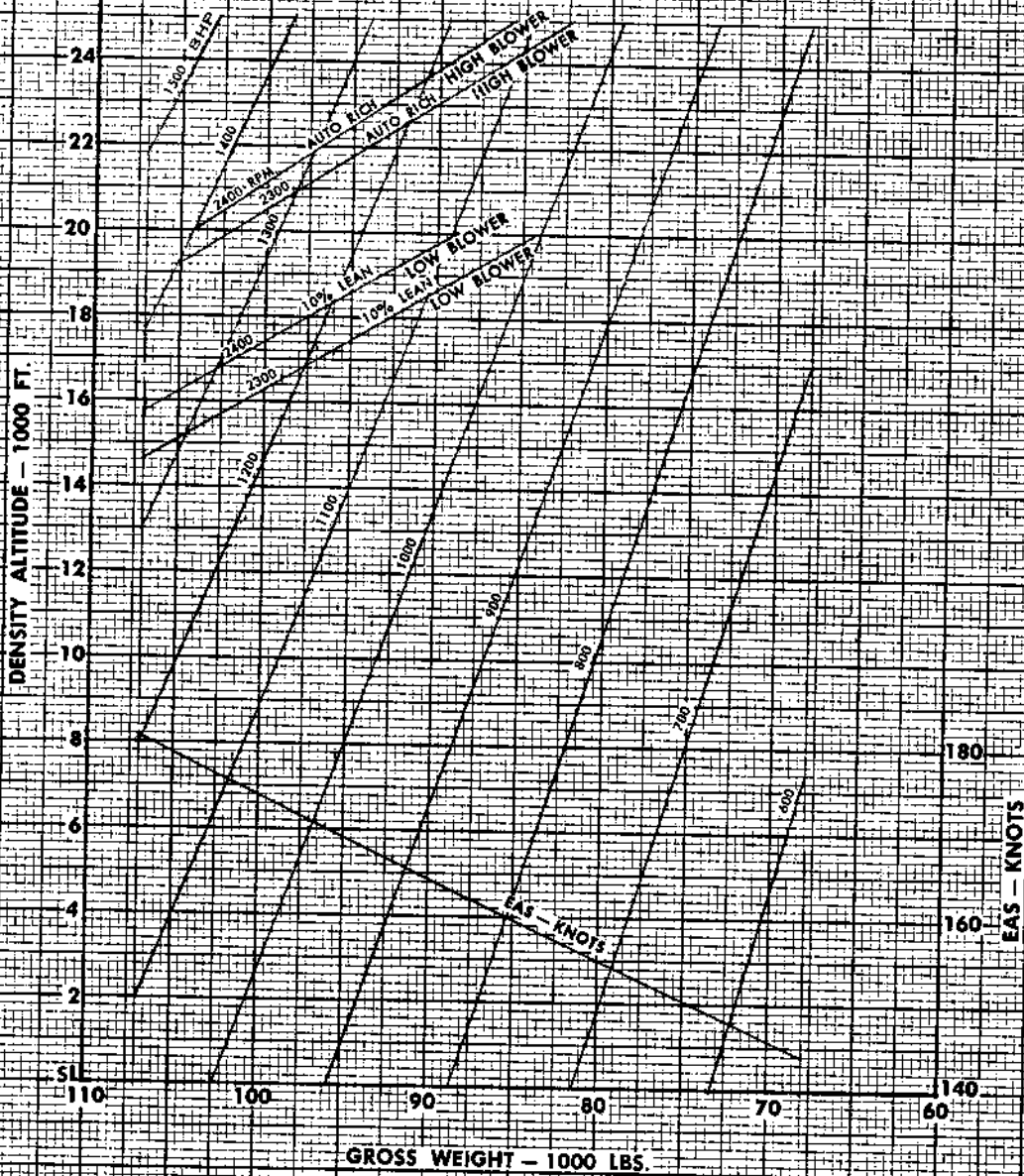

Figure A5-9

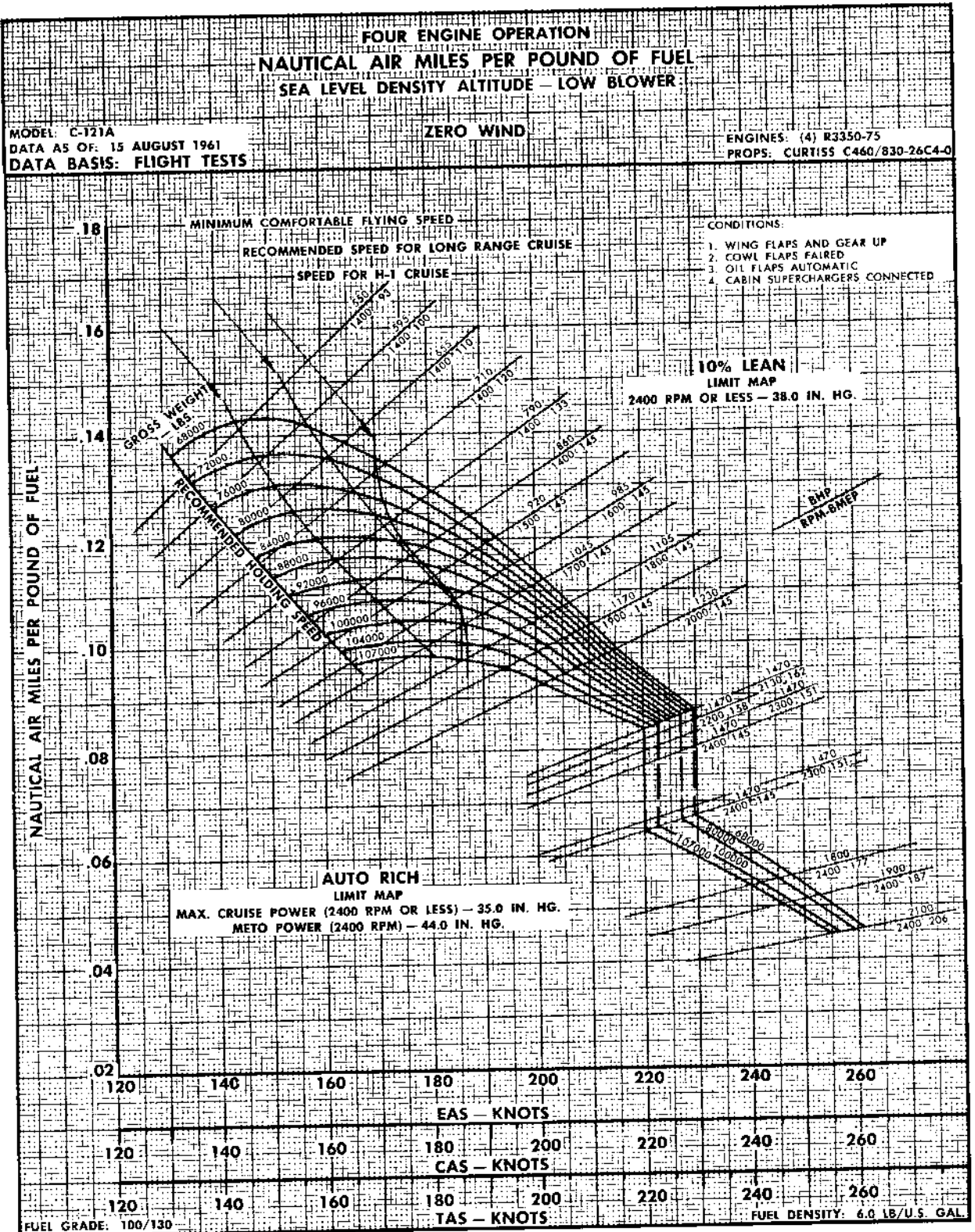

Figure A5-10

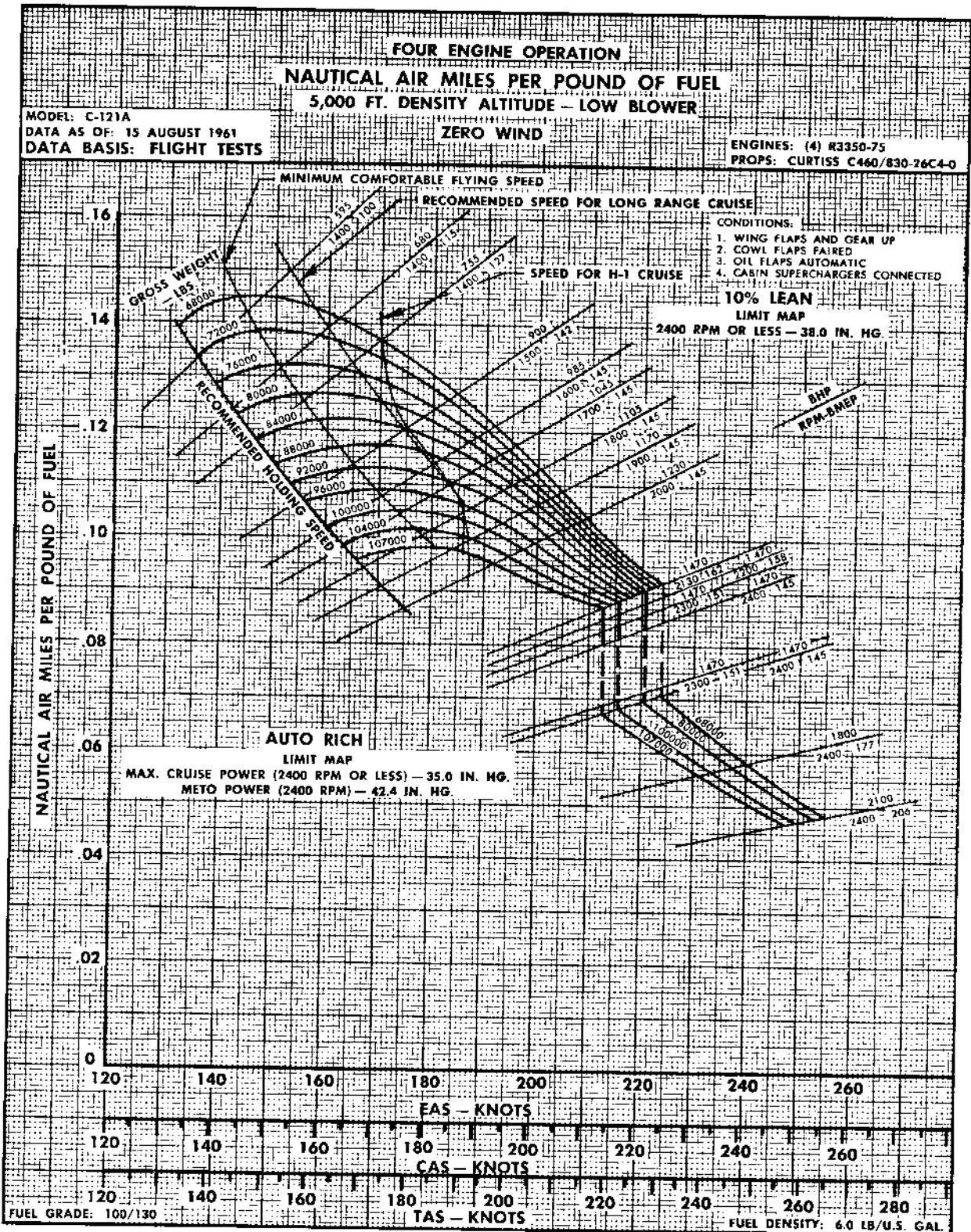

Figure A5-11

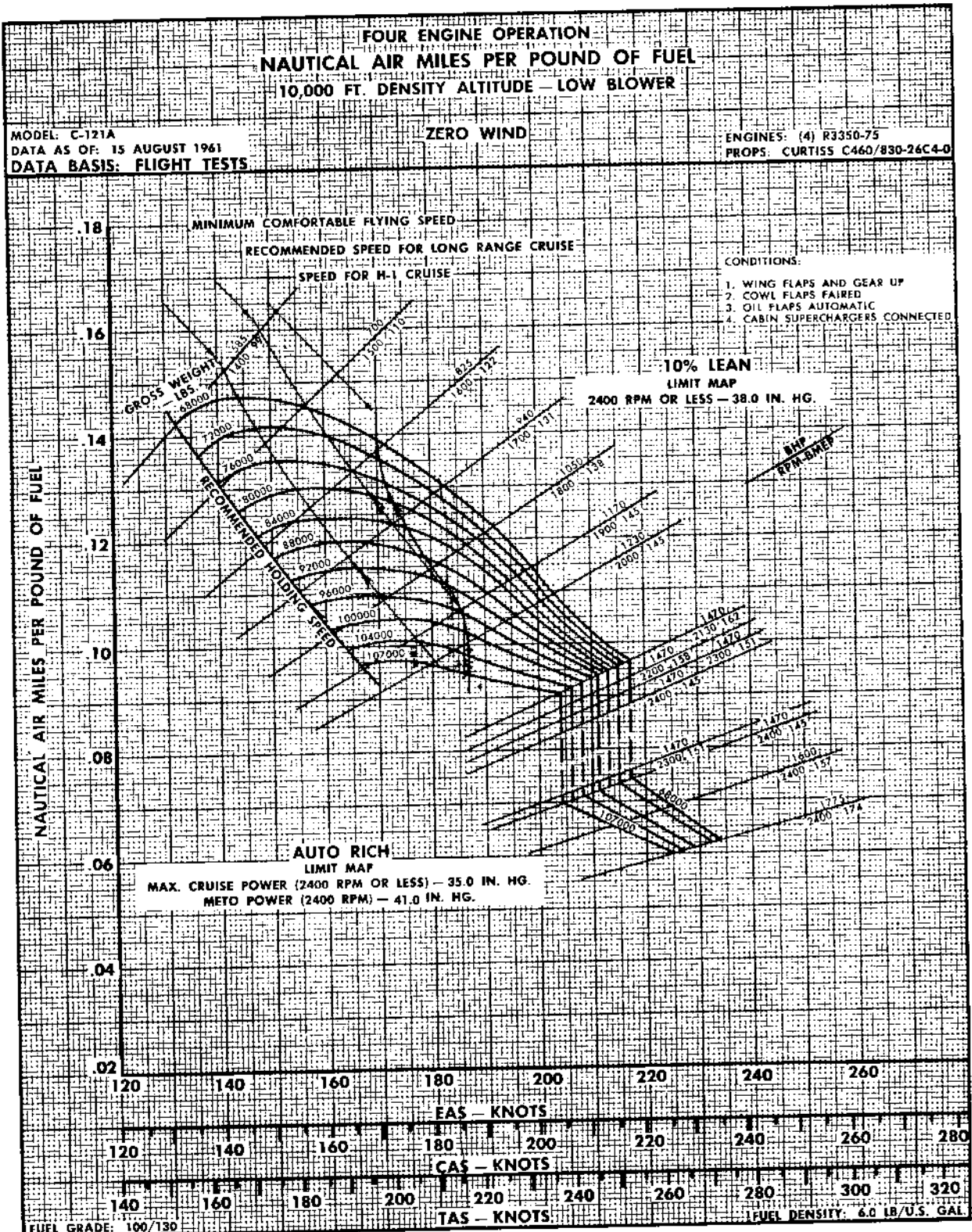

Figure A5-12

FOUR ENGINE OPERATION
NAUTICAL AIR MILES PER POUND OF FUEL
15,000 FT. DENSITY ALTITUDE - LOW BLOWER

MODEL: C-121A
DATA AS OF: 15 AUGUST 1961
DATA BASIS: FLIGHT TESTS

ZERO WIND

ENGINES: (4) R3350-75
PROPS: CURTISS C460/830-26C4-0

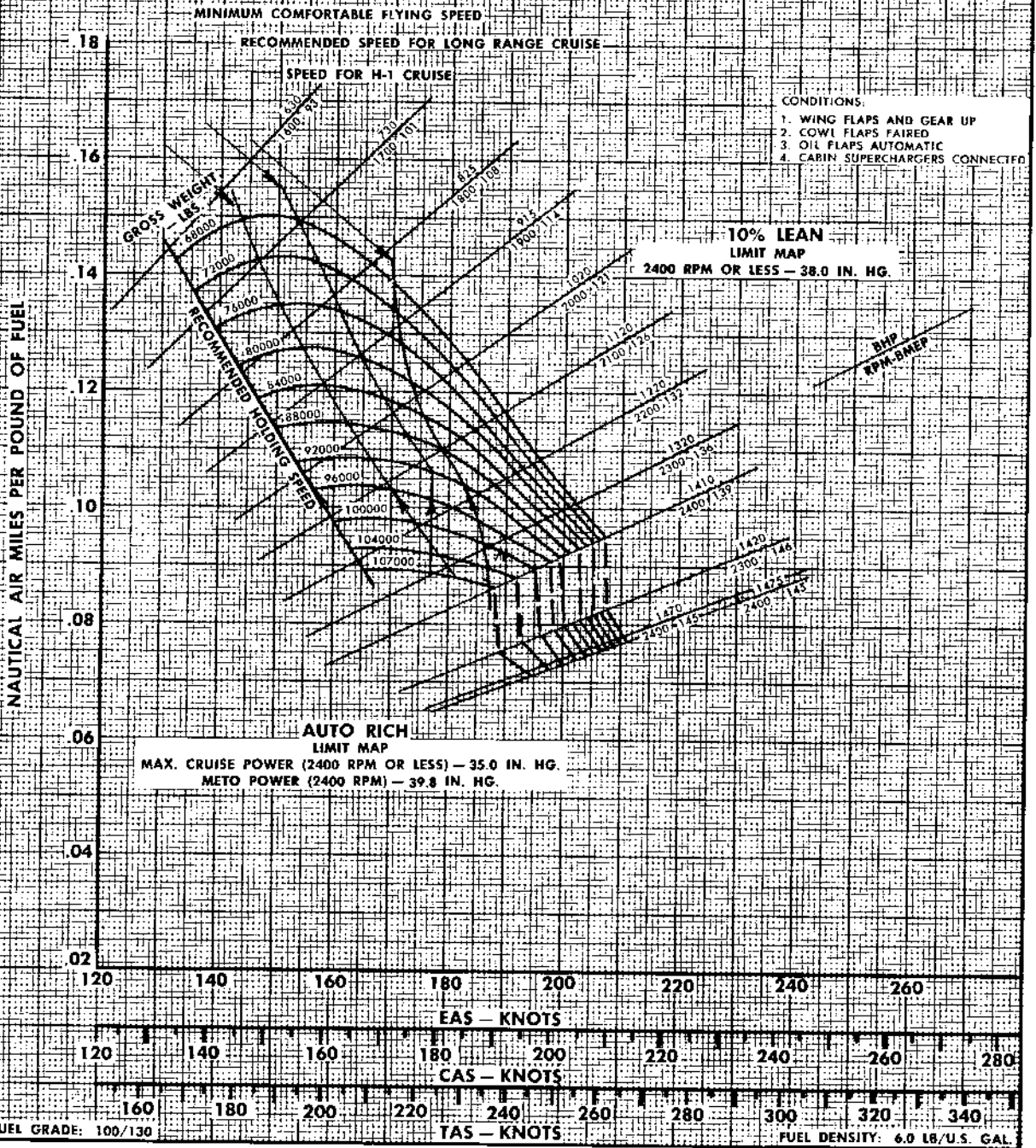

Figure A5-13

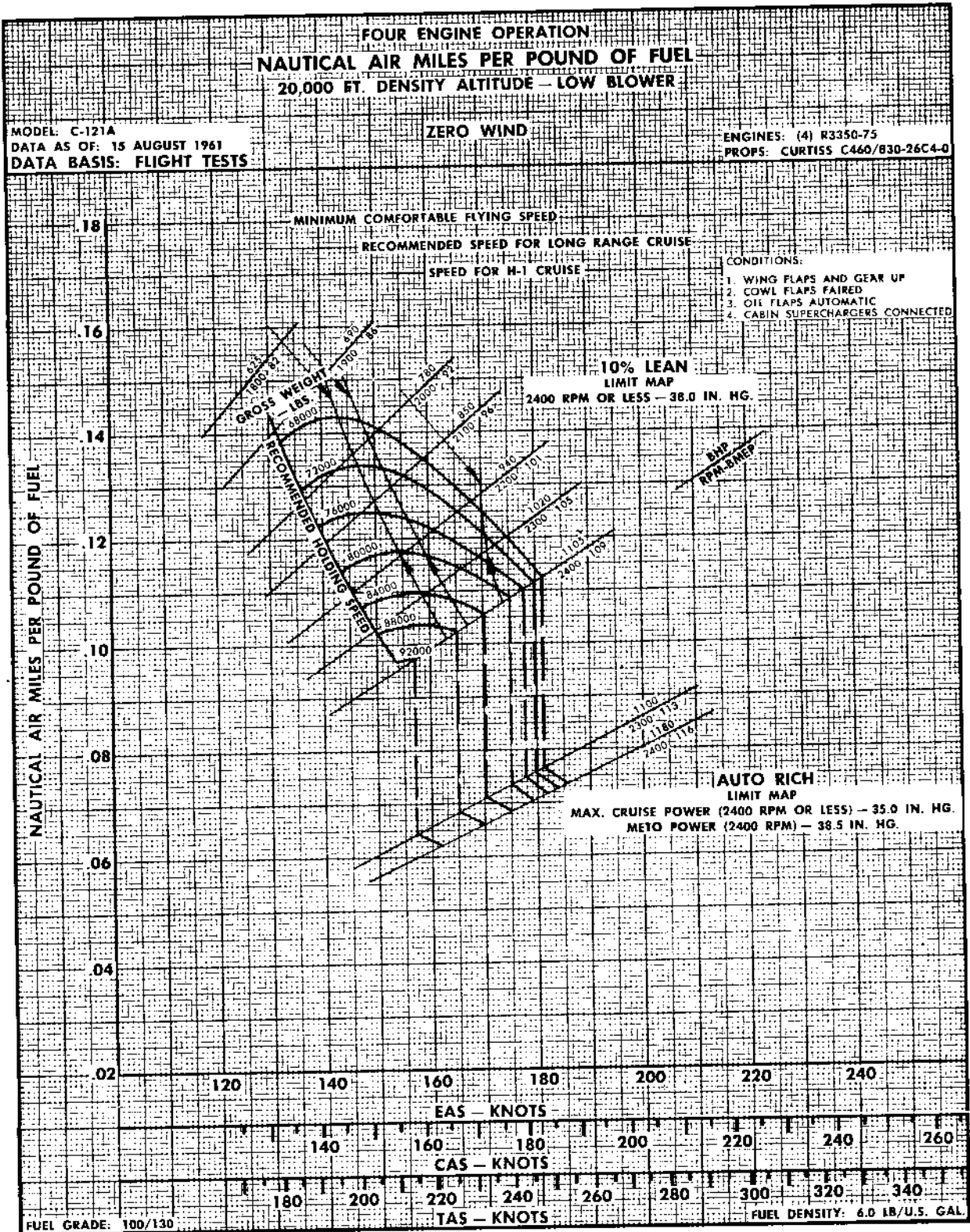

Figure A5-14

FOUR ENGINE OPERATION
NAUTICAL AIR MILES PER POUND OF FUEL
10,000 FT. DENSITY ALTITUDE - HIGH BLOWER

MODEL: C-121A
DATA AS OF: 15 AUGUST 1961
DATA BASIS: FLIGHT TESTS

ZERO WIND

ENGINES: (4) R3350-73
PROPS: CURTISS C460/830-26C4-0

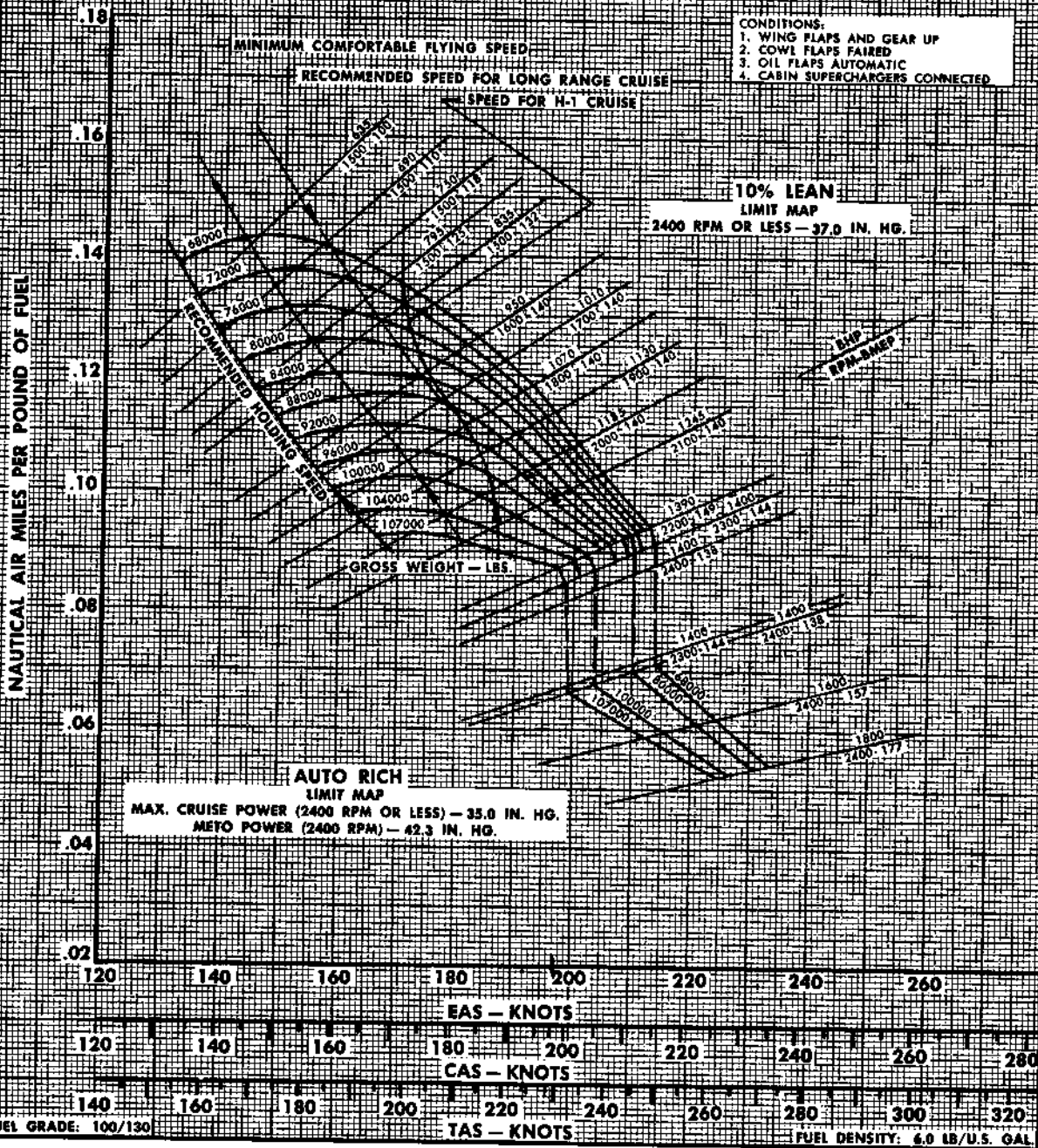

Figure A5-15

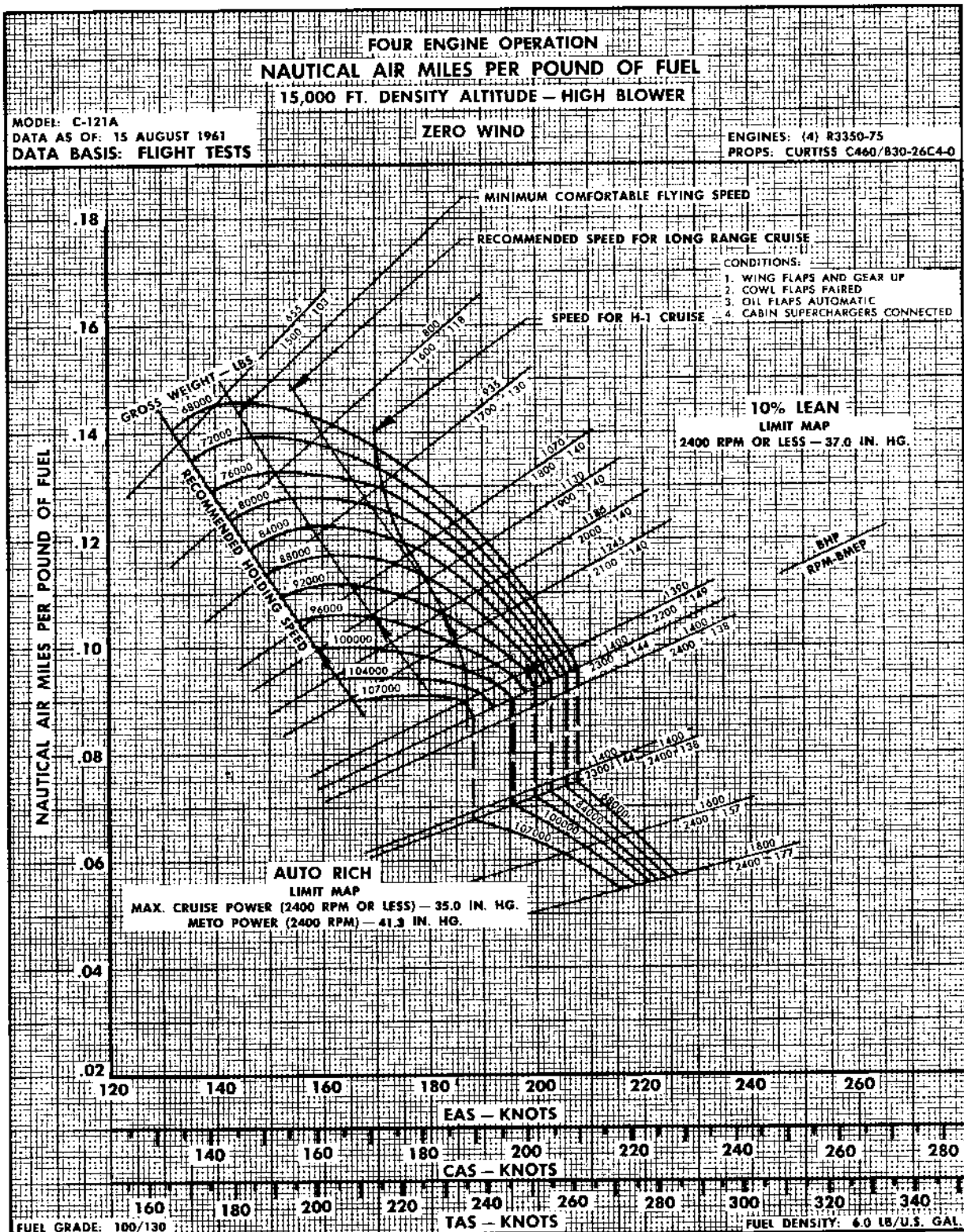

Figure A5-16

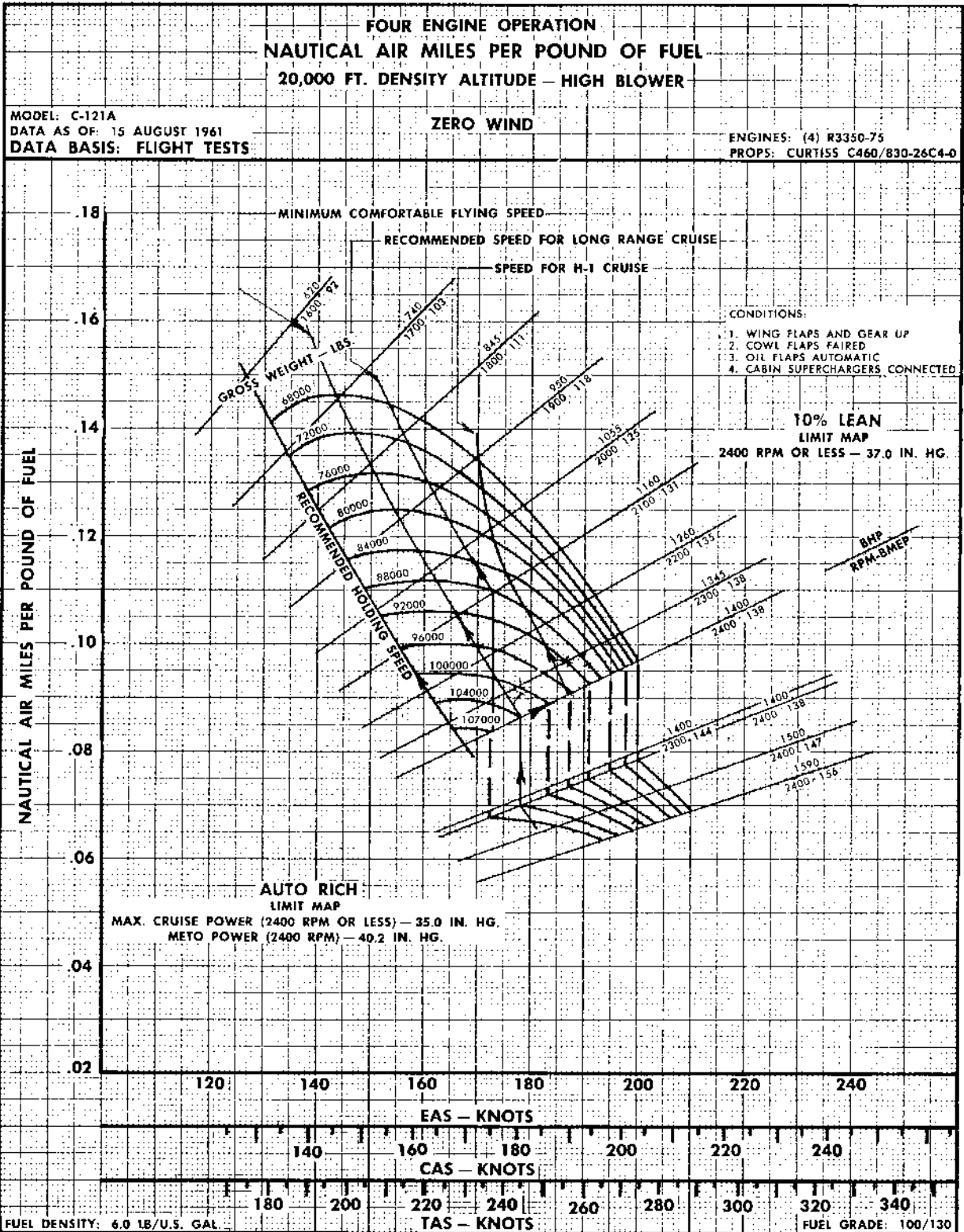

Figure A5-17

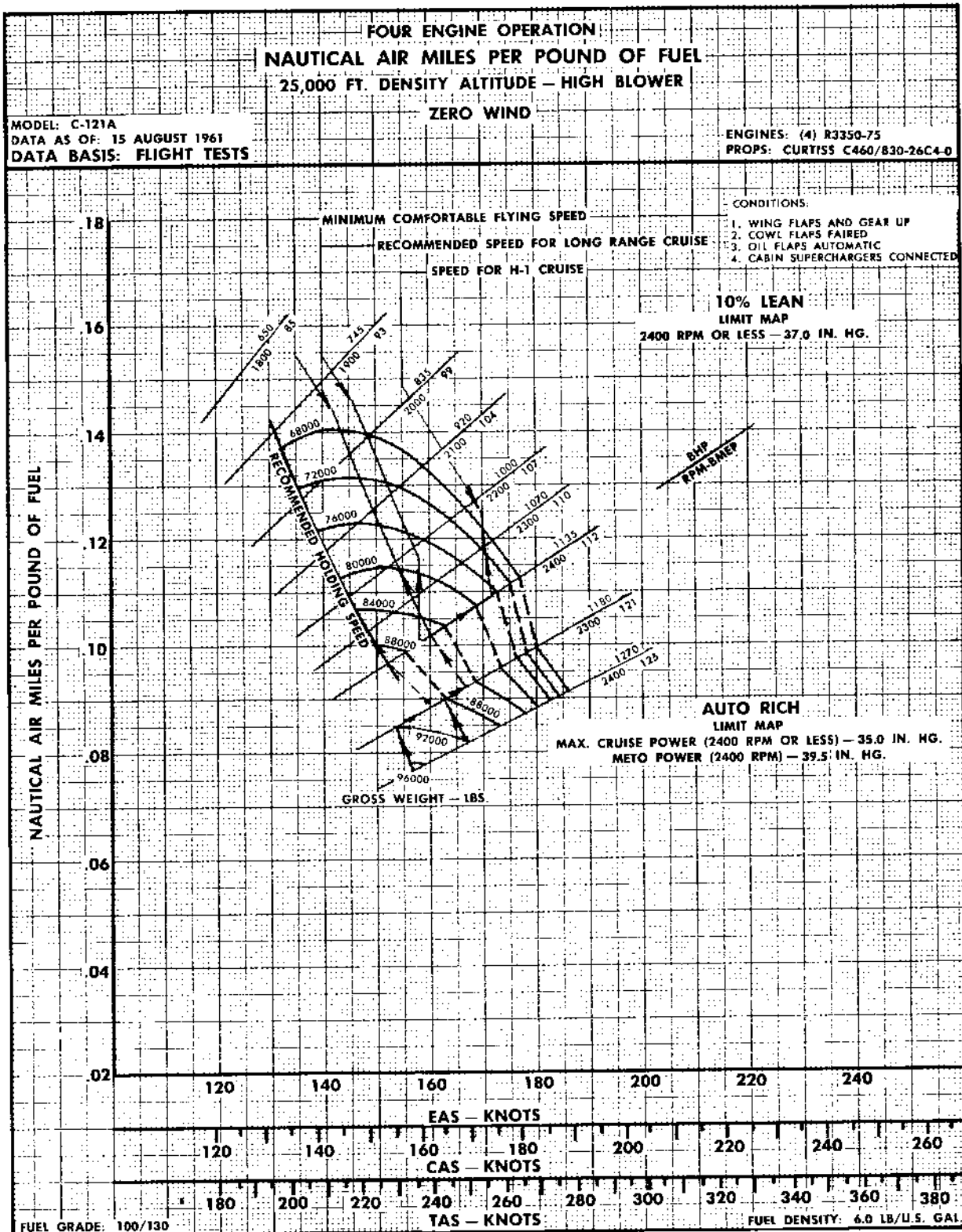

Figure A5-18

THREE ENGINE OPERATION
NAUTICAL AIR MILES PER POUND OF FUEL
SEA LEVEL DENSITY ALTITUDE - LOW BLOWER

MODEL: C-121A
DATA AS OF: 15 AUGUST 1961
DATA BASIS: FLIGHT TESTS

ZERO WIND

ENGINES: (4) R3350-75
PROPS: CURTISS C460/830-26C4-0

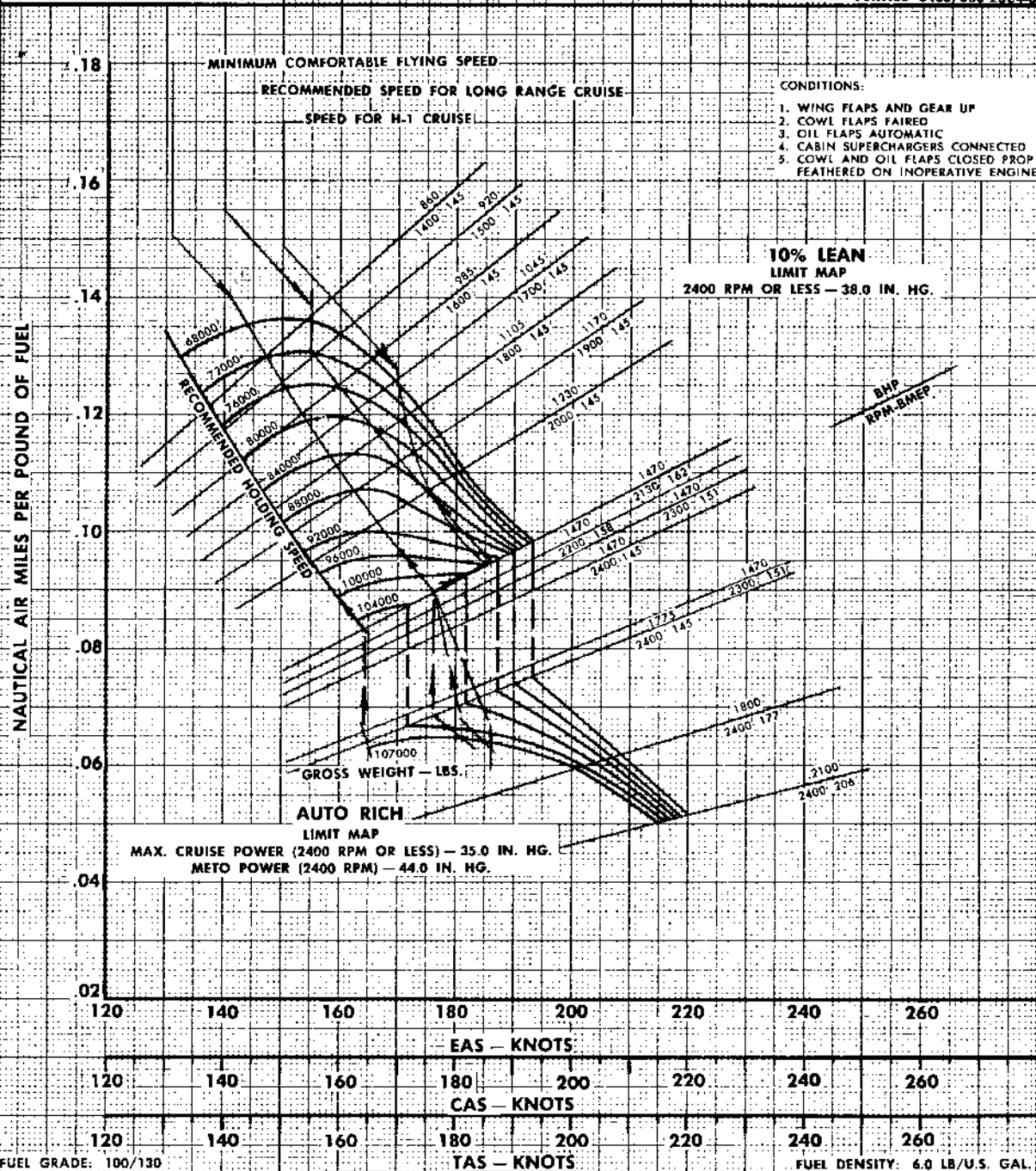

Figure A5-19

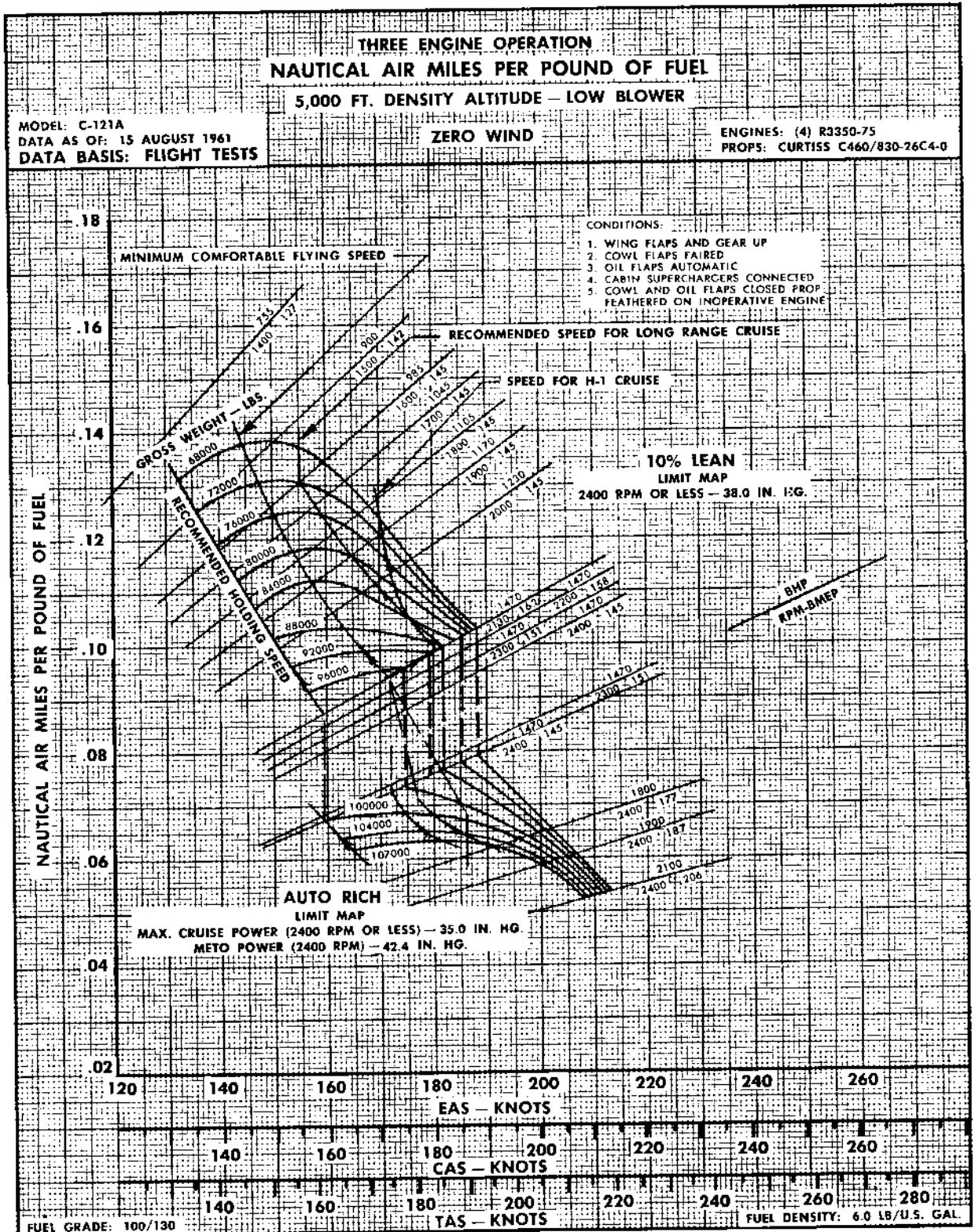

Figure A5-20

THREE ENGINE OPERATION
NAUTICAL AIR MILES PER POUND OF FUEL
10,000 FT. DENSITY ALTITUDE - LOW BLOWER

MODEL: C-121A
DATA AS OF: 15 AUGUST 1961
DATA BASIS: FLIGHT TESTS

ZERO WIND

ENGINES: (4) R3350-75
PROPS: CURTISS C460/830-26C4-0

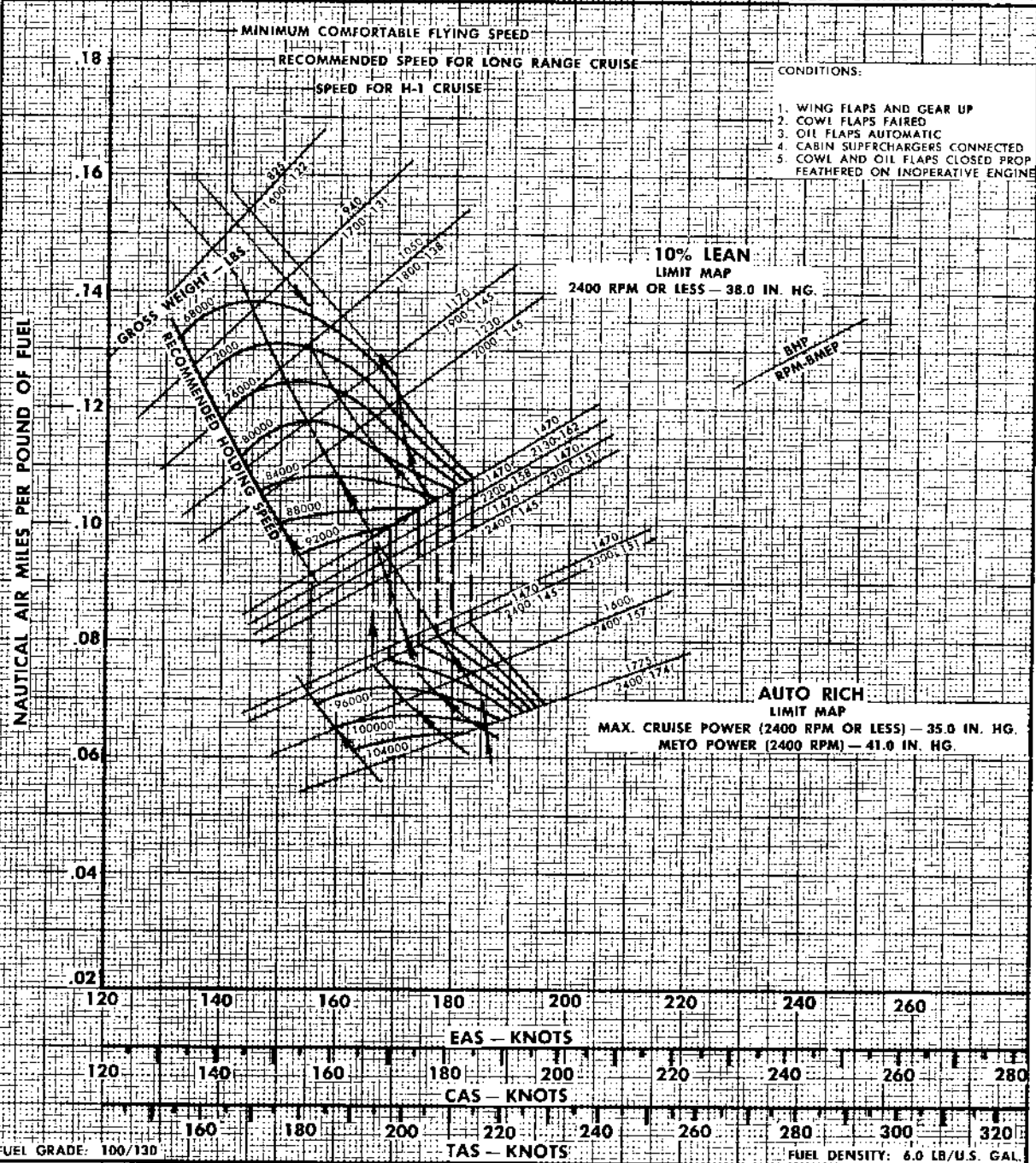

Figure A5-21

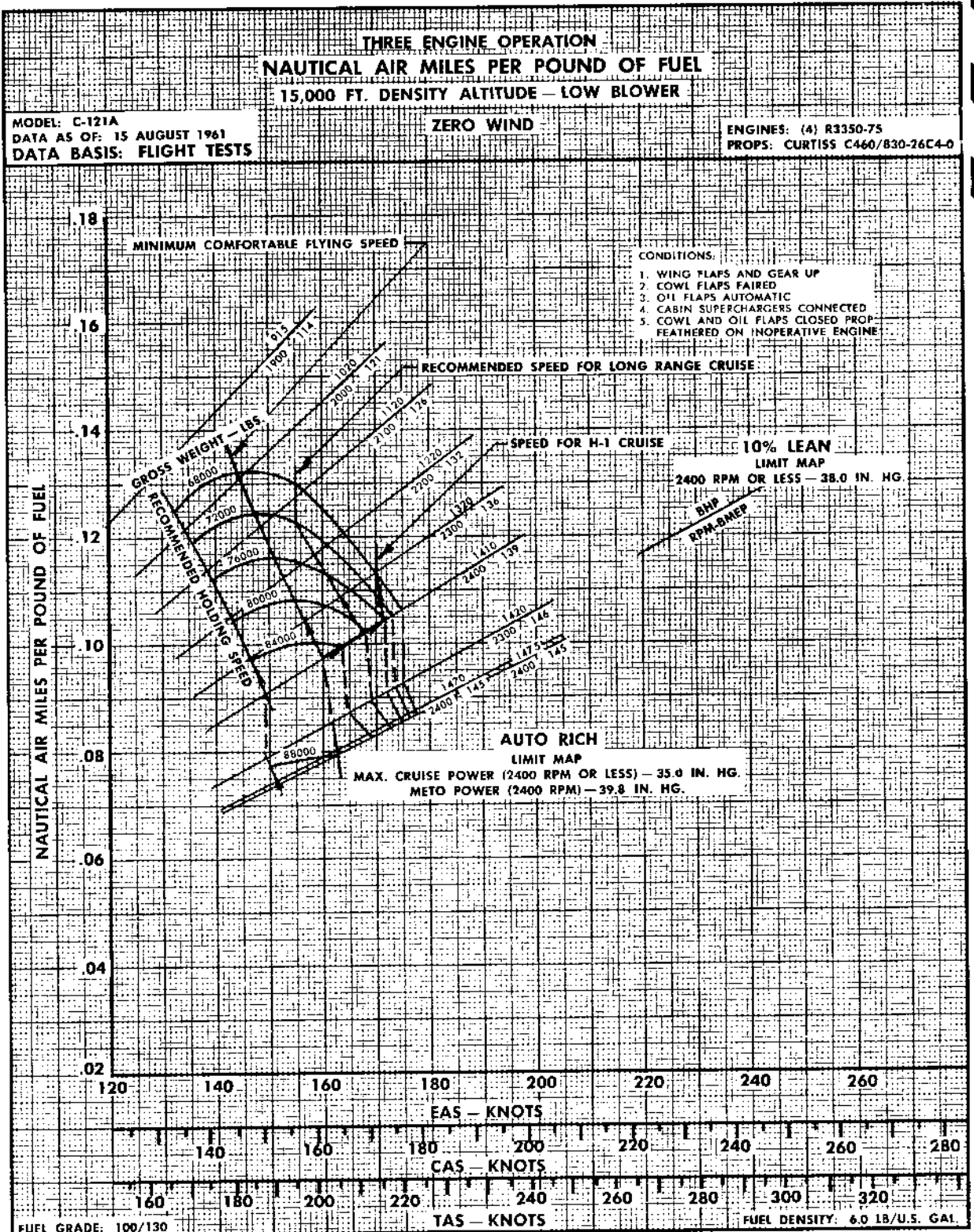

Figure A5-22

THREE ENGINE OPERATION
NAUTICAL AIR MILES PER POUND OF FUEL
10,000 FT. DENSITY ALTITUDE - HIGH BLOWER

MODEL: C-121A
DATA AS OF: 15 AUGUST 1961
DATA BASIS: FLIGHT TESTS

ZERO WIND

ENGINES: (4) R3350-75
PROPS: CURTISS C460/830-26C4-0

- CONDITIONS:
1. WING FLAPS AND GEAR UP
 2. COWL FLAPS FAIRED
 3. OIL FLAPS AUTOMATIC
 4. CABIN SUPERCHARGERS CONNECTED
 5. COWL AND OIL FLAPS CLOSED PROP FEATHERED ON INOPERATIVE ENGINE

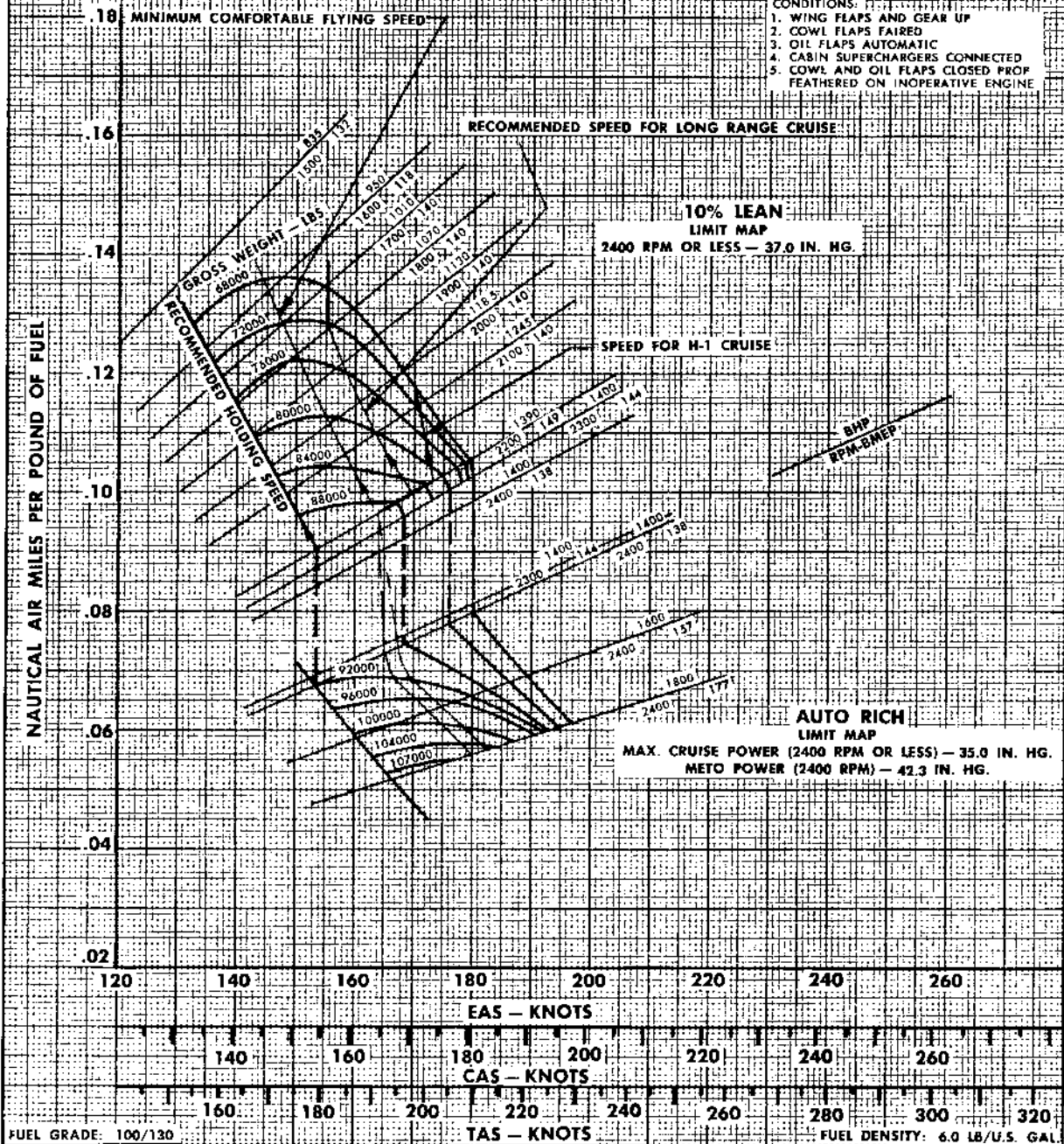

Figure A5-23

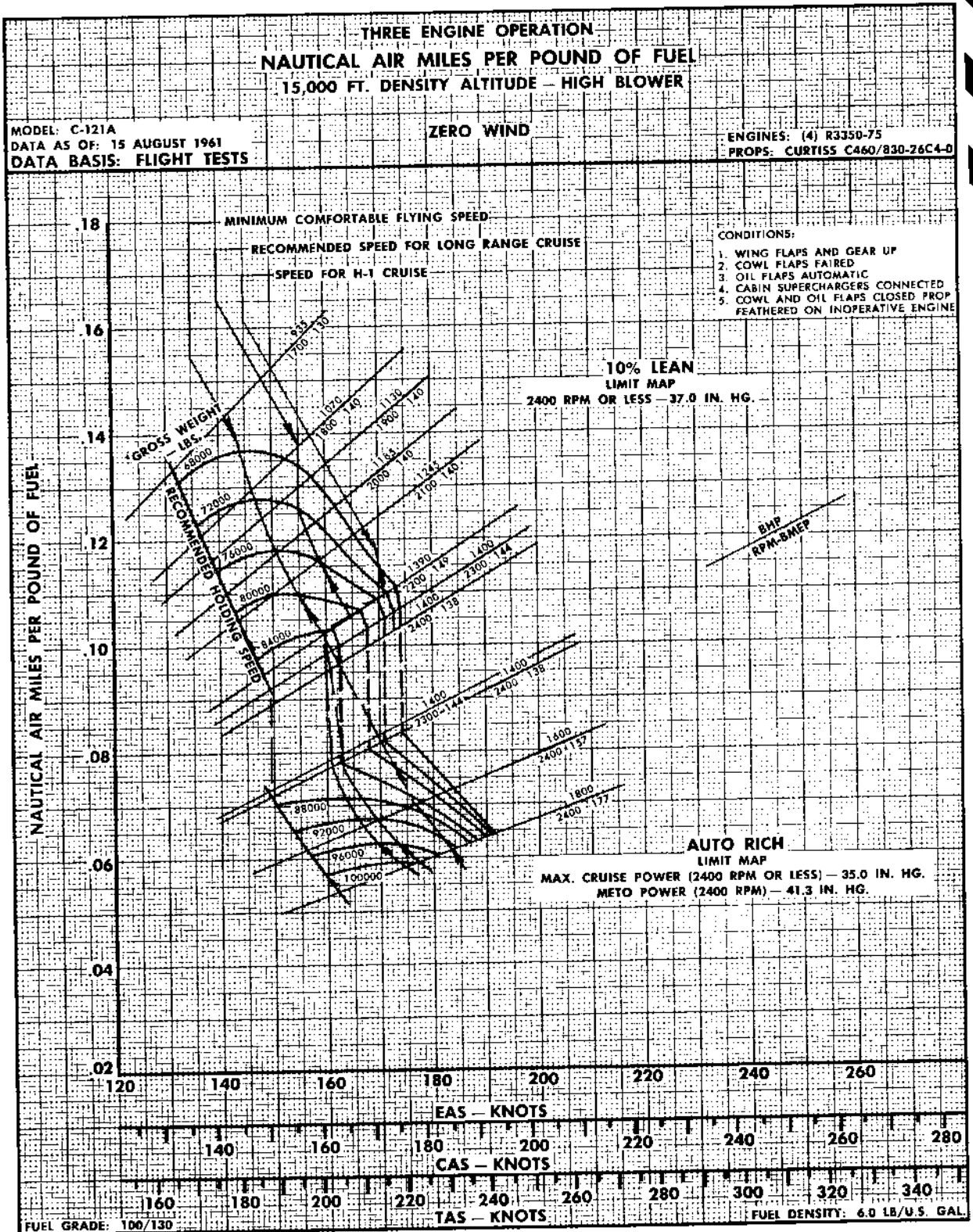

Figure A5-24

THREE ENGINE OPERATION
NAUTICAL AIR MILES PER POUND OF FUEL
20,000 FT. DENSITY ALTITUDE - HIGH BLOWER

ZERO WIND

MODEL: C-121A
DATA AS OF: 15 AUGUST 1961
DATA BASIS: FLIGHT TESTS

ENGINES: (4) R3350-75
PROPS: CURTISS C460/B30-26C4-0

CONDITIONS:

1. WING FLAPS AND GEAR UP
2. COWL FLAPS FAIRED
3. OIL FLAPS AUTOMATIC
4. CABIN SUPERCHARGERS CONNECTED
5. COWL AND OIL FLAPS CLOSED PROP FEATHERED ON INOPERATIVE ENGINE

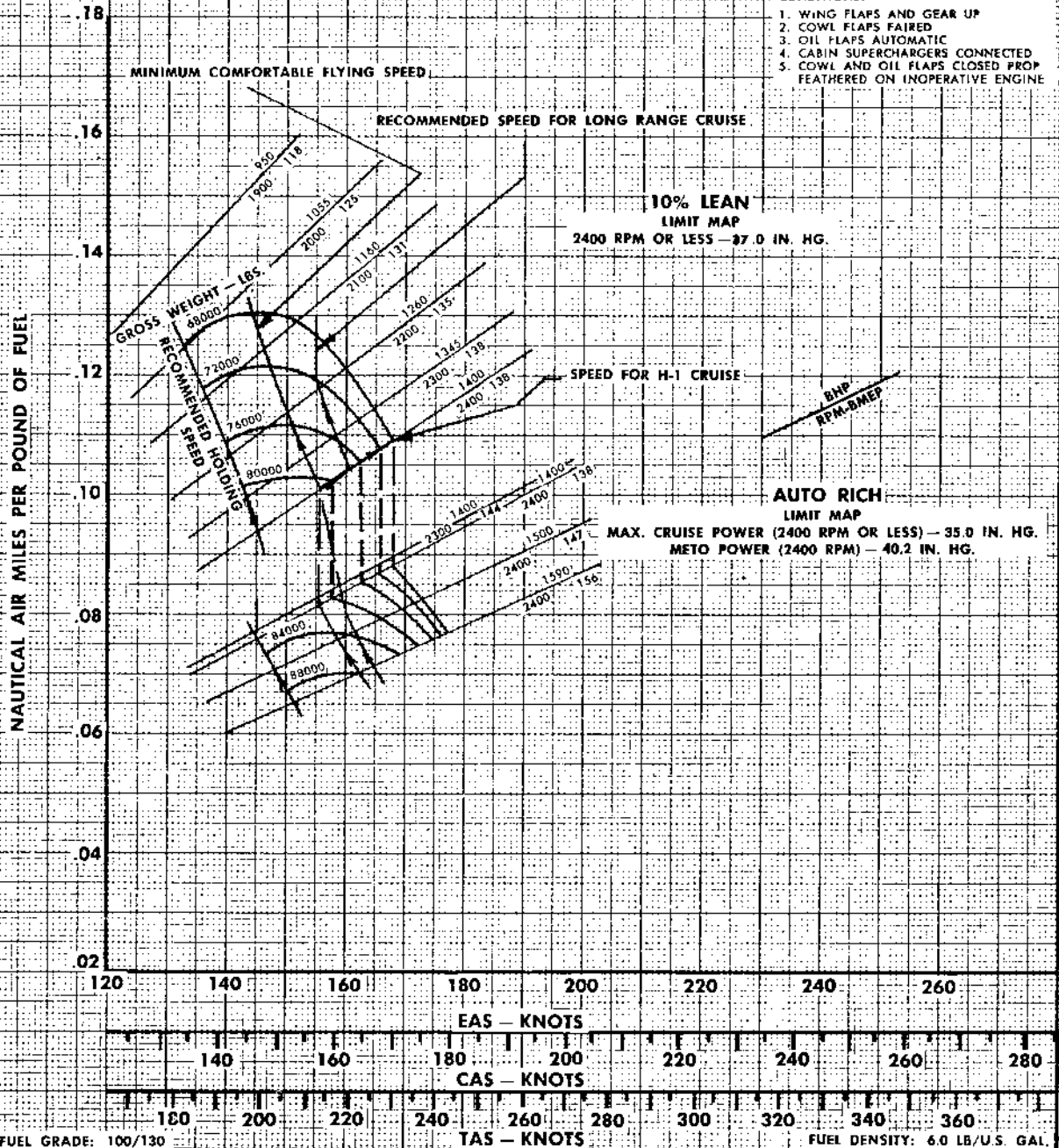

Figure A5-25

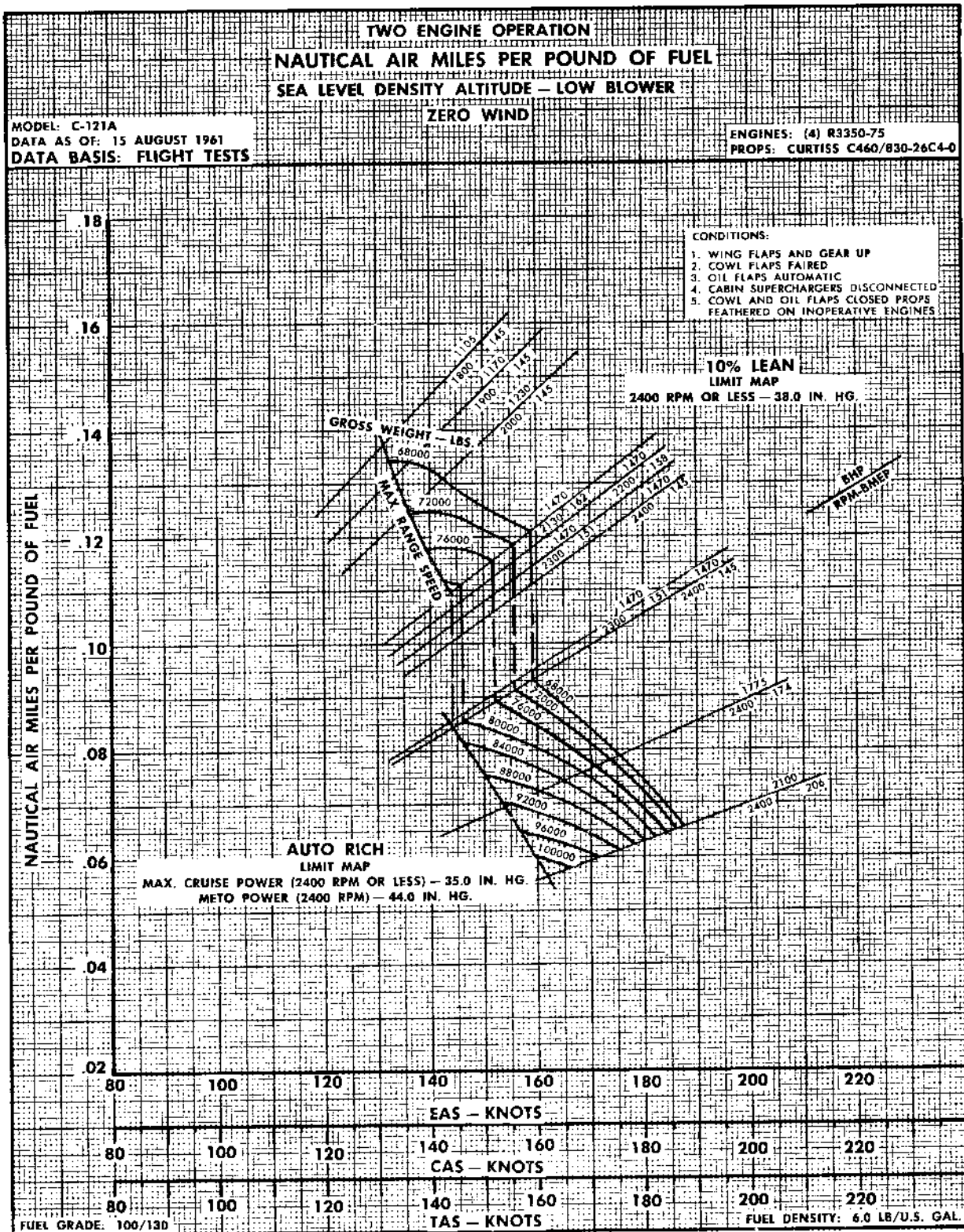

Figure A5-26

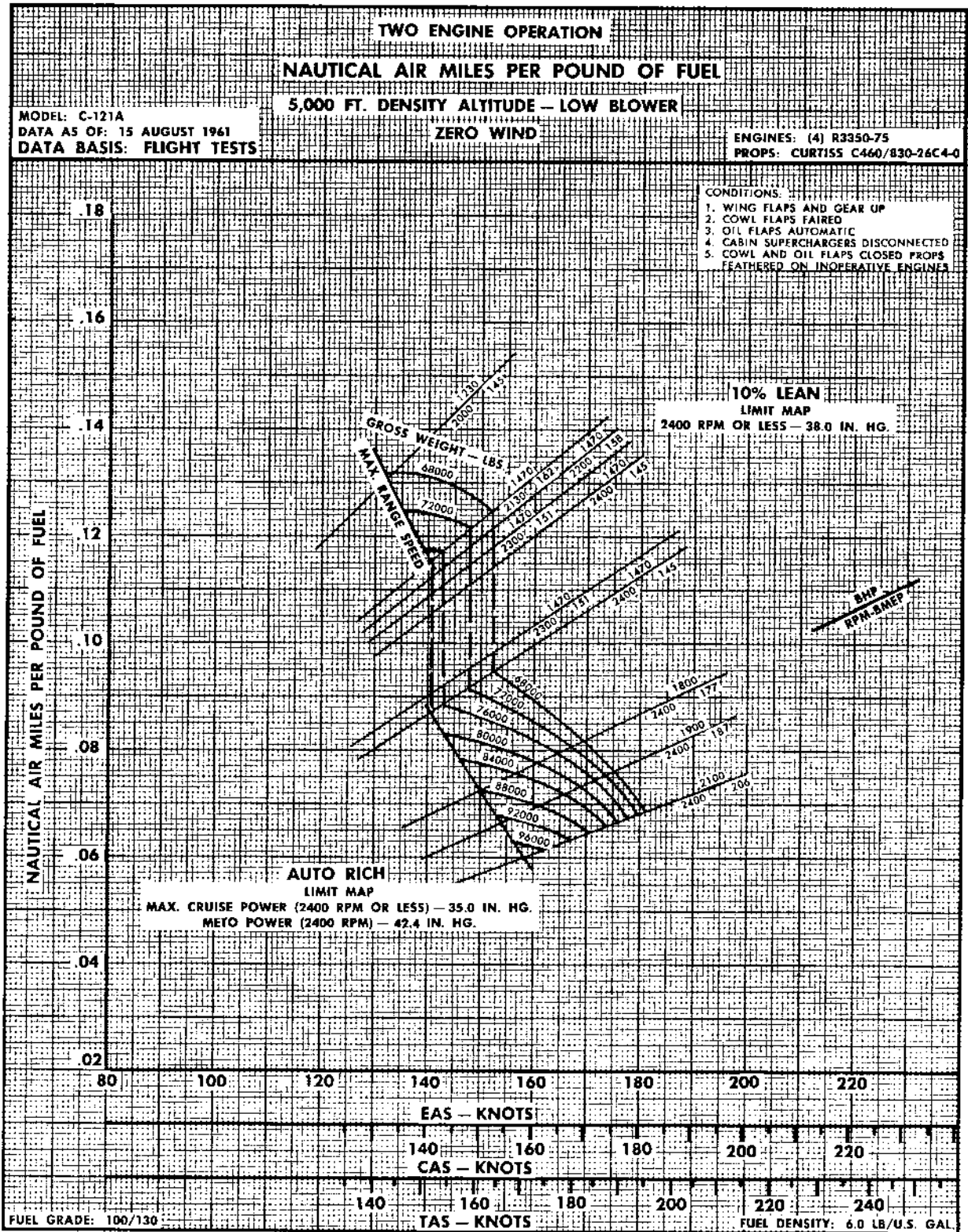

Figure A5-27

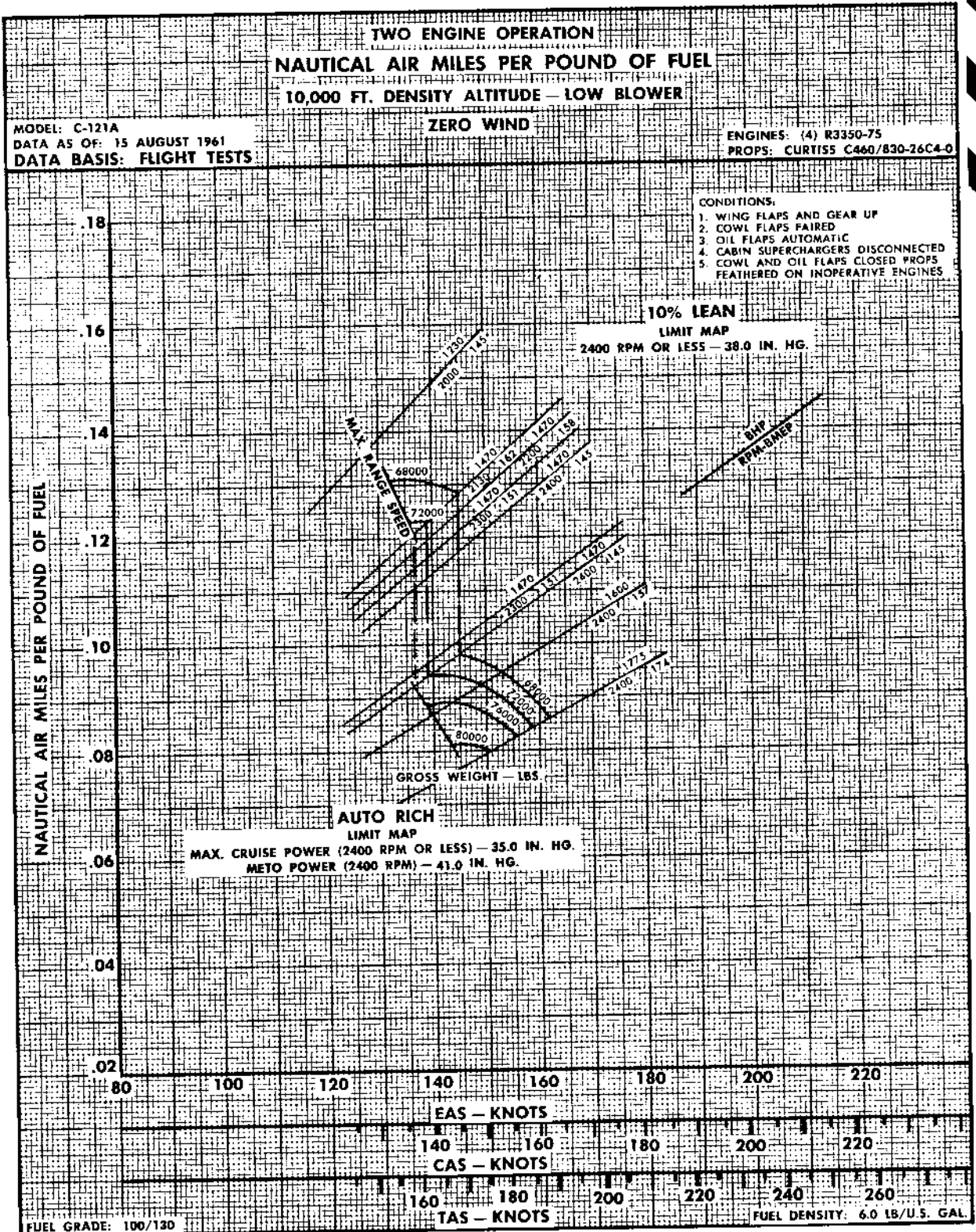

Figure A5-28

**FOUR ENGINE OPERATION
H-1 CRUISE PERFORMANCE
TIME PREDICTION**

MODEL: C-121A
DATA AS OF: 15 AUGUST 1961
DATA BASIS: FLIGHT TESTS

ENGINES: (4) R3350-75
PROPS: CURTISS C460/830-26C4-0

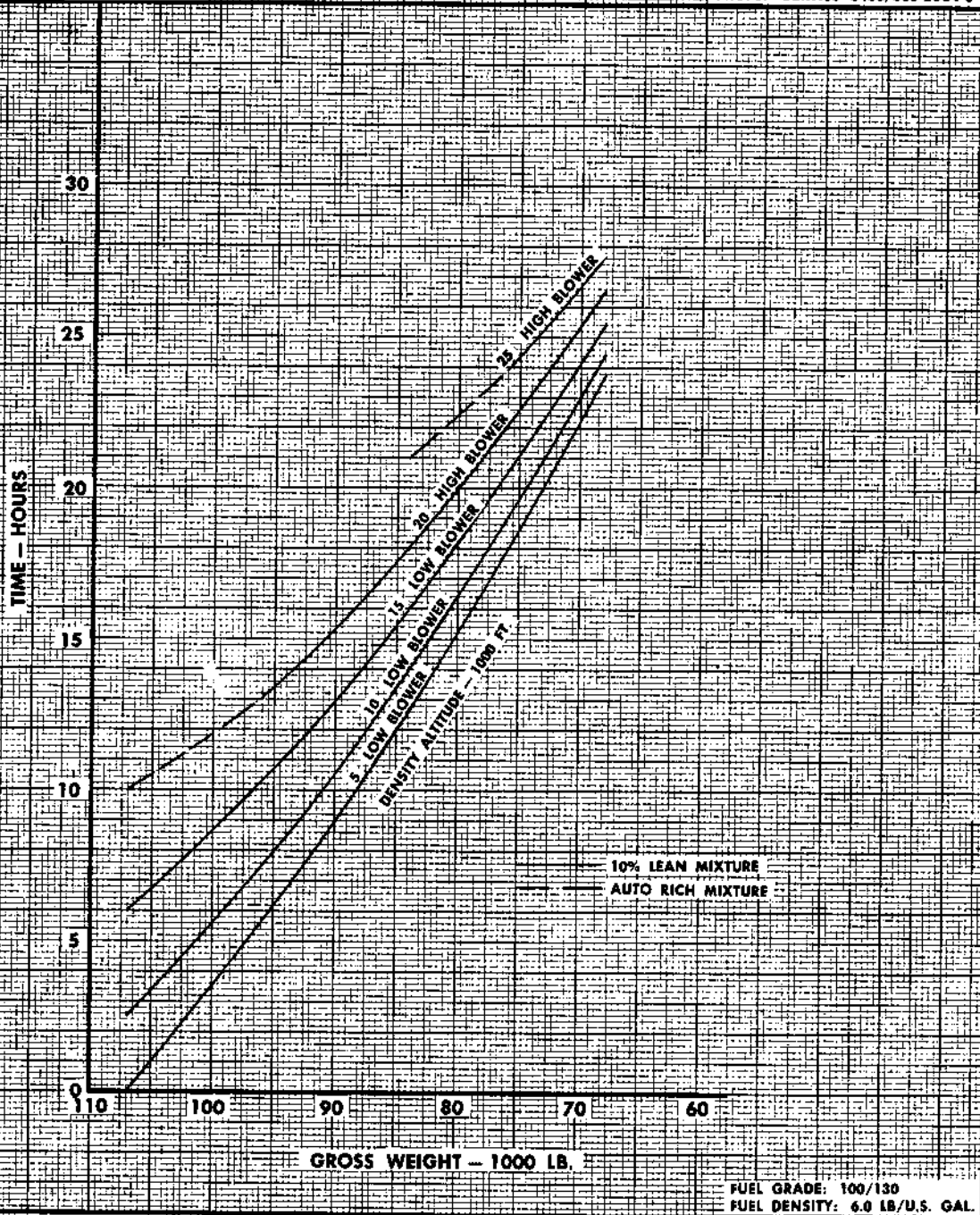

Figure A5-29

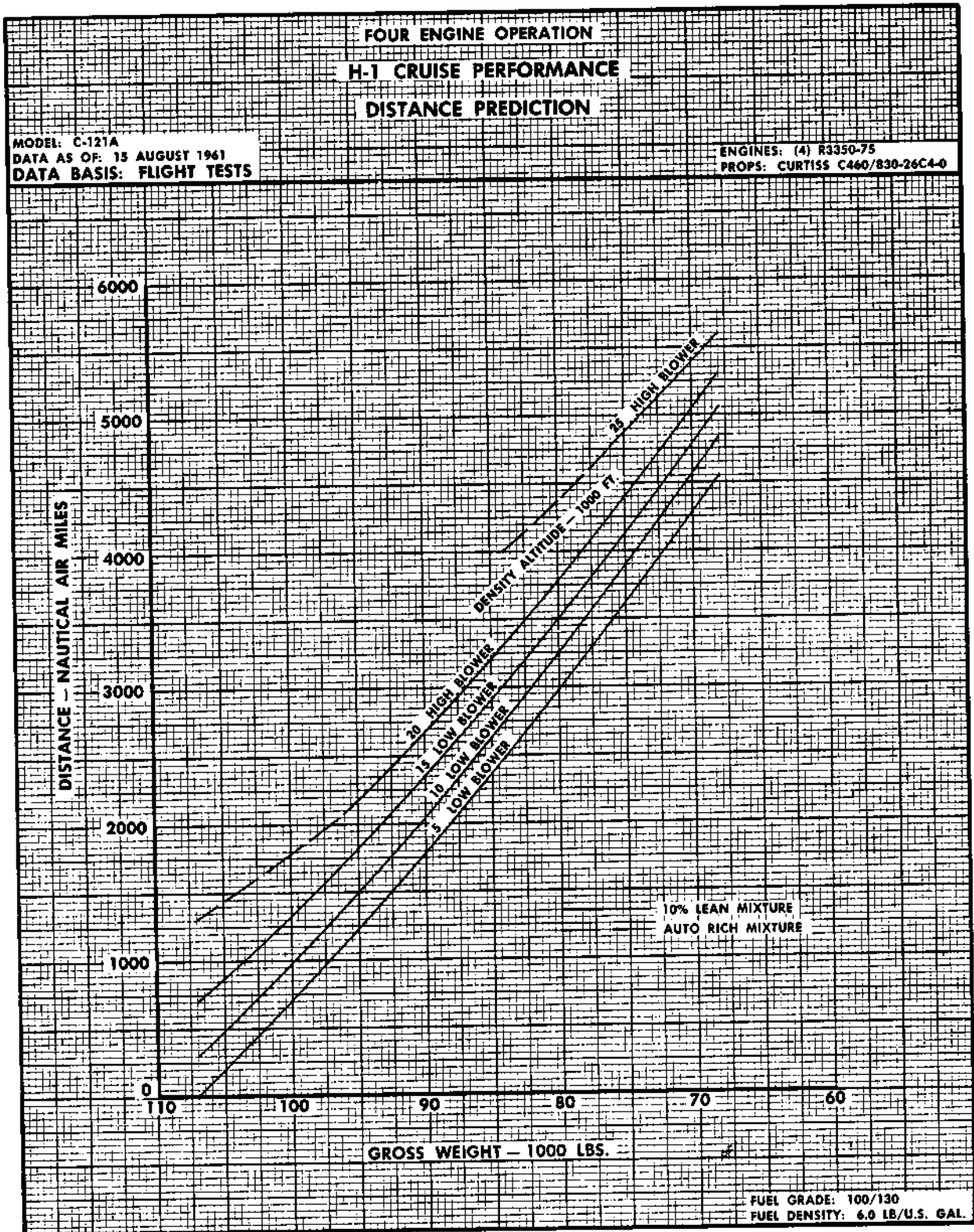

Figure A5-30

**FOUR ENGINE OPERATION
CONSTANT POWER CRUISE PERFORMANCE - 1300 BHP
TIME PREDICTION**

MODEL: C-121A
DATA AS OF: 15 AUGUST 1961
DATA BASIS: FLIGHT TESTS

10% LEAN

ENGINES: (4) R3330-75
PROPS: CURTISS C460/830-26C4-0

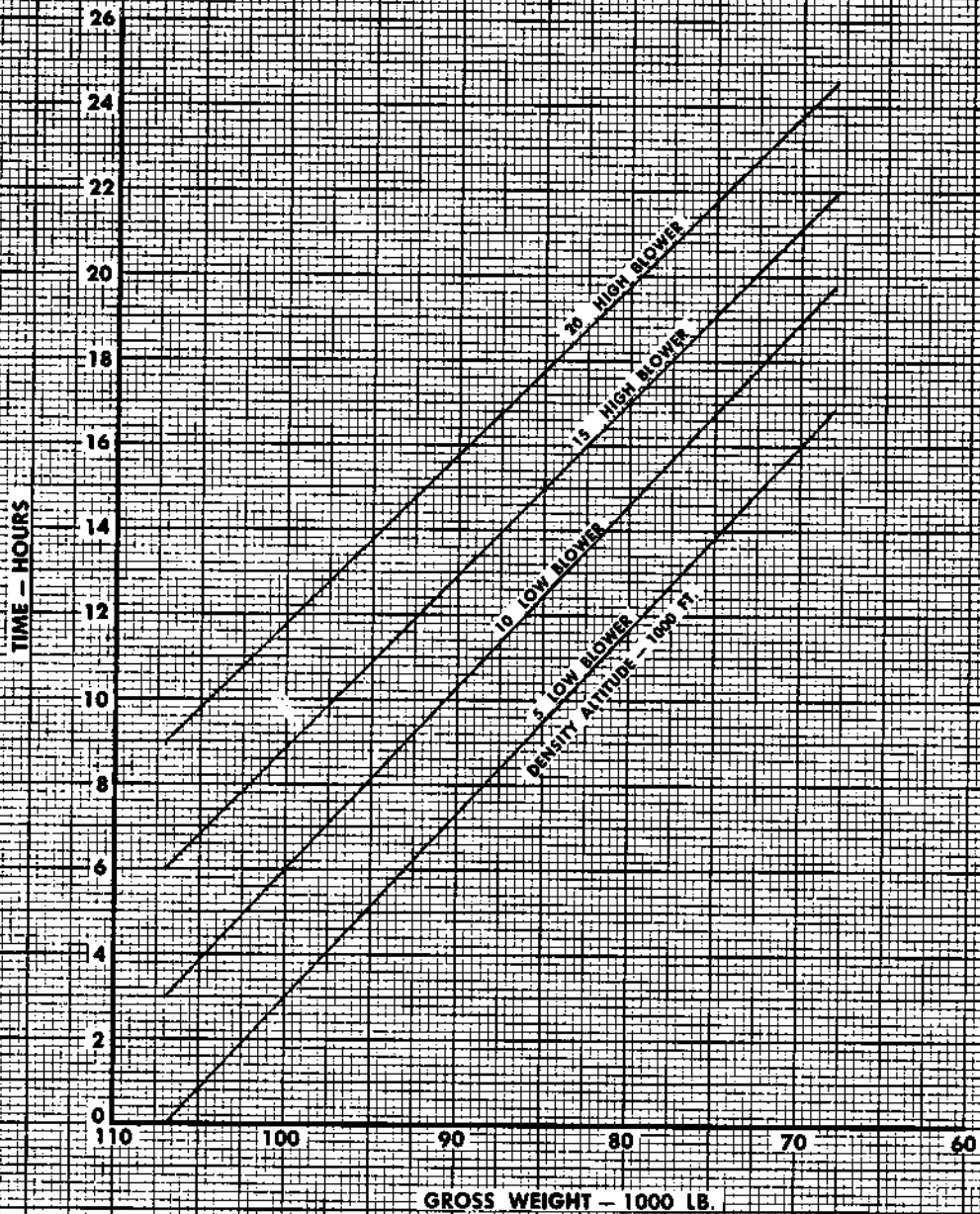

FUEL GRADE: 100/130
FUEL DENSITY: 6.0 LB/U.S. GAL

Figure A5-31

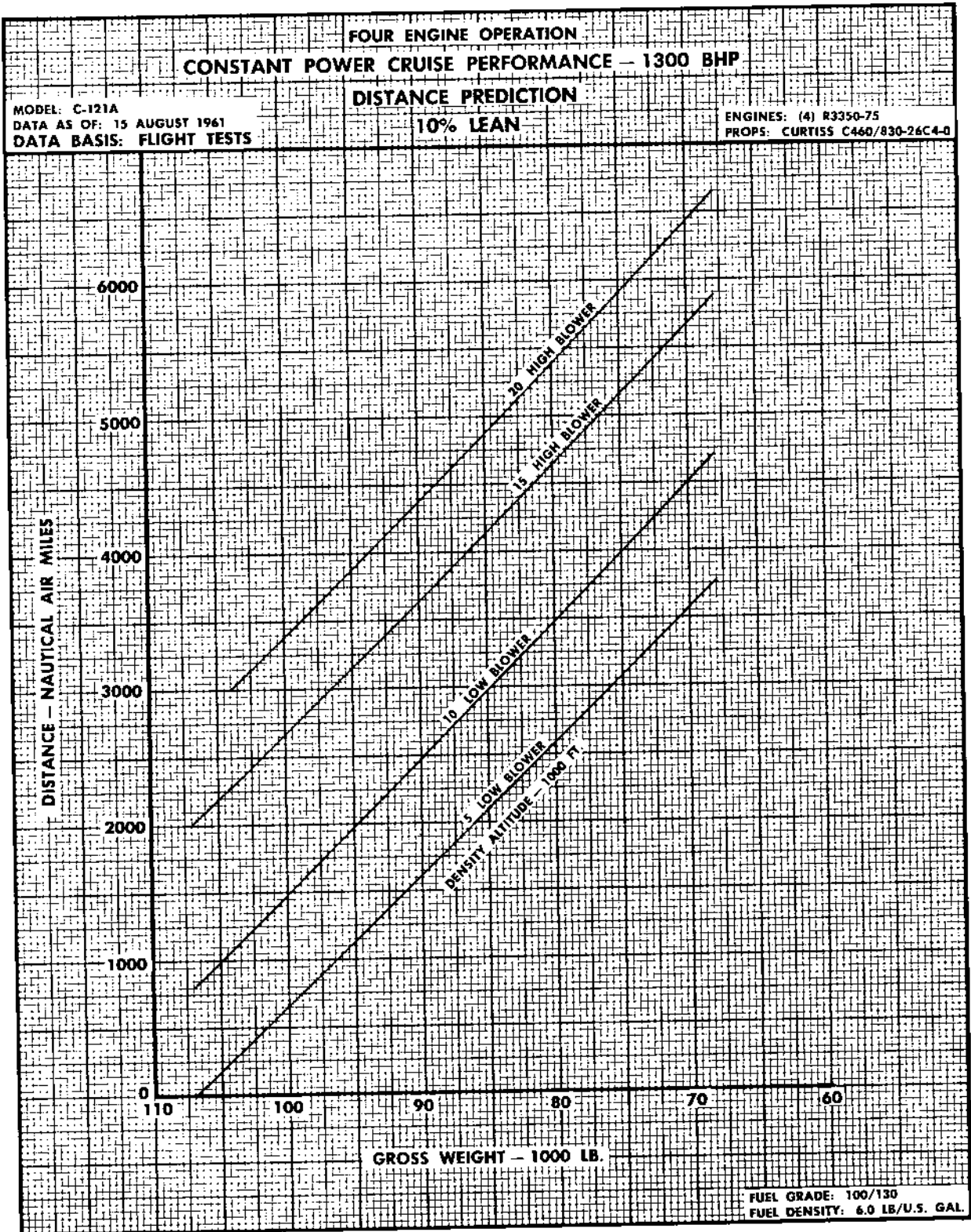

Figure A5-32

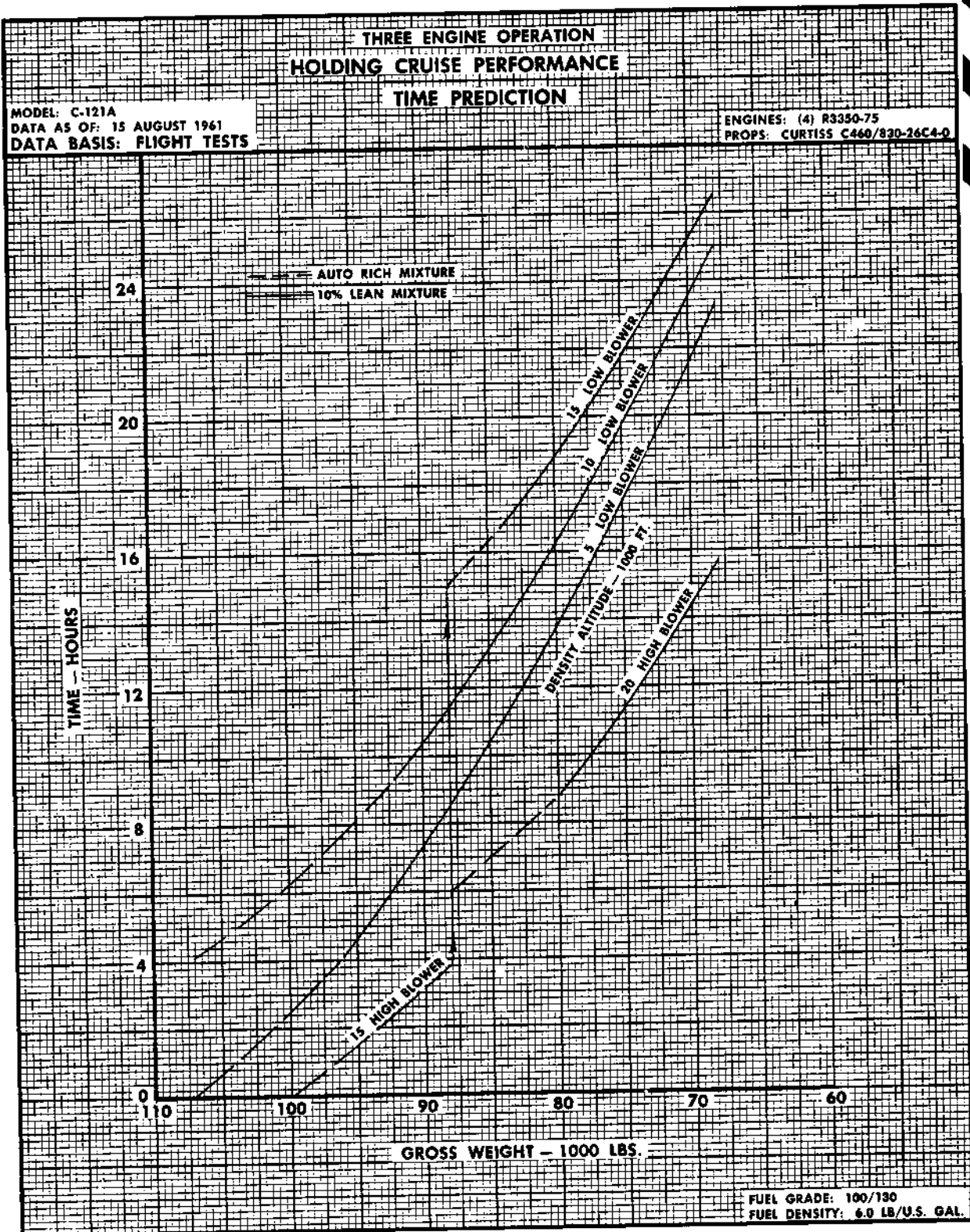

Figure A5-34

TWO ENGINE OPERATION HOLDING CRUISE PERFORMANCE TIME PREDICTION

MODEL: C-121A
DATA AS OF: 15 AUGUST 1961
DATA BASIS: FLIGHT TESTS

ENGINES: (4) R3350-75
PROPS: CURTISS C460/830-26C4-0

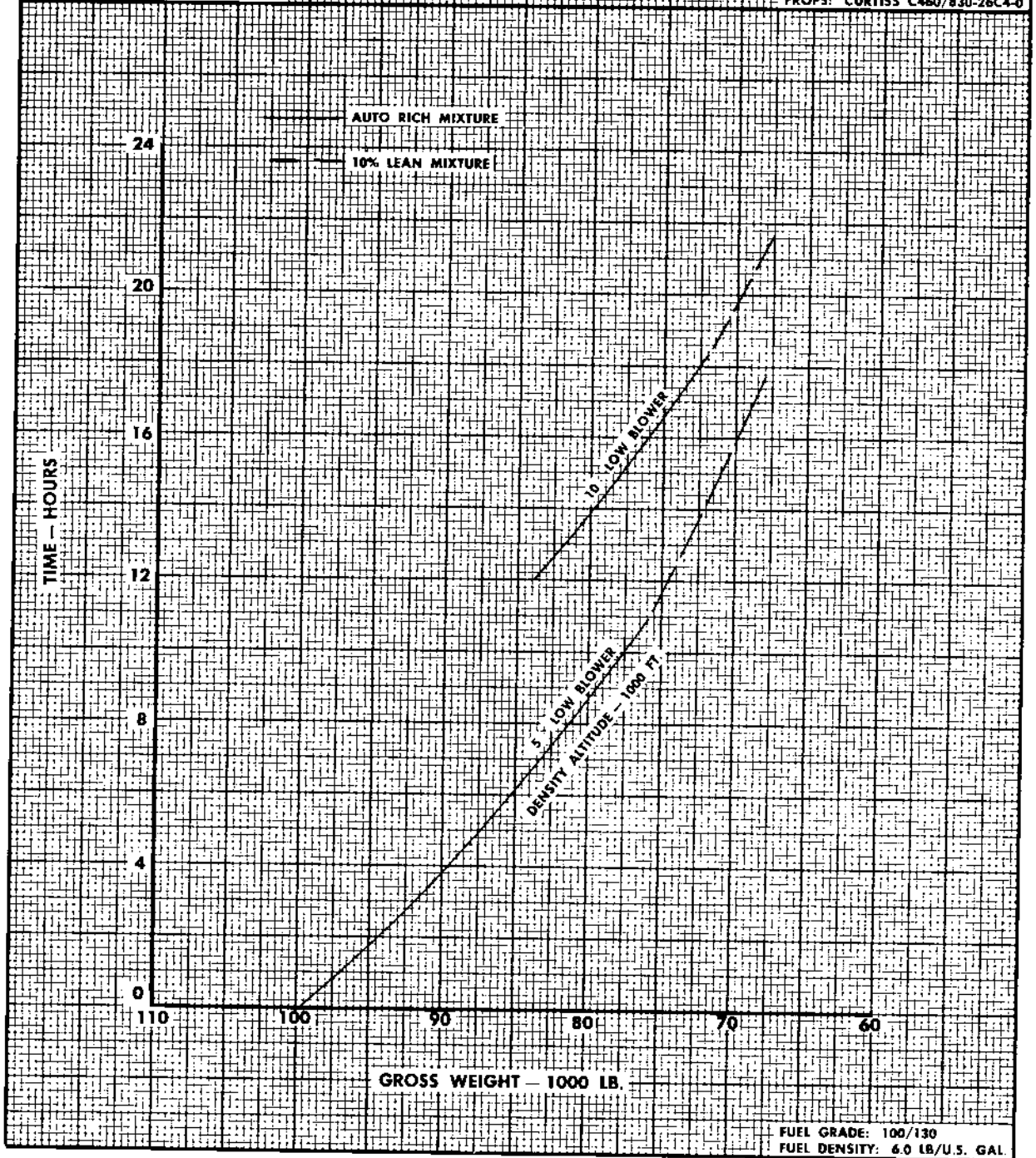

Figure A5-35

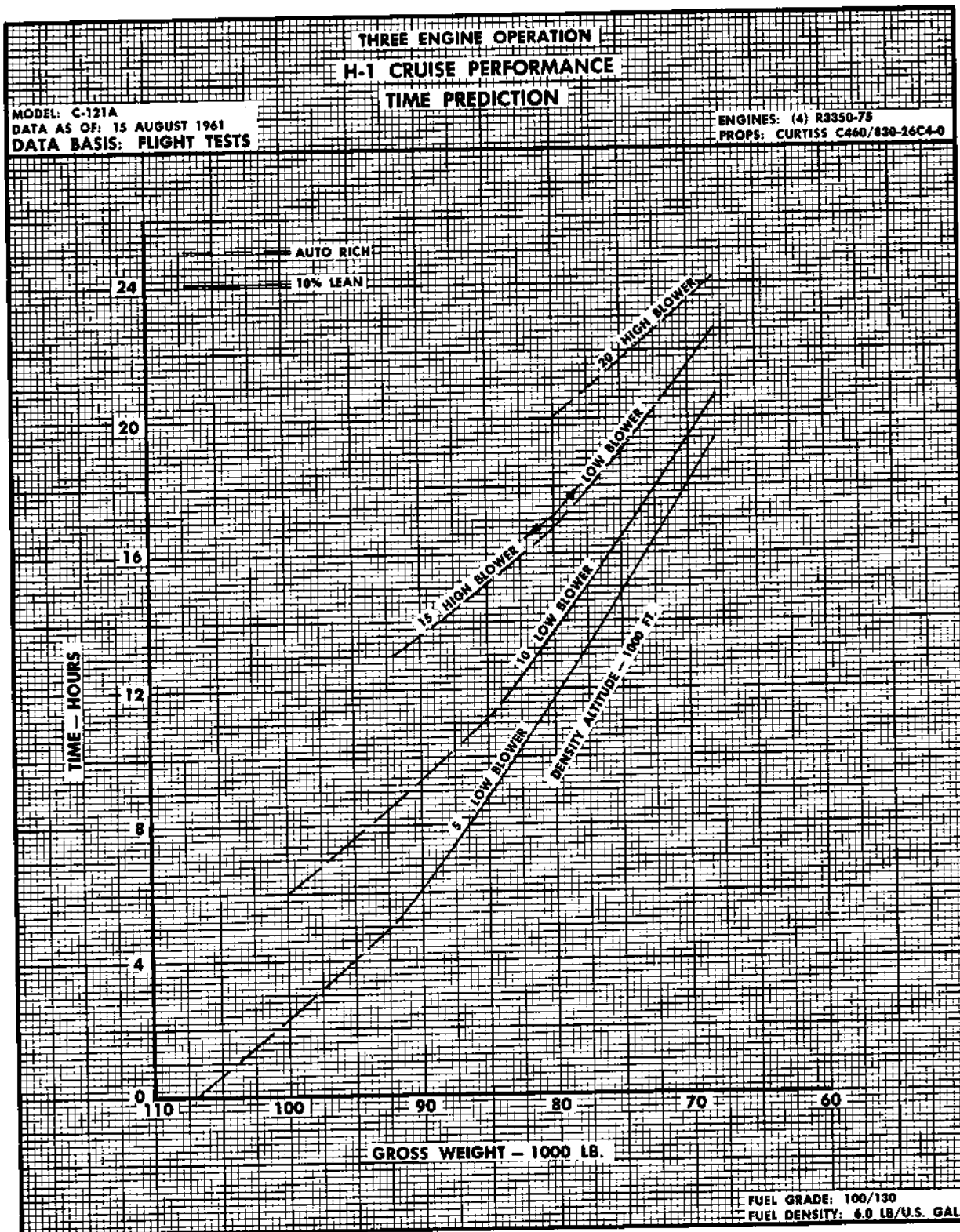
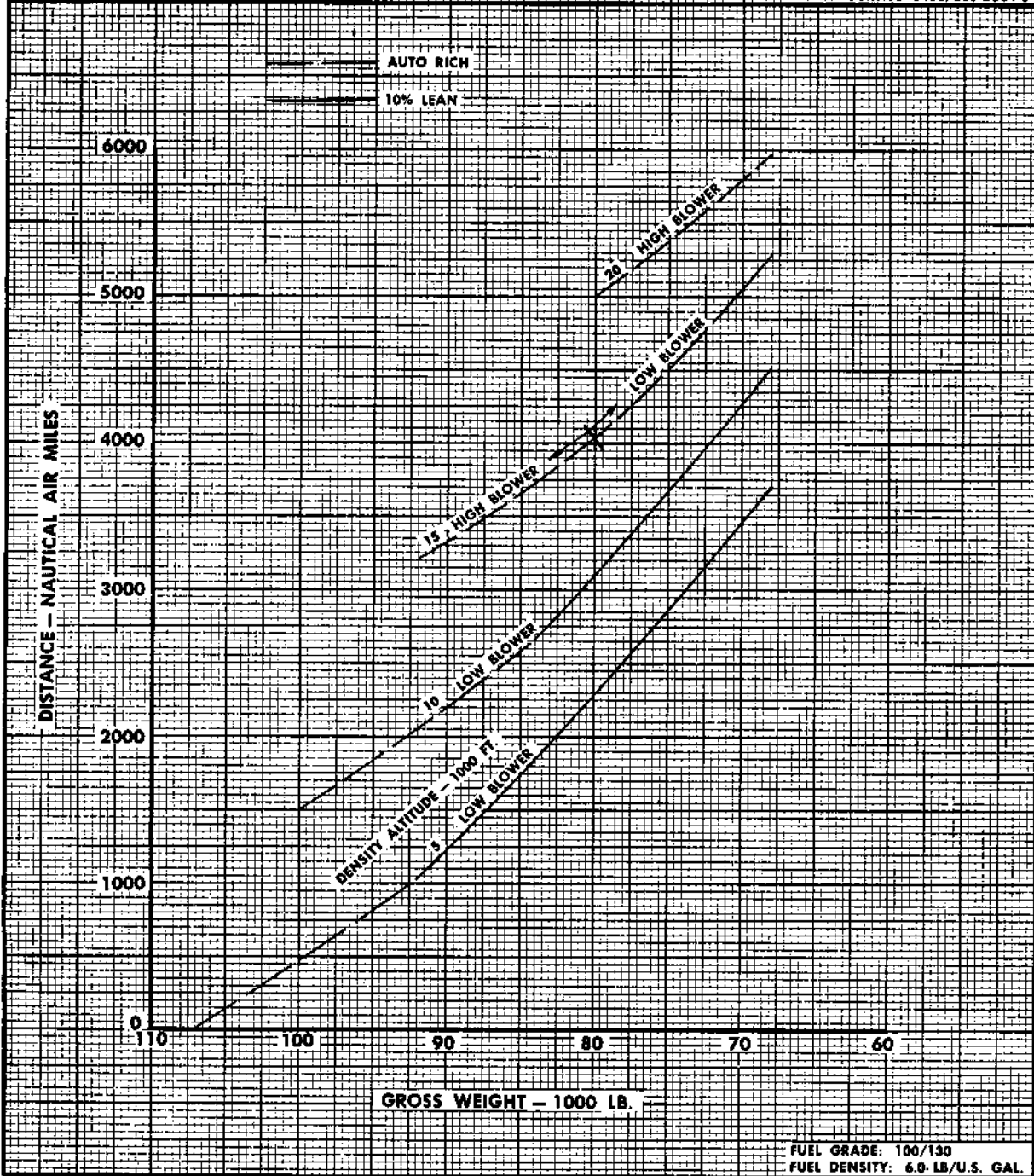

Figure A5-36

THREE ENGINE OPERATION H-1 CRUISE PERFORMANCE DISTANCE PREDICTION

MODEL: C-121A
DATA AS OF: 15 AUGUST 1961
DATA BASIS: FLIGHT TESTS

ENGINES: (4) R3350-75
PROPS: CURTISS C460/830-26C4-0



FUEL GRADE: 100/130
FUEL DENSITY: 6.0 LB./U.S. GAL.

Figure A5-37

FOUR ENGINE OPERATING TABLES
H-1 CRUISE - OPERATING TABLES

MODEL: C-121A
DATA AS OF: 15 AUGUST 1961
DATA BASIS: FLIGHT TESTS

ENGINES: (4) R3350-75

PROPS: CURTISS C460/830-26C4-0

GROSS WEIGHT -LB.	LOW BLOWER										HIGH BLOWER																																																																																																																																																																																																																																																																																																																																																																																																																																																																																																																																																																																																							
	5	6	7	8	9	10	11	12	13	14	15	16	17	18	19	20	21	22	23	24	25																																																																																																																																																																																																																																																																																																																																																																																																																																																																																																																																																																																													
107,000	1080 1925 145	1195 1945 145	1220 1975 145	1230 2000 145	1250 2035 145	1270 2060 148	1305 2080 148	1325 2125 147	1350 2200 145	1370 2275 142	1400 2350 139	1335 2300 139	1380 2305 141	1410 2310 144	1440 2315 147	1465 2320 149	1535 2400 151	1470 2315 141	1440 2310 144	1410 2310 144	1380 2305 141	1350 2300 139	1335 2300 139	1305 2305 141	1270 2310 141	1240 2315 144	1210 2320 147	1180 2325 149	1150 2350 150	1120 2400 151	1090 2450 152	1060 2500 153	1030 2550 154	1000 2600 155	970 2650 156	940 2700 157	910 2750 158	880 2800 159	850 2850 160	820 2900 161	790 2950 162	760 3000 163	730 3050 164	700 3100 165	670 3150 166	640 3200 167	610 3250 168	580 3300 169	550 3350 170	520 3400 171	490 3450 172	460 3500 173	430 3550 174	400 3600 175	370 3650 176	340 3700 177	310 3750 178	280 3800 179	250 3850 180	220 3900 181	190 3950 182	160 4000 183	130 4050 184	100 4100 185	70 4150 186	40 4200 187	10 4250 188	10 4300 189	10 4350 190	10 4400 191	10 4450 192	10 4500 193	10 4550 194	10 4600 195	10 4650 196	10 4700 197	10 4750 198	10 4800 199	10 4850 200	10 4900 201	10 4950 202	10 5000 203	10 5050 204	10 5100 205	10 5150 206	10 5200 207	10 5250 208	10 5300 209	10 5350 210	10 5400 211	10 5450 212	10 5500 213	10 5550 214	10 5600 215	10 5650 216	10 5700 217	10 5750 218	10 5800 219	10 5850 220	10 5900 221	10 5950 222	10 6000 223	10 6050 224	10 6100 225	10 6150 226	10 6200 227	10 6250 228	10 6300 229	10 6350 230	10 6400 231	10 6450 232	10 6500 233	10 6550 234	10 6600 235	10 6650 236	10 6700 237	10 6750 238	10 6800 239	10 6850 240	10 6900 241	10 6950 242	10 7000 243	10 7050 244	10 7100 245	10 7150 246	10 7200 247	10 7250 248	10 7300 249	10 7350 250	10 7400 251	10 7450 252	10 7500 253	10 7550 254	10 7600 255	10 7650 256	10 7700 257	10 7750 258	10 7800 259	10 7850 260	10 7900 261	10 7950 262	10 8000 263	10 8050 264	10 8100 265	10 8150 266	10 8200 267	10 8250 268	10 8300 269	10 8350 270	10 8400 271	10 8450 272	10 8500 273	10 8550 274	10 8600 275	10 8650 276	10 8700 277	10 8750 278	10 8800 279	10 8850 280	10 8900 281	10 8950 282	10 9000 283	10 9050 284	10 9100 285	10 9150 286	10 9200 287	10 9250 288	10 9300 289	10 9350 290	10 9400 291	10 9450 292	10 9500 293	10 9550 294	10 9600 295	10 9650 296	10 9700 297	10 9750 298	10 9800 299	10 9850 300	10 9900 301	10 9950 302	10 10000 303	10 10050 304	10 10100 305	10 10150 306	10 10200 307	10 10250 308	10 10300 309	10 10350 310	10 10400 311	10 10450 312	10 10500 313	10 10550 314	10 10600 315	10 10650 316	10 10700 317	10 10750 318	10 10800 319	10 10850 320	10 10900 321	10 10950 322	10 11000 323	10 11050 324	10 11100 325	10 11150 326	10 11200 327	10 11250 328	10 11300 329	10 11350 330	10 11400 331	10 11450 332	10 11500 333	10 11550 334	10 11600 335	10 11650 336	10 11700 337	10 11750 338	10 11800 339	10 11850 340	10 11900 341	10 11950 342	10 12000 343	10 12050 344	10 12100 345	10 12150 346	10 12200 347	10 12250 348	10 12300 349	10 12350 350	10 12400 351	10 12450 352	10 12500 353	10 12550 354	10 12600 355	10 12650 356	10 12700 357	10 12750 358	10 12800 359	10 12850 360	10 12900 361	10 12950 362	10 13000 363	10 13050 364	10 13100 365	10 13150 366	10 13200 367	10 13250 368	10 13300 369	10 13350 370	10 13400 371	10 13450 372	10 13500 373	10 13550 374	10 13600 375	10 13650 376	10 13700 377	10 13750 378	10 13800 379	10 13850 380	10 13900 381	10 13950 382	10 14000 383	10 14050 384	10 14100 385	10 14150 386	10 14200 387	10 14250 388	10 14300 389	10 14350 390	10 14400 391	10 14450 392	10 14500 393	10 14550 394	10 14600 395	10 14650 396	10 14700 397	10 14750 398	10 14800 399	10 14850 400	10 14900 401	10 14950 402	10 15000 403	10 15050 404	10 15100 405	10 15150 406	10 15200 407	10 15250 408	10 15300 409	10 15350 410	10 15400 411	10 15450 412	10 15500 413	10 15550 414	10 15600 415	10 15650 416	10 15700 417	10 15750 418	10 15800 419	10 15850 420	10 15900 421	10 15950 422	10 16000 423	10 16050 424	10 16100 425	10 16150 426	10 16200 427	10 16250 428	10 16300 429	10 16350 430	10 16400 431	10 16450 432	10 16500 433	10 16550 434	10 16600 435	10 16650 436	10 16700 437	10 16750 438	10 16800 439	10 16850 440	10 16900 441	10 16950 442	10 17000 443	10 17050 444	10 17100 445	10 17150 446	10 17200 447	10 17250 448	10 17300 449	10 17350 450	10 17400 451	10 17450 452	10 17500 453	10 17550 454	10 17600 455	10 17650 456	10 17700 457	10 17750 458	10 17800 459	10 17850 460	10 17900 461	10 17950 462	10 18000 463	10 18050 464	10 18100 465	10 18150 466	10 18200 467	10 18250 468	10 18300 469	10 18350 470	10 18400 471	10 18450 472	10 18500 473	10 18550 474	10 18600 475	10 18650 476	10 18700 477	10 18750 478	10 18800 479	10 18850 480	10 18900 481	10 18950 482	10 19000 483	10 19050 484	10 19100 485	10 19150 486	10 19200 487	10 19250 488	10 19300 489	10 19350 490	10 19400 491	10 19450 492	10 19500 493	10 19550 494	10 19600 495	10 19650 496	10 19700 497	10 19750 498	10 19800 499	10 19850 500	10 19900 501	10 19950 502	10 20000 503	10 20050 504	10 20100 505	10 20150 506	10 20200 507	10 20250 508	10 20300 509	10 20350 510	10 20400 511	10 20450 512	10 20500 513	10 20550 514	10 20600 515	10 20650 516	10 20700 517	10 20750 518	10 20800 519	10 20850 520	10 20900 521	10 20950 522	10 21000 523	10 21050 524	10 21100 525	10 21150 526	10 21200 527	10 21250 528	10 21300 529	10 21350 530	10 21400 531	10 21450 532	10 21500 533	10 21550 534	10 21600 535	10 21650 536	10 21700 537	10 21750 538	10 21800 539	10 21850 540	10 21900 541	10 21950 542	10 22000 543	10 22050 544	10 22100 545	10 22150 546	10 22200 547	10 22250 548	10 22300 549	10 22350 550	10 22400 551	10 22450 552	10 22500 553	10 22550 554	10 22600 555	10 22650 556	10 22700 557	10 22750 558	10 22800 559	10 22850 560	10 22900 561	10 22950 562	10 23000 563	10 23050 564	10 23100 565	10 23150 566	10 23200 567	10 23250 568	10 23300 569	10 23350 570	10 23400 571	10 23450 572	10 23500 573	10 23550 574	10 23600 575	10 23650 576	10 23700 577	10 23750 578	10 23800 579	10 23850 580	10 23900 581	10 23950 582	10 24000 583	10 24050 584	10 24100 585	10 24150 586	10 24200 587	10 24250 588	10 24300 589	10 24350 590	10 24400 591	10 24450 592	10 24500 593	10 24550 594	10 24600 595	10 24650 596	10 24700 597	10 24750 598	10 24800 599	10 24850 600	10 24900 601	10 24950 602	10 25000 603	10 25050 604	10 25100 605	10 25150 606	10 25200 607	10 25250 608	10 25300 609	10 25350 610	10 25400 611	10 25450 612	10 25500 613	10 25550 614	10 25600 615	10 25650 616	10 25700 617	10 25750 618	10 25800 619	10 25850 620	10 25900 621	10 25950 622	10 26000 623	10 26050 624	10 26100 625	10 26150 626	10 26200 627	10 26250 628	10 26300 629	10 26350 630	10 26400 631	10 26450 632	10 26500 633	10 26550 634	10 26600 635	10 26650 636	10 26700 637	10 26750 638	10 26800 639	10 26850 640	10 26900 641	10 26950 642	10 27000 643	10 27050 644	10 27100 645	10 27150 646	10 27200 647	10 27250 648	10 27300 649	10 27350 650	10 27400 651	10 27450 652	10 27500 653	10 27550 654	10 27600 655	10 27650 656	10 27700 657	10 27750 658	10 27800 659	10 27850 660	10 27900 661	10 27950 662	10 28000 663	10 28050 664	10 28100 665	10 28150 666	10 28200 667	10 28250 668	10 28300 669	10 28350 670	10 28400 671	10 28450 672	10 28500 673	10 28550 674	10 28600 675	10 28650 676	10 28700 677	10 28750 678	10 28800 679	10 28850 680	10 28900 681	10 28950 682	10 29000 683	10 29050 684	10 29100 685	10 29150 686	10 29200 687	10 29250 688	10 29300 689	10 29350 690	10 29400 691	10 29450 692	10 29500 693	10 29550 694	10 29600 695	10 29650 696	10 29700 697	10 29750 698	10 29800 699	10 29850 700	10 29900 701	10 29950 702	10 30000 703	10 30050 704	10 30100 705	10 30150 706	10 30200 707	10 30250 708	10 30300 709	10 30350 710	10 30400 711	10 30450 712	10 30500 713	10 30550 714	10 3060

FOUR ENGINE OPERATION
H-1 CRUISE - OPERATING TABLES

MODEL: C-121A
DATA AS OF: 15 AUGUST 1961
DATA BASIS: FLIGHT TESTS

ENGINES: (4) R3350-75

PROPS. CURTISS C460/830-26C4-0

GROSS WEIGHT - LB.	LOW BLOWER															HIGH BLOWER														
	5	6	7	8	9	10	11	12	13	14	15	16	17	18	19	20	21	22	23	24	25									
88,000 to 84,000	INBD BHP	930	945	955	965	975	985	995	1010	1035	1045	1070	1090	1100	1115	1150	1180	1195	1225	1250	1160									
	RPM	1525	1570	1610	1660	1700	1755	1810	1875	1925	1925	2000	2070	1875	1920	1990	2050	2110	2200	2290	2400	2320								
	INBD BMEP	144	142	140	137	135	134	132	130	128	128	126	124	139	138	136	133	132	128	126	123	118								
	F. F.	400	405	410	420	430	435	440	450	465	480	485	490	485	500	510	525	545	570	600	635	755								
	AVG. IAS	172	172	172	172	172	172	172	172	172	173	173	173	173	173	173	173	173	174	174	174	174								
84,000 to 80,000	AVG. TAS	191	194	197	199	203	206	209	213	216	220	223	227	231	234	238	242	246	250	256	260	260								
	Δ TIME	2:30	2:28	2:26	2:23	2:20	2:18	2:16	2:13	2:09	2:05	2:02	2:02	2:03	2:00	1:57	1:54	1:45	1:40	1:35	1:19	1:19								
	Δ DIST.	477	476	474	474	474	474	474	473	473	465	457	455	467	462	458	445	445	418	402	344	344								
	INBD BHP	870	890	905	915	930	935	955	975	995	1010	1035	1070	1090	1100	1115	1150	1180	1195	1225	1250	1160								
	RPM	1490	1530	1575	1610	1660	1700	1760	1815	1880	1940	1940	2000	2070	1875	1920	1990	2050	2110	2200	2290	2400								
80,000 to 76,000	INBD BMEP	138	137	135	134	132	130	128	127	125	123	120	135	133	133	131	128	126	123	121	118	116								
	F. F.	380	385	390	395	400	410	415	425	435	445	455	460	470	485	495	510	530	550	580	620	705								
	AVG. IAS	169	169	169	169	169	169	169	169	169	170	170	170	170	170	170	170	170	171	171	171	171								
	AVG. TAS	187	190	193	196	199	202	206	209	212	216	219	223	227	231	234	238	242	246	252	255	260								
	Δ TIME	2:38	2:35	2:33	2:31	2:30	2:27	2:25	2:21	2:18	2:15	2:12	2:10	2:10	2:08	2:04	2:01	1:58	1:53	1:49	1:45	1:37								
76,000 to 72,000	Δ DIST.	493	493	493	494	498	496	495	492	488	485	482	484	483	475	473	467	457	448	441	412	389								
	INBD BHP	835	850	865	870	880	890	915	935	945	955	965	985	995	1025	1035	1060	1070	1095	1110	1130	1100								
	RPM	1465	1500	1545	1580	1625	1665	1725	1775	1825	1895	1930	1990	2060	1875	1920	1990	2050	2130	2215	2300	2300								
	INBD BMEP	135	134	132	130	128	126	124	122	121	119	117	131	129	128	126	125	122	121	118	116	113								
	F. F.	365	370	375	380	385	390	395	405	415	425	435	440	450	455	470	485	500	515	535	565	640								
72,000 to 68,000	AVG. IAS	167	167	167	167	167	167	167	167	167	168	168	168	168	168	168	168	168	168	169	169	169								
	AVG. TAS	185	188	191	194	197	200	203	206	210	214	217	220	224	228	232	236	240	244	248	252	255								
	Δ TIME	2:45	2:43	2:41	2:38	2:36	2:34	2:32	2:28	2:25	2:22	2:18	2:17	2:14	2:11	2:07	2:04	2:00	1:56	1:52	1:46	1:31								
	Δ DIST.	508	511	511	512	514	514	511	505	504	499	499	505	500	497	493	485	479	473	462	445	389								
	INBD BHP	800	815	820	835	845	860	870	880	900	920	930	945	955	975	1000	1015	1040	1045	1060	1080	1105								
72,000 to 68,000	RPM	1440	1475	1510	1555	1595	1640	1680	1735	1800	1835	1925	1740	1790	1840	1900	1965	2025	2090	2160	2250	2350								
	INBD BMEP	131	130	128	127	125	124	122	120	118	116	114	128	126	125	124	122	121	118	116	113	111								
	F. F.	350	355	360	365	370	375	380	390	395	405	415	420	430	440	450	460	475	495	510	535	560								
	AVG. IAS	166	166	166	166	166	166	166	166	166	166	167	167	167	167	167	167	167	167	167	168	168								
	AVG. TAS	184	187	190	193	196	199	202	206	209	212	216	219	223	227	230	234	238	242	247	251	254								
68,000	Δ TIME	2:52	2:49	2:47	2:45	2:42	2:40	2:37	2:34	2:31	2:28	2:25	2:22	2:19	2:16	2:13	2:10	2:06	2:01	1:58	1:52	1:47								
	Δ DIST.	527	527	527	528	529	531	532	527	526	525	519	520	517	515	508	505	490	484	470	455	455								
	INBD BHP	760	780	795	800	810	825	840	850	865	875	895	900	915	935	960	970	990	1010	1020	1040	1050								
	RPM	1400	1450	1490	1525	1570	1610	1650	1700	1755	1810	1890	1710	1760	1810	1870	1925	1975	2050	2110	2200	2275								
	INBD BMEP	128	127	126	124	122	121	120	118	116	114	112	124	123	121	120	119	118	116	114	112	109								
68,000	F. F.	340	345	350	355	360	365	370	375	380	380	400	405	410	420	430	440	455	470	480	500	520								
	AVG. IAS	165	165	165	165	165	165	165	165	165	166	166	166	166	166	166	166	166	166	166	167	167								
	AVG. TAS	183	186	189	192	195	198	201	204	208	211	214	218	222	226	229	233	237	240	246	250	252								
	Δ TIME	2:37	2:34	2:32	2:31	2:29	2:27	2:24	2:22	2:20	2:17	2:14	2:18	2:22	2:26	2:29	2:33	2:37	2:40	2:46	2:50	2:52								
	Δ DIST.	539	540	542	545	547	550	551	551	552	552	536	536	536	536	535	531	520	515	510	500	487								

- NOTES: 1. Cowl flaps forced, oil radiator flaps automatic and cabin supercharger scoop closed.
 2. High blower operation to right of double line. Shaded area represents AUTO-RICH operation.
 3. Data are for weight bracket mid-point.
 4. Average IAS values are for flush static system.

Figure A5-38 (Sheet 2 of 6)

**FOUR ENGINE H-1 CRUISE SCHEDULE
FLIGHT PLANNING FUEL CONSUMPTION TABLES**

GROSS WEIGHT - 107,000 POUNDS

FUEL DENSITY: 6.0 LB./U.S. GAL.

FUEL INDICATED IN POUNDS

DENSITY ALTITUDE - 6,000 FEET								DENSITY ALTITUDE - 8,000 FEET							
TIME	FUEL	TIME	FUEL	TIME	FUEL	TIME	FUEL	TIME	FUEL	TIME	FUEL	TIME	FUEL	TIME	FUEL
00:06	1200	05:06	11,260	10:06	20,120	15:06	27,950	00:07	1360	05:06	11,700	10:06	20,800	15:06	28,760
:12	1400	:12	11,430	:12	20,280	:12	28,100	:12	1510	:12	11,900	:12	20,970	:12	28,900
:18	1600	:18	11,630	:18	20,420	:18	28,240	:18	1720	:18	12,100	:18	21,140	:18	29,050
:24	1810	:24	11,810	:24	20,580	:24	28,380	:24	1950	:24	12,300	:24	21,310	:24	29,200
:30	2030	:30	12,010	:30	20,750	:30	28,520	:30	2190	:30	12,500	:30	21,480	:30	29,360
:36	2250	:36	12,200	:36	20,910	:36	28,670	:36	2400	:36	12,690	:36	21,660	:36	29,510
:42	2480	:42	12,390	:42	21,070	:42	28,810	:42	2610	:42	12,890	:42	21,830	:42	29,670
:48	2700	:48	12,580	:48	21,230	:48	28,940	:48	2830	:48	13,070	:48	22,000	:48	29,820
:54	2900	:54	12,770	:54	21,380	:54	29,090	:54	3060	:54	13,260	:54	22,170	:54	29,960
01:00	3120	06:00	12,950	11:00	21,540	16:00	29,240	01:00	3290	06:00	13,450	11:00	22,340	16:00	30,110
:06	3320	:06	13,120	:06	21,710	:06	29,390	:06	3490	:06	13,630	:06	22,510	:06	30,260
:12	3520	:12	13,310	:12	21,870	:12	29,540	:12	3710	:12	13,820	:12	22,680	:12	30,420
:18	3720	:18	13,500	:18	22,030	:18	29,690	:18	3920	:18	14,000	:18	22,850	:18	30,570
:24	3930	:24	13,680	:24	22,190	:24	29,830	:24	4120	:24	14,190	:24	23,010	:24	30,720
:30	4140	:30	13,870	:30	22,350	:30	29,980	:30	4350	:30	14,390	:30	23,170	:30	30,880
:36	5420	:36	16,690	:36	26,160	:36	34,510	:36	4570	:36	14,580	:36	23,330	:36	31,020
:42	4560	:42	14,240	:42	22,670	:42	30,280	:42	4790	:42	14,760	:42	23,500	:42	31,170
:48	4770	:48	14,420	:48	22,820	:48	30,420	:48	5000	:48	14,950	:48	23,670	:48	31,320
:54	4980	:54	14,610	:54	22,990	:54	30,560	:54	5220	:54	15,130	:54	23,830	:54	31,470
02:00	5190	07:00	14,800	12:00	23,150	17:00	30,710	02:00	5420	07:00	15,300	12:00	24,000	17:00	31,520
:06	5390	:06	14,980	:06	23,300	:06	30,840	:06	5620	:06	15,480	:06	24,160	:06	31,770
:12	5590	:12	15,160	:12	23,450	:12	30,990	:12	5850	:12	15,670	:12	24,320	:12	31,910
:18	5790	:18	15,340	:18	23,610	:18	31,130	:18	6060	:18	15,850	:18	24,480	:18	32,050
:24	5990	:24	15,520	:24	23,780	:24	31,280	:24	6270	:24	16,020	:24	24,670	:24	32,200
:30	6190	:30	15,700	:30	23,930	:30	31,430	:30	6490	:30	16,200	:30	24,800	:30	32,350
:36	6390	:36	15,880	:36	24,090	:36	31,570	:36	6700	:36	16,390	:36	24,960	:36	32,500
:42	6890	:42	16,060	:42	24,230	:42	31,710	:42	6900	:42	16,580	:42	25,110	:42	32,650
:48	6790	:48	16,240	:48	24,400	:48	31,860	:48	7100	:48	16,750	:48	25,260	:48	32,800
:54	6990	:54	16,410	:54	24,560	:54	32,000	:54	7300	:54	16,920	:54	25,410	:54	32,950
03:00	7190	08:00	16,590	13:00	24,720	18:00	32,140	03:00	7510	08:00	17,100	13:00	25,570	18:00	33,100
:06	7380	:06	16,770	:06	24,860	:06	32,280	:06	7710	:06	17,280	:06	25,710	:06	33,240
:12	7560	:12	16,940	:12	25,010	:12	32,430	:12	7910	:12	17,470	:12	25,860	:12	33,480
:18	7760	:18	17,110	:18	25,160	:18	32,580	:18	8110	:18	17,630	:18	26,010	:18	33,520
:24	7960	:24	17,290	:24	25,320	:24	32,720	:24	8320	:24	17,800	:24	26,170	:24	33,670
:30	8150	:30	17,470	:30	25,480	:30	32,860	:30	8540	:30	17,980	:30	26,320	:30	33,820
:36	8340	:36	17,650	:36	25,650	:36	33,000	:36	8740	:36	18,160	:36	26,480	:36	33,970
:42	8530	:42	17,830	:42	25,810	:42	33,140	:42	8940	:42	18,340	:42	26,620	:42	34,110
:48	8730	:48	18,010	:48	25,970	:48	33,280	:48	9150	:48	18,510	:48	26,760	:48	34,250
:54	8930	:54	18,180	:54	26,110	:54	33,420	:54	9350	:54	18,690	:54	26,910	:54	34,390
04:00	9130	09:00	18,320	14:00	26,270	19:00	33,560	04:00	9550	09:00	18,870	14:00	27,070	19:00	34,530
:06	9320	:06	18,500	:06	24,430	:06	33,700	:06	9750	:06	19,050	:06	27,240	:06	34,680
:12	9520	:12	18,680	:12	26,590	:12	33,860	:12	9950	:12	19,230	:12	27,400	:12	34,820
:18	9720	:18	18,820	:18	26,740	:18	33,990	:18	10,150	:18	19,400	:18	27,550	:18	34,970
:24	9910	:24	19,000	:24	26,890	:24	34,130	:24	10,360	:24	19,560	:24	27,700	:24	35,100
:30	10,100	:30	19,160	:30	27,040	:30	34,280	:30	10,560	:30	19,760	:30	27,850	:30	35,240
:36	10,210	:36	19,320	:36	27,200	:36	34,410	:36	10,750	:36	19,930	:36	28,010	:36	35,390
:42	10,480	:42	19,480	:42	27,350	:42	34,570	:42	10,940	:42	20,110	:42	28,170	:42	35,530
:48	10,670	:48	19,630	:48	27,500	:48	34,700	:48	11,130	:48	20,280	:48	28,310	:48	35,680
:54	10,870	:54	19,800	:54	27,640	:54	34,840	:54	11,320	:54	20,450	:54	28,460	:54	35,820
05:00	11,070	10:00	19,970	15:00	27,790	20:00	34,980	05:00	11,520	10:00	26,630	15:00	28,610	20:00	35,960

NOTE: 1. Warm up, taxi, take-off, and climb fuel allowance included.
2. Time calculated from start of climb.

Figure A5-38 (Sheet 3 of 6)

**FOUR ENGINE H-1 CRUISE SCHEDULE
FLIGHT PLANNING FUEL CONSUMPTION TABLES**

GROSS WEIGHT - 707,000 POUNDS

FUEL INDICATED IN POUNDS

FUEL DENSITY: 6.0 LB./U.S. GAL.

DENSITY ALTITUDE - 10,000 FEET								DENSITY ALTITUDE - 12,000 FEET							
TIME	FUEL	TIME	FUEL	TIME	FUEL	TIME	FUEL	TIME	FUEL	TIME	FUEL	TIME	FUEL	TIME	FUEL
00:08	1550	05:06	12,250	10:06	21,600	15:06	29,690	00:10	1760	05:06	12,910	10:06	22,440	15:06	30,980
:12	1700	:12	12,450	:12	21,780	:12	29,850	:12	1880	:12	13,120	:12	22,620	:12	31,130
:18	1920	:18	12,650	:18	21,950	:18	30,000	:18	2110	:18	13,330	:18	22,790	:18	31,280
:24	2160	:24	12,850	:24	22,130	:24	30,150	:24	2360	:24	13,540	:24	22,970	:24	31,440
:30	2400	:30	13,060	:30	22,310	:30	30,320	:30	2600	:30	13,750	:30	23,140	:30	31,610
:36	2630	:36	13,270	:36	22,490	:36	30,480	:36	2850	:36	13,960	:36	23,310	:36	31,770
:42	2870	:42	13,450	:42	22,650	:42	30,630	:42	3090	:42	14,160	:42	23,480	:42	31,920
:48	3090	:48	13,630	:48	22,830	:48	30,790	:48	3330	:48	14,370	:48	23,660	:48	32,080
:54	3330	:54	13,830	:54	23,000	:54	30,940	:54	3570	:54	14,580	:54	23,830	:54	32,230
01:00	3560	06:00	14,030	11:00	23,160	16:00	31,100	01:00	3790	06:00	14,780	11:00	24,000	16:00	32,380
:06	3780	:06	14,220	:06	23,320	:06	31,250	:06	4020	:06	14,980	:06	24,170	:06	32,530
:12	4000	:12	14,420	:12	23,480	:12	31,410	:12	4260	:12	15,180	:12	24,340	:12	32,690
:18	4210	:18	14,620	:18	23,630	:18	31,570	:18	4500	:18	15,380	:18	24,510	:18	32,830
:24	4430	:24	14,820	:24	23,800	:24	31,710	:24	4740	:24	15,580	:24	24,690	:24	32,990
:30	4660	:30	15,030	:30	23,970	:30	31,880	:30	4970	:30	15,780	:30	24,870	:30	33,150
:36	4890	:36	15,230	:36	24,130	:36	32,030	:36	5200	:36	15,980	:36	25,030	:36	33,300
:42	5110	:42	15,420	:42	24,300	:42	32,180	:42	5430	:42	16,180	:42	25,200	:42	33,450
:48	5340	:48	15,610	:48	24,460	:48	32,320	:48	5660	:48	16,370	:48	25,370	:48	33,600
:54	5580	:54	15,800	:54	24,620	:54	32,470	:54	5890	:54	16,570	:54	25,540	:54	33,740
02:00	5790	07:00	16,000	12:00	24,790	17:00	32,620	02:00	6110	07:00	16,750	12:00	25,710	17:00	33,890
:06	6000	:06	16,150	:06	24,950	:06	32,780	:06	6330	:06	16,940	:06	25,890	:06	34,040
:12	6200	:12	16,350	:12	25,120	:12	32,930	:12	6570	:12	17,130	:12	26,060	:12	34,180
:18	6410	:18	16,530	:18	25,280	:18	33,090	:18	6790	:18	17,320	:18	26,220	:18	34,340
:24	6630	:24	16,710	:24	25,440	:24	33,240	:24	7010	:24	17,520	:24	26,390	:24	34,490
:30	6880	:30	16,910	:30	25,600	:30	33,390	:30	7240	:30	17,710	:30	26,570	:30	34,640
:36	7090	:36	17,090	:36	25,760	:36	33,540	:36	7470	:36	17,910	:36	26,740	:36	34,790
:42	7300	:42	17,280	:42	25,920	:42	33,690	:42	7700	:42	18,110	:42	26,910	:42	34,920
:48	7510	:48	17,470	:48	26,080	:48	33,840	:48	7930	:48	18,290	:48	27,080	:48	35,050
:54	7720	:54	17,650	:54	26,240	:54	33,990	:54	8150	:54	18,480	:54	27,240	:54	35,190
03:00	7930	08:00	17,830	13:00	26,400	18:00	34,140	03:00	8380	08:00	18,660	13:00	27,400	18:00	35,330
:06	8140	:06	18,000	:06	26,560	:06	34,290	:06	8610	:06	18,840	:06	25,570	:06	35,480
:12	8350	:12	18,180	:12	26,720	:12	34,440	:12	8840	:12	19,030	:12	27,730	:12	35,630
:18	8560	:18	18,370	:18	26,890	:18	34,590	:18	9060	:18	19,220	:18	27,910	:18	35,780
:24	8780	:24	18,550	:24	27,030	:24	34,740	:24	9280	:24	19,410	:24	28,090	:24	35,930
:30	8990	:30	18,730	:30	27,200	:30	34,890	:30	9490	:30	19,590	:30	28,270	:30	36,080
:36	9200	:36	18,920	:36	27,340	:36	35,040	:36	9710	:36	19,780	:36	28,440	:36	36,230
:42	9400	:42	19,100	:42	27,480	:42	35,190	:42	9930	:42	19,950	:42	28,620	:42	36,380
:48	9610	:48	19,290	:48	27,640	:48	35,330	:48	10,150	:48	20,120	:48	28,800	:48	36,530
:54	9820	:54	19,470	:54	27,800	:54	35,480	:54	10,370	:54	20,310	:54	28,970	:54	36,680
04:00	10,030	09:00	19,650	14:00	27,950	19:00	35,620	04:00	10,590	09:00	20,490	14:00	29,130	19:00	36,730
:06	10,220	:06	19,820	:06	28,120	:06	35,780	:06	10,800	:06	20,670	:06	29,300	:06	36,980
:12	10,430	:12	20,000	:12	28,270	:12	35,920	:12	11,020	:12	20,840	:12	29,480	:12	37,130
:18	10,640	:18	20,180	:18	28,420	:18	36,070	:18	11,220	:18	21,030	:18	29,650	:18	37,280
:24	10,850	:24	20,350	:24	28,580	:24	36,210	:24	11,400	:24	21,220	:24	29,830	:24	37,430
:30	11,060	:30	20,530	:30	28,740	:30	36,350	:30	11,660	:30	21,390	:30	30,000	:30	37,580
:36	11,270	:36	20,710	:36	28,910	:36	36,490	:36	11,880	:36	21,570	:36	30,160	:36	37,730
:42	11,470	:42	20,900	:42	29,080	:42	36,640	:42	12,090	:42	21,740	:42	30,320	:42	37,880
:48	11,670	:48	21,080	:48	29,220	:48	36,790	:48	12,290	:48	21,920	:48	30,490	:48	38,010
:54	11,870	:54	21,250	:54	29,370	:54	36,930	:54	12,500	:54	22,100	:54	30,650	:54	38,160
05:00	12,060	10:00	21,420	15:00	29,530	20:00	37,070	05:00	12,710	10:00	22,270	15:00	30,810	20:00	38,300

NOTE: 1. Warm up, taxi, take-off, and climb fuel allowance included.
2. Time calculated from start of climb.

Figure A5-38 (Sheet 4 of 6)

**FOUR ENGINE H-1 CRUISE SCHEDULE
FLIGHT PLANNING FUEL CONSUMPTION TABLES**

GROSS WEIGHT - 107,000 POUNDS

FUEL DENSITY: 6.0 LB./U.S. GAL.

FUEL INDICATED IN POUNDS

DENSITY ALTITUDE - 14,000 FEET						DENSITY ALTITUDE - 16,000 FEET									
TIME	FUEL	TIME	FUEL	TIME	FUEL	TIME	FUEL	TIME	FUEL	TIME	FUEL	TIME	FUEL		
00:06		05:06	13,550	10:06	23,470	15:06	32,090	00:06		05:06	14,460	10:06	24,500	15:06	33,310
:12	1950	:12	13,710	:12	23,650	:12	32,250	:14	2170	:12	14,680	:12	24,690	:12	33,480
:18	2200	:18	13,990	:18	23,840	:18	32,420	:18	2430	:18	14,890	:18	24,880	:18	33,650
:24	2450	:24	14,190	:24	24,030	:24	32,580	:24	2750	:24	15,110	:24	25,060	:24	33,810
:30	2700	:30	14,400	:30	24,200	:30	32,740	:30	3080	:30	15,330	:30	25,240	:30	33,980
:36	2950	:36	14,620	:36	24,370	:36	32,910	:36	3350	:36	15,550	:36	25,430	:36	34,150
:42	3200	:42	14,830	:42	24,550	:42	33,050	:42	3630	:42	15,780	:42	25,610	:42	34,310
:48	3450	:48	15,040	:48	24,730	:48	33,220	:48	3900	:48	16,010	:48	25,800	:48	34,480
:54	3700	:54	15,250	:54	24,910	:54	33,380	:54	4130	:54	16,220	:54	25,990	:54	34,650
01:00	3950	06:00	15,460	11:00	25,080	16:00	33,550	01:00	4400	06:00	16,430	11:00	26,170	16:00	34,810
:06	4190	:06	15,670	:06	25,260	:06	33,710	:06	4650	:06	16,640	:06	26,350	:06	34,980
:12	4440	:12	15,880	:12	25,450	:12	33,860	:12	4900	:12	16,850	:12	26,530	:12	35,140
:18	4680	:18	16,080	:18	25,630	:18	34,020	:18	5170	:18	17,060	:18	26,720	:18	35,300
:24	4930	:24	16,290	:24	25,820	:24	34,190	:24	5440	:24	17,280	:24	26,900	:24	35,470
:30	5170	:30	16,490	:30	25,990	:30	34,350	:30	5700	:30	17,490	:30	27,090	:30	35,630
:36	5420	:36	16,690	:36	26,160	:36	34,510	:36	5950	:36	17,700	:36	27,280	:36	35,800
:42	5660	:42	16,900	:42	26,340	:42	34,670	:42	6200	:42	17,900	:42	27,460	:42	35,970
:48	5910	:48	17,100	:48	26,520	:48	34,820	:48	6450	:48	18,100	:48	27,640	:48	36,130
:54	6150	:54	17,340	:54	26,700	:54	34,970	:54	6710	:54	18,300	:54	27,820	:54	36,300
02:00	6390	07:00	17,520	12:00	26,870	17:00	35,130	02:00	6960	07:00	18,500	12:00	28,000	17:00	36,470
:06	6630	:06	17,730	:06	27,050	:06	35,290	:06	7210	:06	18,700	:06	28,180	:06	36,630
:12	6860	:12	17,930	:12	27,220	:12	35,450	:12	7450	:12	18,900	:12	28,350	:12	36,790
:18	7100	:18	18,130	:18	27,390	:18	35,610	:18	7700	:18	19,100	:18	28,520	:18	36,960
:24	7340	:24	18,330	:24	27,570	:24	35,770	:24	7750	:24	19,300	:24	28,700	:24	37,120
:30	7570	:30	18,540	:30	27,740	:30	35,940	:30	8200	:30	19,500	:30	28,880	:30	37,280
:36	7810	:36	18,750	:36	27,910	:36	36,100	:36	8450	:36	19,700	:36	29,050	:36	37,440
:42	8050	:42	18,940	:42	28,080	:42	36,250	:42	8700	:42	19,900	:42	29,220	:42	37,600
:48	8290	:48	19,150	:48	28,250	:48	36,400	:48	8950	:48	20,100	:48	29,400	:48	37,770
:54	8520	:54	19,350	:54	28,410	:54	36,550	:54	9200	:54	20,300	:54	29,580	:54	37,930
03:00	8760	08:00	19,550	13:00	28,590	18:00	36,710	03:00	9440	08:00	20,500	13:00	29,750	18:00	38,090
:06	8990	:06	19,750	:06	28,760	:06	36,870	:06	9690	:06	20,690	:06	29,920	:06	38,250
:12	9230	:12	19,950	:12	28,940	:12	37,030	:12	9930	:12	20,880	:12	30,100	:12	38,410
:18	9460	:18	20,140	:18	29,110	:18	37,170	:18	10,170	:18	21,060	:18	30,270	:18	38,580
:24	9710	:24	20,320	:24	29,280	:24	37,340	:24	10,420	:24	21,240	:24	30,430	:24	38,750
:30	9950	:30	20,510	:30	29,450	:30	37,480	:30	10,670	:30	21,430	:30	30,610	:30	38,910
:36	10,180	:36	20,700	:36	29,620	:36	37,640	:36	10,930	:36	21,620	:36	30,780		
:42	10,420	:42	20,890	:42	29,780	:42	37,770	:42	11,100	:42	21,810	:42	30,960		
:48	10,660	:48	21,070	:48	29,950	:48	37,940	:48	11,360	:48	22,010	:48	31,130		
:54	10,880	:54	21,260	:54	30,110	:54	38,100	:54	11,620	:54	22,200	:54	31,300		
04:00	11,090	09:00	21,450	14:00	30,270	19:00	38,250	04:00	11,870	09:00	22,400	14:00	31,480		
:06	11,310	:06	21,650	:06	30,440	:06	38,410	:06	12,120	:06	22,600	:06	31,640		
:12	11,540	:12	21,840	:12	30,600	:12	38,550	:12	12,370	:12	22,800	:12	31,810		
:18	11,770	:18	22,030	:18	30,760	:18	38,700	:18	12,600	:18	22,990	:18	31,980		
:24	11,990	:24	22,200	:24	30,930	:24	38,840	:24	12,830	:24	23,180	:24	32,150		
:30	12,220	:30	22,370	:30	31,100	:30	38,980	:30	13,070	:30	23,360	:30	32,320		
:36	12,450	:36	22,570	:36	31,270			:36	13,320	:36	23,550	:36	32,490		
:42	12,680	:42	22,740	:42	31,430			:42	13,550	:42	23,740	:42	32,650		
:48	12,900	:48	22,940	:48	31,590			:48	13,780	:48	23,930	:48	32,810		
:54	13,120	:54	23,110	:54	31,750			:54	14,000	:54	24,120	:54	33,000		
05:00	13,330	10:00	23,270	15:00	31,920			05:00	14,230	10:00	24,310	15:00	33,150		

NOTE: 1. Warm up, taxi, take off, and climb fuel allowance included.
2. Time calculated from start of climb.

Figure A5-38 (Sheet 5 of 6)

**FOUR ENGINE H-1 CRUISE SCHEDULE
FLIGHT PLANNING FUEL CONSUMPTION TABLES**

GROSS WEIGHT — 107,000 POUNDS

FUEL INDICATED IN POUNDS

FUEL DENSITY: 6.0 LB./U.S. GAL

DENSITY ALTITUDE — 18,000 FEET								DENSITY ALTITUDE — 20,000 FEET							
TIME	FUEL	TIME	FUEL	TIME	FUEL	TIME	FUEL	TIME	FUEL	TIME	FUEL	TIME	FUEL	TIME	FUEL
00:06		05:06	15,820	10:06	26,080	15:06	35,100	00:06		05:06	17,360	10:06	28,060	15:06	37,290
:16	2430	:12	16,040	:12	26,270	:12	35,270	:17	2730	:12	17,600	:12	28,260	:12	37,470
:18	2510	:18	16,270	:18	26,460	:18	35,440	:18	2790	:18	17,840	:18	28,460	:18	37,640
:24	2820	:24	16,490	:24	26,660	:24	35,610	:24	3170	:24	18,080	:24	28,650	:24	37,810
:30	3190	:30	16,720	:30	26,850	:30	35,780	:30	3550	:30	18,320	:30	28,840	:30	37,980
:36	3550	:36	16,940	:36	27,040	:36	35,950	:36	3920	:36	18,570	:36	29,030	:36	38,150
:42	3900	:42	17,170	:42	27,240	:42	36,120	:42	4290	:42	18,810	:42	29,230	:42	38,330
:48	4260	:48	17,390	:48	27,430	:48	36,300	:48	4650	:48	19,030	:48	29,430	:48	38,500
:54	4620	:54	17,600	:54	27,630	:54	36,480	:54	5010	:54	19,250	:54	29,620	:54	38,670
01:00	4980	06:00	17,810	11:00	27,820	16:00	36,650	01:00	5380	06:00	19,470	11:00	29,820	16:00	38,840
:06	5330	:06	18,020	:06	28,010	:06	36,820	:06	5760	:06	19,690	:06	30,010	:06	39,000
:12	5680	:12	18,240	:12	28,200	:12	36,980	:12	6130	:12	17,930	:12	30,200		
:18	6030	:18	18,460	:18	28,390	:18	37,140	:18	6500	:18	20,170	:18	30,390		
:24	6380	:24	18,680	:24	28,580	:24	37,300	:24	6880	:24	20,410	:24	30,590		
:30	6730	:30	18,900	:30	28,770	:30	37,470	:30	7240	:30	20,620	:30	30,780		
:36	7060	:36	19,110	:36	28,960	:36	37,640	:36	7610	:36	20,830	:36	30,970		
:42	7330	:42	19,320	:42	29,140	:42	37,810	:42	7980	:42	21,040	:42	31,150		
:48	7600	:48	19,530	:48	29,320	:48	37,980	:48	8330	:48	21,270	:48	31,340		
:54	7840	:54	19,750	:54	29,510	:54	38,150	:54	8680	:54	21,500	:54	31,530		
02:00	8100	07:00	19,980	12:00	29,700	17:00	38,320	02:00	9020	07:00	21,720	12:00	31,720		
:06	8360	:06	20,120	:06	29,870	:06	38,500	:06	9370	:06	21,930	:06	31,900		
:12	8620	:12	20,360	:12	30,040	:12	38,670	:12	9710	:12	22,140	:12	32,190		
:18	8880	:18	20,560	:18	30,220	:18	38,830	:18	10,050	:18	22,360	:18	32,280		
:24	9140	:24	20,760	:24	30,400	:24	39,000	:24	10,390	:24	22,680	:24	32,460		
:30	9400	:30	20,970	:30	30,580			:30	10,720	:30	22,800	:30	32,630		
:36	9660	:36	21,180	:36	30,760			:36	11,040	:36	23,030	:36	32,810		
:42	9920	:42	21,380	:42	30,940			:42	11,340	:42	23,260	:42	33,000		
:48	10,170	:48	21,580	:48	31,120			:48	11,610	:48	23,470	:48	33,190		
:54	10,410	:54	21,780	:54	31,300			:54	11,880	:54	23,650	:54	33,380		
03:00	10,670	08:00	21,980	13:00	31,470			03:00	12,130	08:00	23,850	13:00	33,560		
:06	10,920	:06	22,170	:06	31,650			:06	12,380	:06	24,050	:06	33,740		
:12	11,180	:12	22,370	:12	31,830			:12	12,640	:12	24,250	:12	33,920		
:18	11,430	:18	22,570	:18	32,000			:18	12,900	:18	24,460	:18	34,110		
:24	11,680	:24	22,760	:24	32,170			:24	13,150	:24	24,670	:24	34,280		
:30	11,930	:30	22,940	:30	32,340			:30	13,400	:30	24,870	:30	34,460		
:36	12,180	:36	23,130	:36	32,520			:36	13,650	:36	25,060	:36	34,630		
:42	12,430	:42	23,330	:42	32,700			:42	13,900	:42	25,270	:42	34,820		
:48	12,670	:48	23,530	:48	32,880			:48	14,150	:48	25,480	:48	34,990		
:54	12,920	:54	23,730	:54	33,050			:54	14,400	:54	25,670	:54	35,180		
04:00	13,170	09:00	23,930	14:00	33,220			04:00	14,660	09:00	25,860	14:00	35,360		
:06	13,410	:06	24,130	:06	33,390			:06	14,920	:06	26,050	:06	35,540		
:12	13,650	:12	24,320	:12	33,560			:12	15,160	:12	26,250	:12	35,720		
:18	13,890	:18	24,520	:18	33,730			:18	15,420	:18	26,440	:18	35,900		
:24	14,130	:24	24,720	:24	33,900			:24	15,660	:24	26,640	:24	36,080		
:30	14,380	:30	24,910	:30	34,070			:30	15,910	:30	26,830	:30	36,250		
:36	14,630	:36	25,110	:36	34,240			:36	16,150	:36	27,030	:36	36,430		
:42	14,880	:42	25,300	:42	34,410			:42	16,390	:42	27,230	:42	36,600		
:48	15,120	:48	25,500	:48	34,590			:48	16,650	:48	27,430	:48	36,780		
:54	15,360	:54	25,700	:54	34,770			:54	16,880	:54	27,640	:54	36,950		
05:00	15,600	10:00	25,890	15:00	34,940			05:00	17,120	10:00	27,850	15:00	37,120		

NOTE: 1. Warm up, taxi, take-off, and climb fuel allowance included.
2. Time calculated from start of climb.

Figure A5-38 (Sheet 6 of 6)

MODEL: C-121A DATA AS OF: 15 AUGUST 1961 DATA BASIS: FLIGHT TESTS		THREE ENGINE OPERATION H-1 CRUISE - OPERATING TABLES																				
		ENGINES: (4) R3350-75										PROPS: CURTISS C460/830-26C4-0										
		LOW BLOWER										HIGH BLOWER										
GROSS WEIGHT - LB.	H ₀ - 1000 FT.	5	6	7	8	9	10	11	12	13	14	15	16	17	18	19	20	21	22	23	24	25
107,000 to 104,000	INBD BHP	1710	1740	1770	1790	1820																
	RPM	2400	2400	2400	2400	2400																
	INBD BMEP	168	171	174	176	179																
	F. F.	1035	1060	1080	1100	1125																
	AVG. EAS	181	181	181	181	181																
104,000 to 100,000	AVG. TAS	200	203	207	210	213																
	Δ TIME	0:58	0:57	0:56	0:55	0:53																
	Δ DIST.	194	192	191	191	190																
	INBD BHP	1670	1700	1720	1740	1770																
	RPM	2400	2400	2400	2400	2400																
100,000 to 96,000	INBD BMEP	164	167	169	171	174																
	F. F.	1000	1020	1040	1070	1090																
	AVG. EAS	181	181	181	181	181																
	AVG. TAS	200	203	207	210	213																
	Δ TIME	1:20	1:18	1:17	1:15	1:13																
Δ DIST.	268	266	265	261	260																	
100,000 to 96,000	INBD BHP	1630	1650	1670	1700	1720	1750	1780														
	RPM	2400	2400	2400	2400	2400	2400	2400														
	INBD BMEP	160	162	164	167	169	172	175														
	F. F.	965	980	1000	1025	1050	1070	1220														
	AVG. EAS	181	181	181	181	182	182	182														
96,000 to 92,000	AVG. TAS	200	200	203	207	210	213	216	220													
	Δ TIME	1:23	1:22	1:20	1:18	1:16	1:15	1:06														
	Δ DIST.	277	277	276	273	271	270	240														
	INBD BHP	1550	1570	1600	1620	1650	1680	1700	1730	1750	1780											
	RPM	2400	2400	2400	2400	2400	2400	2400	2400	2400	2400											
92,000 to 88,000	INBD BMEP	152	154	157	159	162	165	167	170	172	175											
	F. F.	905	925	940	960	980	1000	1025	1165	1190	1220											
	AVG. EAS	179	181	181	181	181	181	180	221	221	228											
	AVG. TAS	198	201	204	208	211	214	218	221	225	228											
	Δ TIME	1:28	1:26	1:25	1:23	1:22	1:20	1:18	1:09	1:07	1:06											
Δ DIST.	292	289	290	288	287	286	283	253	252	250												
92,000 to 88,000	INBD BHP	1460	1490	1520	1540	1570	1590	1620	1640	1660	1700	1720	1750	1770								
	RPM	2130	2400	2400	2400	2400	2400	2400	2400	2400	2400	2400	2400	2400								
	INBD BMEP	162	146	149	151	154	156	159	161	163	167	169	172	174								
	F. F.	660	660	660	660	660	660	660	975	975	975	1110	1130	1160	1180	1210						
	AVG. EAS	176	198	201	204	207	211	214	217	221	225	228	232	236								
88,000	AVG. TAS	195	198	201	204	207	211	214	217	221	225	228	232	236								
	Δ TIME	2:01	1:32	1:31	1:29	1:27	1:26	1:24	1:22	1:12	1:11	1:09	1:08	1:06								
	Δ DIST.	395	305	304	303	302	300	298	297	265	265	262	262	260								

NOTES: 1. Cowl flaps faired, oil radiator flaps automatic and cabin supercharger scoop closed.
 2. High blower operation to right of double line. Shaded area represents AUTO-RICH operation.
 3. Data are for weight bracket mid-point.
 4. Average IAS values are for flush static system.

Figure A5-39 (Sheet 1 of 2)

FOUR ENGINE OPERATION
CONSTANT POWER CRUISE - OPERATING TABLES

1300 BHP

MODEL: C-121A
DATA AS OF: 15 AUGUST 1961
DATA BASIS: FLIGHT TESTS

ENGINES: (4) R3350-75

PROPS: CURTISS C460/830-26C4-0

GROSS WEIGHT - LB.	LOW BLOWER										HIGH BLOWER										
	5	6	7	8	9	10	11	12	13	14	15	16	17	18	19	20	21	22	23	24	25
88,000 to 84,000	INBD BHP	1300	2060	2060	2060	2060	2060	2060	2060	2060	2060	2060	2060	2060	2060	2060	2060	2060	2060	2060	2060
	INBD BMEP	2060	149	149	149	149	149	149	149	149	149	149	149	149	149	149	149	149	149	149	149
	F. F.	575	580	580	580	580	580	580	580	580	580	580	580	580	580	580	580	580	580	580	580
	AVG. IAS	204	202	201	201	199	198	197	195	194	193	191	190	188	187	186	184	182	180	178	177
	AVG. TAS	225	226	229	231	233	235	237	239	241	245	246	248	250	252	254	256	258	260	262	264
Δ TIME	1:44	1:44	1:44	1:43	1:43	1:43	1:43	1:43	1:42	1:42	1:39	1:38	1:38	1:38	1:37	1:36	1:34	1:32	1:18	1:16	
Δ DIST.	399	392	395	398	401	404	407	409	408	406	404	403	406	409	411	410	406	397	340	335	
84,000 to 80,000	INBD BHP	1300	2060	2060	2060	2060	2060	2060	2060	2060	2060	2060	2060	2060	2060	2060	2060	2060	2060	2060	2060
	INBD BMEP	2060	149	149	149	149	149	149	149	149	149	149	149	144	144	144	144	144	144	144	144
	F. F.	575	580	580	580	580	580	580	580	580	580	580	580	580	580	580	580	580	580	580	580
	AVG. IAS	206	204	203	202	201	199	198	197	196	194	193	192	190	189	188	186	184	183	181	180
	AVG. TAS	226	228	230	232	234	237	239	241	243	245	248	250	252	255	257	260	261	263	266	268
Δ TIME	1:44	1:44	1:44	1:43	1:43	1:43	1:43	1:43	1:42	1:42	1:40	1:39	1:38	1:38	1:37	1:36	1:34	1:32	1:18	1:16	
Δ DIST.	392	395	397	400	404	407	410	412	412	412	409	407	410	413	416	415	411	402	345	340	
80,000 to 76,000	INBD BHP	1300	2060	2060	2060	2060	2060	2060	2060	2060	2060	2060	2060	2060	2060	2060	2060	2060	2060	2060	2060
	INBD BMEP	2060	149	149	149	149	149	149	149	149	149	149	149	144	144	144	144	144	144	144	144
	F. F.	575	580	580	580	580	580	580	580	580	580	580	580	580	580	580	580	580	580	580	580
	AVG. IAS	207	205	204	203	202	201	200	198	197	196	195	193	192	191	189	188	187	185	184	182
	AVG. TAS	227	219	231	234	236	238	241	243	247	250	252	254	257	259	262	264	266	267	269	272
Δ TIME	1:44	1:44	1:44	1:43	1:43	1:43	1:43	1:43	1:42	1:42	1:40	1:39	1:38	1:38	1:37	1:36	1:34	1:32	1:18	1:16	
Δ DIST.	394	397	400	403	407	410	413	415	415	415	412	410	412	416	419	420	416	407	349	345	
76,000 to 72,000	INBD BHP	1300	2060	2060	2060	2060	2060	2060	2060	2060	2060	2060	2060	2060	2060	2060	2060	2060	2060	2060	2060
	INBD BMEP	2060	149	149	149	149	149	149	149	149	149	149	149	144	144	144	144	144	144	144	144
	F. F.	575	580	580	580	580	580	580	580	580	580	580	580	580	580	580	580	580	580	580	580
	AVG. IAS	208	206	205	204	203	202	201	200	198	197	196	195	193	192	191	190	188	187	186	185
	AVG. TAS	228	230	233	235	237	239	242	244	246	249	251	254	256	259	262	264	266	269	272	275
Δ TIME	1:44	1:44	1:44	1:43	1:43	1:43	1:43	1:43	1:42	1:42	1:40	1:39	1:38	1:38	1:37	1:36	1:34	1:32	1:18	1:16	
Δ DIST.	396	399	401	405	409	412	415	417	417	417	415	413	416	418	422	423	419	411	353	348	
72,000 to 68,000	INBD BHP	1300	2060	2060	2060	2060	2060	2060	2060	2060	2060	2060	2060	2060	2060	2060	2060	2060	2060	2060	2060
	INBD BMEP	2060	149	149	149	149	149	149	149	149	149	149	149	144	144	144	144	144	144	144	144
	F. F.	575	578	580	580	580	580	580	580	580	580	580	580	580	580	580	580	580	580	580	580
	AVG. IAS	209	207	206	205	204	203	202	201	200	198	197	196	195	194	193	192	190	189	188	186
	AVG. TAS	230	232	234	236	238	240	243	245	248	250	253	256	258	260	263	266	268	271	274	277
Δ TIME	1:44	1:44	1:44	1:43	1:42	1:42	1:43	1:43	1:42	1:42	1:39	1:38	1:38	1:38	1:37	1:36	1:34	1:32	1:18	1:16	
Δ DIST.	398	401	403	406	411	414	417	419	419	419	417	415	419	422	425	427	422	414	356	351	

- NOTES: 1. Cowl flaps faired, oil radiator flaps automatic and cabin supercharger scoop closed.
 2. High blower operation to right of double line. Shaded area represents AUTO-RICH operation.
 3. Data are for weight bracket mid-point.
 4. Average IAS values are for flush static system.

Figure A5-40 (Sheet 2 of 2)

GROSS WEIGHT — LB.		PROPS: CURTISS C460/830-26C4-0																					
		LOW BLOWER										HIGH BLOWER											
		5	6	7	8	9	10	11	12	13	14	15	16	17	18	19	20	21	22	23	24	25	
MODEL: C-121A DATA AS OF: 15 AUGUST 1961 DATA BASIS: FLIGHT TESTS		ENGINES: (4) R3350-75																					
Hi. — 1000 FT.																							
107,000 to 104,000	INBD BHP	1045	1060	1080	1100	1120	1130	1145	1160	1175	1200	1230	1250	1255	1280	1305	1340						
	RPM	1700	1725	1760	1790	1815	1860	1915	1985	2050	2125	2075	2105	2150	2130	2200	2290						
	INBD BMEP	145	145	145	145	145	143	141	138	135	133	140	140	140	140	142	140	138					
	F. F.	450	455	465	475	480	490	500	510	525	540	560	580	595	610	625	650	605					
	AVG. IAS	160	181	183	186	189	192	195	198	201	205	208	212	215	219	222	226	226					
AVG. TAS	178	198	200	203	206	209	212	215	218	221	224	227	230	233	236	239	242						
Δ TIME	1:41	1:38	1:37	1:35	1:33	1:32	1:30	1:28	1:26	1:24	1:23	1:20	1:18	1:16	1:14	1:12	1:10						
Δ DIST.	298	297	296	294	294	294	293	292	287	283	278	273	271	269	266	262	262						
104,000 to 100,000	INBD BHP	1000	1015	1030	1040	1060	1070	1085	1105	1120	1130	1175	1190	1210	1230	1250	1265	1290					
	RPM	1625	1650	1670	1700	1760	1815	1870	1930	2000	2065	1980	2005	2035	2075	2135	2210	2300					
	INBD BMEP	145	145	145	144	142	139	137	135	132	129	140	140	140	140	140	138	135	132				
	F. F.	430	435	440	450	455	465	475	485	500	515	520	530	540	555	580	605	630	605				
	AVG. IAS	157	177	180	183	186	189	192	195	198	201	204	208	211	215	218	222	226	226				
AVG. TAS	174	194	196	199	202	205	208	211	214	217	220	223	226	229	232	235	239	242					
Δ TIME	2:20	2:18	2:15	2:14	2:11	2:09	2:06	2:03	2:00	1:56	1:55	1:53	1:51	1:48	1:44	1:39	1:35	1:35					
Δ DIST.	407	407	407	407	406	405	405	403	401	396	390	392	390	389	388	376	367	358					
100,000 to 96,000	INBD BHP	945	960	970	980	985	1000	1020	1030	1065	1080	1100	1120	1140	1165	1180	1200	1220	1240				
	RPM	1540	1525	1620	1660	1705	1760	1815	1850	1950	2000	1860	1890	1940	1940	2010	2075	2140	2210	2310			
	INBD BMEP	145	144	141	139	136	134	131	129	127	127	140	140	139	137	134	132	130	127	130			
	F. F.	405	410	420	425	430	435	450	455	470	485	485	485	500	510	525	560	585	515	585			
	AVG. IAS	134	174	177	179	182	185	188	191	194	197	200	204	207	211	214	218	222	226	225			
AVG. TAS	158	178	180	182	184	187	190	194	197	200	204	208	211	215	218	222	226	230	234				
Δ TIME	2:28	2:27	2:23	2:21	2:19	2:17	2:14	2:11	2:07	2:04	2:03	2:01	2:00	1:58	1:55	1:52	1:49	1:42	1:38				
Δ DIST.	424	424	423	422	422	422	422	422	419	413	408	412	410	406	403	399	396	377	366				
96,000 to 92,000	INBD BHP	880	890	910	915	935	950	965	980	1000	1025	1030	1050	1070	1085	1110	1120	1150	1180				
	RPM	1495	1525	1575	1615	1660	1710	1770	1820	1890	1950	1780	1825	1880	1940	2000	2070	2135	2220	2300			
	INBD BMEP	134	132	131	129	127	126	125	123	121	118	137	136	134	132	131	128	126	124	123	121	118	116
	F. F.	385	390	395	400	405	410	420	430	440	445	455	455	475	490	505	520	535	560	590	560	535	565
	AVG. IAS	151	171	173	176	179	182	184	187	190	194	197	200	203	207	210	214	217	221	225			
AVG. TAS	168	188	190	192	194	197	200	204	208	212	216	219	223	227	231	235	239	243	247				
Δ TIME	2:36	2:34	2:32	2:30	2:27	2:26	2:22	2:20	2:17	2:15	2:12	2:09	2:06	2:03	2:00	1:56	1:52	1:47	1:42				
Δ DIST.	437	438	438	440	440	440	436	436	435	435	432	430	427	422	416	412	405	395	382				
92,000 to 88,000	INBD BHP	825	835	845	860	865	880	900	920	930	945	960	990	995	1020	1030	1050	1075	1105	1130			
	RPM	1450	1490	1525	1575	1610	1650	1700	1760	1820	1890	1950	1780	1820	1880	1935	2000	2065	2125	2210	2300		
	INBD BMEP	134	132	131	129	127	126	125	123	121	118	137	136	134	132	131	128	126	124	123	121	118	116
	F. F.	360	365	370	375	380	385	395	405	410	420	430	440	450	460	470	485	500	515	535	565	535	565
	AVG. IAS	147	164	166	169	171	174	177	180	183	186	189	192	195	198	201	205	208	212	215	219	223	223
AVG. TAS	164	184	186	188	190	192	194	197	200	204	208	212	216	220	224	228	232	236	240	244	248	252	
Δ TIME	2:47	2:44	2:42	2:39	2:37	2:35	2:32	2:29	2:26	2:23	2:19	2:17	2:15	2:14	2:11	2:08	2:04	2:00	1:57	1:52	1:46	1:46	
Δ DIST.	455	455	455	455	455	455	455	455	454	453	448	445	445	442	440	438	430	424	419	408	395	395	

NOTES: 1. Cowl flaps failed, oil radiator flaps automatic and cabin supercharger scoop closed.
 2. High blower operation to right of double line. Shaded area represents AUTO-RICH operation.
 3. Data are for weight bracket mid-point.
 4. Average IAS values are for flush static system.

Figure A5-41 (Sheet 1 of 2)

FOUR ENGINE OPERATION
HOLDING CRUISE - OPERATING TABLES

MODEL: C-121A
DATA AS OF: 15 AUGUST 1961
DATA BASIS: FLIGHT TESTS

ENGINES: (4) R3350-75

PROPS: CURTISS C460/830-26CA-0

GROSS WEIGHT - LB.	H ₁ - 1000 FT.	LOW BLOWER										HIGH BLOWER										
		5	6	7	8	9	10	11	12	13	14	15	16	17	18	19	20	21	22	23	24	25
88,000 to 84,000	INBD BHP	770	780	795	810	820	835	855	855	875	885	905	920	935	950	970	995	1010	1025	1045	1050	1070
	INBD BMEP	1435	1450	1490	1525	1575	1615	1660	1700	1765	1815	1895	1960	1775	1820	1880	1940	1990	2065	2120	2210	2300
	F. F.	128	127	126	125	123	122	121	119	117	115	113	111	110	108	106	104	102	100	98	96	94
	AVG. IAS	340	345	350	355	360	365	370	375	380	390	400	410	420	422	435	450	460	475	495	515	535
	AVG. TAS	144	163	166	168	171	173	176	179	182	185	188	191	194	197	201	204	208	211	215	219	223
84,000 to 80,000	Δ TIME	2:56	2:54	2:51	2:49	2:47	2:45	2:42	2:40	2:37	2:33	2:29	2:26	2:24	2:20	2:17	2:13	2:10	2:06	2:02	1:57	1:52
	Δ DIST.	472	472	472	472	475	475	476	477	477	475	472	466	463	465	462	454	450	442	435	426	417
	INBD BHP	710	725	740	755	760	775	790	805	815	830	840	860	870	880	900	920	935	950	965	975	1010
	INBD BMEP	1400	1405	1440	1485	1520	1565	1610	1650	1700	1760	1810	1890	1710	1760	1815	1875	1925	1990	2050	2115	2200
	F. F.	120	122	121	120	118	117	116	115	113	111	109	107	107	106	104	102	100	98	96	94	92
80,000 to 76,000	AVG. IAS	320	325	330	335	340	345	350	355	360	365	370	380	390	400	405	415	425	440	455	465	485
	AVG. TAS	140	159	161	164	166	169	171	174	177	180	183	186	189	192	195	199	202	206	209	213	217
	Δ TIME	3:09	3:06	3:03	3:00	2:58	2:55	2:52	2:51	2:47	2:43	2:41	2:37	2:34	2:31	2:28	2:25	2:21	2:16	2:12	2:09	2:04
	Δ DIST.	491	491	491	491	493	493	493	493	495	495	490	486	486	488	483	480	478	474	467	460	454
	INBD BHP	660	670	675	695	710	720	735	740	755	765	770	785	800	815	830	850	860	880	895	915	925
INBD BMEP	1400	1400	1400	1440	1480	1520	1560	1600	1650	1700	1750	1800	1660	1700	1750	1810	1860	1920	1975	2035	2100	
F. F.	111	113	114	114	113	112	111	109	108	106	104	103	103	102	101	100	98	96	94	92	90	
AVG. IAS	300	305	310	315	320	325	330	335	340	345	350	360	370	380	390	385	395	405	415	425	440	
AVG. TAS	136	154	157	159	162	164	167	169	172	175	178	181	184	187	190	193	197	200	203	207	211	
Δ TIME	3:21	3:18	3:15	3:12	3:10	3:08	3:04	3:02	2:59	2:54	2:50	2:46	2:43	2:39	2:36	2:32	2:29	2:25	2:21	2:16	2:11	
Δ DIST.	508	508	509	510	512	512	512	514	514	515	515	513	507	506	502	501	497	495	490	485	480	
76,000 to 72,000	INBD BHP	610	615	630	640	655	665	680	680	700	710	710	725	740	750	760	775	795	810	835	840	845
	INBD BMEP	1400	1400	1400	1430	1470	1510	1550	1600	1645	1700	1750	1800	1650	1690	1740	1800	1850	1910	1960	2020	2070
	F. F.	103	104	106	108	108	107	106	104	103	102	99	98	97	97	106	105	104	103	102	101	99
	AVG. IAS	280	285	285	290	295	300	305	305	310	320	325	330	335	340	350	355	360	370	380	395	400
	AVG. TAS	149	151	153	156	158	161	163	166	168	171	174	177	180	183	186	189	192	196	199	203	206
Δ TIME	3:34	3:31	3:29	3:27	3:23	3:21	3:18	3:16	3:12	3:08	3:06	3:03	2:59	2:56	2:52	2:50	2:47	2:42	2:37	2:33	2:29	
Δ DIST.	531	531	535	536	536	537	538	540	540	540	540	539	539	535	537	534	534	529	520	515	512	
72,000 to 68,000	INBD BHP	565	570	580	595	600	615	625	635	645	655	660	675	680	690	705	715	725	745	755	770	785
	INBD BMEP	1400	1400	1400	1430	1470	1510	1550	1600	1645	1700	1750	1800	1650	1690	1740	1800	1850	1910	1960	2020	2070
	F. F.	95	96	98	100	101	102	101	99	98	97	95	94	92	102	101	100	99	98	97	96	95
	AVG. IAS	260	265	270	275	280	285	290	295	300	305	310	320	330	340	350	355	360	370	380	395	400
	AVG. TAS	129	147	149	151	154	156	158	161	164	166	169	172	175	178	181	184	187	190	193	197	200
Δ TIME	3:50	3:47	3:44	3:42	3:39	3:36	3:33	3:30	3:26	3:23	3:20	3:17	3:14	3:09	3:06	3:02	2:59	2:55	2:51	2:47	2:42	
Δ DIST.	555	555	555	560	560	562	562	562	562	562	563	564	563	563	559	557	557	557	553	553	546	540

- NOTES: 1. Cowl flaps fairied, oil radiator flaps automatic and cabin supercharger scoop closed.
 2. High blower operation to right of double line. Shaded area represents AUTO-RICH operation.
 3. Data are for weight bracket mid-point.
 4. Average IAS values are for flush static system.

Figure A5-41 (Sheet 2 of 2)

THREE ENGINE OPERATION
HOLDING CRUISE - OPERATING TABLES

MODEL: C-121A DATA AS OF: 15 AUGUST 1961 DATA BASIS: FLIGHT TESTS		ENGINES: (4) R3350-75										PROPS: CURTISS C460/830-26C4-0													
GROSS WEIGHT — LB.	H ₀ — 1000 FT.	LOW BLOWER					HIGH BLOWER					23	24	25											
		5	6	7	8	9	10	11	12	13	14				15	16	17	18	19	20	21	22			
107,000 to 104,000	INBD BHP	1645	1680	1700	1730	1750	1780																		
	RPM	2400	2400	2400	2400	2400	2400																		
	INBD BMEP	162	165	167	170	172	175																		
	F. F.	985	1005	1030	1050	1075	1095																		
104,000 to 100,000	AVG. IAS	175	197	200	203	206	210																		
	AVG. TAS	194	197	200	203	206	210																		
	Δ TIME	1:01	1:00	0:58	0:57	0:56	0:55																		
	Δ DIST.	197	196	195	193	192	191																		
104,000 to 100,000	INBD BHP	1575	1585	1615	1635	1670	1690	1720	1740	1770	1800														
	RPM	2400	2400	2400	2400	2400	2400	2400	2400	2400	2400														
	INBD BMEP	155	156	159	161	164	166	169	171	174	177														
	F. F.	925	940	960	980	1000	1025	1160	1180	1205	1240														
100,000 to 96,000	AVG. IAS	170	192	195	198	201	204	207	211	214	218														
	AVG. TAS	189	189	192	195	198	201	204	207	211	214														
	Δ TIME	1:27	1:25	1:23	1:22	1:20	1:18	1:09	1:08	1:06	1:05														
	Δ DIST.	272	272	271	269	268	266	238	238	237	234														
100,000 to 96,000	INBD BHP	1475	1495	1515	1545	1565	1595	1615	1635	1660	1690	1720	1750	1780											
	RPM	2400	2400	2400	2400	2400	2400	2400	2400	2400	2400	2400	2400	2400											
	INBD BMEP	145	147	149	152	154	157	159	161	163	166	169	172	175											
	F. F.	850	870	885	900	920	935	960	980	1105	1130	1155	1180	1210											
96,000 to 92,000	AVG. IAS	166	187	190	193	196	199	202	205	209	212	216	219	223											
	AVG. TAS	184	184	190	193	196	199	202	205	209	212	216	219	223											
	Δ TIME	1:34	1:32	1:30	1:29	1:27	1:25	1:23	1:22	1:22	1:21	1:11	1:09	1:08											
	Δ DIST.	289	286	286	285	283	283	283	281	279	252	250	249	248											
96,000 to 92,000	INBD BHP	1380	1400	1425	1435	1470	1495	1525	1545	1575	1585	1625	1645	1680	1710										
	RPM	2090	2100	2115	2120	2300	2400	2400	2400	2400	2400	2400	2400	2400	2400										
	INBD BMEP	156	157	159	160	161	164	166	169	171	174	177	180	182	185										
	F. F.	615	625	635	645	655	665	675	685	690	700	710	720	730	740										
92,000 to 88,000	AVG. IAS	163	184	187	189	193	196	199	202	205	208	212	215	219	223										
	AVG. TAS	181	184	187	189	193	196	199	202	205	208	212	215	219	223										
	Δ TIME	2:10	2:08	2:06	2:04	2:02	1:59	1:56	1:54	1:52	1:50	1:48	1:46	1:44	1:42										
	Δ DIST.	393	393	391	391	310	302	299	298	291	268	265	264	264	263										
92,000 to 88,000	INBD BHP	1280	1310	1325	1355	1380	1400	1440	1455	1470	1495	1525	1555	1585	1635										
	RPM	2030	2045	2060	2075	2085	2100	2165	2230	2300	2400	2400	2400	2400	2400										
	INBD BMEP	149	151	152	154	156	158	157	154	151	147	150	153	156	159										
	F. F.	580	590	600	605	615	630	650	675	830	870	980	995	1020	1045										
88,000 to 84,000	AVG. IAS	160	181	184	187	189	192	195	198	201	205	209	211	215	218										
	AVG. TAS	178	181	184	187	189	192	195	198	201	205	209	211	215	218										
	Δ TIME	2:19	2:16	2:14	2:12	2:10	2:07	2:04	2:02	1:59	1:56	1:52	1:50	1:48	1:46										
	Δ DIST.	410	410	409	409	409	409	409	402	392	323	314	284	283	281										

- NOTES: 1. Cowl flaps faired, oil radiator flaps automatic and cabin supercharger scoop closed.
 2. High blower operation to right of double line. Shaded area represents AUTO-RICH operation.
 3. Data are for weight bracket mid-point.
 4. Average IAS values are for flush static system.

Figure A5-42 (Sheet 1 of 2)

MODEL: C-121A DATA AS OF: 15 AUGUST 1961 DATA BASIS: FLIGHT TESTS		THREE ENGINE OPERATION HOLDING CRUISE - OPERATING TABLES													PROPS: CURTISS C460/830-26C4-0								
		ENGINES: (4) R3350-75													HIGH BLOWER								
		LOW BLOWER																					
GROSS WEIGHT - LB.	H ₀ - 1000 FT.																						
	5	6	7	8	9	10	11	12	13	14	15	16	17	18	19	20	21	22	23	24	25		
88,000 to 84,000	INBD BHP	1210	1230	1235	1250	1275	1295	1310	1355	1380	1395	1450	1485	1505	1535	1535							
	RPM	1970	2000	2010	2020	2030	2040	2050	2160	2230	2300	2300	2400	2400	2400	2400							
	INBD BMEP	145	145	145	146	148	150	151	148	146	143	145	143	146	148	151	153						
	F. F.	530	540	555	565	575	585	595	610	630	660	660	800	930	950	970	995						
84,000 to 80,000	AVG. IAS	155	172	178	183	186	189	192	195	198	202	205	208	212	215	219							
	AVG. TAS	231	228	224	222	219	217	215	211	207	201	141	128	125	124	122							
	Δ TIME	434	433	429	426	425	425	424	421	414	401	365	302	299	298	294							
	Δ DIST.																						
84,000 to 80,000	INBD BHP	1130	1150	1165	1175	1200	1220	1245	1265	1295	1310	1315	1335	1360	1395	1435	1485						
	RPM	1840	1875	1900	1915	1950	1985	2030	2075	2155	2220	2300	2300	2400	2400	2400	2400						
	INBD BMEP	145	145	145	145	145	145	145	144	142	139	135	145	147	149	141	143						
	F. F.	485	495	510	520	530	540	555	565	580	600	625	635	645	660	675	900						
80,000 to 76,000	AVG. IAS	155	170	173	175	181	184	187	190	193	196	199	202	206	209	213	216						
	AVG. TAS	245	242	237	234	231	228	224	222	218	213	208	206	204	201	132	129						
	Δ TIME	469	466	459	457	456	455	450	449	445	436	426	425	426	423	324	320						
	Δ DIST.																						
80,000 to 76,000	INBD BHP	1055	1070	1095	1110	1120	1145	1160	1175	1200	1220	1230	1240	1265	1280	1315	1340	1365					
	RPM	1715	1740	1780	1805	1825	1880	1925	1995	2070	2145	2215	2105	2120	2125	2200	2290	2300	2320				
	INBD BMEP	145	145	145	145	144	144	142	139	137	134	131	139	141	142	141	138	139					
	F. F.	455	460	470	480	485	495	505	520	530	550	570	580	600	610	630	650	825	855				
76,000 to 72,000	AVG. IAS	150	170	172	175	178	180	183	186	189	192	195	199	202	205	209	212	217	220				
	AVG. TAS	167	170	172	175	178	180	183	186	189	192	195	199	202	205	209	212	217	220				
	Δ TIME	256	253	250	248	244	242	238	234	231	226	221	218	218	213	211	207	203	137	134			
	Δ DIST.	490	490	489	489	489	486	484	478	476	466	459	459	459	450	444	436	349	342				
76,000 to 72,000	INBD BHP	975	985	1000	1025	1030	1045	1060	1075	1100	1120	1140	1155	1180	1200	1220	1240	1265					
	RPM	1590	1605	1640	1690	1735	1800	1850	1905	1990	2050	2135	1945	1990	2035	2100	2180	2275	2380				
	INBD BMEP	145	145	144	143	140	137	135	133	131	129	126	140	140	139	137	134	131	128				
	F. F.	420	425	430	435	445	455	465	475	485	505	520	520	530	545	560	585	610	640				
72,000 to 68,000	AVG. IAS	145	164	167	169	172	175	177	180	183	186	189	192	195	199	202	206	209	213				
	AVG. TAS	162	164	167	169	172	175	177	180	183	186	189	192	195	199	202	206	209	213				
	Δ TIME	311	308	305	303	300	296	292	288	284	280	276	272	268	264	260	256	252	248	211	205		
	Δ DIST.	515	515	516	516	516	514	509	506	505	498	487	493	491	489	481	471	458	445				
72,000 to 68,000	INBD BHP	895	915	925	940	955	965	985	1000	1015	1035	1050	1080	1085	1115	1135	1140	1175	1195				
	RPM	1500	1550	1590	1630	1680	1725	1790	1840	1900	1970	2030	1840	1900	1960	2030	2090	2160	2240	2335			
	INBD BMEP	141	139	137	136	134	132	130	128	126	124	122	138	135	134	132	129	128	124	121			
	F. F.	385	390	400	405	415	425	430	435	445	460	475	473	485	500	510	525	550	575	605			
68,000	AVG. IAS	141	160	162	165	167	170	173	175	178	181	184	187	190	193	197	200	203	207	211			
	AVG. TAS	157	160	162	165	167	170	173	175	178	181	184	187	190	193	197	200	203	207	211			
	Δ TIME	328	324	320	317	313	309	306	304	300	294	288	284	279	275	271	267	263	259	255	211	205	
	Δ DIST.	545	545	541	541	538	538	538	538	538	534	524	516	529	524	516	509	494	481	466			

NOTES: 1. Cowl flaps faired, oil radiator flaps automatic and cabin supercharger scoop closed.
 2. High blower operation to right of double line. Shaded area represents AUTO-RICH operation.
 3. Data are for weight bracket mid-point.
 4. Average IAS values are for flush static system.

Figure A5-42 (Sheet 2 of 2)

**TWO ENGINE OPERATION
HOLDING CRUISE - OPERATING TABLES**

MODEL: C-121A
DATA AS OF: 15 AUGUST 1961
DATA BASIS: FLIGHT TESTS

ENGINES: (4) R3350-75

PROPS: CURTISS C460/830-26C4-0

GROSS WEIGHT — LB.	H ₀ — 1000 FT.	LOW BLOWER																															
		5	6	7	8	9	10	11	12	13	14	15	16	17	18	19	20	21	22	23	24	25											
88,000 to 84,000	INBD BHP	1730	1750	1770	1800	1830																											
	RPM	2400	2400	2400	2400	2400																											
	INBD BMEP	170	172	174	177	180																											
	F. F.	1050	1070	1090	1110	1130																											
	AVG. IAS	143	160	165	167	170																											
84,000 to 80,000	AVG. TAS	154	152	150	148	146																											
	Δ TIME	304	302	302	300	300																											
	Δ DIST.	1595	1625	1660	1680	1700	1730																										
	INBD BHP	2400	2400	2400	2400	2400	2400																										
	RPM	157	160	163	165	167	170																										
80,000 to 76,000	INBD BMEP	950	970	985	1005	1030	1050																										
	F. F.	140	158	161	163	166	168																										
	AVG. IAS	156	158	161	163	166	168																										
	AVG. TAS	206	204	202	198	196	194																										
	Δ TIME	328	326	326	324	322	320																										
76,000 to 72,000	Δ DIST.	1495	1515	1535	1555	1585	1605	1635																									
	INBD BHP	2400	2400	2400	2400	2400	2400	2400	2400																								
	RPM	147	149	151	153	156	158	161	163																								
	INBD BMEP	865	880	900	910	930	950	975	1000																								
	F. F.	136	154	157	159	162	164	167	170																								
72,000 to 68,000	AVG. IAS	152	154	157	159	162	164	167	170																								
	AVG. TAS	218	216	214	211	209	206	203	200																								
	Δ TIME	350	350	349	348	348	344	342	340																								
	Δ DIST.	1380	1420	1450	1480	1505	1495	1515	1545	1565																							
	INBD BHP	2085	2095	2110	2120	2130	2130	2140	2150	2160	2170	2180	2190	2200	2210	2220	2230	2240	2250	2260	2270	2280	2290	2300	2310	2320	2330	2340	2350	2360	2370		
72,000 to 68,000	INBD BMEP	156	160	162	165	167	167	167	167	167	167	167	167	167	167	167	167	167	167	167	167	167	167	167	167	167	167	167	167	167	167		
	F. F.	610	620	630	640	660	665	665	665	665	665	665	665	665	665	665	665	665	665	665	665	665	665	665	665	665	665	665	665	665	665		
	AVG. IAS	132	150	153	155	157	160	162	165	168	170	172	174	176	178	180	182	184	186	188	190	192	194	196	198	200	202	204	206	208	210		
	AVG. TAS	148	150	153	155	157	160	162	165	168	170	172	174	176	178	180	182	184	186	188	190	192	194	196	198	200	202	204	206	208	210	212	
	Δ TIME	317	314	310	308	302	299	299	299	299	299	299	299	299	299	299	299	299	299	299	299	299	299	299	299	299	299	299	299	299	299	299	
72,000 to 68,000	Δ DIST.	485	484	484	484	477	477	477	477	477	477	477	477	477	477	477	477	477	477	477	477	477	477	477	477	477	477	477	477	477	477		
	INBD BHP	1270	1285	1300	1325	1350	1380	1405	1425	1445	1485																						
	RPM	2025	2035	2050	2060	2070	2085	2140	2210	2290	2400																						
	INBD BMEP	148	149	150	152	154	156	155	155	155	155																						
	F. F.	565	575	585	590	600	610	620	650	685	720																						
72,000 to 68,000	AVG. IAS	129	147	149	151	154	156	159	161	164	166																						
	AVG. TAS	144	147	149	151	154	156	159	161	164	166																						
	Δ TIME	332	329	325	322	319	317	314	305	295	285																						
	Δ DIST.	510	509	509	509	509	509	510	510	495	476																						
	Δ DIST.	510	509	509	509	509	509	510	510	495	476																						

NOTES: 1. Cowl flaps faired, oil radiator flaps automatic and cabin supercharger scoop closed.
2. High blower operation to right of double line. Shaded area represents AUTO-RICH operation.
3. Data are for weight bracket mid-point.
4. Average IAS values are for flush static system.

Figure A5-43 (Sheet 2 of 2)

PART 6— LANDING AND GO-AROUND

TABLE OF CONTENTS

	<i>Page</i>
Normal Landing Distances	A6-1
Wind Velocities	A6-1
Maximum Performance	A6-1
Use of Reverse Thrust	A6-1
Landing Go-Around Rates of Climb	A6-1

LIST OF ILLUSTRATIONS

<i>Figure</i>	<i>Title</i>	<i>Page</i>
A6-1	Minimum Effective Landing Runway Length — Scheduled Stops	A6-2
A6-2	Landing Distance From Height of 50 Feet	A6-3
A6-3	Go-Around Rates of Climb — Landing Configuration Maximum Power	A6-4

NORMAL LANDING DISTANCES.

Gross weight and pilot flight and braking technique are the major variables affecting landing distances. Figure A6-1 shows *normal* landing field length requirements for landings from a height of fifty feet. It may be said to represent aircraft performance which can be obtained without undue effort on the part of the flight crew or strain on the aircraft. Values given are $1\frac{1}{4}$ times the average obtained during a series of minimum distance landing tests.

WIND VELOCITIES.

Corrections to performance assume that headwind components at the runway are one-half of the values obtained from reported information, and that the tailwind components are one and one-half times the values obtained from reported information.

The conversion from reported wind speed and direction to runway and crosswind components can be made by using Figure A3-2.

MAXIMUM PERFORMANCE.

Figure A6-2 shows minimum distances to land and stop. Duplication of the performance given requires hard wheel braking without skidding and close adherence to the touchdown speeds shown.

USE OF REVERSE THRUST.

Use of reverse thrust in conjunction with wheel braking will reduce the landing ground roll distances shown appreciably. If used, it should be applied as quickly as possible after touchdown, since this type of braking is most effective at the higher speeds.

LANDING GO-AROUND RATES OF CLIMB.

Rates of climb available with maximum power are shown on Figure A6-3 for four engine performance with landing gear extended and 100% wing flap setting. The data are directly applicable under standard day conditions. The speed schedule is that for manual approach and provides a 30% margin over the zero thrust stall speeds.

**MINIMUM EFFECTIVE LANDING RUNWAY LENGTH
- SCHEDULED STOPS**

MODEL: C-121A
DATA AS OF: 15 AUGUST 1961
DATA BASIS: FLIGHT TESTS

ENGINES: (4) R3350-75
PROPS: CURTISS C460/830-26C4-0

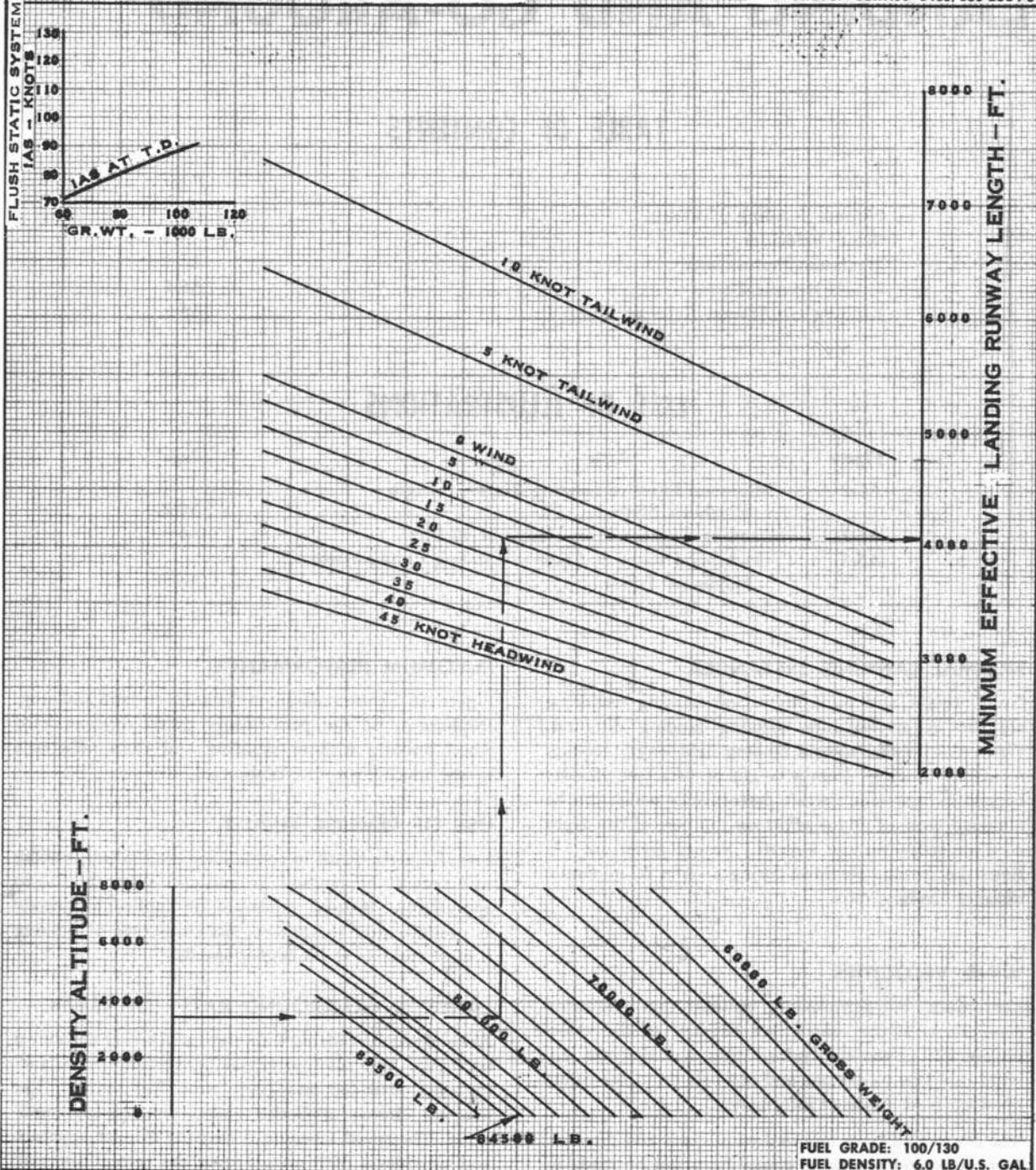

FUEL GRADE: 100/130
FUEL DENSITY: 6.0 LB/U.S. GAL

Figure A6-1

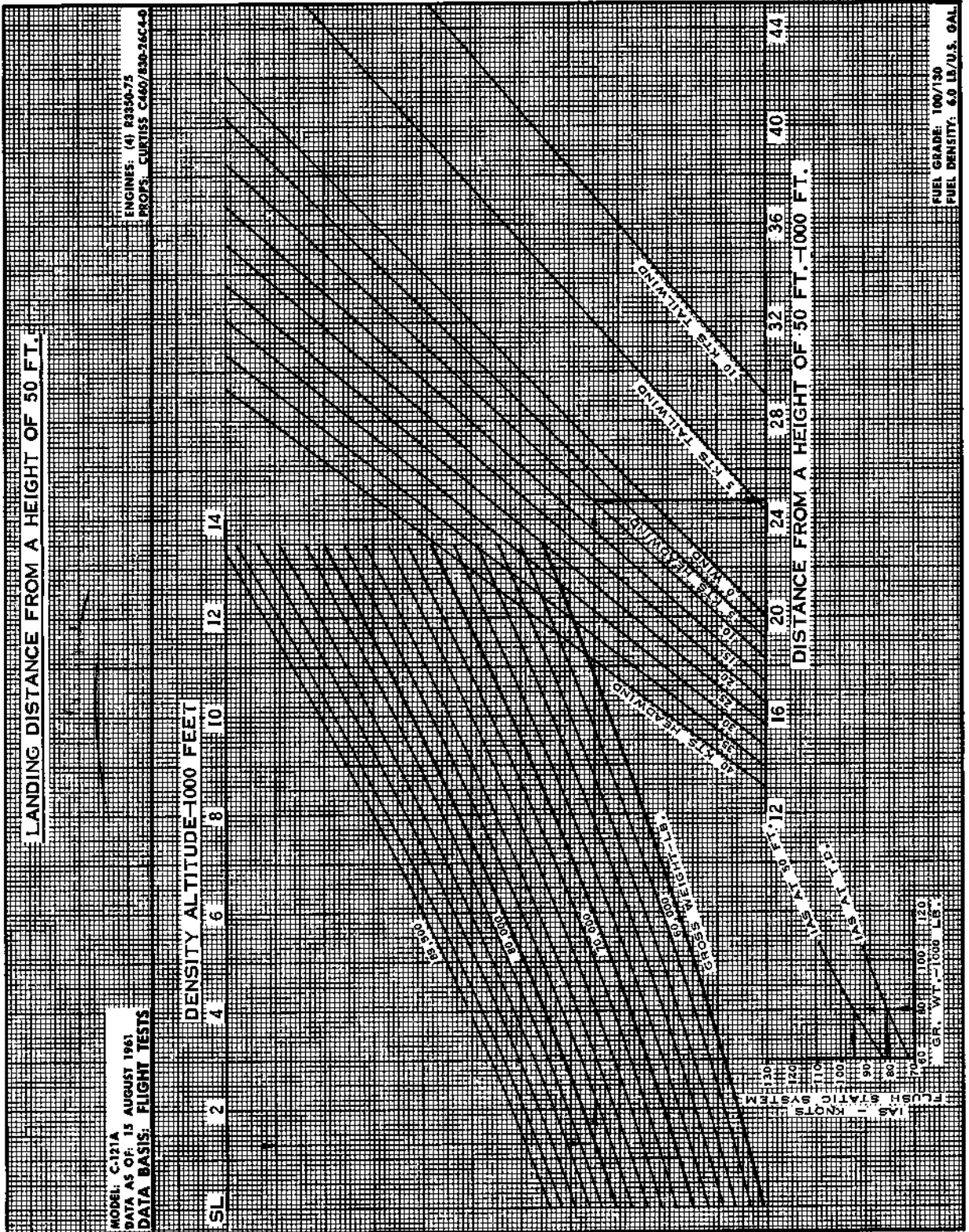

Figure A6-2

GO-AROUND RATES OF CLIMB - LANDING CONFIGURATION

MODEL: C-121A
DATA AS OF: 15 AUGUST 1961
DATA BASIS: FLIGHT TESTS

MAXIMUM POWER

ENGINES: (4) R3350-75
PROPS: CURTISS C460/830-26C4-0

GEAR DOWN - WING FLAPS 100% EXTENDED
COWL FLAPS FAIRED
OIL RADIATOR FLAPS IN AUTO POSITION

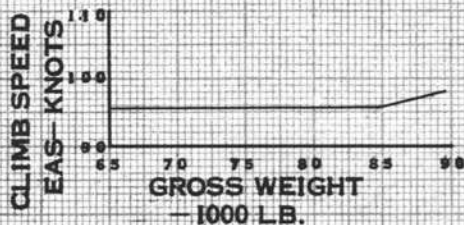

IAS - KNOTS
FLUSH STATIC SYSTEM

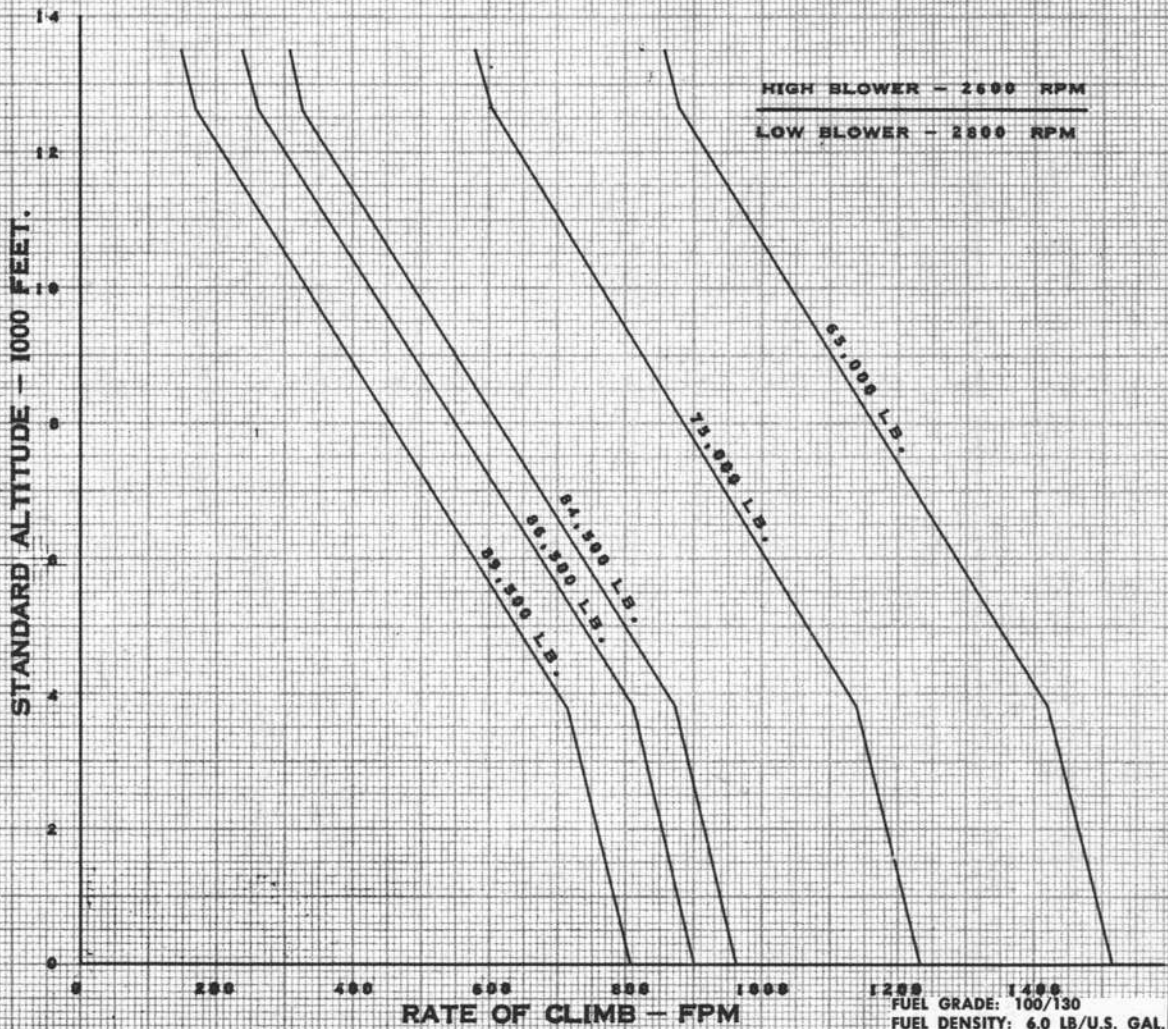

Figure A6-3

PART 7— MISSION PLANNING WITH SAMPLE PROBLEM

TABLE OF CONTENTS

	<i>Page</i>
Summary	A7-1
Preflight Planning	A7-1
Sample Problem	A7-1

SUMMARY.

The following general procedures and example problem are intended as an aid in gaining familiarity with the performance data presented in this appendix and its application to practical operational problems.

PREFLIGHT PLANNING.

When the basic mission is known, perform the following operations in advance of boarding the aircraft to develop a flight plan which will make most effective use of the aircraft:

1. Determine fuel reserves to be carried, and alternate bases available for landing.
2. Determine the weight to which the aircraft must be loaded to accomplish the mission.
3. Prepare a flight plan which incorporates the information obtained.
4. Determine performance available and procedures to be followed in the event of an emergency during take-off or during flight.
5. Decide what procedures are to be followed in the event of an unexpected contingency, such as re-routing because of weather.

SAMPLE PROBLEM.

The problem is presented to illustrate the use of the charts, and may or may not be typical of normal operation. Some flight plans will require a more detailed analysis if maximum efficiency is to be obtained. Others such as local training flights, will require considerably less planning.

Mission.

Make a long range flight from Travis AFB, California to Hickam AFB, Honolulu, with Barber's Point as the alternate. The trip distance is 2142 nautical miles, the time from the destination to the alternate is 15 minutes. Compute fuel reserves on the basis of 10% of trip fuel plus 1 hour and 15 minutes holding at the alternate and 15 minutes of landing fuel. Assume the aircraft's zero fuel weight to be 77,000 pounds.

Take-off Conditions.

- a. Runway length — 11,000 feet
- b. Pressure altitude — sea level
- c. Outside Air Temperature — 80° F (27° C)
- d. Dew Point — 50° F (10° C)
- e. Runway Slope — 0%
- f. Tailwind — 10 knots

Enroute Conditions.

- a. Winds to Destination: 10-knot headwind component at sea level; 15-knot headwind component at 10,000 ft.
- b. Wind — Destination to alternate: 0 wind at 10,000 ft.

Determine the Following Items:

Fuel Requirements.

- a. Holding fuel requirements
- b. Cruise fuel from destination to alternate
- c. Level flight enroute fuel
- d. Climb fuel using Alternate Climb Power to cruise altitude.
- e. Enroute reserve fuel
- f. Warm-up, taxi, and take-off allowance

Power and Range Data.

- a. Power settings
- b. Flight progress chart
- c. Three-engine cruising

Take-off and Landing Performance.

- a. Take-off power available
- b. Take-off and landing data cards

Determination of Fuel Requirements.

This portion of the reserve is normally computed at 10,000 ft. density altitude using the Holding Cruise Performance curve. Enter the holding cruise time prediction graph (figure A5-33) with zero fuel weight of 77,000 lb. Proceed vertically to the 10,000 ft. low-blower line, then left to the time scale and read 21.4 hours. Subtract 1.5 hours from this number (combining landing fuel with holding reserve) and re-enter chart with 19.9 hours. Move horizontally to the 10,000 ft. altitude line and then downward, reading 79,000 lb. Holding reserve is then 79,000 — 77,000, or 2,000 lb. (NOTE: Landing fuel may be given as a fixed quantity, such as 800 lb., in some cases. Total holding and landing fuel then becomes 800 lb. plus 1.25 hr. at holding altitude (800 + 1500, or 2300 lb.)

Cruise Fuel from Destination to Alternate.

This portion of the reserve is normally computed at cruising altitude, using the cruise tables or the H-1

cruise chart. Entering the chart at 79,000 and proceeding as before, cruise fuel of 79,500 — 79,000 = 500 lb. is required. 79,500 lb. is the forecast landing weight if 10% trip fuel reserve is consumed.

Level Flight Enroute Fuel.

The first steps necessary are to obtain the average level flight speed (TAS) and the air miles to be flown. Enter the H-1 cruise (Distance Prediction) chart at 79,500 pounds and read 3320 nautical miles at the 10,000 ft. low-blower line. Subtract the trip distance (3320 — 2142) to obtain a value of 1178 nautical miles. Read a gross weight of 98,000 pounds at this position on the 10,000-ft. line. (98,000 pounds would be the initial cruise weight for zero wind conditions if it were not necessary to allow for climb performance.) Next, find the zero-wind flight time, using Figure A5-29. Reading along the 10,000-ft. low-blower line, note chart times of 16.75 and 6.55 hours. The difference, 10.20 hours, is the value desired. Average true airspeed is now computed as 2142 mi./10.20 hrs., or 210 knots. The ground speed with a 15-knot headwind is 210 — 15, or 195 knots. The air distance to be flown is 2142 miles x 210/195, or 2300 miles. Re-enter the distance prediction chart at 3320 — 2300, or 1020 miles and read a weight value of 99,750 pounds. This is the initial cruise weight corrected for wind conditions; however, no climb allowances have been included.

Climb Allowance.

The foregoing computation did not allow for the rich mixtures and low airspeeds used during climb. In this example, METO climb power at 138 knots IAS will be used (Figure A4-2). A take-off gross weight of 100,000 lb. will be assumed. Therefore, distance to climb is 21 nautical air miles, time to climb is 8 minutes, and fuel used is 750 pounds. The average wind component between sea level and 10,000 feet is 12.5 knots which sets the aircraft back 8/60 hr. x 12.5 knots, or 1.7 miles. Actual distance to 10,000 ft. is 19.3 miles from start of climb.

From the cruise data (Figure A5-30) the level flight fuel required to fly 19.3 miles is 200 pounds. The initial cruise weight at the end of climb would be 99,750 lb. — 200 lb., or 99,550 lb. The initial climb weight would be 99,550 lb. + 750 lb., or 100,300 lb. if no trip fuel reserve were carried.

Cruise Time.

To determine the cruise time, re-enter Figure A5-29 with 79,500 and 99,550 pounds and read 12.3 and 22.9 hours, respectively. The cruise time is 16.8 — 5.8 or 11.0 hours.

Trip Fuel Reserve.

As determined by the preceding paragraphs, enroute fuel for the 2142 mile trip distance is (100,300 - 79,500), or 20,800 pounds. Ten percent of 20,800 is 2080 pounds and this amount is added to the fuel load. It should be noted that this increase in weight will not affect the performance enough to warrant recalculation of trip fuel in this case.

Warm-up, Taxi, and Take-Off Allowance.

A fixed quantity of fuel is added to the other fuel requirements to allow for the fuel used from the time the engines are started until the aircraft is airborne. The values are 450 lb. for warm-up and taxi, 250 lb. for take-off, i.e., up to the time when climb speed and power is reached, and an additional 15 lb. per each minute on the ground in excess of 20 minutes. In this example, we will assume normal take-off conditions and use 700 lb., which brings the total gross weight up to 103,080 pounds, with a total fuel on board equal to 103,080 - 77,000 or 26,080 pounds.

TABULAR METHOD FOR DETERMINING FUEL REQUIREMENTS.

The cruise tables may also be used to determine the fuel requirements. This method has the advantage of providing detailed information for individual weight brackets at the various altitudes.

Start with the known weight condition, destination weight of 79,530 lb. in this case.

From Figure A5-38:

(1) Wt. Bracket 1000 lb.	(2) Time Hr:Min	(3) Δ Dist. NMI.	(4) *Δ Dist.	(5) Total Distance
79.5-80	0:19	64	59	59
80-84	2:27	496	459	518
84-88	2:18	474	439	957
88-92	2:09	453	421	1378
92-96	2:01	430	400	1778
96-99.6	1:43	371	345	2123

*Corrected for 15-knot headwind
(Col. 3)-(15 x Col. 2), converting Col. 2 to hours and tenths of hours.

Cruise fuel is 99,600 - 79,500, or 20,100 lb. A 10% reserve would be 2010 lb. Time required to fly from Travis to Hickam would be 10.96 hours at cruise altitude.

The climb, warmup, taxi, and take-off fuel will be the same as shown previously. The following table illustrates the comparison of the two methods:

	Using Time and distance Prediction Curves—lb. (Figures A5-29, -33)	H-1 Cruise Tables (Figure A5-38)
Zero fuel weight — lb.	77,000	77,000
Holding — lb.	2,000	2,000
Cruise — Hickam to Barber's Point — lb.	500	500
Cruise to Hickam at altitude — lb.	20,050	20,100
Climb to altitude — lb.	750	750
10% trip reserve — lb.	2,080	2,085
Warm-up, taxi and take-off — lb.	700	700
Total fuel on board — Travis — lb.	26,080	26,135
Gross weight on ramp—lb. ...	103,080	103,135
Gross weight at start of cruise — lb.	101,630	101,685
Gross weight at Hickam with reserve remaining ...	81,580	81,585
Time, Travis to Hickam — hr.	11.25	11.21

As is shown, the values for both methods are almost the same. Therefore, the use of the cruising tables should be readily apparent. Flight planning can be accomplished rapidly while accumulating all pertinent data for each specific weight bracket at any altitude.

POWER AND RANGE DATA.

Power Settings.

The power settings required to realize the long-range performance determined in the flight plan can be obtained from the H-1 Cruise tables (Figure A5-38). These settings are for 4000-lb. weight brackets. For example, select 104,000 lb. to 100,000 lb. for a weight bracket at 10,000 ft. H₁. On Figure A5-38 for the H-1 cruising airspeed, the corresponding power settings are: 1245 BHP, 2025 RPM, and 145 BMEP. Total fuel flow, in pounds per hour, may be found by multiplying the fuel flow by 4.

Flight Progress Chart.

From the tables in this section, time and distance values together with the climb data and fuel reserves may be used to plot a *Flight Progress Chart*. On this chart, in graph form, time and distance are usually plotted versus pounds of fuel. Three engine return and three engine ahead predictions should also be made and plotted to determine the *point of no return* and the *equi-time point*. This chart provides a constant check of the progress being made during the flight by showing a comparison of actual with predicted performance.

Three-Engine Cruising.

The effect on range of losing an engine during the flight should be considered. From the weight determined at the equi-time point, the three-engine range can be computed by use of the three-engine specific range graphs or by tabulating the data in a manner similar to that illustrated for four engines. Whenever possible, a low enough altitude should be selected so as to avoid the necessity of using *Auto-Rich* mixtures. For this sample problem, the weights encountered during the latter portion of the trip are so low that the decrease in specific range for three-engine operation is negligible. This can be readily checked by comparing the three and four-engine specific ranges at these weights at 10,000 feet density altitude and the long range cruising airspeeds corresponding to each type of operation.

Take-Off Performance.

Although the field length available in the sample is ample, take-off performance should be checked and the take-off data card filled out. This will include take-off distance, critical field length and speed and distance checks which are discussed in Part 3. Take-off weight is

103,135 lb. minus 450 lb. allowance for warmup and taxi, or 102,385 lb.

Determination of Power Available.

Find power available for take-off by using Figure A3-1. Entering with the given pressure altitude, dewpoint, temperature, and runway temperature the predicted INBD BMEP is found to be 205 psi; 95% predicted INBD BMEP is 195 psi.

Take-Off Ground Run.

Take-off data is obtained from Part 3. Entering Figure A3-3 with 1300-ft. density altitude, the ground run distance is 3280 ft. Take-off speed at 102,385 lb. is 104 knots, IAS (FLUSH static).

Figures A3-7 and A3-8 are used to determine the critical field length and critical airspeed for engine failure. The critical field length is found to be 4640 ft. and in cognizance of the excess runway available the refusal speed should be used to more practically restrict the ground run. Figure A3-5 shows the refusal speed to be beyond the take-off speed and therefore the take-off can be rejected safely at 104 knots, the take-off speed. Acceleration during ground run is checked using Figure A3-6. At an acceleration check distance of 2000 ft., the acceleration check speed (minimum allowable speed) is found to be 77 knots, IAS (FLUSH static). Three-engine climb-out speed is shown on Figure A3-16, and is 109 knots, IAS.

Obstacle Clearance.

If any obstacles exist beyond the runway, the three-engine climb-out flight paths (figures A3-14 and A3-15) should be used to determine the ground distance necessary for clearance. Three engine rates-of-climb for various emergency take-off configurations are shown in Figure A3-16. To clear a 410-ft. obstacle on three engines, a distance of 11,000 ft. from start of take-off is necessary. The 11,000 ft. distance is obtained by adding the three-engine climb-out distance of 6360 ft. (figures A3-14 and A3-15) to the critical field length of 4640 ft. (figure A3-7). The initial rate-of-climb with the propeller windmilling, flaps 60%, and gear down is 475 fpm. (figure A3-16).

For conservatism, take-off performance may be based on 95% predicted INBD BMEP instead of the predicted INBD BMEP which was used in this example.

TAKE-OFF DATA CARD**Conditions:**

Take-Off Gross Weight	102,385 lb.
Runway Length Available	11,000 ft.
Runway Wind	10 knots tailwind
Runway Slope	0%
Field Elevation H_p	Sea level
Field Elevation H_D	1300 ft.
Runway Temperature	80° F (27° C)
Dewpoint	50° F (10° C)

Resulting Data:

Predicted Inb'd BMEP (Figure A3-1)	205 psi.
Minimum Inb'd BMEP (Figure A3-1)	195 psi.
Critical Field Length (Zero Obstacle) (Figure A3-7)	3300 ft.
Critical Field Length (50-ft. Obstacle) (Figure A3-9)	4360 ft.
Ground Run to Take-off (Figure A3-3)	3280 ft.
Refusal Speed (Figure A3-5)	104 knots
Take-off Speed (Figure A3-3)	104 knots
Acceleration Check Distance (Figure A3-6)	2000 ft.
Acceleration Check Speed (Figure A3-6)	77 knots

Landing Performance.

Landing performance is discussed in Part 6. For this example, assume a sea-level pressure altitude, zero wind, zero slope, and a temperature of 80° F (27° C). For conservatism, the landing weight should be based on not utilizing the 10% enroute fuel reserve, holding fuel or alternate fuel. The landing weight is estimated to be 81,585 lb. From Figure A6-2 the IAS (FLUSH static)

at 50 ft. and touchdown is 95.5 knots and 81.5 knots, respectively. The normal landing distance from 50 ft. height and using wheel brakes only is 2750 ft.

Landing Data Card. Landing weight, landing distance from 50 ft. height, airspeeds for touchdown and at 50 ft. and for go-around should be noted on landing data card. The go-around speed and rate-of-climb is shown on Figure A6-3, should they be desired.

LANDING DATA CARD

Condition:

Landing Weight	81,585 lb.
Field Elevation H_p	S. L.
Field Elevation H_D	1300 ft.
Runway Length	8000 ft.
Runway Temperature	80° F (27° C)
Runway Wind	0 knots
Runway Slope	0%

Resulting Data:

Landing Distance (50-ft. height)	2750 ft.
1.3 x Stall Speed (IAS — FLUSH Static)	97 knots
1.1 x Stall Speed (IAS — FLUSH Static)	82 knots

FOUR ENGINE OPERATION
CONSTANT POWER CRUISE PERFORMANCE
1300 BHP/ENG

MODEL: C-121A

ENGINES: (4) R3350-75

PROPS: CURTISS 830-21C4-0

DENSITY ALTITUDE CHART						DENSITY ALTITUDE FT.	GROSS WEIGHT: 107,000 - 104,000					
AMBIENT AIR TEMPERATURE, °C.							RPM	Inb'd BMEP	Avg. Fuel Flow	Initial-Final CAS	Air Miles	Time Hr.: Min.
1.494						25,000						
1.468						24,000						
1.443						23,000						
1.418						22,000						
1.394						21,000						
1.370						20,000						
1.347						19,000						
1.325						18,000	2300	144	716	180 - 188	255	1:03
1.303						17,000	2280	143	702	180 - 188	256	1:04
1.282						16,000	2250	142	683	180 - 180	253	1:06
1.261						15,000	2200	136	670	180 - 183	246	1:07
1.240						14,000	2230	139	642	180 - 188	265	1:10
1.221						13,000	2160	142	622	180 - 188	270	1:12
1.201						12,000	2120	145	615	183 - 190	273	1:13
1.182						11,000	2120	145	615	188 - 192	272	1:13
1.164						10,000	2120	145	615	189 - 193	270	1:13
1.146						9,000	2120	145	615	191 - 195	270	1:13
1.128						8,000	2120	145	615	193 - 197	268	1:13
1.111						7,000	2120	145	615	195 - 198	267	1:13
1.094						6,000	2120	145	615	197 - 200	265	1:13
1.077	5,000	2120	145	615	199 - 202	263	1:13					
1.061	4,000	2120	145	615	201 - 203	261	1:13					
1.045	3,000	2120	145	615	203 - 205	259	1:13					
1.030	2,000	2120	145	615	204 - 206	257	1:13					
1.015	1,000	2120	145	615	206 - 208	256	1:13					
1.000	Sea Level	2120	145	615	207 - 209	253	1:13					

GROSS WEIGHT: 104,000 - 100,000						DENSITY ALTITUDE FT.	GROSS WEIGHT: 100,000 - 96,000					
RPM	Inb'd BMEP	Avg. Fuel Flow	Initial-Final CAS	Air Miles	Time Hr.: Min.		RPM	Inb'd BMEP	Avg. Fuel Flow	Initial-Final CAS	Air Miles	Time Hr.: Min.
						25,000						
						24,000						
						23,000						
						22,000						
						21,000						
						20,000						
						19,000						
						18,000	2200	140	651	179 - 185	376	1:32
2300	144	716	179 - 182	343	1:24	18,000	2200	140	651	182 - 188	279	1:32
2280	143	702	180 - 184	346	1:26	17,000	2200	140	651	184 - 188	371	1:32
2200	140	651	180 - 188	361	1:32	16,000	2200	140	651	186 - 189	370	1:32
2200	135	648	183 - 188	361	1:33	15,000	2280	135	648	188 - 191	370	1:33
2220	138	635	186 - 190	366	1:34	14,000	2220	138	635	190 - 193	372	1:34
2160	142	623	188 - 192	371	1:36	13,000	2160	142	623	192 - 194	377	1:36
2120	145	615	190 - 193	373	1:38	12,000	2120	145	615	193 - 196	379	1:38
2120	145	615	192 - 195	371	1:38	11,000	2120	145	615	195 - 197	375	1:38
2120	145	615	193 - 195	368	1:38	10,000	2120	145	615	196 - 199	373	1:38
2120	145	615	195 - 198	366	1:38	9,000	2120	145	615	196 - 200	370	1:38
2120	145	615	197 - 199	362	1:38	8,000	2120	145	615	199 - 201	368	1:38
2120	145	615	198 - 201	360	1:38	7,000	2120	145	615	201 - 203	365	1:38
2120	145	615	200 - 202	362	1:38	6,000	2120	145	615	202 - 205	362	1:38
2120	145	615	202 - 204	356	1:38	5,000	2120	145	615	204 - 206	359	1:38
2120	145	615	203 - 205	352	1:38	4,000	2120	145	615	205 - 207	356	1:38
2120	145	615	205 - 207	350	1:38	3,000	2120	145	615	207 - 208	351	1:38
2120	145	615	206 - 208	346	1:38	2,000	2120	145	615	208 - 210	350	1:38
2120	145	615	208 - 210	345	1:38	1,000	2120	145	615	210 - 211	347	1:38
2120	145	615	209 - 211	341	1:38	Sea Level	2120	145	615	211 - 212	344	1:38

1. Cowl flaps faired, oil radiators automatic, cabin supercharger scoops closed. Allow for effect on air-speed if other settings used.

2. Shift to high blower indicated by heavy horizontal line. Auto rich operation indicated by dash-line box.

DATA AS OF: 1 January 1959

DATA BASIS: FLIGHT TEST

FUEL GRADE: 100/130

FUEL DENSITY: 6.0 lb/U.S. Gal.

Figure A7-1 (Sheet 1)

FOUR ENGINE OPERATION
CONSTANT POWER CRUISE PERFORMANCE
1300 BHP/ENG

MODEL: C-121A

ENGINES: (4) R3350-75

PROPS: CURTISS 830-21CU-0

DENSITY ALTITUDE CHART						DENSITY ALTITUDE FT.	GROSS WEIGHT: 96,000 - 92,000					
AMBIENT AIR TEMPERATURE, °C.							RPM	Inb'd BMEP	Avg. Fuel Flow	Initial-Final CAS	Air Miles	Time Hr.: Min.
1.494						25,000						
1.468						24,000						
1.443						23,000						
1.418						22,000						
1.394						21,000						
1.370						20,000						
1.347						19,000	2200	140	651	185 - 187	385	1:32
1.325						18,000	2200	140	651	186 - 189	383	1:32
1.303						17,000	2200	140	651	188 - 190	379	1:32
1.282						16,000	2200	140	651	189 - 192	375	1:32
1.261						15,000	2280	135	648	191 - 194	375	1:33
1.240						14,000	2220	138	635	193 - 195	378	1:34
1.221						13,000	2160	142	623	194 - 198	381	1:36
1.201						12,000	2120	145	615	196 - 198	385	1:38
1.182						11,000	2120	145	615	197 - 199	379	1:38
1.164						10,000	2120	145	615	199 - 200	376	1:38
1.146						9,000	2120	145	615	200 - 202	373	1:38
1.128						8,000	2120	145	615	201 - 203	370	1:38
1.111						7,000	2120	145	615	203 - 204	368	1:38
1.094	6,000	2120	145	615	205 - 206	365	1:38					
1.077	5,000	2120	145	615	206 - 207	362	1:38					
1.061	4,000	2120	145	615	207 - 208	358	1:38					
1.045	3,000	2120	145	615	208 - 210	354	1:38					
1.030	2,000	2120	145	615	210 - 211	351	1:38					
1.015	1,000	2120	145	615	211 - 212	349	1:38					
1.000	Sea Level	2120	145	615	212 - 213	346	1:38					

GROSS WEIGHT: 92,000 - 88,000						DENSITY ALTITUDE FT.	GROSS WEIGHT: 88,000 - 84,000					
RPM	Inb'd BMEP	Avg. Fuel Flow	Initial-Final CAS	Air Miles	Time Hr.: Min.		RPM	Inb'd BMEP	Avg. Fuel Flow	Initial-Final CAS	Air Miles	Time Hr.: Min.
						25,000						
						24,000						
						23,000						
						22,000						
						21,000						
						20,000						
2200	140	651	187 - 190	390	1:32	19,000	2200	140	651	190 - 192	395	1:32
2200	140	651	189 - 192	389	1:32	18,000	2200	140	651	192 - 194	393	1:32
2200	140	651	190 - 193	384	1:32	17,000	2200	140	651	193 - 195	389	1:32
2200	140	651	192 - 194	380	1:32	16,000	2200	140	651	194 - 196	384	1:32
2280	135	648	194 - 195	376	1:33	15,000	2280	135	648	195 - 197	380	1:33
2220	138	635	195 - 197	375	1:34	14,000	2220	138	635	197 - 198	377	1:34
2160	142	623	196 - 198	377	1:36	13,000	2160	142	623	198 - 199	380	1:36
2120	145	615	198 - 199	388	1:38	12,000	2120	145	615	199 - 200	389	1:38
2120	145	615	199 - 200	383	1:38	11,000	2120	145	615	200 - 202	385	1:38
2120	145	615	200 - 202	383	1:38	10,000	2120	145	615	202 - 203	383	1:38
2120	145	615	202 - 203	376	1:38	9,000	2120	145	615	203 - 204	379	1:38
2120	145	615	203 - 204	373	1:38	8,000	2120	145	615	204 - 206	375	1:38
2120	145	615	204 - 206	370	1:38	7,000	2120	145	615	206 - 207	369	1:38
2120	145	615	206 - 207	366	1:38	6,000	2120	145	615	207 - 208	369	1:38
2120	145	615	207 - 208	364	1:38	5,000	2120	145	615	208 - 209	365	1:38
2120	145	615	208 - 209	360	1:38	4,000	2120	145	615	209 - 211	363	1:38
2120	145	615	210 - 211	357	1:38	3,000	2120	145	615	211 - 212	359	1:38
2120	145	615	211 - 212	353	1:38	2,000	2120	145	615	212 - 213	355	1:38
2120	145	615	212 - 213	350	1:38	1,000	2120	145	615	212 - 214	352	1:38
2120	145	615	213 - 215	349	1:38	Sea Level	2120	145	615	213 - 216	350	1:38

- Cowl flaps faired, oil radiators automatic, cabin supercharger scoops closed. Allow for effect on air-speed if other settings used.
- Shift to high blower indicated by heavy horizontal line. Auto rich operation indicated by dash-line box.

DATA AS OF: 1 January 1959

FUEL GRADE: 100/130

DATA BASIS: FLIGHT TEST

FUEL DENSITY: 6.0 lb/U.S. Gal.

Figure A7-1 (Sheet 2)

FOUR ENGINE OPERATION
CONSTANT POWER CRUISE PERF.
1300 BHP/ENG

MODEL: C-121A

ENGINES: (4) R3350-75

PROPS: CURTISS 830-21C4-0

DENSITY ALTITUDE CHART						DENSITY ALTITUDE FT.	GROSS WEIGHT: 84,000 - 80,000					
AMBIENT AIR TEMPERATURE, °C.							RPM	Inb'd BMEP	Avg. Fuel Flow	Initial-Final CAS	Air Miles	Time Hr.: Min.
1.494						25,000						
1.468						24,000						
1.443						23,000						
1.418						22,000						
1.394						21,000						
1.370						20,000						
1.347						19,000	2200	140	651	192 - 194	400	1:32
1.325						18,000	2200	140	651	194 - 195	396	1:32
1.303						17,000	2200	140	651	195 - 196	391	1:32
1.282						16,000	2200	140	651	196 - 197	387	1:32
1.261						15,000	2200	135	648	197 - 198	385	1:33
1.240						14,000	2220	138	638	198 - 199	396	1:34
1.221						13,000	2160	142	623	199 - 201	388	1:36
1.201						12,000	2120	145	615	200 - 202	392	1:38
1.182						11,000	2120	145	615	202 - 203	388	1:38
1.164						10,000	2120	145	615	203 - 204	385	1:38
1.146						9,000	2120	145	615	204 - 206	382	1:38
1.128						8,000	2120	145	615	206 - 207	377	1:38
1.111						7,000	2120	145	615	207 - 208	374	1:38
1.094						6,000	2120	145	615	208 - 209	371	1:38
1.077	5,000	2120	145	615	209 - 211	368	1:38					
1.061	4,000	2120	145	615	211 - 212	365	1:38					
1.045	3,000	2120	145	615	212 - 213	362	1:38					
1.030	2,000	2120	145	615	213 - 214	357	1:38					
1.015	1,000	2120	145	615	214 - 215	353	1:38					
1.000	Sea Level	2120	145	615	216 - 217	352	1:38					

GROSS WEIGHT: 80,000 - 76,000						DENSITY ALTITUDE FT.	GROSS WEIGHT: 76,000 - 72,000					
RPM	Inb'd BMEP	Avg. Fuel Flow	Initial-Final CAS	Air Miles	Time Hr.: Min.		RPM	Inb'd BMEP	Avg. Fuel Flow	Initial-Final CAS	Air Miles	Time Hr.: Min.
						25,000						
						24,000						
						23,000						
						22,000						
						21,000						
						20,000						
2200	140	651	194 - 196	404	1:32	19,000	2200	140	651	196 - 197	404	1:32
2200	140	651	195 - 197	399	1:32	18,000	2200	140	651	197 - 198	398	1:32
2200	140	651	196 - 198	394	1:32	17,000	2200	140	651	190 - 199	394	1:32
2200	140	651	197 - 199	390	1:32	16,000	2200	140	651	199 - 200	390	1:32
2280	135	648	198 - 200	388	1:33	15,000	2280	135	648	200 - 203	390	1:33
2220	138	635	199 - 201	390	1:34	14,000	2220	138	638	20 - 203	392	1:34
2160	142	623	201 - 202	390	1:36	13,000	2160	142	623	202 - 204	393	1:36
2120	145	615	202 - 203	395	1:38	12,000	2120	145	615	203 - 205	397	1:38
2120	145	615	202 - 203	390	1:38	11,000	2120	145	615	204 - 206	395	1:38
2120	145	615	203 - 204	386	1:38	10,000	2120	145	615	205 - 207	390	1:38
2120	145	615	204 - 205	386	1:38	9,000	2120	145	615	207 - 209	390	1:38
2120	145	615	206 - 207	385	1:38	8,000	2120	145	615	208 - 210	384	1:38
2120	145	615	207 - 208	379	1:38	7,000	2120	145	615	209 - 211	379	1:38
2120	145	615	208 - 209	376	1:38	6,000	2120	145	615	210 - 212	375	1:38
2120	145	615	209 - 210	370	1:38	5,000	2120	145	615	212 - 213	372	1:38
2120	145	615	211 - 212	370	1:38	4,000	2120	145	615	213 - 214	368	1:38
2120	145	615	212 - 213	366	1:38	3,000	2120	145	615	214 - 216	366	1:38
2120	145	615	213 - 214	364	1:38	2,000	2120	145	615	215 - 216	362	1:38
2120	145	615	214 - 215	358	1:38	1,000	2120	145	615	216 - 217	358	1:38
2120	145	615	215 - 216	353	1:38	Sea Level	2120	145	615	218 - 219	356	1:38

1. Cowl flaps fairied, oil radiators automatic, cabin supercharger scoops closed. Allow for effect on air-speed if other settings used.
2. Shift to high flow indicated by heavy horizontal line. Auto rich operation indicated by dash-line box.

DATA AS OF: 1 January 1959

FUEL GRADE: 100/130

DATA BASIS: FLIGHT TEST

FUEL DENSITY: 6.0 lb/U.S. Gal.

Figure A7-1 (Sheet 3)

FOUR ENGINE OPERATION
CONSTANT POWER CRUISE PERFORMANCE
1300 BHP/ENG

MODEL: C-121A

ENGINES: (4) R3350-75

PROPS: CURTISS B30-2104-0

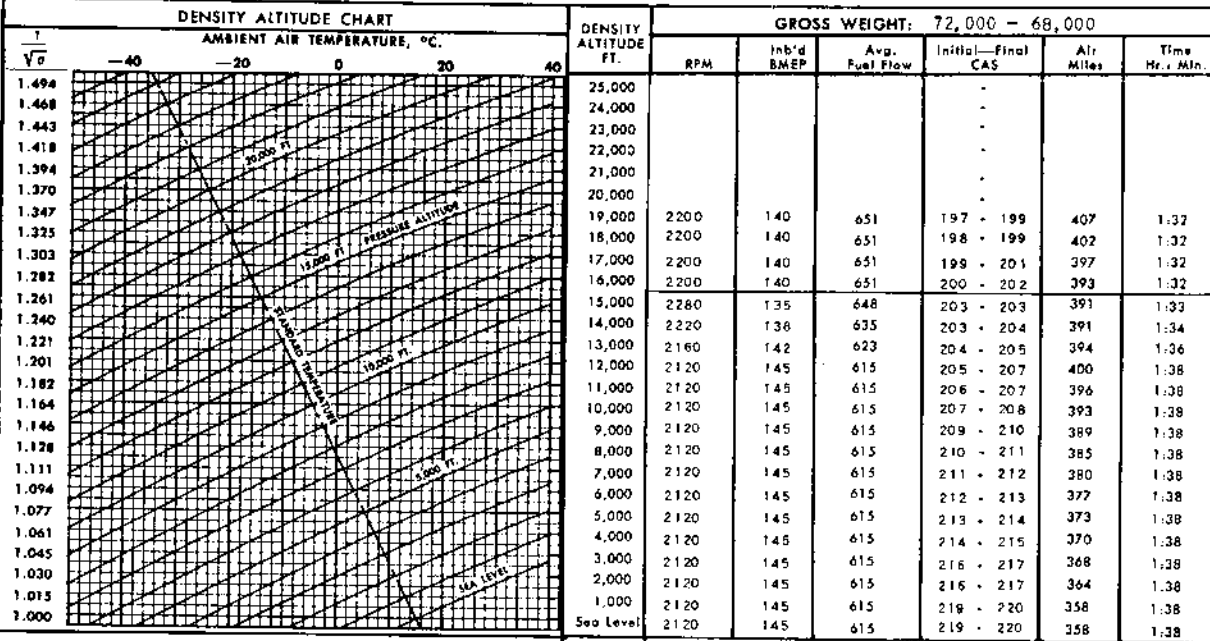

GROSS WEIGHT:						DENSITY ALTITUDE FT.	GROSS WEIGHT:					
RPM	Inb'd BMEP	Avg. Fuel Flow	Initial—Final CAS	Air Miles	Time Hr.: Min.		RPM	Inb'd BMEP	Avg. Fuel Flow	Initial—Final CAS	Air Miles	Time Hr.: Min.
			-			25,000				-		
			-			24,000				-		
			-			23,000				-		
			-			22,000				-		
			-			21,000				-		
			-			20,000				-		
			-			19,000				-		
			-			18,000				-		
			-			17,000				-		
			-			16,000				-		
			-			15,000				-		
			-			14,000				-		
			-			13,000				-		
			-			12,000				-		
			-			11,000				-		
			-			10,000				-		
			-			9,000				-		
			-			8,000				-		
			-			7,000				-		
			-			6,000				-		
			-			5,000				-		
			-			4,000				-		
			-			3,000				-		
			-			2,000				-		
			-			1,000				-		
			-			Sea Level				-		

1. Cowl flaps faired, oil radiators automatic, cabin supercharger scoops closed. Allow for effect on air-speed if other settings used.
 2. Shift to high blower indicated by heavy horizontal line. Auto rich operation indicated by dash-line box.

DATA AS OF: 1 January 1959 FUEL GRADE: 100/130
 DATA BASIS: FLIGHT TEST FUEL DENSITY: 6.0 lb/U.S. Gal.

Figure A7-1 (Sheet 4)

FOUR ENGINE OPERATION
HOLDING CRUISE CONTROL

MODEL: C-121A

ENGINES: (4) R3350-75

PROPS: CURTISS 830-2104-0

DENSITY ALTITUDE CHART						GROSS WEIGHT: 107,000 - 104,000						
AMBIENT AIR TEMPERATURE, °C.						DENSITY ALTITUDE FT.	RPM	Inb'd BMEP	Avg. Fuel Flow	Initial-Final CAS	Air Miles	Time Hr.: Min.
1/√σ	-40	-20	0	20	40							
1.494						25,000
1.488						24,000
1.443						23,000						
1.418						22,000						
1.394						21,000	2300	137	843	168	204	1:53
1.370						20,000	2260	137	669	168	252	1:07
1.347						19,000	2190	139	646	167	256	1:10
1.325						18,000	2155	140	630	167	259	1:11
1.303						17,000	2125	140	614	166	261	1:13
1.282						16,000	2090	140	600	165	263	1:15
1.261						15,000	2060	140	588	165	264	1:17
1.240						14,000	2025	140	575	165	265	1:18
1.221						13,000	2055	136	556	165	270	1:21
1.201						12,000	1980	139	539	165	274	1:23
1.182						11,000	1915	141	525	165	276	1:26
1.164						10,000	1850	144	512	165	278	1:28
1.146						9,000	1815	145	504	165	274	1:29
1.128						8,000	1795	145	495	165	280	1:31
1.111						7,000	1765	145	466	165	281	1:33
1.094						6,000	1735	145	475	165	283	1:35
1.077						5,000	1705	145	470	165	282	1:36
1.061						4,000	1685	145	464	165	282	1:37
1.045						3,000	1655	145	456	165	282	1:39
1.030						2,000	1630	145	450	165	281	1:40
1.015						1,000	1605	145	445	165	280	1:40
1.000						Sea Level	1585	145	439	165	280	1:43

GROSS WEIGHT: 104,000 - 100,000						DENSITY ALTITUDE FT.	GROSS WEIGHT: 100,000 - 96,000					
RPM	Inb'd BMEP	Avg. Fuel Flow	Initial-Final CAS	Air Miles	Time Hr.: Min.		RPM	Inb'd BMEP	Avg. Fuel Flow	Initial-Final CAS	Air Miles	Time Hr.: Min.
....	25,000
....	24,000						
						23,000						
						22,000						
2265	132	650	166	345	1:32	21,000	2195	129	606	162	364	1:39
2190	135	626	165	350	1:36	20,000	2115	132	580	162	373	1:43
2110	138	600	164	361	1:40	19,000	2045	134	560	161	379	1:47
2050	140	584	164	366	1:43	18,000	1980	136	544	161	385	1:50
2015	140	569	164	368	1:45	17,000	1930	138	529	161	389	1:53
1985	140	557	163	370	1:48	16,000	1880	139	518	160	391	1:56
1955	140	545	163	371	1:50	15,000	1840	140	508	160	391	1:58
1925	140	533	163	373	1:53	14,000	1815	140	499	159	392	2:00
1895	140	523	162	375	1:55	13,000	1790	140	490	159	393	2:02
1935	135	511	162	377	1:57	12,000	1875	131	480	159	395	2:05
1870	138	498	162	382	2:00	11,000	1820	133	471	159	397	2:07
1820	140	487	162	384	2:03	10,000	1760	135	460	159	400	2:10
1760	142	477	162	385	2:06	9,000	1710	137	450	159	402	2:13
1720	143	469	162	386	2:08	8,000	1670	139	444	159	401	2:15
1685	144	461	162	387	2:10	7,000	1615	141	438	159	401	2:17
1650	145	455	162	386	2:12	6,000	1570	143	431	159	401	2:19
1625	145	449	162	386	2:14	5,000	1530	145	425	159	400	2:21
1600	145	443	162	386	2:15	4,000	1505	145	420	159	399	2:23
1580	145	436	162	385	2:18	3,000	1485	145	415	159	398	2:25
1555	145	431	162	384	2:19	2,000	1455	145	409	159	397	2:27
1530	145	426	162	383	2:21	1,000	1435	145	404	159	397	2:29
1505	145	420	162	383	2:23	Sea Level	1415	145	398	159	397	2:31

1. Cowl flaps open, oil radiators automatic, cabin supercharger scoops closed. Allow for effect on air-speed if other settings used.
2. Shift to high blower indicated by heavy horizontal line. Auto rich operation indicated by dash-line box.

DATA AS OF: 1 January, 1959

FUEL GRADE: 100/130
FUEL DENSITY: 6.0 lb/U.S. Gal.

DATA BASIS: FLIGHT TEST

Figure A7-2 (Sheet 1)

FOUR ENGINE OPERATION
HOLDING CRUISE CONTROL

MODEL: C-121A

ENGINES: (4) R3350-75

PROPS: CURTISS 830-21C4-0

DENSITY ALTITUDE CHART							GROSS WEIGHT: 96000 - 92000						
1 / √σ AMBIENT AIR TEMPERATURE, °C.							DENSITY ALTITUDE FT.	RPM	Inb'd BMEP	Avg. Fuel Flow	Initial-Final CAS	Air Miles	Time Hr.: Min.
1.494							25,000						
1.468							24,000						
1.443							23,000	2295	120	609	160	368	1:39
1.418							22,000	2195	123	583	160	376	1:43
1.394							21,000	2120	126	560	158	385	1:47
1.370							20,000	2050	128	541	158	392	1:51
1.347							19,000	1980	130	523	158	398	1:55
1.325							18,000	1925	132	509	157	404	1:58
1.303							17,000	1875	134	497	157	406	2:01
1.282							16,000	1820	135	487	157	408	2:03
1.261							15,000	1775	137	478	156	409	2:06
1.240							14,000	1720	139	469	156	410	2:08
1.221							13,000	1680	140	460	156	410	2:10
1.201							12,000	1830	127	453	156	411	2:12
1.182							11,000	1765	129	441	156	415	2:16
1.164							10,000	1715	131	433	156	416	2:19
1.146							9,000	1665	133	425	156	418	2:21
1.128							8,000	1615	135	420	156	416	2:23
1.111							7,000	1570	137	415	156	415	2:25
1.094							6,000	1530	138	409	156	415	2:27
1.077	5,000	1490	139	402	156	414	2:29						
1.061	4,000	1455	141	397	156	414	2:31						
1.045	3,000	1415	142	392	156	413	2:33						
1.030	2,000	1400	142	386	156	412	2:35						
1.015	1,000	1400	140	382	156	411	2:37						
1.000	Sea Level	1400	138	377	156	410	2:39						

GROSS WEIGHT: 92000 - 88000							GROSS WEIGHT: 88000 - 84000					
RPM	Inb'd BMEP	Avg. Fuel Flow	Initial-Final CAS	Air Miles	Time Hr.: Min.	DENSITY ALTITUDE FT.	RPM	Inb'd BMEP	Avg. Fuel Flow	Initial-Final CAS	Air Miles	Time Hr.: Min.
						25,000						
2200	117	562	152	390	1:47	24,000	2200	112	540	153	404	1:51
2120	120	539	152	400	1:51	23,000	2120	115	519	153	414	1:56
2050	122	520	152	408	1:55	22,000	2050	117	500	153	423	2:00
1980	124	501	152	415	2:00	21,000	1990	118	485	152	428	2:04
1925	126	490	152	419	2:02	20,000	1930	120	471	152	432	2:07
1875	127	476	152	422	2:06	19,000	1870	122	459	151	438	2:11
1820	129	467	152	424	2:08	18,000	1820	124	449	151	440	2:14
1770	131	459	152	425	2:11	17,000	1775	125	440	151	441	2:16
1720	133	449	152	427	2:14	16,000	1730	126	433	151	442	2:19
1680	134	442	152	426	2:16	15,000	1890	114	426	151	440	2:21
1625	121	434	152	428	2:18	14,000	1840	115	418	150	442	2:24
1770	123	423	152	431	2:22	13,000	1775	117	407	150	446	2:27
1720	125	416	152	432	2:24	12,000	1720	119	399	150	448	2:30
1670	126	409	152	433	2:27	11,000	1670	121	391	150	450	2:33
1620	128	402	152	432	2:29	10,000	1615	123	387	150	449	2:35
1570	130	397	152	431	2:31	9,000	1570	124	381	150	448	2:37
1525	132	392	152	431	2:33	8,000	1530	126	376	150	447	2:40
1490	133	386	152	430	2:35	7,000	1490	127	371	150	447	2:42
1450	134	381	152	429	2:37	6,000	1450	129	366	150	446	2:44
1420	135	376	152	429	2:40	5,000	1410	130	360	150	445	2:47
1400	135	376	152	429	2:40	4,000	1400	129	356	150	444	2:49
1400	133	367	152	428	2:43	3,000	1400	127	352	150	443	2:50
1400	131	361	152	427	2:46	2,000	1400	125	347	150	442	2:53
1400	130	357	152	426	2:48	1,000	1400	124	342	150	441	2:55
						Sea Level	1400	122	338	150	440	2:58

1. Cowl flaps open, oil radiators automatic, cabin supercharger scoops closed. Allow for effect on air-speed if other settings used.
2. Shift to high blower indicated by heavy horizontal line. Auto rich operation indicated by dash-line box.

DATA AS OF: 1 January, 1959

FUEL GRADE: 100/130

DATA BASIS: FLIGHT TEST

FUEL DENSITY: 6.0 lb/U.S. Gal.

Figure A7-2 (Sheet 2)

FOUR ENGINE OPERATION
HOLDING CRUISE CONTROL

MODEL: C-121A

ENGINES: (4) R3350-75

PROPS: CURTISS 830-21C4-0

DENSITY ALTITUDE CHART						GROSS WEIGHT: 84000 - 80000						
AMBIENT AIR TEMPERATURE, °C.						DENSITY ALTITUDE FT.	RPM	Inb'd BMEP	Avg. Fuel Flow	Initial-Final CAS	Air Miles	Time Hr.: Min.
-40 -20 0 20 40												
1.494						25,000	2190	107	515	145	421	1:57
1.468						24,000	2110	109	494	149	431	2:01
1.443						23,000	2035	111	475	149	440	2:06
1.418						22,000	1975	113	460	148	447	2:10
1.394						21,000	1920	114	448	148	452	2:14
1.370						20,000	1870	115	437	147	454	2:17
1.347						19,000	1815	117	428	147	458	2:20
1.325						18,000	1765	118	418	147	458	2:24
1.303						17,000	1720	120	411	147	460	2:26
1.282						16,000	1675	121	405	147	459	2:28
1.261						15,000	1630	109	398	147	459	2:31
1.240						14,000	1775	111	388	146	464	2:35
1.221						13,000	1720	113	380	146	466	2:38
1.201						12,000	1660	115	374	146	466	2:40
1.182						11,000	1610	117	369	146	465	2:43
1.164						10,000	1570	118	363	146	465	2:45
1.146						9,000	1525	119	357	146	465	2:48
1.128						8,000	1480	121	353	146	463	2:50
1.111						7,000	1450	122	348	146	460	2:52
1.094						6,000	1410	123	342	146	462	2:55
1.077						5,000	1400	122	338	146	461	2:58
1.061						4,000	1400	120	335	146	459	2:59
1.045						3,000	1400	119	331	146	457	3:01
1.030						2,000	1400	117	327	146	457	3:03
1.015						1,000	1400	115	322	146	456	3:06
1.000						Sea Level	1400	113	317	146	457	3:09

GROSS WEIGHT: 80000 - 76000						GROSS WEIGHT: 76000 - 72000						
RPM	Inb'd BMEP	Avg. Fuel Flow	Initial-Final CAS	Air Miles	Time Hr.: Min.	DENSITY ALTITUDE FT.	RPM	Inb'd BMEP	Avg. Fuel Flow	Initial-Final CAS	Air Miles	Time Hr.: Min.
2100	103	467	147	453	2:08	25,000	2015	99	426	144	483	2:21
2030	105	451	146	461	2:13	24,000	1950	101	412	143	492	2:26
1970	107	436	146	470	2:18	23,000	1900	102	399	143	498	2:30
1910	108	424	145	474	2:22	22,000	1845	103	391	142	501	2:33
1860	109	414	145	478	2:25	21,000	1795	105	382	142	503	2:37
1805	111	405	144	479	2:28	20,000	1745	106	375	142	505	2:40
1755	112	396	144	481	2:32	19,000	1700	107	366	142	507	2:44
1715	113	392	144	482	2:33	18,000	1655	108	361	141	506	2:46
1670	115	383	144	483	2:37	17,000	1620	97	356	141	505	2:49
1625	103	378	144	481	2:39	16,000	1755	99	342	141	516	2:55
1770	105	369	144	486	2:43	15,000	1700	101	339	138	513	2:57
1710	107	359	143	490	2:47	14,000	1650	102	335	138	510	2:59
1660	108	355	143	489	2:49	13,000	1600	104	330	138	510	3:02
1610	110	350	143	488	2:51	12,000	1555	105	325	138	509	3:05
1560	112	345	143	487	2:54	11,000	1510	106	320	138	509	3:08
1520	113	340	143	486	2:56	10,000	1470	107	316	138	508	3:10
1480	114	335	143	486	2:59	9,000	1430	109	312	138	506	3:12
1440	115	331	143	484	3:01	8,000	1400	109	308	138	505	3:15
1405	116	327	143	482	3:03	7,000	1400	108	304	138	504	3:17
1400	115	322	143	482	3:06	6,000	1400	106	300	138	502	3:20
1400	113	317	143	481	3:09	5,000	1400	104	296	138	501	3:23
1400	112	314	143	479	3:11	4,000	1400	103	292	138	501	3:25
1400	110	310	143	478	3:14	3,000	1400	101	289	138	499	3:28
1400	108	307	143	476	3:15	2,000	1400	100	285	138	497	3:31
1400	107	301	143	477	3:19	1,000	1400	99	282	138	495	3:33
1400	105	298	143	476	3:21	Sea Level	1400	97	278	138	495	3:36

1. Cowl flaps open, oil radiators automatic, cabin supercharger scoops closed. Allow for effect on air-speed if other settings used.

2. Shift to high blower indicated by heavy horizontal line. Auto rich operation indicated by dash-line box.

DATA AS OF: 1 January, 1959

DATA BASIS: FLIGHT TEST

FUEL GRADE: 100/130

FUEL DENSITY: 6.0 lb/U.S. Gal.

Figure A7-2 (Sheet 3)

FOUR ENGINE OPERATION
HOLDING CRUISE CONTROL

MODEL: C-121A

ENGINES: (4) R3350-75

PROPS: CURTISS 830-21C4-0

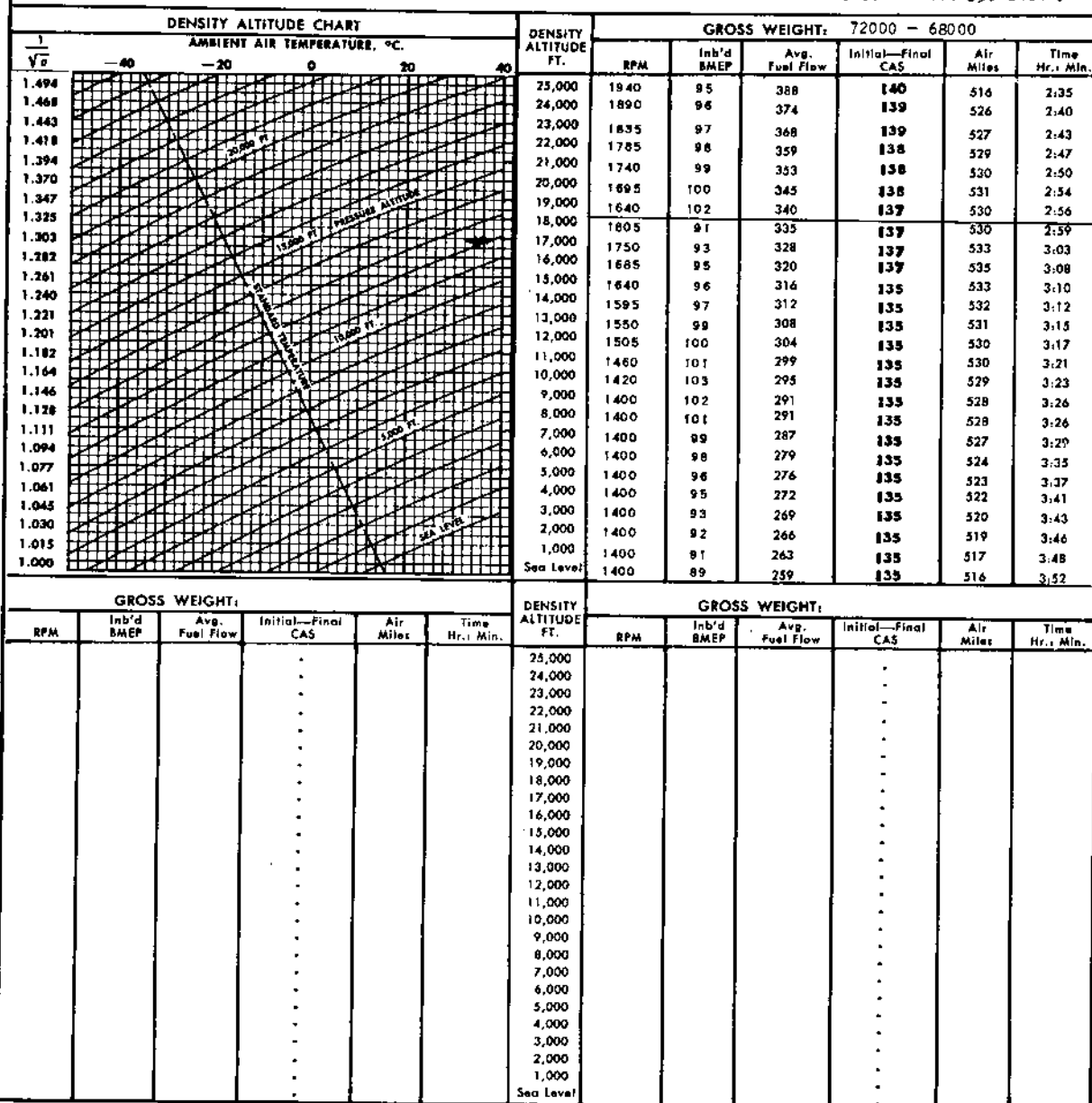

1. Cowl flaps open, oil radiators automatic, cabin supercharger scoops closed. Allow for effect on air-speed if other settings used.
 2. Shift to high blower indicated by heavy horizontal line. Auto rich operation indicated by dash-line box.
 DATA AS OF: 1 January, 1959
 DATA BASIS: FLIGHT TEST
 FUEL GRADE: 100/130
 FUEL DENSITY: 6.0 lb/U.S. Gal.

Figure A7-2 (Sheet 4)

THREE ENGINE OPERATION
H-1 CRUISE PERFORMANCE

MODEL: C-121A

ENGINES: (4) R3350-75

PROPS: CURTISS 830-2104-0

DENSITY ALTITUDE CHART						DENSITY ALTITUDE FT.	GROSS WEIGHT: 107,000 to 104,000 LBS.					
AMBIENT AIR TEMPERATURE, °C.							RPM	Inb'd BMEP	Avg. Fuel Flow	Initial-Final CAS	Air Miles	Time Hr.: Min.
$\frac{1}{\sqrt{\sigma}}$	-40	-20	0	20	40							
1.494						25,000						
1.468						24,000						
1.443						23,000						
1.418						22,000						
1.394						21,000						
1.370						20,000						
1.347						19,000						
1.325						18,000						
1.303						17,000						
1.282						16,000						
1.261						15,000						
1.240						14,000						
1.221						13,000						
1.201						12,000						
1.182						11,000						
1.164						10,000						
1.146	9,000	2400	179	1190	184 - 188	179	.50					
1.128	8,000	2400	176	1165	184 - 183	180	.52					
1.111	7,000	2400	174	1141	184 - 186	184	.53					
1.094	6,000	2400	171	1121	184 - 188	181	.53					
1.077	5,000	2400	169	1100	184 - 188	185	.55					
1.061	4,000	2400	166	1082	184 - 188	185	.56					
1.045	3,000	2400	164	1059	184 - 188	185	.57					
1.030	2,000	2400	163	1050	184 - 188	188	.57					
1.015	1,000	2400	159	1021	184 - 188	189	.59					
1.000	Sea Level	2400	151	960	184 - 188	198	1:02					

GROSS WEIGHT: 104000 - 100000						DENSITY ALTITUDE FT.	GROSS WEIGHT: 100,000 to 96,000 LBS.					
RPM	Inb'd BMEP	Avg. Fuel Flow	Initial-Final CAS	Air Miles	Time Hr.: Min.		RPM	Inb'd BMEP	Avg. Fuel Flow	Initial-Final CAS	Air Miles	Time Hr.: Min.
						25,000						
						24,000						
						23,000						
						22,000						
						21,000						
						20,000						
						19,000						
						18,000						
						17,000						
						16,000						
						15,000	2400	176	1292	175 - 180	231	1:02
						14,000	2400	176	1292	178 - 182	230	1:02
						13,000	2400	176	1293	181 - 184	230	1:02
						12,000	2400	176	1291	183 - 186	229	1:02
						11,000	2400	174	1262	183 - 186	231	1:03
2400	175	1154	182 - 185	248	1:09	10,000	2400	171	1121	183 - 186	256	1:11
2400	174	1146	183 - 187	249	1:10	9,000	2400	168	1096	183 - 186	255	1:13
2400	171	1121	183 - 187	249	1:11	8,000	2400	165	1075	183 - 186	258	1:14
2400	169	1100	183 - 187	251	1:13	7,000	2400	163	1056	183 - 186	257	1:16
2400	166	1082	183 - 187	250	1:14	6,000	2400	161	1041	183 - 186	260	1:17
2400	164	1060	183 - 187	253	1:13	5,000	2400	158	1017	183 - 186	262	1:19
2400	161	1041	183 - 187	255	1:17	4,000	2400	150	996	183 - 186	261	1:20
2400	159	1021	183 - 187	254	1:18	3,000	2400	154	979	183 - 186	263	1:22
2400	158	1015	183 - 187	256	1:19	2,000	2400	153	973	183 - 186	266	1:22
2400	154	983	183 - 187	259	1:21	1,000	2400	152	966	183 - 186	268	1:23
2400	152	966	183 - 187	258	1:23	Sea Level	2300	151	871	181 - 184	278	1:32

1. Cowl flaps faired, oil radiators automatic, cabin supercharger scoops closed. Allow for effect on air-speed if other settings used.
2. Shift to high blower indicated by heavy horizontal line. Auto rich operation indicated by dash-line box.

DATA AS OF: 1 January, 1959

FUEL GRADE: 100/130

DATA BASIS: FLIGHT TEST

FUEL DENSITY: 6.0 lb/U.S. Gal.

Figure A7-3 (Sheet 1)

THREE ENGINE OPERATION
H-1 CRUISE PERFORMANCE

MODEL: C-121A

ENGINES: (4) R3350-75

PROPS: CURTISS 830-21C4-0

DENSITY ALTITUDE CHART							DENSITY ALTITUDE FT.	GROSS WEIGHT: 96000 to 92000 LBS.					
$\frac{1}{\sqrt{\rho}}$	AMBIENT AIR TEMPERATURE, °C.					RPM		Inb'd BMEP	Avg. Fuel Flow	Initial-Final CAS	Air Miles	Time Hr.: Min.	
1.494						25,000							
1.468						24,000							
1.443						23,000							
1.418						22,000							
1.394						21,000							
1.370						20,000							
1.347						19,000							
1.325						18,000							
1.303						17,000	2400	175	1283	175 - 180	239	1:02	
1.282						16,000	2400	176	1293	177 - 181	240	1:02	
1.261						15,000	2400	176	1293	181 - 185	238	1:02	
1.240						14,000	2400	174	1275	181 - 185	238	1:03	
1.221						13,000	2400	172	1252	181 - 185	237	1:04	
1.201						12,000	2400	169	1218	181 - 185	241	1:06	
1.182						11,000	2400	166	1194	181 - 185	243	1:07	
1.164						10,000	2400	165	1075	181 - 185	270	1:15	
1.146						9,000	2400	161	1041	181 - 185	272	1:17	
1.128						8,000	2400	159	1021	181 - 185	272	1:18	
1.111						7,000	2300	151	727	169 - 176	350	1:50	
1.094	6,000	2300	151	727	172 - 177	349	1:50						
1.077	5,000	2300	151	727	175 - 179	348	1:50						
1.061	4,000	2300	151	727	177 - 181	337	1:50						
1.045	3,000	2300	151	727	179 - 183	346	1:50						
1.030	2,000	2300	151	727	180 - 183	345	1:50						
1.015	1,000	2285	150	715	181 - 185	345	1:52						
1.000	Sea level	2275	148	705	181 - 185	346	1:53						

GROSS WEIGHT: 92000 - 88000							DENSITY ALTITUDE FT.	GROSS WEIGHT: 88000 to 84000 LBS.					
RPM	Inb'd BMEP	Avg. Fuel Flow	Initial-Final CAS	Air Miles	Time Hr.: Min.	RPM		Inb'd BMEP	Avg. Fuel Flow	Initial-Final CAS	Air Miles	Time Hr.: Min.	
						25,000							
						24,000							
						23,000							
						22,000							
						21,000							
						20,000							
						19,000							
2400	168	1215	172 - 177	253	1:06	18,000	2400	161	1149	170 - 173	268	1:10	
2400	173	1262	178 - 181	249	1:03	17,000	2400	165	1186	175 - 178	264	1:07	
2400	172	1253	178 - 181	248	1:04	16,000	2400	162	1160	175 - 178	267	1:09	
2400	168	1215	178 - 181	248	1:06	15,000	2400	162	1052	175 - 178	266	1:09	
2400	165	1180	178 - 181	250	1:08	14,000	2300	151	727	162 - 169	381	1:50	
2400	162	1157	178 - 181	253	1:09	13,000	2300	151	727	166 - 171	382	1:50	
2400	160	1135	178 - 181	253	1:10	12,000	2300	151	727	168 - 172	382	1:50	
2300	151	727	166 - 172	365	1:50	11,000	2300	151	727	170 - 174	378	1:50	
2300	151	727	169 - 174	364	1:50	10,000	2300	151	727	172 - 175	377	1:50	
2300	151	727	171 - 176	363	1:50	9,000	2285	150	715	175 - 178	374	1:50	
2300	151	727	173 - 177	360	1:50	8,000	2260	149	704	175 - 178	375	1:50	
2300	151	727	176 - 179	360	1:50	7,000	2245	148	688	175 - 178	376	1:54	
2300	151	727	178 - 181	358	1:50	6,000	2235	146	679	175 - 178	379	1:56	
2280	150	712	178 - 181	361	1:52	5,000	2220	146	668	175 - 178	380	1:58	
2280	150	701	178 - 181	363	1:54	4,000	2190	145	649	175 - 178	380	2:00	
2250	148	690	178 - 181	363	1:56	3,000	2145	145	630	175 - 178	384	2:03	
2235	146	684	178 - 181	365	1:57	2,000	2140	146	636	175 - 178	390	2:07	
2215	146	666	178 - 181	364	2:00	1,000	2105	144	605	175 - 178	385	2:12	
2200	145	654	178 - 181	365	2:02	Sea level	2080	145	597	175 - 178	395	2:14	

1. Cowl flaps faired, oil radiators automatic, cabin supercharger scoops closed. Allow for effect on air-speed if other settings used.
2. Shift to high blower indicated by heavy horizontal line. Auto rich operation indicated by dash-line box.

DATA AS OF: 1 January, 1959
DATA BASIS: FLIGHT TEST

FUEL GRADE: 100/130
FUEL DENSITY: 6.0 lb/U.S. Gal.

Figure A7-3 (Sheet 2)

THREE ENGINE OPERATION
H-1 CRUISE PERFORMANCE

MODEL: C-121A

ENGINES: (4) R3350-75

PROPS: CURTISS 830-21C4-0

DENSITY ALTITUDE CHART						GROSS WEIGHT: 84000 - 80000 LBS.						
AMBIENT AIR TEMPERATURE, °C.						DENSITY ALTITUDE FT.	RPM	Inb'd BMEP	Avg. Fuel Flow	Initial-Final CAS	Air Miles	Time Hr.: Min.
$\sqrt{\sigma}$	-40	-20	0	20	40							
1.494						25,000				-		
1.468						24,000						
1.443						23,000						
1.418						22,000						
1.394						21,000						
1.370						20,000	2400	154	1183	158 - 165	274	1:08
1.347						19,000	2400	149	1035	167 - 171	296	1:12
1.323						18,000	2400	143	983	165 - 169	306	1:21
1.303						17,000	2400	138	938	158 - 165	304	1:25
1.282						16,000	2300	144	716	158 - 165	390	1:52
1.261						15,000	2300	144	716	163 - 168	388	1:52
1.240						14,000	2300	141	686	163 - 168	397	1:57
1.221						13,000	2300	151	726	172 - 175	390	1:50
1.201						12,000	2280	149	710	172 - 175	390	1:53
1.182						11,000	2265	148	695	172 - 175	394	1:55
1.164						10,000	2245	147	684	172 - 175	394	1:57
1.146	9,000	2225	146	669	172 - 175	397	2:00					
1.128	8,000	2205	145	656	172 - 175	397	2:07					
1.111	7,000	2175	145	636	172 - 175	404	2:06					
1.094	6,000	2140	145	624	172 - 175	407	2:08					
1.077	5,000	2100	145	604	172 - 175	412	2:12					
1.061	4,000	2080	145	595	172 - 175	412	2:14					
1.045	3,000	2050	144	585	172 - 175	414	2:17					
1.030	2,000	2035	145	581	172 - 175	412	2:18					
1.015	1,000	1980	144	562	172 - 175	419	2:22					
1.000	Sea Level	1960	145	551	172 - 175	418	2:25					

GROSS WEIGHT: 80000 - 76000						GROSS WEIGHT: 76000 - 72000 LBS.						
RPM	Inb'd BMEP	Avg. Fuel Flow	Initial-Final CAS	Air Miles	Time Hr.: Min.	DENSITY ALTITUDE FT.	RPM	Inb'd BMEP	Avg. Fuel Flow	Initial-Final CAS	Air Miles	Time Hr.: Min.
						25,000						
						24,000						
						23,000						
						22,000						
						21,000						
2400	154	1082	171 - 174	292	1:14	20,000	2300	138	690	160 - 164	430	1:56
2300	144	716	160 - 165	407	1:52	19,000	2300	144	716	170 - 172	428	1:52
2300	144	716	162 - 166	404	1:52	18,000	2300	144	716	170 - 172	421	1:52
2300	144	716	164 - 168	402	1:52	17,000	2300	144	716	170 - 172	413	1:52
2300	144	716	164 - 168	401	1:52	16,000	2300	144	716	170 - 172	412	1:52
2300	144	716	168 - 171	397	1:52	15,000	2300	144	716	170 - 172	412	1:52
2275	144	702	166 - 171	380	1:54	14,000	2280	143	701	170 - 172	410	1:54
2245	147	685	171 - 173	410	1:57	13,000	2275	141	672	170 - 172	421	1:59
2220	146	668	171 - 173	413	2:00	12,000	2175	145	643	170 - 172	434	2:04
2200	145	655	171 - 173	413	2:02	11,000	2150	144	629	170 - 172	436	2:07
2175	144	640	171 - 173	416	2:05	10,000	2110	145	610	170 - 172	443	2:11
2135	145	622	171 - 173	422	2:09	9,000	2030	144	598	170 - 172	442	2:14
2110	144	609	171 - 173	425	2:11	8,000	2055	144	588	170 - 172	445	2:16
2075	145	595	171 - 173	428	2:14	7,000	2020	144	572	170 - 172	450	2:20
2050	145	585	171 - 173	430	2:17	6,000	1985	145	560	170 - 172	452	2:23
2000	145	567	171 - 173	435	2:21	5,000	1925	145	551	170 - 172	451	2:25
1980	145	559	171 - 173	434	2:23	4,000	1960	144	539	170 - 172	456	2:28
1950	145	549	171 - 173	436	2:26	3,000	1900	144	529	170 - 172	458	2:31
1940	145	545	171 - 173	437	2:27	2,000	1860	145	529	170 - 172	451	2:31
1890	145	528	171 - 173	440	2:32	1,000	1850	145	525	170 - 172	477	2:32
1860	145	519	171 - 173	442	2:34	Sea Level	1850	145	502	170 - 172	460	2:39
							1785	145	496	170 - 172	459	2:41

- Cowl flaps faired, oil radiators automatic, cabin supercharger scoops closed. Allow for effect on air-speed if other settings used.
- Shift to high blower indicated by heavy horizontal line. Auto rich operation indicated by dash-line box.

DATA AS OF: 1 January, 1959

DATA BASIS: FLIGHT TEST

FUEL GRADE: 100/130

FUEL DENSITY: 6.9 lb/gal. U.S.

Figure A7-3 (Sheet 3)

THREE ENGINE OPERATION
H-1 CRUISE PERFORMANCE

MODEL: C-121A

ENGINES: (4) R3350-75

PROPS: CURTISS 830-21C4-0

DENSITY ALTITUDE CHART						GROSS WEIGHT: 72000 - 68000 LBS.						
AMBIENT AIR TEMPERATURE, °C.						DENSITY ALTITUDE FT.	RPM	Inb'd BMEP	Avg. Fuel Flow	Initial-Final CAS	Air Miles	Time Hr., Min.
1/°	-40	-20	0	20	40							
1.494						25,000				-		
1.468						24,000				-		
1.443						23,000				-		
1.418						22,000				-		
1.394						21,000				-		
1.370						20,000	2300	138	670	162 - 165	445	1:39
1.347						19,000	2300	144	695	169 - 171	440	1:55
1.325						18,000	2300	144	693	169 - 171	432	1:55
1.303						17,000	2275	143	680	169 - 171	436	1:58
1.282						16,000	2255	142	666	169 - 171	441	2:00
1.261						15,000	2235	141	656	169 - 171	435	2:02
1.240						14,000	2260	134	637	169 - 171	442	2:06
1.221						13,000	2105	145	609	169 - 171	454	2:11
1.201						12,000	2075	145	595	169 - 171	457	2:14
1.182						11,000	2040	145	583	169 - 171	459	2:17
1.164						10,000	2010	145	571	169 - 171	462	2:20
1.146						9,000	1980	145	559	169 - 171	464	2:23
1.128						8,000	1950	145	549	169 - 171	466	2:26
1.111						7,000	1920	145	537	169 - 171	470	2:29
1.094						6,000	1895	145	528	169 - 171	470	2:32
1.077						5,000	1860	145	517	169 - 171	470	2:35
1.061						4,000	1830	145	509	169 - 171	472	2:37
1.045						3,000	1800	145	497	169 - 171	476	2:41
1.030						2,000	1795	145	497	169 - 171	474	2:41
1.015						1,000	1755	145	485	169 - 171	476	2:45
1.000						Sea Level	1725	145	476	169 - 171	475	2:48

GROSS WEIGHT:						DENSITY ALTITUDE FT.	GROSS WEIGHT:					
RPM	Inb'd BMEP	Avg. Fuel Flow	Initial-Final CAS	Air Miles	Time Hr., Min.		RPM	Inb'd BMEP	Avg. Fuel Flow	Initial-Final CAS	Air Miles	Time Hr., Min.
						25,000						
						24,000						
						23,000						
						22,000						
						21,000						
						20,000						
						19,000						
						18,000						
						17,000						
						16,000						
						15,000						
						14,000						
						13,000						
						12,000						
						11,000						
						10,000						
						9,000						
						8,000						
						7,000						
						6,000						
						5,000						
						4,000						
						3,000						
						2,000						
						1,000						
						Sea Level						

- Cowl flaps faired, oil radiators automatic, cabin supercharger scoops closed. Allow for effect on air-speed if other settings used.
- Shift to high blower indicated by heavy horizontal line. Auto rich operation indicated by dash-line box.

DATA AS OF: 1 January, 1959

FUEL GRADE: 100/130

DATA BASIS: FLIGHT TEST

FUEL DENSITY: 6.0 lb/u. S. Gal.

Figure A7-3 (Sheet 4)

TWO ENGINE OPERATION
HOLDING CRUISE CONTROL

MODEL: C-121A

ENGINES: (4) R3350-75

PROPS: CURT ISS 830-21C4-0

DENSITY ALTITUDE CHART						GROSS WEIGHT: 104000 - 100000 LB						
AMBIENT AIR TEMPERATURE, °C.						DENSITY ALTITUDE FT.	RPM	Inb'd BMEP	Avg. Fuel Flow	Initial—Final CAS	Air Miles	Time Hr.: Min.
1.494						25,000						
1.468						24,000						
1.443						23,000						
1.418						22,000						
1.394						21,000						
1.370						20,000						
1.347						19,000						
1.325						18,000						
1.303						17,000						
1.282						16,000						
1.261						15,000						
1.240						14,000						
1.221						13,000						
1.201						12,000						
1.182						11,000						
1.164						10,000	2400	206	1475	161	220	1:21
1.146						9,000	2400	203	1436	161	223	1:24
1.128						8,000						
1.111						7,000						
1.094						6,000						
1.077	5,000											
1.061	4,000											
1.045	3,000											
1.030	2,000											
1.015	1,000											
1.000	Sea Level											

GROSS WEIGHT: 100000 - 96000 LB						GROSS WEIGHT: 96000 - 92000 LB						
RPM	Inb'd BMEP	Avg. Fuel Flow	Initial—Final CAS	Air Miles	Time Hr.: Min.	DENSITY ALTITUDE FT.	RPM	Inb'd BMEP	Avg. Fuel Flow	Initial—Final CAS	Air Miles	Time Hr.: Min.
						25,000						
						24,000						
						23,000						
						22,000						
						21,000						
						20,000						
						19,000						
						18,000						
						17,000						
						16,000						
						15,000						
						14,000						
						13,000						
						12,000						
						11,000						
						10,000						
						9,000						
						8,000						
						7,000						
						6,000	2400	196	1374	155	246	1:27
2400	206	1480	158	228	1:21	5,000	2400	195	1338	155	249	1:30
2400	204	1440	158	231	1:23	4,000	2400	192	1309	155	250	1:32
2400	200	1402	158	234	1:26	3,000	2400	189	1282	155	252	1:34
2400	197	1368	158	237	1:28	2,000	2400	186	1255	155	254	1:36
2400	195	1338	158	239	1:30	1,000	2400	184	1230	155	256	1:38
2400	192	1309	158	241	1:32	Sea Level	2400	181	1207	155	258	1:39

1. Cowl flaps open, oil radiators automatic, cabin supercharger scoops closed. Allow for effect on air-speed if other settings used.
2. Shift to high blower indicated by heavy horizontal line. Auto rich operation indicated by dash-line box.

DATA AS OF: 1 JANUARY 1959

DATA BASIS: FLIGHT TEST

FUEL GRADE: 100/130

FUEL DENSITY: 6.0 lb/U.S. Gal.

Figure A7-4 (Sheet 1)

TWO ENGINE OPERATION
HOLDING CRUISE CONTROL

MODEL: C-121A

ENGINES: (4) R3350-75

PROPS: CURTISS 830-21C4-0

DENSITY ALTITUDE CHART							GROSS WEIGHT: 92000 - 88000 LB						
AMBIENT AIR TEMPERATURE, °C.							DENSITY ALTITUDE FT.	RPM	Inb'd BMEP	Avg. Fuel Flow	Initial-Final CAS	Air Miles	Time Hr.: Min.
1.494	25,000												
1.468	24,000												
1.443	23,000												
1.418	22,000												
1.394	21,000												
1.370	20,000												
1.347	19,000												
1.325	18,000												
1.303	17,000												
1.282	16,000												
1.261	15,000												
1.240	14,000												
1.221	13,000												
1.201	12,000												
1.182	11,000												
1.164	10,000												
1.146	9,000												
1.128	8,000												
1.111	7,000	2400	188	1272	152	265	1:34						
1.094	6,000	2400	185	1245	152	268	1:36						
1.077	5,000	2400	182	1217	152	270	1:39						
1.061	4,000	2400	180	1195	152	270	1:40						
1.045	3,000	2400	177	1171	152	271	1:42						
1.030	2,000	2400	174	1149	152	273	1:44						
1.015	1,000	2400	172	1128	152	273	1:46						
1.000	Sea Level	2400	169	1106	152	277	1:48						

GROSS WEIGHT: 88000 - 84000 LB							GROSS WEIGHT: 84000 - 80000 LB					
RPM	Inb'd BMEP	Avg. Fuel Flow	Initial-Final CAS	Air Miles	Time Hr.: Min.	DENSITY ALTITUDE FT.	RPM	Inb'd BMEP	Avg. Fuel Flow	Initial-Final CAS	Air Miles	Time Hr.: Min.
						25,000						
						24,000						
						23,000						
						22,000						
						21,000						
						20,000						
						19,000						
						18,000						
						17,000						
						16,000						
						15,000						
						14,000						
						13,000						
						12,000						
						11,000						
2400	179	1188	149	284	1:41	10,000	2400	171	1118	145	304	1:47
2400	176	1167	149	285	1:43	9,000	2400	168	1096	145	305	1:49
2400	174	1145	149	286	1:45	8,000	2400	165	1075	145	307	1:52
2400	171	1120	149	288	1:47	7,000	2400	163	1055	145	309	1:54
2400	168	1100	149	290	1:49	6,000	2400	160	1035	145	310	1:56
2400	166	1080	149	290	1:51	5,000	2400	158	1014	145	311	1:58
2400	164	1060	149	292	1:53	4,000	2400	156	996	145	312	2:00
2400	161	1040	149	294	1:55	3,000	2400	153	977	145	314	2:03
2400	159	1020	149	296	1:58	2,000	2400	151	961	145	315	2:05
						1,000	2400	149	929	145	316	2:09
						Sea Level	2400	147	910	145	319	2:12

1. Cowl flaps open, oil radiators automatic, cabin supercharger scoops closed. Allow for effect on air-speed if other settings used.
2. Shift to high blower indicated by heavy horizontal line. Auto rich operation indicated by dash-line box.

DATA AS OF: 1 JANUARY 1959

FUEL GRADE: 100/130

DATA BASIS: FLIGHT TEST

FUEL DENSITY: 6.01b/U.S. Gal.

Figure A7-4 (Sheet 2)

**TWO ENGINE OPERATION
HOLDING CRUISE CONTROL**

MODEL: C-121A

ENGINES: (4) R3350-75

PROPS: CURTISS 830-21C4-G

DENSITY ALTITUDE CHART						DENSITY ALTITUDE FT.	GROSS WEIGHT: 80000 - 76000 LB					
$\frac{1}{\sqrt{\sigma}}$	AMBIENT AIR TEMPERATURE, °C.				RPM		Inb'd BMEP	Avg. Fuel Flow	Initial—Final CAS	Air Miles	Time Hr.: Min.	
1.494					25,000							
1.468					24,000							
1.443					23,000							
1.418					22,000							
1.394					21,000							
1.370					20,000							
1.347					19,000							
1.325					18,000							
1.303					17,000							
1.282					16,000							
1.261					15,000							
1.240					14,000							
1.221					13,000							
1.201					12,000							
1.182					11,000	2400	159	1024	142	327	1:57	
1.164					10,000	2400	157	1005	142	328	1:59	
1.146	9,000	2400	154	987	142	329	2:02					
1.128	8,000	2400	152	968	142	330	2:04					
1.111	7,000	2400	150	950	142	332	2:06					
1.094	6,000	2400	147	930	142	334	2:09					
1.077	5,000	2400	145	916	142	337	2:11					
1.061	4,000											
1.045	3,000	150	719		142	412	2:47					
1.030	2,000	2270	149	705		414	2:50					
1.015	1,000	2250	148	693		416	2:53					
1.000	Sea Level	2235	147	679		418	2:57					
GROSS WEIGHT: 76000 - 72000 LB						DENSITY ALTITUDE FT.	GROSS WEIGHT: 72000 - 68000 LB					
RPM	Inb'd BMEP	Avg. Fuel Flow	Initial—Final CAS	Air Miles	Time Hr.: Min.		RPM	Inb'd BMEP	Avg. Fuel Flow	Initial—Final CAS	Air Miles	Time Hr.: Min.
						25,000						
						24,000						
						23,000						
						22,000						
						21,000						
						20,000						
						19,000						
						18,000						
						17,000						
						16,000						
						15,000						
						14,000						
						13,000						
						12,000						
						11,000						
2400	147	930	138	352	2:09	10,000	2220	146	669	134	463	2:59
2300	151	727	138	434	2:45	9,000	2205	145	656	134	467	3:03
2285	150	714	138	435	2:48	8,000	2175	145	640	134	471	3:08
2265	149	701	138	437	2:51	7,000	2140	145	623	134	477	3:13
2245	148	686	138	440	2:55	6,000	2105	145	609	134	481	3:17
2225	147	672	138	441	2:59	5,000	2075	145	595	134	484	3:22
2210	146	661	138	442	3:02	4,000	2045	145	585	134	486	3:25
2190	145	649	138	444	3:05	3,000	2015	145	574	134	488	3:29
2160	145	632	138	450	3:10	2,000	1985	145	561	134	490	3:34
2130	145	614	138	455	3:15	1,000	1955	145	553	134	492	3:37
2095	145	603	138	458	3:19	Sea Level	1930	145	542	134	494	3:41

- Cowl flaps open, oil radiators automatic, cabin supercharger scoops closed. Allow for effect on air-speed if other settings used.
- Shift to high blower indicated by heavy horizontal line. Auto rich operation indicated by dash-line box.

DATA AS OF: 1 JANUARY 1959

DATA BASIS: FLIGHT TEST

FUEL GRADE: 100/130

FUEL DENSITY: 6.0lb/u.S. Gal.

Figure A7-4 (Sheet 3)

ALPHABETICAL INDEX

	<i>Page</i>	<i>Page</i>
A		
A. C. Electrical System	1-22	
A.C. Power Supply	1-23*	
Abort Take-Off Procedure	3-24A	
ADF and Range Procedures	9-7*	
ADF Landing Gear Down Correction Circuit & Panel	4-57	
After Landing	2-39	
After Take-Off/Climb	2-25	
Aftercooler and Refrigerator Schematic	4-18*	
Aftercooler Scoop and Refrigerator Control	4-14*	
Aileron Control System	1-32	
Air Conditioning System	4-1	
—Controls	4-16, 4-25*	
—Duct System	4-23*	
—Electrical Location Diagram	4-11*	
—Emergency Procedures	4-26	
—Normal Procedures	4-24	
Air Conditioning with Ground Truck	4-6*	
Air Induction System, Engine	1-4	
Aircraft, The	1-1	
Aircraft Configurations	A1-2	
Airspeed and Altimeter Correction Charts	A1-2	
Airspeed Compressibility Correction Graph	A1-11*	
Airspeed Installation Error Correction	A1-6*	
Airspeed Limitations	5-4	
Alcohol Anti-Icing Systems	4-35	
All Weather Operation	9-1	
Altimeter Installation Error Correction	A1-8*	
Altitude Relationship	A1-5	
Amplified Check Lists	2-6	
AN/AIC-10A Interphone Communication System	4-37	
AN/APN-1 Radio Altimeter	4-61	
AN/APN-9 Loran Receiver	4-59	
AN/APS-42 Search Radar	4-62	
AN/APX-25 Radar Identification Transponder	4-62	
AN/ARC-27 UHF Transmitter-Receiver Set	4-48	
AN/ARC-58 SSB-AM HF Equipment	4-55	
AN/ARC-58 Circuit Breaker Panel	4-57*	
AN/ARC-58 Control Panel	4-56*	
AN/ARC-58 Liaison Transceiver	4-54*	
AN, ARC-8 Communication System	4-49	
AN/ARN-6 ADF Systems	4-56	
AN/ARN-14 VOR Systems	4-57	
AN/ARN-18 Glide Slope Receiver	4-59	
AN/ARN-21 Tacan System	4-57	
AN/ART-13A Transmitter	4-49	
AN/CRT-3 Emergency Transmitter	1-52A	
AN/URC-4 Emergency Transmitter	1-52A	
Antenna Diagram	4-42*	
Anti-Icing System, Carburetor Alcohol	4-35, 4-28*	
Appendix Data Basis	A1-2	
Appendix Symbols and Definitions	A1-3	
Approach Horizon	1-43	
Approach Procedures	9-3	
APS-42 Scope, Pilots'	4-63*	
APU Fire	3-21	
Asymmetry Protection System, Wing Flap	1-34	
Automatic Approach	9-6	
Automatic Pilot	4-70	
—Controls	4-72*	
—Failures	4-75	
Auxiliary Equipment	1-54	
Auxiliary Fuel Pump Operation	7-4	
Auxiliary Power Unit	4-76, 4-77*	
—Wiring and Controls	4-78*	
Auxiliary Vent Control Knob	4-20*	
Auxiliary Ventilation and Pressurization Control, Wiring Diagram	4-12*	
Auxiliary Ventilation In Flight with Heating	4-2*	
—Without Heating	4-8*	
Auxiliary Ventilation on Ground	4-4*	
B		
Bail Out	3-24	
Batteries	1-19	
BC-348 HF Receiver	4-55	
Before Interior Inspection	2-7	
Before Landing	2-33	
Before Leaving Aircraft	2-40	
Before Starting Engines	2-7	
Before Take-Off	2-21	
Before Taxiing	2-14	
BMEP Bleeds	1-13	
BMEP Limit Considerations	A2-2	
Boosters, Flight Control	1-32	
Boost Off Landing	3-29	
Boost Out, Practice With	3-12A	
Brake Operation, Emergency	3-58	

	<i>Page</i>	<i>Page</i>
Brake System	1-38	
Brakes, Use of Landing Wheel	7-6	
C		
Cabin Fire	3-13	
Cabin Heater Ducting	4-9*	
Cabin Heater Fire	3-19	
Cabin Pressurization Limitation	5-4	
Cabin Supercharger Drive Shafts, Procedure for Disconnecting	3-59	
Cabin Temperature Control	4-15*	
Cabin Utility	1-3	
Carburetor (Fuel Master Control Unit)	1-3	
Carburetor Alcohol Anti-Icing System	4-35	
Carburetor Icing	7-4	
Cargo Compartment Fire	3-16	
Characteristics and Limits, Engine	A2-2, A2-6*	
Circling Approaches	9-3, 9-4*	
Circuit Breaker Panels	1-27*	
- AN ARC-58	4-57*	
Clean Out Procedure, Plug	7-1	
Climb Four Engine Maximum Cruise Power	A4-5*	
-Instrument	9-2	
Climb, Mto Power - Four Engine Enroute	A4-3*	
- Three Engine Enroute	A4-7*	
- Two Engine Enroute	A4-9*	
Climb Performance, Cruise Power	A4-2	
Four Engine	A4-6*	
Three Engine	A4-8*	
Two Engine	A4-10*	
Climb Power Manifold Pressure Limits	A2-3	
Climb Power Settings	A4-2	
Clocks	1-43	
Cold Weather Procedures	9-9	
Collins 618S-1 Transmitter-Receiver	4-49	
Communication System VHF 101	4-48	
Communications and Associated Electronic Equipment	4-36	
Compasses	1-40	
Compass System & RMI Voltage Supply	1-24B*	
Composite Cruise Control Chart - Four Engine Operation	A5-12*	
- Three Engine Operation	A5-15*	
- Two Engine Operation	A5-18*	
Composite Cruising Charts	A5-3	
Compressibility Correction Table	A1-10*	
Configuration and Performance	5-7	
Cooling in Cabin and Heat in Flight Station	4-7*	
Copilot	8-1	
Copilot's Side Panel	1-45*	
Corona Radio Static	9-2	
Correction and Conversion Charts, Temperature	A1-3	
Correction Charts, Airspeed and Altimeter	A1-2	
Cowl Flaps, Engine	1-4	
Crash Landing Stations, Crew	3-26*	
Crew Requirements	1-3, 5-1	
Crew Interphone Control Panel	4-41*	
Crew Seats	1-53	
Critical Engine Failure Speed	A5-19*	
Critical Field Length	A3-8, A3-18*	
Crossfeed Levers, Fuel	1-19*	
Crosswind Landings	2-37	
Crosswind Take-Off Procedures	2-25	
Cruise	2-30	
Cruise Ceilings	A5-4, A5-20*	
Cruise Checks	2-29	
Cruise Control	A5-6	
-H-1	A5-40*, A5-47*	
Cruise Control Chart - Four Engine Operation	A5-12*	
- Three Engine Operation	A5-15*	
- Two Engine Operation	A5-18*	
Cruise Performance - Constant Power H-1 Cruise	A5-40*, A5-47*	
- 1300 BHP	A5-42*, A5-59*	
- Holding	A5-44*, A5-63*	
Cruise Power Climb Performance	A4-2	
Cruise Power Manifold Pressure Limits	A2-3	
Cruising Ceilings	A5-4	
Cruising Flight	6-4	
D		
D.C. Electrical Power System	1-18	
D.C. Power Distribution	1-20*	
De-Icing System	4-32*	
- Wing and Empennage Leading Edge	4-30	
Decompression, Explosive	3-24A	
Defogging System, Window	4-33	
Density Altitude Chart	A1-3, A1-15*	
Descent	2-31, 9-3	
Descent Procedure, Emergency	3-24A	
Design Gross Weight	1-3	
Dimensions, Aircraft	1-3	
Dinghy Radio, Emergency (AN/CRT-3)	1-52A	
Directional Indicators	1-40	
Disconnecting the Cabin Supercharger Drive Shafts	3-59	
Distance Prediction Charts, Time and	A5-4	
Distance to Take Off and Climb 50 Feet	A3-13*	
Ditching and Survival	3-31	
Ditching Lights, Emergency	1-52A	
Ditching Procedures	3-40	
Diving	6-4	
Downlocks, Landing Gear	1-36	

	<i>Page</i>	<i>Page</i>		
Drag Struts, Main Gear	1-36	Engine Restart During Flight	3-8	
Driftmeter	4-79	Engine Run-Up	2-18	
Dump Controls, Fuel	1-19*	Engine Starting Procedure	2-11	
Dump System, Fuel	1-15, 1-18*	Engine Supercharger Shift	7-2	
Dumping, Fuel	3-45	Engines	1-3, 7-1	
—Rates	3-46*	Enroute Climb—Four Engine	A4-3*	
E			—Three Engine	A4-7*
Effect of Humidity on Take-Off Performance	A3-2	—Two Engine	A4-9*	
Effects of Ram on Power Available	A2-3	Escape Routes—Land	3-27*	
Electric Ladder	4-83	—Water	3-33*	
Electrical Circuits, Hydraulic System	1-30*	Explosive Decompression	3-24A	
Electrical Fire	3-22	Exterior Inspection	2-7, 2-4*	
Electrical Power System	1-18	Exterior Lights	4-65	
—Failure	3-48	Evacuation Chutes	1-52A	
Electrical Schematic, Fuel System	1-17*	F		
Electronic Equipment, Communications and		Failures, Automatic Pilot	4-75	
Associated	4-36	Feathering	1-12	
Elevator Control System	1-32	Feathering Procedure with Feather Switch		
Emergency Brake Operation	3-58	Inoperative	3-12B	
Emergency Brake System	1-38	Ferry Configuration, Minimum Take-Off.		
Emergency Control Boost Shutoff Checklist	3-52A	Runway Distances	A3-28*	
Emergency Descent Procedure	3-24A	Ferry Configuration Take-Off Performance,		
Emergency Entrance	3-31	Three Engine	A3-9	
Emergency Equipment Location	3-14*, 3-15*	Filler Wells and Dip Sticks	1-15	
Emergency Escape Routes—Land	3-27*	Filling Hydraulic Reservoir in Flight	7-5	
—Water	3-33*	Fire	3-12B	
Emergency Extension, Wing Flaps	1-35*	Fire and Smoke, Engine	3-5*	
Emergency Hand Pump Power System	1-28	Fire Detection System	1-48	
Emergency Inverter	1-22	Fire During Flight, Engine Failure and/or	3-3	
Emergency Inverter Power	1-24*	Fire Extinguishing System	1-51, 1-54*	
Emergency Jettisoning	3-45	Fireman's Hand Axe	1-52A	
Emergency Landing Gear Extension	1-36, 3-57	First Aid Kits	1-52A	
Emergency Operating Procedures, Autopilot	4-75	Fixed Oxygen System	4-69	
Emergency Operation, Auxiliary Vent Control		Flap Asymmetry Protection System	1-34	
Knob	4-21*	Flap Malfunction	3-53	
Emergency Procedures—Air Conditioning System	4-26	Flaps	1-34	
Flight Attendant's	8-4	Flaps Emergency Extension	1-35*	
—Radio Operator's	8-3	Flight Attendant's Aft Panel	4-67*	
Emergency Systems	1-48	Flight Attendant's Emergency Procedures	8-4	
Emergency Take-Off Performance	A3-7, A3-17*	Flight Attendant's Crew Duties	8-4	
Emergency Wing Flap Operation	3-54	Flight Characteristics	6-1	
Empennage Leading Edge De-Icing System,		—Under Partial Power Conditions	3-2	
Wing and	4-30	Flight Control Boost-Off Landing	3-29	
Engine Air Induction System	1-4	Flight Control Precautions	5-4, 6-3	
Engine Failure	3-2	Flight Control System	1-31, 3-50	
Engine Failure and/or Fire During Flight	3-3	Flight Controls	6-3	
Engine Failure During Take-Off	3-3, 3-24B	Flight Engineer	8-1	
Engine Fire and Smoke	3-5*	—Control Quadrant and Lower Switch Panel	1-52*	
Engine Limitations	5-1	—Instrument Panels	1-50*	
Engine Limits and Characteristics Curves	A2-2, A2-6*	Interphone Console	4-40*	
Engine Oil System	1-13	Seat	1-53	
Engine Power Schedule Tables	A2-4, A2-9*			

PAGE NUMBERS WITH ASTERISK (*) DENOTE ILLUSTRATIONS

	<i>Page</i>	<i>Page</i>	
Flight Paths, Three Engine Climb-Out	A3-7	Heat in Cabin and Flight Station	4-3*
Flight Planning Fuel Consumption Charts	A5-49*	Heat in Flight Station and Cooling in Cabin	4-7*
Flight Station Radio Rack	4-44*, 4-45*	Heater and Hot Wall Systems, Wiring Diagram	4-13*
Flight System, Integrated	1-43, 7-8*	Heater System	4-17*
Flux Gate Compass Master Direction Indicator	4-74	Heating	4-1
Flying the Picture	7-10*	High Speed Flight	6-4
Four Engine Climb Performance	A4-6*	Holding Ceilings	A5-4, A5-19*
Four Engine Enroute Climb, Meto Power	A4-3*	Holding Cruise Control	A5-44*, A5-63*
Four Engine Maximum Cruise Power Climb	A4-5*	Holding Procedures	9-3
Fuel and Fuel Density	A1-2	Horizon, Approach	1-43
Fuel Consumption Charts, Flight Planning	A5-49*	Hydraulic Access Door Unlatched in Flight	3-59
Fuel Crossfeed Levers	1-19*	Hydraulic Crossover	1-32*
Fuel Dump Controls	1-19*	Hydraulic Power System	1-25, 1-29*
Fuel Dumping	3-45	Hydraulic Power System Failure	3-49
—Limitations	5-4	Hydraulic System Electrical Circuits	1-30*
—Rates	3-46*		
Fuel Dumping System	1-18*	I	
Fuel Flow Curves	A2-4, A2-11*	Ice Crystal or Corona Radio Static	9-2
Fuel Management Considerations	5-4	Idle Mixture Check	2-40
Fuel Master Control Unit (Carburetor)	1-3	ILS on ILS	7-11*
Fuel Pressure Drop	3-9	Ignition Analyzer Controls	1-5*
Fuel Stabilizing Time	7-4	Ignition Analyzer Operation	7-2
Fuel System	1-14, 7-4, 1-16*	Ignition Analyzer Patterns	1-6*
Fuel System Management	7-4	Ignition System	1-5
Fuel System Electrical Schematic	1-17*	ILS Procedures	9-9, 9-11*
Fume Elimination, Smoke	3-22	Inadvertent Reversing in Flight	3-12B
		Inclinometer	1-43
G		Initial Descent Procedure	2-30
Galley Switch Panel	4-66*	Instrument Climb	9-2
GCA and ILS Procedure	9-9	Instrument Flight	9-1
GCA Procedures	9-10*	Instrument Markings	5-2*
Gear Retracted, Landing with	3-28	Instrument or Radio Inverter Failure	3-49
General Arrangement	1-3, 1-2*	Instrument Panels — Flight Engineer's	1-50*
Generator Malfunction or Failure	3-48A	—Pilots	1-42*
Generator Switches	1-19	Instrument Take-Off	9-2
Glare Shield Panel, Pilots'	4-35*	Instrument Vacuum System	4-31*
Glide Slope Receiver, AN/ARN-18	4-59	Instruments	1-38A
Gloves (asbestos)	1-53	Integrated Flight System	1-43, 7-7, 7-8*
Go-Around	2-38	Interior Configurations	4-80
Go-Around Procedure	3-12	Interior Inspection	2-7, 2-2*
Go-Around Rates of Climb	A6-4*	Interior Lights	4-67
Gross Weight, Design	1-3	Interphone Communication System,	
Gross Weight Limitations	5-6*	AN/AIC-10A	4-37
Ground Cooling with Engines Operating	4-5*	Interphone Consoles	4-41, 4-40*
Ground Evacuation	3-30	Interphone Control Panels	4-40*, 4-41*
Ground Run Distances, Take-Off	A3-3, A3-12*	Inverter Failure, Instrument or Radio	3-49
Ground Safety Pins	1-36	Inverter Power, Emergency	1-24*
		Inverters	1-22
		J	
H		Jettisoning, Emergency	3-45
H-1 Cruise Control	A5-40*, A5-47*	Junction Box Panels, Master	1-26*
Hand Fire Extinguishers	1-51		

PAGE NUMBERS WITH ASTERISK (*) DENOTE ILLUSTRATIONS

	<i>Page</i>		<i>Page</i>
L			
Ladders and Rope	1-52A	Meto Power Climb Performance	A4-2
Land Emergency Escape Routes	3-27*	Meto Power - Four Engine Enroute Climb	A4-3*
Landing, Flight Control Boost-Off	3-29	—Three Engine Enroute Climb	A4-7*
Landing Distance from Height of 50 Feet	A6-3*	Two Engine Enroute Climb	A4-9*
Landing Emergencies, Take-Off and	3-24A	Miles Per Pound of Fuel Used, Nautical	
Landing Gear	1-36	—Four Engine Operation	A5-21*
—System Malfunction	3-56	—Three Engine Operation	A5-30*
Landing on Soft Ground or Unprepared Runways	3-25	—Two Engine Operation	A5-37*
Landing Pattern	2-36*	Minimum Crew Requirements	5-1
Landing Runway Length, Minimum Effective	A6-2*	Minimum Effective Landing Runway Length	A6-2*
Landing Technique and Procedure	2-35	Minimum Fuel Loading, Required Operational	7-3*
Landing with Gear Retracted	3-28	Minimum Take-Off Runway Distances	
Landing with One or More Engines Inoperative	3-10	— Ferry Configuration	A3-28*
Landing without All Gears Extended and Locked	3-25	N	
Leaning, Manual	7-5	Nautical Miles Per Pound of Fuel	
Level-Off Procedure	2-29	—Four Engine Operation	A5-21*
Level Flight Characteristics	6-4	—Three Engine Operation	A5-30*
Liaison Receivers, BC-348	4-55	—Two Engine Operation	A5-37*
Liaison Transceiver, AN/ARC-58	4-55, 4-54*	Navigator's Crew Duties	8-1
Life Rafts	1-52A	Navigator's Station	4-79, 4-60*
Life Vests	1-52A	—Instrument Panel	4-61*
Lighting System	4-65	—Interphone Console	4-40*
Limitations — Airspeed	5-4	—Radio Rack	4-58*
—Engine	5-1	Normal Brake System	1-38
—Fuel Dumping	5-4	Normal Procedures, Air Conditioning System	4-24
—Propeller	5-4	Normal Take-Off Performance	A3-2
—Weight	5-4	Nose Gear Emergency Extension Procedures	3-57
Limits and Characteristics, Engine	A2-2, A2-6*	Nose Gear Steering System	1-37
Line-Up	2-23	Nose Radome Pressurization System	4-64
Loading Restrictions, Fuel	1-14	O	
Long Range Cruise Performance	A5-46*	Oil System, Engine	1-13
—Three Engine Operation	A5-55*	Oil Tanks	1-13
—Two Engine Operation	A5-63*	Operating Allowances for Full Throttle	
Loran Receiver, AN/APN-9	4-59	Cruise Power	A2-4
Loose Equipment	4-83	Operating Tables	A5-5
M			
Maneuvering Flight	6-4	—11-1 Cruise	A5-47*
Manifold Pressure Limits	A2-3	—1300 BHP	A5-59*
Manual Leaning	7-5	—Holding	A5-63*
Marker Beacon Receiver, AN/ARN-32	4-59	Operational Minimum Fuel Loading, Required	7-3*
Master Control Unit (Carburetor)	1-3	Outside Temperature Indicators	1-43
Master Direction Indicator, Flux Gate Compass	4-74	Overhead Controls, Pilots'	1-47*
Master Junction Box Panels	1-26*	Overhead Radio Control Panel, Pilots'	4-47*
Maximum Cruise Power Climb, Four Engine	A4-5*	Overspeed Procedures, Propeller	3-12A
Maximum Performance	A6-1	Oxygen Duration	4-71*
Maximum Power Manifold Pressure Limits	A2-3	Oxygen Equipment, Portable	4-69
Maximum Power Prediction Graph	A3-10*	Oxygen Regulator	4-68*
Maximum Take-Off Weight Permitted by		Oxygen System	4-69
Runway Slope	A3-7, A3-26*	Oxygen System Control	4-70*

PAGE NUMBERS WITH ASTERISK (*) DENOTE ILLUSTRATIONS

	<i>Page</i>	<i>Page</i>
P		
Parking Brakes	1-38A	
Partial Power Conditions, Flight Characteristics Under	3-2	
Passenger Address Control, Copilot's Station	4-41*	
Passenger Seats	4-80	
Pedestal, Pilots'	1-49*	
Penetrating the Thunderstorm	9-3	
Performance and Configuration	5-7	
Pilot	8-1	
Pilot's Side Panel	1-44*	
Pilots' Station	1-41*	
—APS-42 Scope	4-63*	
—Glare-Shield Panel	4-35*	
—Instrument Panels	1-42*	
—Overhead Controls	1-47*	
—Overhead Radio Control Panel	4-47*	
—Pedestal	1-49*	
Seats	1-53	
Pitot-Static System	1-48	
Pitot Head De-Icing System	4-36	
Pitot Heaters Circuit	4-34*	
Plug Clean-Out Procedure	7-1	
Power Distribution System	4-37	
Power Prediction Graph, Maximum	A3-10*	
Power Schedule Table, Engine	A2-4, A2-9*	
Practice With Boost-Out	3-12A	
Preflight Planning	A7-1	
Preflight Check	2-7	
—Radio Operator's	8-3	
Pressure Regulator Valve	4-10*	
Pressurization	4-16	
Primary Hydraulic System	1-28	
Failure	3-50	
Priming System	1-10	
Propeller Alcohol Anti-Icing System	4-35	
Propeller Limitations	5-4	
Propeller Overspeed Procedures	3-12A	
Propeller Reversing Indicator Lights	1-13	
Propellers	1-11	
Psychrometric Chart	A1-3, A1-17*	
Public Address System	4-46	
—Copilot's Station	4-41*	
R		
Radar Identification Transponder, AN/APX-25	4-62	
Radio Altimeter, AN/APN-1	4-61	
Radio Altimeter, SCR-718C	4-61	
Radio Compass Receivers, ARN-6	4-56	
Radio Inverter	1-22	
—Failure	3-49	
Radio Junction Box, Main	4-37	
RMI	4-59	
Radio Operator's Control Console	4-52*, 4-53*	
Radio Operator's Seat	4-80	
Radio Operator's Station	4-50*, 4-51*	
Radio Operator Duties	8-3	
Radio Power Control Switch	1-22	
Radio Power Supply	1-24A	
Rain, Snow, Ice Crystal, or Corona Radio Static	9-2	
Range and ADF Procedures	9-7*	
Range Approach, Standard	9-6	
Rapid Descent Procedure	2-32	
Rates of Climb—Go-Around	A6-4*	
—Three Engine Take-Off	A3-7	
Three Engine	A3-25*	
Refrigeration	4-1	
Refrigerator, and Aftercooler Scoop Control	4-14*	
Refrigerator and Aftercooler Schematic	4-18*	
Refueling with Passengers Aboard	7-4	
Refusal Speed	A3-4, A3-14*	
Rejected Take-Off	2-25	
Restart During Flight, Engine	3-8	
Retraction, Emergency Landing Gear	3-57	
Reverse Thrust, Use of	A6-1	
Reversing and Unreversing	1-12	
Reversing in Flight, Inadvertent	3-12B	
Reversing Indicator Lights, Propeller	1-13	
RMI Voltage Supply, Compass System	1-24B*	
Rudder Control System	1-33	
Run-Up, Engine	2-18	
Thru Flight	2-21	
S		
Schedule Table, Engine Power	A2-4, A2-9*	
SCR-718C Radio Altimeter	4-61	
Search Radar, AN/APS-42	4-62	
Seats	1-53	
Secondary Hydraulic System	1-28	
—Failure	3-50	
Service Ceiling	A4-2, A4-11*	
Shift Procedure During Climb, Engine Supercharger	2-29	
Shifting Flight Control Systems From Boost-On To Boost-Off Operation	3-52	
Short Field Landings	2-37	
Slippery Runways, Landing on	2-37	
Slow Flying	6-4	
Smoke/Fume Elimination	3-22	
Smoke and Fire, Engine	3-5*	
Smoke Detection System	1-48	
Smoke Masks	1-53	
Snow, Rain, Ice Crystal, or Corona Radio Static	9-2	
Speed Relationship	A1-4	

PAGE NUMBERS WITH ASTERISK (*) DENOTE ILLUSTRATIONS

	<i>Page</i>		<i>Page</i>
Spin Characteristics	6-3	Three Engine Take-Off Rates of Climb	A3-7
Stall Characteristics	6-1	Throttles	1-3
Stall Speed Curve	6-2*	Thru Flight Engine Run Up	2-21
Standard Atmosphere Table	A1-3, A1-14*	Thunderstorms and Turbulence	9-2
Standard Day Power Available	A2-3, A2-8*	Time and Distance Prediction Charts	A5-4
Standard Range Approach	9-6	H-1 Cruise	A5-40*
Starting Procedure, Engine	2-11	1400 BIIP	A5-42*
Starting System	1-11	—Holding	A5-44*
Steering System, Nose Gear	1-37	Tire Failure	3-24B
Structural Load Limitations	5-4	Touch and Go Procedures	2-38
Stopping Distances	A3-7, A3-27*	Transmitter, AN/ART-13A	4-49
Supercharger Shift, Engine	7-2	Transmitter/Receiver, Collins 618S-1	4-49
During Climb	2-29	Trim Devices	6-3
Superchargers	1-4	Trim Indicator, Three Axis	4-74
Survival	3-37	Turbulence and Thunderstorms	9-2
Synchronizer	1-12	Two Engine Climb Performance	A4-9*
		Two Engine Range Approach	9-3
T		U	
Tacan System, AN/ARN-21	4-57	UHF Transmitter Receiver Set, AN/ARC-27	4-48
Take-Off, Engine Failure During	3-3, 3-24B	Unreversing and Reversing	1-12
Take-Off, Instrument	9-2	Uplocks, Landing Gear	1-36
Take-Off and Landing Data	2-1	Use of Landing Wheel Brakes	7-6
Take-Off and Landing Emergencies	3-24A		
Take-Off Climb, Ferry Configuration	A3-29*	V	
Take-Off Criteria Definitions	A3-3	Vacuum System, Instrument	4-31*
Take-Off Flight Path, Three Engine	A3-20*	Velocity During Take Off Ground Run	A3-6, A3-15*
Take Off Ground Run, Velocity During	A3-6, A3-15*	Ventilation	4-1
Take-Off Pattern	2-27*	VHF 101 Communication Systems	4-48
Take-Off Performance — Emergency	A3-7		
—Normal	A3-2	W	
—Three Engine Ferry Configuration	A3-9	Wash Water System	4-80, 4-81*
Take Off Procedures	2-25	Water Emergency Escape Routes	3-33*
Take-Off Weight as Limited by		Weight and Balance	2-1
Runway Slope	A3-7, A3-26*	Weight Limitations	5-4
Tanks, Fuel	1-14	Wet Runway Landing	2-37
Tanks, Oil	1-13	Wind Component Chart	A3-3
Taxiing	2-16	Wind Velocities	A6-1
Temperature Accountability	A3-2	Window Defogging System	4-33
Temperature Compressibility Correction	A1-12*	Windshield Alcohol Anti-Icing System	4-36
Temperature Conversion Chart	A1-13*	Windshield Wipers	4-83
Temperature Correction and Conversion Charts	A1-3	Wing and Empennage Leading Edge De-Icing	
Temperature Relationship	A1-4	System	4-30
Three-Axis Trim Indicator	4-74	Wing Flap Asymmetry Protection System	1-34
Three Engine Approach, Circling	9-8	Wing Flap Malfunction	3-53
Three Engine Climb Out Flight Paths	A3-7	Wing Flaps	1-34
Three Engine Climb Performance	A4-7*	Emergency Extension	1-35*
Three Engine Ferry Take-Off Performance	A3-9	Wiring Diagram, Heater and Hot	
Three Engine Range Approach	9-8	Wall Systems	4-13*
Three Engine Rates of Climb	A3-25*		
Three Engine Take Off Flight Path	A3-20*		

emergency escape routes—land

T. O. 1C-121A-1

Section III
Emergency Procedures

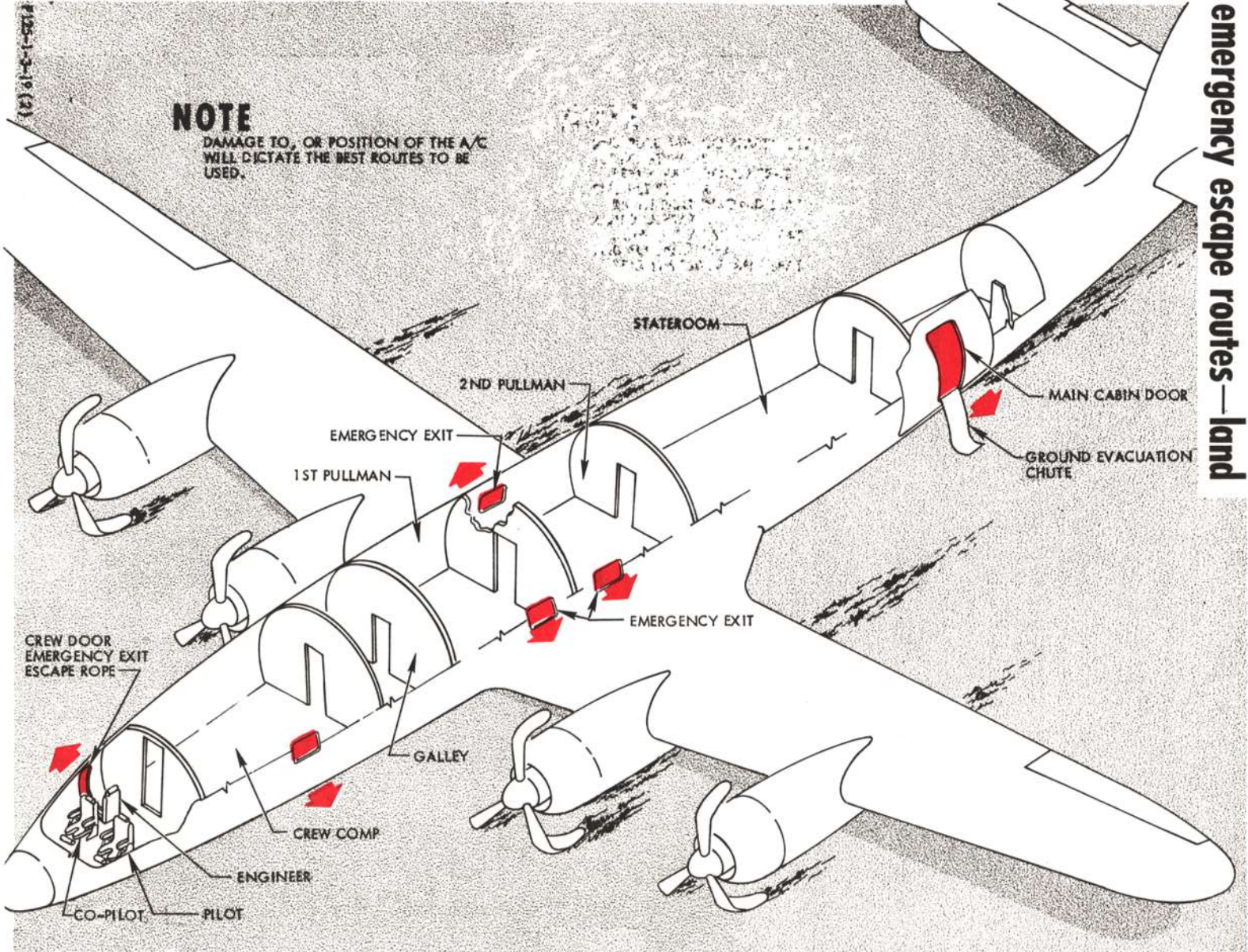
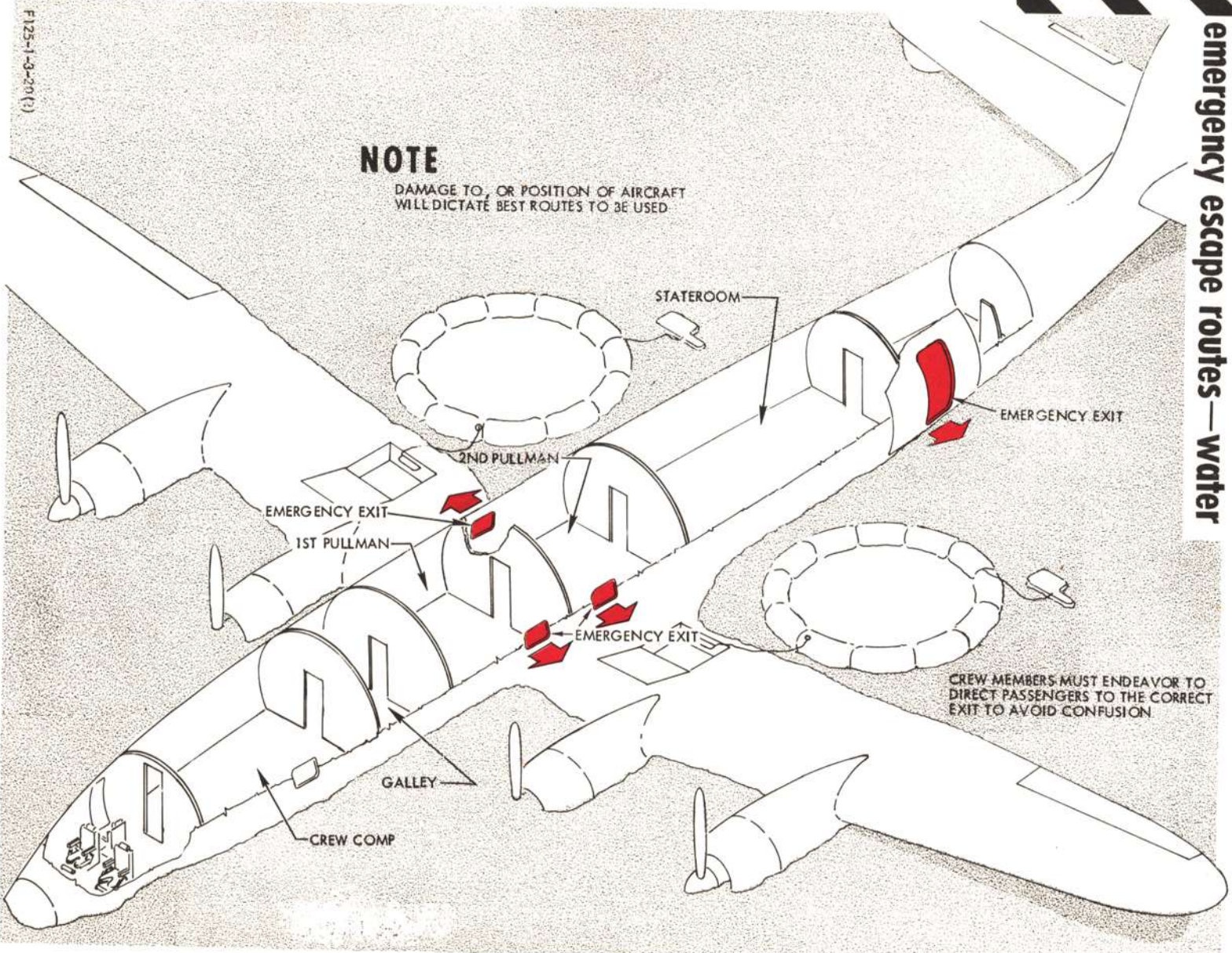

Figure 3-4



NOTE
DAMAGE TO, OR POSITION OF AIRCRAFT
WILL DICTATE BEST ROUTES TO BE USED

CREW MEMBERS MUST ENDEAVOR TO
DIRECT PASSENGERS TO THE CORRECT
EXIT TO AVOID CONFUSION

F125-1-8-20 (1)

3-34

Figure 3-6

auxiliary ventilation on ground with recirculated air and heating

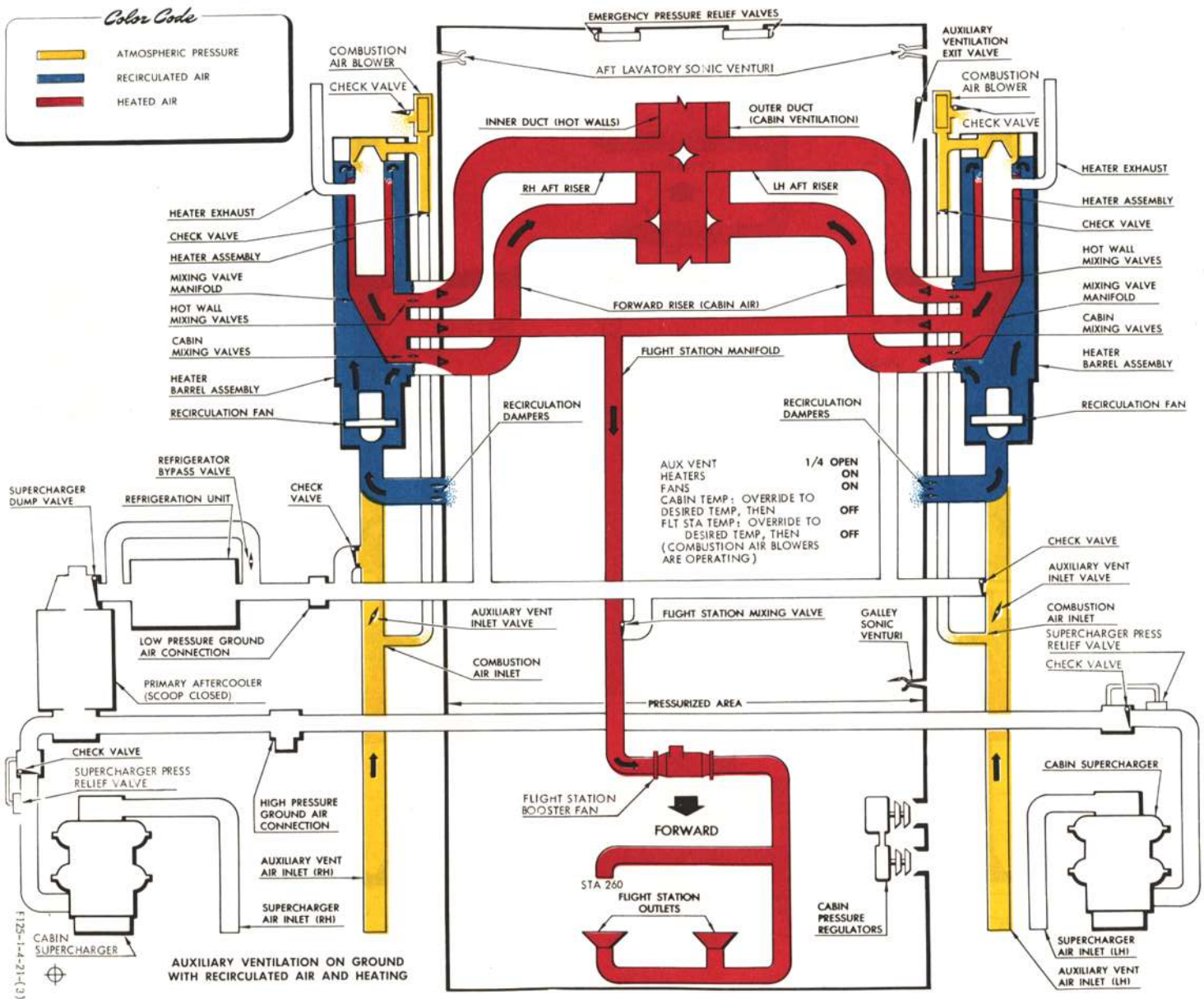

Figure 4-1 (Sheet 3)

ground cooling with engines operating

T. O. 1C-121A-1

Section IV
Auxiliary Equipment

Color Code

- ATMOSPHERIC PRESSURE
- SUPERCHARGER PRESSURE
- RECIRCULATED AIR
- REFRIGERATED AIR

F125-1-4-21(4)

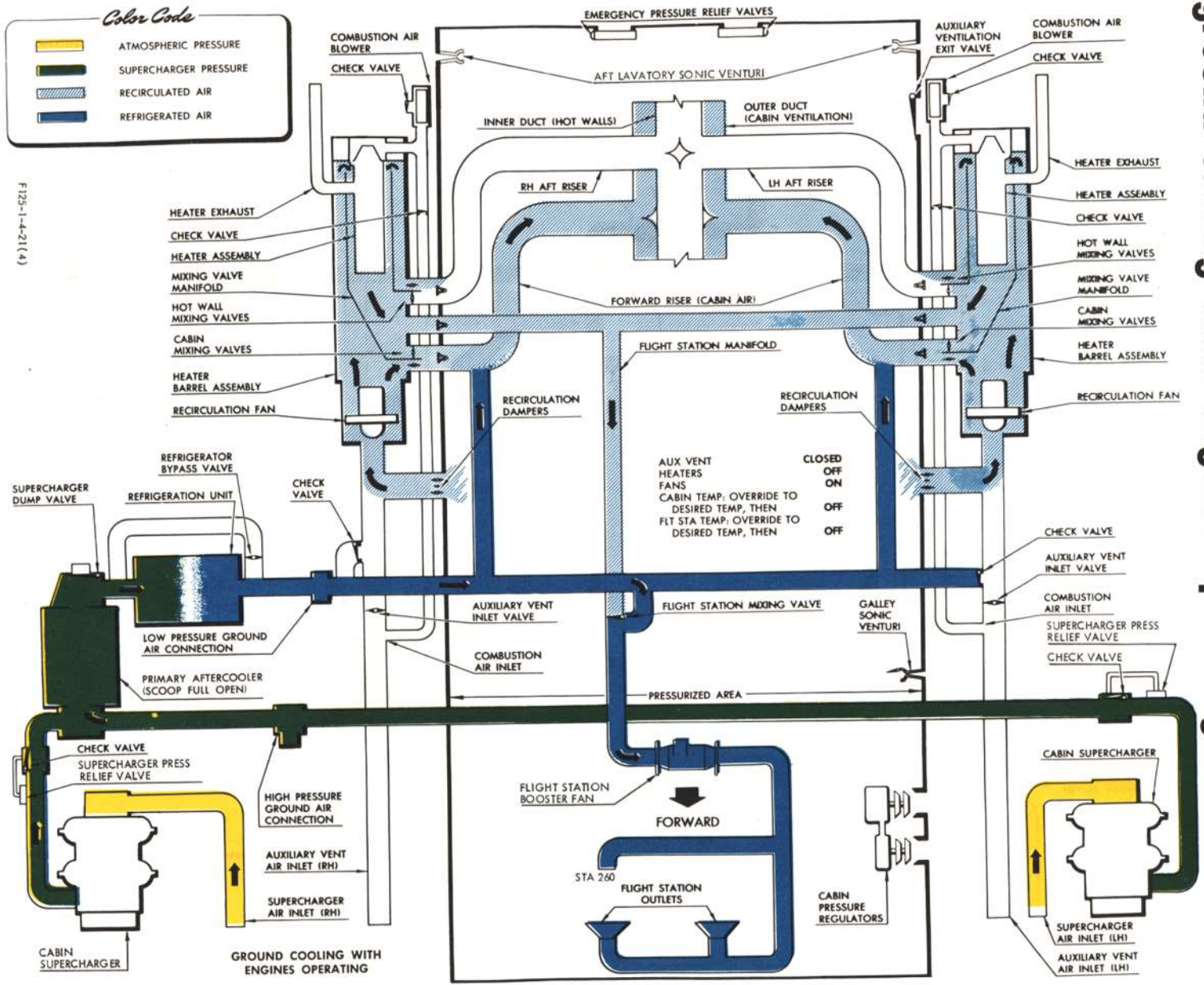
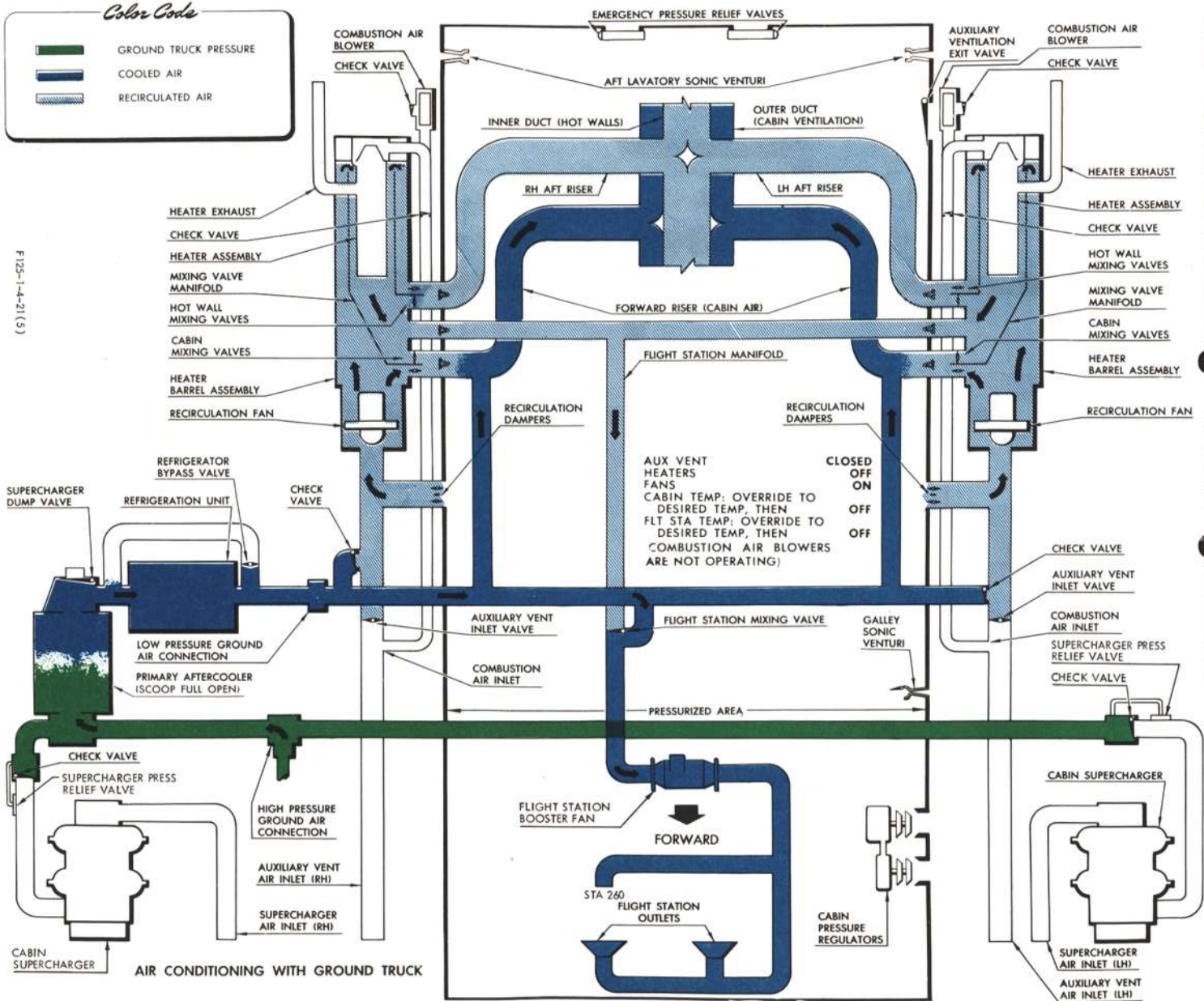

Figure 4-1 (Sheet 4)

air conditioning with ground truck



F125-1-4-21(5)

Figure 4-1 (Sheet 5)

cooling in cabin and heat in flight station

T. O. 1C-121A-1

Section IV
Auxiliary Equipment

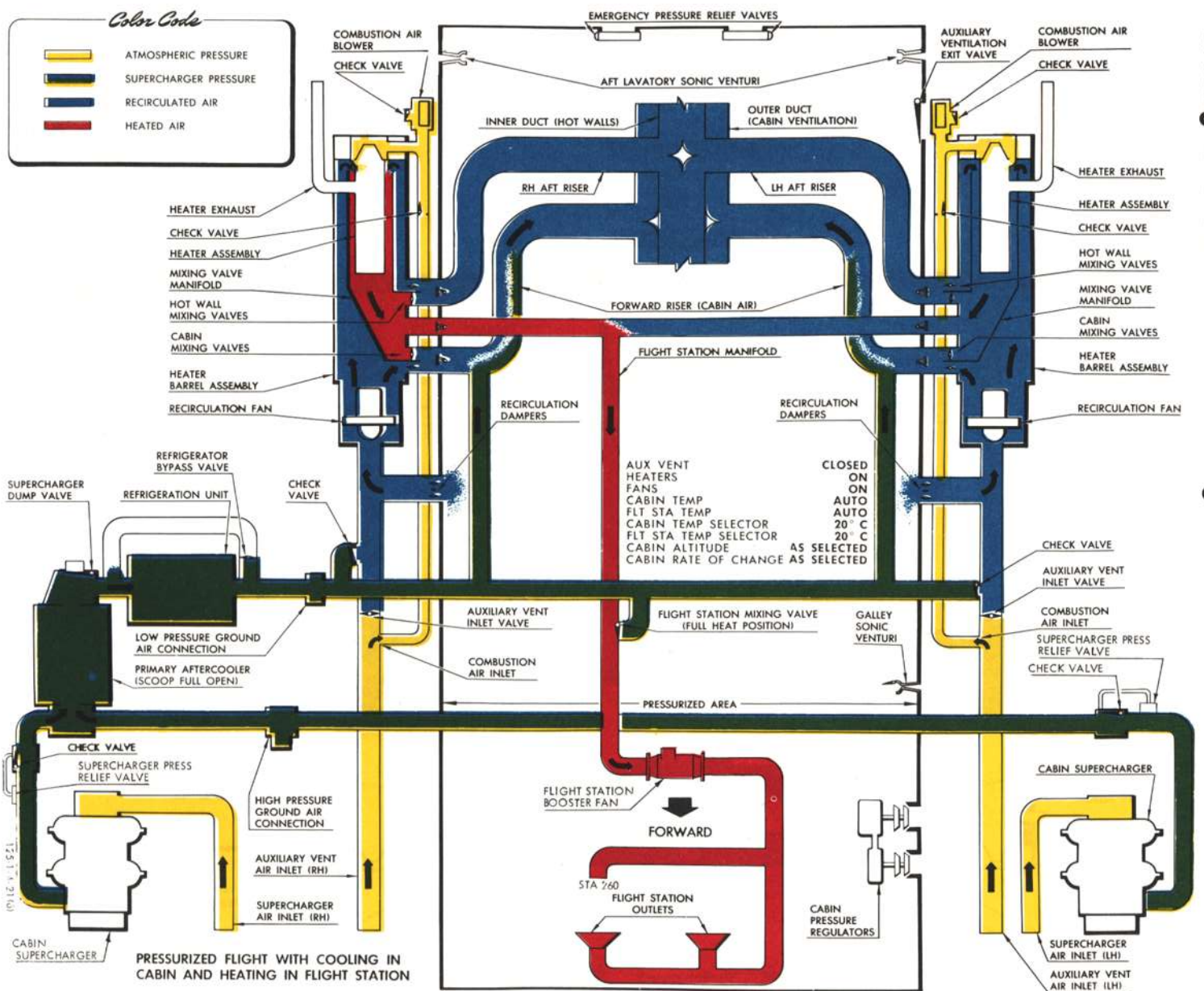
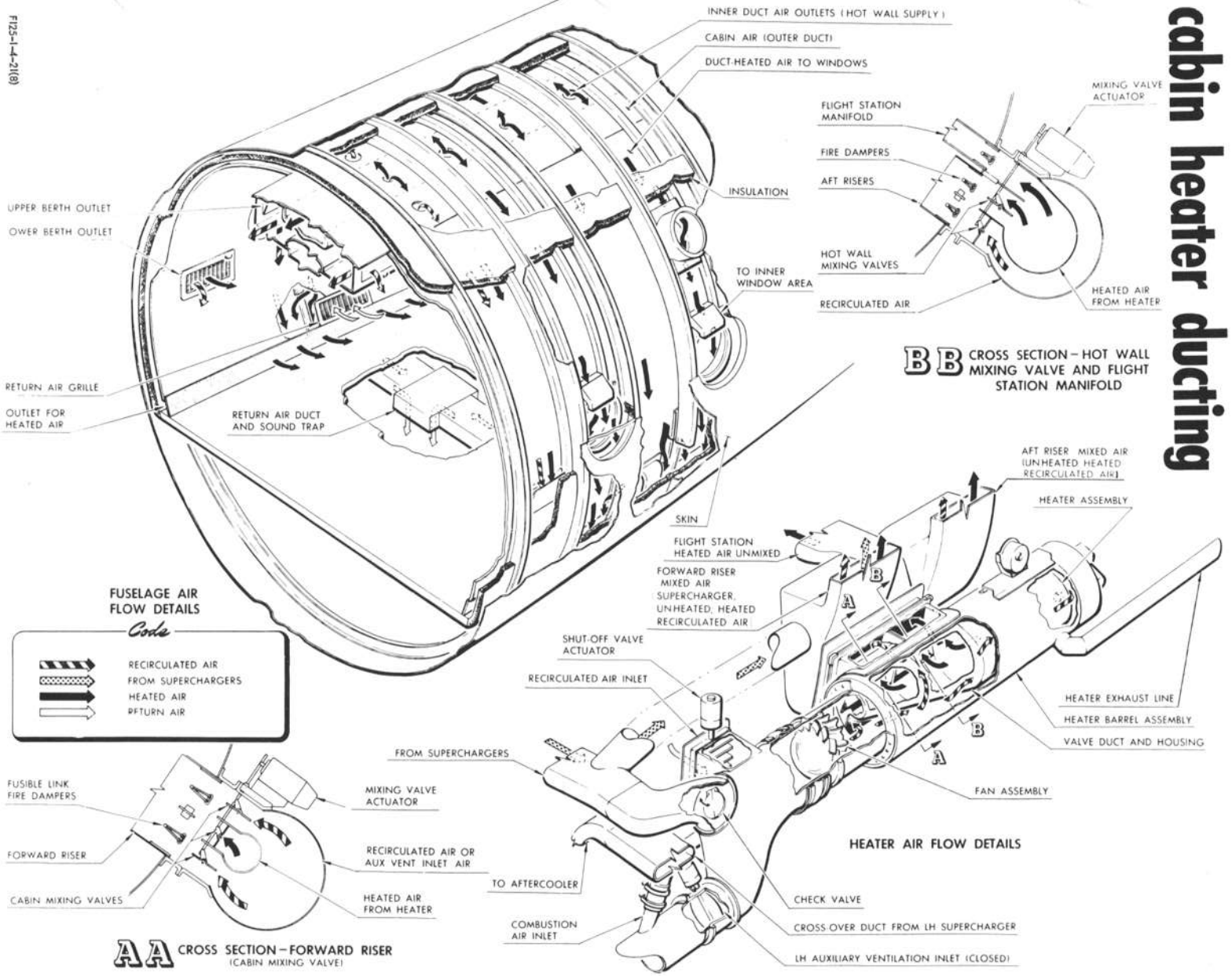

Figure 4-1 (Sheet 6)

cabin heater ducting

T. O. 1C-121A-1
Section IV
Auxiliary Equipment

F125-1-4-2(18)



BB CROSS SECTION - HOT WALL MIXING VALVE AND FLIGHT STATION MANIFOLD

AA CROSS SECTION - FORWARD RISER (CABIN MIXING VALVE)

FUSELAGE AIR FLOW DETAILS

Code



-  RECIRCULATED AIR FROM SUPERCHARGERS
-  HEATED AIR
-  RETURN AIR

Figure 4-1 (Sheet 8)

air conditioning—electrical location diagram

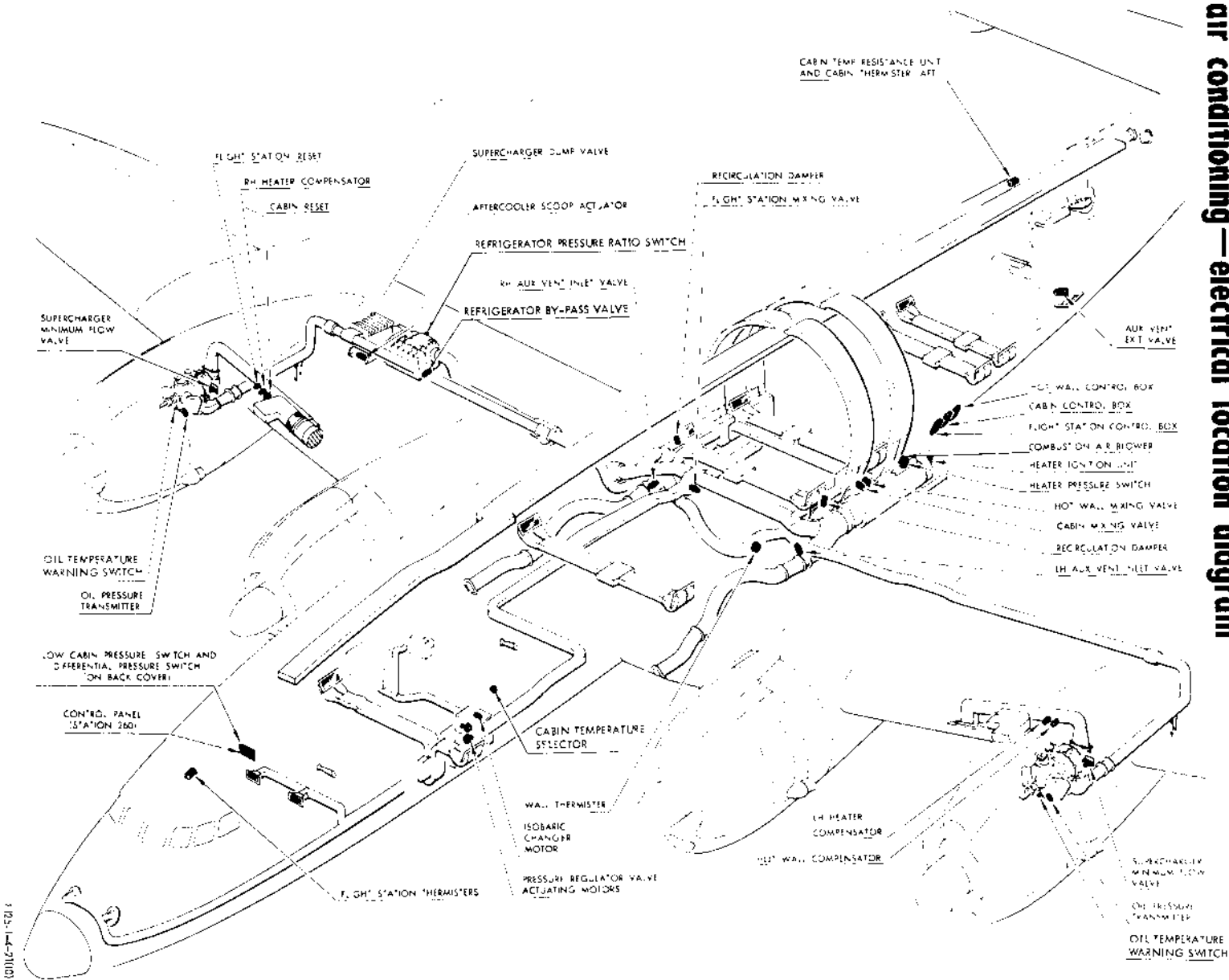
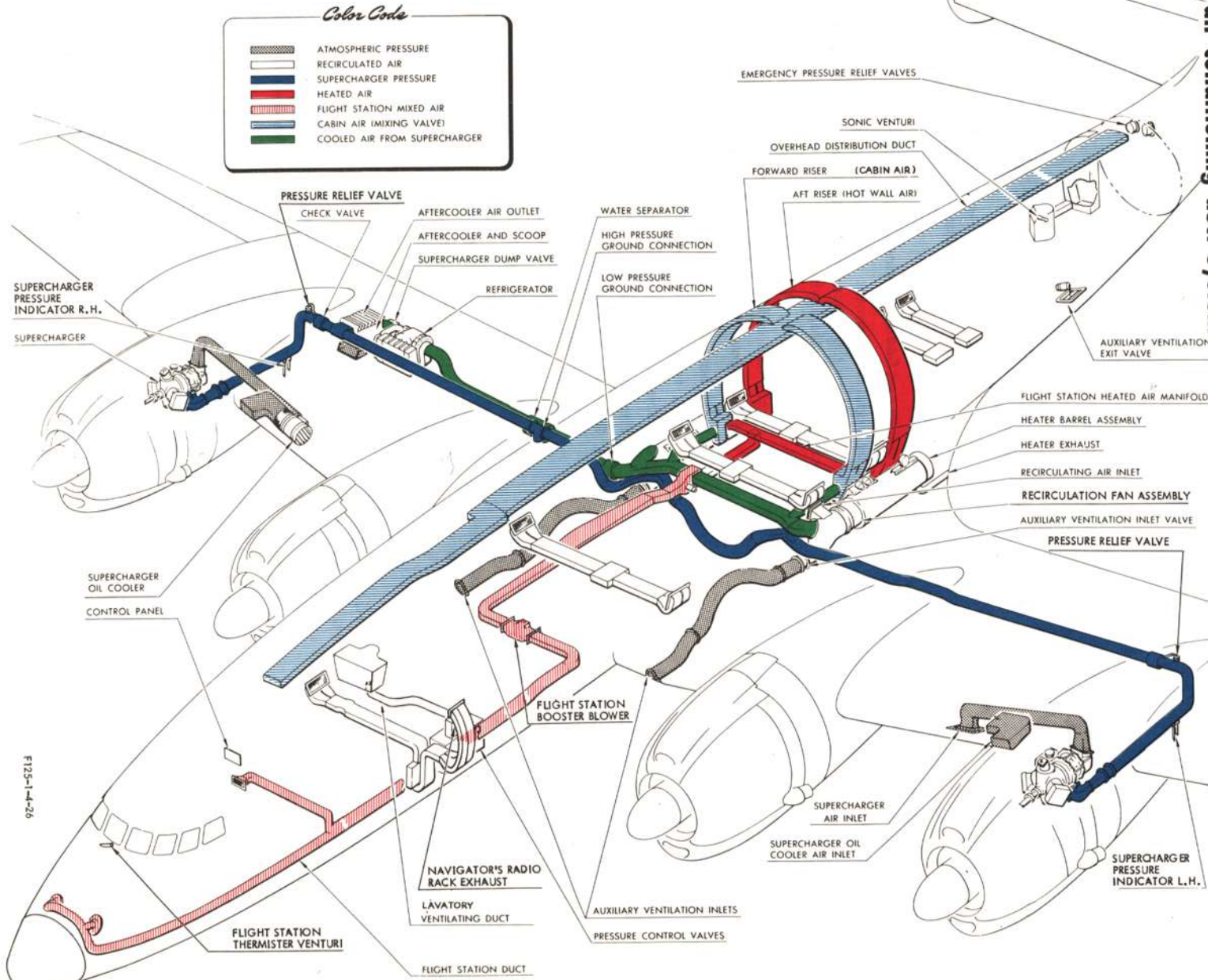

Figure 4-1 (Sheet 10)

125-14-21103

air conditioning duct system



Color Code

	ATMOSPHERIC PRESSURE
	RECIRCULATED AIR
	SUPERCHARGER PRESSURE
	HEATED AIR
	FLIGHT STATION MIXED AIR
	CABIN AIR (MIXING VALVE)
	COOLED AIR FROM SUPERCHARGER

Figure 4-6

FI25-1-4-26

T. O. 1C-121A-1

Section IV
Auxiliary Equipment

PSYCHROMETRIC CHART

VAPOR PRESSURE AND SPECIFIC HUMIDITY DETERMINATION

WHEN WET AND DRY BULB TEMPERATURES ARE GIVEN:

FIND DEW POINT:

- ENTER AT WET BULB TEMPERATURE (1)
- PROCEED VERTICALLY TO DEW POINT LINE (2)
- DRAW A VERTICAL LINE THROUGH DRY BULB TEMPERATURE (3)
- PROCEED PARALLEL TO THE WET BULB TEMPERATURE GUIDE LINE TO THE VERTICAL LINE THROUGH THE DRY BULB TEMPERATURE
- FROM THIS INTERSECTION (4) PROCEED HORIZONTALLY TO THE DEW POINT LINE (5)
- PROCEED VERTICALLY AND READ THE DEW POINT TEMPERATURE AT (6)

WHEN SPECIFIC HUMIDITY AND PRESSURE ALTITUDE ARE GIVEN:

- FIND VAPOR PRESSURE AND DEW POINT:
- ENTER AT THE SPECIFIC HUMIDITY (8)
- PROCEED HORIZONTALLY TO THE PRESSURE ALTITUDE (9)
- FOLLOW THE VAPOR PRESSURE GUIDE LINES TO THE BASE LINE (7)
- AND READ THE VAPOR PRESSURE
- CONTINUE HORIZONTALLY TO THE DEW POINT LINE (5)
- READ THE DEW POINT AT (6)

WHEN DEW POINT IS GIVEN:

- FIND VAPOR PRESSURE:
- ENTER AT THE DEW POINT (6)
- PROCEED VERTICALLY TO THE DEW POINT LINE (5)
- PROCEED HORIZONTALLY TO THE BASE LINE (7) AND READ VAPOR PRESSURE

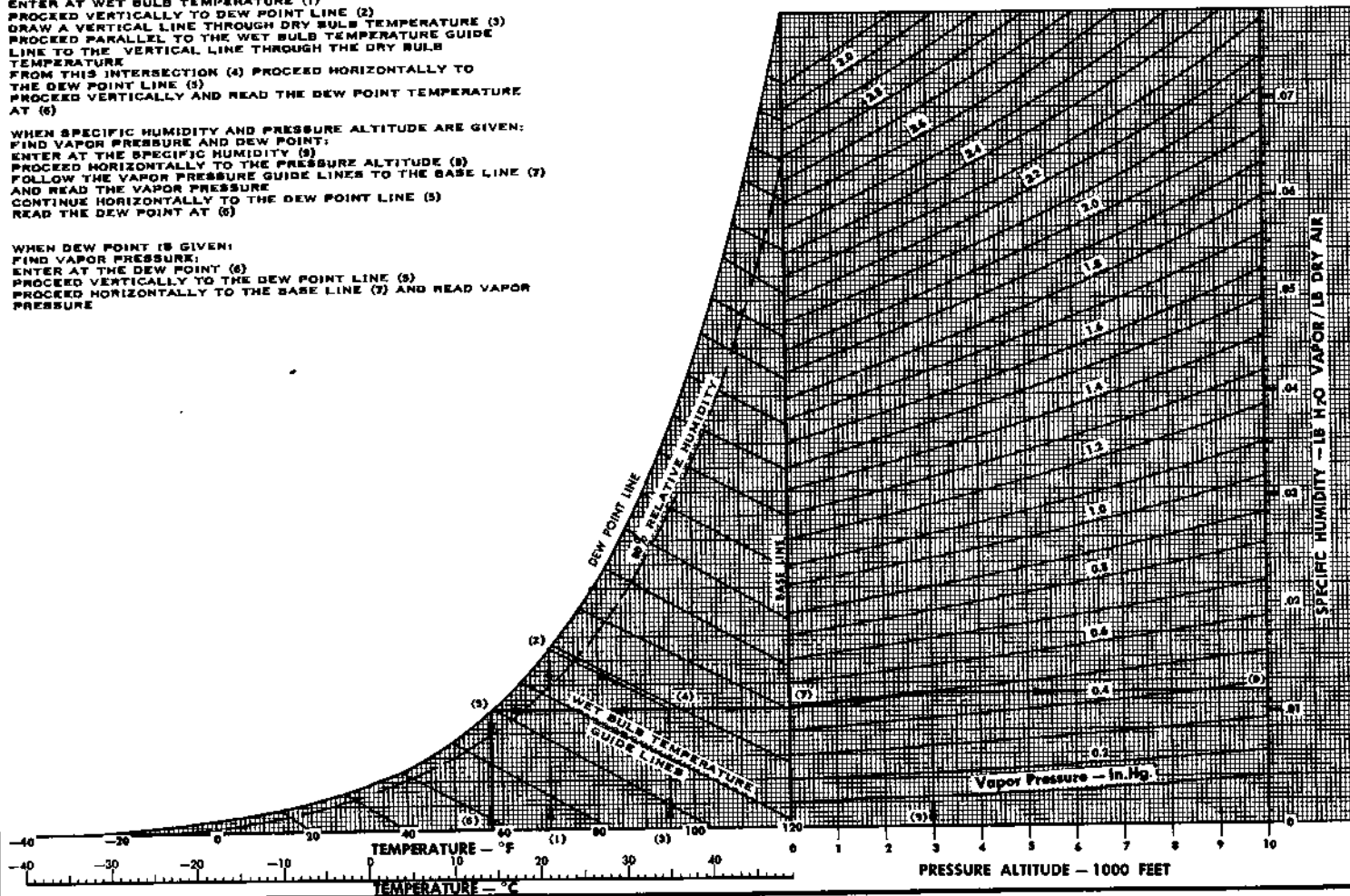

Figure A1-12

R3350-75 ENGINE POWER SCHEDULE TABLE

AUTO RICH MIXTURE

STANDARD DAY

100/130 GRADE FUEL

MODEL: C-121A

ZERO HUMIDITY AT STANDARD TEMPERATURE

DATA AS OF: 15 AUGUST 1961

PROPS: CURTISS C460/830-26C4-0

DATA BASIS: FLIGHT TESTS

ENGINE SPEED RPM	POWER SETTINGS																		
	PRESS. ALT.—FT.	S. L.	2,000	4,000	6,000	8,000	10,000	12,000	14,000	16,000	10,000	12,000	14,000	16,000	18,000	20,000	22,000	24,000	
	BLOWER SETTING				LOW BLOWER						HIGH BLOWER								
2800	MAXIMUM POWER: MAXIMUM ALLOWABLE CYLINDER HEAD TEMPERATURE 260° C, LIMIT BMEP 211, TIME LIMIT 5 MINUTES.																		
	INBOARD BHP	2500	2500	2490 F.T.	2340 F.T.	2195 F.T.													CAUTION — HIGH BLOWER NOT PERMITTED AT 2800 RPM
	INBOARD BMEP	211	211	210	197	185													
	LIMIT MAP	51.5	51.0																
2600	MAXIMUM POWER: MAXIMUM ALLOWABLE CYLINDER HEAD TEMPERATURE 260° C, LIMIT BMEP 172, TIME LIMIT 5 MINUTES.																		
	INBOARD BHP										1900	1900	1900	1900	1810 F.T.	1675 F.T.			
	INBOARD BMEP										172	172	172	172	164	152			
	LIMIT MAP										44.0	44.0	44.0	43.5					
2400	METO POWER: MAXIMUM ALLOWABLE CYLINDER HEAD TEMPERATURE 245° C, TIME LIMIT NONE.																		
	INBOARD BHP	2100	2100	2100	2035 F.T.	1900 F.T.	1775 F.T.	1655 F.T.	1535 F.T.	1410 F.T.	1800	1800	1800	1800	1725 F.T.	1585 F.T.	1445 F.T.	1335 F.T.	
	INBOARD BMEP	207	207	207	200	187	174	163	151	139	177	177	177	177	169	156	143	131	
	LIMIT MAP	44.0	43.5	42.5								42.5	42.0	41.5	41.0				
2400	CRUISE CLIMB POWER: MAXIMUM ALLOWABLE CYLINDER HEAD TEMPERATURE 230° C, TIME LIMIT NONE. LIMIT MAP 35.0 IN. HG.																		
	INBOARD BHP	1470	1470	1470	1470	1470	1470	1470	1470		1400	1400	1400	1400	1400	1400	1400		
	INBOARD BMEP	145*	145*	145*	145*	145*	145*	145*	145*		138*	138*	138*	138*	138*	138*	138*		
2300	CRUISE CLIMB POWER: MAXIMUM ALLOWABLE CYLINDER HEAD TEMPERATURE 230° C, TIME LIMIT NONE. LIMIT MAP 35.0 IN. HG.																		
	INBOARD BHP	1470	1470	1470	1470	1470	1470	1470	1470	1345 F.T.	1400	1400	1400	1400	1400	1400	1365 F.T.	1240 F.T.	
	INBOARD BMEP	151	151	151	151	151	151	151	151	138	144	144	144	144	144	144	140	127	

- NOTES: 1. Set power by RPM and BMEP unless limit MAP is obtained first. Set outboard engine 5 BMEP less at maximum and METO power to allow for cabin supercharger power requirements.
2. Inboard engine BMEP settings are those expected to be available with standard day temperature and ram air. Values shown are limits unless full throttle performance is shown, noted by (F.T.), or unless settings less than limit values are recommended, denoted by (*).
3. No more than 2 in. hg. difference in MAP between engines is allowable for a given power setting after accounting for cabin supercharger power requirements. If a greater difference is observed, reduce power 2 in. hg. or less.

Figure A2-4

A2-9

T. O. 1C-121A-1

Part 2 — Engine Operating Data

Appendix 1

R3350-75 ENGINE POWER SCHEDULE TABLE

10% LEAN MIXTURE

STANDARD DAY

100/130 GRADE FUEL

MODEL: C-121A

DATA AS OF: 15 AUGUST 1961

DATA BASIS: FLIGHT TESTS

ZERO HUMIDITY AT STANDARD TEMPERATURE

PROPS: CURTISS C-460/830-26C4-0

ENGINE SPEED RPM	POWER SETTINGS																		
	PRESS. ALT.—FT.	S. L.	2,000	4,000	6,000	8,000	10,000	12,000	14,000	16,000	18,000	20,000	22,000	24,000					
	Blower Setting	LOW BLOWER									HIGH BLOWER								
MAXIMUM CRUISE POWER: MAXIMUM ALLOWABLE CYLINDER HEAD TEMPERATURE 230° C, LIMIT MAP 38.0 (L.B.) 37.0 (H.B.), TIME LIMIT NONE.																			
2400	INBD BHP	1470	1470	1470	1470	1470	1470	1470	1470	1470	1345 F.T.	1400	1400	1400	1400	1400	1400	1300 F.T.	1185 F.T.
	INBD BMEP	145	145	145	145	145	145	145	145	145	132	138	138	138	138	138	138	128	116
2300	INBD BHP	1470	1470	1470	1470	1470	1470	1470	1470	1385 F.T.	1255 F.T.	1400	1400	1400	1400	1400	1345 F.T.	1230 F.T.	1125 F.T.
	INBD BMEP	151	151	151	151	151	151	151	151	142	129	144	144	144	144	144	138	126	115
2200	INBD BHP	1470	1470	1470	1470	1470	1470 F.T.	1405 F.T.	1285 F.T.	1160 F.T.		1390	1390	1390	1390	1390 F.T.	1260 F.T.	1150 F.T.	1050 F.T.
	INBD BMEP	158	158	158	158	158	158	151	138	124		149	149	149	149	149	135	123	113
2130	INBD BHP	1470	1470	1470	1470	1470	1470 F.T.	1330 F.T.	1210 F.T.	1090 F.T.		1245	1245	1245	1245	1245	1160 F.T.	1060 F.T.	965 F.T.
	INBD BMEP	162	162	162	162	162	162	147	134	121		140	140	140	140	140	130	119	108
2000	INBD BHP	1230	1230	1230	1230	1230	1230	1190 F.T.	1075 F.T.	970 F.T.		1185	1185	1185	1185	1160 F.T.	1055 F.T.	955 F.T.	870 F.T.
	INBD BMEP	145	145	145	145	145	145	140	127	114		140	140	140	140	137	124	113	103
1900	INBD BHP	1170	1170	1170	1170	1170	1170	1070 F.T.	970 F.T.	880 F.T.		1130	1130	1130	1130	1045 F.T.	950 F.T.	865 F.T.	780 F.T.
	INBD BMEP	145	145	145	145	145	145	133	120	109		140	140	140	140	130	118	107	97
1800	INBD BHP	1105	1105	1105	1105	1105	1050 F.T.	960 F.T.	870 F.T.	785 F.T.		1070	1070	1070	1025 F.T.	935 F.T.	845 F.T.	765 F.T.	685 F.T.
	INBD BMEP	145	145	145	145	145	138	126	114	103		140	140	140	134	122	111	100	90
1700	INBD BHP	1045	1045	1045	1045	1030 F.T.	940 F.T.	855 F.T.	770 F.T.	690 F.T.		1010	1010	975 F.T.	895 F.T.	815 F.T.	740 F.T.	665 F.T.	
	INBD BMEP	145	145	145	145	143	130	119	107	96		140	140	135	124	113	103	92	
1600	INBD BHP	985	985	985	985	905 F.T.	825 F.T.	745 F.T.	670 F.T.	595 F.T.		950	915 F.T.	835 F.T.	765 F.T.	690 F.T.	620 F.T.		
	INBD BMEP	145	145	145	145	133	122	110	99	88		140	135	123	113	102	91		
1500	INBD BHP	920	920	920	860 F.T.	775 F.T.	700 F.T.	630 F.T.	560 F.T.	500 F.T.		835 F.T.	760 F.T.	690 F.T.	620 F.T.				
	INBD BMEP	145	145	145	135*	122*	110	99	88	79		131	120	109	97				
1400	INBD BHP	860	860 F.T.	790 F.T.	720 F.T.	655 F.T.	585 F.T.	525 F.T.				700	700	600					
	INBD BMEP	145	145	133	121	110	99	88				110*	110*	94*					
1400	INBD BHP	800	800	700	600	600	500					600	600						
	INBD BMEP	135*	135*	118*	101*	101*	84*					94*	94*						
1400	INBD BHP	700	700	600	500	500													
	INBD BMEP	118*	118*	101*	84*	84*													
1400	INBD BHP	600	600	500															
	INBD BMEP	101*	101*	84*															
1400	INBD BHP	500	500																
	INBD BMEP	84*	84*																

NOTES: 1. Set power by RPM and BMEP unless limit MAP is obtained first.

2. Engine BMEP settings are those to be available with standard day temperatures and ram air. Values shown are limits unless full throttle performance is shown, noted by [F.T.], or unless settings less than limit values are recommended, noted by (*). An arbitrary "pod" of 50 RPM has been included in these full throttle power settings.

3. No more than 2 in. hg. difference in MAP between engines is allowable for a given power setting after accounting for cabin supercharger requirements. If a greater difference is observed, reduce power on engine with the highest MAP until the difference is 2 in. hg. or less.

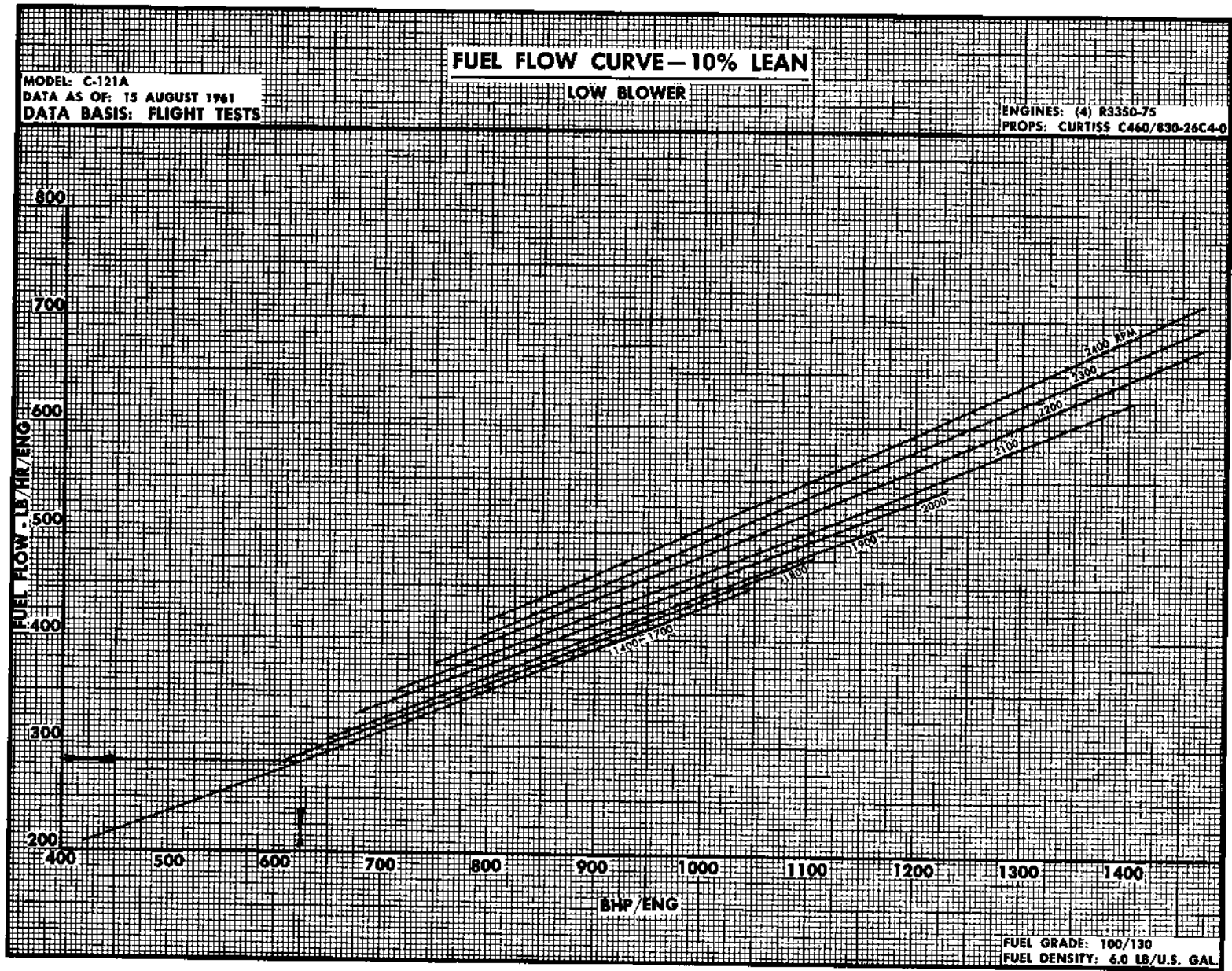

Figure A2-7

FUEL FLOW CURVE - 10% LEAN

MODEL: C-121A
DATA AS OF: 15 AUGUST 1961
DATA BASIS: FLIGHT TESTS

HIGH BLOWER

ENGINES: (4) R3350-75
PROPS: CURTISS C460/830-26C4-D

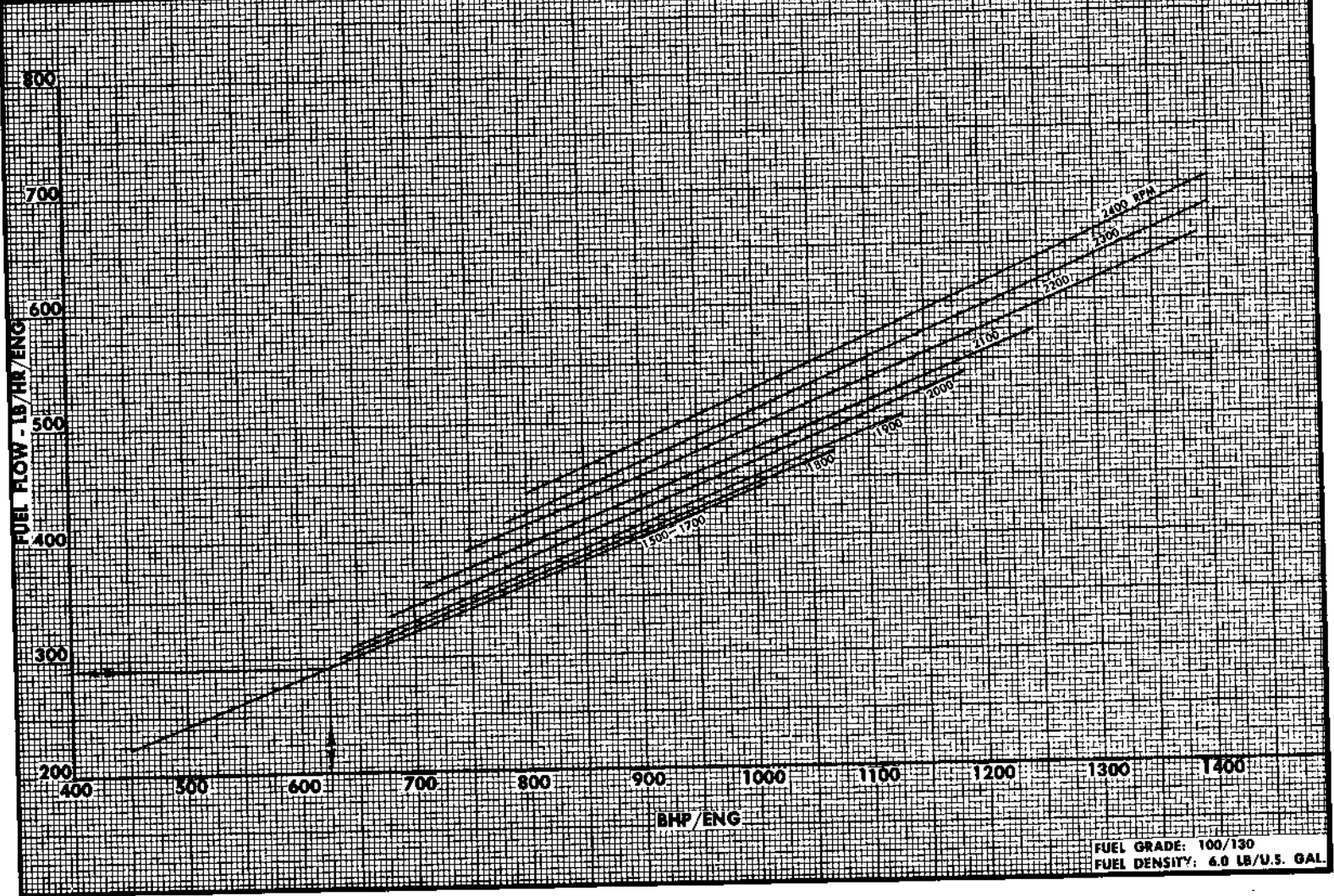

FUEL GRADE: 100/130
FUEL DENSITY: 6.0 LB/U.S. GAL

Figure A2-8

A2-13, A2-14

MAXIMUM POWER PREDICTION GRAPH

MODEL: C-121A
DATA BASED ON: CALCULATIONS
DATA AS OF: 1 January 1959

100/130 FUEL

ENGINE: R3350-75
PROPS: CURTISS 830-21C4-0

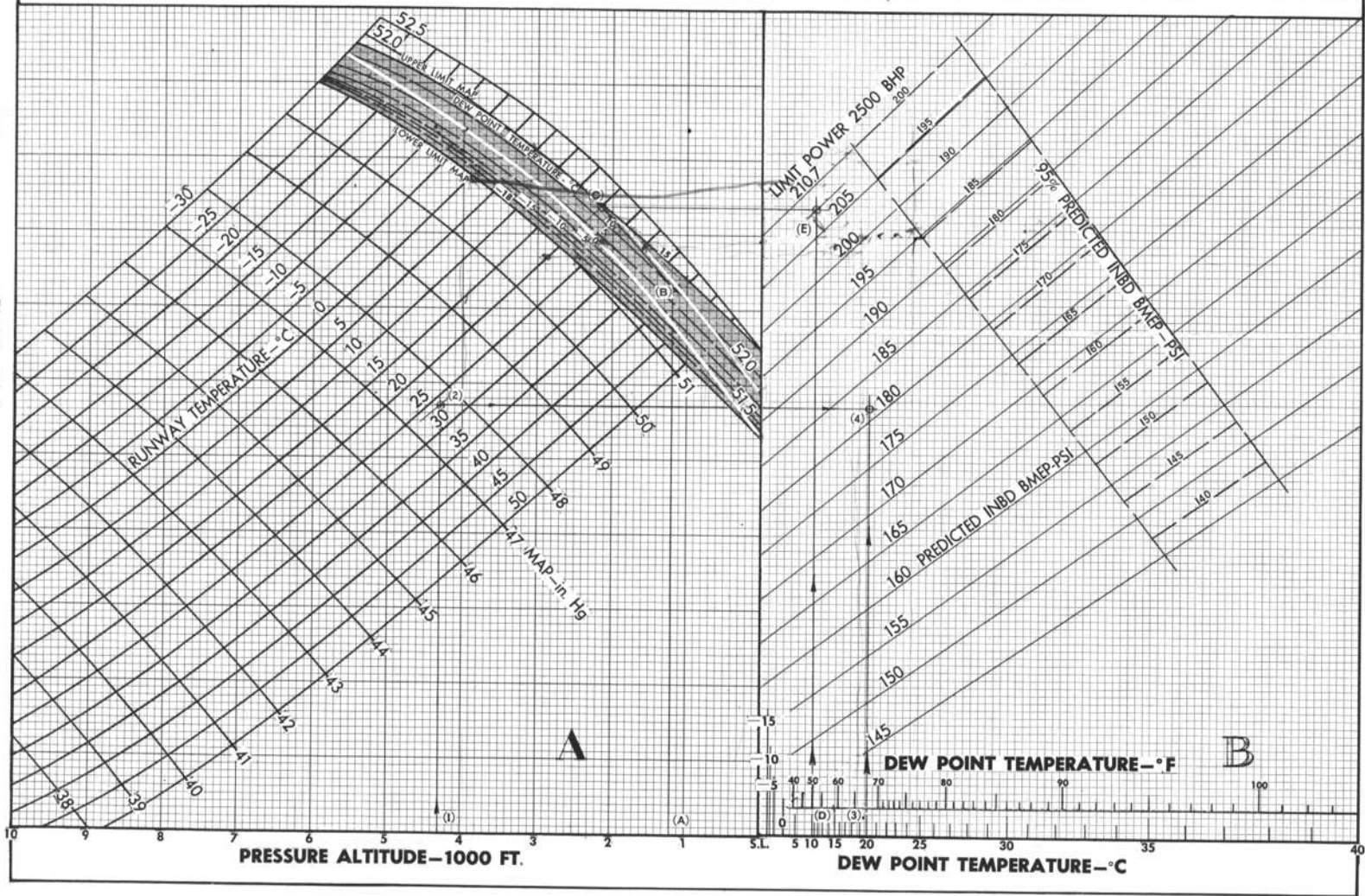

Figure A3-1

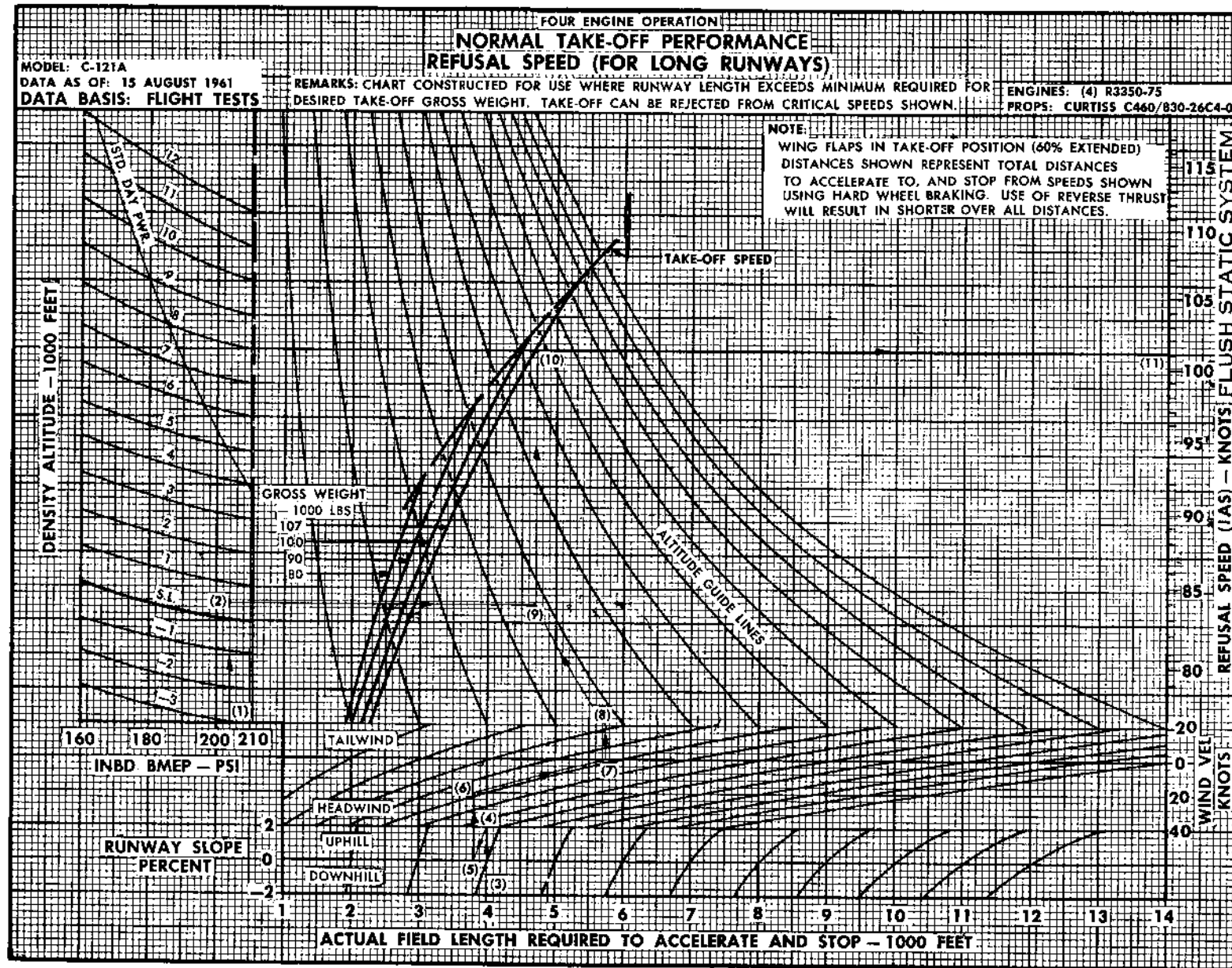

Figure A3-5

ALLOWABLE ALTITUDE OF TERRAIN

MODEL: C-121A

ENGINES: (4) R3350-75

PROPS: CURTISS 830-21C4-0

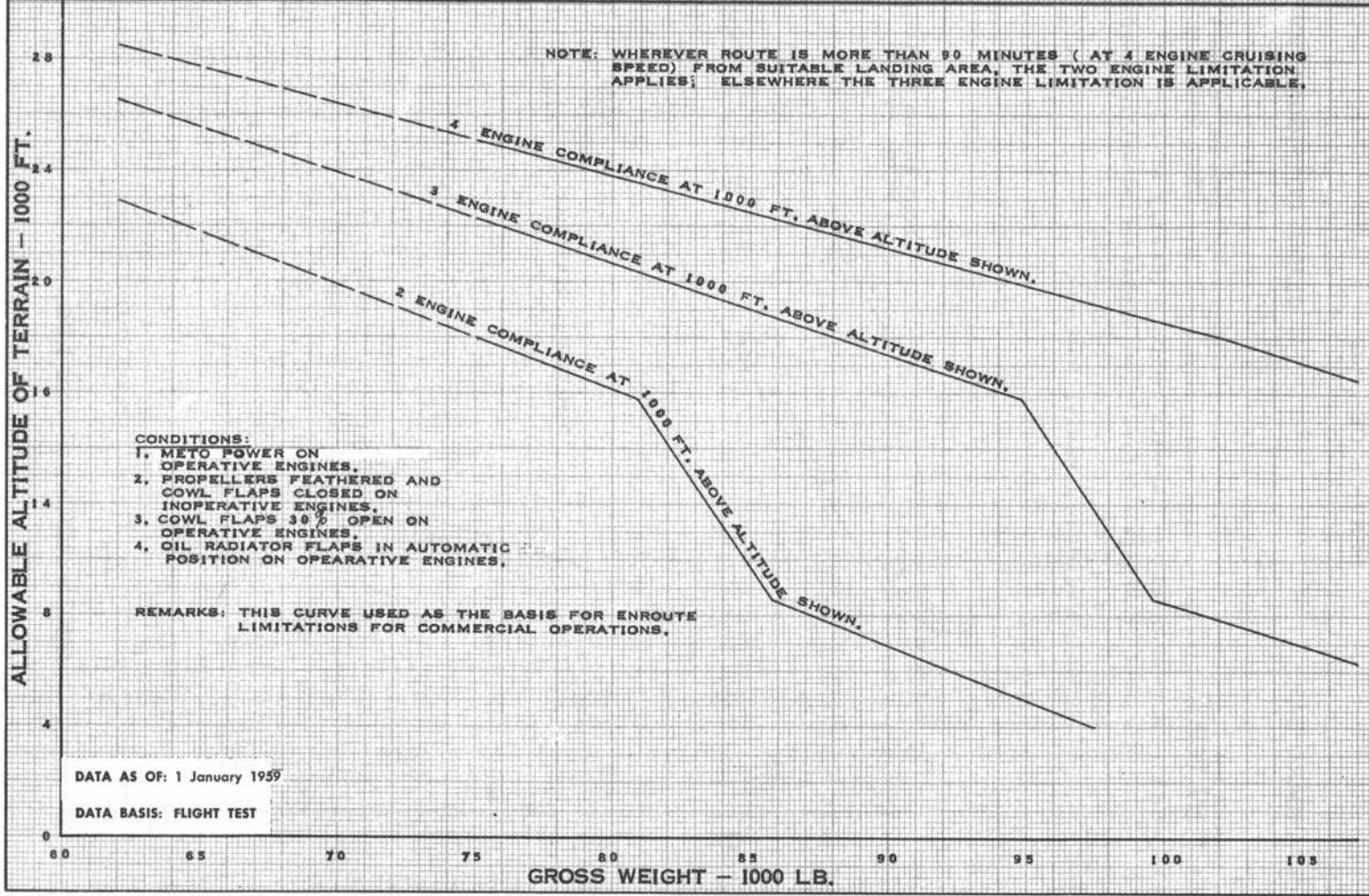

Figure A4-10

FOUR ENGINE OPERATION H-1 CRUISE — OPERATING TABLES

MODEL: C-121A
DATA AS OF: 15 AUGUST 1961
DATA BASIS: FLIGHT TESTS

ENGINES: (4) R3350-75

PROPS: CURTISS C460/830-26C4-0

GROSS WEIGHT —LB.	H ₁ — 1000 FT.	5	6	7	8	9	10	11	12	13	14	15	16	17	18	19	20	21	22	23	24	25	
		LOW BLOWER											HIGH BLOWER										
107,000 to 104,000	INBD BHP	1080	1195	1220	1230	1250	1270	1305	1325	1350	1370	1400	1355	1380	1410	1440	1465	1535					
	RPM	1925	1945	1975	2000	2035	2060	2080	2125	2200	2275	2375	2300	2305	2310	2315	2320	2400					
	INBD BMEP	145	145	145	145	145	145	148	147	145	142	139	139	141	144	147	149	151					
	F. F.	515	525	535	545	560	570	585	595	610	635	665	665	665	685	910	930	955	975				
	AVG. IAS	182	182	182	182	182	183	183	183	183	183	183	183	183	183	183	184	184	184				
	AVG. TAS	201	205	208	211	214	218	221	224	228	232	236	236	240	244	248	252	256	261				
	Δ TIME Δ DIST.	1:27 293	1:26 293	1:24 291	1:22 290	1:20 287	1:19 286	1:17 283	1:16 283	1:14 280	1:11 274	1:08 265	0:52 208	0:51 206	0:49 203	0:48 202	0:47 201	0:46 200					
104,000 to 100,000	INBD BHP	1150	1170	1190	1215	1230	1245	1260	1290	1315	1335	1350	1370	1400	1380	1400	1430	1455					
	RPM	1870	1900	1940	1975	1995	2025	2055	2100	2175	2250	2325	2180	2200	2305	2305	2310	2315					
	INBD BMEP	145	145	145	145	145	145	145	145	143	140	137	148	150	141	143	146	148					
	F. F.	500	510	520	530	540	555	570	580	595	615	640	645	660	670	900	920	940					
	AVG. IAS	182	182	182	182	182	183	183	183	183	183	183	183	183	183	183	184	184	184				
	AVG. TAS	201	205	208	211	214	218	221	224	228	232	236	240	244	248	252	256	261					
	Δ TIME Δ DIST.	2:00 402	1:58 400	1:56 399	1:53 398	1:51 397	1:48 392	1:46 389	1:43 387	1:41 384	1:38 376	1:34 368	1:33 371	1:31 369	1:09 284	1:07 280	1:05 279	1:04 277					
100,000 to 96,000	INBD BHP	1110	1125	1150	1160	1180	1200	1220	1240	1260	1280	1295	1310	1330	1355	1340	1370	1410	1475				
	RPM	1800	1830	1870	1890	1920	1955	1985	2045	2120	2200	2280	2145	2160	2190	2275	2305	2310	2400				
	INBD BMEP	145	145	145	145	145	145	145	143	140	137	134	144	145	146	144	140	144	145				
	F. F.	475	485	495	500	515	525	535	550	565	585	605	620	630	640	670	870	890	915				
	AVG. IAS	181	181	181	181	181	182	182	182	182	182	182	182	182	182	182	183	183	183				
	AVG. TAS	200	203	207	210	213	216	220	224	227	231	234	238	242	246	250	254	260	264				
	Δ TIME Δ DIST.	2:06 422	2:04 419	2:01 417	2:00 416	1:57 414	1:54 412	1:52 410	1:47 406	1:46 402	1:43 395	1:39 388	1:37 384	1:35 384	1:33 384	1:33 376	1:30 293	1:07 291	1:06 288				
96,000 to 92,000	INBD BHP	1060	1075	1095	1110	1130	1140	1160	1175	1195	1220	1243	1250	1265	1285	1310	1340	1360	1280	1305			
	RPM	1725	1750	1780	1800	1845	1875	1930	1995	2075	2150	2230	2100	2115	2130	2200	2290	2400	2320	2400			
	INBD BMEP	145	145	145	145	145	144	142	139	136	133	131	140	141	142	140	138	134	130	128			
	F. F.	455	465	475	480	490	500	505	520	535	550	565	580	595	610	625	645	680	855	870			
	AVG. IAS	179	179	179	179	179	179	180	180	180	180	180	180	180	180	180	181	181	181	181			
	AVG. TAS	198	201	204	207	211	214	218	221	225	228	232	236	240	244	248	252	256	260	266			
	Δ TIME Δ DIST.	2:12 435	2:09 433	2:07 432	2:05 431	2:03 430	2:01 430	1:58 428	1:55 425	1:52 420	1:49 415	1:46 410	1:43 406	1:41 402	1:38 399	1:36 395	1:33 391	1:28 377	1:28 305	1:10 305	1:09 305		
92,000 to 88,000	INBD BHP	1005	1025	1035	1045	1060	1070	1090	1110	1120	1145	1170	1190	1205	1230	1245	1260	1270	1250	1230			
	RPM	1635	1665	1685	1700	1770	1820	1875	1945	2000	2080	2160	1995	2030	2070	2125	2200	2290	2300	2325			
	INBD BMEP	145	145	145	145	142	139	137	135	132	130	128	140	140	140	138	135	132	128	125			
	F. F.	430	435	440	450	455	465	475	485	500	515	530	530	540	555	575	605	625	790	810			
	AVG. IAS	176	176	176	176	176	176	176	177	177	177	177	177	177	177	177	178	178	178	178			
	AVG. TAS	195	198	201	204	207	211	214	217	221	225	228	232	236	240	244	248	252	256	262			
	Δ TIME Δ DIST.	2:20 455	2:18 455	2:16 455	2:13 455	2:12 454	2:10 453	2:09 451	2:07 448	2:04 442	2:00 436	1:57 431	1:53 437	1:53 436	1:51 436	1:48 432	1:44 423	1:39 410	1:36 403	1:27 329	1:24 322		

- NOTES: 1. Cowl flaps faired, oil radiator flaps automatic and cabin supercharger scoop closed.
 2. High blower operation to right of double line. Shaded area represents AUTO-RICH operation.
 3. Data are for weight bracket mid-point.
 4. Average IAS values are for flush static system.

Figure A5-38 (Sheet 1 of 6)

A5-49

T. O. 1C-121A-1

Appendix 1
Part 5 — Cruise

FOUR ENGINE OPERATION H-1 CRUISE - OPERATING TABLES

MODEL: C-121A
DATA AS OF: 15 AUGUST 1961
DATA BASIS: FLIGHT TESTS

ENGINES: (4) R3350-75

PROPS: CURTISS C460/830-26C4-0

GROSS WEIGHT - LB.	H _h - 1000 FT.	5	6	7	8	9	10	11	12	13	14	15	16	17	18	19	20	21	22	23	24	25
		LOW BLOWER											HIGH BLOWER									
88,000 to 84,000	INBD BHP	930	945	955	965	975	995	1010	1035	1045	1070	1090	1100	1115	1150	1155	1180	1195	1225	1250	1160	
	RPM	1525	1570	1610	1660	1700	1755	1810	1875	1925	2000	2070	1875	1920	1990	2050	2110	2200	2290	2400	2320	
	INBD BMEP	144	142	140	137	135	134	132	130	128	126	124	139	138	136	133	132	128	126	126	123	118
	F. F.	400	405	410	420	430	435	440	450	465	480	490	485	500	510	525	545	570	600	635	755	
	AVG. IAS	172	172	172	172	172	172	172	172	172	173	173	173	173	173	173	173	173	173	174	174	174
	AVG. TAS	191	194	197	199	203	206	209	213	216	220	223	227	231	234	238	242	246	250	256	260	
	Δ TIME	2:30	2:28	2:26	2:23	2:20	2:18	2:16	2:13	2:09	2:05	2:02	2:03	2:00	1:57	1:54	1:50	1:45	1:40	1:35	1:19	
Δ DIST.	477	476	476	475	474	474	473	473	465	457	455	467	462	458	452	445	439	418	402	344		
84,000 to 80,000	INBD BHP	870	890	905	915	930	935	955	975	995	1010	1020	1035	1055	1060	1095	1115	1135	1150	1175	1200	1145
	RPM	1490	1530	1575	1610	1660	1700	1760	1815	1880	1940	2000	1810	1870	1925	1990	2050	2120	2200	2290	2400	2325
	INBD BMEP	138	137	135	134	132	130	128	127	125	123	120	135	133	131	130	128	126	123	121	118	116
	F. F.	380	385	390	395	400	410	415	425	435	445	455	460	470	485	495	510	530	550	580	620	705
	AVG. IAS	169	169	169	169	169	169	169	169	170	170	170	170	170	170	170	170	170	171	171	171	171
	AVG. TAS	187	190	193	196	199	202	206	209	212	216	219	223	227	231	234	238	242	246	252	255	260
	Δ TIME	2:38	2:35	2:33	2:31	2:30	2:27	2:25	2:21	2:18	2:15	2:12	2:10	2:08	2:04	2:01	1:58	1:53	1:49	1:45	1:37	1:25
Δ DIST.	493	493	493	494	498	496	495	492	488	485	482	484	483	475	473	467	457	448	441	412	369	
80,000 to 76,000	INBD BHP	835	850	865	870	880	890	915	935	945	955	965	985	995	1025	1035	1060	1070	1095	1110	1130	1100
	RPM	1465	1500	1545	1580	1625	1665	1725	1775	1825	1895	1950	1775	1820	1890	1935	2000	2060	2130	2215	2300	2300
	INBD BMEP	135	134	132	130	128	126	125	124	122	119	117	131	129	128	126	125	122	121	118	116	113
	F. F.	365	370	375	380	385	390	395	405	415	425	435	455	455	470	485	500	515	535	565	660	
	AVG. IAS	167	167	167	167	167	167	167	167	167	168	168	168	168	168	168	168	168	168	169	169	169
	AVG. TAS	185	188	191	194	197	200	203	206	210	214	217	220	224	228	232	236	240	244	248	252	255
	Δ TIME	2:45	2:43	2:41	2:38	2:36	2:34	2:32	2:28	2:25	2:22	2:18	2:17	2:14	2:11	2:07	2:04	2:00	1:56	1:52	1:46	1:31
Δ DIST.	508	511	511	512	512	514	514	511	505	504	499	505	500	497	493	485	479	473	462	445	389	
76,000 to 72,000	INBD BHP	800	815	820	835	845	860	870	880	900	920	930	945	955	975	1000	1015	1040	1045	1060	1080	1105
	RPM	1440	1475	1510	1555	1595	1640	1680	1735	1800	1835	1925	1740	1790	1840	1900	1965	2025	2090	2160	2250	2350
	INBD BMEP	131	130	128	127	125	124	122	120	118	116	114	128	126	125	124	122	121	118	116	113	111
	F. F.	350	355	360	365	370	375	380	390	395	405	415	420	430	440	450	460	475	495	510	535	560
	AVG. IAS	166	166	166	166	166	166	166	166	166	166	167	167	167	167	167	167	167	167	167	168	168
	AVG. TAS	184	187	190	193	196	199	202	206	209	212	216	219	223	227	230	234	238	242	247	251	254
	Δ TIME	2:52	2:49	2:47	2:45	2:42	2:40	2:38	2:34	2:31	2:28	2:25	2:22	2:19	2:16	2:13	2:10	2:06	2:01	1:58	1:52	1:47
Δ DIST.	527	527	527	528	529	531	532	527	526	525	519	520	517	515	508	505	501	490	484	470	455	
72,000 to 68,000	INBD BHP	760	780	795	800	810	825	840	850	865	875	895	900	915	935	960	970	990	1010	1020	1040	1050
	RPM	1400	1450	1490	1525	1570	1610	1650	1700	1755	1810	1890	1710	1760	1810	1870	1925	1975	2050	2110	2190	2275
	INBD BMEP	128	127	126	124	122	121	120	118	116	114	112	124	123	122	121	119	118	116	114	112	109
	F. F.	340	345	350	350	355	360	365	370	375	380	400	405	410	420	430	440	455	470	480	500	520
	AVG. IAS	165	165	165	165	165	165	165	165	165	166	166	166	166	166	166	166	166	166	166	167	167
	AVG. TAS	183	186	189	192	195	198	201	204	208	211	214	218	222	226	229	233	237	240	246	250	252
	Δ TIME	2:57	2:54	2:53	2:51	2:49	2:47	2:45	2:42	2:40	2:37	2:30	2:28	2:26	2:23	2:19	2:17	2:12	2:08	2:05	2:00	1:55
Δ DIST.	539	540	542	545	547	550	551	551	552	552	536	536	536	535	531	531	520	515	510	499	487	

- NOTES: 1. Cowl flaps faired, oil radiator flaps automatic and cabin supercharger scoop closed.
2. High blower operation to right of double line. Shaded area represents AUTO-RICH operation.
3. Data are for weight bracket mid-point.
4. Average IAS values are for flush static system.

THREE ENGINE OPERATION H-1 CRUISE — OPERATING TABLES

MODEL: C-121A
DATA AS OF: 15 AUGUST 1961
DATA BASIS: FLIGHT TESTS

ENGINES: (4) R3350-75

PROPS: CURTISS C460/830-26C4-0

GROSS WEIGHT — LB.	H ₀ — 1000 FT.	5	6	7	8	9	10	11	12	13	14	15	16	17	18	19	20	21	22	23	24	25	
		LOW BLOWER					HIGH BLOWER																
107,000 to 104,000	INBD BHP	1710	1740	1770	1790	1820																	
	RPM	2400	2400	2400	2400	2400																	
	INBD BMEP	168	171	174	176	179																	
	F. F.	1035	1060	1080	1100	1125																	
	AVG. EAS	181	181	181	181	181																	
	AVG. TAS	200	203	207	210	213																	
Δ TIME	0:58	0:57	0:56	0:55	0:53																		
Δ DIST.	194	192	191	191	190																		
104,000 to 100,000	INBD BHP	1670	1700	1720	1740	1770																	
	RPM	2400	2400	2400	2400	2400																	
	INBD BMEP	164	167	169	171	174																	
	F. F.	1000	1020	1040	1070	1090																	
	AVG. EAS	181	181	181	181	181																	
	AVG. TAS	200	203	207	210	213																	
Δ TIME	1:20	1:18	1:17	1:15	1:13																		
Δ DIST.	268	266	265	261	260																		
100,000 to 96,000	INBD BHP	1630	1650	1670	1700	1720	1750	1780															
	RPM	2400	2400	2400	2400	2400	2400	2400															
	INBD BMEP	160	162	164	167	169	172	175															
	F. F.	965	980	1000	1025	1050	1070	1220															
	AVG. EAS	181	181	181	181	181	182	182															
	AVG. TAS	200	203	207	210	213	216	220															
Δ TIME	1:23	1:22	1:20	1:18	1:16	1:15	1:06																
Δ DIST.	277	277	276	273	271	270	240																
96,000 to 92,000	INBD BHP	1550	1570	1600	1620	1650	1680	1700	1730	1750	1780												
	RPM	2400	2400	2400	2400	2400	2400	2400	2400	2400	2400												
	INBD BMEP	152	154	157	159	162	165	167	170	172	175												
	F. F.	905	925	940	960	980	1000	1025	1165	1190	1220												
	AVG. EAS	179	179	180	180	180	180	180															
	AVG. TAS	198	201	204	208	211	214	218	221	225	228												
Δ TIME	1:28	1:26	1:25	1:23	1:22	1:20	1:18	1:09	1:07	1:06													
Δ DIST.	292	289	290	288	287	286	283	253	252	250													
92,000 to 88,000	INBD BHP	1460	1490	1520	1540	1570	1590	1620	1640	1660	1700	1720	1750	1770									
	RPM	2130	2400	2400	2400	2400	2400	2400	2400	2400	2400	2400	2400	2400									
	INBD BMEP	162	146	149	151	154	156	159	161	163	167	169	172	174									
	F. F.	660	865	880	900	915	935	955	975	1110	1130	1160	1180	1210									
	AVG. EAS	176	176	176	176	177	177	177															
	AVG. TAS	195	198	201	204	207	211	214	217	221	225	228	232	236									
Δ TIME	2:01	1:32	1:31	1:29	1:27	1:26	1:24	1:22	1:12	1:11	1:09	1:08	1:06										
Δ DIST.	395	305	304	303	302	300	298	297	265	265	262	262	260										

- NOTES: 1. Cowl flaps faired, oil radiator flaps automatic and cabin supercharger scoop closed.
2. High blower operation to right of double line. Shaded area represents AUTO-RICH operation.
3. Data are for weight bracket mid-point.
4. Average IAS values are for flush static system.

Figure A5-39 (Sheet 1 of 2)

A5-55

T. O. 1C-121A-1

Appendix I
Part 5 — Cruise

THREE ENGINE OPERATION H-1 CRUISE - OPERATING TABLES

MODEL: C-121A
DATA AS OF: 15 AUGUST 1961
DATA BASIS: FLIGHT TESTS

ENGINES: (4) R3350-75

PROPS: CURTISS C460/830-26C4-0

GROSS WEIGHT - LB.	H _D - 1000 FT.	5	6	7	8	9	10	11	12	13	14	15	16	17	18	19	20	21	22	23	24	25	
		LOW BLOWER											HIGH BLOWER										
88,000 to 84,000	INBD BHP	1380	1390	1410	1435	1460	1500	1520	1550	1570	1590	1620	1640	1670	1690								
	RPM	2090	2095	2105	2115	2130	2400	2400	2400	2400	2400	2400	2400	2400	2400								
	INBD BMEP	156	157	158	160	162	147	149	152	154	156	159	161	164	166								
	F. F.	615	620	630	635	655	860	880	900	920	1035	1055	1075	1100	1125								
	AVG. EAS	172									173												
	AVG. TAS	191	194	197	199	202	206	209	213	216	220	223	227	231	234								
Δ TIME	2:10	2:09	2:07	2:06	2:02	1:33	1:31	1:29	1:27	1:17	1:17	1:14	1:13	1:11									
Δ DIST.	415	418	419	419	413	319	316	315	313	282	282	281	280	278									
84,000 to 80,000	INBD BHP	1280	1300	1310	1330	1370	1390	1430	1460	1465	1500	1530	1550	1570	1600	1630							
	RPM	2030	2040	2050	2060	2080	2090	2160	2230	2300	2400	2400	2400	2400	2400	2400							
	INBD BMEP	149	150	151	152	155	157	156	154	150	147	150	152	154	157	160							
	F. F.	575	585	590	600	610	620	635	665	700	870	970	985	1015	1030	1060							
	AVG. EAS	169									168												
	AVG. TAS	187	190	193	196	199	202	206	209	212	216	219	223	227	231	235							
Δ TIME	2:19	2:17	2:16	2:13	2:11	2:09	2:06	2:00	1:54	1:32	1:23	1:21	1:19	1:18	1:16								
Δ DIST.	434	435	437	436	436	435	434	420	415	330	301	301	298	298	295								
80,000 to 76,000	INBD BHP	1195	1235	1245	1270	1290	1345	1355	1375	1400	1420	1445	1470	1510	1530	1550	1570						
	RPM	1995	2005	2010	2020	2030	2050	2100	2175	2250	2320	2350	2400	2400	2400	2400	2400						
	INBD BMEP	145	145	146	148	150	151	152	149	147	144	145	144	148	150	152	154						
	F. F.	545	555	565	575	585	595	605	620	640	675	800	930	950	970	1010							
	AVG. EAS	167									168												
	AVG. TAS	185	188	191	194	197	200	203	206	210	214	217	220	224	228	232	236						
Δ TIME	2:27	2:24	2:22	2:19	2:17	2:14	2:12	2:09	2:05	1:59	1:40	1:26	1:24	1:22	1:21	1:19							
Δ DIST.	454	452	451	451	450	449	448	444	439	424	362	316	314	312	312	310							
76,000 to 72,000	INBD BHP	1180	1200	1220	1235	1250	1270	1290	1330	1350	1370	1400	1420	1440	1470	1510	1530						
	RPM	1920	1955	1985	2005	2015	2025	2040	2125	2200	2280	2375	2400	2400	2400	2400	2400						
	INBD BMEP	145	145	145	145	146	148	149	147	145	142	139	139	142	145	148	150						
	F. F.	520	530	540	550	560	575	585	595	615	635	670	800	890	920	940	960						
	AVG. EAS	166									167												
	AVG. TAS	184	187	190	193	196	199	202	206	209	212	216	219	223	227	230	234						
Δ TIME	2:34	2:31	2:28	2:26	2:23	2:19	2:17	2:14	2:10	2:06	2:00	1:40	1:30	1:27	1:25	1:23							
Δ DIST.	473	471	470	469	467	462	461	460	455	446	429	365	334	328	326	325							
72,000 to 68,000	INBD BHP	1140	1160	1175	1190	1215	1230	1260	1280	1300	1325	1350	1350	1380	1390	1440	1470	1510					
	RPM	1855	1890	1910	1940	1975	2000	2040	2080	2160	2230	2310	2325	2145	2230	2400	2400	2400					
	INBD BMEP	145	145	145	145	145	145	146	145	142	140	138	137	148	147	142	145	148					
	F. F.	490	500	515	525	535	545	560	570	585	605	630	760	650	670	890	910	935					
	AVG. EAS	165									166												
	AVG. TAS	183	186	189	192	195	198	201	204	208	211	214	218	222	226	229	233	237					
Δ TIME	2:43	2:39	2:35	2:32	2:29	2:27	2:23	2:20	2:17	2:12	2:07	1:45	1:35	1:30	1:28	1:26	1:24						
Δ DIST.	499	495	490	489	486	485	480	479	475	466	454	382	345	340	343	341	338						

- NOTES: 1. Cowl flaps faired, oil radiator flaps automatic and cabin supercharger scoop closed.
2. High blower operation to right of double line. Shaded area represents AUTO-RICH operation.
3. Data are for weight bracket mid-point.
4. Average IAS values are for flush static system.

FOUR ENGINE OPERATION CONSTANT POWER CRUISE — OPERATING TABLES

1300 BHP

MODEL: C-121A
DATA AS OF: 15 AUGUST 1961
DATA BASIS: FLIGHT TESTS

ENGINES: (4) R3350-75

PROPS: CURTISS C460/830-26C4-0

GROSS WEIGHT — LB.	H ₁ — 1000 FT.	5	6	7	8	9	10	11	12	13	14	15	16	17	18	19	20	21	22	23	24	25
		LOW BLOWER											HIGH BLOWER									
107,000 to 104,000	INBD BHP	1300										2130	2130	2130	2130							
	RPM	2060	2060	2060	2060	2060	2060	2060	2100	2145	2205	2130	2130	2130	2130							
	INBD BMEP	149	149	149	149	149	149	149	149	146	143	139	144	144	144	144						
	F. F.	575	580	580	580	580	580	580	580	585	590	600	610	610	610	610						
	AVG. IAS	195	193	191	189	188	186	183	181	178	176	173	170	165	163							
	AVG. TAS	216	216	217	218	220	221	222	222	223	223	224	224	222	219							
	Δ TIME	1:18	1:18	1:18	1:18	1:18	1:17	1:17	1:17	1:16	1:15	1:15	1:14	1:14	1:14							
Δ DIST.	280	281	282	282	284	285	285	285	282	279	276	276	273	268								
104,000 to 100,000	INBD BHP	1300										2130	2130	2130	2130	2190	2240	2325				
	RPM	2060	2060	2060	2060	2060	2060	2060	2100	2145	2205	2130	2130	2130	2130	2190	2240	2325				
	INBD BMEP	149	149	149	149	149	149	149	149	146	143	139	144	144	144	144	140	137	132			
	F. F.	575	580	580	580	580	580	580	580	585	590	600	610	610	610	610	615	625	635			
	AVG. IAS	197	196	194	192	191	189	187	185	183	180	178	176	174	171	168	166	160				
	AVG. TAS	218	219	221	222	223	225	226	227	228	229	230	231	231	232	232	231	229				
	Δ TIME	1:44	1:44	1:44	1:43	1:43	1:43	1:43	1:43	1:43	1:42	1:40	1:39	1:38	1:38	1:38	1:36	1:36				
Δ DIST.	377	379	381	382	385	386	388	388	386	381	377	377	378	378	379	376	371	360				
100,000 to 96,000	INBD BHP	1300										2130	2130	2130	2130	2190	2240	2325	2400	2300	2380	
	RPM	2060	2060	2060	2060	2060	2060	2060	2100	2145	2205	2130	2130	2130	2130	2190	2240	2325	2400	2300	2380	
	INBD BMEP	149	149	149	149	149	149	149	149	146	143	139	144	144	144	144	140	137	132	128	133	129
	F. F.	575	580	580	580	580	580	580	580	585	590	600	610	610	610	610	615	625	635	655	770	790
	AVG. IAS	199	198	196	195	193	192	190	188	187	185	183	181	178	176	175	172	169	166	162	159	
	AVG. TAS	220	221	223	225	227	228	230	231	233	234	235	237	238	238	240	241	240	241	239	239	239
	Δ TIME	1:44	1:44	1:44	1:43	1:43	1:43	1:43	1:43	1:43	1:42	1:40	1:39	1:38	1:38	1:38	1:37	1:36	1:34	1:32	1:18	1:16
Δ DIST.	381	383	385	387	391	393	395	395	394	390	386	388	389	389	389	386	379	368	310	303		
96,000 to 92,000	INBD BHP	1300										2130	2130	2130	2130	2190	2240	2325	2400	2300	2380	
	RPM	2060	2060	2060	2060	2060	2060	2060	2100	2145	2205	2130	2130	2130	2130	2190	2240	2325	2400	2300	2380	
	INBD BMEP	149	149	149	149	149	149	149	149	146	143	139	144	144	144	144	140	137	132	128	133	129
	F. F.	575	580	580	580	580	580	580	580	585	590	600	610	610	610	610	615	625	635	655	770	790
	AVG. IAS	201	200	198	197	196	194	193	191	190	188	186	184	183	180	179	177	174	172	170	168	
	AVG. TAS	222	223	225	227	229	231	233	235	236	238	240	241	243	244	246	247	248	249	251	251	
	Δ TIME	1:44	1:44	1:44	1:43	1:43	1:43	1:43	1:43	1:43	1:42	1:40	1:39	1:38	1:38	1:38	1:37	1:36	1:34	1:32	1:18	1:16
Δ DIST.	384	387	388	391	395	397	399	401	400	396	398	395	395	397	398	395	390	381	325	318		
92,000 to 88,000	INBD BHP	1300										2130	2130	2130	2130	2190	2240	2325	2400	2300	2380	
	RPM	2060	2060	2060	2060	2060	2060	2060	2100	2145	2205	2130	2130	2130	2130	2190	2240	2325	2400	2300	2380	
	INBD BMEP	149	149	149	149	149	149	149	149	146	143	139	144	144	144	144	140	137	132	128	133	129
	F. F.	575	580	580	580	580	580	580	580	585	590	600	610	610	610	610	615	625	635	655	770	790
	AVG. IAS	203	201	200	199	197	196	195	193	192	191	189	188	186	184	183	181	179	177	175	173	
	AVG. TAS	223	225	227	229	231	233	235	237	239	241	243	245	247	248	251	253	253	255	257	258	
	Δ TIME	1:44	1:44	1:44	1:43	1:43	1:43	1:43	1:43	1:43	1:42	1:40	1:39	1:38	1:38	1:38	1:37	1:36	1:34	1:32	1:18	1:16
Δ DIST.	386	389	392	395	398	401	404	405	402	405	402	399	398	401	404	406	399	390	333	328		

- NOTES: 1. Cowl flaps faired, oil radiator flaps automatic and cabin supercharger scoop closed.
2. High blower operation to right of double line. Shaded area represents AUTO-RICH operation.
3. Data are for weight bracket mid-point.
4. Average IAS values are for flush static system.

Figure A5-40 (Sheet 1 of 2)

A5-57

T. O. 1C-121A-1

Appendix I
Part 5 — Cruise

FOUR ENGINE OPERATION CONSTANT POWER CRUISE - OPERATING TABLES

MODEL: C-121A
DATA AS OF: 15 AUGUST 1961
DATA BASIS: FLIGHT TESTS

1300 BHP

ENGINES: (4) R3350-75

PROPS: CURTISS C460/830-26C4-0

GROSS WEIGHT - LB.	H ₀ - 1000 FT.	5	6	7	8	9	10	11	12	13	14	15	16	17	18	19	20	21	22	23	24	25			
		LOW BLOWER											HIGH BLOWER												
88,000 to 84,000	INBD BHP	1300										2100	2145	2205	2130	2130	2130	2130	2190	2240	2325	2400	2300	2380	
	RPM	2060	2060	2060	2060	2060	2060	2060	2060	2060	2060	2100	2145	2205	2130	2130	2130	2130	2190	2240	2325	2400	2300	2380	
	INBD BMEP	149	149	149	149	149	149	149	149	149	149	146	143	139	144	144	144	144	140	137	132	128	133	129	
	F. F.	575	580	580	580	580	580	580	580	580	580	585	590	600	610	610	610	610	615	625	635	655	655	770	790
	AVG. IAS	204	202	201	201	199	198	197	195	194	193	191	190	188	187	186	184	182	180	178	177	177	178	177	177
AVG. TAS	225	226	229	231	233	235	237	239	241	245	246	248	250	252	254	256	258	260	262	264	264	262	262	264	
Δ TIME	1:44	1:44	1:44	1:43	1:43	1:43	1:43	1:43	1:42	1:40	1:39	1:38	1:38	1:38	1:38	1:37	1:36	1:34	1:32	1:32	1:32	1:18	1:16		
Δ DIST.	389	392	395	398	401	404	407	409	408	406	403	406	409	411	412	410	406	397	340	335	340	335	340	335	
84,000 to 80,000	INBD BHP	1300										2100	2145	2205	2130	2130	2130	2130	2190	2240	2325	2400	2300	2380	
	RPM	2060	2060	2060	2060	2060	2060	2060	2060	2060	2060	2100	2145	2205	2130	2130	2130	2130	2190	2240	2325	2400	2300	2380	
	INBD BMEP	149	149	149	149	149	149	149	149	149	149	146	143	139	144	144	144	144	140	137	132	128	133	129	
	F. F.	575	580	580	580	580	580	580	580	580	580	585	590	600	610	610	610	610	615	625	635	655	655	770	790
	AVG. IAS	206	204	203	202	201	199	198	197	196	194	193	192	190	189	188	186	184	183	185	185	183	181	180	180
AVG. TAS	226	228	230	232	234	237	239	241	243	245	248	250	252	254	257	259	262	264	266	267	269	269	267	272	
Δ TIME	1:44	1:44	1:44	1:43	1:43	1:43	1:43	1:43	1:42	1:40	1:39	1:38	1:38	1:38	1:38	1:37	1:36	1:34	1:32	1:32	1:18	1:16	1:16		
Δ DIST.	392	395	397	400	404	407	410	413	412	409	407	410	412	413	410	412	416	419	420	419	416	407	349	345	
80,000 to 76,000	INBD BHP	1300										2100	2145	2205	2130	2130	2130	2130	2190	2240	2325	2400	2300	2380	
	RPM	2060	2060	2060	2060	2060	2060	2060	2060	2060	2060	2100	2145	2205	2130	2130	2130	2130	2190	2240	2325	2400	2300	2380	
	INBD BMEP	149	149	149	149	149	149	149	149	149	149	146	143	139	144	144	144	144	140	137	132	128	133	129	
	F. F.	575	580	580	580	580	580	580	580	580	580	585	590	600	610	610	610	610	615	625	635	655	655	770	790
	AVG. IAS	207	205	204	203	202	201	200	198	197	196	195	193	192	191	189	188	187	185	184	182	182	182	181	182
AVG. TAS	227	229	231	234	236	238	241	243	245	247	250	252	254	257	259	262	264	267	269	272	272	269	267	272	
Δ TIME	1:44	1:44	1:44	1:43	1:43	1:43	1:43	1:43	1:42	1:40	1:39	1:38	1:38	1:38	1:37	1:36	1:34	1:32	1:32	1:18	1:16	1:16	1:16		
Δ DIST.	394	397	400	403	407	410	413	415	415	412	410	412	416	419	420	419	416	407	349	345	345	349	345	345	
76,000 to 72,000	INBD BHP	1300										2100	2145	2205	2130	2130	2130	2130	2190	2240	2325	2400	2300	2380	
	RPM	2060	2060	2060	2060	2060	2060	2060	2060	2060	2060	2100	2145	2205	2130	2130	2130	2130	2190	2240	2325	2400	2300	2380	
	INBD BMEP	149	149	149	149	149	149	149	149	149	149	146	143	139	144	144	144	144	140	137	132	128	133	129	
	F. F.	575	580	580	580	580	580	580	580	580	580	585	590	600	610	610	610	610	615	625	635	655	655	770	790
	AVG. IAS	208	206	205	204	203	202	201	200	198	197	196	195	193	192	191	189	188	187	186	185	184	182	182	185
AVG. TAS	228	230	233	235	237	239	242	244	246	249	251	254	256	259	262	264	266	269	272	275	275	272	272	275	
Δ TIME	1:44	1:44	1:44	1:43	1:43	1:43	1:43	1:43	1:42	1:40	1:39	1:38	1:38	1:38	1:37	1:36	1:34	1:32	1:32	1:18	1:16	1:16	1:16		
Δ DIST.	396	399	401	405	409	412	415	417	417	415	413	416	418	422	423	423	419	411	353	348	353	348	353	348	
72,000 to 68,000	INBD BHP	1300										2100	2145	2205	2130	2130	2130	2130	2190	2240	2325	2400	2300	2380	
	RPM	2060	2060	2060	2060	2060	2060	2060	2060	2060	2060	2100	2145	2205	2130	2130	2130	2130	2190	2240	2325	2400	2300	2380	
	INBD BMEP	149	149	149	149	149	149	149	149	149	149	146	143	139	144	144	144	144	140	137	132	128	133	129	
	F. F.	575	578	580	580	580	580	580	580	585	590	600	610	610	610	610	615	625	635	655	655	770	790	790	
	AVG. IAS	209	207	206	205	204	203	202	201	200	198	197	196	195	194	193	192	190	189	188	186	186	186	186	186
AVG. TAS	230	232	234	236	238	240	243	245	248	250	253	256	258	260	263	266	268	271	274	277	277	274	274	277	
Δ TIME	1:44	1:44	1:44	1:43	1:43	1:42	1:43	1:43	1:42	1:40	1:39	1:38	1:38	1:38	1:37	1:36	1:34	1:32	1:32	1:18	1:16	1:16	1:16		
Δ DIST.	398	401	403	406	411	414	417	419	419	417	415	418	421	424	427	426	422	414	356	351	356	351	351	351	

- NOTES: 1. Cowl flaps faired, oil radiator flaps automatic and cabin supercharger scoop closed.
2. High blower operation to right of double line. Shaded area represents AUTO-RICH operation.
3. Data are for weight bracket mid-point.
4. Average IAS values are for flush static system.

FOUR ENGINE OPERATION HOLDING CRUISE — OPERATING TABLES

MODEL: C-121A
DATA AS OF: 15 AUGUST 1961
DATA BASIS: FLIGHT TESTS

ENGINES: (4) R3350-75

PROPS: CURTISS C460/830-26C4-0

GROSS WEIGHT — LB.	Hr. — 1000 TF.	LOW BLOWER										HIGH BLOWER											
		5	6	7	8	9	10	11	12	13	14	15	16	17	18	19	20	21	22	23	24	25	
107,000 to 104,000	INBD BHP	1045	1060	1080	1100	1120	1130	1145	1160	1175	1200	1230	1250	1255	1280	1305	1340						
	RPM	1700	1725	1760	1790	1815	1860	1915	1985	2050	2125	2075	2105	2115	2130	2200	2290						
	INBD BMEP	145	145	145	145	145	143	141	138	135	133	140	140	140	142	140	138						
	F. F.	450	455	465	475	480	490	500	510	525	540	560	580	595	610	625	650						
	AVG. IAS	160										161											
	AVG. TAS	178	181	183	186	189	192	195	198	201	205	208	212	215	219	222	226						
	Δ TIME Δ DIST.	1:41 296	1:38 297	1:37 296	1:35 294	1:33 294	1:32 294	1:30 293	1:28 292	1:26 287	1:23 283	1:20 278	1:18 273	1:16 271	1:14 269	1:12 266	1:10 262						
104,000 to 100,000	INBD BHP	1000	1015	1030	1040	1060	1070	1085	1105	1120	1130	1175	1190	1210	1230	1250	1265	1290					
	RPM	1625	1650	1670	1700	1760	1815	1870	1930	2000	2065	1980	2005	2035	2075	2135	2210	2300					
	INBD BMEP	145	145	145	144	142	139	137	135	132	129	140	140	140	140	138	135	132					
	F. F.	430	435	440	450	455	465	475	485	500	515	520	530	540	555	580	605	630					
	AVG. IAS	157										158											
	AVG. TAS	175	177	180	183	186	189	192	195	198	201	204	208	211	215	218	222	226					
	Δ TIME Δ DIST.	2:20 407	2:18 407	2:15 407	2:14 407	2:11 406	2:09 405	2:06 403	2:03 401	2:00 396	1:56 390	1:55 392	1:53 390	1:51 389	1:48 388	1:44 376	1:39 367	1:35 358					
100,000 to 96,000	INBD BHP	945	960	970	980	985	1000	1020	1050	1065	1080	1100	1120	1140	1165	1180	1200	1220	1240				
	RPM	1540	1525	1620	1660	1705	1760	1815	1890	1950	2000	1860	1890	1940	2010	2075	2140	2210	2310				
	INBD BMEP	145	144	141	139	136	134	133	131	129	127	140	140	139	137	134	132	130	127				
	F. F.	405	410	420	425	430	435	450	455	470	485	485	500	510	525	532	560	585	515				
	AVG. IAS	154										155											
	AVG. TAS	171	174	177	179	182	185	188	191	194	197	200	204	207	211	214	218	222	225				
	Δ TIME Δ DIST.	2:28 424	2:27 424	2:23 423	2:21 422	2:19 422	2:17 422	2:14 422	2:11 419	2:07 413	2:04 408	2:03 412	2:01 410	1:58 406	1:55 403	1:52 399	1:49 396	1:42 377	1:38 366				
96,000 to 92,000	INBD BHP	880	890	910	915	935	950	965	980	1000	1025	1030	1050	1070	1085	1110	1120	1150	1180				
	RPM	1495	1525	1575	1615	1660	1710	1770	1820	1890	1950	1780	1825	1880	1940	2000	2070	2135	2220	2300			
	INBD BMEP	139	138	136	134	133	131	129	127	125	124	137	136	134	132	131	128	127	123	121			
	F. F.	385	390	395	400	405	410	420	430	440	445	455	465	475	490	505	520	535	560	590			
	AVG. IAS	151										152											
	AVG. TAS	168	171	173	176	179	182	184	187	190	194	197	200	203	207	210	214	217	221	225			
	Δ TIME Δ DIST.	2:36 437	2:34 438	2:32 438	2:30 440	2:27 440	2:26 440	2:22 436	2:20 436	2:17 435	2:15 435	2:12 432	2:09 430	2:06 427	2:03 422	1:59 416	1:56 412	1:52 405	1:47 395	1:42 382			
92,000 to 88,000	INBD BHP	825	835	845	860	865	880	900	920	930	945	960	990	995	1020	1030	1050	1075	1090	1105	1130		
	RPM	1450	1490	1525	1575	1610	1650	1700	1765	1820	1890	1950	1820	1880	1935	2000	2065	2125	2210	2300			
	INBD BMEP	134	132	131	129	127	126	125	123	121	118	116	131	129	128	126	124	123	121	118	116		
	F. F.	360	365	370	375	380	385	395	405	410	420	430	440	450	460	470	485	500	515	535	565		
	AVG. IAS	147										148											
	AVG. TAS	164	166	169	171	174	177	180	183	186	189	192	195	198	201	205	208	212	215	219	223		
	Δ TIME Δ DIST.	2:47 455	2:44 455	2:42 455	2:39 455	2:37 455	2:35 455	2:32 455	2:29 454	2:26 453	2:23 448	2:19 445	2:17 445	2:14 442	2:11 440	2:08 438	2:04 430	2:00 424	1:57 419	1:52 408	1:46 395		

- NOTES: 1. Cowl flaps failed, all radiator flaps automatic and cabin supercharger scoop closed.
2. High blower operation to right of double line. Shaded area represents AUTO-RICH operation.
3. Data are for weight bracket mid-point.
4. Average IAS values are for flush static system.

Figure A5-41 (Sheet 1 of 2)

A5-59

T.O. 1C-121A-1

Appendix I
Part 5 — Cruise

FOUR ENGINE OPERATION HOLDING CRUISE - OPERATING TABLES

MODEL: C-121A
DATA AS OF: 15 AUGUST 1961
DATA BASIS: FLIGHT TESTS

ENGINES: (4) R3350-75

PROPS: CURTISS C460/830-26C4-0

GROSS WEIGHT - LB.	H ₁₁ - 1000 FT.	5	6	7	8	9	10	11	12	13	14	15	16	17	18	19	20	21	22	23	24	25
		LOW BLOWER												HIGH BLOWER								
88,000 to 84,000	INBD BHP	770	780	795	810	820	835	855	855	875	885	905	920	935	950	970	995	1010	1025	1045	1050	1070
	RPM	1415	1450	1490	1525	1575	1615	1660	1700	1765	1815	1895	1960	1775	1820	1880	1940	1990	2065	2120	2210	2300
	INBD BMEP	128	127	126	125	123	122	121	119	117	115	113	111	124	123	122	121	119	117	114	112	110
	F. F.	340	345	350	355	360	365	370	375	380	390	400	410	420	422	435	450	460	475	495	515	535
	AVG. IAS	144												145								
AVG. TAS	161	163	166	168	171	173	176	179	182	185	188	191	194	197	201	204	208	211	215	219	223	
Δ TIME	2:56	2:54	2:51	2:49	2:47	2:45	2:42	2:40	2:37	2:33	2:29	2:26	2:24	2:20	2:17	2:13	2:10	2:06	2:02	1:57	1:52	
Δ DIST.	472	472	472	472	475	475	476	477	475	472	466	463	465	462	460	454	450	442	435	426	417	
84,000 to 80,000	INBD BHP	710	725	740	755	760	775	790	805	815	830	840	860	870	880	900	920	935	950	965	975	1010
	RPM	1400	1405	1440	1485	1520	1565	1610	1650	1700	1760	1810	1890	1710	1760	1815	1875	1925	1990	2050	2115	2200
	INBD BMEP	120	122	121	120	118	117	116	115	113	111	109	107	120	118	117	116	114	113	111	109	108
	F. F.	320	325	330	335	335	340	350	350	360	365	370	380	390	400	405	415	425	440	455	465	485
	AVG. IAS	140												141								
AVG. TAS	156	159	161	164	166	169	171	174	177	180	183	186	189	192	195	199	202	206	209	213	217	
Δ TIME	3:09	3:06	3:03	3:00	2:58	2:55	2:52	2:51	2:47	2:43	2:41	2:37	2:34	2:31	2:28	2:25	2:21	2:16	2:12	2:09	2:04	
Δ DIST.	491	491	491	491	493	493	493	495	495	495	490	490	486	484	483	480	478	474	467	460	458	441
80,000 to 76,000	INBD BHP	660	670	675	695	710	720	735	740	755	765	770	785	800	815	830	850	860	880	895	915	925
	RPM	1400	1400	1400	1440	1480	1520	1560	1600	1650	1700	1750	1800	1660	1700	1750	1810	1860	1920	1975	2035	2100
	INBD BMEP	111	113	114	114	113	112	111	109	108	106	104	103	114	113	112	111	109	108	107	106	104
	F. F.	300	305	310	310	315	320	325	330	335	340	345	350	360	370	380	385	395	405	415	425	440
	AVG. IAS	136												137								
AVG. TAS	152	154	157	159	162	164	167	169	172	175	178	181	184	187	190	193	197	200	203	207	211	
Δ TIME	3:21	3:18	3:15	3:12	3:10	3:08	3:04	3:02	2:59	2:59	2:54	2:50	2:46	2:43	2:39	2:36	2:32	2:29	2:25	2:21	2:16	
Δ DIST.	508	508	509	510	512	512	512	514	514	514	515	515	513	507	506	502	501	497	495	490	485	480
76,000 to 72,000	INBD BHP	610	615	630	640	655	665	680	680	700	710	710	725	740	750	760	775	795	810	835	840	845
	RPM	1400	1400	1400	1400	1430	1470	1510	1550	1600	1645	1700	1750	1800	1650	1690	1740	1800	1850	1910	1960	2020
	INBD BMEP	103	104	106	108	108	107	106	104	103	102	99	98	97	107	106	105	104	103	102	101	99
	F. F.	280	285	285	290	295	300	305	305	310	320	325	330	335	340	350	355	360	370	380	395	400
	AVG. IAS	133									134											
AVG. TAS	149	151	153	156	158	161	163	166	168	171	174	177	180	183	186	189	192	196	199	203	206	
Δ TIME	3:34	3:31	3:29	3:27	3:23	3:21	3:18	3:16	3:12	3:08	3:06	3:03	2:59	2:56	2:52	2:50	2:47	2:42	2:37	2:33	2:29	
Δ DIST.	531	531	535	536	536	537	538	540	540	540	539	539	535	537	537	534	534	534	529	520	515	512
72,000 to 68,000	INBD BHP	565	570	580	595	600	615	625	635	645	655	660	675	680	690	705	715	725	745	755	770	785
	RPM	1400	1400	1400	1400	1420	1460	1510	1550	1595	1640	1690	1740	1600	1640	1685	1730	1790	1830	1895	1950	
	INBD BMEP	95	96	98	100	101	102	101	99	98	97	95	94	92	102	101	100	99	98	97	96	95
	F. F.	260	265	270	270	275	275	280	285	290	295	300	305	310	320	325	330	335	340	350	360	370
	AVG. IAS	129									130											
AVG. TAS	144	147	149	151	154	156	158	161	164	166	169	172	175	178	181	184	187	190	193	197	200	
Δ TIME	3:50	3:47	3:44	3:42	3:39	3:36	3:33	3:30	3:26	3:23	3:20	3:17	3:14	3:09	3:06	3:02	2:59	2:55	2:42	2:47	2:42	
Δ DIST.	555	555	555	560	560	562	562	562	562	563	564	563	563	559	559	557	557	555	553	546	546	540

- NOTES: 1. Cowl flaps faired, oil radiator flaps automatic and cabin supercharger scoop closed.
 2. High blower operation to right of double line. Shaded area represents AUTO-RICH operation.
 3. Data are for weight bracket mid-point.
 4. Average IAS values are for flush static system.

Figure AS-47 (Sheet 2 of 2)

THREE ENGINE OPERATION HOLDING CRUISE — OPERATING TABLES

MODEL: C-121A
DATA AS OF: 15, AUGUST 1961
DATA BASIS: FLIGHT TESTS

ENGINES: (4) R3350-75

PROPS: CURTISS C460/830-26C4-0

GROSS WEIGHT — LB.	H _D — 1000 FT.	5	6	7	8	9	10	11	12	13	14	15	16	17	18	19	20	21	22	23	24	25	
		LOW BLOWER							HIGH BLOWER														
107,000 to 104,000	INBD BHP	1645	1680	1700	1730	1750	1780																
	RPM	2400	2400	2400	2400	2400	2400																
	INBD BMEP	162	165	167	170	172	175																
	F. F.	985	1005	1030	1050	1075	1095																
	AVG. IAS	175																					
	AVG. TAS	194	197	200	203	206	210																
	Δ TIME	1:01	1:00	0:58	0:57	0:56	0:55																
	Δ DIST.	197	196	195	193	192	191																
104,000 to 100,000	INBD BHP	1575	1585	1615	1635	1670	1690	1720	1740	1770	1800												
	RPM	2400	2400	2400	2400	2400	2400	2400	2400	2400	2400												
	INBD BMEP	155	156	159	161	164	166	169	171	174	177												
	F. F.	925	940	960	980	1000	1025	1160	1180	1205	1240												
	AVG. IAS	170									171												
	AVG. TAS	189	192	195	198	201	204	207	211	214	218												
	Δ TIME	1:27	1:25	1:23	1:22	1:20	1:18	1:09	1:08	1:06	1:05												
	Δ DIST.	272	272	271	269	268	266	238	238	237	234												
100,000 to 96,000	INBD BHP	1475	1495	1515	1545	1565	1595	1615	1635	1660	1690	1720	1750	1780									
	RPM	2400	2400	2400	2400	2400	2400	2400	2400	2400	2400	2400	2400	2400									
	INBD BMEP	145	147	149	152	154	157	159	161	163	166	169	172	175									
	F. F.	850	870	885	900	920	935	960	980	1105	1130	1155	1180	1210									
	AVG. IAS	166								167													
	AVG. TAS	184	187	190	193	196	199	202	205	209	212	216	219	223									
	Δ TIME	1:34	1:32	1:30	1:29	1:27	1:25	1:23	1:22	1:12	1:11	1:09	1:08	1:06									
	Δ DIST.	289	286	286	285	283	283	281	279	252	250	249	248	246									
96,000 to 92,000	INBD BHP	1380	1400	1425	1435	1470	1495	1525	1545	1575	1585	1625	1645	1680	1710								
	RPM	2090	2100	2115	2120	2300	2400	2400	2400	2400	2400	2400	2400	2400	2400								
	INBD BMEP	156	157	159	160	151	147	150	152	155	156	160	162	165	168								
	F. F.	615	625	635	645	830	865	885	900	940	1040	1065	1085	1105	1130								
	AVG. IAS	163								164													
	AVG. TAS	181	184	187	189	193	196	199	202	205	208	212	215	219	223								
	Δ TIME	2:10	2:08	2:06	2:04	1:36	1:32	1:30	1:29	1:25	1:17	1:15	1:14	1:12	1:11								
	Δ DIST.	393	393	396	391	310	302	299	298	291	268	265	264	264	263								
92,000 to 88,000	INBD BHP	1280	1310	1325	1355	1380	1400	1440	1455	1470	1495	1525	1555	1585	1615	1635							
	RPM	2030	2045	2060	2075	2085	2100	2165	2230	2300	2400	2400	2400	2400	2400	2400							
	INBD BMEP	149	151	152	154	156	158	157	154	151	147	150	153	156	159	161							
	F. F.	580	590	600	605	615	630	650	675	830	870	980	995	1020	1045	1065							
	AVG. IAS	160								161													
	AVG. TAS	178	181	184	187	189	192	195	198	201	205	209	211	215	218	222							
	Δ TIME	2:19	2:16	2:14	2:12	2:10	2:07	2:04	1:59	1:36	1:32	1:22	1:20	1:18	1:17	1:15							
	Δ DIST.	410	410	409	409	409	409	402	392	323	314	284	283	281	279	278							

- NOTES: 1. Cowl flaps faired, oil radiator flaps automatic and cabin supercharger scoop closed.
2. High blower operation to right of double line. Shaded area represents AUTO-RICH operation.
3. Data are for weight bracket mid-point.
4. Average IAS values are for flush static system.

Figure AS-42 (Sheet 1 of 2)

T. O. 1C-121A-1

Appendix 1
Part 5 — Cruise

THREE ENGINE OPERATION HOLDING CRUISE - OPERATING TABLES

MODEL: C-121A
DATA AS OF: 15 AUGUST 1961
DATA BASIS: FLIGHT TESTS

ENGINES: (4) R3350-75

PROPS: CURTISS C460/830-26C4-0

GROSS WEIGHT - LB.	H _D - 1000 FT.	5	6	7	8	9	10	11	12	13	14	15	16	17	18	19	20	21	22	23	24	25	
		LOW BLOWER											HIGH BLOWER										
88,000 to 84,000	INBD BHP	1210	1230	1235	1250	1275	1295	1310	1355	1380	1395	1450	1455	1485	1505	1535	1555						
	RPM	1970	2000	2010	2020	2030	2040	2050	2160	2230	2300	2300	2400	2400	2400	2400	2400						
	INBD BMEP	145	145	145	146	148	150	151	148	146	143	145	143	146	148	151	153						
	F. F.	530	540	555	565	575	585	595	610	630	660	800	910	930	950	970	995						
	AVG. IAS	155										156											
AVG. TAS	172	175	178	180	183	186	189	192	195	198	202	205	208	212	215	219							
Δ TIME	2:31	2:28	2:24	2:22	2:19	2:17	2:15	2:11	2:07	2:01	1:41	1:28	1:25	1:24	1:22	1:20							
Δ DIST.	434	433	429	426	425	425	424	421	414	401	365	302	299	298	296	294							
84,000 to 80,000	INBD BHP	1130	1150	1165	1175	1200	1220	1245	1265	1295	1310	1315	1335	1360	1395	1435	1455	1485					
	RPM	1840	1875	1900	1915	1950	1985	2030	2075	2155	2220	2300	2175	2185	2210	2400	2400	2400					
	INBD BMEP	145	145	145	145	145	145	145	144	142	139	135	145	147	149	141	143	146					
	F. F.	485	495	510	520	530	540	555	565	580	600	625	635	645	660	875	900	925					
	AVG. IAS	153										154											
AVG. TAS	170	173	175	178	181	184	187	190	193	196	199	202	206	209	213	216	220						
Δ TIME	2:45	2:42	2:37	2:34	2:31	2:28	2:24	2:22	2:18	2:13	2:08	2:06	2:04	2:01	1:32	1:29	1:27						
Δ DIST.	469	466	459	457	456	455	450	449	445	436	426	425	426	423	324	320	317						
80,000 to 76,000	INBD BHP	1055	1070	1095	1110	1120	1145	1160	1175	1200	1220	1230	1240	1265	1280	1315	1340	1345	1365				
	RPM	1715	1740	1780	1805	1825	1880	1925	1995	2070	2145	2215	2105	2120	2125	2200	2290	2300	2320				
	INBD BMEP	145	145	145	145	145	144	142	139	137	134	131	139	141	142	141	138	138	139				
	F. F.	455	460	470	480	485	495	505	520	530	550	570	580	600	610	630	650	825	855				
	AVG. IAS	150											151										
AVG. TAS	167	170	172	175	178	180	183	186	189	192	195	199	202	205	209	212	217	220					
Δ TIME	2:56	2:53	2:50	2:48	2:44	2:42	2:38	2:34	2:31	2:26	2:21	2:18	2:13	2:11	2:07	2:03	1:37	1:34					
Δ DIST.	490	490	489	489	489	486	484	478	476	466	459	459	450	449	444	436	349	342					
76,000 to 72,000	INBD BHP	975	985	1000	1025	1030	1045	1060	1075	1100	1120	1140	1155	1180	1200	1220	1240	1265	1290				
	RPM	1590	1605	1640	1690	1735	1800	1850	1905	1990	2050	2135	1945	1990	2035	2100	2180	2275	2380				
	INBD BMEP	145	145	144	143	140	137	135	133	131	129	126	140	140	139	137	134	131	128				
	F. F.	420	425	430	435	445	455	465	475	485	505	520	520	530	545	560	585	610	640				
	AVG. IAS	145											146										
AVG. TAS	162	164	167	169	172	175	177	180	183	186	189	192	195	199	202	206	209	213					
Δ TIME	3:11	3:08	3:05	3:03	3:00	2:56	2:52	2:48	2:45	2:38	2:35	2:34	2:31	2:27	2:23	2:17	2:11	2:05					
Δ DIST.	515	515	516	516	516	514	509	506	505	490	487	493	491	489	481	471	458	445					
72,000 to 68,000	INBD BHP	895	915	925	940	955	965	985	1000	1015	1035	1050	1080	1085	1115	1135	1140	1170	1175	1195			
	RPM	1500	1550	1590	1630	1680	1725	1790	1840	1900	1970	2030	1840	1900	1960	2030	2090	2160	2240	2335			
	INBD BMEP	141	139	137	136	134	132	130	128	126	124	122	138	135	134	132	129	128	124	121			
	F. F.	385	390	400	405	415	425	430	435	445	460	475	473	485	500	510	525	550	575	605			
	AVG. IAS	141											142										
AVG. TAS	157	160	162	165	167	170	173	175	178	181	184	187	190	193	197	200	203	207	211				
Δ TIME	3:28	3:24	3:20	3:17	3:13	3:09	3:06	3:04	3:00	2:54	2:48	2:49	2:45	2:40	2:37	2:33	2:26	2:19	2:12				
Δ DIST.	545	545	541	541	538	538	538	538	534	524	516	529	524	516	509	494	481	466					

- NOTES: 1. Cowl flaps faired, oil radiator flaps automatic and cabin supercharger scoop closed.
2. High blower operation to right of double line. Shaded area represents AUTO-RICH operation.
3. Data are for weight bracket mid-point.
4. Average IAS values are for flush static system.

TWO ENGINE OPERATION HOLDING CRUISE — OPERATING TABLES

MODEL: C-121A
DATA AS OF: 15 AUGUST 1961
DATA BASIS: FLIGHT TESTS

ENGINES: (4) R3350-75

PROPS: CURTISS C460/830-26C4-0

GROSS WEIGHT — LB.	H _D — 1000 FT.	5	6	7	8	9	10	11	12	13	14	15	16	17	18	19	20	21	22	23	24	25
		LOW BLOWER																				
107,000	INBD BHP RPM INBD BMEP																					
to	F. F.																					
104,000	AVG. IAS AVG. TAS Δ TIME Δ DIST.																					
104,000	INBD BHP RPM INBD BMEP																					
to	F. F.																					
100,000	AVG. IAS AVG. TAS Δ TIME Δ DIST.																					
100,000	INBD BHP RPM INBD BMEP	2095																				
to	F. F.	2400																				
96,000	AVG. IAS AVG. TAS Δ TIME Δ DIST.	206																				
		1425																				
		153																				
		170																				
		1:24																				
		238																				
96,000	INBD BHP RPM INBD BMEP	2025																				
to	F. F.	2400																				
92,000	AVG. IAS AVG. TAS Δ TIME Δ DIST.	199																				
		1325																				
		150																				
		167																				
		1:31																				
		252																				
92,000	INBD BHP RPM INBD BMEP	1850	1870	1900																		
to	F. F.	2400	2400	2400																		
		182	184	187																		
		1150	1175	1200																		
		147																				
		163	166	169																		
		1:44	1:42	1:40																		
88,000	AVG. IAS AVG. TAS Δ TIME Δ DIST.	284	282	281																		

- NOTES: 1. Cowl flaps faired, oil radiator flaps automatic and cabin supercharger scoop closed.
2. High blower operation to right of double line. Shaded area represents AUTO-RICH operation.
3. Data are for weight bracket mid-point.
4. Average IAS values are for flush static system.

Figure A5-43 (Sheet 1 of 2)

A5-63

T. O. 1C-121A-1

Appendix 1
Part 5 — Cruise

TWO ENGINE OPERATION HOLDING CRUISE — OPERATING TABLES

MODEL: C-121A
DATA AS OF: 15 AUGUST 1961
DATA BASIS: FLIGHT TESTS

ENGINES: (4) R3350-75

PROPS: CURTISS C460/830-26C4-0

Figure A5-43 (Sheet 2 of 2)

GROSS WEIGHT — LB.	H _D — 1000 FT.	5	6	7	8	9	10	11	12	13	14	15	16	17	18	19	20	21	22	23	24	25
		LOW BLOWER																				
88,000 to 84,000	INBD BHP	1730	1750	1770	1800	1830																
	RPM	2400	2400	2400	2400	2400																
	INBD BMEP	170	172	174	177	180																
	F. F.	1050	1070	1090	1110	1130																
	AVG. IAS	143																				
	AVG. TAS	160	162	165	167	170																
Δ TIME	1:54	1:52	1:50	1:48	1:46																	
Δ DIST.	304	302																				
84,000 to 80,000	INBD BHP	1595	1625	1660	1680	1700	1730															
	RPM	2400	2400	2400	2400	2400	2400															
	INBD BMEP	157	160	163	165	167	170															
	F. F.	950	970	985	1005	1030	1050															
	AVG. IAS	140																				
	AVG. TAS	156	158	161	163	166	168															
Δ TIME	2:06	2:04	2:02	1:58	1:56	1:54																
Δ DIST.	328	326	326	324	322	320																
80,000 to 76,000	INBD BHP	1495	1515	1535	1555	1585	1605	1635														
	RPM	2400	2400	2400	2400	2400	2400	2400														
	INBD BMEP	147	149	151	153	156	158	161														
	F. F.	865	880	900	910	930	950	975														
	AVG. IAS	136																				
	AVG. TAS	152	154	157	159	162	164	167														
Δ TIME	2:18	2:16	2:14	2:11	2:09	2:06	2:03															
Δ DIST.	350	350	349	348	348	344	342															
76,000 to 72,000	INBD BHP	1380	1420	1450	1480	1505	1495	1515	1545	1565												
	RPM	2085	2095	2110	2120	2130	2400	2400	2400	2400												
	INBD BMEP	156	160	162	165	167	147	149	152	154												
	F. F.	610	620	630	640	660	865	880	900	920												
	AVG. IAS	132																				
	AVG. TAS	148	150	153	155	157	160	162	165	168												
Δ TIME	3:17	3:14	3:10	3:08	3:02	2:19	2:16	2:13	2:10													
Δ DIST.	485	484	484	484	477	368	368	366	364													
72,000 to 68,000	INBD BHP	1270	1285	1300	1325	1350	1380	1405	1425	1445	1485											
	RPM	2025	2035	2050	2060	2070	2085	2140	2210	2290	2400											
	INBD BMEP	148	149	150	152	154	156	155	152	149	146											
	F. F.	565	575	585	590	600	610	620	650	685	720											
	AVG. IAS	129																				
	AVG. TAS	144	147	149	151	154	156	159	161	164	166											
Δ TIME	3:32	3:29	3:25	3:22	3:19	3:17	3:14	3:05	2:55	2:47												
Δ DIST.	510	509	509	509	509	510	510	495	476	461												

- NOTES: 1. Cowl flaps faired, oil radiator flaps automatic and cabin supercharger scoop closed.
2. High blower operation to right of double line. Shaded area represents AUTO-RICH operation.
3. Data are for weight bracket mid-point.
4. Average IAS values are for flush static system.

LANDING DISTANCE FROM A HEIGHT OF 50 FT.

MODEL: C-121A
 DATA AS OF: 15 AUGUST 1961
 DATA BASIS: FLIGHT TESTS

ENGINES: (4) R3350-75
 PROPS: CURTISS C460/830-26C4-0

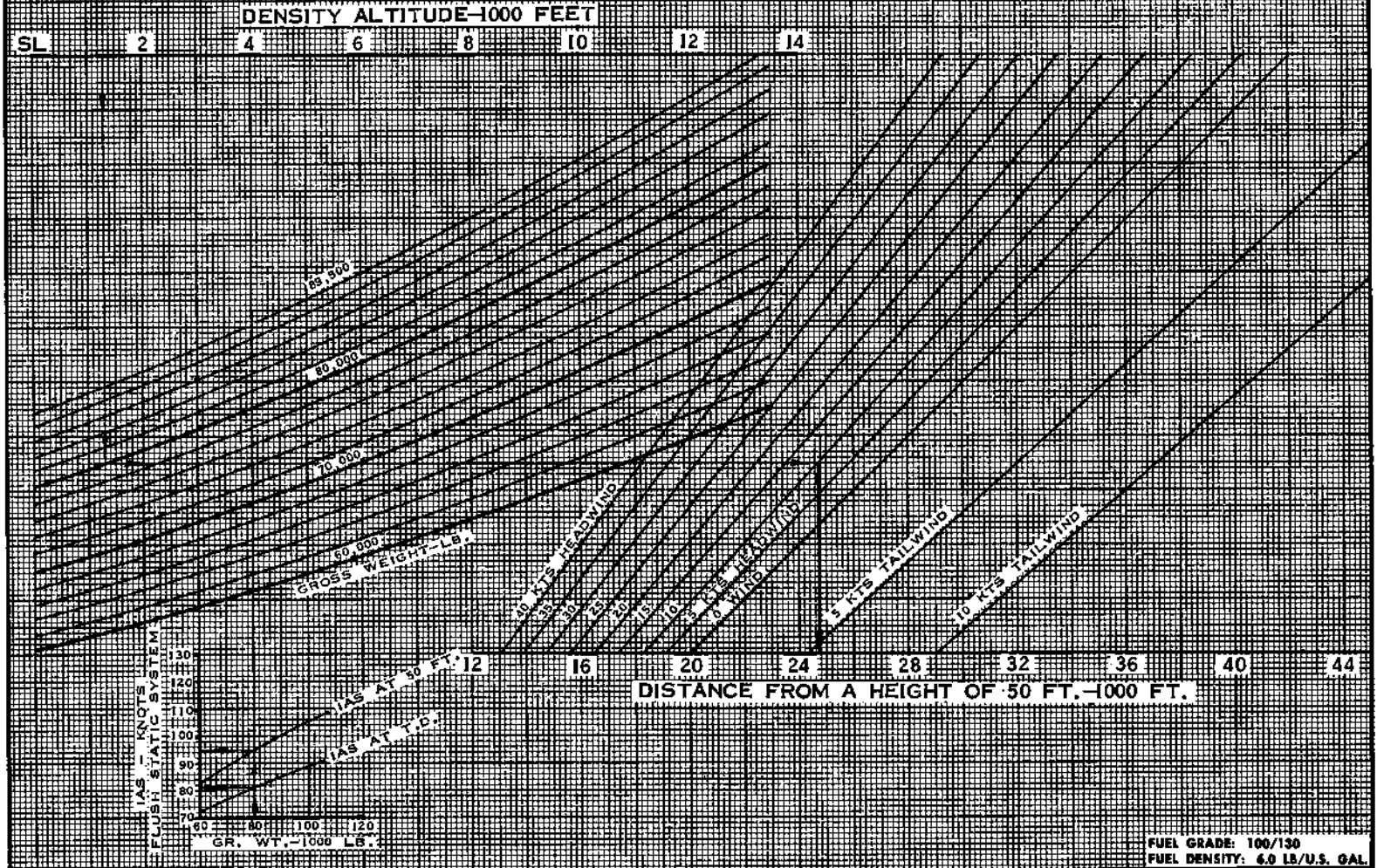

Figure A6-2