

**FLIGHT MANUAL**

**USAF SERIES F-4E AIRCRAFT**

McDonnell Aircraft  
N0w(A) 63-0032-1  
N00383-77-A-7500



This manual supersedes TO 1F-4E-1, dated 1 December 1975, Change 1 thru 9 and TO 1F-4E-1S-28, -1S-53, -1S-57 and -1S-58.

Commanders are responsible for bringing this publication to the attention of all affected personnel.

# LIST OF EFFECTIVE PAGES

Insert latest changed pages; dispose of superseded pages in accordance with applicable regulations.

NOTE: On a changed page, the portion of the text affected by the latest change is indicated by a vertical line, or other change symbol, in the outer margin of the page.

Dates of issue for original and changed pages:

Original . . . 1 Feb 79

Total number of pages in this manual is 510 consisting of the following:

Page No.	# Change No.	Page No.	# Change No.	Page No.	# Change No.
Title . . . . .	0	FO-2 Blank . . . . .	0		
A . . . . .	0	FO-3 . . . . .	0		
i - viii . . . . .	0	FO-4 Blank . . . . .	0		
1-1 - 1-76 . . . . .	0	FO-5 . . . . .	0		
2-1 - 2-32 . . . . .	0	FO-6 Blank . . . . .	0		
3-1 - 3-48 . . . . .	0	FO-7 . . . . .	0		
4-1 - 4-19 . . . . .	0	FO-8 Blank . . . . .	0		
4-20 Blank . . . . .	0	FO-9 . . . . .	0		
5-1 - 5-37 . . . . .	0	FO-10 Blank . . . . .	0		
5-38 Blank . . . . .	0	FO-11 . . . . .	0		
6-1 - 6-15 . . . . .	0	FO-12 Blank . . . . .	0		
6-16 Blank . . . . .	0	FO-13 . . . . .	0		
7-1 - 7-3 . . . . .	0	FO-14 Blank . . . . .	0		
7-4 Blank . . . . .	0	FO-15 . . . . .	0		
8-1 . . . . .	0	FO-16 Blank . . . . .	0		
8-2 Blank . . . . .	0	FO-17 . . . . .	0		
9-1 - 9-8 . . . . .	0	FO-18 Blank . . . . .	0		
A-1 . . . . .	0	FO-19 . . . . .	0		
A-2 Blank . . . . .	0	FO-20 Blank . . . . .	0		
A1-1 - A1-20 . . . . .	0	FO-21 . . . . .	0		
A2-1 - A2-13 . . . . .	0	FO-22 Blank . . . . .	0		
A2-14 Blank . . . . .	0	FO-23 . . . . .	0		
A3-1 - A3-15 . . . . .	0	FO-24 Blank . . . . .	0		
A3-16 Blank . . . . .	0	FO-25 . . . . .	0		
A4-1 - A4-29 . . . . .	0	FO-26 Blank . . . . .	0		
A4-30 Blank . . . . .	0	FO-27 . . . . .	0		
A5-1 - A5-8 . . . . .	0	FO-28 Blank . . . . .	0		
A6-1 . . . . .	0	Glossary 1 -			
A6-2 Blank . . . . .	0	Glossary 3 . . . . .	0		
A7-1 - A7-9 . . . . .	0	Glossary 4 Blank . . . . .	0		
A7-10 Blank . . . . .	0	Index 1 - Index 10 . . . . .	0		
A8-1 - A8-4 . . . . .	0				
A9-1 - A9-97 . . . . .	0				
A9-98 Blank . . . . .	0				
A10-1 - A10-9 . . . . .	0				
A10-10 Blank . . . . .	0				
FO-1 . . . . .	0				

## CURRENT FLIGHT CREW CHECKLIST

# Zero in this column indicates an original page.

# TABLE OF CONTENTS

<b>SECTION I</b>	<i>DESCRIPTION</i>	<i>1-1</i>
<b>SECTION II</b>	<i>NORMAL PROCEDURES</i>	<i>2-1</i>
<b>SECTION III</b>	<i>EMERGENCY PROCEDURES</i>	<i>3-1</i>
<b>SECTION IV</b>	<i>AUXILIARY EQUIPMENT</i>	<i>4-1</i>
<b>SECTION V</b>	<i>OPERATING LIMITATIONS</i>	<i>5-1</i>
<b>SECTION VI</b>	<i>FLIGHT CHARACTERISTICS</i>	<i>6-1</i>
<b>SECTION VII</b>	<i>SYSTEMS OPERATION</i>	<i>7-1</i>
<b>SECTION VIII</b>	<i>CREW DUTIES</i>	<i>8-1</i>
<b>SECTION IX</b>	<i>ALL WEATHER OPERATION</i>	<i>9-1</i>
<b>APPENDIX A</b>	<i>F4E PERFORMANCE DATA</i>	<i>A-1</i>
	<i>FOLDOUT ILLUSTRATIONS</i>	<i>FO-1</i>
	<i>ALPHABETICAL INDEX</i>	<i>INDEX-1</i>

# MEET THE PHANTOM

**SCOPE.** This manual contains necessary information for the safe and efficient operation of the F-4E Phantom II. These instructions provide you with a general knowledge of the aircraft, its characteristics, and specific normal and emergency operating procedures. Your flying experience is recognized, and, therefore, basic flight principles are avoided.

**SOUND JUDGMENT.** Instructions in this manual are for a crew inexperienced in the operation of this aircraft. This manual provides the best possible operating instructions under most circumstances, but it is not intended to be used as a substitute for sound judgment. Multiple emergencies, adverse weather, terrain, etc. may require modification of the procedures.

**PERMISSIBLE OPERATIONS.** The Flight Manual takes a positive approach and normally states only what you can do. Clearance must be obtained from Ogden ALC before any questionable operation is attempted which is not specifically permitted in this manual.

**CURRENCY.** Currency of the manual is maintained through revisions, routine changes, rapid action changes, and safety and operational supplements. The revision is a completely reprinted manual, and, normally contains the results of the Flight Manual Command Review. Routine changes are issued as required and, normally, contain ECP/TCTO coverage and changes/additions to the manual that do not require immediate dissemination. Rapid action changes are expeditiously prepared and published as formal replacement pages for the manual, and are normally issued in lieu of, or to replace, safety/operational supplements.

**SUPPLEMENTS.** Information involving safety or urgent operational requirements will be promptly forwarded to you by either a safety supplement or an operational supplement. Interim supplements (in TWX form) will be replaced by either a formal supplement, a rapid action change, or during a routine change/revision. The title page of the flight manual and the title block of each supplement should be checked to determine the effect they may have on existing supplements. You must remain constantly aware of the status of all supplements. A quarterly information sheet (in TWX form) will list the status of the latest flight manual and checklist changes, and all outstanding supplements.

**CHECKLISTS.** The Flight Manual contains only amplified checklists. Checklists have been issued as separate technical orders - see the back of the title page for TO number and date of your latest checklist. Line items in the Flight Manual and checklists are identical with respect to arrangement and item number. Whenever a Safety Supplement affects the abbreviated checklist, write in the applicable change on the affected checklist page. As soon as possible, a new checklist page incorporating the supplement will be issued. This will keep handwritten entries of Safety Supplement information in your

checklist to a minimum.

**PERFORMANCE DATA.** The Performance Data for the slatted F-4E is contained in Appendix A and performance data for the non-slatted F-4E is contained in Appendix B.

**FLIGHT MANUAL BINDERS.** Loose leaf binders and sectionalized tabs are available for use with your manual. These are obtained through local purchase procedures. The binders are listed in the Federal Supply Schedule (FSC Group 75, Office Supplies, Part 1).

**CHANGE SYMBOL.** The change symbol, as illustrated by the black line in the margin of this paragraph, indicates text and tabular illustration changes made to the current issue. Changes to illustrations (except tabular and plotted illustrations) are indicated by a changed area box located at the upper right side of the illustration. The box is divided into eight equal parts which represent eight proportional areas of the illustration. The shaded area of the box represents the area of the illustration which contains a change. An unshaded box indicates no change. The word "NEW" will appear in the box for new illustrations.

**WARNINGS, CAUTIONS, AND NOTES.** The following definitions apply to Warnings, Cautions, and Notes found throughout the manual.

## WARNING

Operating procedures, techniques, etc., which will result in personal injury or loss of life if not carefully followed.

## CAUTION

Operating procedures, techniques, etc., which will result in damage to equipment if not carefully followed.

## NOTE

An operating procedure, technique, etc., which is considered essential to emphasize.

**YOUR RESPONSIBILITY - TO LET US KNOW.** Review conferences with operating personnel and a constant review of accident and flight test reports assure inclusion of the latest data in the manual. In this regard, it is essential that you do your part. Comments, corrections, and questions regarding this manual or any phase of the Flight Manual program are welcomed. These should be forwarded through your Command Headquarters on AF form 847 in accordance with AFR 60-9 to Hq Ogden ALC, Hill AFB, Utah 84056; Attn: MMSRW

**SAFETY/OPERATIONAL SUPPLEMENT SUMMARY**

The following list contains: the previously cancelled or incorporated Safety/Operational Supplements; the outstanding Safety/Operational Supplements, if any; and the Safety/Operational Supplements incorporated in this issue. In addition, space is provided to list those Safety/Operational Supplements received since the latest issue.

NUMBER	SUBJECT OR DISPOSITION
All Safety/Operational Supplements thru TO 1F-4E-1S-27, -1SS-29 thru -1S-52, -1S-54 and -1S-55.	Previously cancelled or incorporated
TO 1F-4E-1S-28	Incorporated
TO 1F-4E-1SS-53	Incorporated
TO 1F-4E-1S-56	Replaced
TO 1F-4E-1S-57	Incorporated
TO 1F-4E-1S-58	Incorporated

**TECHNICAL ORDER SUMMARY**  
 The Technical Order Summary lists only those technical orders which affect this manual.

Technical Order	ECP	Title	Production Effectivity	Retrofit Effectivity
1F-4-776	852S1	Adds formation lights	69-7579 and up	66-284 thru 69-7578
	827S2P1	Improvement of fuel feed system & incorporation of self sealing fuselage cells	68-495 and up	
	827S2 Part III	Adds provisions for mounting selective armor	68-452 and up	
1F-4-903	827S2P2	Adds APU for longitudinal control	69-304 and up	68-452 thru 69-303
1F-4-908	715R1S 1	Adds integral moisture separator and removes all pressure suit capabilities from air conditioning system	69-7589 and up	66-284 thru 69-7588
1F-4-1051		Reduces AFCS pitch authority, eliminating hardover stabilator condition	none	All
1F-4-1056	Mod 2848	Adds VOR/ILS system	none	All
1F-4-1067		Installs guard over front cockpit canopy control lever	none	All
1F-4-1081		Removes PC and utility accumulators	none	All
1F-4-1082		Removes flap flow divider	72-1490 and up	thru 72-1489
1F-4-1096		Installs improved nose gear strut	none	all
1F-4-1108		Modifies canopy emergency pneumatic system	none	All
1F-4-1116		Install battery bypass switch	none	all
1F-4-1124		Replaces AN/ASQ-19A tacan with AN/ARN-118	none	all
1F-4E-532	703S3	Adds KY-28 speech security unit	none	66-284 thru 72-1499
1F-4E-563		Tank 7 warning light circuit deactivation	none	All
1F-4E-587	7219R1	Adds AN/APX-80 A/A IFF	73-01165 and up	66-284 thru 73-01164
1F-4E-588		Adds provisions for AN/ASQ-153(V) electro-optical target designator system	none	67-342 thru 69-7588 (selected aircraft)
1F-4E-591	7226R1	Adds AN/ALR-46 radar warning system	72-1498 and up	66-284 thru 72-1497

CONTINUED

**TECHNICAL ORDER SUMMARY**  
 The Technical Order Summary lists only those technical orders which affect this manual.

Technical Order	ECP	Title	Production Effectivity	Retrofit Effectivity
1F-4E-610	7087R2	Adds AGM-65/A (maverick) missile capability	71-237 and up	66-284 thru 69-758
1F-4E-611	7242R2	Installs Digital Scan Converter Group	74-00643 and up	66-284 thru 69-7588
1F-4E-614	Mod 2900	Adds AN/ALE-40 Countermeasures Dispenser Set	none	66-284 thru 74-1653
	7151	Adds multiple sensor display group (MSDG)	71-237 and up	none
	7177	Adds target identification system electro-optical (TISEO)	71-237 and up	none
	7219R1	Adds KY-28 speech security unit	73-01165 and up	
11L1-3-15-510		Disables AIM-9 missile jettison circuits	none	All

**BLOCK NUMBERS**

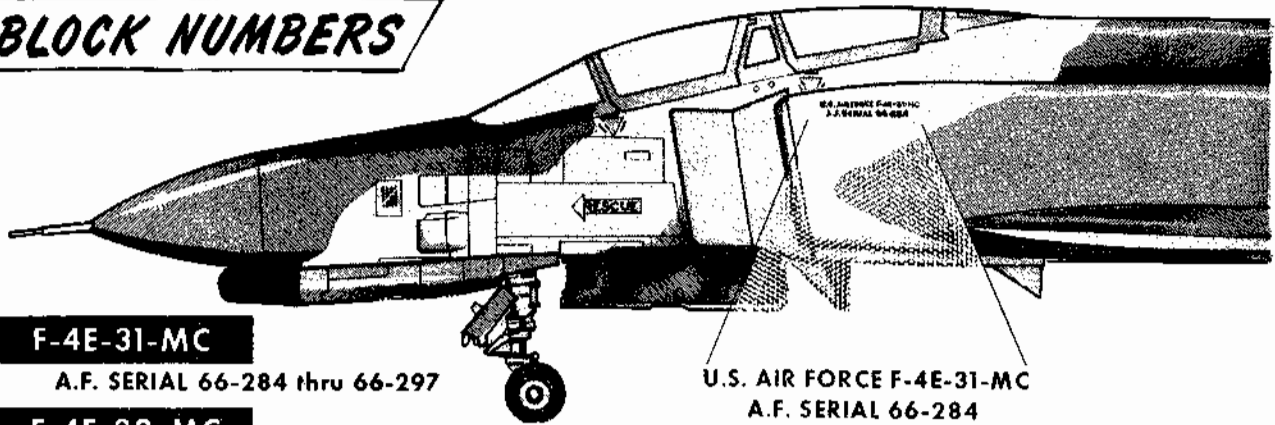

**F-4E-31-MC**

A.F. SERIAL 66-284 thru 66-297

**F-4E-32-MC**

A.F. SERIAL 66-298 thru 66-338

**F-4E-33-MC**

A.F. SERIAL 66-339 thru 66-382  
A.F. SERIAL 67-208 thru 67-219

**F-4E-34-MC**

A.F. SERIAL 67-220 thru 67-282

**F-4E-35-MC**

A.F. SERIAL 67-283 thru 67-341

**F-4E-36-MC**

A.F. SERIAL 67-342 thru 67-398

**F-4E-37-MC**

A.F. SERIAL 68-303 thru 68-365

**F-4E-38-MC**

A.F. SERIAL 68-366 thru 68-395  
A.F. SERIAL 68-400 thru 68-409

**F-4E-39-MC**

A.F. SERIAL 68-410 thru 68-413  
A.F. SERIAL 68-418 thru 68-433  
A.F. SERIAL 68-438 thru 68-451

**F-4E-40-MC**

A.F. SERIAL 68-452 thru 68-453  
A.F. SERIAL 68-458 thru 68-468  
A.F. SERIAL 68-473 thru 68-483  
A.F. SERIAL 68-488 thru 68-494

**F-4E-41-MC**

A.F. SERIAL 68-495 thru 68-498  
A.F. SERIAL 68-503 thru 68-518  
A.F. SERIAL 68-526 thru 68-538

**F-4E-42-MC**

A.F. SERIAL 69-236 thru 69-303

**F-4E-43-MC**

A.F. SERIAL 69-304 thru 69-7260

U.S. AIR FORCE F-4E-31-MC  
A.F. SERIAL 66-284

**F-4E-44-MC**

A.F. SERIAL 69-7261 thru 69-7303  
A.F. SERIAL 69-7546 thru 69-7578

**F-4E-45-MC**

A.F. SERIAL 69-7579 thru 69-7589

**F-4E-48-MC**

A.F. SERIAL 71-224 thru 71-247

**F-4E-49-MC**

A.F. SERIAL 71-1070 thru 71-1093

**F-4E-50-MC**

A.F. SERIAL 71-1391 thru 71-1402  
A.F. SERIAL 72-121 thru 72-138

**F-4E-51-MC**

A.F. SERIAL 72-139 thru 72-144  
A.F. SERIAL 72-157 thru 72-159

**F-4E-52-MC**

A.F. SERIAL 72-160 thru 72-165

**F-4E-53-MC**

A.F. SERIAL 72-166 thru 72-168  
A.F. SERIAL 72-1407

**F-4E-54-MC**

A.F. SERIAL 72-1476 thru 72-1489

**F-4E-55-MC**

A.F. SERIAL 72-1490 thru 72-1497

**F-4E-56-MC**

A.F. SERIAL 72-1498 thru 72-1499

**F-4E-57-MC**

A.F. SERIAL 73-01157 thru 73-01164

**F-4E-58-MC**

A.F. SERIAL 73-01165 thru 73-01184

**F-4E-59-MC**

A.F. SERIAL 73-01185 thru 73-01204



# MAIN DIFFERENCES TABLE

	<b>F-4C</b>	<b>F-4D</b>	<b>F-4E</b>	<b>F-4G</b>
<b>ENGINES</b>	J79-GE-15	J79-GE-15	J79-GE-17	J79-GE-17
<b>NO. 7 FUEL CELL</b>	NO	NO	YES	YES
<b>RAM AIR TURBINE</b>	YES	YES	NO	NO
<b>HYDRAULIC WING FOLD</b>	YES	YES	NO	NO
<b>INTERNALLY MOUNTED GUN</b>	NO	NO	YES	NO
<b>RADAR SET</b>	AN/APQ-100	AN/APQ-109	AN/APQ-120	AN/APQ-120
<b>INTERCEPT COMPUTER</b>	AN/APA-157	AN/APA-157 or AN/APA-165	AN/APQ-120	AN/APQ-120
<b>OPTICAL SIGHT</b>	FIXED	AN/ASG-22	AN/ASG-26	AN/APQ-30
<b>TISEO (AN/ASX-1)</b>	NO	NO	71-237 AND UP	NO
<b>RADAR RECEIVING SET</b>	NO	NO	NO	AN/APR-38
<b>WEAPONS RELEASE COMPUTER</b>	NONE	AN/ASQ-91	AN/ASQ-91	AN/ASQ-91
<b>INERTIAL NAVIGATION SET</b>	AN/ASN-48	AN/ASN-63	AN/ASN-63	AN/ASN-63
<b>NAVIGATION COMPUTER</b>	AN/ASN-46	AN/ASN-46A	AN/ASN-46A	AN/ASN-46A
<b>AUXILIARY POWER UNIT</b>	NO	NO	BLOCK 40 AND UP	YES
<b>SELF SEALING FUSELAGE FUEL CELLS</b>	NO	NO	BLOCK 41 AND UP	YES
<b>BOUNDARY LAYER CONTROL</b>	YES	YES	NO	NO
<b>LEADING EDGE SLATS</b>	NO	NO	YES	YES

4E-1-(14)A

# F-4E

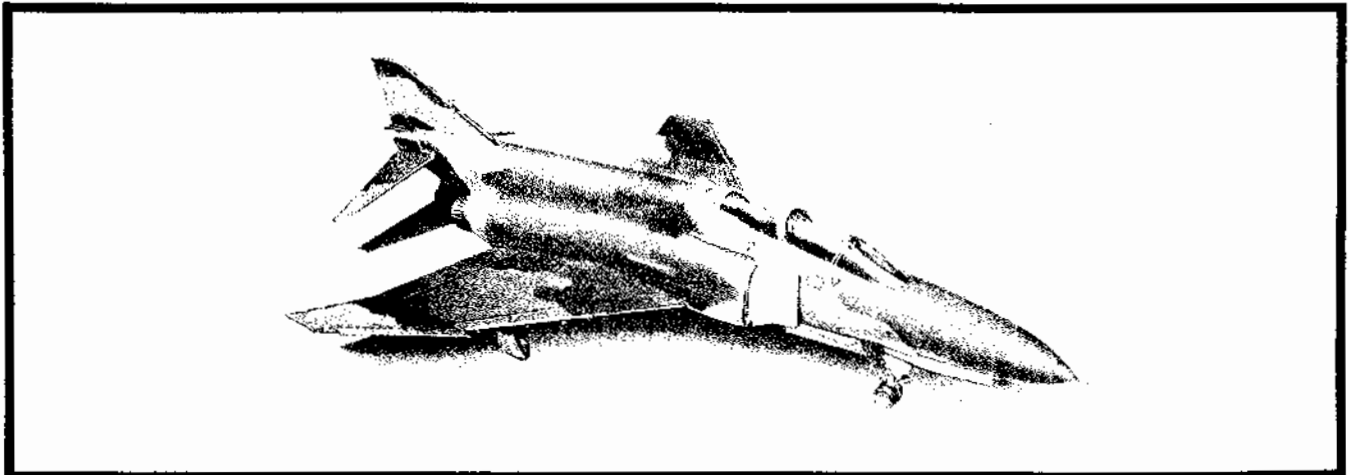
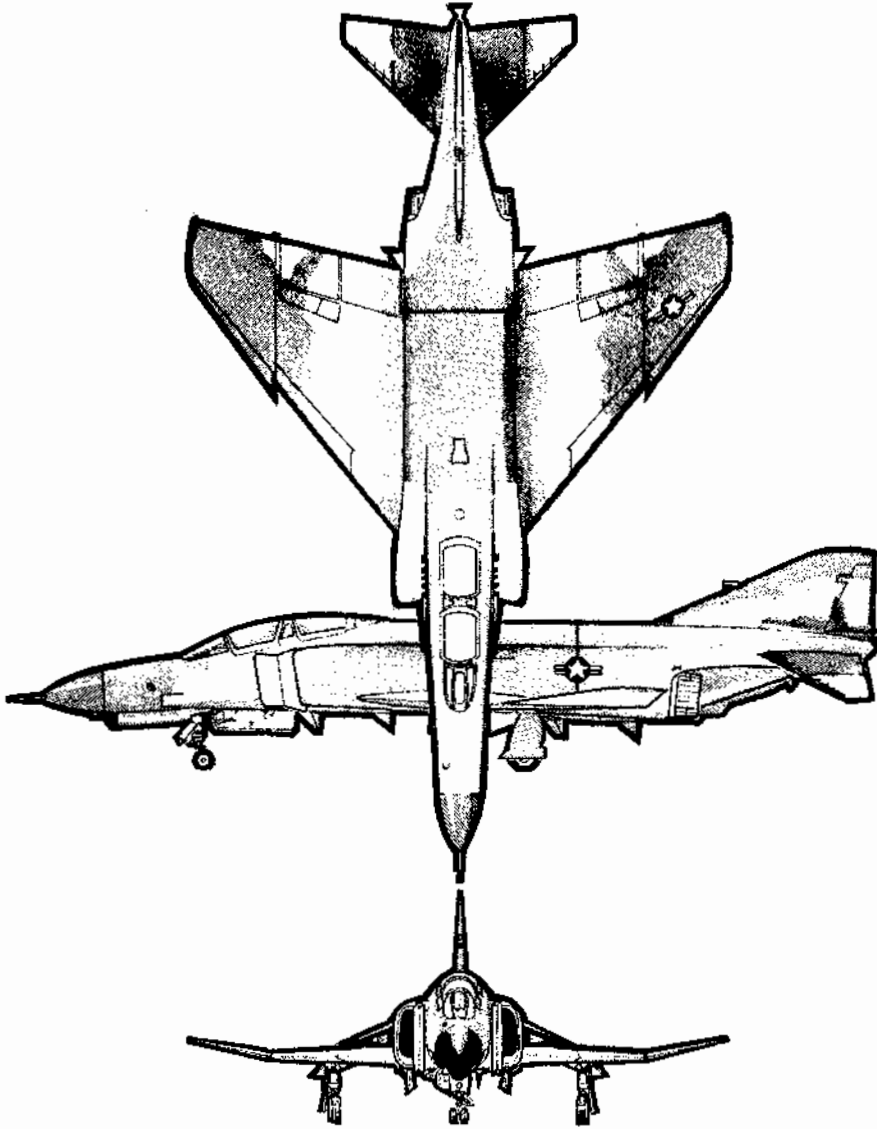

4E-1-(11)

# SECTION I

## DESCRIPTION

### TABLE OF CONTENTS

Aircraft .....	1-1
Engines .....	1-2
Aircraft Fuel System .....	1-10
Electrical Power Supply System .....	1-15
Hydraulic Power Supply System .....	1-18
Pneumatic System .....	1-19
Flight Controls .....	1-20
Slats Flaps System .....	1-24
Speed Brakes .....	1-26
Wing Fold .....	1-26
Landing Gear System .....	1-27
Nose Gear Steering .....	1-28
Wheel Brake System .....	1-28
Arresting Hook System .....	1-29
Drag Chute System .....	1-29
Angle-of-Attack System .....	1-30
Pitot-Static System .....	1-31
Air Data Computer System .....	1-33
Altitude Encoder Unit .....	1-33
Emergency Equipment .....	1-33
Instruments .....	1-37
Flight Director Group .....	1-39
CNI System .....	1-41
Canopies .....	1-61
Lighting Equipment .....	1-62
Oxygen System .....	1-64
MK H7 Ejection Seat .....	1-66
Servicing .....	1-75

### NOTE

- All references to airspeed in this manual quoted in Knots will equate to IAS.
- Throughout the manual, retrofit (TCFO) effectivities are presented in abbreviated form. Refer to the Technical Order Summary at the front of the manual for detailed production/retrofit effectivities.

### AIRCRAFT

#### NOTE

Refer to foldout section for general arrangement illustration.

The F-4 is a two-place (tandem), supersonic, long-range, all-weather fighter-bomber built by McDonnell Douglas Corporation. Mission capabilities include: long-range, high-altitude intercepts utilizing air-to-air missiles as primary armament; a 20mm gun as secondary armament; long-range attack missions utilizing conventional or nuclear weapons as a primary armament; and close air support missions utilizing a choice of bombs, rockets and missiles as primary armament. Aircraft thrust is provided by two axial-flow turbo jet engines with variable stators

and variable afterburner. Airplane appearance is characterized by a low mounted swept back wing with obvious anhedral at the wing tips, and a one piece stabilator with obvious cathedral. Dual, irreversible power control cylinders, position the stabilator, ailerons, and spoilers. A single, irreversible hydraulic power control cylinder positions the rudder. An integral pneumatic system, charged by a hydraulically driven air compressor, supplies compressed air for normal and emergency canopy operation, as well as emergency operation for the landing gear and wing flaps. The wings can be folded for ease of airplane storage and ground handling. A drag chute, contained in the end of the fuselage, significantly reduces landing roll distances and an arresting hook, that is hydraulically retracted, can be utilized to stop the airplane under a wide range of gross weight-airspeed combinations.

### DIMENSIONS

The approximate overall dimensions of the aircraft are:

Span (wings spread) - 38 feet, 5 inches

Span (wings folded) - 27 feet, 7 inches

Length - 63 feet

Height - 16 feet, 5 inches

Distance between main landing gear - 17 feet, 11 inches

Minimum recommended turning radius during taxi for nose boom clearance 41 feet, 1 inch.

### GROSS WEIGHT

The approximate gross weights (to the nearest 500 pounds) are as follows. For specific gross weights refer to the handbook of Weight and Balance Data TO 01-1B-40.

#### Block 35 Aircraft

Operating weight	31,500 lb.
Operating weight, plus a full internal fuel load, and Aero-27A rack	44,500 lb.
Operating weight, plus a full internal fuel load, plus an external centerline tank and the Aero-27A rack	48,500 lb.
Operating weight, plus a full internal fuel load, plus two external wing tanks, and Aero-27A rack	49,500 lb.

## TO 1F-4E-1

Operating weight, plus full internal fuel, plus three external fuel tanks and Aero-27A rack	54,000 lb.
---	------------

### Block 41 Aircraft

Operating weight	32,000 lb.
Operating weight, plus a full internal fuel load, and Aero-27A rack	44,000 lb.
Operating weight, plus a full internal fuel load, plus an external centerline tank and the Aero-27A rack	48,500 lb.
Operating weight, plus a full internal fuel load, plus two external wing tanks, and Aero-27A rack	49,500 lb.
Operating weight, plus a full internal fuel load, plus three external tanks and the Aero-27A rack	53,500 lb.

### Block 50 Aircraft

Operating weight	33,000 lb.
Operating weight, plus a full internal fuel load, and Aero-27A rack	45,500 lb.
Operating weight, plus a full internal fuel load, plus an external centerline tank and the Aero-27A rack	49,500 lb.
Operating weight, plus a full internal fuel load, plus two external wing tanks and the Aero-27A rack	50,500 lb.
Operating weight, plus a full internal fuel load, plus three external fuel tanks and the Aero-27A rack	55,000 lb.

#### NOTE

The operating weight<sup>1</sup> is basic weight plus two crewmembers (440 pounds) and engine oil (99 pounds). The weight of the fuel, centerline ejector rack, external stores, and nose gun ammunition must be added to the operating weight to obtain gross weight. Refer to Airplane Loading chart, appendix A or B.

### ARMOR PLATING

On aircraft 68-452 and up, provisions are provided for attaching parasitic steel armor plating to doors 15, 16, 22, 23, 28 left and right; and internal ceramic armor in the aft fuselage. This armor, when installed, protects the oxygen bay, hydraulic/engine fuel feed compartment and stabilator actuator. The armor adds approximately 144 pounds to the weight of the aircraft and shifts the CG forward approximately 0.1% MAC.

### ARMAMENT

Refer to TO 1F-4E-34-1-1, for information on armament.

### ENGINES

The aircraft is powered by two General Electric J79-GE-17 engines. The engines are light-weight (approximately 4000 pounds each), high thrust, axial-flow turbojets equipped with afterburner for thrust augmentation. Under sea level, static test conditions, the engine is rated at 11,870 pounds thrust at Mil power, while at Max power it is rated at 17,900 pounds thrust. The J79 features variable stators (first six stages), a 17 stage compressor, a combustion chamber with 10 annular combustion liners, a three-stage turbine, a variable area exhaust nozzle, and modulated reheat thrust augmentation (afterburning). A turbine type starter, operated by air from an external source or by the expanding gases of a solid propellant cartridge is used to crank the engines for starting. Either the aircraft battery or an external electrical power source is used to provide electrical power during starting. Engine bleed air, taken from the 17th stage of the compressor, is ducted to the boundary layer control system (aircraft without slats), the cockpit air conditioning and pressurization system, and the equipment air conditioning system. From these systems, it is further ducted to supply air to the air data computer, the engine anti-icing system, the fuel tank pressurization system, the pneumatic system air compressor, and the windshield rain removal system.

### ENGINE FUEL SYSTEM

#### NOTE

Refer to foldout section for airplane and engine fuel system illustration.

The fuel system for each engine is complete in itself, and the systems are identical. For clarity, only one system will be discussed. The afterburner fuel system is discussed separately in this subsection. The engine fuel system routes fuel from the engine driven fuel pump to the combustion chambers, where it is discharged in the proper proportion and state of atomization for complete burning. The engine driven fuel pump receives fuel from the aircraft boost pumps after it has passed through a hydraulic/fuel heat exchanger. The engine driven pump ensures a positive fuel pressure to the fuel control which performs the following functions: provides engine speed control by regulating fuel flow; provides fuel surge protection during throttle bursts; limits turbine inlet temperature to a safe value; schedules variable stator vane angle to control airflow through the compressor; supplies signal to the afterburner; and provides positive fuel cutoff at engine shutdown. The fuel control also incorporates a throttle booster which reduces the amount of effort to move the throttles. Teleflex cables link the exhaust nozzle area control and the afterburner fuel control to the engine fuel control, so that fuel flow and nozzle area are compatible throughout the full range of engine operation. Advancing the throttle from OFF to IDLE mechanically opens the fuel cutoff valve in the fuel control. Fuel passing through the cutoff valve flows through a fuel-oil heat exchanger, which effects a transfer

of heat from the scavenge oil to the fuel. The fuel then flows through the pressurizing and drain valve which prevents fuel from entering the engine fuel nozzles until sufficient fuel pressure is attained in the fuel control to compute the fuel flow schedules.

### Check Fuel Filters Indicator Light

The CHECK FUEL FILTERS indicator light, on the telilight panel, illuminates informing the pilot that the filter is clogged. The filter automatically opens to bypass, allowing normal fuel flow to the engine. There are no operational restrictions on the aircraft with the CHECK FUEL FILTERS indicator light illuminated. If the light illuminates, an entry to that effect should be made on Form 781. The MASTER CAUTION light illuminates in conjunction with the CHECK FUEL FILTERS light.

### Fuel Flow Indicators

The engine fuel flow indicating system consists of a fuel flow transmitter and a fuel flow indicator (one for each engine). The transmitter on the outlet side of the engine fuel control, measures the flow rate of the fuel that passes through it. The flow rate is converted into an electrical impulse which is sent to the fuel flow indicator. The fuel flow indicators on the right side of the front cockpit instrument panel display engine fuel consumption in pounds per hour. The indicator is calibrated from 0 to 12 with readings multiplied by 1000. The engine flow indicating system indicates fuel consumption of the basic engine only (afterburner fuel flow is not indicated). When in full afterburner, total fuel flow is approximately 4 times the indicated fuel flow.

### ENGINE OIL SYSTEM

See figure 1-1. Each engine is equipped with a completely self-contained, dry sump, full pressure oil system. Oil is stored in a 5.3-gallon, pressurized reservoir. The oil tank is constructed so that oil supply to the lubrication system is interrupted during negative G flight, due to the inability of the scavenge pumps to recover oil from the sumps and gear boxes. Engine oil is used for lubrication, variable nozzle positioning, and constant speed drive unit operation. The standpipes which supply the three systems utilizing engine oil are in the reservoir such that the pipe for the constant speed drive unit is the highest, the one for the nozzle control is the next highest, and the lubricating system pipe is the lowest. Therefore, a leak in the constant speed drive unit would probably cause a failure of that system only, while a leak in the nozzle control system may cause failure of that system and the constant speed drive unit. A leak in the lubricating or the scavenging system will cause failure of the constant speed drive unit and the nozzle control system, and ultimately, engine bearing failure will result. After distribution to various points throughout the engine, the oil is picked up by three scavenge pumps, routed through a scavenge filter, through an air-oil heat exchanger and two fuel-oil heat exchangers and finally back to the tank. A pressurizing system maintains the proper relationship between ambient air pressure and air pressure in the bearing sumps, gear boxes, damper bearing, and reservoir to ensure effective oil seal operation, and to prevent damage

to the reservoir and sumps due to high speed ascents or descents. Oil is also supplied directly from the reservoir to the constant speed drive unit, where it is used as both the control and final drive medium for controlling generator speed. See figure 1-31 for oil servicing specifications.

### Oil Pump (Lubricating Element)

The lubrication element of the oil pump supplies oil to cool and lubricate bearings, gears and other rubbing or moving parts in the engine. Lubricating oil is also circulated through the engine-driven generator for cooling purposes.

### Oil Pump (Hydraulic Element)

Engine oil is used as the hydraulic medium for positioning the variable exhaust nozzle flaps. During normal flight attitudes, oil flows through a gravity valve and into an accumulation compartment in the reservoir. During negative G flight, the gravity valve will close and oil for nozzle positioning is available for approximately 30 seconds.

### Oil Pressure Indicators

The oil pressure indicators are on the front cockpit pedestal panel. The scale range on the indicators is 0 to 10 with readings multiplied by 10.

### ENGINE AIR INDUCTION SYSTEM

There are two independent but identical air induction systems, one for each engine. The component units are fixed ramps and variable ramps, which make up the primary air system; and a variable bypass bellmouth and auxiliary air door, which make up the secondary air system.

### Variable Duct Ramp

The variable duct ramp system provides primary air, at optimum subsonic airflow, to the compressor face throughout a wide range of speeds. The ramp assembly consists of a fixed forward ramp and two variable ramps. The forward variable ramp is perforated to allow boundary layer air to be bled off and exhausted overboard. The aft variable ramp is solid. The air data computer supplies a total temperature input to the ramp control amplifier which, in turn, sends a signal to a utility hydraulic system servo unit to position the ramps for optimum airflow at high Mach numbers. The total temperature sensor is below the right air conditioning duct. While taxiing in the exhaust envelope of an operating jet engine, the sensor may detect a temperature change which causes the variable duct ramps to cycle.

### Duct Temperature High Indicator Light

The duct temperature high indicator light, marked DUCT TEMP HI, is on the telilight panel. The light, when illuminated, indicates that the temperature within the engine intake duct (compressor inlet) is beyond allowable

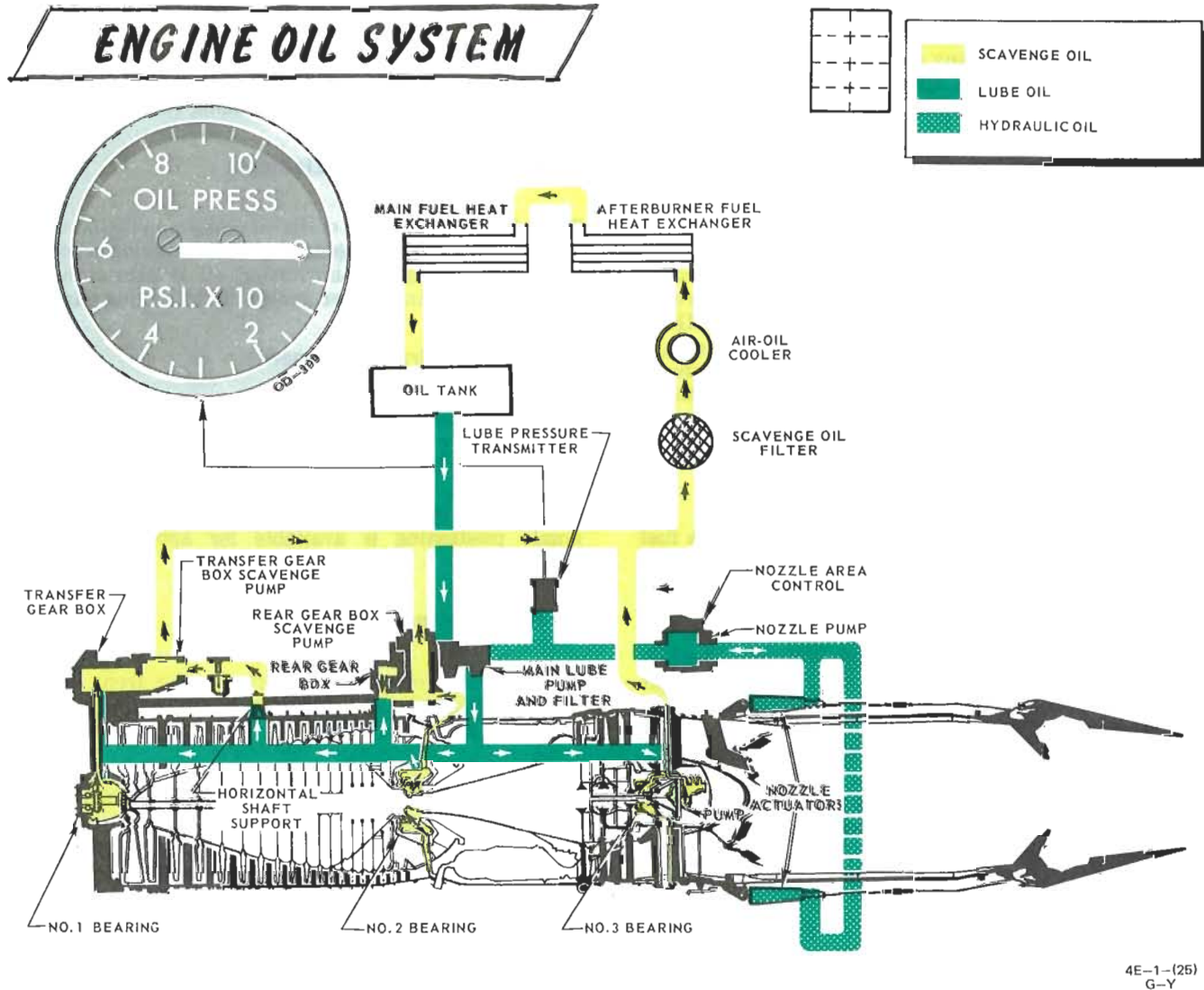

Figure 1-1

limits for steady-state engine operation. Operating the engine at high altitudes, with the compressor inlet temperature above the prescribed limit, will cause the life of the gears, bearings, and carbon seals to be reduced because the lubricating oil will exceed its design temperature. Exceeding the temperature also causes structural components of the engine (compressor rear frame and combustion casings) to exceed their design limit because of high temperatures and pressures.

the optimum airflow (based on duct air velocity) for induction into the engine. When this airflow is exceeded, (rapid throttle retardation) the controller signals a utility system hydraulic actuator which opens the bypass until the optimum airflow to the engine is established.

**Variable Bypass Bellmouth**

The variable bypass bellmouth is an automatic system which diverts excess air that is piling up at the compressor face into the aircraft engine compartment to help prevent compressor stalls. Air diverted in this manner is called secondary air. The variable bellmouth is a perforated ring between the intake duct structure and the engine compressor face. Between 0.4 to 0.98 Mach the bellmouth is closed; however, a limited amount of bypass air flows into the engine compartment through the perforations in the bypass bellmouth and the engine air-oil cooler bleed. Above 0.98 Mach the bypass bellmouth controller senses



The aircraft is equipped with a two-mode bellmouth control which provides an improved stall/flameout margin. One mode of the bellmouth control is wired through the rudder feel trim circuit breaker. With the rudder feel trim circuit breaker pulled, the bellmouth is only optimized for speeds below 0.4 Mach and above 0.98 Mach. This introduces the possibility of an engine stall/flameout in the 0.4 to 0.98 Mach speed range with maximum maneuvering and/or rapid throttle movements.

## Auxiliary Air Doors

Two auxiliary air doors, one for each engine compartment, are on the center underside of the fuselage. They are normally controlled by the landing gear handle and actuated open or closed by utility hydraulic pressure. When the landing gear handle is in the down position, the doors open, making additional air available to the engine compartments for cooling purposes. When the landing gear handle is in the up position, the doors close. If the engine compartment pressures exceed the designed limits, the door will be forced open by an amount proportional to the overpressure. As soon as the overpressure is relieved, the actuator will pull the door closed.

## Auxiliary Air Door Indicator Lights

The auxiliary air door indicator lights, on the telelight panel and marked L AUX AIR DOOR and R AUX AIR DOOR, illuminate when the auxiliary air doors operate out of phase with the landing gear handle. The lights may also illuminate momentarily when engine compartment overpressures are relieved. Illumination of either auxiliary air door indicator light causes the MASTER CAUTION light to illuminate. If either auxiliary air door indicator light illuminates (other than momentarily), corrective action should be taken immediately.

## ENGINE BLEED AIR SYSTEM

The bleed air system supplies high temperature, high pressure air from the engines to the boundary layer control system (on aircraft without slats), the cabin air conditioning system, and the fuel cell pressurization system. Control of the bleed air flow, temperature and pressure is initiated and regulated by the requirements of each system. The system utilizes engine compressor bleed air tapped off the 17th stage compressor. Normally, both engines supply the air for the operation of these systems, but when necessary, single engine operation will supply sufficient air for their operation.

## ENGINE STARTING SYSTEM

The engine starting system utilizes a turbine type cartridge/pneumatic starter unit, mounted on the accessory gear box of each engine. These units provide starting capabilities with either the pneumatic starting unit (MA-1A, AF/M32A-60, or equivalent) or with an MXU-4A solid propellant cartridge. The pneumatic starting units should be capable of delivering 45 lbs/min of air at 50 psia on a standard day. Electrical power for starting is available from the AF/M32A-60. When using the MA-1A, electrical power for starting may be supplied by an external power unit or the aircraft battery.

## Pneumatic Mode Starting

The pneumatic mode is the primary starting mode for all normal and routine flying operations. Air from an auxiliary starting source causes the starter turbine to rotate which, in turn, cranks the engine.

## Cartridge Mode Starting

The cartridge mode is considered an alternate method of starting. Hot gases from a solid propellant cartridge cause the starter turbine to rotate and crank the engine. Cartridge ignition is controlled by the engine start switch providing the respective engine master switch is on.

## Start Switch

The engine start switch is on the left console in the front cockpit inboard of the throttles. The start switch is a three-position, lever-locked toggle switch, and is marked L and R. The switch is spring-loaded to the neutral position. When operating in the cartridge mode, placing the switch momentarily to the left or right ignites the corresponding starter cartridge. When operating in the pneumatic mode, the ground cart is operated by the ground crew and it is not necessary to activate the start switch.

## ENGINE IGNITION SYSTEM

The ignition system consists of an ignition button on each front throttle, a low-voltage, high-energy ignition unit on the engine, a spark plug in the number four and five combustion chambers, and the necessary wiring. The main ignition system produces an electrical arc which ignites the atomized fuel-air mixture in the numbers four and five combustion chambers. The remaining eight combustion chambers are ignited through the crossfire tubes. Depressing the ignition button causes the spark plugs to discharge, igniting the fuel-air mixture as the throttle is moved from OFF to IDLE during engine start. The spark plugs fire only while the ignition button is depressed.

## Ignition Buttons

The ignition buttons are spring-loaded, push-button type switches, located on each front cockpit throttle directly below the throttle grips.

## ENGINE ANTI-ICING SYSTEM

Engine bleed air is supplied to the engine anti-icing system which prevents the formation of ice on the engine frontal area. The bleed air is distributed to ducts in the compressor front frame, inlet guide vanes, nose dome, and nose dome struts. It then flows from these components through small bleed holes, and enters the engine primary airstream. The system is an anti-icing, not a de-icing system, since an actual buildup of ice will block the small bleed holes and render the system inoperative. Engine anti-ice is not needed or desired at high Mach numbers since the compressor inlet temperature is sufficient to prevent any ice accumulation and continued operation in this range could cause engine damage.

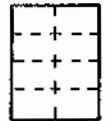

# BLEED AIR AND ASSOCIATED SYSTEMS

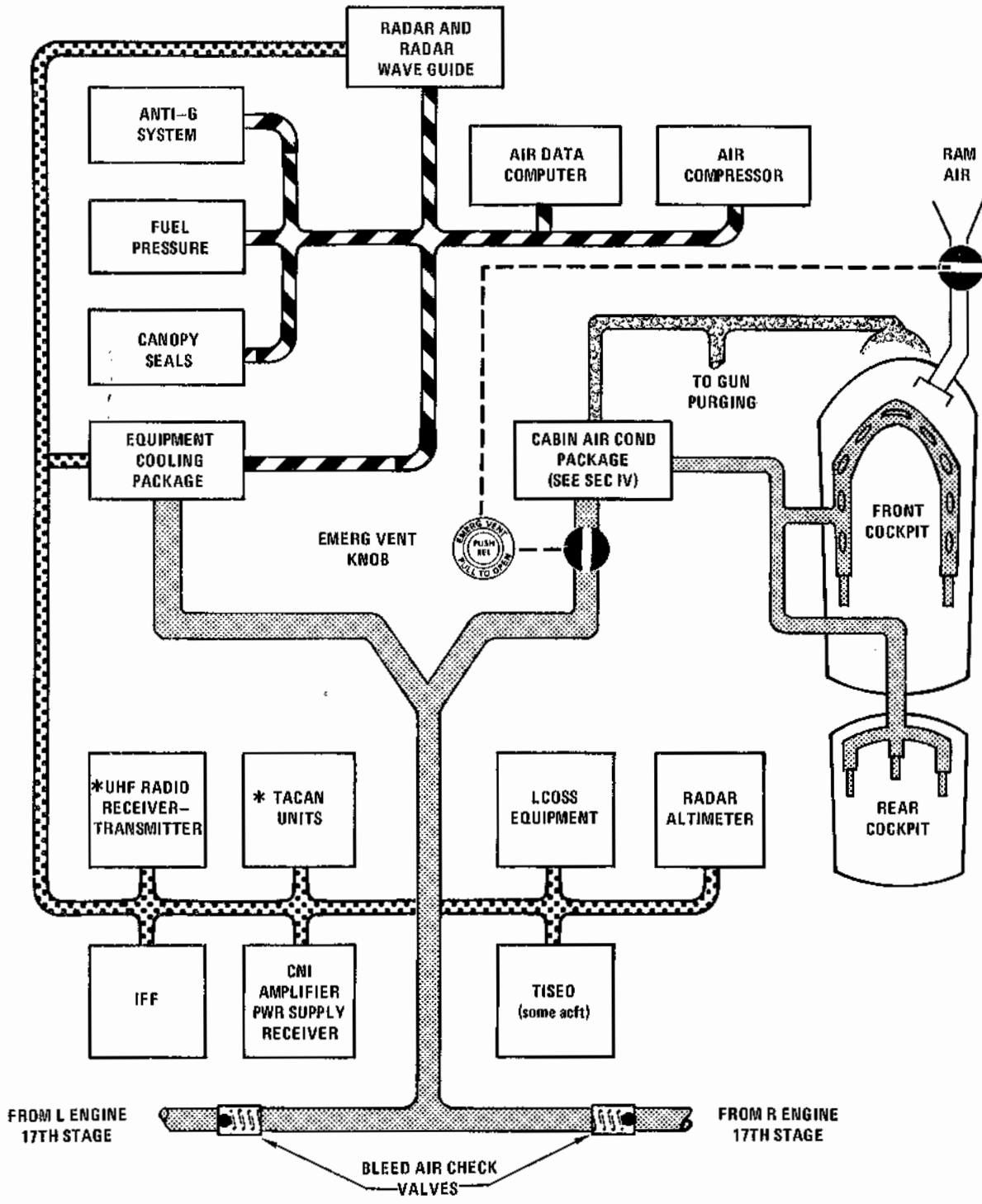

- |  |                   |         |                                  |
|--|-------------------|---------|----------------------------------|
|  | ENGINE BLEED AIR  |         | RAIN REMOVAL                     |
|  | EQUIPMENT AUX AIR | *       | ALSO RECEIVES EQUIPMENT AUX AIR  |
|  | EQUIPMENT COOLING | - - - - | MECHANICAL/ELECTRICAL CONNECTION |

4E-1-(490)

Figure 1-2



## Anti-Icing Switch

A two-position anti-icing switch is on the left console, front cockpit. The switch is marked engine anti-icing and the switch positions are DE-ICE and NORMAL. Placing the switch to DE-ICE, opens the regulator valve which starts anti-icing air flow. With the switch in NORMAL, no anti-icing operation is being performed.

## Anti-Ice Indicator Lights

A set of anti-icing lights, marked L ANTI-ICE ON, and R ANTI-ICE ON, are on the telelight panel. The lights operate from a pressure sensitive switch which is actuated by the pressure of the engine bleed air when the anti-icing system is turned on. If the lights illuminate during flight, with the anti-icing switch in NORMAL, the anti-icing shutoff valve has failed to the open position. If a failed shutoff valve is indicated during high Mach number flight (approximately 1.2 Mach or greater), reduce speed. An illuminated anti-ice light also illuminates the MASTER CAUTION light.

## AFTERBURNER SYSTEM

### Afterburner Fuel System

The afterburner fuel system provides fuel for thrust augmentation. A separate constant pressure drop, variable fuel control meters the afterburner fuel. Ignition is provided by a separate ignition system. In operation, the aircraft boost pumps supply fuel to the inlet of the afterburner pump. The afterburner pump supplies fuel to the check valve which will open under pressure and supply fuel to the remainder of the system. The fuel is scheduled as a function of throttle angle and compressor discharge pressure.

### Afterburner Fuel Pump

The afterburner fuel pump is an engine-driven centrifugal-type pump. It operates continuously, but discharges fuel to the afterburner fuel system only when the inlet to the pump is open. To open the inlet to the afterburner fuel pump, the throttle must be moved into the afterburner modulation range. An engine speed above approximately 90.3% rpm is required to initiate afterburner operation.

### Afterburner Fuel Control

The afterburner fuel control is linked mechanically to the main fuel control through teleflex cabling. Any movement of the throttle moves the main fuel control teleflex and subsequently the teleflex to the afterburner fuel control. Fuel entering the afterburner fuel control is metered in relation to throttle movement and variations in compressor discharge pressure. The afterburner fuel control varies fuel flow between the minimum necessary for afterburner combustion and the maximum fuel flow allowable for any flight condition.

## Afterburner Fuel Distribution

The afterburner fuel pressurizing valve delivers fuel to four separate fuel manifolds: primary annulus, primary core, secondary annulus, and secondary core. The fuel is distributed by these manifolds to 21 multi-jet afterburner fuel nozzles which are equally spaced around the perimeter of the afterburner section. Each multi-jet nozzle contains four tubes, one for each manifold, and holes in the sides of the tubes spray the fuel into the exhaust gasses. When afterburner is first selected, the pressurizing valve directs fuel to the primary core manifold. Further advancement directs fuel to the secondary core manifold which joins the primary core manifold in delivering fuel for afterburner operation. When the throttle is advanced still further, the pressurizing valve directs fuel to the primary annulus manifold. As the throttles are advanced to the maximum afterburner position the fuel is directed to the secondary annulus thus joining the other three manifolds in delivering fuel to the nozzles; this is full afterburner operation. The afterburner fuel manifolds and multi-jet nozzle system give smooth afterburner operation, with no appreciable acceleration surge.

## AFTERBURNER IGNITION SYSTEM

The afterburner ignition system consists of the torch igniter, a spark plug, and an afterburner ignition switch. When the throttle is moved into the afterburner detent, fuel pressure from the main fuel control is directed to the pressure operated afterburner ignition switch and to the torch igniter on-off valve. The afterburner ignition switch closes, completing the electrical circuit and allowing the AB spark plug to supply a continuous arc. When the torch igniter on-off valve is opened by fuel pressure from the afterburner fuel pump, the fuel flows to the torch igniter assembly to be ignited by the AB spark plug. Ignition and fuel flow are maintained until the throttle is removed from the afterburner detent.

### NOTE

Afterburner ignition will not be available to either engine when operating on battery power, or when the left generator is inoperative with a BUS TIE OPEN light. However, if afterburner thrust is required afterburner light offs may be obtainable through turbine torching by jam acceleration of the engine(s) at 90% rpm or above.

## VARIABLE AREA EXHAUST NOZZLE

Two sets of cylindrical nozzles, operating together, make up the variable area exhaust nozzle system. The primary nozzle (inner nozzle), hinged to the aft end of the tail pipe, controls the convergent portion of the nozzle, while the secondary nozzle (outer nozzle), hinged to a support ring, controls the divergent portion of the nozzle. The two sets of nozzles are linked together to maintain a scheduled area and spacing ratio which is infinitely variable between maximum and minimum nozzle opening. The nozzles are regulated by the nozzle area control. Movement of the nozzles is accomplished automatically by four synchronized hydraulic actuators using engine oil as its actuating fluid.

## Exhaust Nozzle Control Unit

Throttle position, nozzle position feedback, and exhaust gas temperature are utilized to schedule the correct nozzle area. (Refer to figure 1-3). During engine operation in the submilitary region, nozzle area is primarily a function of throttle angle and nozzle position feedback. The nozzle is scheduled to approximately  $\frac{1}{2}$  open at idle and the area is decreased as the throttle is advanced toward the military position. However, during a rapid throttle burst from below 79% rpm to 98% rpm, a control alternator supplies engine speed information to the temperature amplifier, which in turn schedules engine speed inputs as a function of temperature limiting. This signal prevents the primary nozzle from closing beyond a preset position, permitting a rapid increase in engine rpm. During engine operation in the military and afterburner region, it becomes necessary to limit the nozzle schedule as established by throttle angle and nozzle feedback to prohibit exhaust gas temperature from exceeding engine design limits. Exhaust gas temperature is sensed by 12 dual-loop thermocouples and the resulting signal is transmitted to the magnetic temperature amplifier. The amplifier which receives its power from the control alternator, compares the thermocouple signal to a pre-set reference voltage, representing desired engine temperature. The difference is amplified and transmitted to the nozzle area control. Nozzle area control output signals direct the operation of the variable pressure, variable displacement nozzle pump.

## Exhaust Nozzle Position Indicators

Exhaust nozzle position indicators, which show the exit area of the exhaust nozzle, are on the front cockpit instrument panel. The instruments are calibrated from CLOSE to OPEN in four increments. The nozzle position indicators enable the pilot to make a comparison of nozzle position between engines, and are also used to establish a relationship between nozzle position and exhaust gas temperature, and nozzle position and throttle settings. On aircraft 71-237 and up, a single exhaust nozzle position indicator with dual pointers is utilized to display nozzle position.

## ENGINE CONTROLS AND INDICATORS

### Engine Master Switches

Two lever-lock, two-position engine master switches are on the left console in the front cockpit on the inboard engine control panel. A guard is installed between the engine master switches to prevent inadvertent operation of the master switch(es) when selecting similar type switches. Placing either switch to ON, directs power to the fuel boost pumps and the fuel transfer pumps if the aircraft is supplied with a source of ac power. On aircraft 68-495 and up, placing the switch to ON, directs power to the corresponding fuel boost pump (left master switch on, left boost pump on) and both fuel transfer pumps if the aircraft is supplied with a source of ac power. On all aircraft if there is no source of ac power, placing either switch to ON, connects the aircraft battery to the essential 28 volt dc bus. Electrical power is then available for operating the fuel shutoff valves and for the engine

ignition circuits. With AC power available, the circuits for the fuel shutoff valve, which are normally operated by the throttles, are such that either valve will be closed when its respective engine master switch is placed OFF, regardless of the throttle position. With 28 volt dc power only, the throttle must be placed in the cutoff position prior to the engine master switches being placed off or the fuel shutoff valves will remain open.

### Throttles

A throttle for each engine is on the front and rear cockpit left console. Movement of the throttle is transmitted by mechanical linkage to the engine fuel control. The fuel control unit incorporates a throttle booster which reduces the amount of effort needed to move the throttles. Boost power is supplied by fuel from the engine driven fuel pump. Teleflex cables, from the engine fuel control, link the nozzle area control, and afterburner fuel control, so that fuel flow and nozzle area are compatible throughout the full range of engine operation. A friction adjusting lever is mounted between the front cockpit throttles to permit adjustment of throttle friction to suit individual requirements. Limit switches, which control the main fuel shutoff valves, are built into the throttle quadrant. Advancing the throttle from OFF to IDLE (with the engine master switch ON) actuates electrical switches which open the corresponding fuel shutoff valve. Afterburner light-off can be initiated anywhere within the afterburner modulation range by shifting the throttles outboard and moving forward from the MIL position. As the throttles are advanced from minimum to the maximum afterburner position, the increase in thrust will be smooth and continuous. Movement of the throttles from IDLE to OFF actuates a switch which closes the fuel shutoff valve, stopping fuel flow to the engine. Throttle movement through the cutouts is as follows: To move from OFF to IDLE or MIL, advance the throttles straight forward. To move from MIL to MAX, shift throttles outboard; throttles can then be moved forward in the afterburner range. The throttles in the front cockpit are equipped with finger lifts, enabling rapid throttle chops to IDLE while preventing inadvertent shutoff. The finger lifts, on forward side of throttles, must be raised before the throttles in either cockpit can be retarded to OFF. The rear cockpit throttles are linked to the front cockpit throttles such that only the pilot can start the engines, or move the throttles into the afterburner thrust range. The rear cockpit throttles can be moved from the OFF position with no front seat assistance. The rear cockpit throttles can be used to control thrust throughout the entire range (providing the pilot selects afterburner). The throttles can be retarded from MAX to IDLE from the rear cockpit although OFF position must be selected from the front cockpit. The rear cockpit throttles each contain a load limiting device to prevent damage of the teleflex cable in the event an opposing force is applied to both front and rear cockpit throttles simultaneously. The rear cockpit throttles become disengaged from the airframe throttle system when a force of 55 to 100 pounds is applied to the rear cockpit throttles (opposing front cockpit throttles) in either the forward or aft direction. Under this condition, selection of maximum afterburner may be restricted. The rear cockpit throttles can be reset by placing the front cockpit throttles against the IDLE or MIL stop and moving the rear cockpit throttles in the opposite direction from which the disconnect occurred. The rear cockpit throttles incorporate only a microphone

# THROTTLES

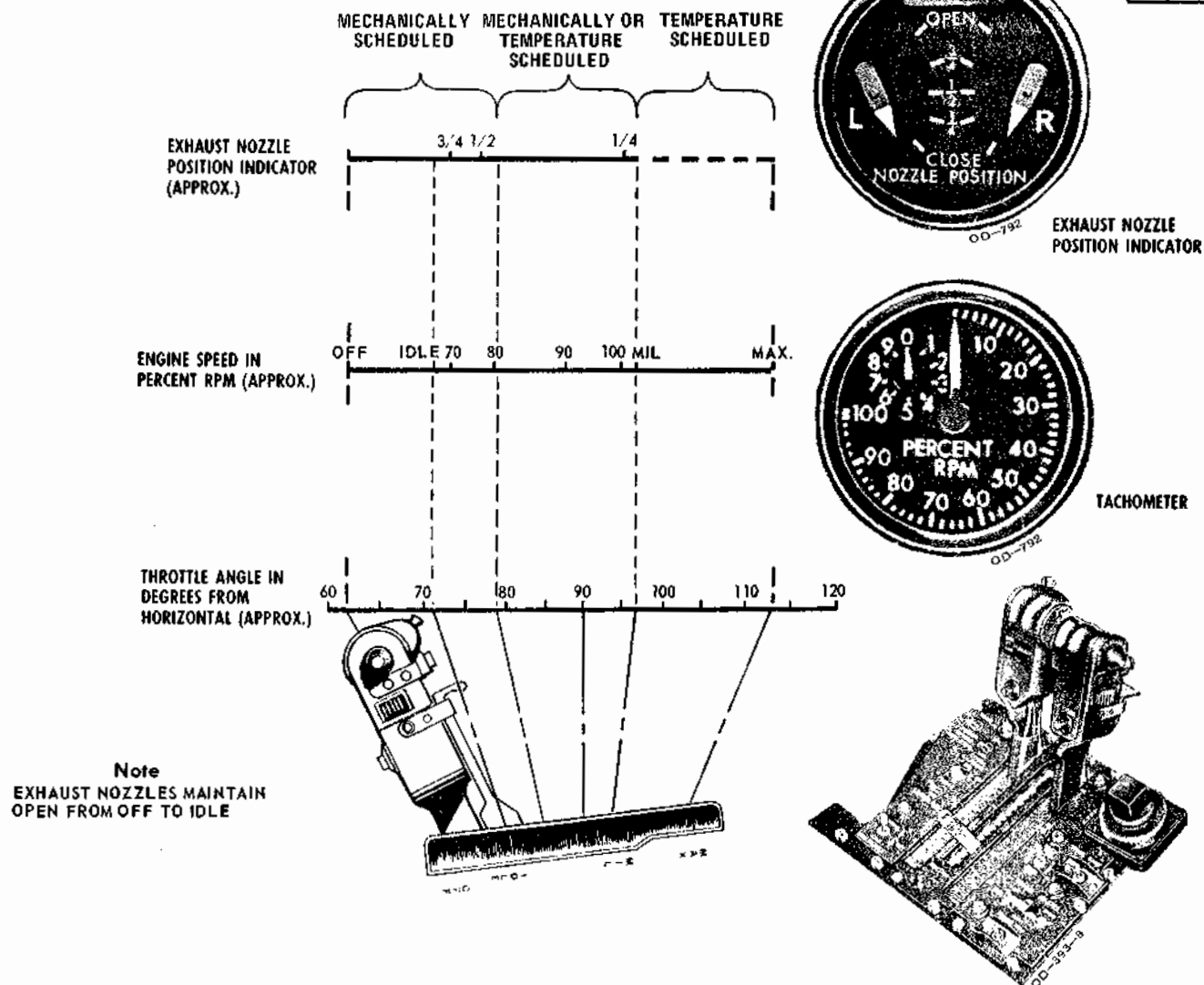

4E-1-(24)

Figure 1-3

button and a speed brake switch.

## WARNING

If the rear cockpit throttles are held steady or jammed, the pilot may be unable to exercise command of the throttles due to the extremely high breakout forces necessary to disconnect rear cockpit throttles.

## NOTE

- Afterburner operation can be terminated from the rear cockpit; however, it will be necessary to give the rear cockpit throttles a hard pull (10 to

15 pounds) to remove the front cockpit throttles from their afterburner detent.

- To avoid the possibility of internal mechanical interference, reconnect throttles prior to retarding to the OFF position.

## Tachometers

A tachometer for each engine is mounted on the right side of the front cockpit instrument panel and on the upper right side of the rear cockpit instrument panel. The system comprises four tachometer indicators and two tachometer generators (one for each engine), and is completely self-contained in that it requires no external source of power. Each indicator includes two pointers: a large

pointer operating from 0 to 100 and a small pointer operating on a separate scale from 0 to 10, which indicate RPM in percent.

### Exhaust Gas Temperature Indicators

The exhaust gas temperature indicators are mounted on the front cockpit instrument panel. Each indicator includes two pointers: a large pointer operating on a scale from 0 to 12 with the readings multiplied by 100 degrees Centigrade, and a smaller pointer operating on a separate scale from 0 to 10 with readings multiplied by 10. The system indicates the temperature of the exhaust gas as it leaves the turbine unit during engine operation. Twelve dual-loop thermocouples are installed on each engine. The indicators are powered by the right main 115 volt ac bus when that bus is energized. When the right main 115 volt ac bus is deenergized, the indicators receive power from an inverter which is powered by the essential 28 volt dc bus. During a battery start, exhaust gas temperature information is available to the pilot.

## AIRCRAFT FUEL SYSTEM

### NOTE

Refer to foldout section for airplane and engine fuel system illustration.

Fuel is carried internally in a fuselage tank, made up of interconnected cells, and two internal wing tanks. External fuel is carried in drop tanks; two 370-gallon, wing-mounted units, and a 600-gallon fuselage mounted unit. All tanks may be refueled on the ground through a single pressure refueling point, or while airborne, through the air refueling receptacle. External tanks may be individually fueled through external filler points. The fuselage cells are arranged so cell 1, the engine feed cell, is behind the aft bulkhead of the rear cockpit. The remainder of the cells are numbered consecutively, with cell 7 being the most aft cell. On aircraft 68-495 and up, the fuselage cells are self-sealing. Flapper valves in cells 1, 2, and 4 prevent reverse flow through the cells when the aircraft is in a climbing attitude. Cells 4 and 6 each contain one hydraulic and one electric fuel transfer pump to transfer fuselage fuel to cells 1 and 2. Regulated engine bleed air pressure transfers internal wing fuel and all external fuel to the fuselage cells. Fuel will not transfer from internal wing or external tanks until the weight is off the gear and the tanks are pressurized. Air pressure is also used to facilitate dumping internal wing fuel, and to maintain a positive pressure in all tanks. Float type fuel level control valves control fuel level during refueling or fuel transfer operations. The fuselage cells and internal wing tanks contain capacitance-type fuel gaging units which read out in pounds on the fuel quantity indicator. The external wing tanks are vented to the internal wing tank dump lines, while all other tanks are vented to the fuel vent mast, located immediately below the rudder. See figures 1-4 and 1-5 for fuel quantities.

### NOTE

Cells 2 through 6 are so arranged that they will gravity flow into cell 1 (with the exception of approximately 1500 pounds) if a complete transfer pump failure occurs.

## SELF-SEALING CELLS

On aircraft 68-495 and up, the fuselage cells have a self-sealing capability for up to 50-caliber ammunition. Reticulated foam has also been placed in each fuselage cell to reduce fire and explosion with straight or tumbling ammo penetration.

## TRANSFER SYSTEM

The electrical fuel transfer pumps run continuously when electrical power is applied to the aircraft and either or both engine master switches are ON. The hydraulically driven fuel pumps run only under the following conditions: when hydraulic power is available with no electrical power on the aircraft, when either engine is in afterburner operation, when automatic transfer is initiated (low level fuel state is reached), or when the air refuel switch is in the EXTEND position. If the hydraulic transfer pumps are started by automatic transfer, and the fuel level is increased above that which starts automatic transfer, the air refuel switch must be cycled from the RETRACT to EXTEND and back to RETRACT to terminate hydraulic pump operation. The pumps transfer fuselage fuel to cells 1 and 2. The level control valves open to allow fuel from the transfer pumps to enter cells 1 and 2 when the fuel level drops below that of the floats. Cell 2 transfers to cell 1 by gravity only; cell 3 gravity feeds cell 4; and cell 5 gravity feeds cell 6. Cell 7 gravity feeds cell 6 when the fuel level in cell 1 and 2 drops below 1960 pounds on aircraft through 68-494, or 1800 pounds on aircraft 68-495 and up, (as indicated on the tape). A dual actuator (air and fuel) transfer valve in cell 7 opens when either fuel or air pressure is applied to the valve. Fuel pressure and regulated air pressure from the boost pumps are applied to the valve in cell 7 when the fuel level in cell 2 drops below the pilot float valve, thus allowing cell 7 fuel to gravity feed cell 6. Fuel carried in the internal wing tanks and all external tanks is transferred by regulated air pressure to the fuselage cells, providing the weight is off the gear and the tanks are pressurized. The internal wing fuel does not enter cell 5 so as to prevent an undesirable aft CG condition. None of the internal or external fuel will enter cell 1 unless the fuel level in this cell drops low enough to allow the refueling level control valve to open. The internal and external fuel transfer is controlled by switches on the fuel control panel. When transfer of external fuel is selected, transfer of internal wing fuel is stopped automatically and cannot be regained until the external transfer switch is returned to OFF. When external fuel tanks are not carried, the external transfer switch is inoperative. An automatic fuel transfer system is incorporated. When the fuel level in cells 1 and 2 drop below a predetermined level all external and internal wing fuel, not previously transferred, will transfer to cells 1 and 3 regardless of the switch positions. On aircraft through 68-494, automatic transfer starts at 2500  $\pm$  200 pounds. On aircraft 68-495 and up, automatic transfer starts at 2300  $\pm$  200 pounds. Since the automatic fuel transfer occurs before cell 7 transfer is initiated, cell 7 fuel is not available until all external fuel and internal wing fuel has transferred. The automatic fuel transfer system is inoperative when the air refuel switch is in the EXTEND position. The automatic transfer system resets during ground or air refueling to allow normal transfer. Fuel will not transfer to cells 5 and 6 during automatic

transfer. The automatic fuel transfer system is completely independent of the fuel quantity indicating system.

### Internal Wing Transfer Switch

A two-position internal wing transfer switch with positions of NORMAL and STOP TRANS is on the fuel control panel. The toggle-type switch, lever-locked to NORMAL, directly controls the positioning of the internal wing transfer low level shutoff valves through the solenoid operated function of the valve. In NORMAL, the valves are deenergized, open, allowing internal wing fuel to transfer to fuselage cells 1 and 3 only, providing the internal wing tanks are pressurized and the fuel level control valves in cells 1 and 3 are open. In STOP TRANS, the internal wing transfer low-level shutoff valves are energized closed, stopping transfer of internal wing fuel to the fuselage cells. Power to operate the internal wing transfer valves is supplied by the essential 28 vdc bus. This provides the capability to transfer internal wing fuel on battery power.

#### WARNING

If the external transfer switch is positioned to an external position (OUTBD or CENTER) on which tanks are installed, internal wing fuel will not transfer until automatic transfer is initiated even though the internal wing transfer switch is positioned to NORMAL.

### External Transfer Switch

The external transfer switch, on the fuel control panel, is a three-position toggle switch with a triangle head. The switch positions are marked CENTER, OFF, and OUTBD. Upon selection of CENTER, the internal wing tanks transfer low-level shutoff valves close, the centerline tank fuel shutoff valve and the fuel shutoff valve in the pressure fueling line are energized open, allowing fuel to transfer. Upon selection of OUTBD, the internal wing tanks transfer low-level shutoff valves close and the left and right external tanks shutoff valves open, allowing external wing fuel to transfer. All external fuel transfers to fuselage cells 1, 3, and 5. Power to operate the external transfer valves is supplied by the essential 28 volt dc bus which provides the capability to transfer external fuel on battery power. The switch is operative only with external tanks installed. If the external transfer switch is placed to a position on which tanks are not installed (OUTBOARD or CENTER), internal wing fuel will transfer in the normal manner, provided the internal wing transfer switch is in the normal position.

### FUEL BOOST SYSTEM

Fuel is supplied to the engine during all flight attitudes by two submerged electric motor-driven centrifugal type boost pumps. The boost pumps are in the engine feed cell. Both pumps are mounted on the bottom of the cell and provide fuel during negative G flight. Due to internal cell baffling and check valves, which trap approximately 850

pounds of fuel in the lower third of the cell during negative G flight, the boost pumps will provide (for a limited time) a continuous fuel flow to the engines. The two boost pumps operate when either engine master switch is ON, provided ac power is supplied to the system. Normal output of each pump, at idle rpm, is  $30 \pm 5$  psi. Both pumps are single high-speed units and operate only if one or both generators are on the line. On aircraft 68-495 and up, the engine feed manifold is divided and the left boost pump supplies fuel to the left engine only, while the right boost pump supplies fuel to the right engine. Each pump is controlled by its corresponding engine master switch (left master switch on, left boost pump on) provided ac power is supplied to the system. Boost pump output for each manifold is indicated on the left or right boost pump pressure indicator. After engine start, each gage will indicate  $30 \pm 5$  psi with its corresponding engine at idle.

### Boost Pump Check Switches

On aircraft through 68-494, the left and right boost pump check switches, with a CHECK position and a spring-loaded NORMAL position, are on the fuel control panel. A boost pump ground check may be made only with external power applied to the aircraft, and with the engine master switches OFF. Holding either check switch in CHECK position operates the corresponding left or right engine shutoff valve allowing a pressure transmitter to pick up boost pump pressure. Fuel boost pump pressure transmitters will transmit an electrical signal to the applicable pressure indicator on the left subpanel.

### Boost Pump Pressure Indicators

The boost pump pressure indicators are mounted on the left subpanel in the front cockpit. The gage dials are calibrated from 0 to 5 and readings must be multiplied by 10. Pressure transmitters mounted on the aircraft keel in the engine compartment measure the pressure in the aircraft fuel system on the inlet side of the engine fuel pump. This signal is transmitted to the indicators in the cockpit.

### FUEL TANK PRESSURIZATION AND VENT SYSTEM

The pressurization and vent system provides regulated engine bleed air pressure to all internal and external tanks for pressurization, fuel transfer, and wing fuel dump. The system also provides pressure relief of the fuel tanks during climbs, and vacuum relief of the fuel tanks, as required, during descents. The pressurization circuit is wired through the right main gear scissor switch and the right main gear down limit switch. This circuitry provides pressurization (through the scissor switch) as soon as the weight is off the gear and continues to provide pressurization (through the down limit switch) as the gear is retracted. When the gear is retracted the scissor switch is in the same position as when the gear is extended and the aircraft is on the ground. Pressurization is terminated when the right main gear strut is compressed at touchdown.

# FUEL QUANTITY DATA TABLE

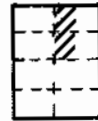

## JP-4

TANK	AIRCRAFT THRU BLK -40				AIRCRAFT BLK-41 AND UP.			
	FULLY SERVICED		USABLE FUEL		FULLY-SERVICED		USABLE FUEL	
	GALLONS	POUNDS	GALLONS	POUNDS	GALLONS	POUNDS	GALLONS	POUNDS
FUSELAGE CELL 1	—	—	231	1501	—	—	215	1397
CELL 2	—	—	207	1345	—	—	185	1203
CELL 3	—	—	164	1066	—	—	147	955
CELL 4	—	—	221	1436	—	—	201	1307
CELL 5	—	—	201	1306	—	—	180	1170
CELL 6	—	—	235	1528	—	—	213	1385
CELL 7	—	—	95	618	—	—	84	546
TOTAL FUSELAGE FUEL	1373	8925	1354	8801	1268	8242	1225	7963
INTERNAL WING TANKS	644	4186	630	4095	644	4186	630	4095
TOTAL INTERNAL FUEL	2017	13,111	1984	12,896	1912	12,428	1855	12,058
EXTERNAL WING TANKS	744	4836	740	4810	744	4836	740	4810
INTERNAL FUEL PLUS EXTERNAL WING TANKS	2761	17,947	2724	17,706	2656	17,264	2595	16,868
EXTERNAL CENTER TANK	602	3914	600	3900	602	3900	600	3900
INTERNAL FUEL PLUS EXTERNAL CENTER TANK	2619	17,025	2584	16,796	2514	16,342	2455	15,958
MAXIMUM FUEL LOAD TOTAL INTERNAL PLUS ALL EXTERNAL TANKS	3363	21,861	3324	21,606	3258	21,178	3195	20,768
TOTAL TRAPPED	39	255	—	—	83	411	—	—

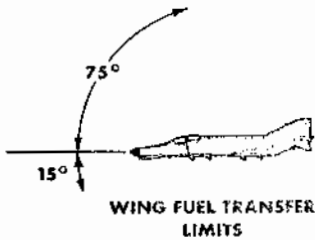

**Note**

- FUEL WEIGHTS ARE BASED ON THE JP-4 AVERAGE WEIGHT OF 6.5 POUNDS PER GALLON AT 60 DEGREES FAHRENHEIT.
- REFER TO FUEL WEIGHT VARIATIONS, SECTION VII, FOR INFORMATION ON FUEL DENSITY VARIATIONS AND TEMPERATURE EFFECTS ON TOTAL FUEL WEIGHT.



Figure 1-4

# FUEL DISTRIBUTION AND INDICATION

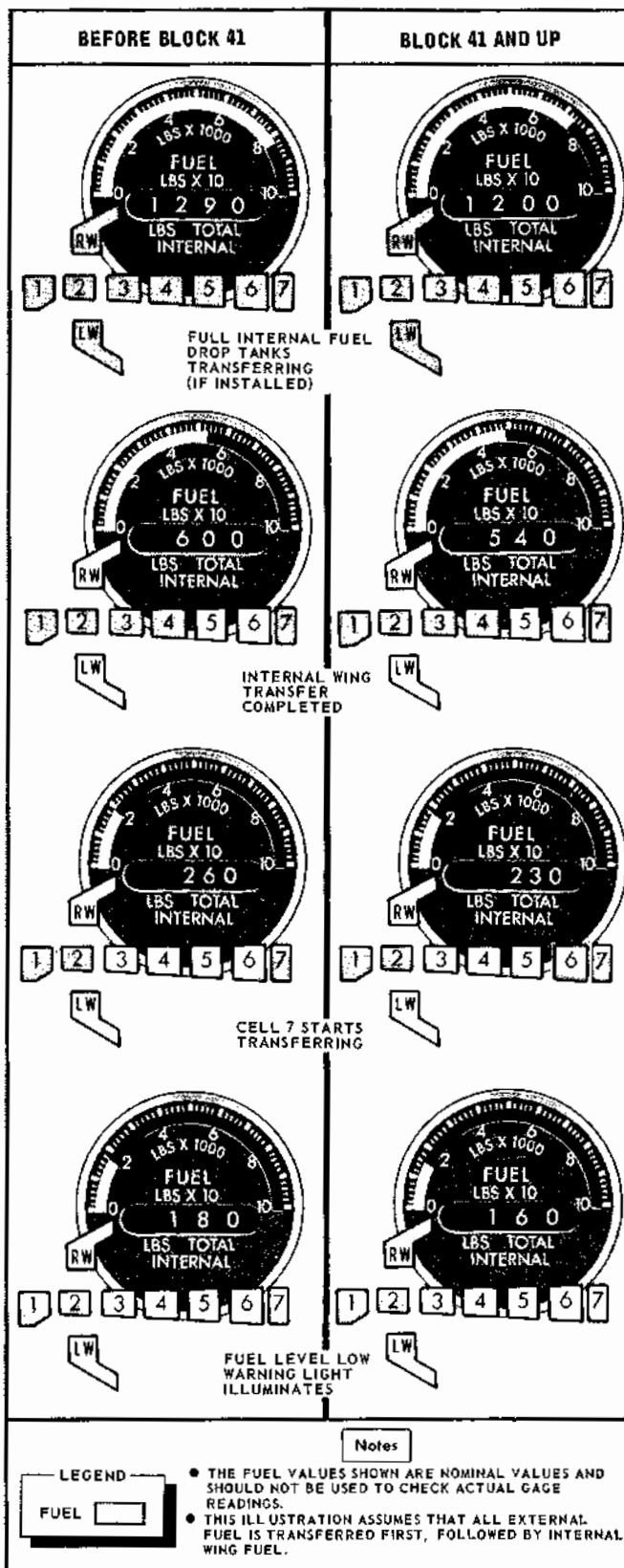
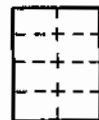

Figure 1-5

## Fuselage Pressurization and Vent

The fuselage tanks are pressurized to minimize boiling of the fuel and to prevent negative pressure from collapsing the cells during high speed descent. The fuselage cells are vented through the pressure relief valve to a common fuel vent manifold which is vented overboard through the fuel vent mast. This also provides fuel tank ventilation and vacuum relief.

## Internal Wing Tank and External Tank Pressurization and Vent

The internal wings and external tanks are pressurized to provide fuel transfer into the fuselage cells and wing fuel dump. The internal wing tank pressure relief valves, which control both pressure and vacuum relief, open into the common manifold and are vented overboard through the fuel vent mast. The external centerline tank is also vented and relieved in this manner. The external wing tanks are vented through their pressure relief valves to the internal wing tank dump lines.

## Tank Depressurization Switch

On aircraft 68-495 and up, a tank depressurization switch is installed on the fuel control panel. This guarded switch is marked NORM, ALL FUS and ALL INT. When the switch is in NORM, fuel cell pressurization operates as previously described. Placing the switch to ALL FUS depressurizes only the fuselage cells. If ALL INT is selected the fuselage cells and wing cells are depressurized. The fuel cells should be depressurized any time the possibility of a fuel vapor explosion exists, a hit is taken in the fuselage cells (depressurized fuel system enhances the self sealing capabilities of the fuselage cells), or during any landing emergency when aircraft damage may be sustained. If the automatic fuel transfer is actuated (2300 pounds) pressurization is restored to the internal wing cells. When the switch is not in NORM, the fuel cells are partially pressurized by the scarf affect of the fuel dump mast. This action supplies sufficient pressurization during most flight regimes to prevent the collapse of the fuselage cells.

### CAUTION

If the depressurization switch is in ALL INT and dive angles greater than 45° at airspeeds less than 300 knots are encountered, the fuselage cells may collapse due to negative pressure within the cells.

## FUEL QUANTITY INDICATING SYSTEM

The fuel quantity indicating system is of the capacitance-type and provides a reading, in pounds, of total usable internal fuel. The system components include the fuel quantity indicator, the fuel check switch, and the FUEL LEVEL LOW warning light. There are 14 fuel gaging units located throughout the internal cells.

## Fuel Quantity Indicator

A combination counter-tape fuel quantity indicator is on the instrument panel in the front cockpit. The counter unit of the gage continuously indicates the total fuel quantity (with readings multiplied by 10) of all usable internal fuel. The tape portion of the indicator simultaneously indicates the total usable fuel quantity (with readings multiplied by 1000) of fuselage fuel in cells 1 through 6 only. Cell 7 fuel quantity is included in the counter reading.

### NOTE

After all wing fuel has transferred, the counter should read  $600 \pm 350$  pounds higher than the tape when fuselage cell 7 is full. With both internal wing tanks and fuselage cell 7 empty, the difference between the tape and counter should not exceed 350 pounds.

### WARNING

- At the low end of the fuel scale, the counter portion of the fuel quantity gage has a tolerance of  $\pm 200$  pounds and the tape portion has a tolerance of  $\pm 150$  pounds. Therefore, if the FUEL LEVEL LOW light illuminates above an indicated 2000 pounds, on aircraft through 68-494; or 1850 pounds, on aircraft 68-495 and up, the fuel level low warning light should be used as the primary indication of a low fuel state.
- There is a possibility that the fuel quantity variations will be noted on the fuel quantity indicator during aircraft accelerations and decelerations. These variations are due to the movement of fuel within the cells which is a result of the high acceleration and deceleration rates of the aircraft. Transient increases in fuel quantity readings may be noted during deceleration, and transient decreases in fuel quantity readings may be noted during acceleration. This erroneous quantity indication combined with allowable indicator tolerances may result in engine flameout from fuel starvation with indicated fuel remaining.

## Feed Tank Check Switch

The two-position feed tank check switch, with switch positions of FEED TANK CHECK and NORM is used to check the fuel quantity in the engine feed tank. When the switch is in the spring-loaded FEED TANK CHECK position, the tape portion and the counter portion of the fuel quantity gage indicate engine feed tank fuel quantity. When cell 1 is full, the tape and counter will read as follows: On aircraft through 68-494, the counter should read  $1500 \pm 200$  pounds and the tape should read  $1500 \pm 150$  pounds. On aircraft 68-495 and up, the counter should read  $1400 \pm 200$  pounds and the tape should read  $1400 \pm 150$  pounds. The feed tank check switch also provides an indication that there is power to the fuel quantity circuits and that the gage is functioning properly.



### Fuel Level Low Warning Light

The FUEL LEVEL LOW warning light, on the front cockpit telight panel, illuminates when the usable fuel in cells 1 and 2 has reached a predetermined low fuel state (stabilized level flight). On aircraft through 68-494, the light illuminates at  $1800 \pm 200$  pounds. On aircraft 68-495 and up, the light illuminates  $1650 \pm 200$  pounds. The low level sensor is located in cell 2. The fuel level low warning system is completely independent of the fuel quantity indicating system.

#### WARNING

If the flapper valve between cells 1 and 2 sticks in the closed position; it is possible to deplete all fuel in cell 1 (sensor is in cell 2) without the illumination of the FUEL LEVEL LOW light.

### Tank 7 Fuel Light

The TANK 7 FUEL light on the telight panel illuminates in conjunction with the FUEL LEVEL LOW indicator light if cell 7 fuel is not transferring. The light indicates that the dual actuator transfer valve in cell 7 did not open. On aircraft after TO 1F-4E-563, the TANK 7 FUEL light is deactivated and will not illuminate in conjunction with the FUEL LEVEL LOW light if cell 7 fuel is not transferring. To identify a cell 7 fuel transfer failure, the fuel quantity indicator must be monitored when the FUEL LEVEL LOW light illuminates. If a  $600 \pm 350$  pounds difference between the tape and counter is present, and continues to exist, a cell 7 fuel transfer failure has occurred. In this event, only the fuel indicated on the tape is available to the engines.

#### WARNING

With the TANK 7 FUEL light illuminated, the counter portion of the fuel quantity indicates 600 pounds more fuel remaining than is actually available

### External Tanks Fuel Lights

The external tank fuel lights, on the telight panel, illuminate when fuel flow ceases, the tank is empty, or the tank is full. Since external fuel transfer is intermittent rather than continuous, the L EXT FUEL, CTR EXT FUEL, or R EXT FUEL light illuminates during any temporary halt of fuel flow. Intermittent external fuel transfer is desired since this means the transfer rate is greater than engine consumption, and that the fuselage fuel is being maintained at its highest possible volume.

#### NOTE

When selecting OUTBD or CENTER the corresponding indicator light illuminates momentarily any time fuel flow is less than 5 gallons per minute. The indicator lights illuminate any time the air refuel switch is placed

in the EXTEND position (provided the refuel selector switch is in ALL TANKS). The lights also illuminate any time both the external and internal wing tanks are empty and the automatic fuel transfer circuit is energized.

### External Tanks Full Lights

The external tanks full indicator lights are just below the canopy/windscreen junction (canopy bow). These lights, marked LH FULL, RH FULL, and CTR FULL illuminate during air refueling when their respective tanks are full. The lights remain illuminated any time the air refueling receptacle is in the extend position, with the engine master switch on, and the respective tanks are full. The lights also illuminate when the tanks become full during ground refueling, and remain illuminated until the ground refueling switch in the right wheel well is moved to OFF.

### INTERNAL WING FUEL DUMP SYSTEM

Wing fuel may be dumped in flight at any time, regardless of any other transfer switch positions, by placing the hex-head dump switch to DUMP. This two-position lever-locked toggle switch is marked NORMAL and DUMP. Selecting DUMP opens the left and right wing dump shutoff valves and closes the wing transfer and vent valves. The wing air regulator will open, allowing the wing tank to remain pressurized and force fuel out the dump lines at the wing-fold trailing edge. The dump valves utilize electrical power from the main dc bus and operate only when external power is applied or the generators are operating. At 85% rpm in level flight, the fuel dumping capability is approximately 650 ppm. The dumping rate varies directly with rpm and pitch attitude; i.e., lower rpm and/or nose pitched down decreases the dumping rate. Air pressure continues to bleed out the dump line until the internal wing dump switch is placed in the NORM position to close the dump valves. Wing fuel cannot be pressure dumped with the air refuel switch in EXTEND or the tank depressurization switch in ALL INT; however, with the internal wing dump switch in DUMP, the tanks will gravity dump at a slow rate.

### EXTERNAL TANK JETTISON SYSTEM

Refer to Jettison Systems, this section.

## ELECTRICAL POWER SUPPLY SYSTEM

#### NOTE

Refer to foldout illustrations for Electrical System schematic and circuit breakers.

The aircraft electrical power supply system consists of two engine driven ac generators, two dc transformer-rectifiers, a battery, and a power distribution (bus) system.

## AC ELECTRICAL POWER

Two 400 cycle, three phase, 115/200 volt ac generators are the primary source of all electrical power. Each generator (one on each engine) is capable of supplying the system with 30,000 volt-amperes of electrical power. The generators are regulated to a speed of 8000 rpm by integral constant speed drive units. Engine oil is used as a hydraulic media in the drive units and also serves to keep the generators cool. The left engine generator supplies power directly to the instrument 115/200 volt ac bus, the left main 115/200 volt ac bus, and the left transformer-rectifier. With the left generator connected to the line, the instrument bus switching relay is energized to supply power from the left generator to the instrument 115/200 volt ac bus through contacts of the instrument bus switching relay. Should the left generator be tripped off the line, the instrument bus switching relay is deenergized causing the instrument 115/200 volt ac bus to be switched from the output of the left generator to the right 115 volt ac bus. Thus, should the left generator go off the line due to malfunction or the left generator control switch being turned off, the power input to the instrument 115/200 volt ac bus is automatically switched from the left generator output to the right 115/200 volt ac bus. The right engine generator supplies power directly to the right main 115/200 volt ac bus and the right transformer-rectifier. Either generator is capable of supplying electrical power to the entire bus system through an auto-paralleled controlled bus tie relay. When the generators are in phase and are operating at approximately the same frequency, the auto-parallel control closes the bus tie relay, thereby connecting the left and right bus systems. If one generator becomes out of phase or frequency with the other, the fault protection circuits will open the bus tie relay. The generators will then be powering only their respective bus systems. If the electrical load division between the two generators becomes unbalanced, the fault protection circuit deenergizes the bus tie relay and each generator will supply power only to its own bus system. If one generator fails, the fault protection circuit drops the malfunctioning generator off the line and the bus tie relay energizes, allowing the remaining generator to supply power to the entire bus system. Each generator may be manually disconnected from the bus system by placing its generator control switch to OFF. Three autotransformers reduce 115/200 volt ac power to 28 and 14 volt ac power and transformer-rectifiers convert 115/200 volt ac power to 28 volt dc power.

### NOTE

At approximately 53% engine rpm, the generators drop off the line. This rpm varies with generator load and condition of CSD.

## DC ELECTRICAL POWER

Two 100 ampere transformer-rectifiers receive 400 cycle, three phase, 115/200 volt ac power from their respective generators and supply 28 volt dc power. The right transformer-rectifier is connected to the essential 28 volt dc bus and the left transformer-rectifier is connected to the main 28 volt dc bus. The essential 28 volt dc bus is connected to the main 28 volt dc bus through the main dc line relay when the relay is energized. Closure of the main dc line relay is determined by the monitoring action of the

dc tie control circuit. Essentially, the dc tie control circuit is designed to disconnect the two dc buses during double generator failure so that loads from the main 28 volt dc bus will not discharge the battery, and also so that in the event of a single transformer-rectifier failure, the remaining transformer-rectifier will power all the dc buses. The main dc line relay is energized when the voltage on the essential 28 volt dc bus reaches  $25.5 \pm 0.5 - 0$  volts. The buses become disconnected whenever the voltage on the combined buses drops below  $24.5 \pm 0.5 - 0$  volts for  $2.0 \pm 0.2$  seconds. The opening of the connection is indicated by illumination of the DC BUS light. If the main 28 volt dc bus becomes disconnected and the voltage on the essential 28 volt dc bus recovers to a value above  $25.5 \pm 0.5$  volts, the dc tie control circuit will not automatically reconnect the two buses together. This can only be done by simultaneously cycling both generator control switches. This feature prevents the control circuitry from recycling, or oscillating. The battery bus is connected to the essential 28 volt dc bus whenever either of the engine master switches is ON or the ground refueling switch is in the DEFUEL or REFUEL position. Whenever a transformer-rectifier(s) is powering the essential 28 volt dc bus and the battery bus is connected, the essential 28 volt dc bus charges the battery. The armament 28 volt dc bus is energized by the main 28 volt bus whenever the landing gear handle is UP or the armament safety override switch is depressed. If one transformer-rectifier fails, the remaining transformer-rectifier will power the entire system. If both transformer-rectifiers fail, the battery provides a limited source of dc power to the essential 28 volt dc and battery buses. The battery bus is energized any time the battery is installed and connected to the aircraft.

## Battery

A 24 volt, 11 ampere-hour, nickle cadmium battery is installed in the rear cockpit outboard of the right rudder pedal. The battery is connected to the battery bus and, through the battery relay, to the essential 28 volt dc bus. The battery relay is closed when either engine master switch is ON or the ground refuel switch is at REFUEL or DEFUEL. A check for battery relay closure is proper indication of gear and flap position. The battery is charged through the essential 28 volt dc bus and will discharge through this bus if the aircraft is parked with the battery relay closed.

Nickle cadmium batteries are subject to thermal runaway. Thermal runaway is caused by prolonged overcharging. This causes the battery temperature to rise, which reduces the battery internal resistance, resulting in a rise in charging current causing a further temperature rise. This cycle progresses until the battery is destroyed. The only cockpit indication of thermal runaway is the smoke and fumes generated by the process.

## BATTERY BYPASS SWITCH

After TO 1F-4-1116, a battery bypass switch is located on the No. 2 circuit breaker panel in the rear cockpit. When the switch is ON, the battery relay is deenergized and the battery is disconnected from the essential 28 volt dc bus and, thus, from the source of charging current. The battery bypass switch is used to discontinue battery charging when thermal runaway is suspected. Refer to

Smoke and Fumes procedure, section III.

## EXTERNAL ELECTRICAL POWER

External electrical power may be connected to the aircraft bus system through an external electrical power receptacle on the bottom of the left engine intake duct. External power required is 400 cycle, three phase, 115/200 volt ac. External electrical power is distributed through the bus system in the same manner as generator output.

### NOTE

On aircraft 68-410 and up, with the external electrical power cable connected to the aircraft but no external electrical power being supplied, the battery will discharge with both generator control switches in the EXT position.

## ELECTRICAL SYSTEM CONTROLS AND INDICATORS

### Generator Control Switches

Two generator control switches, one for each generator, are on the generator control panel. With external electrical power connected to the aircraft, and with the generator control switches in EXT ON, electrical power is supplied to all bus systems except the instrument buses, the CNI and the AFCS. With external electrical power connected and with the generator control switches in EXT ON, electrical power is supplied to the left main 115/200 volt ac bus, the left main 28 and 14 volt ac buses, the right main 115/200 volt ac bus, the right main 28 volt ac bus, the main 28 volt dc bus, and the essential 28 volt dc bus. When either engine driven generator is operating, the output may be connected to the entire bus system by placing its respective generator control switch to GEN ON.

### NOTE

If a generator trips off the line due to a temporary malfunction (low voltage, etc.), the associated generator switch must be cycled to reconnect the generator to the buses. Cycling is performed by placing the switch to the OFF position and then back to ON.

### Instrument Ground Power Switch

When external electrical power is applied to the aircraft, placing the generator switches to EXT ON will not energize the instrument 115/200 volt ac bus, the instrument 28 volt ac bus and the instrument 14 volt ac bus. This reduces the operating time of many of the aircraft instruments during ground repair and system testing. An instrument ground power switch, on the rear cockpit No. 2 circuit breaker panel, connects external electrical power to the instrument busses. The switch is solenoid operated and is engaged by placing the switch in the TEST position providing the generator control switches are in EXT ON and external electrical power is applied. On aircraft 68-410 and up, with the generators not operating, the switch engaged, and the generator control switches then placed out of the EXT position(s), the switch remains engaged and will discharge the battery

unless external electrical power is disconnected. On older block aircraft, the instrument ground power switch will disengage upon loss of external electrical power. With the left generator on the line, the instrument ground power switch disengages and all instrument buses receive power from the left generator. The instrument 115/200 ac bus receives power from the right generator when it is the only power source. The instrument buses may be deenergized, when operating on external power, by manually placing the instrument ground power switch to NORM (down position).

### Autopilot Ground Test Switch

With external power applied to the aircraft buses and the autopilot ground test switch in NORM (down) position, no electrical power can be applied to the AFCS circuits. To apply power to the AFCS, the autopilot ground test switch must be placed to the TEST (up) position (solenoid held). The autopilot ground test switch, on the No. 2 circuit breaker panel remains in TEST with power applied to the autopilot until either external power is removed, a generator comes on the line, or the switch is manually placed to the NORM position. When either generator comes on the line, the autopilot ground test switch can no longer be used to remove power from the AFCS. The purpose of the switch is to prolong AFCS component life by removing power to the system while external power is applied to the aircraft for maintenance of other systems.

### A/A IFF Ground Test Switch

With external power applied to the aircraft buses and the air-to-air ground test switch in the NORM (down) position, no electrical power can be applied to the AN/APX-81 interrogator set before TO 1F-4E-587 or to the APX-80 interrogator set after TO 1F-4E-587. To apply power to the interrogator set, the air-to-air ground test switch must be placed to the TEST (up) position (solenoid held). The air-to-air test switch, on the No. 2 circuit breaker panel, remains in TEST until either external power is removed, a generator comes on the line, or the switch is manually placed to the NORM position. When either generator comes on the line, the air-to-air ground test switch can no longer be used to remove power to the interrogator set. The purpose of the switch is to prolong interrogator set component life by removing power to the set while external power is applied to the aircraft for maintenance of other systems.

### Circuit Breakers

The front cockpit contains eight essential circuit breakers, one on the left subpanel and seven on the right console circuit breaker panel. There are two lighting circuit breakers on the instrument lights intensity circuit breaker panel in the front cockpit outboard of the right subpanel. A circuit breaker is installed on the standby attitude circuit breaker and intensity control panel, located above the right console. All remaining circuit breakers are in the rear cockpit. Refer to the circuit breaker panels in the foldout section for the location and name of each circuit breaker.

**NOTE**

Though a circuit breaker may not appear "popped" it may actually be open. To restore power in such a case, pulling and resetting the circuit breaker is recommended.

**Generator Indicator Lights**

The LH GEN OUT, RH GEN OUT and BUS TIE OPEN indicator lights are on the generator control panel. A generator light illuminates when a generator is removed from the bus system and the BUS TIE OPEN light illuminates when the generators are not paralleled. The generator indicator lights are powered solely by the warning lights 28/14 volts ac bus. Thus, the indicator lights do not illuminate in the event of double generator failure. Refer to Double Generator Failure and Bus Tie Open, section III. The MASTER CAUTION light illuminates in conjunction with the generator indicator lights.

**HYDRAULIC POWER SUPPLY SYSTEM****NOTE**

Refer to foldout illustrations for Hydraulic System schematic.

Hydraulic power is supplied by three, completely independent, closed center hydraulic systems. They are Power Control System One (PC-1), Power Control System Two (PC-2), and Utility System. The systems have an operating pressure of approximately 3000 psi and are pressurized any time the engines are running. The power control systems supply hydraulic pressure to the dual power control cylinders of the ailerons, spoilers and stabilator. The utility hydraulic system supplies hydraulic pressure to all systems except the stabilator actuator. Each system may be pressurized by an external hydraulic power source. On aircraft after TO 1F-4-903, a stabilator auxiliary power unit (APU) is installed. This system is an electrically operated, self-contained unit with an operating pressure of approximately 1700 psi. The APU supplies pressure to the stabilator actuator only.

**POWER CONTROL SYSTEMS**

The PC-1 and PC-2 systems are pressurized to 3000  $\pm$ 250 psi by a hydraulic pump mounted on each engine. The PC-1 pump, on the left engine, supplies pressure to one side of the left aileron, left spoiler, and stabilator dual power control cylinders. Pressure to one side of the right aileron, right spoiler, and stabilator dual power control cylinders is supplied by the PC-2 pump on the right engine. Utility pressure is supplied to the remaining side of both aileron and spoiler dual power control cylinders. Fluid is supplied to the pumps by airless, pressure loaded, piston type hydraulic reservoirs. The reservoirs insure positive hydraulic pressure and fluid supply at the pump suction ports regardless of aircraft altitude or flight attitude. Before TO 1F-4-1081, each PC system has a 50 cubic inch accumulator precharged to 1000 psi. This accumulator is used as a pump surge suppressor and as a limited source of hydraulic fluid and pressure when

system demands exceed pump output. A pressure transmitter, in the main pressure line, supplies pressure indications for the associated PC pressure indicator in the front cockpit. The hydraulic fluid is maintained at a usable temperature by a fuel-hydraulic fluid heat exchanger.

**NOTE**

The PC-1, PC-2, and utility hydraulic systems are independent of each other; therefore, each aileron and spoiler has two independent sources of hydraulic pressure and one system functions as a backup for the other.

**STABILATOR AUXILIARY POWER UNIT (APU)**

On aircraft after TO 1F-4-903, an APU system is installed to provide backup hydraulic pressure for longitudinal control. An electrically driven hydraulic pump pressurizes the APU system to 1700  $\pm$ 100 psi. The APU supplies pressure to the PC-1 side of the stabilator if PC-1 pressure drops below 1000 psi. Fluid is supplied to the pump by an integral, 25 cubic inch reservoir. The reservoir ensures positive hydraulic pressure and fluid supply at the pump suction port at altitudes below 20,000 feet. Fluid pressure is sufficient to supply stabilator demands of moderate flight maneuvers including landing. Flight speed is restricted below 600 knots/.95 Mach with normal load factors from 0 to +4 G. Stick rate input is limited to 1 G per second. A pressure switch in the pump illuminates an APU light on the telelight panel, when the pump is operating. An APU reject switch provides an option to reject the APU system should PC-1 pressure drop below 1000 psi (left engine shut down) with the PC-2 system operating normally. This switch also has a test position for ground check of the system. Operation of the system is automatic, provided the reject switch is in NORMAL, as soon as PC-1 drops below 1000 psi. If the reject switch is in REJECT, operation is automatic as soon as PC-2 pressure drops below 1000 psi (provided PC-1 has previously failed or the left engine was shut down). Momentary drops of the PC system below 1000 psi will cause the APU system to be energized. A holding relay in the control system will keep it activated for 1 minute after the PC pressure has recovered. The APU is powered by the right main 115 volt ac bus and controlled by the main 28 volt dc bus.

**Auxiliary Power Unit Reject Switch**

The APU reject switch, on the outboard engine control panel, is a three position switch marked NORMAL, REJECT and TEST. The TEST position is spring loaded to REJECT and provides an operational check of the APU system with external power (engines shut down). The NORMAL position provides automatic operation of the APU system if PC-1 pressure drops below 1000 psi. The REJECT position is lever locked and provides an option to de-activate the APU after PC-1 fails, and PC-2 is still operating normally. Placing the switch to REJECT (after PC-1 failure) turns off the APU and completes a circuit to automatically re-activate the APU system if PC-2 should also fail. Loss of PC-2 with a good PC-1 system will not activate the APU.

## APU Light

The APU light, on the telelight panel, illuminates anytime the APU is operating. A holding relay in the control circuit causes the light and APU to remain on for 1 minute, if momentary PC pressure drops occur. The APU light does not illuminate the MASTER CAUTION light.

### NOTE

Stick movement in pitch can cause the APU light to flicker or remain ON for as long as six seconds. However, this is normal and should be disregarded. It does not indicate actual operation of the APU.

## UTILITY SYSTEM

The utility hydraulic system is pressurized to  $3000 \pm 250$  psi by a hydraulic pump on each engine. To prevent the utility hydraulic pumps from resonating, check valves with different operating pressures are installed on the pump output lines. As a result, the right engine utility hydraulic pump will deliver  $2775 \pm 225$  psi at idle rpm, and the left engine utility hydraulic pump will deliver approximately  $3000 \pm 250$  psi at idle rpm. Fluid is supplied to the pumps by an airless, pressure loaded, piston type hydraulic reservoir. The reservoir insures positive hydraulic pressure and fluid supply at the suction ports of the pumps regardless of aircraft altitude or flight attitude. Before TO 1F-4-1081, a 50 cubic inch accumulator, precharged to 1000 psi, is utilized as a pump surge suppressor, and as a limited source of hydraulic fluid and pressure when system demands exceed the output of the pumps. The hydraulic fluid is maintained at a usable temperature by two fuel-hydraulic fluid heat exchangers. The utility hydraulic system supplies hydraulic pressure to the:

### AFCS

- Aileron Power Control Cylinders
- Aileron Dampers
- Aileron-Rudder Interconnect
- Air Refueling Receptacle
- Anti-Skid
- Arresting Hook (retraction)
- Auxiliary Air Doors
- Slats Flaps
- Forward Missile Cavity Doors
- Fuel Transfer Pumps (hydraulic)
- Gun Drive
- Gun Gas Purge Door
- Landing Gear
- Lateral Control Servo (autopilot)
- Nose Gear Steering
- Pneumatic System Air Compressor
- Radar Antenna Drive
- Roll Stab Aug
- Rudder Damper
- Rudder-Feel System
- Rudder Power Control Cylinder
- Speed Brakes
- Spoiler Power Control Cylinders
- Variable Engine Bellmouth
- Variable Engine Intake Duct Ramps
- Wheel Brakes (normal and emergency accumulator)
- Yaw Stab Aug

## HYDRAULIC PRESSURE INDICATORS

Two hydraulic pressure indicators are on the pedestal panel in the front cockpit. One is for the utility system and one is for the PC-1 and PC-2 systems. The power control systems indicator has two pointers, one labeled 1 for PC-1 and the other 2 for PC-2. Pressure transmitters, one for each system, convert pressure impulses to electrical impulses which, in turn, are supplied to the indicators. The indicators cover a pressure range of 0 to 5000 psi and are marked from 0 to 5 with readings multiplied by 1000.

## HYDRAULIC SYSTEMS INDICATOR LIGHTS

An amber CHK HYD GAGES indicator light is on the telelight panel. This single light is utilized by both the power control systems and the utility system to indicate loss of hydraulic system pressure and direct the pilot's attention to the hydraulic pressure indicators. Illumination of the CHK HYD GAGES indicator light is controlled by the hydraulic systems pressure switches. The CHK HYD GAGES light illuminates when the pressure in any one system drops below  $1500 \pm 100$  psi and/or when one of the utility hydraulic pumps fail. In all cases a loss of system pressure will be noted on the applicable hydraulic pressure indicator, but, a failed utility pump may not register a significant pressure drop on the utility pressure indicator. An illuminated CHK HYD GAGES light with no noted pressure drop on any of the hydraulic pressure indicators usually signifies that the right utility hydraulic pump has failed. An illuminated CHK HYD GAGES light in conjunction with a utility hydraulic pressure drop of 200 psi signifies that the left utility pump has failed. The MASTER CAUTION light illuminates in conjunction with the CHK HYD GAGES indicator light. The MASTER CAUTION light may be extinguished by depressing the reset button. The CHK HYD GAGES light remains illuminated until the pressure in the faulty system increases beyond 1750 psi. If a failure occurs in one of the remaining hydraulic systems while the CHK HYD GAGES light is already illuminated, the MASTER CAUTION light will not illuminate again and the pilot will not be alerted to the second failure.

### NOTE

The MASTER CAUTION and CHK HYD GAGES lights may illuminate momentarily due to high system demand when the landing gear is lowered or, after TO 1F-4-1081, with rapid control movement. If pressure recovers without delay, disregard this indication.

## PNEUMATIC SYSTEM

### NOTE

Refer to foldout illustrations for Pneumatic System illustration.

The pneumatic system provides high pressure air for the normal and emergency operation of the canopies, and the emergency operation of the landing gear and slats flaps. Air for the pneumatic system is drawn from the engine bleed air supply, via the electronic equipment cooling system, and is compressed by a hydraulic motor driven air compressor. A pneumatic pressure sensor in the system

moisture separator opens a hydraulic shutoff valve, to activate the air compressor, when the system pressure falls below 2750 +50 -0 psi. When the pneumatic system pressure builds to 3100 +100 -50 psi, the pneumatic pressure sensor closes the hydraulic shutoff valve which de-activates the air compressor. The air compressor discharges through a moisture separator and chemical air dryer to the pneumatic system air bottles. Check valves prevent the air bottles from discharging back toward the compressor. Shutoff valves isolate the air bottles from their component systems until they are manually discharged. A pressure transmitter, for the pneumatic pressure indicator, is installed in a main pressure line.

## PNEUMATIC PRESSURE INDICATOR

A pneumatic pressure indicator is on the pedestal panel in the front cockpit. A pressure transmitter supplies electrical inputs to the indicator. The indicator covers a pressure range of 0 to 5000 psi, and is marked from 0 to 50 with readings multiplied by 100. Normal system pressure range is from 2650 to 3300 psi due to pressure transmitter and pressure gage tolerances. The pneumatic pressure indicator shows only manifold pneumatic pressure and not individual emergency pneumatic bottle pressure. If the pneumatic manifold pressure goes to zero or below normal system pressure, and provided there are no leaks in the pneumatic inlet check valves, the emergency pneumatic bottle pressure will be between 2650 and 3300 psi.

## FLIGHT CONTROLS

### NOTE

Refer to foldout illustrations for Flight Controls schematic.

The aircraft primary flight controls consist of the stabilator, rudder, ailerons, and spoilers. The stabilator, ailerons, and spoilers are actuated by irreversible, dual power cylinders. The rudder is actuated by a conventional irreversible power cylinder. Artificial feel systems provide simulated aerodynamic forces to the control stick and rudder pedals. The feel systems have trim actuators which, through the power cylinders, move the entire control surface. Secondary controls are leading edge flaps/slats, trailing edge flaps, and wing mounted speed brakes.

## AILERON-SPOILER CONTROL SYSTEM

The lateral control system (a unique aileron-spoiler combination) consists of tandem forward and aft control sticks connected to the left and right aileron-spoiler by override spring cartridges, push-pull rods, walking beam bellcranks, aileron dual power cylinders with integrated control valves, spoiler power cylinders with follow-up type dual control valves, autopilot series servos, and lateral feel trim actuators. The ailerons travel downward 30° from a full trail position. Upward travel is limited to 1°. The spoilers travel upward 45° from a flush contour position in the upper wing surface. Lateral movement of the control stick is transmitted mechanically by the push-pull rods through the walking beam bellcranks, to the spoiler and aileron control valves. The control valves meter hydraulic

fluid to their respective dual power cylinders in proportion to the mechanical displacement. An override spring cartridge is incorporated in the left and right lateral control rod systems. If one side becomes jammed down stream of the override spring, it will deflect under force, allowing operation of the other lateral control surfaces. The walking beam bellcranks receive control surface movement inputs from three sources; the control stick, the lateral trim system, and the autopilot series servos. A self-serviced hydraulic damper, attached to the aileron backup structure, is utilized as an upstop for the aileron as well as a flutter damper. The control system uses dual power cylinders to allow simultaneous use of PC-1 and utility hydraulic systems in the left wing, and PC-2 and utility hydraulic systems in the right wing. If one system should fail, the remaining system in that wing will supply adequate power for control.

## Aileron Control

The ailerons are controlled by dual, irreversible, power cylinders that receive metered hydraulic fluid from dual integrated control valves. The control valves are controlled by the push-pull rods, through the walking beam bellcranks, and control stick. Each power cylinder contains four parallel inner cylinders with rods and pistons. The piston rods are joined at one end by a yoke that is attached to the aircraft structure. The cylinder portion of the power cylinder is attached to the aileron. The two outer cylinders of the right aileron receive hydraulic fluid from PC-2, and the two inner cylinders receive hydraulic fluid from the utility system. The two outer cylinders of the left aileron receive hydraulic fluid from the utility system and the two inner cylinders receive hydraulic fluid from PC-1. This arrangement provides symmetrical loading of the yoke, should one of the systems fail.

## Spoiler Control

Each wing contains two spoiler surfaces, two spoiler power cylinders, and a dual spoiler control valve. Each surface has a dual, irreversible power cylinder, with a feedback linkage to a dual spoiler control valve. The spoiler control valve divides each power control system input into equal parts which is then distributed to each spoiler dual power cylinder. One portion of the power cylinder of the right spoiler receives hydraulic pressure from PC-2, and the other portion receives hydraulic pressure from the utility system. One portion of the power cylinder of the left spoiler receives hydraulic pressure from PC-1, and the other portion receives hydraulic pressure from the utility system. If one of the systems fail, the other will supply adequate pressure for spoiler control.

## Lateral Control Feel and Trim System

The lateral trim system consists of the trim switch, a rotary power unit, two flexible drive shafts, and two screwjack actuators. When the trim switch is energized, the rotary power unit and flexible drive shafts position the screwjack actuators. The screwjack actuators are connected to the aircraft structure on one end, and the walking beam bellcranks on the other end. As the screwjack actuators extend and retract, the lateral

controls are repositioned and the control stick follows the trim movements. Lateral control artificial feel is provided by double-action spring cartridges connected in tandem with the screwjack actuators. When the control stick is moved from neutral, the springs are compressed. The farther the control stick is moved from neutral, the greater the force required to compress the springs. The spring cartridges return the control stick to neutral when the force on the control stick is removed.

## STABILATOR CONTROL SYSTEM

Longitudinal control is provided by a single-unit horizontal tail surface (stabilator), that is actuated by an irreversible, dual power cylinder. The leading edge of the stabilator is slotted for increased longitudinal control. System components include the control sticks, push-pull rods, cables, bellcranks, integrated control valves, and an irreversible dual power cylinder. Additional components include a ram air bellows and bob weight for system artificial feel, a trim actuator, and an AFCS servo that is integral with the control valve. When the control stick is moved longitudinally, the motion is transmitted by push-pull rods to a bellcrank. It is then transmitted by a cable assembly to another push-pull rod set. The second push-pull rod set actuates the control valve which meters hydraulic fluid to the dual power cylinder. Hydraulic pressure to the stabilator power cylinder is supplied by both power control hydraulic systems. If one of the power control hydraulic systems fail, the remaining system will provide adequate control response. On aircraft after TO 1F-4-903, an APU supplies hydraulic pressure to the PC-1 side of the stabilator actuator if PC-1 system pressure fails. A hydraulic AFCS servo is integrated into the stabilator dual servo valve. It positions the dual servo valve in the same manner as control stick inputs. As a result, when the autopilot signals for a pitch attitude change, the control stick will follow the movement. The bob weight in the control linkage also increases stick forces proportionately to increase in G forces.

### Stabilator Control Feel and Trim System

Artificial feel is provided by a dynamic (ram air) pressure bellows acting through a variable bellcrank on the stabilator trim actuator and a 3 pound per G bob weight. When the aircraft is in trim, the ram air force on the bellows is balanced by the bob weight. As the aircraft increases or decreases in airspeed, the pressure on the bellows changes causing the bellows bob weight assembly to become off balance. The off balance condition is then transmitted through the trim actuator, control cables, and push-pull rods back to the control sticks. Actuating the trim switch causes the stabilator trim actuator to move, balancing the forces between the bellows and bob weight, and thereby eliminating force on the control sticks. An override spring cartridge allows the feel and trim portion of the stabilator control system to be bypassed in the event of a nose-up trim malfunction. Longitudinal handling qualities are improved by the use of an overbalance system. The overbalance system is created by a 16 pound weight at the end of the stabilator trim actuator. With this system, stick forces and stick force gradients are improved, especially during aft CG loading with high stability index numbers and during power approach configurations.

## Stabilator Trim Position Indicator

The stabilator trim indicator is on the left vertical panel in the front cockpit. It is directly controlled by a transmitter which is integral with the stabilator feel trim actuator. The indicator, marked in units of trim, represents trim actuator position.

## CONTROL STICKS

The control sticks (figure 1-6) are mounted in yokes to permit left and right, and fore and aft movement. The front cockpit control stick consists of a stick grip and motion pick-up (force) transducer, and contains six controls: an emergency quick release lever, a trigger switch for missiles and the 20 mm cannon, a bomb release button, a nose gear steering/auto acquisition button, a four-way trim switch, and an air refueling release button. The rear cockpit control stick does not incorporate the motion transducer. The grip contains five WSO operated control switches, as follows: an emergency quick release lever, a trigger switch, a bomb release button, a nose gear steering button and a four-way trim switch. The emergency quick release levers interrupt electrical power to the anti-skid system, the automatic flight control system, stab aug and the aileron-rudder interconnect. The nose gear steering button also serves as a heading hold release for the automatic flight control system, or an auto acquisition button for the radar while airborne. The air refueling release button, aside from its air refueling function, has other ordnance functions (refer to TO 1F-4E-34-1-1-1). The motion pick-up transducer in the front cockpit stick works in conjunction with the automatic flight control system to allow control stick steering when in the AFCS mode. It also causes the automatic flight control system to disengage if the pilot exerts a force on the stick which exceeds the AFCS limits.

## RUDDER CONTROL SYSTEM

The rudder control system consists of the rudder pedals, push-pull rods, cable assemblies, bellcranks, a rudder feel trim system, an aileron-rudder interconnect actuator, a rudder damper, and an irreversible power cylinder with an integral control valve. When the pedals are moved, the motion is transmitted by the push-pull rods, bellcranks, and cable assemblies to the control valve of the power cylinder. The control valve meters utility system hydraulic fluid to the power cylinder which positions the rudder. It is possible to have limited mechanical authority over the rudder in the event of a utility hydraulic system failure. A bypass valve in the power cylinder opens when system pressure is lost, allowing fluid to pass from one side of the cylinder to the other. Total amount of rudder deflection available is then a function of air loads on the rudder. A hydraulic servo for yaw damping and AFCS operation is incorporated into the control valve of the power cylinder. Operation of the AFCS, however, does not move the rudder pedals.

# CONTROL STICKS

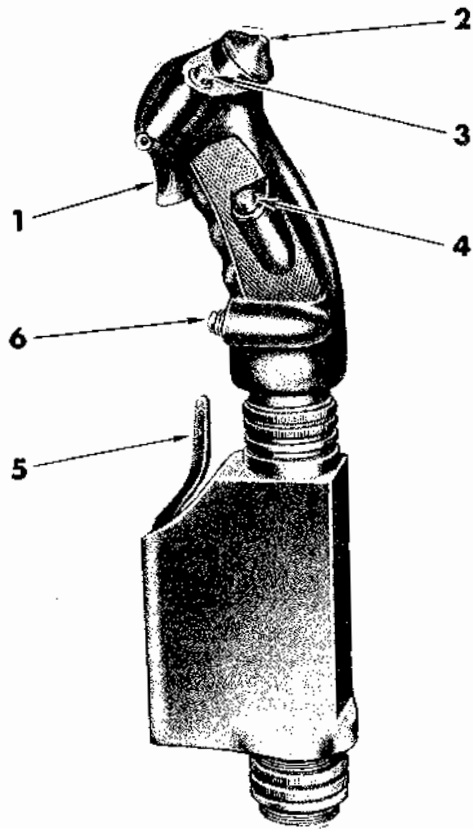

**FRONT COCKPIT**

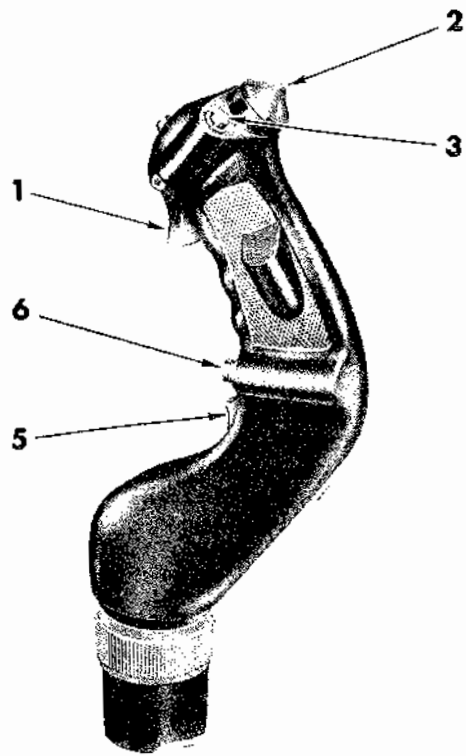

**REAR COCKPIT**

- |                                    |  |
|------------------------------------|--|
| 1. TRIGGER                         | 5. EMERGENCY QUICK<br>RELEASE LEVER                      |
| 2. TRIM SWITCH                     | 6. NOSE GEAR STEERING BUTTON/<br>AUTO ACQUISITION BUTTON |
| 3. BOMB RELEASE BUTTON             |  |
| 4. AIR REFUELING RELEASE<br>BUTTON |  |

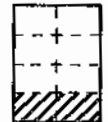

Figure 1-6

4E-1-(318)

## Rudder Feel Trim System

Artificial feel is supplied to the rudder pedals by an artificial feel trim system. A hydraulic cylinder with utility system hydraulic pressure on both sides of a differential area piston, provides a forward cockpit pedal force of approximately 2.6 pounds per degree of rudder deflection on the low gradient and 11.5 pounds per degree of rudder deflection on the high gradient (rear cockpit pedal forces are approximately 1 1/2 times that of the front cockpit pedal forces). Switching between gradients is accomplished through an airspeed pressure switch. The airspeed pressure switch is set to convert from the low to the high gradient at airspeeds between 228 and 252 knots

while accelerating. During deceleration, the airspeed pressure switch will convert from the high gradient to the low gradient between 232 and 218 knots. A rudder trim switch is on the left console. Normal trim range is  $7.5^\circ \pm 1^\circ$  of rudder deflection on each side of neutral.

### CAUTION

The aircraft is equipped with a two-mode bellmouth control which provides an improved stall/flameout margin. One mode of the bellmouth control is wired through the rudder feel trim circuit breaker. With the rudder feel



trim circuit breaker pulled, the bellmouth is only optimized for speeds below 0.4 Mach and above 0.98 Mach. This introduces the possibility of an engine stall/flameout in the 0.4 to 0.98 Mach speed range with maximum maneuvering and/or rapid throttle movements.

### Rudder Trim Switch

The rudder trim switch is in the front cockpit on the inboard engine control panel. This switch controls the trim actuator in the rudder feel and trim system.

### Rudder Pedals

The rudder pedals are conventional type suspended units which are coupled to the rudder push-pull rod system by individual screwjacks. The screwjacks provide adjustment of the rudder pedals for comfort and are adjusted simultaneously by turning the rudder pedal adjusting crank in either cockpit. The pedals are also coupled to the power brake valves so that the pressure on the pedal will apply the brakes. The rudder pedals are also used to control the nose gear steering unit when the nose gear steering button on the control stick grip is depressed.

### Stall Warning Vibrator

A stall warning vibrator is on the front cockpit left rudder pedal to warn of approaching stall conditions. The vibrator consists of an electrical motor which drives an eccentric weight. Rotation of the weight causes the rudder pedal to vibrate, warning of an impending stall. A sufficient margin exists to return to the proper flight attitude by normal reaction to the warning. The vibrator is electrically connected to a switch in the angle of attack indicator. The switch is set to 22.3 units angle of attack and operates regardless of gear and/or flap position (provided weight is off the gear). On aircraft with slats, the stall warning vibrator is inoperative with the landing gear up. The stall warning vibrator motor is powered by the essential 28 volt dc bus through the angle of attack probe heater control circuit breaker. If a malfunction occurs where the vibrator motor runs continuously, it can be rendered inoperative by pulling the circuit breaker. The stall warning system will be in error if the slotted probe becomes iced.

### WARNING

With the angle of attack probe heater control circuit breaker (C7, No. 3 panel) pulled, power is available to nose gear steering while in flight. With gear extended and nose gear steering button inadvertently depressed, rudder displacement will cock the nose gear.

## STABILITY AUGMENTATION

Stability augmentation can be obtained individually or in any combination for pitch, roll or yaw axis by placing the PITCH, ROLL and/or YAW stab aug switches to ENGAGE. In the stability augmentation mode, rate gyros and lateral accelerometers sense any changing motion about or along their respective axis and send signals to the surface controls to oppose any deviation from normal flight attitude. This action decreases any tendency of the aircraft to oscillate in roll, yaw, or pitch, or to develop lateral forces which cause aircraft slip or skid. With the roll stab aug switch engaged, the roll rate for a given stick deflection will be lower for the rear cockpit due to the roll stab aug remaining active during rear cockpit stick commands. Transferring control from the front to the rear cockpit can reduce roll rate. Transferring control from the rear to the front cockpit can cause an abrupt increase in roll rate.

### AILERON RUDDER INTERCONNECT (ARI)

The aileron-rudder interconnect system causes rudder displacement proportional to aileron displacement which provides coordinated turns at low airspeeds. The limits of the system are 15° of rudder displacement when the automatic flight control system is in the stability augmentation or autopilot mode, and 10° rudder displacement when the yaw stab aug switch is disengaged. Components of the system include the control amplifier, the 10° servo actuator acting through a walking beam, airspeed pressure switch and two aileron transducers. The ARI circuit is completed through the flap blowup airspeed pressure switch. When the flap switch is down, and airspeed is below flap blowup speed, 28 volts dc is applied to the engage relay solenoids of the ARI system. Whenever the flaps are raised, or are blown up, the ARI is disengaged through the flap blowup switch. When the system is engaged, the hydraulic 10° servo is allowed to move the control linkage (if aileron displacement is present) and cause rudder displacement. If the flaps are lowered during a turn, a rudder kick will occur as a result of ARI engagement with lateral controls deflected. The system can be disengaged by depressing the emergency disengage switch on the control stick, this will disengage the ARI system and the yaw stab aug as long as the emergency disengage switch is held depressed; when the switch is released the ARI (10°) and the yaw stab aug (5°) rudder authority will be regained. Regardless of the amount of ARI rudder authority engaged, the pilot can easily override the ARI system by pushing on the rudder pedals.

#### NOTE

- To permanently disengage the ARI, the circuit breaker on the left utility panel must be pulled and the yaw stab aug switch must be disengaged. Pulling the circuit breaker only, and keeping the yaw stab aug engaged will still provide 5° of ARI rudder authority. When the ARI circuit breaker is pulled, the anti-skid system is disabled. On aircraft without slats, to disable the ARI but retain the anti-skid and stab aug system, pull the rudder trim circuit breaker and leave stab aug engaged. This will completely disable the ARI and rudder feel trim system only. However, pulling the rudder trim circuit breaker causes the

feel system to revert to low gradient regardless of airspeed. On aircraft with slats, pulling the rudder trim circuit breaker does not disable the ARI.

- There are various inflight situations where rudder jump will be experienced when the ARI system cuts in or out with a lateral input to the control stick. These rudder jumps normally occur when the flaps are raised or lowered during a turn, such as retracting the flaps on climbout after takeoff or during a go-around. Assuming no manual rudder inputs, it is possible that after the flap switch is placed to the UP position during a go-around, for example, the rudder can jump from a deflected position to neutral after the flap switch is actuated. Rudder jumps also occur when the flaps airspeed switch is actuated when the flaps limit switch is exceeded through the action of the airspeed switch or placing the flap switch to DN.

## SLATS FLAPS SYSTEM

### NOTE

For description of wing flaps on former Thunderbird (non-slatted) F-4E aircraft, refer to TO 1F-4C-1.

The slats and flaps system is an integrated system that provides an automatic slat configuration for inflight maneuvering and a selective slat flap configuration for takeoff and landing. Each wing has two leading edge slats (one on the outboard wing panel and one on the inboard wing panel); and one flap mounted on the trailing edge, adjacent to the fuselage. The flaps and slats are electrically selected through a solenoid operated selector valve (essential 28 volt dc) and hydraulically actuated (utility hydraulic system). The slats incorporate an overcenter feature which mechanically locks them in either the retracted or extended position. The flap actuators incorporate an integral lock for the retracted position; however, hydraulic or pneumatic pressure must be available to hold the extended position. Flap and/or slat chatter may occur and can be identified as a rapid-rate machine-gun like chatter similar to an air-hammer. There will be an interrupted electrical noise in the head phones and the slat flap and utility hydraulic pressure indicators will fluctuate in unison. Generally, flap and slat chatter will not occur at the same time. Flap chatter is more common on retraction, whereas slat chatter may occur during any period of operation including maneuvering at altitude. This chatter can be of short duration or continuous. Either can be noted by sound and feel. When chatter occurs, determine whether flaps or slats are chattering by observing the indicators. If the normal system fails, the flaps and slats can be extended by an emergency pneumatic system. Two airspeed switches protect the flaps and slats from structural damage if they are inadvertently left extended above their structural airspeed limit. Refer to figure 1-7 for slats flaps operation.

## SELECTIVE SLATS FLAPS

For takeoff and landing, the flaps and slats operate together and are controlled by a slats flaps switch in the front cockpit. To guard against overrotation on takeoff, the control circuit is wired through the nose gear to prevent a slat-out no-flap takeoff. Anytime the nose gear is down and locked, both the flaps and slats will extend if the slats flaps switch is moved to any position except NORM (provided electrical power and hydraulic pressure is applied). The normal takeoff position of the slats flaps switch is OUT and DOWN.

## MANEUVERING SLATS

With the slats flaps switch in NORM, the maneuvering slats operate automatically as a function of AOA. As the AOA is increased to approximately 11.5 units, the slats will extend and remain extended until the AOA is reduced to approximately 10.5 units. If desired, the slats may be extended (regardless of AOA) by selecting OUT on the slats flaps switch. If OUT is selected and the airspeed is increased above approximately 568 to 602 knots, the slats will automatically retract.

### Slats Flaps Switch

The slats flaps switch (figure 1-7) is in the front cockpit above the left console outboard of the throttles. The switch is airfoil shaped and has positions of NORM, OUT, and OUT AND DOWN. This switch controls the operation of both the flaps and slats. Placing the switch to OUT extends the slats (regardless of landing gear position) and the flaps, providing the nose gear is down. The flaps will remain extended, even though the nose gear is subsequently retracted, until the slats flaps switch is placed to NORM. The OUT AND DOWN position extends the slats to the out position and the flaps to the down position (30°). In NORM, the flaps are up and locked and the slats then operate automatically as a function of AOA.



### Slats Override Switch

The slats override switch is located on the front cockpit left console, aft of the fuel control panel. The two-position cover-guarded switch has positions of IN and NORM. With the switch in NORM, the slats operate as previously described using the slats flaps switch or as a function of AOA. When IN is selected, the slats will retract, if extended, and remain retracted regardless of AOA or slats flaps switch position. Anytime IN is selected a SLATS IN light, on the telelight panel, and the MASTER CAUTION light illuminates.

### Slats In Light

The SLATS IN light, on the telelight panel, illuminates anytime the slats override switch is positioned to IN. The SLATS IN light is powered by the 14/28 volt ac warning lights power bus.

# FLAPS/SLATS OPERATION

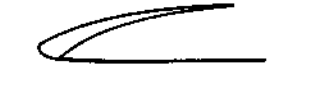
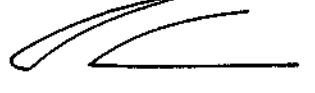
	SLATS IN	SLATS OUT
<b>OUTBOARD SLATS</b>		
<b>INBOARD SLATS</b>		

FLAPS/SLATS SWITCH POSITION	NOSE GEAR POSITION	FLAPS/SLATS OPERATION
NORM	UP	FLAPS UP, SLATS OPERATE AS FUNCTION OF AOA
OUT	UP	SLATS EXTEND
OUT AND DOWN	UP	SLATS AND FLAPS EXTEND, (WHEELS LIGHT FLASHING UNTIL LANDING GEAR IS DOWN)
NORM	DOWN	FLAPS UP, SLATS OPERATE AS FUNCTION OF AOA
OUT	DOWN	SLATS AND FLAPS EXTEND
OUT AND DOWN	DOWN	SLATS AND FLAPS EXTEND

### NOTES

SLATS AIRSPEED SWITCH IS SET AT 568 TO 602 KNOTS (ACCELERATING)  
AND 10 TO 30 KNOTS BELOW ACCELERATING SPEED (DECELERATING)

FLAPS AIRSPEED SWITCH IS SET AT  $237 \pm 7$  KNOTS (ACCELERATING)  
AND  $15 \pm 5$  KNOTS BELOW ACCELERATING SPEED (DECELERATING).

AFTER TAKEOFF, IF THE SLATS FLAPS SWITCH IS NOT RETURNED TO  
NORM THE FLAPS WILL REMAIN EXTENDED EVEN THOUGH THE NOSE  
GEAR IS RETRACTED.

## Emergency Slats Flaps Extension

Emergency extension of the slats flaps is accomplished pneumatically by high pressure air from an emergency air storage bottle. The emergency slats flaps extension handles are on the slats flaps control panel in the front cockpit, and adjacent to the throttles in the rear cockpit. They are marked EMERG. Lowering the slats flaps pneumatically is accomplished by pulling either emergency flap extension handle aft. Since the handles are mechanically connected to the pneumatic actuation valve, emergency extension does not require electrical power. The emergency extension system bypasses the slats flaps blowup provision and, when actuated, the slats flaps extend regardless of airspeed. However, air loads will prevent trailing edge flaps from fully extending until after the airspeed has decreased to approximately 220 knots. The handles are airfoil shaped and painted in black and yellow stripes for ease of identification. The air bottle contains sufficient air for only one extension.

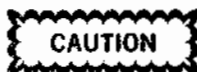

If the emergency system is activated with normal utility hydraulic pressure available, there is a high probability of losing utility hydraulic system pressure.

### NOTE

During emergency extension, the flaps may initially extend asymmetrically; however, upon completion of extension, they will be symmetrical. With dual hydraulic system failure (one PC and utility) lateral control difficulties may result.

## Slats Flaps Indicators

The leading edge slat and trailing edge flap indicators are on the left subpanel in the front cockpit and on the landing gear-slat flap indicator panel in the rear cockpit. Slats in the retracted position are indicated by the word IN; slats in the extended position are indicated by the word OUT. The flap indicator is wired through the flap up limit switch; therefore, normal indications are as follows: When the flaps switch is moved to OUT AND DOWN, the flap indicator immediately shows DN regardless of any intermediate actual flap position. On the flaps up cycle, the indicator does not show UP until the flaps are fully retracted.

## SPEED BRAKES

Hydraulically operated speed brake panels are mounted on the underside of the inboard wing surfaces. They are hinged on the forward side, permitting them to open down and forward. The speed brakes are electrically controlled by throttle mounted switches and a lockout relay. The hydraulic portion of the system includes a flow divider, two actuating cylinders, and a solenoid selector valve. The selector valve directs the flow of hydraulic fluid to the extend or retract side of the actuating cylinder. If the throttle mounted switches fail, the speed brakes may be

retracted by pulling the speed brake circuit breaker. If an electrical failure occurs, the speed brakes automatically retract. If a utility system hydraulic failure occurs, the speed brakes retract (by air loads) to a low drag trail position. The speed brakes are operated by utility hydraulic pressure.

## Speed Brake Switches

The throttle mounted speed brake switches have three positions - front cockpit: maintaining IN, maintaining STOP, and momentary OUT; rear cockpit: momentary IN, maintaining STOP, and momentary OUT. The speed brakes are extended by holding either control switch to OUT. Both sides of the speed brake solenoid selector valve are energized and hydraulic fluid is directed to the extend side of the actuating cylinders. If desired, the speed brakes may be stopped at any intermediate position by releasing the control switch. When released, the control switch returns to the STOP position. If the front cockpit control switch is left in the IN position, it may be bypassed, to extend the speed brakes, by placing the rear cockpit control switch to OUT. A speed brake lockout relay is energized and removes the front cockpit control switch from the circuit. The lockout relay remains energized until the front cockpit switch is moved to the STOP position. The speed brakes may then be controlled by either switch. The speed brakes are retracted by placing either control switch to IN.

### NOTE

With both speed brake switches in the STOP position, the speed brakes may creep enough to illuminate the SPEED BRAKE OUT indicator light. In this event, placing either speed brake switch to IN retracts the speed brakes and extinguishes the indicator light.

## Emergency Speed Brake Operation

Emergency speed brake retraction is accomplished by pulling the speed brake circuit breaker on the right console in the front cockpit.

## Speed Brake Out Indicator Light

A SPEED BRAKE OUT indicator light on the telelight panel illuminates when either or both of the speed brakes are not fully closed. The SPEED BRAKE OUT indicator light does not illuminate the MASTER CAUTION light.

## WING FOLD

The outer wing panel of both wings may be folded to a vertical position. The wing panels are hinged to the inner wings along the upper surface of the wing. The wing fold system is mechanically and manually actuated. Each wing fold incorporates a warning pin that protrudes above the wing surface on each wing when the safety lock is not in the lock position. The red pin is on the top of the wing, 2 inches inboard of the wing fold. The outer wing panel must be raised manually to fold position, and held in this position by a jury strut.

**CAUTION**

Do not operate slats with wings folded as structural damage will occur to the slats and outer wing.

**LANDING GEAR SYSTEM**

The aircraft is equipped with fully retractable, tricycle landing gear. The gear is electrically controlled and hydraulically actuated by the utility hydraulic system. Accidental retraction of the landing gear when the aircraft is on the ground is prevented by safety switches on the main gear. Ground safety locks may also be installed to further secure the gear against inadvertent retraction. The following systems have circuits that are wired through the landing gear control handle or landing gear scissors switches: landing gear control, landing gear position indicator, auxiliary air door, anti-skid, landing gear warning light, landing lights, angle of attack system, fuel pressurization and vent system, nose gear steering system, and the external stores emergency release.

**CAUTION**

A malfunction of the landing gear scissors switch may disable the nose gear steering and also cause the anti-skid system to cut out without warning. This will result in loss of brakes and, ultimately, directional control. The primary method of regaining brakes and, therefore, directional control is by disengaging the anti-skid system. See Wheel Brake Failure, section III.

**MAIN GEAR**

Each main gear is hydraulically retracted and extended. When the gear handle is UP and the weight is off the gear, the gear will retract. As the main gear retracts, the wheels are automatically braked to a stop by the anti-spin system and the struts are mechanically compressed. When the gear is up and locked, pressure is automatically released from the anti-spin system. The struts automatically return to their normally extended position during gear extension. The gear is locked down by an internal finger type latch in each side brace actuator. The main gear retracts inboard and is enclosed by fairing doors that protrude slightly from the underside of the wing. The gear is locked up by a hydraulically actuated overcenter uplatch mechanism. All main gear doors remain open when the gear is extended.

**NOSE GEAR**

The nose gear is hydraulically retracted and extended. The gear is locked in the down position by an internal finger latch within the gear actuating cylinder. A hydraulically actuated overcenter mechanism locks the gear in the up position. The nose gear retracts aft into the fuselage and is covered by mechanically operated doors that close flush with the underside of the fuselage. The

forward door is attached to the nose gear strut, and closes with strut retraction; the aft door is operated and latched closed by the gear uplatch mechanism. The nose gear is equipped with twin nose wheels and a combination shimmy damper steering actuator. A self-centering cam is incorporated in the nose gear strut to position it for retraction. The aircraft can be steered by differential braking of the main gear wheels in the event nose gear steering is not utilized. In this event, the steering-damper unit acts as a shimmy damper.

**LANDING GEAR CONTROL HANDLE**

Operation of the landing gear is controlled by a handle at the left side of the front cockpit instrument panel. The handle has a wheel shaped knob for ease of identification. Placing the handle in the UP or DOWN position energizes a solenoid valve to connect utility system hydraulic pressure to properly position the landing gear. A red warning light is in the landing gear control handle. This light illuminates whenever the control handle is positioned to retract or extend and remains illuminated until the gear is locked in place.

**Landing Gear Emergency Extension Handles**

Two 100 cubic inch air bottles, charged to 3000 psi, provide sufficient compressed air to extend the landing gear in the event of a utility hydraulic system failure. The front cockpit control is incorporated into the landing gear control handle. Pulling the landing gear control handle full aft, when it is in any position, operates an air valve which directs 3000 psi compressed air to open all gear doors, release the gear up-locks and extend the gear. The rear cockpit control is on the rear cockpit left subpanel and is labeled EMERG LDG GEAR. A spring loaded locking plunger locks the rear handle in the emergency position when it is pulled full aft. The front and rear cockpit emergency landing gear control handles are connected to the same air source.

**Landing Gear Warning Light**

The landing gear warning light, marked WHEELS, is on the upper left corner of the front cockpit instrument panel. The WHEELS light will flash when the airspeed drops below flap blow-up (approximately 230 knots), and the landing gear has not been lowered. The landing gear handle light illuminates when the gear is unlocked or when the gear is out of phase with the gear handle.

**Landing Gear Position Indicators**

The landing gear position indicators are on the left subpanel front cockpit and the left subpanel rear cockpit. The position of the landing gear wheels is indicated by drum dials viewed through cutouts in the panel. With gear up, the word UP will appear on the three indicators; gear in transient will be indicated by a barber pole; and with gear down, a picture of a wheel will be seen in each indicator.

## NOSE GEAR STEERING

An electrically controlled, hydraulically operated nose gear steering system is installed in the aircraft. The steering actuator is a vane type hydraulic motor on the nose gear strut. It is geared through a planetary gear train to the strut and performs both steering and damping. A bypass valve in the steer-damper manifold directs hydraulic fluid to an electrically controlled hydraulic servo valve. This valve directs fluid to the actuator which can be pressured on either side as directed. For the damping mode, the bypass valve traps the fluid in the actuator and channels it through damping orifices which absorb energy. When the control stick grip nose gear steering button is held down, with the main gear strut compressed, and the gear handle is in the down position, the system is energized and steering is commanded by rudder pedal movement. The limit of the nose gear steering system is 70° on each side of center; however, with the steering unit deenergized, the nose gear may be rotated 360° for towing or positioning the aircraft. When energized with the nose gear in any position, the nose gear will quickly return to the position commanded by the rudder pedals. The system contains a failure detection circuit which, upon detection of an electrical short or open, or intermittent outputs from system electrical components, will shut off hydraulic pressure to the system. In this event, the nose wheel reverts to a free swivel condition. When the lower UHF antenna is selected, the nose gear steering may be erratic or inoperative; therefore, the upper UHF antenna should be selected before engaging the nose gear steering.

### CAUTION

If no response is noted or unscheduled steering commands occur with nose gear steering engaged, release the nose gear steering button and do not reengage. The aircraft should not be taxied or flown with inoperative nose gear steering, except in an emergency.

## WHEEL BRAKE SYSTEM

The main landing gear wheels are equipped with full powered brakes operated by toe action on the rudder pedals which meters utility hydraulic pressure to the brakes. The brake control valves are in the nose gear well and operate through a linkage arrangement to the rudder pedals. The brake control valves are capable of directing full utility system pressure to the wheel brakes with full pedal deflection. The amount of brake pedal force and the amount of utility pressure directed to the wheel brakes are proportional to pedal displacement. An anti-skid system is incorporated in the normal brake system to prevent wheel skid. An emergency brake system, when actuated, discharges accumulator hydraulic pressure to the brakes in the event of utility system failure. Operation of the brakes on the emergency system is identical to the normal system for the duration of the hydraulic accumulator supply. Anti-skid protection is not available on the emergency brake system. Each main landing wheel contains three fuse plugs to protect against tire explosion. If the brakes are used excessively, causing overheating of

the wheels and tires, the fuse plugs should melt and let the tire go flat before a tire explosion can occur.

## ANTI-SKID SYSTEM

The aircraft is equipped with an electrically controlled anti-skid system which prevents wheel skid. The system detects the start of a skid condition at the wheels and automatically releases the brake pressure in proportion to the severity of the skid. Use of the anti-skid system offers protection from skids, and can provide consistently shorter landing rolls for all runway conditions. The system provides positive assurance that the wheels have an opportunity to spin up at touchdown, even if inadvertent brake pressure is applied and elimination of a single wheel experiencing a gradual or stair step speed reduction due to extremely slippery conditions. The system has a fail-safe circuit that automatically reverts the system to manual braking in the event any of the electrical components of the system fail. The system is activated by placing the anti-skid control switch ON and lowering the landing gear. It may be disengaged by placing the anti-skid control switch to OFF, or by holding either emergency quick release lever depressed. An ANTI-SKID INOPERATIVE light illuminates when the system is not activated.

### NOTE

- The system does not provide full skid protection below 30 knots.
- During maximum braking on a dry runway with speed below 50 knots, a severe "BANG BANG" may be heard. This is normal for low speed operation during maximum braking and should not be interpreted as an anti-skid malfunction.
- Pulling the ARI circuit breaker, on the front cockpit left subpanel, will disconnect control power to the anti-skid system.

### Anti-Skid Control Switch

This two-position toggle switch is on the left console, front cockpit, adjacent to the oxygen quantity gage. When the switch is ON and the landing gear handle is down, power is supplied to the system. The anti-skid system may be shut off by placing the anti-skid control switch to OFF.

### Anti-Skid Inoperative Light

An ANTI-SKID INOPERATIVE light is on the left console in the front cockpit. The light illuminates any time the landing gear handle is down and the anti-skid switch is OFF, circuit continuity is not complete, or when the emergency quick release lever is held depressed. Anytime the light illuminates steady, the anti-skid system is inoperative and the control switch should be placed to OFF. If the light does not illuminate, it can only be assumed that the anti-skid circuitry is good. Anti-skid protection still may not be available due to system component failure. The master caution light does not illuminate in conjunction with the ANTI-SKID INOPERATIVE light.

### Emergency Quick Release Lever (Anti-Skid)

An emergency quick release lever is on each control stick below the stick grip. This lever is provided to disengage the anti-skid system as desired, or in the event of a system malfunction. The lever must be held depressed to disengage the system. Normal wheel braking is immediately available when the lever is depressed and the ANTI-SKID INOPERATIVE light illuminates. The anti-skid emergency quick release lever interrupts electrical power to the system. The circuit to the ANTI-SKID INOPERATIVE light is completed, and the light illuminates. The two control stick mounted emergency quick release levers, and the console mounted control switch are connected in series, and actuation of any one will deactivate the system. When the landing gear handle is up, all power to the anti-skid system including the light, is shut off.

### EMERGENCY HYDRAULIC BRAKE SYSTEM

An emergency hydraulic brake system is incorporated in the event of utility system hydraulic failure. The accumulator is pre-charged pneumatically to 1,000 psi. When normal utility hydraulic pressure is supplied to the accumulator a pressure of 3,000 psi will be indicated. Differential braking pressure can be utilized when operating with the emergency system; however, braking action is limited due to depletion of hydraulic pressure from the accumulator.

### Emergency Brake Handle

An emergency brake handle is on the lower left side of each cockpit instrument panel. It releases hydraulic pressure to two metering valves incorporated in the normal brake control valves and operates with the brake pedals. Pulling the emergency brake handle in either cockpit, approximately 5 inches, discharges the brake system hydraulic accumulator and provides emergency braking with normal feel but with a limited number of applications.



Because of the limited number of brake applications, taxiing should not be attempted when using the emergency brakes.

### ARRESTING HOOK SYSTEM

A large retractable arresting hook under the stabilator provides reliable high energy stopping capabilities during takeoff and landing emergencies. The system consists of the arresting hook, a combination dash pot and actuating cylinder, a solenoid operated selector valve, a mechanical uplatch, a control cable and an arresting hook control handle. The hook extends by the action of the dash pot and gravity. The solenoid selector valve is also deenergized, allowing utility system hydraulic fluid to escape from the upside of the actuating cylinder and, as a result, allows the tail hook to extend smoothly. When the hook retracts, the

solenoid selector valve routes hydraulic fluid to the upside of the actuating cylinder. Hook extension time is approximately 5 seconds, and retraction time is approximately 13 seconds. The hook is prevented from bouncing by the snubbing action of the dash pot.

### ARRESTING HOOK HANDLE

An arresting hook shaped handle is on the right side of the front cockpit instrument panel. When the handle is placed in the down position, the tension on the control cable is relieved and the uplatch releases the arresting hook. When the handle is placed in the up position, the solenoid selector valve is energized and the control cable applies tension to the uplatch. If the arresting hook cable breaks, the hook will automatically extend.

### ARRESTING HOOK WARNING LIGHTS

A red warning light installed in the arresting hook control handle and a HOOK DOWN warning light on the telelight panel illuminates any time the arresting hook is not up and locked.

### DRAG CHUTE SYSTEM

A 16-foot ring-slot type drag chute, contained in the empennage, significantly reduces landing roll distances. The drag chute may also be used for out of control/spin recovery. It is pulled into the airstream by a pilot chute when the spring-loaded compartment door opens. If the compartment door opens inadvertently without cockpit handle operation, or if the cockpit handle is not locked in the up position when the drag chute is deployed, the jaws of the attaching mechanism allows the chute to be released and fall free of the aircraft. The drag chute is normally deployed after each landing, and is considered a servicing item.

### DRAG CHUTE HANDLE

The drag chute is deployed by a control handle alongside of the left console front cockpit. A cable joins the handle, the release and jettison mechanism, and the door latch mechanism. Rotating the handle back to the detent, without depressing the button on the handle, releases the door latch mechanism. The spring-loaded actuator then opens the drag chute door, and at the same time the hook lock is positioned over the drag chute attach ring. The spring-loaded pilot chute pops out, and pulls out the drag chute. The drag chute is jettisoned by depressing the button and pulling back on the handle to clear the detent, and then by lowering the handle. The release and jettison mechanism then returns to its normal position, permitting the drag chute to pull free.

## ANGLE OF ATTACK (AOA) SYSTEM

An AOA system presents a visual indication of optimum airplane flight conditions. The flight conditions of stall, landing approach, takeoff, range, endurance, etc., all occur at specific lift coefficients, and therefore, at specific angles of attack. Optimum angle of attack is not affected by gross weight, bank angle, load factor, airspeed, density altitude, or airplane configuration. For example, the optimum AOA for landing approaches is always the same, regardless of gross weight. Airspeeds automatically vary to compensate for the change in weight. The system consists of an airstream AOA probe transmitter, AOA indicators, AOA indexers, and stall warning vibrator. Two electrical heaters, one in the AOA probe and one in the case (adjacent to the fuselage skin) prevent the formation of ice while flying through precipitation. The AOA probe heater and the AOA case heater are energized when the AOA circuit breakers and the CADC circuit breakers are pushed in and the weight is off the landing gear. The AOA circuit breakers are on the No. 3 circuit breaker panel at zones 6C and 7C in the rear cockpit. The CADC circuit breakers are at zones 1K, 2K, 3L, 4L, and 5L, No. 4 panel.

### ANGLE OF ATTACK INDICATORS

An AOA indicator is on the front and some rear cockpit instrument panels. Measurement of the aircraft angle of attack is accomplished by means of a slotted probe protruding through the fuselage skin. Airflow direction is sensed by means of a pair of parallel slots in the probe. When the airflow changes direction, pressure in one slot becomes greater than the other, and the probe rotates to align the probe slots with the airflow. Probe rotation moves three potentiometer wiper arms, producing electrical resistance variations. The resistance variations comprise the signal which is sent to the AOA indicator in the cockpit. The indicator is calibrated from 0 to 30 in arbitrary units, equivalent to a range of -10 to +40 angular degrees of probe rotation. Indexer reference marks are provided, and are set at approximate cruise (7.9 units), and approach (19.2 units), and stall (30.0 units) angles of attack. The indicator reference mark set at an approximate cruise (7.9 units), pertains to maximum range cruise at optimum cruise altitude for the existing gross weight. Airflow around the AOA probe is altered by extension or retraction of the nosewheel door. As a result of this effect, the indicated AOA at any constant AOA is approximately 1 unit lower with the nose gear retracted than with the nose gear extended. Flap/slat position does not alter this effect. Approach airspeeds quoted in this manual are calculated with the landing gear down and are, therefore, 1 unit slow if an approach is made with the nose gear up. When electrical power to the indicator is interrupted, the word OFF appears in a window in the face of the indicator. The AOA indicator also contains switches that illuminate the indexer lights, actuate the stall warning vibrator and provide a signal for the aural tone generator. If the slotted probe becomes iced, the entire AOA system will be in error, causing erroneous readings/signals from all systems receiving AOA information. If the probe icing was due to a popped AOA probe heater circuit breaker, the stall warning vibrator and the aural tone generator will not be operative. Probe icing most often results in the AOA indicator rotating to 30 units AOA causing the indexer lights to erroneously

indicate very slow and the stall warning vibrator and aural tone generator, if operative, to erroneously indicate stall. It is possible, under some conditions, for the probe to become iced even if the heaters are working properly.

### ANGLE OF ATTACK INDEXERS

The AOA indexers (figure 1-8), which operate from switches in the AOA indicator, are on each side of the windshield above the front cockpit instrument panel and above the rear cockpit instrument panel. The indexers provide continuous AOA visual indication of optimum airplane flight conditions by illuminating symbolic cutouts (low-speed symbol, on-speed symbol, and high-speed symbol). At very slow airspeeds (high AOA), only the low-speed symbol illuminates. At slightly slow airspeeds, the low-speed and on-speed symbols illuminate. At optimum approach airspeeds, only the on-speed symbol is illuminated. At slightly fast airspeeds, the on-speed symbol and the high-speed symbol illuminate. At very fast airspeeds (low AOA), only the high-speed symbol illuminates. In most cases the indexer lights display AOA information continuously during flight. The two exceptions are: When an AGM-45 is installed and selected with the landing gear retracted and when the AN/ASQ-91 is operated in the self-test mode. For AOA indexer lights functions during AGM-45 operation, refer to TO 1F-4E-34-1-1. Refer to section VI for additional information.

### AOA AURAL TONE SYSTEM

The AOA system also provides a continuous aural indication of AOA by means of an aural tone generator. In response to the AOA transmitter input signal, the generator produces an aural signal in the headsets of both crewmembers to describe the aircraft AOA. The generator (figure 1-9) describes the aircraft AOA by producing a steady or interrupted, or a combination of a steady and an interrupted signal depending on the AOA transition range. A volume control knob on the instrument emergency flood lights control panel in the forward cockpit and another in the aft cockpit provide volume control adjustment of the AOA aural tone signal. Once a volume control setting is established, changes in aircraft AOA do not require volume control readjustment. Above 20.3 units AOA the tone cannot be eliminated by the aircraft volume control and the only means of turning off the stall warning tone, if the need arises, is by pulling the angle of attack heater circuit breaker C7, No. 3 panel. With the slats in or landing gear down, the AOA aural tone is present under all flight conditions above 15 units AOA, and produces a 400 Hertz (Hz) tone at an initial rate of 1.5 pulse per second (pps) between 15 and 18.7 units AOA. Within the AOA range, the pulse rate increases linearly from 1.5 to 8.2 pps. In the range between 18.1 and 20.3 units AOA, the generator produces a 900 Hz steady tone. Between 19.7 and 30 units AOA the generator produces a 1600 Hz interrupted tone. The low end of the 900 Hz steady tone (between 18.1 and 18.7 units AOA) is superimposed with a 400 Hz tone, and the high end (between 19.7 and 20.3 units AOA) is superimposed with a 1600 Hz tone. Between 19.7 and 22.3 units AOA the 1600 Hz tone has an initial pulse rate of 1.5 pps which increases linearly to 6.2 pps. Above 22.3 units AOA the 1600 Hz tone is produced with a pulse rate of 20 pps. For airplanes with



# ANGLE OF ATTACK DISPLAYS

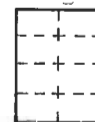

INDICATOR	INDEXER	ANGLE OF ATTACK UNIT	AIRSPEED	ATTITUDE
		20.3-30	VERY SLOW	
		19.7-20.3	SLIGHTLY SLOW	
		18.7-19.6	ON SPEED	
		18.1-18.6	SLIGHTLY FAST	
		0-18.0	VERY FAST	

4E-1-(8)  
R

Figure 1-8

the slats out and the landing gear up, the AOA aural tone produces a 400 Hz pulsed tone between 21 and 23.5 units AOA. The pulse rate is 1.5 pps at 21 units AOA and increases linearly to 6.0 pps at 23.5 units AOA. A 900 Hz steady tone is produced between 23 and 25 units AOA. Both tones are present between 23 and 23.5 units AOA. A 1600 Hz pulsed tone is produced above 24.5 units AOA. Initial pulse rate is 1.5 pps increasing linearly to 9.6 pps at 29 units AOA. Above 29 units AOA the pulse rate is a constant 20 pps. A volume increase occurs at 25 units AOA. The volume increase is such that the tone cannot be eliminated with the volume control.

## WARNING

With the angle of attack heater control circuit breaker (C7, No. 3 panel) pulled, power is available to nose gear steering while in flight. With gear extended and nose gear steering button inadvertently depressed, rudder displacement

will cock the nose gear.

## NOTE

If the AOA heater circuit breaker is pulled, the AOA probe heater, total temperature probe heater, bellmouth pitot probe heater, aural tone generator and stall warning vibrator are disabled.

## STALL WARNING VIBRATOR

Refer to Stall Warning Vibrator, Flight Control System, this section.

## PITOT-STATIC SYSTEM

The pitot-static system supplies impact (pitot) and atmospheric (static) pressures to various flight instruments and airspeed switches. A conventional pitot-static system is used in the aircraft with a single

# ANGLE OF ATTACK AURAL TONE INDICATIONS

## AIRPLANES WITH SLATS IN AND LANDING GEAR DOWN

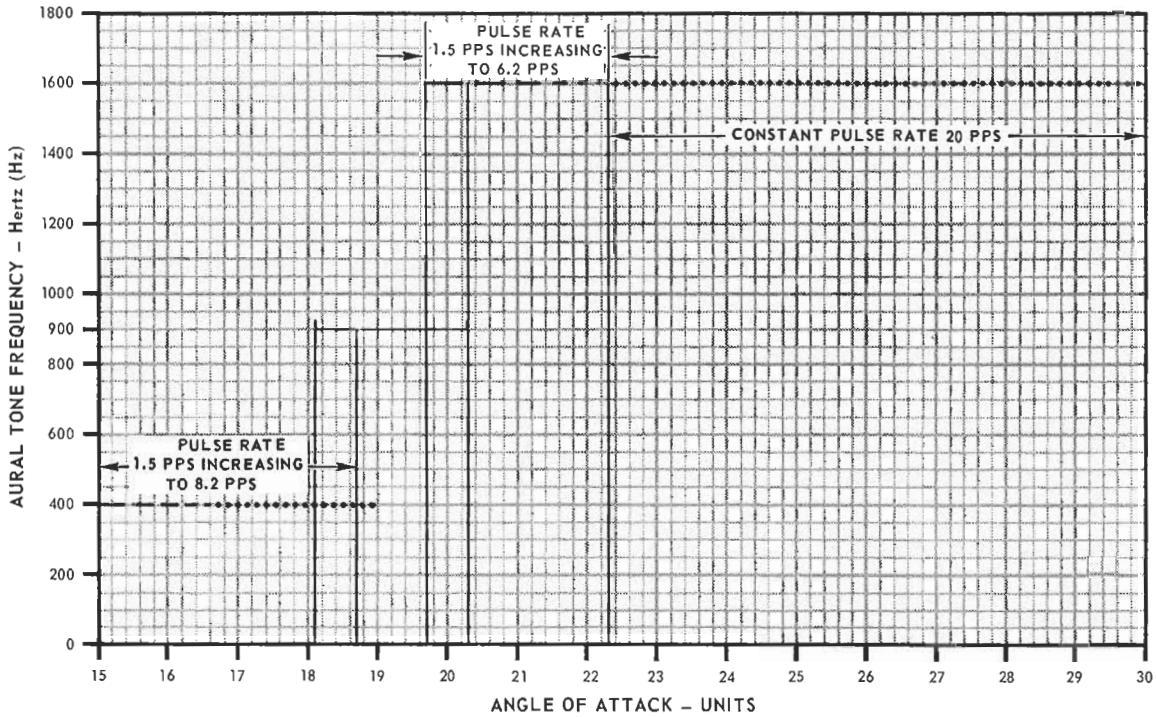

## AIRPLANES WITH SLATS OUT AND LANDING GEAR UP.

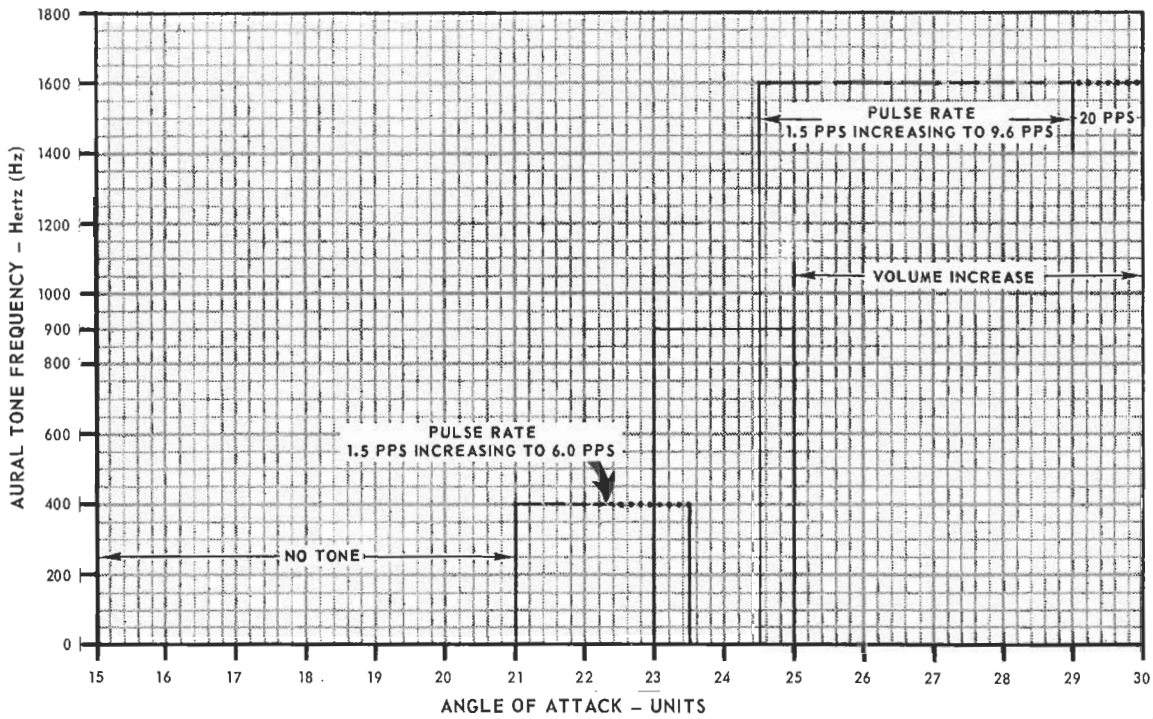

Figure 1-9

4E-1-(23)A

pitot tube and two static ports. Two systems receive inputs from a single pitot-static boom on the nose of the aircraft. Both pressures may be utilized by the same instruments, but at no time do the pressures intermingle. The pitot and static pressures are applied to airspeed pressure switches that retract the flaps; actuate the rudder feel trim system; engage the ARI (providing the flaps are DN).

### PITOT HEAT SWITCH

The pitot heat switch is on the right console in the front cockpit. The switch controls operation of the heating element in the pitot head, the bellows ram air inlet probe, and the stabilator bellows venturi. The heater elements are energized any time electrical power is applied and the pitot heat switch is in the ON position.



Pitot heat should not be used for more than 1 minute during ground operations.

## AIR DATA COMPUTER SYSTEM

The air data computer (ADC) receives inputs of static pressure, pitot pressure, engine bleed air, angle of attack and total temperature. These inputs are utilized by the ADC to provide pneumatic and functionalized electrical analog outputs to the various aircraft systems. The electrical signals (figure 1-10) are used by the following: altitude encoder unit, automatic flight control system, DUCT TEMP HI light, fire control system, air induction system, inertial navigation system, lead computing optical sight, navigational computer, STATIC CORR OFF light, true airspeed indicator, and variable bypass bellmouths. The air data computer may malfunction during flight through ice and/or rain, due to impact forces imposed by ice and water on the total temperature sensor.

### STATIC PRESSURE COMPENSATOR (SPC)

The SPC is a regulating module within the air data computer used to eliminate major altimeter lag during rapid changes in altitude. The CADC switch, located near the throttles, controls only the functioning of the SPC. The CADC switch has positions of RESET CORR, NORM, and CORR OFF. With the switch in NORM and the SPC operating normally, major altimeter lag during rapid changes in altitude is eliminated. If the SPC fails or the CADC switch is placed to CORR OFF, the SPC regulation is no longer applied to the indicated static pressure, the STATIC CORR OFF light will illuminate, and substantial altimeter lag will occur during rapid changes of altitude. Refer to the Altimeter Lag chart in part 1 of the applicable appendix. In this event, extreme caution must be exercised if diving maneuvers are executed. A failure or interruption of the right main ac power supply, essential dc power supply, or equipment auxiliary air system will cause a failure of SPC regulation. If the failure was due to a transient condition, the SPC may be reset by placing the CADC switch to RESET CORR. If the STATIC CORR OFF light remains illuminated, the SPC has failed to reset and substantial altimeter lag will occur during rapid changes

of altitude. The SPC must be reset (CADC switch to RESET CORR) after the engines have been started prior to each flight.

## ALTITUDE ENCODER UNIT

The altitude encoder is a dual purpose electronic unit. It receives static pressure signals from the air data computer. With the SPC engaged, the encoder provides a digital input of altitude in 100 foot increments to the IFF. This input provides automatic altitude reporting to the air traffic control system when mode C is selected on the IFF control panel. In addition, the synchro input nulls out pneumatic errors in the altimeter with the SPC engaged and RESET selected on the altimeter.

### ALT ENCODER OUT LIGHT

An ALT ENCODER OUT light is on the telelight panel in the front cockpit. The light will illuminate if there is an unreliable signal or no signal from the altitude encoder unit. Also the light may illuminate momentarily during a high-rate climb or dive maneuver, or during transonic flight.

## EMERGENCY EQUIPMENT

### WARNING AND INDICATOR LIGHTS

To keep instrument surveillance to a minimum, warning and indicator lights are incorporated throughout the two cockpits. The majority of the lights are in the front cockpit, and most of them are grouped on the right subpanel. All of the warning and indicator lights, with the exception of the FIRE and OVERHT warning lights, and the EJECT light utilize power from the 28/14 volt ac warning lights bus. Additionally, the pull up light, and all radar indicator lights except the radar range lights and skin track light receive power from the warning lights bus. The station and weapon selector lights, the missile status lights, the centerline tank aboard light, and the heads up display lights are powered from the main 28 volt dc bus. Also, the 28/14 volt ac warning lights bus provides power for the following rear cockpit lights: The MASTER CAUTION, RADAR CNI COOL OFF, INERTIAL NAV SYS OUT, and CANOPY UNLOCKED. The bus itself receives 28 volt ac power from the instrument 28 volt ac bus and 14 volt ac from the instrument 14 volt ac bus. Selection of 28 or 14 volts ac for warning lights operation is made automatically with the front cockpit flight instrument panel lights knob. When the instrument panel lights are off, the warning lights operate from 28 volt ac power. When the instrument panel lights are on, the warning lights operate from 14 volts ac. Loss of the main 28 volts dc bus (warning lights control voltage) prevents the warning lights bus from being dimmed, but the warning lights, if illuminated, illuminate bright regardless of the position of the instrument lights knob.

# AIR DATA COMPUTER

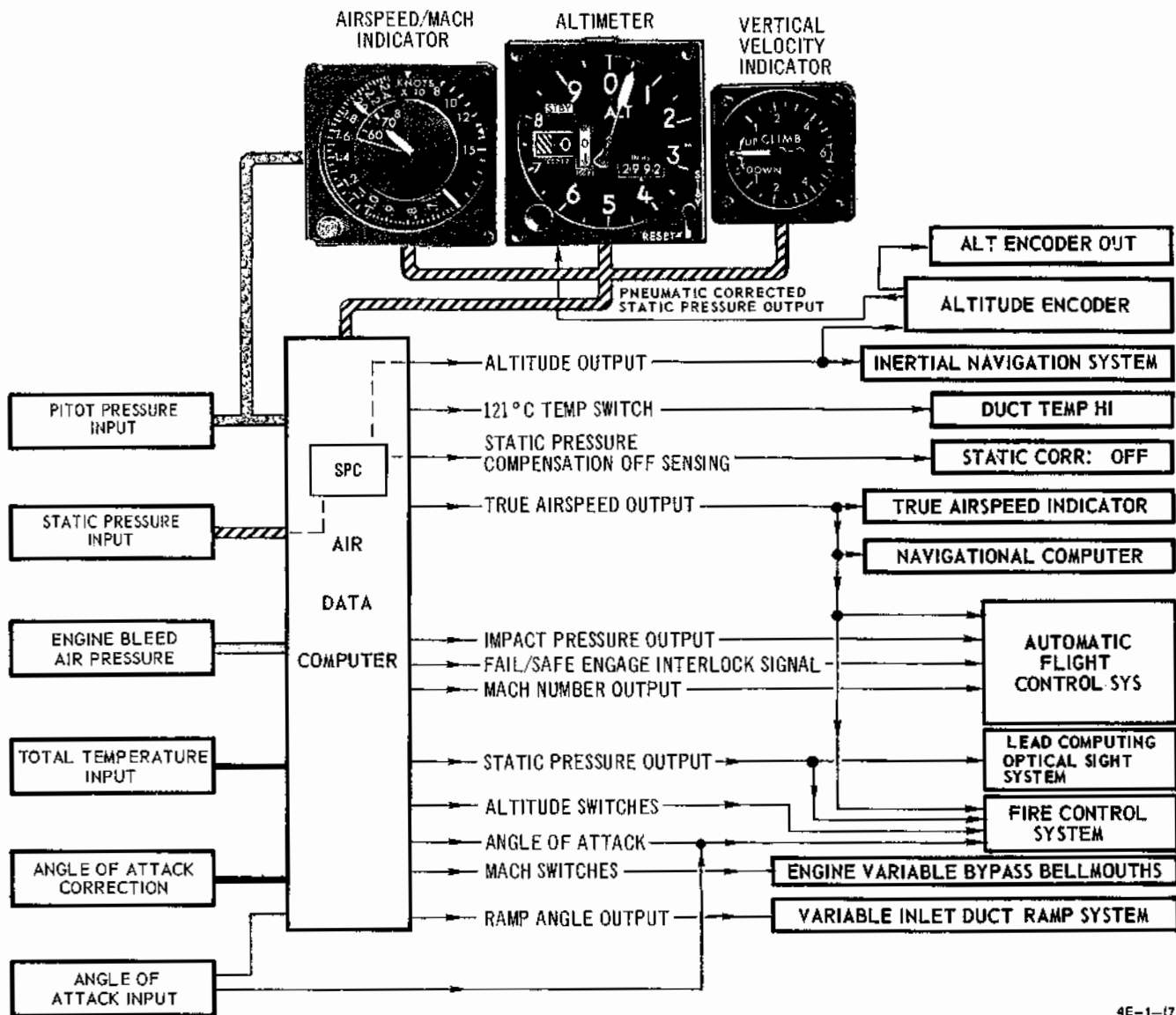
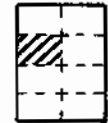

4E-1-(7.A)

Figure 1-10

## Teilight Panel

A teilight panel on the front cockpit right subpanel contains the majority of the warning and indicator lights. When a safety of flight condition exists, one of the red (warning) lights illuminate. When a condition exists that requires corrective action, an amber (indicator) light illuminates. When a condition exists that is worthy of note, a green (indicator) light illuminates. The MASTER CAUTION light illuminates in conjunction with most of the lights on the teilight panel. The MASTER CAUTION light does not illuminate in conjunction with the following lights: SPEED BRAKE OUT, R EXT FUEL, CTR EXT FUEL, L EXT FUEL, TANK 7 FUEL, APU and ALT

ENCODER lights.

## Master Caution Light

The MASTER CAUTION light in the front cockpit operates in conjunction with the generator indicator lights and most of the warning and indicator lights on the teilight panel. A MASTER CAUTION light is installed in the rear cockpit and operates with the front cockpit MASTER CAUTION light. It is only necessary to monitor the MASTER CAUTION light for an indication of a condition requiring attention, and then refer to the teilight panel for the specific condition. The MASTER CAUTION light may be extinguished by depressing the

master caution reset button on the generator control panel. There is no reset button in the rear cockpit. Illuminated lights on the telelight panel will not be extinguished by the master caution reset button, with the exception of the A/P DISENGAGED light, until their respective faults have been corrected. After the MASTER CAUTION light is extinguished, and an additional condition exists that requires attention, the MASTER CAUTION light will again illuminate.

#### NOTE

- If the CHECK HYD GAGES indicator light illuminates and remains illuminated, the hydraulic system gages should be monitored for the remainder of the flight. A second hydraulic system failure warning will not illuminate the MASTER CAUTION light.
- When operating both generators in parallel and the left generator is cycled OFF and then ON, the MASTER CAUTION light may not extinguish when the left generator comes on and parallels with the right generator. The MASTER CAUTION light may be ignored and reset as long as no malfunction is evident in any system.

#### Warning Light Test Circuit

A warning light test circuit is used for testing the operation of the bulbs in the warning and indicator lights. All warning and indicator lights are included in the test circuit which is powered by the 28/14 volt ac warning lights bus. The tank aboard (CL TK) light is also included in this circuit. The circuit does not check the operation of any of the systems utilizing a light, it merely checks the operation of the bulbs. The warning and indicator lights may be illuminated by actuating the warning lights test switch on each interior lights control panel.

#### CANOPY KNIFE

A canopy knife (figure 3-1) is on the left canopy rail on both cockpits. They are used to break away the canopies for emergency egress should all other methods of opening the canopies fail.

#### ENGINE FIRE AND OVERHEAT DETECTOR SYSTEM

Each engine has a fire warning system for the engine compartment, and an overheat warning system for the keel section. These systems are independent of each other. Each system consists of a warning light, a control unit, and a series of continuous type sensing units. Illumination of the lights warns the pilot to initiate emergency procedures.

#### Fire Warning System

The fire warning system serves to alert the pilot to an overheat condition in the engine compartment. The system consists of two sensing element loops (one for each engine), two control units and two warning lights. Each

loop contains seven sensing elements, located such that the entire engine compartment is covered. When a fire or overheat condition exists, the sensors experience an impedance drop. This impedance drop is detected by the control unit, and the fire warning light illuminates. Depressing the fire detector check button applies power to the system for a loop continuity and a light bulb check.

#### NOTE

An illuminated fire warning light may be a valid fire indication even though the self-test circuit may be inoperative.

#### Aft Fuselage Overheat Warning System

This system serves to warn the pilot of an over-temperature condition in the keel section. Sensors are externally visible inboard of each engine nozzle, mounted in a recess in the aft fuselage skin adjacent to the engine nozzle flaps (turkey feathers). The sensors function in the same manner as described in the preceding paragraph, causing the red overheat warning light for the affected engine to illuminate when the temperature reaches approximately 566°C.

#### Fire Detector Check Button

The warning lights may be tested by momentarily placing the warning lights test switch in the TEST position. This check will only test the bulbs. By depressing the fire detector check button the continuity of the circuitry, including the sensor units, may be checked.

#### EJECT LIGHT

An EJECT light provides a positive visual command from the pilot to the WSO to prepare for ejection. The light is controlled only from the front cockpit. The pilot's switch and monitor light are incorporated into a single unit under the left canopy sill just forward of the flap switch. The switch is a push ON, push OFF type, with the push button being the lens of the light. The lens is recessed sufficiently to preclude an accidental actuation. The light in the rear cockpit is a rectangular press to test unit monitored at the bottom right of the instrument panel. Pressing the lens of the rear light will test the rear light bulb and circuitry only. When the switch in the front cockpit is depressed, both EJECT lights illuminate. Depressing the switch again will extinguish both lights. The lights both incorporate red lenses. The rear lens has the word EJECT engraved in black letters on its face. The lens in the front cockpit is plain; however, the front switch has a decal marked EJECT LT. The EJECT lights are powered by the battery bus and are operational at any time.

#### JETTISON SYSTEMS

Provisions are incorporated to allow the flight crew to jettison most of the stores carried on the airplane. The jettison chart, section III of this manual, shows the correct method of jettisoning the stores. For those stores requiring that the front cockpit gear handle be up, or down with the weight off the gear, the circuits are wired through parallel safety switches, one located on the left main landing gear

scissor switch and one in the forward cockpit landing gear handle. These parallel switches are, in turn, wired in series with the rear cockpit emergency landing gear control handle. The scissors switch on the landing gear is open when weight is on the gear, interrupting the jettison circuits. When the oleo strut is extended, the scissors switch closes and the jettison circuits become hot. When the gear is retracted, the shrinker strut shortens the oleo strut as in the weight-on condition and opens the scissors switch. However, the safety switch in the landing gear handle is closed when the handle is in the UP position making the jettison circuits hot (providing the rear cockpit emergency landing gear control handle is IN), regardless of the position of the landing gear. The weight must be off the landing gear or the gear handle must be in the UP position (rear cockpit handle IN) in order to use the external stores emergency release button or the selective jettison control. An armament safety override switch, under the left front canopy sill, is used by the ground crew to allow the safety switches to be bypassed for armament circuit checkout. The spare starter cartridges, stores behind door 137 L & R are not jettisonable.

### External Stores Emergency Release Button

The external stores emergency release button (panic button) is on the front cockpit left subpanel. This button, when depressed, will jettison all jettisonable external stores except special weapons and air-to-air missiles. The button is operative under the following conditions: the aft emergency extension gear handle in the normal (IN) position and the forward gear handle in the up position, or the aft emergency extension gear handle in the normal (IN) position and the weight off the landing gear (left main gear scissors switch closed). Although the button is spring loaded to the normal position, the pilot is provided with a means to determine that the button is not sticking in the RELEASE position, as follows. A black painted lip extends into the switch guard approximately 9/16 inch. Below the 9/16 inch lip the switch is painted yellow. The pilot cannot see yellow paint inside the guard unless the button is depressed to the RELEASE position. If the external fuel transfer switch is in the OUTBD or CENTER position at the time of jettison, all external tanks fuel shutoff valves will close and the external transfer switch will be ineffective, allowing internal wing fuel to transfer normally. The external stores emergency release circuit receives power from the essential 28 volt dc bus.

#### NOTE

On aircraft with BRU-5/A centerline racks, the CL TK light is on before and after the M118 or MK 84 bomb is released when the centerline single bomb shorting plug is installed. Even though the CL TK light is on, the tank aboard relay is not energized, permitting the two forward AIM-7 missiles to be monitored, launched and jettisoned.

### Armament Safety Override Button

The armament safety override button, under the left canopy sill, allows the safety switches to be bypassed for armament circuit checkout. When the override button is depressed, 28 volts dc power is directed to the holding coil which retains the button depressed until electrical power

is removed from the aircraft, the armament bus control circuit breaker is pulled, or the gear handle is up. In an airborne emergency in which all other jettison methods have failed, the pilot can attempt stores jettison by depressing and holding the override button and actuating the applicable jettison switch. Depressing the armament safety override button bypasses the forward and aft emergency extension gear handle safety switches and the left main gear safety switch. This causes the following jettison switches to become hot: external stores emergency release button, and the selective jettison control.

### WARNING

All normal jettison circuits in the aircraft, except those energized by the wing station jettison switch, are disabled once the aft emergency extension gear handle in the rear cockpit is pulled. Jettison may be accomplished by use of the armament safety override button in this case.

#### NOTE

The armament safety override button must be depressed and held with the forward gear handle up, since the button is not solenoid held with the handle in the up position.

### Selective Jettison Control and Station Select Switches

The selective jettison control, in conjunction with the station switches, can jettison any jettisonable store(s) from any of the nine external stores stations. These controls are on the multiple weapons control panel on the lower left of the instrument panel in the forward cockpit. For air-to-air missiles (AIM-7s, and AIM-9s), jettison is performed by selecting the air-to-air missile station position of the control (L FWD, R FWD, L AFT, R AFT, L WING and R WING) and then pushing the PUSH TO JETT button of the control. On aircraft 71-237 and up, the R WING and L WING positions are used to jettison individual AGM-65A missiles from the launchers. The flaps must be up to jettison AIM-9 missiles. In addition, the flaps must also be up to jettison individual AGM-65A missiles using the L WING and R WING position of the selective jettison control. For jettison of non air-to-air stores (fuel tanks, ECM pods, MERs, TERs, air-to-ground missiles, and AGM-65A launchers with the AGM-65A missiles on aircraft 71-237 and up, etc) the selective jettison control and the five station select switches (LO, LI, CTR, RI and RO) are used. Jettison is performed by placing the selective jettison control to STORES, selecting a station or combination of stations on the station select switches, and then pushing the PUSH TO JETT button of the selective jettison control. The selective jettison control is protected by the left main landing gear scissors switch, and the forward and aft gear handle interlocks. Note that the flaps can be up or down when jettisoning the AGM-65A launcher(s) using the STORES position of the selective jettison control and the station select switches.

**NOTE**

After TO 11L1-3-15-510, the AIM-9 missile jettison circuits are disabled.

**INSTRUMENTS****NOTE**

Refer to foldout section for front and rear cockpit instrument panel illustrations.

Most of the instruments are electrically operated by power from the electrical system. Some instruments, such as the accelerometer, are self-contained and do not require any external source of electrical power.

**NOTE**

For information regarding instruments that are an integral part of a particular system, refer to applicable paragraphs in this section and section IV.

**TRUE AIRSPEED INDICATORS**

A true airspeed indicator is on the front cockpit instrument panel and the rear cockpit instrument panel. The airspeed is indicated by a small counter which rotates to show a row of numbers through a window on the indicator face. The indicators read directly in knots TAS, and have a range of 0 to 1500 knots. The system calibrated range is 150 to 1500 knots. Therefore, true airspeed readings below 150 knots are not reliable. The true airspeed inputs are produced by a signal from the total temperature sensor of the air data computer, which is routed through a potentiometer driven by a Mach number function cam. Thus, Mach number is converted into true airspeed. Scale error throughout the full range of the indicator will not exceed  $\pm 5$  knots. During any rates of change throughout the full range of indicator, transient error will not exceed  $\pm 10$  knots. The true airspeed indicator can indicate anywhere below 150 knots while the aircraft is motionless on the ground.

**GROUND SPEED INDICATOR**

The ground speed indicator is on the rear cockpit instrument panel. Ground speed is indicated by a small counter which rotates to show a row of numbers through a window on the indicator face. The indicator reads in knots, with a range of from 0 to 1999 knots. Ground speed inputs are produced by the navigation computer. When the inertial navigation system (INS) is operating, the navigation computer resolves rectangular components of velocity received from the INS to ground speed. The resulting ground speed signal is routed to the ground speed indicator. Actual aircraft ground speeds will be indicated, including taxiing ground speed. When the INS is inoperative, the navigation computer uses true airspeed from the air data computer, with wind direction and velocity manually inserted by the operator, to compute ground speed. The ground speed indications in this case are only as accurate as the manually inserted wind information. With the INS inoperative, the ground speed indicator can indicate anywhere below 150 knots while the aircraft is motionless on the ground.

**ACCELEROMETERS**

An accelerometer, to measure and record positive and negative acceleration G loads, is on the front cockpit instrument panel and the rear cockpit instrument panel. The indicator has three movable pointers. One pointer moves to indicate the G load being applied, while the other two (one for positive G, and one for negative G) follow the indicator pointer to its maximum travel. These recording pointers remain at their maximum travel positions of applied G load. Depressing a PUSH TO SET button, in the lower left corner of the instrument will allow the recording pointers to return to the one G position.



The accelerometers may read  $\frac{1}{2}$  G low, possibly lower when pull-in rates are high.

**AIRSPEED/MACH INDICATORS**

A combination airspeed and Mach number indicator is on the front cockpit instrument panel and the rear cockpit instrument panel. They show airspeed readings below 200 knots and include Mach number readings at high speeds. Both readings are provided by a single pointer moving over a fixed airspeed scale, graduated from 80 to 850 knots, and a movable Mach number scale graduated from Mach 0.4 to Mach 2.5. A movable airspeed marker is included as an approach speed reference and can be positioned by the knob on the face of the instrument. The same knob, when depressed and rotated, will position another pointer on the Mach number scale for indicated Mach reference. The airspeed indicator pointer and the Mach number scale are synchronized so that a proper relationship between the two is assured throughout all altitude changes. There are two types of airspeed/mach indicators which can be installed in the aircraft. In the one type the mach number marker will not follow the movement of the mach number scale but will remain stationary once it is set.

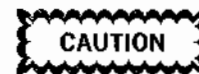

Do not rotate airspeed index pointer below 80 knots or above 195 knots. Do not rotate mach index pointer below 225 knots or above 850 knots. Internal damage to the indicator may result if these limits are exceeded.

**ALTIMETER (AAU-19)**

The altimeters are of the counter-pointer type which display the whole thousands number in a counter window and the increments of the whole number with a pointer which rotates on the face of the instrument. The pointer scale is graduated in 50-foot units with major 100 foot scale divisions from 1 to 10. The range of the altimeter is 0 to 80,000 feet. An adjustable barometric scale is provided so that the altimeter may be set at sea level pressure. In the transonic range, an altimeter jump may be noticed. A servoed altimeter in each cockpit receives both pneumatic pressure and electronic signals from the altitude encoder

unit for operation. A three position switch on the altimeter, labeled RESET and STBY, is springloaded to the center unmarked position. In STBY, only pneumatic pressure is applied to the altimeter and a red flag marked STBY appears on the face of the instrument. In RESET, the electronic signal is also applied to the indicator and the red STBY flag disappears; this condition is considered the normal mode of operation. If a failure occurs in the altimeter, altitude encoder unit, or the air data computer, the altimeter reverts back to STBY and cannot be reset. This is indicated by the appearance of the standby warning flag on the face of the altimeter, and by the possible illumination of associated warning lights (see figure 1-11). Refer to part 1 of appendix A for altimeter lag and altimeter position error correction.

**WARNING**

If the altimeter system is suspected to be in error, select STBY and check the altimeter jump. If altimeter jump is out of limits, select STATIC CORR-OFF (SPC) and apply the proper altimeter position error correction. If the altimeter is still suspected to be in error, depressurize the cockpit and cross check against the cockpit pressure altimeter.

**CAUTION**

To prevent damage to the selector switch, do not use excessive pressure when switching reset/standby switch.

**MAGNETIC COMPASS**

A conventional magnetic compass, one in each cockpit, is provided for navigation if an instrument or electrical malfunction occurs. Compass deviation cards are above the canopy sill on the right side of both cockpits.

**VERTICAL VELOCITY INDICATORS**

The vertical velocity indicators indicate the rate of climb or descent of the aircraft. Each indicator is connected to the static pressure system and actuation of the pointer is controlled by the rate of change of the atmospheric pressure. It is so sensitive that it can register a rate of gain or loss of altitude which would be too small to cause a noticeable change in the altimeter reading. Each half of the indicator face is graduated in 500 foot units from 0 to 6000 feet with 100 foot scale divisions from 0 to 1000 feet. The upper half of the instrument indicates rate of climb and the lower half indicates rate of descent in feet per minute. The vertical velocity indicator is connected to the static pressure system of the airplane and measures the change in atmospheric pressure as the airplane climbs or descends.

**RADAR ALTIMETER**

The radar altimeter provides the pilot with accurate height information, with respect to the terrain, from 0 to 5000 feet. Accuracy of the system is  $\pm 5$  percent of the indicated altitude or  $\pm 2$  feet, whichever is greater. Operational limits allow the system to function normally from 0° to 30° bank angle and/or from 0° to 35° pitch angle. The system consists of a transmitter/receiver, individual transmitting and receiving antennas and a height indicator. The height indicator, on the pilot's instrument panel, provides read-out information for the system. In

**ALTITUDE REPORTING FAILURE INDICATIONS**

TYPE OF FAILURE	ALTIMETER (AAU-19/A)	ALT ENCODER OUT LIGHT	STATIC CORR OFF LIGHT	MASTER CAUTION LIGHT	RESULTING SYSTEM OPERATION
ALTIMETER SERVO FAILURE OR MANUAL STBY SELECTION	STBY	OFF	OFF	OFF	ALTIMETER REVERTS TO PNEUMATIC OPERATION ON CORRECTED STATIC PRESSURE. ALTIMETER INFORMATION IS SUPPLIED TO THE ALTITUDE REPORTING TRANSPONDER
ALTITUDE ENCODER UNIT FAILURE OR AIR DATA COMPUTER FAILURE	STBY	ON	OFF	OFF	ALTIMETER REVERTS TO PNEUMATIC OPERATION ON CORRECTED STATIC PRESSURE, AND NO ALTITUDE INFORMATION SUPPLIED TO ALTITUDE REPORTING TRANSPONDER.
AIR DATA COMPUTER SPC FAILURE OR MANUAL OFF SELECTION	STBY	ON	ON	ON	ALTIMETER REVERTS TO PNEUMATIC OPERATION ON UNCORRECTED STATIC PRESSURE, AND NO ALTITUDE INFO SUPPLIED TO ALTITUDE REPORTING TRANSPONDER.

Figure 1-11



the face of the indicator is a fixed dial scale and altitude pointer, a movable reference marker and an OFF flag window. The dial scale is linear from 0 to 100 feet and logarithmic from 100 to 5000 feet. A function control switch, on the lower left side of the indicator provides complete control of the system. A red, low altitude warning light is on the lower right side of the indicator.

### Function Control Switch

Clockwise rotation of the function control switch applies power to the system components. By rotating the control switch further clockwise, the reference marker may be positioned. This also sets the low altitude warning light limit. Any time the aircraft descends below the preselected altitude, the low altitude warning light illuminates. A self-test function may be initiated by pressing in on the function control switch. This supplies the indicator with an artificial return signal and the altitude pointer indicates  $35 \pm 15$  feet. Above 5000 feet, or when unreliable signals are being received, the altitude pointer is driven counterclockwise behind a mask which is located between the 0 and 5000 feet mark, and the OFF flag will appear. The OFF flag also appears when power is lost or turned off; however, the altitude pointer remains at the altitude it was indicating when the power interruption occurred. With external stores aboard and the aircraft in a maneuvering attitude, the radar altimeter will experience performance degradation. However, no degradation occurs in straight and level flight.

### WARNING

High frequency radar waves can penetrate snow and ice fields. When operating in areas covered with snow and ice, the radar altimeter may indicate a greater terrain clearance than actually exists.

### TURN AND SLIP INDICATORS

A turn and slip indicator is incorporated in the attitude director indicator on the front cockpit instrument panel. An individual 4-minute turn and slip indicator is on the rear cockpit instrument panel. The turn needle in the ADI, operated by a vertically mounted gyro, indicates direction of turn but does not provide accurate turn rate. The turn needle in the rear cockpit, operated by a conventional horizontally mounted gyro, indicates standard rates of turn in the conventional manner of a turn and slip indicator. Complete electrical failure renders both turn needles inoperative.

### ATTITUDE INDICATOR (REAR COCKPIT)

The attitude indicator on the rear cockpit instrument panel receives attitude information from the Attitude Heading and Reference System when the reference system selector switch is in either the PRIM or STBY position. The pitch trim knob is used to electrically rotate the attitude sphere to the desired position in relation to the fixed miniature airplane. An attitude OFF warning flag is

visible on the face of the instrument when power is not applied or when any one phase of ac power to the instrument is lost.

### WARNING

The attitude warning flag does not appear with a slight electrical power reduction or failure of other components within the system. Failure of certain components can result in erroneous or complete loss of pitch and bank presentations without a visible flag.

## FLIGHT DIRECTOR GROUP

The flight director group provides an integrated display of the navigation situation of the airplane. The flight director group consists of a flight director computer, the horizontal situation indicator (HSI), and a selector panel. Although the attitude director indicator (ADI) is not a component of the flight director group, it does receive some signals from the flight director computer and shall be discussed along with the flight director group.

### FLIGHT DIRECTOR COMPUTER

The flight director computer provides navigation information to the HSI and steering information to the ADI. Except for the bearing and distance display on the HSI, all signals for the HSI and signals for portions of the ADI pass through or originate in the computer. The flight director computer has no control over the three-axis sphere portion of the ADI. Steering signals are computed to provide the aircraft commander with flight direction information when flying either manually or remotely set headings, and manually selected tacan radials. These computer signals, together with the required flag signals and off scale signals, are supplied by the computer to the ADI. The steering signals are limited to ensure safe operation without affecting the inherent performance capabilities of the airplane.

### HORIZONTAL SITUATION INDICATOR

The HSI (figure 1-12) provides a horizontal or plan view of the aircraft with respect to the navigation situation. The aircraft symbol in the center of the HSI is the airplane superimposed on a compass rose. The compass card rotates so that the aircraft heading is always under the lubber line. Index marks are provided every 45° around the perimeter of its compass card. The bearing pointer and range indicator provides information as selected by the bearing/ distance switch. The bearing pointer indicates magnetic bearing by pointing to the selected station or destination. Relative bearing is obtained by reading the angular difference in degrees (either left or right of the upper lubber line) between the aircraft magnetic heading and the magnetic bearing pointer. For example, if the aircraft magnetic heading is 270° and the bearing pointer indicates a magnetic bearing of 10°, then the relative bearing indicated is 100° to the right. On aircraft before TO 1F-4-1056, with NAV COMP selected, magnetic and

relative bearing and range to the selected destination are provided. With TACAN selected, magnetic and relative bearing and range to the selected tacan station are provided. With ADF selected, magnetic and relative bearing to an ADF station is provided. If there is a malfunction in the compass system or the compass card, the ADF bearing pointer continues to point to the station and it displays relative bearing only; however, the tacan bearing pointer will continue to indicate magnetic bearing to the tacan station. On aircraft after TO 1F-4-1056, with VOR/TAC selected, magnetic and relative bearing to the VOR station and range to the tacan station are provided. With TAC selected, magnetic and relative bearing and range to the selected tacan station are provided. With ADF/TAC selected, magnetic and relative bearing to the selected ADF station, and range to the tacan station are provided. With NAV COMP selected, magnetic and relative bearing and range to the selected destination are provided. Four different navigational situation displays are provided on the HSI, selected by the mode selector knob on the navigation function selector panel. On aircraft before TO 1F-4-1056, these displays are: ATT (attitude), HDG (heading), TAC (tacan), and NAV COMP (navigation computer). On aircraft after TO 1F-4-1056, these displays are: VOR/ILS (VHF omnidirectional range/instrument landing system), TAC (tacan), NAV COMP (navigation computer), and HDG (heading). The mode selector knob does not affect information displayed by the bearing pointer and the range indicator. When the attitude mode (ATT) is selected, the heading marker, course arrow, and course deviation indicator slave to the magnetic heading; i.e., under the lubber line. The heading marker cannot be adjusted with the heading set knob and the bank steering bar on the ADI is deflected out of view. The course selector window also displays magnetic heading. On aircraft after TO 1F-4-1056, when VOR/ILS mode is selected the heading marker is positioned by the heading set knob to provide the ADI bank steering bar with bank and azimuth information to turn to the selected heading. The course arrow is positioned by the course set knob to the VOR radial or runway heading. The course deviation indicator displays the aircraft deviation from the selected VOR radial or runway heading. In the heading mode, the course arrow and course deviation indicator are slaved to the lubber line and display aircraft magnetic heading. The course selector window also displays magnetic heading. The heading marker may be manually set to the desired heading. This provides ADI bank steering bar information to command an asymptotic approach to the selected heading. The tacan mode provides a display of a navigation situation with respect to selected tacan. To provide a complete tacan display, the bearing/distance switch should be in the TACAN position. The bearing pointer provides magnetic bearing and the range indicator provides slant range to the selected tacan. The course arrow and the course selector window are set manually, using the course set knob, to the desired tacan course. The course deviation indicator and aircraft symbol display a plan view of the aircraft in relation to selected course. Maximum deflection of course deviation indicator is 5° (2½° per dot). The heading set knob is used to manually set the heading marker to a desired tacan course, thus providing bank steering information on the ADI to command an asymptotic approach to desired tacan course. The bank steering bar does not correct for drift. If the heading marker is not set to the desired course, bank steering information, although provided is not correct. The to-from indicator operates when the mode selector is

in the tacan mode or the VOR/ILS mode (after TO 1F-4-1056) when a VOR or tacan station is tuned and received. It indicates whether the course selected, if intercepted and flown, takes the aircraft to or from the selected station. The NAV COMP (navigation computer) mode displays the aircraft magnetic ground track on the course arrow and course selector window. The heading marker is electrically driven to indicate appropriate magnetic heading (command heading) to fly in order to arrive at the selected new nav comp fix. The bank steering bar provides bank steering information to direct an asymptotic approach to the command heading. Six mode-of-operation word messages are shown around the HSI. These words are illuminated to indicate operating mode, providing the instrument panel lights control knob is ON. The intensity of the mode lights is controlled by this knob. The mode words are: TAC (tacan) NAV (navigation computer), UHF (ADF), MAN (HDG), ILS (instrument landing system), and TGT (target). During radar offset bombing operations illumination of the TGT mode word indicates that the WSO has depressed the TGT insert button on the cursor control panel. The data link light does not illuminate since this mode is not available. There is no mode light for the attitude mode of operation.

#### ATTITUDE DIRECTOR INDICATOR (ADI)

The indicator (figure 1-12) consists of an attitude sphere, turn and slip indicator, pitch and bank steering bars, miniature aircraft, vertical displacement pointer, warning flags, and a pitch trim knob. The attitude sphere displays pitch, bank, and heading in relation to the miniature aircraft. The pitch and bank attitude markings on the sphere are in graduations of 10° with the large markings indicating each 30°. Signals to the ADI are received from the primary or standby attitude reference system. Either system can be selected by placing the reference system selector switch, located on the pilot's main instrument panel, to the desired position. When the reference system is changed from PRIM to STBY or vice versa, the ADI may temporarily swing to some random point in azimuth before synchronizing back to the correct heading, and may be accompanied by some unusual gyrations of the attitude director indicator sphere. This phenomenon is a simultaneous large gyration about all three axes after which normal attitude reference is displayed. The pitch reference relationship of the attitude sphere to the miniature aircraft may be adjusted with the pitch trim knob. The turn indicator in the lower portion of the ADI receives its signal from a gyro housed within an AN/AJB-7 system component. However, the operation or malfunction of one system will not affect the other system. The bank steering bar provides command steering information to intercept selected headings, tacan and VOR radials, or navigation computer destinations. Bank steering commands from the heading marker and/or course arrow are transmitted through the flight director computer to the bank steering bar. The pitch steering bar provides steering commands in the ILS mode after glideslope capture during a final approach to a runway. The maximum bank angle command is 35°. In navigation computer mode the maximum heading error that can be commanded is 90°. If the heading marker is manually set at 90° or more from the present aircraft heading, the bank steering bar commands the maximum bank angle. Heading errors of less than 90° results in bank angle commands of less than 35°. If bank angles of more than 35°

are desired during heading course interception, the steering bar must be disregarded. During tacan course interceptions, bank steering information will only be reliable when the selected tacan course is within 60° of the present inbound course. An OFF warning flag on the ADI is visible during the start cycle time delay; when the AN/AJB-7 gyro ac power fails; when the AN/AJB-7 pitch or roll signals fail; or while the fast erect switch is being activated. The attitude warning flag indicates only a failure in the AN/AJB-7 system regardless of the position of the reference system selector switch, and will not be in view if there is a failure or power loss within the INS.

### WARNING

- Failure of certain components can result in erroneous or complete loss of pitch and bank presentations without a visible warning indication.
- If there is a confirmed or suspected ADI failure, switch to the standby attitude reference system and cross check ADI indications with the radar horizon line.
- The radar horizon line receives its input from the INS when the reference system selector switch is in the PRIM position and from the AN/AJB-7 when in the STBY position. If the INS fails, the ADI will indicate incorrect aircraft attitude, and the reference system selector switch should be placed to STBY immediately.

### BEARING-DISTANCE-HEADING INDICATOR (BDHI)

The BDHI (figure 1-13) consists of a rotating compass card, single and double bar bearing pointers numbered 1 and 2 respectively, a range indicator, and a range warning flag. With the navigation mode selector switch in the rear cockpit in the TACAN/UHF/ADF position, the No. 1 pointer indicates UHF magnetic and relative bearing and the No. 2 pointer indicates tacan magnetic and relative bearing. The range indicator displays range to the selected station. If the tacan is not operating, both the No. 1 and No. 2 pointers indicate ADF bearing. With the navigation mode selector switch in NAV COMP, the No. 1 pointer indicates magnetic and relative bearing to the selected navigation computer target coordinates and the No. 2 pointer indicates magnetic ground track. The range indicator displays range to the selected navigation computer target coordinates. On aircraft after TO 1F-4-1056, the navigation mode selector switch contains a VOR/TAC position. With the switch in this position, the No. 1 pointer indicates VOR magnetic and relative bearing and the No. 2 pointer indicates tacan magnetic and relative bearing. If the tacan is not operating, the No. 1 and No. 2 pointers both indicate bearing to the VOR station. The range indicator displays range to the selected tacan station.

### NAVIGATION FUNCTION SELECTOR PANEL

The navigation function selector panel is on the front cockpit instrument panel. The panel contains a mode selector knob and a bearing/distance selector switch.

#### Mode Selector Knob

The mode selector knob is a rotary-type switch with positions of ATT, HDG, TACAN, and NAV COMP. After TO 1F-4-1056, the switch positions are VOR/ILS, TAC, NAV COMP and HDG. The FD switch on the mode selector knob when turned to OFF (vertical position) biases the bank and pitch steering bars out of view. The switch selects the source of information to be displayed on the HSI and ADI as shown in figures 1-14A thru 1-21.

#### Bearing/Distance Selector Switch

The bearing/distance selector switch is a three-position toggle switch with positions of NAV COMP, ADF, and TACAN. On aircraft after TO 1F-4-1056, the switch has four positions: VOR/TAC, TAC, ADF/TAC, and NAV COMP. The switch controls the bearing pointer, range indicator, and the mode word that indicates the mode selected on the HSI. The bearing/distance selector switch and mode selector knob do not have to be set up as a pair. The positions function as described in figures 1-20 and 1-21.

### COMMUNICATION, NAVIGATION, IDENTIFICATION SYSTEM (INTEGRATED ELECTRONIC CENTRAL AN/ASQ-19A)

The integrated electronic central combines the communication, navigation and identification systems into one unit (figure 1-22). Communication functions are provided by a UHF receiver-transmitter, an auxiliary UHF receiver, and an intercom set. Navigation functions are provided by a tacan (tactical air navigation) set and an ADF (automatic direction finding) feature. Aircraft after TO 1F-4-1056 also contain a VOR/ILS system. An IFF (identification friend or foe) set provides coded radar identification of the aircraft when challenged. When the CNI equipment is operating on external power without ground cooling, it is limited to 10 minutes of accumulated operation in a one-hour period. This limit does not apply to the intercom system.

#### EXTERNAL GROUND POWER OPERATION

With external ground power connected to the airplane and neither of the two generators connected to the line, the integrated electronic central will not operate unless the CNI ground power switch is placed to ON. The CNI ground power switch in the left wheel well, applies power to the integrated electronic central for ground operation. The switch is manually operated and electrically held and must be reset after each interruption of external power.

# ADI/HSI (ATTITUDE DIRECTOR INDICATOR/ HORIZONTAL SITUATION INDICATOR)

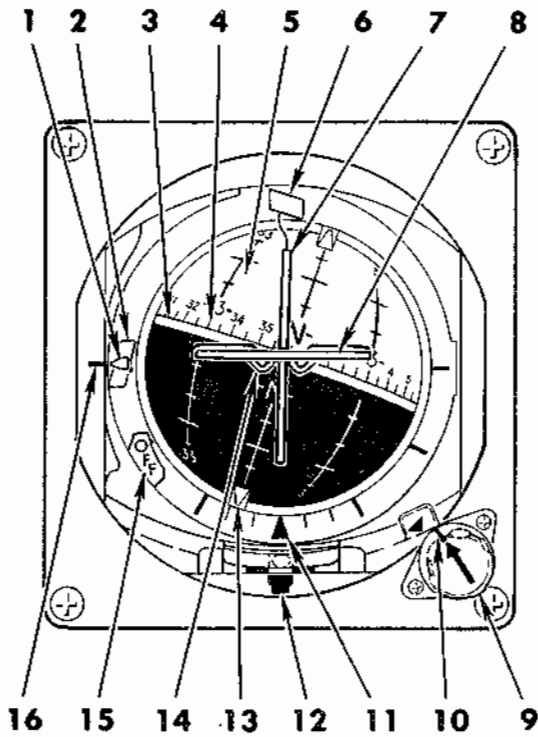
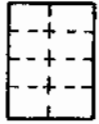

1. GLIDE SLOPE INDICATOR
2. GLIDE SLOPE WARNING FLAG
3. HORIZON BAR
4. HEADING REFERENCE SCALE
5. ATTITUDE SPHERE
6. COURSE WARNING FLAG
7. BANK STEERING BAR
8. PITCH STEERING BAR
9. PITCH TRIM KNOB
10. PITCH TRIM INDEX
11. BANK SCALE
12. TURN AND SLIP INDICATOR
13. BANK POINTER
14. MINIATURE AIRCRAFT
15. ATTITUDE WARNING FLAG
16. GLIDE SLOPE DEVIATION SCALE

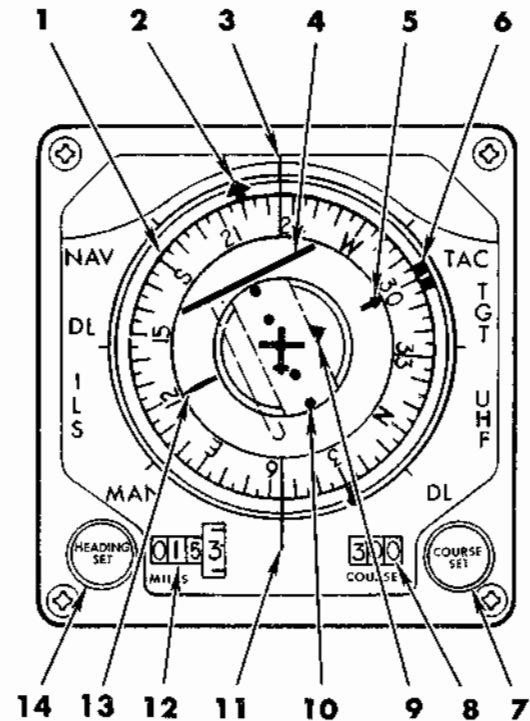

1. COMPASS CARD
2. BEARING POINTER
3. UPPER LUBBER LINE
4. COURSE DEVIATION INDICATOR
5. COURSE ARROW (HEAD)
6. HEADING MARKER
7. COURSE SET KNOB
8. COURSE SELECTOR WINDOW
9. TO-FROM INDICATOR
10. COURSE DEVIATION SCALE
11. LOWER LUBBER LINE
12. RANGE INDICATOR AND WARNING FLAG
13. COURSE ARROW (TAIL)
14. HEADING SET KNOB

Figure 1-12

# BDHI (BEARING-DISTANCE-HEADING INDICATOR)

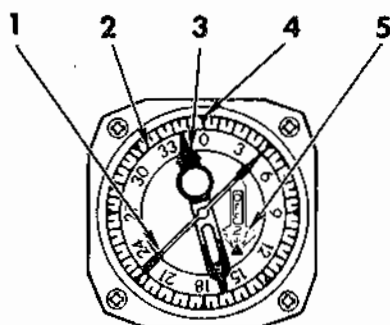
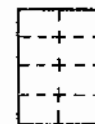

1. NO. 1 POINTER
2. COMPASS CARD
3. NO. 2 POINTER
4. LUBBER INDEX
5. RANGE INDICATOR

Figure 1-13

4E-1--(86)

## INTERCOM SYSTEM

Intercommunications between the aircrew and between the ground crew with either aircrew member, is provided by the intercom system. Each cockpit is provided with a primary and secondary amplifier. During normal operations, the primary amplifier in each cockpit amplifies microphone outputs and audio signals, internal and external, before routing them to the headsets. For example, when the pilot talks on the intercom his microphone output goes to the front cockpit primary amplifier. This amplifier then directs the signal to the audio signal portion of the front and rear cockpit primary amplifiers. From there, a signal is received in the headset of the respective cockpits. If a primary amplifier becomes inoperative, communications may be restored by selecting the appropriate cockpit secondary amplifier. This is done by selecting B/U on the amplifier selector knob.

### NOTE

Since the external intercom is wired in parallel with the WSO's microphone and headset, the ground crew and WSO can block each other during simultaneous transmissions. In addition, the WSO's function selector switch must be in HOT MIC to allow aircraft to ground communications.

## Intercom Control Panel

The intercom system is controlled by intercom control panels in each cockpit. The panels contain a volume control knob, an amplifier selector knob with positions of B/U, NORM, and EMER, and a function selector switch, with positions of RADIO OVERRIDE, HOT MIC, and COLD MIC.

### Volume Control Knob

The intercom volume control knob is on the left side of the intercom panels. The input level of the intercom signals to the headsets is increased by rotating the volume control knob in a clockwise direction. Signals received from other radio receivers are not affected by the intercom volume control knob.

### Function Selector Switch

A three-position toggle switch, with positions marked RADIO OVERRIDE, HOT MIC, and COLD MIC, is on the right side of the intercom control panel. The RADIO OVERRIDE position is momentary, and the HOT MIC and COLD MIC positions are fixed. The HOT MIC position allows automatic operation of the intercom. If both function selector switches are set on COLD MIC, the microphone button on the inboard throttle must be placed to the ICS (aft) position to allow intercom operation. The RADIO OVERRIDE POSITION is identical to HOT MIC,

## ADI AND HSI DISPLAYS (BEFORE TO 1F-4-1056)

INDICATOR		NAVIGATION MODE SELECTOR POSITION			
		ATT	HDG	TACAN	NAV COMP
ADI	BANK STEERING BAR	OUT OF VIEW	STEERING TO SELECTED HEADING (HSI HEADING SET KNOB)	STEERING TO SELECTED TACAN RADIAL (HSI COURSE SET KNOB)	STEERING TO SELECTED DESTINATION (NAVIGATION COMPUTER)
	COURSE WARNING FLAG	OUT OF VIEW	OUT OF VIEW	OUT OF VIEW WHEN TACAN SIGNAL IS RELIABLE	OUT OF VIEW
	PITCH STEERING BAR	OUT OF VIEW	OUT OF VIEW	OUT OF VIEW	OUT OF VIEW
	SPHERE (AZIMUTH)	AIRCRAFT MAGNETIC HEADING	AIRCRAFT MAGNETIC HEADING	AIRCRAFT MAGNETIC HEADING	AIRCRAFT MAGNETIC HEADING
HSI	HEADING MARKER	AIRCRAFT MAGNETIC HEADING	SET TO DESIRED MAGNETIC HEADING WITH HEADING SET KNOB	SET TO SELECTED TACAN RADIAL WITH HEADING SET KNOB	COMMAND HEADING STEERING TO SELECTED DESTINATION (NAVIGATION COMPUTER)
	COURSE ARROW	AIRCRAFT MAGNETIC HEADING	AIRCRAFT MAGNETIC HEADING	SET TO DESIRED TACAN RADIAL WITH COURSE SET KNOB	AIRCRAFT MAGNETIC GROUND TRACK
	COURSE DEVIATION INDICATOR	CENTERED	CENTERED	AIRCRAFT DEVIATION FROM SELECTED TACAN RADIAL	CENTERED
	TO-FROM INDICATOR	OUT OF VIEW	OUT OF VIEW	INDICATES WHETHER COURSE SELECTED WILL TAKE AIRCRAFT TO OR AWAY FROM SELECTED TACAN STATION	OUT OF VIEW
	MODE LIGHT	NO LIGHT	MAN	TAC	NAV
	COMPASS CARD	AIRCRAFT MAGNETIC HEADING	AIRCRAFT MAGNETIC HEADING	AIRCRAFT MAGNETIC HEADING	AIRCRAFT MAGNETIC HEADING

INDICATOR		BEARING DISTANCE SWITCH POSITION		
		NAV COMP	ADF	TACAN
HSI	BEARING POINTER	MAGNETIC BEARING TO DESTINATION SELECTED ON NAVIGATION COMPUTER	RELATIVE BEARING TO UHF STATION SELECTED ON COMMUNICATION CONTROL PANEL	MAGNETIC BEARING TO SELECTED TACAN STATION
	RANGE INDICATOR	RANGE TO DESTINATION SELECTED ON NAVIGATION COMPUTER	BLANK	RANGE TO TACAN STATION (TACAN IN T/R MODE)
	MODE LIGHT	NAV	UHF	TAC

4E-1-(475)A

Figure 1-14

# ADI AND HSI DISPLAYS

(AFTER TO 1F-4-1056)

INDICATOR		NAVIGATION MODE SELECTOR POSITION			
		VOR/ILS	HGG	TAC	NAV COMP
ADI	BANK STEERING BAR	STEERING TO SELECTED VOR RADIAL OR ILS LOCALIZER	STEERING TO SELECTED HEADING (HSI HEADING SET KNOB)	STEERING TO SELECTED TACAN RADIAL (HSI COURSE SET KNOB)	STEERING TO SELECTED DESTINATION (NAVIGATION COMPUTER)
	COURSE WARNING FLAG	OUT OF VIEW WHEN VOR OR LOCALIZER SIGNAL IS RELIABLE	OUT OF VIEW	OUT OF VIEW WHEN TACAN SIGNAL IS RELIABLE	OUT OF VIEW
	PITCH STEERING BAR	STEERING TO GLIDESLOPE CENTER AFTER GLIDESLOPE CAPTURE	OUT OF VIEW	OUT OF VIEW	OUT OF VIEW
	SPHERE (AZIMUTH)	AIRCRAFT MAGNETIC HEADING	AIRCRAFT MAGNETIC HEADING	AIRCRAFT MAGNETIC HEADING	AIRCRAFT MAGNETIC HEADING
HSI	HEADING MARKER	SET TO DESIRED MAGNETIC HEADING WITH HEADING SET KNOB	SET TO DESIRED MAGNETIC HEADING WITH HEADING SET KNOB	SET TO SELECTED TACAN RADIAL WITH HEADING SET KNOB	COMMAND HEADING STEERING TO SELECTED DESTINATION (NAVIGATION COMPUTER)
	COURSE ARROW	SET TO DESIRED VOR RADIAL OR RUNWAY HEADING WITH COURSE SET KNOB	AIRCRAFT MAGNETIC HEADING	SET TO DESIRED TACAN RADIAL WITH COURSE SET KNOB	AIRCRAFT MAGNETIC GROUND TRACK
	COURSE DEVIATION INDICATOR	AIRCRAFT DEVIATION FROM SELECTED VOR RADIAL OR RUNWAY HEADING	CENTERED	AIRCRAFT DEVIATION FROM SELECTED TACAN RADIAL	CENTERED
	TO-FROM INDICATOR	INDICATES WHETHER SELECTED VOR RADIAL LEADS AIRCRAFT TO OR FROM VOR STATION	OUT OF VIEW	INDICATES WHETHER COURSE SELECTED WILL TAKE AIRCRAFT TO OR AWAY FROM SELECTED TACAN STATION	OUT OF VIEW
	MODE LIGHT	ILS (IF ILS FREQ. SELECTED)	MAN	TAC	NAV
	COMPASS CARD	AIRCRAFT MAGNETIC HEADING	AIRCRAFT MAGNETIC HEADING	AIRCRAFT MAGNETIC HEADING	AIRCRAFT MAGNETIC HEADING

**1** WITH THE FLIGHT DIRECTOR SWITCH IN THE OFF POSITION, THE PITCH AND BANK STEERING BARS ARE DRIVEN OUT OF VIEW.

INDICATOR		BEARING DISTANCE SWITCH POSITION			
		VOR/TAC	TAC	ADF/TAC	NAV COMP
HSI	BEARING POINTER	MAGNETIC BEARING TO VOR STATION	MAGNETIC BEARING TO TACAN STATION	RELATIVE BEARING TO SELECTED ADF STATION	MAGNETIC BEARING TO DESTINATION SELECTED ON NAVIGATION COMPUTER
	RANGE INDICATOR	RANGE TO TACAN STATION (TACAN IN T/R MODE)	RANGE TO TACAN STATION (TACAN IN T/R MODE)	RANGE TO TACAN STATION (TACAN IN T/R MODE)	RANGE TO DESTINATION SELECTED ON NAVIGATION COMPUTER
	MODE LIGHT	VOR (IF VOR FREQUENCY SELECTED)	TAC	UHF	NAV

4E-1-(477)A

Figure 1-15

# ATTITUDE AND HEADING DISPLAYS

(BEFORE TO 1F-4-1056)

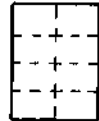

## ATT (Attitude)

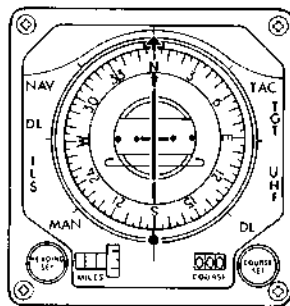

THE COURSE ARROW, COURSE DEVIATION INDICATOR AND HEADING MARKER ARE SLAVED TO THE MAGNETIC HEADING OF THE AIRPLANE (I.E. VERTICAL ON THE FACE OF THE HSI). NO MODE LIGHT IS ILLUMINATED.

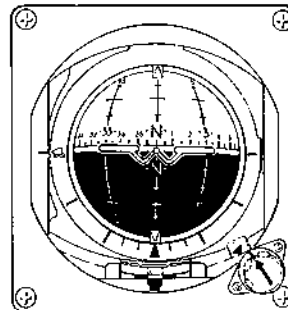

ALL POINTERS ARE DEFLECTED OUT OF VIEW. ONLY ATTITUDE AND AZIMUTH INFORMATION IS DISPLAYED.

## HDG (Heading)

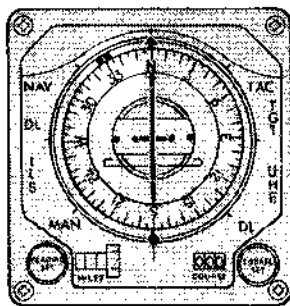

THE HEADING MARKER IS POSITIONED BY THE HEADING SET KNOB TO PROVIDE THE ADI BANK STEERING BAR WITH BANK AND AZIMUTH INFORMATION IN ORDER TO TURN TO THE SELECTED HEADING. THE MAN MODE LIGHT IS ILLUMINATED.

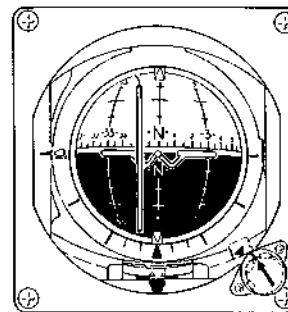

THE BANK STEERING BAR INDICATES BANK ANGLE STEERING UP TO 35° OF BANK TO APPROACH THE HEADING SELECTED BY THE HEADING SET KNOB ON THE HSI.

4E-1-(187) B

Figure 1-16

except that all communications are reduced in volume other than the following: communications between cockpits, the pullup tone from the attitude reference bombing computer set, and the Shrike aural tone. Thus, these signals override all other communications. COLD MIC operation can be selected separately in either cockpit. If either crewmember selects HOT MIC or RADIO OVERRIDE, his system corresponds to that function.

### Amplifier Selector Knob

A three-position rotary type amplifier selector knob is in the center of each intercom control panel. The three settings for the control are: B/U, NORM, and EMER. If the headset amplifier in either ICS station fails, place the knob to B/U (back-up) in the cockpit with the defective station. This switches from the normal headset amplifier to the back-up amplifier and restores normal operation. If selecting B/U does not restore ICS operation, select EMER

(emergency). Audio from the operative station is then connected directly to the back-up headset amplifier in the defective station. The volume control on the station with EMER selected has no effect on the audio level.

### NOTE

If both amplifier selector knobs are in an emergency position (B/U or EMER), and both intercom volume control knobs are above 75 percent of their volume range, a loud squeal is heard in both headsets. To eliminate the squeal, turn either volume control knob to a position below 75 percent of its volume range.

### Intercom Microphone Button

An intercom microphone button is installed on each cockpit inboard throttle grip. The intercom microphone button is utilized in whichever cockpit has COLD MIC



## VOR/ILS AND HEADING DISPLAYS

(AFTER TO 1F-4-1056)

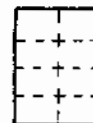

### VOR/ILS

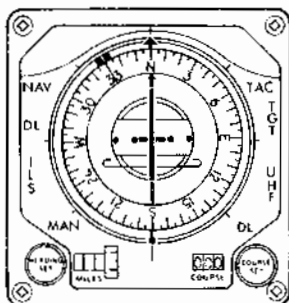

THE HEADING MARKER IS POSITIONED BY THE HEADING SET KNOB TO PROVIDE THE ADI BANK STEERING BAR WITH BANK AND AZIMUTH INFORMATION TO TURN TO THE SELECTED HEADING. THE COURSE ARROW IS POSITIONED BY THE COURSE SET KNOB TO THE VOR RADIAL OR RUNWAY HEADING. THE COURSE DEVIATION INDICATOR DISPLAYS THE AIRCRAFT DEVIATION FROM THE SELECTED VOR RADIAL OR RUNWAY HEADING. THE ILS MODE LIGHT IS ILLUMINATED IF AN ILS FREQUENCY IS SELECTED.

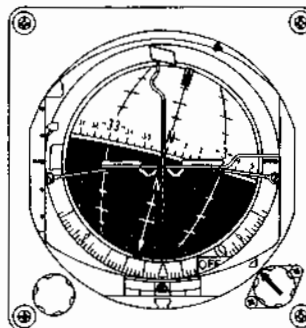

THE GLIDESLOPE INDICATOR DISPLAYS STEERING TO THE SELECTED ILS GLIDESLOPE. THE BANK STEERING BAR DISPLAYS STEERING TO THE VOR RADIAL OR ILS LOCALIZER. THE PITCH STEERING BAR DISPLAYS STEERING TO THE GLIDESLOPE CENTER AFTER GLIDESLOPE CAPTURE. THE WARNING FLAGS ARE NORMALLY OUT OF VIEW.

### HDG (HEADING)

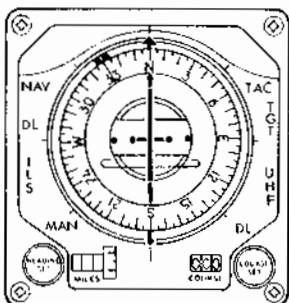

THE HEADING MARKER IS POSITIONED BY THE HEADING SET KNOB TO PROVIDE THE ADI BANK STEERING BAR WITH BANK AND AZIMUTH INFORMATION IN ORDER TO TURN TO THE SELECTED HEADING. THE MAN MODE LIGHT IS ILLUMINATED.

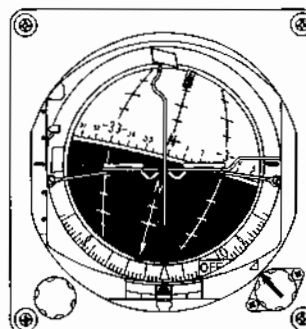

THE BANK STEERING BAR INDICATES BANK ANGLE STEERING UP TO 35° OF BANK TO APPROACH THE HEADING SELECTED BY THE HEADING SET KNOB ON THE HSI.

Figure 1-17

4E-1-(478)A

selected for inter-cockpit and cockpit to ground communication. When the intercom microphone button is actuated, a reduction of UHF volume occurs to facilitate crew communication.

### Intercom Preflight Check

To check the intercom system prior to flight:

1. Volume Control - AS DESIRED
2. Amplifier Selector Knob - NORM
3. Function Selector Switch - HOT MIC

With the intercom controls positioned as stated, check the duplex operation of the system by talking into the microphones. Rotate the volume control knobs to ensure that they are operating properly. Place the amplifiers selector knob to B/U or EMER to ensure that their amplifiers are operating properly. Place the function selector switch to COLD MIC and check the operation of the intercom microphone buttons on the throttles. Individually place the function selector switches to RADIO OVERRIDE and check for reduction of UHF communication and tacan volume. The RADIO OVERRIDE positions should be checked individually since a reduction in volume for the radio receivers is accomplished in both headsets when only one switch is actuated.

# NAVIGATION COMPUTER DISPLAYS

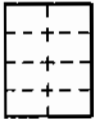

WHEN ON THE COMMAND HEADING, THE HEADING MARKER WILL BE UNDER THE LUBBER LINE. THE COURSE ARROW AND COURSE SELECTOR WINDOW DISPLAY MAGNETIC GROUND TRACK WITHIN NAV COMPUTER ACCURACY. THE DIFFERENCE BETWEEN THE AIRCRAFT HEADING AND THE BEARING POINTER IS WIND DRIFT.

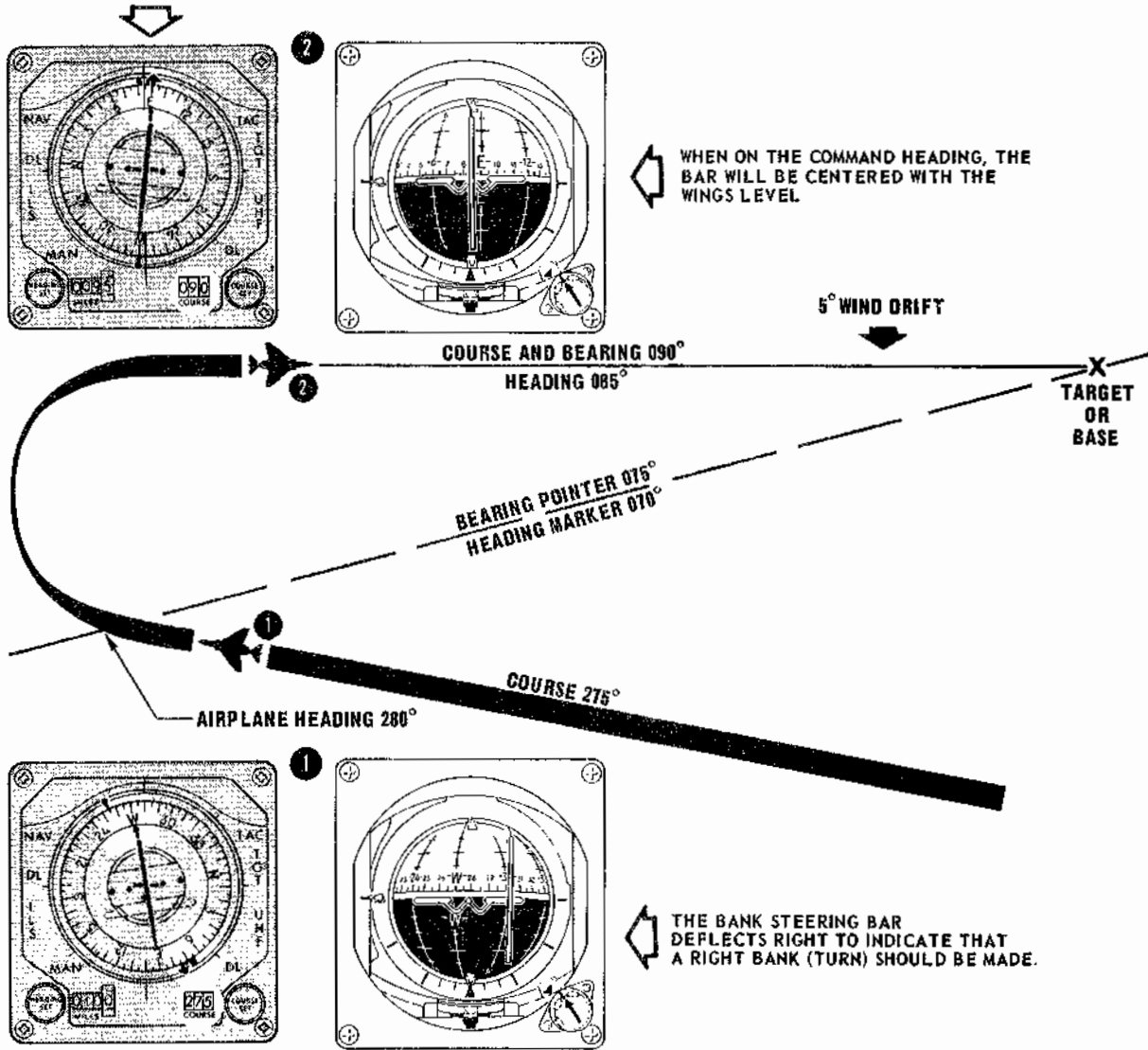

THE HEADING MARKER INDICATES THE MAGNETIC HEADING THAT MUST BE FLOWN TO MAKE GOOD A COURSE DIRECT FROM THE PRESENT POSITION OF THE AIRCRAFT TO THE DESTINATION (TARGET OR BASE) SELECTED ON THE NAV COMPUTER. WHETHER THE HEADING IS CORRECT OR NOT IS DEPENDENT UPON THE ACCURACY OF THE WIND DIRECTION AND VELOCITY, THE VARIATION, AND THE ACCURACY OF THE PRESENT POSITION. THE COURSE ARROW INDICATES THE MAGNETIC TRACK THAT IS CURRENTLY BEING MADE GOOD, ALSO DEPENDENT UPON THE ACCURACY OF THE NAV COMPUTER SETTINGS. THE COURSE DEVIATION INDICATOR IS SLAVED TO THE COURSE ARROW. THE COURSE SELECTOR WINDOW WILL INDICATE THE SAME MAGNETIC TRACK AS THE COURSE ARROW. THE BEARING POINTER INDICATES MAGNETIC BEARING TO DESTINATION. IN ORDER TO OBTAIN NAV COMPUTER INFORMATION FROM THE BEARING POINTER AND THE RANGE INDICATOR, THE BRG/DIST SWITCH MUST BE IN THE NAV COMP POSITION. IN THE REAR COCKPIT, WITH THE NAVIGATION MODE SELECTOR SWITCH IN THE NAV COMP POSITION THE BDHI NO. 1 POINTER WILL INDICATE MAGNETIC BEARING TO THE DESTINATION, AND THE NO. 2 POINTER WILL INDICATE MAGNETIC GROUND TRACK OF THE AIRCRAFT. THE BDHI RANGE INDICATOR WILL DISPLAY DISTANCE TO THE DESTINATION IN NAUTICAL MILES, AND THE AIRCRAFT MAGNETIC HEADING IS INDICATED UNDER THE LUBBER INDEX.

Figure 1-18

# TACAN DISPLAYS

WITH NO DRIFT, THE BANK STEERING BAR WILL BE CENTERED WITH THE WINGS LEVEL WHEN ON THE TACAN RADIAL.

### Notes

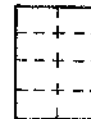

### TACAN STATION

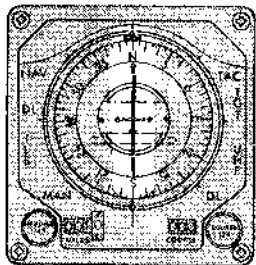

WHEN ON THE TACAN RADIAL, THE COURSE DEVIATION INDICATOR WILL BE CENTERED UNDER THE AIRPLANE SYMBOL.

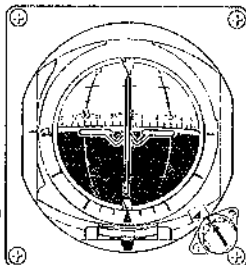

- WHEN OPERATING IN THE TACAN MODE, THE COURSE ARROW AND HEADING MARKER ON THE HSI MUST BE ALIGNED OR AN ERRONEOUS SIGNAL WILL BE SENT TO THE BANK STEERING BAR OF THE ADI. THIS ERRONEOUS SIGNAL WILL CENTER THE BANK STEERING BAR INDICATING THAT A PROPER BANK ANGLE HAS BEEN ESTABLISHED TO INTERCEPT THE SELECTED RADIAL, AND IN REALITY THE AIRPLANE WILL ACTUALLY BE OFF COURSE, WHEN THE AIRCRAFT IS ON THE SELECTED TACAN RADIAL AND HEADING WITH THE HEADING MARKER AND COURSE ARROW SET AT THE SELECTED COURSE. BOTH THE BANK STEERING BAR (ADI) AND THE COURSE DEVIATION INDICATOR (HSI) WILL BE CENTERED. IF IT THEN BECOMES NECESSARY TO ESTABLISH A CRAB ANGLE (AIRCRAFT HEADING DIFFERENT FROM THE SELECTED RADIAL) THE BANK STEERING BAR ON THE ADI WILL INDICATE A HEADING ERROR. TO ELIMINATE THIS APPARENT HEADING ERROR, THE HEADING MARKER SHOULD BE MANUALLY SET TO CORRESPOND TO THE NEW AIRCRAFT HEADING, DO NOT EXPECT THE BANK STEERING BAR TO AUTOMATICALLY CORRECT FOR WIND DRIFTS.
- IN THE REAR COCKPIT WITH THE NAVIGATION MODE SELECTOR SWITCH IN THE TACAN POSITION, THE BDHI NO. 2 POINTER WILL INDICATE BEARING TO THE TACAN STATION. THE BDHI RANGE INDICATOR WILL DISPLAY DISTANCE TO THE TACAN STATION, AND THE AIRCRAFT MAGNETIC HEADING IS INDICATED UNDER THE LUBBER INDEX.

THE BANK STEERING BAR WILL DEFLECT RIGHT AT APPROXIMATELY 15° FROM THE TACAN RADIAL TO INDICATE A RIGHT BANK (TURN) IS NECESSARY TO MAKE AN ASYMPTOTIC APPROACH TO THE TACAN RADIAL. TO INTERCEPT THE TACAN RADIAL AS SOON AS POSSIBLE, THE BANK STEERING BAR SHOULD BE DISREGARDED.

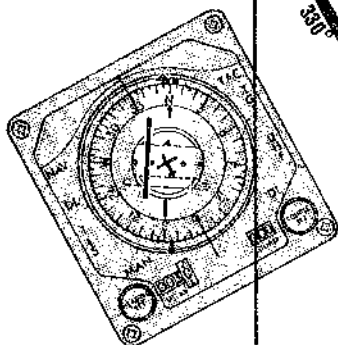

WHEN WITHIN 5° OF THE RADIAL, THE COURSE DEVIATION INDICATOR BEGINS MOVING TOWARD THE CENTER (AIRCRAFT SYMBOL). THE PILOT CAN NOW READ ANGULAR DISPLACEMENT FROM THE RADIAL ON THE COURSE DEVIATION INDICATOR.

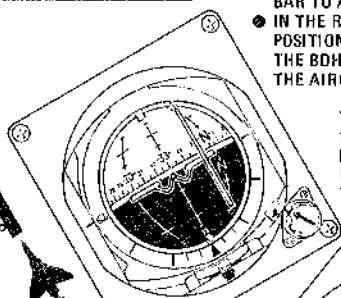

WHEN IN A LEFT BANK (TURN WITH THE BANK STEERING BAR CENTERED), THE BAR WILL DEFLECT RIGHT TO INDICATE A ROLL OUT ON APPROXIMATELY A 50° ANGLE APPROACH TO THE TACAN RADIAL. TO INTERCEPT THE TACAN RADIAL AS SOON AS POSSIBLE, DISREGARD THE BANK STEERING BAR AND INCREASE APPROACH ANGLE TO THE RADIAL.

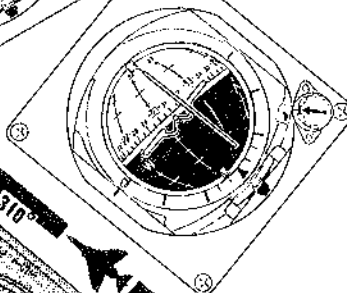

THE BANK STEERING BAR INDICATES BANK ANGLE STEERING UP TO 30° OF BANK TO APPROACH THE SELECTED TACAN RADIAL, HOWEVER, IN ORDER TO ATTAIN CORRECT STEERING INFORMATION, THE HEADING MARKER MUST BE ALIGNED WITH THE SELECTED TACAN RADIAL. A RELIABLE TACAN SIGNAL IS INDICATED BY THE RETRACTION OF THE RED FLAG LOCATED AT THE 12 O'CLOCK POSITION.



THE COURSE DEVIATION INDICATOR REPRESENTS THE ACTUAL TACAN RADIAL AND THE AIRCRAFT SYMBOL REPRESENTS THE AIRCRAFT POSITION RELATIVE TO THE RADIAL. THE DESIRED APPROACH ANGLE CAN BE SET UP BY FLYING THE AIRCRAFT SYMBOL TOWARD THE DEVIATION INDICATOR.

THE BANK STEERING BAR DEFLECTS LEFT INDICATING THAT A LEFT BANK (TURN) IS NECESSARY TO CENTER THE POINTER.

THE COURSE SELECTOR WINDOW AND THE COURSE ARROW ARE POSITIONED BY SELECTING THE DESIRED COURSE (TACAN RADIAL) WITH THE COURSE SET KNOB. THE HEADING MARKER IS MANUALLY ALIGNED WITH THE SELECTED TACAN RADIAL. THE COURSE DEVIATION INDICATOR DEFLECTS TO INDICATE AIRPLANE DISPLACEMENT TO THE RIGHT OR LEFT OF THE SELECTED COURSE. THE TWO DOTS ON EITHER SIDE OF THE COURSE DEVIATION INDICATOR INDICATE 2 1/2° PER DOT OF ANGULAR TRACK ERROR. THE TO-FROM INDICATOR INDICATES WHETHER THE COURSE SELECTED, IF INTERCEPTED AND FLOWN WILL TAKE THE AIRCRAFT TO OR FROM THE SELECTED TACAN STATION. THE BEARING POINTER INDICATES THE CURRENT MAGNETIC BEARING TO THE TACAN, PROVIDED THE BEARING DISTANCE SWITCH IS IN THE TAC POSITION.

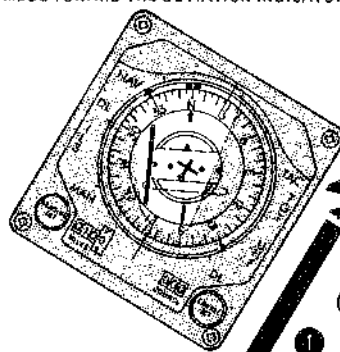

THE AIRCRAFT HEADING MUST BE WITHIN 60° OF THE TACAN RADIAL IN ORDER TO OBTAIN RELIABLE BANK STEERING BAR STEERING INFORMATION.

Figure 1-19

# HORIZONTAL SITUATION INDICATOR BEARING and DISTANCE DISPLAYS

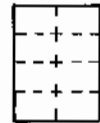

(BEFORE TO 1F-4-1056)

THE BRG/DIST SWITCH CONTROLS ONLY THE INDICATIONS DISPLAYED BY THE BEARING POINTER AND RANGE INDICATOR OF THE HSI.

## BEARING DISTANCE SWITCH

### NAV COMP (Navigation Computer)

THE BEARING POINTER INDICATES MAGNETIC BEARING TO THE DESTINATION SELECTED ON THE NAV COMPUTER. THE RANGE INDICATOR INDICATES THE NAUTICAL MILES TO THE DESTINATION SELECTED ON THE NAV COMPUTER (TARGET OR BASE). THE NAV LIGHT WILL BE ILLUMINATED.

## BEARING DISTANCE SWITCH

### ADF (Automatic Direction Finder)

THE BEARING POINTER INDICATES RELATIVE BEARING TO THE UHF STATION SELECTED ON THE COMMUNICATION CONTROL PANEL (EITHER COMM OR AUX ADF POSITION MUST BE SELECTED). THE RANGE INDICATOR WINDOW WILL BE BLANK. THE UHF LIGHT WILL BE ILLUMINATED.

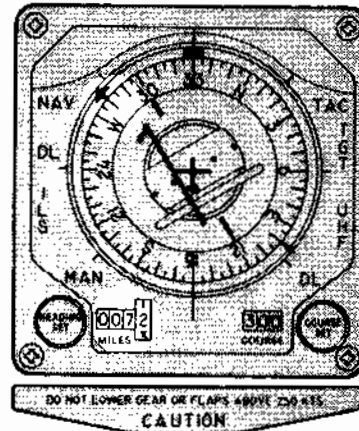

## BEARING DISTANCE SWITCH

### TACAN

THE BEARING POINTER INDICATES MAGNETIC BEARING TO THE SELECTED TACAN STATION. THE RANGE INDICATOR INDICATES THE SLANT RANGE NAUTICAL MILES TO THE TACAN STATION (FOR DISTANCE INDICATIONS, THE TACAN SELECTOR SWITCH MUST BE IN THE T/R POSITION). THE TAC LIGHT WILL BE ILLUMINATED.

Figure 1-20

4E-1-(90) A

## Normal Operation

The intercom system utilizes essential 28 volt dc power. Therefore, with electrical power applied place the function selector switches to HOT MIC, the amplifier selector knob to NOR, and the volume control knob as desired. Intercom can be maintained on battery power alone providing an engine master switch is on.

### NOTE

The intercom system is operative when the engine master switches or the refuel-defuel switch is energized.

## Emergency Operation

Intercommunication can be maintained despite amplifier failure in one or both intercoms. For emergency operation, refer to the Amplifier Selector Knob paragraph, this section.

## UHF RADIO

Ultra high frequency voice communications and automatic direction finding are provided by the UHF radio subsystem of the integrated electronic central. These subsystems contain the communication radio transmitter-receiver, referred to as the comm transmitter-receiver, and the amplifier power supply-receiver unit. The receiver in this unit is referred to as the aux receiver. The subsystems are controlled by control panels in each cockpit. The comm transmitter-receiver transmits and receives signals on 3500 manually selected frequencies, or on 18 preset frequency channels, within the 225.0 to 399.95 MHz frequency range. It is also used to transmit and receive guard (243.0 MHz). The receiver of this unit may be utilized to receive ADF signals, within its frequency range, and display them on the horizontal situation and bearing-distance-heading indicators. The aux receiver complements the receiver in the comm transmitter-receiver unit. It receives signals on 20 preset frequency channels within the 265.0 to 284.9 MHz range and guard, 243.0 MHz. It is also used to receive ADF signals within its frequency range, and display them on the horizontal situation and bearing-distance-heading indicators. The audio signals from the receivers are fed to the secondary amplifiers in the intercom system and then

# HORIZONTAL SITUATION INDICATOR BEARING AND DISTANCE DISPLAYS

(AFTER TO 1F-4-1056)

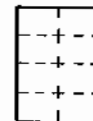

THE BRG/DIST SWITCH CONTROLS ONLY THE INDICATIONS DISPLAYED BY THE BEARING POINTER AND RANGE INDICATOR OF THE HSI.

## BEARING DISTANCE SWITCH

### VOR/TAC (VOR/TACAN)

THE BEARING POINTER INDICATES MAGNETIC BEARING TO THE VOR STATION SELECTED. THE RANGE INDICATOR INDICATES THE NAUTICAL MILES TO THE TACAN STATION SELECTED (TACAN IN T/R MODE). THE VOR LIGHT ILLUMINATES IF A VOR FREQUENCY IS SELECTED.

## BEARING DISTANCE SWITCH

### ADF/TAC (AUTOMATIC DIRECTION FINDER/TACAN)

THE BEARING POINTER INDICATES RELATIVE BEARING TO THE UHF STATION SELECTED ON THE COMMUNICATION CONTROL PANEL (EITHER COMM OR AUX ADF POSITION MUST BE SELECTED). THE RANGE INDICATOR WINDOW WILL DISPLAY SLANT RANGE TO THE TACAN STATION (TACAN IN THE T/R MODE). THE UHF LIGHT WILL BE ILLUMINATED.

## BEARING DISTANCE SWITCH

### NAV COMP (NAVIGATION COMPUTER)

THE BEARING POINTER INDICATES MAGNETIC BEARING TO THE DESTINATION SELECTED ON THE NAV COMPUTER. THE RANGE INDICATOR INDICATES THE NAUTICAL MILES TO THE DESTINATION SELECTED ON THE NAV COMPUTER (TARGET OR BASE). THE NAV LIGHT WILL BE ILLUMINATED.

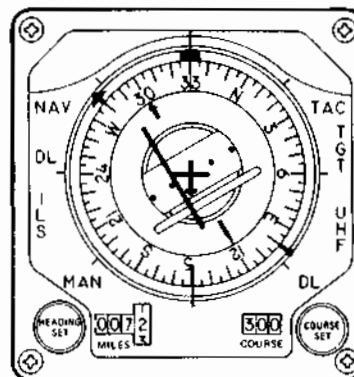

## BEARING DISTANCE SWITCH

### TAC (TACAN)

THE BEARING POINTER INDICATES MAGNETIC BEARING TO THE SELECTED TACAN STATION. THE RANGE INDICATOR INDICATES THE SLANT RANGE NAUTICAL MILES TO THE TACAN STATION (FOR DISTANCE INDICATIONS, THE TACAN SELECTOR SWITCH MUST BE IN THE T/R POSITION). THE TAC LIGHT WILL BE ILLUMINATED.

4E-1-(479)

Figure 1-21

to the headsets. All UHF receivers are susceptible to a squelch trail which can block reception of incoming signals. This problem can be alleviated by reducing the appropriate volume control setting. The subsystems utilize two UHF blade type antennas and one ADF antenna. Selection of either blade antenna is made with the antenna selection switch. Either crewmember may take command of the UHF radio as necessary. If desired, the number of preset channels may be greatly increased by channelizing different frequencies for each cockpit.

#### NOTE

On aircraft after TO 1F-4E-532, provisions for the installation of the speech security system

(KY-28) are provided. This system can have a direct effect on UHF transmission and reception. Refer to TO 1F-4E-34-1-1-1 for detailed description of the system and its operational application.

## UHF RADIO CONTROLS

The 3500 channel UHF radio is operated by controls on the communications control panel (figure 1-23), the antenna selector switch on the outboard engine panel in the front cockpit, the UHF remote channel indicators and the microphone switch. The controls on the communication

# COMMUNICATION-NAVIGATION-IDENTIFICATION EQUIPMENT

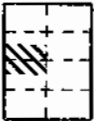

TYPE DESIGNATION	FUNCTION	RANGE
INTERCOM AN/ASQ-19	Intercockpit and cockpit-to-ground communications.	
UHF RADIO AN/ASQ-19	UHF radio communication between airplane and ship, airplane and shore, or between airplanes.	Up to line of sight, depending upon frequency and antenna coverage.
AUTOMATIC DIRECTION FINDER AN/ASQ-19	Indicates relative bearing of and homes on radio signal sources.	Up to line of sight, depending upon frequency and antenna coverage.
TACAN AN/ASQ-19	Indicates bearing and distance to ground stations. Determines identity and dependability of beacon.	Line-of-sight distance up to 196 miles depending upon altitude and attitude.
IFF AN/ASQ-19	Provides the functions of security, personal and traffic control identification.	0-200 miles or line-of-sight.
NAVIGATION COMPUTER AN/ASN-46A	Provides great circle information above 120 NM and rhumb line information below 120 NM.	Not applicable.
INERTIAL NAVIGATOR AN/ASN-63	Provides direction, velocity, and distance inputs to the navigation computer.	Not applicable.

4E-1-(83)A

Figure 1-22

control panels include the communication command button and indicator, UHF volume control knob, mode selector switch, communication channel control knob, set channel pushbutton, communication frequency thumbwheels, auxiliary channel control knob, auxiliary volume control knob, and the communication-auxiliary pushbuttons.

**Communication Command Button and Indicator**

The communication command (COMM CMD) button and indicator are on the upper left corner of the communication control panel. Operation of this button allows the crewmember to take or relinquish command of the comm transmitter-receiver, aux receiver and ADF functions. A green light to the right of the button illuminates in the cockpit which has communication command.

**UHF Volume Control**

The UHF volume control is a thumbwheel type control which is used to turn on the UHF communications and ADF systems, and to control the volume of the comm receiver-transmitter. The thumbwheel also has an on-off switch, with the 0 position being off. When adjusting the volume, the higher the number set, the stronger the incoming audio signal. The volume control is effective in each cockpit, regardless of which cockpit has command.

**Mode Selector Switch**

The mode selector switch is a three-position toggle switch which controls the mode of channel selection as follows:

# COMM-NAV CONTROL PANELS

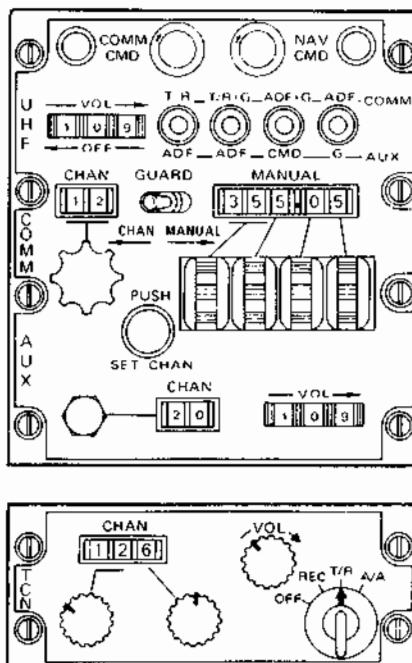
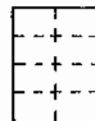

Figure 1-23

4E-1-(84)

- CHAN** When used in conjunction with the comm channel control knob provides a selection of preset channels 1 thru 18.
- GUARD** Channels the comm receiver and transmitter to the guard frequency with the T/R-ADF pushbutton depressed. With the T/R+G - ADF pushbutton depressed, the comm receiver and transmitter are channeled to the guard frequency and the guard receiver is on. This control is effective only from the cockpit with comm cmd.
- MANUAL** Permits manual selection of the comm receiver and transmitter frequency as indicated by the manual frequency dials. This control is effective only from the cockpit with comm cmd.

## Communication Channel Control Knob

The communication (COMM) channel control knob is a rotary switch used to select preset comm channels 1 through 18. The mode selector switch must be in the CHAN position for the comm channel control knob to be operative. The selected channel is indicated in the channel indicator adjacent to the comm channel control knob.

## Set Channel Pushbutton

The set channel pushbutton is used to preset comm channels 1 through 18. To set in a frequency into a channel, the mode selector switch must be placed to the CHAN position, the comm channel control knob must be rotated to the desired channel and the comm frequency thumbwheels must be positioned to the desired frequency. When the set channel pushbutton is then depressed, the frequency is set into the desired channel.

## Communication Frequency Thumbwheels

The communication (COMM) frequency thumbwheels are four rotary controls used to set a frequency into the comm receiver-transmitter or to preset frequencies into the comm receiver-transmitter channels. Frequencies can be set into the comm receiver-transmitter with the mode selector switch in the MANUAL position, and frequencies can be set into the comm receiver-transmitter channels with the mode selector switch in the CHAN position while depressing the set channel pushbutton. Frequencies from 225.00 to 399.95 MHz, in increments of 0.05 MHz, can be set using the comm frequency thumbwheels. The frequency selected is displayed on the manual frequency dial above the thumbwheels. The thumbwheels are effective only from the cockpit with comm cmd except when used for presetting comm channels 1 through 18.

## Auxiliary Volume Control

The auxiliary (AUX) volume control is a thumbwheel type control which is used to control the volume of the AUX receiver.

## AUX Channel Control Knob

The auxiliary (AUX) channel knob is a rotary switch used to select preset AUX channels 1 through 20. The channel frequencies cannot be reset from the cockpit. This control is effective only from the cockpit with comm cmd.

## COMM-AUX Pushbuttons

The COMM-AUX pushbuttons control the mode of operation of the UHF comm receiver-transmitter, AUX receiver, and ADF systems. The comm receiver, comm transmitter, comm guard receiver, AUX receiver and AUX guard receiver are controlled by the pushbuttons as indicated below (only the comm receiver-transmitter shall be discussed at this time):

T/R - ADF	Comm receiver - communication reception. Comm transmitter - communication transmission Comm guard receiver - not used AUX receiver - ADF reception AUX guard - not used
T/R+G - ADF	Comm receiver - communication reception. Comm transmitter - communication transmission Comm guard receiver - guard reception AUX receiver - ADF reception AUX guard receiver - not used
ADF+G - CMD	Comm receiver - ADF reception Comm transmitter - communication transmission with interruption of ADF during transmission Comm guard receiver - guard reception AUX receiver - communication reception within AUX receiver frequency range AUX guard receiver - not used
ADF-G	Comm receiver - ADF reception Comm transmitter - communication transmission with interruption of ADF during transmission Comm guard receiver - not used AUX receiver - not used AUX guard receiver - guard reception

The pushbuttons are effective only from the cockpit with comm cmd.

## Antenna Selection Switch

A two-position antenna selection switch, in the front cockpit on the outboard engine control panel is labeled UPR and LWR. This switch enables the pilot to select either the upper or lower UHF blade antenna for UHF radio operation.

## UHF Remote Channel Indicator

A UHF remote channel indicator is on the front and rear cockpit instrument panels. The indicators provide a secondary means of indicating the channel to which the comm receiver-transmitter is tuned when the mode selector switch is positioned to CHAN. The channel indicated on the UHF remote channel indicator corresponds to the channel indication on the control panel indicator associated with the comm channel control knob. The remote indicators show G when the mode selector switch is positioned to GUARD, and they show M when the mode selector switch is positioned to MANUAL.

## Microphone Switch

Two three-position microphone switches, one on the inboard side of the right throttle control handle in each cockpit, are used to key the comm transmitter when it is desired to communicate with a ground station or another aircraft. The switch has three positions, ICS, UHF and a center off position.

## COMM RECEIVER-TRANSMITTER OPERATION

The comm receiver-transmitter operation is as follows:

1. Rotate the UHF volume control to the ON position and adjust it to about half of its rotation.
2. Place the mode selector switch to the CHAN position.
3. Depress the T/R - ADF comm-aux pushbutton.
4. Rotate the comm channel control knob to the desired channel.
5. After the first receiver signal is heard in the headphones, the volume may be adjusted.
6. Transmitting on the same channel is accomplished by depressing the throttle mounted microphone button.

## Manual Adjustment of Frequencies

1. Place the mode selector switch to MANUAL.
2. Depress the desired comm-aux button, T/R - ADF or T/R+G - ADF.
3. Rotate the comm freq thumbwheel to select the desired frequency.

## Guard Operation

1. Place the mode selector switch to GUARD.
2. Depress the T/R+G - ADF comm-aux pushbutton.



## ADF OPERATION

The ADF operation is as follows:

1. Set the bearing distance selector switches to ADF.
2. Depress either the ADF + G-CMD or the ADF-GRD comm-aux pushbutton.
3. Place the mode selector switch to CHAN (select preset channels 1 thru 18), or MANUAL (select frequency using the comm frequency thumbwheels).

## ADF LOOP PREFLIGHT CHECK

The ADF loop should be checked with each of the two receivers utilized in the system, the comm receiver-transmitter, and the auxiliary receiver. Place the communication function selector knob (comm-aux pushbutton) on either central control panel to the comm receiver-transmitter ADF or the comm receiver-transmitter ADF+G position. Tune the main receiver-transmitter to the frequency of a station of known geographical location by use of the comm frequency control knobs (comm frequency thumbwheels), and adjust the comm vol control knob to obtain a comfortable listening level in the headset. Observe the bearing pointer and note that it indicates the approximate direction of arrival of the known signal relative to the aircraft heading. Place the communication function selector knob (comm-aux pushbuttons) in the auxiliary receiver ADF position and tune the auxiliary receiver to a station of known geographical location by use of the aux chan control knob. Select ADF on the bearing/distance selector switch. Note that the bearing pointer indicates the approximate direction of arrival of the known signal relative to the aircraft heading. Adjust the aux vol control knob for a comfortable listening level. (A 100 cycle buzz may be heard in the headset while the antenna is searching.) A check may also be accomplished by utilizing the transmitting facilities in the base control tower if the aircraft is taxied to a remote point of the base.

### NOTE

A tolerance of  $\pm 3.5^\circ$  of jitter (pointer hunting) of the bearing pointer is permissible.

Due to ADF pattern distortion at the higher frequencies of the UHF band, sizeable bearing inaccuracies can be expected at frequencies above 310 MHz. Precise navigational operation should be limited to assigned ADF frequencies (265 to 284.9 MHz) when using the auxiliary receiver, and to frequencies lower than 310 MHz when using the comm receiver-transmitter.

## TACAN (TACTICAL AIR NAVIGATION) SYSTEM

The tacan system provides precise air-to-ground bearing and distance information at ranges up to 196 miles from an associated ground or shipboard transmitting station. On aircraft after TO 1F-4-1124, the tacan system provides air-to-ground bearing and distance information at ranges up to 390 miles from an associated ground station, or within 200 miles of a cooperating aircraft (air-to-air). It determines the identity of the transmitting

station and indicates the dependability of the transmitted signal. It also provides deviation indication from a selected course. The tacan system utilizes radio navigation frequencies, the propagation of which is virtually limited to line of sight distances.

## TACAN CONTROLS

Controls for tacan operation are on the navigation control panels in each cockpit (figure 1-23). Additional controls are the navigation command buttons and indicators, the mode selector knob, and brg/dist selector switch, on the navigation function selector panel, in the front cockpit, and the navigation function selector switch, on the navigation function control panel, in the rear cockpit.

### Navigation Command Button and Indicator

The navigation command (nav cmd) button and indicator transfers control of tacan functions from one cockpit to the other. The navigation command button and indicator are on the upper right corner of the communication control panel. A green light to the left of the button illuminates in the cockpit which has navigation command.

### Mode Selector Knob

The mode selector knob is a four-position rotary switch used to select the source of information for display on the HSI and ADI. In TACAN, the tacan system supplies the HSI with information to display the source of the selected tacan radial, deviation from the selected radial, and whether the course is to or from the tacan station. A steering signal which aids the pilot in making an asymptotic approach to the selected tacan radial is displayed on the bank steering bar of the ADI. The course warning flag on the ADI is in view when the displayed tacan information is unreliable.

### TACAN CONTROL PANEL

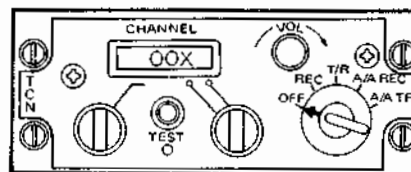

(AFTER TO 1F-4-1124)

4E-1-(489)

Figure 1-24

**BRG/DIST Selector Switch**

The brg/dist selector switch is a three-position switch that controls the source of information to the HSI bearing pointer, range indicator and mode word which indicates mode selected. With the switch in TACAN, the tacan system supplies information to the HSI bearing pointer and range indicator to indicate distance and magnetic bearing to the tacan station.

**Navigation Function Selector Switch**

When the navigation function select switch is placed to the UHF/ADF-TACAN position, the No. 2 pointer of the BDHI uses tacan system information to display magnetic bearing to the tacan station.

**Navigation Channel Control Knobs**

Two nav chan control knobs, one to the right and one to the left of the nav chan window permit channel selection. The left knob selects the tens and hundreds digits of the operating channel. The right knob selects the units digits of the operating channel. On aircraft after TO 1F-4-1124, the right knob contains an outer knob which selects the x or y channel. Placing the knob to x provides capability for 126 channel operation. Placing the knob to y adds an additional 126 channel capability to the tacan system. The dial system is numbered 0 to 129, each number from 1 to 126 represents a specific pair (transmitting and receiving) of frequencies. Number 0, 127, 128 and 129 on the channel dial are not usable.

**Tacan Function Selector Knob**

The tacan function selector knob is a four-position rotary switch with positions marked OFF, REC, T/R and A/A.

- OFF            The tacan system is deenergized.
- REC            Only the receiver portion of the system is energized, and the system receives and decodes bearing signals from the tacan station and provides bearing information for HSI and BDHI bearing display and ADI steering display.
- T/R            The tacan generates distance information which can be displayed on the HSI and BDHI as tacan station distance in nautical miles.
- A/A            The A/A position is inoperative.

**Tacan Function Selector Knob (AFTER TO 1F-4-1124)**

- OFF            The tacan system is deenergized.

REC            Only the receiver portion of the system is energized, and the system receives and decodes bearing signals from the tacan station and provides bearing information for HSI and BDHI bearing display and ADI steering display.

T/R            In addition to the REC functions the system sends a signal to the tacan station and receives information which is used to determine the aircraft distance from the tacan station. This distance is displayed on the HSI and BDHI in nautical miles.

A/A REC        The system receives and decodes bearing information from a cooperating aircraft and provides bearing information for HSI and BDHI displays and ADI steering display.

A/A TR         The tacan system interrogates a reference aircraft and range and bearing to the suitably equipped, cooperating aircraft is displayed on the BDHI and/or HSI. In this mode, the tacan system provides distance replies to other aircraft when interrogated.

**Navigation Volume Control Knob**

The nav vol control knob controls the volume of the audio identification signal received from the transmitting station.

**Tacan Test Button (AFTER TO 1F-4-1124)**

After the tacan system is turned on and warmed up, pressing the tacan test button (figure 1-24) causes the test indicator to flash momentarily indicating that the test indicator is operational.

**Automatic Self Test (AFTER TO 1F-4-1124)**

If the bearing signal is lost or becomes unreliable, the tacan switches to an automatic self test. If there is a detected malfunction in the system the test indicator comes on steady.

**Inflight Confidence Test (AFTER TO 1F-4-1124)**

If tacan indicator readouts become suspect during flight, perform an inflight confidence self test of the tacan system by setting the tacan function selector knob to T/R and then pressing the tacan test button; the test indicator flashes momentarily. If the test indicator lights steady during the test cycle, place the function selector knob to REC and again press the test button. If the indicator lights

steady during the test cycle in both the T/R and REC modes, the bearing, course deviation, to-from, and distance information on the HSI is invalid. If the test indicator came on in the T/R mode but not in the REC mode, the distance information is invalid and the bearing, course deviation, and to-from information displayed on the HSI is valid.

## FLIGHT CHECKS OF TACAN SYSTEM

To check operation of the tacan receiver and transmitter while in flight, proceed as follows:

1. After sufficient warm-up time, set tacan function selector knob to T/R. Set mode and bearing/distance selector switches to TACAN.
2. Tune to and identify a tacan ground station.
3. When the aircraft is directly over a suitable visual checkpoint, note bearing and distance on the BDHI and HSI. This should correspond to the bearing and distance of the tacan ground station as determined from an aeronautical chart.

### WARNING

When in the gear down configuration, reflections and improper polarization of the tacan antenna may cause erratic deviations in the bearing pointer.

These deviations are usually greater close to the station and vary with the relationship of the pattern to the station. When using tacan with gear down, cross check with ground radar, airborne radar, and other means. On aircraft after TO 1F-4-1124, with gear up, the tacan system may occasionally be subject to a false lock-on, which results in an erroneous bearing indication. Because of an inherent characteristic of the system, the error will probably be  $\pm 40^\circ$ , but can be any value which is a multiple of  $40^\circ$  and can be either side of the correct bearing. Therefore, when using the tacan with gear up, cross check for false lock-on with ground radar, airborne radar, dead reckoning, or other available means. These cross checks are especially important when switching channels. If a false lock-on is suspected, switch to another channel, check it for correct bearing, and then switch back to the desired channel. If a false lock-on still persists, utilize other equipment or aids available.

4. Set the navigation channel to an unused channel. After about 10 seconds, the range warning flag on the range indicator should cover the distance display, the bearing pointer of the indicator should resume searching, and the audio identification signal should cease.
5. Turn off the equipment by placing the tacan function selector knob to OFF.

## VOR/ILS SYSTEM (AFTER TO 1F-4-1056)

The VOR/ILS (VHF omnidirectional range, instrument landing system and marker beacon receiver) provides a precise bearing to a ground station and displays deviation of the aircraft from a selected course (VOR). The system also provides the capability for the aircraft to make a precision landing approach and descent (ILS). The VOR function provides steering to the VOR radial and VOR station. The VOR frequency range is 108.00 to 117.95 MHz. The localizer function provides lateral guidance information to position the aircraft on the runway centerline during approach. The localizer frequency range is 108.10 to 111.95 MHz. The glideslope function provides vertical guidance information to position the aircraft on the glideslope angle during the final approach. The ILS glideslope frequency is determined by the localizer frequency selection and operates within the frequency range of 329.15 to 335.00 MHz. The marker beacon is a 75 MHz receiver used as a positioning aid.

## VOR/ILS CONTROLS AND INDICATORS

The VOR/ILS system consists of a VOR/ILS control panel, a course indicator, a VOR light, two marker beacon lights, a VOR/ILS volume control, (labeled NAV VOL), and a marker beacon volume control. The VOR light, on the front cockpit main instrument panel, illuminates when the VOR system is initiated and ready for display. The marker beacon lights, on the main instrument panel of both cockpits, illuminate when the aircraft passes over a marker beacon transmitter during final approach. The VOR/ILS marker beacon volume control, in the rear cockpit left console, is a combination of two knobs. The square knob adjusts the gain of the VOR and localizer audio in the rear cockpit, and the round knob adjusts the gain of the marker beacon audio in the rear cockpit. Components used by the VOR/ILS that are not part of the system are the BDHI, intercom, ADI, HSI, bearing/distance selector switch, navigation mode selector switch, and the flight director switch. The flight director (FD) switch is a two-position rotary switch stacked on the navigation mode selector switch. With the FD switch in the off position, the bank and pitch steering bars are driven out of view in all modes.

## VOR/ILS CONTROL PANEL

The VOR/ILS control panel in the front cockpit left console contains a frequency indicator, two frequency selector knobs, a VOR/ILS volume control knob (NAV VOL), a marker beacon volume control knob, (MB VOL), and a VOR/MKR test pushbutton. The frequency indicator displays the VOR or ILS localizer frequency selected by the concentric frequency selector knob. The outer knob selects the number to the left of the decimal point, and the inner knob selects the numbers to the right. Positioning the NAV VOL volume control knob clockwise from the OFF position enables the VOR/ILS control panel and the VOR/ILS receiver. This knob also adjusts the gain of the VOR and localizer audio in the front cockpit. The MB VOL control knob adjusts the gain of the marker beacon audio in the front cockpit.

## VOR/Marker Test Pushbutton

Pressing the VOR/MKR test pushbutton, after an ILS frequency has been selected on the frequency indicator, causes the marker beacon lights to illuminate. If a VOR frequency is selected, a valid VOR signal must be present and a course of 315° selected on the HSI course selector window before initiating test. Pressing the test pushbutton causes the course deviation indicator on the HSI to move to center (a maximum change of  $\pm 4$  degrees in the course selector window is allowable to center the course deviation indicator), the to-from pointer on the HSI to indicate TO, and the marker beacon light to illuminate.

## COURSE INDICATOR

The course indicator (CI), in the rear cockpit main instrument panel, consists of the set knob, localizer pointer, glideslope pointer, to-from indicator, marker beacon light, course selector window, relative heading pointer, and localizer and glideslope warning flags. The CI is not used in the VOR system. The set knob is rotated manually to set in a course in the course selector window. The course selected has no effect on the localizer pointer. The heading pointer displays aircraft present position relative to the course selected with the course set knob. The localizer and glideslope pointers indicate in which direction the aircraft must travel to align vertically and horizontally with the glideslope and localizer beams. The localizer and glideslope warning flags appear when an unreliable signal or receiver malfunction occurs. The marker beacon light illuminates when the aircraft passes over a marker beacon transmitter.

## NORMAL OPERATION OF VOR/ILS SYSTEM

To initiate the VOR system, rotate the NAV VOL control knob clockwise from the OFF position. Select a VOR frequency on the VOR/ILS control panel. Set the HSI course window to the desired VOR course and maneuver the aircraft to a heading less than 90° from the course selected. Place the navigation mode selector knob to VOR/ILS and the bearing/distance (BRG/DIST) switch to VOR/TAC. The VOR light illuminates indicating the system is ready for display. When the aircraft receives valid VOR bearing signals, the following occurs: the course warning flag on the ADI goes out of view, the bank steering bar deflects to indicate in which direction to bank the aircraft and steer to intercept the VOR radial, the bearing pointer will unlock from its stationary 4 o'clock position and swing to the valid VOR bearing, and VOR audio is heard in the headsets. The ADI steering function enables the aircraft to approach the VOR radial asymptotically and eventually fly directly over the selected VOR station. At the same time that the ADI is steering to intercept the radial, the HSI bearing pointer indicates magnetic heading to the VOR station, the course deviation indicator indicates the aircraft position with respect to the selected VOR radial, the to-from indicator is activated, and if tacan is operating, the range indicator displays slant range to the tacan station. In the rear cockpit, if the navigation mode selector switch is in VOR/TAC and both VOR and tacan are operating, the BDHI displays VOR bearing on the No. 1 pointer, tacan bearing on the No. 2 pointer, and tacan slant range on the

range indicator. If tacan is not operating, the VOR bearing is displayed on both BDHI pointers and a flag covers the range indicator.

### NOTE

VOR information is unreliable if the HSI bearing pointer and the BDHI No. 1 pointer move to a stationary 4 o'clock position, and/or if the ADI course warning flag comes into view. Unreliable VOR information is displayed under marginal VOR signal conditions, such as maximum VOR radio range.

During flight the aircraft could encounter excessive crosswind which causes the aircraft to drift off course and the HSI course deviation indicator not to center under the lubber line while the ADI is showing wings level and no steering commands. To compensate for this condition, fly the aircraft to a heading which causes the HSI course deviation indicator to remain centered, then rotate the heading set knob on the HSI to place the heading marker under the lubber line. This provides additional steering to compensate for the strong crosswind.

To initiate the ILS System, rotate the NAV volume control knob clockwise from OFF. Select the runway localizer frequency on the VOR/ILS control panel. Set the HSI course arrow and the course selector window to the ILS final approach course, and maneuver the aircraft to a heading less than 90° from the selected course. Place the navigation mode selector knob to VOR/ILS and the ILS mode light on the HSI will illuminate. When the aircraft receives a valid localizer signal, the course warning flag on the ADI and the localizer warning flag on the course indicator are driven from view, the localizer identification tone is heard in the headsets and the ADI bank steering bar deflects to indicate in which direction to bank the aircraft and steer to intercept the localizer beam. The bank steering bar commands an asymptotic approach to the localizer centerline. Operational requirements may require a faster intercept in which case the bank steering bar should be disregarded and the intercept completed with reference to the CDI. The HSI course deviation indicator and the CI localizer pointer deflect to indicate the aircraft position with respect to the localizer beam. Prior to glideslope intercept, a strong cross wind may cause the aircraft to track slightly off-center and parallel to the course with bank steering bar centered. Upon glideslope intercept, the heading error is washed out and the bank steering bar computes the localizer centerline. As the aircraft continues inbound on the localizer approaching the glideslope from below, the ADI glideslope indicator and CI glideslope pointer deflect to indicate the aircraft position with respect to the glideslope and the ADI pitch steering bar pops into view indicating in which direction to steer the aircraft to reach glideslope center. Marker beacons associated with the approach will cause the marker beacon lights to illuminate and an identification tone to be heard as the aircraft passes overhead.

## IDENTIFICATION SYSTEM (IFF)

The identification system provides automatic identifications of the airplane in which it is installed when challenged by surface or airborne radar sets. Supplementary purposes are to provide momentary

identification of position upon request, and to transmit a specially coded response to indicate an emergency. In operation, the identification system receives coded interrogation signals and transmits coded response signals to the source of the challenge. Proper reply indicates the target is friendly. Three modes of operation are provided for interrogation or response to interrogation signals. These are known as Mode 1, Mode 2, and Mode 3/A, which are used for security identification, personal identification and traffic identification, respectively. Controls are provided for on the IFF control panel for a fourth mode, Mode 4. The codes for Modes 1 and 3/A can be set in the cockpit, but the code for Mode 2 must be set on the ground. Mode 2 can be set from code 0000 to code 7777.

**IFF CONTROLS AND INDICATORS**

The controls on the IFF control panel (figure 1-25), consist of the MASTER switch, the Mode 1, Mode 2, Mode 3/A and Mode 4 selector switches, the Mode C selector switch, used for altitude reporting (labeled MC-ON-OUT), the Mode 1 and Mode 3/A code selectors, the identification of position switch, the Mode 4 indication switch (with positions AUDIO-OUT-LIGHT), the Mode 4 function switch (with positions ZERO-B-A-HOLD), and the monitor-radiation test enable switch. The IFF indicators are on the IFF control panel. They consist of the self test reply indicator light (labeled TEST) and the Mode 4 reply indicator light (labeled REPLY). There is also an IFF and an ALT ENCODER OUT light on the telelight panel. Steady illumination of the IFF light indicates that the IFF is not responding to Mode 4 interrogations. The ALT ENCODER OUT light illuminates if the altitude reporting signal from the altitude encoder unit is unreliable.

**Master Switch**

The master switch is a five position rotary switch which controls the operation of the entire system as indicated below:

OFF	Identification system deenergized.
STBY	Full power supplied to the system, but with interrogations blocked.
LOW	System operates with reduced sensitivity.
NORM	System operates at full sensitivity.
EMER	Allows the system to respond to interrogations in MODES 1, 2 and 3/A. The reply for Modes 1 and 2 is a special emergency signal of the codes selected on the applicable dials, while Mode 3/A replies are special emergency signals of code 7700.

**Mode 1 Selector Switch**

The three position Mode 1 selector switch controls the operation of Mode 1 as follows:

M-1	Self test position. (Inoperative)
ON	Enables Mode 1 for operation.
OUT	Disables Mode 1.

**Mode 2 Selector Switch**

The three position Mode 2 selector switch controls operation of Mode 2 as follows:

M-2	Self test position. Test light illuminates if Mode 2 is operating properly.
ON	Enables Mode 2 for operation.
OUT	Disables Mode 2.

**Mode 3/A Selector Switch**

The three position Mode 3/A selector switch controls operation of Mode 3/A as follows:

M-3/A	Self test position. Test light illuminates if Mode 3/A is operating properly.
ON	Enables Mode 3/A for operation.
OUT	Disables Mode 3/A.

**Mode C Selector Switch**

The three position Mode C selector switch controls operation of Mode C as follows:

**IDENTIFICATION SYSTEM CONTROL PANEL**

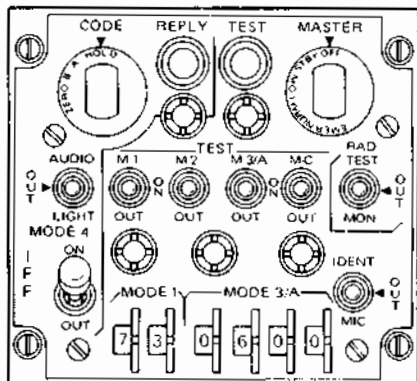
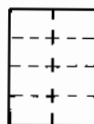

Figure 1-25

4E-1-182)

## TO 1F-4E-1

M-C	Self test position. (Inoperative)
ON	Enables Mode C for operation.
OUT	Disables Mode C

### Mode 1 and Mode 3/A Code Selectors

The Mode 1 code selector is used to select Mode 1 codes for 00 to 73. The Mode 3/A code selector is used to select Mode 3/A codes from 0000 to 7777.

### Mode 4 Selector Switch

The two position selector switch controls the operation of Mode 4 as follows:

ON	Enables Mode 4 for operation.
OUT	Disables Mode 4.

### Mode 4 Indication Switch

This switch has positions of AUDIO, OUT, and LIGHT. In AUDIO, an audio signal indicates Mode 4 interrogations are being received. The Mode 4 REPLY light illuminates when replies are transmitted. In LIGHT, the Mode 4 REPLY light illuminates when Mode 4 replies are transmitted. Audio is not present. In OUT, both light and audio indications are inoperative. The indication switch must be in the AUDIO or LIGHT position to test the press-to-test mode 4 reply indicator light.

### Mode 4 Function Switch

This switch has positions of ZERO, B, A, and HOLD. When the switch is placed to A, the systems transponder responds to Mode 4 interrogations from an interrogator using the same setting as set into the A position. In B, interrogations from an interrogator using the same code setting as that set into the B positions are answered. The code settings for the A and B positions are inserted before flight. Both code settings can be zeroed by placing the Mode 4 function switch to ZERO. The HOLD position is not used in flight but it is used to retain the code setting if another flight is anticipated during the code period. Positioning the switch momentarily to HOLD after landing and waiting 15 seconds before placing the master switch to OFF will retain the code with the power off.

### Monitor-Radiation Test Switch

This switch has positions of RAD TEST, MON, and OUT. The switch is placed to the OUT position and is not used during flight.

### Identification of Position Switch

The identification switch is a three position toggle switch utilized by the pilot upon request to provide momentary identification of position. The three positions are as follows:

IDENT	Allows the system to respond with identification of position replies in all modes that are being used. The response is continued for a 15 to 30 second duration after the switch is released.
OUT	Disables identification of position capability.
MIC	Same as positioning the switch to IDENT, except that the UHF microphone button must be keyed.

## SELF TEST OPERATION

To self test Modes 2 and 3/A, place the master switch to NORM and hold the switch for the mode being tested to the upper (test) position. If the test light on the IFF control panel illuminates, this indicates the mode is operating properly. Mode 1 and Mode C do not have the self test feature.

## NORMAL OPERATION OF IDENTIFICATION SYSTEM - IFF

To operate the system rotate the master switch to STBY. After an approximate 80 second time delay the system is supplied with full power but interrogations are blocked. Set the Mode 1, Mode 2, Mode 3/A, and Mode C switches as directed. Set the Mode 1, Mode 3/A, Mode 4 code selector switches and Mode 4 function switch as directed. Set the master switch to NORM. The system is now ready for operation on the selected modes. If the master switch is rotated from OFF directly to an operating mode, there is an approximate 80 second time delay before the system is fully operational. For I/P switch operation, place the I/P switch in the IDENT position, or place it in the MIC position and key the UHF microphone. The IFF system responds with special I/P signals. If the IFF light (telelight) and Master Caution light illuminates momentarily, place the Mode 4 selector switch to ON and the master switch to LOW or NORMAL. If the master switch must remain in STBY, select a code with the Mode 4 function switch which is not being interrogated.

## IFF EMERGENCY OPERATION

Upon ejection from either cockpit, IFF emergency operation automatically becomes active. If the master switch is in the OFF position prior to ejection, the system will begin operation after an approximate 80 second delay. In an emergency rotate the master switch to EMER. The reply for Modes 1 and 2 are special emergency signals of the codes selected on the applicable dials; while Mode 3/A replies are special emergency signals of code 7700.

## CANOPIES

Each cockpit area is enclosed by a separate transparent, acrylic plastic, clam shell type canopy. The canopies are hinged aft of each cockpit enclosure and open approximately 53°. Canopy operation, both normal and emergency, is accomplished pneumatically. Clean dry air at 3000 psi is supplied by the basic pneumatic system and is reduced by a pressure regulator to 900  $\pm$  100 psi for use in the normal canopy system. Individual manual internal and external controls are provided for each cockpit. Normal canopy closing time, from full open to lock light out is 4 to 9 seconds. Each cockpit employs an inflatable canopy seal to seal the canopies for cockpit pressurization. The canopy seals are automatically inflated and deflated upon opening and closing of the canopies. The respective cockpit canopy internal control handle is on the left side of the cockpit above the flap control panel and below the canopy sill. Each canopy control operates independently of the other. Pull the control handle aft to OPEN the canopy; push forward to CLOSE the canopy. One rod of the mechanical canopy locking linkage on the left side of the cockpit is provided with a painted-on indicator stripe. This stripe, when aligned with a similar stripe on a fixed tab, gives a positive canopy locked indication. The cockpit external canopy control push buttons are on the left side of the aircraft below the respective canopy frame. Push the OPEN button to open the canopy; push the CLOSE button to close the canopy. The push buttons operate the same valves as the internal canopy controls. A guard is installed around the front and rear canopy control to prevent inadvertent actuation of the canopy control due to uncontrolled rearward motion of crewman.

### EXTERNAL CANOPY MANUAL LOCK/UNLOCK HANDLES

The canopy external manual unlock handle is on the left side of the fuselage below the rear end of the respective canopy. Operating a push-type latch causes the handle to pop out about 1¼ inches. A 63° rotation of the handle unlocks the canopy lock mechanism and permits the canopy to be lifted open manually. Operating the handles in the opposite direction, when the canopy is closed, locks the canopy. Before manual locking or unlocking of the canopy, the normal canopy pushbutton must be pressed to close position before locking, to open position before unlocking. The manual lock/unlock handle is used in the event the aircraft pneumatic systems are depleted.

### INTERNAL CANOPY MANUAL UNLOCK HANDLES

The respective cockpit manual canopy unlock handle is on the right side of each cockpit. The handle, when pulled aft, unlocks the canopy so that it may be pushed open. Before manual unlocking of the canopy, the normal control lever must be placed in the OPEN position. The manual unlock handle is used in the event the aircraft pneumatic systems are depleted.

## CANOPY UNLOCKED WARNING LIGHT

A red CANOPY UNLOCKED warning light, on the telilight panel in the front cockpit and on the instrument panel in the rear cockpit, is used to notify the crew that a canopy is unlocked. The front cockpit CANOPY UNLOCKED light illuminates when either canopy is unlocked. The rear cockpit warning light illuminates only when the rear canopy is unlocked.



The canopy should not be stopped in an intermediate position.

## CANOPY EMERGENCY SYSTEMS

The canopies are jettisoned by compressed air at 1170  $\pm$  50 psi supplied from the basic pneumatic system to two independent canopy jettison systems (one for each cockpit). Each canopy jettison system incorporates an air bottle which traps and stores compressed air at 3000 psi and a pressure operated valve that is off-seated by ballistic pressure when the seat mounted or bulkhead mounted initiator is fired. The seat mounted initiator is fired by pulling the face curtain or lower ejection handle during the ejection sequence. The bulkhead mounted initiator is fired by the emergency canopy jettison handle or the external canopy jettison handle. When the external canopy jettison handle is actuated, both canopy jettison systems are operated and both canopies are jettisoned for ground rescue purposes. When the ejection handles or the canopy jettison handles are pulled, an initiator is fired. Gas pressure from the initiator off-seats the pressure operated valve which directs air pressure to the bottom side of the canopy actuator. At the same time, all air pressure from the top of the canopy actuator is directed to a dump valve. The canopy opens quickly and its momentum shears the canopy attaching points. Electrically initiated cartridge thrusters are incorporated in the canopy sills under the forward cockpit canopy. The thrusters are designed to assist the canopy actuating cylinder during canopy jettisoning by providing a thrust on the forward part of the canopy to lift it quickly up into the airstream as soon as the canopy is unlocked. The thrusters are fired electrically by a thermal battery which is activated by gases from either the seat mounted or cockpit mounted initiators. Once having been activated, the battery fires the thrusters through the canopy unlock switch as soon as the canopy unlocks and the switch closes. The thermal battery has a useful life of 15 seconds after activation and the canopy must be unlocked within this time to complete the circuit to the thrusters. The canopy will not jettison when open because the canopy actuator is at the top of the stroke; therefore, the canopy cannot develop momentum. A plastic protector is installed over the aft bulkhead mounted canopy initiator and its adjacent actuating linkages. The purpose of the protector is to prevent inadvertent canopy jettison. Space is provided for installation and removal of the initiator safety pin, and a window is provided in the protector for inspection of the linkages and safety pin. A guard is installed over the seat mounted initiator linkages in the rear cockpit to give added protection against inadvertent initiation due to foreign objects. Before TO 1F-4-1108, the

forward canopy jettison system air bottle is installed in the nose wheelwell. After TO 1F-4-1108, the forward canopy jettison system air bottle is installed behind the forward seat to minimize system damage due to flak, fire, etc. A gage, indicating emergency air bottle pressure, is installed to the left and outboard of the bottle.

### WARNING

Do not jettison front canopy if rear canopy is open and rear seat is occupied because the front canopy will collide with the rear canopy and fall into the rear cockpit.

## LIGHTING EQUIPMENT

### EXTERIOR LIGHTING

The exterior lights consist of the position lights (wing and tail) join-up lights (wing only), fuselage lights, anti-collision light, landing light, taxi light, inflight refueling receptacle light and flood lights and electroluminescent formation lights. The exterior lights control panel is on the right console, front cockpit. The exterior lights control panel contains all the controls for exterior lighting except for the landing/taxi light switch on the left sub-panel.

#### Position and Join-Up Lights

The position lights include a green light on the right wing tip, a red light on the left wing tip, and a white light on the tip of the vertical stabilizer. The join-up lights consist of an additional green and red light on the trailing edge of the applicable wing tip. The wing lights and join-up lights are controlled by one switch, labeled WING, with positions marked OFF, DIM and BRT. The wing and join-up lights do not have flash capabilities. The tail light is controlled by a similar switch labeled TAIL. The tail light will not illuminate unless the flasher switch is in the STEADY or FLASH positions. The tail light flashes when the flasher switch is in the FLASH position. When the switches are in BRT, the lights illuminate at full brilliance. Placing the switches to DIM reduces the brilliance of the lights. The position and join-up lights BRIGHT utilize right main 28 volt ac power, and the lights DIM utilize left main 14 volt ac power.

#### Anti-Collision and Fuselage Lights

Three semi-flush white lights are on the fuselage, one immediately aft of the rear cockpit canopy, and one light below each of the engine intake ducts. One red anti-collision light is on the leading edge of the vertical stabilizer. The anti-collision and fuselage lights are controlled by one switch labeled FUS, with positions marked OFF, DIM and BRT. The anti-collision light illuminates only when the fuselage switch is in the BRT and flasher switch is in the FLASH position. The fuselage lights will not illuminate unless the flasher switch is in the STEADY or FLASH positions. The fuselage lights flash

when the flasher switch is in the FLASH position. The fuselage lights BRIGHT utilize right main 28 volt ac power and the lights DIM utilize left main 14 volt ac power. One of the two lamps in the anti-collision light utilizes right main 28 volt ac power and the other lamp utilizes left main 28 volt ac power.

### Exterior Light Flasher Switch

The exterior light flasher switch, on the exterior lights control panel, actuates a flasher relay and flasher unit when FLASH is selected. The flasher unit operates in conjunction with the fuselage lights, anti-collision light and tail light. The three positions of the exterior lights flasher switch are FLASH, OFF and STEADY. If STEADY is selected, the tail light and fuselage lights produce a steady illumination, provided the FUS light switch and tail light are in the DIM or BRT positions. Placing the flasher switch to FLASH causes the fuselage lights, tail light, and anti-collision lights to flash. By placing the flasher switch to OFF, the fuselage lights, tail light and anti-collision light are turned off. The flasher unit and relay is powered by the main 28 volts dc bus.

### Landing and Taxi Lights

The landing and taxi lights are on the forward nose gear door. The landing and taxi lights switch is on the left sub-panel of the front cockpit. The taxi light is illuminated by right 28 volt ac bus power and the landing light is illuminated by left 28 volt ac bus power. Since circuitry of both lights goes through the left main landing gear down limit switch, the left main landing gear must be down for operation of either light.

### IFR Receptacle Light and Flood Lights

A light in the air refueling receptacle compartment illuminates automatically when the air refueling receptacle is raised. Two IFR flood lights are added to the fuel cell 2 door and face aft to improve illumination of the receptacle. This makes night air refueling contacts more accessible, thereby reducing possible damage to the receptacle or boom. These lights also illuminate automatically when the receptacle is raised. The IFR receiver flood lights circuit breaker is on the No. 2 circuit breaker panel, zone E6. The air refueling receptacle circuit breaker is also on the No. 2 circuit breaker panel, zone D1. The air refueling receptacle receives power from the right main 28 volt ac bus. The IFR receiver flood lights receive their power from the right main 28 volt ac bus.

### Formation Lights

After TO 1F-4-776, electroluminescent formation lights are added to the outer wing tips between the position lights and join-up lights, and on both sides of the vertical stabilizer, mid-fuselage and forward fuselage. These lights are controlled by the FORMATION lights switch and a variable control knob on the front cockpit formation lights control panel. The switch has positions ON, OFF, and MOM (momentary). The control knob, to the right of this switch, controls the intensity of the formation lights with positions OFF, DIM, MED, BRT and JOIN UP, with JOIN



UP the brightest position. The left outer wing tip formation lights are red and the rest of the formation lights are green. Power for these lights is provided by the right 115 volt ac bus.



Use of these lights during daylight hours is prohibited and a 3 amp fuse on the panel protects the dimming circuitry in the event of accidental daytime switch actuation which could result in excessive current. To restrict use on ground at night, lights should not be turned on until just before takeoff and they should be turned off immediately after landing.

## INTERIOR LIGHTING (FRONT COCKPIT)

Most of the lighting controls for the front cockpit, are on the cockpit lights control panel right console. A utility light, under the right canopy sill, has its own on-off switch and intensity control. An emergency red floodlight switch is above the cockpit lights control panel. The interior lights utilize ac power, from the engine driven generators.

### Instrument Panel Lights

Variation in instrument panel lighting is controlled by the instrument panel lights control knob, on the cockpit lights control panel. The control knob, labeled INSTR PANEL, has positions marked OFF and BRT. As the control knob is rotated out of the OFF detent, the instrument panel lights illuminate dimly. As the control knob is rotated toward BRT, the instrument panel lights increase in intensity until they illuminate bright. Secondary instrument panel lighting is provided by emergency (red) floodlights under the instrument panel glare shield. The control for the emergency floodlights is on the emergency floodlights panel above the cockpit lights control panel, and is labeled instrument floods. The emergency floodlights switch is marked OFF, DIM and BRT. The instrument panel lights are powered by the right main 115/200 volt ac bus. The red floodlights BRIGHT are powered by the essential 28 volt dc bus, and DIM by the left main 14 volt ac bus.

### Flight Instrument Lights Control Panel

A flight instrument lights control panel on the left corner of the main instrument panel contains a knob which is used to simultaneously control the intensity of the lights of the following instruments: airspeed/Mach indicator, attitude director indicator, angle of attack indicator, vertical velocity indicator, altimeter, and the horizontal situation indicator. The fully counterclockwise position of the control is OFF. As the control is rotated clockwise from OFF, the intensity of the lights increases. A switch within the control, actuated when the control knob is moved from OFF, dims the warning lights and HSI mode lights. However, the fire and overheat warning lights are not dimmed. With the knob out of the OFF position, the intensity of the flight instrument lights can be individually controlled by the knobs on the instrument

lights intensity control panel.

### Flight Instrument Lights Intensity Control Panel

A flight instrument lights intensity control panel above the right console contains six knobs which are used to independently vary the intensity of the lights on the following instruments: airspeed/Mach indicator, attitude director indicator, angle of attack indicator, vertical velocity indicator, altimeter, and the horizontal situation indicator. The intensity of each light increases as its control knob is rotated clockwise.

### Instrument Lights Intensity Circuit Breaker Panel

An instrument lights intensity circuit breaker panel is installed in the front cockpit outboard of the right subpanel. It contains the two circuit breakers necessary for the operation of the flight instrument lights control knob and for dimming the flight instruments lights and HSI mode lights.

### Console Lights

Console lighting is comprised of a combination of edge lights and floodlights. Variation in edge light intensity is controlled by the console lights control knob on the cockpit lights control panel. The control knob has positions marked OFF and BRT, and controls all edge lighting on the left console, the right console, the pedestal panel, and the armament control panels on the instrument panel. When the control knob is rotated out of the OFF detent, the console lights illuminate dim, and the console floodlights illuminate dim if the console floodlights switch is in the DIM position. The console floodlights switch, on the cockpit lights control panel, selects DIM, MED or BRT brilliance of the console floodlights. The console floodlights are off only when the console floodlights switch is in the DIM position and the console lights control knob is in the OFF detent. The console edge lights and console floodlights DIM receive power from the left main 115/200 volt ac bus. The floodlights BRT position receives power from the instrument 28 volt ac bus and the floodlights MED position receives power from the left 14 volt ac bus.

### White Floodlights

One white floodlight (thunderstorm light) is mounted above each console, under the canopy sill. The white floodlight control switch has positions marked OFF and ON and is on the cockpit lights control panel. The switch is a lever-lock type switch which prevents inadvertent actuation. Power for the white floodlights is provided by the battery through the battery bus, which is energized at all times.

### Magnetic (Standby) Compass Light

The standby magnetic compass light is controlled by the standby compass light switch and the console lights control knob. The light is turned on by placing the standby compass switch to ON and turning the console light control knob from the OFF position. The light intensity is

then varied by the control knob. Power for the light is provided by the left 115/200 volt ac bus forward cockpit console lights autotransformer.

### Indexer Lights

Angle of attack indexer lights are provided for both cockpits. The indexer lights control knob has positions marked DIM and BRT. Rotating the control knob clockwise from DIM to BRT increases the intensity of the indexer lights. Power for the indexer lights is provided by the instrument 28 volt ac bus.

### Utility Light

A detachable utility light is under the right canopy sill. The light has its own on-off and intensity control. The light may be changed from red to white to red by depressing the lens latch button and rotating the lens housing. Power for the utility light is supplied by the left main 28 volt ac bus.

### Warning Lights Test Switch

The warning lights test switch, a two-position toggle switch is on the cockpit lights control panel. The switch has positions marked NORM and TEST, and is spring-loaded to NORM. When the switch is placed to TEST, all warning lights illuminate except the air data mode and eject lights. The warning lights test circuit receives power from the warning lights 28/14 volt ac bus. The warning lights test control circuit receives power from the main 28 volt dc bus.

### Station Select Lights Control

A station select lights control is installed on the lower left instrument panel in the front cockpit. The control knob controls the intensity of the station and weapon select lights when the front cockpit flight instruments control knob is not in OFF. With the front cockpit flight instruments control knob in OFF, the station and weapons select lights, if selected, illuminate bright, regardless of the position of the station select lights control. With the front cockpit flight instruments control knob not in OFF, the intensity of these lights vary with the position of the station select lights control knob, with the extreme clockwise position being the brightest. For either position of the flight instrument control knob, the station and weapons select lights receive power from the main 28 volt dc bus.

### INTERIOR LIGHTING (REAR COCKPIT)

Cockpit lighting control knobs and switches in the rear cockpit are identical to those in the front cockpit. The cockpit lights control panel is on the right console and has a two-position white floodlights switch, a two-position magnetic compass light switch, a three-position console floodlights (red) switch, a two-position warning lights test switch, and instrument panel lights control knob and a console edge lights control knob. All control knobs and switches work identically to those in the front cockpit.

However, the intensity of the rear cockpit warning lights is dependent on the position of the front cockpit instrument panel light control knob.

## OXYGEN SYSTEM

Breathing oxygen is supplied by a 10-liter (10.6 quart) liquid oxygen system. The system basically consists of a converter, a coil to convert from liquid to gaseous oxygen and a console mounted pressure demand regulator in each cockpit. The oxygen system pressure should indicate between 50 and 125 psi until the converter is depleted. Relief valves prevent excessive pressure build-up. Refer to figure 1-26 for the oxygen duration chart. Even though there is no flow from the system, approximately 15% of the system capacity is lost every 24 hours. This loss is due to the conversion of liquid oxygen to gaseous oxygen and subsequent pressure relief.

### OXYGEN REGULATORS

The console mounted oxygen regulator is on the left console in the front cockpit, and the left subpanel in the rear cockpit. The regulator automatically controls the pressure and rate of flow of oxygen based on demand and altitude. It provides a proper mixture of air and oxygen at low altitudes and pressure oxygen at high altitudes. The console mounted oxygen regulator also provides a relief for any excess oxygen mask pressures.

### Supply Lever

A two-position lever, on the lower right corner of the regulator panel, controls the flow (on or off) of oxygen from the regulator.

### WARNING

For regulators other than the CRU-73/A, if the oxygen supply lever is OFF and the diluter lever is in NORMAL, there will be no restriction to breathing but the crewmember will be breathing cockpit air only and hypoxia will occur as cockpit altitudes that require oxygen are reached. It is therefore imperative to check for oxygen flow prior to takeoff. With the diluter lever in 100% or with the CRU-73/A regulator, if the oxygen supply lever is OFF, neither cockpit air nor oxygen will be available at the mask.

### Diluter Lever

A two-position diluter lever, in the center of the regulator panel, controls the mixture of air and oxygen. For a proportional amount of air to oxygen, the NORMAL OXYGEN position should be selected. For only oxygen, the 100% OXYGEN position should be selected.

# OXYGEN DURATION CHART

OXYGEN DURATION-HOURS											
COCKPIT ALTITUDE FEET	GAGE QUANTITY-LITERS										BELOW 1
	10	9	8	7	6	5	4	3	2	1	
35,000 and UP	24.3	21.8	19.4	17.0	14.6	12.1	9.7	7.2	4.8	2.4	-EMERGENCY- DESCEND TO ALTITUDE NOT REQUIRING OXYGEN
	24.3	21.8	19.4	17.0	14.6	12.1	9.7	7.2	4.8	2.4	
30,000	17.8	16.0	14.2	12.5	10.7	8.9	7.1	5.3	3.5	1.7	
	18.0	16.2	14.4	12.6	10.8	9.0	7.2	5.4	3.6	1.8	
25,000	13.7	12.3	10.9	9.6	8.2	6.8	5.4	4.1	2.7	1.3	
	17.0	15.3	13.6	11.9	10.2	8.5	6.8	5.1	3.4	1.7	
20,000	10.3	9.3	8.3	7.2	6.2	5.1	4.1	3.1	2.0	1.0	
	19.2	17.2	15.3	13.4	11.4	9.6	7.6	5.7	3.8	1.9	
15,000	8.3	7.4	6.7	5.8	5.0	4.1	3.3	2.5	1.6	.8	
	23.4	21.0	18.7	16.4	13.9	11.7	9.3	7.0	4.6	2.3	
10,000	6.7	6.0	5.3	4.7	4.1	3.3	2.6	2.0	1.3	.6	
	23.4	21.0	18.7	16.4	13.9	11.7	9.3	7.0	4.6	2.3	

- UPPER FIGURES INDICATE DILUTER LEVER-100% OXYGEN
- LOWER FIGURES INDICATE DILUTER LEVER-NORMAL OXYGEN

#### Note

- THE DURATION TIME IS DOUBLED WHEN ONLY ONE CREWMEMBER IS USING OXYGEN
- DURATION FIGURES BASED ON OXYGEN REQUIREMENT RATES GIVEN IN MIL-D-19326E.
- OXYGEN DURATION INCREASES AS COCKPIT ALTITUDE INCREASES BECAUSE THERE IS LESS AMBIENT PRESSURE ACTING UPON THE LUNGS AT ALTITUDE THAN AT SEA LEVEL. THEREFORE, A SMALLER QUANTITY OF OXYGEN AT ALTITUDE WILL EXPAND THE LUNGS TO THE SAME SIZE THAT THEY WERE AT SEA LEVEL.

4E-1-(22)

Figure 1-26

## Emergency Lever

A three-position emergency lever, on the lower left corner of the regulator panel, permits selection of emergency positive pressure, normal oxygen supply, or testing pressure for a face mask check. The lever should remain in the center (NORMAL) position at all times, unless an unscheduled pressure increase is required. Moving the lever to EMERGENCY provides continuous positive pressure to the face mask for emergency use. Moving the lever to TEST MASK provides positive pressure to test the face mask for leaks.

## Oxygen Flow Indicators

An oxygen flow indicator in each cockpit, alternately shows black and white with each breath, indicating oxygen flow.

## Oxygen Pressure Gages

An oxygen pressure gage indicates oxygen supply pressure in pounds per square inch. The gage is calibrated from 0 to 500 psi with normal pressure indication between 50 and

125 psi.

## OXYGEN QUANTITY GAGE

An oxygen quantity gage in each cockpit has a range from 0 to 10 liters. The indicators are electrically operated, with the front indicator a master indicator and the rear indicator a repeater. Loss of electrical power to either indicator is indicated by appearance of a power off flag on the instrument face. The liquid oxygen quantity gage should indicate 10 liters when the system is fully serviced.

## Oxygen Quantity Gage Test Button

The oxygen quantity gage test button is on the left vertical panel adjacent to the oxygen quantity gage in the front cockpit. The button is used to test operation of the front and rear cockpit gages along with operation of the oxygen low warning system. With the button depressed, both gage needles should rotate from the current oxygen quantity indication to an indication of zero within 15 seconds after the button is depressed. As the pointer in the front cockpit passes through the 1 liter indication, the OXYGEN LOW warning light on the front telelight panel should illuminate, and remain illuminated until the pointer

again rotates above 1 liter. After releasing the button, both gage pointers return to an indication of current oxygen quantity and the OXYGEN LOW warning light goes out when the front indicator indicates above 1 liter.

## OXYGEN SUPPLY

Breathing oxygen can be supplied to the face mask by the pressure demand regulator or the emergency oxygen storage bottle on the ejection seat. Under normal operation, oxygen is converted from a liquid state to a gaseous state by the oxygen converter and warm-up plate assembly. The gaseous oxygen, at a pressure between 75 and 125 psi, is then routed to the console mounted pressure demand regulator. The regulator will then supply oxygen upon demand at low altitudes, or under pressure at high altitudes, to the face mask through the aircraft oxygen supply hose, the oxygen omni-connector, and the face mask hose. In the event of a failure of the main oxygen supply system, a limited amount of oxygen can be obtained from the emergency oxygen storage bottle. When the emergency oxygen manual release knob is pulled, either manually or automatically upon ejection, oxygen at a pressure of 1800 psi is released. The high pressure oxygen passes through a pressure reducer, and into the emergency oxygen supply hose. It then passes through the flow restrictor, the oxygen omni-connector, and the face mask hose to the face mask. The oxygen supply system has a normal and an emergency flow. See figure 1-27 for comparison of normal and emergency flow. Resistance to exhalation is noted when utilizing oxygen in the alternate flow or emergency flow modes. This is caused by a back pressure build up of the oxygen being delivered to the face mask once inhalation has ceased. This condition can be alleviated by spilling oxygen out of the side of the mask.

### WARNING

To prevent excessive emergency oxygen loss, the aircraft oxygen supply hose must be disconnected from the lower portion of the oxygen omni-connector.

## OXYGEN CONNECTION

For proper connection of the normal and emergency oxygen supply system to the face mask:

1. Couple the aircraft oxygen supply hose (right side of the ejection seat) to the lower port of the oxygen omni-connector.
2. Insert the male connector, on the end of the face mask hose, into the female receiving port of the oxygen omni-connector.
3. Connect the emergency oxygen supply hose to the oxygen omni-connector.

## MK-H7 EJECTION SEAT

### NOTE

Refer to foldout section for Ejection Seat illustration.

The MK-H7 ejection seat system can provide the crew with a safe and efficient escape from the aircraft. The seat is propelled from the aircraft by an ejection gun on the back of the seat which is assisted by a rocket motor on the bottom of the seat. The seat system includes an automatic ejection sequencing system through which three ejection sequences can be selected. In the event of an ejection-sequence system malfunction, the automatic features can be manually overridden. If necessary, ejection can be accomplished at ground level between zero and 550 knots airspeed with wings level and no sink rate providing the crewmember does not exceed a maximum boarding weight of 247 pounds. If the 247 pound boarding weight is exceeded, a 50 knot minimum airspeed restriction for safe ground level ejection must be observed. However, the canopy must be closed for it to jettison and remove the interlock block for the zero and 50 knot speed. Boarding weight is defined to include the crewman, his clothing, and personnel equipment; excluding his parachute and seat pan survival kit. Due to the aerodynamic instability of the seats at higher airspeeds, a minimum ejection altitude of 50 feet should be observed at airspeeds greater than 550 knots. The ejection seat is an automatic device that primarily regulates the opening of the personnel parachute at a predetermined altitude or, if below that altitude, after a specified time period. Operation of the ejection seat is divided into two phases: primary and secondary operation. Primary operation of the seat includes all operating events that occur during the ejection sequence. This sequence begins with actuation of the face curtain or lower ejection handle which causes the canopy to jettison and the ejection gun to fire. It continues until a normal parachute descent of the occupant is accomplished. After the seat is initially fired during the ejection sequence, seat operation is completely automatic and requires no additional action by the occupant during the sequence. Secondary operation of the seat consists of controlling shoulder movement, seat bucket positioning, manual release of the leg restraint lines, and leg restraint line adjustment.

## EJECTION SEAT SEQUENCING

Three ejection sequences (figure 1-28) may be selected: (1) Dual ejection may be initiated from the front cockpit, and (2) dual, or (3) single ejection may be initiated from the rear cockpit. A command selector valve is provided in the rear cockpit to select single or dual ejection. Ejection is initiated by pulling the face curtain or the lower ejection handle. When the face curtain or lower ejection handle is pulled to the first position, the seat mounted initiator fires and the automatic ejection sequence is initiated. The ejection gun can be fired manually as soon as the canopy jettisons and removes the interlock block. A safety pin (interdictor link) which safeties the ejection gun firing mechanism sear is also removed when the canopy is jettisoned. If the pull is maintained on the ejection handle the seat is fired before it is fired automatically by the sequence actuator. During single automatic ejection from the rear cockpit the rear canopy is jettisoned after which

# OXYGEN SUPPLY

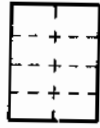

## NORMAL FLOW

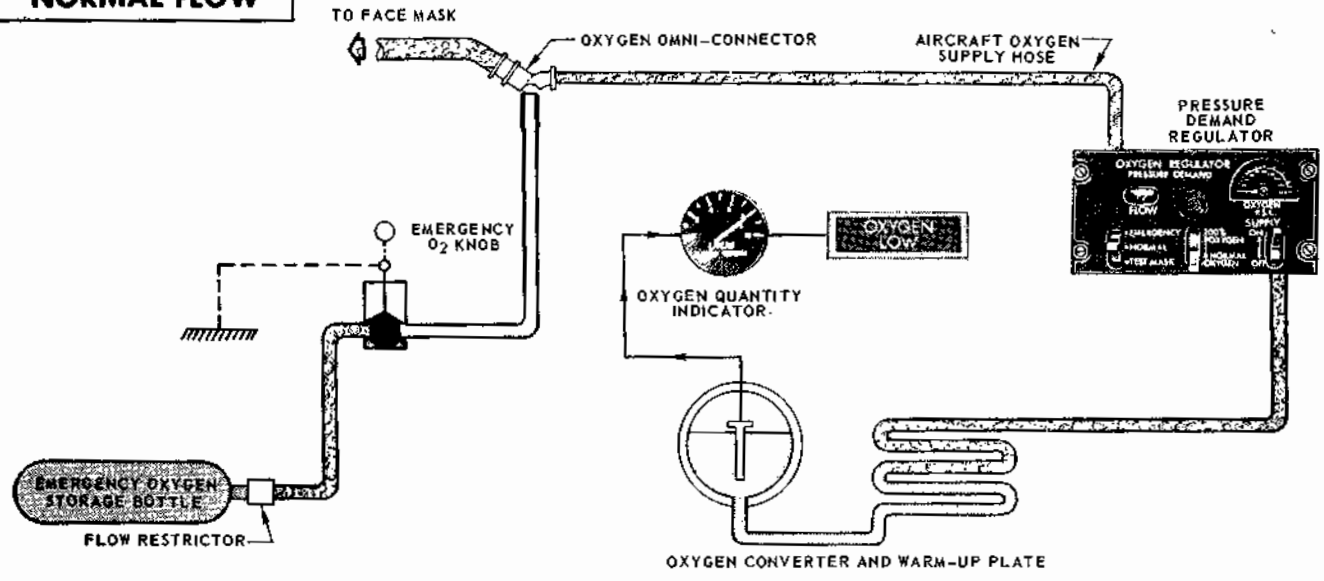

## EMERGENCY FLOW

**Note**  
THIS MODE OCCURS DURING EJECTION AFTER SEAT LEAVES AIRCRAFT BEFORE MAN/SEAT SEPARATION, AND ALSO ANY TIME AFTER EMERGENCY OXYGEN KNOB IS PULLED.

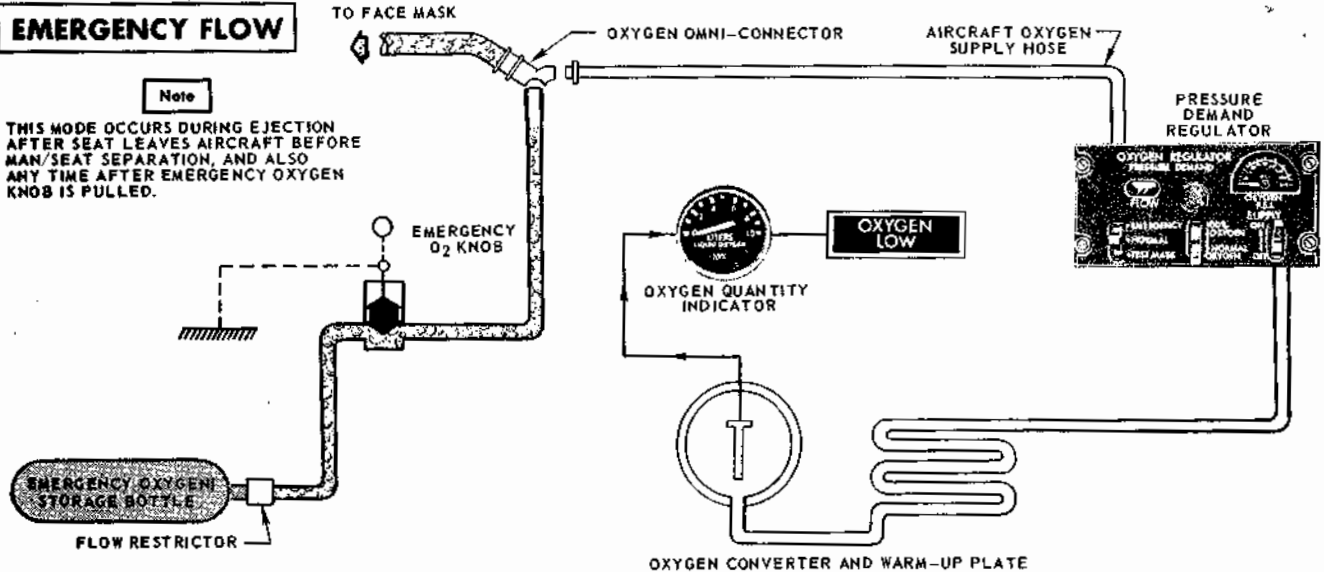

— OXYGEN UNDER PRESSURE  
- - - OXYGEN PRESSURE REDUCED

Figure 1-27

the seat is fired approximately 0.54 seconds after ejection initiation. During dual automatic ejection initiated from either cockpit, the rear seat fires as in single ejection, that is, approximately 0.54 seconds after initiation. Front canopy jettison is initiated after approximately 0.75 seconds and the front sequence actuator will fire the front seat automatically approximately 1.39 seconds after initiation. This ensures adequate clearance between the two ejection seats and the aircraft canopies. The sequence of seat operation after the powered retraction system retracts the shoulder harness (which occurs immediately after ejection initiation) and after the canopy is jettisoned is as follows. As the canopy jettisons, the canopy interlock block, which is attached to the canopy, is pulled from the interruptor mechanism of the seat. A safety pin (interdictor link) which safeties the ejection gun firing mechanism sear is also removed when the canopy is jettisoned. This allows the ejection gun firing linkage to be actuated by the automatic ejection sequencing system or by a continued pull on the ejection handle, thus firing the primary cartridge in the ejection gun. Gas pressure generated by the primary cartridge causes the inner and intermediate tubes of the gun to extend. The initial upward movement of the inner tube unlocks the top latch mechanism which releases the seat from the aircraft. As the gun extends, two auxiliary cartridges are fired as they become exposed to the hot propellant gases within the gun. Staggered firing of the ejection gun cartridges furnishes even stroke. As the seat rises, the emergency oxygen is tripped. Trip rods attached to the aircraft structure trigger the drogue gun and time release mechanisms, and the emergency IFF/SIF is switched ON. As the crewmember ejects, his legs are drawn back, the restraint lines pull through the snubbers, and when all the slack is taken up in the lines, the floor attachments break away at the shear rivets. His legs are restrained against the front of the seat bucket by the snubbers. The rocket pack fires to propel the seat to a greater height and is fired through the action of a 6 foot lanyard connected between the cockpit floor and the rocket initiator sear. Approximately 0.75 second after ejection the drogue fires a drogue projectile to deploy the 22-inch controller drogue which, in turn, deploys a 60-inch stabilizer drogue. The seat is stabilized and decelerated by the drogues as the man/seat descends rapidly through the upper atmosphere with the occupant securely restrained in the seat. Automatic operation of the time release mechanism occurs approximately 2.25 seconds after reaching the preset barostat altitude (11,500 +3000 -0 feet) or, in ejections below this altitude, the time release operates approximately 2.25 seconds after the trip rod is pulled. When the time release mechanism operates, the harness attachment locks are released through mechanical linkages on the seat. At the same time, the scissors open to release the drogues from the seat. The pull of the drogues is transferred to the parachute withdrawal line which releases the face curtain restraint straps and the parachute restraint straps, and the drogues pull the personnel parachute safety pin line and deploy the personnel parachute. The personnel parachute safety line is connected on one end of the parachute withdrawal line and the other end secures the flap on the top of the personnel parachute. The purpose of the pin is to secure the parachute from premature opening due to windblast during descent prior to time release mechanism actuation. The occupant is held to the seat by the sticker clips until the opening shock of the parachute snaps him out of the seat. The automatic ejection sequence takes

approximately 4 seconds from firing the ejection gun to full parachute deployment. If the automatic sequencing system malfunctions, the canopies can be separately jettisoned by the normal canopy control handles or emergency canopy release handles or manual canopy unlock handles; and the ejection seats can then be fired individually from each cockpit by an additional pull on an ejection handle.

### Dual Ejection Initiated From the Front Cockpit

The dual ejection sequence is initiated whenever the crewmember pulls either the face curtain handle or the lower ejection handle to fire the front seat mounted initiator. Gas pressure from the seat mounted initiator is routed to the sequencing system which ejects the rear seat prior to front seat ejection.

### Dual Ejection Initiated From Rear Cockpit

The rear crewmember initiates a dual ejection by placing the command selector valve handle to the horizontal (open) position and pulling either the face curtain or lower handle.

### Single Ejection Initiated From Rear Cockpit

Single ejection occurs when the rear cockpit crewmember pulls the face curtain handle or lower ejection handle with the command selector valve handle in the vertical (closed) position.

## EJECTION SEAT COMPONENTS

The main components of the ejection seat system include: the ejection sequencing system, the main beam assembly, the firing linkages and canopy interlock mechanism, the ejection gun, the drogue gun, the drogue chute scissors mechanism, the time release mechanism, the guillotine assembly, the sticker clips, the rocket motor, the personnel parachute, the leg restrainers, the shoulder harness powered inertia reel lock, and a seat-mounted emergency oxygen bottle. Ejection seat controls include: the face curtain ejection handle, the lower ejection handle, the lower ejection handle guard, the command selector valve handle, the seat positioning switch, the leg restraint release handle, the shoulder harness release handle, the emergency harness release handle, and the emergency oxygen knob.

### Main Beam Assembly

The main beam assembly is a strong lightweight structure built to withstand high G loads. This assembly is the main frame of the seat assembly which supports the seat bucket, drogue container, drogue shackle scissors, drogue gun, time release mechanism, and personnel parachute. It is composed of two vertical beams bridged by three crossmembers. The top latch mechanism is attached to the top of the left vertical beam and secures the seat structure to the catapult gun barrel.

# AUTOMATIC SEQUENCING SYSTEM

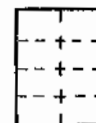

## FORWARD COCKPIT

## REAR COCKPIT

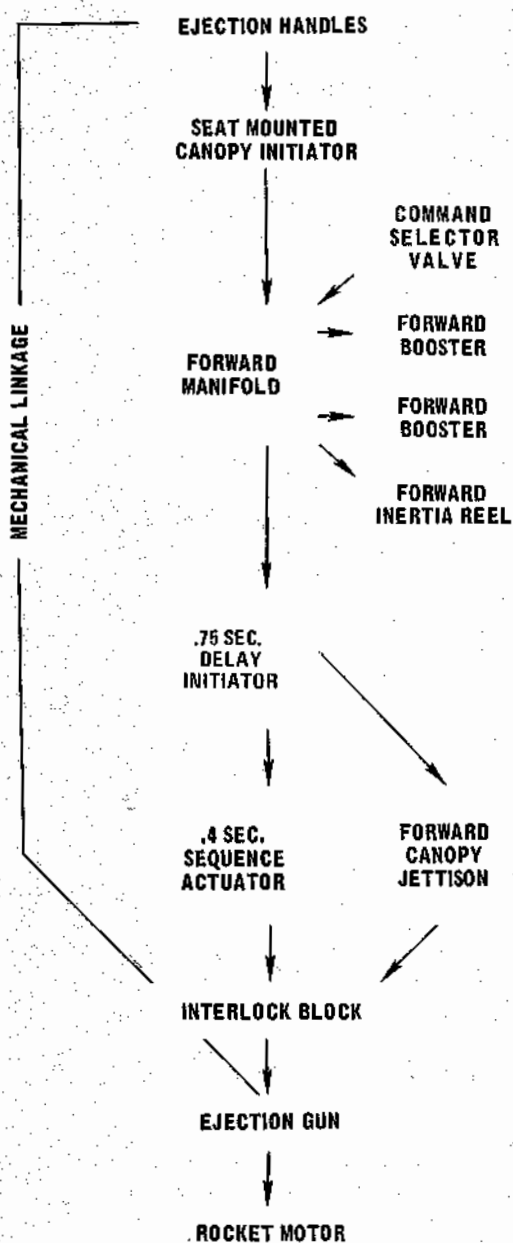

**Note**

ELAPSED TIME TO EJECTION GUN FIRING - 1.392 SECONDS.

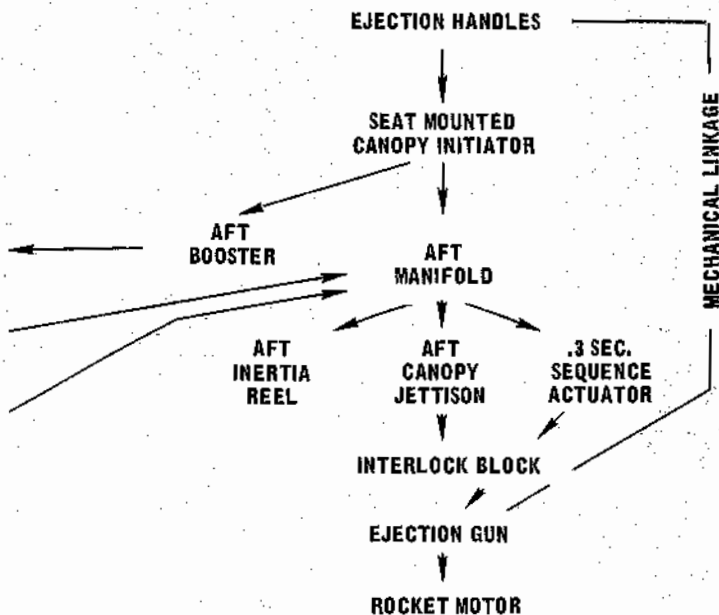

**Note**

ELAPSED TIME TO EJECTION GUN FIRING - 0.54 SECONDS.

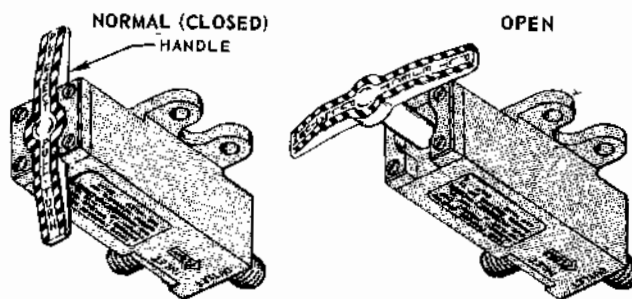

COMMAND SELECTOR VALVE

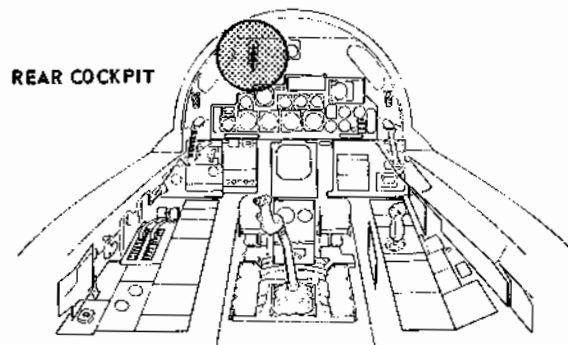

Figure 1-28

## Firing Linkages and Canopy Interlock Mechanism

The firing linkages and canopy interlock mechanism is mounted across the top of the aft corners of the main beams on the seat. This mechanism provides proper sequencing between the canopy and ejection seat during the ejection sequence and also transmits the force of the face curtain handle or lower ejection handle to the seat mounted initiator and ejection gun firing mechanism. An interlock block is connected to the canopy by a cable and is pulled from the interlock mechanism as the canopy jettisons during the ejection sequence. The interlock block engaged in the firing linkage prevents firing of the ejection seat by either ejection handle before the canopy has been jettisoned from the aircraft. A safety link (interdictor) connects the canopy interlock block to a safety pin which is inserted in the ejection gun firing mechanism sear to give added protection against inadvertent initiation due to foreign objects. The canopy interlock block and cable, and the interdictor link and safety pin, are collectively referred to as the canopy interlock cable and interdictor link safety pin assembly. The assembly remains connected to the canopy, inserted in the interlock mechanism, and inserted in the ejection gun firing mechanism sear at all times, except after canopy jettison when the entire assembly withdraws from the seat and departs the aircraft with the canopy.

## Ejection Gun

The ejection gun is mounted between the main beams and is attached to the bulkhead of the cockpit by two mounting lugs. It propels the seat from the cockpit during the ejection sequence.

## Drogue Gun

The drogue gun is mounted on the upper left side of the main beam assembly and is fired by a trip rod connected to the aircraft structure. The unit is triggered by seat ejection and fires a drogue projectile to deploy a 22-inch controller drogue, approximately 0.75 second after ejection. The controller drogue in turn deploys the 60-inch stabilizer drogue. On some aircraft, a cocking indicator is installed on the bottom of the drogue gun. When the gun is cocked, the indicator extends approximately 1/2 inch below the gun housing with the indicator shaft showing. If the indicator is flush with the bottom of the gun housing without the shaft showing, the drogue gun is not cocked and will not fire during ejection.

## Drogue Chute Scissors Mechanism

The drogue chute scissors mechanism is on the top of the seat and is attached to the top crossmember of the main beam assembly. This mechanism connects the drogue chutes to the top of the seat. A movable jaw of the scissor releases the drogue chutes from the seat when the time release mechanism actuates. The right (looking forward) scissors arm, which is allowed to move outboard to open the movable jaw when the time release mechanism actuates, is protected by a guard. The guard prevents lodgement of objects against the scissors arm to prevent opening of the scissors.

## Time Release Mechanism

The time release mechanism is on the right side of the ejection seat headrest. Its function is to delay deployment of the personnel parachute and separation of the occupant from the seat until the occupant has descended from the upper atmosphere and/or has slowed enough to prevent excessive opening shock of the personnel parachute. The mechanism is armed upon ejection. Initiation of the timing sequence follows immediately, providing the altitude is within preset limits. The time release mechanism, releases the drogue chute attachment shackle from the scissors allowing the personnel parachute to be pulled from its container by the drogue chutes. At the same time, it releases the parachute restraint straps, face curtain (if used), lap belt, shoulder harness, and leg restraint lines to allow the occupant to be pulled from the seat when the personnel parachute deploys.

## Guillotine Assembly

Components of the guillotine assembly are on the right side of the seat bucket and on the left side of the main beam assembly near the drogue gun. Under normal ejection conditions, the parachute withdrawal line withdraws from the guillotine as the drogue chutes deploy the personnel parachute. During manual separation from the seat, guillotine actuation is accomplished when the emergency harness release handle is pulled. The guillotine cartridge fires and forces a blade assembly upward which severs the parachute withdrawal line connected to the drogues.

## Sticker Clips

The sticker clips are attached by belts to the survival kit-harness and retain the occupant in the seat until the personnel parachute blossoms and pulls the occupant clear, thus insuring no risk of man seat collision.

## Rocket Motor

A rocket motor sustains the seat thrust after ejection gun separation and increases the ejection altitude of the seat without additional loading on the occupant. The rocket motor is on the bottom of the seat bucket and consists of a number of small diameter combustion tubes containing solid propellant. The rocket motor thrust angle is automatically adjusted according to seat bucket position to compensate for varying CG. As the ejection seat nears the end of the ejection gun stroke a static line attached to the cockpit floor fires the igniter cartridge, causing simultaneous ignition of the propellant. A fiberglass protector is installed on the bottom of the seat around the rocket sear and sear cable. The purpose of the protector is to prevent accidental pulling of the rocket sear. The protector breaks off during ejection when the sear cable becomes taut.



## Personnel Parachute

The personnel parachute is a 28-foot parachute incorporating a hardshell container. The container rests on a bracket on the backrest part of the seat and held in place by two parachute restraint straps and two lines attached to the bottom of the container. The lines are routed downward to loop around the sticker clip lugs. When the restraint straps are installed, two box springs are inserted between the parachute container and ejection seat. These springs are held compressed by the restraint straps. When the restraint straps and lines are released through action of the time delay release mechanism or the emergency harness release handle, the springs serve to eject the parachute container from the seat during ejection or emergency egress. The container separates from the crewmember after chute deployment. There are cross connector straps attached to the front and rear risers to assure the canopy will not collapse in the event one shoulder harness fitting becomes disengaged. The parachute canopy also incorporates two pull down vent lines (PDVL) which provide for a more rapid canopy inflation. During parachute deployment, the pull down vent lines will more than likely be severed by the opening shock of the parachute, and the crewmember should not be overly concerned by the dangling lines. Inclusion of the PDVL on any 28-foot diameter (C-9) canopy does not affect the canopy performance nor does it affect or interfere with normal use of the four line jettison lanyards system. If the PDVL weak links fail (high speed ejection) the C-9 reverts to its normal configuration. If the weak links do not fail (low speed ejection) the C-9 canopy is slightly flattened in shape with an increase in oscillation and decrease in rate of descent. Four line jettison release will relieve the oscillation and institute a slightly higher glide than the normal C-9. In addition, the parachutes incorporate a four line jettison lanyards system which reduces chute oscillation and provides steerability. The lanyards, when pulled, release four lines from the chute to produce a large lobe, or scallop, at the rear center of the canopy. In this configuration, the chute can be steered by pulling on the four line jettison lanyards. The four line jettison lanyards are identified by two red loops, one located half way up the inboard side of each rear chute riser. Pulling the parachute risers has little steering effect.

## Face Curtain Ejection Handle

The face curtain ejection handle is at the top of the seat, projecting forward and is connected by cables to the firing linkages on the seat. The face curtain extends approximately 10 inches before the canopy initiator is fired, and approximately 12-14 inches to fire the ejection gun. The face curtain provides protection for the face and eyes, and a measure of head restraint against the airblast that may be experienced in ejections at high airspeeds. A break-out force of 50-70 pounds is required to release the handle from its stowage and the pull must be in a forward or downward direction. The handle is designed to withstand forces in an upward direction to minimize the risk of inadvertent actuation by airblast in the event of canopy loss in flight. Thus, if the occupant sits high in the seat with the face curtain ejection handle below the level of the flight helmet, some difficulty may be experienced in locating and pulling the handle without sacrificing correct

posture on ejection. Ideally, the sitting height should be adjusted to allow the face curtain to be drawn forward over the helmet without interference. When using the face curtain ejection handle a momentary stop may be encountered while the canopy is jettisoning and the pull force must be maintained on the handle to fire the seat as soon as the interlock block is withdrawn.

## Lower Ejection Handle

The lower ejection handle is on the forward edge of the seat bucket, between the crewmembers legs. The handle is connected to the firing linkages on top of the seat and fires the same canopy initiator as does the face curtain. An upward pull (45 pounds maximum) is required. Approximately 1¼ inch extension of the handle will fire the canopy initiator, and 4½ to 5 inch extension will fire the seat, once the canopy interlock block is removed.

## Lower Ejection Handle Guard

The lower ejection handle has a guard which prevents inadvertent operation. With the guard handle in the down position, the handle is unlocked. With the guard in the up position, the lower ejection handle is locked and cannot be used for ejection.

## Command Selector Valve Handle

The command selector valve handle above the instrument panel on the left side of the rear cockpit, is used to select single or dual ejection. The vertical (closed) position of the handle is the single ejection position. The horizontal (open) position of the handle enables the rear seat occupant to initiate sequenced ejection of both crewmembers. To select dual ejection, the handle should be pulled straight out without applying torque to the handle. The handle will rotate 90° clockwise to the open position through cam action. On some airplanes, the command selector valve is replaced by a more durable valve capable of 20,000 cycles. The new valve operates essentially like the old valve except for the following: the new valve is opened by applying torsion to the handle instead of a pulling action; the valve handle does not move away from the valve body when opening or closing; and the handle, if released in an intermediate position, will not always return to the vertical position, but to the vertical or 90° position depending on which side of the center of travel it is released. The more recent valve handle is stenciled PLT EJECT TURN instead of PLT EJECT PULL TURN as it is on the earlier valve.

## Seat Positioning Switch

The ejection seats may be adjusted vertically only. Seat positioning is accomplished by actuating a momentary contact switch located on the right forward side of the seat bucket. Each seat can be adjusted (up or down) through a total distance of 6 inches. It is not necessary to adjust the seat height before ejection; however, if it is decided to eject by using the face curtain, the seat should be lowered to afford adequate clearance between the helmet and face curtain ejection handle.

## Leg Restrainers

The leg restraint assembly consists of garters worn by the crewmember, leg restraint lines with lock pins, snubber units, and shear fitting secured to the floor. When the seat is ejected, the slack in the leg restraint lines is taken up by the upward travel of the seat, pulling the occupant's legs to the front face of the seat bucket. When all of the slack has been removed in the leg restraint lines, the tension of the lines will cause the shear fitting to fail. The occupant's legs are firmly held against the seat bucket by the snubber unit until the harness is released and the occupant is separated from the seat. Rings on the face of the snubber units are provided to adjust the amount of slack in the leg restraint lines. If the seat is raised and then lowered, it may be necessary to readjust the leg restraint lines by pulling the finger rings and drawing the lines forward through the snubbers. The leg restrainers utilize two garters on each restraint line, a calf garter worn above the flight boot and a thigh garter worn on the thigh above the knee. Each garter contains a quick release which allows the garter to be released and left in the aircraft without disturbing garter adjustment. When buckling the garters, the releases should be on the inside of the legs. The garter with the double ring is worn above the flight boot and the single ring garter is worn on the thigh. When routing the restraint lines through the garters, be certain the lines are not twisted and route through the calf garter (first through outboard ring of calf garter then through inboard ring) then through the thigh garter before inserting the lock pins in the snubber boxes (figure 1-29). To reduce garter slippage, the calf and thigh garters have Velcro tape on one side of each garter strap. After a garter is adjusted, the loose end of the garter strap is pressed and secured to the other part of the garter. In addition, a snap ring is incorporated on the loose end of each garter to prevent loss of the movable male-type garter buckle.

## Leg Restraint Release Handle

The leg restraint release handle is on the left forward side of the seat bucket. When the handle is moved to the aft (unlocked) position, the lock pins on the leg lines are released from the leg lock mechanism and the leg lines can then slide out of the garters.

## Shoulder Harness Powered Inertia Reel Lock

The rocket seat contains a powered inertia reel lock which provides a velocity (G sensing) system (inertia lock) and a power retraction system. The inertia lock system provides safe restraint during aircraft violent maneuvers. Restraint is accomplished by a G sensing mechanism functioning in accordance with reel strap pay-out (strap velocity). In addition, manual locking of the inertia lock can be accomplished by the shoulder harness release handle. The powered retraction system provides automatic retraction of the shoulder harness for ejection. The device is gas powered and functions only when ejection is desired by pulling the face curtain or lower ejection handles.

## Shoulder Harness Release Handle

The shoulder harness release handle has two positions, a forward or locked position, and an aft or unlocked position.

### NOTE

Selecting the unlocked position of the shoulder harness release handle will not prevent the inertia lock from locking when the velocity (G sensing) system detects a high rate of velocity change of the crewmember in a forward direction. Once the shoulder harness is automatically locked, it must be manually unlocked by cycling the release handle full forward then full aft. It is noteworthy that G forces on the aircraft by itself will not lock the inertia lock.

## Emergency Harness Release Handle

The emergency harness release handle is on the right front edge of the seat bucket. The primary purpose of this handle is to provide single action release of the lap belt and leg restraint locks for rapid emergency evacuation on the ground. The handle may also be used to separate manually from the seat after ejection in the unlikely event that the automatic sequence fails. To actuate the handle, squeeze the trigger and pull the handle up and aft until it locks in the UP position. When the handle is pulled, the lap belt, shoulder harness restraints, and leg restraints are released and the guillotine unit fires to cut the parachute withdrawal line. The parachute restraint straps are also released to allow the personnel parachute pack to separate from the seat. Once released from the seat, the lap belt, shoulder harness, etc. cannot be reconnected during flight.

### WARNING

The emergency harness release handle should not be pulled in flight for the following reasons:

- During uncontrollable flight, negative G forces may prevent the occupant from controlling the aircraft or assuming the correct ejection position.
- A hazard to survival is created if the pilot is required to proceed with a forced landing since no harness restraint will be available.
- Safe ejection is impossible because the occupant will separate from the seat during ejection, and severe shock loads will be imposed on the body.

## Seat-Mounted Emergency Oxygen Bottle

A bailout oxygen bottle system is installed on the left side of the ejection seat bucket. Actuation of the oxygen bottle is accomplished automatically on ejection. An actuating arm, attached to the bottle valve by a cable, strikes a bracket mounted on the seat rails as the ejection seat moves up the rails. Manually, the emergency oxygen can be actuated by pulling up on the emergency oxygen knob. The bottle provides approximately a 10 minute supply of oxygen.

## LEG RESTRAINERS

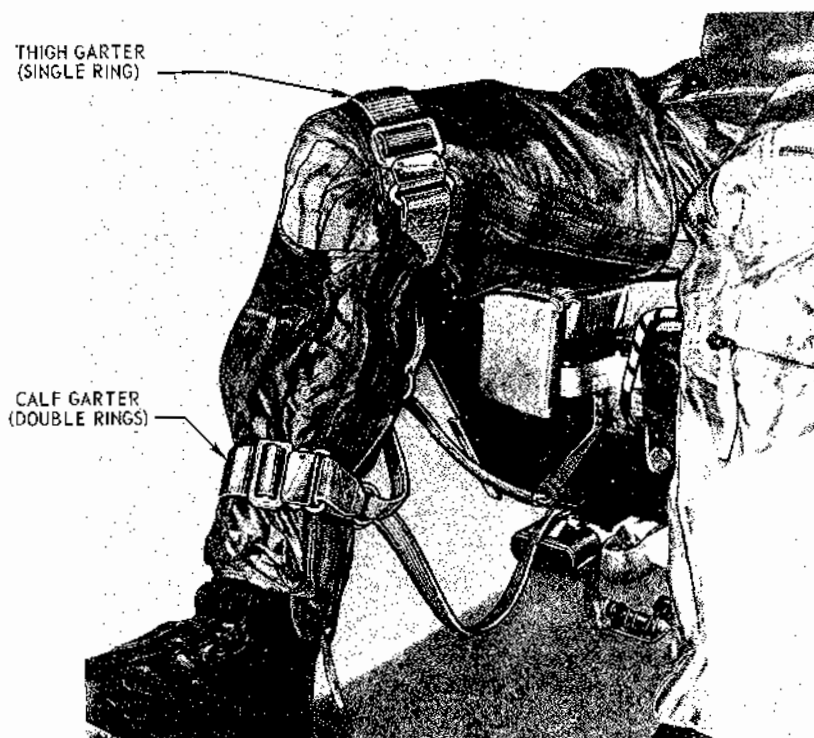
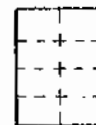

4E-1-(15)

Figure 1-29

### Emergency Oxygen Knob

The emergency oxygen knob is on the forward left side of the seat bucket, just aft of the leg restraint release handle. Once the emergency oxygen knob is pulled the emergency oxygen cannot be shut off.

### INTEGRATED (PARACHUTE) HARNESS

The harness is a vest-like garment worn by the crewmember, and serves the purpose of providing attachment points for connecting the parachute riser-shoulder harness and survival kit to the individual.

### SURVIVAL KIT

Provisions for survival after ejection, bail-out, or ditching are stored in the survival kit (figure 1-30). The kit is composed of a two piece fiberglass container. The kit contains a rucksack filled with emergency provisions, and an inflatable raft. The upper portion of the kit serves as the kit cover and has a cushion attached to the top for the crewmember to sit on. The kit is attached to the crewmember's harness by attachment fittings on the kit

retaining straps. The retaining straps are secured to the kit by retaining strap locks on both sides of the kit. The survival kit release handle, on the right forward outboard corner of the kit, is pulled after seat separation to separate the upper and lower portions of the kit. Following actuation of the survival kit release handle, the upper kit container shell falls away, and the lower kit container shell containing the raft and the emergency provisions drop to a position below the crewmember, where they are held during descent by a drop line which remains attached to the harness by the left retaining strap. During kit deployment, the life raft CO<sub>2</sub> bottle will be actuated by gravity pull to inflate the raft when the drop line reaches full extension. In the event of emergency egress on the ground when it is desired to leave the survival kit in the aircraft, the survival kit release handle is pulled after releasing the parachute riser fittings. Pulling the survival kit release handle actuates the locking assemblies, which releases the survival kit lid and allows the retaining strap locks to release. A lanyard sensor assembly, located on the bottom of the left side of the kit, controls release or retention of the container assembly to the crewmember during emergency egress. If the kit is seated against the ejection seat, this sensor prevents the left-hand retaining strap from engaging the drop line and provides no connection with the crewmember. If the sensor is extended (kit bottom off the ejection seat), the left-hand retaining

**SURVIVAL KIT****TYPICAL**

Figure 1-30

4E-1-(31)A

strap will be attached to the drop line as would be the case during ejection.

**WARNING**

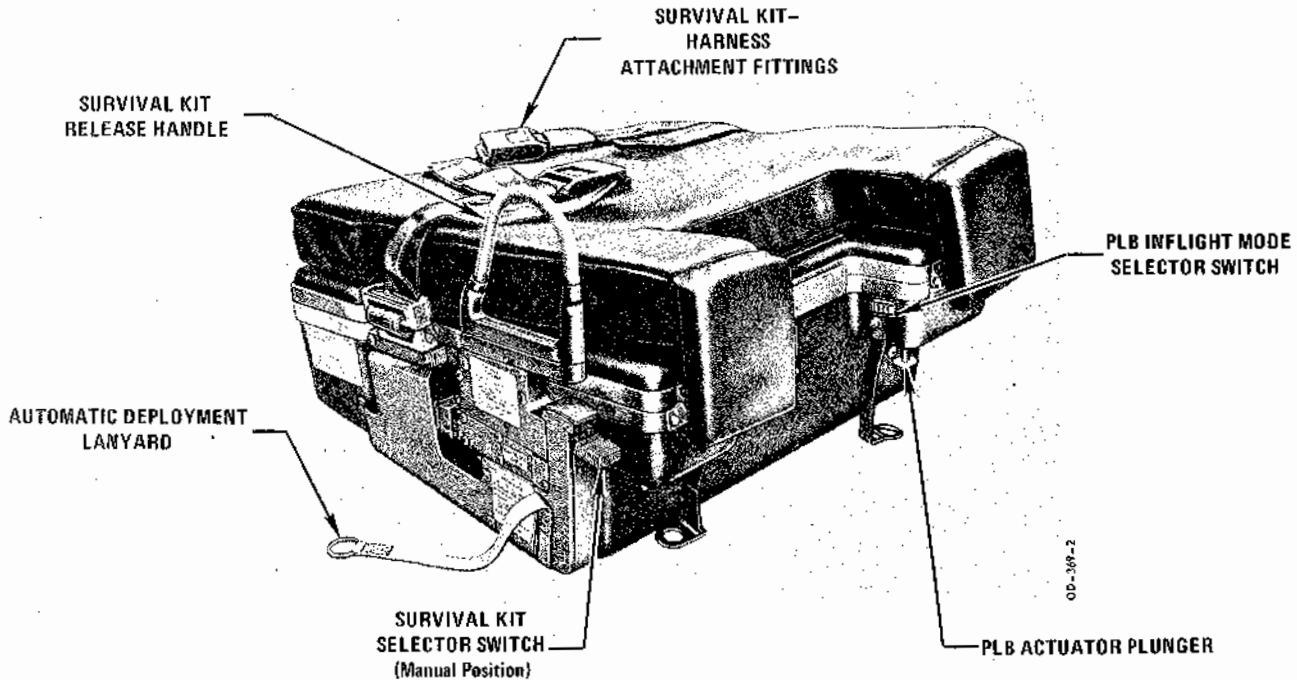
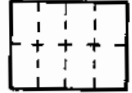
If the survival kit release handle is pulled and the survival kit is not resting on the seat bucket, the crewmember will be attached to the survival kit container by a 25-foot lanyard.

Four hold-down straps are installed on the survival kit. The hold-down straps are on each corner of the kit and are used to attach the kit to the ejection seat so that the kit will not rise above the seat during negative G conditions. The rear hold-down straps attach to the seat at the lap belt lug attachment points and the forward hold-down straps are attached at the leg restraint lines lock pin attachment points. The hold-down straps are released from ejection seat attachment when the time release mechanism releases the leg restraint lines lock pins and lap belt lugs during ejection, or whenever the emergency harness release handle is pulled. The kit incorporates selective deployment which gives the crewman the option of manual or automatic hands off separation of the kit and deployment of raft/rucksack assembly, depending on the mode selected on the survival kit selector switch. Automatic operation is controlled by a lanyard attached on one end to an actuator in the bottom of the kit and to the seat emergency harness release handle on the other

end. When man/seat separation occurs, the lanyard pulls the actuator which subsequently fires a cartridge activated piston. Four seconds later, this piston strikes an arm which is attached to the lid latches, unlocking them and allowing the kit to drop away in a deployed condition, while still being attached to the crewman by his left hand kit-to-man connector. For this sequence to occur the crewman has to select automatic on his selector switch located on the kit forward and slightly below the survival kit release handle. Once the emergency harness release handle is pulled, such as occurs during manual man/seat separation, the automatic feature is negated and the survival kit release handle must be pulled to open the kit. If automatic deployment is not desired, the crewman can select the manual mode and actuate the kit when desired by pulling up on the survival kit release handle. The manual mode is selected by placing the selector switch in the down position and the automatic mode is selected by placing the selector switch in the up position. Selector switch travel is approximately 1/4 inch.

**Personnel Locator Beacon (PLB)**

The AN/URT-33(B) PLB, located in the survival kit left thigh support, provides a convenient means of controlling the operation of the beacon and contains a ground selectable timed battery operation feature which, after the PLB is activated, turns the beacon off automatically after  $10 \pm 2$  minutes of operation. The intended use of the timed battery is to eliminate continued beacon transmission after a parachute landing in hostile territory in the event

the crewmember is incapacitated or otherwise fails to manually turn off his beacon. The timed battery operation feature is a one shot operation which can be used only once per flight. However, timed battery operation, if selected (TIMED position on battery switch), can be overridden on the ground (NORMAL position) so that the beacon can transmit beyond the  $10 \pm 2$  minute limit. With the battery switch set to NORMAL the beacon, when activated, transmits for approximately 15 hours. Inflight operation of the PLB is dependent on the action of the actuator plunger and the setting of the inflight mode selector switch. The actuator plunger, under the left thigh support, is pushed up to a retracted position when the survival kit is installed in the seat pan. The actuator plunger extends whenever the kit is removed from the seat, such as at man/seat separation during ejection and cockpit egress with the survival kit. The PLB is activated automatically when the actuator plunger extends, provided the inflight mode selector switch is in the red dot or A position. The

inflight mode selector switch, on the inside of the left thigh support, has two positions. With the switch in the red dot or A position, the beacon is activated with the actuator plunger extended as previously described. The switch is positioned to the red dot position by pressing inward on the rear arm of the switch. With the switch in the green dot or M position, the beacon will not activate although the actuator plunger is extended. The switch is positioned to the green dot position by pressing inward on the forward arm of the switch. If ejection is accomplished with the the PLB inflight mode selector switch in the green dot position, the beacon can be activated during the parachute descent by placing the switch to the red dot position, provided the survival kit has not been deployed.

## SERVICING

See figure 1-31 for servicing requirements.

# SERVICING DIAGRAM

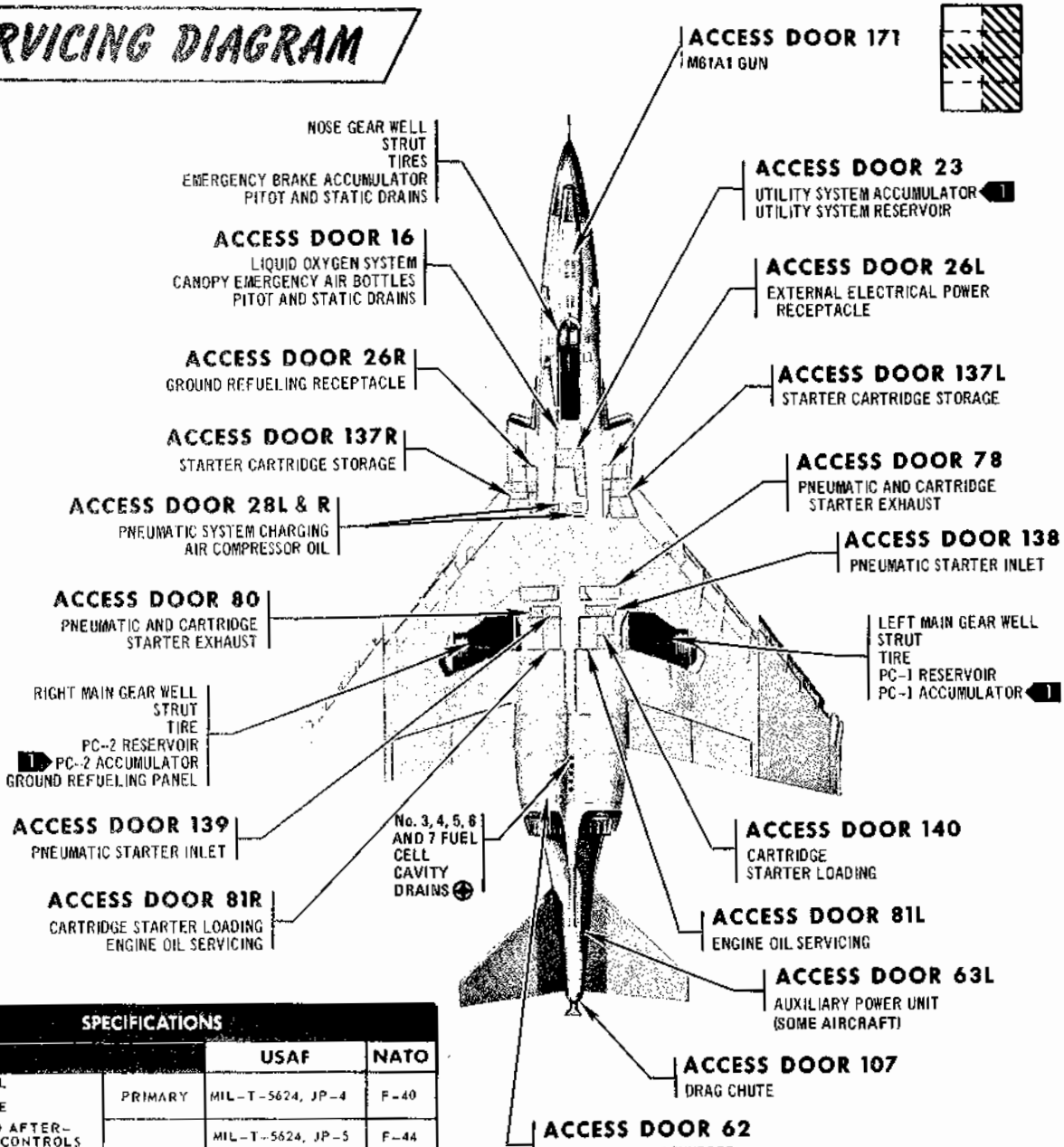

## SPECIFICATIONS

		USAF	NATO
<b>FUEL</b> <b>NOTE</b> • THE BASIC AND AFTER-BURNER FUEL CONTROLS MUST BE ADJUSTED FOR SPECIFIC GRAVITY OF THE FUEL BEING USED. • REFER TO SECTION V, OPERATING LIMITATIONS, FOR ADDITIONAL INFORMATION WHEN EMERGENCY OR ALTERNATE FUEL IS UTILIZED.	PRIMARY	MIL-T-5624, JP-4	F-40
	ALTERNATE	MIL-T-5624, JP-5	F-44
		ASTM JET, A-1, JET A (COMMERCIAL)	F-34
	EMERGENCY	MIL-G-5572, AVGAS GRADE 115/145	F-22
OIL	TURBINE ENGINE	MIL-L-7808 (NO ALTERNATE)	O-148
HYDRAULIC FLUID		MIL-H-5606	H-515
OXYGEN	LIQUID	MIL-O-27210 TYPE II	
NITROGEN	GASEOUS	BB-N-411 TYPE I CLASS I GRADE B	
OIL	M61A1 GUN	MIL-L-4600	
• UTILIZE MA-1A ENGINE STARTING UNIT OR EQUIVALENT FOR A PNEUMATIC START. • UTILIZE A MXU-4A/A SOLID PROPELLANT CARTRIDGE FOR A CARTRIDGE START.			

**Note**

➡ BEFORE TO 1F-4-1081

Figure 1-31

## SECTION II

# NORMAL PROCEDURES

### TABLE OF CONTENTS

Preparation for Flight.....	2-1
Preflight Check.....	2-1
Before Exterior Inspection (Front Cockpit) ..	2-1
Exterior Inspection.....	2-3
Before Entering Front Cockpit.....	2-4
Front Cockpit Interior Check.....	2-6
Before Starting Engines.....	2-8
Starting Engines.....	2-9
Pneumatic Start.....	2-9
Cartridge Start.....	2-11
Engine Ground Operation.....	2-13
Before Taxiing (Front Cockpit).....	2-13
Before Entering Rear Cockpit.....	2-14
Before Electrical Power (Rear Cockpit).....	2-16
After Electrical Power (Rear Cockpit).....	2-16
Rear Cockpit Interior Check.....	2-17
Before Taxiing (Rear Cockpit).....	2-18
Taxiing.....	2-18
Before Takeoff.....	2-20
Takeoff.....	2-21
After Takeoff - Climb.....	2-22
Climb Techniques.....	2-23
Cruise.....	2-23
Flight Characteristics.....	2-24
Descent/Before Landing.....	2-24
Landing.....	2-25
Go-Around Technique.....	2-28
Touch-and-Go Technique.....	2-28
After Landing.....	2-28
Single Engine Taxi.....	2-30
Hot Refueling.....	2-30
Engine Shutdown.....	2-30
Before Leaving Cockpit.....	2-31
Scramble.....	2-31
Quick Turn.....	2-32
Solo Flight Inspection (Rear Cockpit).....	2-32

### NOTE

The aircrew procedures through the Before Taxiing paragraph are separated into individual procedures for the pilot and weapon system officer. These separate procedures allow the individual crewmember to perform the checks without requiring him to read the checks performed by the other crewmember. The remaining procedures are combined and are coded for applicable crewmember action. Items coded (P-WSO) are applicable to both the pilot and weapon system officer. Items coded (WSO) are applicable to the weapon system officer only, and items not coded are applicable to the pilot only.

### PREPARATION FOR FLIGHT

#### FLIGHT RESTRICTIONS

Refer to section V, Operating Limitations, for detailed aircraft and engine operating limitations.

#### FLIGHT PLANNING

Refer to Performance Data, appendix A or B.

#### TAKEOFF AND LANDING DATA CARD

If the takeoff distance exceeds one-half of the available runway length, the takeoff and landing data card in the Aircrew's Checklist should be completed.

#### WEIGHT AND BALANCE

For maximum gross weight limitations, refer to section V, Operating Limitations. For aircraft loading information, refer to Performance Data, appendix A, and to the handbook of Weight and Balance Data, TO 1-1B-40.

### PREFLIGHT CHECK



On aircraft after TO 1F-4E-588, do not use the retractable boarding steps when the AN/AVQ-23A target designator pod is installed in the left forward missile well.

1. Check Form 781 for aircraft status and release.

#### BEFORE EXTERIOR INSPECTION (FRONT COCKPIT)

#### WARNING

During flight operation, no object of any kind should be placed or allowed to remain on top of the ejection seat.

1. Face curtain and seat mounted initiator safety pins - INSTALLED
2. Canopy interlock cable and interdictor link safety pin assembly - INSTALLED CORRECTLY AND ATTACHED TO CANOPY

# COCKPIT ENTRY

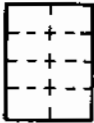

TYPICAL

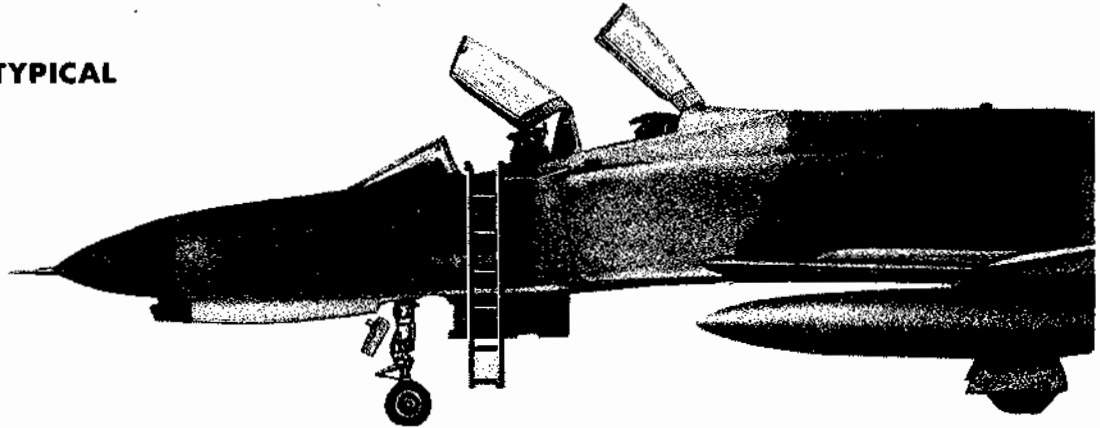

THE CANOPIES ARE OPENED BY PRESSING THE BUTTON LOCATED BELOW EACH CANOPY

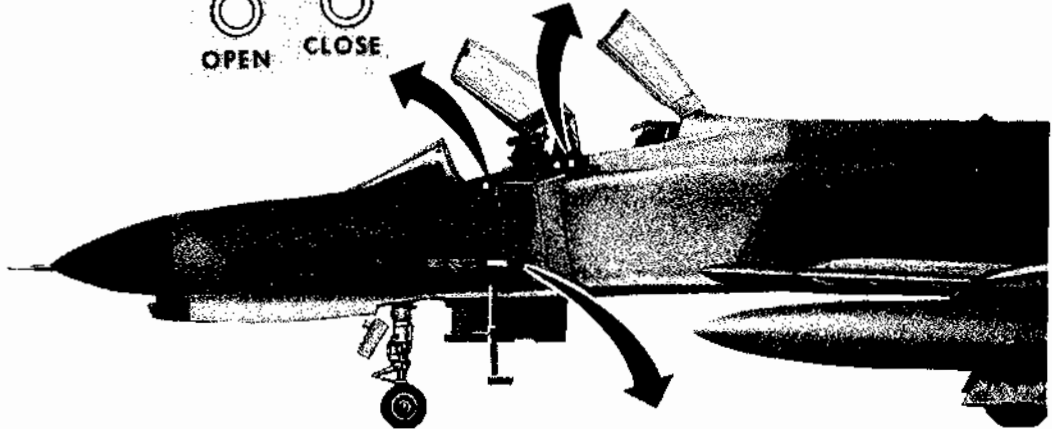
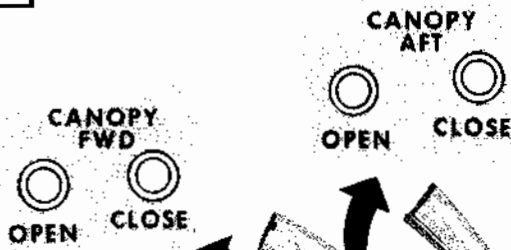

THE BOARDING STEPS ARE RELEASED BY DEPRESSING THE BUTTON INSIDE OF BOTTOM KICK STEP

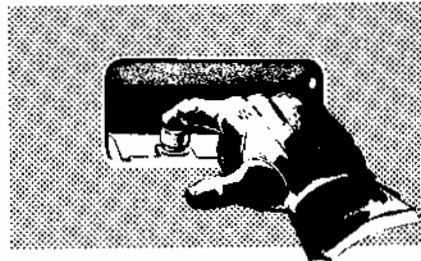

Figure 2-1



3. Lower ejection handle guard - UP
4. Generator switches - OFF
5. Internal wing dump switch - NORM

**CAUTION**

With electrical power applied to the aircraft, wing fuel will be spilled any time the internal wing dump switch is in the DUMP position.

6. Throttles - OFF
7. External stores emergency release - CHECK NO YELLOW SHOWING INSIDE CIRCULAR GUARD
8. Landing gear handle - IN & DOWN
9. MSDG display - OFF (some aircraft)
10. Missile jettison selector - OFF
11. Armament switches - OFF/SAFE
12. Pitot heat - OFF
13. Battery - CHECK  
To determine battery relay closure, turn on engine master switch and check for proper positioning of gear and flaps position indicators.
14. Engine master switches - OFF
15. Formation lights control knob - AS REQUIRED

**CAUTION**

Do not use formation lights during daylight hours.

16. Emergency attitude reference system circuit breaker - IN
17. Reference system selector - STBY
18. Publications and flight data - CHECK
19. External power - CHECK ON
20. Generator switches - EXT ON

**CAUTION**

Do not place the generator control switches to EXT ON until external power has been connected and has reached rated voltage and frequency (400 Hz, 115/200 volts ac).

**NOTE**

If a battery start is to be made, those checks requiring electrical power will have to be performed after the engines have been started.

21. Transformer rectifier - CHECK (Cannot be performed when battery start is made)  
Both transformer-rectifiers are operating if the landing gear indicators indicate gear down with the engine master switches OFF and the generator switches in EXT.
22. Gun camera magazine - INSTALL
23. Gun camera dust cover - STOW (with 780 equipment)

**CAUTION**

Either a camera magazine or dust cover must be installed at all times. The dust cover has serious FOD potential when it is removed to install the magazine.

## EXTERIOR INSPECTION

Check the aircraft exterior for indications of abnormalities which could affect flight (i.e., cracks, leaks, and dents). All sensors (AOA, pitot/static, inlet ice, total temperature) should be checked. Check required doors and panels closed and fastened. The engine intake area should be clear of foreign objects. The nose area and then only the right side of the aircraft is discussed. The left side is identical to the right.

1. Nose area
  - a. Safety pins  
Gear down lock  
Slat
  - b. Pressure gages  
Emergency flap - 2650 to 3300 psi  
Emergency gear - 2650 to 3300 psi  
Emergency brake accumulator - 950 to 1050 psi
  - c. Emergency brake valve
  - d. Tire and strut  
Tire condition and inflation  
Strut leaks and inflation
  - e. Refrigeration unit intakes
  - f. Radome  
Locking indicators - LOCKED
  - g. Pitot boom, static ports, AOA probe  
Protective covers removed  
AOA probe secure and free to rotate
2. Forward fuselage
  - a. Intake  
Ramps secure  
Clear of FOD  
Engine compressor and dome condition
3. Center fuselage and wing
  - a. Aux air door area  
Throttle linkage  
Fire sensing circuitry  
Oil servicing caps in place  
Safety lock removed  
Centerline rack access panels in place and secure  
Starter breech caps secure
  - b. Main gear wheel well area  
PC accumulator - 950 to 1050 psi  
Gear down lock - REMOVED
  - c. Tire and strut  
Tire condition and inflation  
Strut leaks and inflation

**NOTE**

If upper cylinder pressure gage (if installed) reads in the red (above normal range markings), the chamber is overpressurized and may prevent strut from retracting or cause gear failure.

Brake assemblies  
Anti-skid harness

- d. Pylons and stores  
Ensure that no store extends aft of the inboard pylon.
- e. External wing tank jettison shear pins - **INSTALLED**
- f. Wings  
Wings spread and locking indicator flush with top of wing. Visually check left and right center wing fold lower locking lugs for cracks.
- g. Dump mast
- h. Speed brake area  
Leaks and loose fasteners
- 4. Aft fuselage area
  - a. Engine exhaust area  
AB flame holder, spray bars, and ignitor  
Puddled fuel in tailpipe and under AB eyelids
  - b. Hook  
Accumulator - 800 to 1000 psi  
Arresting hook uplock removed
  - c. Fuselage fuel cell cavity drains

**NOTE**

Dripping or puddled fuel or evidence of recent leakage in the area of these drains may indicate a fuel cell leak and is sufficient cause for abort.

- d. Bellows probe  
Visually check cover removed
- e. Stabilator and rudder  
Surface area  
Skid bars
- f. Drag chute

**BEFORE ENTERING FRONT COCKPIT**

- 1. Canopy condition - **CHECK**  
Check for cracks in the canopy and windshield plexiglass. Check condition of the canopy pressure seals.

**CAUTION**

The center mirror on the forward canopy can be tilted sufficiently to prevent canopy closing; therefore, assure that the mirror will clear the windshield bow before closing canopy.

- 2. Canopy safety strut - **REMOVED**  
Ensure normal canopy control handle is in open position if safety strut requires removal.
- 3. Canopy actuator - **SHEAR PIN INTACT**
- 4. Ejection seat - **CHECK**
  - a. Face curtain and seat mounted initiator safety pins - **INSTALLED, ALL OTHER SAFETY PINS REMOVED**

**WARNING**

The rocket motor and igniter sear are located under the seat and must have a fiberglass protector installed around the igniter sear and

sear cable to prevent accidental pulling of the igniter sear. Do not use this area for stowage, and exercise extreme caution when performing any function in the vicinity of the rocket pack; e.g., pulling rocket motor safety pin, adjusting leg restraint lines, etc.

**CAUTION**

Exercise caution regarding hand movements in the vicinity of the bulkhead mounted canopy initiator linkages. Also, do not stow flight equipment or personal items in this area. Failure to comply could result in inadvertent jettisoning of the canopy.

- b. Canopy interlock cable and interdictor link safety pin assembly - **INSTALLED CORRECTLY AND ATTACHED TO CANOPY**
- c. Banana links - **ENGAGED IN MAIN SEAR**
- d. Seat mounted initiator - **LINKAGE CONNECTED**
- e. Scissors - **LOCKED TO SHACKLE AND TIED DOWN, SCISSORS GUARD NOT BROKEN**

**WARNING**

If the scissors shackle safe-tie thread passes through the wire loop, the drogue chute may not deploy.

- f. Drogue chute withdrawal line - **ROUTED OVER ALL OTHER LINES**
- g. Top latch mechanism plunger and locking indicator - **FLUSH WITH HOUSING**

**WARNING**

If the plunger is not flush, the seat is not locked into position and inadvertent ejection could result.

- h. Parachute withdrawal line - **QUICK DISCONNECT IS CONNECTED AND RUNS THROUGH GUILLOTINE**
- i. Safety pin line - **NOT THROUGH GUILLOTINE**
- j. Parachute alignment ring - **SAFETY PIN LINE AND RIPCORDER PIN LINE (ATTACHED TO PARACHUTE WITHDRAWAL LINE) ROUTED THROUGH, PARACHUTE WITHDRAWAL LINE ROUTED AROUND**
- k. Guillotine - **CHECK PASSAGE AND HOSE SECURITY**
- l. Drogue gun assembly - **SHEAR PIN INTACT, SAFETY PIN OUT, TRIP ROD CONNECTED WITH NO RED SHOWING ON INNER BARREL**
- m. Drogue gun cocking indicator - **COCKED**

If the indicator is approximately 1/2 inch below the gun housing, it is cocked. If flush with the housing, it is uncocked and will not fire on ejection.

# EJECTION SEAT AND CANOPY INITIATOR SAFETY PINS

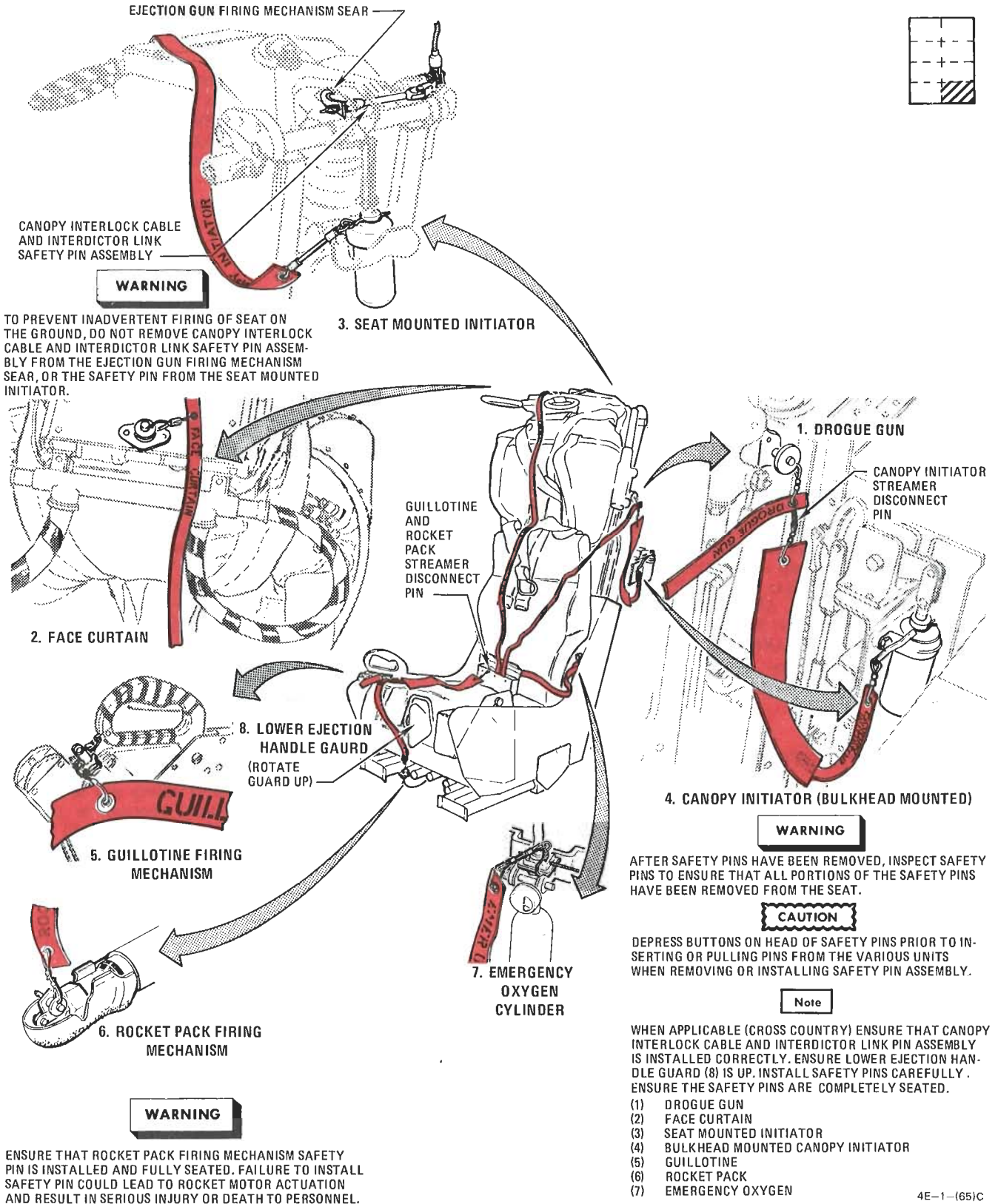

Figure 2-2

4E-1-(65)C  
R

- n. Bulkhead mounted canopy initiator – LINKAGE CONNECTED, SAFETY PIN REMOVED
- o. Harness assembly – CHECK
- p. Emergency oxygen – PRESSURE AND SAFETY PIN REMOVED

Proper servicing of the emergency oxygen bottle is indicated by a gage reading of 1800–2200 psi at 21°C (70°F). The pressure indication varies with temperature. To determine correct indication, add 6.5 psi for each degree above 21°C (3.5 psi/°F) and subtract 6.5 psi for each degree below 21°C. Thus, the bottle is correctly serviced if the gage reads 1890–2290 psi at 35°C (95°F). See ejection seat foldout illustration for approximate pressure values for various gage needle locations.

- q. Emergency oxygen actuation knob and linkage – CHECK  
Check knob not actuated. If actuated, knob is tilted approximately 45° from vertical. Check security of shear pin in cable to linkage connection by applying light tension on cable.
  - r. Rocket motor – FIBERGLASS PROTECTOR INSTALLED AND UNDAMAGED, SAFETY PIN REMOVED AND LEG GUARDS IN PLACE
  - s. Leg garters – LOCKED IN, AND LANYARDS NOT TWISTED
  - t. Survival kit – RELEASE HANDLE DOWN, SELECTOR SWITCH AUTO POSITION (UP)
  - u. Emergency harness release handle – DOWN WITH SEAR ENGAGED, SAFETY PIN OUT, AND ACTUATION LANYARD CONNECTED
  - v. Time release trip rod – CONNECTED
  - w. Personnel locator beacon (PLB) inflight mode selector switch – AUTOMATIC POSITION (RED DOT SHOWING) FOR NORMAL PEACETIME OPERATION. SAFETY STREAMER REMOVED
5. Canopy emergency air bottle gage – CHECK (2750–3200 PSI) (After TO 1F-4-1108)

to the leg restraint line lock pins at the lock pin attachment points.

### WARNING

- The leg restraint lines must be buckled at all times during flight to ensure that the legs will be pulled back upon ejection. This will enhance seat stability and will prevent leg injury by keeping the legs from flailing following ejection.
  - Failure to route the restraint lines properly through the garters could cause serious injury during ejection.
3. Harnessing and personal equipment leads – FASTEN  
Attach the parachute riser–shoulder harness fittings to the integrated harness. Attach and firmly adjust the survival kit straps. Secure and firmly adjust the lap belt. Connect oxygen, communication and anti-G leads. Route the anti-G hose line behind personal harness sling if hose interferes with controls on left console. Check the operation of the shoulder harness locking mechanism.
  4. Ejection seat height – ADJUST (cannot be performed when battery start is made)
  5. Face curtain and seat mounted initiator safety pins – REMOVED  
After all personal leads have been fastened, have ground crewmember remove face curtain and seat mounted initiator safety pins, show them to aircrew member before stowing in bag, and hand bag to aircrew member.

### WARNING

If the seat mounted initiator safety pin is left installed during flight, seat ejection is not possible. The ejection gun firing linkage will be restrained from moving, thus preventing firing of the ejection gun.

## FRONT COCKPIT INTERIOR CHECK

### WARNING

All harnessing, personal equipment leads and leg restraint lines must be secured before closing the canopy.

1. Rudder pedals – ADJUST
2. Leg restraint lines – BUCKLED AND SECURED  
Check leg garters buckled and properly adjusted, with the garter releases on the inside of the legs. Check that lines are secured to seat and floor and not twisted or entangled in rocket motor sear cable. Check that leg restraint lines are threaded through the calf garters (double D-ring), routing first through the outboard ring and then through the inboard ring, then through the thigh garters (single D-ring) before the lock pins are inserted in the snubber boxes. Check that the leg restraint line lock pins are threaded through hold-down strap lugs on the survival kit. Check that the survival kit-to-seat retention straps are attached
6. Stick grip and boot – CHECK  
Check stick grip firmly attached to stick and stick boot in place with no tears.
7. Auxiliary armament control panel – SET
  - a. Gyro switch – NORM
  - b. Aural tone control knob – LOW
  - c. Boarding steps position indicator – PROTRUDING
8. Slats override switch – NORM (some aircraft)
9. Suit vent air knob – OFF (some aircraft)
10. Intercom control panel – SET
  - a. Volume control – AS DESIRED
  - b. Amplifier selector knob – NORM
  - c. Function selector switch – HOT MIC
11. Fuel control panel – SET
  - a. Internal wing transfer switch – NORMAL
  - b. Internal wing dump switch – NORM
  - c. Refuel selection switch – ALL TANKS

- d. External transfer switch – AS REQUIRED
  - e. Air refuel switch – RETRACT
  - f. Tank depressurization switch – NORM (some aircraft)
12. Stab aug switches – OFF
13. Boost pumps and engine fuel shutoff valve – CHECK (some aircraft), (cannot be performed when a battery start is made)
- Actuate the left boost pump check switch and
- observe that the left boost pump pressure indicator reads  $30 \pm 5$  psi. Also, note that zero fuel flow is registered on the left fuel flow indicator. Allow 3 seconds after release of left switch, then repeat the procedure using the right boost pump check switch. Ensure boost pump check switches return to the NORMAL position after actuation. Failure of the switches to return will cause an interruption of fuel valve electrical power and could result in engine fuel starvation at start. Zero fuel flow reading is an indication that the fuel shutoff valves are closed.
14. VOR/ILS control panel – SET (some aircraft)
- a. Volume control knob – AS DESIRED
  - b. Marker volume knob – AS DESIRED
  - c. Frequency – AS DESIRED
  - d. VOR/MKR test switch – TEST
- Cannot be performed when battery test is made.
15. Flaps/slats switch – UP OR NORM
16. Emergency flaps/slats handle – FORWARD
17. Drag chute control handle – DOWN AND SECURE
18. Speed brake switch – IN
19. Throttle friction lever – SET AS DESIRED
20. Communication antenna selector switch – UPR

**WARNING**

Electromagnetic interference radiating from the lower UHF antenna may interfere with the nose wheel steering system. Therefore, the upper UHF antenna should be used any time the aircraft is not airborne.

- 21. Engine anti-icing switch – NORMAL
- 22. Anti-skid – CHECK (cannot be performed when battery start is made)
  - a. Anti-skid switch on – LIGHT OFF
  - b. Emergency quick release lever – DEPRESS/LIGHT ON AND RELEASE/LIGHT OFF
  - c. Anti-skid switch off – LIGHT ON
- 23. Aileron rudder interconnect circuit breaker – IN
- 24. Landing and taxi lights switch – OFF
- 25. Flaps/slats position indicators – UP OR IN AND UP
- 26. Landing gear position indicators – GEAR DOWN INDICATION
- 27. Emergency brake control handle – IN AND SECURE
- 28. Canopy emergency jettison handle – FORWARD
- 29. Multiple weapons control panel – SET
  - a. Master arm switch – SAFE
  - b. Delivery mode knob – OFF
  - c. Weapon select knob – C
  - d. Radar missile power switch – OFF

- e. Selective jettison knob – OFF
- f. Interlock switch – IN

**WARNING**

If the missile power switch is in the PWR ON or CW ON position, and the radar power switch in the rear cockpit is in any position other than OFF or TEST, radiation will be emitted which can be harmful to ground personnel.

- 30. Accelerometer – SET
- 31. Flight instrument light control – AS REQUIRED
- 32. Clock – WIND AND SET
- 33. Optical sight – AS REQUIRED
- 34. Film magazine/dust cover – SECURE
- 35. ADI – CHECK & SET (cannot be performed when battery start is made)
  - a. Rotate pitch trim knob to check travel ( $-10^\circ$   $+5^\circ$  minimum)
  - b. Set horizon bar level with miniature aircraft.

**WARNING**

If the horizon bar will not move with the pitch trim knob, the ADI is unsafe for flight.

- 36. Emergency attitude indicator – CHECK
  - a. Cage and do not lock
  - b. Set miniature aircraft level with horizon bar
- 37. Navigation function selector panel – SET
  - a. Bearing distance selector switch – AS DESIRED
  - b. Mode selector knob – AS DESIRED
- 38. Fire warning lights – TEST (cannot be performed when battery start is made)
 

Check that fire and overheat warning lights illuminate when the fire warning lights test button is depressed.
- 39. Fuel quantity gage – CHECK (cannot be performed when battery start is made)
 

Actuate and hold feed tank check switch to check fuel quantity (counter and tape) in feed tank.
- 40. Canopy manual unlock handle – FORWARD
- 41. Arresting hook control handle – UP
- 42. Communication-navigation control panel – SET
  - a. Communication frequency control knobs – AS REQUIRED
  - b. Communication channel control knob – AS REQUIRED
  - c. Mode select switch – AS REQUIRED (some aircraft)
  - d. Communication volume control knob – AS DESIRED
  - e. Auxiliary channel control knob – AS REQUIRED
  - f. Auxiliary volume control knob – AS DESIRED
  - g. COMM-AUX pushbutton – TR + G – ADF
  - h. Navigation channel control knobs – AS REQUIRED
  - i. Navigation volume control knobs – AS DESIRED
  - j. Tacan function selector knob – OFF/STBY
  - k. Communication command button – AS DESIRED
  - l. Navigation command button – AS DESIRED

43. Emergency vent knob - IN
44. Rain removal switch - OFF
45. Pitot heat - CHECK (cannot be performed when battery start is made)
46. Defog-foot heat control handle - AS DESIRED
47. IFF mode IV function switch - SET (cannot be performed when battery start is made)
48. IFF master control knob - OFF
49. Circuit breakers - CHECK
50. Temperature control panel - SET
  - a. Temperature control knob - AS DESIRED
  - b. Mode selector switch - AUTO
51. DCU-94/A bomb control monitor panel - SET (some aircraft)
  - a. Station selector switches - AFT
  - b. Master release lock switch - AFT
  - c. Option selector knob - OFF
52. Cockpit lights control panel - AS REQUIRED
  - a. White floodlight switch - OFF
  - b. Instrument panel lights control knob - AS REQUIRED
 

The warning and caution light dimming is controlled by the flight instruments control knob.
  - c. Console lights control knob - AS REQUIRED
  - d. Standby compass light switch - AS REQUIRED
  - e. Console floodlight switch - AS REQUIRED
  - f. Indexer lights control knob - AS REQUIRED
53. Warning and indicator lights - TEST (cannot be performed when battery start is made)
 

Ensure cover assembly on wheels warning light is properly latched.
54. Instrument flood lights - OFF
55. Aural stall warning volume - AS DESIRED
56. Compass control panel - SET
  - a. Latitude compensator - SET
  - b. Mode control knob - SLAVED
  - c. Synchronization indicator - CHECK
57. KY-28 power selector knob - OFF
58. KY-28 Mode selector - P
59. Exterior lights control panel - SET
  - a. Fuselage lights switch - AS REQUIRED
  - b. Wing lights switch - AS REQUIRED
  - c. Tail lights switch - AS REQUIRED
  - d. Exterior lights flasher switch - AS REQUIRED
  - e. Formation lights switch - OFF
60. Instrument lights intensity control panel - SET
61. Intercom system - CHECK
62. APU system - CHECK (some aircraft), (cannot be performed when a battery start is made)
  - a. APU reject switch - TEST (APU light on)
  - b. Move control stick very slightly fore and aft and check corresponding stabilator movement
 

Excessive movement of the control stick will cause failure of the PC-2 reservoir.
  - c. APU reject switch - NORMAL (APU light out after 1 minute)
63. Oxygen quantity gage - CHECK (cannot be performed when battery start is made)
 

Check that the oxygen quantity is sufficient for the intended mission, the OFF flag on the gage face is not visible, and the OXYGEN LOW light is extinguished. Press oxygen test button and check OXYGEN LOW light and MASTER CAUTION light illuminate at 1 liter. Notify man in rear cockpit, if applicable, that test is in progress.
64. Oxygen supply system - CHECK AND SET

- a. Oxygen supply lever - FULLY ON
 

On the CRU-73/A regulator, it is possible for the oxygen supply lever to stop in an intermediate position between ON and OFF. Assure the lever is all the way on.
- b. Emergency and diluter levers - NORMAL
- c. Check the oxygen pressure gage 50 to 125 psi.
- d. Put mask on and place emergency lever in emergency position; breathe normally and check flow indicator operation. Hold breath; all flow should stop and the flow indicator should return to no-flow position (black). A white indicator indicates flow due to a leak that must be corrected before flight
- e. Return emergency lever to NORMAL

**WARNING**

For regulators other than the CRU-73/A, if the oxygen supply lever is OFF and the diluter lever is in NORMAL, there will be no restriction to breathing but the crewmember will be breathing cockpit air only and hypoxia will occur as cockpit altitudes that require oxygen are reached. It is therefore imperative to check for oxygen flow prior to takeoff. With the diluter lever in 100% or with the CRU-73/A regulator, if the oxygen supply lever is OFF, neither cockpit air nor oxygen will be available at the mask.

65. RWR systems - CHECK (as required) THEN OFF
 

Refer to TO 1F-4E-34-1-1.
66. Eject light - CHECK
 

Press the light and check that both front and rear EJECT lights illuminate. Press the light again and check that both lights extinguish.

## BEFORE STARTING ENGINES

1. CNI switch - ON
 

Have ground personnel place the CNI switch in the left wheel well to the ON position.

**CAUTION**

When the CNI equipment is operating on external power without cooling air applied, it is limited to 10 minutes of accumulated operation in a 1 hour period in order to prevent heat damage to the equipment.

2. Fore and aft area - CLEAR
 

Ensure the wheels are chocked and the engine intake, and exhaust areas, starter exhaust areas, and cockpit and canopy rail areas are clear of personnel and equipment. Refer to Danger Areas Illustration, this section.
3. Fire guard - POSTED
4. Throttles - OFF

**CAUTION**

Attempting a pneumatic start with throttles out of OFF will result in fuel puddling and the possibility of a hot start or fire.

**STARTING ENGINES**

The engines can be started by utilizing electrical power from an external power source or the aircraft battery, and by utilizing air pressure from a ground cart or a pyrotechnic cartridge. As a result, several starting combinations can be realized; i.e., external power source and ground cart, external power source and cartridge, battery and cartridge, and battery and ground cart. Refer to section VII, System Operation, for a description of engine starter operation. This procedure establishes the right engine as being started first. This procedure was adopted in order to ascertain that both utility hydraulic system pumps are operating properly. The right engine pump delivers  $2775 \pm 225$  psi at idle, while the left engine pump delivers  $3000 \pm 250$  psi at idle. Because of this, the single needle utility hydraulic pressure indicator cannot be used to determine pump operation unless the right engine is started first. As the left engine is started, the utility hydraulic pressure will increase slightly indicating the left engine pump is operating. This procedure is based upon external power being available. During a start in which battery power is used, the oil pressure indicator, fuel flow indicator, hydraulic pressure indicator, and FIRE and OVERHT warning light will not be operative until airplane generated power is available. Cold weather procedures, section IX are to be used any time the initial oil pressure exceeds 50 psi. This can occur even when the outside temperatures are not extremely cold.

**WARNING**

Under no circumstances will the aircraft be flown with unfired cartridges in the starter.

**CAUTION**

During engine start, if rpm increases rapidly from 0 to 30%, immediately abort the start. Such an rpm increase is an indication of failure within the starter-to-engine drive train. Further rotation of the engine is impossible with such a failure. Continued fuel flow to the engine under this condition may result in engine fire.

**PNEUMATIC START****CAUTION**

Do not make a pneumatic start with an unfired cartridge installed in the starter. The cartridge may ignite and the resulting added torque may shear the starter output shaft.

1. External air source – CONNECT TO RIGHT STARTER (MA-1A starting unit or equivalent).
2. Engine master switches – ON
3. Engine – CRANK  
Signal ground crew to start external airflow and monitor the tachometer for the first indication of engine rotation.

**CAUTION**

If there is no indication of engine rpm within 15 seconds or no indication of oil or hydraulic pressure within 30 seconds after external air is applied discontinue the start and investigate.

4. At 10% rpm, ignition button – DEPRESS AND HOLD WHILE ADVANCING THROTTLE

Depress the ignition button and simultaneously advance the throttle to a position halfway up the throttle quadrant, then snap the throttle to IDLE while monitoring fuel flow. If the fuel flow drops below 225 pph or more than 75 pph below initial fuel flow indication, the throttle rigging is out of limits and an entry shall be made in the Form 781. Do not accept the aircraft for flight where a snap deceleration is anticipated as flameout may occur. Rear crewmember will check for appropriate throttle movement during start. If throttles are not engaged, reconnect after engine start.

**CAUTION**

Do not attempt to start the engine before reaching 10% rpm. If the starting procedure is initiated at a lower rpm additional heat distress of the engine hot section is anticipated. Overtemperature of the turbine will generally occur during a low rpm start if starter air is inadvertently interrupted during the start cycle.

5. Release ignition button as soon as lightoff is indicated.

Lightoff is indicated by a rise in exhaust gas temperature followed by an increase in engine rpm. Engine lightoff is usually noted at approximately 13 to 16% rpm with a fuel flow of 225 to 750 pounds per hour. Higher fuel flow values are likely to result in hot starts. To prevent an overtemperature condition from occurring, the engines should be shut down prior to reaching the actual EGT limit. In the event of a hot or false start, and the throttle cannot be returned to OFF, the engine may be shutdown from any throttle setting by placing its engine master switch OFF. This closes the fuel shutoff valve and deprives the engine of fuel. The engine will flameout in approximately 30 seconds from idle and approximately 2 seconds from military. After any wet or false start, allow 1 minute or longer for the combustion system to drain before restarting the engine. If the engine does not lightoff within 15 seconds after fuel flow is indicated, discontinue the start and investigate. If the engine does not

# DANGER AREAS

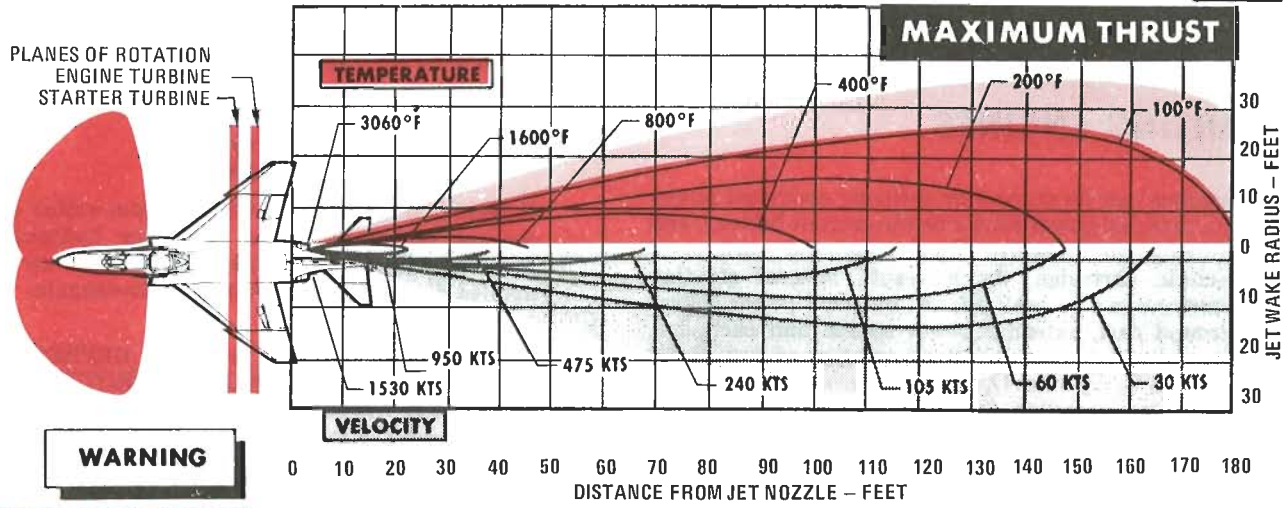
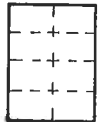

**WARNING**

AT HIGH THRUST SETTINGS, THE DANGER AREA ROUND THE INTAKE DUCTS MAY EXTEND AS FAR AS FOUR FEET AFT OF DUCT LIP

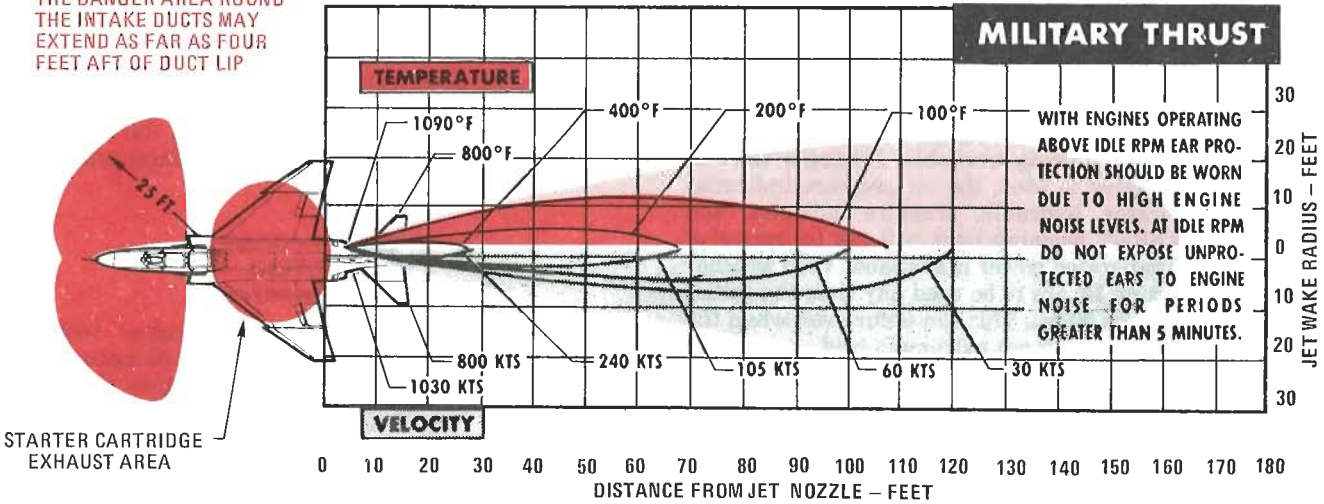

RADIATION BURN HAZARD MAY EXIST IN THIS AREA

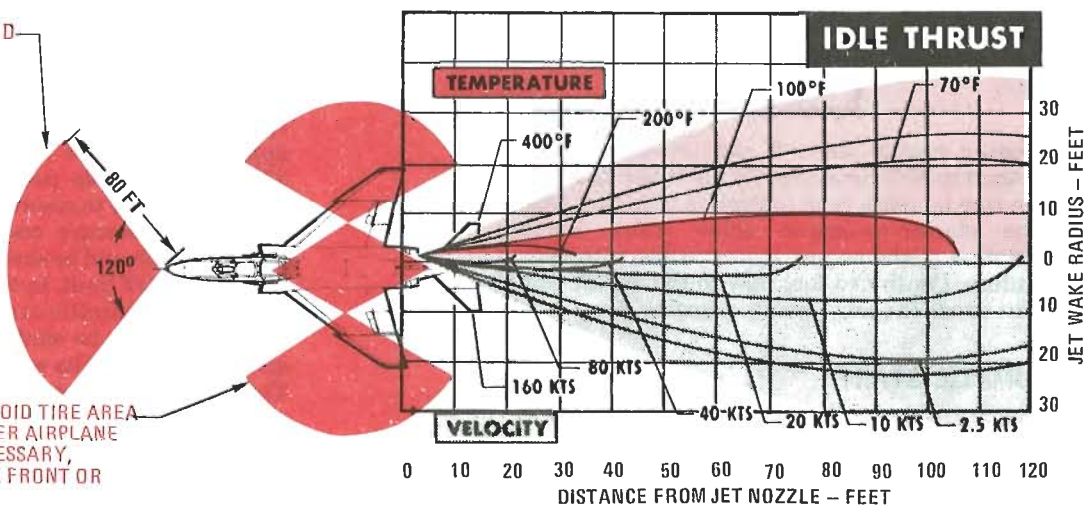

FOR HOT BRAKES, AVOID TIRE AREA FOR 60 MINUTES AFTER AIRPLANE HAS STOPPED. IF NECESSARY, APPROACH FROM THE FRONT OR REAR ONLY.

Figure 2-3



continue to accelerate after lightoff, discontinue the start.

6. At 45% rpm, signal ground crew to stop external airflow
7. Exhaust gas temperature indicator - 220° to 420°C
8. Fuel flow indicator - WITHIN LIMITS  
Fuel flow should not exceed 750 pph at lightoff, and 800 to 1400 pph at idle. Fuel consumed during starting is approximately 65 pounds per engine.
9. Idle rpm - 65  $\pm$  1%
10. Right boost pump indicator - 30  $\pm$  5 PSI (some aircraft)
11. Oil pressure indication - 12 PSI MIN
12. Hydraulic pressure indicators - WITHIN LIMITS  
With the right engine started, the PC-2 hydraulic pressure indicator should read 3000  $\pm$  250 psi and the utility hydraulic pressure indicator should read 2775  $\pm$  225 psi. The check hydraulic gage indicator light remains illuminated until the left engine is started and all four hydraulic pumps are operating above 1750 psi. When the left engine is started, the utility hydraulic pressure indicator should read 3000  $\pm$  250 psi.

### CAUTION

With only one engine operating, excessive rapid movement of the control stick may rupture the inoperative power control system reservoir.

13. Right generator control switch - GEN ON  
Ensure RH GEN OUT and BUS TIE OPEN lights go out. To avoid an electrical power interruption which could result in an INS No-Go indication, the pilot should ensure that INS is not in the align mode when the generator switches are placed to GEN ON.

### WARNING

Check that auxiliary air doors and speed brakes (if out) are clear prior to cycling generator switches. Any interruption in electrical power will cause them to close violently, with possible injury to ground crew personnel.

14. APU light - CHECK ON (some aircraft)  
The APU light will remain illuminated for approximately 1 minute after the left engine is started.
15. Spoiler actuator - CHECK  
With the right engine operating, slowly deflect control stick approximately 1 inch to the left. Have ground crew or rear seat occupant verify that the spoiler does not fully deflect and that it returns to a flush position when the stick is returned to neutral. Abort if the spoiler check is not good.
16. Start the left engine per steps 1 through 12, substituting LEFT in all cases.
17. Left generator control switch - GEN ON  
Ensure that the LH GEN OUT light goes out. If the BUS TIE OPEN light does not go out within

approximately 18 seconds, accelerate either engine to approximately 70% rpm and cycle right generator. In low ambient temperatures, the BUS TIE OPEN light may not immediately go out after the left engine is started and the left generator light goes out. This may be due to failure of the generators to synchronize quickly because of cold oil in the left generator CSD.

18. External air - DISCONNECT
19. External electrical power - DISCONNECT
20. Right generator control switch - CYCLE  
Cycle the right generator control switch (OFF, then GEN ON), and check that the RH GEN OUT light illuminates.

### WARNING

Do not cycle both generator control switches at once. Any interruption in electrical power will cause the auxiliary air doors and the speed brakes (if out) to close violently, with possible injury to ground crew personnel.

21. BUS TIE OPEN light - OUT  
Ensure that the BUS TIE OPEN light remains out when placing the right generator control switch to OFF, and that it flashes on momentarily when the switch is returned to the GEN ON position.
22. Interior check - COMPLETE (if applicable)
23. Inertial navigation set - ALIGN (battery start)  
If a battery start was made, perform a heading memory or gyro compass alignment (as desired) as outlined in the After Electrical Power check.

### CARTRIDGE START

This procedure is based upon external power not being available. During routine (other than scramble/exercise) cartridge starts, it is advisable to use external electrical power, if available, as this will allow use of the CNI, fire and overheat warning circuits, and all engine instruments during the start. If external power is used, normal generator switching should be used. To avoid possible irritation caused by cartridge exhaust smoke/gases, it may be advisable to close canopies and select 100% oxygen during start cycle.

### WARNING

Never attempt to load or unload a cartridge in either starter with the engine master switches on, ground refueling switch on, or external electrical power applied. If a malfunction in safety circuits occurs, serious injury could result.

1. Engine master switches - ON
2. Right generator control switch - GEN ON
3. Ignition button - DEPRESS AND HOLD WHILE ADVANCING THROTTLE  
Depress the ignition button and simultaneously

move the throttle halfway up the quadrant, and then return the throttle to idle. The rear crewmember will check for appropriate throttle movement during start. If throttles are not engaged, reconnect after engine start.

4. Engine start switch - R (right)

The start switch should be returned to the center position once cartridge ignition is started. Releasing the spring-loaded switch may allow it to bounce across the neutral position and fire the left cartridge. Once cartridge ignition has been initiated, the engine will continue to accelerate until the cartridge propellant is consumed. The start may be discontinued by moving the throttle to OFF or, with the other engine master switch ON, moving the engine master switch to OFF.

**WARNING**

- If there is absolutely no indication of an engine rpm rise and no smoke is visible at the starter exhaust port, a misfire has occurred. It will not be possible to start the engine until the starter is reloaded. Refer to Cartridge Mode Starting Malfunctions, section III.
  - If there is a delay in obtaining engine rotation or brief engine rotation to a low rpm is produced, and smoke is visible at the starter exhaust port, a hangfire has occurred. The cartridge may smolder from 20 to 150 seconds. Refer to Cartridge Mode Starting Malfunctions, section III.
  - If engine rotation advances to 15% rpm or more but will not advance to IDLE rpm, a hangstart has occurred. Refer to Cartridge Mode Starting Malfunctions, section III.
5. Release ignition button as soon as lightoff is indicated.  
Lightoff will be indicated by a rapid rise in exhaust gas temperature, followed by an increase in engine rpm. Engine lightoff is usually noted at approximately 13 to 16% rpm. To prevent an over temperature condition from occurring, the engines should be shutdown prior to reaching the actual EGT limit. If the engine does not continue to accelerate after lightoff, discontinue the start. In the event of a hot or false start and the throttle cannot be returned to OFF, the engine may be shut down from any throttle setting by placing its engine master switch OFF providing the other engine master switch is ON. This will close the fuel shutoff valve and deprive the engine of fuel. The engine will flameout in approximately 30 seconds from idle and approximately 2 seconds from military. After any wet or false start, allow 1 minute or longer for the combustion system to drain before restarting the engine.
6. Exhaust gas temperature indicator - 220° to 420°C
7. Idle rpm - 65 +1%  
Ensure RH GEN OUT and BUS TIE OPEN lights go out.

**CAUTION**

If there is no indication of oil or hydraulic pressure within 30 seconds, shut down engine and investigate.

8. Right boost pump indicator - 30 ±5 PSI (some aircraft)
9. Oil pressure indication - 12 PSI MIN
10. Fuel flow indicator - WITHIN LIMITS  
Fuel flow should not exceed 800 to 1400 pph at idle. Fuel consumed during starting is approximately 65 pounds per engine.
11. Hydraulic pressure indicators - WITHIN LIMITS  
With the right engine started, the PC-2 hydraulic pressure indicator should read 3000 ±250 psi and the utility hydraulic pressure indicator should read approximately 2775 ±225 psi. The check hydraulic gage indicator light remains illuminated until the left engine is started and all four hydraulic pumps are operating above 1750 psi. When the left engine is started, the utility hydraulic pressure indicator should read 3000 ±250 psi.

**CAUTION**

With only one engine operating, excessive rapid movement of the control stick may rupture the inoperative power control system reservoir.

12. APU light - CHECK ON (some aircraft)  
The APU light will remain illuminated until approximately 1 minute after the left engine is started.
13. Spoiler actuator - CHECK  
With the right engine operating, slowly deflect control stick approximately 1 inch to the left. Have ground crew or rear seat occupant verify that the spoiler does not fully deflect and that it returns to the flush position when the stick is returned to neutral. Abort if the spoiler check is not good.
14. Start the left engine per steps 4 through 12 substituting LEFT in all cases.
15. Left generator switch - GEN ON  
Ensure that the LH GEN OUT light goes out. If the BUS TIE OPEN light does not go out within approximately 18 seconds, accelerate either engine to approximately 70% rpm and cycle right generator. In low ambient temperatures, the BUS TIE OPEN light may not immediately go out after the left engine is started and the left generator light goes out. This may be due to failure of the generators to synchronize quickly because of cold oil in the left generator CSD.
16. Right generator control switch - CYCLE  
Cycle the right generator control switch (OFF, then GEN ON), and check that the RH GEN OUT light illuminates.

**WARNING**

Do not cycle both generator control switches at once. Any interruption in electrical power will cause the auxiliary air doors and the speed brakes (if out) to close violently, with possible injury to ground crew personnel.

**17. BUS TIE OPEN light - OUT**

Ensure that the bus tie open light remains out when placing the right generator control switch to OFF, and that it flashes on momentarily when the switch is returned to the GEN ON position.

**18. Interior check - COMPLETE****19. Inertial navigation set - ALIGN**

Perform a heading memory or gyro compass alignment (as desired) as outlined in the After Electrical Power (Rear Cockpit) check.

**ENGINE GROUND OPERATION**

No engine warm-up is necessary; however, allow the engines to operate at idle until instrument readings stabilize. As soon as instrument readings stabilize, the throttle may be advanced to maximum thrust.

**CAUTION**

During extended ground operation, the radar may become overheated due to insufficient cooling during operation at high ambient temperatures or low engine power setting. Under the above conditions, if the radar overtemp light illuminates, turn the radar OFF. To reduce the probability of an overtemperature light, a maximum of 20 minutes ground operation is recommended.

**BEFORE TAXIING  
(FRONT COCKPIT)****NOTE**

Since pressure vibrations in some types of shelters may cause instrument fluctuations and/or inaccurate readings, the Before Taxiing checks should be performed outside the shelter when practical.

1. Communication and navigation equipment - ON & CHECK
2. IFF - CHECK
 

Prior to this point the IFF should remain OFF as any interruption of power would cause loss of the mode 4 code.
3. Radar altimeter - ON & CHECK
  - a. Function control switch - ON
 

Allow 5 minutes warm-up. Check that the OFF flag moves out of view and altitude pointer fluctuates.
  - b. Function control switch - DEPRESS

Check that pointer moves to  $35 \pm 15$  feet and stabilizes.

- c. Low altitude warning light - CHECK
 

With function control switch depressed, move reference marker above and below pointer. Warning light must illuminate within  $\pm 5$  feet of indicated altitude.
- d. Function control switch - RELEASE
 

Move reference marker to below 5 feet. Check that warning light is off and altitude pointer fluctuates.
- e. Reference marker - SET
 

Set to desired low altitude limit.
4. Speed brakes - CYCLE
 

Open and close the speed brakes to check proper operation. Have ground crew check that speed brakes extend simultaneously. Obtain a signal from the ground crew that the speed brakes are fully closed and observe that the SPEED BRAKE OUT indicator light is extinguished.
5. Slats flaps - CHECK
 

Place slats flaps switch to OUT; observe that slats indicate OUT and flaps indicate DN. Place slats override switch to NORM; observe slats extend. On aircraft after TO 1F-4-1082, the flaps may not extend or retract together without airloads on them. This condition is normal and the flaps should extend and retract together when airborne. Place slats override switch to IN; observe slats retract. Place slats override switch to NORM; observe slats extend. If slats indicate barberpole or indication does not match switch position, leave switch as set and abort the mission. If an audible (noticeable in head phones) chattering associated with slat flap and utility hydraulic pressure indicators fluctuating in unison occurs, cycle the slats flaps. If chatter persists, abort the mission. If cycling stops chatter, continue mission and make an appropriate entry in AF Form 781.

**CAUTION**

Continued or prolonged operation with flap or slat chatter will damage actuator(s) and mechanisms.

6. Flight controls - CHECK (slats flaps OUT AND DOWN)
 

Ground crew should confirm all flight control positions. After TO 1F-4-1081, the MASTER CAUTION and CHK HYD GAGES lights may illuminate momentarily during this check. If pressure recovers without delay, disregard this indication.

  - a. Control stick - PULL FULL AFT AND RELEASE
 

Movement forward should be smooth and free of any restriction. The stick may not return to the full forward position. The stick should move forward at least to the  $\frac{1}{2}$  travel position and further movement toward the stop should require no more than one pound push force.
  - b. Rudder - CHECK FULL TRAVEL LEFT AND RIGHT
  - c. Ailerons/ARI - CHECK
 

Move control stick full left. Observe left spoiler

up, right aileron down and rudder slightly left. Engage yaw stab aug. Observe rudder move further left. Depress emergency quick release lever. Observe rudder move toward neutral. Release emergency quick release lever, neutralize stick and disengage yaw stab aug. Repeat check substituting right for left.

7. Slats flaps - NORM
8. ARI disengage - CHECK  
Move stick full right and left. Observe no rudder movement.
9. Stab aug switches - ENGAGE AND CHECK  
Engage each axis of stab aug individually. Observe no movement of any control surface (¼ inch allowable).
10. Reference system selector - PRIM (ensure INS is in NAV)
11. Compass mode control knob - SYNC (if necessary)  
Allow 10 seconds for automatic synchronization before manually synchronizing system.
12. Automatic flight control system - CHECK
  - a. AFCS - ENGAGE  
Grasp stick below stick grip. Position stick near neutral. Hold switch to engage position until AFCS engages. Check that stick does not immediately drive in either direction nor any control surface jump more than ½ inch. After TO 1F-4-1051, abruptly move control stick forward or aft and check that AFCS switch disengages. Re-engage AFCS switch.
  - b. Altitude hold - ENGAGE  
Observe no control surface jump or rapid stick motion.
  - c. AFCS - DISENGAGE  
Depress and hold the front cockpit emergency quick release lever. Observe PITCH AUG OFF, AUTOPILOT DISENGAGE and MASTER CAUTION lights illuminate. Release lever. Observe PITCH AUG OFF light goes out.
  - d. AFCS - ENGAGE
  - e. (WSO) AFCS - DISENGAGE  
Depress and hold the rear cockpit emergency quick release lever. Observe PITCH AUG OFF, AUTOPILOT DISENGAGE and MASTER CAUTION lights illuminate. Release lever. Observe PITCH AUG OFF light goes out.

#### NOTE

Ground checks can not assure operational AFCS during flight. If AFCS does not engage during ground checks, do not use during flight.

13. Stab aug switches - DISENGAGE
14. Trim - CHECK AND SET 1 TO 3 UNITS NOSE DOWN  
With 3 units nose down trim, expect a nose heavy tendency on the takeoff roll which quickly approaches a trimmed condition as the aircraft lifts off and the gear and flaps are retracted. With 1 unit nose down trim, a very marked nose up trim occurs after approximately 230 knots requiring a large nose down trim change at a very low altitude. Check operation of the trim indicator. Receive a signal from the ground crew/rear cockpit occupant that the ailerons and rudder are set at neutral.
15. Slats flaps - OUT AND DOWN (ground crew

visually check)

16. IFR door and exterior air refueling lights - CHECK (if required)
17. Seat pins - CHECK REMOVED AND STOWED

#### NOTE

Do not move aircraft with INS in ALIGN mode.

18. Optical sight reticle - CHECK
19. Pneumatic pressure - CHECK
20. Altimeter and SPC - SET & CHECK
  - a. Set current altimeter setting on the barometric scale.
  - b. Altimeter pointer should indicate the field elevation within  $\pm 75$  feet.
  - c. Place the SPC switch to RESET CORR. The STATIC CORR OFF light should go out and remain out. Disregard initial momentary engagement oscillations. Altimeter reading after oscillations stop should not exceed  $\pm 25$  feet from original reading. Continued altimeter oscillations of any magnitude are unacceptable.
  - d. With the static correction on (SPC engaged), the altimeter should indicate the field elevation within  $\pm 90$  feet.
  - e. The difference between the front and rear cockpit altimeters should not exceed 100 feet.
  - f. Place the altimeter switch to RESET. Altimeter should not vary more than  $\pm 75$  feet and the red STBY flag should not be in view.
  - g. The altimeter should indicate the field elevation within  $\pm 75$  feet.
  - h. With both altimeters in RESET, the difference between the front and rear cockpit should not exceed 75 feet.

#### NOTE

If the altimeter is not within tolerance in RESET, the aircraft may be flown in the STBY mode provided that, in the STBY mode, the altimeter checks within  $\pm 75$  feet of field elevation. The  $\pm 75$  feet of field elevation is an operational restriction and does not necessarily reflect instrument tolerances.

21. Wheel chocks and ground interphone cord - REMOVED

#### BEFORE ENTERING REAR COCKPIT

1. Canopy condition - CHECK  
Check for cracks in the canopy and windshield plexiglass. Check condition of the canopy pressure seals.
2. Canopy safety strut - REMOVED  
Ensure normal canopy control handle is in open position if safety strut requires removal.
3. Canopy actuator - SHEAR PIN INTACT
4. Lower ejection handle guard - UP

**WARNING**

During flight operation, no object of any kind should be placed or allowed to remain on the top of the ejection seat.

5. Command selector valve - VERTICAL
6. Ejection seat - CHECK
  - a. Face curtain and seat mounted initiator safety pins - INSTALLED; ALL OTHER SAFETY PINS REMOVED

**WARNING**

The rocket motor and igniter sear are located under the seat and must have a fiberglass protector installed around the igniter sear and sear cable to prevent accidental pulling of the igniter sear. Do not use this area for stowage, and exercise extreme caution when performing any function in the vicinity of the rocket pack; e.g., pulling rocket motor safety pin, adjusting leg restraint lines, etc.

**CAUTION**

Exercise caution regarding hand movements in the vicinity of the bulkhead mounted canopy initiator linkages. Also, do not stow flight equipment or personal items in this area. Failure to comply could result in inadvertent jettisoning of the canopy.

- b. Canopy interlock cable and interdicator link safety pin assembly - INSTALLED CORRECTLY AND ATTACHED TO CANOPY
- c. Banana links - ENGAGED IN MAIN SEAR
- d. Seat mounted initiator - LINKAGE CONNECTED
- e. Scissors - LOCKED TO SHACKLE AND TIED DOWN, SCISSORS GUARD NOT BROKEN

**WARNING**

If the scissors shackle safe-tie thread passes through the wire loop, the drogue chute may not deploy.

- f. Drogue chute withdrawal line - ROUTED OVER ALL OTHER LINES
- g. Top latch mechanism - plunger and locking indicator - FLUSH with Housing

**WARNING**

If the plunger is not flush, the seat is not locked into position and inadvertent ejection could result.

- h. Parachute withdrawal line QUICK DISCONNECT IS CONNECTED AND RUNS THROUGH GUILLOTINE
- i. Safety pin line - NOT THROUGH GUILLOTINE
- j. Parachute alignment ring - SAFETY PIN LINE AND RIPCORDER PIN LINE (ATTACHED TO PARACHUTE WITHDRAWAL LINE) ROUTED THROUGH, PARACHUTE WITHDRAWAL LINE ROUTED AROUND
- k. Guillotine - CHECK PASSAGE AND HOSE SECURITY
- l. Drogue gun assembly - SHEAR PIN INTACT, SAFETY PIN OUT, TRIP ROD CONNECTED WITH NO RED SHOWING ON INNER BARREL
- m. Drogue gun cocking indicator - COCKED
 

If the indicator is approximately 1/2 inch below the gun housing, it is cocked. If flush with the housing it is uncocked and will not fire on ejection.
- n. Bulkhead mounted canopy initiator - LINKAGE CONNECTED, SAFETY PIN REMOVED
- o. Harness assembly - CHECK
- p. Emergency oxygen - PRESSURE AND SAFETY PIN REMOVED
 

Proper servicing of the emergency oxygen bottle is indicated by a gage reading of 1800-2200 psi at 21°C (70°F). The pressure indication varies with temperature. To determine correct indication, add 6.5 psi for each degree above 21°C (3.5 psi/°F) and subtract 6.5 psi for each degree below 21°C. Thus, the bottle is correctly serviced if the gage reads 1890-2290 psi at 35°C (95°F). See ejection seat foldout illustration for approximate pressure values for various gage needle locations.
- q. Emergency oxygen actuation knob and linkage - CHECK
 

Check knob not actuated. If actuated, knob is tilted approximately 45° from vertical. Check security of shear pin in cable to linkage connection by applying light tension on cable.
- r. Rocket motor - FIBERGLASS PROTECTOR INSTALLED AND UNDAMAGED, SAFETY PIN REMOVED AND LEG GUARDS IN PLACE
- s. Leg garters - LOCKED IN, AND LANYARDS NOT TWISTED
- t. Survival kit - RELEASE HANDLE DOWN, SELECTOR SWITCH AUTO POSITION (UP)
- u. Emergency harness release handle - DOWN WITH SEAR ENGAGED, SAFETY PIN OUT, AND ACTUATION LANYARD CONNECTED
- v. Time release trip rod - CONNECTED
- w. Personnel locator beacon (PLB) inflight mode selector switch - AUTOMATIC POSITION (RED DOT SHOWING) FOR NORMAL PEACETIME OPERATIONS. SAFETY STREAMER REMOVED.

**BEFORE ELECTRICAL POWER (REAR COCKPIT)**

1. AN/ALE-40 chaff dispenser - OFF (After TO 1F-4E-614)
  - a. Chaff mode switch - OFF
  - b. Flare mode switch - OFF
  - c. Ripple switch - OFF
2. Throttles - AFT
3. Radar power - OFF



The radar power selector knob should remain OFF until the aircraft is operating on internal power and the engines are up to IDLE power (or 50% rpm minimum).

4. MSDG/DSCG - OFF (some aircraft)
5. ECM equipment - OFF (some aircraft)  
Refer to TO 1F-4E-34-1-1-1 and TO 1F-4C-34-1-1-2.
6. INS - OFF
7. Nuclear store consent switch - SAFE
8. Nav computer - OFF
9. Battery bypass switch - OFF (some aircraft)
10. SST-181X pulse selector switch - OFF
11. Circuit breaker panels - CHECK
12. Electrical test receptacle plug 3P325 - ENSURE PLUG SEATED FLUSH, KNURLED LOCK RING SECURE, CAP TIGHT.  
It is possible to trip both generators off the line if the electrical test receptacle plug 3P325 under the right canopy sill is loose. The plug uses a (twist clockwise to lock) knurled lock ring which should not be confused with the chain equipped threaded cap.
13. Publications and flight data - CHECK

**AFTER ELECTRICAL POWER (REAR COCKPIT)**

1. Instrument ground power switch - ACTUATE (cannot be performed when battery start is made)  
Actuate the instrument ground power switch to connect the instrument 115/200 volt ac bus and the instrument 28 volt ac bus to the electrical system.
2. Navigation computer - SET
  - a. Function select knob - STBY
  - b. Wind counters - SET PREFLIGHT WIND DIRECTION AND SPEED
  - c. Variation counter - SET LOCAL MAGNETIC VARIATION
  - d. Position update switch - NORM
  - e. Present position counters - SET
  - f. Target counters - SET FOR TGT 2
  - g. Function selector knob - RESET  
Coordinates may be stored in the navigation computer by placing the function selector knob to RESET. The coordinates stored in the AN/ASN-46A are those in the target windows.
  - h. Function selector knob - STBY  
The function selector knob must be placed in STBY and present position coordinates set prior to aligning the INS.

- i. Target counters - SET FOR TGT 1
3. TISEO - OFF (some aircraft)
4. INS alignment - AS DESIRED  
Navigation accuracy is adversely affected if the aircraft is disturbed during INS alignment.

**Gyro compass alignment -**

- a. Align mode switch - GYRO COMP
- b. Power control knob - STBY  
From this time until completion of gyro compass alignment, the airplane must not be moved.
- c. When HEAT light is out, power control knob - ALIGN
- d. After ALIGN light has cycled from off to steady and then to flashing, null out the variation sensed by the system with the magnetic variation control knob. INS system accuracy is enhanced by complete temperature stabilization of the platform. To achieve this, allow the ALIGN light to flash as long as possible before switching to NAV or perform a double alignment by setting the MAG VAR knob approximately one degree either side of the null value and repeating steps b thru d.
- e. Power control knob - NAV

**NOTE**

To avoid electrical power interruption which could result in an INS NO-GO indication, ensure INS is not in the ALIGN mode when the generator switches are placed to ON. If a power interruption does occur, switch the power control knob to OFF. When power is restored, go from OFF to ALIGN pausing momentarily at STBY.

**Heading memory alignment -**

- a. Perform a normal INS alignment through the flashing ALIGN light.
- b. Align mode switch - HDG MEM
- c. Inertial navigation set - OFF (STBY if power remains applied to the aircraft)
- d. Navigation computer - OFF (STBY if power remains applied to the aircraft)  
From this time until completion of the heading memory alignment, the airplane must not be moved.

**After ground power available and before taxiing, perform the following steps -**

- e. Navigation computer - STBY
- f. Inertial navigation set - ALIGN  
If time permits the INS may first be placed to STBY until the heat light extinguishes and then to align for greater system accuracy.
- g. Inertial navigation set - NAV  
Place the INS to NAV after the ALIGN light flashes and prior to aircraft power transfer.
- h. Align mode switch - GYRO COMP  
If the align mode switch is placed to GYRO COMP prior to switching to NAV the heading memory information will be lost.

## REAR COCKPIT INTERIOR CHECK

**WARNING**

All harnessing, personal equipment leads and leg restraint lines must be secured before closing the canopy.

1. Rudder pedals - ADJUST
2. Leg restraint lines - BUCKLED AND SECURE  
Check leg garters buckled and properly adjusted, with garter releases on the inside of the legs. Check that lines are secure to seat and floor, and not twisted or entangled in cockpit motor seat cable. Check that leg restraint lines are threaded through the calf garters (double D-ring), routing first through the outboard ring and then through the inboard ring, then through the thigh garters (single D-ring) before the lock pins are inserted in the snubber boxes. Check that the leg restraint line lock pins are threaded through hold-down strap lugs on the survival kit. Check that the survival kit-to-seat retention straps (if incorporated) are attached to the leg restraint line lock pins at the lock pin attachment points.

**WARNING**

- The leg restraint lines must be buckled at all times during flight to insure legs will be pulled back upon ejection. This will enhance seat stability and will prevent leg injury by keeping legs from flailing following ejection.
  - Failure to route the restraint lines properly through the garters could cause serious injury during ejection.
3. Harnessing and personal equipment leads - FASTEN  
Attach the parachute riser-shoulder harness fittings to the integrated harness. Attach and firmly adjust the survival kit straps. Secure and firmly adjust the lap belt. Connect oxygen, communication and anti-G leads. Route the anti-G hose line behind personal harness sling if hose interferes with controls on left console. Check the operation of the shoulder harness locking mechanism.
  4. Ejection seat height - ADJUST (cannot be performed when battery start is made)
  5. Face curtain and seat mounted initiator safety pins - REMOVED  
After all personal leads have been fastened, have ground crewmember remove face curtain and seat mounted initiator safety pins, show them to aircrew member before stowing in bag, and hand bag to aircrew member.

**WARNING**

If the seat mounted initiator safety pin is left installed during flight, seat ejection is not possible. The ejection gun firing linkage will be restrained from moving, thus preventing firing of the ejection gun.

6. Stick grip and boot - CHECK  
Check stick grip firmly attached to stick and stick boot in place with no tears.
7. Communication navigation control panel - SET
  - a. Communication frequency control knobs - AS REQUIRED
  - b. Communication channel control knobs - AS REQUIRED
  - c. Mode select switch - AS REQUIRED (some aircraft)
  - d. Communication volume control knob - AS DESIRED
  - e. Auxiliary channel control knob - AS REQUIRED
  - f. Auxiliary volume control knob - AS DESIRED
  - g. COMM-AUX pushbutton - TR + G - ADF
  - h. Navigation channel control knob - AS REQUIRED
  - i. Navigation volume control knob - AS REQUIRED
  - j. Tacan function selector knob - OFF/STBY
  - k. Communications command button - AS DESIRED
  - l. Navigation command button - AS DESIRED
- 7a. VOR/ILS/marker beacon volume - AS DESIRED (some aircraft)
8. Emergency slats flaps handle - FORWARD
9. Intercom control panel - SET
  - a. Volume control knob - AS DESIRED
  - b. Amplifier selector knob - NORM
  - c. Function selector knob - HOT MIC
10. Emergency gear handle - IN & SECURE
11. Emergency brake handle - IN & SECURE
12. Slats flaps position indicators - IN AND UP
13. Landing gear position indicators - GEAR DOWN INDICATION
14. Canopy emergency jettison handle - FORWARD
15. Radar scope - SECURE  
Check that radar scope retaining pins are properly installed.
16. Attitude indicator - CHECK & SET (cannot be performed when battery start is made)
  - a. Rotate pitch trim knob to check travel (-10° to +5°)
  - b. Set horizon bar level with miniature aircraft.

**WARNING**

If the horizon bar will not move with the pitch trim knob, the attitude indicator is unsafe for flight.

17. Clock - WIND AND SET
18. Accelerometer - SET
19. Navigation function selector switch - AS DESIRED
20. Canopy manual unlock handle - FORWARD

21. Aural tone - AS REQUIRED
22. Cockpit lights control panel - SET
  - a. White floodlight switch - OFF
  - b. Instrument panel lights control knob - AS REQUIRED
  - c. Console lights control knob - AS REQUIRED  
With the console lights control knob in the OFF position, the radar scope camera green operate light will be inoperative.
  - d. Standby compass light switch - AS REQUIRED
  - e. Console floodlights switch - AS DESIRED
  - f. Indexer lights control knob - AS DESIRED
23. Warning and indicator lights - TEST (cannot be performed when battery start is made)
24. Intercom system - CHECK
25. Oxygen quantity gage - CHECK (cannot be performed when battery start is made)  
Check that the oxygen quantity is sufficient for the intended mission, and the OFF flag on the gage face is not visible.
26. Oxygen supply system - CHECK AND SET
  - a. Oxygen supply lever - FULLY ON  
On the CRU-73/A regulator, it is possible for the oxygen supply lever to stop in an intermediate position between ON and OFF. Assure the lever is all the way ON.
  - b. Emergency and diluter levers - NORMAL
  - c. Check the oxygen pressure gage 50 to 125 psi.
  - d. Put mask on and place emergency lever in emergency position; breathe normally and check flow indication operation. Hold breath; all flow should stop and the flow indicator should return to no-flow position (black). A white indicator indicates flow due to a leak that must be corrected before flight.
  - e. Return emergency lever to NORMAL

**WARNING**

For regulators other than the CRU-73/A, if the oxygen supply lever is OFF and the diluter lever is in NORMAL, there will be no restriction to breathing but the crewmember will be breathing cockpit air only and hypoxia will occur as cockpit altitudes that require oxygen are reached. It is therefore imperative to check for oxygen flow prior to takeoff. With the diluter lever in 100% or with the CRU-73/A regulator, if the oxygen supply lever is OFF, neither cockpit air nor oxygen will be available at the mask.

27. RWR systems - CHECK (as required) THEN OFF (cannot be performed when battery start is made)

1. Interior check - COMPLETE (battery start)
2. Communication and navigation equipment - ON & CHECK
3. APX-80 mode switch - PASSIVE/OFF
4. Radar power - TEST
5. After 30 seconds, 0 thru 250 vdc reads in 1 area, +35 vdc reads 2.0 or greater.
6. Radar scopes - ON (some aircraft)
7. Target designator - POWER ON AND STOWED (some aircraft)
8. Tiseo - ON (some aircraft)
9. Radar BIT checks - INITIATE
10. WRCS BIT checks - INITIATE
11. Navigation computer function selector knob - AS DESIRED
12. Altimeter - SET & CHECK
  - a. Set current altimeter setting on the barometric scale.
  - b. Altimeter pointer should indicate the field elevation within  $\pm 75$  feet.
  - c. With the SPC switch at RESET CORR, the STATIC CORR OFF light should go out and remain out. Disregard initial momentary engagement oscillations. Altimeter reading after oscillations stop should not exceed  $\pm 25$  feet from original reading. Continued altimeter oscillations of any magnitude are unacceptable.
  - d. With the static correction on (SPC engaged), the altimeter should indicate the field elevation within  $\pm 90$  feet.
  - e. The difference between the front and rear cockpit altimeters should not exceed 100 feet.
  - f. Place the altimeter switch to RESET. Altimeter should not vary more than  $\pm 75$  feet and the red STBY flag should not be in view.
  - g. The altimeter should indicate the field elevation within  $\pm 75$  feet.
  - h. With both altimeters in RESET, the difference between the front and rear cockpit should not exceed 75 feet.

**NOTE**

If the altimeter is not within tolerance in RESET, the aircraft may be flown in the STBY mode provided that, in the STBY mode, the altimeter checks within  $\pm 75$  feet of field elevation. The  $\pm 75$  feet of field elevation is an operational restriction and does not necessarily reflect instrument tolerances.

13. Target designator system - STOWED
14. Seat pins - CHECK REMOVED & STOWED

**BEFORE TAXIING (REAR COCKPIT)**

**NOTE**

Since pressure vibrations in some types of shelters may cause instrument fluctuations and/or inaccurate readings, the Before Taxiing checks should be performed outside the shelter when practical.

**TAXIING**

1. Nose gear steering - ENGAGE & CHECK  
Engage nose gear steering and actuate in both directions to ensure proper operation.
2. Wheel brakes - TEST  
After initial roll, apply the wheel brakes to check their operation.



# TURNING RADIUS AND GROUND CLEARANCE

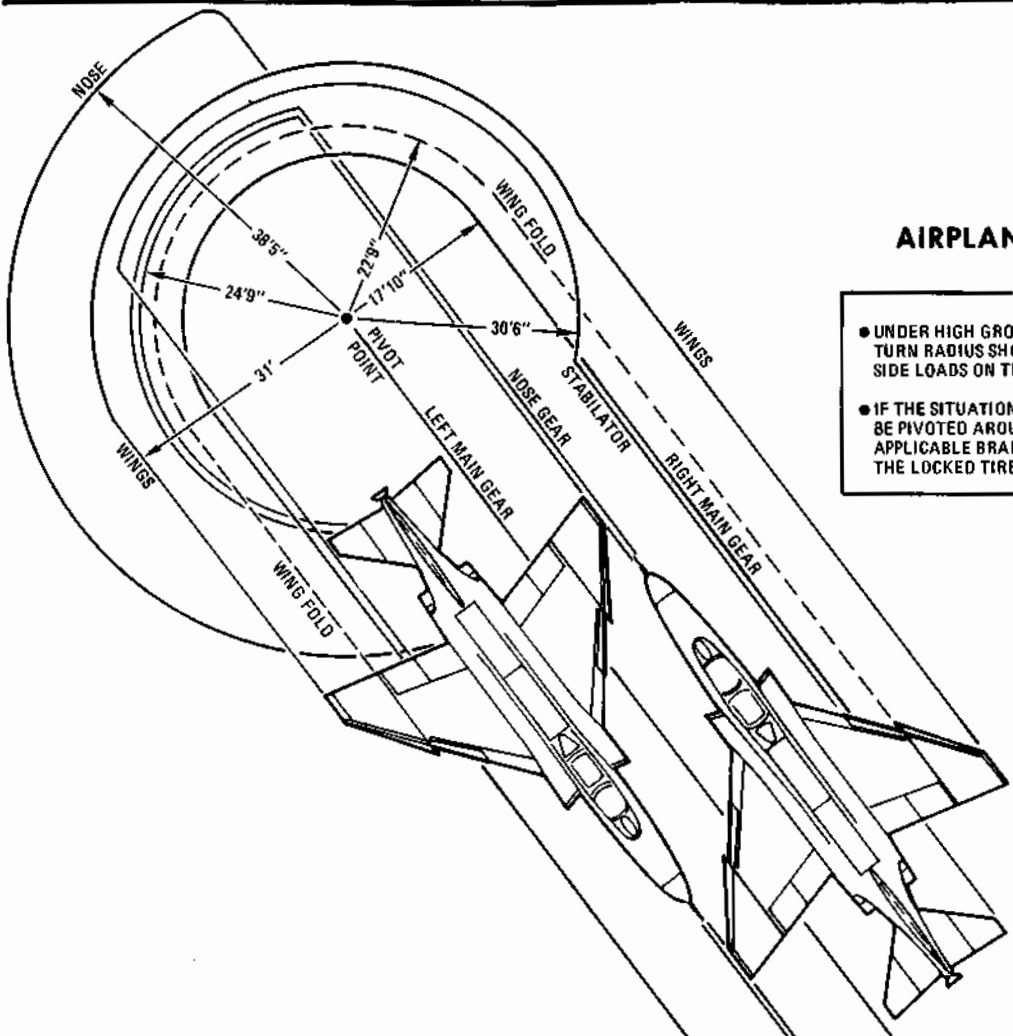
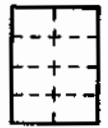

## AIRPLANE BEING TAXIED

### Notes

- UNDER HIGH GROSS WEIGHT CONDITIONS THE TURN RADIUS SHOULD BE INCREASED TO RELIEVE SIDE LOADS ON THE MAIN GEAR TIRES.
- IF THE SITUATION WARRANTS THE AIRPLANE CAN BE PIVOTED AROUND THE GEAR BY LOCKING THE APPLICABLE BRAKE. HOWEVER, DOING SO SCUFFS THE LOCKED TIRE EXCESSIVELY.

## AIRPLANE BEING TOWED

### Note

TURNING THE AIRPLANE WITH THE TOW BAR 90° TO THE AXIS OF THE AIRPLANE WILL PROVIDE THE SHORTEST OVER ALL TURN RADIUS.

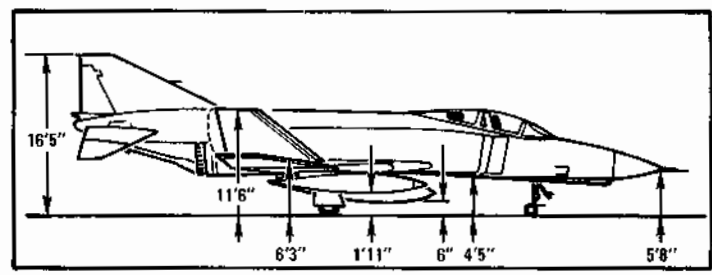
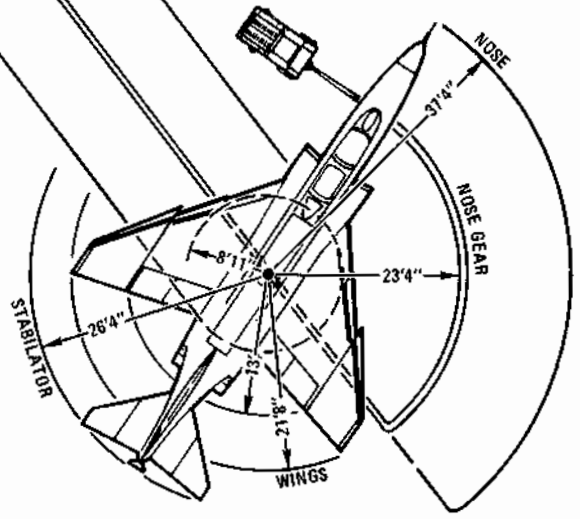

Figure 2-4

**CAUTION**

- Taxi with canopies full open or full closed; with the canopies open, maintain taxi speeds below 60 knots to prevent damage to the canopy operating mechanism.
  - Adequate distance between aircraft must be maintained during formation taxi. An open canopy may be damaged by engine exhaust blast.
  - While taxiing during high gross weight conditions, the turning radius should be increased to relieve excessive side loads on the main landing gear struts, wheels, and tires.
3. (P-WSO) Flight instruments - CHECK OPERATION
  4. (P-WSO) Oxygen diluter lever - AS REQUIRED

**BEFORE TAKEOFF**

**CAUTION**

Exercise care in positioning the aircraft on the runway during formation operations. Clearance behind aircraft should be 150 feet at military thrust settings and 300 feet at maximum thrust settings. Try to stagger the airplane positions so that no aircraft is directly behind another. Ensure that the canopies are closed and locked. Refer to figure 2-3 for Danger Areas.

1. Optical sight - CHECK
2. (P-WSO) Harnessing and leads - FASTENED  
Parachute risers, lap belt, leg restraint lines and all other harnessing and leads fastened.
3. Internal wing transfer switch - NORMAL
4. Stab aug switches - ENGAGE
5. Flight controls - UNRESTRICTED (WSO visually check control surfaces)
6. Anti-ice switch - AS REQUIRED
7. Stabilator trim - CHECK 1 TO 3 UNITS NOSE DOWN
8. Fuel quantity - CHECK
9. (P-WSO) Canopies - CLOSE, CHECK WARNING LIGHT OUT AND STRIPES ALIGNED
  - a. Operate engines at idle rpm.

**CAUTION**

Closing of either canopy with engine rpm above idle may result in the canopy not fully locking due to premature canopy seal inflation and/or back pressure caused by cockpit pressurization system.

- b. Set air temp control knob in the 2 o'clock position, and the defog-foohat lever in foot heat.
- c. Close aft canopy. Ensure closing time does not exceed 9 seconds from lever actuation to completion of locking cycle. Check aft CANOPY

UNLOCKED light out, forward CANOPY UNLOCKED light ON.

- d. Close forward canopy. Ensure closing time does not exceed 9 seconds from lever actuation to completion of locking cycle. Check forward CANOPY UNLOCKED light out. WSO observe front canopy actuator sheer pin for integrity and actuating cylinder full up.

**CAUTION**

The center mirror on the forward canopy can be tilted sufficiently to prevent canopy closing; therefore, assure that the mirror will clear the windshield bow before closing canopy.

- e. Check that alignment tape on canopy lock push rod aligns with the alignment mark on the bracket hanging from the left canopy sill.

**WARNING**

If a canopy malfunction occurs during the closing cycle or in the event that either the front or aft CANOPY UNLOCKED light remains on after attempted closure, refer to Canopy Malfunction, section III.

**CAUTION**

To ensure canopy retention during flight, the canopy control handle must be retained in the closed (full forward detent) position.

10. Defog-foohat and temperature controls - AS REQUIRED

When operating in high humidity conditions, a higher than normal temperature setting (3 o'clock or above) may be required to prevent cockpit fogging.

**WARNING**

A cockpit temperature malfunction (cold) in high humidity conditions may cause sufficient fog to obscure forward visibility during takeoff roll. A defog-foohat setting forward of foohat may compound the forward visibility problem and require immediate action to dump the cabin pressure in order to maintain visual contact with the runway or leader.

11. (WSO) Command selector valve - AS BRIEFED
12. (P-WSO) Lower ejection handle safety guard - CLEAR  
Rotate the lower ejection handle safety guard to the down (horizontal) position.

**WARNING**

The lower ejection handle safety guard, when lowered, can rebound to the safe position if it is lowered too rapidly.

**After runway line-up -****13. External transfer switch - OUTBD OR OFF**

Do not select centerline tank before takeoff. Selection of centerline tank will cause it to pressurize immediately after liftoff and can contribute to a centerline tank fire if it leaks. If a Royal Jet centerline tank is installed, consider feeding from that tank for at least 2 minutes after takeoff to increase the unsymmetrical flight G limit.

**WARNING**

- If external tanks are installed, and the external transfer switch is positioned to OUTBD or CENTER, internal wing fuel will not transfer even though the internal wing transfer switch is positioned to NORMAL.
- Have any leak which cannot be positively identified as the dump mast investigated prior to takeoff.

**14. Anti-skid - ON, LIGHT OUT****15. Compass heading - CHECK**

If a significant error exists on the HSI compass card, re-sync the compass by placing the reference system selector to STBY and back to PRIM.

**16. Pitot heat - ON****17. IFF - AS REQUIRED****18. (P-WSO) Circuit breakers - CHECK****19. Warning lights - CHECK****TAKEOFF****NORMAL TAKEOFF**

The slats out-flaps down position is recommended for all takeoffs. After taking the runway and completing necessary pre-takeoff checks, engines can be run to 85% with brakes held and nose gear steering engaged to ensure nose gear alignment (figure 2-5). With both engines operating in excess of 85% and the brakes locked, there is a possibility of rotating the tires on the wheel rims or skidding the tires. Check for normal rpm response and approximate readings of 450°C EGT, 4000 pph fuel flow, ¼ nozzles, and 30-40 psi oil pressure. After releasing brakes, advance both throttles rapidly to full military power and check rpm, exhaust temperatures and nozzle position. WSO check the ramps fully retracted. If an afterburner takeoff is desired, shift the throttles into the afterburner detent and advance full forward for max thrust. Maintain

directional control with nose gear steering or rudder as required. The rudder becomes effective for steering at approximately 70 knots. Wheel braking should not be used for directional control during takeoff roll. Nose gear steering should be disengaged when rudder steering becomes effective. If it becomes necessary to re-engage nose gear steering at the higher speeds, rudder pedals should be returned to neutral prior to engagement since rudder displacement necessary for rudder steering will generally be excessive for nose gear steering. Sufficient aft stick should be applied prior to nose wheel liftoff speed to attain the desired pitch attitude. As the nose rises, pitch attitude must be controlled to maintain a 10° to 12° (first pitch mark) nose high attitude for aircraft fly-off. Caution must be exercised to preclude over-rotation due to excessive aft stick rate or an extended takeoff roll due to late lift-off. The basic takeoff attitude should be held during acceleration and transition to a clean configuration. Trim change and control action during this period are normal. The AUX AIR DOORS, WHEELS, and MASTER CAUTION lights may illuminate momentarily as the landing gear and flaps are retracted.

**CAUTION**

Rapid full aft movement of the stick between takeoff airspeed and 30 knots below takeoff airspeed may result in the stabilator hitting the runway with the possibility of stabilator actuator damage.

**NO-FLAP TAKEOFF**

No-flap takeoffs are not recommended. However, if it is determined that no-flap takeoffs must be performed to satisfy mission requirements, aircrews should be aware that takeoff roll and airspeed will be increased and the takeoff attitude will be slightly steeper. Stabilator effectiveness is considerably increased and extreme caution must be exercised to prevent overrotation which could result in the stabilator striking the runway.

**WARNING**

Due to increased stabilator authority with the flaps up, aircraft rotation can be initiated at lower than normal airspeeds and overrotation is a definite possibility. If it appears that overrotation is occurring, positive control movement (stick forward) must be taken to prevent the stabilator from contacting the runway and/or loss of aircraft control.

**MINIMUM RUN/HEAVY GROSS WEIGHT TAKEOFF**

A minimum run/heavy gross weight takeoff (aircraft over 55,500 pounds) is accomplished in the same manner as a normal takeoff with the following exceptions: It is recommended that all minimum run/heavy gross weight takeoffs be made with afterburner. During the takeoff run, full aft stick must be applied prior to reaching 80 knots. As the aircraft starts to rotate, the stick should be adjusted to

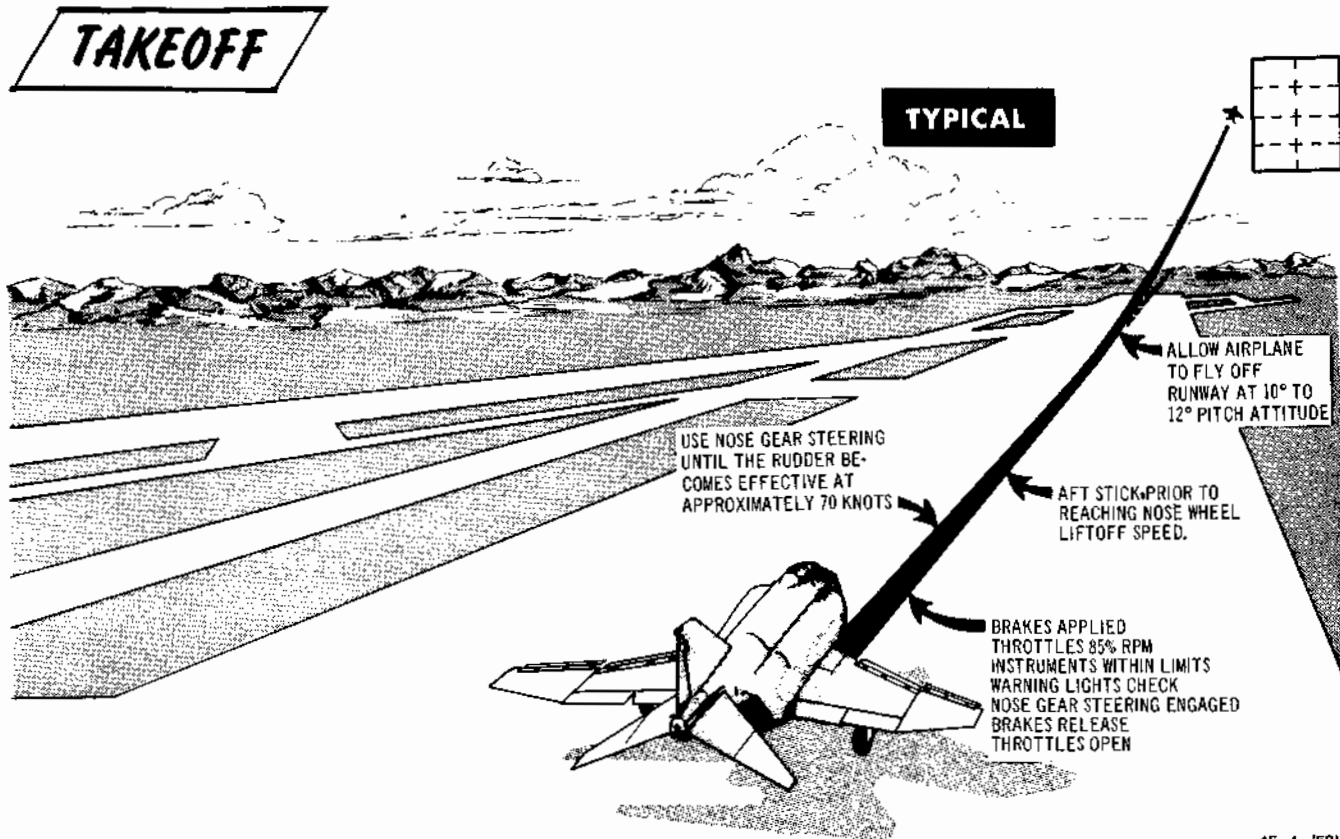

Figure 2-5

4E-1-(59)

maintain 10° to 12° pitch attitude for aircraft fly-off. The possibility of a main landing gear tire failure increases with an extended takeoff ground run under heavy gross weight conditions. Nose wheel liftoff speed and takeoff speed is increased during heavy gross weight conditions. In the event of an aborted takeoff, it must be remembered that stopping distance is greatly increased as abort speed increases.

### CAUTION

With a combination of light gross weight and aft CG, the minimum run takeoff technique (i.e., full aft stick prior to reaching 80 knots) produces rapid pitch rates during nose rotation. This combination can exist when the radar package and nose gun (or equivalent ballast) are not installed.

### CROSSWIND TAKEOFF

Under crosswind conditions, the aircraft tends to weather vane into the wind. The weather vaning tendency can be easily controlled with nose gear steering. As forward speed increases, weather vaning tendency decreases. At speeds above 70 knots rudder effectiveness will normally be sufficient to maintain directional control. After the nose is lifted to takeoff attitude, the aircraft will have a tendency to drift toward the downwind side of the runway. Therefore, when a long time period is expected between

nose lift-off and aircraft fly-off, or when the crosswind effect is particularly severe, nose lift-off can be delayed accordingly. Under normal operational conditions this action should not be required. As the aircraft leaves the ground, it should be crabbed into the wind, wings level, to maintain runway alignment. Takeoff in gusty crosswind or severe wake turbulence conditions can result in an abrupt wing low attitude at or near lift-off. When these conditions are anticipated, use higher than computed takeoff speed to provide additional lateral control after lift-off.

### AFTER TAKEOFF – CLIMB

When the aircraft is definitely airborne—

#### 1. Gear – UP

Check that the landing gear position indicators display the word UP, and that the landing gear handle warning light is out.

### CAUTION

- The landing gear and gear doors should be completely up and locked before the gear limit airspeed of 250 knots is reached, otherwise, excessive air loads may damage the landing gear mechanism and prevent subsequent operation.

- When actuating the landing gear, keep a forward pressure on the landing gear control handle to prevent inadvertent actuation of the emergency system.

## 2. Slats flaps - NORM

Check that slat flap indicators display IN and UP. Rudder jumps may occur during flap retraction with a lateral stick input. If an audible (noticeable in head phones) chattering associated with slat flap and utility hydraulic pressure indicator fluctuating in unison occurs during slats flaps retraction, maintain airspeed below 250 knots and cycle slats flaps. If slat chatter occurs during maneuvering at altitude, it may require opposite slats positioning from where chatter occurs. If chatter persists, extend slats flaps and land as soon as practical. If cycling (slats repositioning) eliminates chatter, continue mission and make an appropriate entry in AF Form 781.



Continued or prolonged operation with flap or slat chatter will damage actuator(s) and mechanisms.

### NOTE

- During the climb, it may be necessary to place the antenna selector switch to the LWR position to maintain ground communication.
- When transmitting on UHF using the lower antenna, a change in engine operation could occur. This can be seen as a shift or fluctuation of EGT, RPM, FUEL FLOW, and NOZZLE position.

## CLIMB TECHNIQUES

A simplified climb can be made by maintaining a 10° to 12° (first pitch mark) nose high attitude until reaching 350 knots and then vary pitch as necessary to maintain 350 knots until reaching cruise Mach/TAS. Vary pitch as necessary to maintain cruise Mach/TAS until reaching cruise altitude. A simplified Maximum thrust climb, at normal gross weights, can be made by maintaining a 10° to 12° nose high attitude until reaching 350 knots and then vary pitch as necessary to maintain 350 knots until reaching Mach 0.9. Vary the pitch attitude as necessary to maintain Mach 0.9 until reaching cruise altitude.

## CRUISE

1. (P-WSO) Altimeters - SET, CHECK STBY, RESET, COMPARE

The following maximum tolerances should be met at subsonic speeds:

ALT FT	DIFF FRONT & REAR		ALTM JUMP (STBY TO RESET)
	BOTH STBY	BOTH RESET	
10,000	150 FT	75 FT	100 FT
20,000	250 FT	75 FT	150 FT
30,000	350 FT	75 FT	200 FT

### NOTE

- If the altimeter is not within tolerance in RESET, the mission may be continued in STBY. Altimeter accuracy will be degraded.
  - The allowable difference between the front and rear altimeters in different modes is 200, 300 and 400 feet for altitudes of 10,000, 20,000 and 30,000 feet respectively.
2. (P-WSO) Survival kit selector switch - AS DESIRED
  3. (P-WSO) Ops check
    - a. Oxygen quantity/pressure/blinker
    - b. Cockpit pressure indicator
    - c. Fuel quantity/transfer switches  
If carrying external tanks, turn external fuel transfer switch to OFF after external tanks are empty, and keep internal wing transfer switch in NORMAL.
    - d. Standby compass
    - e. Circuit breakers
  4. Anti-ice switch - AS REQUIRED

### WARNING

- When transfer of external fuel is selected, transfer of internal wing fuel is stopped automatically and cannot be regained until the external wing fuel transfer switch is turned OFF, even though the internal wing transfer switch is positioned to NORMAL. However internal wing fuel and external fuel will simultaneously transfer when the automatic fuel transfer circuit is energized. When the external fuel tanks are not carried, the external wing tank transfer switch is inoperative.
- The possibility exists that engine flameout may occur while flying above 35,000 feet in cirrus clouds. Such incidents have occurred, and are generally believed to have been caused by excessive ingestion of ice crystals. Under such conditions, ice buildup on the duct lips or other parts of the aircraft are not likely to occur and flameouts can, therefore, occur without warning. However, in all known incidents of this type, relights have been accomplished and maintained at lower altitudes. Therefore, if flameout occurs at high altitudes in clouds, it is recommended that relight attempts be deferred until descent to a lower altitude and, if possible, to a less dense part of the cloud.

- During negative G flight, a foreign object may become lodged between the top of the ejection seat banana link area and the canopy actuator. Upon opening the canopy, the actuator may jam the foreign object down on the primary seat mounted initiator, or the ejection gun firing mechanism, causing the seat to fire. Therefore, be alert to the position of foreign objects in the cockpit.



If radar has malfunctioned while at altitude, do not turn radar power off unless further damage is imminent. The radar components will cold soak and collect moisture upon descent causing additional costly repairs.

#### NOTE

- The windshield defogging system should be operated at the highest temperature possible (consistent with crew comfort) during all high altitude flights. This will provide sufficient preheating to prevent the formation of frost or fog during descent.
- When making throttle chops from the rear cockpit, avoid violently slamming against the idle stops and also avoid maintaining a high force to hold them against the stops. This practice can, in a few instances, induce an engine flameout.
- The UHF upper antenna should be used for communication between aircraft, and the lower antenna should be used for aircraft to ground communication. However, antenna switching may be necessary to obtain best results.

## FLIGHT CHARACTERISTICS

### RIG CHECK

A rig check shall be performed if an out-of-rig or unintentional asymmetric load condition is suspected and before maximum-performance/high- $\text{AOA}$  maneuvering. With all axes of the stab aug engaged, center the rear cockpit ball and check that aircraft does not roll more than  $2^\circ$ /second with ailerons and spoilers trimmed neutral. If a large amount of lateral trim (equivalent to more than 1 inch aileron down at 350 knots) is required to prevent roll, an out-of-rig, malfunctioning stab aug, or asymmetrical load condition exists. Do not maneuver at high angle of attack if this condition exists.

### STAB AUG CHECK

A stab aug check shall be performed before maximum-performance/high- $\text{AOA}$  maneuvering. Do not perform maximum performance maneuvers if any of the following checks are unsatisfactory.

- Pull nose up with 2G acceleration and release the stick. Aircraft should stabilize in one cycle.
- Yaw aircraft to one ball width and release rudder.

- Aircraft should stabilize in one cycle.
- Roll to  $30\text{--}45^\circ$  bank and release stick. Aircraft should maintain bank angle. Roll to level flight and release stick. Aircraft should maintain wings level.
- Gradually increase  $\text{AOA}$  through 11  $1/2$  units and ensure slats extend together. Decrease  $\text{AOA}$  below 10  $1/2$  units and ensure slats retract together.

Refer to section VI, Flight Characteristics.

## DESCENT/BEFORE LANDING

The Descent/Before Landing check should be accomplished above 10,000 feet AGL and at a time when mission/flight demands are not critical. Prior to performing a rapid descent, the windshield and canopy surfaces should be preheated to prevent the formation of frost or fog. If it becomes necessary to dump fuel during a descent, thrust settings in excess of 85% rpm may be required to ensure rapid inflight dumping.

- Defog-footeat/temperature controls - AS DESIRED
- Bearing/distance selector switch - AS DESIRED
- Radar altimeter - ON AND CHECK (as required)  
Allow at least a 5 minute warmup period before relying on the radar altimeter.
- (P-WSO) Pressure altimeter - SET, CHECK STBY, RESET, COMPARE  
Check STBY position and return to RESET.
- Communications antenna selector switch - UPR
- (WSO) Target designator - POWER ON AND STOW (some aircraft)  
The pod should be stowed before landing to prevent FOD to the pod head dome.
- Armament switches - OFF or SAFE
- Landing/taxi light - LANDING
- Fuel quantity - CHECK
- Anti-ice switch - AS REQUIRED  
If the automatic fuel transfer circuit is energized and external tanks are installed and empty, their corresponding external fuel flow lights will illuminate.

### WARNING

- Due to fuel quantity indicator tolerances at the low end of the fuel scale, the FUEL LEVEL LOW warning light may illuminate above 2000 pounds fuel remaining on aircraft through 68-494; 1850 pounds on aircraft 68-495 and up. Therefore, the FUEL LEVEL LOW light should be used as the primary indication of a low fuel state in the engine feed tank.
- Transient fuel readings are especially hazardous when decelerating in the emergency fuel range. When decelerating and descending, the fuel quantity indicator may read higher than the actual usable fuel on board. This erroneous quantity indication combined with allowable indicator tolerances may result in engine

flameout, from fuel starvation with indicated fuel remaining.

- On aircraft after TO 1F-4E-563, the TANK 7 FUEL light does not illuminate in conjunction with the FUEL LEVEL LOW light. The fuel quantity indicator must be monitored to determine if a cell 7 fuel transfer failure has occurred. In this event, only the fuel indicated on the tape will be available to the engines.

## LANDING

In the pattern -

1. Gear - DOWN
2. Slats flaps - OUT AND DOWN

### WARNING

Maintain wings level flight when extending or retracting the flaps.

3. Hydraulic pressure - CHECK
4. Warning lights - CHECK
5. Anti-skid - ON, LIGHT OUT

## LANDING TECHNIQUE

For a normal landing, fly the pattern as illustrated in figure 2-6. Enter the pattern as local policy dictates.

### WARNING

If high angles of attack develop during the turn to downwind, the rudder should be used as a primary means of rollout since adverse yaw may be introduced by the use of ailerons. Altitude may be insufficient for recovery if uncontrolled flight is encountered.

Avoid buffet throughout the landing pattern. Adjust power, as necessary, to attain allowable gear lowering airspeed. Extend landing gear and slats and flaps in level flight on downwind. Actual flap extension may not occur until slowing to 210 knots. Ensure slats out-flaps down prior to initiating turn to base leg. The optimum indicated AOA for approach is 19.2 units, and is adequate for all gross weight and normal slat flap configurations. The AOA aural tone system provides an audible cue to maintain an on-speed approach. During very gusty flight conditions, full aileron may not be sufficient to correct a wing low condition. When landing in gusty or crosswind conditions, with wake turbulence, with high internal fuel load (aft CG), or with an abnormal configuration (slats in, asymmetric slats or slats partially extended), a 17 unit AOA approach is recommended. A transition to ON SPEED and a flared landing will reduce the touchdown speed. The AOA indexer and aural tone indications remain unaffected. Establish and maintain On Speed

angle-of-attack on the base leg or final approach, adjusting pitch attitude to maintain AOA and power to maintain desired glide slope/rate of descent. Cross-check computed airspeed and On Speed AOA to detect gross errors in AOA. When the aircraft reaches 20 to 30 feet altitude above the ground, ground effect will tend to rotate the aircraft in the nose-down direction. Maintaining pitch attitude will result in transition to a slightly slow indication at touch-down which is desired. Flying a 2 1/2° to 3° glide slope will produce an approach rate of descent of about 700 feet per minute. Sink rate at touchdown will be appreciably reduced by ground effect.

### CAUTION

Flying a steeper than normal final approach or not maintaining pitch attitude when entering ground effect, can cause touchdown sink rates to exceed the design limit of the main landing gear struts. (Refer to section V for touchdown sink rates vs gross weight limitations.)

At touchdown, reduce power to idle and deploy drag chute. Use full aft stick to help decelerate. Use rudder and ailerons for directional control down to 70 knots then use differential braking. Nose gear steering should not be required for directional control in light crosswind conditions. However, if rudder, aileron, and/or differential braking are not effective in maintaining directional control, use nose gear steering as required. Engage nose gear steering only with the rudder at or near neutral.

### WARNING

Nose gear steering malfunctions can cause loss of directional control if engaged at high ground speed; therefore, it should not be engaged above taxi speed unless required to maintain directional control during crosswind landing conditions. If no response is noted or unscheduled steering responses are detected when engaging nose gear steering, disengage immediately and do not reengage.

During braking, cycling of the anti-skid system can be detected by a change in longitudinal deceleration. Cycling may not be apparent when braking at high speed immediately after landing, with drag chute failure, or with a wet or icy runway. Do not misinterpret this as anti-skid failure.

## NO-FLAP LANDING

(Refer to section III.)

## SHORT FIELD LANDING

Short field landings require that normal final approach procedures be followed with precision and the aircraft be touched down as close to the end of the runway as safety permits. Full aft stick throughout the landing roll

# LANDING PATTERN

TYPICAL

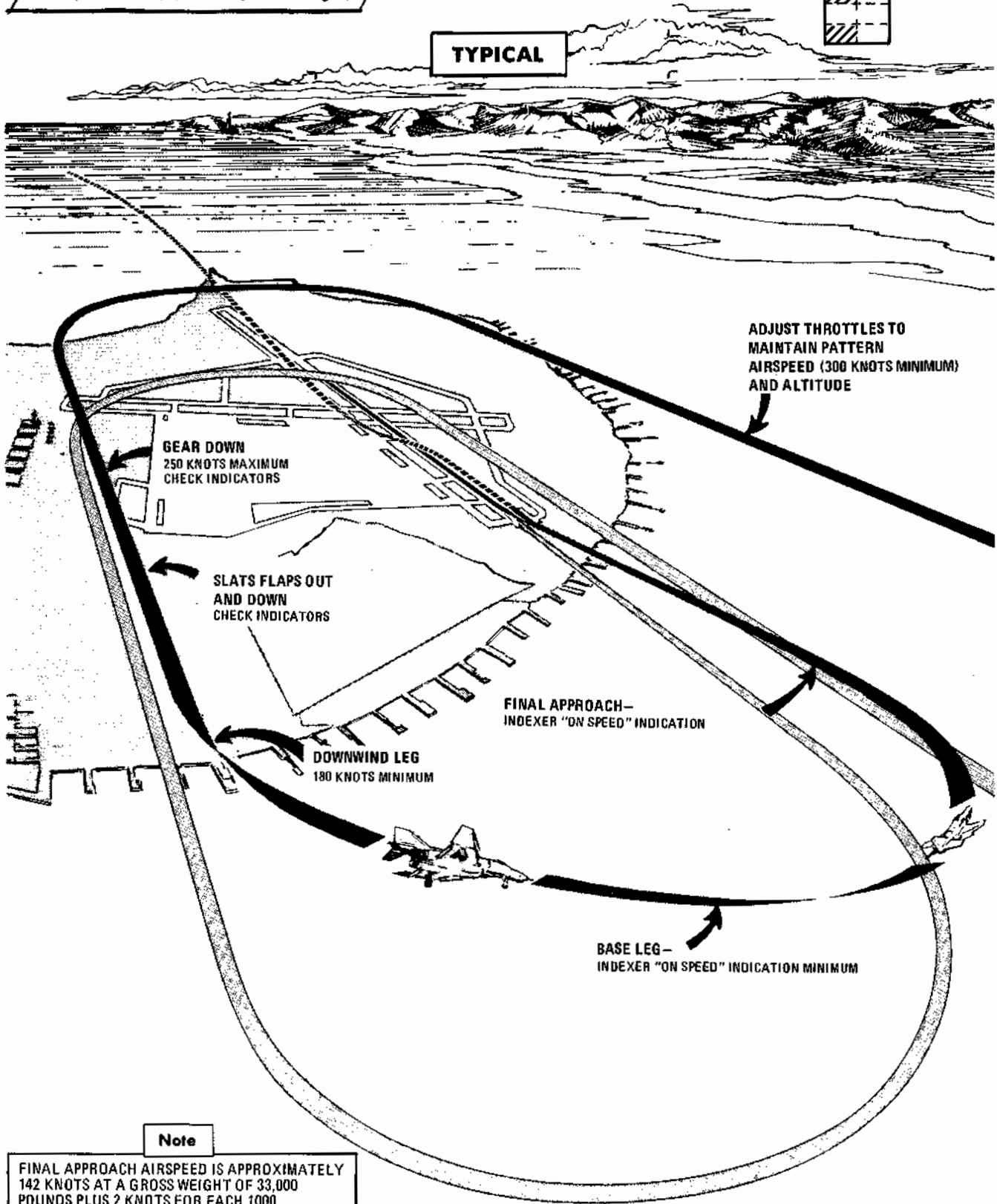

**Note**

FINAL APPROACH AIRSPEED IS APPROXIMATELY 142 KNOTS AT A GROSS WEIGHT OF 33,000 POUNDS PLUS 2 KNOTS FOR EACH 1000 POUNDS ABOVE 33,000 POUNDS

4E-1-1-(60)C

Figure 2-6



increases both aerodynamic drag and wheel brake effectiveness. Apply maximum braking by fully depressing the brake pedals to the pedal stops as soon as the nose gear is on the ground and nose gear steering is engaged. Nose gear steering should be used to maintain runway alignment and supplemented with differential braking only if required.

Operation on the AM-2 aluminum mat is similar to that conducted on a concrete runway of equivalent size. Arrestment should be regarded as an emergency procedure. However, since the aircraft is fully suitable for arrested landings, extremely adverse meteorological or operational conditions may warrant consideration of landing into a suitable approach-end arresting gear.

### CROSSWIND LANDING (DRY RUNWAY)

Carefully compensate for crosswind in the traffic pattern to guard against undershooting or overshooting the final turn. Fly the final approach course with the aircraft ground track properly aligned with the runway. The crosswind may be compensated for either by using the wing low method, the crab method, or a combination of the two. When using the wing low method, the ARI can be overpowered by use of the rudder pedals or the ARI can be disengaged by pulling the rudder trim circuit breaker. If the crab method is employed, the aircraft heading should be aligned with the runway just prior to touchdown. After touchdown, use rudder, aileron and spoiler, and nose gear steering as required to maintain directional control. Crosswind effect on the aircraft is not severe; however, rudder, differential braking, and/or nose gear steering must be used as required to maintain alignment with the runway. Use of the drag chute intensifies the weather vane effect for any given deployment condition. The weather vane effect increases as the forward velocity of the aircraft decreases, therefore, if the drag chute is to be used, it should be used at the initial portion rather than the latter portion of the landing roll. This also assures use of the drag chute in the speed region where it is most effective. If the drag chute is used and excessive weathervaning is encountered, jettison drag chute. Since the nose gear will rapidly assume a position relative to the rudder pedals, nose gear steering should be initiated with the rudder pedals at or near the neutral position. For this reason the use of nose gear steering is advocated early in the landing roll rather than at a time when large amounts of rudder are required to hold the aircraft aligned on the runway. The most important aspect of directional control under crosswind conditions is keeping the aircraft precisely aligned with the runway rather than trying to correct back to the runway centerline after it has deviated.

### WET OR ICY RUNWAY LANDING

Wet or icy runway conditions pose severe problems in directional control and braking effectiveness. On wet runways, these problems are primarily the result of hydroplaning where the tire rides on a thin layer of water and produces little or no traction. The probability of hydroplaning increases with increased water depth, increased ground speed, decreased tire pressure and decreased tire tread depth and is also affected by runway surface texture and tire tread design. Hydroplaning can occur on runways which appear only damp if severe

braking is applied at high speeds. Hydroplaning and glare ice present essentially the same problems. Due to the reduced directional control, all landings on a wet or icy runway should be made utilizing a crosswind technique. Refer to the Crosswind Landing Guide (figure 2-7) to determine the advisability of making an approach-end engagement. The pilot should also consider the desirability of delaying the landing to permit the runway to dry or diverting to another field. Gross weight should be reduced to the minimum practicable. Plan the pattern to be well established on final with the aircraft tracking straight down the runway centerline with an ON SPEED indication. Use a wings - level crab, if required, to maintain the track. Establish the rate of descent at 800 fpm (slightly steeper than normal) and plan to touchdown on the centerline within the first 500 feet. Make a firm touchdown (500-600 fpm) while maintaining the wings-level crab. Immediately after touchdown retard the throttles to idle. Do not attempt to align the aircraft heading with the runway as this will result in a drift off the runway if the aircraft is sliding or hydroplaning. Maintain full forward stick to increase nosewheel traction. As wheel cornering capability overcomes aerodynamic effects the aircraft will align itself with the runway. Do not attempt to hasten this process. When the aircraft heading is aligned with the runway centerline, deploy the drag chute. Be prepared to jettison the drag chute if the weathervaning effect interferes with maintaining the track straight down the runway centerline. Nose gear steering is the primary method of directional control and should be utilized as early as

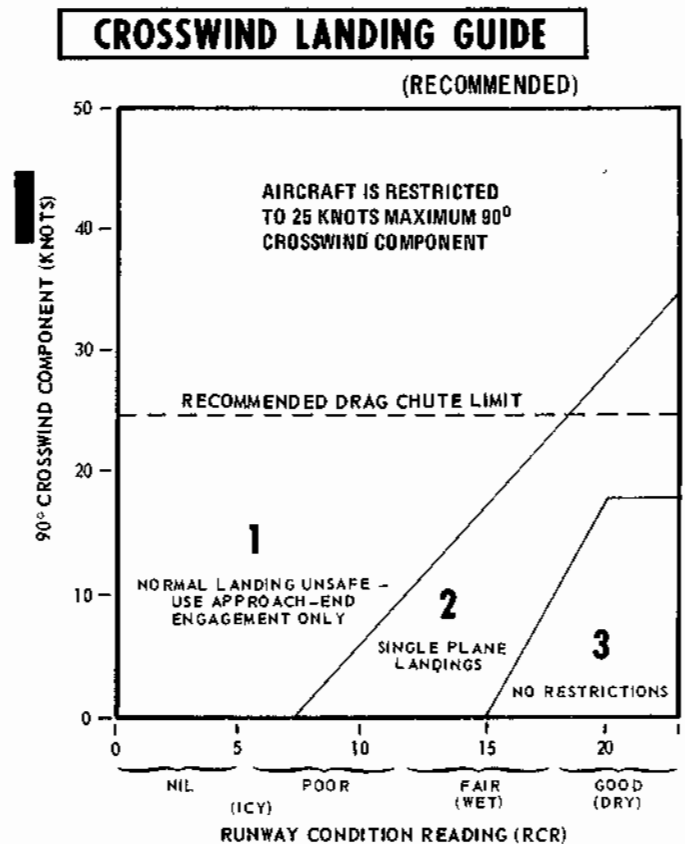

4E-1-(611A)

Figure 2-7

possible. Nose gear steering should be engaged only with the rudder pedals at or near neutral. When directional control is firmly established utilize maximum anti-skid braking. Brake pedals must be fully depressed to achieve maximum deceleration. At high speeds the braking potential will be very low and little deceleration will be felt. As braking potential increases with decreasing speed, the anti-skid system will increase deceleration accordingly. Unless the pilot is familiar with the variables in braking potential, the low deceleration at high speed may be mistakenly interpreted as a brake or anti-skid failure.

### CAUTION

Rubber deposits on the last 2000 feet of wet runway make directional control a difficult problem even at very low speeds. Braking should be started in sufficient time so as not to require excessive braking on the last portion of the runway.

## HEAVY GROSS WEIGHT LANDING

The heavy gross weight landing pattern is the same as the basic pattern shown in figure 2-6 with the exception that it should be expanded slightly to compensate for the lower maneuvering capability of the heavy gross weight aircraft at low speeds. As in the normal pattern, an on-speed indication on the indexer will provide the optimum angle of attack and airspeed for the aircraft in the landing configuration for both level flight and maneuvering flight. Refer to Performance Data, appendix A, for airspeed versus gross weight at approach AOA.

## GO-AROUND TECHNIQUE

Any decision to go around should be made as early as possible. When the decision to go around is made, smoothly increase thrust to military (afterburner if required). Do not attempt to rotate the nose or stop rate-of-descent until adequate airspeed is built up. Continue to use the on speed indication as the optimum angle of attack until level flight is attained. As airspeed increases, establish normal takeoff attitude, retract gear when a positive rate of climb is established, retract slats and flaps at a safe airspeed (180 knots minimum) and go around. Rudder jumps may occur during flap retraction with lateral stick input. For a closed pattern, accomplish a climbing 180° turn to roll out on downwind at 220 to 250 knots. Refer to Go-Around, figure 2-8. During go-around a rapid trim change is required to preclude high forward stick forces.

### WARNING

Do not exceed 18 units AOA during go-around with gear retracted. Refer to Angle of Attack, section VI.

### CAUTION

- If a decision is made to go around after touchdown, do not exceed normal takeoff attitude for the aircraft can drag the stabilator and possibly leave the ground in a stalled condition.
- Because of the extremely high thrust/weight ratio and the excessive fuel consumption of afterburner use, it should be used only if required for safety of flight.

## TOUCH-AND-GO TECHNIQUE

After making a normal approach and touchdown, smoothly advance throttles to full military power. Apply aft stick until the nose rotates 10° to 12° of pitch attitude maintaining this attitude until the aircraft is flying. When definitely airborne retract the gear, followed by the flaps as the aircraft accelerates through 180 knots minimum.

## AFTER LANDING

1. Anti-skid switch – OFF BELOW 30 KNOTS

### NOTE

After clearing the active runway, a single engine may be shut down for taxiing. Refer to Engine Shutdown procedures and/or Hot Refueling procedures, this section. Single engine taxiing requires no special technique. On aircraft after TO 1F-4-903, if the left engine is shut down, the APU reject switch should be placed in REJECT.

2. (WSO) Command selector valve – CLOSED (vertical position)
3. (WSO) TISEO – OFF (some aircraft)
4. (P-WSO) MSDG/DSCG – OFF (some aircraft)
5. (WSO) Radar power – OFF
6. Cockpit pressure indicator – CHECK

### WARNING

- Prior to opening the canopies, check the cockpit pressure altimeter to assure that the cockpit is fully depressurized. Attempting to open a canopy while the cockpit is pressurized may cause damage or loss of the canopy. Refer to cockpit overpressurization, section III.
- Account for all loose items before opening canopy. Inadvertent seat ejection may occur if any foreign object in the cockpit becomes jammed between canopy actuator and the primary seat mounted initiator or the ejection gun firing mechanism sear. If all known loose objects cannot be accounted for, leave the canopy closed after flight until an inspection of the banana link area is made by a knowledgeable person.

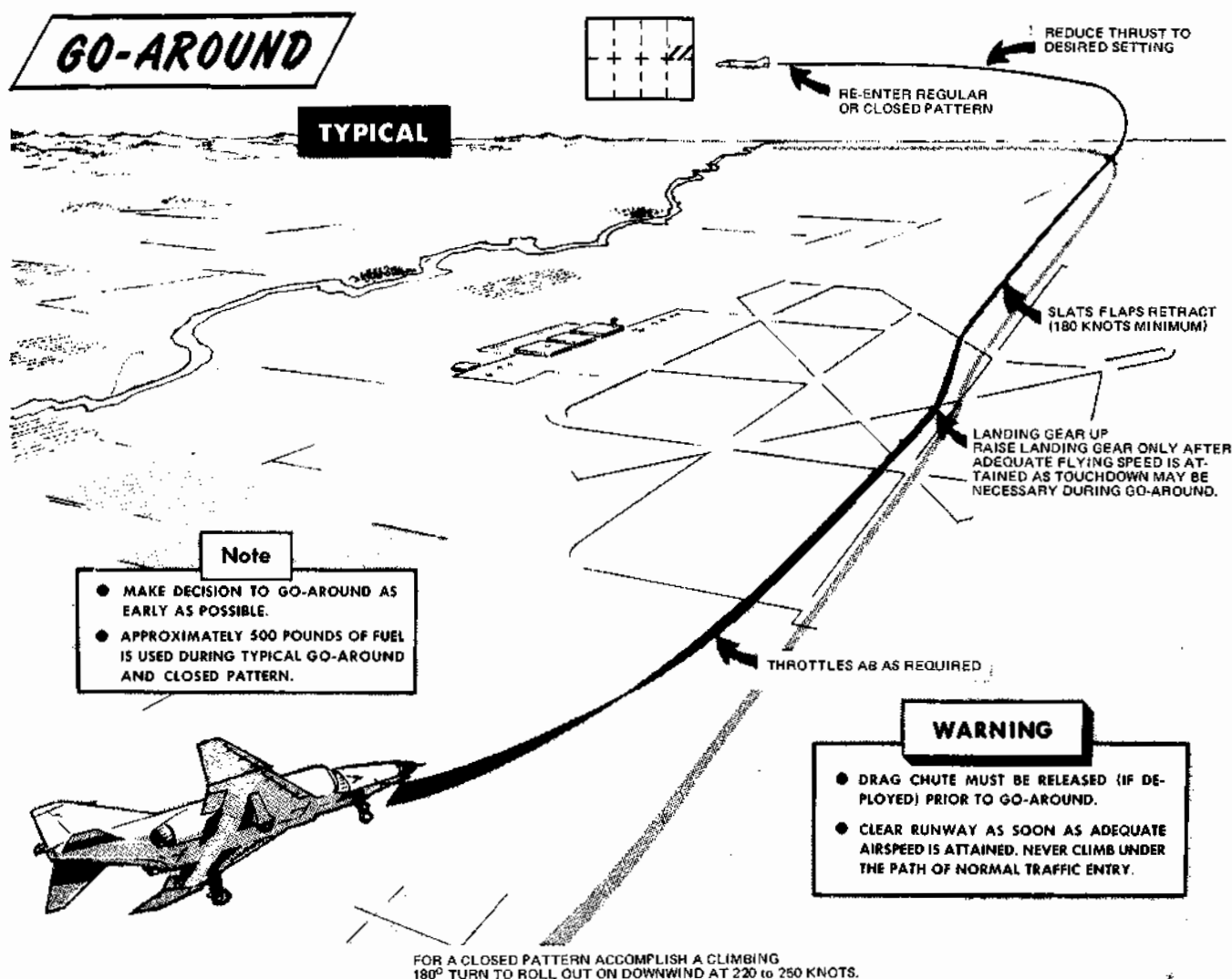

Figure 2-8

4E-1 (62)D

- After flight, except in those instances where emergency ground egress is the primary consideration, remain completely strapped in until the canopy is fully open and will remain open.

7. (P-WSO) Lower ejection handle guard - UP
8. Landing/taxi light - AS REQUIRED
9. Slats flaps - NORM
10. Drag chute - JETTISON

### CAUTION

The drag chute should be jettisoned before taxiing downwind in winds exceeding 15 knots because of the possibility of the chute collapsing and burning upon contact on hot areas of the engine exhaust nozzles.

11. Mode 4 selector - HOLD (if another flight is anticipated in code period).  
If HOLD is used, wait 15 seconds before turning

IFF master switch OFF.

12. Stab aug switches - OFF
13. Internal wing dump switch - NORMAL

### CAUTION

The internal wing dump switch must be placed to NORMAL position prior to engine shutdown. If the switch is left in DUMP, fuel spillage will occur during refueling with battery power.

14. VOR/ILS control panel - OFF
15. Engine anti-ice switch - NORMAL
16. Radar altimeter function selector knob - OFF
17. Stabilator trim - SET 1 TO 3 UNITS NOSE DOWN
18. Reference system selector - STBY
19. Rain removal switch - OFF
20. Pitot heat switch - OFF
21. IFF - OFF
22. Temperature control knob - FULL HOT

Place the temperature control knob to full HOT to evaporate any water that may have collected in the air conditioning system during descent.

- 23. Defog-foohat control handle - DEFOG
- 24. (P-WSO) Tacan - OFF/STBY
- 25. Formation lights - OFF
- 26. Sight shutter - CLOSED

**During refueling -**

- 1. Remain alert to all visual and voice signals from the refueling supervisor.
- 2. Monitor ground control frequency.

**SINGLE ENGINE TAXI**

- 1. After landing checklist - COMPLETED
- 2. (P-WSO) Leg restraints, harness and personnel equipment leads (except oxygen and communications) - DISCONNECT IF CANOPY FULLY OPEN AND WILL REMAIN OPEN
- 3. Internal wing transfer switch - NORMAL
- 4. External transfer switch - OFF
- 5. Air refuel switch - EXTEND
- 6. Right generator switch - OFF
- 7. BUS TIE OPEN light - OUT
- 8. Utility hydraulic pressure indicators - WITHIN LIMITS
- 9. Right engine throttle - OFF
- 10. Stop aircraft as directed by ground crew for tire/brake inspection and pinning of external tanks.

**WARNING**

- Radio transmissions are prohibited in the hot pad area except in an emergency.
- If fuel starts venting from the aircraft, place the refuel selection switch to INT ONLY and discontinue refueling immediately.
- In the event of fire or fuel leak on the aircraft or ramp area under the aircraft, shut down the left engine and evacuate aircraft.
- In the event of fire or fuel leak in the refueling hydrant control area (other than immediate vicinity of aircraft), discontinue refueling and taxi out of area if directed by ground crew.

**WARNING**

- Do not turn generator switches off during this time as any interruption in electrical power will cause the auxiliary air doors to close violently with possible injury to ground crew.
- Do not enter hot pad area with hung ordnance aboard or if a known hot brake condition exists. If notified of hot brakes, taxi clear of the refueling area.

**After refueling -**

- 1. Air refuel switch - RETRACT
- 2. Refuel selection switch - INT ONLY

**HOT REFUELING**

**Before refueling -**

- 1. Single engine taxi procedures - COMPLETE
- 2. After entering hot pad area, establish three-way voice contact (intercom with pilot, refueling supervisor and servicing crewman).

**WARNING**

Any time three-way voice contact cannot be maintained, discontinue refueling immediately.

- 3. Refuel selection switch - AS DESIRED  
Fuel configuration should be determined by mission requirements/local directives.

**ENGINE SHUTDOWN**

- 1. Wheels - CHOCKED
- 2. (P-WSO) Ejection seat - RAISE  
Elevate the seat to facilitate cockpit cleaning, and to gain clearance for insertion of rocket motor safety pin.
- 3. Defog-foohat control handle - FULL AFT
- 4. Temperature control knob - 12 O'CLOCK POSITION
- 5. Air refuel switch - AS REQUIRED  
Extend air refueling receptacle if air refueling was accomplished during mission.
- 6. (WSO) Inertial navigation power control knob - OFF (or align if required - then OFF)
- 7. (WSO) Navigation Computer - OFF
- 8. (WSO) Target designator - OFF (some aircraft)
- 9. Right throttle - OFF  
On aircraft before 69-7579, the right generator out light illuminates when the generator drops off the line. On aircraft 69-7579 and up, the BUS TIE OPEN light illuminates prior to the right generator out light and then goes out as the right generator out light illuminates.

**CAUTION**

Excessive rapid movement of the control stick with one engine operating may rupture the inoperative power control system reservoir.

## 10. Spoiler actuator - CHECK

With the left engine operating and PC-2 pressure zero, slowly deflect the control stick approximately 1 inch to the right. Have ground crew or rear seat occupant verify that the spoiler does not fully deflect and that it returns to the flush position when the stick is returned to neutral. Any discrepancy should be entered in AF Form 781.

## 11. Left throttle - OFF

**WARNING**

When generator drops off the line the auxiliary air doors slam closed violently.

## 12. Engine master switches - OFF

## 13. APU reject switch - NORMAL (some aircraft)

**BEFORE LEAVING COCKPIT**

1. (P-WSO) All switches and controls - OFF
2. (P-WSO) Face curtain safety pin - INSTALLED

**WARNING**

Ensure that all personal equipment leads and straps are free of cockpit controls and ejection seat handles.

**SCRAMBLE**

The following scramble procedures assume that the following actions have been completed prior to the aircraft being placed on an alert status (subject to scramble type activities):

- a. Complete preflight inspection to include a power-on cockpit inspection, engine operational check, and operational check of speed brakes, flaps, flight controls and stab aug in accordance with normal BEFORE TAXIING (FRONT COCKPIT) checks.
- b. INS aligned and placed in heading memory.
- c. Aircraft is cocked for scramble per local policy and instructions.

If the above actions are not completed prior to scramble, normal procedure should be used.

**BEFORE TAXIING (FRONT COCKPIT)**

1. Communication and navigation equipment - ON AND CHECK
2. Emergency attitude indicator - SET
3. Altimeter & SPC - SET & CHECK
4. Takeoff trim - CHECK
5. Slats flaps - OUT AND DOWN (groundcrew visually check)

## 6. Clearance to taxi from WSO.

## 7. Reference system selector - PRIM

## 8. Seat pins - CHECK REMOVED &amp; STOWED

## 9. Personal equipment - CHECK

## 10. Wheel chocks and ground interphone cord - REMOVED

**BEFORE TAXIING (REAR COCKPIT)**

1. Communication and navigation equipment - ON AND CHECK
2. APX-80 mode switch - PASSIVE/OFF
3. Pressure altimeter - SET & CHECK
4. Radar power - STBY
5. Radar overtemp light - OFF, MONITOR
6. Navigation computer function selector knob - STBY
7. Heading memory alignment - COMPLETE  
If the inertial navigation set has not been previously aligned for heading memory, attitude reference can be obtained by performing a coarse alignment (ALIGN - wait 40 seconds - NAV).

**WARNING**

When coarse alignment is utilized, the pilot must be prepared to switch to the standby attitude reference system at the first indication of primary system failure or malfunction.

8. Navigation computer function selector knob - AS DESIRED
9. Seat pins - CHECK REMOVED & STOWED
10. Personal equipment - CHECK
11. Notify pilot - CLEAR TO TAXI

**BEFORE TAKEOFF**

1. Flight instruments - CHECK AND SET
2. Stab aug switches - ENGAGE
3. Flight controls - UNRESTRICTED (WSO visually check ailerons and spoilers)
4. (P-WSO) Canopies - CLOSE & CHECKED
5. (P-WSO) Lower ejection handle guards - CLEAR
6. Fuel panel - SET & CHECKED
  - a. Internal wing transfer switch - NORMAL
  - b. External transfer switch - AS REQUIRED
7. Slats flaps - CHECK OUT AND DOWN
8. Anti-skid - ON; LIGHT OFF
9. Warning lights - CHECKED
10. Pitot heat/anti-ice - AS REQUIRED
11. IFF - AS REQUIRED
12. Variable inlet ramps - CHECK FULLY RETRACTED  
As throttles are advanced to 85% RPM, check that variable ramps are in fully retracted (flush) position.
13. (WSO) Command selector valve - AS BRIEFED
14. (P-WSO) Circuit breakers - CHECK

## QUICK TURN

### Prior to engine shutdown -

1. After Landing check - COMPLETE
2. (P-WSO) Personal equipment leads (except oxygen and communications) - DISCONNECT (only if canopy is fully open and will remain open)
3. Left generator switch - OFF
4. BUS TIE OPEN light - OUT
5. Utility hydraulic pressure - WITHIN LIMITS
6. Left throttle - OFF

## SOLO FLIGHT INSPECTION (REAR COCKPIT)

1. Command selector valve handle - VERTICAL (closed)
2. Bulkhead mounted canopy initiator safety pin - REMOVED (all other pins installed)  
With the initiator safety pin installed, the front canopy cannot be jettisoned by means of the canopy jettison lanyard.



Exercise caution regarding hand movements in the vicinity of the bulkhead mounted canopy initiator linkages. Also, do not stow flight equipment or personal items in this area. Failure to comply could result in inadvertent jettisoning of the canopy.

3. Lap belt, leg restraints, and harness assembly -

### SECURED

4. Communication-navigation control panel - SET
  - a. COMM-AUX pushbutton - TR + G - ADF
  - b. Communication channel control knob/mode selector switch - GUARD
  - c. Navigation function selector knob - T/R
  - d. Navigation channel control knob - AS REQUIRED
5. Emergency slat flap handle - FORWARD
6. Function selector switch - HOT MIC
7. Amplifier selector knob - NORM
8. Oxygen supply lever - OFF
9. Emergency gear handle - IN & SECURE
10. Emergency brake handle - IN & SECURE
11. Radar scope retaining pins - INSTALLED
12. Radar power selector knob - OFF
13. Battery bypass switch - OFF (some aircraft)
14. Circuit breakers - IN
15. Electrical test receptacle plug 3P325 - ENSURE PLUG SEATED FLUSH, KNURLED LOCK RING SECURE, CAP TIGHT.  
It is possible to trip both generators off the line if the electrical test receptacle plug 3P325 under the right canopy sill is loose. The plug uses a knurled (twist clockwise to lock) lock ring which should not be confused with the chain equipped threaded cap.
16. Cockpit light switches - OFF
17. All loose items - SECURE
18. All other equipment - AS REQUIRED
19. Instrument ground power switch - ACTUATE (cannot be performed when battery start is made)  
Actuate the instrument ground power switch to energize the instrument 115/200 volt ac bus and the instrument 28 volt ac bus.
20. Inertial navigation set - ALIGNED  
Align the INS as outlined in After Electrical Power (Rear Cockpit).
21. Canopy - CLOSED

## SECTION III

# EMERGENCY PROCEDURES

### TABLE OF CONTENTS

<b>GROUND - OPERATION EMERGENCIES</b>			
Canopy Malfunction.....	3-2	Single Power Control System Failure.....	3-30
Cartridge Mode Starting Malfunctions.....	3-3	Smoke and Fumes.....	3-21
Cockpit Overpressurization.....	3-2	Speed Brake Emergency Operation.....	3-29
Emergency Entrance and Exit.....	3-4	Upright Spins.....	3-7
Emergency Evacuation.....	3-4	Utility Hydraulic And Engine Failure (With Or Without Single PC Failure).....	3-30
Engine Fire or Overheat During Start/Shutdown.....	3-3	Utility Hydraulic And Single PC Failure ..	3-30
Wheel Brake Failure.....	3-3	Utility Hydraulic System Failure.....	3-29
<b>TAKEOFF EMERGENCIES</b>		Variable Area Inlet Ramp Failure.....	3-10
Abort.....	3-4	<b>LANDING EMERGENCIES</b>	
ADI/INS Failure.....	3-6	Approach-End Arrestment.....	3-40
Afterburner Fails To Light.....	3-4	Arresting Hook Emergency Operation.....	3-40
Afterburner Fails After Light.....	3-4	Aux Air Door Malfunction (Gear Down) ..	3-40
Auxiliary Air Door Malfunction (Gear Up).....	3-6	Blown Tire During Landing Rollout.....	3-37
Blown Tire During Takeoff.....	3-6	Departure - End Arrestment.....	3-43
Engine Fire/Overheat or Failure During Takeoff.....	3-4	Directional Control After Landing With Utility Hydraulic System Failure.....	3-38
Fuel Siphoning During Takeoff/Climb.....	3-7	Emergency Landing Pattern.....	3-33
Landing Gear Fails to Retract.....	3-7	Engine Failure on Final.....	3-33
<b>INFLIGHT EMERGENCIES</b>		Engine Fire/Overheat on Final.....	3-34
Air Refueling of Fuselage Tanks Only.....	3-23	Landing From the Rear Cockpit With Pilot Disabled.....	3-37
Bleed Air Check Valve Failure.....	3-11	Landing Gear Emergency Lowering.....	3-39
Bleed Air Duct Failure.....	3-11	Landing Gear Emergency Retraction.....	3-40
Bus Tie Open.....	3-25	Landing Gear Fails to Extend.....	3-39
Compressor Stall.....	3-10	Landing With A Blown Tire.....	3-35
Complete Bellows Failure or Ice/Water Blockage of Bellows Ram Air Inlet.....	3-28	Landing With a Hard-Over Rudder.....	3-38
Controllability Check.....	3-33	Landing With Anti-skid Failure.....	3-37
DC Bus Light Illuminated.....	3-28	Landing With Both Engines Inoperative ..	3-35
Double Engine Failure During Flight.....	3-9	Landing With Double Exhaust Nozzle Failure.....	3-35
Double Exhaust Nozzle Failure.....	3-11	Landing With One Utility Hydraulic Pump Failed.....	3-38
Double Generator Failure.....	3-24	Landing With Utility Hydraulic System Failure.....	3-38
Double Power Control System Failure.....	3-31	Landing With Variable Inlet Ramp Failure.....	3-35
Ejection.....	3-11	No Slats Flaps Landing.....	3-35
Electrical Fire.....	3-21	Single Engine Go-Around.....	3-34
Engine Failure During Flight.....	3-8	Single Engine Landing.....	3-34
Engine Fire or Overheat During Flight.....	3-9	Slats Flaps Emergency Lowering.....	3-34
Equipment Cooling Turbine Failure.....	3-22	Split Flap/Deflected Rudder.....	3-34
Extreme Cockpit Temperatures.....	3-21	<b>CHARTS</b>	
Flight Control Malfunction.....	3-28	Airspeed Indicator Failure.....	3-45
Fuel Boost Pumps Inoperative.....	3-23	Airstart Envelope.....	3-9
Fuel Transfer Failures.....	3-23	Ditching.....	3-44
Fuselage Fuel Leak.....	3-23	Emergency Entrance/Exit.....	3-5
Glide Distance.....	3-11	Emergency Power Distribution.....	3-26
Hard-Over Rudder In Flight.....	3-28	Ejection Altitude vs. Sink Rate.....	3-18
INS Inflight Alignment.....	3-33	Ejection Procedures.....	3-12
Inverted Spins.....	3-8	Ejection Seat Descent Time.....	3-20
Jettisoning.....	3-31	Field Arrestment Gear Data.....	3-46
Oil System Failure.....	3-22	Flame-out Approach.....	3-36
Out-of-Control Recovery.....	3-7	Jettisoning.....	3-32
Runaway Stabilator Trim.....	3-29	Landing Gear Malfunctions - Emergency Landings.....	3-41
Single Generator Failure.....	3-24	Minimum Ejection Altitude vs. Airspeed and Dive Angle.....	3-19
		Warning/Indicator Lights.....	3-47

This section contains procedures to be followed to correct an emergency condition. These procedures will insure maximum safety for the crew and/or aircraft until a safe landing or other appropriate action is accomplished. The procedures are arranged in the most desirable sequence for the majority of cases; therefore, the steps should be performed in the listed sequence unless the pilot can determine a good cause for deviation. Multiple emergencies, adverse weather, and other peculiar conditions may require modification of these procedures. The critical items (**BOLD FACE LETTERS**) contained in the various emergency procedures cover the most adverse conditions. Aircrew members should be able to accomplish bold face procedures without reference to the checklist. The nature and severity of the encountered emergency will dictate the necessity for complying with the critical items in their entirety. It is essential, therefore, that aircrews determine the correct course of action by use of common sense and sound judgement. As soon as possible, the pilot should notify the WSO, flight or flight leader, and tower of any existing emergency and of the intended action.

The terms "Land as soon as possible" and "Land as soon as practical" are used in this section. These terms are defined as follows:

**Land as soon as possible** – An emergency will be declared. A landing should be accomplished at the nearest suitable airfield considering the severity of the emergency, weather conditions, field facilities, ambient lighting, aircraft gross weight, and command guidance.

**Land as soon as practical** – Emergency conditions are less urgent, and although the mission is to be terminated, the degree of the emergency is such that an immediate landing at the nearest adequate airfield may not be necessary.

The following basic rules apply to all aircraft emergencies and should be thoroughly understood by all aircrew:

1. Maintain aircraft control.
2. Analyze the situation and take proper action.
3. Land as soon as practical.

### WARNING

- The canopies should be retained during all emergencies, except ditching, that could result in a crash or fire such as crash landings, aborted takeoffs, and arresting gear engagements. The protection the canopies afford the crew during these emergencies far outweigh the isolated risk of entrapment due to a canopy malfunction or overturn. During the aircraft abandonment phase, normal canopy opening procedures should be considered first to preclude the possibility of a static seat ejection.
- During uncontrolled runway departure, consider shutting engines down to eliminate fire sources such as hot engine, pressurized hydraulics, and full power electronics.
- All odors not identifiable by the flight crew shall be considered toxic. Immediately go on 100% oxygen. Properly vent the aircraft and land as soon as practical. Do not take off when unidentified odors are detected.

## GROUND-OPERATION EMERGENCIES

### CANOPY MALFUNCTION

In the event of unusual noise or other abnormal occurrence when the canopy is being closed or opened:

1. Notify egress personnel
2. Do not actuate canopy lever
3. Remain strapped in until egress personnel check/safe the seat/canopy

### WARNING

Do not taxi the aircraft with a known canopy malfunction with the canopy open. The canopy may separate from the aircraft causing damage to the aircraft and/or injury to the aircrew.

### COCKPIT OVERPRESSURIZATION

1. Emergency vent knob – PULL

### WARNING

Do not attempt to open the canopy by the normal method if the cockpit is overpressurized since this may cause the canopy to lift and separate from the aircraft and fall on the banana links resulting in an inadvertent ejection.

If vent knob does not relieve pressure –

2. Cockpit heat and vent circuit breakers – PULL (C8, D6, No. 3 panel)



## CARTRIDGE MODE STARTING MALFUNCTIONS

Failure to start while in cartridge mode may be caused by a malfunction in the cartridge, the starter, or the engine. Malfunctions are classified as misfires, hangfires, and hangstarts. The pilot and ground crew can recognize a misfire; however, they may not be able to distinguish between a hangfire and hangstart.

### MISFIRE

A misfire is defined as a failure of the cartridge ignitor squib to fire. This may be caused by a failure of electrical ignition system, failure of cartridge squib, or no contact between cartridge ground clips and starter. A misfire may be detected by the absence of engine rotation and absence of smoke at starter exhaust door. When a misfire occurs, follow the Cartridge Start Malfunction procedure. After removal of misfired cartridge, inspect cartridge ground clips to ensure they have been bent up sufficiently to make contact. Ensure that safety clip has been removed. If no obvious correctable fault can be found with misfired cartridge, another cartridge start with a new cartridge may be attempted.

### HANGFIRE/HANGSTART

A hangfire/hangstart is a condition where the engine fails to accelerate in a normal manner after initiation of cartridge start. A hangfire is a cartridge malfunction where main propellant grain does not burn or only partially ignites. In either case, ignitor squib fires, as evidenced by a small amount of smoke at starter exhaust and engine rotation to a low rpm. If main propellant grain partially ignites, it may smolder until enough pressure has built up in starter breech for complete ignition to occur. The smoldering may last as long as 2½ minutes. Hangfire is usually associated with extremely low cartridge soak temperature (-55°C). A hangstart is a start in cartridge mode in which engine rotation is produced but the engine does not accelerate to idle rpm.

Since the symptoms of a hangfire and a hangstart are similar and difficult to distinguish from each other, the following common procedure is established. If rpm hangs up below idle, complete the first two steps of Cartridge Start Malfunction procedure by retarding throttle to off and releasing ignition button. Be alert for possible engine rotational acceleration and re-initiate starting procedures as applicable, once sustained rotation is assured. If rotation ceases and there is no evidence of burning, complete Cartridge Start Malfunction procedure. To preclude a catastrophic failure due to a malfunctioning starter, do not attempt a second cartridge start until a successful pneumatic start has been accomplished. The malfunctioned start must be entered on Form 781 and both a successful pneumatic start and subsequent cartridge start are required to clear the 781 entry. If pneumatic start or second cartridge is unsuccessful, starter must be removed and inspected. The second cartridge start requirement is not cause for grounding the aircraft and may be accomplished at a later time.

## CARTRIDGE START MALFUNCTION PROCEDURE

1. Throttles - OFF
2. Ignition button - RELEASE
3. Engine master switches - OFF
4. External electrical power - DISCONNECT
5. Wait 5 minutes

**WARNING**

- Do not attempt to remove a cartridge until 5 minutes after all evidence of burning has ceased.
- Do not attempt to perform any work in auxiliary door area when utility hydraulic system is pressurized unless auxiliary air door lock is installed, since any interruption of electrical power will cause the auxiliary air doors to close forcefully and could cause injury.

## ENGINE FIRE OR OVERHEAT DURING START/SHUTDOWN

1. Throttles - OFF
2. Engine master switches - OFF

## WHEEL BRAKE FAILURE

Wheel brake failure may be caused by mechanical malfunction, utility hydraulic system failure, or a malfunction of the anti-skid system. Wheel brake failure during normal anti-skid cycling is difficult to recognize and, at any time, the cause of wheel brake failure is difficult to diagnose rapidly. Therefore, the following procedure ensures that, regardless of cause, actions are taken sequentially to provide for the various contingencies.

1. Brakes - RELEASE
2. Emergency quick release lever - HOLD DEPRESSED
3. Brakes - APPLY  
If normal braking is available without anti-skid, it is possible to lock the wheels which may cause a blown tire. Runway condition and aircraft speed will dictate the amount of braking which can be applied.
4. HOOK - DOWN (if required)

### If braking returns -

5. Anti-skid switch - OFF
6. Emergency quick release lever - RELEASE

### If still no brakes -

5. Brakes - RELEASE
6. Emergency brake handle - PULL AND HOLD  
If the emergency brake handle in one cockpit is

not effective, pull and hold the emergency brake handle in the other cockpit.

#### 7. Brakes - APPLY

Pedal pressure is identical to the normal system. Brakes should be slowly applied to the desired amount and held until the airplane stops. Anti-skid is inoperative and it is possible to lock the wheels which may cause a blown tire. Since application and release of the brakes dumps the fluid used, use steady brake application without pumping. Do not attempt to taxi after the emergency brake handle has been pulled.

#### 4. OUTSIDE HANDLE - LOCK UP

Emergency harness release handle

#### 5. Canopy - OPEN

a. Normal

b. Manual unlock handle

With the normal canopy select lever in CLOSED and an operational normal system, it is impossible to unlock the canopy with the manual unlock handle.

c. Emergency canopy jettison handle

### WARNING

## EMERGENCY ENTRANCE AND EXIT

See figure 3-1.

## EMERGENCY EVACUATION

#### 1. LOWER GUARD - UP

#### 2. SHOULDER HARNESS - RELEASE

#### 3. INSIDE HANDLE - ROTATE AFT (completely disengage and discard)

Survival kit release handle

If the survival kit retaining straps fail to release or the drop line is attached to the left retaining strap, depress the quick disconnect(s) in the survival kit harness attachment fittings.

- If there is any indication of fire inside or outside the cockpit, ensure both crewmembers are ready to egress before opening either canopy.

- To prevent injury to rear crewmember, front crewmember must jettison his canopy first.

d. Break canopy with canopy knife

### WARNING

Knife cutting edge must face crewmember to prevent possible injury.

## TAKEOFF EMERGENCIES

### NOTE

The takeoff phase of operation is from the time the throttles are advanced for takeoff until the aircraft attains initial climb speed.

temperature. In this circumstance, the nozzle moves as a function of temperature limiting only.

#### 1. Throttle bad engine - RECYCLE

## ABORT

#### 1. THROTTLES - IDLE

#### 2. CHUTE - DEPLOY

#### 3. HOOK - DOWN

If afterburner fails to relight -

#### 2. Throttle bad engine - MIL

#### 3. Engine instruments - MONITOR

### CAUTION

Loss of afterburner during takeoff could be an early indication of engine failure or fire.

## AFTERBURNER FAILS TO LIGHT

If the afterburner fails to light, recycle the throttle to MIL and then back into the afterburner range. If the afterburner lights, continue the mission. If the afterburner still fails to light, discontinue the takeoff.

## ENGINE FIRE/OVERHEAT OR FAILURE DURING TAKEOFF

## AFTERBURNER FAILS AFTER LIGHT

If an afterburner fails after light, the resulting loss of thrust is significant. Takeoff need not be aborted if remaining runway is compatible with thrust available. After failure, the variable area exhaust nozzle will continue to function as directed by exhaust gas

If an engine fails before aircraft lift-off, the decision to abort or continue the takeoff is dependent on the length of runway remaining, aircraft gross weight, airspeed at time of failure, field elevation, runway temperature and arresting gear availability. Takeoff speed with a failed engine is approximately 8 knots higher than two-engine takeoff speed. Excessive application of aft stick which

# EMERGENCY ENTRANCE/EXIT

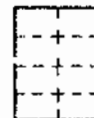

## WARNING

WHEN CANOPY OR EJECTION SEAT DAMAGE IS SUSPECTED OR HAS OCCURRED DUE TO BATTLE DAMAGE, BIRD STRIKE, ETC., THE EJECTION SEAT FIRING MECHANISM AREA SHOULD BE VISUALLY INSPECTED FOR FOD PRIOR TO CANOPY OPENING. WHEN POSSIBLE, THE EJECTION SEAT SHOULD BE RENDERED SAFE PRIOR TO OPENING THE CANOPY FRAME.

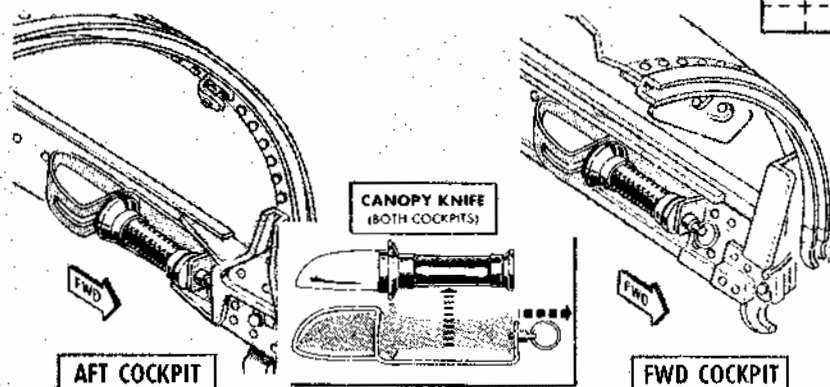

IF EITHER CANOPY CANNOT BE OPENED BY THE AIRCREW, BREAK THROUGH THE CANOPY WITH THE CANOPY KNIFE.

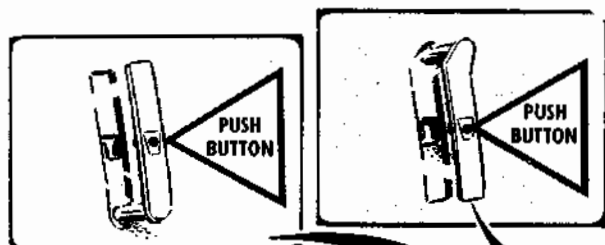

To manually open the canopies, depress the push buttons on the manual release handles. Depress the OPEN buttons on each normal canopy control. Rotate the FORWARD canopy manual release handle COUNTERCLOCKWISE. Rotate the AFT canopy manual release handle CLOCKWISE. After the canopies have been unlocked they can be lifted open manually.



Entrance to the cockpits while the engines are running is hazardous because of the possibility of being drawn into the intake duct. To reduce this hazard, it is suggested that a crash truck be driven up against the duct, thereby blocking the duct. The canopies can then be jettisoned or opened, and entry can be made from the top of the vehicle or from the wing.

## WARNING

THE CANOPIES MUST BE HELD OR PROPPED UP IN THE OPEN POSITION WHEN RAISED MANUALLY.

To jettison the canopies, open access door 7, extend canopy jettison lanyard to its full length (approximately 20 inches) and PULL.

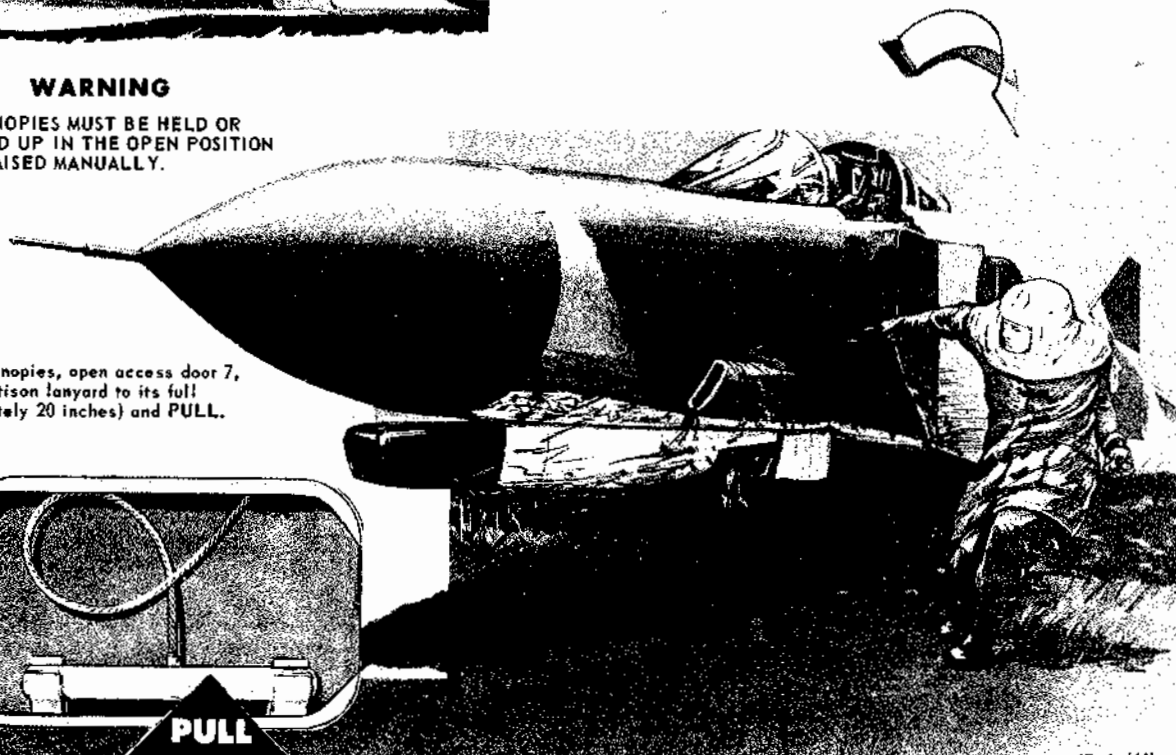
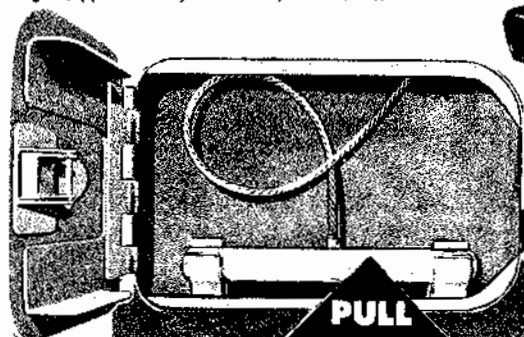

4E-1-(44)

Figure 3-1

causes a higher angle of attack than necessary for takeoff will increase drag and reduce acceleration. If engine failure occurs after rotation, it may be necessary to lower the nose to the runway to attain single-engine takeoff speed. This is especially important at high gross weights and low density ratios. Increase airspeed as much above single-engine takeoff speed as available runway permits (not to exceed 210 knots) before attempting takeoff. If an engine fails immediately after becoming airborne, it may be necessary to allow the aircraft to settle back on the runway until single-engine takeoff speed is attained. Immediately after becoming airborne, establish near level flight for acceleration prior to climb. Lateral and directional control can be maintained if the aircraft remains above stall speed but the ability to maintain altitude or to climb depends upon aircraft gross weight, configuration, airspeed, altitude and temperature. When safely airborne, retract the landing gear. External stores should be jettisoned if necessary to reduce weight and drag. Reduction of gross weight and drag will enhance climbout performance with available thrust. Flaps should not be raised until a safe altitude and airspeed have been attained. Accelerate and climb straight ahead if terrain permits. If turns are necessary, they should be made with minimum angle of bank. All control movements should be smoothly coordinated.

#### If decision to stop is made -

1. ABORT
2. THROTTLE BAD ENGINE - OFF
3. Engine master switch - OFF

#### If takeoff is continued -

1. THROTTLES - AFTERBURNER
2. EXTERNAL LOAD - JETTISON (if necessary)

### WARNING

A leaking centerline fuel tank may be the cause of an engine fire/overheat. Consider jettisoning the tank as soon as possible. Delay in jettisoning a burning centerline tank can result in destruction of the jettisoning circuitry. With fire/overheat indications and jettison of the centerline tank not feasible, the air refuel switch should be placed to EXTEND and the external transfer switch placed OFF.

#### NOTE

Placing the air refuel to EXTEND depressurizes all tanks and possibly reduces the fuel source to the fire. With the air refuel switch in EXTEND, wing fuel cannot be pressure dumped.

3. Throttle bad engine - AS REQUIRED  
After reaching safe ejection altitude, proceed with Engine Fire Or Overheat During Flight or Engine Failure During Flight procedures.
4. Flaps - DO NOT RETRACT BELOW 230 KNOTS

## BLOWN TIRE DURING TAKEOFF

The decision to continue the takeoff or abort will depend on the speed at the time of the failure, stopping distance required, and arresting gear available. Generally it is better to continue the takeoff if the tire blows above 100 knots.

### CAUTION

Directional control is extremely critical; therefore, immediate corrective action must be taken and all available means of maintaining directional control must be considered.

#### If decision to stop is made -

1. ABORT
2. NOSE GEAR STEERING - ENGAGE
3. ANTI-SKID - OFF  
Release brakes prior to disengaging the anti-skid to prevent blowing the good tire.
4. Use opposite braking to slow aircraft and aid directional control

### CAUTION

Avoid braking on the wheel with the blown tire. Heavy braking could cause a flat spot on the wheel which could prevent further rotation and make aircraft control more difficult.

#### If takeoff is continued -

1. Gear & flaps - DO NOT RETRACT  
Leave wing flaps extended and stay below flap-blowup speed if practical. If the wing flap seals were damaged as a result of a blown tire, retracting the flaps will increase the damage.
2. Tire - CHECK  
Check the condition of the blown tire, if possible, by verification from another aircraft/tower.
3. Refer to Landing With Blown Tire procedure, this section.

## ADI/INS FAILURE

1. Emergency attitude indicator - CHECK
2. Radar horizon - CHECK
3. Reference system selector - STBY

## AUXILIARY AIR DOOR MALFUNCTION (GEAR UP)

If the L AUX AIR DOOR, and/or R AUX AIR DOOR indicator lights illuminate with landing gear handle UP:

1. Maintain 250 knots or less.

2. Landing gear - CYCLE

If light(s) remain on -

3. Auxiliary air door control circuit breaker(s) - PULL (A2, A3, No. 3 panel) RESET BEFORE LANDING

If light(s) still remain on -

4. Maintain no more than cruise power

### CAUTION

Extended engine operation at high power settings will result in engine compartment and aft fuselage overheating.

### NOTE

The auxiliary air doors can be closed by pulling the left and right AUX AIR DOOR circuit breakers. This will not affect normal operation of the aux air doors in flight. However, it should be remembered, the circuit breakers must be reset prior to lowering the landing gear.

## FUEL SIPHONING DURING TAKEOFF/CLIMB

Excessive fuel siphoning on takeoff could result in a torching effect if the afterburners are utilized. No damage will result from torching siphoned fuel; however, excessive fuel siphoning does unnecessarily deplete the fuel supply. If excessive fuel siphoning is noted:

1. External transfer switch - OFF
2. Internal wing transfer switch - STOP TRANSFER

When siphoning ceases -

3. Internal wing transfer switch - NORMAL
4. External transfer switch - AS DESIRED

## LANDING GEAR FAILS TO RETRACT

1. Climb to a safe altitude while maintaining airspeed below 250 knots.

### WARNING

Airspeed is critical and should be maintained consistent with gross weight. Avoid abrupt throttle reductions.

2. Landing gear control circuit breaker - IN

### CAUTION

If landing gear handle is stuck in the down position, do not attempt to force the gear handle to the up position.

3. If landing gear does not retract or continues to indicate unsafe, move landing gear handle down, and remain below 250 knots.

# INFLIGHT EMERGENCIES

## OUT-OF-CONTROL RECOVERY

Recovery from most out-of-control conditions can be made rapidly with the application of forward stick. Unless at low altitude, retard the throttle to IDLE immediately to prevent engine flameout. Probability of flameout is reduced at lower altitudes. If both engines flame out, airstart at least one engine immediately to prevent loss of electrical and hydraulic power. Use the following procedure at the first indication of departure from controlled flight:

1. STICK - FORWARD
2. AILERONS AND RUDDER - NEUTRAL
3. IF NOT RECOVERED - MAINTAIN FULL FORWARD STICK AND DEPLOY DRAG CHUTE
4. Throttles - IDLE (unless at low altitude)

### WARNING

Abrupt application of forward stick may cause a negative angle of attack stall. When inverted, instinctive or rote application of forward stick may aggravate the stall and prevent recovery. To recover from an inverted stall, relax forward stick pressure and maintain 3 to 8 units AOA until recovered. Recognition of inverted stall during consecutive stall/post-stall gyrations may be difficult. If large yaw and roll motions are present, disregard AOA and follow Out-Of-Control Recovery procedure.

## UPRIGHT SPINS

The Out-Of-Control Recovery procedure will recover the aircraft from nearly all spins regardless of CG position or external store loading. Do not apply aileron until you are certain that a spin exists. Use outside-the-cockpit visual

cues, excessive yaw rate, and turn needle to verify spin and spin direction. The turn needle will always be pegged in the spin direction. AOA is not a primary indicator. When airspeed increases through 200 knots, the aircraft is no longer in a spin but may be in a rolling spiral preparatory to normal dive recovery. Maintain the stick full forward until the aircraft unloads and yaw and roll motions cease. Use the following procedure only if the aircraft has not recovered using the Out-Of-Control Recovery procedure.

### WARNING

Under most conditions, about 15,000 feet is required for spin recovery. If there is insufficient altitude for recovery, eject.

1. **STICK - MAINTAIN FULL FORWARD**
2. **AILERONS - FULL WITH SPIN (TURN NEEDLE)**
3. **AIRCRAFT UNLOADED - AILERONS NEUTRAL**
4. If out of control at or below 10,000 feet AGL - **EJECT**

### INVERTED SPINS

The aircraft is highly resistant to an inverted spin and will recover rapidly with neutral ailerons and rudder. The out-of-control procedure should be used if an inverted spin is entered. When roll and yaw oscillations cease, maintain 3 to 8 units AOA until speed is sufficient to perform a normal dive recovery. Refer to Flight Characteristics, section VI.

### ENGINE FAILURE DURING FLIGHT

If a malfunction is not immediately evidenced by explosion, engine vibration, or engine seizure, depress and hold the ignition button(s) in an attempt to restart the engine(s) before excessive rpm is lost. A normal relight and acceleration should not be expected above 60,000 feet. Refer to Airstart Envelope, figure 3-2. If engine failure occurs during air refueling, immediately disengage from the tanker and place the air refuel switch to RETRACT. On aircraft after TO 1F-4-903, the APU will provide back-up PC-1 hydraulic pressure for longitudinal control with the left engine inoperative.

### CAUTION

To reduce the possibility of engine seizure, do not delay an airstart attempt.

### AIRSTART

1. Throttle - OFF
2. Ignition button - HOLD DEPRESSED
3. Throttle - IDLE  
If no fuel flow is observed, slowly advance throttle until fuel flow is noted.
4. Engine rpm, exhaust temperature, and fuel flow - MONITOR

An engine relight is indicated by an increase in exhaust temperature, followed by an increase in engine rpm.

### CAUTION

If a relight does not occur within 30 seconds; or the engines do not accelerate after light-off; or the exhaust temperature exceeds its maximum limits; or the oil pressure does not reach its minimum limit; retard the throttle to OFF.

### MECHANICAL MALFUNCTION

An engine mechanical malfunction is usually accompanied by engine vibrations, explosions, surges, or engine seizure. If one or more of the above symptoms occur, analyze and determine the malfunctioning engine through throttle manipulation and aircraft instruments.

#### When the malfunctioning engine is determined -

1. Throttle - IDLE

If engine malfunction is still evident (vibrations, noises, surges, etc.) or if engine has failed (insufficient rpm or fuel flow for start)-

2. Generator - OFF  
The generator is turned OFF before placing the throttle OFF to prevent the bus tie from opening when an underspeed occurs as rpm decreases.
3. Throttle - OFF
4. Engine master switch - OFF
5. Land as soon as practical

### SINGLE-ENGINE FLIGHT CHARACTERISTICS

With one engine inoperative, slight to moderate rudder deflection is required to prevent yaw toward the failed engine, providing the recommended angle of attack of 17 units is not exceeded. The sideslip should be kept as small as possible. Banking 5° into the good engine will reduce the rudder force required to maintain zero sideslip. The aircraft design is such that no one system is entirely dependent upon a specific engine, thus loss of one engine will not result in the loss of a complete system. Be sure to monitor the utility hydraulic system (especially during turns) as the handling qualities are severely degraded with its failure. Aircraft service ceiling for single-engine operation (military thrust or afterburner) is a function of aircraft configuration and gross weight. A simple rule of thumb to use in the event of an engine failure is: maintain 250 knots (military thrust on good engine). If 250 knots cannot be maintained, descend at 250 knots until rate-of-descent stops. This places the aircraft close to the service ceiling for the operating gross weight and power available. If a climb is desired, use afterburner thrust on the good engine. During single-engine operation with various landing gear and wing flap configurations, exercise care to avoid rapid airspeed bleed-off and/or excessive sink rates. Limited thrust available makes

# AIRSTART ENVELOPE

## ENGINE INFIGHT STARTING LIMITS

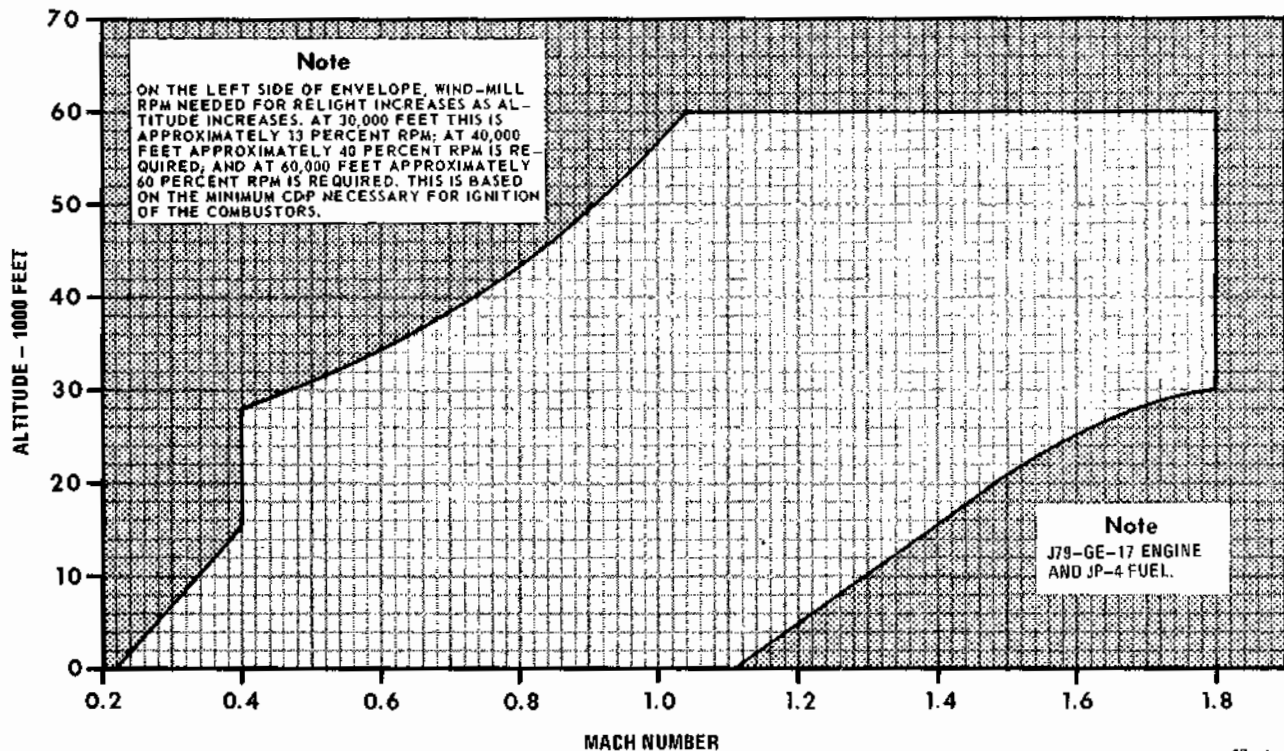

4E-1-(43)

Figure 3-2

airspeed response to power much slower than normal two-engine operation.

## DOUBLE ENGINE FAILURE DURING FLIGHT

1. Either engine - AIRSTART

### NOTE

It may take up to 30 seconds to obtain a relight and longer for thrust response. If engine rpm drops to 10-12%, approximately 40 seconds from lightoff is required to accelerate the engine to military thrust.

2. Reference system selector - STBY

If neither engine starts -

3. Fuel status - CHECK
  - a. Tape and fuel low level warning light - CHECK
  - b. External transfer switch - OFF
  - c. Internal wing transfer - NORMAL
4. Engine master switches - CHECK ON

5. Either throttle - OFF  
To provide maximum fuel flow to accomplish an airstart, retain throttle on one engine in the OFF position.
6. Other engine - AIRSTART
7. Remaining engine - AIRSTART
8. If neither engine can be started, attempt airstart by holding boost pump check switches in CHECK position and pull left and right main fuel control circuit breakers, (H3, J1, No. 2 panel) (aircraft thru block 40).

If neither engine can be started -

9. Eject

## ENGINE FIRE OR OVERHEAT DURING FLIGHT

1. Throttle bad engine - IDLE
2. If warning light goes out - CHECK FIRE DETECTION SYSTEM  
Depress fire test button to determine that the fire detecting elements are not burned through.
3. If detection system check is satisfactory (i.e.,

warning lights illuminate when checked) - LAND AS SOON AS PRACTICAL

**CAUTION**

Increasing thrust on the bad engine after the throttle has been retarded and the warning light has been extinguished may cause fire or overheating damage, and/or possible burn through of the fire detecting elements.

**If warning light on, detection system inoperative, or fire confirmed -**

4. Generator bad engine - OFF  
The generator is turned OFF before placing the throttle OFF to prevent the bus tie from opening when an underspeed occurs as rpm decreases.
5. Throttle bad engine - OFF
6. Master switch bad engine - OFF
7. If fire persists - EJECT
8. If fire ceases - LAND AS SOON AS PRACTICAL

**CAUTION**

Do not attempt to restart the bad engine. If the fire ceases, and a landing is to be accomplished, make a single engine landing.

## VARIABLE AREA INLET RAMP FAILURE

There are no provisions made for emergency operation of the inlet ramps. Malfunction of the inlet ramp control or actuating system may cause the ramp to assume the fully retracted (maximum duct area) position or the fully extended (minimum duct area) position. Extended inlet ramps may be detected by: observing the ramp position in the rear view mirror; significantly reduced fuel flow at power settings above 85% rpm; high pitched howl at airspeeds above 300 knots; and significantly reduced thrust (approximately 35%) at power settings above 90% rpm. Engine acceleration time and response to throttle movement are not affected by the extended ramp. No special procedures are required for throttle manipulation under these conditions below 18,000 feet altitude.

## RAMPS RETRACTED AT SPEEDS ABOVE 1.5 MACH

If the inlet ramps fail to extend while accelerating between 1.5 and 1.8 Mach, reduce airspeed to below 1.5 Mach and continue the mission.

**CAUTION**

Compressor stalls may occur at airspeeds above 1.7 Mach with the inlet ramps in the retracted position.

## RAMPS EXTENDED AT SPEEDS BELOW 1.5 MACH

Engine operation below 80% rpm is usually normal under stabilized conditions. However, as a rule, jam accelerations, afterburning, airstarts, and stall margin degrades as altitude increases. Rapid throttle movements can result in compressor stall/flameout above 18,000 feet. Range, altitude and go-around performance are also degraded. Power settings above 94% rpm produce increased fuel flows without increasing engine thrust output. If the inlet ramps fail to the extend position, maintain the highest altitude at which the maximum range Mach number recommended for existing gross weight and configuration can be maintained with 94% rpm or less (assuming stabilized engine operation is possible at selected altitude). It may be possible to retract a ramp which has failed in the extended position by pulling or cycling either ramp control circuit breaker G6 or G7, No. 2 panel. With the inlet ramps extended, the reduction in maximum range varies from 5% at 10,000 feet to 18% at 30,000 feet. Single engine range is reduced by 10% at all attainable altitudes.

**CAUTION**

- Compressor stall and flameout may occur at power settings above 80% rpm with the inlet ramps in the extended position.
- Sustained power settings above 90% rpm at subsonic airspeeds above 30,000 feet with the inlet ramps in the extended position may result in a faintly glowing fire warning light. Altitude and power setting should be reduced to extinguish the warning light.

## COMPRESSOR STALL

A compressor stall is an aerodynamic disruption of airflow through the compressor, and is caused by subjecting the compressor to a pressure ratio above its capabilities at the existing conditions. The compressor capability may be reduced by FOD, corrosion, rocket/missile motor exhaust, gun gases, misrigged or malfunctioning IGV's. In addition, the compressor may also be subject to abnormal operating conditions as a result of a malfunction of the ramp or bellmouth system. Compressor stalls may be self clearing, may cause the engine to flameout, or may result in a steady state, fully developed stall. The first case requires no immediate action. In the second case, the flameout clears the stall and an airstart is required. The third case requires recognition and corrective action to restore thrust and prevent engine damage by overtemperature. The stall can be recognized by the simultaneous existence of high EGT, low rpm, low fuel flow, open nozzle, loss of thrust, and lack of engine response to throttle. Compressor stalls may be accompanied by muffled bangs. The most positive stall clearing procedure is to stopcock the engine and perform an airstart. In the event of a compressor stall, shut off and restart one engine at a time. A throttle chop to idle may clear the stall if a significant fuel flow reduction from the stall condition is achieved. If the stall is cleared but desired thrust cannot be obtained because of repeated stalling, the engine may be operated at any



obtainable rpm, as long as EGT is within limits.

1. Throttle - IDLE

**If stall does not clear -**

2. Generator switch - OFF

The generator is turned OFF before placing the throttle OFF to prevent the bus tie from opening when an underspeed occurs as rpm decreases. Turn the generator switch ON after the engine is restarted.

3. Throttle - OFF
4. Ignition button - HOLD DEPRESSED
5. Throttle - IDLE

If throttle position beyond normal cruise setting is used, engine hang-up may occur due to back pressure caused by reduced nozzle area.

6. Engine rpm, exhaust temperature, and fuel flow-MONITOR

## BLEED AIR DUCT FAILURE

Severe damage to the aircraft may result from a bleed air duct failure due to the high temperature produced by the bleed air system. This air, leaking from a failed duct, may ignite flammable material in the vicinity of the leak and may cause failure of unrelated aircraft systems which have components in the vicinity of the leak. The following symptoms may be indicative of a bleed air system failure: a mild audible thump or bang on the airframe; complete or partial loss of cockpit pressurization; loss of pylons, missiles or other external stores; generator failure, popping of circuit breakers and illumination of several warning/indicator lights; erratic fuel quantity indications; mild stick transients; stiffness of throttles; hydraulic/pneumatic failure; smoke emitting from the intake duct louvers; fuel fumes in the cockpit; high fuel flow/erratic response to throttle movement (indicative of main fuel hose rupture).

### CAUTION

Early analysis of a bleed air duct failure is required to prevent serious damage or loss of the aircraft and/or to prepare for ejection if the situation rapidly deteriorates.

**If several symptoms occur -**

1. Attain and maintain safe ejection altitude
2. Reduce power to minimum practicable
3. Oxygen - 100%
4. Check for indications of fire

**If fire confirmed -**

5. Eject

**If fire not confirmed -**

5. Maintain minimum practical power
6. Landing gear - DOWN AS SOON AS PRACTICAL
7. Maintain safe ejection altitude as long as practical
8. Land as soon as possible.

## BLEED AIR CHECK VALVE FAILURE

No indication of a bleed air check valve failure will be noted in flight until the throttle is retarded and then readvanced on the engine with the failed bleed air check valve. If the throttle has been retarded and then readvanced, either rpm will hang-up or a minor compressor stall and flame-out will occur at approximately 85% rpm. If a flame-out occurs, a restart can be made, but rpm will probably not go above 65%, EGT will rise to approximately 625°, and the nozzle will go full open. In either case normal engine performance can be regained as follows:

1. Throttle good engine - IDLE  
Idling the good engine will equalize the pressure in the air line.
2. Throttle bad engine - ADVANCE
3. Throttle good engine - ADVANCE  
The good engine should not be accelerated to, or operated at, a rpm greater than that of the affected engine for the remainder of the flight.
4. Land as soon as practical

## DOUBLE EXHAUST NOZZLE FAILURE

In the event both exhaust nozzles fail to the open position, the total thrust available in MIL range will be approximately equal to the thrust available during single-engine operation in MIL range. Afterburner light-off above 15,000 feet is marginal; however, afterburner light-off probability increases with a decrease in altitude and normal afterburner thrust is available.

## GLIDE DISTANCE

The aircraft will glide approximately 6 nautical miles for every 5000 feet of altitude. The recommended glide airspeed is 215 knots. Below 50,000 feet 215 knots provides near maximum glide distance and allows the windmilling engines to maintain power control hydraulic pressures within safe limits.

## EJECTION

Ejection can be accomplished at ground level between zero and 550 knots airspeed with wings level and no sink rate providing the crewmember does not exceed a maximum boarding weight of 247 pounds. If the 247 pound boarding weight is exceeded, a 50 knot minimum airspeed restriction for safe ground level ejection must be observed. Boarding weight is defined to include the crewman, his

# EJECTION PROCEDURES

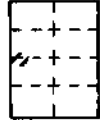

## BEFORE EJECTION

- A. IF TIME AND CONDITIONS PERMIT
  - ALERT OTHER CREWMEMBER
  - LOCK SHOULDER HARNESS
  - TIGHTEN LAP BELT
  - INSERT OXYGEN MASK BAYONETS TO LAST LOCKING POSITION OF HELMET RECEIVERS
  - LOWER HELMET VISOR(S) AND TIGHTEN CHIN STRAP
  - ADJUST SITTING HEIGHT AS NECESSARY
- B. SIT ERECT, BUTTOCKS BACK, SHOULDERS AGAINST PARACHUTE PACK, HEAD ERECT, SPINE STRAIGHT, LEGS EXTENDED AND THIGHS ON SEAT CUSHION.
- C. THE FORWARD CREWMEMBER WILL NORMALLY INITIATE EJECTION SEQUENCING, HOWEVER, THE AFT CREWMEMBER MAY INITIATE SINGLE OR DUAL SEQUENCING WHEN REQUIRED. THE CREWMEMBER NOT INITIATING THE EJECTION SHOULD BE ALERTED AND ASSUME THE PROPER BODY POSITION WITH HANDS ON THE HANDLE TO AVOID POSSIBLE INJURY.

### 1. Ejection Handle - PULL .....

#### LOWER HANDLE METHOD

**Note**

IF THE PILOT IS USING FULL BACK STICK, USE OF THE LOWER EJECTION HANDLE IN THE REAR COCKPIT MAY BE RESTRICTED DUE TO INTERFERENCE FROM AFT COCKPIT CONTROL STICK.

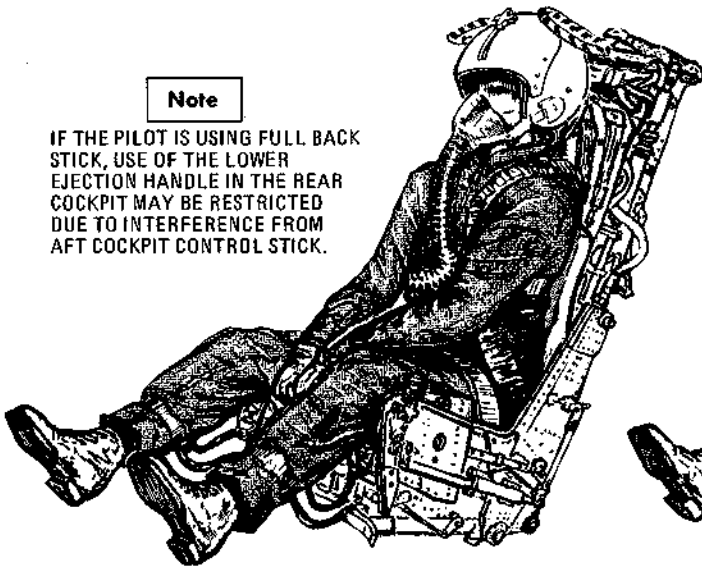

GRASP THE LOWER EJECTION HANDLE USING A TWO HANDED GRIP WITH THE THUMB AND AT LEAST TWO FINGERS OF EACH HAND. PULL STRAIGHT UP ON LOWER HANDLE AND MAINTAIN A CONTINUED PULL. WHEN CANOPY JETTISONS, CONTINUE PULLING UP ON LOWER EJECTION HANDLE UNTIL FULL TRAVEL IS REACHED.

**WARNING**

FAILING TO PULL THE LOWER EJECTION HANDLE STRAIGHT UP CAUSES BINDING WHICH CAN PREVENT THE LOWER EJECTION HANDLE FROM WITHDRAWING FROM ITS LOCKING DETENT.

#### FACE CURTAIN METHOD



REACH OVERHEAD WITH PALMS AFT KEEPING ELBOWS SHOULDER WIDTH APART. GRASP FACE CURTAIN HANDLE. PULL FORWARD AND DOWN AND MAINTAIN A CONTINUED PULL. WHEN CANOPY JETTISONS, CONTINUE PULLING FACE CURTAIN UNTIL FULL TRAVEL IS REACHED.

**WARNING**

ONCE FACE CURTAIN HAS BEEN UTILIZED, DO NOT RELEASE HANDLE. IF THE HANDLE IS RELEASED IT MAY BECOME ENTANGLED IN THE SEAT DROGUE CRUTE DURING THE EJECTION SEQUENCE.

**WARNING**

MINIMUM ALTITUDES ARE DEPENDENT UPON DIVE ANGLE, AIRSPEED, AND BANK ANGLE. RECOMMENDED MINIMUMS ARE 10,000 FEET (AGL) IF OUT OF CONTROL, AND 2,000 FEET (AGL) IN CONTROLLED FLIGHT.

Figure 3-3 (Sheet 1 of 4)

# CANOPY AND EJECTION SEAT FAILURES

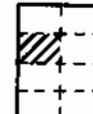

## CANOPY FAILS TO SEPARATE

If canopy fails to separate—

1. Continue holding ejection handle without applying tension and keep elbows in toward aircraft centerline.
2. Normal canopy control handle — OPEN
3. Manual canopy unlock handle — PULL  
With the normal canopy control handle in CLOSED and an operational normal system, it is impossible to unlock the canopy with the manual unlock handle.

OPEN CANOPY CLOSE  
DO NOT OPERATE ABOVE 50 KNOTS

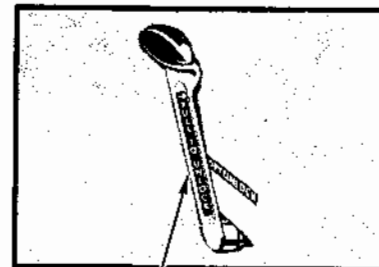

MANUAL  
CANOPY  
UNLOCK  
HANDLE

If canopy still fails to separate—

4. Emergency canopy release handle — PULL

If canopy still fails to separate—

5. Put negative G's on aircraft and firmly bump forward edge of canopy with heel of hand.

### Note

As last resort use canopy breaker knife and follow procedures for ejection seat failure



EMERGENCY  
CANOPY  
RELEASE  
HANDLE

When canopy separates —

6. Pull ejection seat handle

## EJECTION SEAT FAILURE

After canopy separation, if seat fails to fire —

1. Ejection handles — PULL

If seat still fails to fire —

2. Perform manual bailout

## MANUAL BAILOUT

1. Canopy — JETTISON
2. Maintain 200–250 knots (if possible)
3. Outside handle (emergency harness release) — LOCK UP
4. Full nose down trim, full rudder trim and opposite aileron trim as required to hold wings level
5. Stick — RELEASE
6. Parachute — DEPLOY (below 10,000 feet)
7. Inside handle (survival kit) — PULL (as applicable)

**AFTER EJECTION SEQUENCE**

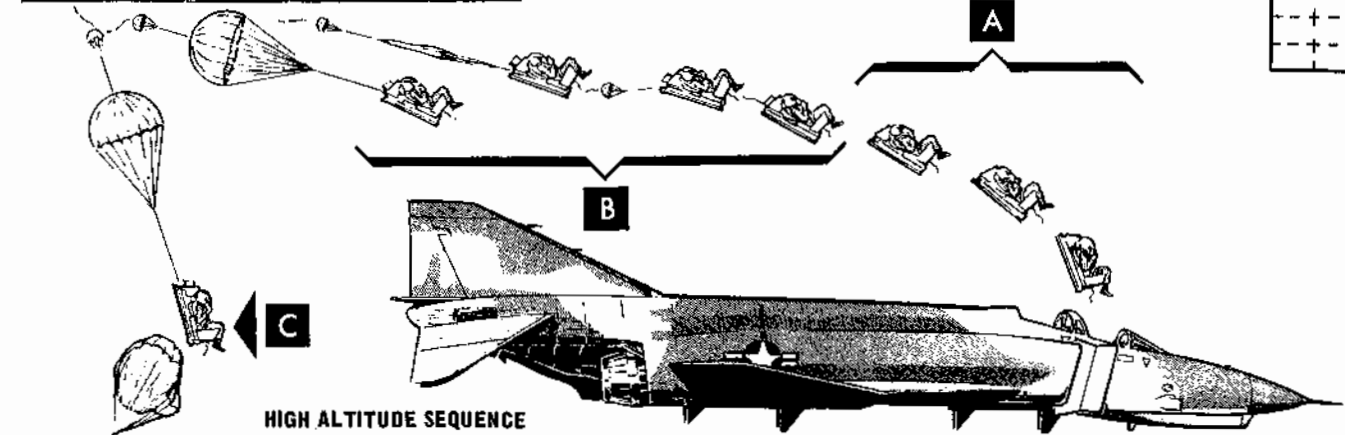

**HIGH ALTITUDE SEQUENCE**

PULL EITHER EJECTION HANDLE TO INITIATE THE EJECTION SEQUENCE. CANOPY JETTISONS PULLING THE CANOPY INTER-LOCK BLOCK, INERTIA REEL RETRACTS AND LOCKS, SEQUENCE SYSTEM FIRES EJECTION GUN. A CONTINUED PULL ON HANDLE DURING A SEQUENCED EJECTION IS DESIRED TO PROVIDE POSITIVE FIRING IN SHORTEST POSSIBLE TIME AND TO PROVIDE AN IMMEDIATE FIRING OF SEAT IN CASE OF AUTOMATIC SYSTEM MALFUNCTION.

- A** SEAT IS PROPELLED UP GUIDE RAIL. LEGS ARE RESTRAINED, EMERGENCY OXYGEN IS ACTUATED, TIME RELEASE MECHANISM AND DROGUE GUN ARE TRIPPED, EMERGENCY IFF IS ACTUATED, AND THE ROCKET PACK FIRES.
- B** DROGUE GUN FIRES .75 SECOND AFTER EJECTION, DEPLOYS CONTROLLER DROGUE, WHICH IN TURN, DEPLOYS STABILIZER DROGUE. SEAT IS STABILIZED AND DECELERATED BY DROGUE CHUTES.
- C** SEAT AND OCCUPANT DESCEND THRU UPPER ATMOSPHERE WHEN AN ALTITUDE OF APPROXIMATELY 11,500 FT. IS REACHED. THE BAROSTAT RELEASES THE ESCAPEMENT MECHANISM, WHICH IN TURN, ACTUATES TO RELEASE THE OCCUPANT'S HARNESING, LEG RESTRAINT LINES AND CHUTE RESTRAINT STRAPS. THE DROGUE CHUTES PULL THE PARACHUTE WITHDRAWAL LINE TO DEPLOY THE PERSONNEL PARACHUTE.

**11,500 + 3000-0 FEET IF NECESSARY PROCEED WITH MANUAL SEPARATION**

- D** OCCUPANT IS HELD TO SEAT BY STICKER CLIPS UNTIL OPENING SHOCK OF PARACHUTE SNAPS SEAT FROM HIM. PERSONNEL LOCATOR BEACON (PLB) IS ACTIVATED AT MAN/SEAT SEPARATION IF AUTOMATIC IS SELECTED. THE SURVIVAL KIT, IF IN THE AUTOMATIC MODE, OPENS IN 4 SECONDS.

**LOW ALTITUDE SEQUENCE**

- E** SAME AS CORRESPONDING STEPS **A-B** IN HIGH ALTITUDE SEQUENCE EXCEPT:
- F** APPROXIMATELY 2.4 SECONDS AFTER IT IS TRIPPED THE TIME RELEASE MECHANISM ACTUATES TO RELEASE THE OCCUPANT'S HARNESING, LEG RESTRAINT LINES AND CHUTE RESTRAINT STRAPS. THE DROGUE CHUTES PULL THE PARACHUTE WITHDRAWAL LINE TO DEPLOY THE PERSONNEL PARACHUTE. PERSONNEL LOCATOR BEACON (PLB) IS ACTIVATED AT MAN/SEAT SEPARATION IF AUTOMATIC IS SELECTED. THE SURVIVAL KIT, IF IN THE AUTOMATIC MODE, OPENS IN 4 SECONDS. TOTAL TIME FROM EJECTION INITIATION TO FULL PARACHUTE FOR THE BACK SEAT VARIES FROM APPROXIMATELY 3.5 SECONDS AT HIGH SPEED TO 6.5 SECONDS AT LOW SPEED. THE FRONT SEAT REQUIRES AN ADDITIONAL 1.4 SECONDS OVER THE BACK SEAT TIME.

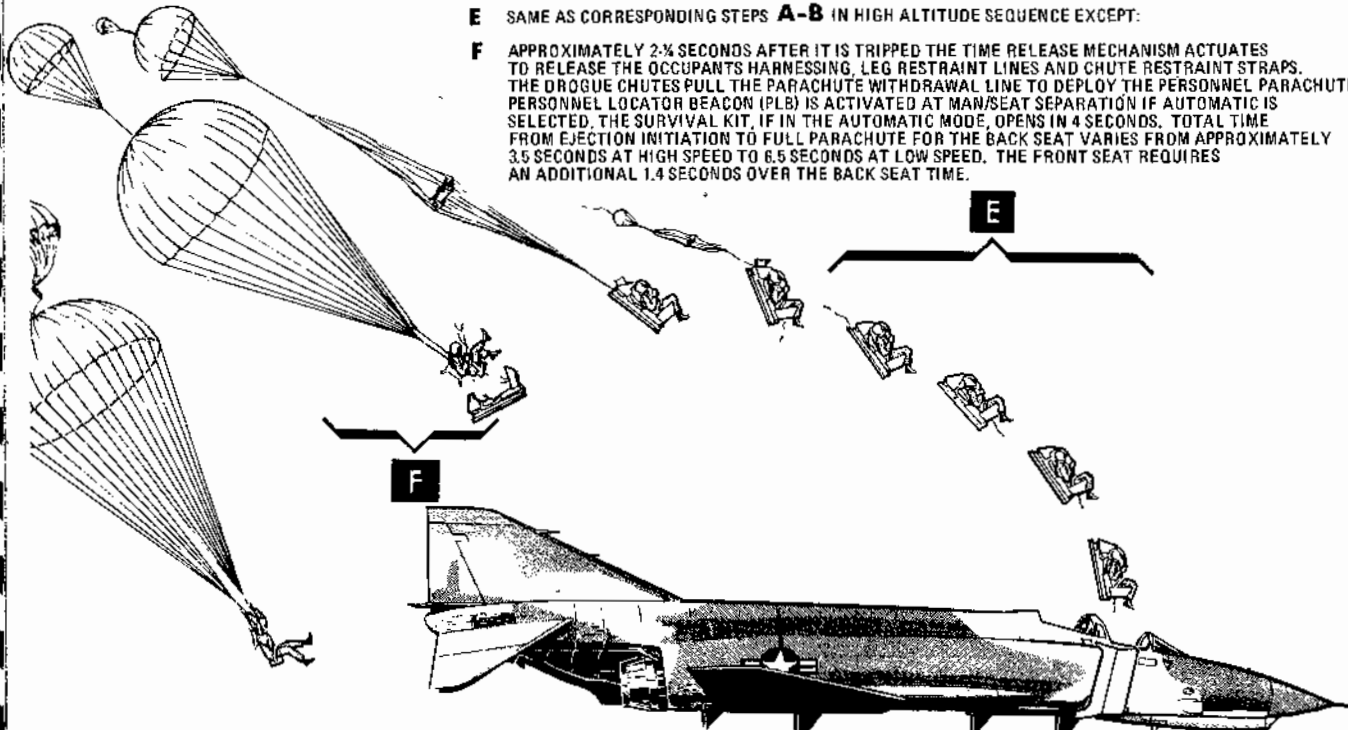

Figure 3-3 (Sheet 3 of 4)

## PARACHUTE DESCENT AND SURVIVAL EQUIPMENT DEPLOYMENT

### PRIOR TO MAN/SEAT SEPARATION

1. Emergency oxygen knob (green apple) – PULL (if necessary)

If for some reason the oxygen fails to trip automatically, pull the emergency oxygen knob on left side of seat.

#### WARNING

Do not pull inside handle before man/seat separation since this causes the kit to be lost.

### AUTOMATIC MAN/SEAT SEPARATION FAILURE

If time release mechanism fails to operate automatically, manually separate from the seat as follows –

1. Grasp ripcord handle housing with left hand.  
Firmly grasp left parachute riser with left hand around the ripcord handle housing before actuating the emergency harness release handle.
2. Outside handle (emergency harness release handle) – LOCK UP  
Actuate outside handle on right side of seat to full aft position. This will release the parachute restraint lines, lap belt, leg restraint cords, and severs the parachute withdrawal line. The occupant is now held in seat only by sticker clips.

#### CAUTION

Activation of outside handle results in loss of both parachute and survival kit automatic features. PLB activation is not affected.

3. Push free of sticker clips and clear seat.

#### Note

If all other means of separation are exhausted and crewman is still unable to push free from sticker clips due to injury, etc, lean forward with upper torso nearly resting on top both knees, and pull ripcord assembly.

4. Ripcord handle – PULL  
Having located the parachute ripcord assembly with left hand (located on left shoulder), pull ripcord handle sharply with the right hand. When possible, re-stow ripcord handle.

### AFTER MAN/SEAT SEPARATION DURING PARACHUTE DESCENT

1. Check parachute canopy and suspension lines.

#### Note

The fourline jettison system will not be used if any parachute suspension line is cut. The pulldown vent lines (PDVL) should not be confused with cut suspension lines.

2. Raise helmet visor and unmask.  
After the parachute has opened (about 11,500 ft) open face visor/mask to prevent suffocation when emergency oxygen supply is disconnected.
3. Personnel locator beacon (PLB) – ACTIVATE (if required)  
PLB must be activated before survival kit is opened.
4. Inside handle (survival kit release handle) – ACTUATE (if required)  
If survival kit has not automatically deployed, actuate inside handle, if required. Continue pull on handle until it completely releases from the kit. Pulling the kit handle opens the survival kit. Life raft inflation is initiated by gravity when the drop line is fully extended after kit opening. If landing terrain so dictates, do not deploy the survival kit.
5. Actuate underarm life preserver, if applicable.

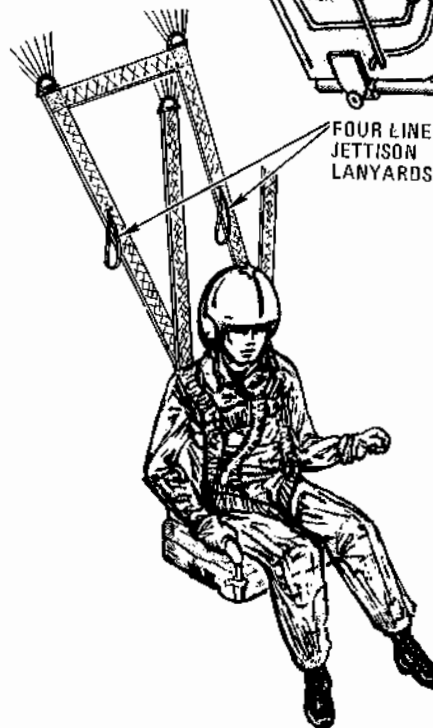
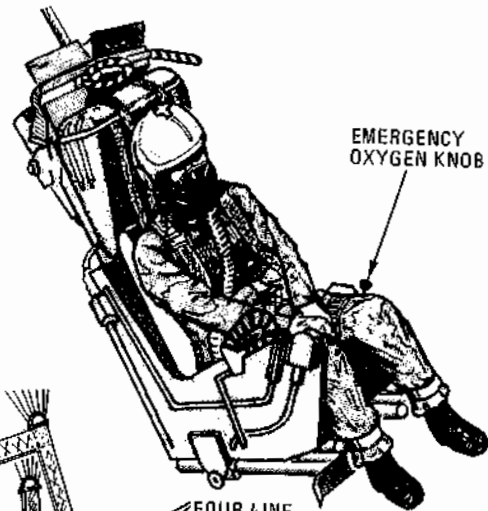

6. Four line jettison system – DEPLOY (if permissible)  
If canopy is visible, accomplish fourline jettison by pulling on both fourline jettison lanyards, after assuring canopy and suspension lines are intact. To steer parachute, pull down on the right fourline jettison lanyard for a right turn and pull the left fourline jettison lanyard for a left turn. Refer to personnel parachute under ejection seat, Section I.
7. Turn into wind and assume appropriate parachute landing fall (PLF) position.  
If fourline jettison system cannot be used, steer with the parachute risers, pulling down on the right rear riser for a right turn and pulling down on the left rear riser for a left turn.

#### WARNING

- Do not attempt parachute corrections below 200 feet.
- After landing, to insure the collapsing of the parachute canopy, it is necessary to release both parachute riser-shoulder harness release fittings.

4E-1-(75-4)E

Figure 3-3 (Sheet 4 of 4)

clothing, and personnel equipment; excluding his parachute and seat pan survival kit. Due to the aerodynamic instability of the seats at higher airspeeds, a minimum ejection altitude of 50 feet should be observed at airspeeds greater than 550 knots. Although the H-7 seat is qualified to 600 knots, a human factors study and analysis reveals that ejections between 450 and 600 knots exposes the crewmember to hazardous windblast forces which can result in possible serious injury. It is therefore recommended that ejection be initiated at or below 450 knots, circumstances permitting. Under level flight conditions, eject at least 2000 feet above the terrain whenever possible. Under out-of-control conditions, eject at least 10,000 feet above the terrain whenever possible.

### WARNING

- Do not delay ejection below 2000 feet above the terrain in futile attempts to start the engine, or for other reasons that may commit you to an unsafe ejection or a dangerous flame-out landing. Accident statistics emphatically show a progressive decrease in successful ejections as altitudes decrease below 2000 feet above the terrain.
- The emergency harness release handle shall not be pulled prior to ejection, regardless of altitude, because of several serious disadvantages:

During uncontrolled flight negative G forces may prevent proper body positioning for ejection

Extreme hazard to survival in the event altitude becomes too low for ejection and a forced landing is required.

Ejection will result in premature seat separation and severe shock loads will be imposed on the body.

Cancellation of the automatic features of the ejection seat and parachute actuator, which precludes parachute deployment if the crewmember is unconscious.

If the harness release handle is pulled during flight and escape from the aircraft then becomes necessary, perform a Manual Bailout as outlined in figure 3-3.

### SEAT EJECTION PROCEDURES

Basic ejection seat escape procedures and associated separation sequences are shown in figure 3-3. The following ejection procedures should be utilized by all crewmembers:

- a. Time and circumstances permitting, the pilot will make the decision to eject.
- b. Time and circumstances permitting, the pilot will alert the WSO to prepare for ejection and then direct individual ejections or initiate ejection for both crewmembers, as briefed. The following sequence will be

used to alert the WSO for ejection:

Primary - Intercom

First Alternate - Eject light

Second Alternate - Rapid movement of stick from side to side to gain crewmembers attention, then -

daylight: Signal with left fist, thumb up, over left shoulder

night: Signal with vertical wave of flashlight over left shoulder.

c. WSO initiated ejection of the pilot shall be limited to emergency/combat situations when so directed by the pilot or when the pilot is incapacitated. The pilot shall consider the experience level of the WSO, the degree of training/proficiency, and meticulously brief on ejection signals (ICS and visual) and the exact circumstances under which the WSO will eject the crew.

d. The above procedures in no way preclude either occupant from initiating ejection at any time he determines that circumstances warrant such action.

### WARNING

- If the dual ejection sequence is initiated from either cockpit without first alerting the other crewmember, incapacitation from improper body position on ejection could result.
- If fire/smoke is the major cause factor for ejection, a dual sequenced ejection should be used. An individual ejection by the rear seat occupant could result in incapacitation of the pilot from intense heat and fire caused by windblast and draft effects of a jettisoned canopy.
- Should the front canopy be lost, the front canopy interlock cable and interdicator link safety pin assembly with its ejection sequence time delay will also be lost. If ejection is then initiated from the front seat, this could expose the rear crewmember to the front seats rocket blast and a collision between seats could possibly result. Should loss of the front canopy or both canopies occur, the rear crewmember should rotate the command selector valve handle to the horizontal (open) position and initiate ejection for both crewmembers. With loss of the rear canopy only, normal ejection can be initiated from either cockpit. If the rear ejection system fails for any reason, the front ejection sequence will still occur in normal time frame. The rear crewmember must then initiate corrective action.

### LOW ALTITUDE EJECTION

During any low altitude ejection, the chances for a successful ejection can be greatly increased by zooming the aircraft (if airspeed permits) to exchange airspeed for altitude and to gain an upward vector for ejection. The zoom should not exceed a 20° nose up attitude. Ejection should be accomplished while the aircraft is in a positive climb. This will result in a more nearly vertical trajectory for the seat, thus providing more altitude and time for seat

separation and parachute deployment. After ejection do not attempt to beat the automatic system in low altitude ejection or benefits of automatic seat separation/parachute deployment will be lost. Fastest parachute deployment occurs at approximately 250 knots. At speeds below 130 knots, airflow is not sufficient to effect rapid chute deployment. After ejection, manual separation from the seat should only be made if the seat fails to function automatically (approximately 2 seconds required). If manual seat separation is performed, the automatic feature of the parachute is lost. If a decision is made to manually separate:

- a. Grasp ripcord handle housing with left hand. Firmly grasp left parachute riser with left hand around the ripcord handle housing before actuating the emergency harness release handle.
- b. Emergency harness release handle - LOCK UP.
- c. Push free of sticker clips and clear of the seat.
- d. Pull parachute ripcord handle.

### WARNING

The minimum ejection altitudes quoted in figure 3-4 are provided to show seat capability (with and without reaction time) as affected by the aircraft sink rate. Figure 3-5 shows the minimum ejection altitude for a given airspeed and dive angle. These figures do not provide any safety factor for such matters as equipment malfunction delays in separating from the seat, etc. The above minimum ejection altitudes shall not be used as the basis for delaying ejection when above 2000 feet, since accident statistics emphatically show a progressive decrease in successful ejections as altitudes decrease below 2000 feet.

## HIGH ALTITUDE EJECTION

For a high altitude ejection the basic ejection procedures (figure 3-3) are applicable. The zoom maneuver is still useful to slow the aircraft to a safer ejection speed, or to provide more time and glide distance as long as an immediate ejection is not necessary. After high altitude ejections, considerable time will elapse during drogue chute descent before automatic chute deployment. Refer to figure 3-6. No attempt should be made to manually separate from the seat except when terrain altitude exceeds the preset barostat altitude or there is a definite failure of the automatic sequence. Manual separation requires considerably more time and altitude before chute deployment than automatic operation.

## EJECTION SEAT FAILURE

In the event the canopy jettisons, but the seat does not fire, pull face curtain or lower ejection handle again. If the first handle tried does not work, attempt pulling the other ejection handle. Care should be taken not to release the face curtain handle once it is pulled. Refer to figure 3-3 for ejection seat failure procedures.

## TIME RELEASE MECHANISM FAILURE (ACTIVATION) INFLIGHT

Isolated instances have occurred in which the timer mechanism has failed (actuated) in flight. In this situation, the crewmember is not restrained in the seat since the lap belt, leg restraints, and parachute restraints are released and cannot be reset in flight. If ejection is attempted personal parachute deployment will occur approximately 1 second after ejection because the scissors also opens upon timer mechanism failure (activation). If the emergency harness release handle is pulled prior to ejection in this situation then the automatic features of the parachute are removed and the chute would have to be manually deployed. In either case, ejection when not restrained in the seat would be extremely hazardous and should be attempted only as a last resort. In the event of timer failure (actuation) in flight and escape from the aircraft then becomes necessary, the recommended procedure is to pull the emergency harness release handle, which fires the guillotine assembly, allowing the crewmember to separate from the seat, open the canopy with either normal or emergency jettison procedures, and then escape from the aircraft by using the procedures (without pulling an ejection handle) outlined in Manual Bailout, figure 3-3.

### WARNING

Escape from the aircraft will be impossible until the emergency harness release handle is pulled because the drogue projectile restraining pin cannot be manually sheared thus the crewmember is still linked to the seat.

## SURVIVAL KIT DEPLOYMENT

The survival kit functions under two conditions, ejection and emergency evacuation. During ejection as the seat leaves the aircraft, the emergency oxygen is automatically tripped, and is supplied to the occupant as the occupant and seat are descending. If emergency oxygen was not tripped automatically upon ejection, an emergency oxygen knob on the left forward side of the seat can be pulled to provide emergency oxygen for descent from altitude. The emergency oxygen provides a 10 minute supply of breathing oxygen while the crewmember is in the seat. Once man/seat separation occurs, the emergency oxygen bottle remains with the seat and there is no oxygen available to the crewmember. At approximately 11,500 - 0 + 3000 feet the ejection seat time release mechanism deploys the personal parachute, the occupant and survival kit are snapped from the seat. At this time the survival kit release handle should be actuated to release the kit and inflate the raft. If the survival kit selector switch is in the automatic (up) position when man/seat separation occurs, the kit deploys approximately 4 seconds later. Whenever the emergency harness release handle is pulled, the automatic feature of the survival kit is lost and manual opening procedures must be used. With the selector switch in the manual (down) position, the kit is deployed by pulling the survival kit release handle. The handle should be pulled with one continuous motion. The handle separates from the kit when the kit lid is unlatched. After kit opening, the upper kit container falls free, the life raft

# EJECTION ALTITUDE VS. SINK RATE

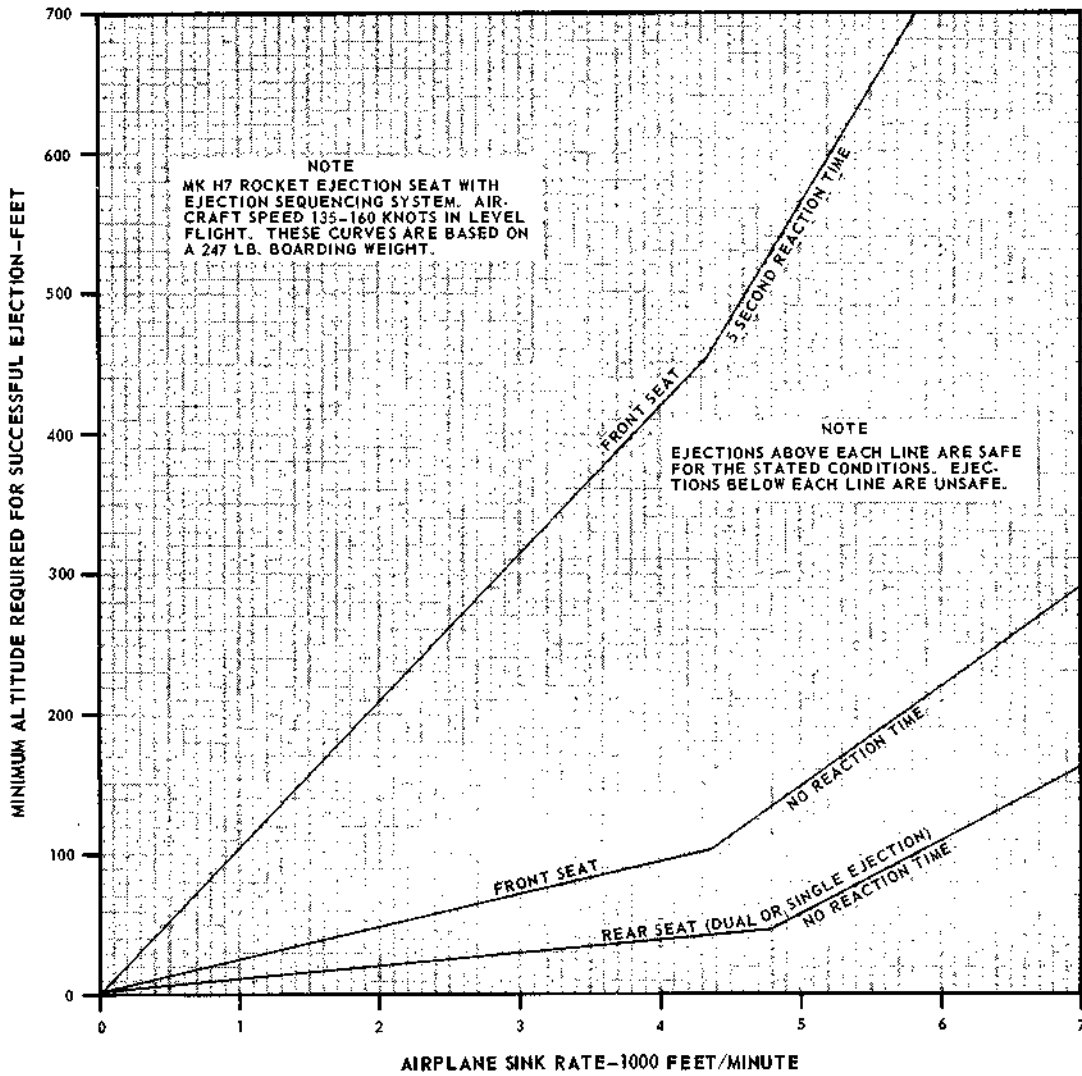
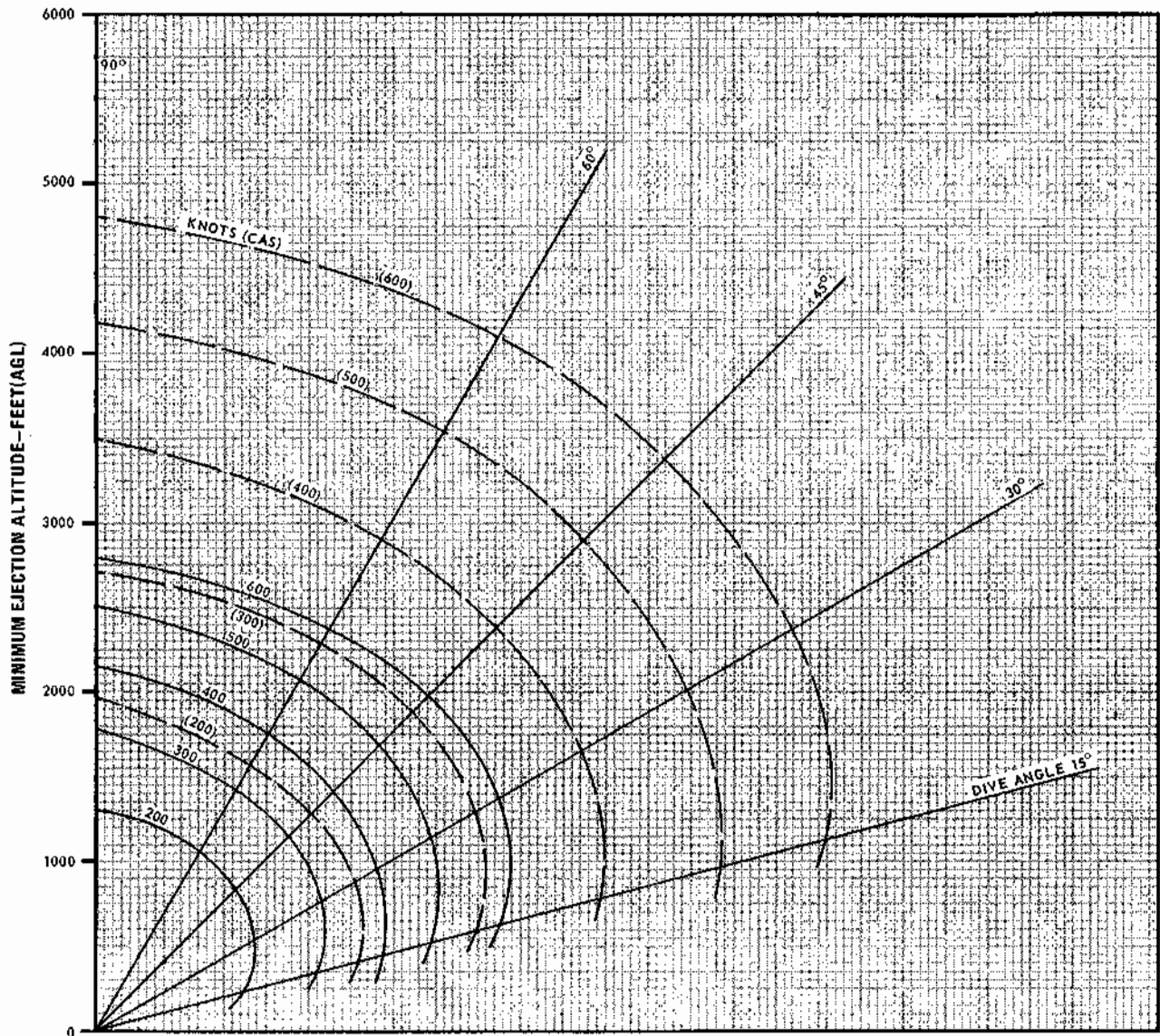

Figure 3-4



# MINIMUM EJECTION ALTITUDE vs. AIRSPEED AND DIVE ANGLE



### Note

These curves are based on a 247 lb. boarding weight. The solid curves indicate minimum terrain clearance with no crew member reaction time. The dashed curves indicate minimum terrain clearance with a two (2) second crew member reaction time. The curves are based on wings level bank attitude and appropriate angle of attack. Time required for the sequencing system to eject both canopies and both seats is included. It is assumed that the pilot initiates the sequencing system and continues pulling either ejection handle to fire the front seat as soon as the front canopy and interlock block are clear. If the pilot does not continue pulling, or the sequence is initiated by the rear crew member, relying on the front seat mounted time delay initiator to fire the front seat, an additional 250 feet altitude is required for a 90° dive angle at 600 knots, with proportionately less additional altitude required as dive angle and speed decrease. The curves do not include a correction for barometric altimeter lag; for proper values refer to part I of applicable index.

4E-1-(29)A

Figure 3-5

# EJECTION SEAT DESCENT TIME

## STABILIZER DROGUE DEPLOYED

### NOTE

TIME OF DESCENT FROM HEIGHT  $H_0$  TO 10,000 FT.  
AND FROM 10,000 FT. TO SEA LEVEL OF EJECTION  
SEAT WITH 5 FT. DROGUE CHUTE DEPLOYED.  
TOTAL WEIGHT OF SEAT AND PILOT—450 LB.

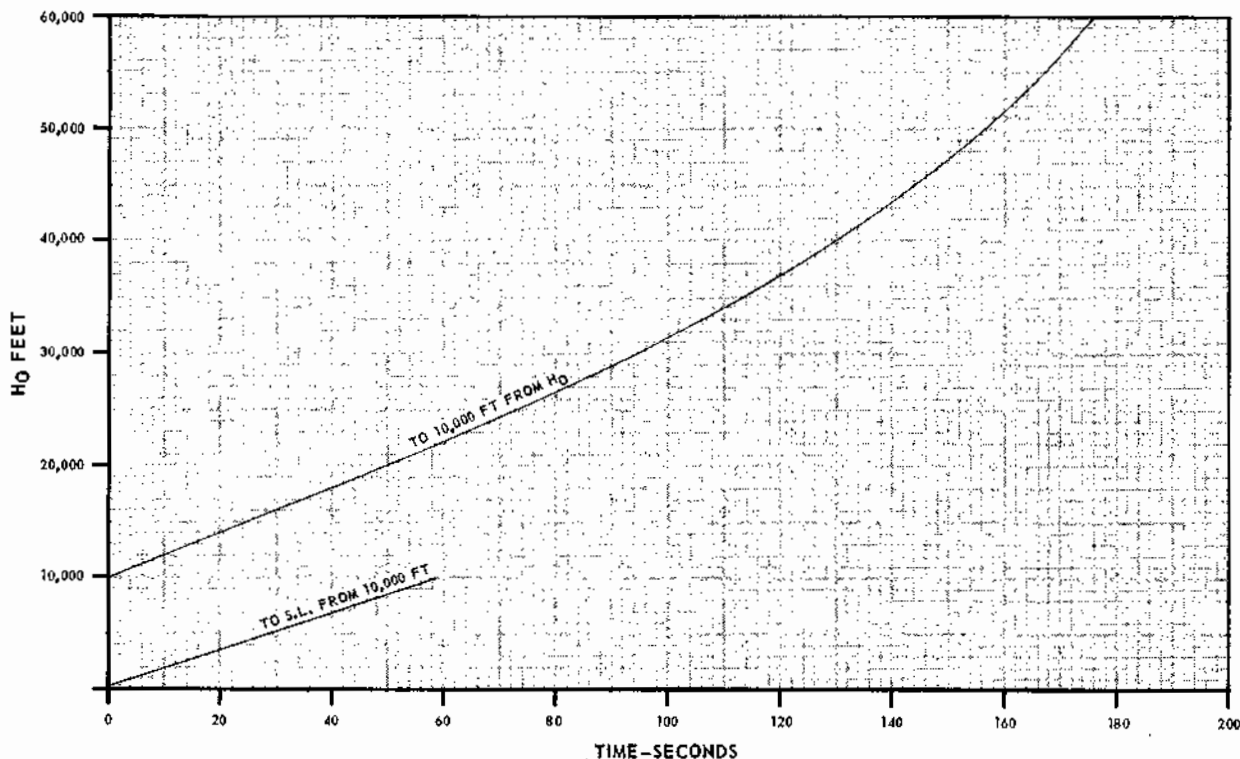

4E-1-(28)

Figure 3-6

inflates by gravity pull when the drop line attached to the raft  $CO_2$  bottle actuator reaches its limit of downward travel, and the lower kit container with the emergency provisions drops below the life raft. The drop line, which retains the raft and lower kit, remains attached to the crewmember's harness by the left retaining strap.

### WARNING

- During ejection, do not pull the survival kit release handle while sitting in the seat. The kit drop line from the crewmember will be detached, and the kit will be lost when the personnel chute opens.
- If the survival kit handle is pulled after landing in water, the kit cover must be pulled from the lower portion of the kit and a snatch pull on the

drop line is required to inflate the life raft.

### Personnel Locator Beacon (PLB) Operation

Operation of the beacon is dependent on the position of the PLB inflight mode selector switch on the inside of the left thigh support of the survival kit. With the switch in the red dot or A position, the beacon is activated at man/seat separation (when PLB actuator plunger extends). With the switch in the green dot or M position, the beacon will not activate although the actuator plunger is extended. When possible, the proper switch position should be selected prior to ejection or egress, depending on whether over friendly, neutral or unfriendly territory. If ejection is accomplished with the PLB inflight mode selector switch in the green dot position, the beacon can be activated during the parachute descent by placing the switch to the red dot position, provided the survival kit has not been deployed. Once on the ground the beacon can be turned off (or on) by placing the PLB inflight mode selector switch to

the appropriate position (OFF-MANUAL/GREEN DOT SHOWING; ON-AUTOMATIC/RED DOT SHOWING). The beacon may be removed from the survival kit for ground operation. If the timed mode of operation has been used, a red fuse post plunger will be extended into the hole on the side of the survival kit. This plunger must be depressed before the PLB can be extracted from the kit. The beacon has two antennas, a flexible type and a telescopic type. If the beacon is removed from the kit for ground operation, the flexible antenna must be removed from the beacon and the telescopic antenna extended. Retaining the flexible antenna reduces the beacon's range. In addition, the timed battery operation feature can be turned off or on when on the ground. With the battery mode switch in NORMAL the beacon should transmit for approximately 15 hours. With the switch in the TIMED position, the beacon transmits for 10 ± 2 minutes and then automatically shuts off. The TIMED position can be used only once, and time expiration is indicated by the small red fuse post extending below the bottom edge of the beacon. After timed battery operation is expired, the switch can be placed to NORMAL and the beacon will resume operation. A complete set of operating instructions for the PLB is contained on the beacon case.

## ELECTRICAL FIRE

Circuit breakers and fuses protect most circuits and tend to automatically isolate an electrical fire. If an electrical fire occurs:

1. Generator switches - OFF  
When both generator switches are turned off, boost pump pressure and primary attitude reference systems will be lost. Front cockpit emergency attitude indicator power is supplied from the battery.
2. Stab aug switches - OFF
3. All electrical switches - OFF
4. Generator switches - ON
5. Essential electrical equipment - ON
6. Stab aug switches - ENGAGE

If fire persists -

7. Generator switches - OFF
8. Land as soon as possible.

## SMOKE AND FUMES

### WARNING

Smoke and fumes in the cockpit may be the first indication of a serious fire. Be alert for a rapid deterioration in the situation and catastrophic failure of aircraft systems. Maintain safe ejection altitude until the situation is under control.

To eliminate smoke and fumes from cockpit -

1. Oxygen - 100%
2. (WSO) Battery bypass switch - ON (some aircraft)  
This disconnects the battery from the essential 28 volt dc bus and its source of charging current to stop thermal runaway. If both generators fail, the battery will power only engine ignition, white flood light, and eject light.
3. Emergency vent knob - PULL
4. Descend to below 25,000 feet as soon as practical

If smoke or fumes persists -

5. Command selector valve - OPEN
6. Aft canopy - JETTISON  
The aft canopy is jettisoned so that, if ejection becomes necessary, proper ejection sequencing will occur. If the front canopy were to be jettisoned and ejection was initiated from the front cockpit, both seats would eject simultaneously subjecting the WSO to rocket blast and probably resulting in seat collision.

### WARNING

Be prepared for immediate ejection when the canopy is jettisoned. The wind blast and draft after the canopy is jettisoned may cause fumes or smouldering material to ignite with catastrophic and incapacitating effect.

## EXTREME COCKPIT TEMPERATURES

### WARNING

Extreme cockpit temperatures due to equipment malfunction may result in aircrew disablement and permanent injury. If the cockpit temperature becomes extreme, abort the mission and land as soon as practical.

If the cockpit air conditioning system malfunctions with a resulting extreme hot or cold cockpit temperature, check suit vent air lever off and proceed as follows: (Perform only those steps necessary to control temperature for safe recovery).

1. Temperature control switch - MANUAL  
Temperature adjustment may be obtained by bumping the temperature control switch to the hot or cold position.
2. Temperature control switch - AUTO  
When the cockpit temperature becomes extreme and cannot be controlled with manual temperature controls, placing the temperature control switch to auto will allow temperature range schedule to be selected by positioning the defog foot heat control lever forward for high and

aft for low.

3. Defog foot heat control lever - FORWARD OR AFT
4. Cockpit air conditioning inlets - OPEN  
Placing the defog foot heat lever forward and checking the eyeball type nozzles in the rear seat open will give maximum dispersion of the extreme temperatures and prevent a concentration being deflected toward confined body areas.
5. Cockpit heat and vent circuit breaker - PULL (C8, No. 3 panel)
6. Emergency vent knob - PULL

#### NOTE

When necessary to depressurize the cockpit, descend to below 25,000 feet if possible.

7. Command selector valve - OPEN
8. Aft Canopy - JETTISON

## EQUIPMENT COOLING TURBINE FAILURE

A malfunction of the equipment cooling turbine is evidenced by a high pitched whine and/or vibration forward and outboard of the pilot's left foot. Delay in shutting down this turbine could lead to disintegration and probable injury to the pilot. The turbine may be shut down by the steps listed below. This procedure shuts off equipment air conditioning and turns on emergency ram air cooling but does not affect fuel tank pressurization and transfer, anti-G suits, etc.

1. Equipment cooling circuit breakers - PULL (A6,B6, No. 3 panel)

### If undue delay is involved in locating the proper circuit breaker -

2. Generators - OFF  
Turn off both generators to shut down the cooling turbine.

### After circuit breakers are located and pulled -

3. Stab aug switches - OFF
4. Generators - GEN ON
5. Stab aug switches - ON

## OIL SYSTEM FAILURE

An oil system failure is recognized by a drop in oil pressure, a complete loss of pressure, or excessive oil pressure. In general, it is advisable to shut the engine down as early as possible after a loss of oil pressure is indicated, to prevent damage to the engine. The engine operates satisfactorily at military thrust for a period of 1 minute with an interrupted oil supply. The engine may operate for 4 to 5 minutes at 80 to 90% before a complete failure occurs. However, continuous operation, at any engine speed, with the oil supply interrupted will result in

bearing failure and eventual engine seizure. The rate at which a bearing will fail, measured from the moment the oil supply is interrupted, cannot be accurately predicted. Malfunctions of the oil system are indicated by a change from normal operating pressure, sometimes followed by vibrations. Vibrations may increase progressively until complete bearing failure occurs. Engine seizure is imminent. Oil pressure above 110 psi can cause failure of the carbon seals. The throttle should be reduced to maintain oil pressure below 100 psi or the engine shut down if necessary and practical.

#### NOTE

Variable area exhaust nozzle failure or generator failure are possible indications of an impending oil system failure.

### If a minimum oil pressure of 30 psi at Mil thrust cannot be maintained -

1. Throttle - IDLE
2. Land as soon as practical

### If a minimum of 12 psi at IDLE cannot be maintained and shutdown feasible -

3. Generator switch - OFF  
Turn the generator OFF before placing the throttle OFF to prevent the bus tie from opening when an underspeed occurs as rpm decreases.
4. Throttle - OFF
5. Engine master switch - OFF

#### NOTE

If the throttle is retained in idle and asymmetric thrust in combination with other flight control problems degrades handling characteristics (e.g., single engine approach and utility failure), the throttle should be set at 80-90% rpm on final to reduce yaw and/or rolling induced by asymmetric thrust.

### Oil pressure change accompanied by vibrations and engine shutdown feasible -

1. Generator switch - OFF  
Turn the generator OFF before placing the throttle OFF to prevent the bus tie from opening when an underspeed occurs as rpm decreases.
2. Throttle - OFF  
Retard the throttle to OFF to prevent major engine damage, and possible airplane damage.
3. Engine master switch - OFF

### If engine shutdown is not feasible -

1. Throttle - 80% - 90% rpm
2. Avoid abrupt maneuvers causing high G forces.
3. Avoid unnecessary throttle changes.

## FUEL BOOST PUMPS INOPERATIVE

Provision is made to supply fuel to the affected engine by gravity flow if a boost pump failure occurs. This provision will allow engine operation at all power settings up to military power below approximately 20,000 feet. Afterburner operation is not recommended. Above 20,000 feet and/or high power settings, flameout or an unstable rpm indication on the affected engine may occur. The possibility of simultaneous mechanical failure of both boost pumps is highly remote. However, a failure may occur as a result of electrical malfunction.

### If one boost pump fails -

1. Afterburner modulated or shutoff to maintain a 5 psi minimum boost pump pressure.

A 5 psi boost pump pressure will generally permit unrestricted use of the engine without afterburner at any altitude. On aircraft 68-495 and up, afterburner and normal engine operation is degraded for the engine with the failed boost pump only.

### If both boost pumps fail -

1. Adjust throttles and/or descend until a stable rpm can be maintained.  
Afterburner operation is not recommended. Unrestricted military thrust operation is available from sea level to 20,000 feet.

## AIR REFUELING OF FUSELAGE TANKS ONLY

If the internal wing tanks become damaged and can not hold fuel, emergency refueling of the fuselage tanks can only be accomplished as follows:

1. External transfer switch - OFF
2. Refuel selection switch - INT ONLY
3. Fuel valve power circuit breaker - PULL(H1, No. 2 panel).
4. Air refuel switch - EXTEND
5. Commence refueling.

### NOTE

Do not attempt to refuel external tanks. Damage to internal wing tanks may prevent external wing tanks from transferring. The centerline tank cannot be refueled using the above procedure.

## FUEL TRANSFER FAILURES

### INTERNAL WING FUEL FAILS TO TRANSFER

Failure of internal wing fuel to transfer can be caused by the tanks failing to pressurize or the transfer valves failing to open.

1. External transfer switch - OFF
2. Internal wing transfer switch - NORMAL
3. Tank depressurization switch - NORM (some aircraft)
4. Air refuel switch - RETRACT (If retracted, cycle)  
To cycle the fuel pressurization system without opening the receptacle door, pull the air refuel receptacle circuit breaker (D1, No. 2 panel)
5. Internal wing fuel transfer control circuit breaker - IN(H2, No. 2 panel)

### If fuel still fails to transfer -

6. Reduce airspeed below 250 knots, lower landing gear and check for fuel transfer.

### EXTERNAL FUEL FAILS TO TRANSFER

Failure of external fuel to transfer can be caused by the tank shutoff valve failing to the closed position or the tank failing to pressurize.

1. External transfer switch - CENTER/OUTBD
2. Air refuel switch - RETRACT (If retracted, cycle)  
To cycle the fuel pressurization system without opening the receptacle door, pull the air refuel receptacle circuit breaker (D1, No. 2 panel)
3. External wing fuel transfer control circuit breaker - IN(J2, No. 2 panel)
4. Fuel valve power circuit breaker - IN (H1, No. 2 panel)

### If fuel still fails to transfer -

5. Reduce airspeed below 250 knots, lower landing gear and check for fuel transfer.

## FUSELAGE FUEL LEAK

If fuel fumes are detected, an abnormal decrease in fuel quantity is noted, or fuel is observed emitting from the fuselage, a fuselage fuel cell rupture may exist. The greatest danger is a catastrophic fire resulting from ignition of the leaking fuel. If a fire did not occur immediately, it probably will not erupt unless conditions are changed so as to provide an ignition source. The pilot must avoid the normal reaction to land immediately. Instead, he must do as little as possible to change conditions while attempting to stop the leak. All actions should be deliberate and unhurried. Any descent should be gradual to avoid excessive pitch angles, to maintain the recommended airspeed, and to avoid collapsing unpressurized external tanks. Landing should not be attempted until fuselage fuel is reduced below 2600 pounds since opening the auxiliary air doors at approach speeds will cause reverse air flow through the engine bay which may provide an ignition source.

1. Air refuel switch - EXTEND  
Placing the air refuel switch to EXTEND deactivates the automatic fuel transfer feature, depressurizes all tanks and prevents transfer of

internal wing and external tank fuel to the fuselage cells. Fuel transfer is not recommended unless required to prevent flameout due to cell 1 fuel exhaustion. Wing fuel cannot be pressure dumped with the air refuel switch in EXTEND, however, with the internal wing dump switch in DUMP, the dump valves will open and the tanks will gravity dump at a slow rate.

2. Maintain 350 knots  
This airspeed is optimum for ventilation of fuel tank and engine bay areas.
3. Follow Smoke and Fumes procedure, this section (if required).
4. Use minimum bank and pitch angles for maneuvering.  
Maintaining near straight and level flight may reduce fuel spillage.
5. Do not use afterburner
6. Reduce fuselage fuel to 2600 pounds (if practical)  
The danger of fire or explosion is reduced if all fuselage fuel is in cells 1 and 2.
7. External stores - JETTISON (if required)
8. Make straight-in approach

## SINGLE GENERATOR FAILURE

Single generator failure is indicated by illumination of the appropriate GEN OUT light. One generator (with bus tie relay closed) is sufficient to support the entire electrical load. Refer to Emergency Power Distribution chart figure 3-7 for equipment that will be lost with one or both generators inoperative. If generator failure occurs, proceed as follows:

1. Affected engine instruments - CHECK  
A GEN OUT light may be the first indication of engine failure or CSD failure due to oil starvation. Refer to Oil System failure, this section.
2. Stab aug switches - OFF IF RIGHT GENERATOR FAILED  
If failure of the right generator occurs, disengage the stab aug switches before cycling the generator. This prevents possible control surface transients. Stab aug may be re-engaged with the right generator switch OFF or after the switch is returned to ON.
3. Generator switch - CYCLE (day VMC only)  
Cycle generator switch from ON to OFF to ON.
4. Generator light - OUT  
If generator fault has been corrected, the generator will be reconnected to the system and the light will go out.

### If generator light still on -

5. Generator switch - OFF
6. Oil pressure gage - MONITOR  
CSD failure due to oil starvation may be the source of trouble and subsequent engine failure could result.
7. Land as soon as practical.
8. Slats flaps - OUT AND DOWN
9. Fly 17 units AOA on final

## DOUBLE GENERATOR FAILURE

In most cases the generators will not fail simultaneously; it is more likely that one generator will fail, followed by the failure of the other generator. The GEN OUT lights do not illuminate for a double generator failure. However, double generator failure is accompanied by illumination of the DC BUS light. With a double generator failure, boost pump pressure and primary attitude reference systems will be lost. Front cockpit emergency attitude indicator power is supplied from the battery. When power is interrupted, the SPC will disengage. The STATIC CORR OFF light may not illuminate. The CADC switch should be turned off, the telelight panel checked and, after power is restored, the CADC should be reset.

### CAUTION

With a double generator failure, rudder feel force will automatically revert from 11.5 to 2.6 pounds per degree of rudder deflection. As a result, rudder pedal force at high airspeeds becomes extremely sensitive, and excessive structural loads can be imposed on the aircraft if full rudder deflection is commanded.

1. Reference system selector - STBY
2. Unessential electrical switches - OFF
3. Stab aug switches - OFF WHILE CYCLING GENERATORS
4. Generator switches - CYCLE

### If generator(s) do not come on the line -

5. (WSO) Electrical test receptacle plug 3P325 - ENSURE PLUG SEATED FLUSH, KNURLED LOCK RING SECURE, CAP TIGHT.  
It is possible to trip both generators off the line if the electrical test receptacle plug 3P325 under the right canopy sill is loose. The plug uses a knurled (twist clockwise to lock) lock ring which should not be confused with the chain equipped threaded cap.
6. Generator switches - CYCLE

### If generator(s) are still inoperative -

7. Generator switch(es) - OFF

### NOTE

The SPC will not operate on battery power, and the STATIC CORR OFF light will not illuminate. The altimeter lag chart must be utilized because altimeter lag will increase significantly.

8. Land as soon as practical
9. If gear not down and locked - BLOW DOWN  
Refer to Landing Gear Emergency Lowering, this section. If gear was down and locked before loss of electrical power, do not blow down.

**NOTE**

- The engine variable bypass bellmouth and auxiliary air door are rendered inoperative. Refer to Auxiliary Air Door Malfunction (Gear Down) this section.
- Slats and flaps operate normally. If flaps slats are out and down and the battery fails, the slats will remain out and the flaps will retract to a low-drag trail position.

10. Make approach-end arrestment if possible.

**BUS TIE OPEN**

An illuminated BUS TIE OPEN light is an indication that the right and left generator bus systems are no longer interconnected. If the left generator is disconnected and the bus tie relay is open, the left main ac buses will be lost. If the right generator is disconnected and the bus tie relay is open, the right main ac buses are lost. Refer to Emergency Power Distribution charts to determine affected systems. During night or IMC, consideration should be given to the possible loss of additional electrical power due to cycling a generator.

**BUS TIE OPEN (BOTH GENERATORS OPERATING)**

A BUS TIE OPEN light with both generators operating should not necessitate aborting the mission if the bus tie can be closed by cycling a generator switch. In most cases the bus tie can be closed by cycling a generator. If the bus tie remains open after generator cycling, an out of phase/frequency condition exists. Therefore, it is possible to create an undesirable difference frequency oscillation which may impair performance of systems utilizing inputs derived from both generators. The irregularities may be eliminated by turning a generator off and thus supplying the same phase/frequency to all systems. The utility power dc circuit breaker must be IN before the bus tie relay can be closed. If the circuit breaker is out and will not reset, cycling and/or turning off a generator will not close the relay and in fact will cause interruption of power to the applicable buses as long as the generator switch is off. In view of the above, proceed as follows:

1. Utility power dc circuit breaker - IN (D5, No. 2 panel)

**If circuit breaker will not reset -**

2. Land as soon as practical

**If circuit breaker in or resets -**

2. Stab aug switches - OFF WHILE CYCLING RIGHT GENERATOR
3. Right generator switch - CYCLE (day VMC only)

**If BUS TIE OPEN light stays on -**

4. Right generator switch - OFF
5. Land as soon as practical

**If BUS TIE OPEN light still on or comes on -**

5. Right generator switch - ON
6. Land as soon as practical

**LEFT GENERATOR OUT - BUS TIE OPEN**

1. Left engine instruments - CHECK  
A GEN OUT light may be the first indication of engine failure or CSD failure due to oil starvation. Refer to Oil System Failure, this section.
2. Left generator switch - CYCLE  
If the LH GEN OUT and BUS TIE OPEN lights stay on, the left main ac buses will be lost.

**If BUS TIE OPEN and LH GEN OUT lights stay on -**

3. Left generator switch - OFF
4. Unessential electrical equipment - OFF  
Turn off all electrical equipment not essential to flight. Refer to emergency power distribution chart.
5. Left engine oil pressure - MONITOR  
CSD failure due to oil starvation may be the source of trouble and subsequent engine failure may result.
6. Land as soon as practical
7. Slats flaps - OUT AND DOWN
8. Fly 17 units AOA on final
9. Make an approach-end arrestment if possible

**RIGHT GENERATOR OUT - BUS TIE OPEN**

A right generator out and bus tie open will cause random flight control inputs which can be as much as 15° rudder, 11° spoiler, and ½° stabilator deflection. Actuation of the emergency quick release lever or disengagement of stab aug switches and ARI will correct this but it may take as long as 40 seconds before all surfaces return to neutral. Any momentary re-engagement will again cause another random input. The amount, rate of deflection, and rate of correction is neither predictable nor repeatable.

1. Emergency quick release lever - HOLD DEPRESSED
2. Right engine instruments - CHECK  
A GEN OUT light may be the first indication of engine failure or CSD failure due to oil starvation. Refer to Oil System Failure, this section.
3. Stab aug switches - OFF WHILE CYCLING RIGHT GENERATOR  
The stab aug switches should be disengaged before cycling the generator switch to prevent possible control surface transients. Stab aug may be reengaged with the right generator switch OFF or after the switch is returned to ON.
4. ARI circuit breaker (front cockpit) - PULL  
With the ARI circuit breaker pulled, the anti-skid system is inoperative.
5. Emergency quick release lever - RELEASE

# EMERGENCY POWER DISTRIBUTION

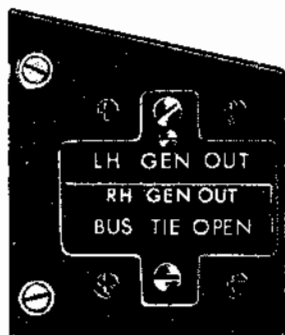

## INOPERATIVE EQUIPMENT

### LH Gen Out-Bus Tie Open

#### CRITICAL ITEMS

ANTI-ICE  
ANTI-SKID  
AFTERBURNER IGNITION (RIGHT & LEFT)  
INS HEATER  
LANDING LT  
NOSE WHEEL STEERING

#### NON-CRITICAL ITEMS

AN/ARW-77  
ANTI-COLLISION LT (ONE FILAMENT)  
22 APX 81A/A IFF  
5 CORDS HTR  
25 CORDS PWR  
9 DSCG  
ECM PODS (STA 2, 4, & 5)  
EQPT COOLING  
FUSLG LTS  
FRONT CKPT CONSOLE LTS  
FRONT CKPT RED INSTR FLOODS (DIM)  
L COSS  
LH 28V TRANSFORMER  
12 LH FUEL BOOST PUMP  
LH MISSILE FIRING  
LH MISSILE POWER  
LH TRANSFORMER RECTIFIER  
8 MSDG

NO. 4 ELEC FUEL XFR PUMP  
NOSE GUN  
RADAR  
RADAR SCOPE CAMERA  
RED CONSOLE FLOODS MED  
11 RH FUEL BOOST PUMP  
RH MISSILE PWR  
SEAT ADJUST  
SHRIKE GUIDANCE  
13 TARGET DESIGNATOR  
UTILITY LT  
UTILITY PWR AC  
WING AND TAIL LT DIM  
WRCS PWR

## INOPERATIVE EQUIPMENT

### RH Gen Out-Bus Tie Open

#### CRITICAL ITEMS

AIRSPPEED PITOT HEATER  
AOA PROBE HEATER  
BELLMOUTH PITOT HTR  
CKPT HEAT & VENT  
ENGINE FIRE & OVHT DET  
FUEL QUANTITY INDICATOR  
IFF  
TACAN  
UHF RADIO (EXCEPT GUARD RECEIVER IF LH GEN IS OPERATIVE)  
23 VOR

#### NON-CRITICAL ITEMS

ADF  
AILERON FEEL TRIM  
AILERON RUDDER INTERCONNECT  
3 ALR-46 WARNING SYS  
ALTITUDE ENCODER  
ANTI COLLISION LT (ONE FILAMENT)  
6 APR-36/37  
7 APU  
24 APX 80 A/A IFF  
ARMAMENT POWER  
AUTO PILOT  
AUX RECEIVER  
CADC  
5 CORDS PWR  
ECM PODS (STA 6 & 8)  
4 FORM LTS  
FRONT CKPT INSTR LIGHTS  
GUNSIGHT CAMERA

2 IFR RCPT FLOOD LTS  
11 LH FUEL BOOST PUMP  
L ENGINE RAMP CONT  
NO. 6 ELEC FUEL XFR PUMP  
OXYGEN GAGE  
RADAR ALTIMETER  
RIGHT ENGINE RAMP CONT  
RH 28V TRANSFORMER  
1 RWR PWR  
12 RH FUEL BOOST PUMP  
RH TRANSFORMER RECTIFIER  
STAB AUG  
TAXI LT  
WINDSHIELD TEMP SENSING  
WING & TAIL LT BRT

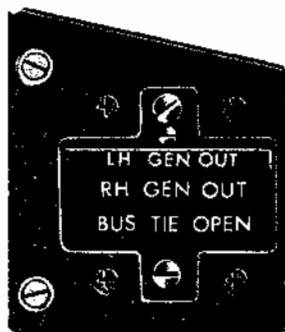

Figure 3-7 (Sheet 1 of 2)



**INOPERATIVE EQUIPMENT****Main 28 Volt DC Bus Out****CRITICAL ITEMS**

ANTI-SKID  
 CKPT HEAT & VENT  
 INTERNAL WING FUEL DUMP  
 LANDING GEAR CONTROL  
 LANDING & TAXI LTS  
 NOSE WHEEL STEERING  
 TACAN  
 TURN & SLIP INDICATOR (REAR CKPT)

**NON-CRITICAL ITEMS**

ADF  
 AILERON RUDDER INTERCONNECT  
 ALTIMETER VIBRATOR  
 6 APR-36/37  
 7 APU  
 24 APX 80 A/A IFF  
 22 APX 81 A/A IFF  
 ARRESTING HOOK (UP OPERATION)  
 AUX AIR DOORS  
 AUX RECEIVER  
 BUS TIE RELAY (BUS TIE OPEN LT ILLUMINATES)  
 CONVENTIONAL WEAPONS RELEASE & FIRE  
 17 COMBAT DOCUMENTATION CAMERAS  
 25 CORDS PWR  
 10 DSCG  
 ECM CONTROL  
 ECM PODS & DESTRUCT (STA 2, 4, 5, 6 & 8)

ENG VARIABLE BELLMOUTH  
 EQPT COOLING CONTROL  
 FUSLG, ANTI COLLISION & TAIL LTS  
 GUNSIGHT CAMERA  
 LCOSS  
 LH FUEL BOOST PUMP  
 MISSILE FIRING  
 6 MSDG  
 NAV COMPUTER  
 NO. 4 ELEC FUEL XFR PUMP  
 NO. 6 ELEC FUEL XFR PUMP  
 NOSE GUN  
 PNEUMATIC COMPRESSOR  
 RADAR  
 RAIN REMOVAL  
 RADAR SCOPE CAMERA



1 RWR PWR  
 RH FUEL BOOST PUMP  
 RMU-8/A (NORMAL OPERATION)  
 RUDDER TRIM/BELLMOUTH CONT  
 SPEED BRAKE  
 SPECIAL WEAPONS C ARM  
 STABILATOR POSITION INDICATOR  
 STATION & SELECT LTS  
 13 TARGET DESIGNATOR  
 UTILITY POWER D-C  
 VGH RECEIVER POWER D-C  
 WALLEYE INDENT POWER  
 WARNING LIGHTS DIM  
 WRCS POWER

**OPERATIVE EQUIPMENT****Battery Power Only****CRITICAL ITEMS:**

ADA INDICATOR  
 EGT INDICATORS  
 EJECTION LIGHT  
 EXTERNAL WING FUEL XFR (CONTROL)  
 FLAPS/SLATS CONTROL  
 FLAPS/SLATS POSITION INDICATOR  
 INFLIGHT REFUELING  
 INTERCOM

INTERNAL WING FUEL XFR (CONTROL)  
 LANDING GEAR POSITION INDICATOR  
 LEFT & RIGHT MAIN IGNITION  
 STABILATOR FEELTRIM  
 WHITE FLOOD LIGHT

**NON-CRITICAL ITEMS:**

ALL STORES EMER JETT  
 ADA AURAL TONE GENERATOR  
 EMER ATTITUDE IND  
 FUEL CONTROL  
 FUEL VALVE POWER  
 FRONT CKPT INSTR FLOODS BRT  
 15 KY-28

MISSILE FAIRING  
 MISSILE JETT  
 NOZZLE POSITION INDICATOR  
 OUTBOARD STATION JETT  
 RMU-8/A EMER POWER  
 SPECIAL WEAPONS C SAFE  
 SPECIAL WEAPONS UNLOCK  
 TRIM CONTROL

1 AIRCRAFT 66-368 THRU 68-538  
 2 AIRCRAFT 67-220 AND UP  
 3 AFTER TO 1F-4E-591  
 4 AFTER TO 1F-4-776  
 5 AIRCRAFT 66-284 THRU 68-409  
 6 AIRCRAFT 67-342 THRU 72-1497  
 7 AIRCRAFT 68-452 AND UP  
 8 AIRCRAFT 69-7589 THRU 73-01204  
 9 AIRCRAFT TO 1F-4E-611  
 10 AIRCRAFT 68-410 AND UP  
 11 AIRCRAFT 66-284 THRU 68-494  
 12 AIRCRAFT 63-495 AND UP

13 AFTER TO 1F-4E-588  
 14 DELETED  
 15 AFTER TO 1F-4E-532  
 16 DELETED  
 17 AIRCRAFT 69-7579 AND UP  
 18 DELETED  
 19 DELETED  
 20 DELETED  
 21 DELETED  
 22 BEFORE TO 1F-4E-587  
 23 AFTER TO 1F-4-1056  
 24 AFTER TO 1F-4E-587  
 25 BEFORE TO 1F-4E-611

Figure 3-7 (Sheet 2 of 2)

4E-1-(93-2)F

6. Right generator switch - CYCLE  
If the RH GEN OUT and BUS TIE OPEN lights stay on, the right main ac bus will be lost.

**If RH GEN OUT or BUS TIE OPEN light out -**

7. ARI circuit breaker - RESET

**If RH GEN OUT and BUS TIE OPEN lights stay on -**

7. Right generator switch - OFF
8. Right engine oil pressure - MONITOR  
CSD failure due to oil starvation may be the source of trouble and subsequent engine failure may result.
9. Land as soon as practical
10. Slats flaps - OUT AND DOWN
11. Fly 17 units AOA on final
12. Consider approach-end arrestment  
With the ARI circuit breaker pulled, anti-skid is inoperative.

## DC BUS LIGHT ILLUMINATED

Illumination of the DC BUS light indicates that the electrical tie between the essential 28 volts dc bus and main 28 volts dc bus is open. The cause could be failure of the voltage monitoring system which ties the dc buses together, loss of both generators or both transformer-rectifiers, or a dc bus fault causing a voltage depression on both buses for 2 seconds or longer. If the voltage monitoring system fails, there is no effect on electrical operation of equipment powered by the dc buses. If both generators and/or both transformer-rectifiers fail, the battery will power the essential dc bus for a period of time. When the DC BUS light illuminates, it may be due to a low voltage condition. If the condition is permanent, probably one of the dc buses will be dead or degraded. If the DC BUS light should come on, check operation of equipment powered by each bus in order to determine its condition. The main 28 volt dc bus can be checked by operating the speed brakes or checking the warning lights dimming feature. In addition, if the main 28 volt dc bus is lost, the BUS TIE OPEN light will illuminate, since bus tie relay voltage comes from this bus. Illumination of the BUS TIE OPEN light should not have any adverse effect on the remainder of the electrical system. Condition of the essential 28 volts dc bus may not be so easily determined as it will be powered by the battery until it is discharged to the point where they are disconnected. If the DC BUS light comes on, proceed as follows:

1. Equipment operated by both dc buses - CHECK
2. Stab aug switches - OFF WHILE CYCLING GENERATORS
3. Reference system selector - STBY
4. Generators - CYCLE SIMULTANEOUSLY (day VMC only)

**If DC BUS light stays on -**

5. Land as soon as practical

**If main dc bus failed -**

6. If gear not down and locked - BLOW DOWN  
Refer to Landing Gear Emergency Lowering, this section. Lower the gear as soon as practical

- since the pneumatic system compressor is inoperative with the main dc bus failed.
7. Make approach-end arrestment, if possible

## FLIGHT CONTROL MALFUNCTION

Upon initial detection of any abnormal flight control movement, immediately depress the emergency quick release lever and hold in order to determine if the stab aug or AFCS was causing the abnormality.

1. Emergency quick release lever - HOLD DEPRESSED  
It may take up to 40 seconds for the rudder to streamline after depressing the emergency quick release lever or turning the stab aug off.
2. AFCS - DO NOT ENGAGE
3. Stab aug switches - AS REQUIRED
4. Emergency quick release lever - RELEASE
5. Malfunction other than AFCS - LAND AS SOON AS PRACTICAL

### NOTE

With pitch aug disengaged or inoperative, do not exceed 300 knots below 10,000 feet, and avoid abrupt control movements.

## HARD-OVER RUDDER IN FLIGHT

1. Maintain approximately 250 knots, not to exceed 13 units angle of attack.
2. Avoid abrupt pull-up maneuvering at high angle of attack.
3. AFCS - DO NOT ENGAGE
4. Emergency quick release lever - HOLD DEPRESSED
5. ARI circuit breaker - PULL  
With the ARI circuit breaker pulled, the anti-skid system is inoperative.
6. Yaw stab aug - OFF

## COMPLETE BELLOWS FAILURE OR ICE/WATER BLOCKAGE OF BELLOWS RAM AIR INLET

The following malfunctions to the ram air bellows system will normally give corresponding indications to the pilot:

a. Overpressurized bellows: This condition results when the bellows bleed hole is plugged. Sudden blockage of the bellows bleed air orifice will induce an immediate control stick drive in the aft direction (aircraft pitch-up). Severity of the pitch-up will depend on airspeed and pilot reaction. A plugged bellows bleed air orifice, after initial drive, will produce stick forces slightly higher than normal and trim position will be slightly more nose down for any given flight condition.

b. No bellows pressure: This is caused by complete bellows failure or blockage of the ram air line. When this occurs, the aircraft will be sensitive in pitch control. There will be a nose down force on the control stick not to exceed 3 pounds per G. This force cannot be trimmed out; therefore, it is likely the pilot will apply full nose up trim attempting to trim out the stick force before detecting the malfunction.

c. Low bellows pressure: This is caused by a leak in the

bellows system. This will produce stick forces lighter than normal and trim position will be more nose up than normal for any given flight condition.

Any of these malfunctions may be intermittent depending on the source of the blockage or leak. Sudden restoration of normal bellows pressure will result in pitch transients. The magnitude of these transients will depend on flight conditions and trim setting. The severity increases in proportion to increasing airspeed and the degree of mistrim. Should a bellows malfunction occur or be suspected:

1. Reduce airspeed to minimum practical.
2. Discontinue high G maneuvering.
3. Stab trim - 0 UNITS (if required)
4. Pitot heat switch - ON
5. Avoid abrupt fore and aft stick movements.
6. AFCS - DO NOT ENGAGE

## RUNAWAY STABILATOR TRIM

If the stabilator trim appears to be running away, it is possible, under certain conditions, to alleviate it by engaging the autopilot, providing: the stabilator feel trim circuit breaker has been pulled immediately upon detection of runaway trim; runaway trim is in the nose up direction; or runaway trim has not exceeded 2½ units out of trim nose down and airspeed is reduced to 300 knots or less.

If the above conditions are met -

1. Pull stabilator feel trim circuit breaker.
2. Reduce airspeed to 300 knots or less.
3. Autopilot - ENGAGE (if desired)

### CAUTION

If the autopilot is used to alleviate excessive out-of-trim forces (for example full nose down runaway trim) the autopilot pitch parallel servo may be overpowered, thus preventing normal operation. If the pilot supplies stick force in an attempt to help the autopilot hold against the overpowering trim forces, the autopilot may alternately disengage and reengage accompanied by large transients in pitch force. If the autopilot cannot maintain flight attitude without assistance from the pilot, disengage the autopilot. Be prepared to accept large transients when disengaging the autopilot after it has been used to hold against runaway trim.

4. Land as soon as practical.

## SPEED BRAKE EMERGENCY OPERATION

Three basic failures, and their combinations, can affect the brakes. They are: switch failure, electrical failure, and utility hydraulic system failure. If utility hydraulic system fails with the speed brakes extended the speed brakes will be forced by air loads to a low drag trail position, regardless of switch positions. If an electrical failure occurs, the speed brakes automatically retract to a fully closed position. If both throttle-mounted switches fail, the speed brakes may be fully retracted by pulling the speed brake circuit breaker.

## UTILITY HYDRAULIC SYSTEM FAILURE

1. Land as soon as practical.  
Refer to Landing With Utility Hydraulic System Failure, this section.

### NOTE

- Due to the possibility of leaking check valves in the emergency air bottles, it is advisable to lower the gear as soon as possible after utility hydraulic system failure.
- If the CHECK HYD GAGES indicator light comes on and remains on, monitor the hydraulic system gages for the remainder of the flight, since warning of a second hydraulic system failure will not be given.

The following equipment is inoperative with utility hydraulic failure -

- a. Air refueling receptacle
- b. AFCS
- c. Anti-skid protection
- d. ARI
- e. Arresting hook retraction
- f. Auxiliary air doors
- g. Fuel transfer pumps (hydraulic)
- h. Nose gear steering
- i. Nose gun drive and gun gas purge door
- j. Pneumatic system air compressor
- k. Radar antenna drive
- l. Roll stab aug
- m. Rudder feel trim
- n. Variable engine bellmouth
- o. Variable engine intake duct ramps
- p. Yaw stab aug

The following equipment is affected by utility hydraulic failure -

- a. Aileron power control cylinders  
PC-1 will assume full demand of left aileron.  
PC-2 will assume full demand of right aileron.
- b. Slats flaps  
Slats and flaps are available with pneumatic operation.

If flaps are down when utility failure occurs, flaps will move to the trail position.

- c. Landing gear  
Gear extension by pneumatic system.
- d. Rudder  
Limited manual rudder available.
- e. Speed brakes  
If extended, will move to trail position.
- f. Spoiler power control cylinder  
PC-1 will assume full demand of the left spoiler.  
PC-2 will assume full demand of the right spoiler.
- g. Wheel brakes  
Emergency braking available.

## SINGLE POWER CONTROL SYSTEM FAILURE

A hydraulic pump failure of either PC-1 or PC-2 presents no immediate problem, since the utility system provides satisfactory power to the rudder and to the failed lateral control system. The remaining PC system will provide stabilator power. Before TO 1F-4-903, if PC-1 hydraulic pressure is lost or drops below 500 psi, stab aug in the pitch axis and AFCS is inoperative but the AUTO PILOT DISENGAGE and PITCH AUG OFF lights do not illuminate. After TO 1F-4-903, the stabilator auxiliary power unit, if not rejected, supplies hydraulic power to the AFCS and pitch augmentation systems. If either power control system should fail:

### NOTE

The CHK HYD GAGES indicator light remains illuminated; therefore monitor the hydraulic system indicators for the remainder of the flight, since warning of a second hydraulic system failure will not be given.

1. Anticipate utility system failure
2. Land as soon as practical.
3. Plan for straight-in, slats flaps out and down approach.
4. Gear - DOWN

### NOTE

Maintain a minimum maneuvering airspeed of 230 knots to insure adequate control in the event of utility failure during gear extension.

5. Slats flaps - OUT AND DOWN
6. Fly 17 units AOA on final.

## UTILITY HYDRAULIC AND SINGLE PC FAILURE

If a simultaneous loss of the utility system and one of the power control systems occurs, the operable aileron and spoiler will provide adequate lateral control for an emergency landing; however, handling qualities are significantly degraded. Stabilator and aileron spoiler combination of only one wing will be powered by the remaining power control system. With this combined failure the rudder is unpowered; however, some manual rudder is available and should be used to the maximum to

counter any rolling tendency. Asymmetric thrust may be used judiciously to aid lateral control. Excessive asymmetric thrust may compound the emergency. The most noticeable change will be variable response to lateral inputs depending upon which control surface (aileron or spoiler) is used for rolling or turning. The aileron will be the more effective surface; therefore, turns should be made into the operating wing (use of spoiler), thus allowing use of aileron for rollout. Lateral control response is reduced below 300 knots and continues to be degraded down to final approach airspeed. Rapid roll rates should be avoided.

1. Maintain a minimum maneuvering speed of 230 knots.
2. Jettison any asymmetric load.
3. Reduce gross weight to minimum practical (Below 37,000 lbs, if possible).  
Reduce gross weight to provide a final approach airspeed that is below the maximum engagement speed for the type approach arrestment gear available.
4. Plan straight-in, no-slats flaps approach, and approach-end arrestment, if possible.  
The emergency pattern should be flown so that minimum maneuvering is accomplished prior to final approach.
5. If gear not down and locked - BLOW DOWN  
Refer to Landing Gear Emergency Lowering, this section. If a Controllability Check is impractical lower the landing gear a minimum of 4-5 miles from the runway. If the gear was down and locked before loss of utility hydraulic system, do not blow down.
6. Make a controllability check, if possible.  
If a controllability check can be accomplished or landing gear is lowered due to earlier utility hydraulic system failure, maintain a minimum of 230 knots after the controllability check/gear lowering until on final.
7. Anti-skid - OFF
8. Fly final no slower than 17 units AOA.

### NOTE

Only emergency brakes are available during landing; nose gear steering, and anti-skid systems are inoperative.

## UTILITY HYDRAULIC AND ENGINE FAILURE (WITH OR WITHOUT SINGLE PC FAILURE)

The problems associated with landing with a combination single engine and utility hydraulic failure are severe. The effects of losing powered rudder, rudder trim, yaw and roll augmentation, and possibly roll control surfaces on one wing when flying with only one engine seriously degrade flying qualities and control of the aircraft. If the combination of weather, landing facilities, and aircrew experience is less than ideal, consideration should be given to a controlled ejection. If the decision is made to land, plan straight-in, no-slats flaps approach. The emergency pattern should be flown so that minimum maneuvering is

accomplished prior to final approach and required turns are always away from the dead engine. A steep, low power final should be planned. When assured of making the runway, power should be reduced slowly to minimize yaw/roll transients. The transition from approach to touchdown is critical. Touchdown should be planned to be in the first third of the runway. Use manual rudder and then emergency brakes for steering after touchdown. Plan to lower hook after landing to make a midfield or departure end engagement.

1. Do not make a controllability check
2. Maintain a minimum speed of 250 knots.
3. External stores - JETTISON
4. Reduce gross weight to minimum practical (below 37,000 pounds, if possible).
5. Plan straight-in, no-slat flap, steep, low-power approach.
6. If gear not down and locked - Blow gear down at a minimum of 5,000 feet AGL, if possible. Extend gear before commencing final approach. Maintain 230 knots minimum.
7. If the pilot runs out of lateral control authority - Reduce power, lower the nose, and recover or eject rather than add power.

### WARNING

- If afterburner is required at any time during the approach there may not be sufficient roll authority to compensate for the asymmetric thrust.
  - Go-around capability in afterburner may not exist if airspeed is below 230 knots because of inadequate lateral directional control. Airspeeds should not be slowed below 230 knots until the pilot is firmly committed to land. In any case, power must be added slowly and airspeed increased to insure adequate control during any attempted go around. Afterburner should not be selected below 230 knots unless absolutely essential to prevent catastrophe and the aircrew must be aware that this use could cause loss of control.
  - Any throttle movements should be made slowly to minimize rapid yaw/roll transients. Minimum practical power should be used at all times to minimize yaw and roll due to yaw. Minimum control speed in this situation is a direct function of throttle setting.
8. Anti-skid - OFF
  9. When landing is assured, gradually reduce power to touchdown no slower than the airspeed given in figure 3-8.
  10. Land or Eject

### NOTE

Only emergency brakes are available during landing; Nose gear steering and antiskid systems are inoperative. Differential emergency braking

should be used for control. Braking at high speeds to maintain directional control must be performed carefully. Drag chute use in a cross wind may increase directional control difficulties.

FUEL LOAD X 1000 NO EXT STORES	GRWT	TCHDN FLAPS UP, GEAR DN
		KNOTS
1.0	34,000	184
2.0	35,000	187
3.0	36,000	190
4.0	37,000	192
5.0	38,000	195
6.0	39,000	198
7.0	40,000	200

4E-1-(45)A

Figure 3-8

After landing -

11. Hook - DOWN (make mid-field or departure-end arrestment)

## DOUBLE POWER CONTROL SYSTEM FAILURE

Without APU -

On aircraft before TO 1F-4-903, if a complete power control system hydraulic failure occurs, the aircraft becomes uncontrollable; i.e., airloads will force stabilator leading edge down, causing the aircraft to pitch-up.

1. Eject

With APU -









On aircraft after TO 1F-4-903 after a complete PC-1 and PC-2 failure, degraded longitudinal control is available from the APU. If both power control systems fail rapid control inputs should be avoided to prevent system saturation and control stiffening.

1. Reduce speed below 600 knots or .95 Mach.
2. Descend to 20,000 feet or below.
3. Use moderate control inputs.
4. Follow procedures for Single Power Control System failure, this section.
5. If the APU or utility system fails - EJECT

## JETTISONING

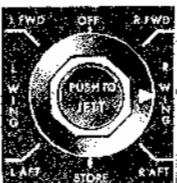
The procedures for jettisoning are shown in Jettison Chart, figure 3-9.

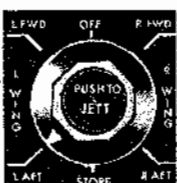
# JETTISON CHART

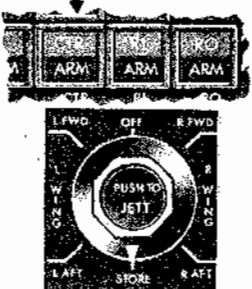
STATION JETTISON	JETTISON CONTROL	JETT PROCEDURE	LOCATION
 <p>MULTI-STATION</p>	 <p>EXTERNAL STORES EMERGENCY RELEASE (PANIC BUTTON)</p> <p>3 5</p>	PUSH	LEFT SUB PANEL
<b>AIM-9 MISSILE JETTISON (ALSO AGM-65 JETTISON)</b>			
	 <p>SELECTIVE JETTISON</p> <p>3 6 7</p>	SELECT L WING AND PUSH TO JETT	MAIN INSTRUMENT PANEL
	 <p>SELECTIVE JETTISON</p> <p>3 6 7</p>	SELECT R WING AND PUSH TO JETT	MAIN INSTRUMENT PANEL
 <p>FUSELAGE MISSILES</p>	 <p>SELECTIVE JETTISON (ONE STATION CONSIDERED)</p> <p>3 2</p>	SELECT L FWD, R FWD, L AFT, or R AFT and PUSH TO JETT	MAIN INSTRUMENT PANEL
 <p>WING &amp; CL STORES</p>	 <p>STATION SELECT BUTTON(S)</p> <p>SELECTIVE JETTISON</p> <p>3 4</p>	<ol style="list-style-type: none"> <li>DEPRESS DESIRED STATION(S) (CL STATION CONSIDERED).</li> <li>SELECT STORES.</li> <li>PUSH TO JETT</li> </ol>	MAIN INSTRUMENT PANEL

### Notes

- Refer to Section V for jettison limitations. Inflight lockout pins must be installed on all MAU-12 armament pylons.
- With CL tank or MER aboard (TK light on), L FWD and R FWD missiles will not jettison.
- For all jettison, rear emergency gear handle must be IN with weight off left main gear or the landing gear handle UP; or the armament safety Override button pushed IN.
- AIM-9 missiles will not jettison.
- AIM-7 and AIM-9 missiles will not jettison.
- Wing flaps must be up to jettison AIM-9 and AGM-65 missiles. This procedure is used to jettison a single AGM-65 missile.
- After TO 11L1-3-15-510, the AIM-9 jettison circuits are disabled.

4E-1-(76)C

Figure 3-9

## INS INFLIGHT ALIGNMENT

If it is necessary to perform an inflight alignment to provide attitude information to the ADI, proceed as follows:

1. Aircraft straight and level
2. Reference system selector knob - STBY
3. Power control knob - CYCLE OFF, STBY FOR 15 SECONDS, NAV
  - The length of time the primary attitude is usable after an inflight alignment is not predictable. Subsequent alignments may be required.
4. Reference system selector knob - PRIM

## CONTROLLABILITY CHECK

During any inflight emergency, except utility hydraulic and engine failure, when structural damage or any other failure is known or suspected that may adversely affect aircraft handling characteristics, a controllability check should be performed as follows:

1. Proceed to a safe altitude (minimum 5000 feet

- AGL).
2. Reduce gross weight to minimum practical.
3. Establish landing configuration required by type emergency (gear down - slats in flaps up for structural damage).
4. Slats override switch - IN (for structural damage)
5. Slow aircraft to determine the airspeed that produces acceptable approach and landing handling characteristics, no slower than 17 units AOA.

### NOTE

- For aircraft with asymmetrical load, airspeed should be no slower than that at which full aileron trim will maintain wings level.
- Arresting gear limitations and field conditions must be considered.

If adequate control is available -

6. Maintain landing configuration and make straight-in approach.
7. In route to final approach, fly no slower than 230 knots with gear down and flaps up; or 200 knots with gear down and slats out flaps down.
8. Fly final approach no slower than minimum control airspeed determined during controllability check.

# LANDING EMERGENCIES

## EMERGENCY LANDING PATTERN

The emergency landing pattern is a pattern to be flown when engine thrust is available and an emergency exists or there is a malfunction which could result in an emergency. The primary objective of the pattern is to land the aircraft safely in the first attempt with least amount of risk. Because of the many variables involved, such as type of emergency, position and altitude in relation to the field, gross weight, fuel remaining, weather, populated areas, runway length, availability of arresting gear, etc., a standard pattern cannot be prescribed. Depending on the circumstances it might be desirable to utilize GCA, make a straight-in approach, enter the pattern from downwind or base leg, or make a 360° overhead pattern. Because of the various circumstances, the pilot's evaluation of all factors and his judgment will determine the type of landing pattern to be flown. However, there are some general guidelines which are applicable regardless of approach selected: Reduce gross weight to minimum practical. Prior to establishing the landing configuration, maintain a minimum maneuvering airspeed of 230 knots. The pattern should be planned to avoid abrupt, steep or hard turns and large or abrupt power changes especially with a flight control malfunction or a hydraulic system failure. Circumstances permitting, a long straight-in final should be planned and the landing configuration established when on final. The air refuel switch should be placed to EXTEND prior to landing to depressurize the fuel tanks. Should the nature of the emergency or other factors dictate establishing the landing configuration prior to final, 230 knots-flaps up, or 200 knots - slats flaps

OUT AND DOWN should be maintained until established on final. These airspeeds will provide a margin of safety for maneuvering flight. If the pattern must be entered on downwind, base or from an overhead pattern, the pattern should be expanded, the landing configuration established prior to final, and roll-out on final should be at least 2 - 3 miles out. A normal 2 - 3° glide slope should be flown. For most emergencies, final approach airspeeds are increased and AOA decreased to provide adequate aircraft handling characteristics.

## ENGINE FAILURE ON FINAL

At the first indication of engine failure, advance both throttles to maximum thrust rather than trying to determine which engine has failed. Any delay in applying power will result in an excessive sink rate and/or airspeed bleed-off. Accept a continued descent until level-off can be smoothly effected. External store drag is negligible at low airspeed and has little effect on performance. Gross weight dictates the thrust required to continue the approach or go-around. Very little yaw is induced by military thrust on one engine. Afterburner thrust creates a slight yaw which can be controlled with rudder. Normally the approach can be continued to a single-engine landing.

1. THROTTLES - AFTERBURNER
2. Follow Single Engine Landing and/or Single Engine Go-Around procedures (this section) as appropriate and time permitting.

**NOTE**

If the left engine fails and the bus tie remains open, afterburner ignition will not be available. If afterburner thrust is required, afterburner light-offs are generally obtainable through turbine torching by jam accelerating the right engine at 90% rpm or above.

**ENGINE FIRE/OVERHEAT ON FINAL**

1. Land as soon as possible

**If time permits -**

2. Throttle good engine - AS REQUIRED
3. Throttle bad engine - IDLE
4. If warning light goes out - CHECK FIRE DETECTION SYSTEM  
Depress fire test button to determine that fire detecting elements are not burned through.

**If warning light on, detection system inoperative, or fire confirmed -**

5. Generator bad engine - OFF
6. Throttle bad engine - OFF
7. Master switch bad engine - OFF
8. Follow Single Engine Landing procedure, this section.

**SINGLE-ENGINE LANDING**

1. Reduce the airplane gross weight to minimum practical.
2. Inlet ramp on good engine - CHECK FULLY RETRACTED.  
If inlet ramp is in the extended position, the AB must be utilized to make a safe approach.
3. All nonessential electrical equipment - OFF
4. Gear - DOWN
5. Slats flaps - OUT AND DOWN
6. Fly 17 units AOA on final.

**WARNING**

If the utility system on the operating engine fails, the wing flaps will retract to a low drag trail position.

**NOTE**

If the left engine is shut down, and the bus tie is open, afterburner ignition on the right engine is not available. However, if afterburner thrust on the right engine is required, afterburner light-offs are generally obtainable through turbine torching by jam accelerating the right engine at 90% rpm or above.

**SINGLE ENGINE GO-AROUND**

At the first indication that a go-around may be necessary, advance the throttle of operating engine to maximum thrust. Continue the approach until sufficient airspeed to level off is attained. Begin a shallow angle climb and retract the landing gear and wing flaps to minimize drag.

**SPLIT-FLAP/DEFLECTED RUDDER**

An unusual roll occurring when the flaps are extended may be due to a split-flap condition. A similar yaw/roll will occur when the flaps are extended if the ARI signal excitation circuit breaker (E9, No. 2 panel) is popped or a fuse in the ARI amplifier is blown. In this case, when the flaps reach the down position the rudder will deflect 10°. The rudder deflection can be overcome by rudder pedal pressure or alleviated by depressing the emergency quick release lever, retracting the flaps or resetting the ARI signal excitation circuit breaker, if popped. When a split-flap condition or rudder deflection occurs or is suspected:

1. Emergency quick release lever - HOLD DEPRESSED
2. Immediately accelerate above 200 knots.
3. Slats flaps - NORM  
Retract slats flaps while maintaining positive aircraft control.
4. Emergency quick release lever - RELEASE (After flaps up)
5. ARI signal excitation circuit breaker - RESET (E9, No. 2 panel)
6. Follow No-Slats Flaps Landing procedure.
7. AFCS - DO NOT ENGAGE

**SLATS FLAPS EMERGENCY LOWERING****CAUTION**

The emergency slat flap extension system should be activated only if the utility system fails. If the emergency system is activated with normal utility hydraulic pressure available, there is a high probability of losing utility hydraulic system pressure. With utility system pressure available and a known or suspected slats flaps malfunction, a no-flap landing is recommended.

If normal slats flaps operation fails, slats flaps can be lowered pneumatically by executing the following steps:

1. Airspeed - BELOW 250 KNOTS  
Air loads will prevent trailing edge flaps from fully extending to the down stop until after airspeed has decreased to approximately 220 knots. During this period trailing edge flaps will indicate barber pole.
2. Slats flaps circuit breaker - PULL



### 3. Slats flaps emergency extension handle - PULL AFT

If front cockpit emergency slats flaps lowering fails, retain front cockpit handle in the aft position and utilize rear cockpit emergency slats flaps handle. Asymmetric flap extension may occur when flaps are extended by the emergency method. This will result in a momentary roll which can be countered by normal application of aircraft controls. Leave emergency slats flaps extension handle in the full aft position. Returning handle to its normal position allows compressed air from the slats flaps down side of the actuating cylinders to be vented overboard.

- ### 4. Slats flaps position indicators - CHECK
- Slats flaps extension by the emergency method will place the slats out and the flaps down. In this configuration, slats will not operate automatically and will remain out regardless of airspeed.

## NO-SLATS FLAPS LANDING

A straight-in approach is recommended. For all abnormal slats flaps configurations, on-speed AOA on final will provide satisfactory control, but noticeable buffet will be present. If a no-slats flaps landing is a result of flap switch failure or split flaps on the downwind of an overhead pattern, expand the pattern and fly a minimum of 230 knots on the downwind. The slats will extend automatically in accordance with their AOA schedule if electrical and hydraulic power are available unless the slats override switch is placed to IN. The slats override switch should remain at NORM unless an asymmetric slat condition occurs. Refer to AOA conversion chart for corresponding airspeeds for no-slats flaps approaches.

1. Gear - DOWN
2. Slats flaps - NORM
3. Slats override switch - NORM (IN FOR ASYMMETRIC SLATS)
4. Fly on-speed AOA on final (17 units for abnormal slat configuration)

### CAUTION

After touchdown, use of excessive back stick to provide aerodynamic braking can result in dragging the stabilator due to increased stabilator effectiveness at the higher touchdown speed.

## LANDING WITH VARIABLE INLET RAMP FAILURE

If both engines are operating, slats flaps OUT AND DOWN landings can be safely made with one inlet ramp fully extended. Reduce gross weight prior to landing. Normal thrust settings must be increased 1 to 2% rpm to maintain an on-speed approach. Afterburner may be required for a late go-around.

### Both ramps extended -

1. Gear - DOWN
2. Slats flaps - OUT AND DOWN
3. Fly 17 units AOA on final.

## LANDING WITH DOUBLE EXHAUST NOZZLE FAILURE

If only one exhaust nozzle fails to the open position, make a normal approach and landing. In the event both exhaust nozzles fail to the open position, the total thrust available in MIL range will be approximately equal to the thrust available during single-engine operation in MIL range.

1. Reduce the airplane gross weight to minimum practical.
2. Gear - DOWN
3. Slats flaps - OUT AND DOWN
4. Fly 17 units AOA on final.

## LANDING WITH BOTH ENGINES INOPERATIVE

Landing with both engines inoperative will not be attempted unless escape from the aircraft is impossible. See figure 3-10.

## LANDING WITH A BLOWN TIRE

The situation may occur when a landing with a blown tire must be made, or a tire may rupture during the landing ground roll or during a touch and go landing. If a rupture occurs during a touch and go, the procedures for Blown Tire During Takeoff will apply. A blown tire and high speed require immediate corrective action to keep the aircraft aligned with the runway, therefore:

### LANDING WITH A KNOWN BLOWN TIRE

1. Anti-skid switch - OFF  
Turn the anti-skid switch OFF to prevent loss of braking on the good tire resulting from skid indications from the blown tire.
2. Plan to make an approach-end arrestment.  
Refer to Approach-End Arrestment Procedure, this section.

### If an approach-end arrestment is not feasible-

3. Fly a normal on-speed approach.
4. Land on side of runway opposite blown tire.
5. Touchdown with weight on good tire.
6. Use nose gear steering to maintain directional control.

If nose gear steering is inoperative, use of differential thrust and/or aerodynamic steering should be considered. Maintaining full forward stick will increase nose wheel traction and

# FLAME-OUT APPROACH

**WARNING**

THIS PATTERN WILL NOT BE ATTEMPTED UNLESS ESCAPE FROM THE AIRPLANE IS IMPOSSIBLE!

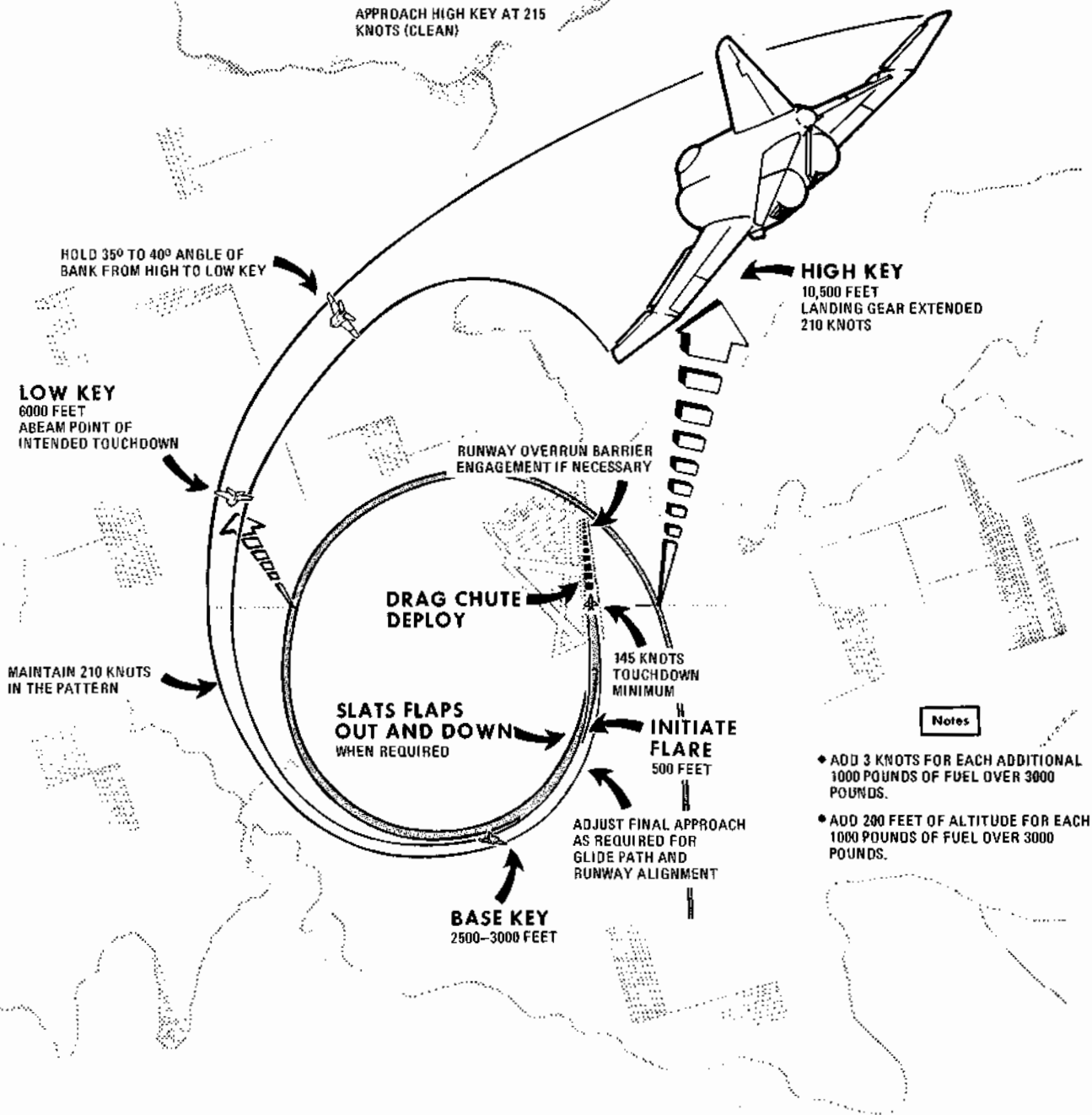

**Notes**

- ◆ ADD 3 KNOTS FOR EACH ADDITIONAL 1000 POUNDS OF FUEL OVER 3000 POUNDS.
- ◆ ADD 200 FEET OF ALTITUDE FOR EACH 1000 POUNDS OF FUEL OVER 3000 POUNDS.

Figure 3-10

- improve steering capability.
7. Drag chute - DEPLOY
  8. Use opposite braking to slow aircraft and aid directional control.

**CAUTION**

Avoid braking on the wheel with the blown tire. Heavy braking could cause a flat spot on the wheel which could prevent further wheel rotation and make aircraft control more difficult.

9. Do not retract flaps.  
The wing flap seal may have been damaged by piece of broken tire and retracting the wing flaps will increase the damage.

### BLOWN TIRE DURING LANDING ROLLOUT

#### 1. NOSE GEAR STEERING - ENGAGE

**NOTE**

Maintaining full forward stick will increase nose wheel traction and improve steering capability.

2. ANTI-SKID - OFF
3. HOOK - DOWN
4. Use opposite braking to slow aircraft and aid directional control.

**CAUTION**

- Avoid braking on the wheel with the blown tire. Heavy braking could cause a flat spot on the wheel which could prevent further wheel rotation and make aircraft control more difficult.
  - If both main tires fail, directional control difficulties may not be apparent until the latter part of the landing roll.
5. Do not retract flaps.  
The wing flap seals may have been damaged by pieces of broken tire and retracting the wing flaps will increase damage.

### LANDING WITH ANTI-SKID FAILURE

Landing with a known anti-skid failure requires no special technique except that braking during landing roll must be done with extreme caution to avoid skidding a tire. At high speed and particularly with wet or icy conditions, a wheel can be locked with relatively low applied brake pressure. Apply very light braking initially and slowly increase pedal force as speed decreases. If a skid is sensed, fully relieve brake pressure momentarily to allow the locked wheel(s) to come back up to speed.

Differential braking cannot correct for swerving for fishtailing due to wheel skid. The aircraft tends to swerve away from the locked wheel requiring release of the brake you would instinctively apply.

An approach-end arrestment should be considered in light of existing environmental factors such as runway condition, crosswind, and arrestment cable location. If the ANTI-SKID INOPERATIVE light illuminates:

1. ARI and rudder trim circuit breakers - CHECK IN
2. Anti-skid switch - CYCLE

#### If anti-skid is still inoperative -

3. Anti-skid switch - OFF
4. Consider approach-end arrestment. Refer to Approach-End Arrestment, this section
5. Avoid heavy braking

### LANDING FROM THE REAR COCKPIT WITH PILOT DISABLED

A landing made from the rear seat when the pilot is incapacitated presents a number of problems. The problem areas are: slats flaps and gear lowering, directional control, braking, and engine shutdown. The landing gear and slats flaps can be lowered by the emergency method (blown down) from the aft cockpit. Assuming normal utility pressure, there is a possibility of rupturing the utility hydraulic reservoir when the gear and slats flaps are blown down. However, tests have shown that the probability of the reservoir rupturing when the gear is lowered is fairly remote. These same tests have shown the probability of the reservoir rupturing when the slats flaps are lowered is almost certain. Therefore, it would be advisable to land with flaps up, if practical. If the flaps are blown down, the resultant rupture of the utility hydraulic reservoir will make a landing without nosewheel steering or normal brakes necessary. Anti-skid and nose gear steering will be inoperative with the front cockpit gear handle in the UP position. The auxiliary air doors will remain closed and auto-acceleration (with no means to shut down an engine from the rear seat) must be anticipated. If the situation permits, pull the RH AUX AIR DOOR CONTROL circuit breaker (A3, No. 3 panel). This will open the left auxiliary air door and prevent auto-acceleration of the left engine. In addition, this will regain nose gear steering. Additional items not available: utility hydraulic pressure indicator (loss of radar antenna drive, speed brakes and power rudder indicates utility failure), arresting hook, and drag chute.

**CAUTION**

Because of the limited number of brake applications, taxiing should not be attempted when using the emergency brakes.

## LANDING WITH ONE UTILITY HYDRAULIC PUMP FAILED

1. Make straight-in approach
2. Slats flaps - OUT AND DOWN
3. Fly 17 units AOA on final
4. Consider an approach-end arrestment

## LANDING WITH UTILITY HYDRAULIC SYSTEM FAILURE



- If ordnance and/or stores jettison is required, they should be jettisoned prior to lowering the landing gear to prevent gear damage.
- When landing with a utility hydraulic system failure, nose gear steering and anti-skid protection will not be available, and auto acceleration will probably occur.

### NOTE

If CHK HYD GAGES indicator light comes on and remains on, monitor the hydraulic system indicators for the remainder of the flight, since warning of a PC hydraulic system failure will not be given.

1. Fly emergency landing pattern.
2. If gear not down and locked - BLOW DOWN  
Refer to Landing Gear Emergency Lowering, this section. If the gear was down and locked before loss of utility hydraulic system, do not blow down.
3. Extend slats flaps pneumatically  
Refer to Slats Flaps Emergency Lowering this section.
4. Anti-skid - OFF.
5. Fly 17 units AOA on final.  
The increase in speed at 17 units AOA will help preclude directional control difficulties in the event that subsequent failures degrade available lateral control.
6. Make an approach end arrestment, if possible.  
Refer to Approach End Arrestment, this section.
7. Utilize emergency braking.  
Refer to Wheel Brake Failure, this section.
8. Anticipate auto acceleration.  
Refer to Aux Air Door Malfunction, this section.

## DIRECTIONAL CONTROL AFTER LANDING WITH UTILITY HYDRAULIC SYSTEM FAILURE

Without utility hydraulic system pressure available, differential braking, spoilers, ailerons, and asymmetric power will become the primary method of maintaining directional control. Differential braking is accomplished by utilizing emergency brake system. The brakes should be cycled as little as possible to conserve emergency

accumulator pressure. Should accumulator pressure become depleted through repeated applications of the brakes, the manual rudder plus spoilers, ailerons and asymmetric power will be the only remaining source for directional control. Small deflections of the manual rudder are available at landing speeds; therefore, in crosswinds and at low roll-out speeds, directional control must be provided by differential braking. Use of the drag chute in a strong crosswind will require additional differential braking. It may be necessary to jettison the drag chute to regain directional control in a crosswind. On wet runways, this could be a very significant factor in maintaining heading through the use of differential brakes.

## LANDING WITH HARD-OVER RUDDER

The aircraft can be flown and landed with a hard-over rudder if the proper procedures are followed. Satisfactory aileron control is available up to 16 units angle of attack. Above 16 units full lateral stick is required to maintain level flight. If an inadvertent roll into the hard-over rudder occurs and full lateral stick will not reduce the roll rate, the angle of attack must be reduced to regain lateral control. When a hard-over rudder occurs, angle of attack indications are in error due to aircraft sideslip. If the hard-over rudder is to the right, the indicated angle of attack is 2 units lower than actual. If the hard-over rudder is to the left, the indicated angle of attack is 2 units higher than actual. Therefore, when flying an approach, it is imperative that an approach airspeed be used and that the angle of attack be disregarded. Inflight deployment of the drag chute considerably reduces sideslip and bank angles resulting in an easier approach and landing. However, due to the low reliability of the drag chute during inflight deployments, it is recommended that this procedure be used only if approach-end arresting gear is not available. Use of asymmetric thrust also reduces sideslip and bank angles and should be used if a hard-over rudder landing is made without the drag chute. If sufficient single engine thrust is available, additional asymmetric thrust effect can be obtained by extending the speed brakes.

If approach-end arresting gear is available -

1. Slats flaps - OUT AND DOWN
2. Fly final approach airspeed as shown in figure 3-11.

FUEL LOAD X1000 NO EXT STORES	GRWT	APRCH SP GEAR DN
		KNOTS
1.0	34,000	161
2.0	35,000	163
3.0	36,000	165
4.0	37,000	168
5.0	38,000	170
6.0	39,000	172
7.0	40,000	174

Figure 3-11

4E-1-(47)A

3. Engine opposite hard-over rudder - IDLE
4. If sufficient single engine thrust is available - EXTEND SPEED BRAKES
5. Make an approach-end arrestment.

Refer to Approach-End Arrestment procedure, this section.

6. Drag chute - DEPLOY AT TOUCHDOWN  
Deploy drag chute immediately upon touchdown to assist in directional control while approaching the arresting gear.

#### If approach-end arresting gear is not available -

1. Slats flaps - OUT AND DOWN
2. Maintain 15 knots above the airspeed shown in figure 3-11.
3. Deploy drag chute on final approach 1½ miles from touchdown.
4. Fly final approach airspeed as shown in figure 3-11. Approximately 90% rpm will be required.
5. Land on side of runway opposite the hard-over rudder.
6. Use nose gear steering (only if rudder pedals are neutral) and light braking on the wheel opposite the hard-over rudder to maintain directional control.

## LANDING GEAR FAILS TO EXTEND

An unsafe landing gear indication does not necessarily constitute an emergency. The unsafe indication could be caused by a malfunction within the indicating system. Cross-check all landing gear indications (landing gear handle, landing gear handle warning light, landing gear position indicators) and the utility system hydraulic pressure. If possible, obtain a visual gear check. If the nose gear fails to extend, it is usually due to the breakout force of the nose gear being in excess of available hydraulic pressure. Pulling and resetting the landing gear circuit breaker with the landing gear handle down provides a sudden buildup of hydraulic pressure (surge) to be exerted on the nose gear actuator which may be sufficient to extend the nose gear. If gear indicates unsafe:

1. Airspeed below 250 knots.
2. Landing gear circuit breaker - PULL (wait a few seconds) then reset

#### If unsafe condition still exists -

3. Landing gear - RECYCLE  
If the utility system hydraulic pressure is within limits, recycle the landing gear.
4. Check that the gear indicates locked.

#### If unsafe condition still exists -

5. Landing gear handle - UP
6. Apply negative G
7. While under negative G, place gear handle down.  
Negative G will help if unsafe gear is caused by high break-out forces.

#### If landing gear is still unsafe -

8. Use landing gear emergency lowering procedure.

## LANDING GEAR EMERGENCY LOWERING

### CAUTION

- Do not use this procedure if the landing gear is already down and locked and subsequent electrical or hydraulic failure occurs. In this circumstance, emergency gear lowering does not make the gear safer and, rarely, has caused a previously down and locked gear to become unsafe.
- If the landing gear is inadvertently extended in flight by emergency pneumatic pressure, they must be left in the extended position until post-flight servicing. If retraction in flight is attempted, rupture of the utility reservoir will probably occur with subsequent loss of the utility hydraulic system.

If normal landing gear operation fails, the landing gear can be lowered by the following procedures:

1. Landing gear circuit breaker - PULL
2. Landing gear handle - DOWN
3. Landing gear handle - HOLD FULL AFT  
Hold handle in full aft position until gear indicates down and locked, and then leave the landing gear handle in the full aft position. It is possible to actuate the landing gear emergency system by pulling the landing gear control handle aft while the handle is in any position from UP through DOWN. If the handle cannot be pulled aft while in the down position, slowly raise the handle while continuing to pull aft. Once the handle moves aft, hold the handle in the full aft position until the landing gear indicates down and locked; then continue to hold back pressure on the handle and return it to the full down position.

### WARNING

All normal jettison circuits in the aircraft are disabled once the emergency landing gear control handle in the rear cockpit is pulled. Jettison may still be accomplished by holding the armament safety override button in while actuating the appropriate jettison switch.

#### If landing gear is still unsafe -

4. Retain front cockpit handle in extend position and pull rear cockpit emergency gear lowering handle.
5. Yaw airplane to assist in locking main gear.

6. Bounce airplane on main gear (during touch-and-go) to assist lowering/locking the nose gear.

Due to increased stabilator effectiveness, a no-flap touch and go is recommended.

7. If one main gear is still unsafe and the utility system pressure is within limits, refer to Landing Gear Emergency Retraction this section.
8. If gear is still unsafe and the utility system pressure is not within limits, refer to Landing Gear Malfunctions-Emergency Landings chart, figure 3-12.

## LANDING GEAR EMERGENCY RETRACTION

If gear retraction is desired after an attempted Landing Gear Emergency Lowering, and utility system pressure is within limits, retract the gear using the following procedures:

1. Return the emergency gear handle(s) to the normal position.

### NOTE

The aft cockpit spring-loaded locking plunger must be pushed UP before the rear handle can be reset.

2. Wait as long as practical (minimum 1 minute)
3. Landing gear handle - UP
4. Landing gear circuit breaker - RESET

### CAUTION

The landing gear circuit breaker must not be reset until the emergency handle(s) is/are returned to normal, maintained in that position for a minimum of 1 minute, and then landing gear handle placed UP. Only then may the circuit breaker be safely reset.

5. After gear is retracted, refer to Landing Gear Malfunctions-Emergency Landings chart, figure 3-12.

## AUXILIARY AIR DOOR MALFUNCTION (GEAR DOWN)

If the auxiliary air doors fail to open when the landing gear is lowered, there is a possibility that the engines may automatically accelerate up to 100% rpm. A utility hydraulic system failure or double generator failure will render the variable bypass bellmouth and auxiliary air doors inoperative. Operation of an engine with an open variable bypass bellmouth and closed auxiliary air door will allow engine compartment secondary air to recirculate to the engine compressor inlet. During low altitude or ground operation, the temperature of the recirculating air may be high enough to initiate T2 reset through normal detection by the compressor inlet

temperature sensor. As T2 reset occurs, it increases the engine idle speed to maintain proper airflow and thrust under high temperature conditions, and can cause the idle speed to increase to 100% rpm. The auto-accelerated engine can be shut down by placing the throttle to OFF. If a false reset occurs while airborne, a near normal landing can be made by modulating the exhaust nozzles of the affected engine(s).

## AUTO-ACCELERATION OF ONE ENGINE

1. Throttle bad engine - IDLE
2. Fly ON SPEED approach
  - Modulate throttle of good engine for desired thrust. The combined thrust of the auto-accelerated engine in idle, and the good engine in idle, will not be in excess of that required to make an optimum on speed approach.
3. At touchdown, bad engine - SHUTDOWN

## AUTO-ACCELERATION OF BOTH ENGINES

1. Throttle of either engine - IDLE
2. Modulate throttle of remaining engine for desired thrust.
3. Fly 17 units AOA on final.
4. At touchdown, right engine - SHUTDOWN
  - The right engine is shutdown in order to retain nose gear steering and anti-skid in event of bus tie failure.

## ARRESTING HOOK EMERGENCY OPERATION

If the arresting hook fails to extend when the control handle is placed in the down position, deenergize the solenoid selector valve by pulling the hook control circuit breaker in the rear cockpit. Pressure is then removed from the up side of the arresting hook actuator cylinder and the hook will extend. There are no provisions for arresting hook retraction in the event of a utility hydraulic failure or double generator failure.

1. Arresting hook circuit breaker - PULL (A4, No. 3 panel)

## APPROACH-END ARRESTMENT

Approach end arrestments are considered practical whenever a malfunction or adverse weather conditions present a threat to directional control and there is suitable landing surface in front of the arrestment cable on which to land and lower the nose prior to cable contact. A touchdown point should be selected based on existing environmental factors such as arrestment cable location, runway condition, crosswind, nature of emergency and anticipated difficulty in high speed directional control. Consideration should also be given to the engaging speed limits to prevent structural failure to the arresting gear or the aircraft. See Field Arresting Gear Data (figure 3-16)

# LANDING GEAR MALFUNCTIONS-EMERGENCY LANDINGS

BEFORE ATTEMPTING LANDING, CONSIDER: ARRESTING GEAR LIMITATIONS  
CROSSWIND  
RUNWAY AND OVERRUN CONDITION

IF CONSIDERATIONS NOT FAVORABLE-EJECT

## BEFORE LANDING-

1. JETTISON ARMAMENT (CONSIDER RETAINING RACKS)
2. DUMP OR BURN EXCESS FUEL
3. RETAIN EMPTY EXTERNAL WING TANKS (DEPRESSURIZE)
4. REQUEST RUNWAY FOAM
5. SLATS FLAPS - OUT AND DOWN
6. FLY COMPUTED ON SPEED +10 KNOTS WITH FLAT APPROACH

## LANDING NOT RECOMMENDED



ONE MAIN-NO NOSE

- RETRACT GEAR AND REFER TO ALL GEAR UP

IF GEAR WILL NOT RETRACT-

- RECOMMEND EJECT

## ARRESTMENT NOT RECOMMENDED

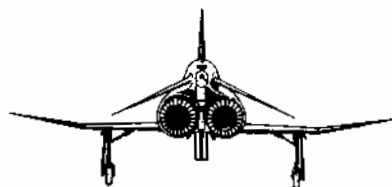

BOTH MAIN-STUB NOSE

- RETRACT GEAR AND REFER TO ALL GEAR UP

IF GEAR WILL NOT RETRACT -

- REQUEST REMOVAL OF APPROACH-END/  
MIDFIELD ARRESTING GEAR CABLES
- JETTISON  $\zeta$  TANK
- LAND BEYOND APPROACH-END ARRESTING  
GEAR (IF INSTALLED)
- DO NOT SHUT DOWN ENGINES UNTIL STOPPED
- DEPLOY CHUTE AFTER NOSE LOWERED



BOTH MAIN-NO NOSE

- REQUEST REMOVAL OF APPROACH-END/  
MIDFIELD ARRESTING GEAR CABLES /
- JETTISON  $\zeta$  TANK
- LAND BEYOND APPROACH-END ARRESTING  
GEAR (IF INSTALLED)
- DO NOT SHUT DOWN ENGINES UNTIL STOPPED
- DEPLOY CHUTE AFTER NOSE LOWERED

## APPROACH END ARRESTMENT RECOMMENDED



ALL GEAR UP

- JETTISON  $\zeta$  TANK
- DEPLOY CHUTE AT TOUCHDOWN

IF ARRESTMENT NOT PRACTICAL-

- JETTISON  $\zeta$  TANK
- DEPLOY CHUTE AT TOUCHDOWN

# LANDING GEAR MALFUNCTIONS-EMERGENCY LANDINGS

## APPROACH END ARRESTMENT RECOMMENDED

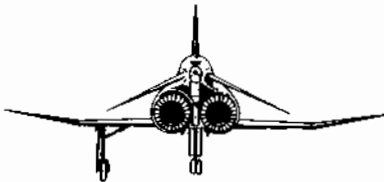

ONE MAIN NOSE DOWN

- RETRACT GEAR AND REFER TO ALL GEAR UP IF GEAR WILL NOT RETRACT—
- DO NOT DEPLOY CHUTE (EXCEPT MISSED ENGAGEMENT)

- IF ARRESTMENT NOT PRACTICAL—
- JETTISON Q TANK
  - LAND OFF Q OPPOSITE FAILED GEAR
  - DO NOT SHUT DOWN ENGINES UNTIL STOPPED

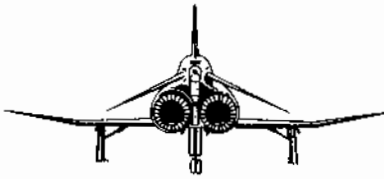

STUB MAIN OR BOTH STUB MAIN—NOSE DOWN

- RETRACT GEAR AND REFER TO ALL GEAR UP IF GEAR WILL NOT RETRACT—
- JETTISON Q TANK
- LAND OFF Q OPPOSITE FAILED GEAR
- DO NOT DEPLOY CHUTE (EXCEPT MISSED ENGAGEMENT)

- IF ARRESTMENT NOT PRACTICAL—
- JETTISON Q TANK
  - LAND OFF Q OPPOSITE FAILED GEAR
  - DO NOT SHUT DOWN ENGINES UNTIL STOPPED



NO MAIN - NOSE DOWN

- JETTISON Q TANK
  - DEPLOY CHUTE AT TOUCHDOWN
- IF ARRESTMENT NOT PRACTICAL—
- JETTISON Q TANK
  - DEPLOY CHUTE AT TOUCHDOWN
  - DO NOT SHUT DOWN ENGINES UNTIL STOPPED



1. Notify tower.
2. Reduce gross weight to lowest practical.
3. Fly pattern as dictated by emergency.
4. Arresting hook - DOWN  
Ensure landing gear is down and locked before lowering hook.
5. Air refuel switch - EXTEND
6. Inertia reel - LOCKED
7. Plan for missed engagement  
Consider type of emergency, availability of back-up barriers, runway length, runway condition reading (RCR), fuel state, weather, and other pertinent factors.
8. Fly final approach to touchdown a minimum 300 feet short of cable.
9. Throttles - IDLE
10. Stick - FORWARD

**CAUTION**

To preclude nose gear slap and damage, engage arresting gear with the nose gear on the runway.

11. Drag chute - AS DESIRED  
Use of the drag chute during approach-end arrestments should be considered in light of existing environmental factors such as arrestment cable location, runway condition, crosswind, nature of emergency, and probability of go-around. When drag chute is utilized the pilot must be prepared to jettison the drag chute should a go-around be required.
12. Engage cable in center at 90° with brakes off.  
The throttles may be inadvertently advanced should deceleration forces cause the pilot's hand to be thrown forward on the throttles.

**NOTE**

If runway centerline lights are installed, a 90° slightly off-centerline engagement is recommended due to possible hook bounce and missed engagement.

13. Control rate and direction of roll back with throttles and brakes.

The arrestment cable will pull the aircraft rearward after engagement. Be prepared to counteract any excessive rearward acceleration with normal or emergency brakes. Normal brakes may not operate until the anti-skid is disengaged.

**CAUTION**

The arrestment cable may be damaged by the wheel rims of aircraft with blown tires. In instances where wheels are locked, the damage to the cable is more severe and cable failure is probable.

## DEPARTURE-END ARRESTMENT

1. Hook - DOWN
2. Engage cable in center at 90° with brakes off.  
If rudder control, nose gear steering, and brakes are lost, steering can be accomplished only by differential thrust and/or ailerons and spoilers if sufficient airspeed is available.

**NOTE**

If runway centerline lights are installed, a 90° slightly off-centerline engagement is recommended due to possible hook bounce and missed engagement.

**CAUTION**

Cables may be damaged by the wheel rims of aircraft with blown tires. In instances where wheels are locked, damage to the cable is more severe and cable failure is probable.

3. Slats flaps - DO NOT CHANGE POSITION  
Do not retract slats flaps until cleared to taxi by ground personnel.

# DITCHING CHART

## BEFORE IMPACT

1. Canopy -- JETTISON (fwd first) (PILOT -- WSO)
2. Arresting hook -- DOWN
3. Leg restraint release handle -- PULL AFT (PILOT -- WSO)  
 Pull leg restraint lines and lock pins thru garter rings before ditching to expedite egress from cockpit.
4. Oxygen mask -- TIGHTEN (PILOT -- WSO)
5. Oxygen diluter selector -- 100% (PILOT -- WSO)
6. Shoulder harness -- LOCK (PILOT -- WSO)
7. Survival Kit selector switch -- MANUAL (PILOT -- WSO)
8. Fly parallel to swell pattern.
9. Attempt touchdown along wave crest.

### WARNING

THE AIRCRAFT SHOULD BE DITCHED ONLY WHEN ALL OTHER ATTEMPTS OF EGRESS HAVE FAILED.

## AFTER IMPACT

1. Shoulder harness -- RELEASE (Pilot--WSO)

### WARNING

Do not pull the survival kit release handle until clear of the aircraft. Pulling the handle with the kit resting on the seat will cause the kit to be left in the aircraft. Pulling the handle while standing up in the cockpit will cause the kit to open and remain in the cockpit, and the crewmember will remain attached to the kit by the dropline.

### WARNING

• If the lower ejection handle guard is down, rotate the guard up prior to evacuating the cockpit.

2. Pull up on the emergency harness release handle and using a hand--hold for additional leverage stand straight up without twisting to release sticker clips from the seat. (PILOT -- WSO)
3. Abandon aircraft (PILOT -- WSO)
4. Inflate life vest (PILOT -- WSO)

### WARNING

To prevent the lungs from bursting due to differential pressure, the crewmember must exhale while ascending to the surface from substantial depths.

5. Inflate life raft (PILOT -- WSO)

### Note

To inflate the raft the survival kit release handle must be pulled, then the CO<sub>2</sub> bottle cable in the kit must be pulled.

Figure 3-13

# AIRSPEED INDICATOR FAILURE

FLIGHT CONDITION	ANGLE-OF-ATTACK UNITS
<b>MILITARY POWER CLIMB</b>	
Drag Index = 0 . . . . .	Sea level . . . . . 5.0 combat ceiling . . . . . 9.5
Drag Index = 120 . . . . .	Sea level . . . . . 8.5 combat ceiling . . . . . 10.0
<b>MAXIMUM POWER CLIMB</b>	
All Drag Indexes . . . . .	Sea level . . . . . 4.5 combat ceiling . . . . . 11.5
<b>CRUISE AT ALTITUDES BELOW 20,000 FT.</b> (all gross weights)	
Drag Index = 0 . . . . .	7.0
Drag Index = 130 . . . . .	8.5
<b>CRUISE AT OPTIMUM ALTITUDE</b>	
Drag Index = 0 . . . . .	8.5
Drag Index = 130 . . . . .	9.0
<b>ENDURANCE AT OPTIMUM ALTITUDE</b>	
Drag Index = 0 . . . . .	9.5
Drag Index = 130 . . . . .	14.0
<b>DESCENTS (low to medium gross weight)</b>	
250 KNOTS, idle power . . . . .	9.0
300 KNOTS, 80% rpm. . . . .	7.0
<b>APPROACH</b>	
GCA Pattern (250 knots, gear up, slats flaps up) . . . . .	9.0
Gear extension (250 knots) . . . . .	9.0
Slats flaps extension (gear down, 200 knots). . . . .	11.5
Final "On Speed" approach (slats flaps any position, gear down) . . . . .	19.2
<b>STALL</b>	
Staff warning (pedal shaker) . . . . .	22.3

### Notes

- Due to the basic difficulty of setting up flight conditions (other than landing approach) by reference to the angle of attack indicator, the information included in this table should be used only in an emergency situation.
- The ranges shown for angle of attack versus drag index, while not entirely linear, may be interpolated linearly for practical purposes.
- The flap extension and retraction airspeeds are sensed from the pitot static system.
- During landing approach, with unreliable airspeed indications above the 210-234 range, the flaps will not extend and the rudders will remain in the high gradient level.

### WARNING

During landing approach with flaps selected and indicated airspeed fluctuations above and below the 210-234 range, the flaps will extend or retract without warning.

# FIELD ARRESTMENT GEAR DATA

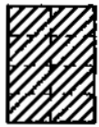

AIRCRAFT WEIGHT-POUNDS	BAK-6	BAK-9	BAK-12/14 STD	BAK-12/14 1200' R.O.	BAK-13	M-21	MA-1/1A (MA-1A Mod)	E-28
	MAXIMUM ENGAGEMENT SPEED - KNOTS							
30,000	160	172	180	180	180	140	92	180
32,000	160	170	180	180	180	140	90	180
34,000	160	168	180	180	180	140	88	180
36,000	158	166	180	180	180	140	86	180
38,000	156	164	177	180	180	140	84	180
40,000	154	162	175	180	180	140	82	180
42,000	153	158	170	180	180	140	81	180
44,000	152	155	165	180	180	135		177
46,000	150	150	160	180	180	135		177
48,000	148	146 •	156	180	180	135		177
50,000	146	142	152	180	180	135		177
52,000	145	140	148	179	180	135		177
54,000		135	145	178	180	135		177
56,000		134	143	177	180	125		176
58,000		132	141	176	180	125		176
60,000		130	140	175	180	125		176

**CAUTION**

TO PREVENT DAMAGE TO THE LANDING GEAR WHEN UTILIZING THE MA-1/1A(MA-1A MODIFIED) ARRESTMENT GEAR, ENSURE WEBBING IS IN THE DOWN (INOPERATIVE) POSITION.

Figure 3-15

# WARNING / INDICATOR LIGHTS

LIGHT	CAUSE	CORRECTIVE ACTION/REMARKS
WHEELS	BELOW APPROX 230K - GEAR UP	LOWER GEAR OR ACCELERATE ABOVE FLAP BLOW-UP SPEED
FIRE OVERHT	EXCESSIVE TEMPERATURES IN ENGINE OR AFT COMPARTMENT.	CARRY OUT EMERGENCY PROCEDURES
MASTER CAUTION	CAUTION CONDITION EXISTS	CHECK TELELIGHTS
ALT ENCODER OUT	UNRELIABLE OR NO SIGNAL FROM ALT ENCODER	IF LIGHT STAYS ON: USE VOICE COMMUNICATIONS IF LIGHT FLASHES CONTINUOUSLY: PULL AEU CB (H9, NO. 2 PANEL)
IFF	MODE 4 FAILED	LIGHT INOPERATIVE UNTIL MODE 4 INSTALLED
CANOPY UNLOCKED	CANOPY UNLOCKED	GROUND: • REFER TO CANOPY MALFUNCTION PROCEDURE INFLIGHT: • COCKPIT PRESS-DUMP • REDUCE POWER AND AIRSPEED • COMMAND SELECTOR VALVE-VERTICAL IF REAR CANOPY UNSAFE • CANOPY HANDLE-DO NOT MOVE
FUEL LEVEL LOW	FUEL REMAINING: 1800 ± 200 POUNDS BLK 41 AND UP: 1650 ± 200 POUNDS	CHECK ALL FUEL TRANSFERRED
L EXT FUEL CTR EXT FUEL R EXT FUEL	• TANK EMPTY • FLOW STOPPED • TANK FULL (DURING AIR REFUELING).	INTERMITTENT ILLUMINATION DURING TRANSFER IS NORMAL.
CHK HYD GAGES	PRESSURE BELOW 1500 ± 100 PSI IN PC-1, PC-2, SYS OR AT LEAST 1 UTILITY PUMP BELOW THIS PRESS	CARRY OUT EMERGENCY PROCEDURES
WINDSHIELD TEMP HIGH	WINDSHIELD OVERHEATED	• RAIN REMOVAL SWITCH - OFF • ILLUMINATES IF R GEN DROPS OFF LINE AND BUS TIE IS OPEN. • INTERMITTENT LT DURING HI MACH FLT. RAIN REMOVAL SYS OFF, IS NORM.
DUCT TEMP HI	INLET TEMP ABOVE 121°C	REDUCE SPEED
SPEEDBRAKE OUT	SPEEDBRAKES NOT CLOSED	INFO ONLY
AUTOPILOT PITCH TRIM	AUTOPILOT PITCH TRIM IS MALFUNCTIONING (OTHER THAN MOMENTARY)	• STICK - GRASP FIRMLY • AUTOPILOT - DISENGAGE
OXYGEN LOW	QUANTITY IS 1 LITER OR LESS	DESCEND TO SAFE ALTITUDE
CABIN TURB OVERSPEED	TURBINE PRESSURE/TEMP. TOO HIGH.	• REDUCE THRUST AND SPEED. • IF LIGHT STAYS ON: EMER VENT KNOB - PULL
R OR L AUX AIR DOOR	DOOR(S) OUT OF PHASE WITH GEAR HANDLE.	CARRY OUT EMERGENCY PROCEDURES
R OR L ANTI-ICE ON	NORMAL IF SWITCH ON	IF SWITCH OFF: REDUCE AIRSPEED. • IF LIGHT GOES OUT, ACCELERATE AND DISREGARD LIGHT. • IF LIGHT STAYS ON: REMAIN AT REDUCED SPEED

**WARNING / INDICATOR LIGHTS**

CONTINUED

LIGHT	CAUSE	CORRECTIVE ACTION/REMARKS
PITCH AUG OFF	PITCH STAB AUG NOT ENGAGED	DO NOT EXCEED 300 KNOTS BELOW 10,000 FEET
STATIC CORR OFF	SPC INOPERATIVE	<ul style="list-style-type: none"> <li>• CADC SWITCH - RESET CORR.</li> <li>• IF LIGHT STAYS ON:</li> <li>• CADC SWITCH - CORR OFF</li> <li>• USE AS AND ALT CORR DATA</li> </ul>
RADAR CNI COOL OFF	EQUIPMENT COOLING TURBINE	<ul style="list-style-type: none"> <li>• REDUCE AIRSPEED, WAIT 15 SECONDS</li> <li>• RESET - PUSH</li> <li>• IF LIGHT STAYS ON: REMAIN AT REDUCED AIRSPEED</li> </ul>
AUTOPILOT DISENGAGE	AUTOPILOT IS NOT ENGAGED	INFO ONLY
CHECK FUEL FILTERS	FUEL FILTER(S) ARE CLOGGED	NOTE IN FORM 781
HOOK DOWN	HOOK IS UNLOCKED	INFO ONLY
INERTIAL NAV SYS OUT	INS MALFUNCTION	REFERENCE SYSTEM SELECTOR - STBY
LH GEN OUT RH GEN OUT	GEN OFF THE LINE	CARRY OUT EMERGENCY PROCEDURES
BUS TIE OPEN	GEN. ARE OUT OF FREQUENCY PHASE, OR FAULTED CSD UNDERSPEED SWITCH	CARRY OUT EMERGENCY PROCEDURES
ANTI-SKID INOPERATIVE	ANTI-SKID HAS MALFUNCTIONED	<ul style="list-style-type: none"> <li>• CARRY OUT EMERGENCY PROCEDURES</li> <li>• DISREGARD MOMENTARY LIGHT</li> </ul>
DC BUS	MAIN 28VDC BUS DISCONNECTED FROM ESS 28VDC BUS BECAUSE OF LOW VOLTAGE ON 28VDC	<ul style="list-style-type: none"> <li>• CHECK DC OPERATED EQUIPMENT</li> <li>• CYCLE GENERATORS SIMULTANEOUSLY (DAY VMC ONLY)</li> <li>• LAND AS SOON AS PRACTICAL</li> </ul>
APU	PC-1 PRESS BELOW 1000 PSI	IF PC-2 SYSTEM NORMAL: APU REJECT SWITCH - AS DESIRED
TANK 7 FUEL	CELL 7 TRANSFER VALVE FAILED TO OPEN	<ul style="list-style-type: none"> <li>• CELL 7 FUEL NOT AVAILABLE</li> <li>• ONLY FUEL READ ON TAPE IS AVAILABLE</li> </ul>
SLATS IN	SLAT OVERRIDE SWITCH AT IN POSITION	INFO ONLY

Figure 3-16 (Sheet 2 of 2)

## SECTION IV

# AUXILIARY EQUIPMENT

### TABLE OF CONTENTS

Air Conditioning and Pressurization System.....	4-1
Anti-G Suit System.....	4-6
Automatic Flight Control System AN/ASA-32.....	4-6
Inertial Navigation and Attitude Heading Reference System.....	4-11
Attitude Reference System.....	4-12
Emergency Attitude Reference System.....	4-14
Navigation Computer Set AN/ASN-46A.....	4-14
Air Refueling System.....	4-17
Fire Control System.....	4-18
Radar Recording and Strike Camera Systems.....	4-18
Multiple Weapons Control System.....	4-18
Lead Computing Optical Sight.....	4-19
Weapons Release Computer Set AN/ASQ-91.....	4-19
Weapon Suspension Equipment.....	4-19
Special Weapons Delivery Systems.....	4-19
Nose Gun System M61A1.....	4-19
Low Altitude Bombing System (LABS).....	4-19
Tow Target Systems.....	4-19
Radar Warning Receiver (RWR).....	4-19
Electronic Countermeasures Pods (ALQ SERIES).....	4-19
Radar X Band Transponder SST-181X.....	4-19
Speech Security Unit (KY-28).....	4-19
Electro-Optical Target Designator System AN/ASQ-153(V).....	4-19
Interrogator Set AN/APX-80/81.....	4-19
AN/ALE - 40 Countermeasures Dispensing Set.....	4-19
Miscellaneous Equipment.....	4-19

### AIR CONDITIONING AND PRESSURIZATION SYSTEM

Air conditioning in the aircraft is divided into two major systems, one for cockpit areas and one for electronic equipment cooling. The cockpits for both crewmembers are pressurized and supplied with conditioned air from the cockpit air conditioning system. The same air that pressurizes and heats the cockpit is used to keep the windshield free of fog, frost, rain and to purge the gun gases from the breech of the M61A1 nose gun. The equipment air conditioning system provides cooling air for the main radar package and communication-navigation-identification equipment. Both systems utilize high temperature, high pressure, 17th stage engine compressor bleed air from either or both engines.

### AIR CONDITIONING

The cockpit air conditioning system on the right side of the forward fuselage (figure 4-1) consists of two air-to-air heat exchangers, ground ejector, an expansion turbine, pressure regulator and shutoff valve, mixing valves, and a temperature control which allows a selection of cockpit conditioning temperatures, vent air temperatures, defogging, rain removal, and ram air operations. Individual temperature ranges and control systems for the vent air and cockpit are provided. High temperature, high pressure, engine compressor bleed air passes through the primary and secondary heat exchanger and is expanded (cooled) through the cooling turbine. After being mixed with hot compressor bleed air (as required by the temperature selection) it enters the cockpit through several manifolds, one near the front cockpit rudder pedals, one near the rear cockpit rudder pedals, one along the lower surface of each windshield side panel and one at the base of the flat optical panel of the windshield. Two eyeball type air nozzles are located just below the canopy sill on the right and left side of the rear cockpit.

### COCKPIT AIR CONDITIONING

The cockpit air conditioning system operation can best be explained by referring to the cockpit temperature schedule (figure 4-2). The lower temperature range (refer to the curve labeled foot heat) produces temperatures from  $-29^{\circ}\text{C}$  to  $38^{\circ}\text{C}$ . These temperatures refer to the inlet air and not cockpit temperature; therefore, cockpit temperature will be determined by a combination of inlet air and environmental conditions. The low temperature curve is the governing schedule for all air entering the cockpit while in automatic temperature control with the defog-foot heat lever in the LOW range. A little air is always entering through the defog port and this air increases (while foot heat air decreases) as the lever is moved forward. Until a switch is made, both defog and foot heat air enter on the low temperature schedule. The switchover to the high temperature curve occurs at approximately 50% of forward lever travel. This allows the pilot to use a greater portion of air for windshield defog while on the low temperature schedule, and affords the flight crew a greater degree of comfort. Thus full range on the auto rheostat (from 7 o'clock to 5 o'clock positions) will only produce  $-29^{\circ}\text{C}$  to  $38^{\circ}\text{C}$  air unless the defog-foot heat lever is moved into the HI range. When the switch is made, the temperature schedule of all entering air switches to the high temperature curve. Thus, if 3:00 o'clock were the knob position,  $31^{\circ}\text{C}$  would be the temperature of incoming air in the low temperature range, but when the switch is made, the temperature would change to  $58^{\circ}\text{C}$ . As the defog-foot heat lever is moved forward through full travel, the foot heat butterfly valves for both front and rear cockpits close as the defog valve opens. Thus the defog air volume increases on a rather steep slope, and when the lever is closed to full defog position (full forward), the

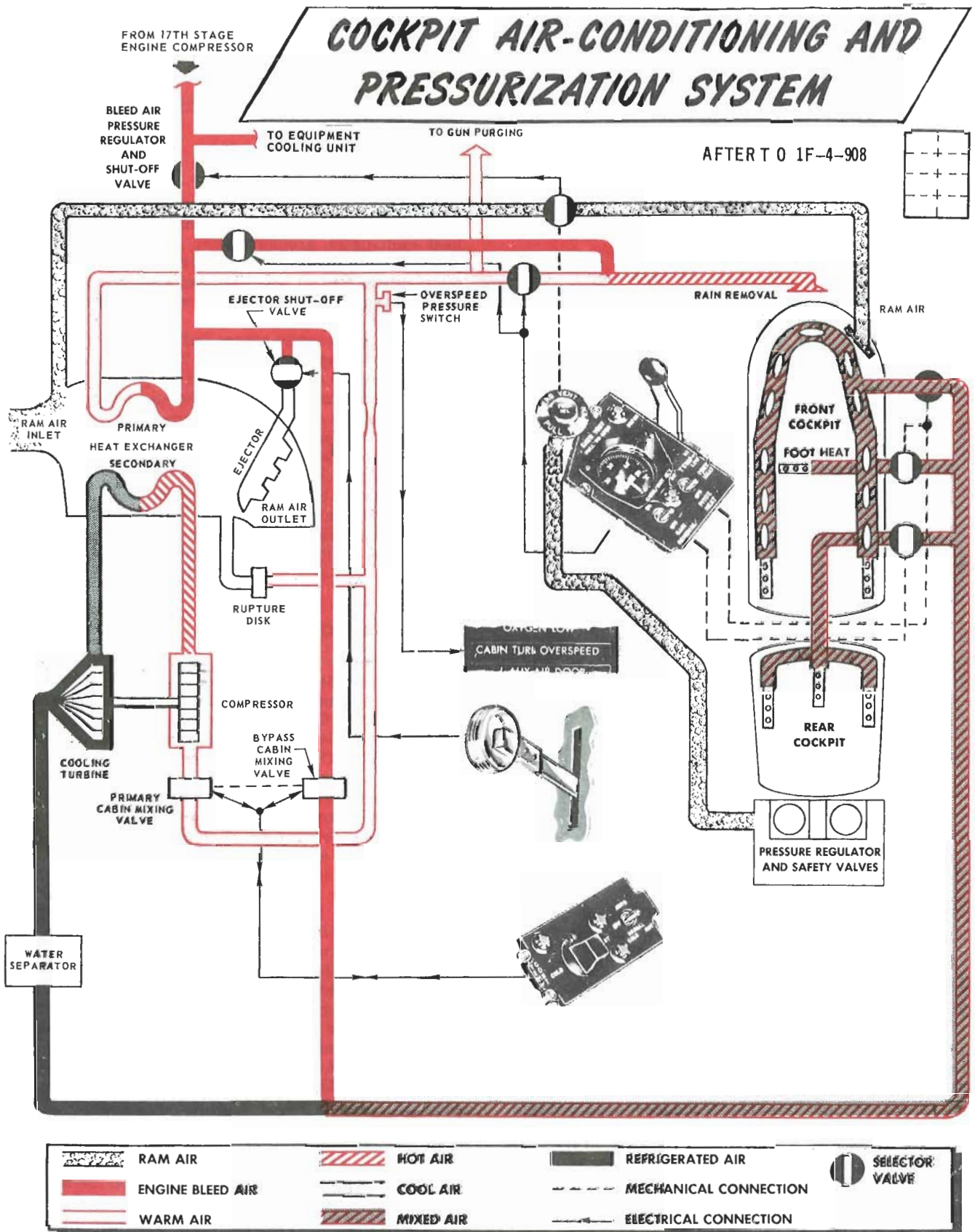
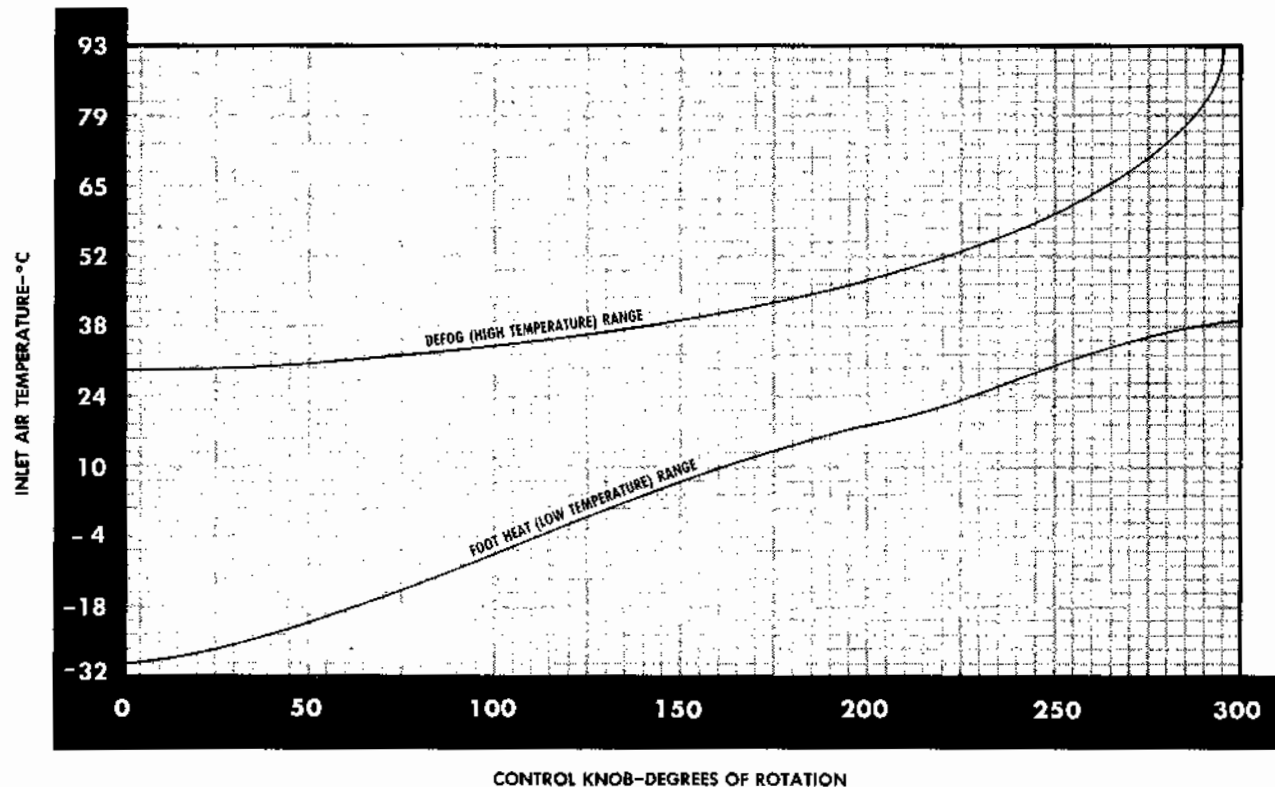
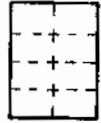

Figure 4-1

4E-1-(4)  
R



# COCKPIT TEMPERATURE SCHEDULE



4E-1-(20)

Figure 4-2

temperature of the air entering the cockpit is quite warm.

## Manual Override-Cockpit Temperature Mixing Valve

If the automatic temperature control system malfunctions, the manual position of the temperature control auto-manual switch can be used to select a full range of temperatures up to 110°C. The HI/LOW switch on the defog-foot heat lever is bypassed. Thus the entire temperature range for both foot heat and defog air is scheduled directly by the mixing valve position, which in turn is moved only when the temperature control switch is held to either HOT or COLD. The switch is spring-loaded to OFF and in the OFF position the mixing valve is held stationary. Should a failure in the automatic system warrant a manual override selection, ensure the switch is moved only in the direction of the desired temperature change. Movement in the opposite direction could cause extreme aircrew discomfort. Extremely hot conditions can be alleviated by pulling the emergency vent knob (below 25,000 feet), lowering the flaps, (aircraft without slats, below 220 knots), pulling the cockpit heat and vent circuit breaker or as a last resort, jettisoning the rear cockpit canopy.

## Anti-Exposure Suit Ventilation

Before TO 1F-4-908, the anti-exposure suit may be ventilated by connecting it to the pressure suit vent air outlet and controlling the vent air with the suit vent air knob. After TO 1F-4-908, anti-exposure suit ventilation is not available.

## Cockpit Fogging

It is possible, through selection of cold temperature settings, particularly on humid days, for the air conditioning system to deliver air at temperatures well below the dewpoint, with resultant cockpit fogging. This fog can be dissipated by selecting a slightly warmer temperature. When operating in high humidity conditions, it is recommended that a warmer than normal temperature be selected, prior to starting the takeoff run, to preclude the possibility of cockpit fogging as thrust is increased. Should cockpit fogging occur, the quickest means of eliminating this condition is by activating the emergency vent knob.

# COCKPIT PRESSURE SCHEDULE

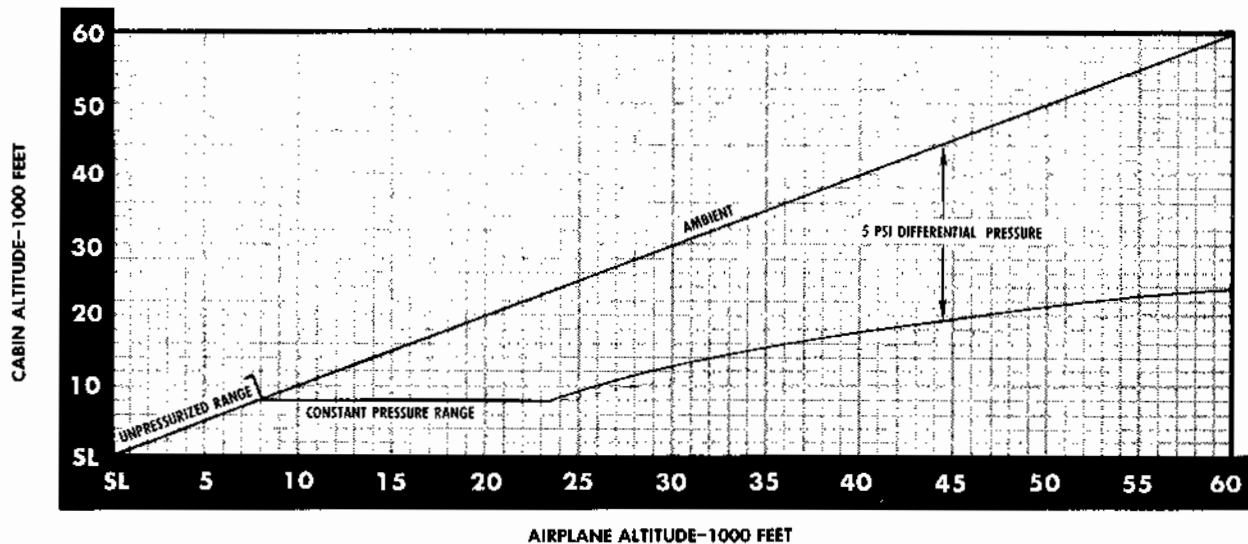
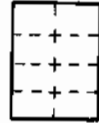

4E-1-(19)A

Figure 4-3

## COCKPIT PRESSURIZATION

With the canopy closed and the engine and cockpit refrigeration system in operation, the cockpit automatically becomes pressurized at an altitude of 8000 feet and above (figure 4-3). The pressure in the cockpit is maintained by a cockpit pressure regulator (located on the floor of the rear cockpit), which controls the outflow of air from the cockpit. Below 8000 feet, the regulator relieves cockpit air at a rate to keep the cockpit unpressurized. From 8000 feet up to approximately 23,100 feet, the regulator maintains a cockpit altitude of 8000 feet. From 23,100 feet and up, the regulator maintains a pressure differential of 5 psi between the cockpit altitude and airplane altitude. Operation of the pressure regulator is completely automatic. The cockpit safety valve is used to prevent the cockpit pressure differential from exceeding positive or negative differential pressure limits in case of a malfunction of the cockpit pressure regulator, and to provide an emergency means of dumping the cockpit air. The dump feature of the safety valve is pneumatically connected to a dump feature on the cockpit pressure regulator. The cockpit safety valve and cockpit pressure regulator, which are both operated pneumatically from a single control, have sufficient capacity to permit the cockpit differential pressure to be reduced from 5.5 psi to 0.05 psi within 5 seconds or less.

### Cockpit Pressure Indicators

The pressure altitude of the cockpit is indicated on a pressure indicator. The front cockpit pressure indicator is on the right console. The rear cockpit pressure indicator is on the left console. The cockpit pressure indicators are vented directly to cockpit pressure.

### Cabin Turbine Overspeed Indicator Light

The cabin turbine overspeed indicator light is on the telelight panel front cockpit. The light illuminates when the cooling turbine in the refrigeration unit is being subjected to pressures and temperatures in excess of normal operation. If possible, the aircraft speed and engine thrust should be reduced until the light goes out. If the light fails to go out, select ram air by pulling UP on the emergency vent knob. This diverts ram air into the cockpit and at the same time, shuts off bleed air to the air conditioning system, thereby stopping the cooling turbine.

### WINDSHIELD DEFOGGING

Fogging of the windshield is prevented by heating the inside surface of the glass with incoming cockpit air that is diverted into the defogging manifolds, located along the lower surfaces of the side and center windshield panels. The defog-foot heat lever provides selection of windshield defogging. The lever proportions the cockpit airflow between the footheat diffusers and windshield defogging tubes, such that, in the FOOT-HEAT position approximately 90% of the total cockpit airflow is delivered to the cockpit air distribution manifolds, and 10% through the windshield defog manifold. At the DEFOG position approximately 20% of the total airflow is delivered through the footheat manifolds, and 80% through the windshield defog manifold. Actuation of the high range temperature schedule is achieved only after the lever travel has moved approximately 50% of forward lever travel. The pilot should attempt to anticipate fogging conditions, so that, through proper management of temperature and airflow, it will not become necessary to subject the windshield and the crew to high temperatures and defog airflows which are required to clear an already

fogged windshield.

### Windshield Rain Removal

The rain removal system utilizes partially cooled air, taken from the cockpit air conditioning system, as its air/heat source. This air is 17th stage engine compressor bleed air which is bled off the cockpit air conditioning system after it passes through the air-to-air heat exchanger. Placing the rain removal switch to ON causes the rain removal valve to open, and allows the air to flow across the windshield center panel. The action of the rain removal air on the rain droplets breaks them up into small particles and pushes them off the windshield. Since the system uses bleed air, it will be most effective with the flaps up and the boundary layer control system inoperative. The rain removal system is adequate when flying through light rain, but is marginal when operating in moderate to heavy precipitation. The WINDSHIELD TEMP HI indicator light on the telelight panel and the MASTER CAUTION light illuminates if the windshield approaches a temperature which will cause optical distortion. The system must be turned OFF immediately upon illumination of the WINDSHIELD TEMP HIGH light. The rain removal system may require as much as 30 seconds after the switch is placed to OFF to shut down completely. If the rain removal system does not shut down normally, the system may be shut down by pulling up on the emergency vent knob. The temperature sensing control unit utilizes a bridge network to sense the high temperature condition. It is possible for the bridge to be improperly calibrated, in which case the light may illuminate during high Mach flight with the rain removal switch in the OFF position. In this case, the light may be disregarded. Use of the rain removal system during takeoff should be limited to those cases where visibility, due to precipitation, is a problem. The system should not be operated with a dry windshield except during ground checks.

#### CAUTION

- To prevent possible heat damage to the windshield, turn the rain removal system ON only when operation of the system is essential to safety.
- For a static ground check the system must be operated with the engines running at or below 80% rpm.
- Do not operate the rain removal system after takeoff under maximum power/supersonic conditions.

### EMERGENCY VENT KNOB

The cockpit may be cleared of smoke or fumes, and/or the cockpit air conditioning system may be shut down by pulling up on the emergency vent knob. When the emergency vent knob is pulled, all conditioned air to the cockpit, rain removal, and nose gun compartment is shut off; the cockpit pressure regulator dump valve is opened; and the ram air shutoff valve is opened. The emergency

vent knob is the quickest means to eliminate condensation (fogging) from the cockpit.

#### CAUTION

The emergency vent knob and the cockpit heat and vent circuit breakers are the only means of shutting down the cockpit air conditioning system when the engines are operating except for turning off both generators which should only be done in VMC conditions or as a last resort.

### COCKPIT HEATING PROCEDURE

1. Temperature control switch - AUTO
2. Temperature control knob - AS DESIRED  
Adjust the temperature control knob for any desired cockpit temperature.
3. Defog-foot heat control lever - AS DESIRED  
Adjust the defog-foot heat control lever for personal comfort and effective windshield defogging.  
A transient flow disturbance may occur if the defog-foot heat control lever is moved from one extreme to the other.

#### NOTE

If the automatic temperature control system fails, a temporary adjustment may be obtained by bumping the temperature control switch to the HOT or COLD position.

### WINDSHIELD DEFOGGING PROCEDURE

1. Temperature control switch - AUTO
2. Defog-foot heat control lever - DEFOG  
During cruise operations prior to letdown, place the defog-foot heat lever into the DEFOG position to preheat windshield and canopy surfaces.
3. Temperature control knob - AS DESIRED  
During cruise operations, prior to letdown, place the temperature control knob in the 2 o'clock position (200° of clockwise rotation) to increase the defog temperature for windshield and canopy preheating. For airplanes without slats, if the flaps are lowered for letdown and fogging persists, retract the flaps or increase power (use speed brakes as necessary to maintain airspeed) to provide higher defogging air flow.

### EQUIPMENT AIR CONDITIONING SYSTEM

The equipment air conditioning system, on the left side of the forward fuselage, supplies cooled air for electronic equipment cooling. The electronic equipment cooled by this system is; in the radar compartment in the nose, in the electronic equipment compartment aft of the nosewheel well, and in the electronic equipment shelf behind the rear cockpit bulkhead. The air conditioning system also supplies partially cooled air to the equipment auxiliary air system. The equipment air conditioning system utilizes a cooling (expansion) turbine and a

compressor, mounted at opposite ends of a common shaft. High pressure, high temperature 17th stage engine compressor bleed air is directed to the periphery of the cooling turbine after passing through an air-to-air heat exchanger. As the air passes through the turbine, it causes the turbine to rotate (and thus the compressor) while at the same time undergoing rapid expansion, with a resulting temperature and pressure drop. This air is then directed through the various equipment cooling circuits. Ram air enters the airplane at the forward left fuselage air scoop and splits into two parts. One part is directed through the compressor and the other through the air-to-air heat exchanger where it acts as a cooling media and thence to the ram air exit duct. The compressor performs two functions. It serves as the balance load for the turbine, while its exhaust is discharged through an ejector assembly located in the ram air exit duct. The purpose of the ejector is to ensure airflow through the ram air duct (and thus the air-to-air heat exchanger) during periods of low ram air pressure.

### Controls and Indicators

Control of the system is entirely automatic. The temperature is controlled at approximately 29°C from sea level to 25,000 feet and 4°C from 25,000 feet and up. Overtemperature conditions are sensed in the cooling duct and, should they occur, the air conditioning system will be shut down and the RADAR-CNI COOL OFF indicator lights in the front and rear cockpits, will be illuminated and emergency ram air cooling will be provided. Reset buttons, one for each cockpit, serve to reset the temperature limiter and to restart the air conditioning system. If the indicator light should illuminate, wait at least 15 seconds and if feasible, reduce power before depressing the Reset Button. If the light remains illuminated, no further attempt should be made to restart the air conditioning system. Avoid operation for prolonged periods with RADAR-CNI COOL OFF light illuminated unless operational necessity dictates otherwise. An impending failure/seizure of the equipment cooling turbine may be detected by moderate to severe vibrations and/or abnormal cockpit noises. The equipment cooling turbine may be shutdown by pulling the equipment cooling circuit breaker (B6, No. 3 panel). If maximum allowable cooling temperatures are exceeded, equipment life and/or reliability may be adversely affected.

### EQUIPMENT AUXILIARY AIR SYSTEM

The equipment auxiliary air system utilizes partially cooled air from the equipment air conditioning system. The air is 17th stage engine compressor bleed air which is bled off the equipment air conditioning system after it has passed through the air-to-air heat exchanger. The partially cooled air is distributed to the anti-G suits, front and rear canopy seals, air data computer, radar wave guide, WSO's radar scope, radio receiver(s)-transmitter, fuel system pressurization and the pneumatic system air compressor.

## ANTI-G SUIT SYSTEM

The anti-G system delivers low pressure equipment auxiliary air to the anti-G suits. The air is routed through the anti-G suit control valve and then to the suit. The suit remains deflated up to approximately 1.5 G. As this force is reached or exceeded, air flows into the suit in proportion to the G forces experienced. When the G force levels off to a constant, the suit remains inflated in proportion to the constant G force. As the G forces decrease, the suit begins to deflate, again in proportion to the decreasing G forces. A manual inflation button in the anti-G suit control valve allows the crewman to manually inflate his suit for purposes of checking the system or for fatigue relief. A pressure relief valve incorporated within the system is set to relieve at approximately 11 psi and is used as a safety back-up in the event of a malfunction. The system is automatic and operates any time an engine is running. The CSU-12/P anti-G suit has a dual purpose check valve installed in the suit connector. This check valve will automatically deflate the suit to about 1 psi when the suit hose is disconnected from the air source, providing rapid relief from an over-pressurized suit caused by a malfunctioning anti-G valve. The pressure remaining in the suit may provide G protection in the event the hose becomes disconnected; however, reconnect is necessary since the check valve provides for rapid bleed-down of the suit pressure. The valve will also prevent water from entering the suit, thereby providing an additional flotation device, should overwater ejection occur.

### WARNING

- Ensure that the anti-G suit hose is free and clear of all other cockpit equipment, so that in an emergency, quick detachment is possible.
- If the CSU-12/P or CSU-3/P anti-G suit fails to deflate after a maneuver, first check to determine that the suit hose has not become disconnected. If still connected, separate the connectors and the suit will automatically deflate to about 1 psi. Further deflation of the CSU-12/P suit or the CSU-3/P with water check valve installed is accomplished by depressing the ring on the end of the suit connector. Failure of the suit to deflate while connected to the aircraft pressure source will occur as a result of anti-G valve malfunction. The valve may be stuck in the open position and may be corrected by activating the manual press-to-test feature of the anti-G valve. The suit must be disconnected when this is accomplished.

## AUTOMATIC FLIGHT CONTROL SYSTEM (AN/ASA-32)

The automatic flight control system (AFCS) is an electro-hydraulic system designed to provide stable, accurate, and coordinated flight maneuvers without interfering with manual control. The automatic flight control system is capable of performing two modes of operation, stability augmentation and AFCS. Stability

augmentation improves airplane stability in pitch, roll, and yaw; it opposes any change of attitude but does not return the airplane to a given attitude or ground track. This mode of operation may be used while the aircraft is under manual control. Stability augmentation can be engaged individually or in any combination for pitch, roll, or yaw axis. The AFCS switch can be engaged with only the pitch stab aug switch engaged; however, to provide full AFCS operation, all three stab aug switches must be engaged. The AFCS mode of operation maintains any aircraft heading and/or attitude selected within the AFCS limits and corrects for any deviation from the selected heading or attitude of the aircraft within the AFCS limits. The altitude hold mode of operation holds any altitude selected while in the AFCS mode.

## STABILITY AUGMENTATION

In the stability augmentation mode of operation, the system senses motion about the longitudinal, lateral, and directional axes and acceleration along the lateral axis, by means of rate gyro and accelerometer sensors, respectively. All attitude changes cause these sensing devices to transmit signals representing the rate of change of motion about or along their respective axes. These signals are sent to servo valves in the control surface actuators. Therefore, any output signals from the rate gyro sensors, indicating yawing, pitching, or rolling motion, or from the lateral accelerometer indicating side slip, cause the automatic flight control system to position the appropriate control surface to oppose that motion. This action decreases any tendency of the airplane to oscillate in roll, yaw, or pitch, or to develop lateral forces which cause airplane slip or skid. In the stability augmentation mode, the rate gyros or lateral accelerometer send signals to the surface controls to oppose any deviation from selected flight attitudes but do not return the airplane to its original ground track or attitude. Stability augmentation can be obtained individually or in any combination for pitch, roll, or yaw axis by placing the pitch, roll, and yaw stab aug switches to the ENGAGE position.

## AFCS MODE

In the AFCS mode, the displacement gyro (pitch and roll) heading reference signals are used, in addition to the rate gyro sensor signals, to maintain the airplane in a desired attitude with maximum pitch, roll, and yaw stability. The AFCS system can be engaged and hold maneuvers and attitudes within a range of  $\pm 70^\circ$  pitch,  $70^\circ$  in bank and  $360^\circ$  in azimuth, providing the G limits are not being exceeded. Aircraft after TO 1F-4-1051, rapid stabilator movements, whether pilot induced or uncommanded, will cause the AFCS switch to disengage. The AFCS components are the AFCS panel, the control amplifier, force transducer, accelerometers, and rate gyro sensors. Equipment used in connection with AFCS operation are the attitude reference and bombing computer, air data computer, lateral series servos, directional series servo, and longitudinal servo.

## CONTROL AMPLIFIER

The control amplifier comprises the control center for the entire automatic flight control system. It receives the signals from the various sensing elements in the system and supplies power to the automatic flight control components.

## ATTITUDE REFERENCE AND BOMBING COMPUTER (AN/AJB-7)

The attitude reference and bombing computer provides the vertical and directional references for the AFCS. The directional reference is controlled by the compass controller on the front cockpit right console. With the compass controller in the SLAVED mode, the AFCS receives magnetic heading as a directional reference. The DG mode on the compass controller provides deviations from a manually-set heading as a directional reference to the AFCS. The COMP mode is an emergency mode of the AN/AJB-7 and an interlock is opened to prevent AFCS engagement. This prevents erratic magnetic heading signals from being applied to the AFCS. The AFCS is also disengaged when the mode selector on the compass controller is switched between SLAVED and DG, or when the reference system selector switch is switched between PRIM and STBY. However, the AFCS can be re-engaged after either of the controls has been switched to its new position.

## AIR DATA COMPUTER.

The air data computer performs two functions for the AFCS. First, it provides all required gain changes. This is necessary to maintain constant maneuvering rates, regardless of changes in airspeed and altitude. Second, it contains a clutched synchro which supplies the AFCS with a signal proportional to the deviation from the barometric altitude which existed when the altitude switch was placed in the engaged position. This signal is used by the AFCS to move the stabilator as necessary to maintain constant barometric altitude.

## FORCE TRANSDUCER

The force transducer senses the physical force applied to the control stick. This unit actually comprises the visible portion of the control stick with the stick grip mounted on top of it. The force transducer contains pressure sensitive switches which react to longitudinal and lateral stick forces. A lateral stick force of approximately 1.5 pounds closes a force switch. When a roll force switch closes the roll rate gyro signal in stab aug and the roll rate and attitude gyro signals in AFCS mode are cut out so that pilot initiated maneuvers are not opposed while in the AFCS mode. The pilot maneuvers the aircraft by mechanical linkages until the lateral stick force is reduced to less than approximately 1.5 pounds. At this time the roll channel is returned to normal AFCS operation. A forward stick force of  $3.75 \pm 0.25$  pounds or an aft stick force of  $2.55 \pm 0.25$  pounds closes switches to operate certain AFCS components, and cause a force sensing device to send a signal, proportional to the applied stick force, to the servo amplifier and stabilator position is controlled through the

AFCS. If the pitch or roll limits of the AFCS are exceeded ( $\pm 70^\circ$ ), the AFCS in effect, is disengaged, although the AFCS switch remains ENGAGED. Therefore, when the aircraft returns to within the limits of the AFCS, the AFCS is again engaged.

There is no stick force transducer in the rear cockpit. The AFCS and roll stab aug will oppose rear cockpit stick inputs. Do not fly the aircraft from the rear cockpit with AFCS engaged. Exercise care in transferring control between cockpits while rolling with roll stab aug engaged.

## ACCELEROMETERS

During AFCS mode, two accelerometers are utilized to insure proper functioning of the AFCS system. One of the accelerometers, a G limiting type prevents excess G loads from occurring as a result of AFCS operation. The other accelerometer is a lateral accelerometer which is used to perform coordinated maneuvers while in AFCS or stab aug operation.

### G-Limit Accelerometer

The normal load factor interlock (G - disengage) feature of the AFCS is designed to inhibit the system from commanding excessive load factors on the airplane. The system reverts automatically from whatever mode is engaged to stability augmentation in the event that plus 4 or minus 1 G is sensed by the G - disengage accelerometer switch. This switch is mounted forward on the radar bulkhead so that if the airplane is rotated rapidly into a maneuver, disengagement occurs at lower values of normal load factor due to the anticipation resulting from the forward location sensing a component of pitching acceleration. The G - disengage feature is inoperative outside the  $\pm 70^\circ$  limits of the autopilot.

### WARNING

The G switch does not disengage the autopilot under conditions of low airspeed or heavy gross weight before the aircraft stalls. If the autopilot remains engaged during a stall, the autopilot provides pro-spin controls.

### Lateral Accelerometer.

This accelerometer detects airplane skids or slips and produces error signals proportional to the lateral forces developed. These error signals cause the AFCS to take corrective action with the rudder to coordinate the maneuver being performed.

## SERVOS

The automatic flight control system contains four control servos which operate the aircraft flight controls during stability augmentation and AFCS operation. Two lateral series servos (one in each wing) operate the spoilers and ailerons. A directional series servo, on the rudder power

control cylinder, operates the rudder. A longitudinal servo, integral with the stabilator power cylinder, functions in series to operate the stabilator during stab aug operation. This same servo functions in parallel to operate the stabilator during AFCS operation.

### NOTE

With AFCS engaged (parallel mode), if a malfunction occurs this mode can be overpowered by exerting sufficient force on the control stick. The AFCS is then disengaged by depressing the emergency quick release lever.

## RATE GYRO SENSORS

Refer to Stability Augmentation Mode, previously discussed in this section.

## AFCS CONTROLS

The automatic flight control system panel is on the front cockpit left console. This panel contains all the controls for the normal operation of the flight control system.

### Stab Aug Switches

The three stab aug switches for pitch, roll and yaw are two-position toggle switches on the AFCS panel. Placing any one of these switches in the ENGAGE position establishes the stability augmentation mode for the axis selected. These switches can be engaged individually or in any combination for stability augmentation in pitch, roll, or yaw. The switches are lever lock type switches and the toggle must be lifted slightly before the switch position can be changed.

### AFCS Switch

The AFCS switch is a two-position toggle switch on the AFCS panel. The switch can be engaged with only the pitch stab aug switch engaged. However, for the AFCS mode to be fully effective, holding attitude and heading selected, all three stab aug switches must be engaged.

### Altitude Hold Switch

The altitude hold switch is a two-position toggle switch on the AFCS panel. The switch positions are ALT and ENGAGE. The altitude hold feature functions only if AFCS is engaged. Placing the switch to the ENGAGE position energizes an altitude sensor in the air data computer which is controlled by barometric altitude. As the altitude varies, an error signal is produced and fed to the pitch servo amplifier. The amplifier then sends a signal to the stabilator actuator which deflects the stabilator as necessary to return the aircraft to its hold altitude. The altitude sensor holds the aircraft within  $\pm 50$  feet or  $\pm 0.3$  percent of the reference altitude, whichever is greater, at speeds up to 0.9 Mach and at speeds greater than 1.0 Mach. Altimeter fluctuations while accelerating through the transonic range (0.9 to 1.0 Mach) will produce transient fluctuations which, although not violent, may cause the reference altitude to slip. Engaging the altitude

hold mode in climbs greater than 1000 feet per minute may result in a reference altitude other than the engage altitude.

### Emergency Quick Release Lever (AFCS)

A spring-loaded emergency quick release lever is on each control stick. This lever operates in the same manner from both the front and the rear cockpits. Depressing the lever causes the AFCS and altitude hold switch to return to OFF. The stability augmentation mode, ARI and anti-skid, are disengaged as long as the lever is held depressed. When the lever is released, the stability augmentation and ARI are again in operation, but the AFCS is no longer engaged. To permanently disengage the stability augmentation mode, the pitch, roll, and yaw stab aug switches must be placed off. To permanently disengage the ARI and anti-skid, the yaw stab aug switch must be off and the ARI circuit breaker, on the front cockpit left subpanel, must be pulled. On aircraft without slats an alternate method of permanently disengaging the ARI, which allows the anti-skid system and stab aug to remain operative, is to pull the rudder trim circuit breaker and leave stab aug ON.

### Autopilot Disengage Indicator Light

An AUTOPILOT DISENGAGE indicator light is on the telelight panel. After initial engagement of the AFCS mode, the AUTOPILOT DISENGAGE indicator light and the MASTER CAUTION light illuminates when the AFCS is disengaged. Both lights are extinguished by pressing the master caution reset switch. The lights remain extinguished until the AFCS is again engaged and disengaged.

#### NOTE

On aircraft before TO 1F-4-903, if PC-1 hydraulic pressure is lost or drops below 500 psi, the pitch axis in stab aug and AFCS is inoperative. If utility hydraulic pressure is lost or drops below 500 psi, the roll axis and the yaw axis in stab aug and AFCS are inoperative. In either case, the AUTOPILOT DISENGAGE light and the PITCH AUG OFF light do not illuminate. The CHECK HYD GAGES light and the MASTER CAUTION light illuminate at approximately 1500 psi. On aircraft after TO 1F-4-903, the stabilator auxiliary power unit supplies pressure to the stabilator actuator if PC-1 fails. Therefore, the pitch axis in stab aug and AFCS is inoperative only if the APU reject switch is placed to REJECT.

### Pitch Aug Off Indicator Light

The PITCH AUG OFF indicator light is on the telelight panel. The PITCH AUG OFF and MASTER CAUTION lights illuminate when power is on the airplane and the pitch stab aug switch is not engaged. Depressing the master caution reset button extinguishes the MASTER CAUTION light; however, the PITCH AUG OFF light remains illuminated until the pitch stab aug is engaged.

## AUTOPILOT PITCH TRIM

An automatic pitch trim feature is included in the AFCS which attempts to keep the airplane longitudinally trimmed to the flight conditions experienced while in AFCS mode. Thus, an out-of-trim condition (which would not be sensed while in autopilot mode) is prevented, ensuring against an excessive pitch transient when disengaging the autopilot. The automatic pitch trim operates at approximately 40% the speed of the normal trim system, resulting in a slight delay after changing flight conditions before the basic airplane is properly trimmed. During control stick steering maneuvering, the auto-trim is inoperative. Auto-trim operation can be observed on the pitch trim indicator after changing flight conditions in the AFCS mode.

### Autopilot Pitch Trim Light

An AUTOPILOT PITCH TRIM indicator light is on the telelight panel. This light illuminates during AFCS operation if the automatic pitch trim follow up is inoperative or lagging sufficiently behind airplane maneuvering to cause an out-of-trim condition in the basic airplane. Since (1) auto pitch trim rate is only 40% of normal trim rate, and (2) auto trim is inoperative anytime the stick grip transducer switches are made (i.e., during CSS maneuvering), it is possible to develop an out-of-trim condition in the basic airplane while maneuvering in the AFCS mode. However, this out-of-trim condition must exist for approximately 10 seconds before the AUTOPILOT PITCH TRIM indicator light illuminates, thus eliminating constant on-off light flickering. Momentary illumination of the light does not necessarily indicate a malfunction; however, if the light remains on and it is apparent from the pitch trim indication that the trim is not working, the pilot should realize that a pitch transient may be experienced when the AFCS mode is disengaged. Airspeed/pitch trim indicator relationship should provide an indication of the severity of the condition. If an out-of-trim condition is realized by the steady illumination of the AUTOPILOT PITCH TRIM indicator light, the pilot should grasp the stick firmly before disengaging the AFCS mode in anticipation of a pitch bump. However, before disengaging the AFCS following an automatic pitch trim malfunction, the pilot may elect to alleviate the out-of-trim condition by operating the manual trim button and observing the pitch trim indicator. If the out-of-trim condition is thus reduced to within 5 pounds of trim, the AUTOPILOT PITCH TRIM indicator light is extinguished. Illumination of the AUTOPILOT PITCH TRIM indicator light also illuminates the MASTER CAUTION light. Depressing the master caution reset button only extinguishes the MASTER CAUTION light, leaving the AUTOPILOT PITCH TRIM indicator light illuminated.

## NORMAL OPERATION

1. To engage the stability augmentation mode, place the pitch, roll, and yaw stab aug switches to ENGAGE.

**NOTE**

The stability augmentation mode can be selected individually or in any combination for pitch, roll, and yaw axis. The pitch stab aug switch must be engaged for the AFCS switch to energize. However, all three switches must be engaged for complete AFCS operation.

2. Trim aircraft in the stability augmentation mode before engaging AFCS mode.
3. To engage AFCS mode, establish an aircraft attitude within AFCS limits. Place the AFCS switch to ENGAGE.

**WARNING**

- Do not attempt to change pitch attitude of the aircraft from the rear cockpit in the AFCS mode. Since no force transducer is in the rear cockpit control stick, applying force will cause pitch trim to run up and down depending on pressure applied. If the pilot attempts to take control at that point, violent transients may be encountered.
- When selecting the AFCS mode, have hand on control stick to counteract any abrupt control movements in the event of an AFCS malfunction.
- Do not have the AFCS engaged when the bombing mode(s) are being used. These modes use the AN/AJB-7 and transients introduced into the attitude input of the AFCS at pull-up could cause pitch and/or roll oscillations.

**NOTE**

- Do not operate manual trim button while in the AFCS mode unless the AUTOPILOT PITCH TRIM light is illuminated. Use a small amount of manual trim to extinguish the AUTOPILOT PITCH TRIM light.
  - The pitch rate gyro, as utilized by the AFCS modes, inadvertently senses structural vibrations of the airframe and tends to amplify these vibrations by generating commands through the autopilot to the stabilator. These vibrations can become quite pronounced while flying at very low indicated airspeeds. There should be no cause for alarm if this phenomenon occurs and the vibration, or chatter, can be eliminated by reverting to stability augmentation mode or by increasing airspeed above approximately 190 to 200 knots.
4. When altitude hold mode is desired, place altitude hold switch to ENGAGE.

**NOTE**

- To change altitude when operating in altitude hold, use the control stick. This disengages the altitude hold circuits and the altitude hold switch moves to OFF. Re-engage altitude hold at the new altitude if altitude hold is desired.

- The AFCS is disengaged when the emergency quick release lever on the control stick is depressed. The stability augmentation and ARI are disengaged as long as the lever is held depressed but returns to operation when the lever is released.

**GENERATOR SWITCHING**

Power to the autopilot, air data computer, and the AJB-7 may be momentarily interrupted during the starting and stopping of the airplane engines or generators. When the right engine or generator is started with the left generator already on the line, the connection between the right and left main buses is momentarily opened to allow the right generator to come on the line. The stab aug switches are not solenoid held, and remain on without electrical power. The AFCS, AJB-7 and air data computer are not affected by starting or stopping the left engine or generator with the right generator on the line.

**NOTE**

If failure of the right generator occurs, disengage the stab aug switches prior to cycling the generator. This prevents the possible occurrence of control surface transients. Stab aug may be re-engaged with the right generator control switch retained OFF or stab aug may be re-engaged after the generator control switch has been returned to the ON position.

**OPERATIONAL PRECAUTIONS****Roll Reversal**

There is a possibility of a condition called roll reversal occurring when operating the automatic flight control system in the AFCS mode. This condition occurs infrequently and is apparent only when attempting small changes in bank angle. Roll reversal is associated with a small out-of-trim condition in the lateral channel, and is apparent as a slow rolling of the airplane in the opposite direction of the stick force. If, for instance, the airplane is out of trim laterally to the left when the AFCS mode is engaged, roll reversal may occur when right stick forces are applied. A roll reversal situation may be caused by operating the manual lateral trim button while in the AFCS mode, followed by small stick forces being applied opposite to the direction of the trim. There is a possibility of roll reversal occurring even if the airplane has been trimmed prior to engaging the AFCS mode, and the manual trim button has not been touched. This condition is caused by changes in airplane trim accompanying changed flight conditions. In view of the above, the following instructions should be observed:

1. Trim airplane in stability augmentation mode before engaging AFCS mode.
2. Do not operate manual trim button while AFCS mode is engaged. If roll reversal is encountered due to change in flight condition; disengage roll, retrim, then reengage.



## Pitch Oscillations

When using the altitude hold mode, the aircraft may experience pitch oscillations in the transonic regions due to fluctuations in the air data computer airspeed system. The nature of these oscillations vary from stick pumping to divergent pitch oscillations. It is recommended that if pitch oscillations occur at transonic speeds, the following corrective steps be attempted:

1. AFCS switch - DISENGAGE
2. Static pressure compensator switch - OFF
3. AFCS switch - ENGAGE
4. Engage altitude hold mode

If the oscillations persist after the above action, or if they are encountered at supersonic speeds:

1. Disengage altitude hold mode.

### WARNING

Divergent pitch oscillations should not be allowed to develop. If any divergent pitch activity is noted, corrective action should be taken immediately.

## INERTIAL NAVIGATION AND ATTITUDE-HEADING REFERENCE SYSTEM

The system consists of two separate gyro reference components and a navigation computer. The inertial navigation set AN/ASN-63 supplies the primary azimuth and attitude reference, and in addition supplies direction, velocity, and distance inputs to the navigation computer. The INS also supplies aircraft attitude, true heading, velocities, and height above sea level to the Weapons Release Computer Set (WRCS). The AN/AJB-7 is the standby attitude reference and in addition supplies information for LABS and LADD bombing maneuvers. The AN/AJB-7 is also used in conjunction with the WRCS.

### INERTIAL NAVIGATION SET

The inertial navigation set (INS) is a self-contained, fully automatic unit which uses a gyro stabilized (inertial) platform upon which are mounted three sensitive accelerometers. During alignment, the sensitive axes of the accelerometers are aligned through interaction of the accelerometers and gyros; one is aligned to the north-south axis, one to the east-west axis, and one to the vertical axis. With the platform stabilized in pitch and roll by gyros, and oriented to true north, the accelerometers sense acceleration in any direction. This acceleration is integrated by a computer to produce velocity (ground speed), course, and distance traveled. The AN/ASN-63 contains circuitry to correct for apparent precession, based on the latitude of the INS position. The AN/ASN-63 provides navigation and attitude information to various

aircraft systems, and in addition provides output signals to the WRCS, Lead Computing Optical Sight System and Radar.

### Inertial Navigation System Out Lights

The INERTIAL NAV SYS OUT lights, on the front cockpit right subpanel, and on the rear cockpit main instrument panel, illuminate when the INS is in OFF, or a malfunction has occurred. If the set is operating normally, the lights extinguish when the power control knob is placed to the STBY position.

### Inertial Navigation Control Panel

The inertial navigation control panel provides the controls for operating the inertial navigation set. The controls include a power control knob with positions of OFF, STBY, ALIGN and NAV; and an align mode switch with positions of HDG MEM and GYRO COMP. The mode selector knob controls system operation. The STBY position applies power to bring the inertial platform up to operating temperature as indicated by the illumination of the amber HEAT light. The HEAT light goes out when the unit reaches operating temperature. The ALIGN position is selected for stabilization of the platform and alignment to true north. The sequence of alignment is indicated by the green ALIGN light. The NAV position is selected after the align phase is completed (as noted by the green ALIGN light flashing) and is the normal operating position for the inertial navigation set. The align mode switch determines the method of alignment. The Gyro Comp alignment is the most accurate means of aligning the system. The HDG MEM alignment is used for aircraft on alert or under possible scramble situations. Heading information obtained from a previous gyro compass alignment is maintained in the system after the set is turned off.

### ALIGNMENT PROCEDURES

During the align sequence of the inertial navigation set, the compass system is automatically in the compass mode and the horizontal situation indicator and bearing distance heading indicator compass cards read magnetic heading directly from the flux valve. ADI azimuth information is not usable. If the wings are folded, the flux valve reading is not accurate and a greater magnetic variation is required to realize a variation synchronization on the navigation computer control panel. The reason is that in the wings folded position condition, the flux valve which is in the left wing, is oriented about 60° from its proper position. If the magnetic variation of the local area is not used, gyro compass alignment takes longer to complete. Before aligning the inertial navigation set, place the navigation computer function selector knob to STBY, the position update switch to NORMAL, the variation counter to the local magnetic variation, and the position counter to the local latitude and longitude.

## Gyro Compass Alignment

The gyro compass mode of alignment is the most accurate means of alignment, with a 3 nautical miles of error per hour of circular error probability (CEP). However, it requires a longer period of time to accomplish than the other modes. To gyro compass align the system, place the align mode switch to GYRO COMP and then the power control knob to STBY. The amber HEAT light then illuminates. The cold start feature of the system enables the gyros to spin during standby and heat the system more evenly, therefore obtaining greater system accuracy. Coarse alignment is accomplished during the heating cycle. The time required for the system to reach operating temperature (160°F) is determined by the ambient temperature. The system warms up at the rate of at least 20°F per minute. When the HEAT light goes out, place the power control knob to ALIGN. There is a heat delay in the computer of 110 seconds after the system reaches operating temperature, and the HEAT light extinguishes after this time delay has elapsed. Gyro compass alignment cannot be accomplished until the HEAT light has extinguished. If the HEAT light illuminates again during the align phase, continue with the alignment, but make an entry in the AFTO Form 781. Completion of Best Available True Heading Alignment (BATH) is indicated by illumination of the green align light. This light comes on after 75 seconds. When the align light illuminates gyro compass alignment has commenced. The time for completion of the gyro compass alignment cycle varies due to the error present after BATH alignment. When the axis of the platform reaches within 10 arc minutes (1/6°) of true north, a flasher circuit delay energizes to ensure the system maintains alignment. The duration of the delay is 50 seconds and the align light does not flash indicating completion of gyro compass alignment until the delay has elapsed. The system should be left in the ALIGN mode as long as possible for greater system accuracy. The power control knob is then placed to NAV for system operation and the align light goes out. The heat or align light is not functional in the NAV mode.

### Best Available True Heading Alignment

If operational considerations dictate, the time required to align the INS can be reduced, with a corresponding reduction in INS operational accuracy, by performing a Best Available True Heading (BATH) alignment. A normal Gyro Compass alignment is accomplished up to a steady green ALIGN light. With the ALIGN light on steady, instead of waiting for the light to flash, place the power control knob to NAV. Since the set was not allowed to complete gyro compass alignment (precise alignment with true north) accuracy of the INS outputs is reduced. The degree of inaccuracy cannot be predicted; however, a 5½ nautical mile per hour circular error probability can normally be expected, but greater inaccuracies are not uncommon.

#### NOTE

A BATH alignment should not be used when the aircraft is in a hangar, near any large metal objects (power carts, etc.), or when the wings are not spread and locked. Gyro compass alignment should be used whenever the aircraft magnetic heading signal is unreliable.

## Heading Memory Alignment

Heading memory alignment is used when minimum alignment time is required and provides a 5½ nautical mile per hour circular error probability. If heading memory alignment is accomplished within 2 hours after a gyro compass alignment has been performed, the heading memory alignment accuracy approaches gyro compass accuracy. Prior to heading memory alignment, a gyro compass alignment must have been performed through the flashing of the ALIGN light indicating that the system is aligned. The power control knob must be left in ALIGN until after placing the align mode switch to HDG MEM. The power control knob is then placed to OFF or STBY. From this time until the completion of the heading memory alignment, the aircraft must not be moved. When the unit is shut down in the heading memory mode, the platform retains the true north information obtained from the above procedure. To align the unit by the heading memory method, the align mode switch is in the HDG MEM position. The power control knob is placed to align mode until the align light flashes and then to NAV. If time permits, the system may be placed in the STBY mode until the heat light is extinguished, and then to ALIGN for greater system accuracy.

### Inflight Alignment Procedure

An inflight alignment of the INS platform may be accomplished to provide attitude information to the Attitude Director Indicator. Navigation information from the INS is unusable since the aircraft is moving when this alignment is performed. To perform the procedure, first fly the aircraft straight and level. Cycle the power control knob to OFF, to STBY for 15 seconds, then to NAV. The length of time the primary attitude is usable after an inflight alignment is not predictable. Subsequent alignments may be required.

## ATTITUDE REFERENCE SYSTEM

The AN/AJB-7 is a two gyro all attitude reference platform which supplies standby azimuth information to the attitude director indicator, the horizontal situation indicator, and the bearing distance heading indicator. Additionally, the AN/AJB-7 supplies standby attitude information to the attitude director indicator. It also provides a standby attitude horizon for the front and rear cockpit radar indicators. The rear cockpit remote attitude indicator, the autopilot, and the bombing computer receive attitude information from the AN/AJB-7 at all times.

### Compass Controller

The compass controller provides the controls and indicator necessary for proper operation of the azimuth system. The mode selector knob initiates the proper relay switching in the compass adapter compensator to select the operating modes (compass, DG and slaved). The SYNC position of the mode selector knob, spring-loaded to return to the SLAVED position, is used for fast synchronization of the compass flux valve and the azimuth reference system. The degree of synchronization is indicated by the sync

indicator meter. The set heading control knob, spring-loaded to return to the center or zero position, manually adjusts the azimuth setting of the ADI, HSI and BDHI. When operating the compass system using the AJB-7 directional gyro (STBY selected on the reference system selector switch and DG on the mode switch), corrections for gyro precession are required to maintain system accuracy. Compensation is provided by the hemisphere switch (N-S) and the latitude control when they are set to the local hemisphere and latitude respectively.

## REFERENCE SYSTEM SELECTOR SWITCH

The reference system selector switch on the ADI provides selection between the inertial navigation set and the AN/AJB-7 displacement gyroscope as the source of attitude information. The following inputs are provided by the inertial navigation set when the reference system selector switch is in PRIM, or by the AN/AJB-7 when the switch is in STBY.

- a. Azimuth and attitude information to the attitude director indicator.
- b. Azimuth information to the horizontal situation indicator.
- c. Azimuth information to the bearing distance heading indicator (rear cockpit).
- d. Attitude information to the fire control system.

### NOTE

Primary (inertial) information is not available unless the selector switch on the inertial navigator control panel is in the NAV position.

When switching from STBY to PRIM or vice versa, attitude information appears almost immediately but may be accompanied by some unusual gyrations of the attitude director indicator. This phenomenon is a simultaneous large gyration about all three axes after which normal attitude reference is displayed. Whether or not this occurs is determined by which side of the AJB-7 is uppermost during the initial erection. Accurate heading information may not be immediately available when switching between PRIM and STBY, if the aircraft is in a turn having a turn rate of more than 15° per minute. In this condition, the fast synchronization feature of the compass is cut out. This is done to prevent erroneous heading errors resulting from turning errors which are generated in the flux gate compass. Switching between PRIM and STBY under the preceding conditions can result in random erroneous heading information. To correct this situation, the aircraft must be flown straight and level (rate of turn less than 15° per minute) for approximately 20 seconds and then manually synchronized by placing the compass controller mode switch to the SYNC position.

### NOTE

The pilot may fast erect the AN/AJB-7 gyro platform by selecting the FAST ERECT position on the gyro switch. This applies an electrical cage signal to the gyro caging mechanisms. As the caging signal is applied, the aircraft should be in level, non-accelerating flight. The switch must not be held in FAST ERECT for more than 60 seconds or damage to the gyro may result.

## OPERATING MODES

### Compass Mode

The compass mode is considered an emergency mode. When the reference systems are not usable because of malfunctions, the compass mode provides a source of magnetic heading information to other aircraft systems. However, the interlock with the AFCS mode of operation of the automatic flight control system is automatically opened in the compass mode to prevent erratic magnetic heading signals from being applied to the autopilot. Also, the attitude director indicator azimuth indications should not be used since it is still connected to the malfunctioning reference system. To place the attitude reference system in the compass mode proceed as follows:

1. Mode switch on the compass controller - COMP

### DG Mode

The DG mode is used in north and south latitudes greater than 70° and in areas where the earth's magnetic field is appreciably distorted. When the DG mode is initially selected, the magnetic heading of the aircraft must be set into the system with the set heading control on the compass controller. The system then uses this reference for subsequent heading indications. Apparent drift compensating voltages are inserted by use of the hemisphere switch (N-S) and latitude control on the compass system controller when operating with the reference system selector switch in the STBY (AN/AJB-7) position. However, when operating with the reference system selector switch in the PRIM (inertial) position, the latitude control knob must be set at zero, as a heading error is induced in the system if the control knob is set at any other value. To place the reference system in the DG mode proceed as follows:

1. Mode switch on compass controller - DG
2. Hemisphere switch - LOCAL HEMISPHERE
3. Latitude control knob - ZERO (with reference system selector switch in PRIM) - LOCAL LATITUDE (with reference system selector switch in STBY)
4. Aircraft magnetic heading - SET  
Set aircraft magnetic heading on the HSI, using the set heading knob.
5. Readjust the latitude control knob for each 2° change in latitude, if operating the reference system selector in STBY.

### Slaved Mode

The slaved mode is the mode ordinarily used under normal conditions. In the slaved mode, the azimuth system is primarily controlled by signals from the compass transmitter (flux valve). Because system accuracy, is now dependent upon the earth's magnetic field, the slaved mode should not be used in latitudes greater than 70° and in areas where the earth's magnetic field is distorted. To place the reference system in the slaved mode proceed as follows:

1. Mode switch on compass controller - SLAVED
2. Sync indicator meter - CHECK  
Allow 10 seconds for automatic fast synchronization and check the sync indicator meter for a center-scale indication. Slight deviation of the needle from the center position is corrected by normal sync.
3. Pitch trim control on ADI - ADJUST  
Adjust the pitch trim control on the ADI for zero pitch attitude.

## EMERGENCY ATTITUDE REFERENCE SYSTEM

The emergency attitude reference system operates independently of other systems. The system provides indications of aircraft pitch and roll attitude during normal operation and continues to provide reasonably accurate information ( $\pm 6^\circ$ ) for 9 minutes if power to the system is lost and the OFF flag is in view. The system contains a standby (emergency) attitude indicator (SAI) inverter and circuit breaker. The system is powered by the aircraft battery.

### EMERGENCY ATTITUDE INDICATOR

The emergency attitude indicator is a 2-inch self-contained instrument on the main instrument panel in the front cockpit. Except for the gyro spin motor and the indicator lights, the unit is entirely mechanical. The indicator includes an attitude sphere similar to the ADI, an OFF flag, and a pull to cage knob. The upper portion of the attitude sphere consists of a gray area which is always in view to indicate the direction of up or skyward. Power to the system should be applied at least 1 minute before pulling the cage knob. The pitch attitude markings on the sphere are in graduations of  $5^\circ$ , and the roll markings are in graduations of  $10^\circ$  with the larger markings indicating each  $30^\circ$ . The presentation on the indicator consists of a miniature airplane viewed against a rotating sphere. The indicator displays aircraft roll through  $360^\circ$ . Pitch is limited by mechanical stops set at  $92^\circ$  in climb and  $78^\circ$  in dive to prevent gimbal lock. As the aircraft climbs or dives to the mechanical stops, the pitch attitude changes smoothly until the stop is reached. The indicator sphere then tumbles  $180^\circ$  in roll to display the inverted position as the aircraft pitch attitude increases toward the inverted flight position. The indicator OFF flag appears if there is a power failure, or if the pull to cage knob is pulled. When the knob is pulled during initial erection, the emergency attitude indicator erects to  $0^\circ$  in pitch and roll regardless of the aircraft attitude. The knob also provides pitch trim in climb or dive. Rotating the knob clockwise or counterclockwise moves the miniature airplane up or down  $5^\circ$ . It is possible to lock the emergency attitude indicator gyro in the caged position by pulling the knob out and then turning it clockwise to engage the detent.



Do not lock the gyro in the caged position with the pull to cage knob if the gyro is spinning. Damage

to the gyro might occur if it is moved while in the caged position. If the knob is in the locked position, it must be pulled out to clear the detent before it can be turned counterclockwise. The pull to cage knob should always be pulled back gently and released without being allowed to snap back.

### EMERGENCY ATTITUDE INDICATOR (SAI) INVERTER

The SAI inverter is above the right console in the front cockpit. This unit contains one circuit breaker labeled AI PWR and an intensity control knob labeled LTG. The circuit breaker must be engaged for power to be supplied to the gyro motor. The intensity control knob varies the intensity of the lights on the face of the emergency attitude indicator.

### EMERGENCY ATTITUDE INDICATOR OPERATION

To initially erect the emergency attitude gyro, pull the cage knob out and hold until the indicator displays  $0^\circ$  in pitch and roll. Release the knob and within 3 minutes the gyro will be fully erected. Adjust the miniature airplane level with horizon bar. After the aircraft is in flight and in a wings level attitude, rotate the cage knob to adjust the miniature airplane on the indicator to the desired pitch position. The mechanical erecting mechanism will drive the indicator to the desired position at the rate of  $3^\circ$  per minute. Do not recage the gyro.

#### NOTE

Recage the gyro only when large errors are present. Large errors can be induced by more than  $10^\circ$  banks for such a period of time that an error of more than  $10^\circ$  is present which locks out the erecting mechanism. If recaging is necessary, attain a wings level attitude, recage the gyro and maintain the level attitude for 2 minutes after caging.

## NAVIGATION COMPUTER SET AN/ASN-46A

The AN/ASN-46A navigation computer set contains both a great circle and a rhumb line computer. The great circle computer is utilized at ranges of greater than 120 nautical miles. At  $120 \pm 10$  nautical miles, the set automatically switches to rhumb line computations. The navigation computer consists of a control panel and an amplifier computer. The set may be operated with the INS turned OFF (Air Data Mode). Readouts available from the navigation computer are the same in either mode, but more accurate in the inertial mode. When operating in the inertial mode, all inputs necessary for the operation of the navigation computer are supplied by the INS except initial aircraft position, initial magnetic variation, and the desired target coordinates, which must be provided by the operator. In the air data mode, the operator must continuously provide the navigation computer with true wind direction and velocity, magnetic variation, and desired target coordinates. True airspeed is provided by the air data computer (ADC); magnetic heading comes

from the compass system. If a failure of the INS occurs, the navigation computer automatically transfers to the air data mode, which is indicated by the illumination of the AIR DATA MODE light on the computer control panel. The navigation computer provides the aircrew with the following readouts:

- a. Aircraft present position in latitude and longitude, based on INS information in the inertial mode or dead reckoning computations in the air data mode.
- b. The continuous great circle (over 120 NM) or rhumb line (under 120 NM) bearing and distance to either of two preset targets.
- c. Aircraft ground speed.
- d. Aircraft magnetic ground track.
- e. Aircraft drift angle (magnetic heading relative to magnetic track).

Accuracy of the present position readout in the inertial mode is 3 nautical miles per hour, or less, circular error of probability. In air data mode, the accuracy of the present position readout depends primarily on the accuracy of the wind and magnetic variation information provided manually by the operator. Assuming correct wind and magnetic variation information, the accuracy of the equipment in air data mode is as follows:

- a. Present position latitude (between 72° N or S latitude)  $\pm 17$  nautical miles per hour of operation.
- b. Present position longitude (between 72° N or S latitude)  $\pm 27$  nautical miles per hour.

For purposes of discussion, the navigation computer can be divided into two functional sections; a present position computer, and a course and distance computer.

### PRESENT POSITION COMPUTER

In the inertial mode, the present position computer functions to provide a readout of aircraft position in latitude and longitude. Prior to flight, the operator sets the initial position into the navigation computer present position counters. During alignment, these coordinates are also inserted into the INS. As the aircraft moves in any horizontal direction, the navigation computer receives change in latitude and longitude signals from the INS. The changing latitude and longitude signals are used to drive the present position counters, thereby continuously reflecting the aircraft's present position. In air data mode, the present position computer uses true airspeed from the ADC, wind and magnetic variation information manually set by the operator, and magnetic heading information from the compass system to compute ground speed and true course traveled. Ground speed is integrated with time to attain distance, which is converted to a change in latitude and longitude. The changing latitude and longitude is reflected in the present position counters, thereby providing a continuous dead reckoning aircraft position.

### COURSE AND DISTANCE COMPUTER

The basis of course and distance computation at ranges greater than 120 nautical miles (great circle computer) is the solution of the spherical triangle, formed on the

earth's surface by the geographic north pole (true north), the present position, and the preselected target or memorized coordinates. The rhumb line computer solves a plane right triangle whose known sides are the latitude and longitude difference between the present position and the selected target or memorized coordinates. The system automatically switches from great circle computations to rhumb line computations when the great circle range to the selected target is 120  $\pm 10$  miles.

### NAVIGATION COMPUTER CONTROL PANEL

The navigation computer control panel contains all controls and counters necessary for the operation of the navigation computer.

#### Function Selector Knob

The function selector knob is a five-position rotary switch with positions of OFF, STBY, TARGET 1, TARGET 2, and RESET. The OFF position removes all power from the system. The STBY position supplies filament voltage to the amplifier computer but the latitude and longitude integrator channels of the system are inoperative. The TARGET 1 position selects readouts of range and bearing to preselected coordinates set on the target counters. The TARGET 2 position selects range and bearing readouts referenced to memorized coordinates. The RESET position is used to place any desired set of coordinates into the memory circuits. Placing the knob to RESET causes the previously memorized coordinates to be lost. Moving the knob from RESET to any other position causes the coordinates appearing on the target counters to be memorized. A restriction on the knob prevents accidental switching to OFF or RESET. The knob must be pulled out slightly to override this restriction.

#### Wind Control Knobs

The wind control knobs consist of the wind speed and the wind from control knob. The wind speed control knob is used to manually insert the wind speed affecting flight into the system and is displayed on the wind speed counter. The wind from control knob is used to manually insert the true wind direction.

#### Magnetic Variation Control Knob

The magnetic variation control knob is used to manually insert the magnetic variation angle into the system.

#### Position Control Knobs

The position control knobs are used to manually insert present position latitude and longitude to establish an initial fix for the dead reckoning function of the navigation computer or as a reference for INS alignment. The position latitude and longitude counters continuously indicate the aircraft present position in degrees and minutes during flight.

## Target Control Knobs

The target control knobs serve two purposes; one is to insert any desired set of coordinates (base, alternate target, or destination point) into the memory circuits of the system, the other is to manually insert the target latitude and longitude into the system. The system provides output displays to fly to memorized coordinates when the function selector knob is placed to TARGET 2, and to the coordinates appearing on the target counters when the function selector knob is placed to TARGET 1.

## Position Update Switch

The position update switch is used to update the position latitude and longitude during flight. The switch positions are SET, NORMAL, and FIX.

## Variation Sync Meter

The variation sync meter indicates the error in the manual magnetic variation setting during the inertial mode. Rotating the variation control knob in the appropriate direction centers the vertical bar in the variation sync meter, indicating that the correct magnetic variation is set on the variation counter. Rotation of the variation control knob in the air data mode has no effect on the meter.

## Test Cap Off Light

This light illuminates when the test cap on the front of the amplifier-computer is not properly connected, or when the true airspeed circuit from the air data computer is open. Either condition will only affect computer operation in the air data mode.

## Latitude and Longitude Sync Lights

The LAT and LONG sync lights illuminate when the latitude and longitude position counters do not agree with the inertial navigation set latitude or longitude output.

## NAVIGATION COMPUTER OPERATION

All control knobs required to operate the navigational computer are on the computer control panel. To simplify the procedure, it should be understood that where a counter setting is specified, the control knob associated with the particular counter is rotated to set the counter. In the case of the position latitude and longitude counters and the magnetic variation counter, the associated control knobs must be pressed in to engage them with their respective counters before they can be rotated effectively. To set the flight plan into the navigation computer, proceed as follows:

1. Place function switch to STBY.
2. Set magnetic variation counter to local magnetic variation.
3. Set wind from and wind speed counters to true wind

direction and wind speed that affects the flight, to facilitate operation in the air data mode if necessary.

4. Place position update switch to NORMAL.
5. Set the local latitude and longitude in the present position counters.
6. Set target counters to the target 2 latitude and longitude coordinates (if an alternate target or destination is desired).
7. Place the function selector knob to RESET.  
Target 2 coordinates will be memorized and stored in the computer.
8. Place the function selector knob to STBY.
9. Set target counters to the target 1 latitude and longitude.
10. When aircraft leaves starting point, place function selector knob to desired operating mode.

## OUTPUT DISPLAYS

The navigation computer display information in the front cockpit is shown in section I. To display navigation computer information on the BDHI, select the NAV COMP position on the navigation selection switch. The display information on the BDHI is as follows:

- a. Magnetic bearing to target or base displayed on No. 1 pointer when read against the compass card. A relative bearing to the target or base can also be read by noting the number of degrees from the index clockwise to the No. 1 pointer.
- b. Magnetic ground track displayed on No. 2 pointer when read against the compass card. Left or right drift angle can also be read by noting the number of degrees left or right from the index.
- c. Distance to the target or base displayed on the range counter.
- d. Magnetic heading when compass card is read under the index.

To travel the great circle route to the target or base, the aircraft should be flown on a course that causes the bearing and track pointers to be coincident. However, it is not necessary to fly the course shown by the coincidental pointers. Departure from the route may be made, as a part of evasive maneuvers or to fly a search pattern, without affecting the operation of the system. Since computations are being made continuously, the current position of the airplane is shown at all times on the position counters regardless of the path flown. As the target (or base) is approached, the distance on the range counter decreases. When the target is reached, uncertainty is exhibited by the No. 1 pointer which turns 180° as the target is passed in order to indicate bearing to target.

## Updating Methods

The position counters should be checked and updated at each opportunity by one of the following methods:

- a. VISUAL/RADAR reference to a geographical position. Adjust the position latitude and longitude to agree with the latitude and longitude of the VISUAL/RADAR fix. This latitude and longitude may be obtained from maps, charts, or publications.

b. TACAN fix. Set the latitude and longitude of the acquired tacan station in the target counters or in base memory. Adjust the present position counters so that the No. 1 pointer and range counter on the BDHI agree with the tacan readout.

c. GCI or radar monitored fix. Set the latitude and longitude of the controlling agency in the target counters or in base memory. Adjust the position counters so that the No. 1 pointer and range counter on the BDHI agree with the bearing and distance provided by the controller.

### Updating Procedures, Inertial Mode

Aircraft present position (represented by the position latitude and longitude counters) may be updated in the inertial mode as follows:

a. A few minutes before reaching the point of known coordinates, pull outward on the position update switch and place it to SET. This disengages the position latitude and longitude counters.

b. Rotate the position latitude and longitude control knobs until the coordinates of the approach point appear in the position latitude and longitude counters.

c. Place the position update switch to FIX and hold in this position.

d. When exactly over the known point, release the switch; it is spring-loaded and returns to the NORMAL position, completing the updating procedure.

The inertial navigation set updates at a rate of approximately 3 minutes of latitude and 3 minutes of longitude per second. For example, if the latitude was changed by 5 minutes and the longitude was changed by 15 minutes, the longitude change would determine the amount of time the position update switch must be held in FIX position. In this example, the position update switch must be held in the FIX position for a minimum time of 5 seconds prior to reaching the known point, otherwise the INS is only partially updated. When the position update switch is moved from SET to FIX, it must pass through NORMAL position. A time delay circuit in the computer control panel prevents the position counters from going to normal operation for about one-half second. Therefore, the switch movement from SET to FIX must be a smooth continuous movement in order to prevent an unwanted interval of NORMAL operation.

### Updating Procedures, Air Data Mode

The aircraft present position may be updated in the air data mode by either of two methods. One method of updating is to rotate the position latitude and longitude control knobs until the coordinates of the aircraft actual present position appear in the position latitude and longitude counters. This may be accomplished with the function selector knob in any position except RESET or OFF. The other method utilizes the position update switch and has the advantage that the navigation computer may be instantaneously updated when the aircraft is over the point of known coordinates.

### Leap Frog Operation

A leap frog type of operation may be used wherein the aircraft is normally flown in TGT 2 toward a memorized point. While enroute, the next point is set on the target counters. When the first destination (the initial TGT 2) is reached, the function selector knob is momentarily moved to RESET and then to TGT 2. When this is done, the target counter settings are transferred to the memory circuits and the coordinates of the point just reached are erased. The target counters are now free to receive new coordinates. While on the second leg, the target counters may be set to a third destination without interfering with steering to the second. When the second destination is reached, the procedure may be repeated and a fourth destination can be established while flying to the third. This procedure can be repeated as many times as desired.

## AIR REFUELING SYSTEM

### NOTE

Refer to foldout section for cockpit illustration.

The air refueling system utilizes a receptacle, aft of the rear cockpit, above the number 2 fuselage fuel cell. Actuation of the receptacle is controlled by the air refuel switch on the fuel control panel. Placing the air refuel switch to EXTEND, extends the receptacle, interrupts the fuel control panel continuity, and illuminates the air refuel READY light. When the receptacle is extended, the air refueling lights (exterior) illuminate. With the receptacle extended, the pilot must fly a formation position with the tanker. The boom operator in the tanker then extends the boom into the receptacle. When the boom nozzle is seated in the receptacle, a solenoid actuated shuttle valve opens and directs utility hydraulic pressure to the two locking toggles in the refueling receptacle. These toggles grip the nozzle and lock the boom to the refueling receptacle. These toggles may be unlocked by the tanker when the tanker is in automatic mode. The tanker cannot release the toggles if refueling in TANKER MANUAL mode. The air refueling release button or the air refuel receptacle circuit breaker (No. 2 circuit breaker panel) will release the toggles regardless of the tanker refueling mode.

### NOTE

- If the tanker informs the receiver that they are refueling in TANKER MANUAL mode, the receiver must initiate the disconnect by using the air refueling release button or pulling the air refuel receptacle circuit breaker.
- During any abnormal engagement, the automatic and tanker disengage features are lost and the receiver must initiate the disconnect.

Once the boom is locked in the receptacle; the READY light goes out and fuel is transferred (at a rate up to 3900 pounds per minute) to any fuel cell or tank that will accept it. An induction coil in the receptacle connects the receiver refueling amplifier and tanker electrical circuits. This illuminates the director lights, and establishes the automatic (tanker initiated) disengage capabilities. If the boom becomes disengaged, an air refuel DISENGAGED light illuminates indicating fuel transfer is interrupted.

Once disengaged, the system must be reset to resume taking fuel. When the fuel system is reset, the READY light illuminates indicating a new hook-up can be made. At the completion of the air refueling sequence, the boom receptacle may be retracted and continuity restored to the fuel control panel, by placing the air refuel switch to RETRACT. On aircraft 67-398 and up, an amplifier override relay is added to the air refueling circuit to permit normal boom-receptacle engagement with a failed amplifier. For normal and emergency air refueling procedures refer to F/RF-4 Flight Crew Air Refueling Procedures (TO 1-1C-1-8).

### Air Refuel Switch

The air refuel switch is a two-position toggle switch on the fuel control panel. Placing the air refuel switch to EXTEND, extends the boom receptacle, interrupts the normal continuity to the fuel control panel, and illuminates the air refuel READY light. The ready light will not illuminate until the receptacle is fully extended. After the boom is locked into the receptacle, fuel is transferred to any fuel cell or tank that will accept it. Fuel to each cell or tank is automatically shut off by its fuel level control valve. Three external tanks FULL indicator lights illuminate when their respective tanks become full. Placing the air refuel switch to RETRACT, retracts the receptacle and restores normal continuity to the fuel control panel. The air refuel switch is used to reset the fuel system during air refueling by cycling from EXTEND to RETRACT and back to EXTEND. With the air refuel switch in EXTEND, pressurization to all internal and external fuel tanks is shut off. Fuel will not transfer from internal wing or external fuel tanks nor can fuel be pressure dumped from the internal wing tanks. If receptacle door is damaged during refueling operations, pull the air refuel receptacle circuit breaker (D1, No. 2 panel) and place the air refuel switch to RETRACT to pressurize fuel tanks and transfer or dump fuel.

### Refuel Selection Switch

A two-position refuel selection switch, marked INT ONLY and ALL TANKS, is on the fuel control panel. The INT ONLY position closes the external tank(s) fuel shutoff valves allowing only the fuselage and wing tanks to be refueled. The ALL TANKS position opens the external tank(s) fuel shutoff valves, allowing all fuel tanks to be refueled.

### Air Refueling Release Button

The refueling release button is a push-button type switch on the front cockpit stick grip. When release from the boom is desired, depress and hold the release button down until the air refuel DISENGAGED light illuminates. Throttle or attitude changes should not be made until the boom is clear of the receptacle. If the above methods of disengagement fail, pull the AIR REFUEL RECEPT circuit breaker (No. 2 circuit breaker panel). Once disengagement is effected, reset the circuit breaker.

### Ready Light

The air refuel READY light indicates that the fuel system is being conditioned to receive fuel. On aircraft 66-284 thru 67-397, the READY light illuminates when the air refuel switch is placed to EXTEND. On aircraft 67-220 and up, the READY light illuminates when the air refuel receptacle is fully extended. The air refuel READY light remains illuminated until the boom is locked into the receptacle or the air refuel switch is placed to RETRACT.

### Disengaged Light

The air refuel DISENGAGED light indicates boom disengagement during the refueling cycle. The air refuel DISENGAGED light remains illuminated until the fuel system is reset to continue refueling, or the receptacle is retracted.

#### NOTE

- Illumination of the DISENGAGED light is not a positive indication of disconnect.
- On aircraft 67-398 and up, a marginal or improperly rigged contact limit switch can cause the DISENGAGED light to illuminate after the boom is locked in the receptacle. If this occurs, refueling can be continued using the procedures for a failed refueling amplifier.

### External Tanks Full Lights

Three external tanks full lights, marked L.H. FULL, CTR. FULL and R.H. FULL, illuminate during air refueling when their respective tanks become full. The external tanks full light(s) remain illuminated until the air refueling receptacle is retracted.

## FIRE CONTROL SYSTEM

Refer to TO 1F-4E-34-1-1 for detailed description of the system and its operational application.

## RADAR RECORDING AND STRIKE CAMERA SYSTEMS

Refer to TO 1F-4E-34-1-1 for detailed description of the system and its operational application.

## MULTIPLE WEAPONS CONTROL SYSTEM

Refer to TO 1F-4E-34-1-1 for detailed description of the system and its operational application.



## LEAD COMPUTING OPTICAL SIGHT

Refer to TO 1F-4E-34-1-1 for detailed description of the system and its operational application.

## WEAPONS RELEASE COMPUTER SET AN/ASQ-91

Refer to TO 1F-4E-34-1-1 for detailed description of the system and its operational application.

## WEAPON SUSPENSION EQUIPMENT

Refer to TO 1F-4E-34-1-1 for detailed description of the system and its operational application.

## SPECIAL WEAPONS DELIVERY SYSTEMS

Refer to TO 1F-4C-25 series for detailed description of the system and its operational application.

## NOSE GUN SYSTEM, M61A1

Refer to TO 1F-4E-34-1-1 for detailed description of the system and its operational application.

## LOW ALTITUDE BOMBING SYSTEM (LABS)

Refer to TO 1F-4E-34-1-1 for detailed description of the system and its operational application.

## TOW TARGET SYSTEMS

Refer to TO 1F-4E-34-1-1 for detailed description of the system and its operational application.

## RADAR WARNING RECEIVER

Refer to TO 1F-4E-34-1-1-1 for detailed description of the system and its operational application.

## ELECTRONIC COUNTERMEASURES PODS (ALQ SERIES)

Refer to TO 1F-4E-34-1-1-1 for detailed description of the system and its operational application.

## TARGET IDENTIFICATION SYSTEM - ELECTRO OPTICAL (TISEO)

Refer to TO 1F-4E-34-1-1 for detailed description of the system and its operational application.

## RADAR X-BAND TRANSPONDER SST-181X

Refer to TO 1F-4E-34-1-1 for detailed description of the system and its operational application.

## SPEECH SECURITY UNIT (KY-28)

Refer to TO 1F-4E-34-1-1 for detailed description of the system and its operational application.

## ELECTRO-OPTICAL TARGET DESIGNATOR SYSTEM AN/ASQ-153(V)

Refer to TO 1F-4E-34-1-1 for detailed description of the system and its operational application.

## INTERROGATOR SET AN/APX-80A/81

Refer to TO 1F-4C-34-1-1-2 for detailed description of the system and its operational application.

## COUNTERMEASURES DISPENSER SET AN/ALE-40

Refer to TO 1F-4E-34-1-1 for detailed description of the system and its operational application.

## MISCELLANEOUS EQUIPMENT

### REAR VIEW MIRRORS

There are three rear view mirrors installed on the front cockpit canopy arch, and two mirrors installed on the rear cockpit arch. After TO 1F-4-1032, two externally mounted rear view mirrors are installed on the rear canopy arch.

### SPARE LAMPS

Spare lamps for the console panels are provided. The lamps are adjacent to the utility electrical receptacle on the right console front cockpit and on the oxygen/cabin altimeter panel on the left console in the rear cockpit.

# SECTION V

## OPERATING LIMITATIONS

---

### TABLE OF CONTENTS

Crew Requirements .....	5-1
Instrument Markings .....	5-1
Instrument Fluctuations.....	5-1
Engine Limitations.....	5-1
Airspeed Limitations.....	5-6
Angle Of Attack Limitations .....	5-6
Prohibited Maneuvers.....	5-6
Gross Weight Limitations.....	5-6
Touchdown Limitations.....	5-6
Center of Gravity Limitations.....	5-6
Acceleration Limitations .....	5-6
External Stores Limitations.....	5-8
CNI Equipment Limitations .....	5-8

#### NOTE

Refer to other sections of the Flight Manual for operating limitations that are characteristic of a particular phase of operation; i.e., emergency procedures, starting procedures, auxiliary equipment operation, etc.

### CREW REQUIREMENTS

The minimum crew for safe flight is one. An additional crewmember, as required, will be added at the discretion of the Commander.

### INSTRUMENT MARKINGS

Instrument range markings are shown in figure 5-1.

### INSTRUMENT FLUCTUATION

#### FUEL FLOW

100 PPH maximum for indicator readings of 0 - 3000 PPH.  
750 PPH maximum for indicator readings of 3001 - 12,000 PPH.

#### RPM

$\pm 0.2\%$  from steady-state condition.

#### EGT

$\pm 5^{\circ}\text{C}$  maximum for steady-state operation from IDLE through MIL power settings.  $\pm 10^{\circ}\text{C}$  maximum for steady-state afterburner operation.

### EXHAUST NOZZLE

Limited by EGT fluctuation.

### OIL PRESSURE

$\pm 2.5$  PSI from steady-state pressure.

#### NOTE

Changes in engine compartment pressure affects oil pressure readings. Therefore, during afterburner lightoff and high Mach flight oil pressure changes down to 30 psi are acceptable.

### ENGINE LIMITATIONS

#### CARTRIDGE START DUTY CYCLE

No more than two cartridge start cycles can be performed within 5 minutes in any 60 minute period. If cartridge and pneumatic starts are interspersed, the total number of cycles is limited to three in any 15 minute period and first condition applies.

#### ENGINE SPEED

Engine rpm (not time-limited) is: 103% rpm for ground operation and 102% rpm for inflight operation.

#### AFTERBURNER LIGHT-OFF TIME

During takeoff, when initiating afterburner, ignition may require as long as 3 seconds.

#### RPM DROP

Drop-off to 87% rpm with a 12-second recovery time is allowable when initiating afterburner.

#### ENGINE EXHAUST TEMPERATURE LIMITATIONS

##### Starting

a. If EGT exceeds  $750^{\circ}\text{C}$  during start, shut-down engine and abort the flight. Do not attempt to re-start.

b. Temperatures from  $733^{\circ}\text{C}$  to  $750^{\circ}\text{C}$  are allowable, providing they do not exceed 1 minute 30 seconds duration. If EGT exceeds  $733^{\circ}\text{C}$  for longer than 1 minute 30 seconds the flight must be aborted.

c. Any temperature above  $705^{\circ}\text{C}$  that does not exceed the above limitation must be written up on form 781, but the flight need not be aborted.

# INSTRUMENT MARKINGS

BASED ON JP-4 FUEL

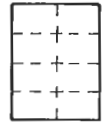

## EXHAUST TEMPERATURE



**678° MAXIMUM STEADY STATE**

## TACHOMETER



**102% RPM – MAXIMUM STEADY STATE  
OVERSPEED (IN FLIGHT)**

## ACCELEROMETER



### POSITIVE LOAD FACTOR (G) LIMITS

- 8.5G** MAXIMUM CLEAN SUBSONIC (M = 0.72 OR LESS)  
AT COMBAT DESIGN GROSS WEIGHT – 37,500 POUNDS
- 6.5G** MAXIMUM CLEAN SUPERSONIC (M = 1.05 OR GREATER)  
AT COMBAT DESIGN GROSS WEIGHT – 37,500 POUNDS
- 4.2G** MAXIMUM AT MAXIMUM GROSS WEIGHT – 58,000 POUNDS

### NEGATIVE LOAD FACTOR (G) LIMITS

- 1.9G** MAXIMUM AT MAXIMUM GROSS WEIGHT – 58,000 POUNDS
- 3.0G** MAXIMUM CLEAN AT COMBAT DESIGN GROSS WEIGHT –  
37,500 POUNDS

Figure 5-1 (Sheet 1 of 2)

- █ 12 PSI – MINIMUM AT IDLE RPM
- █ 60 PSI – MAXIMUM
- █ 35 PSI – STATIC MINIMUM AT MILITARY THRUST
- █ 30-60 PSI – INFLIGHT MILITARY

**Notes**

- FROM FLIGHT TO FLIGHT, INDICATED PRESSURE AT MILITARY THRUST MUST REPEAT WITHIN  $\pm 5$  PSI OF THE KNOWN NORMAL INDICATED PRESSURE OF A PARTICULAR AIRPLANE ENGINE COMBINATION.
- AT MILITARY THROTTLE SETTING DURING T<sub>2</sub> CUTBACK OR ANY OTHER SPEED REDUCTION, INDICATED PRESSURE WILL DECREASE BELOW PLACARD PRESSURE APPROXIMATELY 1 PSI PER 1% REDUCTION IN RPM BELOW 100% RPM.
- ANY STEADY-STATE OPERATION ERRATIC PRESSURE CHANGE WHICH EXCEEDS 5 PSI FOR MORE THAN 1 SECOND MUST BE INVESTIGATED.

**OIL PRESSURE**

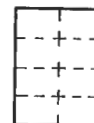

**MIL THRUST OIL PRESSURE CHECK**

AT MILITARY THROTTLE SETTING ADD 1 PSI TO THE INDICATED OIL PRESSURE FOR EACH % RPM BELOW 100%. THIS VALUE MUST BE WITHIN  $\pm 5$  OF THE PLACARD OIL PRESSURE.

- \* █ 2750-3250 PSI – NORMAL **PC-1**
- \* █ 2750-3250 PSI – NORMAL **PC-2**
- \* █ 2750-3250 PSI – NORMAL **UTILITY**

█ 2000-2750 NORMAL WITH RAPID CONTROL MOVEMENT.

█ 3250-3400 IF PRESSURE EXCEEDS 3250 STEADY STATE, AN ENTRY MUST BE LOGGED ON FORM 781.

█ 3400 MAXIMUM

**HYDRAULIC PRESSURE**

\* PRESSURE WITH NO DEMAND ON SYSTEM.



- █ 2650-3300 PSI NORMAL
- █ 3300-3500 PSI CAUTION AREA
- █ 3500 PSI MAXIMUM

**PNEUMATIC PRESSURE**



Figure 5-1 (Sheet 2 of 2)

**All Except Start**

- a. Above 750°C – 3 seconds maximum duration.
- b. 716°C to 750°C – 1 minute maximum duration.
- c. 679°C to 715°C – 5 minutes maximum duration.
- d. 678°C no limit – Any steady state (3 seconds or longer) temperature above 678°C must be written up on form 781

**NOTE**

Engine exhaust temperature must be within operating limits of figure 5-2 prior to takeoff.

**THROTTLE BURSTS**

On aircraft without slats, when operating with maximum engine compressor bleed air (flaps down and cockpit pressurized) in outside air temperatures of -37°C and below, rapid throttle bursts may result in an rpm hang-up. If a throttle burst into maximum afterburner is made, cyclic engine operation may result. When rapid throttle bursting is necessary under these conditions, it is recommended that the throttle be advanced to minimum afterburner first and the engine rpm be allowed to stabilize before advancing further into the afterburner range.

**WINDMILLING LIMITATIONS**

Prior to shutdown under non-emergency conditions, reduce thrust to idle and allow EGT to stabilize. For non-emergency shutdowns, do not allow engine windmill rpm to remain below 7% for longer than 10 minutes. The number of intervals operating below 7% rpm is not limited, provided each 10-minute period below 7% rpm is followed by at least a 10-minute period operating above 7% rpm. Operation at 7% rpm or above is required to provide adequate circulation of lubricating oil to various engine components.

**THRUST LIMITATIONS**

Figure 5-2 is used to determine engine temperature/rpm operating limits in relation to steady state military thrust for takeoff. Under these conditions ambient air temperature may be considered as compressor inlet temperature. The chart depicts minimum and maximum limits.

**IGNITION LIMITATIONS**

The engine ignition time-cycle is limited to 2 minutes ON, 3 minutes OFF, 2 minutes ON, and 23 minutes OFF.

**AFTERBURNER SHUTDOWN LIMITATIONS**

Gradual afterburner shutdown is required in certain areas of the airplane flight envelope. It is intended to allow the airplane to decelerate from high speeds to medium speeds before the engine exhaust nozzles close. This prevents the exhaust nozzles from becoming overpressurized due to peak pressures between maximum thrust and military thrust. Refer to Airplane Speed Restrictions (figure 5-3)

for gradual afterburner shutdown speeds in relation to altitude.

**ENGINE G LIMITATIONS**

Due to limited oil distribution to the variable nozzle system during negative G or zero G flight, the airplane is limited to:

- a. 30 seconds of negative G flight.
- b. 10 seconds of zero G flight.

**ALTERNATE FUEL**

The engines may be operated on JP-5 (NATO F-44), ASTM JET A-1 (NATO F-34), ASTM JET A, or ASTM JET B (NATO F-45) fuel as an alternate when JP-4 (NATO F-40) is not available. When alternate fuels are utilized, the main and afterburner fuel controls should be set to the corresponding specific gravity. The engines start and operate satisfactorily on these fuels; however, air temperature must be higher than -29°C and the fuel temperature above -23°C. Relights can be expected at altitudes up to 35,000 feet and at speeds up to 1.0 Mach. A one-time flight on an alternate fuel with control settings on JP-4 is permissible, provided the following

**MILITARY POWER OPERATING LIMITS**

(Static Condition Only)

OAT °C	RPM (±1%)	EGT °C
-50	90.5	533-564
-45	91.0	533-578
-40	91.5	540-588
-35	92.0	552-600
-30	92.5	564-610
-25	93.0	576-620
-20	93.5	588-634
-15	94.0	600-642
-10	94.5	614-654
-5	95.0	628-664
0	95.5	638-676
+5	96.0	650-678
+10	96.5	661-678
+15	97.0	661-678
+20	97.5	661-678
+25	98.0	650-678
+30	98.5	642-670
+35	99.0	637-662
+40	99.5	637-656
+45	100.0	637-654
+50	100.0	637-654

**NOTES**

- INDICATED RPM MUST BE WITHIN ± 1% FOR A GIVEN OUTSIDE AIR TEMPERATURE.
- EGT MUST BE IN THE RANGE AS SHOWN USING ACTUAL INDICATED RPM.

4E-1-(138)

Figure 5-2

# AIRPLANE SPEED RESTRICTIONS

## CLEAN OR (4) AIM-7 MISSILES

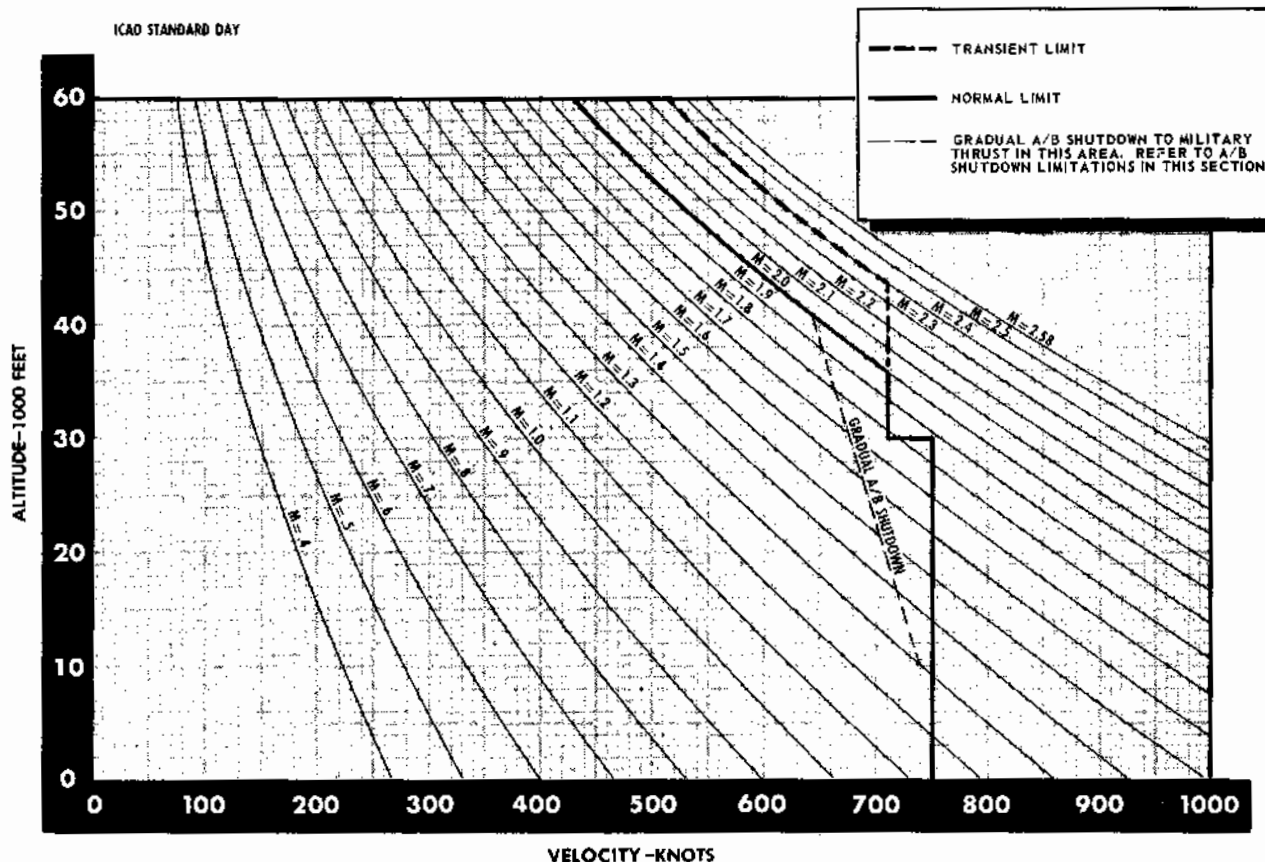

**Note** UNDER SOME CONDITIONS, MAXIMUM AIRSPEEDS ARE DETERMINED BY INLET TEMPERATURE LIMITATIONS AND TRANSIENT OPERATIONS LIMITATIONS. REFER TO ENGINE AIRSPEED LIMITATIONS CHART, THIS SECTION.

4E-1-(39)

Figure 5-3

precautions are followed:

ENGINE AIRSPEED LIMITS		
ALTITUDE RANGE	STEADY STATE LIMIT	TRANSIENT LIMIT
SEA LEVEL TO 30,000 FEET	POINT AT WHICH DUCT TEMP HI LIGHT ILLUMINATES (121 C), OR 750 KNOTS WHICHEVER OCCURS FIRST.	NONE
30,000 FEET AND UP	POINT AT WHICH DUCT TEMP HI LIGHT ILLUMINATES OR 710 KNOTS WHICHEVER OCCURS FIRST.	5 MINUTES PER FLIGHT ABOVE THE STEADY STATE LIMIT, NOT TO EXCEED 710 KNOTS OR .4 MACH ABOVE THE SPEED AT WHICH THE STEADY STATE LIMIT IS REACHED.

4E-1-(40)

Figure 5-4

- a. The flight must be a point-to-point subsonic cruise type flight where minimum maneuvering and power changes are required.
- b. Rapid throttle movements are allowed only under emergency conditions.
- c. Throttle movement during ground operation is as follows: idle to military 6 seconds, 85% to military 3 seconds, stabilize in military before AB initiation, AB stabilize at minimum AB, then a 3-second advance to maximum AB.
- d. The above throttle advance times should be doubled when operating above 20,000 feet.
- e. Throttle chops are permitted; however, the engine may decelerate slower and idle higher.
- f. Air refueling with any alternate fuel is not permitted unless main and afterburner fuel controls are set to the corresponding specific gravity.

**CAUTION**

Continued operation on an alternate fuel with the control specific gravity adjustments set on JP-4 fuel is absolutely prohibited.

**EMERGENCY FUEL**

In an emergency, the engines may be operated on MIL-G-5572B 115/145 AVGAS (NATO F-22) if JP-4 or an alternate fuel is not available. When AVGAS is used, the aircraft is restricted to one flight at subsonic speeds. AVGAS has a specific gravity range between 0.730-0.685. The pilot should be aware that the following degradations in engine performance will occur:

- Longer time to start and accelerate, with possible missed-starts or start-stalls.
- Maximum engine RPM and EGT may not be attained.
- Slow acceleration throughout the operating range.
- Lower than normal afterburner thrust.
- Reduced aircraft range.

**AIRPEED LIMITATIONS**

The maximum permissible airspeeds for flight in smooth or moderately turbulent air are shown in figure 5-3. Under some conditions, maximum airspeeds are determined by inlet temperature limitations and transient operations limitations; refer to Engine Airspeed Limits (figure 5-4). Limiting airspeeds for operation of various airplane systems are presented in figure 5-5.

**NOTE**

When flying below 10,000 feet, caution should be used when operating the aircraft above 0.87 Mach to preclude oscillations in case of stability augmentation failure.

**AOA LIMITATIONS**

The maximum allowable angle of attack is:

- Above 35,000 feet - 25 units.
- 35,000 feet and below - 30 units.

**PROHIBITED MANEUVERS**

- Full-deflection aileron roll in excess of 360°
- Intentional spins.

**GROSS WEIGHT LIMITATIONS**

The maximum allowable gross weights are:

- 58,000 pounds for any ground operation.
- 46,000 pounds for landing.

To estimate aircraft takeoff gross weight, refer to Airplane Loading chart in part 1 of Performance Data appendix A.

**TOUCHDOWN LIMITATIONS**

Refer to figure 5-6. The normal landing technique (outlined in section II) will result in descent rates of approximately 700 fpm during approach and 500 fpm touchdown at typical landing gross weights.

**CENTER OF GRAVITY LIMITATIONS**

Center of gravity (CG) position has a direct effect on aircraft flight characteristics. Refer to section VI for discussion of aircraft flight characteristics in relation to CG location.

The maximum allowable forward CG limits are:

- Slats flaps - NORM:22% MAC
- Slats flaps - OUT AND DOWN:22.5% MAC

The maximum allowable aft CG is 36% MAC. However, to determine the maximum allowable aft CG when wing-mounted stores or suspension equipment are on the aircraft, you must consider aircraft stability index. Refer to part 1 of the Performance Data appendix for a description of the method used to compute the stability index number.

After computing the aircraft stability number, refer to the Aft CG Limits Chart, figure 5-7, to determine the maximum allowable aft CG and the neutral stability point for that configuration. Although the aft CG limit and neutral stability point apply to all phases of flight so long as the wing-mounted stores configuration is unchanged, for planning purposes, the CG at engine start is used to determine if flight is authorized. Refer to the Handbook of Weight and Balance Data (TO 1-1B-40) and the DD Form 365F for the particular aircraft and configuration to determine CG at engine start. If the CG at engine start is aft of the aft CG limit for the computed stability index, flight is prohibited.

**CAUTION**

If CG position is less than 1% MAC forward of the computed neutral stability point (refer to figure 5-7) at engine start, thoroughly review the flight characteristics discussion in section VI before flight.

**ACCELERATION LIMITATIONS**

The limits which determine maximum accelerations permitted for any given flight depend upon aircraft systems, external stores limitations, aircraft/stores compatibility, and aircraft's basic structural design limits. The pilot must be aware of the governing criteria which will determine maximum accelerations permitted for his particular flight.

## SYSTEMS OPERATION LIMITATIONS

CONDITION		AIRPEED or MACH Whichever is Less	LOAD FACTOR
LANDING GEAR EXTENDED		250 KNOTS IAS	0 TO +2.0 G
WING FLAPS EXTENDED		250 KNOTS IAS	0 TO +2.0 G
SLATS EXTENDED		600 KNOTS IAS OR 2.0 MACH	SAME AS BASIC AIRPLANE
AIR REFUELING RECEPTACLE	EXTENSION	320 KNOTS IAS OR 0.85 MACH	-1.5 TO +3.0 G
	AFTER EXTENSION	400 KNOTS IAS OR 0.85 MACH	
CANOPY OPEN, GROUND OPERATION		60 KNOTS IAS	NOT APPLICABLE
CANOPY JETTISON, INFLIGHT		SAME AS BASIC AIRPLANE	SAME AS BASIC AIRPLANE
DRAG CHUTE DEPLOYMENT		200 KNOT IAS	NOT APPLICABLE
COCKPIT ACCESS STEPS EXTENDED		400 KNOT IAS	NOT APPLICABLE
APU		600 KNOTS IAS OR .95 MACH	0 TO +4.0 G

Figure 5-5

4E-1-(411)

Systems operations limitations are presented in figure 5-5. Stores limitations are presented in tabular form in the External Stores Limitations charts (figure 5-10) and in graphic form in the Acceleration Limitations chart (figure 5-8). Stores limitations appear as dashed lines in the Acceleration Limitations charts except in those cases where they are superimposed on an aircraft structural limit line. Exceeding these limits is exceeding the store limits and/or supporting structure limits including local wing area. Accordingly, the dashed lines represent a store only limit as established at time of flight certification and, though the dashed lines may not reflect actual G-limit of a given store, they represent limits for stores when used in combination with this aircraft. Thus, if a flight profile has exceeded the respective dashed line for a given store, that store has encountered an over -G condition and should be reported to ensure surveillance of the structural integrity of stores, suspension equipment and local wing area.

Aircraft structural limits depend on aircraft configuration (with and without stores) and on basic design limits. The Acceleration Limitations charts define structural limits due to aircraft/stores compatibility and basic design. Hence, the solid lines represent aircraft structural limits for a clean aircraft and for certain stores configured aircraft. If a flight profile has exceeded a solid line, the aircraft has encountered an over -G condition and should be reported. These limits are imposed due to adverse aerodynamic impact that the external stores cause on aircraft wings and structure as well as general design limits for particular airspeeds of the clean aircraft (configured with fuselage missiles). These limits are for smooth or moderately turbulent air. Separate plots are provided for symmetrical (neutral aileron and rudder) and unsymmetrical maneuvers (any rudder and/or aileron input). The wing and centerline station stores lines

generally define aircraft structural limits when stores are carried in these positions. The AIM-9 missile is an exception to this rule.

### CAUTION

- Accelerations of 8.5G are permissible only for symmetrical maneuvering when gross weight and airspeed are less than 37,500 pounds and 0.72 Mach respectively, and/or only with certain centerline stores installed. Since aircraft fatigue life depends largely on the number and magnitude of G applications, accelerations should be used only as necessary in mission performance. It is emphasized that care should be taken to avoid G overshoot beyond the limits authorized in figures 5-8 and 5-9.
- Rolling (unsymmetrical) G-allowable is significantly less than that allowable for symmetrical maneuvers. Aileron or rudder input will immediately create an unsymmetrical condition and reduce allowable G 20% at all gross weights.

### FLIGHT STRENGTH DIAGRAM

The flight strength diagram (figure 5-9) is a composite presentation of the basic aircraft operating envelope (with or without fuselage missiles) at different gross weights. The parameters of each envelope include maximum allowable Mach number, wings level stall speed at sea level, and positive and negative load factor limits. This diagram further restricts allowable negative load factors



at speeds above 1.5 Mach and decreases positive load factors between 0.72 and 1.0 Mach. Further restrictions to positive load factors occur above 1.8 Mach.

## EXTERNAL STORES LIMITATIONS

Only the external stores listed in the External Stores Limitations chart (figure 5-10) may be carried and released, singly or in combination. Different stores authorized for carriage on a specific station will not be combined unless depicted in combination. Any station loading depicted in figure 5-10 may be used in combination with any other depicted station loading on adjacent or opposite stations, unless otherwise annotated. The chart indicates store-to-airframe structural and flight handling characteristic compatibility only; electromagnetic radiation compatibility is indicated in the applicable equipment technical order when not stated in the Remarks column.

### WARNING

Jettison and release limits are based on test data with the landing gear and flaps up. If centerline or inboard release or jettisoning is required with the landing gear down, or with the landing gear and flaps down, damage may occur to the aircraft which may result in loss of control.

### NOTE

- Where applicable, alternate limitations are also included within a boxed area. These alternate limitations permit higher speeds if the indicated lower acceleration limits are observed.
- Avoid jettisoning or releasing any store(s) at the extremities of the published envelopes whenever

possible.

- Release of weapons with a load factor in excess of 3 G may result in a small percentage of hung bombs: i.e., the failure of the bomb to release from the MER or TER ejector unit.
- When stores are released in either ripple or salvo mode, G jump (nose rise) up to 3.5 G can occur. Aircrews must ensure that maximum G limit for the configuration is not exceeded.
- Unless otherwise annotated, aircraft roll rates with external stores must be limited to 120 degrees per second below 550 KIAS and 90 degrees per second above 550 KIAS. Amount of stick throw is only limited by maximum roll rate.

## PARTIAL CONFIGURATIONS.

a. Partial configurations are obtained from the configurations presented in figure 5-10 by deleting stores from the existing approved configurations.

b. Flight restrictions and limitations for all partial configurations are the same as the restrictions or limitations applying to the original configuration.

c. Partial configuration must be obtained by deleting stores in the normal release sequence. This rule is necessary to assure that only configurations that have been analyzed and flight tested are flown. Any configuration shown in figure 5-10 can be down loaded in accordance with these rules.

## CNI EQUIPMENT LIMITATIONS

The maximum permissible altitude with CNI equipment on is 60,000 feet. Flight above 60,000 feet with CNI equipment on may result in damage to the equipment.

# TOUCHDOWN SINK RATE LIMITS

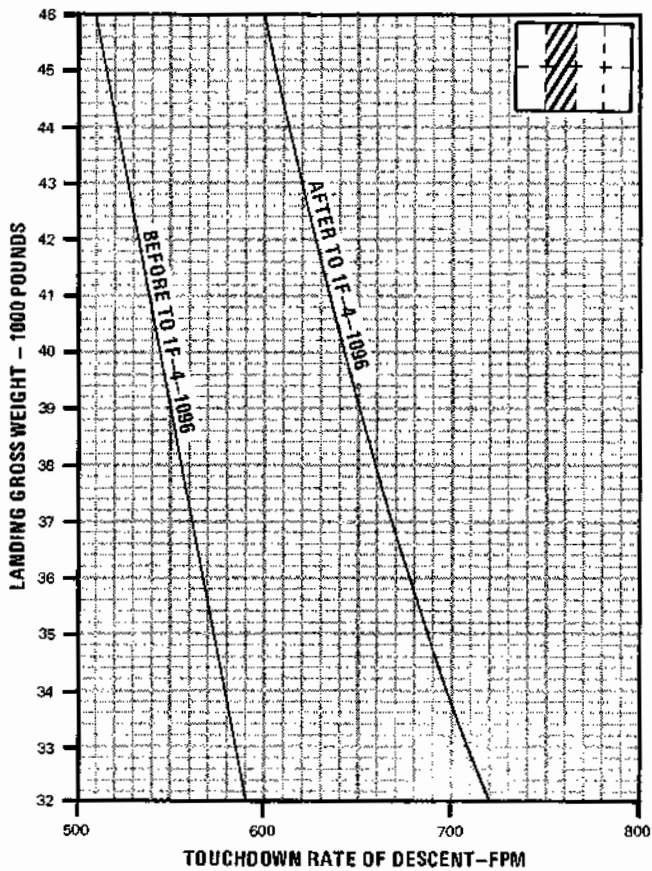

4E-1-(37)B

Figure 5-6

# AFT CG LIMITS

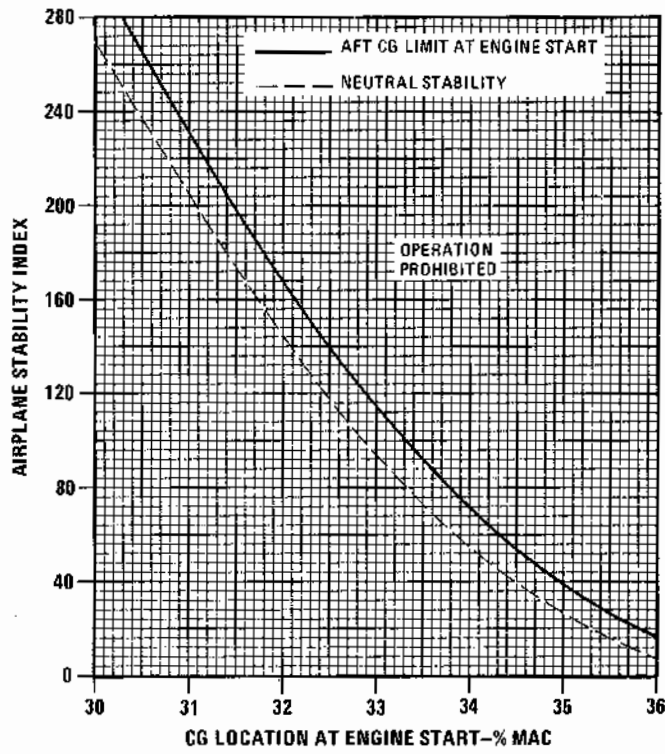
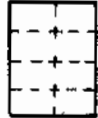

4E-1-(36)A

Figure 5-7

# ACCELERATION LIMITATIONS



## SYMMETRICAL MANEUVERS

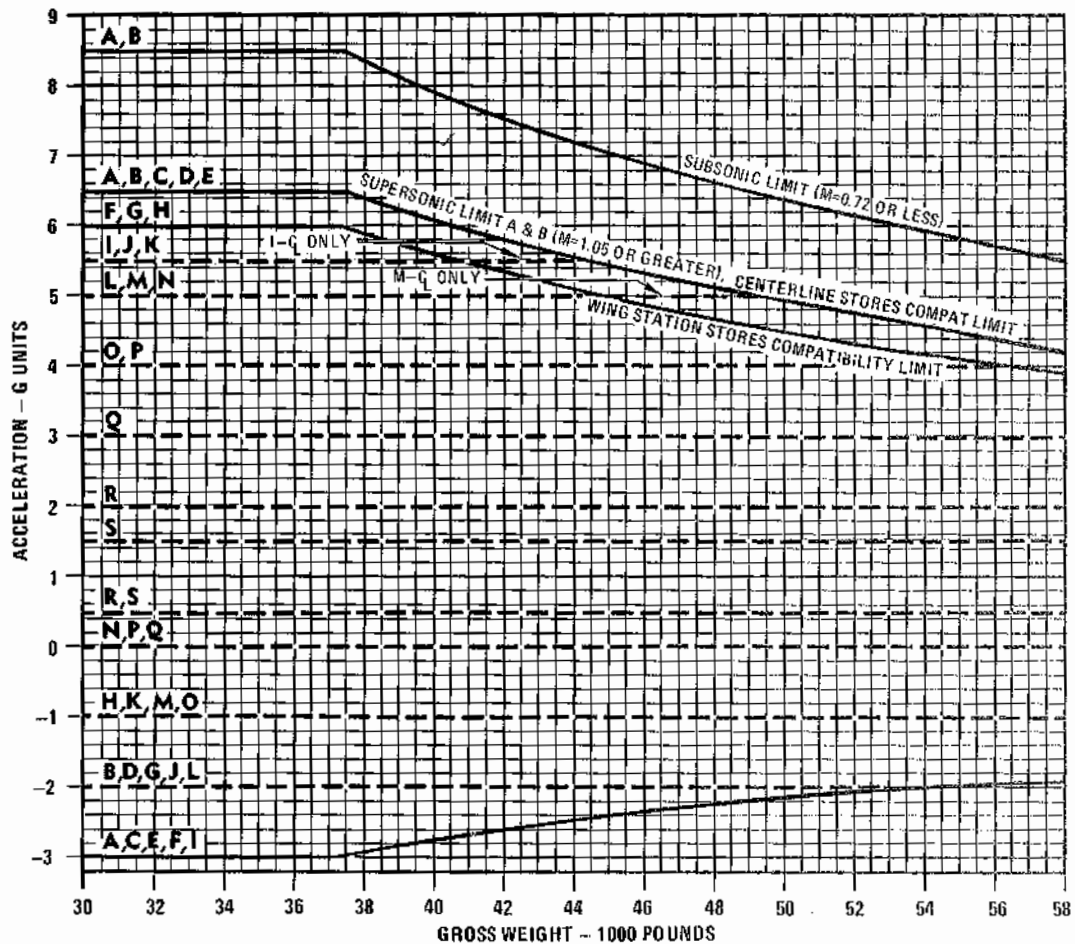

NOTE: DOTTED LINES INDICATE STORE/SUSPENSION STRUCTURE LIMITS ONLY.  
SOLID LINES REPRESENT AIRCRAFT STRUCTURAL LIMITS DUE TO AIRCRAFT/STORES COMPATIBILITY.

### CONFIGURATIONS:

- |  |  |
|--|--|
| <p>A. BASIC AIRPLANE WITH OR WITHOUT FUSELAGE MISSILES.<br/>SUU-16/A OR SUU-23/A GUN POD AT STATION 5.<br/>ECM PODS WITH MISSILE WELL ADAPTER.<br/>AAQ-8 I/RCM POD.</p> <p>B. EMPTY TO 10% FULL MAC CENTERLINE TANK.</p> <p>C. SUU-21/A BOMB DISPENSER AT STATION 5.<br/>B28, B43, B57, B61 BOMB OR DUMMY UNIT AT STATION 5.<br/>AN/ASQ-T-11 ACMI POD.</p> <p>D. 10% FULL TO 75% FULL MAC CENTERLINE TANK.</p> <p>E. AIM-9B/E/J/J-1 MISSILE</p> <p>F. SUU-16/A OR SUU-23/A GUN POD AT STATIONS 1 &amp; 9.<br/>ECM PODS (WING STATIONS).<br/>B57, B61 OR DUMMY UNIT AT STATIONS 2 &amp; 8 WITH ADAPTER.<br/>AGM-45A, B OR ATM-45 MISSILE.<br/>AGM-62 MK1 MOD 0 (WALLEYE).<br/>AGM-65A, B (MAVERICK) MISSILE OR TGM-65 TRAINER.</p> <p>G. EMPTY TO 10% FULL EXTERNAL WING TANKS.</p> <p>H. AN/AVQ-23(V)-2 PAVE SPIKE POD.</p> <p>I. MK84 GP BOMB</p> | <p>J. B28, B61 BOMB OR DUMMY UNIT AT STATION 1.<br/>B43 BOMB OR DUMMY UNIT AT STATIONS 1, 2 &amp; 8.<br/>B57 BOMB OR DUMMY UNIT AT STATION 1 &amp; AT STATIONS 2 &amp; 8 WITH 14 INCH EXTENDER.</p> <p>K. SUU-21/A DISPENSER AT STATIONS 1, 2, 8 &amp; 9.</p> <p>L. 75% FULL TO FULL MAC CENTERLINE TANK.<br/>10% FULL TO 75% FULL EXTERNAL WING TANKS.<br/>SUU-20/A, A/A, B/A BOMB &amp; ROCKET DISPENSER.</p> <p>M. ALL OTHER AUTHORIZED STORES THAT ARE NOT SPECIFICALLY NOTED.</p> <p>N. EMPTY TO 75% FULL ROYAL JET CENTERLINE TANK.</p> <p>O. 75% FULL TO FULL EXTERNAL WING TANKS.<br/>CBU-42/A DISPENSER AT STATIONS 1 &amp; 9.<br/>GBU-11/B GUIDED BOMB.</p> <p>P. ALE-38 CHAFF DISPENSER.</p> <p>Q. 75% FULL TO FULL ROYAL JET CENTERLINE TANK.<br/>AAVS TYPE IV CAMERA POD AT STATIONS 1, 5 &amp; 9 (MER SHIFTED FWD).</p> <p>R. RMU-8A REEL LAUNCHER.</p> <p>S. A/A-37U-15 TOW TARGET (TARGET STOWED).</p> |
|--|--|

Figure 5-8 (Sheet 1 of 2)

**ACCELERATION LIMITATIONS** (Continued)

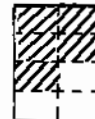

**UNSYMMETRICAL MANEUVERS**

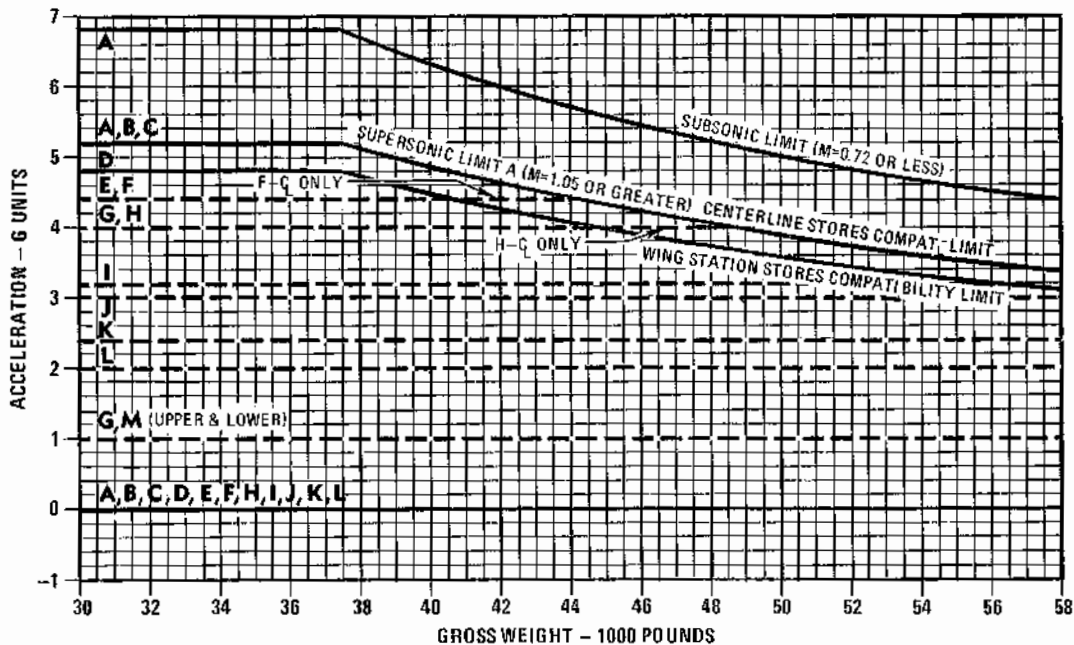

NOTE: DOTTED LINES INDICATE STORE/SUSPENSION STRUCTURE LIMITS ONLY.  
SOLID LINES REPRESENT AIRCRAFT STRUCTURAL LIMITS DUE TO AIRCRAFT/ STORES COMPATIBILITY.

**CONFIGURATIONS:**

- A. BASIC AIRPLANE WITH OR WITHOUT FUSELAGE MISSILES.  
EMPTY TO 10% FULL MAC CENTERLINE TANK.  
ECM PODS WITH MISSILE WELL ADAPTER.  
SUU-16/A OR SUU-23/A GUN POD AT STATION 5.  
AAQ-8 IRCM POD.
- B. 10% FULL TO 75% FULL MAC CENTERLINE TANK.  
B28, B43, B57, B61 BOMB OR DUMMY UNIT AT STATION 5.  
SUU-21/A BOMB DISPENSER AT STATION 5.  
AN/ASQ-T-11 ACMI POD.
- C. AIM-9B/E/J/J-1 MISSILE
- D. EMPTY TO 10% FULL EXTERNAL WING TANKS.  
B57, B61 BOMB OR DUMMY UNIT AT STATIONS 2 & 8 WITH ADAPTER.  
AGM-45A, B OR ATM-45 MISSILE.  
AGM-62 MKI MOD 0 (WALLEYE).  
AGM-65A, B (MAVERICK) MISSILE OR TGM-65 TRAINER.  
ECM PODS (WING STATIONS)  
SUU-16/A OR SUU-23/A GUN POD AT STATIONS 1 & 9.
- E. B28, B61 BOMB OR DUMMY UNIT AT STATION 1.  
B43 BOMB OR DUMMY UNIT AT STATIONS 1, 2 & 8  
B57 BOMB OR DUMMY UNIT AT STATION 1 & AT STATIONS 2 & 8  
WITH 14 INCH EXTENDER.  
SUU-21/A DISPENSER AT STATIONS 1, 2, 8 & 9.
- F. MK84 GP BOMB.
- G. EMPTY TO 75% FULL ROYAL JET CENTERLINE TANK.
- H. ALL OTHER AUTHORIZED STORES THAT ARE NOT SPECIFICALLY NOTED.
- I. CBU-42/A DISPENSER AT STATIONS 1 & 9.  
ALE-38 CHAFF DISPENSER.
- J. GBU-11/B GUIDED BOMB.
- K. AAVS TYPE IV CAMERA POD AT STATIONS 1, 5 & 9 (MER SHIFTED FWD).
- L. 75% FULL TO FULL EXTERNAL WING TANKS.
- M. 75% FULL TO FULL ROYAL JET CENTERLINE TANK.

Figure 5-8 (Sheet 2 of 2)

# FLIGHT STRENGTH DIAGRAM

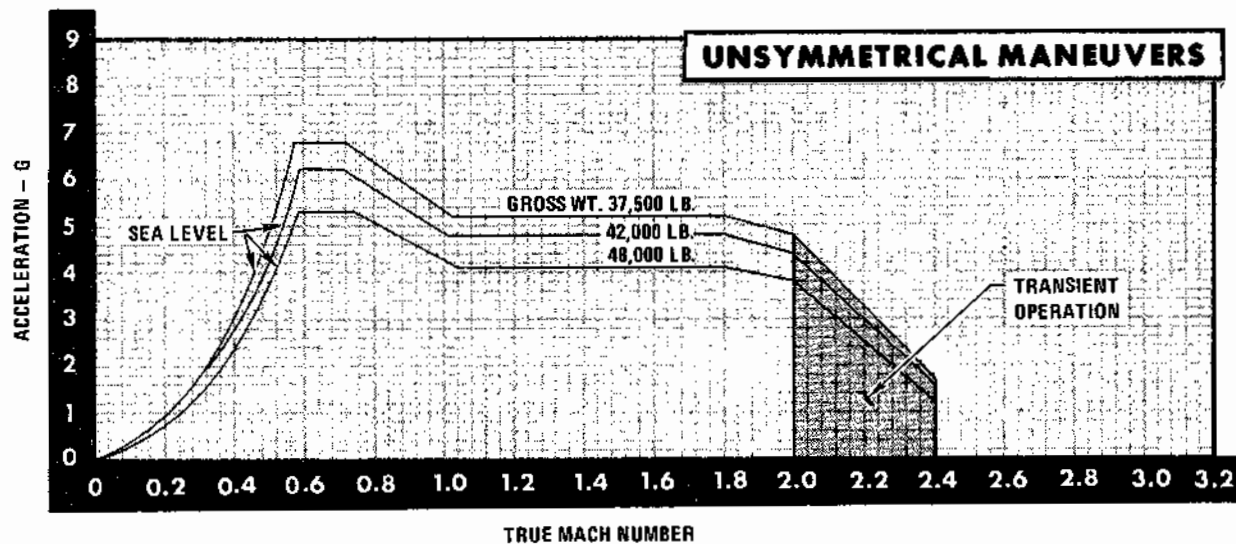
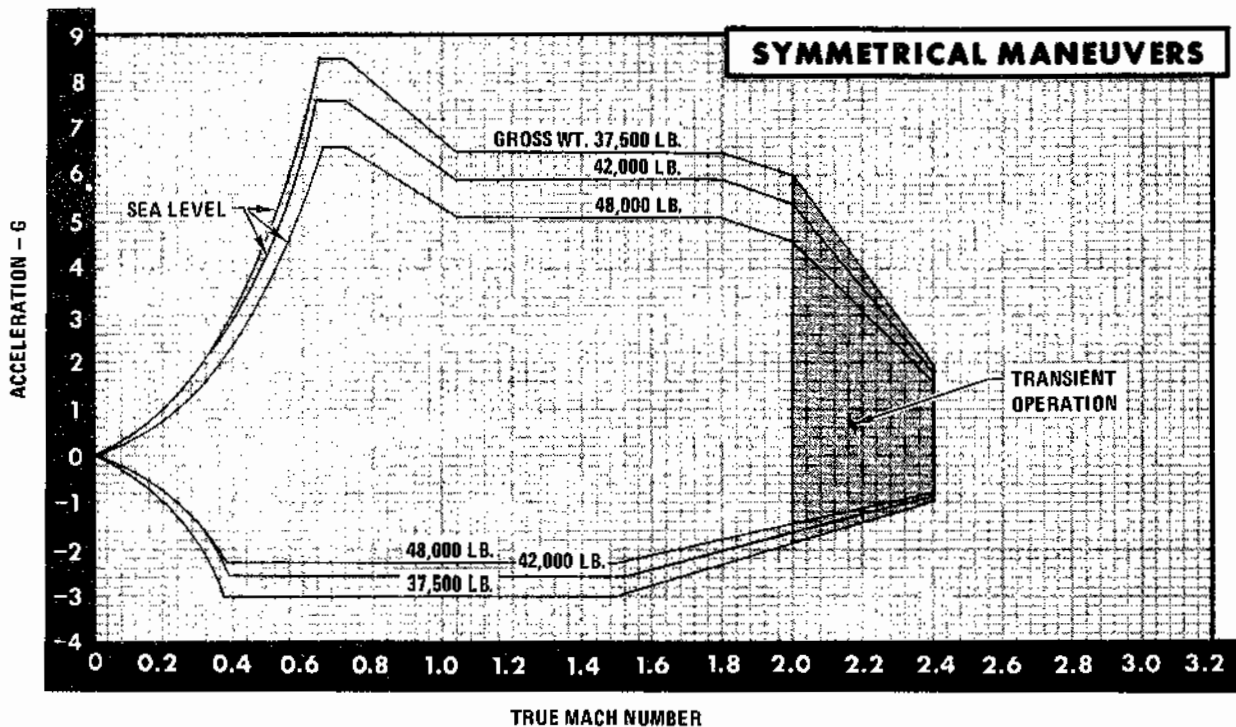

Figure 5-9

# EXTERNAL STORES LIMITATIONS

## TABLE OF CONTENTS

### GENERAL

- A. The minimum acceleration for release or employment in level flight is 1G. The minimum acceleration for employment or release in a dive delivery is the normal G loading for a given dive angle which can be obtained only when a wings level straight line flight path is maintained prior to release or employment.
- B. Speeds or G quoted in the "employment" column are applicable to the dispensing limitations of the CBU's, the firing limitations of the guns, the launching limitations of the rockets and missiles, etc.
- C. Speeds or G quoted in the "Release" column are applicable only to releasing the store from its suspension equipment.
- D. Speeds quoted in the "Jettison" column are applicable to jettisoning the combined suspension equipment and store from the airplane.
- E. The term "ripple" in the "External Stores Notes" applies to the single-ripple and single-continuous release modes.
- F. Unless otherwise indicated in the "External Stores Notes" the minimum INTVL setting for the single-ripple and single-continuous release modes is .06 SEC.
- G. Unless otherwise indicated in the "External Stores Notes" the minimum INTVL setting for the salvo release mode is .20 SEC when adjacent weapon stations are selected and .06 SEC when a single weapon station or non-adjacent weapon stations are selected.
- H. With partially loaded MER/TER's, use a minimum interval of .09 SEC to step over one empty MER/TER position in the ripple or salvo mode. To step over two empty MER/TER positions, use a minimum interval of .14 SEC.
- I. If the situation warrants, store(s) may be jettisoned with flaps and slats extended. However, release, jettison and employment of stores should be accomplished with slats in automatic operation only.
- J. Refer to figure 5-8 for reduced acceleration G limits as a result of gross weight.

NA, Not Applicable/Authorized

NE, Not Established



Aircraft Limits.

Alternate Limitations - Either primary or alternate limitations apply to all configurations for station loading.

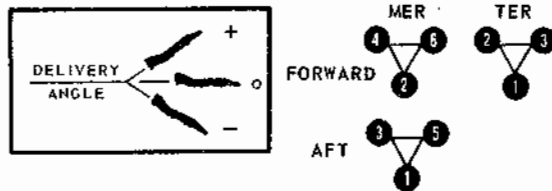

EXTERNAL STORES	SHEETS
CAMERA POD	22 and 23
CARGO POD	18 and 19
<b>DISPENSERS AND CLUSTER BOMB UNITS</b>	
CBU-7 (SUU-13)	14 and 15
CBU-9 (SUU-7)	12 and 13
CBU-12 (SUU-7)	12 and 13
CBU-30 (SUU-13)	14 and 15
CBU-38 (SUU-13)	14 and 15
CBU-42 (SUU-38)	14 and 15
CBU-46 (SUU-7)	12 and 13
CBU-49 (SUU-30)	12 and 13
CBU-52 (SUU-30)	12 and 13
CBU-58 (SUU-30)	12 and 13
CBU-71 (SUU-30)	12 and 13
CHAFF DISPENSERS	18 and 19
ROCKEYE 11 MK 20 MOD 2	14 and 15
SUU-20	14 and 15
SUU-21	14 and 15
ECM PODS	18 and 19
FIRE BOMBS	12 and 13
FLARE DISPENSERS AND FLARES	8 and 19
FUEL TANKS	2 and 3

GP BOMBS	SHEETS
GP BOMBS WITH FUZE EXTENDERS	10 and 11
M36E2	6 and 7
M117D/RE/RE (LD)	8 and 9
M117GP (MAU-103A/B FIN)	8 and 9
M117GP (M131A1 CONICAL FIN)	6 and 7
M118GP	8 and 9
M129E1 AND M129E2	8 and 9
MC-1 GAS BOMB	8 and 9
MK 36 DESTRUCTOR	10 thru 11
MK 81 LDGP	8 and 9
MK 82 LDGP	10 and 11
MK 82 SNAKEYE 1/SNAKEYE (LD)	10 and 11
MK 83 LDGP	10 and 11
MK 84 LDGP	10 and 11
GUIDED BOMBS	22 and 23
GUN PODS	18 and 19
MISCELLANEOUS	20 and 21
MISSILES	4 and 5
MISSILE MIXED LOADS	6 and 7
PRACTICE BOMBS	16 and 18
ROCKET LAUNCHERS (FFAR)	16 thru 19
SPECIAL WEAPON BOMBS	2 thru 5
SPRAY TANKS	20 and 21
SUSPENSION EQUIPMENT	20 thru 23
TOW TARGET SYSTEM	20 and 21

Figure 5-10 (Sheet 1 of 23)

# EXTERNAL STORES LIMITATIONS

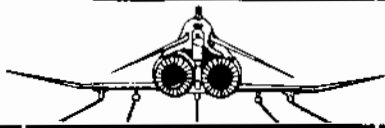

**FUEL TANKS AND SPECIAL WEAPONS**



STORE	SUSPENSION	STATION LOADING					CARRIAGE				JETTISON 1G LEVEL FLIGHT	
							AIRSPEED		ACCEL G		MIN	MAX
		1	2	5	8	9	KNOTS	MACH	SYM.	UNSYM.	KNOTS	KNOTS
McDonnell 600 Gallon Centerline Tank	Aero 27/A BRU-5/A	Empty to 10% Full	●				✈	✈	+8.5 -2.0	✈	175	390
		10% Full to 75% Full	●				✈	✈	+6.5 -2.0	+5.2 0.0	Not Authorized	
		75% Full to Full	●				✈	✈	+5.0 -2.0	+4.0 0.0	175	390
Royal Jet 600 Gallon Centerline Tank	Aero 27/A BRU-5/A	Empty to 10% Full	●				600	1.8	+5.0 -0.0	+4.0 +1.0	175	390
		10% Full to 75% Full	●				600	1.8	+5.0 0.0	+4.0 +1.0	Not Authorized	
		75% Full to Full	●				600	1.8	+3.0 0.0	+1.0 +1.0	175	390
Sargent- Fletcher 370 Gallon Wing Tank	Pylon Installed as part of Wing Tank	Empty to 10% Full	●				750	1.6	+6.0 -2.0	+4.8 0.0	(1G Level Flight) 175 to 375 (2G Sym Flight) 400 to 445 (3G Sym Flight) 425 to 510	
		10% Full to 75% Full	●				550	1.6	+5.0 -2.0	+4.0 0.0		
		75% Full to Full	●				550	1.6	+4.0 -1.0	+2.0 0.0		
B28 Bomb or Dummy Unit  Maximum Load-2	MAU-12	●					550	1.1	+5.5 -2.0	+4.4 0.0	175	550
	Aero 27/A BRU-5/A		●				✈	✈	+6.5 -3.0	+5.2 0.0	175	✈
B43 Bomb, or Dummy Unit  Maximum Load-4	MAU-12	●					550	1.1	+5.5 -2.0	+4.4 0.0	175	550
	Aero 27/A BRU-5/A		●				✈	✈	+6.5 -3.0	+5.2 0.0	175	✈
	MAU-12 (With Adapter)		●		●		750	1.8	+5.5 -2.0	+4.4 0.0	175	750
B57 Bomb or Dummy Unit  Maximum Load-4	MAU-12 30 inch	●					550	1.1	+5.5 -2.0	+4.4 0.0	175	550
	Aero 27/A 30 inch BRU-5/A		●				✈	✈	+6.5 -3.0	+5.2 0.0	175	600
	MAU-12 14 inch		●		●		✈	✈	+5.5 -2.0	+4.4 0.0	175	550
	MAU-12 14 inch (With Adapter)		●		●		750	1.8	+6.0 -3.0	+4.8 0.0	175	750

4E-1-(91)-21E

Figure 5-10 (Sheet 2 of 23)



**FUEL TANKS AND SPECIAL WEAPONS**

	EMPLOYMENT			RELEASE			DELIVERY ANGLE	REMARKS
	MAX	MIN	MAX	MAX	MIN	MAX		
	ACCEL G	KNOTS	KNOTS	ACCEL G	KNOTS	KNOTS		
A	NA	NA	NA	NA	NA	NA	NA	<ul style="list-style-type: none"> <li>● If gross weight is over 37,500 lbs, refer to Acceleration Limitations Chart.</li> <li>● (Full or Empty): Jettison between 350 and 390 knots below 15,000 may cause airplane contact and minor damage.</li> <li>● (Empty to 10% Full): Roll rate limited to 200 deg/sec.</li> </ul>
B	NA	NA	NA	NA	NA	NA	NA	<ul style="list-style-type: none"> <li>● If gross weight is over 45,000 lbs, refer to Acceleration Limitations Chart.</li> <li>● (Full or Empty): Jettison between 350 and 390 knots below 15,000 may cause airplane contact and minor damage.</li> <li>● Roll rate limited to 60 deg/sec.</li> </ul>
C	NA	NA	NA	NA	NA	NA	NA	<ul style="list-style-type: none"> <li>● If gross weight is over 37,500 lbs, refer to Acceleration Limitations Chart.</li> <li>● (Empty to 10% Full): Roll rate is aircraft limits.</li> </ul>
D	NA	NA	NA	*	175	550	*	<ul style="list-style-type: none"> <li>● If gross weight is over 37,500 lbs on STA 5 or is over 41,000 lbs on STA 1, refer to Acceleration Limitations Chart.</li> <li>● Slatted aircraft with external fatigue strap are limited to 550 KIAS with special weapon on STA 5.</li> <li>* Refer to T.O. 1F-4C-25.</li> </ul>
				*	175			
				*	175			
E	NA	NA	NA	*	175	750	+45° to -20°	<ul style="list-style-type: none"> <li>● If gross weight is over 41,000 lbs, refer to Acceleration Limitations Chart.</li> <li>● Carriage of one B43 or dummy unit imposes the following limitations in lateral control:                             <ul style="list-style-type: none"> <li>● with a load factor of plus 1 – minimum speed is 140 KIAS</li> <li>● with a load factor of plus 2 – minimum speed is 175 KIAS</li> <li>● with a load factor of plus 3 – minimum speed is 220 KIAS</li> <li>● with a load factor of plus 4 – minimum speed is 260 KIAS</li> </ul> </li> <li>● B43 with short time delay chute (0.4 sec.); maximum release is Mach 1.32.</li> <li>● Dummy Unit; maximum release is Mach .95.</li> </ul>
F	NA	NA	NA	*	175	550	*	<ul style="list-style-type: none"> <li>● If gross weight is over 37,500 lbs on STA 5 or is over 41,000 lbs on STA 1, 2, 8, refer to Acceleration Limitations Chart.</li> <li>● (STA 1 &amp; 5): Maximum release speed with short delay (.1 sec.) is 550 Knots or .95 Mach. (STA 2 &amp; 8): Short time delay not authorized.</li> <li>● Slatted aircraft with external fatigue strap are limited to 550 KIAS with special weapon on STA 5.</li> <li>* Refer to TO 1F-4C-25.</li> </ul>
				*	175	600		
				*	175	550		
				+4.0 +1.0	175	750		

4E-1-(91-3)N

Figure 5-10 (Sheet 3 of 23)

# EXTERNAL STORES LIMITATIONS

SPECIAL WEAPONS  
AND MISSILES

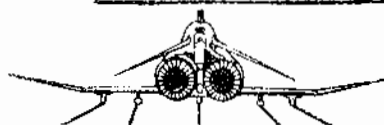

STORE	SUSPENSION	STATION LOADING					CARRIAGE				JETTISON 1G LEVEL FLIGHT	
							AIRSPEED		ACCEL G		MIN	MAX
		1	2	5	8	9	KNOTS	MACH	SYM.	UNSYM.	KNOTS	KNOTS
B61 Bomb or Dummy Unit  Maximum Load-4	MAU-12	●					550	1.1	+5.5 -2.0	+4.4 0.0	175	550
	Aero 27/A BRU-5/A			●			✈	✈	+6.5 -3.0	+5.2 0.0	175	✈
	MAU-12 (With Adapter)		●		●		750	1.8	+6.0 -3.0	+4.8 0.0	175	750
AGM-45A, 8 ATM-45 Missile  Maximum Load-4	LAU-34/A Launcher	✈	✈		✈	✈	✈	✈	+6.0 -3.0	+4.8 0.0	175	550
AGM-65A or AGM-65B (Maverick) Missile  Maximum Load - 6  TGM-65 (Maverick Trainer)  Maximum Load-6	LAU-88 Launcher		✈		✈		✈	✈	+6.0 -3.0	+4.8 0.0	175	550
AIM-7E-2/3 Missiles  Maximum Load-4	Aero-7A	MISSILE STATIONS					✈	✈	✈	✈	175	✈
			3	4	6	7						
		FWD		✈	✈							
		AFT	✈			✈						
AIM-9B/E/J/J-1 Missile  Maximum Load-4	Aero-3/B Launcher		✈		✈		**	**	+6.5 -3.0	+5.2 0.0	175 ***	750 ***

Figure 5-10 (Sheet 4 of 23)

**SPECIAL WEAPONS  
AND MISSILES**



	EMPLOYMENT			RELEASE			DELIVERY ANGLE	REMARKS
	MAX	MIN	MAX	MAX	MIN	MAX		
	ACCEL G	KNOTS	KNOTS	ACCEL G	KNOTS	KNOTS		
A	NA	NA	NA	*	175	550	*	<ul style="list-style-type: none"> <li>If gross weight is over 37,500 lbs on STA 5 or is over 41,000 lbs on STA 1, refer to Acceleration Limitations Chart.</li> <li>* Refer to TO 1F-4C-25.</li> </ul>
				*	175			
				+4.0 +1.0	175	750		
B	*	175		NA	NA	NA	+50° to -50°	<ul style="list-style-type: none"> <li>If gross weight is over 37,500 lbs, refer to Acceleration Limitations Chart.</li> <li>The ATM-45 can be flown as a training missile without wings or fins. Jettison or installation of jettison cartridges is not authorized.</li> <li>Roll rate limit is 200 deg/sec.</li> <li>* Refer to TO 1F-4E-34-1-1-1.</li> </ul>
C	+3.0 -0.5	250	750	NA	NA	NA	LEVEL to -60°	<ul style="list-style-type: none"> <li>If gross weight is over 37,500 lbs, refer to Acceleration Limitations Chart.</li> <li>Speed brakes must be retracted when launching from stations 2 and 8.</li> <li>Shoulder-mounted AIM-4 and AIM-9 missiles are not cleared for carriage with the AIM-85 missiles.</li> <li>CG position could become critical.</li> <li>A mixed Load of AGM-85 missiles and TGM-85 trainers is not authorized.</li> <li>No other TGM-85 will be installed on the same launcher when one is equipped with recorder.</li> <li>All partial load configurations are authorized without sequencing restrictions for AGM-85 and TGM-85.</li> </ul>
D	*	220		NA	NA	NA	NA	<ul style="list-style-type: none"> <li>If gross weight is over 37,500 lbs, refer to Acceleration Limitations Chart.</li> <li>If the tank aboard relay is energized (TK light illuminated), the missiles mounted on fuselage stations 4 and 6 cannot be launched or jettisoned.</li> <li>Roll rate is aircraft limits.</li> <li>* Refer to TO 1F-4E-34-1-1-1.</li> </ul>
	*	175	750	NA	NA	NA	NA	<ul style="list-style-type: none"> <li>If gross weight is over 37,500 lbs, refer to Acceleration Limitations Chart.</li> <li>Roll rate limit is 200 deg/sec.</li> <li>* Refer to TO 1F-4E-34-1-1-1.</li> <li>** Aircraft limits except with MK 8 warhead; see figure 5-11.</li> <li>*** Not jettisonable after TO 1FL1-3-15-510.</li> </ul>

Figure 5-10 (Sheet 5 of 23)

# EXTERNAL STORES LIMITATIONS

**MISSILES,  
MISSILE MIXED LOADS,  
GP AND INCENDIARY  
BOMBS**

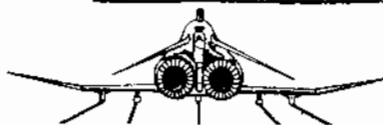

STORE	SUSPENSION	STATION LOADING					CARRIAGE				JETTISON 1G LEVEL FLIGHT	
		1	2	5	8	9	AIRSPEED		ACCEL G		MIN	MAX
							KNDTS	MACH	SYM.	UNSYM.	KNOTS	KNDTS
AIM-9B/E/J with ALQ-71(V)-2, 71(V)-3, ALQ-72, ALQ-87 ALQ-101 AIM-9B/E/J/J-1 with ALQ-101(V)-8	Aero 3/B with 3-inch extender on MAU-12 Pylon						*	*	+6.0 -3.0	+4.8 0.0	175	750
Matra 250 Kg Bomb (unretarded) Maximum Load-6	TER-9A						500	0.9	+5.0 -1.0	+4.0 0.0	175	500
M36E2 Cluster Incendiary Bomb Maximum Load-10	MER (Fwd) TER MAU-12						550	0.9	+5.0 -1.0	+4.0 0.0	300 175	500 550
M117 GP Bomb with M131A1 Conical Fin Maximum Load-17	MER (Fwd) TER						550	1.1	+5.0 -1.0	+4.0 0.0	275 275 275	550 450 550

**MISSILES,  
MISSILE MIXED LOADS,  
GP AND INCENDIARY  
BOMBS**

	EMPLOYMENT			RELEASE			DELIVERY ANGLE	REMARKS
	MAX	MIN	MAX	MAX	MIN	MAX		
	ACCEL G	KNOTS	KNOTS	ACCEL G	KNOTS	KNOTS		
A	6.0	175	750	NA	NA	NA	NA	<ul style="list-style-type: none"> <li>● If gross weight is over 37,500 lbs, refer to Acceleration Limitations Chart.</li> <li>● Cartridges are not to be installed in MAU-12 pylon.</li> <li>* Aircraft limits except with MK 8 warhead; See figure 5-11.</li> </ul>
B	NA	NA	NA	+1.0 +0.8	175	500	Level to -20°	<ul style="list-style-type: none"> <li>● If gross weight is over 45,000 lbs, refer to Acceleration Limitation Chart</li> <li>● Minimum ripple release interval is 0.14 seconds.</li> <li>● Configure MAU-12 bomb rack with two ARD-863-1 cartridges and two 0.081-inch diameter dash three orifices.</li> <li>● Configure TER ejector units with one ARD-863-1 cartridge.</li> <li>● This munition is certified only for the contingency rearming of USAF aircraft at allied bases with this munition from allied inventories.</li> </ul>
C	NA	NA	NA	+4.0 +4.0	200 175	550 550	Level to -45°	<ul style="list-style-type: none"> <li>● If gross weight is over 45,000 lbs, refer to Acceleration Limitations Chart.</li> <li>● Nose cone removed.</li> </ul>
D	NA	NA	NA	+5.0	175	550	+60° to -60°	<ul style="list-style-type: none"> <li>● If gross weight is over 45,000 lbs, refer to Acceleration Limitations Chart.</li> </ul>

Figure 5-10 (Sheet 7 of 23)

# EXTERNAL STORES LIMITATIONS

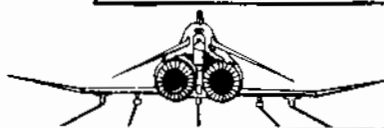

GP BOMBS

STORE	SUSPENSION	STATION LOADING					CARRIAGE				JETTISON 1G LEVEL FLIGHT	
							AIRSPEED		ACCEL G		MIN	MAX
		1	2	5	8	9	KNOTS	MACH	SYM.	UNSYM.	KNOTS	KNOTS
M117 GP Bomb with MAU-103A/B Fin Maximum Load-17	MER (fwd)	⏏				⏏	550	1.1	+5.0 -1.0	+4.0 0.0	275	550
		⏏				⏏	600	1.3	+3.0 0.0	+2.4 0.0		
	TER	⏏				⏏					275	450
		⏏				⏏					275	550
M117D (Destructor) M117RE and M117RE (LD) (Retarded) Bomb Maximum Load Single - 16 Ripple - 4	MER (Fwd)	⏏				⏏	550	1.1	+5.0 -1.0	+4.0 0.0	375	500
		⏏				⏏	600	1.3	+3.0 0.0	+2.4 0.0		
	TER	⏏				⏏					275	450
		⏏				⏏					175	550
M118GP Bomb	AERO-27/A or BRU-5/A			●			600	1.1	+5.0 -1.0	+4.0 0.0	175	600
M129E1, M129E2 Leaflet Bomb Maximum Load-18	MER (Fwd)	●	●			●	550	1.1	+5.0 -1.0	+4.0 0.0	175	550
		⏏				⏏					275	550
	TER	⏏				⏏					275	450
		⏏				⏏					175	550
MC-1 Gas Bomb Maximum Load-17	MAU-12	●	●			●	550	1.1	+5.0 -1.0	+4.0 0.0	175	550
	MER (Fwd)	⏏				⏏					275	550
		TER	⏏				⏏				275	450
	⏏				⏏					175	550	
MK 81 LDGP Bomb Maximum Load-24	MER (Fwd)	⏏				⏏	550	1.1	+5.0 -1.0	+4.0 0.0	275 Single Speed 275	
		⏏				⏏					175	450
	TER	⏏				⏏					175	550
		⏏				⏏						

4E-1-191-81E

Figure 5-10 (Sheet 8 of 23)

GP BOMBS

	EMPLOYMENT			RELEASE			DELIVERY ANGLE	REMARKS
	MAX	MIN	MAX	MAX	MIN	MAX		
	ACCEL G	KNOTS	KNOTS	ACCEL G	KNOTS	KNOTS		
	NA	NA	NA	+5.0	175	550	+60° to -60°	● If gross weight is over 45,000 lbs, refer to Acceleration Limitations Chart.
				+3.0	175	600		
A	NA	NA	NA	1	175	600	Level to -45°	● If gross weight is over 45,000 lbs, refer to Acceleration Limitations Chart.
B	NA	NA	NA	+4.0	175	600	+60° to -60°	● If gross weight is over 45,000 lbs, refer to Acceleration Limitations Chart.
C	NA	NA	NA	1	175	550	Level to -45°	● If gross weight is over 45,000 lbs, refer to Acceleration Limitations Chart.
D	NA	NA	NA	1	175	550	LEVEL to -60°	● If gross weight is over 45,000 lbs, refer to Acceleration Limitations Chart.
E	NA	NA	NA	+5.0	175	550	+60° to -60°	● If gross weight is over 45,000 lbs, refer to Acceleration Limitations Chart.
F								

4E-1-(91-9)H

Figure 5-10 (Sheet 9 of 23)

# EXTERNAL STORES LIMITATIONS

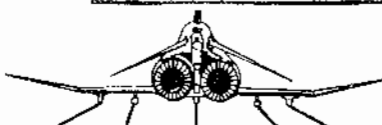

**GP BOMBS AND  
GP BOMBS WITH  
FUZE EXTENDERS**

STORE	SUSPENSION	STATION LOADING					CARRIAGE				JETTISON 1G LEVEL FLIGHT	
							AIRSPEED		ACCEL G		JETTISON	
		1	2	5	8	9	KNOTS	MACH	SYM.	UNSYM.	MIN KNOTS	MAX KNOTS
MK 82 LDGP, MK 82 or MK-36 Destructor W/Mau-93B or W/MK-15 Fin (banded closed)  Maximum Load-24	MER (Shifted Fwd)						550	1.1	+5.0 -1.0	+4.0 0.0	175	450
	TER						650	1.3	+3.0 0.0	+2.4 0.0	175	550
MK 83 LDGP Bomb  Maximum Load-13	MER (Outboard Shifted Aft) (Centerline Shifted Fwd)	Singles					550	1.1	+5.0 -1.0	+4.0 0.0	175	450
			TER									
	TER	Ripple					550	1.1	+5.0 -1.0	+4.0 0.0	175	450
			TER									
MK 84 LDGP Bomb  Maximum Load-3	MAU-12						600	1.3	+5.5 -3.0	+4.4 0.0	175	600
	AERO-27/A or BRU-5/A						650	1.4	+3.0 0.0	+2.4 0.0		
MK 82 Snakeye 1 or MK 36 Destructor W/MK 15 Mod 3A or Mod 4 Fins (high or low drag)  Maximum Load: Single-24 Ripple-21	MER (Shifted Fwd)	Single Release Mode or Ripple					550	1.1	+5.0 -1.0	+4.0 0.0	175	450
	TER											175
MK 81 with M1A1 Fuze Extender	MER (Fwd)					550	1.1	+5.0 -1.0	+4.0 0.0	175	450	
												275
MK 82 with M1A1 Fuze Extender	MER (Fwd)					550	1.1	+5.0 -1.0	+4.0 0.0	175	450	
	TER										175	550
MK 83 with M1A1 Fuze Extender	MER (Fwd)					550	1.1	+5.0 -1.0	+4.0 0.0	175	450	
	MER (Aft)										175	550
	TER										175	550
MK 84 with M1A1 Fuze Extender	Aero 27 or BRU-5						600	1.1	+5.0 -1.0	+4.0 0.0	175	600
	MAU-12										175	550
M118 GP with M1A1 Fuze Extender	Aero 27 or BRU-5						600	1.1	+5.0 -1.0	+4.0 0.0	175	600

4E-1-(91-10)G

Figure 5-10 (Sheet 10 of 23)



**GP BOMBS AND  
GP BOMBS WITH  
FUZE EXTENDERS**

	EMPLOYMENT			RELEASE			DELIVERY ANGLE	REMARKS
	MAX	MIN	MAX	MAX	MIN	MAX		
	ACCEL G	KNOTS	KNOTS	ACCEL G	KNOTS	KNOTS		
A	NA	NA	NA	+5.0	175	550	+60° to -60°	<ul style="list-style-type: none"> <li>If gross weight is over 45,000 lbs, refer to Acceleration Limitations Chart.</li> </ul>
B	NA	NA	NA	+5.0	175	550	+40° to -40°	<ul style="list-style-type: none"> <li>If gross weight is over 45,000 lbs, refer to Acceleration Limitations Chart.</li> </ul>
							+60° to -60°	
C	NA	NA	NA	+4.0	175	600	+60° to -60°	<ul style="list-style-type: none"> <li>If gross weight is over 41,000 lbs, refer to Acceleration Limitations Chart.</li> </ul>
				+3.0	175	650	+30° to -30°	
D	NA	NA	NA	+5.0	175	500 * 550	Level to -60°	<ul style="list-style-type: none"> <li>If gross weight is over 45,000 lbs, refer to Acceleration Limitations Chart.</li> <li>Simultaneous release from TER and centerline MER is prohibited.</li> <li>To prevent bomb-to-bomb collision when released from station 1, 5 and 9; select an interval setting which will provide 0.20 seconds or greater between tandem bomb releases on each station.</li> </ul> <p>* MK 82 Snakeye 1 (LB) Low Drag. ** Loading on station 5 is restricted to MER stations 1, 4 and 6 whenever ripple or continuous release mode is selected.</p>
D	NA	NA	NA	+5.0	175	475	+60° to -60°	<ul style="list-style-type: none"> <li>If gross weight is over 45,000 lbs, refer to Acceleration Limitations Chart.</li> <li>Dive toss delivery of bombs with M1 fuze extenders in excess of 3 G's may cause arming wire problems.</li> </ul>
				+4.0	175	550		
				+4.0	175	600	Level to -45°	

4E-1--(91-11)N

Figure 5-10 (Sheet 11 of 23)

# EXTERNAL STORES LIMITATIONS



**FIRE BOMBS  
DISPENSERS AND  
CLUSTER BOMB UNITS**

STORE	SUSPENSION	STATION LOADING					CARRIAGE				JETTISON 1G LEVEL FLIGHT		
		1	2	5	8	9	AIRSPEED		ACCEL G		MIN	MAX	
							KNOTS	MACH	SYM.	UNSYM.	KNOTS	KNOTS	
BLU-1/B BLU-1B/B BLU-1C/B or BLU-27/B BLU-27A/B BLU-27B/B BLU-27C/B Fire Bomb (Unfined) Maximum Load-11	MER (Fwd)	▽				▽	550	1.1	+5.0 -1.0	+4.0 0.0	340	400	
		Single Only			▽		600	1.3	+3.0 -0.0	+2.4 0.0	275	400	
	TER		▽		▽						275	500	
	MAU-12	●	●		●	●					300	500	
BLU-1/B, B/B, C/B BLU-27A/B BLU-27B/B BLU-27C/B BLU-27B Fire Bomb (Finned) Maximum Load-4	MER (Aft)			▽			550	1.1	+5.0 -1.0	+4.0 0.0	275	500	
		▽				▽	600	1.3	+3.0 0.0	+2.4 0.0	250	500	
	MAU-12	●				●					175	550	
CBU-      SUU- 9A/A      7B/A 9B/A      7C/A 12A/A     7B/A 12A/A     7C/A 46A/A, A/A   7C/A  Dispenser and Bomb Maximum Load-5	MER (Shifted Fwd)	FULL			▽		550	1.1	+5.0 -1.0	+4.0 0.0	325 Single Speed 325		
			▽				▽					300 Single Speed 300	
			▽				▽						
			▽				▽						
			▽				▽						
			▽				▽						
CBU-      SUU- 49 B/B     30 B/B 52 B/B     30 H/B 58/B       30 H/B 71/B       30 H/B  Dispenser and Bomb Maximum Load -15	MER (Shifted Fwd)			▽			550	1.1	+5.0 -1.0	+4.0 0.0	300	500	
		TER		▽		▽		600	1.3	+3.0 0.0	+2.4 0.0	175	500
	MER (Shifted Fwd)	▽				▽					375	500	
	MAU-12	●	●		●	●					175	550	
BL - 755 Cluster Bomb (MK1, MK2 No. 1, and MK2 No. 1A)  Maximum Load - 6	TER-9A		▽		▽		550	1.1	+5.0 -1.0	+4.0 0.0	175	550	
		MER-1 ON (Shifted Fwd)			▽			600	1.3	+3.0 0.0	+2.4 0.0	300	500

4E-1-(91-12)N

Figure 5-10 (Sheet 12 of 23)

**FIRE BOMBS  
DISPENSERS AND  
CLUSTER BOMB UNITS**

	EMPLOYMENT			RELEASE			DELIVERY ANGLE	REMARKS
	MAX	MIN	MAX	MAX	MIN	MAX		
	ACCEL G	KNOTS <sup>a</sup>	KNOTS	ACCEL G	KNOTS	KNOTS		
A	NA	NA	NA	+3.0	250	400	+10° to -30°	<ul style="list-style-type: none"> <li>• If gross weight is over 45,000 lbs, refer to Acceleration Limitations Chart.</li> <li>• To preclude store to store collision at stations 1, 2, 8 and 9, select an interval which will provide: .14 sec or greater between releases from stations 2 and 8. .10 sec or greater between releases from stations 1 and 9.</li> </ul>
				+2.0	300	400		
				+2.0	250	400		
				+3.0	300	500		
B	NA	NA	NA	+3.0	175	600	+10° to -30°	<ul style="list-style-type: none"> <li>• If gross weight is over 45,000 lbs, refer to Acceleration Limitations Chart.</li> <li>• MER: Minimum Release Interval Setting is 100 msec.</li> </ul>
B	1	450	550	1	275	550	EMPLOY 0° to -30° RELEASE Level	<ul style="list-style-type: none"> <li>• If gross weight is over 45,000 lbs, refer to Acceleration Limitations Chart.</li> <li>• SUU-7 dispensers that have ballast bands can be expected to safely separate from aircraft stations 1 and 9 when released in 1G straight and level flight. Release from the bottom aft MER stations between 475 and 550 knots, as close as possible to 515 knots. Release from the outboard MER stations between 375 and 475 knots, as close as possible to 415 knots.</li> </ul>
	NA	NA	NA	1	325	500		
C	NA	NA	NA	+4.0	175	550	+60° to -60°	<ul style="list-style-type: none"> <li>• If gross weight is over 45,000 lbs, refer to Acceleration Limitations Chart.</li> <li>• (STA 2 &amp; 8): Ripple and salvo release in 1G level or dive flight only.</li> <li>• Maximum release is .9 Mach.</li> </ul>
D	NA	NA	NA	+5.0 to +0.9	175	550	Level to -20°	<ul style="list-style-type: none"> <li>• If gross weight exceeds 45,000 lbs., refer to Acceleration Limitations Chart.</li> <li>• Minimum release air speed for station 5 does not attest to weapons ability to function at this speed.</li> <li>• Configure MAU-72 rack with two ARD-863-1 cartridges and two 0.081-inch diameter dash three orifices.</li> <li>• Configure AERO 27 or BRU-5 rack with two MK2 cartridges and a forced jettison prevention sleeve.</li> <li>• Minimum ripple release interval is 0-14 seconds.</li> <li>• The BL-765 series cluster bombs have not received safety certification by USAF Non-nuclear Munitions Safety Board (NNMSB).</li> </ul>
						175		

4E-1-(91-13) N

Figure 5-10 (Sheet 13 of 23)

# EXTERNAL STORES LIMITATIONS

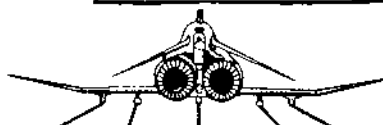

DISPENSERS  
AND CLUSTER  
BOMB UNITS

STORE	SUSPENSION	STATION LOADING					CARRIAGE				JETTISON 1G LEVEL FLIGHT		
							AIRSPEED		ACCEL G		JETTISON		
		1	2	5	8	9	KNOTS	MACH	SYM.	UNSYM.	MIN	MAX	
										KNOTS	KNOTS		
<b>UNFINNED</b>		MER (Shifted Fwd)	FULL					550	0.9	+5.0 -1.0	+4.0 0.0	275	400
CBU-	SUU-												
7A/A 30/A 38/A 38A/A 38B/A,C/A	13A/A 13/A 13A/A 13B/A 13C/A												
Dispenser and Bomb Maximum Load-18													
		TER	FULL					550	0.9	+5.0 -1.0	+4.0 0.0	250	450
		MER (Shifted Fwd)	EMPTY					550	0.9	+5.0 -1.0	+4.0 0.0	400	400
		TER	EMPTY					550	0.9	+5.0 -1.0	+4.0 0.0	275	375
		TER	EMPTY					550	0.9	+5.0 -1.0	+4.0 0.0	250	450
<b>FINNED</b>		MER (Aft)	FULL					550	1.1	+4.0 -1.0	+3.2 0.0	425	475
CBU-	SUU-												
42/A	38/A												
Dispenser and Mine Maximum Load-13													
		MER (Shifted Fwd)	FULL					550	1.1	+5.0 -1.0	+4.0 0.0	400	450
								550	1.1	+5.0 -1.0	+4.0 0.0	400	450
		TER	FULL					550	1.1	+5.0 -1.0	+4.0 0.0	400	550
Mk 20 Mod 2, 3, 4 CLUSTER BOMB (ROCKEYE III) Maximum Load-12		MER (Fwd)	FULL					550	1.1	+5.0 -1.0	+4.0 0.0	175	450
		TER	FULL					550	1.1	+5.0 -1.0	+4.0 0.0	175	550
SUU-20/A SUU-20A/A SUU-20B/A Bomb and Rocket Dispenser with MK 106, BDU-33B/B Maximum Load-2		MAU-12	FULL					550	1.2	+5.0 -2.0	+4.0 0.0	375 Single Speed	375
		MAU-12	FULL					550	1.2	+5.0 -2.0	+4.0 0.0	375 Single Speed	375
		MAU-12	FULL					550	1.3	+3.0 0.0	+2.4 0.0	375 Single Speed	375
SUU-21/A Bomb Dispenser with MK 106 BDU-33B/B, D/B Maximum Load-5		Aero 27/A or BRU-5/A	FULL					550	1.3	+6.5 -3.0	+5.2 0.0	NA	NA
		MAU-12	FULL					550	1.1	+5.5 -1.0	+4.4 0.0	NA	NA

4E-1-(91-14)N

Figure 5-10 (Sheet 14 of 23)

**DISPENSERS  
AND CLUSTER  
BOMB UNITS**

EMPLOYMENT			RELEASE			DELIVERY ANGLE	REMARKS
MAX	MIN	MAX	MAX	MIN	MAX		
ACCEL G	KNOTS	KNOTS	ACCEL G	KNOTS	KNOTS		
1	175	550	1	250	450	EMPLOY Level to -45°  RELEASE Level	<ul style="list-style-type: none"> <li>● If gross weight is over 45,000 lbs, refer to Acceleration Limitations Chart.</li> <li>● To preclude possible missile collision between adjacent CBU-7/A dispensers, the 50-millisecond dispenser release interval may be used only when a single aircraft station is selected or when aircraft stations 1 and 9 or 2 and 8 are selected.</li> <li>● From the TER on aircraft stations 2 and 8, CBU-7/A dispensers may be released in the single and pairs release modes, in the ripple release mode with a minimum INTVL setting of .15 SEC, and in the salvo release mode with a minimum INTVL setting of .30 SEC.</li> <li>● After employment, an airborne visual check of the dispenser must be accomplished to preclude return to base of any non-ejected or partially ejected munitions. If a visual check cannot be accomplished or if any munitions remain in the SUU-13, the dispenser must be released or jettisoned to prevent inadvertent munitions release during aircraft recovery.</li> <li>● Special fuel sequencing required. Refer to TO 1F-4E-5.</li> </ul>
			1	175	500		
			1	250	500		
NA	NA	NA	1	400 Single Speed 400			
			1	325	400		
			1	350	400		
A 1	175	550	1	425	450	EMPLOY Level to -45°  RELEASE Level	<ul style="list-style-type: none"> <li>● If gross weight is over 45,000 lbs, refer to Acceleration Limitations Chart.</li> <li>● Special fuel sequencing required. Refer to TO 1F-4E-5.</li> <li>● (STA 2 &amp; 8) Use TER-9A only.</li> </ul>
			1	325	525		
			1	350	550		
B NA	NA	NA	+4.0	175	550	Level to -45°	<ul style="list-style-type: none"> <li>● If gross weight is over 45,000 lbs, refer to Acceleration Limitations Chart.</li> </ul>
C +4.0	ROCKETS		NA	NA	NA	EMPLOY +60° to -60°	<ul style="list-style-type: none"> <li>● If gross weight is over 45,000 lbs, refer to Acceleration Limitations Chart.</li> <li>● Either 14 or 30-inch suspension hooks may be used.</li> <li>● Maximum employment is .9 Mach.</li> </ul>
	300	450					
	BOMBS						
	300	550					
D +6.5	175	550	NA	NA	NA	EMPLOY +60° to -60°	<ul style="list-style-type: none"> <li>● If gross weight is over 37,500 lbs, refer to Acceleration Limitations Chart.</li> <li>● DCU-94/A release system only.</li> </ul>

4E-1-(91-15)H

Figure 5-10 (Sheet 15 of 23)

# EXTERNAL STORES LIMITATIONS

PRACTICE BOMBS, AND  
ROCKET LAUNCHERS (FFAR)



STORE	SUSPENSION	STATION LOADING					CARRIAGE				JETTISON 1G LEVEL FLIGHT	
							AIRSPEED		ACCEL G		MIN	MAX
		1	2	5	8	9	KNOTS	MACH	SYM.	UNSYM.	KNOTS	KNOTS
BDU-33B/B, D/B Practice Bomb	MER (Shifted Fwd)						550	0.95	+5.0 -1.0	+4.0 0.0	350	450
						275 Single Speed 275						
	TER					175					550	
LAU-3/A Rocket Launcher Maximum Load-15	MER (Aft)						550	1.1	+5.0 -1.0	+4.0 0.0	175	275
	TER	FULL									175	450
	MAU-12					175					450	
											250	500
	MER (Aft)										250	275
											175	225
	TER	EMPTY									175	400
MAU-12					175	550						
LAU-68A/A 68B/A Maximum Load 4	TER					550	1.1	+5.0 -1.0	+4.0 0.0	200	450	
	MAU-12											

Figure 5-10 (Sheet 16 of 23)

**PRACTICE BOMBS, AND  
ROCKET LAUNCHERS (FFAR)**

EMPLOYMENT			RELEASE			DELIVERY ANGLE	REMARKS	
MAX	MIN	MAX	MAX	MIN	MAX			
ACCEL G	KNOTS	KNOTS	ACCEL G	KNOTS	KNOTS			
NA	NA	NA	5.0	175	550	+60° to -60°	<ul style="list-style-type: none"> <li>● If gross weight is over 45,000 lbs, refer to Acceleration Limitations Chart.</li> </ul>	
A	+5.0	300	450	1	175	275	EMPLOY 0° to -60° RELEASE Level	<ul style="list-style-type: none"> <li>● If gross weight is over 45,000 lbs, refer to Acceleration Limitations Chart.</li> <li>● When carrying tanks on stations 1 and/or 9, do not release rocket pods (either full or empty) from the outboard shoulder of TER's on stations 2 and 8.</li> <li>● Nosecone and/or tailcone failure can be expected at speeds above 400 knots.</li> <li>● Speed brakes must be retracted when launching from stations 2 and 8.</li> <li>● If stores are installed at stations 4 and 6, do not launch rockets from station 5.</li> <li>● Maximum release and employment is .9 Mach.</li> </ul>
				1	225	400		
				1	175	450		
				1	250	500		
B	NA	NA	NA	1	300	350	Level	
				1	225	375		
				1	350	500		
				1	175	550		
B	5.0	175	550	1.0	275	550	EMPLOY 0° to -60° RELEASE Level	<ul style="list-style-type: none"> <li>● If gross weight is over 45,000 lbs, refer to Acceleration Limitations Chart.</li> <li>● Maximum release and employment is .9 Mach.</li> <li>● Speed brakes must be retracted when launching from stations 2 and 8.</li> </ul>
				1.0	175	450		

Figure 5-10 (Sheet 17 of 23)

# EXTERNAL STORES LIMITATIONS

**DISPENSERS, CARGO, ECM AND GUN PODS**

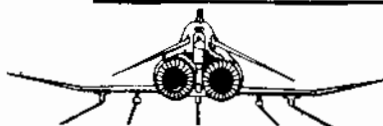

STORE	SUSPENSION	STATION LOADING					CARRIAGE				JETTISON 1G LEVEL FLIGHT	
							AIRSPEED		ACCEL G		MIN	MAX
		1	2	5	8	9	KNOTS	MACH	SYM.	UNSYM.	KNOTS	KNOTS
ALE-38 Chaff Dispenser Maximum Load-2	MAU-12		●		●		550	1.2	+4.0 0.0	+3.2 0.0	275	375
ALE-40 Flare/Chaff Dispenser (2 Disp per pylon) Maximum Load-4	MAU-12		+		+		▶	▶	▶	▶	NA	NA
SUU-16/A, SUU-23/A Gun Pod Maximum Load-3	MAU-12	●				●	▶	▶	+6.0 -3.0	+4.8 0.0	250	325
	Adapter			●			▶	▶	▶	▶		
SUU-25A/A Flare Dispenser With MK 24 or LUU-1/B, -2/B, -2A/B, -2B/B, -5/B Maximum Load-7	MER (Shifted Fwd)			◡			500	1.1	+5.0 -1.0	+4.0 0.0	200	300
		◡				◡					350	450
SUU-25B/A Flare Dispenser With MK 24 or LUU-1/B, -2/B, -2A/B, -2B/B, -2C/B, -5/B Maximum Load-6	MAU-12	●				●	550	1.1	+5.0 -1.0	+4.0 0.0	250	450
	MER (Shifted Fwd)			◡							200	300
		◡				◡					400	450
SUU-25C/A and SUU-25E/A Flare Dispenser with MK24 or LUU-1/B, -2/B, -2A/B, -2B/B, -2C/B, -5/B Maximum Load-6	MAU-12	●				●	550	1.1	+5.0 -1.0	+4.0 0.0	325	550
	MER (Shifted Fwd)	◡				◡					400	450
				◡							200	300
MXU-648/A Cargo Pod	MAU-12		●		●		500	.95	+5.0 -1.0	+4.0 0.0	NA	NA
AAQ-8 IRCM Pod with or without RAT Maximum Load-3	MAU-12		●		●	●	▶	▶	▶	▶	250	525
ALQ-71(V) -2, -3 ALQ-72 ALQ-87 ECM Pods With RAT	MAU-12		●		●	●	▶	▶	+6.0 -3.0	+4.8 0.0	NA	NA
ALQ-71(V) -2, -3 -72, -87, -101; 101(V)-8 119(V)-4 -7, -8, -10, -11, -12 and -14	MAU-12		●		●							
ECM PODS Without RAT	Missile Well Adapter	MISSILE STATIONS					▶	▶	▶	▶		
		3	4	6	7							

4E-1-(91-18)N

Figure 5-10 (Sheet 18 of 23)



**DISPENSERS, CARGO, ECM AND GUN PODS**

	EMPLOYMENT			RELEASE			DELIVERY ANGLE	REMARKS
	MAX	MIN	MAX	MAX	MIN	MAX		
	ACCEL G	KNOTS	KNOTS	ACCEL G	KNOTS	KNOTS		
A	+4.0	175	550	NA	NA	NA	NA	<ul style="list-style-type: none"> <li>Maximum jettison is .9 Mach.</li> </ul>
B				NA	NA	NA	NA	
C				NA	NA	NA	Employ Level to -60°	<ul style="list-style-type: none"> <li>If gross weight is over 37,500 lbs, refer to Acceleration Limitations Chart.</li> <li>Roll rate - 200 deg/sec.</li> </ul>
D	1	450	550	1	275	375	EMPLOY and RELEASE Level	<ul style="list-style-type: none"> <li>If gross weight is over 45,000 lbs, refer to Acceleration Limitations Chart.</li> </ul>
				1	350	450		
E	1	275	550	1	250	450	EMPLOY and RELEASE Level	<ul style="list-style-type: none"> <li>If gross weight is over 45,000 lbs, refer to Acceleration Limitations Chart.</li> <li>Release and Jettison Full or Empty.</li> </ul>
				1	250 (FULL) 500	400 (EMPTY) 500		
				1	350	450		
F	1	275	550	1	325	525	EMPLOY and RELEASE Level	<ul style="list-style-type: none"> <li>If gross weight is over 45,000 lbs, refer to Acceleration Limitations Chart.</li> <li>The 5-ohm resistor switch on front of SUU-25E/A must be in the OUT position when carried on any station.</li> <li>* SUU-25C/A is restricted from carriage on centerline, station 5, before TCTO 11A21- 5-501.</li> </ul>
G	NA	NA	NA	NA	NA	NA	NA	<ul style="list-style-type: none"> <li>If gross weight is over 45,000 lbs, refer to Acceleration Limitations Chart.</li> <li>Cartridges are not to be installed in MAU-12 pylon.</li> </ul>
H	NA	NA	NA	NA	NA	NA	NA	<ul style="list-style-type: none"> <li>If gross weight is over 37,500 lbs, refer to Acceleration Limitations Chart.</li> <li>STA 9 requires RAT.</li> </ul>
I	NA	NA	NA	NA	NA	NA	NA	<ul style="list-style-type: none"> <li>If gross weight is over 37,500 lbs, refer to Acceleration Limitations Chart.</li> <li>Roll rate-aircraft limits.</li> <li>Cartridges are not to be installed in MAU-12 pylon.</li> </ul>
J	NA	NA	NA	NA	NA	NA	NA	<ul style="list-style-type: none"> <li>If gross weight is over 37,500 lbs, refer to Acceleration Limitations Chart.</li> <li>* (STA 6): ALQ-101(V) and ALQ-119(V) ECM pods not authorized for carriage.</li> <li>Roll rate - 200 deg/sec.</li> </ul>

4E-1-(91-19)N

Figure 5-10 (Sheet 19 of 23)

# EXTERNAL STORES LIMITATIONS

**SPRAY TANKS, TARGETS,  
SUSPENSION EQUIPMENT  
AND MISCELLANEOUS**

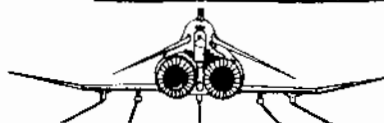

STORE	SUSPENSION	STATION LOADING					CARRIAGE				JETTISON 1G LEVEL FLIGHT	
							AIRSPEED		ACCEL G		MIN	MAX
		1	2	5	8	9	KNOTS	MACH	SYM.	UNSYM.	KNOTS	KNOTS
TMU-28/B Spray Tank  Maximum Load-2	MAU-12	●				●	550	1.1	+5.0 -1.0	+4.0 0.0	275	500
Modified A/A-37U-15 Tow Target System  Maximum Load-1  Configuration limited to Tow target only; or tow target, wing tank, and/or centerline tank.	Tow Target Adapter Target Stowed	✱●					250 *	NE	+1.5 +0.5	NA	NA	NA
	Target Deployment	✱●					NA	NA	NA	NA		
	Target Towed	✱					500	1.1	+5.0 -1.0	NA		
	Target Released	●					500	1.1	+5.0 -1.0	+4.0 0.0		
RMU-8A Reel Launcher W/TDU-22	Aero 27/A or BRU-5/A			●			500	0.9	+2.0 +0.5	NA	NA	NA
AN/ASQ-T-11, -T-13 AIS Pod (ACMI System) Maximum Load-X4	Aero-3/B Launcher		●●		●●		→	1.6	+6.5 -3.0	+5.2 0.0	NA	NA
APX-95 Maximum Load-1	MAU-12		●		●		550	.95	+5.0 -1.0	+4.0 0.0	NA	NA
AN/AVQ-23A/B Pave Spike Pod  Maximum Load-1	Missile Well Adapter	MISSILE STATIONS					550	1.2	+6.0 -1.0	+4.0 0.0	NA	NA
		FWD		●			600 *	1.2 *	+3.0 0.0	+2.4 0.0		
Empty MER  Maximum Load-3	MAU-12	▽				▽	→	→	→	→	350	550
	Q Adapter			▽							275	350
Empty TER Maximum Load-2	MAU-12		▽		▽		→	→	→	→	175	550
Empty Aero-3/B Launchers	MAU-12		+		+		→	→	→	→	NA	NA

4E-1-(91-20)N

Figure 5-10 (Sheet 20 of 23)

**SPRAY TANKS, TARGETS,  
SUSPENSION EQUIPMENT  
AND MISCELLANEOUS**

	EMPLOYMENT			RELEASE			DELIVERY ANGLE	REMARKS
	MAX	MIN	MAX	MAX	MIN	MAX		
	ACCEL G	KNOTS	KNOTS	ACCEL G	KNOTS	KNOTS		
A	1	300	550	1	275	500	Level	<ul style="list-style-type: none"> <li>● If gross weight is over 45,000 lbs, refer to Acceleration Limitations Chart.</li> <li>● Lower tail fins must be removed.</li> <li>● Maximum employment is .95 Mach.</li> <li>● After employment, the dispenser shall be released or jettisoned before landing.</li> </ul>
B	NA	NA	NA	NA	NA	NA	NA	<ul style="list-style-type: none"> <li>● If gross weight is over 45,000 lbs, refer to Acceleration Limitations Chart.</li> <li>● Maximum crosswind component for takeoff or landing with a stowed target is 15 knots.</li> <li>* 275 knots is permissible under non-turbulent flight conditions. Only gradual coordinated turns (max bank angle of 20°) are permitted.</li> </ul>
	+5.0	200	500	NA	NA	NA	NA	<ul style="list-style-type: none"> <li>● If gross weight is over 45,000 lbs, refer to Acceleration Limitations Chart.</li> <li>● Only gradual coordinated turns are permitted.</li> </ul>
	NA	NA	NA				NA	<ul style="list-style-type: none"> <li>● If gross weight is over 45,000 lbs, refer to Acceleration Limitations Chart.</li> <li>● After tow cable is cut.</li> </ul>
C	*	*	*	NA	NA	NA	NA	<ul style="list-style-type: none"> <li>● Maximum roll rate is 60 deg/sec.</li> <li>* Refer to TO 1F-4E-34-1-1.</li> </ul>
D	NA	NA	NA	NA	NA	NA	NA	<ul style="list-style-type: none"> <li>● If gross weight is over 37,500 lbs, refer to Acceleration Limitations Chart.</li> <li>● Maximum roll rate is 200 deg/sec.</li> <li>● AIM-9 or AIM-7 not authorized when configured with AIS Pod. However, captive AIM-9 with inert rocket motor and AIM-7 Simulator Plug are authorized.</li> </ul>
E	NA	NA	NA	NA	NA	NA	NA	<ul style="list-style-type: none"> <li>● If gross weight is over 45,000 lbs, refer to Acceleration Limitations Chart.</li> </ul>
F	NA	NA	NA	NA	NA	NA	NA	<ul style="list-style-type: none"> <li>● If gross weight is over 37,500 lbs, refer to Acceleration Limitations Chart.</li> <li>● Rocket launchers not authorized on STA 5 when Pave Spike is loaded.</li> <li>* WITH VISOR CLOSED - speeds are aircraft limits.</li> </ul>
G	NA	NA	NA	NA	NA	NA	NA	<ul style="list-style-type: none"> <li>● Maximum roll rate is aircraft limits.</li> </ul>
H	NA	NA	NA	NA	NA	NA	NA	<ul style="list-style-type: none"> <li>● (STA 2 and 8): One or two empty Aero 3/8 launchers and spacers may be carried in combination with any other certified stores subject to the following restrictions:                         <ul style="list-style-type: none"> <li>● Only one type of store in addition to the launchers permitted on each aircraft station and the weight limitations of the more restrictive of the two will be observed.</li> <li>● Fit clearance of at least one inch must exist between the launchers and the other stores mounted on the station.</li> </ul> </li> <li>● Maximum roll rate is aircraft limits.</li> </ul>

4E-1-(91-21)N

Figure 5-10 (Sheet 21 of 23)

# EXTERNAL STORES LIMITATIONS

**CAMERA POD AND GUIDED BOMBS**

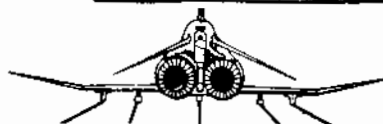

STORE	SUSPENSION	STATION LOADING					CARRIAGE				JETTISON 1G LEVEL FLIGHT	
							AIRSPEED		ACCEL G		JETTISON	
		1	2	5	8	9	KNOTS	MACH	SYM.	UNSYM.	MIN KNOTS	MAX KNOTS
AAVS TYPE IV CAMERA POD (Nellis Pod) Maximum Load-5	MER (Shifted Aft)	▽		▽		▽	550	1.3	+5.0 -1.0	+4.0 0.0	NE	NE
	TER		▽		▽							
	MER (Shifted Fwd)	▽		▽		▽	600	1.3	+3.0 0.0	+2.4 0.0		
	MAU-12	●	●		●	●	550	1.3	+5.0 -1.0	+4.0 0.0		
	AERO-27/A or BRU-5A			●			650	1.6	+3.0 0.0	+2.4 0.0		
GBU-10/B A/B, B/B (MK, 84 LGB) Maximum Load-4	MAU-12	●	●		●	●	550	0.95	+5.0 -1.0	+4.0 0.0	175	650
							650	1.4	+3.0 0.0	+2.4 0.0		
GBU-8/B (MK-84EO) Maximum Load-4	MAU-12	●	●		●	●	550	0.95	+5.0 -1.0	+4.0 0.0	175	550
							650	1.4	+3.0 0.0	+2.4 0.0		
GBU-11/B (M118 LGB) or GBU-9/B (M118 EO) Maximum Load-2	MAU-12		●		●		550	0.95	+4.0 -1.0	+3.0 0.0	200	550
GBU-12/B, B/B (MK-82 LGB) HIGH AND LOW SPEED VERSIONS Maximum Load-4	MAU-12	●	●		●	●	550	1.1	+5.0 -1.0	+4.0 0.0	175	550

Figure 5-10 (Sheet 22 of 23)

**CAMERA POD AND GUIDED BOMBS**

	EMPLOYMENT			RELEASE			DELIVERY ANGLE	REMARKS
	MAX	MIN	MAX	MAX	MIN	MAX		
	ACCEL G	KNOTS	KNOTS	ACCEL G	KNOTS	KNOTS		
	NA	NA	NA	NE	NE	NE	NA	<ul style="list-style-type: none"> <li>If gross weight is over 45,000 lbs, refer to Acceleration Limitations Chart.</li> </ul>
A	NA	NA	NA	1	175	650	Level to -45°	<ul style="list-style-type: none"> <li>If gross weight is over 45,000 lbs, refer to Acceleration Limitations Chart.</li> <li>Extended wing version of bomb will not fit on stations 1 and 9 pylon due to interference between bomb wing and aircraft wing.</li> <li>Landing with 2 bombs on the same wing is not recommended because the asymmetric moment exceeds that of one full external wing tank.</li> <li>Weight and balance of each aircraft loaded with one or two Guided Bombs must be examined for CG location during all possible takeoff and landing conditions.</li> </ul>
B	NA	NA	NA	1	175	550	Level to -45°	<ul style="list-style-type: none"> <li>If gross weight is over 45,000 lbs, refer to Acceleration Limitations Chart.</li> <li>Landing with 2 bombs on the same wing is not recommended because the asymmetric moment exceeds that of one full external wing tank.</li> <li>Weight and balance of each aircraft loaded with one or two Guided Bombs must be examined for CG location during all possible takeoff and landing conditions.</li> </ul>
C				1	175	650		
D	NA	NA	NA	1	200	550	Level to -45°	<ul style="list-style-type: none"> <li>Weight and balance of each aircraft loaded with one or two Guided Bombs must be examined for CG location during all possible takeoff and landing conditions.</li> <li>Landing with one M118 LGB should be avoided. One M118 LGB on an inboard pylon may exceed forward CG limit at landing gross weight; aircraft roll attitude during landing should be maintained within plus or minus one degree, and the maximum recommended sink rate is 8 feet per second.</li> <li>Roll rate limit is 90 deg/sec.</li> </ul>
	NA	NA	NA	+5.0	175	550	+45° to -45°	<ul style="list-style-type: none"> <li>If gross weight is over 45,000 lbs, refer to Acceleration Limitations Chart.</li> </ul>

Figure 5-10 (Sheet 23 of 23)

# AIM-9B, 9E, 9J, 9J-1 AIRSPEED LIMITATIONS

**MK 8 MOD 0/1/2 WARHEAD ONLY**

Note

THE MK 8 MOD 3 WARHEAD IS UNRESTRICTED.

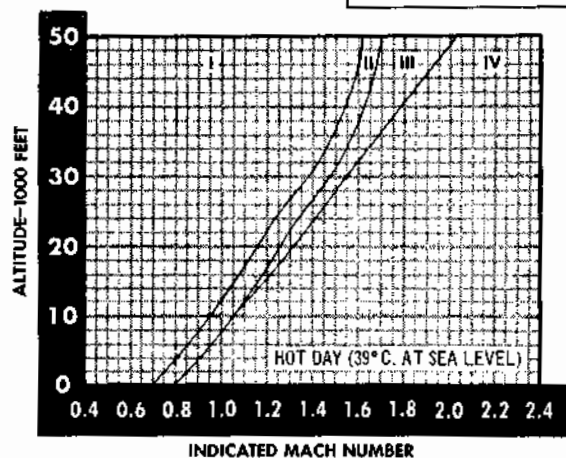
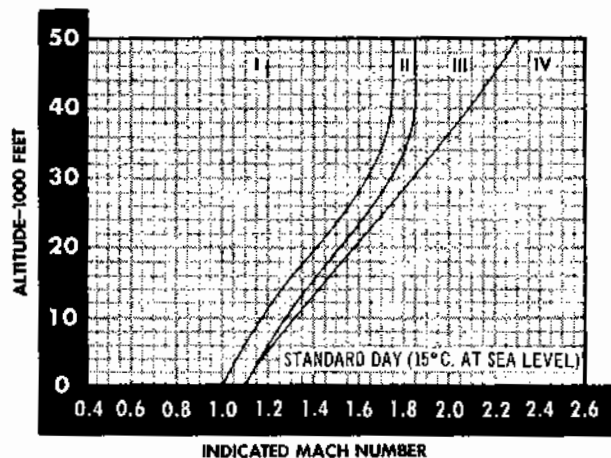

- ZONE I - NO RESTRICTIONS.  
 ZONE II - REPEATED EXCURSIONS OF NO MORE THAN 10 MINUTES EACH ARE PERMITTED.  
 ZONE III - REPEATED EXCURSIONS OF NO MORE THAN 5 MINUTES EACH ARE PERMITTED. INSPECTION OF WARHEADS IS RECOMMENDED AFTER EACH FLIGHT INVOLVING EXCURSIONS INTO ZONES II AND III.  
 ZONE IV - AVOID.

IF LIMITATIONS OF ZONES II, III, AND IV ARE VIOLATED THE WARHEAD SHOULD BE DESTROYED BY JETTISONING THE MISSILE IF POSSIBLE. LANDINGS CAN BE MADE WITH LOW ORDER RISK IF JETTISONING IS NOT POSSIBLE. THESE LIMITATIONS DO NOT APPLY TO AIRCRAFT CLIMB SCHEDULES, INCLUDING MAXIMUM PERFORMANCE.

4E-1-(33)B

Figure 5-11

## Section VI

# FLIGHT CHARACTERISTICS

### TABLE OF CONTENTS

STABILITY AND CONTROL	
General .....	6-1
Longitudinal Stability .....	6-1
CHARACTERISTICS	
Angle of Attack .....	6-6
Handling Qualities .....	6-7
Stalls .....	6-9

Departures .....	6-11
Spins .....	6-11
Zoom Climb .....	6-15

#### NOTE

All information in this section is based on flight test data. Departures and spins have been performed only on aircraft without slats. Revised or additional information will be supplied in subsequent revisions as it becomes available.

## STABILITY AND CONTROL

### GENERAL

Aircraft flight characteristics represent a compromise between the control response required to achieve desired performance and the stability necessary to keep pilot work load acceptable. As stability increases, responsiveness to control inputs or other disturbances (such as turbulence) decreases. As stability decreases, responsiveness to control inputs or other disturbances increases. Control effectiveness is a function of Mach number, but is even more dependent on dynamic pressure ( $q$ ). Stability varies with Mach number and CG location. Longitudinal stability has the most critical effect on aircraft control. These factors must be considered and understood in order to safely and effectively operate the aircraft throughout the flight envelope.

may be insufficient to counter the pitch change.

### LONGITUDINAL STABILITY

Longitudinal stability is stability in pitch. A measure of longitudinal stability is static margin, which is the distance, expressed as a percent of the mean aerodynamic chord (% MAC), between the aircraft center of gravity (CG) and the aerodynamic center (AC) or nominal point of lift (A, Figure 6-1). The neutral stability line on the AFT CG LIMITS chart (figure 5-7) plots the subsonic AC location as a function of the aircraft stability index. If the CG and AC are coincident, the static margin is zero and the aircraft has neutral longitudinal stability (B, Figure 6-1). A neutrally stable aircraft will remain at any angle of attack to which it is displaced by control movement or other disturbance. If the CG is forward of the AC, the static margin is positive and the aircraft is longitudinally stable. It will tend to return to the trim angle of attack following a control movement or other disturbance. Conversely, if the CG is aft of the AC, the static margin is negative and the aircraft is longitudinally unstable. In this condition, the aircraft will continue to pitch in the direction toward which it is disturbed by control movement or other disturbance. Beyond the aft CG limit, stabilator authority

Static margin will be continually changing during flight due to fuel consumption or a change in stability index number caused by the release of external stores. These are no sharp demarcation lines below which the aircraft becomes suddenly uncontrollable or above which the Pilot can completely disregard longitudinal stability considerations. The aft CG limit (0.4% MAC negative static margin) is established to minimize the probability of loss of control while providing sufficient loading flexibility to meet tactical requirements. In establishing this limit, it is assumed that the Pilot is familiar with aircraft flight characteristics. At low static margins (less than 1% MAC positive static margin), the tendency to overcontrol must be anticipated and carefully avoided. In this regime, the stick force required to induce a pitch change is noticeably less than that required with higher static margin, and there will be a tendency to overshoot desired pitch changes. Maneuvers requiring precise control, such as weapons delivery, inflight refueling, and close formation, are more difficult at low static margin. During high gross weight, maximum performance maneuvering or low speed flight, smooth longitudinal and lateral control inputs are required to prevent reaching stall angle of attack. The pitch stab aug is very effective in this regime, but smooth longitudinal control inputs are still required. No allowances are made for abrupt over-control inputs, regardless of static margin. If longitudinal stability becomes critical, the Pilot should consider jettisoning external wing tanks/stores to decrease the stability index number and increase static margin. At the first indication of departure from controlled flight, the OUT-OF-CONTROL RECOVERY procedure must be initiated.

# STABILITY EFFECTS

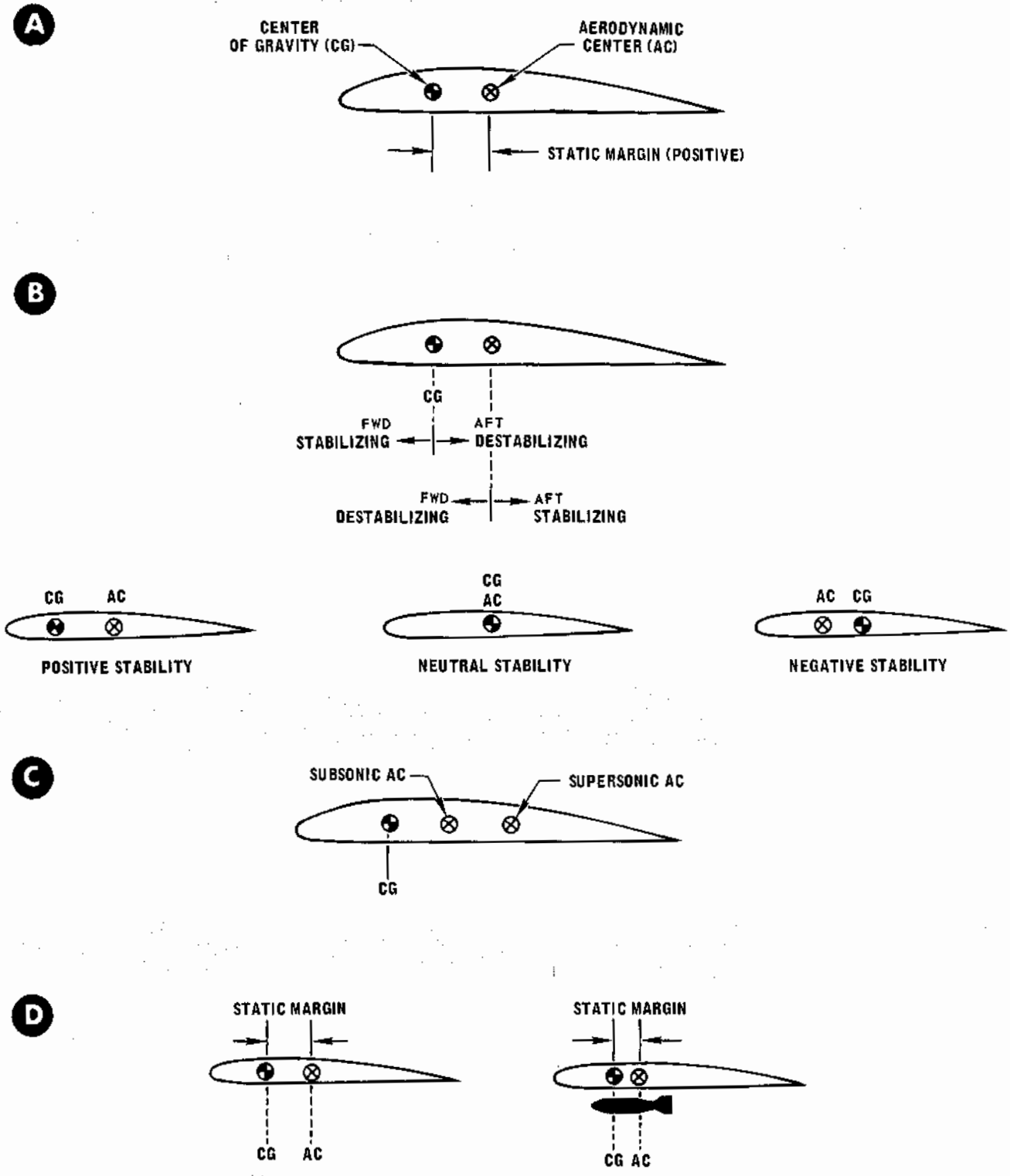

Figure 6-1



# C.G. TRAVEL DUE TO FUEL CONSUMPTION

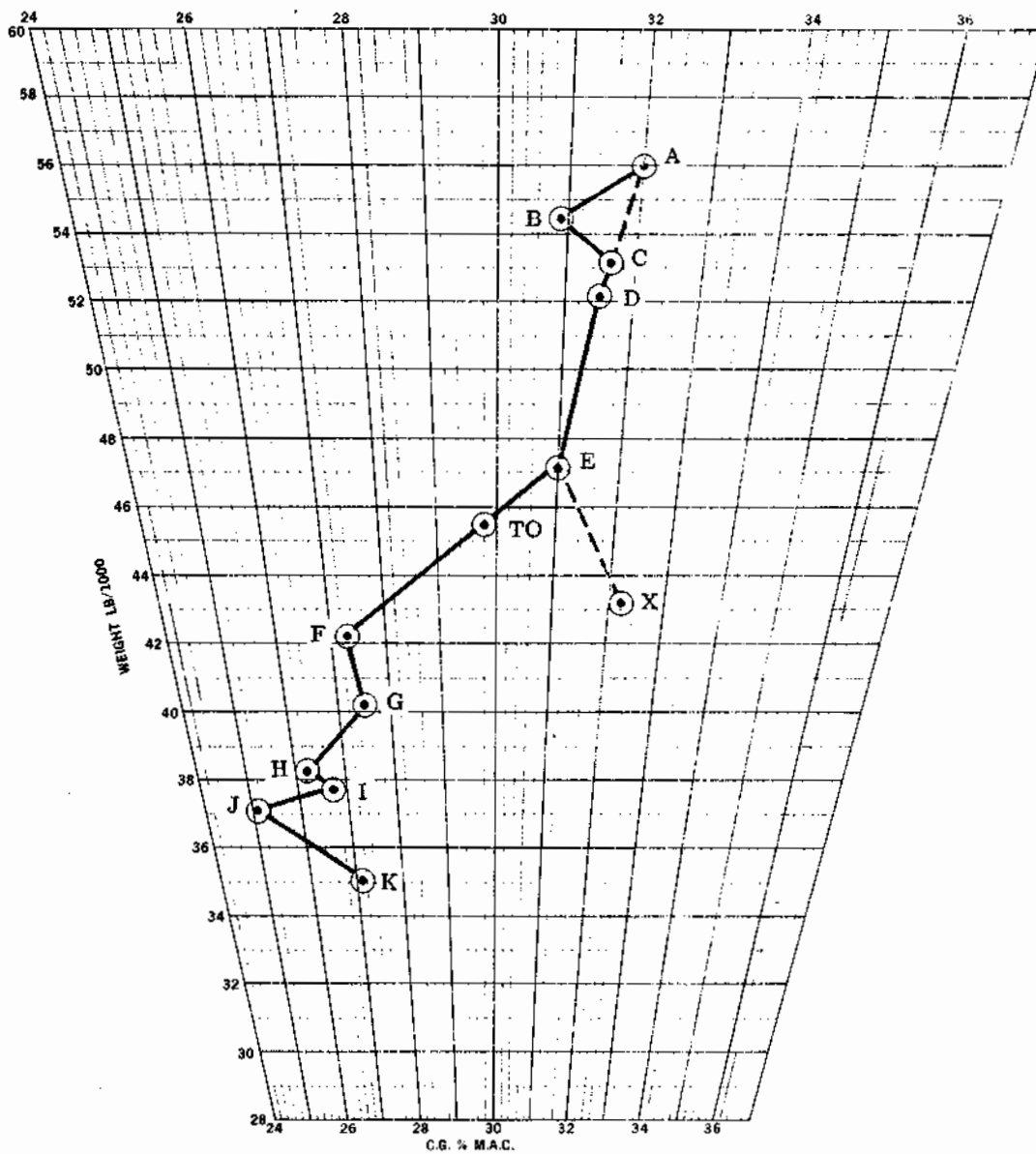

Figure 6-2

4E-1-(96)B

# C.G. TRAVEL DUE TO FUEL CONSUMPTION

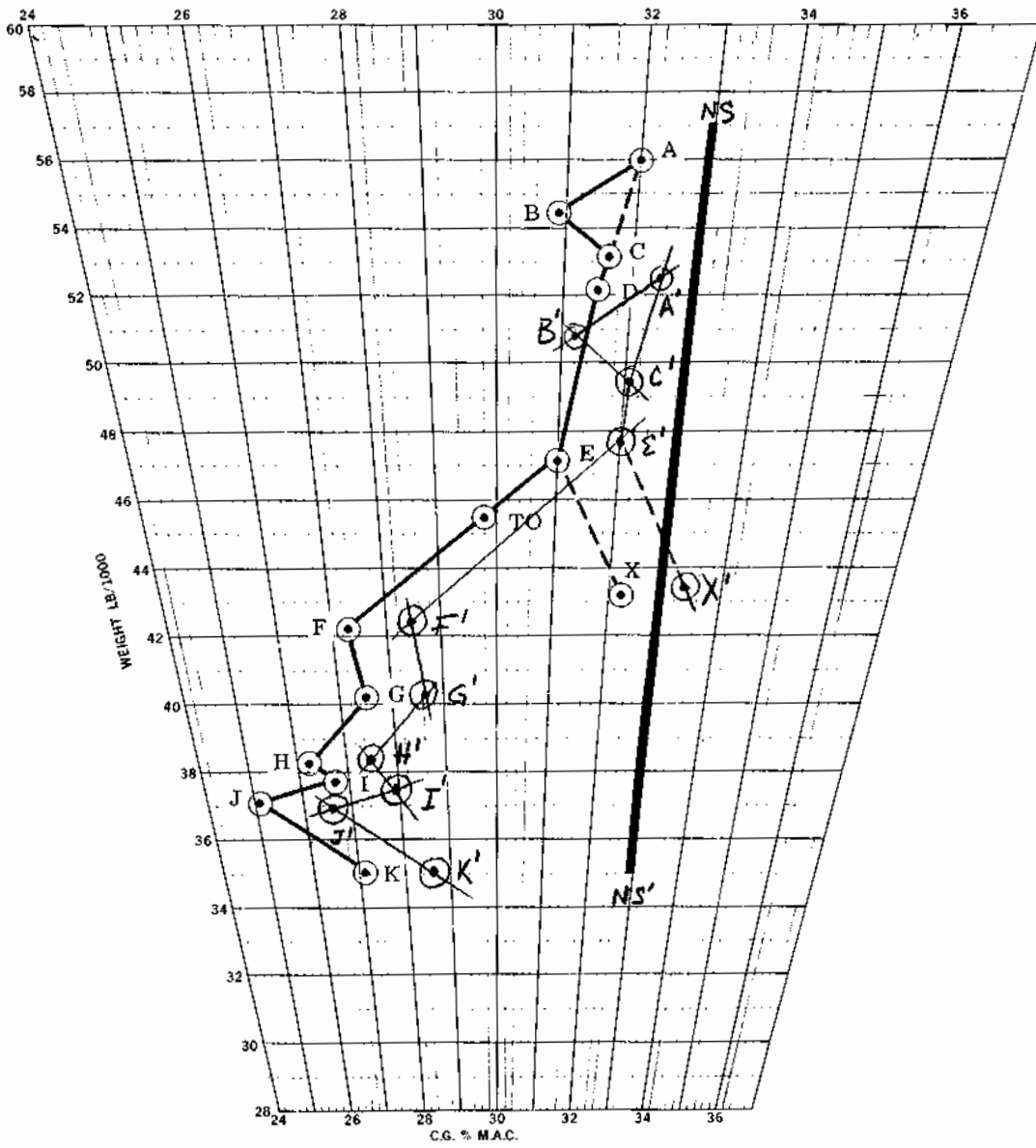

Figure 6-3

<b>WARNING</b>
----------------

- Removal of equipment from a position forward of the aircraft AC (e.g. cameras, radar black boxes, etc.) will move the CG aft and decrease static margin.
- Dumping internal wing fuel with full or nearly full fuselage fuel moves the CG aft approximately 1.2% MAC and may place the aircraft in a regime where operation is prohibited and aircraft control is marginal.

The forward CG limit is based on longitudinal control effectiveness (nose-up stabilator capability). Refer to CG limitations. Section V. Normally, the forward CG limit will not be exceeded when landing at high gross weights with heavy external stores retained. Jettisoning the store will move the CG within limits. If Jettisoning is impossible, make a no-flap landing.

### CG TRAVEL DUE TO FUEL CONSUMPTION

If other factors such as external loading remain constant, fuel distribution determines CG position. Figure 6-2 illustrates approximate CG travel for an aircraft configured with three external tanks, at an engine start gross weight of 56,000 pounds and the CG at 32% MAC. The points designated by letters on Figure 6-2 correspond to fuel states which can be observed in the cockpit. The lines on the chart may be shifted to fit any initial condition, as discussed later in this section.

A. Gage 7400/12,000. ENGINE START/COMPLETION OF AIR REFUELING

B. Gage 5900/10,500. LIFTOFF. It is assumed that 1500 pounds of fuel are consumed during start, taxi, engine checks, and takeoff roll. This fuel is all from the fuselage tanks, CG will move forward rapidly. If less fuel is used before liftoff, longitudinal stability will be less. If more fuel is used before liftoff, the vector A-B will be longer and CG will be farther forward at liftoff, with an increased nosewheel liftoff speed.

C. Gage 7400/12,000. After liftoff, with the centerline tank selected, fuel will transfer from the centerline tank to fill all fuselage tanks. The CG will move rapidly aft along the vector A-C until fuselage tanks are full (point C). Note that point C is on the dashed line vector A-D which represents the vector for the centerline tank if no fuel were used before liftoff. Point C is the most aft CG during flight and represents the point at which aircraft stability is lowest with normal fuel sequencing. This occurs shortly after takeoff, and may result in a formation join-up during a period of decreasing or minimum stability.

D. Gage 7400/12,000. CTR EXT FUEL light on. Centerline tank empty. Outboard tanks selected.

E. Gage 7400/12,000. L&R EXT FUEL lights on. External wing tanks empty. This is also the engine start point if no external tanks are installed.

X. Gage 6800/7350. The vector E-X depicts the effect of dumping internal wing fuel at point E. As can be seen, this moves the CG rapidly aft.

TO. Gage 5900/10,500. LIFTOFF when no external

tanks are installed. The E-TO represents CG travel prior to liftoff if no external tanks are installed.

F. Gage 6050/8200.

G. Gage 4900/5400.

H. Gage 2600/3100.

I. Gage 1800/2300.

J. Gage 1800/1800. The CG is at the most forward point for the flight. This occurs near normal landing fuel weight and may place the aircraft near the forward CG limit for landing. Longitudinal stability is high. The aircraft will be less responsive to stabilator inputs and large aft stick displacement may be required to maintain pitch attitude just prior to touchdown.

K. Gage 0/0.

### SHIFTING THE CURVE

The general curve for CG Travel due to Fuel Consumption, Figure 6-2, may be shifted to adapt to any initial gross weight, CG position, and external stores configuration. CG travel in % MAC due to fuel consumption will vary depending on initial gross weight and CG location. Figure 6-2 is constructed so that any portion of the CG travel lines can be shifted to any position on the chart, as long as the slope and length of the applicable vectors are identical. Figure 6-3 illustrates this process for the following configuration.

Example:

2 external wing tanks  
Inboard pylons  
2 SUU-20/A Dispensers

1. Determine initial gross weight from DD form 365F - 52,000 pounds
2. Determine initial CG from DD form 365F - 32.4% MAC
3. Plot point A' (engine start)
4. Plot A'-B' parallel and equal to A-B.
5. Plot B'-C' parallel and equal to B-C.
6. Plot A'-E'. This line is parallel and equal to D-E. This line eliminates the centerline tank as shown on the general chart and converts the plot to one in which only two wing tanks are installed. Point C' should fall on this line.
7. Plot E'-F' parallel and equal to E-F. Point TO is not plotted since it is of interest only when no external tanks are installed.
8. Plot remainder of line segments parallel and equal to corresponding line segments.
9. Determine stability index from part 1 of the Performance Data appendix - 98.4.
10. Determine neutral stability point from figure 5-7 - 32.9% MAC.
11. Plot line NS-NS' which represents neutral stability point.

Transparent templates for various external tank configurations may be prepared locally so that an individual plot need not be made for each mission. The template may be shifted horizontally with different initial CG positions and/or vertically for different initial gross weights so long as the orientation is not changed and each line maintains the same slope. A few randomly spaced

horizontal lines on the template which can be matched parallel to gross weight lines on the chart will aid in ensuring the slope is not changed.

## CHARACTERISTICS

### ANGLE OF ATTACK

Angle of attack (AOA) is of major importance in this aircraft, particularly during maneuvering and in low speed flight. AOA is defined as the angle formed by the chord line of the wing and the aircraft flight path (relative wind). At constant flight conditions, the indicated AOA will increase approximately 1 unit when the nose gear is extended; retracting the gear produces a corresponding decrease in indication. A change in airflow pattern over the AOA probe caused by the nose gear door is responsible for this AOA change. All references to indicated AOA take this factor into consideration. An error in AOA indication can also be induced as a result of sideslipping the aircraft. This proportional error is approximately 2 units for a low speed, full rudder sideslip. Right rudder sideslips produce AOA indications that are lower than actual. The reverse is true for left rudder sideslips.

#### NOTE

Lag in the AOA indicator is significant during high rates of change in AOA.

### LOW ANGLE OF ATTACK MANEUVERING

Drag is at a minimum at approximately 5 units angle of attack (nearly zero G). To achieve maximum performance acceleration, a 5-unit angle of attack pushover will provide minimum drag and allow gravity to enhance aircraft acceleration. This technique provides the minimum time, fuel, and distance to accelerate from subsonic Mach numbers to the optimum supersonic climb schedule.

### MEDIUM ANGLE OF ATTACK MANEUVERING

Maneuvering at an AOA from 5 to 20 units will produce normal response to control movement. Normally, buffet onset will not occur below 17 units AOA.

### HIGH ANGLE OF ATTACK MANEUVERING

Above 20 units AOA, the response and flight characteristics begin to exhibit the changes expected in swept-wing high performance aircraft. The primary roll-yaw flight characteristics at high AOA are dihedral effect (roll due to yaw) and adverse yaw (yaw due to aileron deflection). Buffet intensity increases with angle of attack. Mild buffet increases to moderate at approximately 28-30 units AOA. At high angles of attack, aircraft equipped with TISEO show a tendency to roll left and a reluctance to roll right. This effect is similar to that from an

asymmetric load but is not directly related to the drag index.

#### WARNING

If slats are not programming properly and are not extended above 20 units AOA, departure from controlled flight may result.

### Dihedral Effect

Dihedral effect is the roll caused by sideslip. Attempts to yaw the airplane with rudder will produce roll in the same direction as the rudder input as well as an increase in AOA. Dihedral effect is strong at high AOA, and rudder inputs produce adequate and comfortable roll rates. Above 25 units AOA, more roll rate can be generated with rudder than with aileron. The best technique is a combination of rudder and aileron in the direction of the turn.

### Adverse Yaw

At high AOA, attempts to roll the airplane with aileron result in yaw opposite to the direction of the intended turn or roll. This yaw is partially produced by the drag of the down going aileron; and the dihedral effect, in turn, inhibits the roll. Adverse yaw is negligible. Aileron deflection at high AOA produces little opposite yaw, and ailerons are effective for roll control to 25 units AOA. The most effective roll technique is a combination of rudder and aileron in the direction of the turn.

#### WARNING

Operation above 30 units AOA at altitudes above 28,000 feet may result in engine flameout(s). Above 30,000 feet this critical AOA is reduced approximately 1 unit per 3000 feet (e.g. 29 units AOA at 33,000 feet).

### PITCH CONTROL AT LOW SPEEDS

The control of AOA at slow speeds is difficult because stick forces are lighter and aircraft stability is reduced. The AOA indicator is the primary recovery instrument when confronted with a condition of low airspeed and high pitch attitude. A smooth pushover to 3 to 8 units AOA will unload the airplane and prevent a stall. Recovery can be accomplished safely at any speed which will provide

stabilator effectiveness (ability to control pitch attitude). Smooth control of AOA is required, and no attempt to control bank angle or yaw should be made until 3 to 8 units is established.

## MAXIMUM PERFORMANCE MANEUVERING

The factors that determine maximum performance maneuvering capability are structural limitations, stabilator effectiveness, and aerodynamic limitations. Structural limitations are outlined in section V. The limit of stabilator effectiveness occurs at supersonic Mach numbers at high altitude, where full aft stick can be attained without reaching either aerodynamic or structural limits. Aerodynamic limitations are primarily a function of angle of attack. Subsonic maximum performance turns are achieved by maintaining approximately 25 units AOA while utilizing afterburner as required. Good flying qualities and only moderate buffet exists to 30 units AOA. However, the drag increase must be considered as a significant reduction in energy occurs at AOA above 25 units. Rolling performance is adequate at all usable angles of attack, and can be best achieved at high AOA by a combination of aileron and rudder in the direction of the turn. During maximum performance maneuvering, higher roll rates may be achieved by momentarily unloading the airplane (reducing AOA to between 3 and 8 units); utilizing aileron to roll to the desired bank angle; then neutralizing aileron and reestablishing the required angle of attack. Ailerons should be neutralized prior to reestablishing a high angle of attack. The AOA aural tone system provides audible cues to help achieve optimum turning performance.

### WARNING

Nose rise can occur during high AOA maneuvering. This is characterized by a reduction or reversal of stick forces and can result in inadvertent increase in AOA and possible overstressing of the aircraft or loss of control.

## LANDING

Refer to Landing Technique, section II.

## HANDLING QUALITIES

A large variation in handling qualities exist throughout the flight envelope. Consideration must be given in Mach number, CG position, indicated airspeed, AOA, and external store loading.

### SUBSONIC REGION

#### Takeoff Configuration

The full aft stick takeoff technique provides the lowest nosewheel lift-off speed. Nosewheel lift-off speeds will normally be lower than computed takeoff speeds (refer to

Performance Data appendix); however, with a forward CG position it is possible to have nosewheel lift-off speeds which exceed computed takeoff speeds. With aft CG locations high rotation rates can be achieved, and caution should be exercised to avoid over-rotation. Roll response is low and may not be sufficient to correct a wing low condition at low speed after over-rotation. In computing CG for takeoff, allowance must be made for a forward CG shift during ground operation. This forward movement is approximately 1 percent MAC for every 1000 pounds of internal fuel used. In the forward CG range, nosewheel lift-off speed is increased approximately 3 to 4 knots for each 1 percent of forward CG movement.

#### Landing Configuration

In the landing configuration, pitch or airspeed changes require few, if any, trim changes to relieve stick pressures. This is due to control system friction and weak stick centering. Landings at aft CG positions require more attention to AOA control than landing with a forward CG. This is due to increased stick sensitivity and a mild nose rise tendency at about 18 units AOA. Aileron and rudder response in the landing configuration is good; however, adverse yaw produces a decrease in roll response due to strong dihedral effect. Rudder can be used to provide roll due to dihedral effect. The aileron-rudder interconnect feeds in rudder automatically to improve roll performance and turn coordination.

#### Cruise Configuration

Maneuverability and handling qualities are degraded at lower airspeeds with sluggish response and low available G; therefore, maintain a minimum of 300 knots except during low speed tactical maneuvers, maximum range descents, holding, instrument approaches, and landing. This minimum airspeed provides reasonable handling qualities and adequate maneuver margins for terrain and collision avoidance. At and above this speed, control effectiveness is good. Roll rate capability is quite high and coordinated turns can be made without the use of rudder at 12 units AOA or less. When adverse yaw is experienced, the yaw stability augmentation is relatively effective in returning the ball to center.

### TRANSONIC REGION

#### High Altitude

A significant change in handling qualities occurs at 0.92 to 0.95 Mach where the shift of aerodynamic pressures are the greatest. Below this transition area, static longitudinal stability is low and stabilator effectiveness high, causing some pitch sensitivity and low stick forces. Above this Mach number, static longitudinal stability is higher as the pressures shift aft, and stabilator effectiveness is somewhat lower, causing less sensitivity and higher forces. Consequently, during acceleration through this region, a slight nose drop or nose heaviness may be noted. Conversely, upon deceleration, a slight nose rise tendency (or dig in) may be noted which increases in magnitude with G and with decreasing altitude. If caution is not used, this tendency could place the airplane in buffet at high altitude

or cause a significant load factor increase at low altitude and high G levels with a possible resultant overstress. Speed brakes increase this nose rise tendency. Lateral and directional control in the transonic region is about the same as that experienced in the subsonic region except that roll rate capability is slightly higher.

### Low Altitude (Below 15,000 feet MSL)

Flight in the low altitude, high speed region is most critical at high subsonic indicated airspeeds (475 knots to 0.95 Mach) where airplane response is high and stick forces are low, resulting in an area of increased sensitivity and possible over-control. Even though the inherent dynamic stability of the airplane is positive, it may be possible to create a short period longitudinal oscillation if the pilot's response becomes out of phase with the airplane motion, thereby inducing negative damping. Such a condition is commonly known as pilot induced oscillation (PIO). Since pitch aug decreases the stabilator response to rapid stick inputs, the possibility of inducing PIO is reduced with pitch aug on. Stability augmentation should, therefore, be used when flying at high speeds and low altitudes. Afterburner shutdown at high indicated airspeeds can produce pitch transients. Abrupt pitch inputs can cause a pitch oscillation to start; therefore, all corrections should be performed smoothly. An out-of-trim condition is conducive to PIO; therefore, it is advisable to remain trimmed for approximately 1G flight while in the low altitude, high speed region. The standard and most effective recovery technique from a pilot induced oscillation is to release the controls. If the altitude is such that it would not be desirable to release the controls, recovery from the PIO can be accomplished by freezing the stick in the approximate trim position or applying a slightly positive G loading.

### SUPERSONIC REGION

As Mach number is increased in the supersonic region, stabilator effectiveness decreases somewhat. Maneuvering stick forces are high. Maneuvering capability is limited by stabilator effectiveness at the higher Mach numbers and altitudes; for example, full aft stick at Mach 2 at 50,000 feet will produce about 3.5 G, while full aft stick at Mach 1.5 at 36,000 feet will produce about 5G. More maneuvering capability is available at aft CG conditions than at forward CG conditions. No abnormal control problems exist during supersonic flight. Roll rate, although decreasing with Mach number, remains adequate out to limit Mach numbers.

### EFFECT OF EXTERNAL STORES

The addition of external stores generally increases pitch sensitivity and nose-rise tendencies (refer to CG Limitations, section V). In addition, inertial effects are evidenced during abrupt maneuvers especially at high AOA. The most noticeable inertial effect takes place during rolling maneuvers. It takes longer to build up a given roll rate, but once the rate is established, it takes longer to stop. This inertial effect results in less wing rock when approaching the stall. Most high speed flight restrictions with external stores are based on structural considerations. Takeoff with external stores will normally

increase rotation rate. A minimum-speed lift-off results in reduced lateral directional stability, and roll control activity is higher during gusty flight conditions.

### SINGLE ENGINE FLIGHT CHARACTERISTICS

See Engine Failure During Flight, Section III.

### FLIGHT WITH ASYMMETRIC LOADING

#### Takeoff

Takeoff with asymmetric loads equivalent to one full external wing tank can be made. Recommended techniques are essentially the same as for crosswind operation. A strong turning moment into the heavy wing will exist during takeoff roll and will increase during rapid accelerations. Nose gear steering and rudder (when rudder becomes effective) should be used for directional control. As the aircraft breaks ground, it will tend to roll into the heavy wing if not previously trimmed to counteract the asymmetric condition. Approximately 5° aileron (3 seconds trimming from neutral) away from the heavy wing is sufficient for asymmetric loads equivalent to one full external wing tank. Abrupt lift-offs should be avoided. Establish an attitude and allow the aircraft to fly itself off using rudder and aileron as required.

#### Landing

Landing with asymmetric loads equivalent to one full external wing tank can be made. Recommended techniques are essentially the same as for crosswind operation. A straight-in pattern avoiding abrupt or accelerated maneuvers is recommended. To determine approach speed and AOA, establish the landing configuration and slow to a speed at which full aileron trim will hold wings level. This should result in 16 to 17 units AOA for an asymmetric load equivalent to one full external wing tank. A check for roll capability by applying additional aileron to pick up the heavy wing should be made. This AOA should be maintained during the approach and touchdown. An abrupt flare will cause a strong roll into the heavy wing. During landing roll, the aircraft may turn away from the heavy wing as brakes are applied. This can be controlled by rudder and nose gear steering.

#### Go-Around

If a go-around is necessary from an established final, abrupt stick movement should be avoided. Power should be advanced to military and the nose smoothly raised to the desired attitude. When no longer in a descent, the gear may be retracted; however, flap retraction should be delayed until at least 200 knots has been attained. Rudder and afterburner may be required to maintain wings level flight.

## Maneuvering

There will be a rapid build-up of asymmetric forces during maneuvering. Roll tendencies increase with load factor, whereas control of this roll is a function of airspeed. Loss of roll control can occur at angles of attack well below buffet and stall. Use of excessive aileron will produce adverse yaw. Control can be reacquired only by reducing AOA. The rolling moment produced by failure of one internal wing tank to transfer will be essentially undetectable in 1 G flight. At higher load factors this rolling moment will be more significant. Every asymmetric condition has airspeed and load factor combinations beyond which control cannot be maintained. Control can be regained only by an increase in airspeed and/or reduction of AOA.

### WARNING

Smooth control inputs should be used with asymmetric loads. Rapid inputs will result in abrupt rollofs at high angles of attack. An AOA of 16 units should not be exceeded when maneuvering with the equivalent of one full external wing tank asymmetry. If an abrupt roll occurs due to an asymmetric load, immediately reduce AOA, since the combination of high AOA and adverse yaw can lead to loss of control. If a departure occurs, spin entry is highly probable. Normal stall warning cues may be absent when maneuvering with asymmetric loads.

## FLIGHT WITH ASYMMETRIC SLATS

Asymmetric slats produce roll, and therefore limit maneuvering capability. Roll-off is first experienced at 14 units AOA, and full cross-controls will be required to maintain straight and level flight when reaching 19 units AOA. A symmetrical slat configuration (extended or retracted) is necessary for combat maneuvering.

## STALLS

A stall, as discussed in the Flight Manual, is defined as a breakdown in directional stability (i.e., nose slicing). Characteristics normally experienced while approaching a stall include buffet onset, nose rise, and wing rock. These characteristics and the violence of the stall itself are dependent upon the external loading, CG location, and control technique. They are not entirely predictable or repeatable.

### WARNING

The pilot should not depend upon wing rock, buffet, directional instability (nose slice), or any classic characteristics for a stall warning. In any configuration or loading, and especially with moderately high pitch change rates, it is possible to increase AOA above 30 units without wing rock

or directional instability, at which time loss of control may result.

### NOTE

Refer to section I for rudder pedal shaker and AOA aural tone operation.

## CRUISE/COMBAT CONFIGURATION

### 1 G Stalls

Conventional stalls do not normally occur until well above 30 units AOA. Departures and/or engine stall/flameout can occur above 30 units AOA. Buffet is mild, and wing-rock will not normally occur below 30 units AOA. Pitch control is positive, and the AOA can be easily reduced by forward stick movement. Rolling departures appear more probable than yawing departures; however, recovery is positive when using the normal technique. Recovery, if initiated rapidly, is effected by positioning the stick forward (3-8 units angle of attack) and advancing the throttles to military power while maintaining ailerons and rudder neutral. If a 1G stall is encountered during low-level flight, altitude loss can be minimized by applying maximum power, easing the stick forward momentarily to attain 15 to 19.2 units AOA, then stabilize AOA at 19.2 units. Also refer to Stall characteristics chart (figure 6-4). If a recovery is not effected, deploy the drag chute.

### Accelerated Stalls

Accelerated stalls produce only mild to moderate buffet. Wing-rock normally does not occur below 25 units AOA, and often does not occur until reaching 28-30 units AOA. Departures which occur above 30 units tend to be gentle, and are predominantly roll rather than yaw. Normal recoveries are positive. Prompt neutralization of controls will generally effect recovery from accelerated stall approaches. Control of angle of attack with stick position is of paramount importance to effect recovery from the stall. Oscillations in roll and yaw which may be present during recovery should be allowed to damp themselves out and should not be countered with aileron or rudder.

### WARNING

The use of aileron or excessive rudder when approaching either a 1 G or accelerated stall condition will produce yaw and increase AOA. This increases the probability of loss of control. Left stick produces a right yaw, and right stick produces left yaw.

### Negative Angle Of Attack Stalls

A negative angle of attack stall can be entered with abrupt application of full forward stick. Light to moderate buffet will occur at the stall and there are no distinct yaw or roll tendencies. Recovery from the inverted stall is effected by relaxing the forward stick pressure and maintaining an angle of attack between 3 to 8 units until recovered.

# STALL CHARACTERISTICS

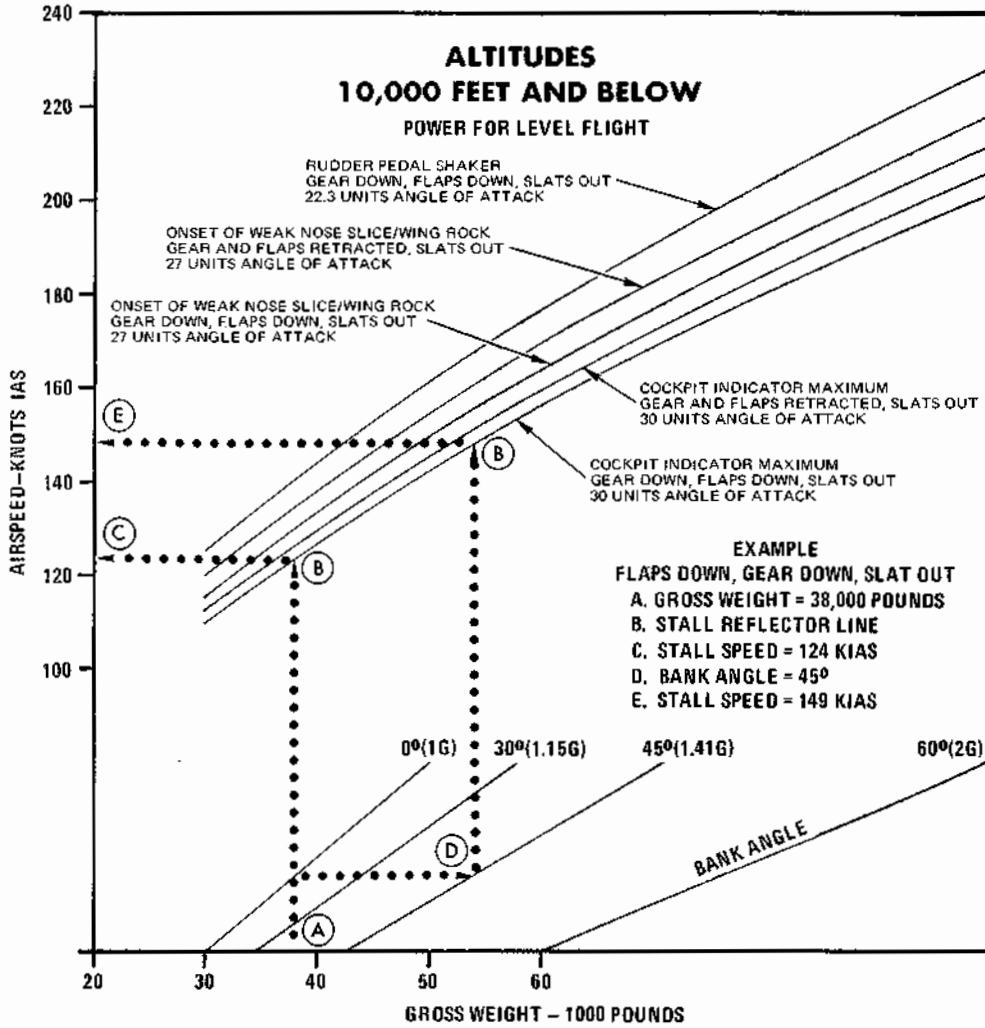

Figure 6-4



## Landing Configuration Stalls

Stall approaches in the landing configuration are safe, with satisfactory control about all axes up to 26 to 28 units angle of attack. In the landing configuration, the aircraft will generally stall at higher AOA than in the cruise configuration. Above 26 units AOA, the increase in stick forces serves to reduce the potential for inadvertent stalls. Approaching the stall, the airplane exhibits a slight nose rise (a reduction in the stick force required to hold pitch attitude). The magnitude of this stick force lightening is a function of the center of gravity position (aft CG gives lighter forces). Stick force lightening occurs between 23 and 25 units AOA. Wing rock usually increases in intensity as angle of attack is increased, but seldom exceeds  $+40^\circ$  bank angle at the stall. If bank angles in excess of  $30^\circ$  or nose slicing are experienced, the stall approach should be discontinued. Moderate buffet and wing rock will occur above 26 to 28 units AOA. Recovery is effected by advancing the throttles to maximum thrust and placing the stick forward to attain and maintain 21 to 25 units AOA. Stalls with flaps display essentially identical characteristics.

### WARNING

Do not depend on the wing rock or buffet for natural stall warning. In any configuration or loading, it is possible to exceed 30 units AOA without any wing rock or buffet, at which time loss of control may result. Loss of at least 3000 feet altitude should be anticipated.

## DEPARTURES

Post-stall gyrations are uncontrolled aircraft motions following aggravated stall penetrations. They are best described as uncontrolled motions about any or all axes following a departure from controlled flight. Post-stall gyrations are caused by excessive AOA and can be prevented only by proper control of angle of attack. Directional stability deteriorates and goes negative at high AOA. Without directional stability, the aircraft will depart regardless of aileron or rudder position. Misapplication of lateral/directional controls may tend to aggravate the departure; however, the aircraft can depart and enter a spin with neutral ailerons and rudder. Departure and spin susceptibility is greater in the high subsonic and transonic (0.8 to 1.0) Mach regime. The severity of the departure is dependent upon the aircraft loading, airspeed, Mach number, and type of entry and is not predictable. Normally, the pilot will sense a buildup of side forces in the cockpit just prior to a departure. The AOA at departure is dependent upon the configuration; the more external stores, the lower the AOA at departure. The departure is characterized by a nose rise followed by an immediate yaw with a roll in the direction of yaw. Landing configuration departures evidence the same characteristics as the clean configuration.

## RECOVERY CHARACTERISTICS AND TECHNIQUES

At the first indication of departure, the ailerons and rudder should be neutralized while moving the stick smoothly forward (full forward if necessary). Recovery from most out-of-control situations will be effected rapidly with forward stick, in some cases before reaching the full forward position. The throttles should be retarded to idle to reduce the possibility of engine flameout unless at low altitude where thrust may be needed for recovery, and the probability of flameout is reduced. The drag chute will effect recovery from most departures and should be deployed without hesitation if the aircraft does not recover rapidly with full forward stick.

Large oscillations in pitch, roll and yaw may be present as the aircraft unloads (zero or negative G) during the recovery. This unloading, using forward stick, is the best means of reducing these oscillations and is a positive indication that recovery is imminent. To preclude pitching back into another out-of-control condition, forward stick should be maintained until all oscillations stop. No attempt should be made to fly AOA while large roll and yaw motions are present because the AOA probe gives erroneous information under these conditions. The aircraft may enter a series of uncommanded rapid rolls as it recovers and accelerates. While AOA will indicate less than 30 units, the rudder and ailerons are ineffective in stopping these recovery rolls. These rolls should not be mistaken for a spin and will cease within two or three rolls. Once all oscillations have stopped, normal throttle and control use will be effective for regaining the desired flight attitude. Do not exceed buffet onset during the dive recovery or 25 units maximum AOA if at low altitude. Normally, the drag chute should not be jettisoned since it will fail and streamline behind the aircraft as speed builds up. Refer to figure 6-5 for a summary of out-of-control recovery techniques. Recovery characteristics and techniques are the same for the landing configuration.

## SPINS

Spins have been entered from level flight stalls and tactical maneuvers including accelerated turns, reversals, and vertical and inverted climbs and dives. Departure and spin characteristics have been investigated over operational CG positions at Stability Indexes ranging from zero to 180. Asymmetric configurations up to the maximum allowable (one full 370-gallon external wing tank) have also been tested. Spin progression can be defined in two phases: incipient and developed. The incipient phase is the initial phase characterized by irregular oscillations about all three axes. The developed spin is attained when equilibrium conditions are approached and the oscillations are more or less consistent about all three axes from one turn to the next.

### NOTE

- The out-of-control procedure will recover the aircraft from nearly all spins regardless of CG position or external store loading. While the rudder is relatively ineffective in a spin, applying full aileron in the direction of the spin will effect a more rapid recovery. Aileron should not be applied, however, until the pilot has ascertained that a spin condition exists.

# OUT-OF-CONTROL RECOVERY

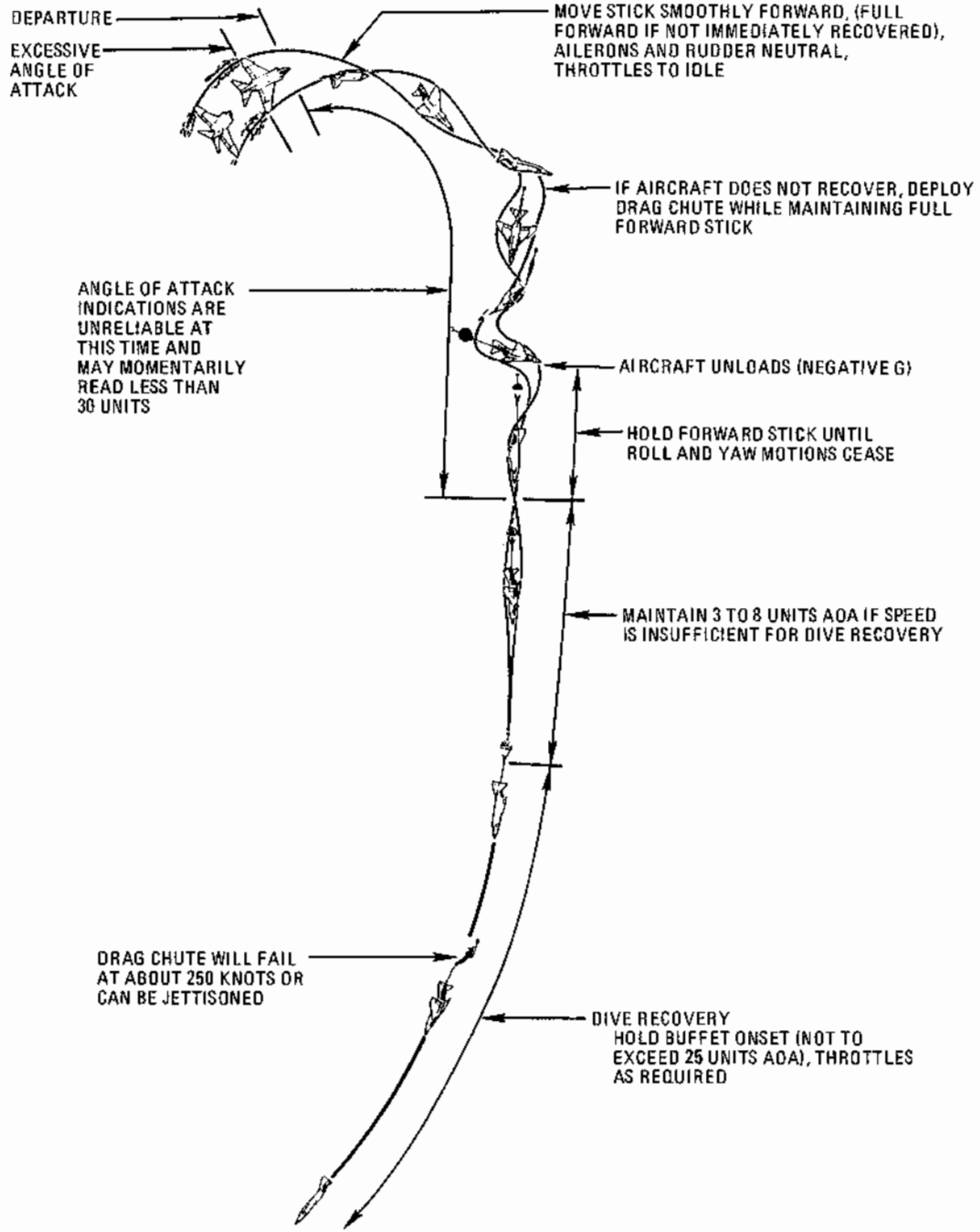
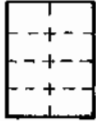

Figure 6-5

- Visual cues outside the cockpit, an excessive yaw rate, and the turn needle (not the ball) should all be used to verify a spin condition and the spin direction. The turn needle will always be pegged in the spin direction.
- AOA is not a primary indication to determine a spin condition as the AOA probe gives erroneous information when large roll and yaw motions are present. The AOA indicator may show less than 30 units and even below 15 units momentarily during a spin; however, the AOA indicator will be 30 units during most of an upright spin. Even if the indicated AOA comes down during an out-of-control condition, the stick should remain forward until the aircraft unloads and yaw and roll motions cease.



External stores should be retained if a spin is entered. Jettisoning stores is not required for spin recovery and will only increase the risk of aircraft damage due to probable aircraft-store collision.

## UPRIGHT SPINS

### Recoverable Mode (Oscillatory)

The oscillatory mode is by far the most prevalent spin mode of the aircraft, and an aerodynamic recovery can always be accomplished if altitude conditions permit. This spin may oscillate rather violently in pitch, roll, and yaw, especially during the first few turns. The severity and magnitude of the oscillations are dependent upon the entry conditions and aircraft loading. External stores, particularly asymmetric loadings, will cause the spin to be more oscillatory. The pitch attitude may initially vary from greater than 90° nose low to 60° above the horizon until steady state conditions are approached. The oscillations in yaw rate can vary between 20° and 100° per second and roll oscillations can be as much as  $\pm 60^\circ$  of bank angle. Bank angle changes opposite to the spin direction (e.g., rolling left in a right spin) can be confusing when trying to determine the spin direction. The spin direction can be determined by observing the arc made by the nose of the airplane across the ground or horizon, but the spin direction should be verified by checking the turn needle. In the clean configuration the aircraft spins more steeply (at a lower AOA) with relatively mild oscillations about all axes. The drag chute is an effective recovery device. In the clean configuration, spin susceptibility is reduced and recovery characteristics are enhanced with the inboard pylons installed. As external stores are added, the spin becomes more oscillatory, the aircraft spins at a higher nominal angle of attack, and the drag chute becomes less effective for recovery. Cockpit accelerations vary with the magnitude of the oscillations and may become somewhat uncomfortable in asymmetric configurations. The yaw rate will decrease and then increase at least once a turn (airplane tends to hesitate briefly and then wrap back up in yaw). Bank angle is also quite oscillatory. These oscillations are quite noticeable and indicate that the aircraft is not in a flat spin. The altitude loss in an oscillatory spin will average 1500 to 2000 feet per turn.

While the drag chute may be completely ineffective in a highly oscillatory spin, aerodynamic recovery can be accomplished within several turns. As forward stick and/or forward stick and aileron start to recover the aircraft, the magnitude of the oscillations will increase. The most violent oscillations and the most uncomfortable portion of the spin will generally occur as the aircraft unloads (zero to negative G) during recovery. This unloading using forward stick is the best means of reducing these oscillations and is a positive indication that recovery is imminent. When airspeed increases through 200 knots, the aircraft is no longer in a spin but may be in a rolling spiral preparatory to a normal dive recovery.

Reversals (changing spin direction) are rare using forward stick for spin recovery. If a reversal should occur, maintain forward stick and re-apply aileron with the spin. When the aircraft unloads and yaw rate decreases, the ailerons should be neutralized; however, forward stick should be maintained until all oscillations cease to preclude pitching back into another out-of-control condition. The timing involved in detecting recovery using forward stick and aileron is not critical. The unloading at recovery will, in most cases, be rather abrupt. As the aircraft recovers and accelerates, it may enter a series of rapid rolls. While AOA will indicate less than 30 units, the rudder and aileron are relatively ineffective in stopping these recovery rolls. These rolls should not be mistaken for a spin or spin reversal, and will cease within 2 or 3 rolls.

The drag chute becomes more effective as the aircraft unloads and will quickly reduce the recovery oscillations. After recovery (aircraft unloaded and oscillations stopped), thrust should be applied and the dive recovery accomplished by holding buffet onset, or 25 units maximum, if at low altitude, until level. Refer to figure 6-6 for a summary of spin recovery techniques.

### Non-Recoverable Mode

There have been isolated cases of upright spins progressing rapidly into a flat mode. The flat spin can develop within one or two turns after a departure from controlled flight; however, it is doubtful that an oscillatory spin will go flat if forward stick is maintained. The characteristics of the flat spin mode are quite different from those of the oscillatory mode. Once the flat spin is developed, oscillations in pitch and roll will not be noticeable. Yaw rate will increase rapidly to 80° per second or higher and there will be no hesitations in yaw during each turn. The flat spin is very smooth and the only accelerations on the crew will be a push forward (1 to 1.5 G). The altitude loss in a flat spin will average between 1000 and 1800 feet per turn. Recovery from a flat spin cannot be accomplished by either aerodynamic controls or the drag chute.

## INVERTED SPINS

A true inverted spin is extremely unlikely even though the aircraft may be inverted at some point during a departure. An inverted spin would be characterized by negative G, an angle of attack of zero units, and is less oscillatory than the upright oscillatory spin. Spin direction can be determined by the yawing motion of the aircraft and the deflection of the turn needle. Recovery from inverted spins can be

# SPIN RECOVERY

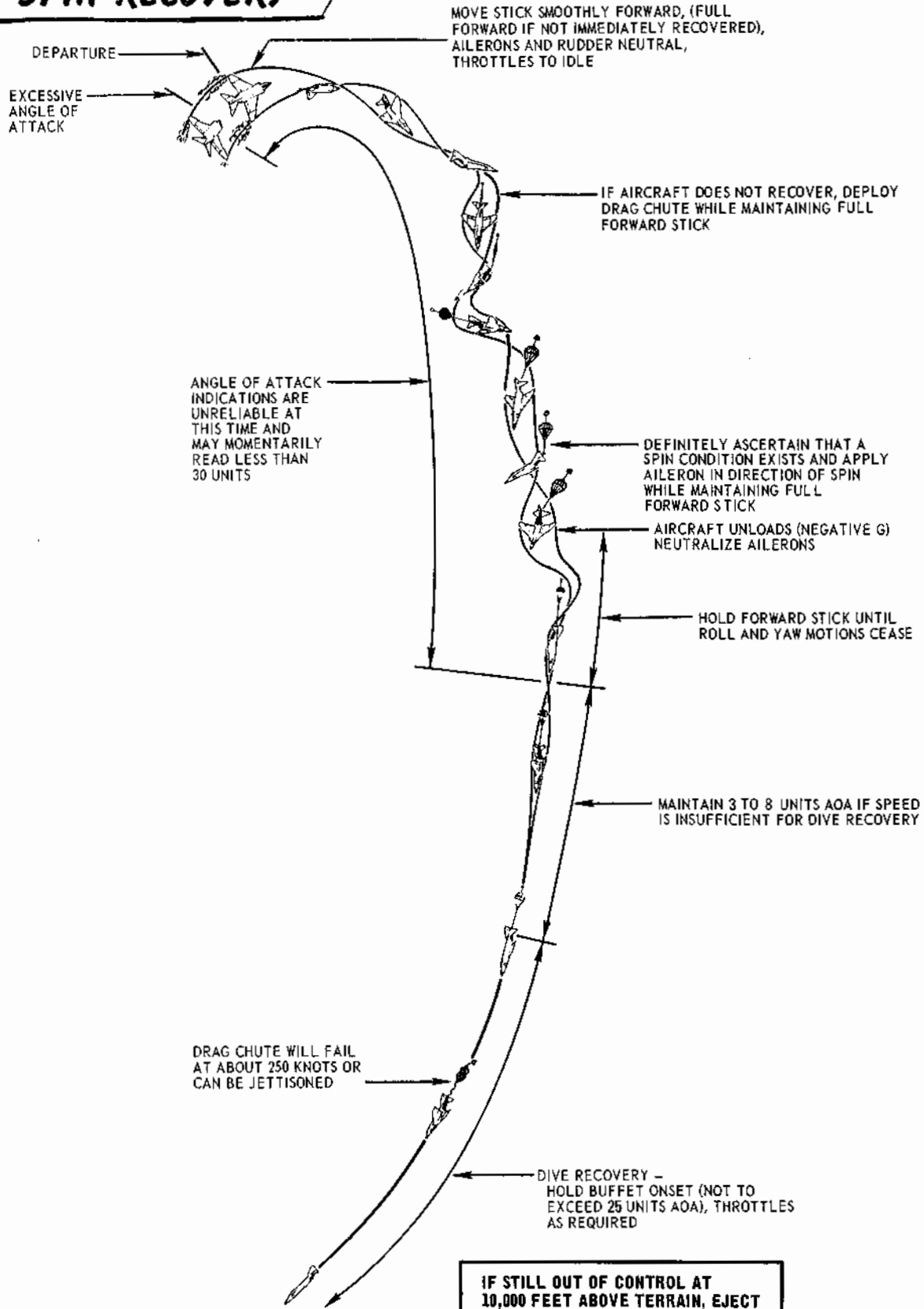
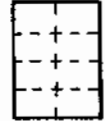

Figure 6-6

accomplished rapidly with neutral ailerons and rudder. The Out-of-Control procedure will recover the aircraft from an inverted spin. However, if the pilot misidentifies inverted flight for an inverted spin and applies and holds full forward stick, a steady state inverted stall then becomes possible. A 3 to 8 units AOA recovery should be flown until sufficient speed for dive recovery is obtained.

## ENGINE EFFECTS

If the engines are at high power settings, a flameout of one or both engines will probably occur at or just after departure. At initial departure from controlled flight, the pilot should retard the throttles to idle if altitude conditions permit. This normally will prevent engine stalls or flameouts and retain hydraulic and electric power during the post stall gyration or spin. Should a flameout occur, an airstart can be obtained with the throttles at idle even during a spin. If both engines flameout and an airstart is not obtained, electrical power will be lost within 3 to 4 turns and normal operation of flight controls will deteriorate after approximately 4 turns and will be lost shortly thereafter.

## ZOOM CLIMB

A zoom climb can be performed by accelerating to a high energy condition and then slowly rotating to a pitch attitude higher than normal climb. Pitch angles in excess of 60° detract from the zoom climb capability and produce more uncomfortable recovery conditions. During a zoom climb to altitudes above 65,000 feet, the EGT must be monitored. Afterburner blowout will usually occur around 67,000 to 70,000 feet. When the afterburners blow out, the throttles should be taken out of the afterburner range to preclude unexpected or hard light-offs during descent. Above 70,000 feet, the engines will have to be shut down if they tend to over-speed or over-temp. Engine windmill speed at altitudes above 70,000 feet is high enough to maintain some cockpit pressurization and normal electrical power. Stabilator effectiveness will decrease noticeably above 50,000 feet and an increased amount of aft stick will be required to hold a given pitch attitude. Zoom climb recovery can be initiated at any time during the zoom maneuver by relaxing back pressure on the control stick and flying the aircraft over the top at a G loading which will prevent stall. Maintaining a constant value of angle of attack between 3 and 8 units will properly decrease G with decreasing airspeed during the recovery while still maintaining a safe positive G loading on the aircraft. Negative G recoveries are not recommended due to aircraft and physiological limitations and lack of aircrew ability to detect impending stall. Two basic methods of recovering from the zoom climb are possible. A wings-level recovery can be effected by smoothly

decreasing angle of attack to the minimum positive G value and holding this until the aircraft is diving. An inverted recovery can be effected by controlling angle of attack while rolling the aircraft to inverted and then increasing angle of attack to produce the maximum G loading on the aircraft. A comparison of the two techniques shows that the positive G loading on the aircraft assists the recovery trajectory in the inverted case whereas it detracts from the recovery trajectory in the wings-level case. The resulting flatter trajectory of the wings-level recovery produces a lower minimum airspeed and higher maximum altitude over the top in addition to a longer overall recovery time. Although the inverted recovery is superior from the standpoint of speed, altitude, and exposure time, it exhibits certain risks due to the capabilities required to properly control the angle of attack during the rolling maneuvers. All zoom climb recoveries demand smooth coordinated control action. The angle of attack indication is the primary recovery aid regardless of recovery method. As speed decreases, the stabilator required to develop a given pitch command increases. Higher than normal stick displacement and rates will be necessary to command or hold angle of attack at very low speeds. Inadvertent pitch inputs due to abrupt roll action or pilot inattention to required pitch control can quickly put the aircraft in a stalled condition. Zoom climb recoveries initiated from indicated airspeeds in excess of 250 knots can be made inverted or wings-level. For the wings-level recovery, smoothly reduce angle of attack to 5 units and hold this value until the aircraft is in a recovery dive and speed has increased through 250 knots. Attempts to hasten the recovery by pushing over to a value below 5 units AOA produces negative G on the aircraft and possible stall. Precise roll attitude is not important during the recovery. Any aileron used to correct or maintain roll attitudes should be smooth and coordinated. For the inverted recovery, smoothly reduce angle of attack to 5 units and, holding this value, smoothly roll the aircraft to inverted. Increase and hold angle of attack at 8 units to produce maximum safe G loading on the aircraft. When the aircraft is in an inverted recovery dive, the roll to wings-level must again be accomplished with smooth slow control action while holding angle of attack between 3-8 units. As before, angle of attack should be maintained in the recovery dive until airspeed builds up to 250 knots. Zoom climb recoveries initiated at indicated airspeeds less than 250 knots should be accomplished with the pilot's sole attention devoted to proper control of angle of attack between 3-8 units. Roll attitude should be completely ignored with aileron and rudder held generally neutral to maintain coordinated flight. If the pilot becomes confused or disoriented during any recovery, he should immediately concentrate only on angle of attack and ignore all other parameters. If angle of attack is maintained between 3-8 units, the aircraft will recover safely to nose-down accelerating condition regardless of roll attitude.

# SECTION VII

## SYSTEMS OPERATION

---

### TABLE OF CONTENTS

Engine Operating Characteristics .....	7-1
Engine Starter Operation.....	7-2
Fuel Weight Variations .....	7-2

## ENGINE OPERATING CHARACTERISTICS

The engine has several characteristics that are utilized to achieve optimum engine performance in all flight conditions without exceeding the operating limits of the engine. These characteristics are discussed in the following paragraphs.

### T2 RESET

During high compressor inlet temperature operation (high speed flight), engine idle speed is rescheduled upward to maintain sufficient airflow to prevent compressor stall. As compressor inlet temperature increases from  $56^{\circ}\text{C} \pm 5$  to  $108^{\circ}\text{C} \pm 5$ , engine idle speed is raised from normal idle (65 percent) to 100 percent regardless of the throttle position. To reduce engine idle speed once it has been reset, compressor inlet temperature must be reduced. This is effected by retarding the throttles out of afterburner to reduce thrust. Thrust can be further reduced by retarding the throttles below the military position so that the exhaust nozzles open, lowering exhaust gas velocity and temperature. As thrust decreases, compressor inlet temperature decreases as a result of lower airspeed, and engine speed control is returned to the throttle. T2 reset may also occur during ground operation when hot exhaust gases from other aircraft are directed at the intake of the affected engine.

### T2 CUTBACK

When the compressor inlet temperature (T2) falls below  $+45^{\circ}\text{C}$ , the maximum engine rpm is limited to prevent excessive mass airflow through the engine. The rpm maximum speed reduction starts at  $+45^{\circ}\text{C}$  and is reduced until, at  $-54^{\circ}\text{C}$ , the maximum rpm is approximately 90 percent.

### T5 RESET

The engine incorporates an exhaust gas temperature (T5) reset during military and full afterburner operation. This T5 reset occurs at the same point as T2 cutback, and reduces EGT at the same time that T2 cutback is reducing rpm. As a result of T5 reset, the engines run at lower EGT's, operate with larger nozzle areas, provide less net thrust and consume less fuel while operating in the speed cutback region at low compressor inlet temperature

conditions.

### AUTO-ACCELERATION

If the auxiliary air doors fail to open when the landing gear is lowered, there is a possibility that the engines may automatically accelerate up to 100% rpm. A utility hydraulic system failure renders the variable bypass bellmouth and auxiliary air doors inoperative. Operation of an engine with an open variable bypass bellmouth and closed auxiliary air doors will allow engine compartment secondary air to recirculate to the engine inlet. During low altitude or ground operation, the temperature of the recirculating air may be high enough to initiate T2 reset. When T2 reset is initiated the engine(s) will auto-accelerate. The auto-accelerated engine(s) can be shut down, if on the ground, by placing the throttle to OFF. If engine operation is required, the thrust output can be regulated by modulation of the engine throttle. Modulation of the engine throttles will re-position the exhaust nozzles. However, the engine rpm will not be affected.

### ENGINE OPERATING ENVELOPE

The engine operating envelopes (figure 7-1) show pertinent engine operating data for an ICAO Standard Day. The various envelopes are plotted to show an approximate area of operation; therefore, air-starts, afterburner light-offs, minimum airspeed operation, etc. may occur, depending on prevailing flight conditions, on either side of the plotted operational area. However, under 1G level flight conditions, satisfactory engine operations can be expected within the plotted envelopes. The transient operation zone (Mach 2.0 to 2.4) and the maximum engine operation curve are standard day airspeed restrictions and are shown for reference only. In all cases the Airplane Speed Restriction Chart and Engine Airspeed Limit Chart in section V of this manual shall take precedence over any or all operations shown herein.

### NOTE

When firing the nose gun during maneuvering flight at very high altitudes (especially during high AOA), engine compressor stall or flameout may occur due to gun-gas ingestion. At the first indication of stall/flameout, depress ignition button while moving throttle to OFF and then back to IDLE. Attempting an airstart without cycling the throttle to OFF will probably result in a hung start.

# ENGINE OPERATING ENVELOPES

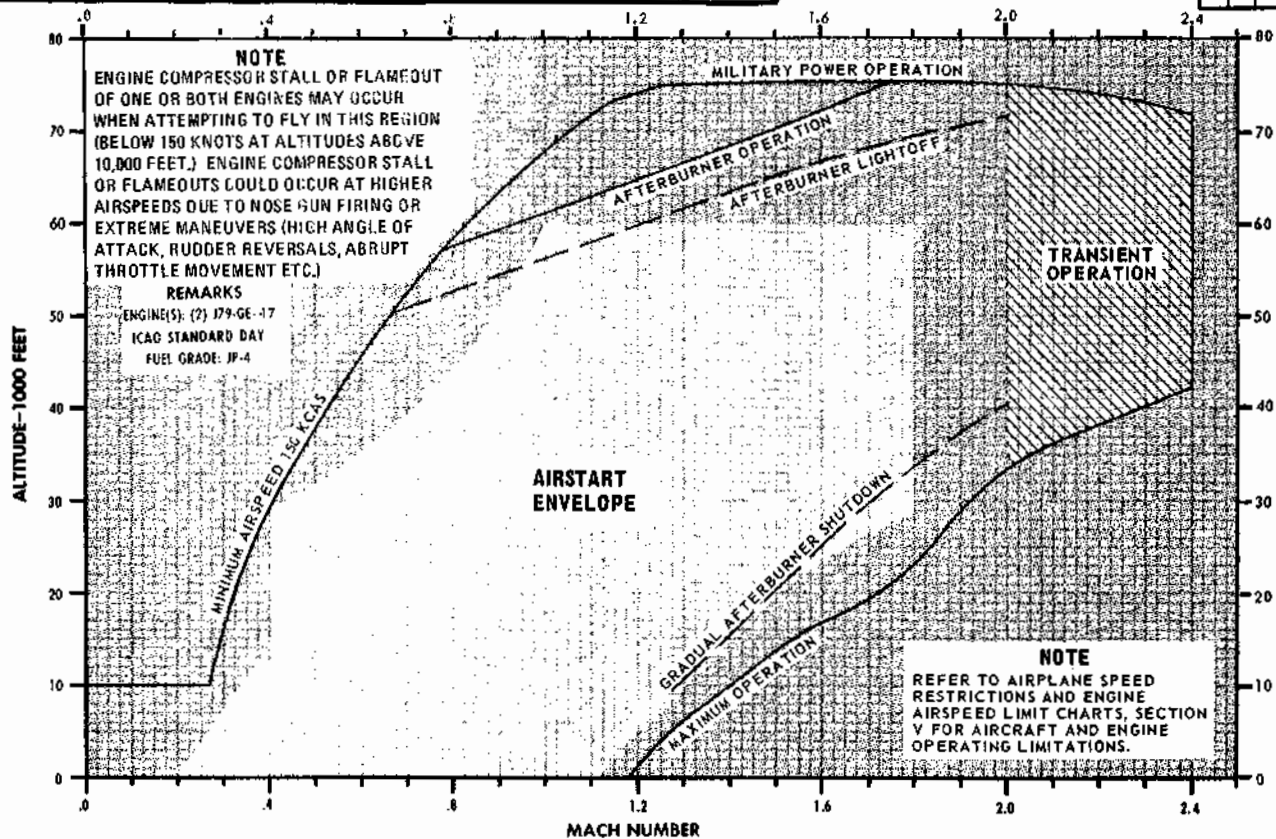

4E-1-(53)A

Figure 7-1

## ENGINE STARTER OPERATION

**WARNING**

The engine starting system utilizes a turbine type cartridge/pneumatic starter unit, mounted on the accessory gear box of each engine. These units provide starting capabilities with either the pneumatic starting unit, (type MA-1A or equivalent), or with a MXU-4/A or MXU-4A/A solid propellant cartridge. Electrical power for starting may be supplied by an external electrical power unit or the aircraft battery.

Under no circumstances should electrical contacts of the starter cartridge be brought in contact with the surface of an aircraft.

### STARTER CARTRIDGES

The MXU-4/A or MXU-4A/A engine starter cartridges are used for starting the engines. Spare cartridges, two per aircraft, may be stored behind access doors 137, left and right on aircraft without combat documentation cameras.

**NOTE**

Stored cartridges are limited to a maximum of 20 captive flights. Cartridges which exceed this limitation must be removed for Explosive Ordnance Disposal.

## FUEL WEIGHT VARIATIONS

Fuel quantity indications vary from day-to-day, even though the aircraft is serviced with the same total number of gallons of fuel. These variations between fuel quantity and weight are a source of considerable difficulty in the accurate determination of aircraft performance. The factors that cause the fuel weight to change, in respect to a constant quantity, are temperature effects and specific density tolerances. Fuel production specifications for JP-4, permit the specific density to range from 6.2 to 6.7 pounds per gallon at standard day conditions, or a maximum of one-half pound per gallon. The usable fuselage fuel, as indicated on the tape portion of the quantity indicator, can vary about 650 pounds, and the total usable fuel (all internal tanks) as indicated on the counter portion of the quantity indicator, can vary about 950 pounds, depending on specific density tolerances alone. Added to the specific density variations, is the effect

of temperature. For each change in the fuel temperature of 1°C, the fuel density varies inversely by 0.01 percent. Therefore, with the additional weight variations caused by temperature changes, a wide range of fuel weights for the same quantity can be realized. For example, if the fuselage cells were filled with JP-4 manufactured at the low end of the specific density scale (6.2 pounds per gallon), and the fuel temperature was 40°C, the tape portion of the quantity indicator would show approximately 7600

pounds of usable fuel. However, if the fuselage cells were filled with JP-4 manufactured at the high end of the specific density scale (6.7 pounds per gallon), and the fuel temperature was -10°C, the tape portion of the fuel quantity indicator would show approximately 8600 pounds of usable fuselage fuel. While it is not expected that a clinical study of the fuel density be made prior to each flight, it should be remembered that the engine fuel control schedules fuel in pounds, not gallons.



## SECTION VIII

# CREW DUTIES

---

### GENERAL AIRCREW RESPONSIBILITIES

The safe operation of the aircraft is the responsibility of both aircrew members. The flight manual and checklist is based on a definite division of responsibilities between cockpits. Each aircrew member should have a thorough working knowledge of Aircraft Systems, Normal/Emergency Procedures, Operating Limitations, and Aircraft Flight Characteristics.

### CREWMEMBER IN COMMAND OF AIRCRAFT

The primary responsibility of the crewmember in command of the aircraft is to ensure mission accomplishment within acceptable safety limits. Specific responsibilities are:

- a. Conduct adequate integral aircrew briefings to ensure definite division of responsibility during flight.
- b. Accomplish Normal/Emergency Procedures as outlined in this manual.
- c. Operation of the aircraft within published operating and structural design limitations.
- d. Ensure use of abbreviated checklist on all flights.

### CREWMEMBER IN CONTROL OF AIRCRAFT

The crewmember actually in control of the aircraft is responsible for flying the aircraft and operating auxiliary

equipment under his control in accordance with this manual. Those procedures requiring immediate response will be accomplished as required; however, aircrew member not in control of the aircraft will be required to read the procedure from the checklist when time and circumstances permit. The crewmember in control of the aircraft will call for checklist items when required during flight profile.

### CREWMEMBER NOT IN CONTROL OF AIRCRAFT

The crewmember not in control of the aircraft shares overall responsibility for the safe accomplishment of the mission. In addition, he is responsible for operating auxiliary equipment under his control in accordance with this manual. Specifically, his responsibilities are:

- a. Perform navigational duties as required.
- b. Assist other aircrew member in monitoring flight progress.
- c. Assist other aircrew member in monitoring aircraft systems and detecting system malfunctions.
- d. Initiate required inflight checklist items when not called for by crewmember in control of aircraft.
- e. Monitor instruments during all climbs and descents and advise the other crewmember of any deviations from established flight parameters.
- f. Clear the flight area whenever possible.

# SECTION IX

## ALL WEATHER OPERATION

### TABLE OF CONTENTS

Instrument Flight Procedures.....	9-1
Night Flying .....	9-4
Cold Weather Procedures.....	9-4
Hot Weather Procedures .....	9-6
Turbulence and Thunderstorms .....	9-6

Ice and Rain.....	9-7
-------------------	-----

This section provides information for operation during conditions of instrument flight, flight in turbulent air, various penetration/approach procedures, and extreme temperature conditions. These are procedures that differ from, or are in addition to, those contained in the normal operating procedures covered in section II.

## INSTRUMENT FLIGHT PROCEDURES

This all weather aircraft is designed to perform operational missions in all extremes of weather. Rapid acceleration rates and high pitch angles during climb, dictate some modification of standard instrument procedures. When flight through clouds, precipitation, or visible moisture is anticipated:

1. Pitot heat switch - ON
2. Engine anti-icing switch - DE-ICE

Upon reaching clear air -

3. Engine anti-icing switch - NORMAL

### INSTRUMENT TAKEOFF

An instrument takeoff is the same as a normal takeoff.

### INSTRUMENT CLIMB (MIL THRUST)

An instrument mil thrust climb is the same as a normal mil thrust climb.

### INSTRUMENT CLIMB (MAX THRUST)

An instrument A/B climb is the same as a normal A/B climb.

### HOLDING/LOITER

Holding patterns or loitering flight may be flown at most altitudes at 280 knots, using approximately 30° of bank.

### INSTRUMENT DESCENT

Refer to figure 9-1 for typical penetration pattern.

#### NOTE

- Do not reduce thrust below 80% rpm (85% single engine) to ensure adequate windshield defogging/rain removal/engine anti-ice effectiveness. If the throttle is retarded to idle in heavy precipitation a lower than normal idle rpm indication may be noted.
- The pressure altimeter should be crossed checked with the radar altimeter to confirm terrain clearance at low altitude.

### PRECISION APPROACH

See figure 9-2 for closed PAR/ILS approach.

1. Descend to GCA pick-up altitude and transition to landing configuration approximately 10 miles out on final or base leg (as appropriate).
2. Maintain minimum on-speed angle of attack.

When directed to commence descent -

3. Retard power to approximately 82-84% rpm.
4. Adjust power and pitch as necessary to maintain desired rate of descent.

A straight-in TACAN penetration followed by a GCA or ILS final requires approximately 500-800 pounds of fuel. A missed approach followed by a second GCA requires an additional 1000 pounds of fuel.

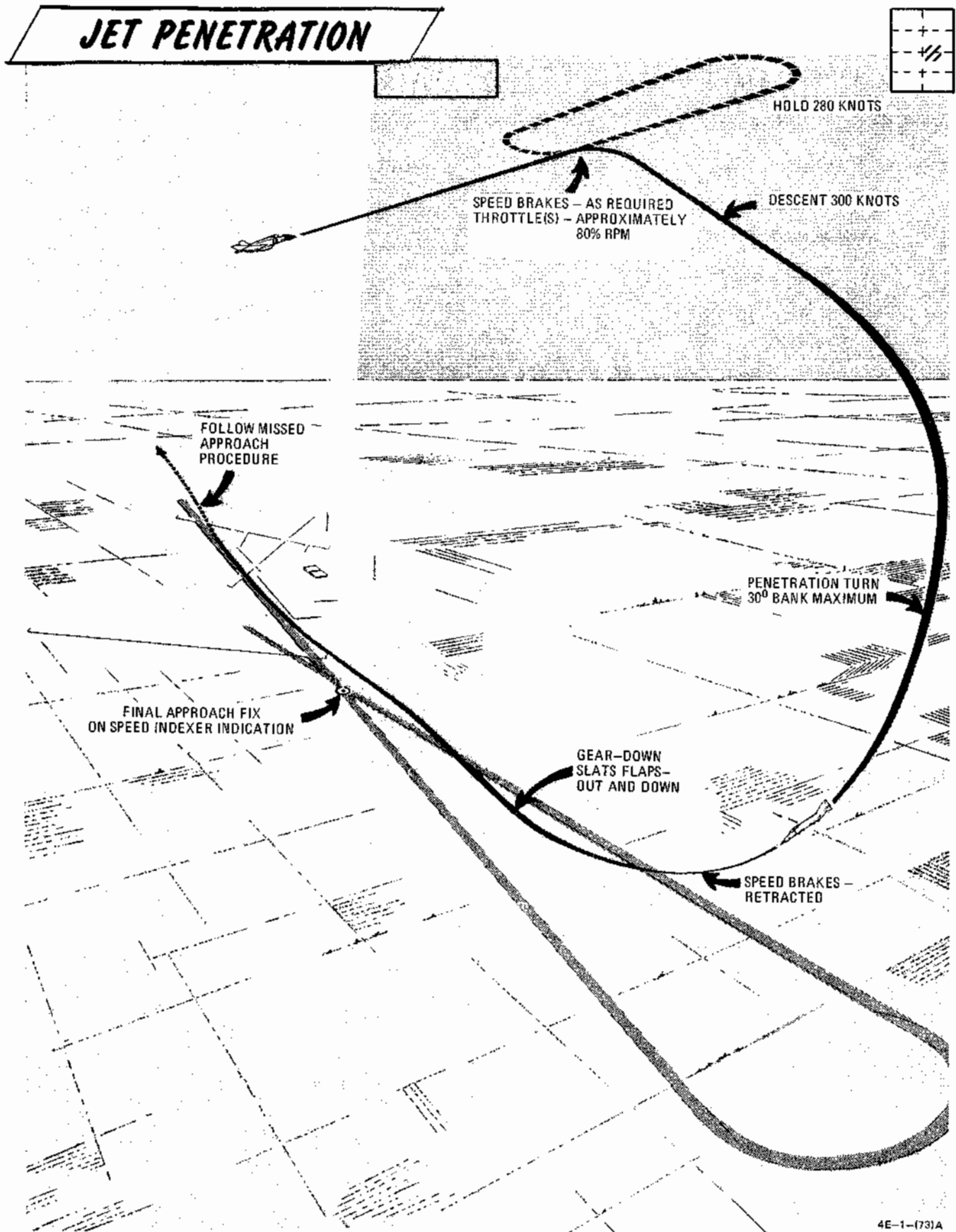

Figure 9-1

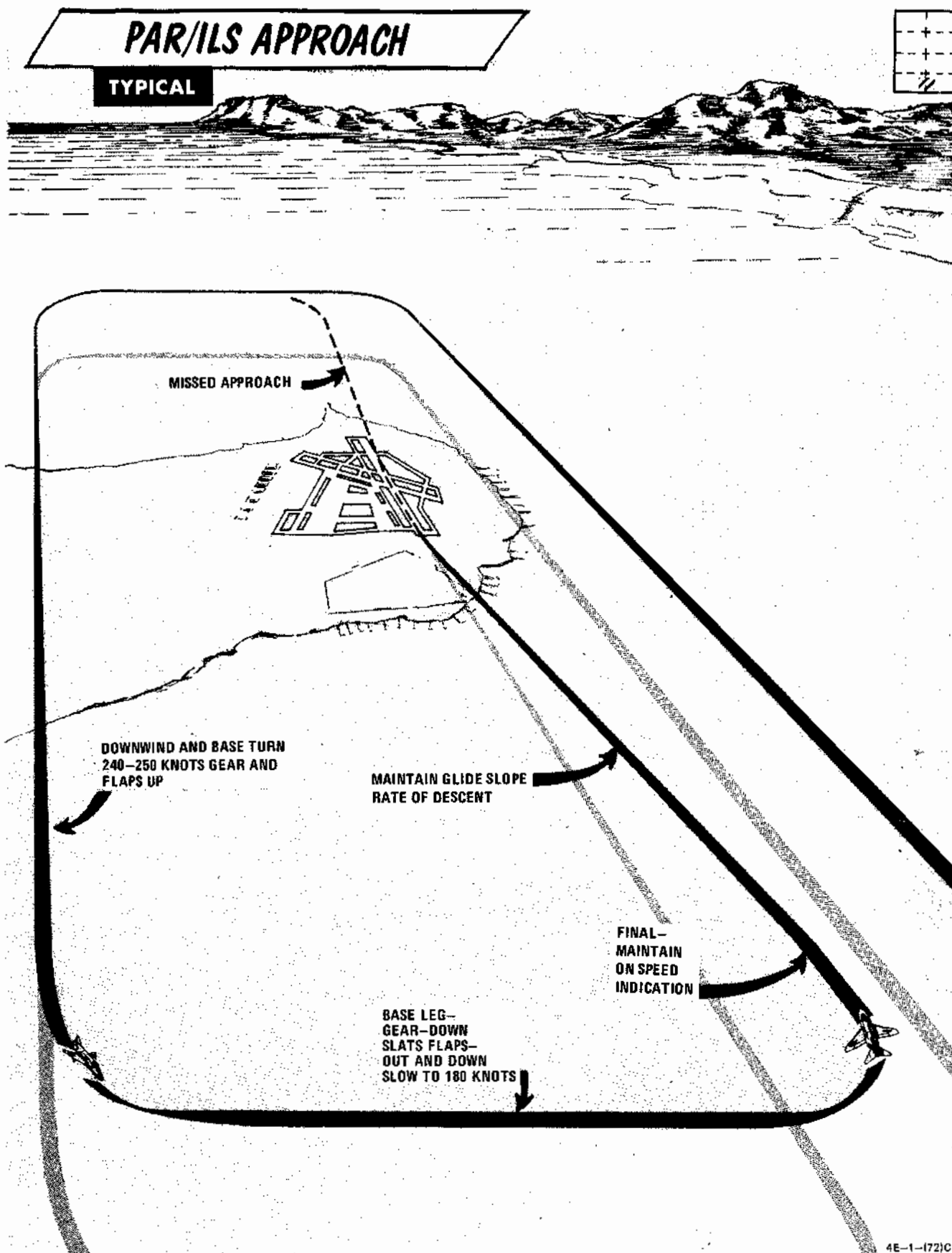

Figure 9-2

## CIRCLING APPROACH

Recommended airspeed from TACAN final approach fix for a circling TACAN approach, is 180 knots with gear and flaps extended.

## MISSED APPROACH PROCEDURES

1. Throttles - MILITARY
2. Gear - UP
3. Slats flaps - NORM (minimum of 180 knots)
4. Power as required to maintain 240-250 knots and maintain a 1500 to 2500 feet per minute climb.
5. Follow published missed approach procedures.

---

## NIGHT FLYING

---

### ON ENTERING AIRCRAFT

1. Interior lighting - CHECK
2. Emergency floodlights - CHECK
3. Navigation lights and exterior lights - CHECK
4. Landing and taxi lights - CHECK

### DURING FLIGHT

#### NOTE

During instrument conditions, exterior lights should be on STEADY due to vertigo inducing effect of flashing light reflections from surrounding clouds.

---

## COLD WEATHER PROCEDURES

---

### BEFORE ENTERING COCKPIT

The entire aircraft should be free of snow, ice, and frost collections. These conditions are a major flight hazard and result in a loss of lift and increased stall speeds. They must be removed before flight, but do not chip or scrape away ice as damage to aircraft may result. Special emphasis must be placed on the following:

1. Shock struts, pitot tube, fuel vents, and actuating cylinders are free of ice or dirt.
2. Fuel drain cocks free of ice and insure that all pneumatic bottles have been adequately serviced.
3. All exterior covers removed.
4. Closely inspect the nozzle shroud flaps for any signs of ice deposits. If any ice is present, apply heat to the nozzle control feedback housing area for 5 to 10 minutes just prior to engine start.

### ENGINE START

During pneumatic engine start operation, depress ignition buttons at approximately 6% rpm; however, do not advance the throttles until approximately 10% rpm is reached. During cartridge start operation, press ignition buttons approximately 5 seconds before advancing throttles. Depressing the ignition buttons prior to throttle advance will dry out the igniter plugs, thereby enhancing a successful start. If any abnormal sounds or noises are present during starting, discontinue starting and apply intake duct preheating for 10 to 15 minutes. Immediately after starting the engine at extremely low temperatures, the engine oil pressure indication will become excessive and may peg out at 100+ psi. When this condition occurs, the generators may not connect to the aircraft load when the generator control switch is placed to GEN ON. This is caused by either the limit governor not porting oil to the underspeed switch or the contacts within the underspeed switch not closing. Both of these problems are associated with low temperature, high viscosity oil. Repeated cycling of the generator switch in an attempt to get a generator on the line may prove futile until the engine/oil warms up (oil pressure drops below 50 psi). Occasionally because of cold oil, the spool valve in the limit governor does not move fully to the open position. If this occurs, it also prevents the generators from connecting to the aircraft load. An increase in oil temperature does not always correct this condition. However, engine shut down and restart often exercises the system sufficiently to free the spool valve. Spool valve operation is not critical as this valve operates once to open at engine start and again to close at engine

### INTERIOR CHECK

In temperatures below 0°C, difficulty may be experienced when connecting the oxygen mask hose to the T-connector, due to a stiff O-ring in the T-connector. Application of a small amount of heat to the T-connector will alleviate this problem. Also, if the oxygen mask is not fastened, keep it well clear of the face to prevent freezing of the valves.

shut down. An aircraft flight should not be aborted for failure of a generator to come on or stay on the line prior to engine/oil warm-up nor should an abort be declared if an engine shut-down and restart will bring and keep a generator on the line.

### CAUTION

Ensure that GEN OUT and BUS TIE OPEN lights go out. The maximum amount of time that the engine can run at 100 psi oil pressure before discontinuing the start is 2 minutes when the temperature is below  $-18^{\circ}\text{C}$  ( $0^{\circ}\text{F}$ ) and 4 minutes when the temperature is below  $-35^{\circ}\text{C}$ .

### NOTE

In extremely cold weather, the throttle linkage is very stiff and both hands may be required to move the throttles out of the OFF position.

## WARM-UP AND GROUND CHECK

When checking the flight controls, lateral stick movement will be extremely stiff. Slowly cycle the control stick until full lateral stick throw is available. Repeated control cycling will alleviate the stiffness somewhat, but normal system feel may not return until after approximately 1 hour of system operation. Before takeoff, assure all instruments are allowed an adequate warm-up period and are operating normally.

### CAUTION

During engine ground operation when icing conditions are present, rapid throttle movement with possible ice accumulation in the compressor could result in a stall. Do not operate below 82% rpm for more than 5 minutes. Operate at MIL for at least 30 seconds for each period below 82% rpm.

## TAXIING

Avoid taxiing in deep or rutted snow since frozen brakes will likely result. Also, increase space between aircraft while taxiing at sub-freezing temperatures, to insure safe stopping distance and to prevent icing of aircraft surfaces by melted snow and ice blown by the jet blast of a preceding aircraft.

## BEFORE TAKEOFF

The thrust developed by the engine in low temperature is noticeably greater and brake demands will be greater to hold position; however, when operating with maximum engine compressor bleed air (cockpit pressurized) in

outside air temperatures of  $-37^{\circ}\text{C}$  and below, rapid throttle bursts may result in an rpm hang-up. If engine icing conditions are anticipated, place the engine anti-ice switch in the DE-ICE position and place the pitot heat switch ON.

### NOTE

When operating under extremely low temperatures (approximately  $-40^{\circ}\text{C}$  or below), RPM hang-up, cyclic afterburner operation, or engine flameout may be experienced.

## TAKEOFF

### NOTE

- When operating from runways which are covered with excessive water, snow or slush, high-speed aborts may result in engine flame-out due to precipitation ingestion. The probability of flame-out is highest when throttles are chopped from afterburner to IDLE at speeds above 100 knots. With a double flame-out, normal braking, anti-skid protection, and nose gear steering will be lost. After takeoff from runways covered with snow or slush, packed snow/slush in the auxiliary air door area may make throttle movement difficult until the snow/slush can be melted.
- If inflight freezing within the longitudinal control system is experienced, excessive stick forces may be required to move the control stick. Normal airplane control is available but requires higher initial force inputs. Normal control forces should return at lower (warmer) altitudes.

## AFTER LANDING

When wearing bulky arctic survival clothing and winter flying gloves, rapid egress from the cockpit by disconnecting the torso harness will be impeded due to the inability to see the connectors and by a degraded sense of touch. During operations where the temperature is below freezing with heavy rain, or expected to drop below freezing with heavy rain, the aircraft should be parked with wings spread.

## BEFORE LEAVING AIRCRAFT

Leave canopy open, unless weather prevents, to permit circulation. This helps prevent canopy cracking from differential cooling and decreases windshield and canopy frosting. Also check that all protective covers are installed.

## HOT WEATHER PROCEDURES

### CAUTION

Do not attempt takeoff or engine operation in a sand storm or dust storm, if avoidable. Park aircraft crosswind and shut down engine to

prevent sand or dirt from damaging engine.

## TURBULENCE AND THUNDERSTORMS

### WARNING

The following factors, singly or in combination, could cause engine flame-outs:

- Penetration of cumulus build-ups with associated high moisture content.
- Engine icing of either nose cowl or inlet guide vanes.
- Turbulence associated with penetration can result in extreme angles of attack which may cause marginal engine performance.
- Above 40,000 feet, the surge margin of the engine is reduced and there is poor air distribution across the face of the compressor.
- In view of the above, the pilot should avoid areas of turbulent air, hail storms, or thunderstorms, whenever possible, because of the increased danger of engine flame-out. If these areas cannot be avoided, the engine anti-icing system should be turned on prior to weather penetration. EGT gages should be monitored continuously during weather penetration. A rise of EGT is an indication of engine icing. The engine anti-icing systems prevent the formation of ice and is not a de-icer. Whenever possible, icing conditions should be anticipated in advance and the anti-icing system should be turned on to warm up the engine air inlet.

## PENETRATION

The basic structure of the aircraft is capable of with-standing the accelerations and gust loadings associated with the largest thunderstorms at subsonic airspeed. Supersonic thunderstorm penetrations have not been investigated to date. The aircraft is exceptionally stable and comparatively easy to control in the severe turbulence; however, the effects of turbulence becomes noticeably more abrupt and uncomfortable at airspeeds above optimum cruise and below 35,000 feet. The aircraft is not displaced significantly from the intended flight path and desired heading. Attitude can be maintained with

reasonable accuracy.

## PENETRATION AIRSPEED

The optimum thunderstorm penetration speed is 300 knots. Afterburner may be necessary to maintain this airspeed above 35,000 feet.

### NOTE

Optimum thunderstorm penetration airspeed is a compromise between pilot comfort, controllability, structural stress (due to gust loads and impact precipitation), and engine inlet air distortion. At high airspeeds, aircrew discomfort and structural stress are greater. At slow speeds, controllability is somewhat sacrificed and inlet airflow distortion (due to turbulence) may induce compressor stalls and/or engine flameout.

## APPROACHING THE STORM

If storm cannot be seen, it may be located by use of radar. Establish the recommended penetration airspeed and perform or check the following:

1. Adjust throttle to maintain desired penetration speed.
2. Pitot heat switch - CHECK ON
3. Engine anti-icing switch - DE-ICE
4. Autopilot - OFF
5. Lower seat
6. Inertia reel - MANUALLY LOCK

If night penetration -

7. White floodlights - ON
8. Instrument lights - FULL BRIGHT
9. Console lights - FULL BRIGHT

### CAUTION

Do not try to top thunderstorms at subsonic speeds above 40,000 feet. The stall margin of both the airframe and engines becomes critical in this region. Flight through a thunderstorm at the

proper airspeeds is much more advantageous than floundering into the storm at a dangerously slow airspeed while attempting to reach the top.

## IN THE STORM

1. Maintain a normal instrument scan with added emphasis on the attitude indicator (ADI). Attempt to maintain attitude, and accept altitude and airspeed fluctuations.



- If compressor stall or engine stagnation develops, retard throttle to idle momentarily, then attempt

to regain normal engine operation by advancing the throttle. If the stall persists, shut down the engine and attempt a relight. If engine remains stagnated at reduced power, and EGT is within limits, maintain reduced power until clear of the thunderstorm.

- The angle of attack probe may become distorted by impact ice and/or hail, which may result in erroneous actuation of the aural tone generator. Pulling the angle of attack heater circuit breaker (zone C7, No.3 panel) will disable the rudder pedal shaker and aural tone generator.

---

## ICE AND RAIN

---

### BEFORE TAXIING

Before taxiing prior to severe weather flight, the engine anti-ice system should be checked as follows:

1. Engine rpm - IDLE
2. Anti-ice switch - DE-ICE

#### NOTE

If an anti-ice light cannot be illuminated at idle, advance engine to 80% rpm or higher.

3. EGT - CHECK  
Check for rise in EGT of approximately 10°C.
4. Fuel flow - CHECK  
Check for slight increase in fuel flow.
5. Anti-ice switch - OFF

### INFLIGHT

The possibility of engine and/or airframe icing is always present when the aircraft is operating under instrument conditions. Icing is most likely to occur when takeoffs must be made into low clouds with temperature at or near freezing. Normal flight operations are carried on above the serious icing levels and the aircraft's high performance capabilities will usually enable the pilot to move out of the dangerous areas quickly. When an icing condition is encountered, immediate action should be taken to avoid further accumulation. Flight through ice and/or rain requires no special technique; however, certain aircraft systems do require particular attention. These systems are engine anti-ice, windshield rain removal, longitudinal feel, and ADC.

#### NOTE

Selection of lower antenna may reduce static caused by heavy precipitation.

### ENGINE ANTI-ICE SYSTEM

There is no immediate indication during flight of engine icing, such as decreased power or reduction in fuel flow; however, as ice build-up becomes critical, fuel flow will decrease, EGT will increase, and there will be a noticeable power loss. Therefore, the engine anti-ice system should be used whenever icing conditions are anticipated. Anti-ice system operation can be noted by an increase in EGT and fuel flow when the system is actuated. After clearing all precipitation and clouds, turn the anti-ice switch off. Unnecessary use of engine anti-ice air produces the following adverse effects:

- a. Probable compressor front end damage at high supersonic speeds.
- b. Probable decrease in compressor stall margin.
- c. Slightly increased fuel consumption.

### WINDSHIELD RAIN REMOVAL

The following precautions should be observed when contemplating the use of the windshield rain removal system:

- a. Do not operate on a dry windshield.
- b. Turn the system OFF immediately if WINDSHIELD TEMP HIGH indicator light illuminates.
- c. Do not operate above Mach 1.0.
- d. The system should be turned on at 3 to 5 miles on final to ensure proper operation during the landing phase.

### STABILATOR FEEL AND TRIM

When flying through areas of precipitation, partial or complete failure of the longitudinal control artificial feel system may result due to ice and/or water blockage of the bellows ram air line. If this condition occurs, excessive stick force will be required to maintain the desired aircraft attitude. Since sudden longitudinal trim changes may



occur several minutes after flying through freezing precipitation, especially during descent to altitudes below the freezing level, the application of corrective longitudinal trim when a blocked bellows inlet is suspected is not recommended. A heater has been incorporated in the longitudinal feel system bellows inlet. The heater is turned on when the pitot heat switch is moved to the ON position.



If ice and/or water blockage of the artificial feel bellows ram air line is suspected, longitudinal trim should not be applied to relieve control stick force, due to intermittent nature of the failure and suddenness of return to normal. Instead, use extra effort on stick to maintain desired airplane attitude. If nose up trim has been applied before the bellows failure was recognized, trim should be returned to near neutral (0 units if in doubt) before attempting any corrective action.

#### AIR DATA COMPUTER

The air data computer may malfunction during flight through ice and/or rain due to impact forces imposed by water and ice on the ADC total temperature sensor. A

momentarily flashing DUCT TEMP HI warning light usually indicates that the sensor probe has been blocked or shorted by ice accumulation. A sensor probe that has completely failed will be evidenced by a continuously flashing DUCT TEMP HI warning light. These total temperature malfunctions result in erroneous true airspeed signals to the navigation computer, and cyclic operation of the intake duct ramps at all airspeeds. A malfunction in the ADC may also be caused by rain and/or ice impact damage to the angle of attack probe. The probe may become fixed at its extreme limits, thereby actuating the rudder pedal shaker with landing gear down. If the above malfunctions occur, proceed as follows:

#### If DUCT TEMP HI light flashes intermittently or continuously -

1. Decelerate as rapidly as practical to subsonic flight.
2. Maintain normal subsonic cruise airspeeds.

## APPENDIX

## A

## PERFORMANCE DATA

F-4E

The appendix is divided into parts, as outlined below, to present the performance data in proper sequence for preflight planning. Each part contains descriptive text and sample problems for the applicable charts.

PART

1

INTRODUCTION

A1-1

PART

2

TAKEOFF

A2-1

PART

3

CLIMB

A3-1

PART

4

RANGE

A4-1

PART

5

ENDURANCE

A5-1

PART

6

AIR REFUELING

A6-1

PART

7

DESCENT

A7-1

PART

8

LANDING

A8-1

PART

9

COMBAT PERFORMANCE

A9-1

PART

10

MISSION PLANNING

A10-1

# PART 1

## INTRODUCTION

### TABLE OF CONTENTS

#### Charts

Airplane Loading .....	A1-6
Aft CG Limits .....	A1-10
Drag Due to Asymmetric Loading .....	A1-11
Standard Atmosphere Table .....	A1-12
Temperature Conversion .....	A1-13
Airspeed Conversion .....	A1-14
Airspeed Position Error Correction .....	A1-16
Altimeter Position Error Correction .....	A1-18
Altimeter Lag .....	A1-19
Wind Components .....	A1-21

### DRAG INDEX SYSTEM

Most of the charts utilize the drag index system to effectively present the many combinations of weight/drag effects on performance. The Airplane Loading chart (figure A1-1) contains the drag number and weight of each externally carried store and its associated suspension equipment. The drag index for a specific configuration may be found by multiplying the number of stores carried by its drag number, and adding the drag number of the applicable suspension equipment. The total drag index may then be used to enter the planning data charts. Charts applicable for all loads and configurations are labeled ALL DRAG INDEXES. Charts labeled INDIVIDUAL DRAG INDEXES contain data for a range of drag numbers; i.e., individual curves/columns for a specific drag number. Supersonic data is not compatible to the drag index system; therefore, each chart is labeled for a specific configuration.

#### Sample Problem

Configuration: 6 - MK81 general purpose bombs on stations 1 & 9 (3 each station)	
6 - MK81 general purpose bombs on station 5	
6 - LAU-3/A rocket launchers with nose and tail cones (full) on stations 2 & 8 (3 each station)	
A. MK81 drag number	$0.8 \times 12 = 9.6$
B. MK81 suspension equipment stations 1 & 9	$10.1 \times 2 = 20.2$
C. MK81 suspension equipment=station 5	$10.0 \times 1 = 10.0$
D. LAU-3/A drag number	$4.2 \times 6 = 25.2$

E. LAU-3/A suspension equipment stations 2 & 8	$6.8 \times 2 = 13.6$
F. Total drag index	78.6

### STABILITY INDEX SYSTEM

The stability index system is established to account for the destabilizing effect of wing-mounted stores. Wing-mounted stores shift the aerodynamic center (AC) forward and thereby reduce the static longitudinal stability. When the loading configuration is determined, enter the Airplane Loading chart, figure A1-1, to obtain the stability index number for each wing-mounted store loaded. Unit stability numbers are assigned for single mounted and cluster mounted weapons. Tandem mounted weapons count as a single weapon. The cluster mounted unit stability number is used when two or more weapons are not mounted in tandem. Each weapon in the cluster is assigned this number. For stability index computation of cluster mounted weapons, the maximum number of stores per station is three. The total of the stability index numbers for all stores loaded is the aircraft stability index. The aircraft stability index is used to determine the aft CG limit and the neutral stability point. Refer to Center of Gravity Limitations, section V.

#### Sample Problem

##### NOTE

The following example is based on the aircraft operating weight plus a full internal fuel load (45,160 pounds). The external loading is the same as used in determining the drag index.

A. MK81 (cluster mounted stations 1 & 9)	$2.4 \times 6 = 14.4$
B. MK81 (suspension equipment)	$11.4 \times 2 = 22.8$
C. LAU-3/A (cluster mounted stations 2 & 8)	$13.5 \times 6 = 81.0$
D. LAU-3/A (suspension equipment)	$13.5 \times 2 = 27.0$
E. Stability Index	145.2
F. Aft CG limit (at engine start) based on stability index	32.5% MAC
G. Takeoff gross weight	52,700 Lb
H. Aircraft CG location	32.1% MAC

Result - airplane CG within limits.

## DRAG DUE TO ASYMMETRIC LOADING

This chart (figure A1-3) provides the drag number due to trimming asymmetric store loading. The drag number is added to the computed drag of the airplane to obtain the drag index. This chart is unlike the Airplane Loading chart in that the drag varies with Mach number and altitude.

### USE

Find the net asymmetric load on stations 2 and 8 (left vertical axis) by subtracting the lighter from the heavier weight. Attach to this net load the position, RWH (right wing heavy) or LWH (left wing heavy) as applicable. In the same manner, find the net asymmetric load on stations 1 and 9 (diagonal parallel lines). Enter the chart with the net asymmetric load for stations 2 and 8 (RWH or LWH). Proceed horizontally to the right to the net asymmetric load on stations 1 and 9 (RWH or LWH). Proceed vertically downward to the applicable altitude, horizontally to the right to the applicable Mach number, and then vertically downward to obtain the incremental drag number.

### Sample Problem

- A. Load on station 2 = 1000 Lb  
 Load on station 8 = 3000 Lb  
 Net asymmetric load on stations 2 & 8 = 2000 Lb RWH
- B. Load on station 1 = 2500 Lb  
 Load on station 9 = 2000 Lb  
 Net asymmetric load on stations 1 & 9 = 500 Lb LWH
- C. Altitude 25,000 Ft
- D. Mach number 0.7
- E. Incremental drag number 5.25

## AIRSPEED CONVERSION

The Airspeed Conversion chart, (figure A1-6) provides a means of converting calibrated airspeed to true Mach number and true airspeed.

### INDICATED AIRSPEED

Indicated airspeed (IAS) is the uncorrected airspeed read directly from the indicator.

### CALIBRATED AIRSPEED

Calibrated airspeed (CAS) is indicated airspeed corrected for static source error.

## EQUIVALENT AIRSPEED

Equivalent airspeed (EAS) is calibrated airspeed corrected for compressibility. There is no provision made for reading equivalent airspeed.

## TRUE AIRSPEED

True airspeed (TAS) is equivalent airspeed corrected for density altitude. Refer to the Airspeed Conversion charts (figure A1-6).

## AIRSPEED POSITION ERROR CORRECTION

These charts (figures A1-7 and A1-8) provide the means to correct indicated airspeed and Mach number to calibrated and true values respectively.

### Sample Problem

Configuration: Slats Out, Flaps Down, Gear Down

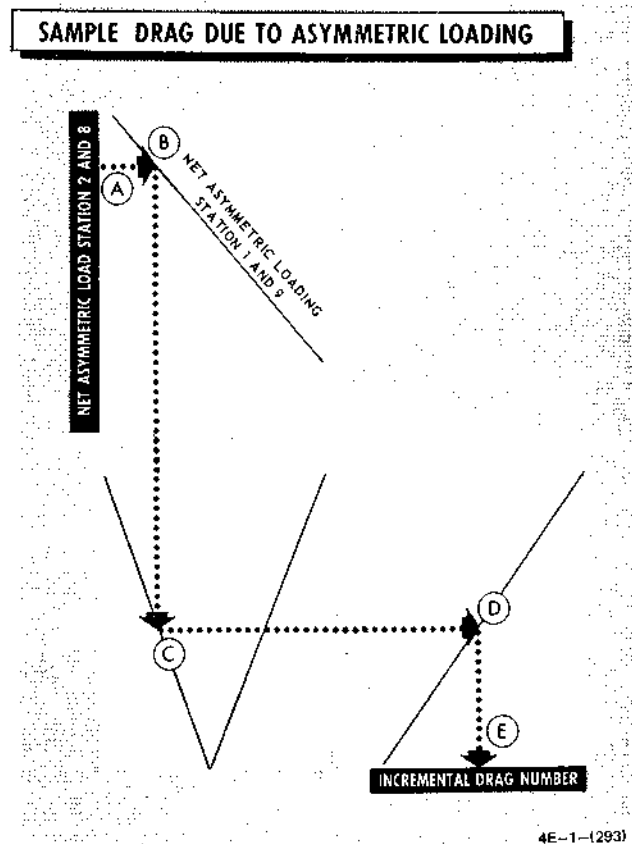

- A. Indicated airspeed 180 Kt
- B. Reflector curve 178 Kt
- C. Calibrated airspeed 178 Kt

- A. Indicated Mach number 1.4
- B. Assigned altitude 40,000 Ft
- C. Δ H correction +75 Ft
- D. Indicated altitude necessary to maintain assigned altitude (B+C) 40,075 Ft

Configuration: Slats In, Flaps Up, Gear Up

- A. Indicated Mach number 1.1
- B. Reflector curve 1.08
- C. True Mach number 1.08

**SAMPLE AIRSPEED POSITION ERROR CORRECTION**

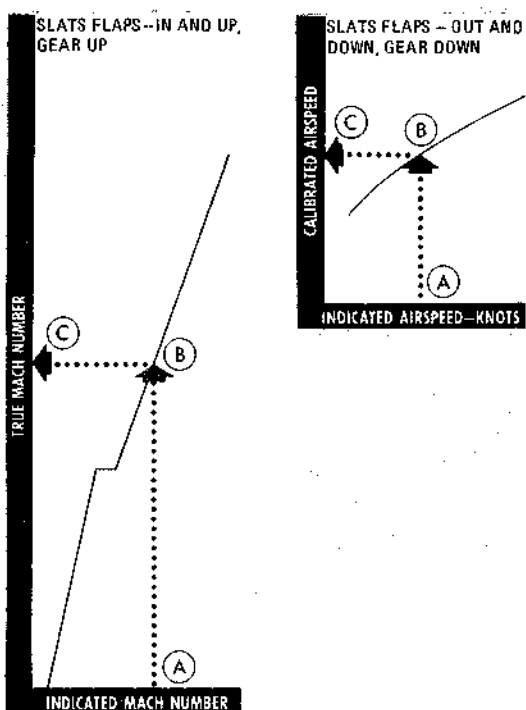

4E-1-(294) A

**ALTIMETER POSITION ERROR CORRECTION**

This chart (figure A1-9) provides altimeter error corrections for given Mach numbers at various altitudes. An altitude correction factor is included for landing configurations.

**Sample Problem**

Configuration: Slats In, Flaps Up, Gear Up

**SAMPLE ALTIMETER POSITION ERROR CORRECTION**

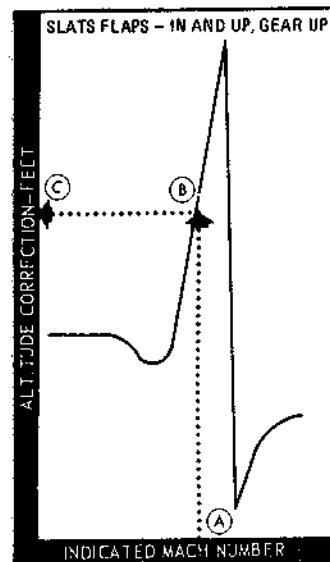

4E-1-(295)

**ALTIMETER LAG CHART**

These charts (figures A1-10 and A1-11) provide a means of obtaining the altimeter lag (difference between indicated altitude and actual altitude) resulting from diving flight. Data is provided for dive angles up to 60° and airspeeds up to 600 knots TAS.

**USE**

Enter the chart with dive airspeed, and project horizontally to the right to intersect the dive angle curve. From this point, project vertically downward to read the resulting altimeter lag. Add the altimeter lag data to desired/required pullout altitude to obtain indicated altitude for pullout.

**Sample Problem**

Aircraft with SPC Inoperative

- A. Dive airspeed (TAS) 400 Kt
- B. Dive angle 45°
- C. Altimeter lag 1,120 Ft

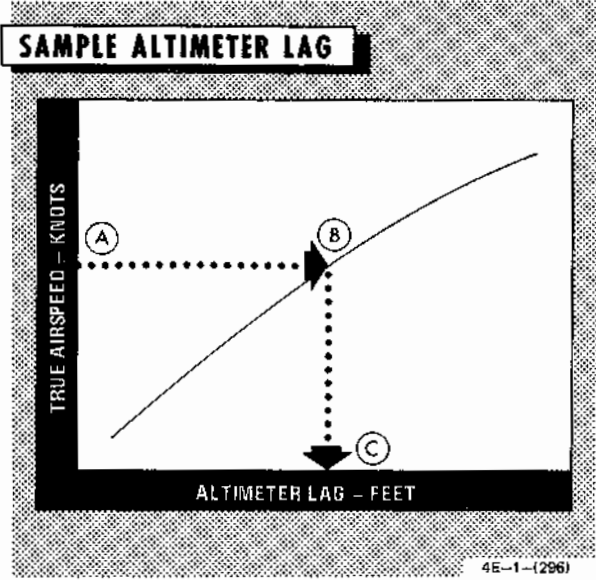

### WIND COMPONENTS CHART

A standard Wind Components chart (figure A1-12) is included. It is used primarily for breaking a forecast wind down into crosswind and headwind components.

#### USE

Determine the effective wind velocity by adding one-half the gust velocity (incremental wind factor) to the steady state velocity; e.g., reported wind 050/20 G30, effective wind is 050/25. Reduce the reported wind direction to a relative bearing by determining the difference between the wind direction and runway heading. Enter the chart with the relative bearing. Move along the relative bearing to intercept the effective wind speed arc. From this point, descend vertically downward to read the crosswind component. From the intersection of bearing and wind speed, project horizontally to the left to read headwind component.

### Sample Problem

Reported wind 050/35, runway heading 030

- |                            |       |
|----------------------------|-------|
| A. Relative bearing        | 20°   |
| B. Intersect windspeed arc | 35 Kt |
| C. Crosswind component     | 12 Kt |
| D. Headwind component      | 33 Kt |

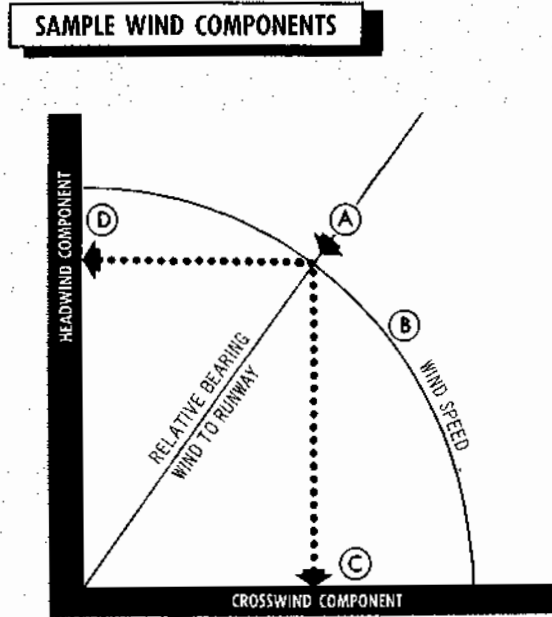

F-4E

**AIRPLANE LOADING****WARNING**

FOR PRECISE BASIC WEIGHT, EXTERNAL STORE AND ATTACHMENT INFORMATION, REFER TO CHARTS C AND E OF THE WEIGHT AND BALANCE DATA HANDBOOK (T.O. 1-18-40) FOR THE PARTICULAR AIRPLANE.

SUSPENSION EQUIPMENT	WEIGHT PER STATION	DRAG PER STATION	STABILITY INDEX NUMBER
AERO 27A EJECTOR RACK	51	N/A	N/A
BRU-5/A (MODIFIED AERO-27A EJECTOR RACK)	45	N/A	N/A
AERO 27A EJECTOR RACK CENTERLINE MER ADAPTER AND SWAYBRACE ADAPTERS	122	3.9	N/A
AERO 27A EJECTOR RACK AND CENTERLINE MER WITH ADAPTER	321	10.0	N/A
INBOARD ARMAMENT PYLON	264	2.6	6.9
INBOARD ARMAMENT PYLON AND TER	359	6.8	13.5
INBOARD ARMAMENT PYLON AND TWO AERO-38 MISSILE LAUNCHERS	403	3.4	9.1
INBOARD ARMAMENT PYLON AND LAU-34/A MISSILE LAUNCHER	350	4.0	9.3
INBOARD ARMAMENT PYLON AND LAU-88/A LAUNCHER	740	13.7	21.5
INBOARD ARMAMENT PYLON AND TWO ALE-40 DISPENSERS	F-332 E-309	5.4	6.9
OUTBOARD ARMAMENT PYLON	190	2.1	4.3
OUTBOARD ARMAMENT PYLON AND OUTBOARD MER	405	10.1	11.4
OUTBOARD ARMAMENT PYLON AND LAU-34/A MISSILE LAUNCHER	276	3.4	6.8

**Notes** • ARMAMENT PYLON WEIGHTS ARE BASED ON MAU-128/A. FOR MAU-12C/A, ADD 9 POUNDS.

F-4E STORE	WEIGHT PER STORE (POUNDS)	DRAG PER STORE	UNIT STABILITY NUMBER	
			SINGLE MOUNTED	CLUSTER MOUNTED
WING TANK AND PYLON	F-2713 E-308	6.4	SEE BELOW	
WITHOUT INBOARD STORES OR PYLONS			20.0	N/A
WITH INBOARD STORE AND/OR PYLON			30.0	N/A
WITH INBOARD LAU-88 LAUNCHER			46.5	N/A
MAC 600-GAL EXT TANK WITH UNUSABLE FUEL	300	9.6	N/A	N/A
MAC 600-GAL EXT TANK WITH FULL FUEL	4200	9.6	N/A	N/A
ROYAL JET 600-GAL EXT TANK WITH UNUSABLE FULL	304	9.6	N/A	N/A
ROYAL JET 600-GAL EXT TANK WITH FULL FUEL	4204	9.6	N/A	N/A
A/A 37U-15 TOW TARGET SYSTEM (WITH TOW TARGET)	674 (983)	14.3(45.6)	7.0	N/A
AAVS TYPE IV CAMERA POD	142	4.0	4.1	N/A
AGM-45A, -45B OR ATM-45 TRAINING MISSILE	400	2.3	2.7	N/A
AGM-65A MISSILE	463	2.8	17.6	23.5
AIM-7E-2, -7E-3 MISSILE	435	1.3	N/A	N/A
AIM-9B, -9E, -9J, -9J-1 MISSILE	168/167/165	1.3	1.0	1.4
AIS POD (AN/ASQ-T-11)	160	1.3	1.0	N/A
AAQ-8 IRCM POD (WITH RAT)	235 (264)	2.0	4.4	N/A
ALE-38 CHAFF DISPENSER	F-470 E-212	4.0	21.0	N/A
ALQ-71(V)-2	242	WING-2.0 FUS-1.3	4.4	N/A
ALQ-71(V)-3	334	WING-2.0 FUS-1.3	4.4	N/A
ALQ-72	237	WING-2.4 FUS-1.6	4.4	N/A
ALQ-87	300	WING-2.1 FUS-1.4	4.4	N/A
ALQ-101	232	WING-1.8 FUS-1.1	4.7	N/A
ALQ-101(V)-8	540	WING-2.0 FUS-1.3	5.0	N/A
ALQ-119(V)-4, (V)-7, (V)-10	565	WING-2.4 FUS-1.6	9.3	N/A
ALQ-119(V)-8, (V)-11	307/392	WING-2.4 FUS-1.6	9.3	N/A
ALQ-119(V)-12, (V)-13, (V)-14	580/319/406	WING-2.5 FUS-1.7	12.2	N/A
B28EX, B28RE SPECIAL STORE	2027/2170	4.1	11.2	N/A
B43 SPECIAL STORE WITH MOD 0 NOSE	2125	4.1	9.2	N/A
B43 SPECIAL STORE WITH MOD 1 NOSE	2135	4.1	9.2	N/A
B57 SPECIAL STORE	510	2.2	4.9	N/A
B61 SPECIAL STORE	716	2.2	2.5	N/A
BDU-33B/B, D/B PRACTICE BOMB	23	0.2	0.6	0.8
BLU-1/B, -1B/B, -1C/B FIRE BOMB	UNFINNED	707	3.4	14.0
	FINNED	721	3.8	10.7
BLU-27/B, A/B, B/B, C/B FIRE BOMB	UNFINNED	827	3.4	14.0
	FINNED	842	3.8	10.7
BLU-52/B, -52A/B BOMB (FIRE/CHEM/INERT)	360/375/315	3.8	10.7	14.3
BL-755 BOMB	610	4.4	7.8	10.4

N/A - NOT APPLICABLE      F - FULL  
 N/E - NOT ESTABLISHED      E - EMPTY

Figure A1-1 (Sheet 2 of 4)



STORE	WEIGHT PER STORE (POUNDS)	DRAG PER STORE	UNIT STABILITY NUMBER		
			SINGLE MOUNTED	CLUSTER MOUNTED	
CBU-7A/A DISPENSER (UNFINNED)	F-810 E-157	F-4.4 E-6.9	13.0	13.0	
CBU-12/A DISPENSER	F-650 E-158	3.3	10.0	13.0	
CBU-29A/B DISPENSER	825	4.2	7.4	9.9	
CBU-24/B OR CBU-29/B DISPENSER	811	4.2	7.4	9.9	
CBU-29B/B DISPENSER	832	4.6	7.4	9.9	
CBU-49C/B DISPENSER	802/810	4.6	7.4	9.9	
CBU-30/A DISPENSER (UNFINNED)	F-385 E-188	F-4.4 E-6.9	13.0	13.0	
CBU-42/A DISPENSER (FINNED)	F-922 E-268	F-3.3 E-5.6	14.0	14.0	
CBU-38/A, B/A, C/A DISPENSER (UNFINNED)	F-704 E-188	F-4.4 E-6.9	13.0	13.0	
CBU-46/A, A/A DISPENSER	F-886 E-165	3.3	10.0	13.3	
CBU-49/B DISPENSER	818	4.2	7.4	9.9	
CBU-49A/B DISPENSER	823	4.2	7.4	9.9	
CBU-49B/B, -52A/B, DISPENSERS	839	4.6	7.4	9.9	
CBU-52B/B DISPENSER	785	4.6	7.4	9.9	
CBU-58/B, -71/B DISPENSER	800	4.6	7.4	9.9	
COMBAT DOCUMENTATION CAMERAS	16	3.7 (PAIR)	N/A	N/A	
GBU-8/B (MK-84 EO GUIDED BOMB)	2265	4.8	39.5	N/A	
GBU-9/B (M118 EO GUIDED BOMB)	3450	8.0	N/E	N/A	
GBU-10/B, A/B, B/B, C/B (MK84 LASER GUIDED BOMB)	2052	6.3	26.2	N/A	
GBU-11/B (M118 LASER GUIDED BOMB)	3065	8.2	54.0	N/A	
GBU-12B, B/B (MK82 LASER GUIDED BOMB)	HIGH SPEED FIN LOW SPEED FIN	2.3	9.4	12.5	
		3.1			
LAU-3/A ROCKET POD	WITH NOSE AND TAIL CONE	427	4.1	10.1	13.5
	WITHOUT NOSE AND TAIL CONE (EMPTY)	71	5.8	10.1	13.5
LAU-68A/A LAU-68B/A ROCKET PODS	WITH NOSE AND TAIL CONE	211	1.6	3.9	5.2
	WITH NOSE AND WITHOUT TAIL CONE	209	2.1	3.9	5.2
	WITHOUT NOSE AND TAIL CONE (FULL)	207	5.4	3.9	5.2
	WITHOUT NOSE AND TAIL CONE (EMPTY)	67	2.5	3.9	5.2

N/A - NOT APPLICABLE

F - FULL

N/E - NOT ESTABLISHED

E - EMPTY

Figure A1-1 (Sheet 3 of 4)

**F-4E**

STORE	WEIGHT PER STORE (POUNDS)	DRAG PER STORE	UNIT STABILITY NUMBER	
			SINGLE MOUNTED	CLUSTER MOUNTED
M36E2 INCENDIARY CLUSTER BOMB	F-975 E-880	4.7	8.4	11.2
M117 GENERAL PURPOSE BOMB WITH M131A1 FIN	820	3.0	7.5	10.0
M117 GENERAL PURPOSE BOMB WITH MAU-103A/B FIN	806	3.2	7.5	10.0
M117 (RETARDED) GENERAL PURPOSE BOMB OR M117D (DESTRUCTOR)	880	4.2	7.5	10.0
M118 GENERAL PURPOSE BOMB	3020	10.1	N/A	N/A
M129E1 LEAFLET BOMB	200	3.0	7.3	9.7
MATRA 250 KG BOMB (UNRETARDED)	FR-545 GER-523	4.4	4.2	5.5
MC-1 GAS BOMB	720	3.0	7.3	9.7
MK 20 MOD 2, 3 OR 4 ROCKEYE II	490	2.9	7.2	9.6
MK 36 MOD 0 DESTRUCTOR	560	2.4	2.8	3.7
MK 81 GENERAL PURPOSE BOMB	270	0.8	1.8	2.4
MK 82 GENERAL PURPOSE BOMB	510	1.1	2.8	3.7
MK 82 SNAKEYE 1 BOMB	550	2.4	2.8	3.7
MK 83 GENERAL PURPOSE BOMB	985	1.8	4.6	6.1
MK 84 GENERAL PURPOSE BOMB	1970	3.4	7.2	N/A
MXU-648/A CARGO PODS	F-460 E-125	3.4	14.0	N/A
NOSE GUN AMMO (639 ROUNDS PRIOR TO FIRING/AFTER FIRING)	373/169	N/A	N/A	N/A
PAVE SPIKE POD (AN/AVQ-23 (V)-2)	422	WING-2.0 FUS-1.3	N/A	N/A
RMU-8/A REEL LAUNCHER WITH TDU-22 TARGET AND TOW CABLE	1866	N/E	N/A	N/A
SUU-16/A GUN POD (50 ROUNDS AMMO)/(FULLY LOADED)	1042/1702	8.1	26.4	N/A
SUU-20/A, -20A/A PRACTICE BOMB ROCKET DISPENSER	E-240/330	F-3.1 E-3.7	12.3	N/A
SUU-21/A PRACTICE BOMB DISPENSER WITH SIX BDU-33/B,D/B	F-622 E-470	3.3	11.8	N/A
SUU-21/A PRACTICE BOMB DISPENSER WITH SIX MK 106	F-500 E-470	3.3	11.8	N/A
SUU-23/A GUN POD (50 ROUNDS AMMO)/(FULLY LOADED)	1080/1739	8.1	26.4	N/A
SUU-25A/A, -25B/A, -25C/A FLARE DISPENSER	F-367/377/480 E-161/161/284	10.0	8.0	10.6
TISEO SCOPE HOUSING (LEFT WING)	NE	5.8	N/A	N/A
TMU-28/B SPRAY TANK	F-1923 E-567	4.9	27.6	N/A

N/A - NOT APPLICABLE                      F - FULL  
 N/E - NOT ESTABLISHED                      E - EMPTY

Figure A1-1 (Sheet 4 of 4)

# AFT CG LIMITS

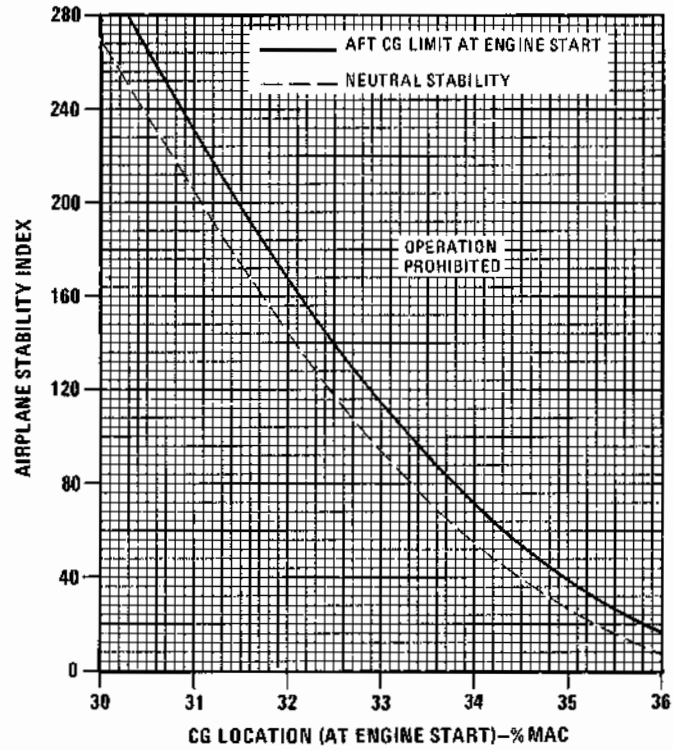

Figure A1-2

4E-1-(288) B

# F-4E DRAG DUE TO ASYMMETRIC LOADING

**REMARKS**  
ENGINE(S): (2) J79-GE-17  
ICAO STANDARD DAY

**GUIDE**

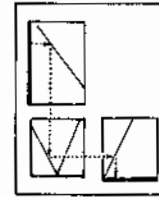

FUEL GRADE: JP-4  
FUEL DENSITY: 6.5 LB/GAL

DATE: 15 JULY 1965  
DATA BASIS: FLIGHT TEST

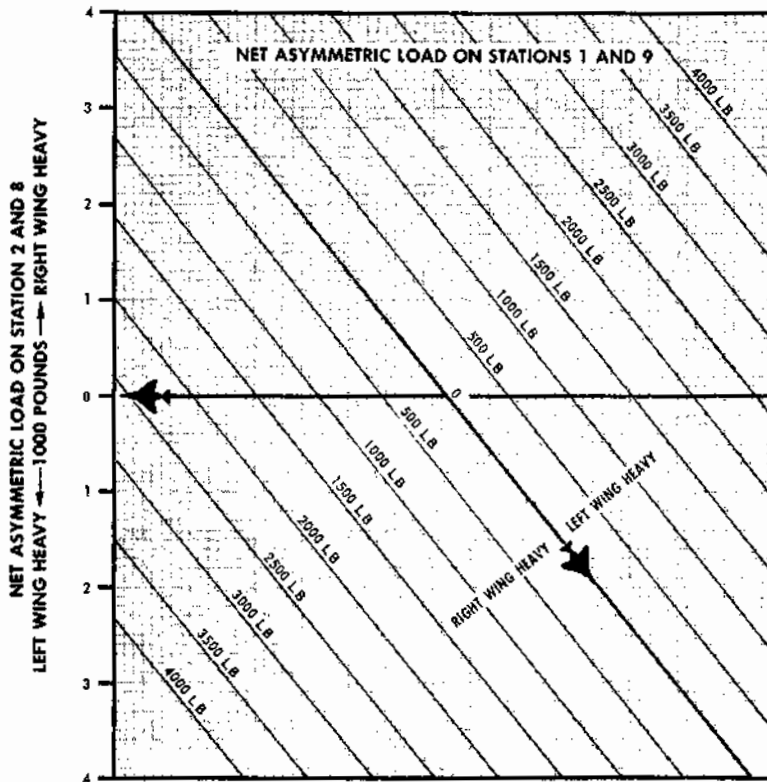

**NOTE:**

- INCREMENTAL DRAG NUMBER IS INDEPENDENT OF TOTAL AIRCRAFT GROSS WEIGHT
- INCREMENTAL DRAG NUMBER VARIES WITH MACH NUMBER AND ALTITUDE

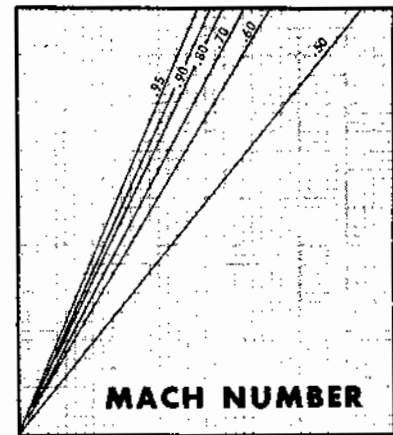
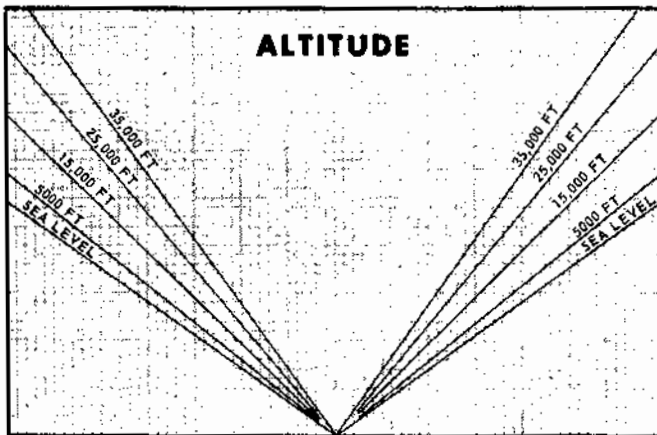

INCREMENTAL DRAG NUMBER

4E-1-(299)

Figure A1-3

# F-4E STANDARD ATMOSPHERE TABLE

STANDARD SEA LEVEL AIR:  
T=15°C.  
P=29.921 INCHES OF Hg.

W=.07651 POUNDS/CUBIC FOOT       $\rho_0=0.002378$  SLUGS/CUBIC FOOT  
1" OF Hg.=70.732 POUNDS/SQUARE FOOT=0.4912 POUND/SQUARE INCH  
 $a_0=1116$  FEET/SECOND

ALTITUDE FEET	DENSITY RATIO $\rho/\rho_0$	$\frac{1}{\sqrt{\sigma}}$	TEMPERATURE		SPEED OF SOUND RATIO $a/a_0$	PRESSURE	
			DEG. C	DEG. F		IN. OF Hg	RATIO $P/P_0$
0	1.0000	1.0000	15.000	59.000	1.000	29.92	1.0000
1000	.9710	1.0148	13.019	55.434	.987	28.85	.9844
2000	.9428	1.0299	11.038	51.868	.983	27.82	.9796
3000	.9151	1.0454	9.056	48.301	.990	26.81	.9862
4000	.8881	1.0611	7.075	44.735	.986	25.84	.9836
5000	.8616	1.0773	5.094	41.169	.983	24.89	.8320
6000	.8358	1.0938	3.113	37.603	.979	23.98	.8013
7000	.8106	1.1107	1.132	34.037	.976	23.09	.7716
8000	.7859	1.1280	-0.850	30.471	.972	22.22	.7427
9000	.7619	1.1456	-2.831	26.904	.968	21.38	.7147
10,000	.7384	1.1637	-4.812	23.338	.965	20.58	.6876
11,000	.7154	1.1822	-6.793	19.772	.962	19.79	.6614
12,000	.6931	1.2012	-8.774	16.206	.958	19.03	.6359
13,000	.6712	1.2206	-10.756	12.640	.954	18.29	.6112
14,000	.6498	1.2404	-12.737	9.074	.950	17.57	.5873
15,000	.6291	1.2608	-14.718	5.507	.947	16.88	.5642
16,000	.6088	1.2816	-16.699	1.941	.943	16.21	.5418
17,000	.5891	1.3029	-18.680	-1.625	.940	15.56	.5202
18,000	.5698	1.3247	-20.662	-5.191	.936	14.94	.4992
19,000	.5509	1.3473	-22.643	-8.757	.932	14.33	.4790
20,000	.5327	1.3701	-24.624	-12.323	.929	13.75	.4594
21,000	.5148	1.3937	-26.605	-15.890	.925	13.18	.4405
22,000	.4974	1.4179	-28.586	-19.456	.922	12.63	.4222
23,000	.4805	1.4426	-30.568	-23.022	.917	12.10	.4045
24,000	.4640	1.4681	-32.549	-26.588	.914	11.59	.3874
25,000	.4480	1.4940	-34.530	-30.154	.910	11.10	.3709
26,000	.4323	1.5209	-36.511	-33.720	.906	10.62	.3550
27,000	.4171	1.5484	-38.493	-37.287	.903	10.16	.3397
28,000	.4023	1.5768	-40.474	-40.853	.899	9.720	.3248
29,000	.3879	1.6056	-42.465	-44.419	.895	9.293	.3106
30,000	.3740	1.6352	-44.436	-47.985	.891	8.880	.2968
31,000	.3603	1.6659	-46.417	-51.551	.887	8.483	.2834
32,000	.3472	1.6971	-48.399	-55.117	.883	8.101	.2707
33,000	.3343	1.7295	-50.379	-58.684	.879	7.732	.2583
34,000	.3218	1.7628	-52.361	-62.250	.875	7.377	.2465
35,000	.3098	1.7966	-54.342	-65.816	.871	7.036	.2352
36,000	.2981	1.8315	-56.323	-69.382	.868	6.712	.2243
36,089	.2971	1.8347	-56.500	-69.700	.867	6.683	.2234
37,000	.2843	1.8753	-58.500	-69.700	.867	6.387	.2138
38,000	.2710	1.9209	-60.500	-69.700	.867	6.097	.2038
39,000	.2583	1.9677	-62.500	-69.700	.867	5.811	.1942
40,000	.2462	2.0155	-64.500	-69.700	.867	5.538	.1851
41,000	.2346	2.0645	-66.500	-69.700	.867	5.278	.1764
42,000	.2236	2.1148	-68.500	-69.700	.867	5.030	.1681
43,000	.2131	2.1662	-70.500	-69.700	.867	4.794	.1602
44,000	.2031	2.2189	-72.500	-69.700	.867	4.569	.1527
45,000	.1936	2.2728	-74.500	-69.700	.867	4.355	.1456
46,000	.1845	2.3281	-76.500	-69.700	.867	4.151	.1387
47,000	.1758	2.3848	-78.500	-69.700	.867	3.956	.1322
48,000	.1676	2.4428	-80.500	-69.700	.867	3.770	.1260
49,000	.1597	2.5022	-82.500	-69.700	.867	3.593	.1201
50,000	.1522	2.5630	-84.500	-69.700	.867	3.425	.1145

Figure A1-4

F-4E

# TEMPERATURE CONVERSION

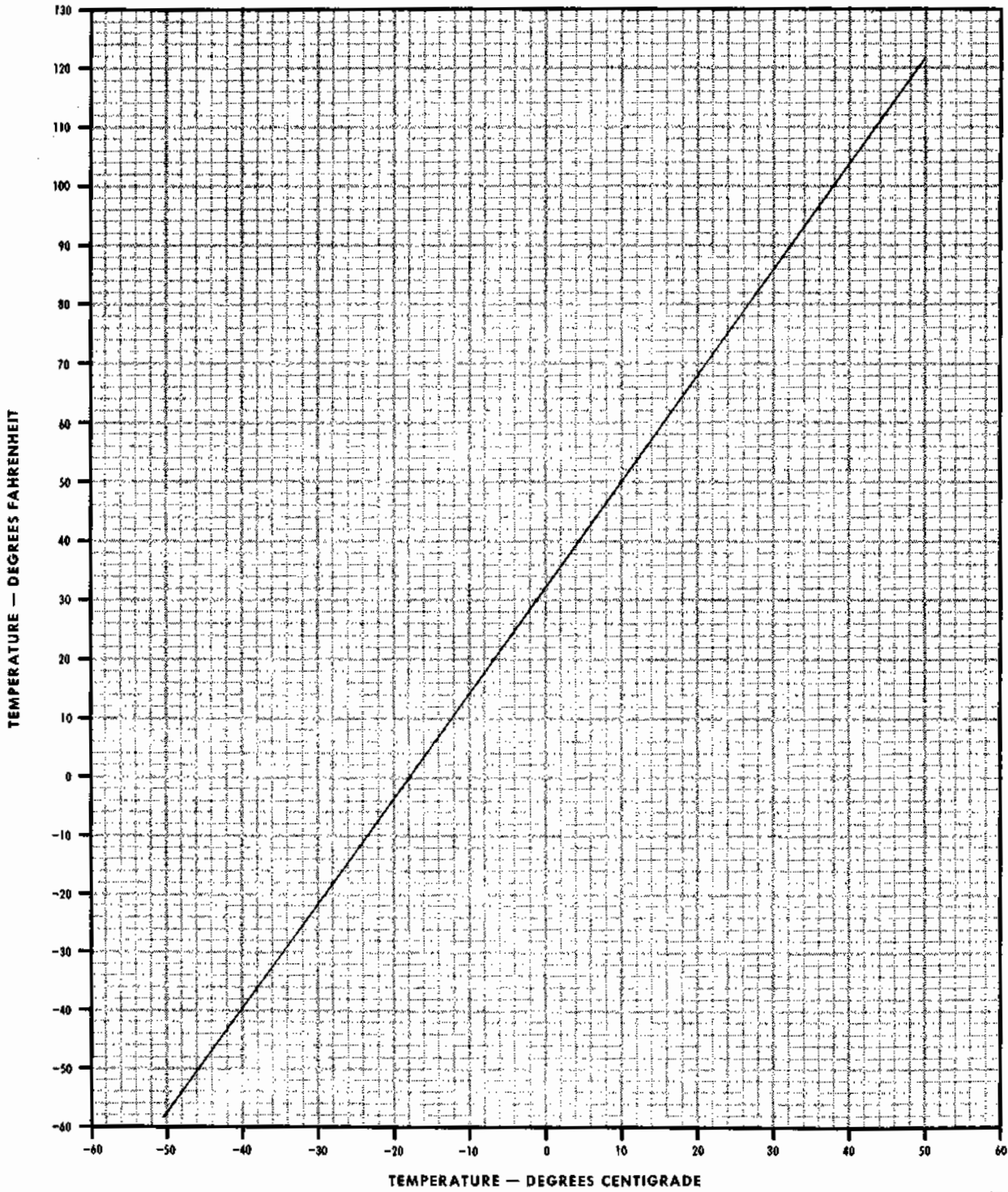

4E-1-(474)

Figure A1-5

**F-4E**

# AIRSPED CONVERSION

## LOW MACH

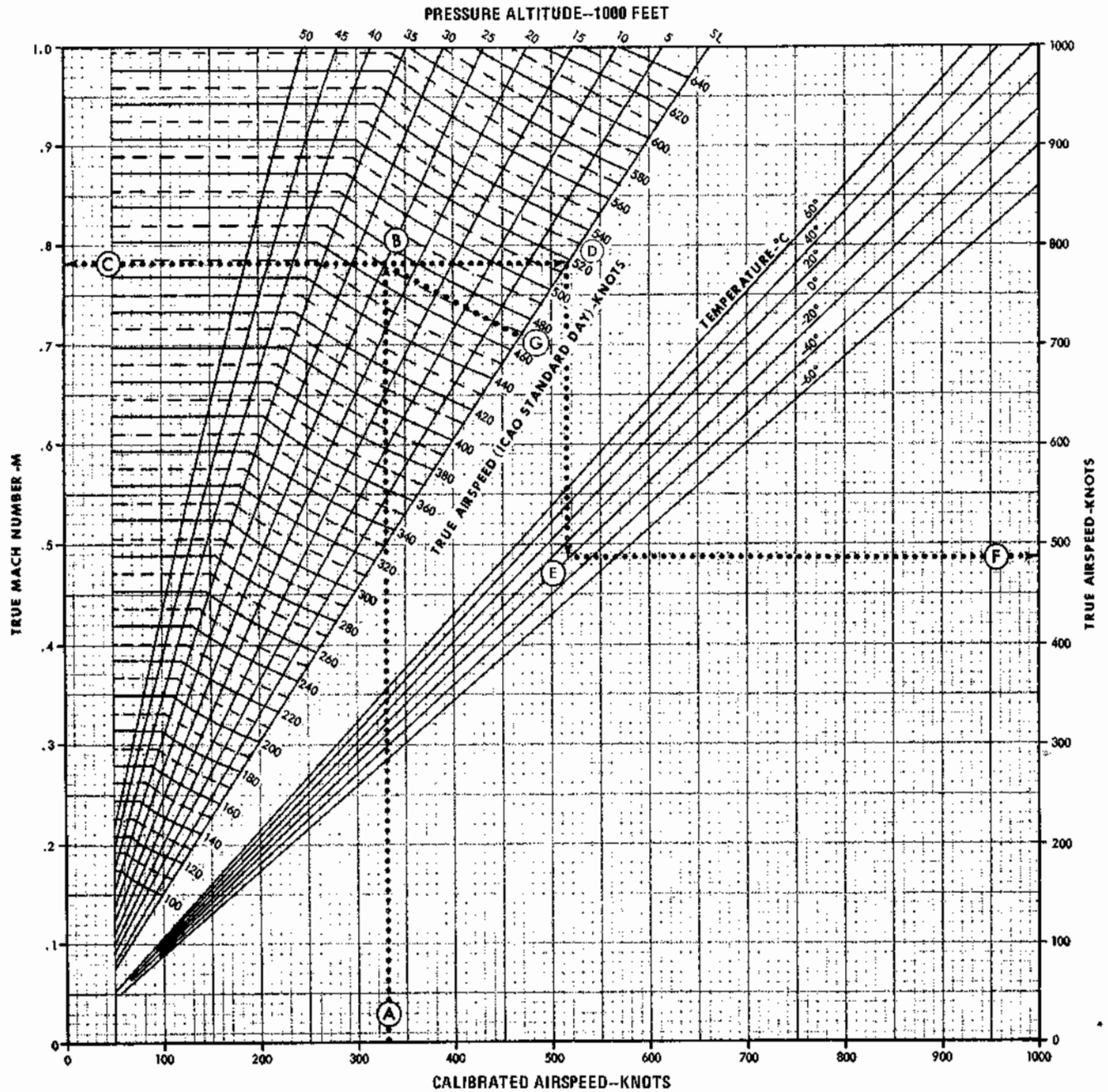

**EXAMPLE**

- A = CAS = 330 KNOTS
- B = ALTITUDE = 25,000 FEET
- C = MACH = .782
- D = SEA LEVEL LINE
- E = TEMPERATURE = -20°C
- F = TAS = 486 KNOTS
- G = TAS (STANDARD DAY) = 472 KNOTS

4E-1-(301-1)A

Figure A1-6 (Sheet 1 of 2)

F-4E

# AIRSPEED CONVERSION

## HIGH MACH

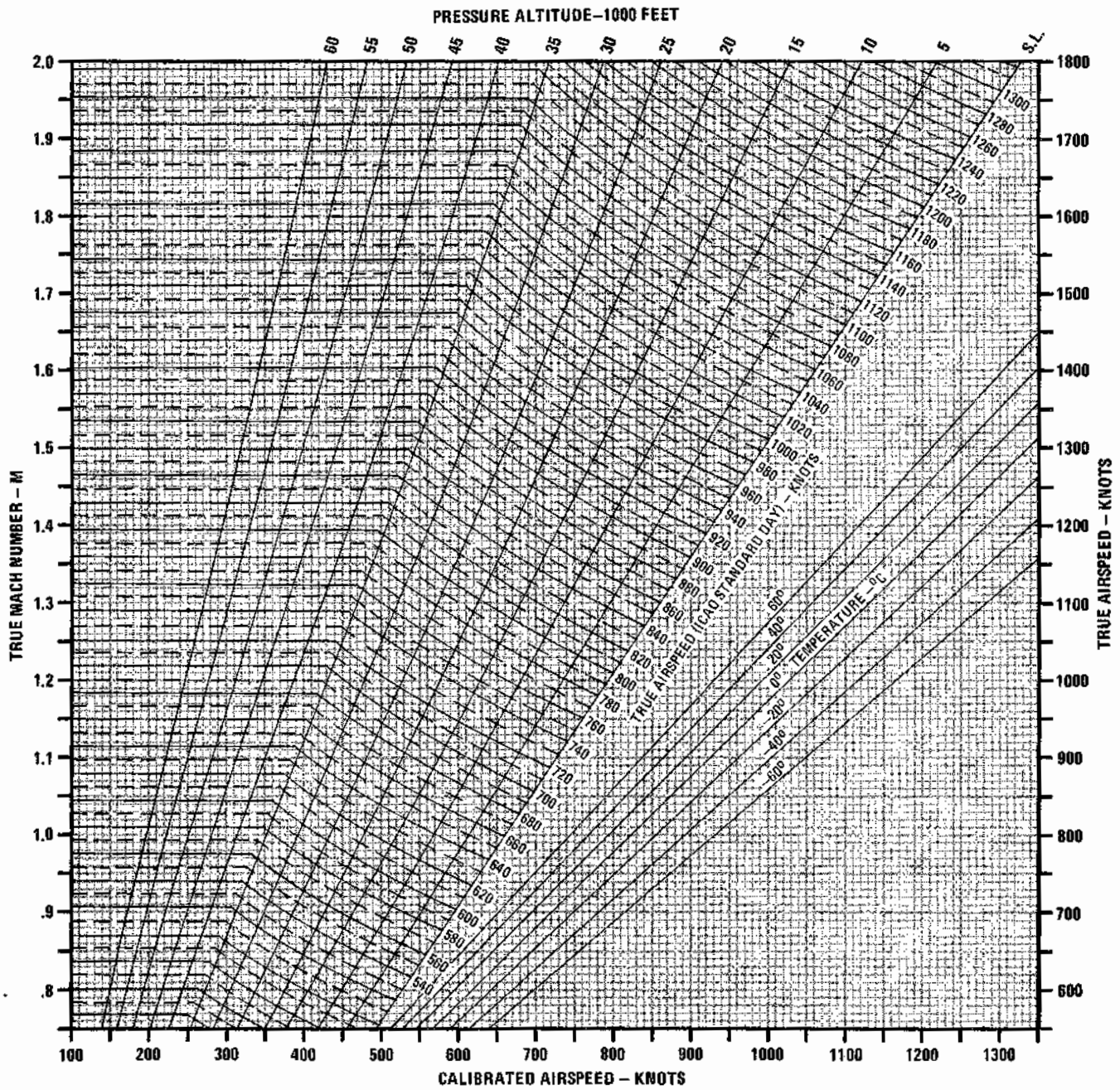

4E-1-(301-2)A

Figure A1-6 (Sheet 2 of 2)



**F-4E**

# AIRSPEED POSITION ERROR CORRECTION INDICATED AIRSPEED

AIRPLANE CONFIGURATION  
ALL DRAG INDEXES  
SLATS, FLAPS AND  
GEAR AS NOTED

REMARKS  
ENGINE(S): (2) J79-GE-17  
ICAO STANDARD DAY

GUIDE

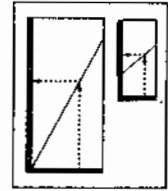

DATE: 1 AUGUST 1968  
DATA BASIS: FLIGHT TEST

FUEL GRADE: JP-4  
FUEL DENSITY: 6.5 LB/GAL

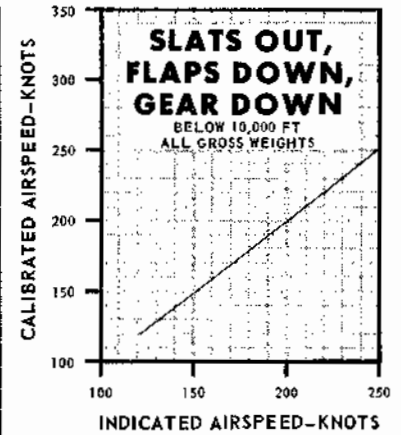
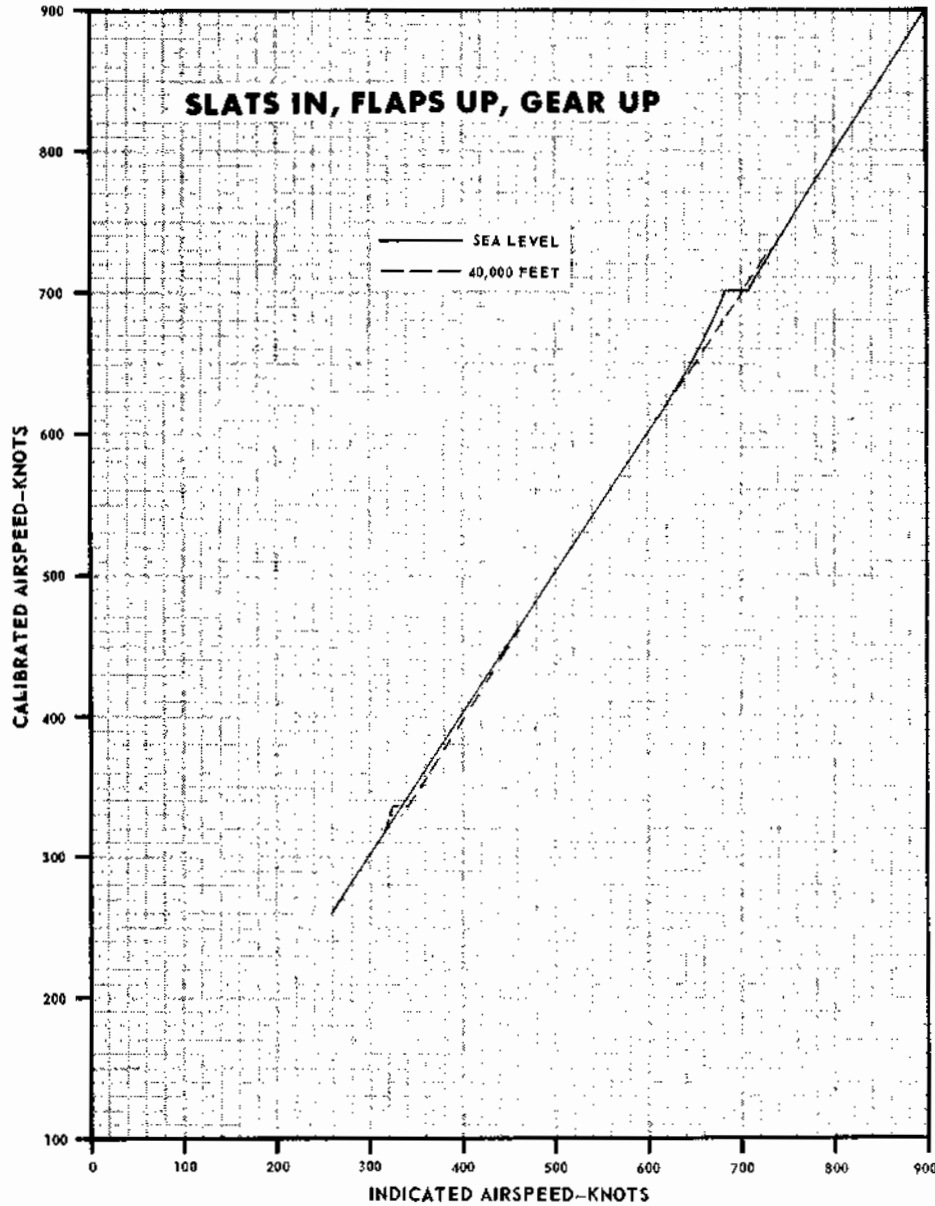

Figure A1-7

**F-4E**

# AIRSPEED POSITION ERROR CORRECTION MACH NUMBER

AIRPLANE CONFIGURATION  
ALL DRAG INDEXES  
SLATS IN, FLAPS UP  
GEAR UP

REMARKS  
ENGINE(S): (2) J79-17  
ICAO STANDARD DAY

GUIDE

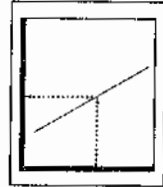

DATE: 1 AUGUST 1968  
DATA BASIS: FLIGHT TEST

FUEL GRADE: JP-4  
FUEL DENSITY: 6.5 LB/GAL

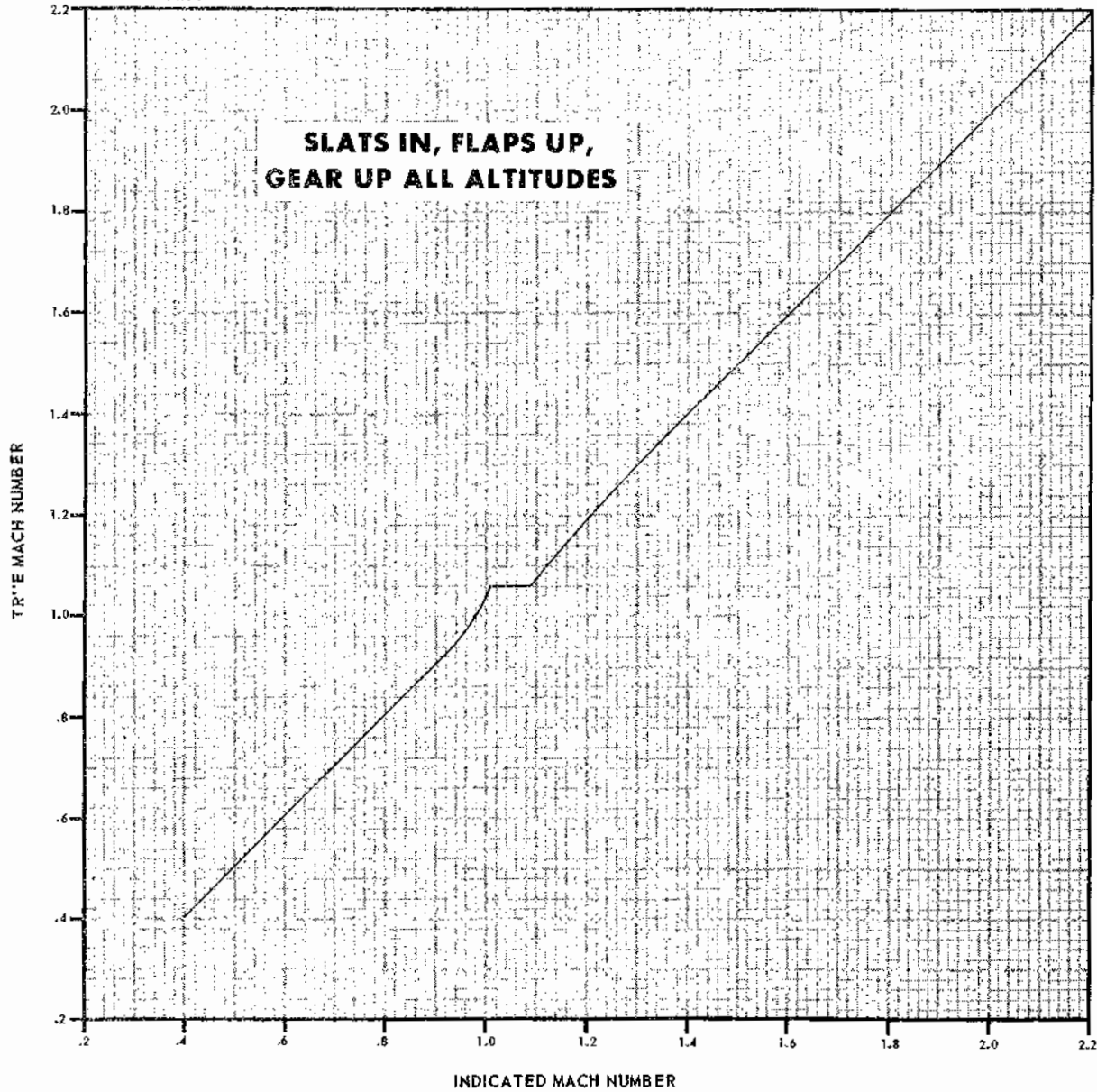

Figure A1-8

**F-4E**

# ALTIMETER POSITION ERROR CORRECTION

**AIRPLANE CONFIGURATION**  
 ALL DRAG INDEXES  
 SLATS, FLAPS AND  
 GEAR AS NOTED

**REMARKS**

ENGINE(S): (2) J79-GE-17  
 ICAO STANDARD DAY

**NOTE**  
 FLYASSIGNED ALTITUDE +  $\Delta H$

**GUIDE**

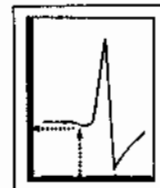

FUEL GRADE: JP-4  
 FUEL DENSITY: 6.5 LB/GAL

DATE: 1 AUGUST 1968  
 DATA BASIS: FLIGHT TEST

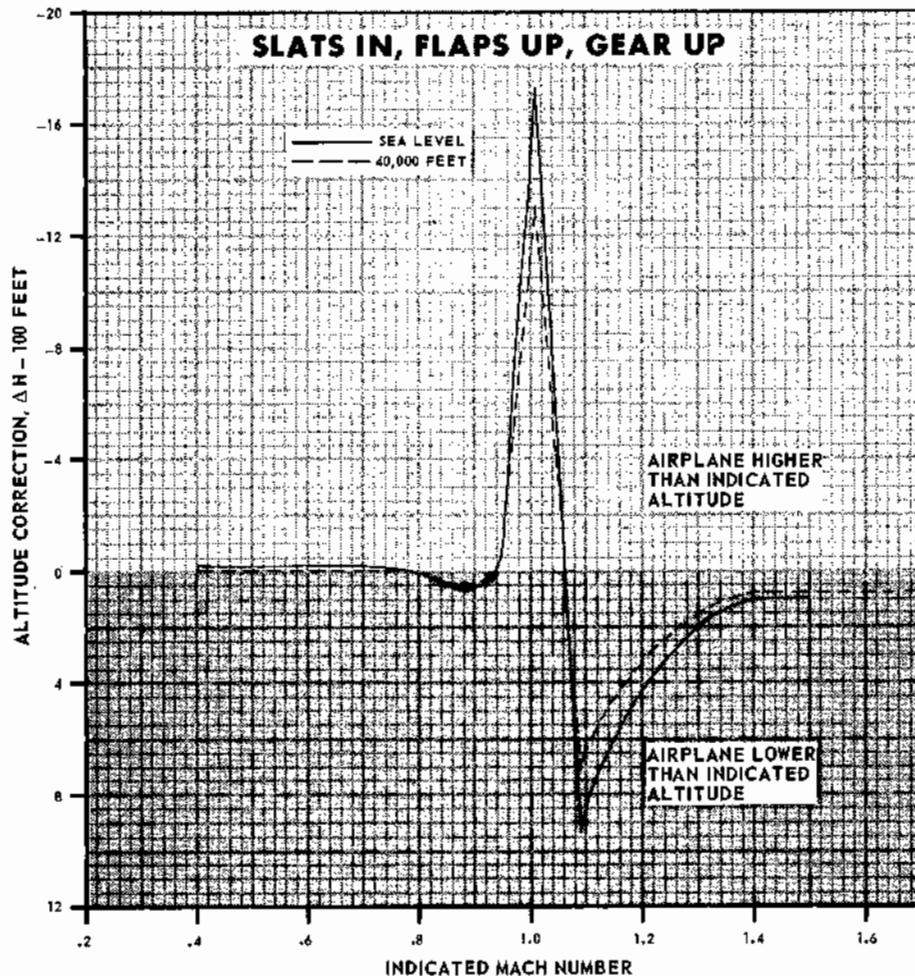

**SLATS OUT,  
 FLAPS DOWN,  
 GEAR DOWN**

BELOW 10,000 FEET  
 ALL GROSS WEIGHTS:  
 ADD 25 FEET TO ASSIGNED  
 ALTITUDE TO OBTAIN  
 INDICATED ALTITUDE.

Figure A1-9

# F-4E ALTIMETER LAG

AIRPLANE CONFIGURATION  
ALL DRAG INDEXES

REMARKS  
ENGINE(S): (2) J79-GE-17

GUIDE

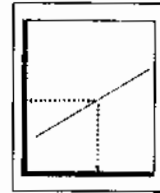

## AIRCRAFT WITH SPC OPERATIVE

DATE: 15 DECEMBER 1968  
DATA BASIS: FLIGHT TEST

FUEL GRADE: JP-4  
FUEL DENSITY: 6.5 LB/GAL

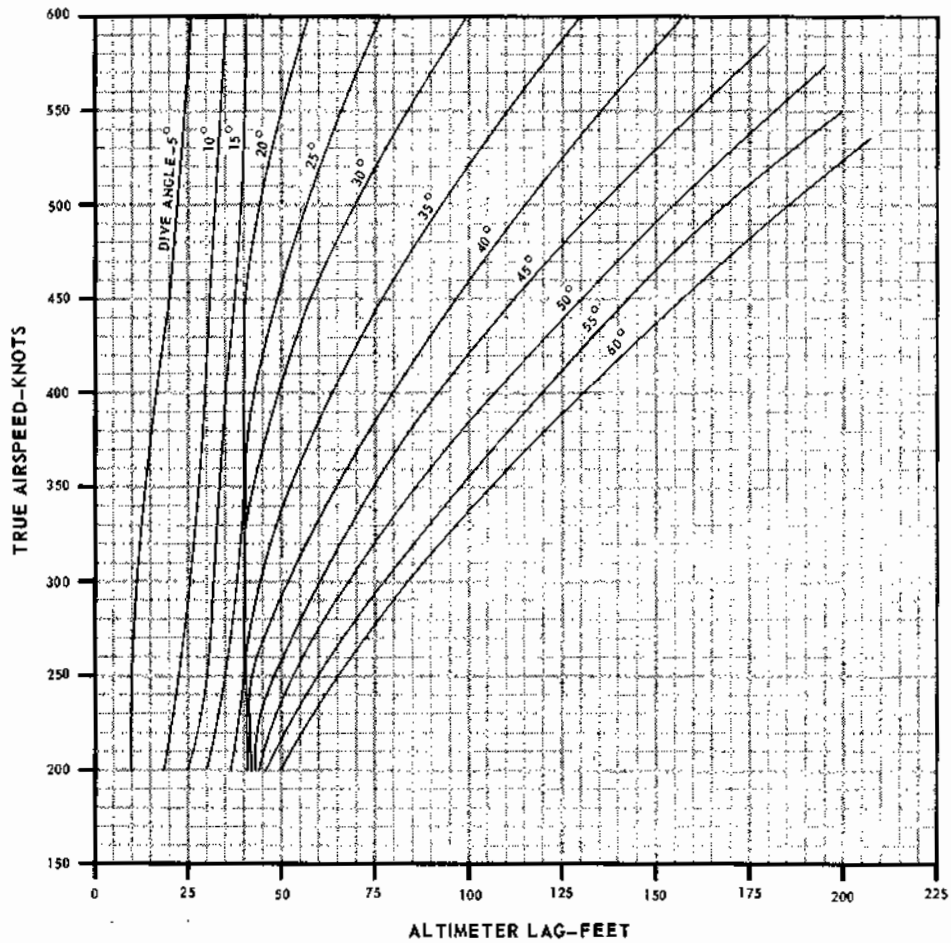

Figure A1-10

**F-4E**

# ALTIMETER LAG

**AIRPLANE CONFIGURATION**  
ALL DRAG INDEXES

**REMARKS**  
ENGINE(S): (2)J79-GE-17

GUIDE

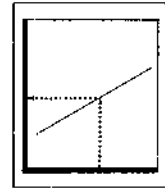

## AIRCRAFT WITH SPC INOPERATIVE

DATE: 15 DECEMBER 1968  
DATA BASIS: FLIGHT TEST

FUEL GRADE: JP-4  
FUEL DENSITY: 6.5 LB/GAL

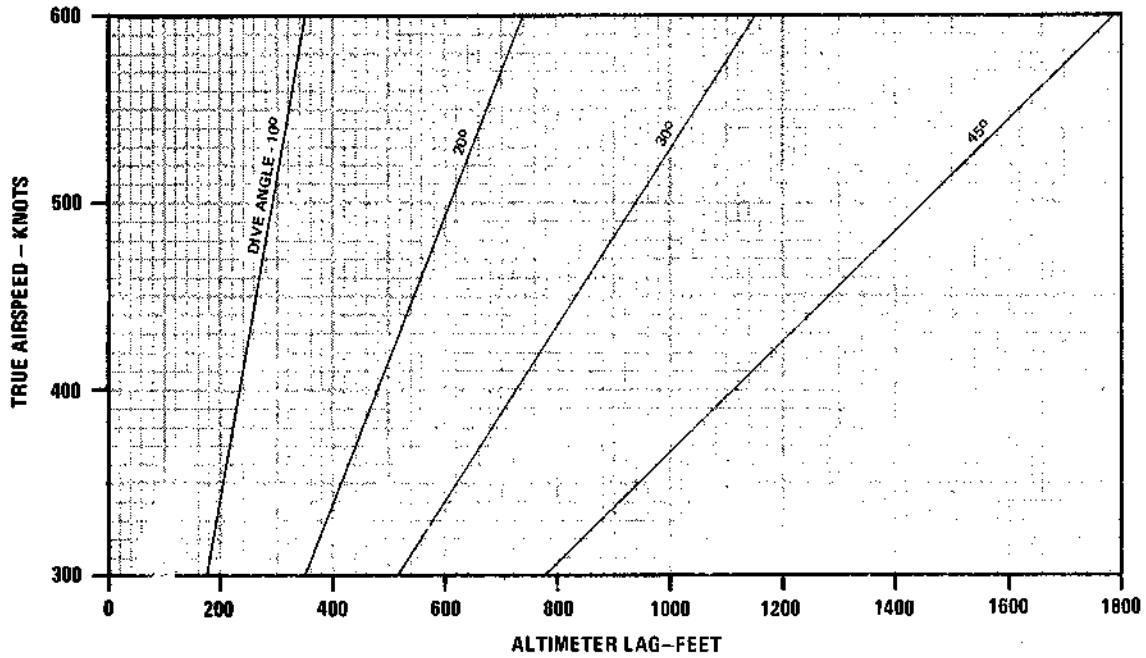

Figure A1-11

F-4E

# WIND COMPONENTS

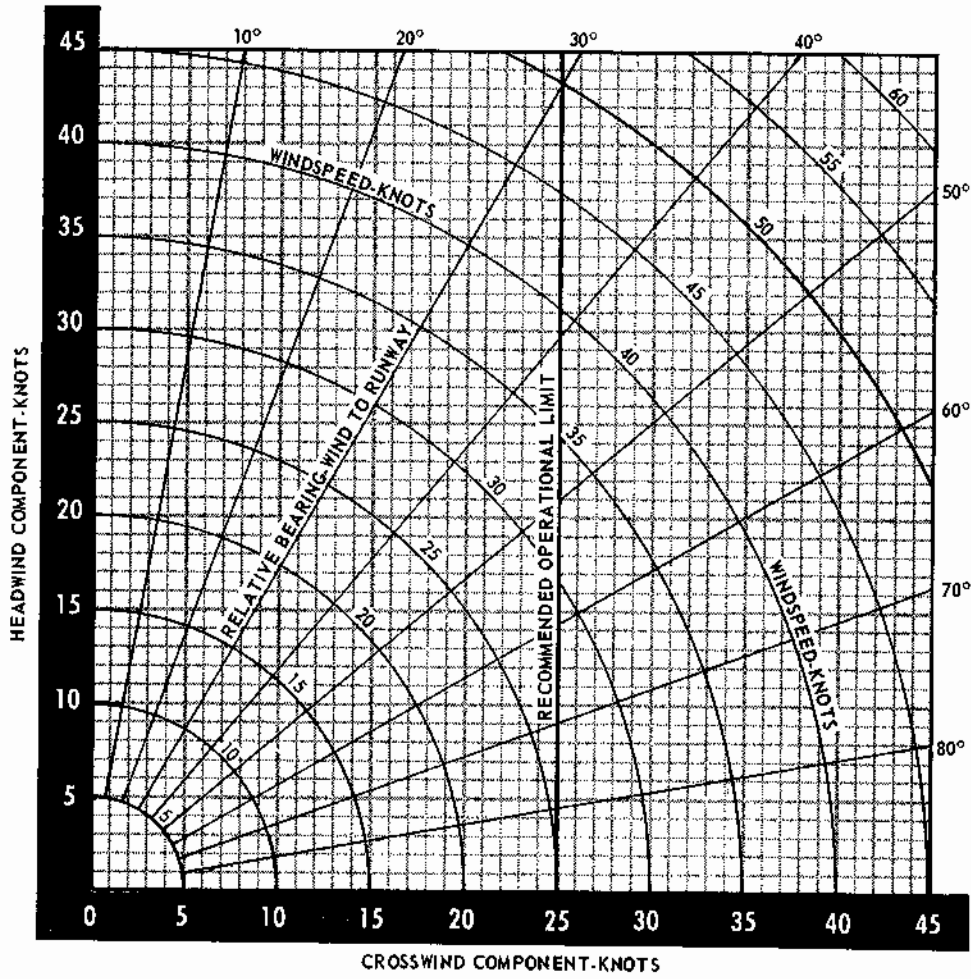

Figure A1-12

# PART 2

## TAKEOFF

### TABLE OF CONTENTS

#### Charts

Density Ratio.....	A2-6
Minimum Go Speed.....	A2-7
Maximum Abort Speed.....	A2-8
Takeoff Distance.....	A2-10
Velocity During Takeoff Ground Run and CG Correction.....	A2-12

### DENSITY RATIO CHART

This chart (figure A2-1) provides a means of obtaining a single factor (density ratio) that may be used to represent a combination of temperature and pressure altitude. Density ratio must be determined before the takeoff data charts can be utilized.

#### USE

Enter the chart with existing temperature, and project vertically to intersect the applicable pressure altitude curve. From this point, project horizontally to the left scale to read density ratio.

#### Sample Problem

A. Temperature	60°F
B. Pressure Altitude	2000 Ft
C. Density ratio	0.93

#### SAMPLE DENSITY RATIO

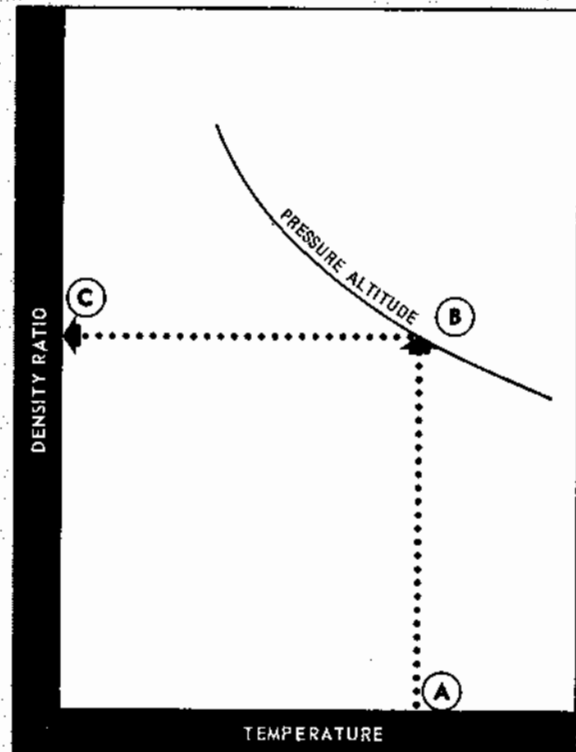

4E-1--(308)

## MINIMUM GO SPEED CHART

This chart (figure A2-2) provides the means of determining the minimum speed at which the aircraft can experience an engine failure and still take off under existing conditions of temperature, pressure altitude, gross weight, and the runway length remaining. Separate plots are provided for maximum and military thrust conditions. The data is based on an engine failure occurring at the minimum go speed and allows for a 3-second decision period with one engine operating at its initial thrust setting. In the case of a military thrust takeoff, an additional 3-second period is allowed for advancing the operating engine throttle to maximum thrust.

### WARNING

Under heavy gross weight/high temperature and/or low RCR factors, it is possible to have a minimum go speed that is higher than the maximum abort speed. Under these conditions, if an engine is lost above the maximum abort speed but below the minimum go speed, the pilot can neither abort nor take off safely on the runway length remaining without considering such factors as reducing gross weight or engaging the overrun end arrestment cable. Refer to Engine Failure During Takeoff, section III.

### USE

Enter the applicable plot with the prevailing density ratio, and project horizontally to the available runway length grid line. Parallel the nearest guideline up or down to intersect the baseline. From this point descend vertically to intersect the applicable takeoff gross weight curve, then horizontally to read minimum go speed. If this projected

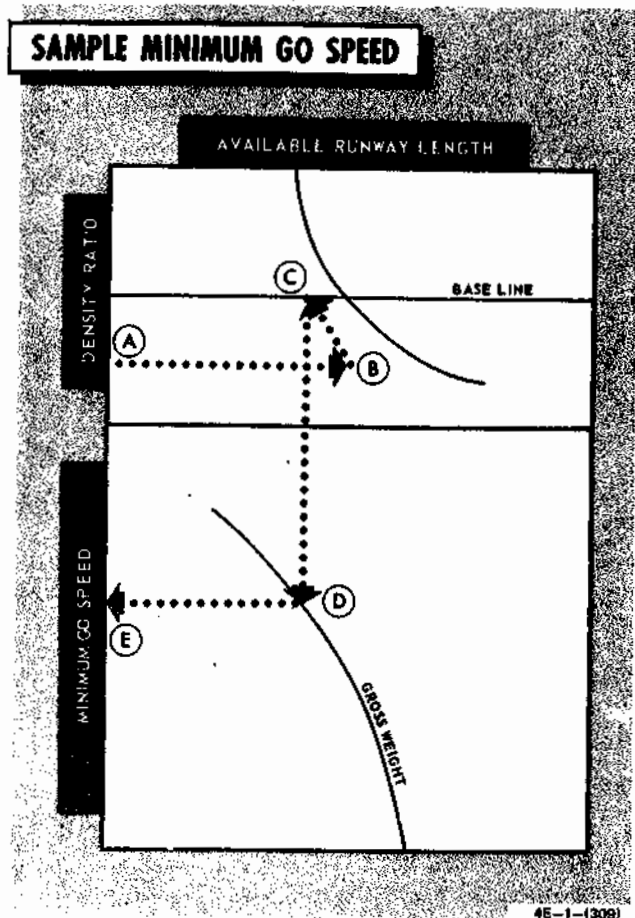



line does not intersect the computed takeoff gross weight curve, then there will be no corresponding minimum go speed. If the gross weight curve lies to the right of the projected line, a single engine takeoff cannot be made under the combined conditions.

### Sample Problem

#### Military Thrust Takeoff

A. Density ratio	0.95
B. Available runway length	6800 Ft
C. Parallel guideline to baseline	
D. Takeoff gross weight	52,000 Lb
E. Minimum go speed	128 KIAS

#### NOTE

This problem assumes maximum thrust on operating engine within 6 seconds after engine failure.

## MAXIMUM ABORT SPEED CHARTS

#### NOTE

The maximum abort speed charts do not include the capability of any arrestment gear which may be installed, and take into account only aircraft stopping performance for the given field conditions.

These charts (figures A2-3 and A2-4) provide a means of determining the maximum speed at which an abort may be started and the aircraft stopped within the remaining runway length. Separate charts are provided for maximum and military thrust and each chart has separate plots to relate drag chute effects. Allowances included in this data are based on a 3-second decision period (with both engines operating at the initial thrust setting) and a 5-second period to accomplish abort procedures.

#### USE

Enter applicable plot with the prevailing density ratio, and project horizontally to intersect the available runway length curve. From this point descend vertically to the runway condition baseline, and parallel nearest guideline down to the forecast runway condition. From this point, descend further to intersect the computed takeoff gross weight, then horizontally to read the corresponding maximum abort speed.

### Sample Problem

Maximum Thrust Takeoff, Without Drag Chute

## SAMPLE MAXIMUM ABORT SPEED

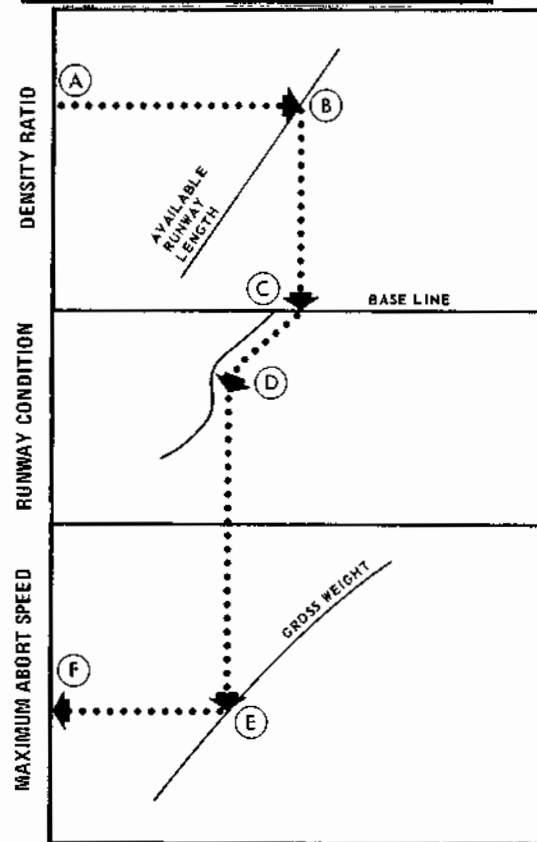

4E-1-(310)A

A. Density ratio	1.0
B. Available runway length	10,000 Ft
C. Runway condition baseline	
D. Runway condition	Wet
E. Gross weight	50,000 Lb
F. Maximum abort speed	65 Kt

## TAKEOFF DISTANCE CHARTS

These charts (figures A2-5 and A2-6) are used to determine the no wind ground run distance for a CG location of 33% MAC, wind adjusted ground run and the total distance required to clear a 50-foot obstacle. Separate charts are provided for maximum and military thrust. A table has been provided to show nosewheel lift-off speed with the corresponding aircraft takeoff speed for various gross weight and CG combinations.

#### USE

Enter the chart with the applicable density ratio, and proceed horizontally to the right and intersect the takeoff weight line. Then descend vertically to read no wind ground run distance. Parallel the appropriate wind guideline (headwind or tailwind) to intersect the takeoff wind velocity. From this point project vertically down to read the ground run adjusted for wind effects. To find the total distance required to clear a 50-foot obstacle, continue

downward to the reflector line and project horizontally to the left scale. To correct for CG locations other than 33% MAC, use Velocity During Takeoff Ground Run and CG Correction chart.

**Sample Problem**

Maximum Thrust, Takeoff CG 27% MAC

A. Density ratio	0.98
B. Gross weight	42,000 Lb
C. No wind Ground run distance	1750 Ft
D. Effective headwind	10 Kt
E. Ground run (wind corrected)	1500 Ft
F. Intersect reflector line	
G. Total distance required to clear 50-foot obstacle	2650 Ft
H. Nosewheel lift-off speed for CG of 27 MAC (from table)	131 Kt
I. Takeoff speed for a CG of 27% MAC	162 Kt
J. No wind ground run for a CG of 27% MAC	2200 Ft
K. Ground run corrected for wind and a CG of 27% MAC	2000 Ft
L. Total distance to clear a 50-foot obstacle for a CG of 27% MAC	3250 Ft

**VELOCITY DURING TAKEOFF GROUND RUN AND CG CORRECTION CHARTS**

These charts (figures A2-7 and A2-8) provide takeoff speeds for various gross weights and CG locations, and are used primarily to adjust takeoff distances resulting from adverse conditions of high gross weight and forward CG. The charts can also be used to obtain any line distance and speed relationship during takeoff ground run and to adjust the computed ground run distance for wind effects.

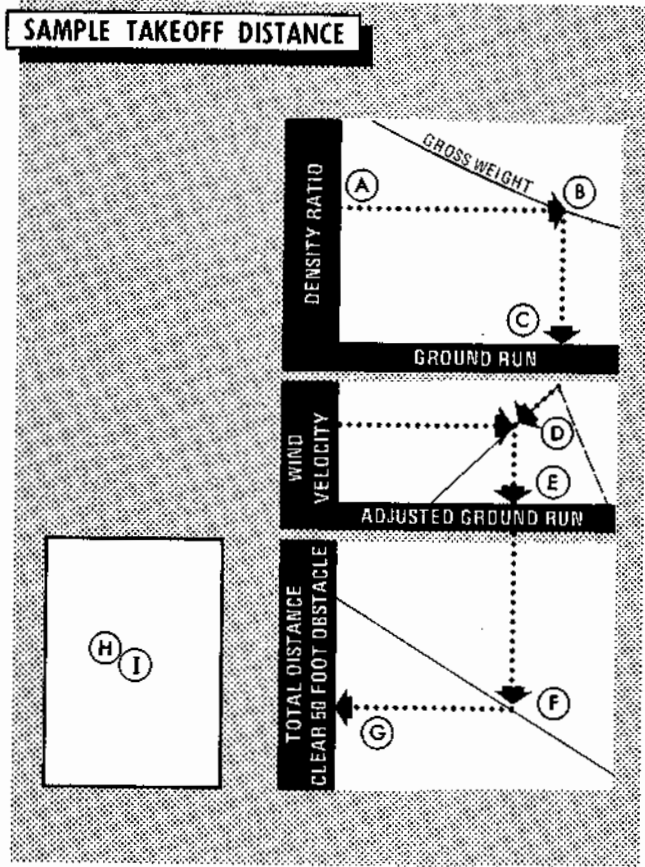

4E-1-(97)

**USE**

To find takeoff speeds for various gross weight and CG combinations, enter the upper plot with the applicable gross weight and project horizontally to the right and intersect the applicable CG line. From this point, descend vertically and read takeoff airspeed. To adjust ground run computed on Takeoff Distance charts for forward CG effects, enter the upper plot with the applicable gross weight and project horizontally to the right to intersect

the normal aircraft takeoff speed line. From this point descend vertically and read normal aircraft takeoff speed. Reenter the chart at the ground run scale with the computed normal ground run distance (from Takeoff Distance chart) and project horizontally to the left and intersect line projected vertically from normal aircraft takeoff speed scale. From this intersection, parallel nearest acceleration guideline. Reenter with the tabulated takeoff speed, and descend vertically to intersect newly plotted acceleration guideline. From this intersection, project horizontally to the right and read CG adjusted no wind ground run. Continue to the right and parallel the appropriate wind guideline to the takeoff wind velocity. From this point project horizontally to the right to read the adjusted ground run with wind effect.

**Sample Problem**

**Maximum Thrust**

A. Gross weight	42,000 Lb
B. Normal aircraft takeoff speed	148 Kt
C. Normal no wind ground run (from Takeoff Distance chart)	1750 Ft
D. Parallel acceleration guideline	
E. Tabulated takeoff speed	162 Kt
F. Adjusted no wind ground run	2100 Ft
G. Effective headwind	10 Kt
H. Adjusted ground run (wind corrected)	1850 Ft

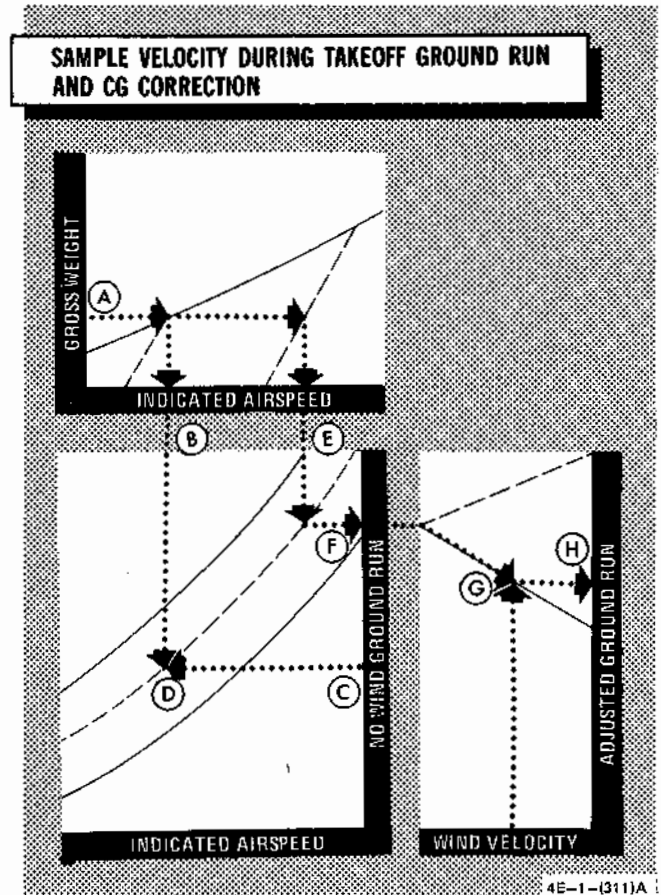

# F-4E DENSITY RATIO

AIRPLANE CONFIGURATION  
ALL DRAG INDEXES

GUIDE

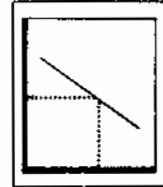

DATE: 1 NOVEMBER 1970  
DATA BASIS: FLIGHT TEST

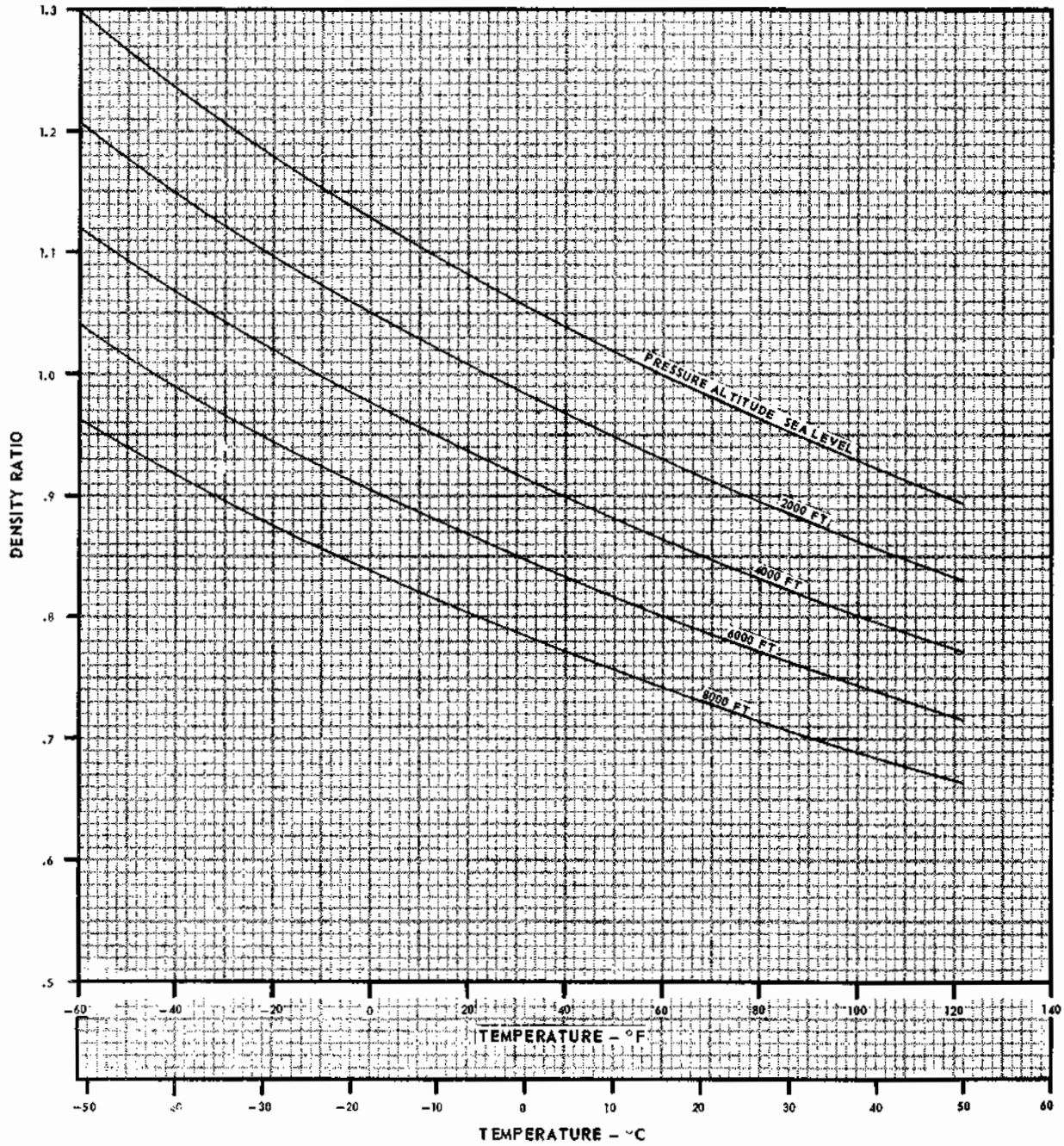

Figure A2-1

4E(1-1312)

F-4E

# MINIMUM GO SPEED (WITH SINGLE-ENGINE FAILURE)

**AIRPLANE CONFIGURATION**

ALL DRAG INDEXES  
SLATS OUT  
FLAPS DOWN

**REMARKS**

ENGINE(S): (2) J79-GE-17

**NOTE**

- SINGLE-ENGINE TAKEOFF, WITH AFTERBURNER IGNITED ON OPERATING ENGINE AFTER FAILURE DURING MILITARY THRUST TAKEOFF
- SINGLE-ENGINE TAKEOFF/CLIMB-OUT CAPABILITY IS CRITICAL WITH HIGH GROSS WEIGHT AT LOW DENSITY RATIOS.

DATE: 15 APRIL 1972  
DATA BASIS: FLIGHT TEST

**GUIDE**

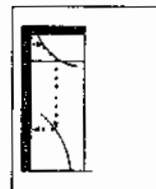

FUEL GRADE: JP-4  
FUEL DENSITY: 6.5 LB/GAL

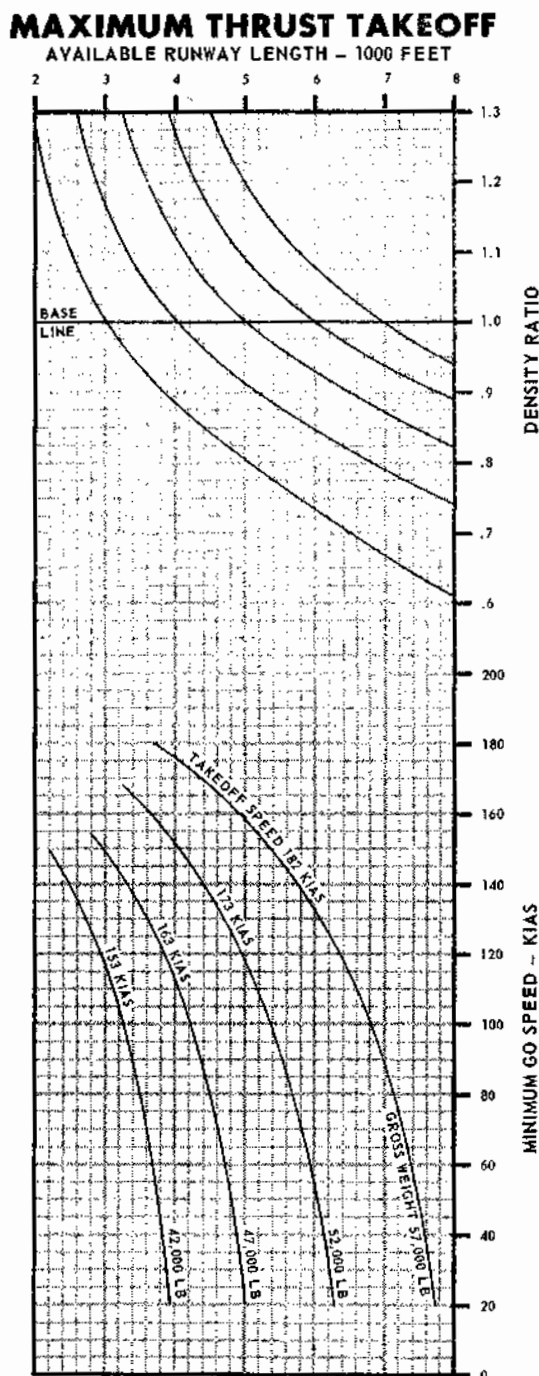
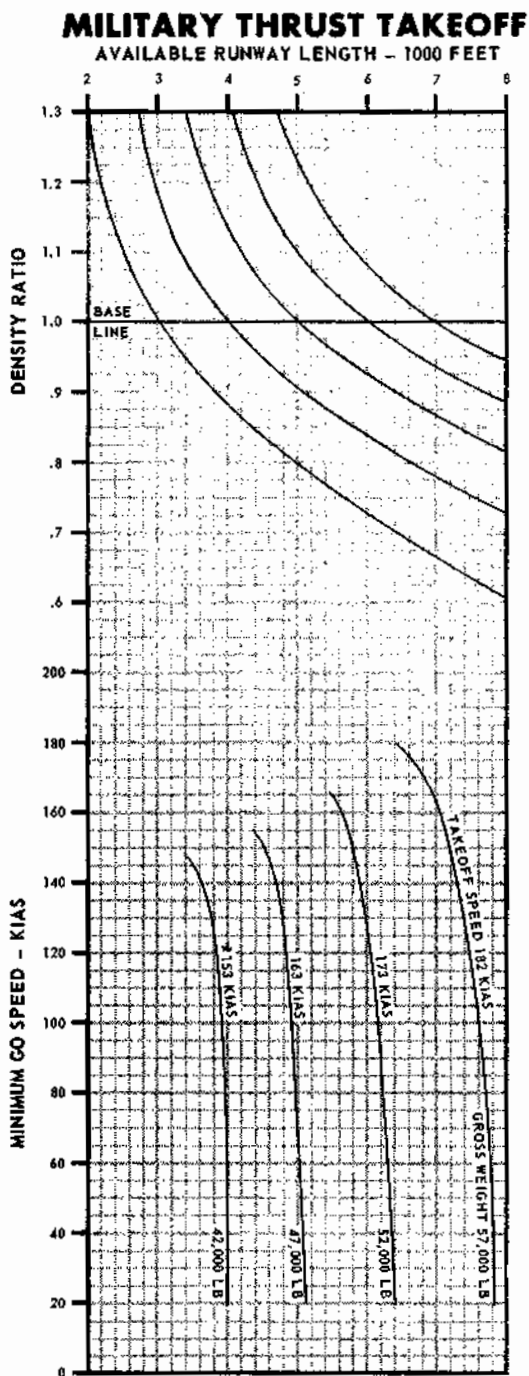

Figure A2-2

4E-1-(313)

**F-4E**

**MAXIMUM ABORT SPEED  
MAXIMUM THRUST**

**AIRPLANE CONFIGURATION**  
ALL DRAG INDEXES  
SLATS OUT  
FLAPS DOWN

REMARKS  
ENGINE(S): (2) J79-GE-17

DATE: 1 JUNE 1977  
DATA BASIS: FLIGHT TEST

GUIDE

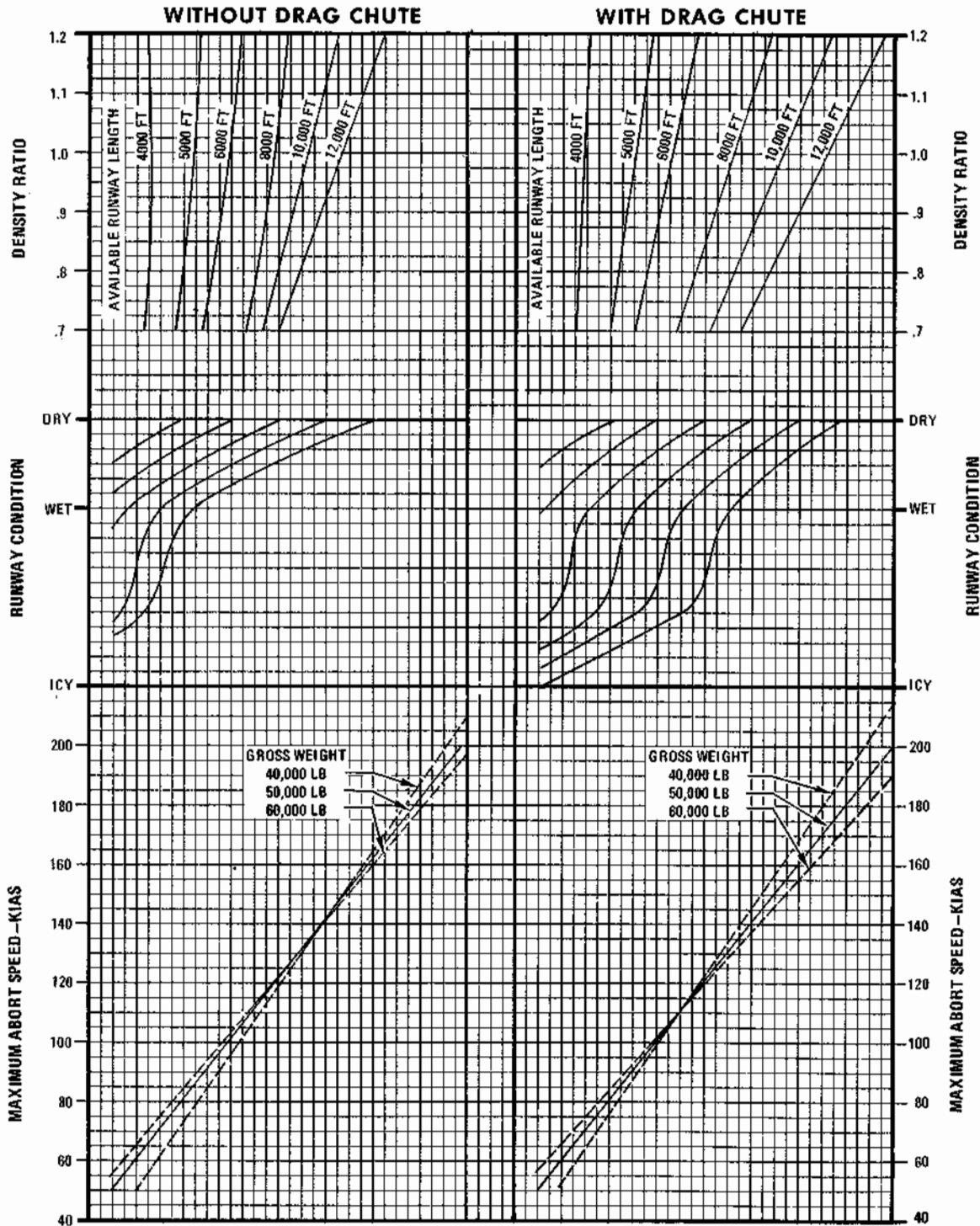
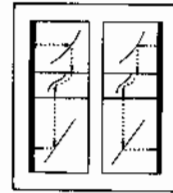

4E-1-(488) A

Figure A2-3

**F-4E**

# MAXIMUM ABORT SPEED

MILITARY THRUST

REMARKS

ENGINE(S): 12 J79-GE-17

AIRPLANE CONFIGURATION  
ALL DRAG INDEXES  
SLATS OUT  
FLAPS DOWN

DATE: 1 JUNE 1977  
DATA BASIS: FLIGHT TEST

GUIDE

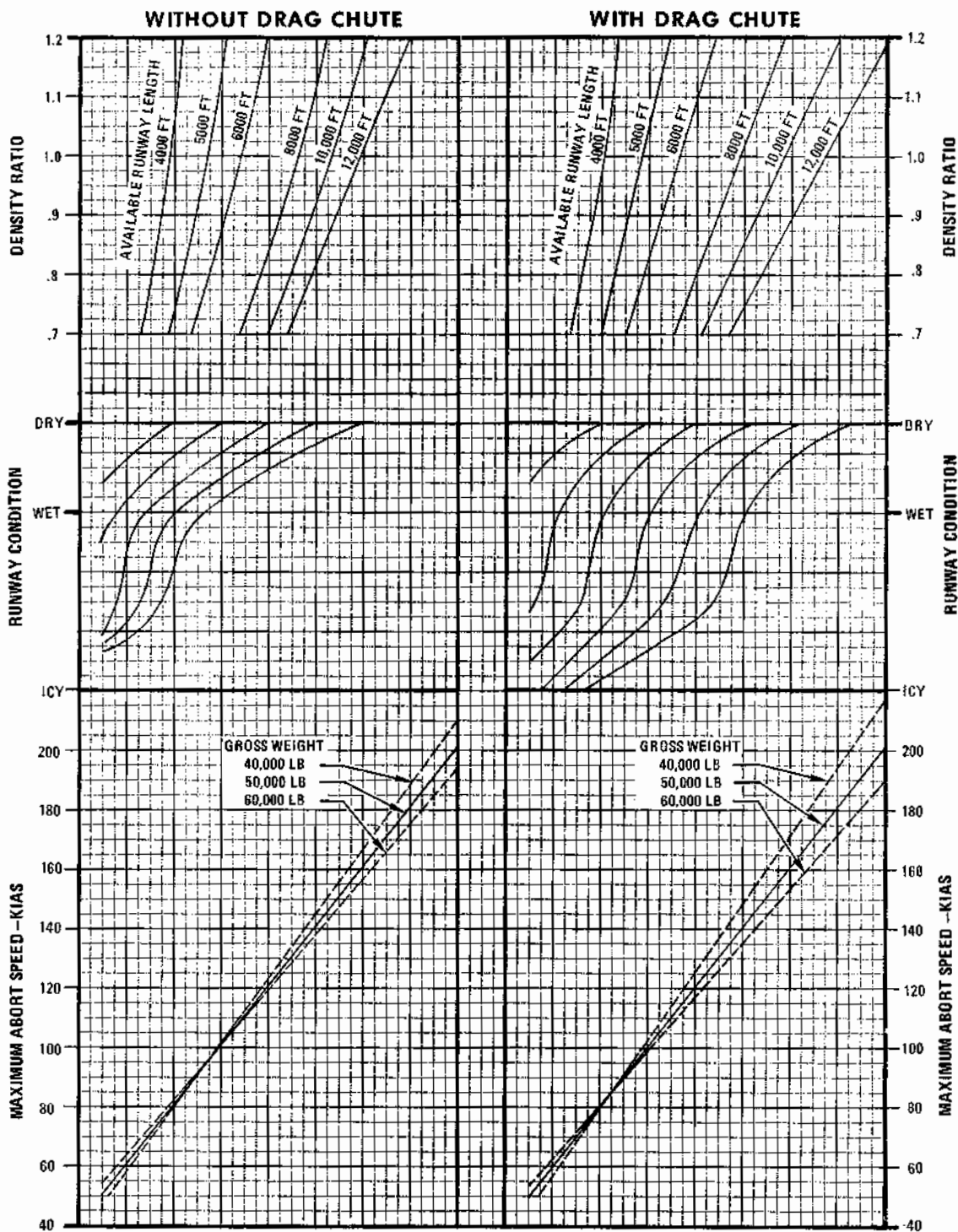
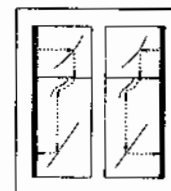

4E-1-(487) A

Figure A2-4

**F-4E**

**TAKEOFF DISTANCE  
MAXIMUM THRUST  
HARD DRY RUNWAY**

AIRPLANE CONFIGURATION  
ALL DRAG INDEXES  
SLATS OUT  
FLAPS DOWN  
GEAR DOWN

REMARKS  
ENGINE(S): (2)J79-GE-17

GUIDE

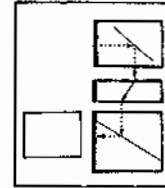

FUEL GRADE: JP-4  
FUEL DENSITY: 6.5 LB/GAL

DATE: 1 AUGUST 1973  
DATA BASIS: FLIGHT TEST

**NOTES**

- DATA IS FOR A CG LOCATION OF 33% MAC. USE VELOCITY DURING TAKEOFF GROUND RUN AND CG CORRECTION CHART TO CORRECT GROUND RUN DISTANCE FOR A CG LOCATION OTHER THAN 33% MAC.
- IF ONE AFTERBURNER FAILS TO LIGHT, TAKEOFF DISTANCE WILL BE INCREASED BY 35%.
- GROSS WEIGHTS SHOWN REFLECT LIFT-OFF VALUES.
- ENGINE START AND TAXI FUEL WEIGHTS ARE FOUND IN PART 3.
- LIFT-OFF CENTER OF GRAVITY SHALL BE CALCULATED USING WEIGHT AND BALANCE HANDBOOK, TO 1-1B-40.

CG % MAC	GROSS WEIGHT - 1000 POUNDS							
	42		47		52		57	
	NOSEWHEEL	LIFT-OFF SPEED	LIFT-OFF SPEED	LIFT-OFF SPEED	LIFT-OFF SPEED	TAKEOFF SPEED	TAKEOFF SPEED	
27	131 / 162	139 / 166	146 / 170	154 / 179				
29	125 / 157	133 / 161	140 / 170	147 / 179				
31	119 / 150	126 / 159	133 / 170	140 / 179				
33	112 / 148	120 / 159	126 / 170	133 / 179				
35	105 / 148	112 / 159	119 / 170	125 / 179				

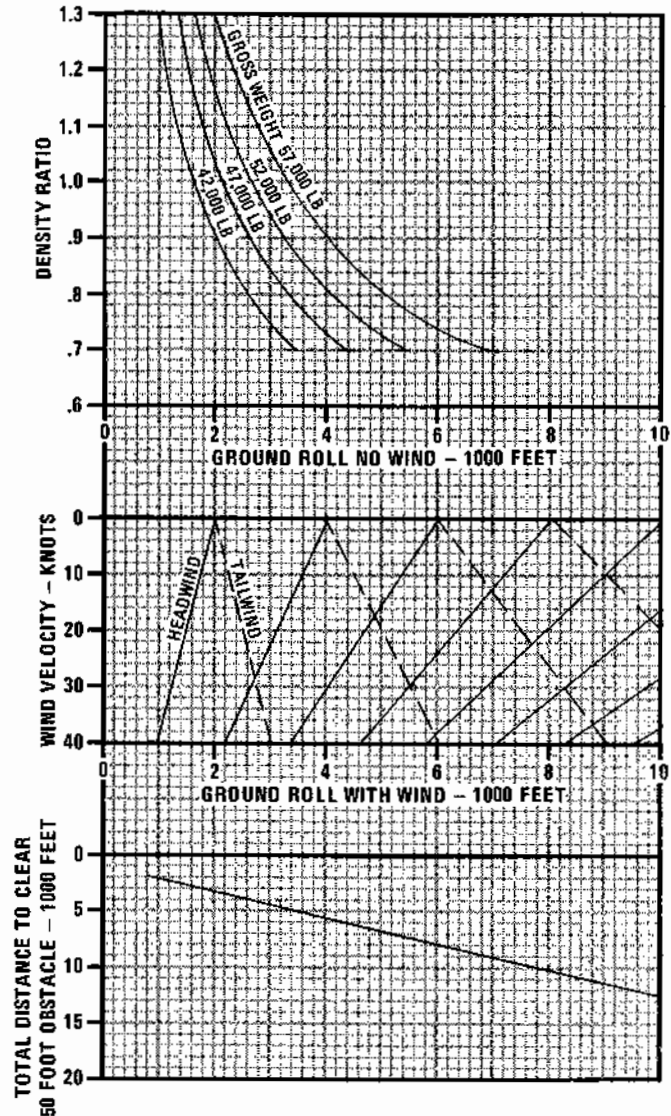

4E-1-(316)A

Figure A2-5



**F-4E**

# TAKEOFF DISTANCE

## MILITARY THRUST HARD DRY RUNWAY

**AIRPLANE CONFIGURATION**  
ALL DRAG INDEXES  
SLATS OUT  
FLAPS DOWN  
GEAR DOWN

**REMARKS:**  
ENGINE(S): (2) J79-GE-17



PISTON GRADE: 3P-4  
FUEL DENSITY: 6.8 LB/GAL

DATE: 1 AUGUST 1973  
DATA BASIS: FLIGHT TEST

**NOTES**

- DATA IS FOR A CG LOCATION OF 33% MAC. USE VELOCITY DURING TAKEOFF GROUND RUN AND CG CORRECTION CHART TO CORRECT GROUND RUN DISTANCE FOR A CG LOCATION OTHER THAN 33% MAC.
- GROSS WEIGHTS SHOWN REFLECT LIFT-OFF VALUES.
- ENGINE START AND TAXI FUEL WEIGHTS ARE FOUND IN PART 3.
- LIFT-OFF CENTER OF GRAVITY SHALL BE CALCULATED USING WEIGHT AND BALANCE HANDBOOK, TO 1-1B-40.

CG % MAC	GROSS WEIGHT - 1000 POUNDS							
	42		47		52		57	
	NOSEWHEEL	LIFT-OFF SPEED	NOSEWHEEL	LIFT-OFF SPEED	NOSEWHEEL	LIFT-OFF SPEED	NOSEWHEEL	LIFT-OFF SPEED
27	132	156	140	166	147	176	155	186
29	126	156	134	166	141	176	147	186
31	120	156	127	166	134	176	141	186
33	113	156	121	166	127	176	134	186
35	106	156	113	166	120	176	126	186

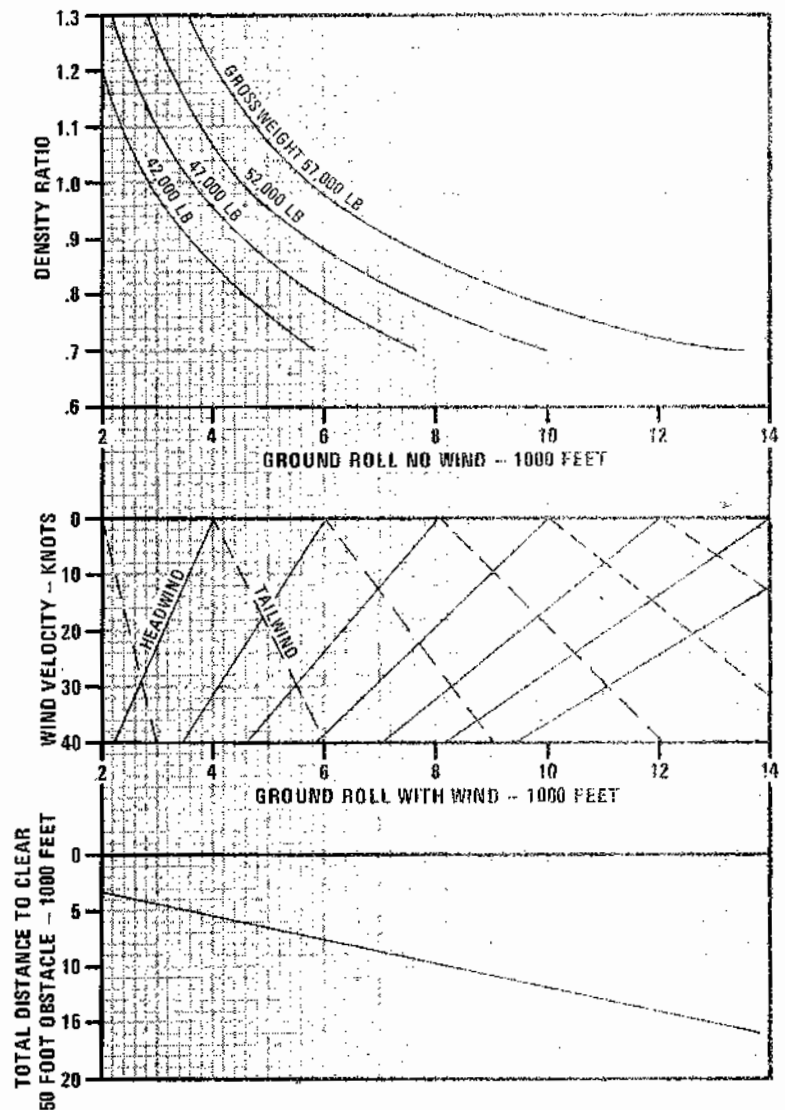

4E-1-1317B

Figure A2-6

**F-4E**

# VELOCITY DURING TAKEOFF GROUND RUN AND CG CORRECTION

**AIRPLANE CONFIGURATION**  
 ALL DRAG INDEXES  
 SLATS OUT  
 FLAPS DOWN  
 GEAR DOWN

**MAXIMUM THRUST  
 HARD DRY RUNWAY**

**REMARKS**  
 ENGINE(S): (2) J79-GE-17  
 ICAO STANDARD DAY

GUIDE

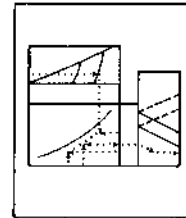

DATE: 1 AUGUST 1973  
 DATA BASIS: FLIGHT TEST

FUEL GRADE: JP-4  
 FUEL DENSITY: 6.5 LB/GAL

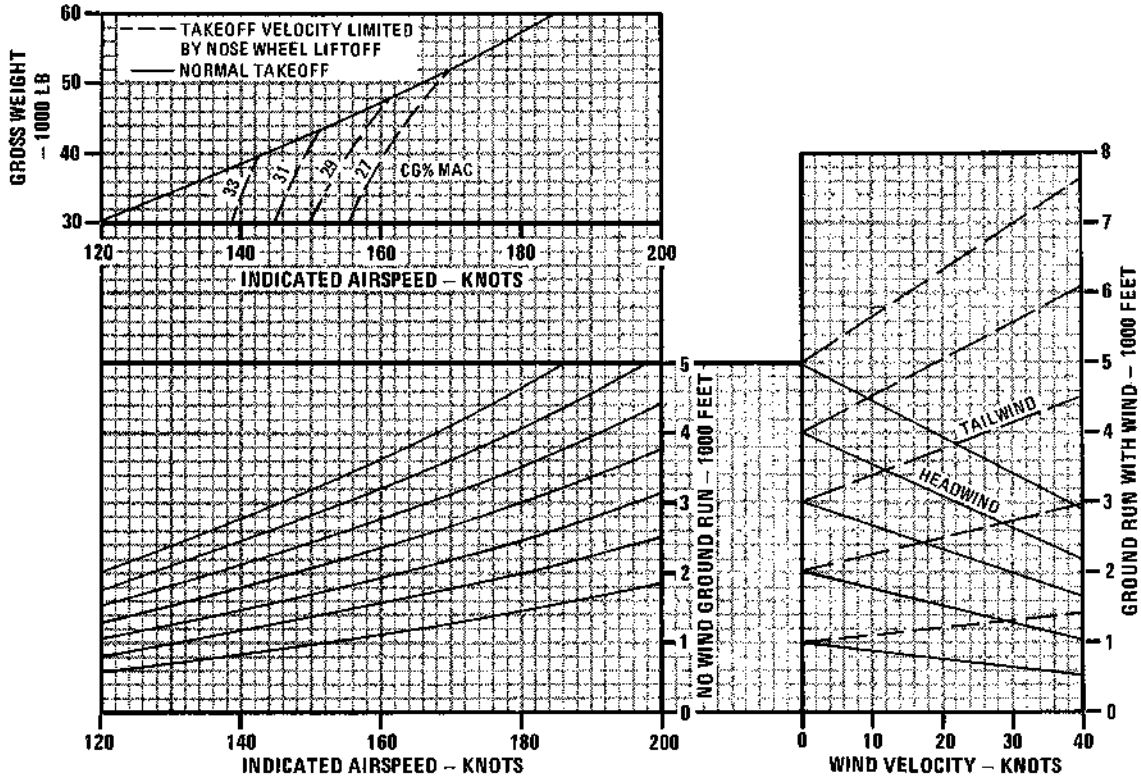

Figure A2-7

**F-4E**

# VELOCITY DURING TAKEOFF GROUND RUN AND CG CORRECTION

**AIRPLANE CONFIGURATION**

ALL DRAG INDEXES  
SLATS OUT  
FLAPS DOWN  
GEAR DOWN

**MILITARY THRUST  
HARD DRY RUNWAY**

**REMARKS**

ENGINE(S): 2 J79-GE-17  
ICOA STANDARD DAY

GUIDE

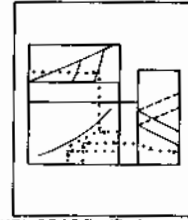

FUEL GRADE: JP-4  
FUEL DENSITY: 6.5 LB/GAL

DATE: 1 AUGUST 1973  
DATA BASIS: FLIGHT TEST

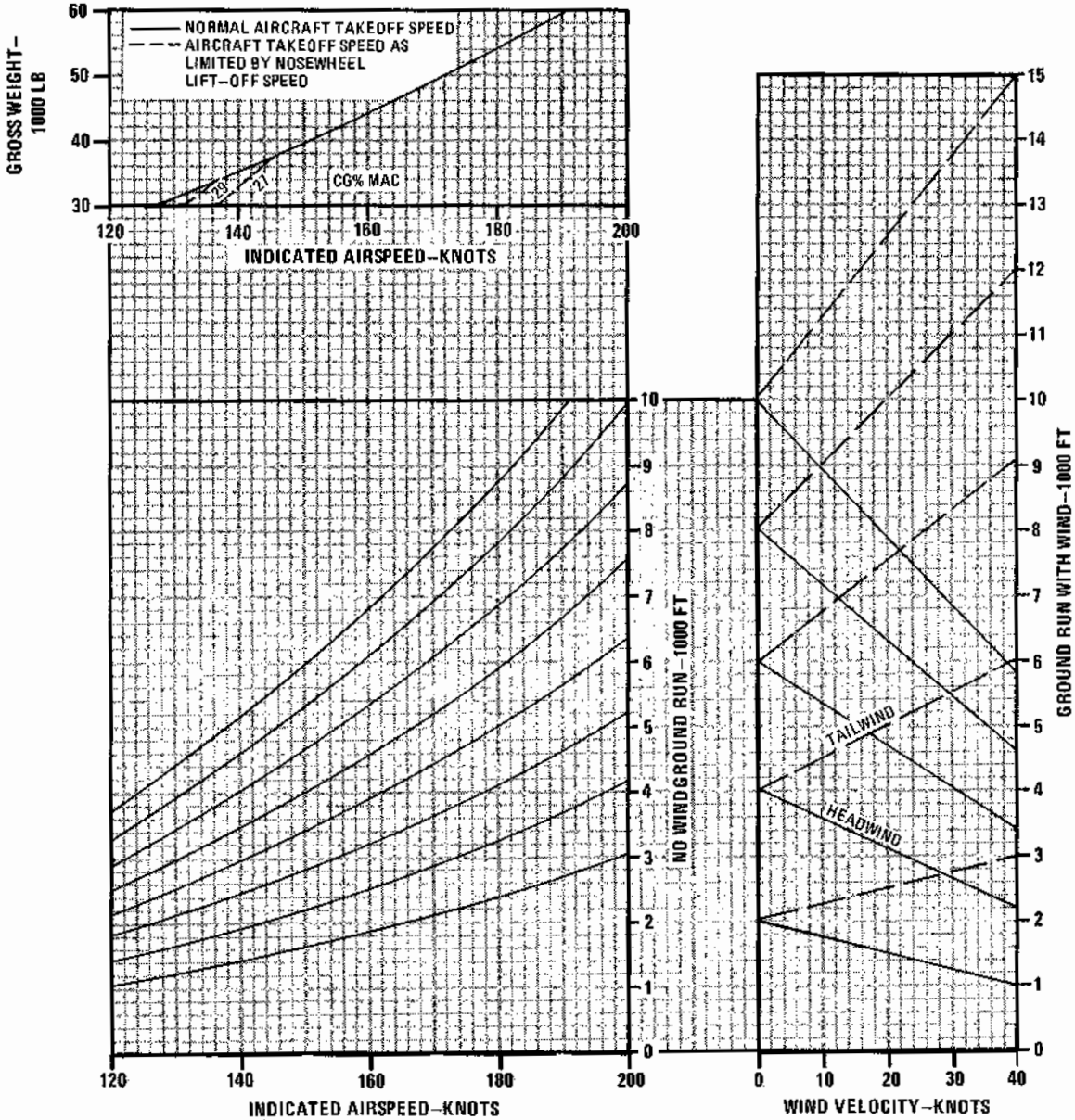

4E-1-(319)A

Figure A2-8

# PART 3 CLIMB

## TABLE OF CONTENTS

### Charts

Climb .....	A3-3
Combat Ceiling .....	A3-14

### NOTE

For aircraft with TISEO scope housing (with or without scope) on the left wing and/or combat documentation cameras installed, additional units of drag must be applied to the computed drag index. Refer to the Airplane Loading chart in part 1.

## CLIMB CHARTS

Two series of charts are presented, one for military and one for maximum thrust climb schedules (figures A3-1 and A3-2). Each series includes charts for determining time, distance covered and fuel used while in the climb, and tables for determining climb airspeed and Mach number. Pre-climb requirements are included in a table that presents time, fuel, and distance to intercept the climb schedule after takeoff. Time, fuel, and distance for a simplified military thrust climb are presented in figure A3-3. This data is based on climbing at 350 knots until interception of optimum cruise Mach/TAS, then maintaining cruise Mach to cruise altitude.

### USE

#### Tables

Enter the Climb Speed Schedule tables corresponding to the climb thrust and the computed drag index. Read the column of airspeeds and the Mach numbers to be used during climb. Determine the preclimb fuel, distance, and time to climb schedule which corresponds to the applicable takeoff and acceleration options.

#### Charts

The method of presenting data on the time, distance, and fuel charts is identical, and the use of all three charts will be undertaken simultaneously here. Enter the charts with the initial climb gross weight. Project horizontally to the right and intersect the assigned cruise altitude, or the optimum cruise altitude for the computed drag index. Project vertically downward to intersect the applicable drag index line, then project horizontally to the left to the temperature deviation baseline (corresponds to ICAO Standard day (°C)). Parallel the applicable guideline (hotter or colder) to intersect a vertical grid line corresponding to the degree of deviation between forecast

flight temperature and standard ICAO day temperature. From this point continue horizontally to the left to read the planning data.

### Sample Problem

#### Fuel Required - Military Thrust

A. Gross weight	50,000 Lb
B. Cruise altitude	30,000 Ft
C. Drag Index	60.0
D. Temperature baseline	
E. Temperature deviation	+5°C
F. Fuel required	1980 Lb
G. Time to Climb	8.3 Min
H. Distance nautical miles	62

### SAMPLE CLIMB

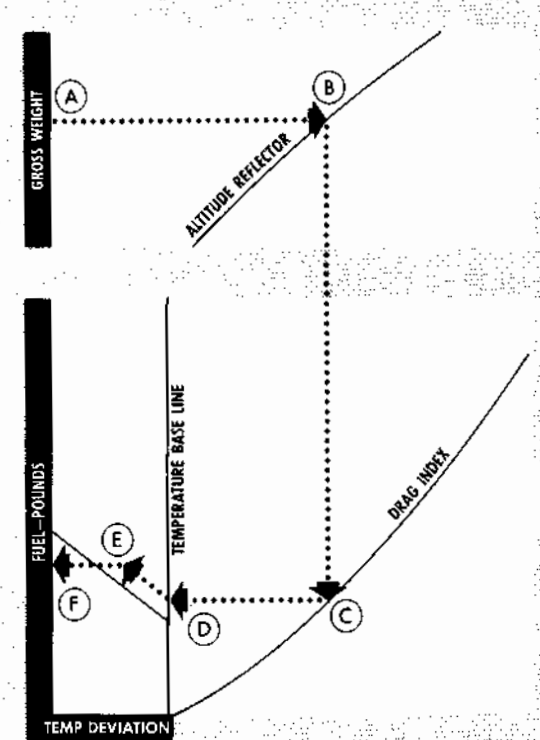

## COMBAT CEILING CHARTS

These charts (figures A3-4 and A3-5) present the military and maximum thrust combat ceiling for normal two engine and emergency single engine operation. The variables of gross weight, pressure altitude and drag index are taken into consideration.

### USE

Enter the applicable graph with estimated gross weight at end of climb. Project vertically upward to intersect applicable drag index, then horizontally to the left to the temperature baseline (corresponds to ICAO Standard day (°C)). From this point, parallel the applicable guideline

(hotter or colder) to intersect a vertical grid line corresponding to the degree of deviation between the altitude at the end of climb and standard day temperature. From this point continue horizontally to the left to read combat ceiling.

### Sample Problem

#### Maximum Thrust - (2) Engines

A. Gross weight at end of climb	45,000 Lb
B. Drag index	40.0
C. Temperature baseline	
D. Temperature deviation	+8°C
E. Combat ceiling	48,300 Ft

**F-4E**

# CLIMB SPEED SCHEDULE

AIRPLANE CONFIGURATION  
INDIVIDUAL DRAG INDEXES

## MAXIMUM THRUST

DATE: 1 JANUARY 1973  
DATA BASIS: FLIGHT TEST

REMARKS  
ENGINE(S): (2) J79-GE-17  
ICAO STANDARD DAY

FUEL GRADE: JP-4  
FUEL DENSITY: 6.5 LB/GAL

		DRAG INDEX													
		0		10		20		30		40		50		60	
		KIAS	MACH	KIAS	MACH	KIAS	MACH	KIAS	MACH	KIAS	MACH	KIAS	MACH	KIAS	MACH
ALTITUDE	S.L.	596	.90	589	.89	589	.89	582	.88	569	.86	563	.85	556	.84
	5,000	551	.90	551	.90	545	.89	538	.88	533	.87	526	.86	519	.85
	10,000	508	.90	508	.90	502	.89	495	.88	489	.87	484	.86	478	.85
	15,000	464	.90	464	.90	464	.90	459	.89	454	.88	448	.87	442	.86
	20,000	429	.91	429	.91	429	.91	418	.89	413	.88	408	.87	403	.86
	25,000	394	.92	389	.91	389	.91	384	.90	379	.89	375	.88	370	.87
	30,000	355	.92	355	.92	351	.91	347	.90	342	.89	342	.89	338	.88
	35,000	322	.93	318	.92	314	.91	314	.91	310	.90	307	.89	307	.89
	40,000	288	.93	284	.92	280	.91	280	.91	277	.90	277	.90	273	.89
	45,000	256	.93	253	.92	250	.91	250	.91	247	.90	247	.90	244	.89

		DRAG INDEX															
		70		80		90		100		110		120		130		140	
		KIAS	MACH	KIAS	MACH	KIAS	MACH	KIAS	MACH	KIAS	MACH	KIAS	MACH	KIAS	MACH	KIAS	MACH
ALTITUDE	S.L.	543	.82	529	.80	516	.78	496	.75	477	.72	457	.69	443	.67	437	.66
	5,000	507	.83	495	.81	482	.79	469	.77	451	.74	432	.71	420	.69	407	.67
	10,000	472	.84	460	.82	448	.80	437	.78	425	.76	408	.73	397	.71	384	.69
	15,000	432	.84	427	.83	416	.81	410	.80	399	.78	388	.76	378	.74	367	.72
	20,000	398	.85	393	.84	388	.83	378	.81	373	.80	364	.78	353	.76	348	.75
	25,000	366	.86	361	.85	356	.84	342	.83	347	.82	343	.81	333	.79	324	.77
	30,000	333	.87	329	.86	329	.86	325	.85	321	.84	317	.83	312	.82	304	.80
	35,000	303	.88	303	.88	299	.87	299	.87	299	.87	295	.86	287	.84	283	.83
	40,000	270	.88	270	.88	270	.88	266	.87	266	.87	266	.87	259	.85	256	.84
	45,000	240	.88	240	.88	240	.88	237	.87	237	.87	237	.87	231	.85	228	.84

## TAKEOFF ALLOWANCES & ACCELERATION TO CLIMB SPEED

START	65 LB/ENG
RUNUP	50 LB/ENG
TAXI	21 LB/MIN/ENG

BRAKE RELEASE TO CLIMB SPEED	
MAX. T.O.	
MAX. ACCEL. TO	
MAX. CLIMB SPEED	

FUEL - LB	1225
DIST - NM	5.0
TIME - MIN	1.0

4E-1-(287-11A)

Figure A3-1 (Sheet 1 of 4)

# F-4E

## TIME TO CLIMB

### MAXIMUM THRUST

AIRPLANE CONFIGURATION  
INDIVIDUAL DRAG INDEXES

REMARKS  
ENGINE(S): (2) J79-GE-17

GUIDE

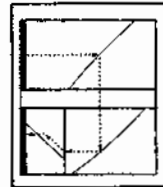

NOTE

DATE: 1 JANUARY 1973  
DATA BASIS: FLIGHT TEST

CRUISE ALTITUDE AT END OF CLIMB MUST BE READ  
ON THE CONSTANT ALTITUDE CRUISE CHART.

FUEL GRADE: JP-4  
FUEL DENSITY: 6.5 LB/GAL

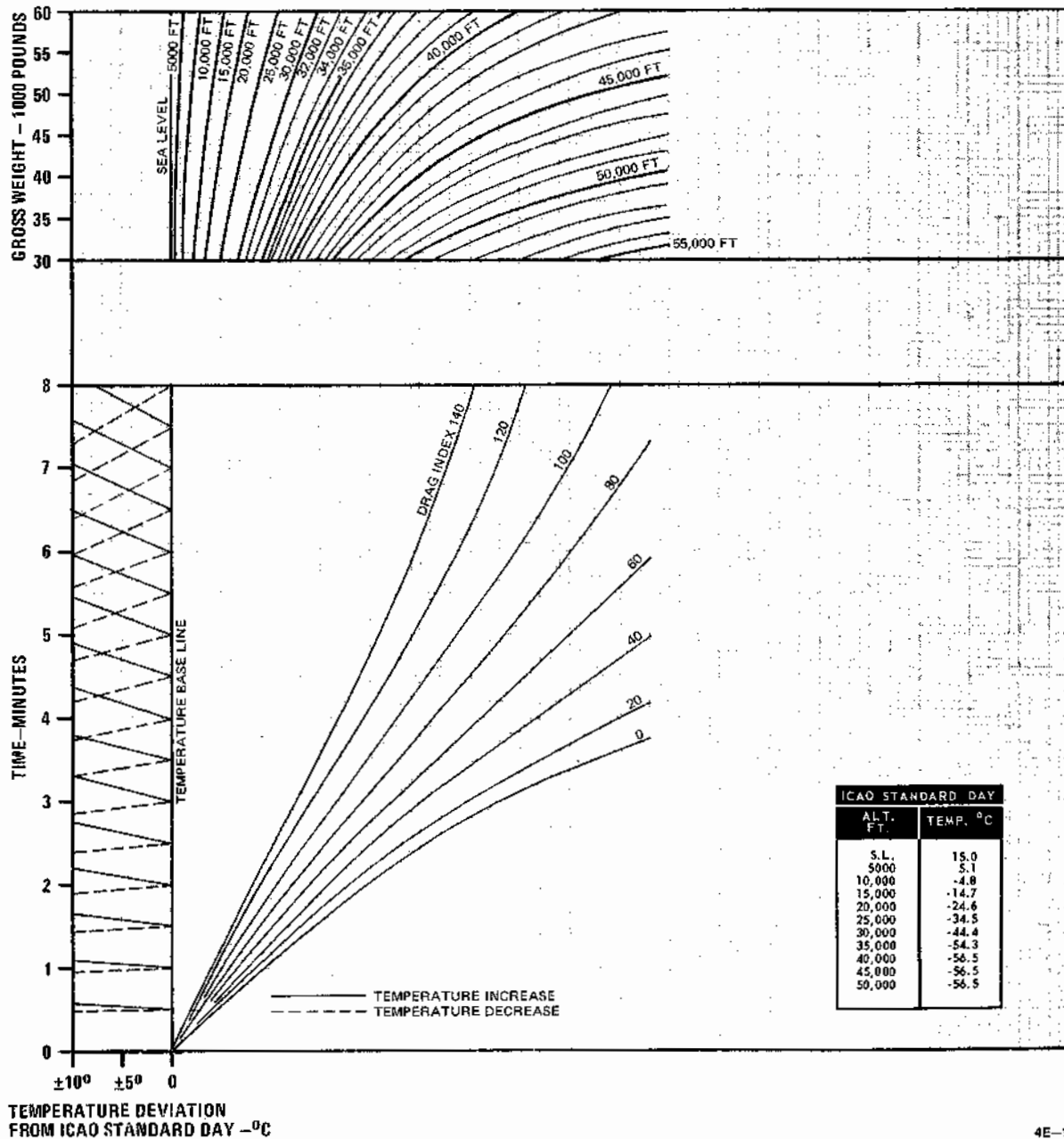

Figure A3-1 (Sheet 2 of 4)

**F-4E**

# FUEL REQUIRED TO CLIMB

## MAXIMUM THRUST

AIRPLANE CONFIGURATION  
INDIVIDUAL DRAG INDEXES

REMARKS  
ENGINE(S): (2) J79-GE-17

GUIDE

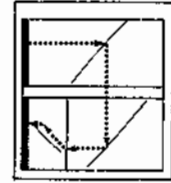

**NOTE**

CRUISE ALTITUDE AT END OF CLIMB MUST BE OBTAINED FROM THE CRUISE ALTITUDE CHART.

DATE: 1 JANUARY 1973  
DATA BASIS: FLIGHT TEST

FUEL GRADE: JP-4  
FUEL DENSITY: 6.5 LB/GAL

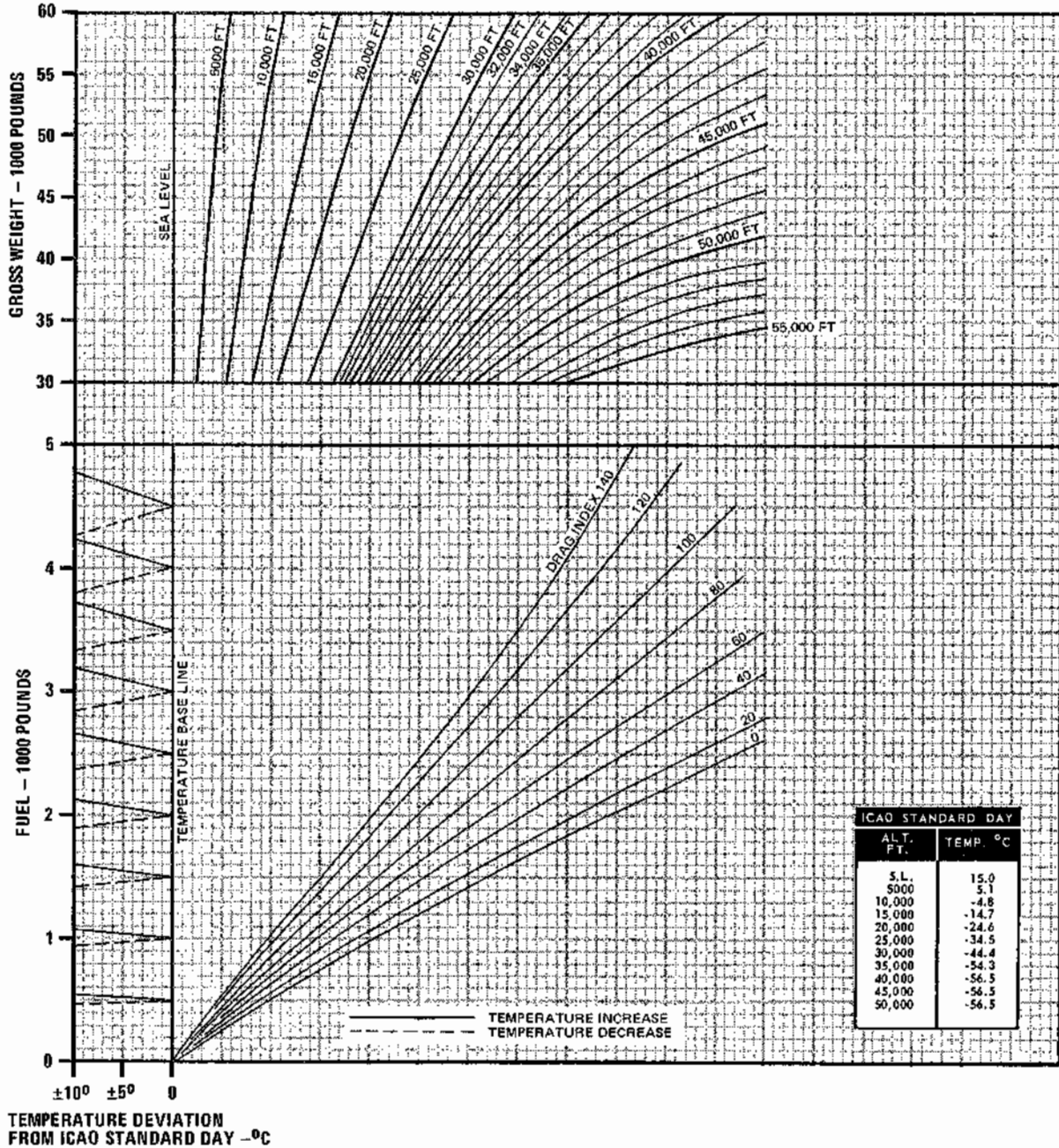

Figure A3-1 (Sheet 3 of 4)



**F-4E**

# DISTANCE REQUIRED TO CLIMB

## MAXIMUM THRUST

AIRPLANE CONFIGURATION  
INDIVIDUAL DRAG INDEXES

REMARKS  
ENGINE(S): (2) J79-GE-17

NOTE

GUIDE

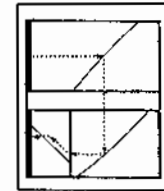

DATE: 1 JANUARY 1973  
DATA BASIS: FLIGHT TEST

CRUISE ALTITUDE AT END OF CLIMB MUST BE READ  
ON THE CONSTANT ALTITUDE CRUISE CHART.

FUEL GRADE: JP-4  
FUEL DENSITY: 6.5 LB/GAL

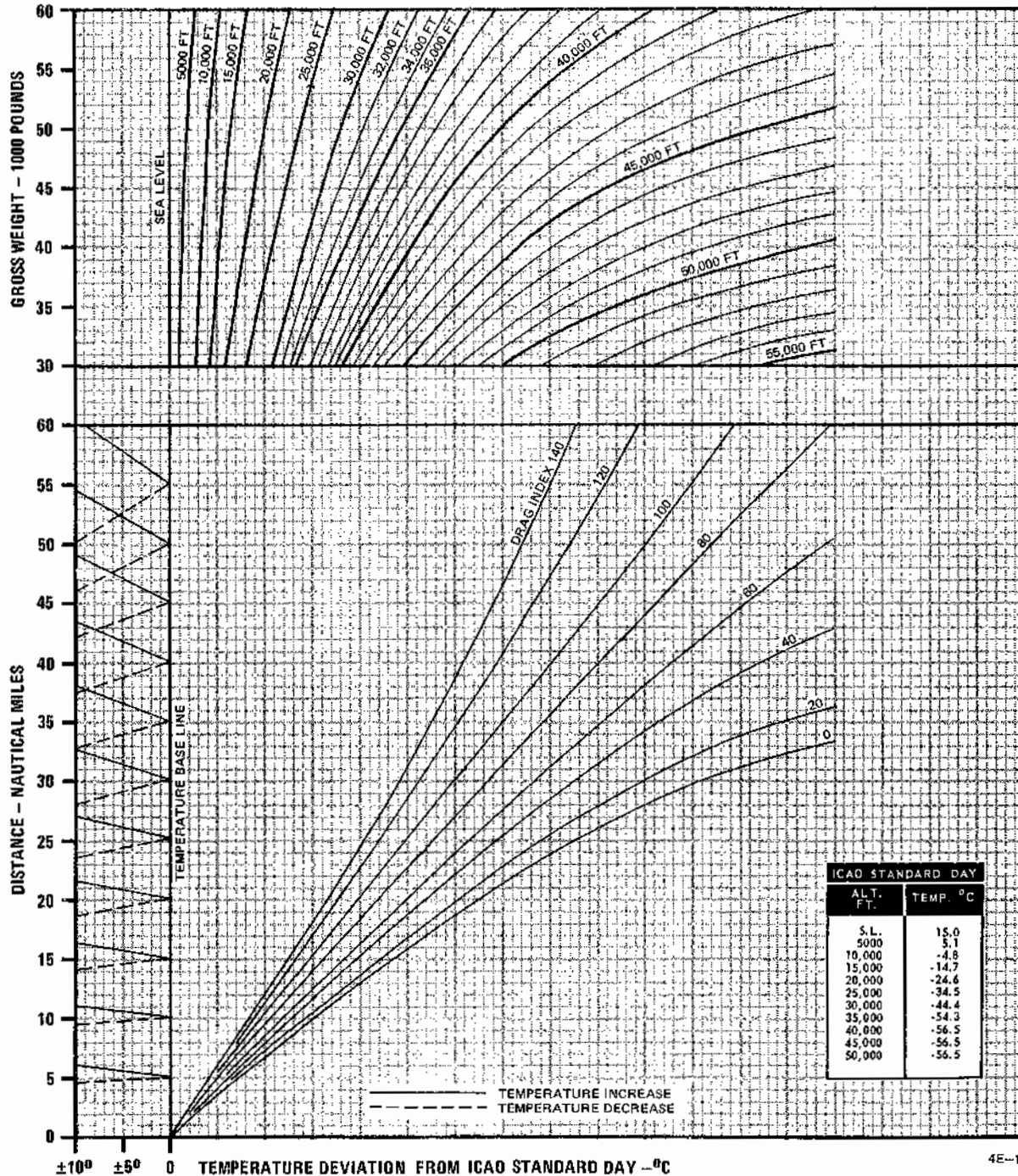

4E-1-(287-4)

Figure A3-1 (Sheet 4 of 4)

**F-4E**

**CLIMB SPEED SCHEDULE**

AIRPLANE CONFIGURATION  
INDIVIDUAL DRAG INDEXES

**MILITARY THRUST**

DATE: 1 JANUARY 1973  
DATA BASIS: FLIGHT TEST

REMARKS  
ENGINE(S): (2) J79-GE-17  
ICAD STANDARD DAY

FUEL GRADE: JP-4  
FUEL DENSITY: 6.5 LB/GAL

		DRAG INDEX													
		0		10		20		30		40		50		60	
		KIAS	MACH	KIAS	MACH	KIAS	MACH	KIAS	MACH	KIAS	MACH	KIAS	MACH	KIAS	MACH
ALTITUDE	S.L.	503	.76	483	.73	456	.69	436	.66	417	.63	407	.60	377	.57
	5,000	470	.77	451	.74	433	.71	414	.68	395	.65	377	.62	364	.60
	10,000	442	.79	426	.76	409	.73	397	.71	379	.68	368	.66	351	.63
	15,000	411	.80	399	.78	389	.76	373	.73	362	.71	351	.69	341	.67
	20,000	383	.82	373	.80	368	.79	358	.77	348	.75	338	.73	329	.71
	25,000	356	.84	352	.83	347	.82	338	.80	333	.79	324	.77	315	.75
	30,000	325	.85	325	.85	325	.85	321	.84	317	.83	308	.81	304	.80
	35,000	299	.87	303	.88	303	.88	303	.88	299	.87	291	.85	287	.84
	40,000	270	.88	273	.89	273	.89	-	-	-	-	-	-	-	-

		DRAG INDEX															
		70		80		90		100		110		120		130		140	
		KIAS	MACH	KIAS	MACH	KIAS	MACH	KIAS	MACH	KIAS	MACH	KIAS	MACH	KIAS	MACH	KIAS	MACH
ALTITUDE	S.L.	364	.55	344	.52	338	.51	324	.49	318	.48	311	.47	304	.46	298	.45
	5,000	353	.58	340	.56	328	.54	316	.52	309	.51	303	.50	297	.49	291	.48
	10,000	339	.61	328	.59	317	.57	305	.55	300	.54	294	.53	288	.52	283	.51
	15,000	330	.65	320	.63	309	.61	299	.59	293	.58	283	.56	278	.55	273	.54
	20,000	319	.69	309	.67	299	.65	289	.63	285	.62	275	.60	266	.58	261	.57
	25,000	306	.73	297	.71	288	.69	279	.67	275	.66	266	.64	257	.62	253	.61
	30,000	296	.78	284	.75	275	.73	267	.71	263	.70	254	.68	-	-	-	-
	35,000	279	.82	272	.80	-	-	-	-	-	-	-	-	-	-	-	-
	40,000	-	-	-	-	-	-	-	-	-	-	-	-	-	-	-	-

**TAKEOFF ALLOWANCES & ACCELERATION TO CLIMB SPEED**

START - 65 LB/ENG
RUNUP - 50 LB/ENG
TAXI - 21 LB/MIN/ENG

BRAKE RELEASE TO CLIMB SPEED		
MIL. T.O.	MAX. T.O.	MAX. T.O.
MIL. ACCEL. TO	MIL. ACCEL. TO	MAX. ACCEL. TO
MIL. CLIMB SPEED	MIL. CLIMB SPEED	MIL. CLIMB SPEED

FUEL - LB	525	725	925
DIST. - NM	6.0	5.3	3.0
TIME - MIN	1.7	1.3	.8

4E-1-(286-1)A

Figure A3-2 (Sheet 1 of 4)

**F-4E**  
**TIME TO CLIMB**  
**MILITARY THRUST**

AIRPLANE CONFIGURATION  
 INDIVIDUAL DRAG INDEXES

REMARKS  
 ENGINE(S): (2) J79-GE-17

GUIDE

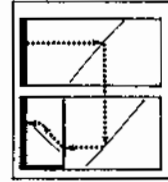

NOTE

CRUISE ALTITUDE AT END OF CLIMB MUST BE READ  
 ON THE CONSTANT ALTITUDE CRUISE CHART

DATE: 1 JANUARY 1973  
 DATA BASIS: FLIGHT TEST

FUEL GRADE: JP-4  
 FUEL DENSITY: 6.5 LB/GAL

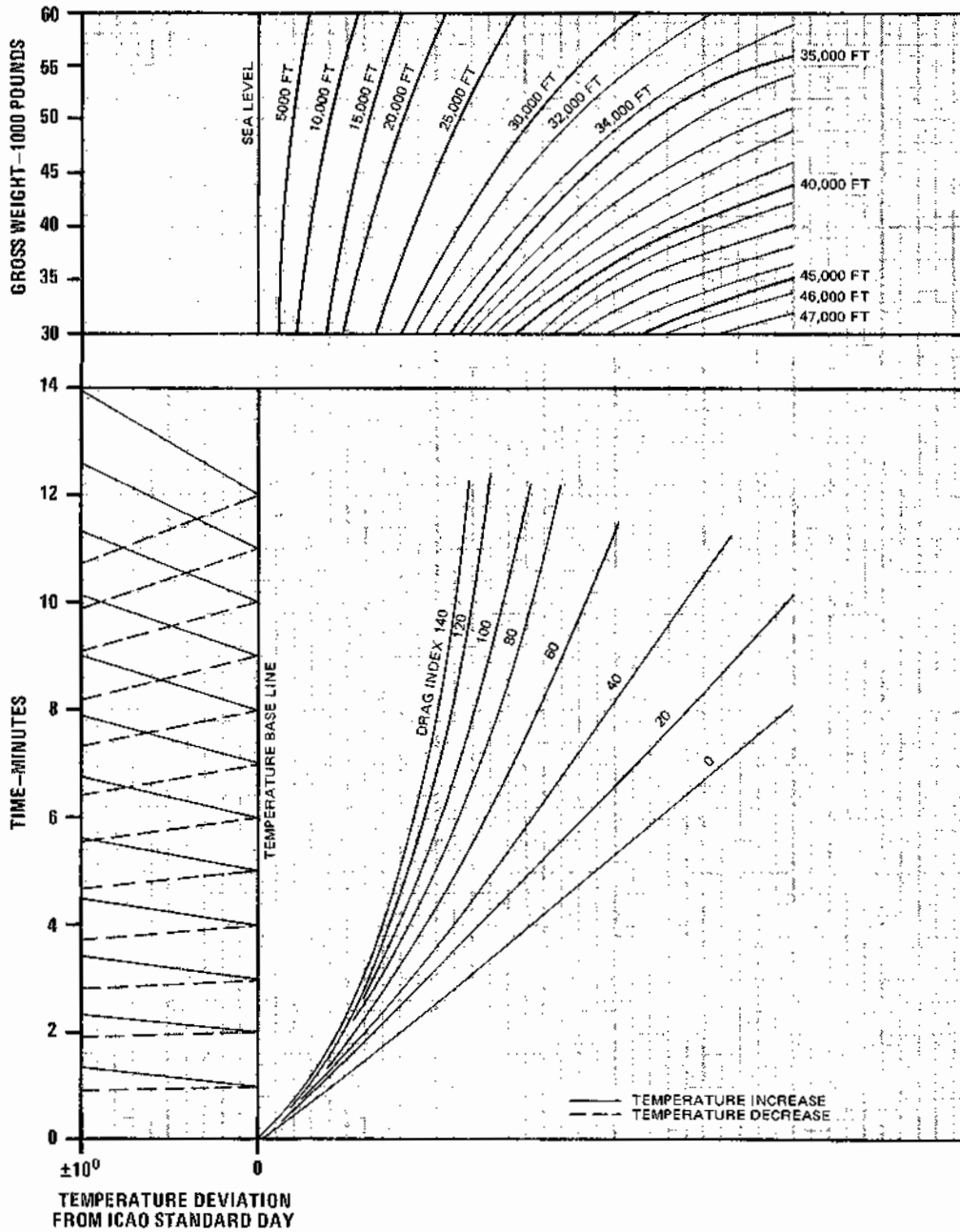

4E-1-(286-2)

Figure A3-2 (Sheet 2 of 4)

**F-4E**

# FUEL REQUIRED TO CLIMB

## MILITARY THRUST

AIRPLANE CONFIGURATION  
INDIVIDUAL DRAG INDEXES

REMARKS  
ENGINE(S): (2) J79-GE-17

**NOTE**

CRUISE ALTITUDE AT END OF CLIMB MUST BE READ  
ON THE CONSTANT ALTITUDE CRUISE CHART

GUIDE

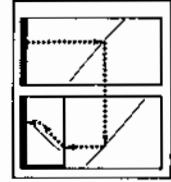

DATE: 1 JANUARY 1973  
DATA BASIS: FLIGHT TEST

FUEL GRADE: JP-4  
FUEL DENSITY: 6.5 LB/GAL

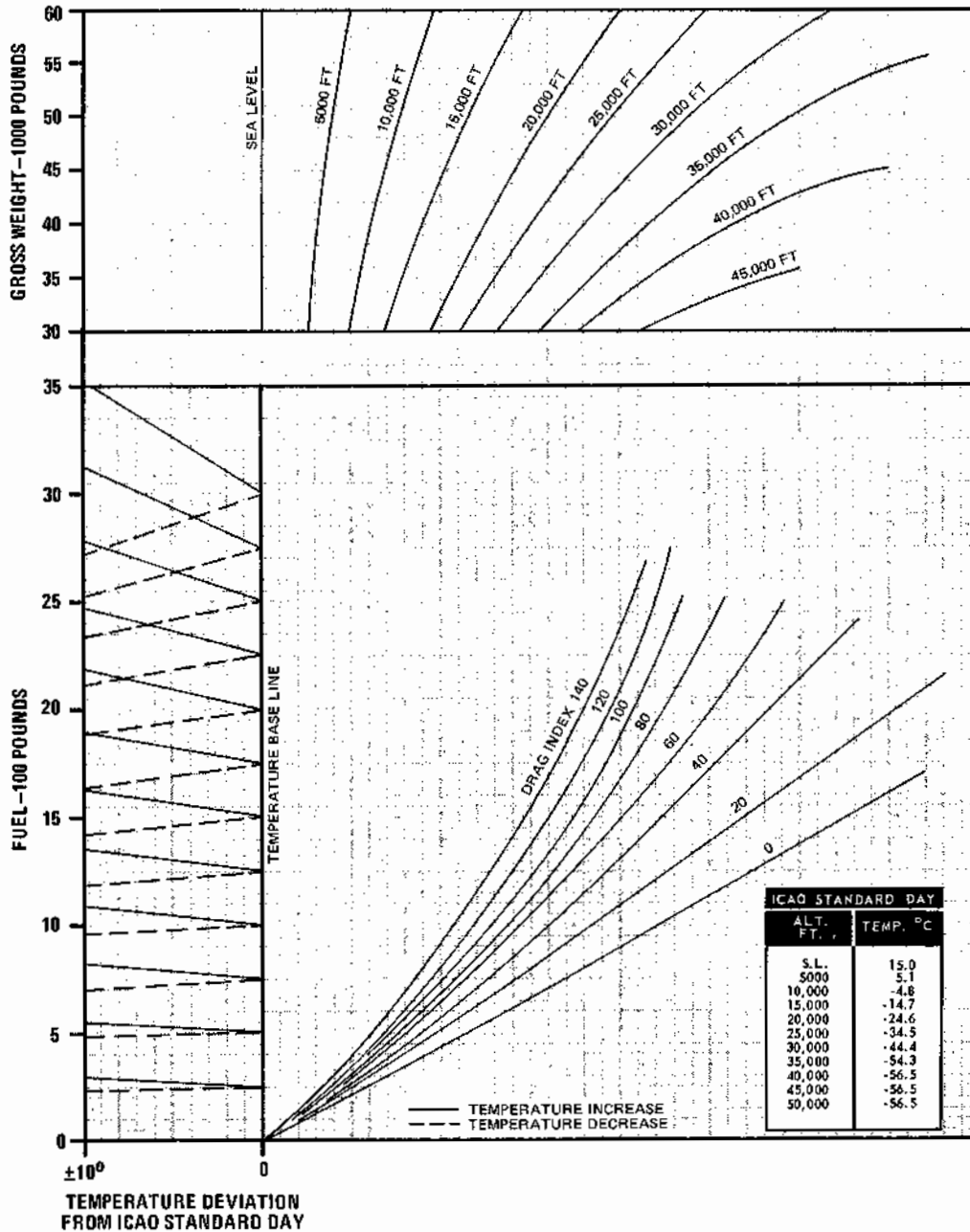

4E-1-1286-31

Figure A3-2 (Sheet 3 of 4)

**F-4E**

# DISTANCE REQUIRED TO CLIMB MILITARY THRUST

AIRPLANE CONFIGURATION  
INDIVIDUAL DRAG INDEXES

REMARKS  
ENGINE(S): (2) J79-GE-17

NOTE  
CRUISE ALTITUDE AT END OF CLIMB MUST BE READ  
ON THE CONSTANT ALTITUDE CRUISE CHART

GUIDE

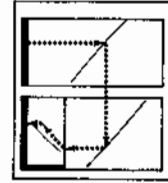

DATE: 1 JANUARY 1973  
DATA BASIS: FLIGHT TEST

FUEL GRADE: JP-4  
FUEL DENSITY: 6.5 LB/GAL

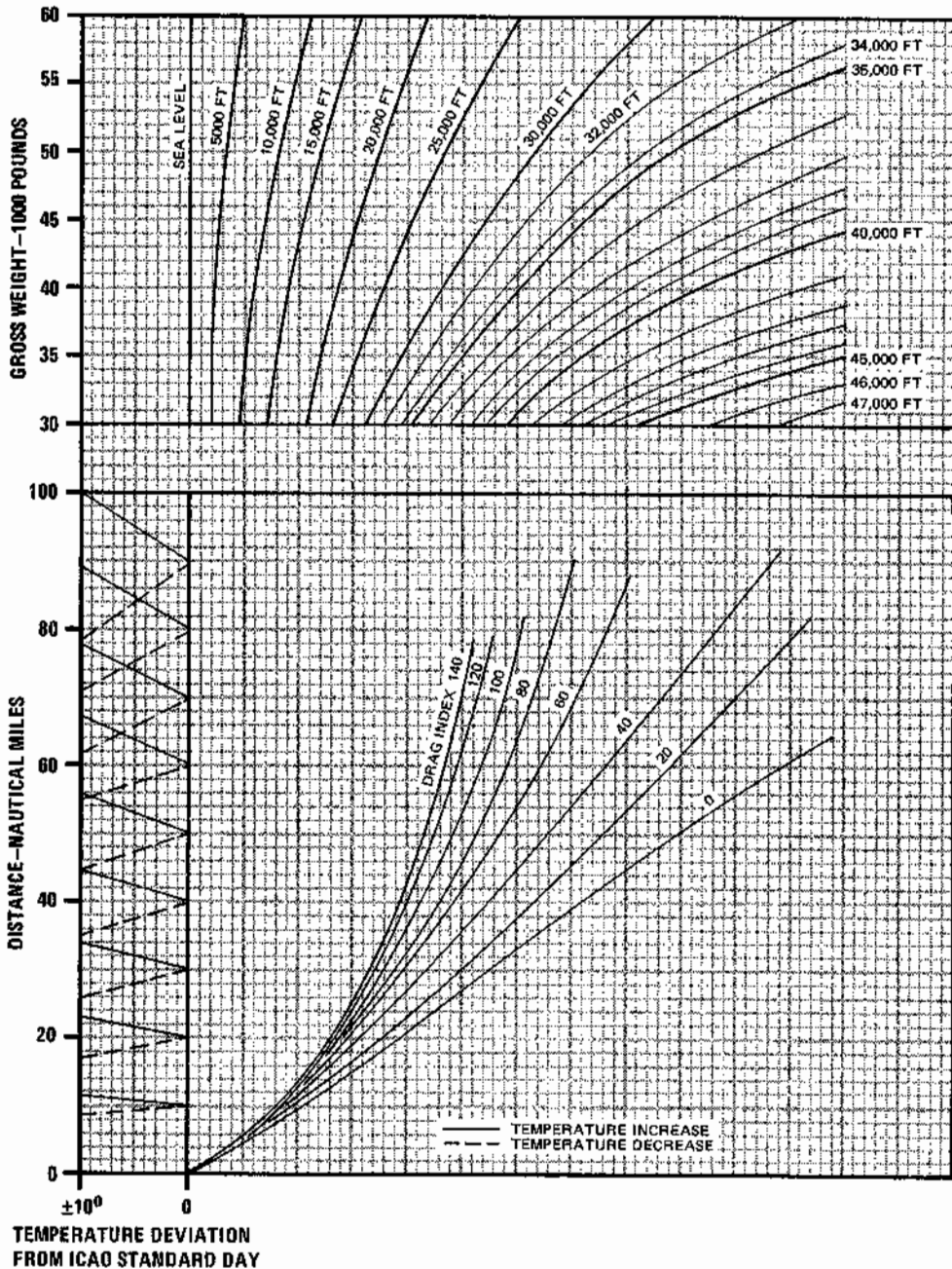

Figure A3-2 (Sheet 4 of 4)

**F-4E**

# TIME TO CLIMB

## 350 KIAS-MILITARY THRUST

AIRPLANE CONFIGURATION  
INDIVIDUAL DRAG INDEXES

**REMARKS**

ENGINE(S): (2)J79-GE-17

**NOTE**

DATA BASED ON 350-KNOT CLIMB UNTIL INTERCEPTION OF OPTIMUM CRUISE MACH/TAS, THEN MAINTAIN CRUISE MACH TO CRUISE ALTITUDE. REFER TO PART 4 TO OBTAIN CRUISE ALTITUDES.

GUIDE

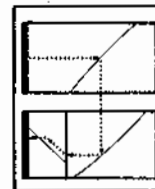

DATE: 1 JANUARY 1973  
DATA BASIS: FLIGHT TEST

FUEL GRADE: JP-4  
FUEL DENSITY: 6.5 LB/GAL

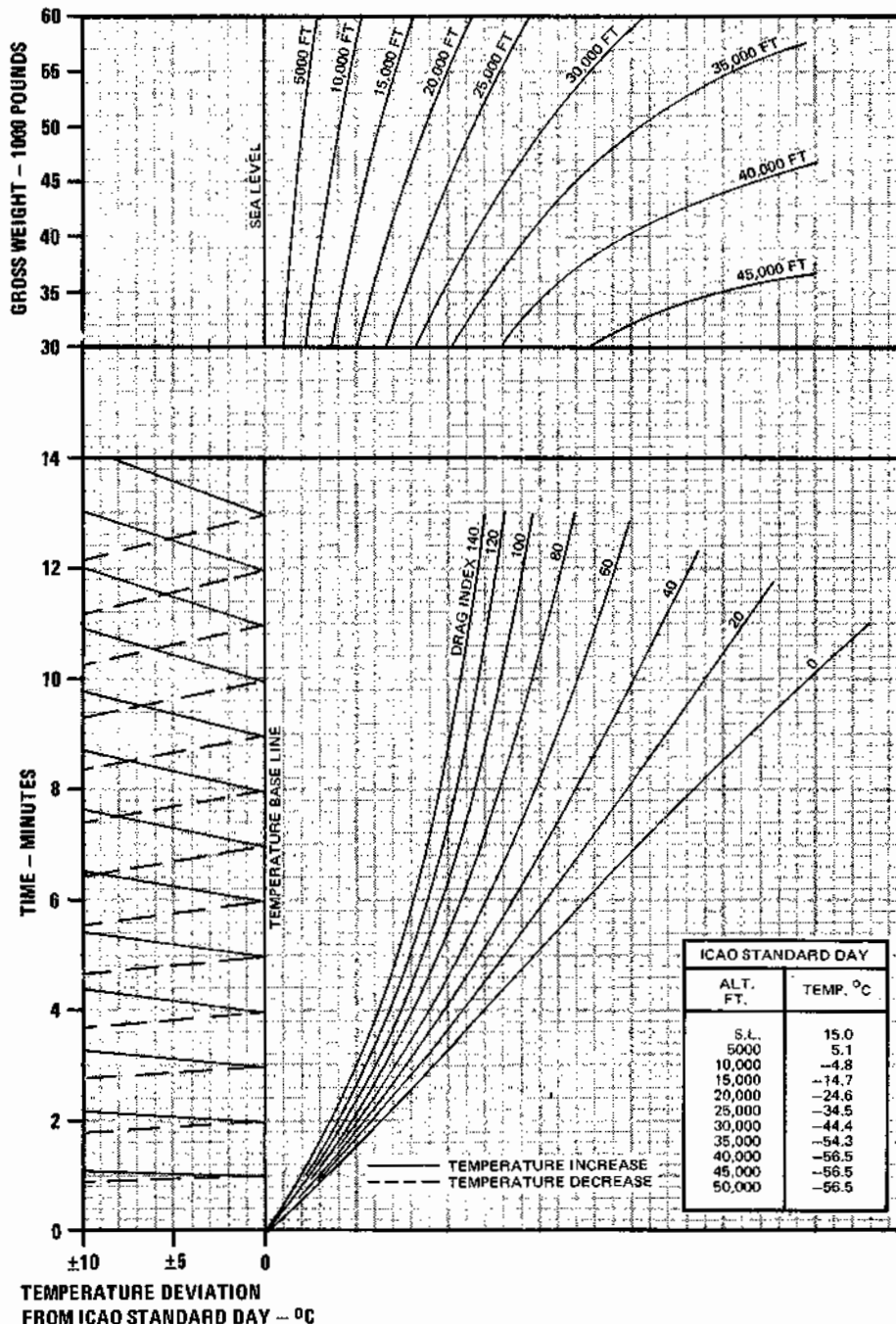

Figure A3-3 (Sheet 1 of 3)

**F-4E**

# FUEL REQUIRED TO CLIMB

## 350 KIAS-MILITARY THRUST

AIRPLANE CONFIGURATION  
INDIVIDUAL DRAG INDEXES

REMARKS  
ENGINE(S): (2)J79-GE-17

NOTE

DATA BASED ON 350-KNOT CLIMB UNTIL INTERCEPTION OF OPTIMUM CRUISE MACH/TAS, THEN MAINTAIN CRUISE MACH TO CRUISE ALTITUDE. REFER TO PART 4 TO OBTAIN CRUISE ALTITUDES.

GUIDE

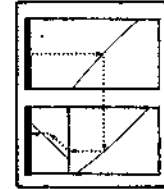

DATE: 1 JANUARY 1973  
DATA BASIS: FLIGHT TEST

FUEL GRADE: JP-4  
FUEL DENSITY: 6.5 LB/GAL

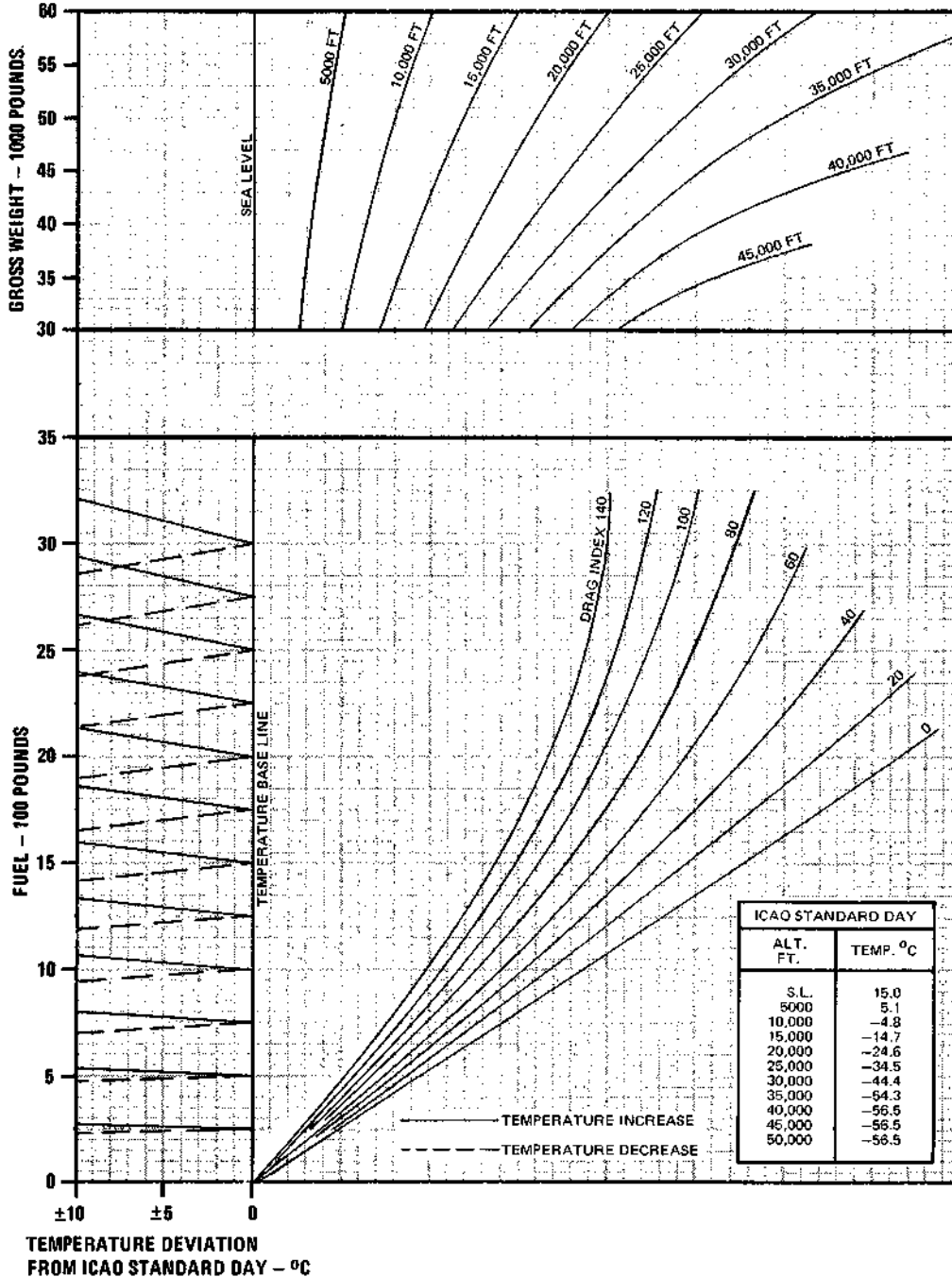

Figure A3-3 (Sheet 2 of 3)

**F-4E**

# DISTANCE REQUIRED TO CLIMB

## 350 KIAS-MILITARY THRUST

AIRPLANE CONFIGURATION  
INDIVIDUAL DRAG INDEXES

REMARKS  
ENGINE(S): (2)J79-GE-17

**NOTE**

DATA BASED ON 350-KNOT CLIMB UNTIL INTERCEPTION OF OPTIMUM CRUISE MACH/TAS, THEN MAINTAIN CRUISE MACH TO CRUISE ALTITUDE. REFER TO PART 4 TO OBTAIN CRUISE ALTITUDES.

DATE: 1 JANUARY 1973  
DATA BASIS: FLIGHT TEST

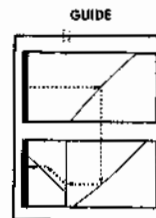

FUEL GRADE: JP-4  
FUEL DENSITY: 6.5 LB/GAL

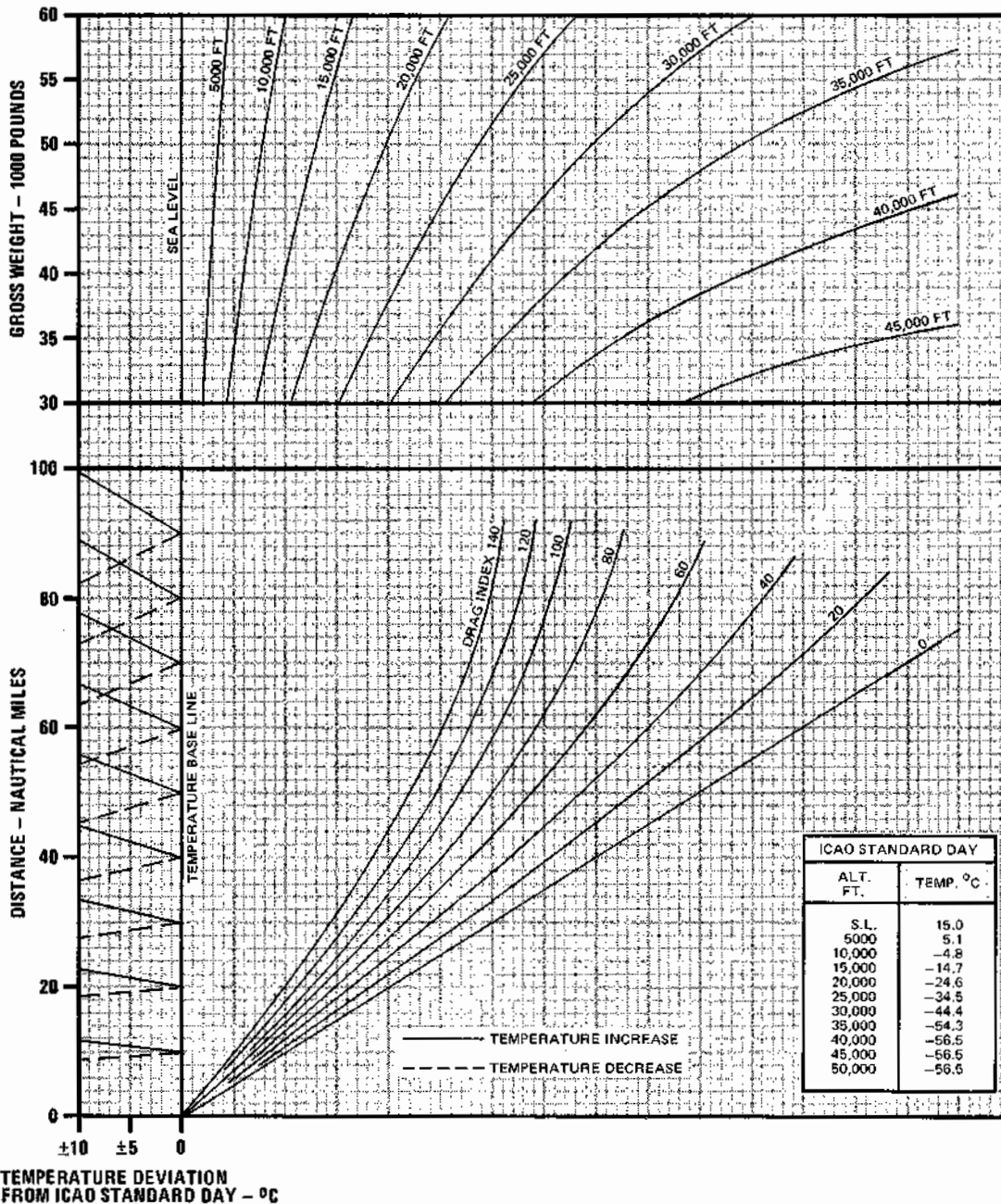

Figure A3-3 (Sheet 3 of 3)



**F-4E**

# COMBAT CEILING

**AIRPLANE CONFIGURATION  
INDIVIDUAL DRAG INDEXES**

ICAO STANDARD DAY	
ALT. FT.	TEMP. °C
S.L.	15.0
5000	5.1
10,000	-4.8
15,000	-14.7
20,000	-24.6
25,000	-34.5
30,000	-44.4
35,000	-54.3
40,000	-56.5
45,000	-56.5
50,000	-56.5

**REMARKS**  
ENGINE(S): (2) J79-GE-17  
ICAO STANDARD DAY

**NOTE**

COMBAT CEILING IS THE PRESSURE ALTITUDE AT WHICH THE AIRCRAFT CAN CLIMB AT A MAXIMUM RATE OF 500 FEET PER MINUTE.

**GUIDE**

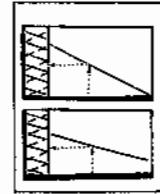

FUEL GRADE: JP-4  
FUEL DENSITY: 6.5 LB/GAL

DATE: 1 JANUARY 1973  
DATA BASIS: FLIGHT TEST

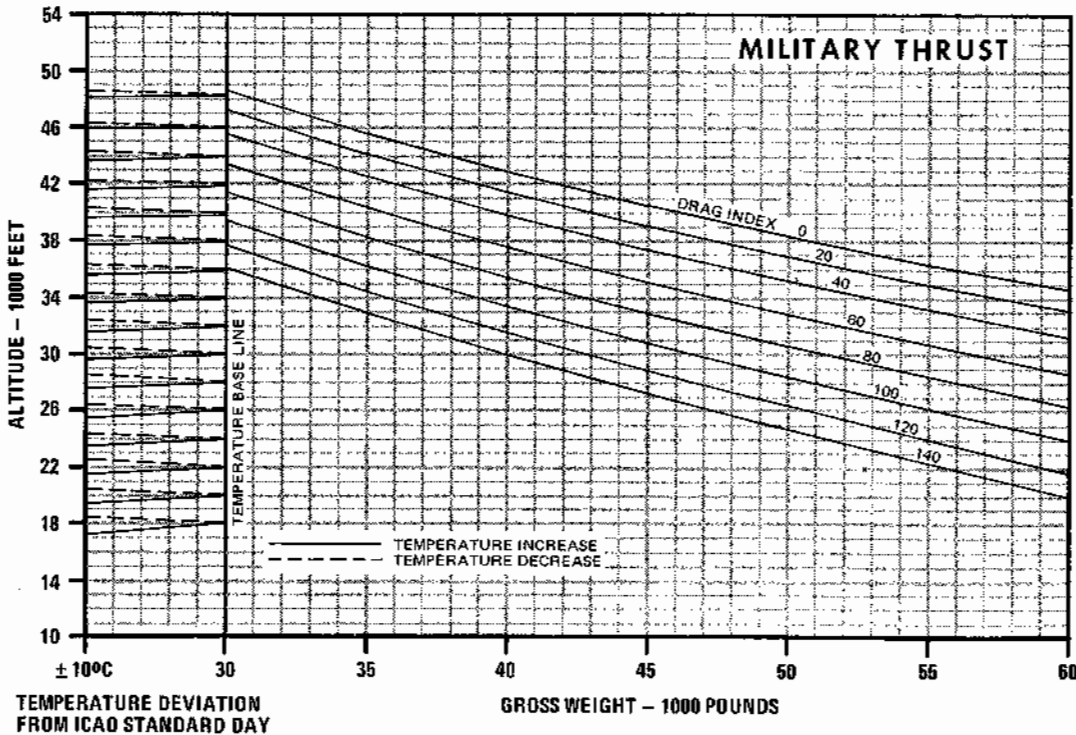
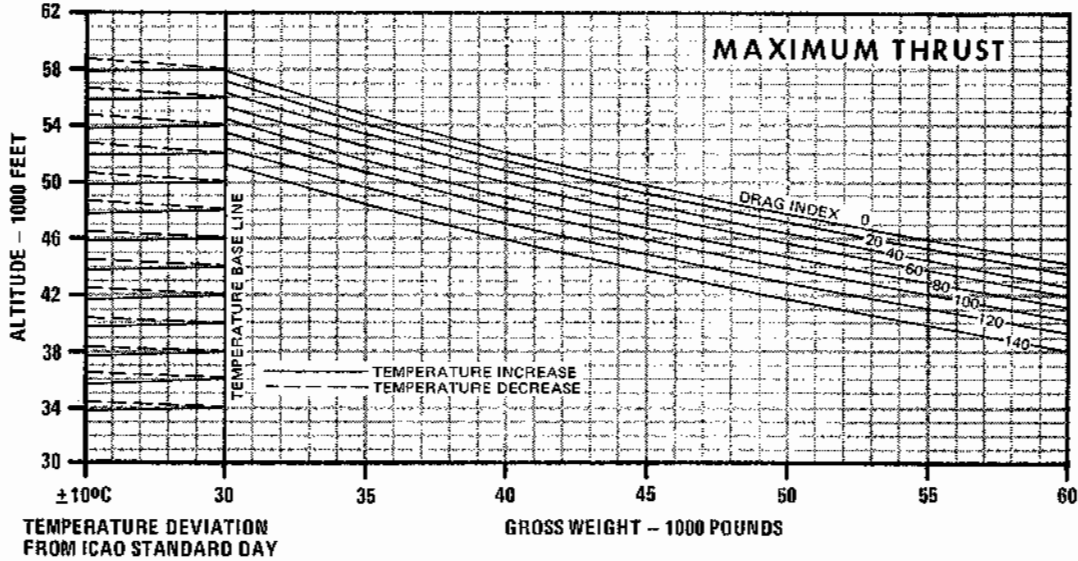

4E-1-(322)

Figure A3-4

**F-4E**

# COMBAT CEILING

## ONE ENGINE OPERATING

AIRPLANE CONFIGURATION  
INDIVIDUAL DRAG INDEXES

ICAO STANDARD DAY	
ALT. FT.	TEMP. °C
S.L.	15.0
5,000	5.1
10,000	-4.8
15,000	-14.7
20,000	-24.6
25,000	-34.5
30,000	-44.4
35,000	-54.3
40,000	-64.2
45,000	-74.1
50,000	-84.0

**REMARKS**  
ENGINE(S): (2) J79-GE-17  
ICAO STANDARD DAY  
INOPERATIVE ENGINE WINDMILLING

**NOTE**

- COMBAT CEILING IS THE PRESSURE ALTITUDE AT WHICH THE AIRCRAFT CAN CLIMB AT A MAXIMUM RATE OF 500 FEET PER MINUTE.
- IF INOPERATIVE ENGINE IS NOT WINDMILLING, INCREASE DRAG INDEX BY 53 ADDITIONAL UNITS.

GUIDE

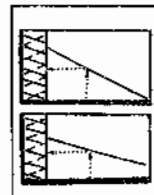

FUEL GRADE: JP-4  
FUEL DENSITY: 6.5 LB/GAL

DATE: 1 JANUARY 1973  
DATA BASIS: FLIGHT TEST

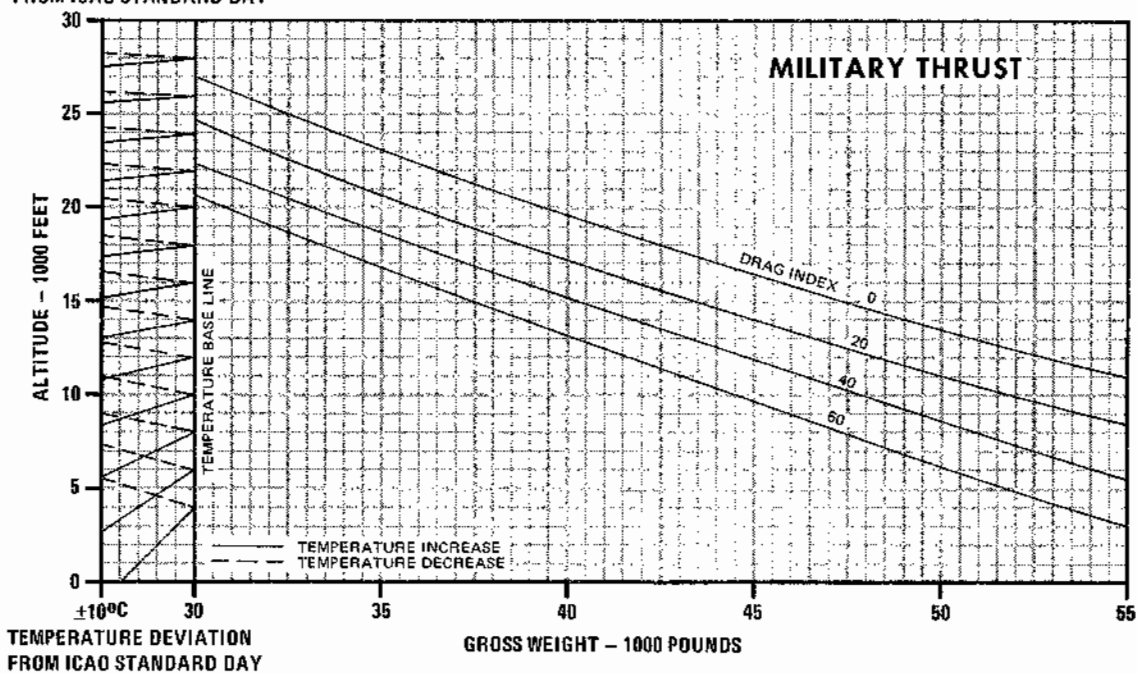
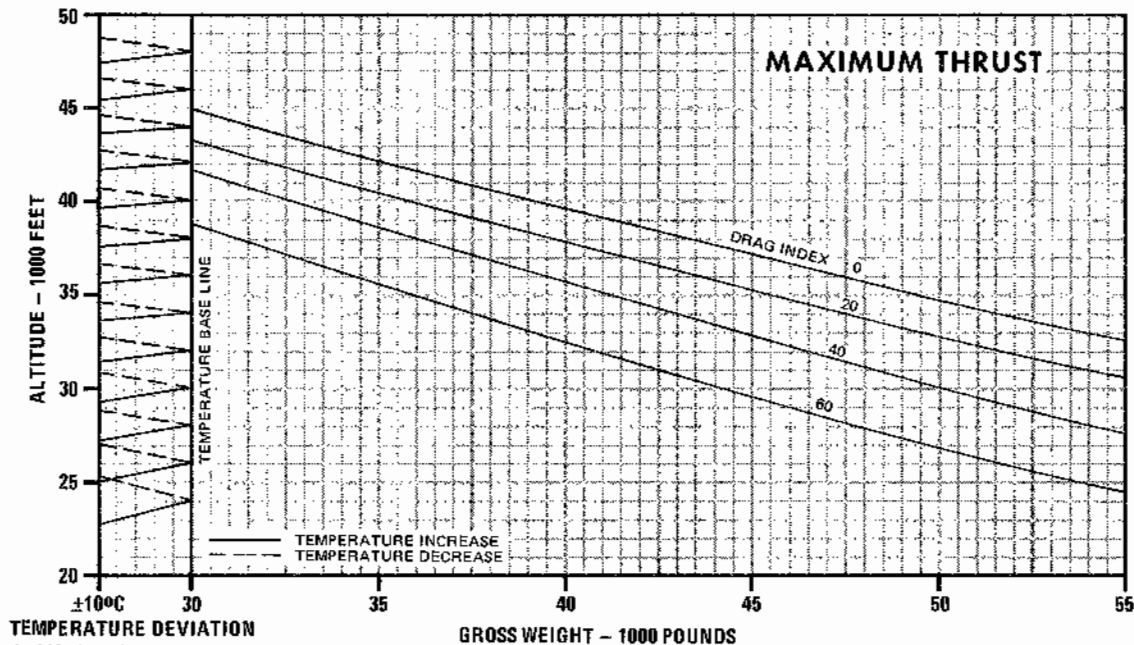

4E-1-(323)

Figure A3-5

# PART 4

## RANGE

### TABLE OF CONTENTS

#### Charts

Rangewind Correction.....	A4-5
Cruise Summary.....	A4-6
Low Altitude Cruise.....	A4-8
High Altitude Cruise.....	A4-14
Constant Mach/Altitude Cruise.....	A4-19
Constant Altitude Cruise.....	A4-26

#### NOTE

For aircraft with TISEO scope housing (with or without scope) on the left wing and/or combat documentation cameras installed, additional units of drag must be applied to the computed drag index. Refer to the Airplane Loading chart in part 1.

### RANGEWIND CORRECTION

This chart (figure A4-1) provides a means of correcting computed range (specific or total) for existing wind effect. The presented range factors consider wind speeds up to 150 knots from any relative wind direction for airplane speeds of 200 to 1300 knots (TAS).

#### USE

Determine the relative wind direction by subtracting the aircraft heading from the forecast wind direction. If the aircraft heading is greater than the forecast wind direction, add 360° to wind direction and then perform the subtraction. Enter the chart with relative wind direction and proceed vertically to the interpolated wind speed. From this point, project horizontally to intersect the airplane true airspeed and reflect to the lower scale to read the range factor. Multiply computed range by this range factor to find range as affected by wind.

#### Sample Problem

A. Relative wind direction	150°
B. Wind speed	125 Kt
C. Airplane speed (TAS)	400 Kt
D. Range factor	1.25

### CRUISE SUMMARY

These charts (figures A4-2 and A4-3) present cruise data for both two engine and single engine operation. The charts depict optimum cruise altitude, specific range (in nautical miles per pound) and cruise Mach number for all gross weights and drag indexes.

#### USE

Enter the chart with the previously computed drag index, and project vertically to intersect the gross weight curves of all three plots. At the intersection of the appropriate gross weight curves, reflect horizontally to the left and read cruise Mach number, specific range in nautical miles per pound, and cruise altitude.

#### Sample Problem

(2) Engines

A. Drag index	20
B. Gross weight	40,000 Lb
C. Mach number	0.86
D. Specific range	0.092 NMPP
E. Cruise altitude	38,700 Ft

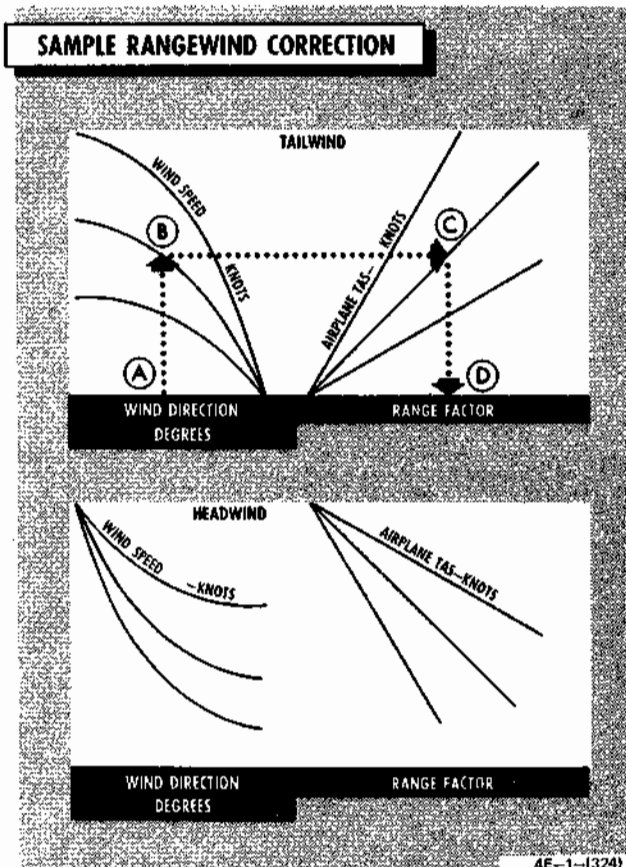

4E-1-(1324)

**SAMPLE CRUISE SUMMARY**

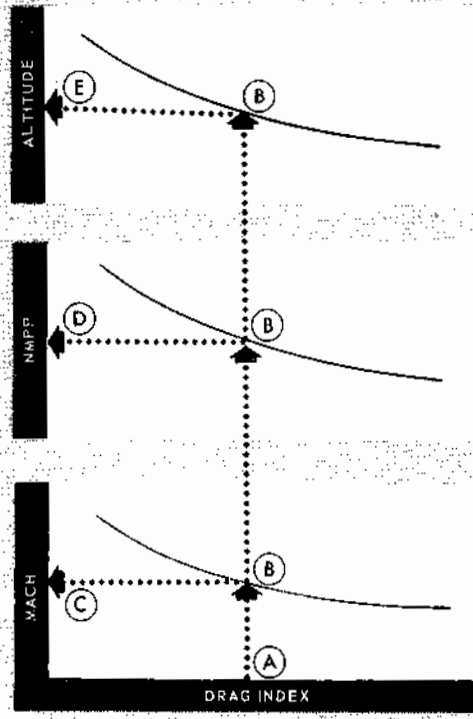

4E-1-(325)

**LOW ALTITUDE CRUISE TABLES**

These tables (figures A4-4 thru A4-9) present total fuel flow values for various combinations of cruise airspeed and drag index at altitudes of Sea Level, 4000, 8000, 12,000 and 16,000 feet. Also included for each altitude are the total fuel flow values and resultant  $V_{max}$  (maximum attainable TAS) for a MIL thrust setting. Separate tables are provided for several gross weights. Fuel flow values are tabulated for ICAO Standard Day; however, correction factors are given for non-standard temperatures.

**USE**

After selecting the applicable table for gross weight and altitude, determine the equivalent standard day true airspeed by dividing the desired true airspeed by the nonstandard day temperature correction factor obtained from the appropriate TEMP EFFECTS column. Enter the table with the equivalent standard day true airspeed and project horizontally to the applicable drag index column and read total fuel flow for a standard day. To obtain the total fuel flow at the desired true airspeed, multiply the total fuel flow for a standard day by the nonstandard day temperature correction factor.

**Sample Problem**

Gross weight 50,000 Lb, Sea Level (15°C)

A. Desired airspeed	540 KTAS
B. Drag Index	0.20
C. Nonstandard day temperature	-20°C
D. Correction factor	.937
E. Equivalent standard day true airspeed (A ÷ D)	576 KTAS
F. Standard day total fuel flow	21266 PPH
G. Total fuel flow at desired true airspeed (F × D)	19926 PPH

**HIGH ALTITUDE CRUISE TABLES**

These charts (figures A4-10 thru A4-14) present total fuel flow values for various combinations of cruise airspeed and drag index at altitudes of 20,000 feet thru 40,000 feet in 5000 foot increments. Also included for each altitude are the total fuel flow values and resultant  $V_{max}$  (maximum attainable TAS) for a MIL thrust setting. Separate charts are provided for several gross weights. Fuel flow values are tabulated for ICAO Standard Day; however, correction factors are given for non-standard temperatures.

**USE**

After selecting the applicable table for gross weight and altitude, determine the equivalent standard day true airspeed by dividing the desired true airspeed by the nonstandard day temperature correction factor obtained from the appropriate TEMP EFFECTS column. Enter the table with the equivalent standard day true airspeed and project horizontally to the applicable drag index column and read total fuel flow for a standard day. To obtain the total fuel flow at the desired true airspeed, multiply the total fuel flow for a standard day by the nonstandard day temperature correction factor.

**Sample Problem**

Gross weight 40,000 Lb, 35,000 ft. (-55°C)

A. Desired airspeed	440 KTAS
B. Drag Index	0.20
C. Nonstandard day temperature	-20°C
D. Correction factor	1.074
E. Equivalent standard day true airspeed (A ÷ D)	473 KTAS
F. Standard day total fuel flow	5568 PPH
G. Total fuel flow at desired true airspeed (F × D)	5980 PPH

**CONSTANT MACH/ALTITUDE CRUISE**

These charts (figures A4-15 thru A4-21) present nautical miles per pound and total fuel flow for various combinations of Mach number, gross weight, altitude, and drag index. This data is based on cruise at a constant Mach

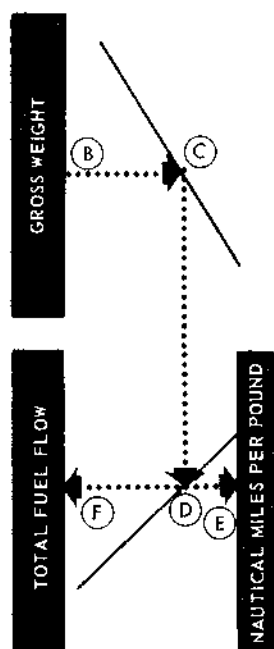
**SAMPLE CONSTANT MACH/ALTITUDE CRUISE**

4E-1-(326)

number and a constant altitude. Fuel flow is presented for 0°C; however, correction factors are provided for temperature deviations.

**USE**

After selecting the desired cruise Mach, enter the chart with the estimated gross weight at end of climb. Project horizontally to the right to intersect the desired cruise altitude, then vertically downward to intersect the applicable drag index. From this point project horizontally to both sides of the graph and read nautical miles per pound and total fuel flow for 0°C temperature. If required, correct the total fuel flow for the actual temperature.

**Sample Problem**

A. Mach number	0.85
B. Gross weight	40,000 Lb
C. Altitude	30,000 Ft
D. Drag index	40
E. Specific range	0.075 NMPP
F. Total fuel flow	7300 PPH
G. Total fuel flow (corrected)	6643 PPH

**CONSTANT ALTITUDE CRUISE**

These charts (figures A4-22 and A4-23) present the necessary planning data to set up optimum cruise schedules for normal two engine and single engine operation at a constant altitude. The recommended procedure is to use an average gross weight for a given leg of the mission. One way to find the average gross weight is to divide the mission into weight segments. With this method, readjust the cruise schedule each time a given amount of fuel is used. Subtract one-half of the fuel weight allotted for the first leg from the initial cruise gross weight. The remainder is the average gross weight for the leg. It is possible to obtain instantaneous data if desired.

**USE**

Enter the left side of sheet 1 with the average gross weight. Project horizontally to the right to intersect desired cruise altitude, and then vertically downward to the computed drag index, then horizontally to the right to obtain specific range (nautical miles per pound). Repeat these projections on the right side of sheet 1 to obtain optimum cruise Mach number for the desired altitude. Enter sheet 2 with the optimum cruise Mach number. Project horizontally to the right to intersect predicted flight-level temperature, then vertically downward to obtain corresponding true airspeed. Continue this projection vertically downward to intersect the interpolated specific range (obtained from sheet 1), then horizontally to the left to obtain total fuel flow required in pounds per hour.

**Sample Problem**

(2) Engines

A. Average gross weight for first leg	45,000 Lb
B. Cruise altitude	30,000 Ft
C. Computed drag index	40.0
D. Specific range	0.072 NMPP
E. Gross weight	45,000 Lb
F. Altitude	35,000 Ft
G. Drag index	40.0
H. True Mach number	0.83
J. True Mach number	0.83
K. Temperature at flight altitude	-40°C
L. True airspeed	495 Kt
M. Specific range	0.072 NMPP
N. Total fuel flow	6800 PPH

**SAMPLE CONSTANT ALTITUDE CRUISE**

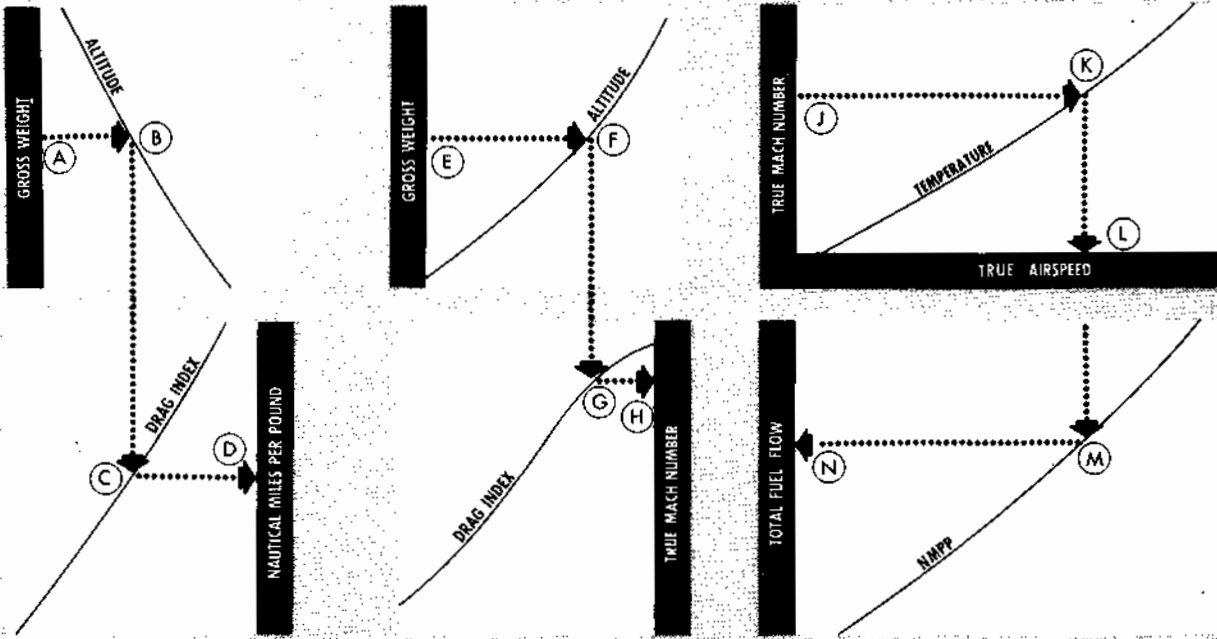

4E-1-(327)

F-4E

# RANGEWIND CORRECTION

AIRPLANE CONFIGURATION  
ALL CONFIGURATIONS



GUIDE

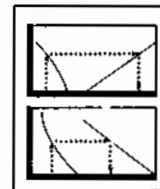

NOTE: RELATIVE WIND DIRECTION = ANGULAR DIFFERENCE  
MEASURED CLOCKWISE, BETWEEN AIRPLANE HEADING  
AND TRUE WIND DIRECTION

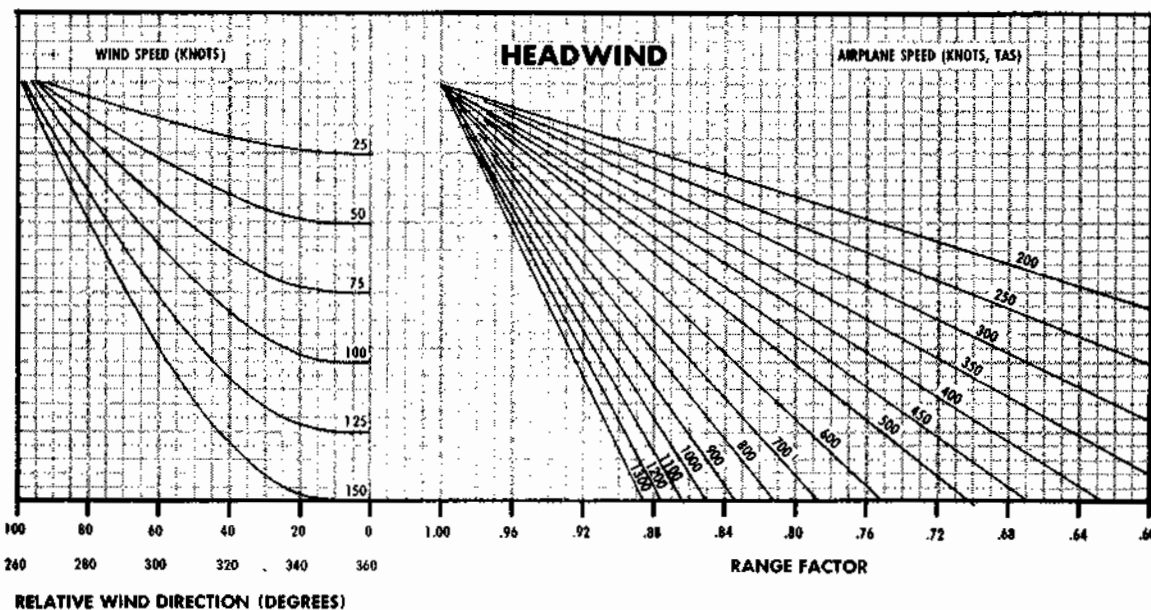
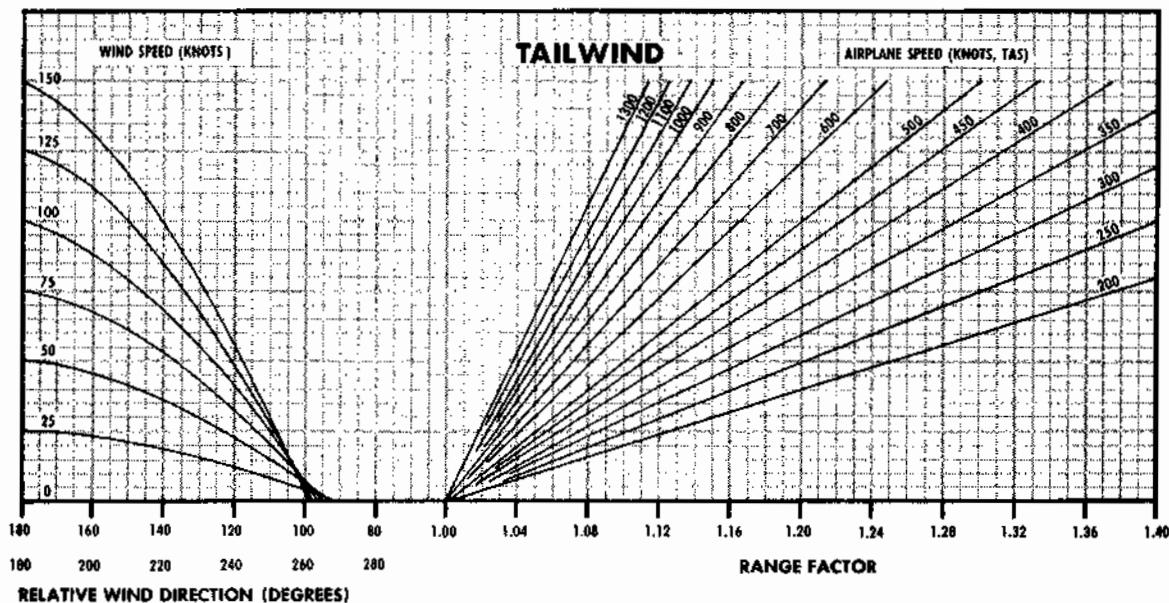

4E-1-(328)

Figure A4-1

**F-4E**

# OPTIMUM CRUISE SUMMARY

AIRPLANE CONFIGURATION  
INDIVIDUAL DRAG INDEXES

REMARKS  
ENGINE(S): (2) J79-GE-17  
ICAO STANDARD DAY

GUIDE

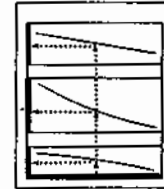

DATE: 1 JANUARY 1973  
DATA BASIS: FLIGHT TEST

FUEL GRADE: JP-4  
FUEL DENSITY: 6.5 LB/GAL

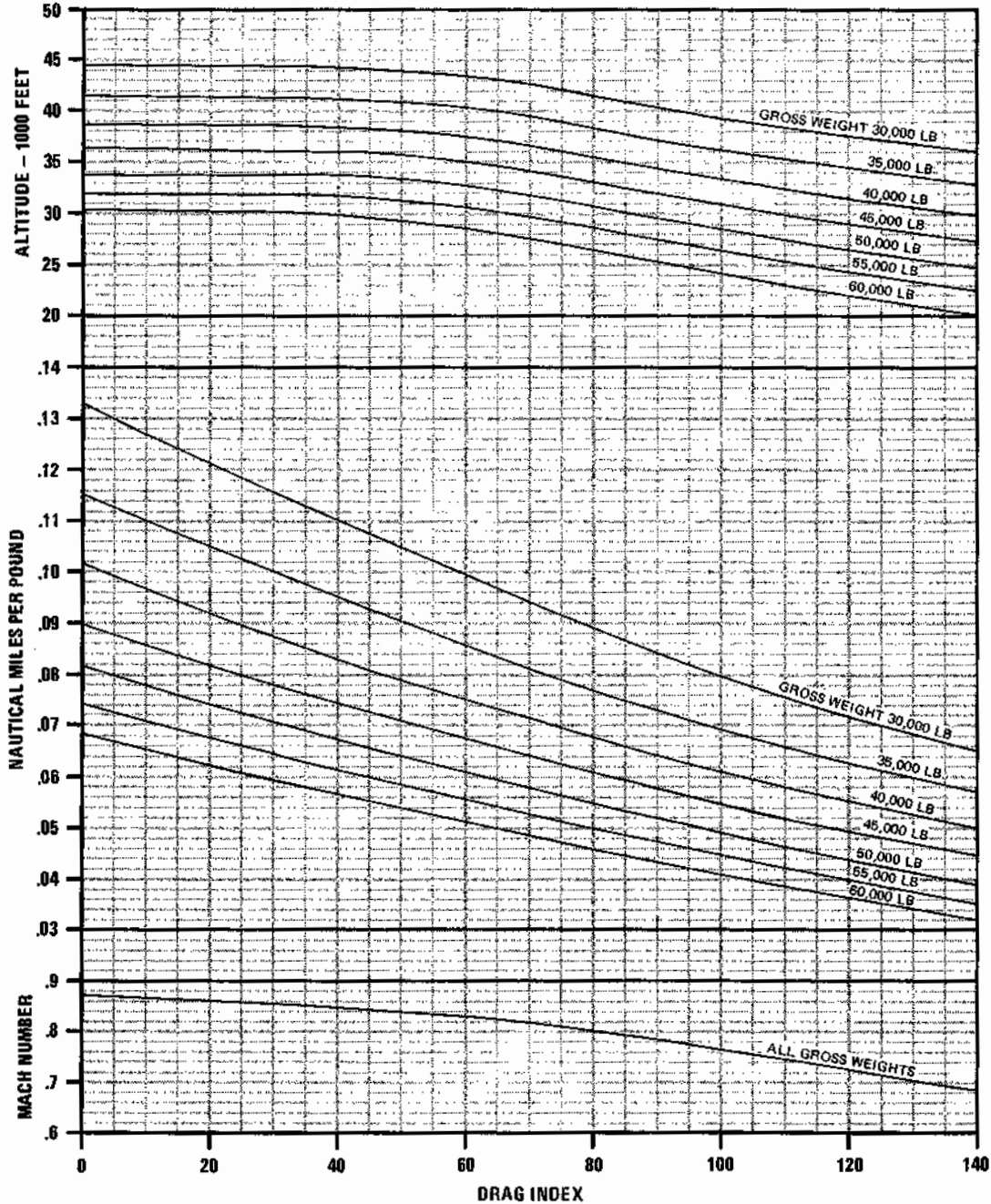

4E-1-(329)

Figure A4-2



**F-4E**

# OPTIMUM CRUISE SUMMARY

## ONE ENGINE OPERATING

AIRPLANE CONFIGURATION  
INDIVIDUAL DRAG INDEXES

**REMARKS**  
ENGINE(S): (2) J79-GE-17  
ICAO STANDARD DAY  
INOPERATIVE ENGINE WINDMILLING

**NOTE**  
IF INOPERATIVE ENGINE IS NOT  
WINDMILLING, INCREASE DRAG INDEX  
BY 53 ADDITIONAL UNITS.

GUIDE

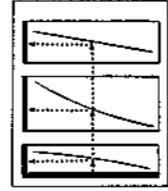

DATE: 1 JANUARY 1973  
DATA BASIS: FLIGHT TEST

FUEL GRADE: JP-4  
FUEL DENSITY: 6.5 LB/GAL

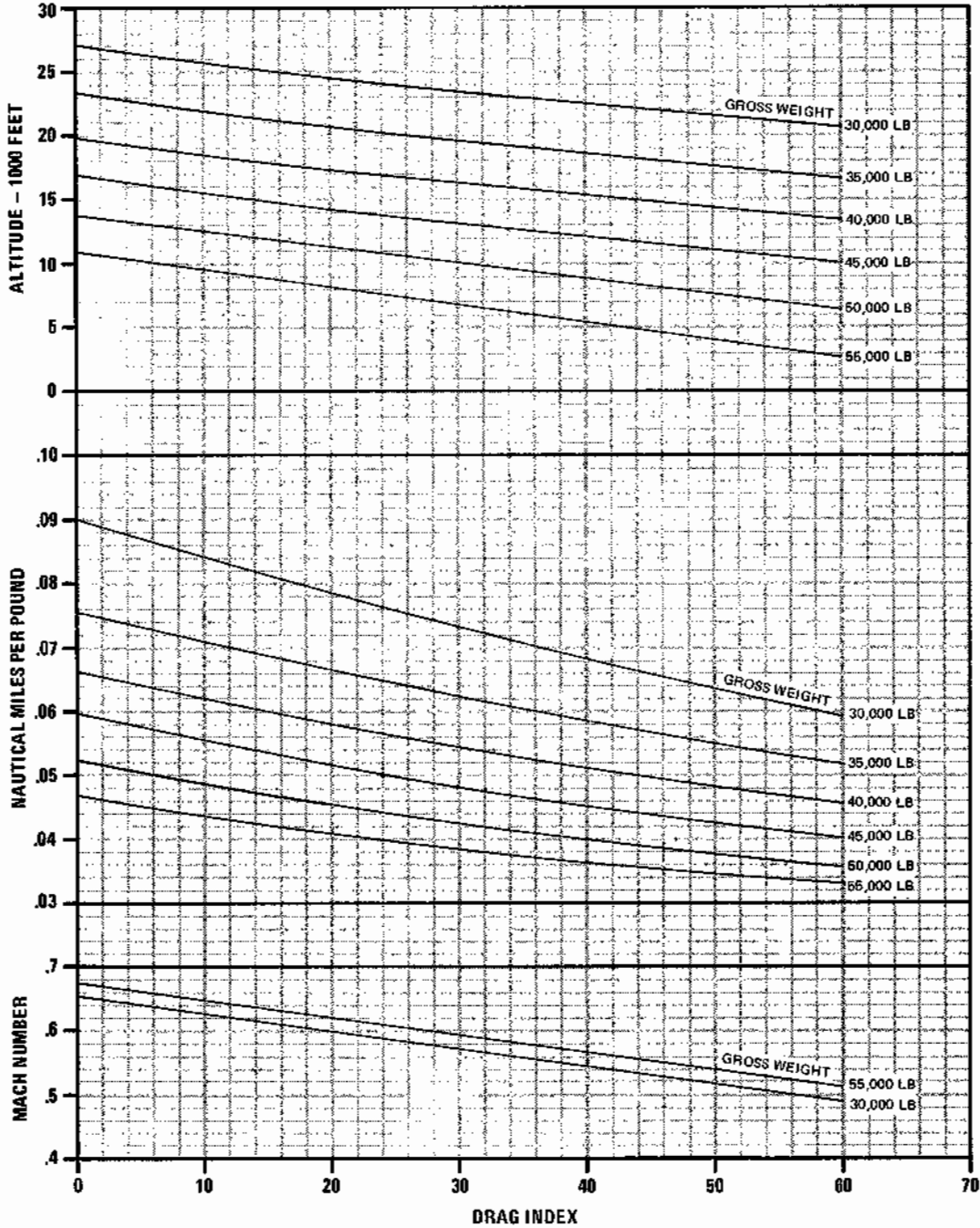

4E-1-(330)

Figure A4-3

**F-4E**

**LOW ALTITUDE CRUISE**

AIRPLANE CONFIGURATION  
INDIVIDUAL DRAG INDEXES

GROSS WEIGHT - 36,000 POUNDS  
REMARKS  
ENGINES: (2) J79-GE-17

DATE: 1 JANUARY 1973  
DATA BASIS: FLIGHT TEST

FUEL GRADE: JP-4  
FUEL DENSITY: 6.5 LB/GAL

	KTAS	DRAG INDEX	TOTAL FUEL FLOW - LBS/HR						TEMP EFFECTS	
			0	20	40	60	80	100	120	°C
SEA LEVEL (15°C)	360	7364	8144	8947	9771	10619	11480	12322		
	420	9320	10473	11681	12841	14166	15467	16828	-40	.899
	480	11704	13279	14953	16733	18562	20456	22861	-20	.937
	540	14769	16860	18957	21609	25049			0	.973
	600	20345	23408	27150					20	1.008
	MIL	28219	27948	27630	27183	26648	26042	25412	40	1.042
	VMAX	631.5	617.6	601.8	580.6	556.2	529.7	503.9		
4,000 FEET (7°C)	360	6625	7339	8063	8784	9527	10291	11099		
	420	8315	9347	10390	11463	12530	13777	15130	-40	.913
	480	10342	11750	13129	14752	16685	18575	20442	-20	.949
	540	13059	14926	16872	19783	22632			0	.987
	600	19049	22630						20	1.022
	MIL	25726	25431	25054	24647	24130	23600	23076	40	1.057
	VMAX	628.0	614.9	599.3	581.7	558.8	534.1	509.3		
8,000 FEET (-1°C)	360	5958	6588	7210	7886	8524	9188	9898		
	420	7392	8310	9232	10150	11136	12087	13241	-40	.925
	480	9135	10360	11613	12892	14475	16394	18465	-20	.963
	540	11573	13109	14800	17256	20364			0	1.001
	600	17694	21416						20	1.037
	MIL	23181	22832	22522	22175	21780	21379	21022	40	1.072
	VMAX	624.2	610.8	596.6	580.5	560.6	538.8	515.0		
12,000 FEET (-9°C)	360	5391	5938	6493	7043	7651	8220	8839		
	420	6575	7349	8170	9002	9859	10731	11614	-40	.939
	480	8070	9149	10226	11388	12599	14087	15935	-20	.978
	540	10221	11609	13025	14965	17519	19100		0	1.016
	600	16377	19967						20	1.052
	MIL	20795	20492	20248	19996	19741	19404	19079	40	1.088
	VMAX	620.1	606.2	592.9	578.3	561.8	541.6	518.8		
16,000 FEET (-16°C)	360	4910	5384	5862	6355	6837	7391	7907		
	420	5881	6566	7242	7963	8760	9536	10409	-40	.953
	480	7126	8060	8997	10035	11162	12331	13762	-20	.993
	540	9135	10332	11701	13449	15301	17280		0	1.032
	600	15451	17462						20	1.069
	MIL	18681	18436	18243	18080	17882	17569	17207	40	1.105
	VMAX	615.2	600.8	588.3	575.8	561.5	542.2	520.3		

Figure A4-4

F-4E

**LOW ALTITUDE CRUISE**AIRPLANE CONFIGURATION  
INDIVIDUAL DRAG INDEXESGROSS WEIGHT - 40,000 POUNDS  
REMARKS

ENGINES: (2) J79-GE-17

DATE: 1 JANUARY 1973  
DATA BASIS: FLIGHT TESTFUEL GRADE: JP-4  
FUEL DENSITY: 6.5 LB/GAL

	KTAS	DRAG INDEX	TOTAL FUEL FLOW - LBS/HR						TEMP EFFECTS	
			0	20	40	60	80	100	120	0°C
SEA LEVEL (15°C)	360	7605	8394	9195	10020	10871	11712	12590		
	420	9491	10655	11878	13028	14338	15672	17016	-40	.899
	480	11816	13392	15062	16837	18690	20582	23019	-20	.937
	540	14895	16984	19078	21739	25222			0	.973
	600	20480	23587	27322					20	1.008
	MIL	28202	27931	27612	27177	26610	26003	25383	40	1.042
	VMAX	630.9	617.0	601.1	580.0	554.8	528.4	502.6		
4,000 FEET (7°C)	360	6867	7566	8303	9046	9781	10543	11331		
	420	8501	9536	10578	11641	12719	13971	15364	-40	.913
	480	10495	11919	13295	14926	16832	18782	20622	-20	.949
	540	13161	15027	16995	19901	22786			0	.987
	600	19219	22856						20	1.022
	MIL	25710	25415	25037	24613	24094	23563	23048	40	1.057
	VMAX	627.3	614.3	598.6	580.4	557.5	532.8	508.0		
8,000 FEET (-1°C)	360	6237	6873	7497	8158	8842	9488	10190		
	420	7592	8511	9438	10368	11352	12318	13506	-40	.926
	480	9316	10550	11785	13088	14691	16613	18745	-20	.963
	540	11678	13216	14905	17406	20506			0	1.001
	600	17865	21662						20	1.037
	MIL	23165	22816	22506	22143	21755	21362	20974	40	1.072
	VMAX	623.6	610.1	596.8	579.2	559.3	537.5	513.0		
12,000 FEET (-9°C)	360	5685	6238	6792	7365	7948	8564	9156		
	420	6822	7602	8416	9240	10110	10995	11876	-40	.939
	480	8264	9343	10405	11549	12795	14306	16185	-20	.978
	540	10377	11757	13192	15137	17788			0	1.016
	600	16544	20214						20	1.052
	MIL	20787	20478	20218	19995	19724	19377	19058	40	1.088
	VMAX	619.5	605.5	591.6	577.7	560.6	539.6	516.8		
16,000 FEET (-16°C)	360	5267	5746	6232	6714	7242	7760	8330		
	420	6143	6828	7527	8235	9024	9830	10730	-40	.953
	480	7320	8255	9197	10241	11360	12574	14039	-20	.993
	540	9324	10501	11873	13630	15535	17532		0	1.032
	600	15628	17595						20	1.069
	MIL	18673	18428	18235	18064	17857	17542	17164	40	1.105
	VMAX	614.5	600.2	587.7	574.6	559.6	540.3	517.8		

4E-1-(332)

Figure A4-5

**F-4E**

**LOW ALTITUDE CRUISE**

GROSS WEIGHT -- 45,000 POUNDS

REMARKS

ENGINES: (2) J79-GE-17

AIRPLANE CONFIGURATION  
INDIVIDUAL DRAG INDEXES

DATE: 1 JANUARY 1973  
DATA BASIS: FLIGHT TEST

FUEL GRADE: JP-4  
FUEL DENSITY: 6.5 LB/GAL

	KTAS	DRAG INDEX	TOTAL FUEL FLOW - LBS/HR						TEMP EFFECTS	
			0	20	40	60	80	100	120	0°C
SEA LEVEL (15°C)	360	7823	8626	9448	10282	11135	11954	12870		
	420	9669	10843	12040	13221	14514	15883	17208	-40	.899
	480	11984	13561	15224	16992	18862	20769	23253	-20	.937
	540	15024	17109	19201	21870	25399			0	.973
	600	20617	23769	27485					20	1.008
	MIL	28215	27944	27607	27172	26604	25976	25342	40	1.042
	VMAX	630.9	617.0	600.5	579.3	554.2	527.0	501.3		
4,000 FEET (7°C)	360	7154	7856	8585	9333	10098	10861	11623		
	420	8717	9745	10791	11846	12964	14222	15668	-40	.913
	480	10677	12107	13493	15133	17029	18992	20833	-20	.949
	540	13265	15130	17119	20020	22943			0	.987
	600	19393	23085						20	1.022
	MIL	25720	25398	25020	24578	24087	23537	23001	40	1.057
	VMAX	627.3	613.6	598.0	579.1	556.9	531.5	506.0		
8,000 FEET (-1°C)	360	6540	7164	7832	8472	9140	9828	10524		
	420	7841	8760	9685	10617	11590	12598	13822	-40	.925
	480	9505	10733	11949	13290	14913	16839	19033	-20	.963
	540	11842	13382	15067	17642	20726			0	1.001
	600	18040	21915						20	1.037
	MIL	23150	22801	22499	22135	21730	21328	20947	40	1.072
	VMAX	623.0	609.5	595.3	578.6	558.0	535.5	511.1		
12,000 FEET (-9°C)	360	6049	6613	7163	7762	8346	8935	9573		
	420	7083	7890	8695	9507	10372	11244	12167	-40	.939
	480	8469	9536	10604	11743	13034	14573	16490	-20	.978
	540	10557	11910	13384	15333	18098			0	1.016
	600	16718	19100						20	1.052
	MIL	20752	20463	20218	19972	19685	19351	19014	40	1.088
	VMAX	618.2	604.9	591.0	576.4	558.6	537.8	514.3		
16,000 FEET (-16°C)	360	5690	6173	6656	7174	7690	8239	8779		
	420	6455	7128	7854	8581	9356	10168	11045	-40	.953
	480	7568	8503	9445	10500	11609	12879	14388	-20	.993
	540	9487	10676	12049	13816	15782			0	1.032
	600	15911							20	1.069
	MIL	18647	18420	18219	18028	17831	17495	17106	40	1.105
	VMAX	613.3	599.6	586.5	572.7	557.8	537.8	514.7		

Figure A4-6

**F-4E**

# LOW ALTITUDE CRUISE

AIRPLANE CONFIGURATION  
INDIVIDUAL DRAG INDEXES

GROSS WEIGHT - 50,000 POUNDS  
REMARKS  
ENGINES: (2) J79-GE-17

DATE: 1 JANUARY 1973  
DATA BASIS: FLIGHT TEST

FUEL GRADE: JP-4  
FUEL DENSITY: 6.5 LB/GAL

	KTAS	DRAG INDEX	TOTAL FUEL FLOW - LBS/HR						TEMP EFFECTS	
			0	20	40	60	80	100	120	0°C
15,000 FEET (-10°C)	360	8098	8901	9725	10573	11436	12255	13219	-40	.899
	420	9895	11055	12241	13464	14736	16127	17448	-20	.937
	480	12177	13755	15409	17169	19038	20982	23520	0	.973
	540	15151	17236	19326	22002	25578			20	1.008
	600	20755	23953	27610					40	1.042
	MIL	28198	27926	27620	27122	26566	25936	25293		
	VMAX	630.2	616.3	600.5	578.0	552.8	525.7	499.3		
12,000 FEET (-8°C)	360	7444	8184	8905	9644	10408	11188	11949	-40	.913
	420	8956	9991	11048	12091	13258	14523	16034	-20	.949
	480	10865	12271	13696	15345	17230	19171	21049	0	.987
	540	13421	15285	17305	20198	23177			20	1.022
	600	19569	23319						40	1.057
	MIL	25704	25382	25014	24571	24051	23502	22965		
	VMAX	626.7	613.0	597.3	578.4	555.6	529.5	504.1		
9,000 FEET (-5°C)	360	6911	7535	8194	8876	9527	10205	10926	-40	.925
	420	8109	9026	9948	10881	11842	12896	14158	-20	.963
	480	9714	10924	12135	13521	15168	17097	19243	0	1.001
	540	12028	13569	15251	17909	20975			20	1.037
	600	18218	22173						40	1.072
	MIL	23135	22801	22459	22103	21706	21276	20919		
	VMAX	622.3	609.5	594.0	577.3	556.8	533.0	509.2		
6,000 FEET (-2°C)	360	6461	7012	7622	8184	8784	9381	9997	-40	.939
	420	7384	8204	9035	9847	10704	11558	12536	-20	.978
	480	8713	9785	10860	11991	13340	14915	16879	0	1.016
	540	10733	12066	13582	15534	18419			20	1.052
	600	17013	19300						40	1.088
	MIL	20744	20456	20188	19949	19660	19331	18983		
	VMAX	617.6	604.3	589.7	575.7	556.8	535.8	511.8		
3,000 FEET (1°C)	360	6181	6664	7183	7698	8239	8768	9351	-40	.953
	420	6795	7486	8196	8933	9740	10563	11394	-20	.993
	480	7834	8767	9708	10773	11869	13194	14754	0	1.032
	540	9691	10894	12268	14046	16109			20	1.069
	600	16201							40	1.105
	MIL	18632	18398	18189	18022	17786	17454	17029		
	VMAX	612.0	598.3	584.6	571.5	555.3	535.3	510.4		

Figure A4-7

**F-4E**

**LOW ALTITUDE CRUISE**

AIRPLANE CONFIGURATION  
INDIVIDUAL DRAG INDEXES

GROSS WEIGHT - 55,000 POUNDS  
REMARKS  
ENGINES: (2) J79-GE-17

DATE: 1 JANUARY 1973  
DATA BASIS: FLIGHT TEST

FUEL GRADE: JP-4  
FUEL DENSITY: 6.5 LB/GAL

	KTAS	DRAG INDEX	TOTAL FUEL FLOW - LBS/HR						TEMP EFFECTS	
			0	20	40	60	80	100	120	0°C
SEA LEVEL (15°C)	360	8414	9216	10041	10891	11731	12594	13546		
	420	10132	11311	12488	13763	15006	16377	17741	-40	.899
	480	12377	13955	15598	17349	19217	21199	23794	-20	.937
	540	15286	17376	19471	22183	25823			0	.973
	600	20896	24141						20	1.008
	MIL	28181	27909	27802	27117	26660	25890	25256	40	1.042
	VMAX	629.6	615.7	599.8	577.3	552.3	523.7	497.3		
4,000 FEET (7°C)	360	7793	8524	9273	10033	10792	11540	12352		
	420	9209	10250	11317	12347	13566	14836	16305	-40	.913
	480	11055	12439	13906	15564	17436	19354	21269	-20	.949
	540	13602	15464	17521	20404	23448			0	.987
	600	19745	23559						20	1.022
	MIL	25688	25305	24997	24547	24026	23428	22928	40	1.057
	VMAX	626.0	612.3	596.7	577.1	554.3	526.9	502.1		
8,000 FEET (-1°C)	360	7274	7946	8595	9255	9941	10628	11313		
	420	8433	9359	10289	11231	12173	13289	14604	-40	.925
	480	9956	11183	12387	13824	15513	17445	19514	-20	.963
	540	12196	13762	15438	18184	21230			0	1.001
	600	18499	22583						20	1.037
	MIL	23120	22761	22452	22079	21664	21258	20891	40	1.072
	VMAX	621.7	608.2	593.4	576.0	554.8	531.0	506.6		
12,000 FEET (-9°C)	360	6940	7539	8107	8713	9297	9897	10550		
	420	7714	8524	9344	10166	11036	11892	12929	-40	.939
	480	8972	10047	11128	12249	13628	15273	17288	-20	.978
	540	10904	12235	13777	15752	18770			0	1.016
	600	17318	19934						20	1.052
	MIL	20716	20420	20187	19933	19627	19295	18926	40	1.088
	VMAX	616.3	603.0	589.1	573.9	554.8	533.3	508.0		
16,000 FEET (-16°C)	360	6807	7349	7848	8402	8915	9499	10152		
	420	7168	7892	8626	9340	10156	10985	11820	-40	.953
	480	8162	9103	10052	11115	12214	13585	15245	-20	.993
	540	9950	11172	12546	14337	16526			0	1.032
	600	16501							20	1.069
	MIL	18610	18377	18173	17992	17746	17403	16941	40	1.105
	VMAX	610.8	597.1	583.3	569.6	552.8	532.2	505.4		

Figure A4-8

F-4E

# LOW ALTITUDE CRUISE

GROSS WEIGHT -- 60,000 POUNDS

REMARKS

ENGINES: (2) J79-GE-17

AIRPLANE CONFIGURATION  
INDIVIDUAL DRAG INDEXES

DATE: 1 JANUARY 1973  
DATA BASIS: FLIGHT TEST

FUEL GRADE: JP-4  
FUEL DENSITY: 6.5 LB/GAL

	KTAS	DRAG INDEX	TOTAL FUEL FLOW - LBS/HR						TEMP EFFECTS	
			0	20	40	60	80	100	120	0°C
SEA LEVEL (150°C)	360	8731	9554	10399	11261	12070	12985	13888		
	420	10379	11579	12745	14044	15287	16635	18044	-40	.899
	480	12556	14161	15792	17533	19399	21421	24074	-20	.937
	540	15454	17546	19645	22410	26130			0	.973
	600	21038	24331						20	1.008
	MIL	28181	27892	27585	27080	26503	25823	25186	40	1.042
	VMAX	629.6	615.0	599.1	576.0	550.2	521.1	494.6		
4,000 FEET (70°C)	360	8196	8919	9658	10421	11200	11942	12813		
	420	9532	10575	11638	12669	13907	15232	16616	-40	.913
	480	11306	12689	14206	15888	17742	19622	21594	-20	.949
	540	13788	15647	17742	20614	23726			0	.987
	600	19970	23881						20	1.022
	MIL	25672	25349	24963	24485	24001	23393	22882	40	1.057
	VMAX	625.4	611.7	595.4	575.2	553.0	524.9	499.5		
8,000 FEET (-10°C)	360	7792	8435	9105	9792	10460	11137	11849		
	420	8744	9669	10601	11530	12523	13683	15078	-40	.925
	480	10211	11454	12650	14110	15874	17808	19792	-20	.963
	540	12352	13961	15631	18467	21491			0	1.001
	600	18809	21421						20	1.037
	MIL	23104	22754	22420	22055	21656	21215	20826	40	1.072
	VMAX	621.0	607.5	592.1	574.8	553.5	528.5	502.7		
12,000 FEET (-80°C)	360	7577	8141	8744	9333	9929	10560	11153		
	420	8124	8956	9755	10566	11414	12332	13460	-40	.939
	480	9288	10357	11424	12559	13971	15705	17781	-20	.978
	540	11150	12478	14017	16097	19283			0	1.016
	600	17634	20147						20	1.052
	MIL	20687	20398	20164	19901	19586	19250	18860	40	1.088
	VMAX	615.0	601.7	587.8	572.0	552.3	530.2	503.6		
16,000 FEET (-100°C)	360	7559	8079	8614	9155	9748	10422	10992		
	420	7640	8342	9072	9827	10669	11433	12341	-40	.953
	480	8476	9418	10375	11423	12586	14007	15779	-20	.993
	540	10224	11433	12837	14640	16965			0	1.032
	600	16839							20	1.068
	MIL	18570	18356	18162	17953	17676	17343	16843	40	1.105
	VMAX	608.9	595.8	582.1	567.1	549.0	528.4	499.7		

Figure A4-9

# HIGH ALTITUDE CRUISE

AIRPLANE CONFIGURATION  
INDIVIDUAL DRAG INDEXES

GROSS WEIGHT - 35,000 POUNDS  
REMARKS  
ENGINES: (2) J79-GE-17

DATE: 1 JANUARY 1973  
DATA BASIS: FLIGHT TEST

FUEL GRADE: JP-4  
FUEL DENSITY: 6.5 LB/GAL

	KTAS	DRAG INDEX	TOTAL FUEL FLOW - LBS/HR						TEMP EFFECTS		
			0	20	40	60	80	100	120	0°C	FACTOR
20,000 FEET (-25°C)	360	4553		4969	5393	5821	6252	6684	7185	-40	.968
	400	5032		5562	6101	6625	7208	7802	8474	-20	1.008
	440	5615		6276	6912	7626	8393	9224	10190	0	1.048
	480	6331		7099	7907	8833	9868	11079	12286	20	1.085
	520	7319		8259	9257	10640	12062	13822		40	1.122
	560	9375		10626	12397	14550					
	MIL	16941		16645	16412	16214	15999	15690	15274		
	VMAX	611.7		586.4	584.1	571.2	557.1	539.9	518.4		
	25,000 FEET (-35°C)	360	4239		4592	4951	5311	5669	6043	6407	-40
400		4523		4968	5422	5870	6329	6808	7341	-20	1.029
440		4949		5495	6042	6591	7220	7869	8634	0	1.069
480		5505		6156	6777	7551	8385	9323	10525	20	1.108
520		6410		7150	8037	9149	10376	11823		40	1.145
560		8515		9697	11267	13263					
MIL		14493		14163	13901	13641	13365	13000	12546		
VMAX		604.2		587.4	574.1	561.5	548.2	530.8	509.1		
30,000 FEET (-44°C)		360	4165		4455	4746	5041	5344	5677	6032	-40
	400	4207		4569	4923	5286	5693	6124	6613	-20	1.051
	440	4439		4875	5312	5787	6313	6912	7612	0	1.092
	480	4859		5381	5907	6565	7307	8237	9361	20	1.131
	520	5672		6288	7097	8098	9152			40	1.170
	560	7929		9143	10529						
	MIL	11871		11526	11268	11017	10732	10383	9887		
	VMAX	591.6		574.5	561.5	548.5	533.8	516.1	490.2		
	35,000 FEET (-55°C)	360	4170		4432	4715	5013	5338	5708		-40
400		4092		4404	4720	5080	5490	5943		-20	1.074
440		4111		4472	4850	5284	5811	6414		0	1.116
480		4383		5215	5716	6432	7221	8224		20	1.157
520		5159		5734	6574	7625				40	1.196
560		7804									
MIL		9359		9065	8814	8602	8321	7944			
VMAX		572.8		557.8	544.6	531.3	514.0	491.6			
40,000 FEET (-57°C)		360	4597		4898						-40
	400	4121		4430	4766	5149				-20	1.080
	440	4055		4380	4756	5221				0	1.122
	480	4166		4550	5002	5655				20	1.162
	520	4798		5339	6189					40	1.202
	560										
	MIL	7190		7012	6812	6519					
	VMAX	559.1		544.7	528.7	505.2					

Figure A4-10



F-4E

TO 1F-4E-1

# HIGH ALTITUDE CRUISE

AIRPLANE CONFIGURATION  
INDIVIDUAL DRAG INDEXES

GROSS WEIGHT - 40,000 POUNDS  
REMARKS  
ENGINES: (2) J79-GE-17

DATE: 1 JANUARY 1973  
DATA BASIS: FLIGHT TEST

FUEL GRADE: JP-4  
FUEL DENSITY: 6.5 LB/GAL

	KTAS	DRAG INDEX	TOTAL FUEL FLOW - LBS/HR						TEMP EFFECTS	
			0	20	40	60	80	100	120	0°C
20,000 FEET (-25°C)	360	4978	5403	5830	6260	6681	7176	7642	-40	0.968
	400	5362	5894	6436	6957	7562	8173	8850	-20	1.008
	440	5903	6560	7196	7906	8708	9575	10566	0	1.048
	480	6577	7344	8149	9085	10154	11348	12618	20	1.085
	520	7499	8440	9447	10863	12290	14088		40	1.122
	560	9577	10849	12652	14834					
	MIL	16904	16607	16374	16197	15982	15654	15201		
	VMAX	609.9	594.5	582.3	570.0	555.8	538.0	514.7		
25,000 FEET (-35°C)	360	4813	5173	5532	5890	6241	6632	7059	-40	0.988
	400	4928	5380	5833	6269	6729	7249	7786	-20	1.029
	440	5273	5817	6362	6906	7542	8240	9035	0	1.069
	480	5792	6438	7059	7831	8678	9682	10804	20	1.108
	520	6636	7395	8283	9418	10681	12185		40	1.145
	560	8763	9951	11564						
	MIL	14434	14127	13879	13604	13302	12924	12422		
	VMAX	601.2	585.6	572.9	559.7	545.2	527.2	503.1		
30,000 FEET (-45°C)	360	4837	5139	5441	5761	6104	6500	6951	-40	1.009
	400	4741	5099	5466	5857	6294	6773	7326	-20	1.051
	440	4825	5260	5705	6198	6749	7403	8181	0	1.092
	480	5186	5706	6240	6927	7724	8680		20	1.131
	520	5979	6600	7461	8496	9659			40	1.170
	560	8270	9515							
	MIL	11772	11467	11209	10960	10653	10219	9635		
	VMAX	586.8	571.5	558.6	545.6	529.7	507.9	476.1		
35,000 FEET (-55°C)	360	4925	5242	5580	5946	6338			-40	1.032
	400	4632	4975	5345	5748	6226			-20	1.074
	440	4620	5005	5421	5932	6509			0	1.116
	480	5202	5688	6248	7022	7919			20	1.157
	520	5570	6171	7096	8116				40	1.196
	560	8332								
	MIL	9246	8963	8731	8473	8098				
	VMAX	567.1	552.7	539.4	523.3	500.8				
40,000 FEET (-57°C)	360								-40	1.037
	400	5078							-20	1.080
	440	4689	5105						0	1.122
	480	4775	5239						20	1.162
	520	5397	6044						40	1.202
	560									
	MIL	7055	6869							
	VMAX	548.2	533.3							

4E-1(338)

Figure A4-11

**F-4E**

**HIGH ALTITUDE CRUISE**

AIRPLANE CONFIGURATION  
INDIVIDUAL DRAG INDEXES

GROSS WEIGHT - 45,000 POUNDS  
REMARKS  
ENGINES: (2) J79-GE-17

DATE: 1 JANUARY 1973  
DATA BASIS: FLIGHT TEST

FUEL GRADE: JP-4  
FUEL DENSITY: 6.5 LB/GAL

	KTAS	DRAG INDEX	TOTAL FUEL FLOW - LBS/HR						TEMP EFFECTS	
			0	20	40	60	80	100	120	0°C
20,000 FEET (-25°C)	360	5511	5934	6358	6792	7273	7741	8270	-40	.968
	400	5742	6275	6798	7381	7963	8609	9324	-20	1.008
	440	6214	6851	7536	8237	9051	9948	10974	0	1.048
	480	6838	7622	8421	9367	10475	11646	12988	20	1.085
	520	7752	8691	9710	11139	12605	14456		40	1.122
	560	9789	11080	12918	15129					
	MIL	16867	16587	16362	16181	15956	15583	15118		
	VMAX	608.0	593.3	581.0	568.7	554.0	534.4	510.4		
25,000 FEET (-35°C)	360	5589	5867	6219	6588	7003	7402	7848	-40	.988
	400	5424	5871	6306	6743	7254	7773	8375	-20	1.029
	440	5656	6195	6712	7312	7947	8677	9550	0	1.069
	480	6107	6730	7399	8173	9035	10119	11308	20	1.108
	520	6903	7667	8563	9733	11044	12409		40	1.145
	560	9055	10275	11943						
	MIL	14387	14079	13830	13552	13238	12810	12233		
	VMAX	598.8	583.1	570.5	557.3	542.2	521.8	494.1		
30,000 FEET (-44°C)	360	5479	5801	6145	6524	6956	7352		-40	1.009
	400	5328	5706	6108	6527	7048	7551		-20	1.051
	440	5297	5741	6203	6718	7344	8069		0	1.092
	480	5566	6092	6635	7385	8257	9192		20	1.131
	520	6308	6948	7840	8904	9967			40	1.170
	560	8658	9864							
	MIL	11692	11396	11131	10846	10490	9984			
	VMAX	582.7	568.0	554.4	539.7	521.4	495.5			
35,000 FEET (-55°C)	360	6058	6438						-40	1.032
	400	5347	5743	6183	6616				-20	1.074
	440	5196	5636	6129	6671				0	1.116
	480	5759	6311	6926	7879				20	1.157
	520	6050	6706	7713					40	1.196
	560	8950								
	MIL	9133	8860	8621	8244					
	VMAX	561.3	547.5	532.5	509.4					
40,000 FEET (-57°C)	360								-40	1.037
	400								-20	1.080
	440	5635							0	1.122
	480	5407							20	1.162
	520	6166							40	1.202
	560									
	MIL	6862								
	VMAX	532.7								

Figure A4-12

F-4E

TO 1F-4E-1

# HIGH ALTITUDE CRUISE

AIRPLANE CONFIGURATION  
INDIVIDUAL DRAG INDEXES

GROSS WEIGHT - 50,000 POUNDS

REMARKS

ENGINES: (2) J79-GE-17

DATE: 1 JANUARY 1973  
DATA BASIS: FLIGHT TEST

FUEL GRADE: JP-4  
FUEL DENSITY: 6.5 LB/GAL

	KTAS	DRAG INDEX	TOTAL FUEL FLOW - LBS/HR						TEMP EFFECTS	
			0	20	40	60	80	100	120	0°C
20,000 FEET (-25°C)	360	6146	6566	7029	7491	7972	8490	9036		
	400	6211	6734	7306	7863	8507	9171	10049	-40	.968
	440	6580	7217	7899	8650	9491	10415	11396	-20	1.008
	480	7135	7943	8771	9737	10896	12035	13473	0	1.048
	520	8002	8947	9978	11397	12936	14843		20	1.085
	560	10102	11381	13321	15575				40	1.122
	MIL	16830	16562	16334	16143	15900	15517	15008		
	VMAX	606.2	592.1	579.2	566.3	550.9	530.7	504.9		

25,000 FEET (-35°C)	360	6166	6528	6936	7321	7738	8213	8714		
	400	6052	6481	6944	7417	7951	8544	9234	-40	.988
	440	6104	6824	7183	7770	8468	9258	10209	-20	1.029
	480	6475	7095	7755	8564	9475	10672	11811	0	1.069
	520	7232	8004	8928	10147	11503			20	1.108
	560	9367	10620	12348					40	1.145
	MIL	14314	14034	13768	13492	13125	12672	11967		
	VMAX	595.2	580.7	567.5	554.2	536.8	515.1	481.4		

30,000 FEET (-44°C)	360	6294	6692	7132	7476	7857				
	400	5929	6332	6781	7265	7792			-40	1.009
	440	5871	6334	6835	7428	8138			-20	1.051
	480	6028	6557	7162	7978	8850			0	1.092
	520	6720	7411	8333	9338				20	1.131
	560	9092	10270						40	1.170
	MIL	11609	11313	11039	10734	10266				
	VMAX	578.6	563.9	549.7	533.8	510.2				

35,000 FEET (-55°C)	360									
	400	6290	6729						-40	1.032
	440	5849	6343	6873					-20	1.074
	480	6363	6965	7668					0	1.116
	520	6649	7413						20	1.157
	560								40	1.196
	MIL	8974	8722	8417						
	VMAX	553.2	538.8	519.8						

40,000 FEET (-57°C)	360									
	400									
	440									
	480									
	520									
	560									
	MIL									
	VMAX									

4E-1 (340)

Figure A4-13

**F-4E**

# HIGH ALTITUDE CRUISE

GROSS WEIGHT - 55,000 POUNDS

REMARKS

ENGINES: (2) J79-GE-17

AIRPLANE CONFIGURATION  
INDIVIDUAL DRAG INDEXES

DATE: 1 JANUARY 1973  
DATA BASIS: FLIGHT TEST

FUEL GRADE: JP-4  
FUEL DENSITY: 6.5 LB/GAL

	KTAS	DRAG INDEX	TOTAL FUEL FLOW - LBS/HR						TEMP EFFECTS		
			0	20	40	60	80	100	120	0°C	FACTOR
20,000 FEET (-25°C)	360	6888		7362	7827	8336	8840	9456	10442		
	400	6733		7305	7862	8476	9134	9955	11061	-40	.968
	440	6942		7631	8313	9074	9959	10933	11878	-20	1.008
	480	7459		8261	9095	10101	11243	12450	13997	0	1.048
	520	8288		9246	10308	11739	13378	15360		20	1.085
	560	10394		11693	13700	16047				40	1.122
	MIL	16797		16529	16292	16092	15830	15432	14850		
	VMAX	604.4		590.2	576.7	563.2	547.2	526.4	496.9		
25,000 FEET (-35°C)	360	6863		7255	7664	8115	8583	9134			
	400	6645		7133	7596	8123	8714	9411		-40	.988
	440	6584		7136	7694	8342	9086	9962		-20	1.029
	480	6841		7510	8173	8997	10003	11166		0	1.069
	520	7584		8365	9312	10588	12000			20	1.108
	560	9763		11033	12882					40	1.145
	MIL	14270		13986	13704	13391	13000	12434			
	VMAX	592.8		578.3	564.5	549.4	530.8	503.7			
30,000 FEET (-44°C)	360	7415		7787							
	400	6630		7121	7586	8117				-40	1.009
	440	6427		6943	7502	8178				-20	1.051
	480	6528		7123	7776	8650				0	1.092
	520	7187		7909	8867	9976				20	1.131
	560	9609								40	1.170
	MIL	11514		11233	10936	10513					
	VMAX	573.9		559.7	544.4	522.6					
35,000 FEET (-55°C)	360										
	400									-40	1.032
	440	6686								-20	1.074
	480	7068								0	1.116
	520	7363								20	1.157
	560									40	1.196
	MIL	8786									
	VMAX	542.9									
40,000 FEET (-57°C)	360										
	400										
	440										
	480										
	520										
	560										
	MIL										
	VMAX										

Figure A4-14

**F-4E**

# CONSTANT MACH/ALTITUDE CRUISE

**AIRPLANE CONFIGURATION**  
INDIVIDUAL DRAG INDEXES

DATE: 1 JANUARY 1973  
DATA BASIS: FLIGHT TEST

**REMARKS**  
ENGINE(S): (2) J79-GE-17  
ICAO STANDARD DAY

GUIDE

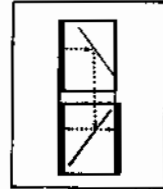

FUEL GRADE: JP-4  
FUEL DENSITY: 6.5 LB/GAL

ICAO STANDARD DAY	
ALT. FT.	TEMP. °C
S.L.	15.0
5,000	5.1
10,000	-4.8
15,000	-14.7
20,000	-24.6
25,000	-34.5
30,000	-44.4
35,000	-54.3
40,000	-54.5
45,000	-56.5
50,000	-56.5

FUEL FLOW CORRECTION FACTORS						
TEMPERATURE °C	-60	-40	-20	0	20	40
FUEL FLOW FACTOR	0.88	0.92	0.96	1.00	1.04	1.07

**0.60 MACH**

**0.70 MACH**

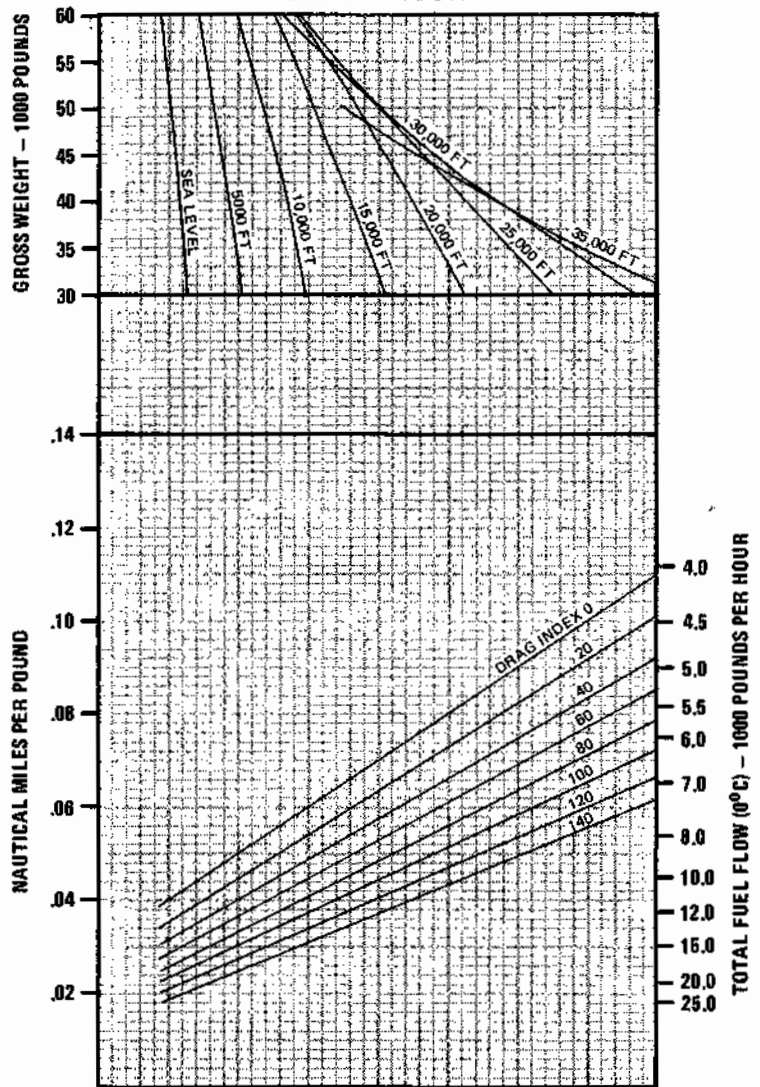
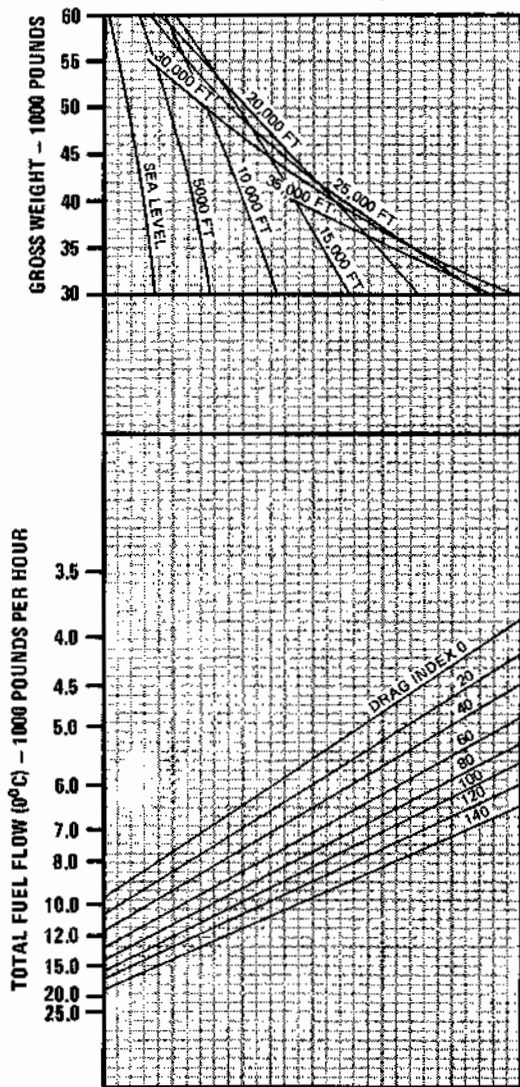

Figure A4-15

**F-4E**

# CONSTANT MACH/ALTITUDE CRUISE

**AIRPLANE CONFIGURATION**  
INDIVIDUAL DRAG INDEXES

ICAO STANDARD DAY	
ALT. FT.	TEMP. °C
S.L.	15.0
5000	5.1
10,000	-4.8
15,000	-14.7
20,000	-24.6
25,000	-34.5
30,000	-44.4
35,000	-54.3
40,000	-56.5
45,000	-56.5
50,000	-56.5

**REMARKS**  
ENGINE(S): (2) J79-GE-17  
ICAO STANDARD DAY

GUIDE

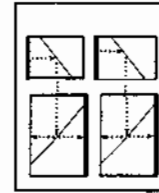

FUEL GRADE: JP-4  
FUEL DENSITY: 6.5 LB/GAL

DATE: 1 JANUARY 1973  
DATA BASIS: FLIGHT TEST

FUEL FLOW CORRECTION FACTORS						
TEMPERATURE °C	-60	-40	-20	0	20	40
FUEL FLOW FACTOR	0.88	0.92	0.96	1.00	1.04	1.07

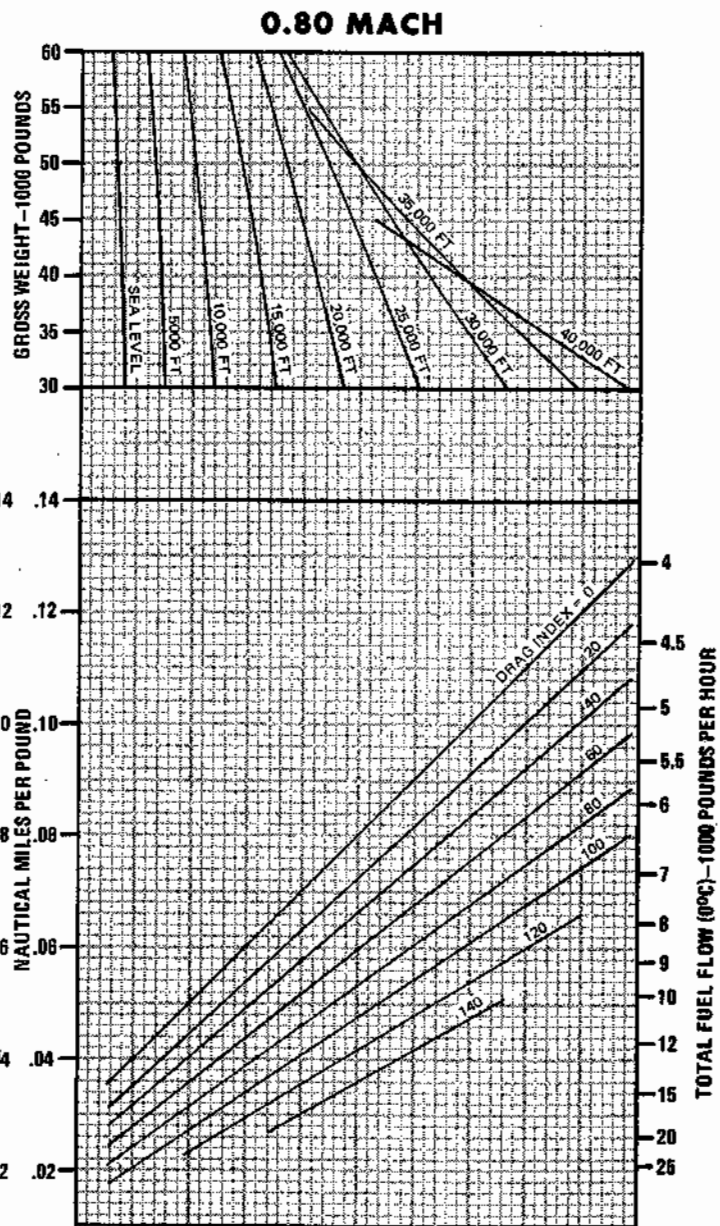
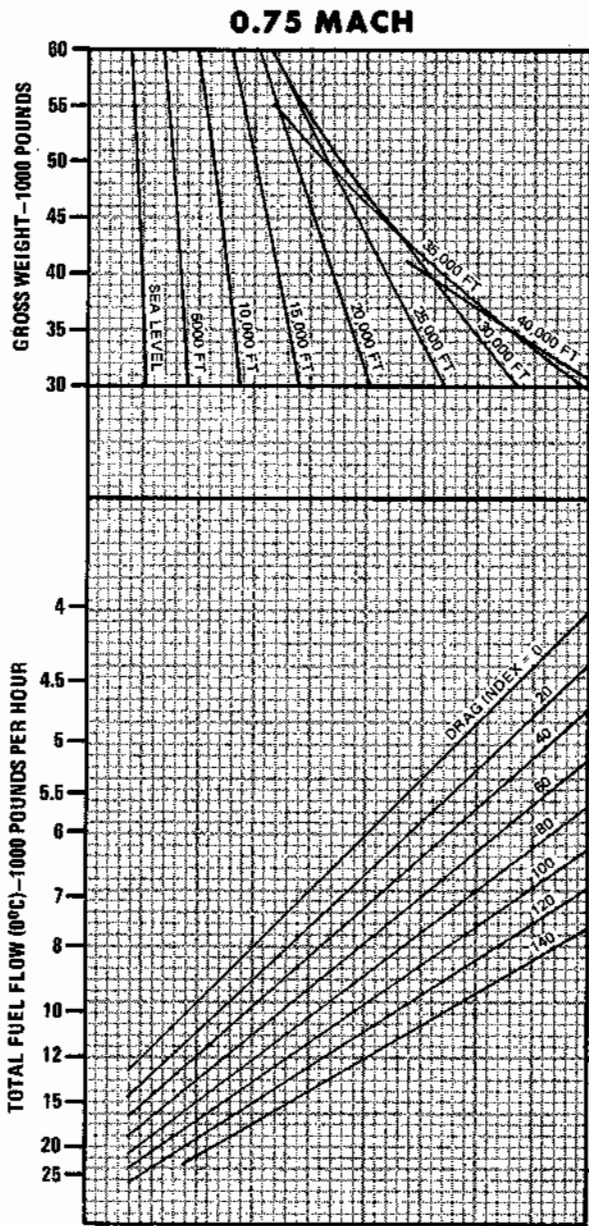

4E-1-12851

Figure A4-16

# CONSTANT MACH/ALTITUDE CRUISE

**AIRPLANE CONFIGURATION**  
INDIVIDUAL DRAG INDEXES

**REMARKS**  
ENGINE(S): (2) J79-GE-17  
ICAO STANDARD DAY

GUIDE

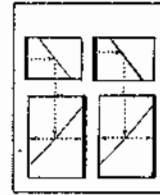

ICAO STANDARD DAY	
ALT. FT.	TEMP. °C
S.L.	15.0
5000	5.1
10,000	-4.8
15,000	-14.7
20,000	-24.6
25,000	-34.5
30,000	-44.4
35,000	-54.3
40,000	-56.5
45,000	-56.5
50,000	-56.5

FUEL GRADE: JP-4  
FUEL DENSITY: 6.5 LB/GAL

FUEL FLOW CORRECTION FACTORS						
TEMPERATURE °C	-60	-40	-20	0	20	40
FUEL FLOW FACTOR	0.88	0.92	0.96	1.00	1.04	1.07

DATE: 1 JANUARY 1973  
DATA BASIS: FLIGHT TEST

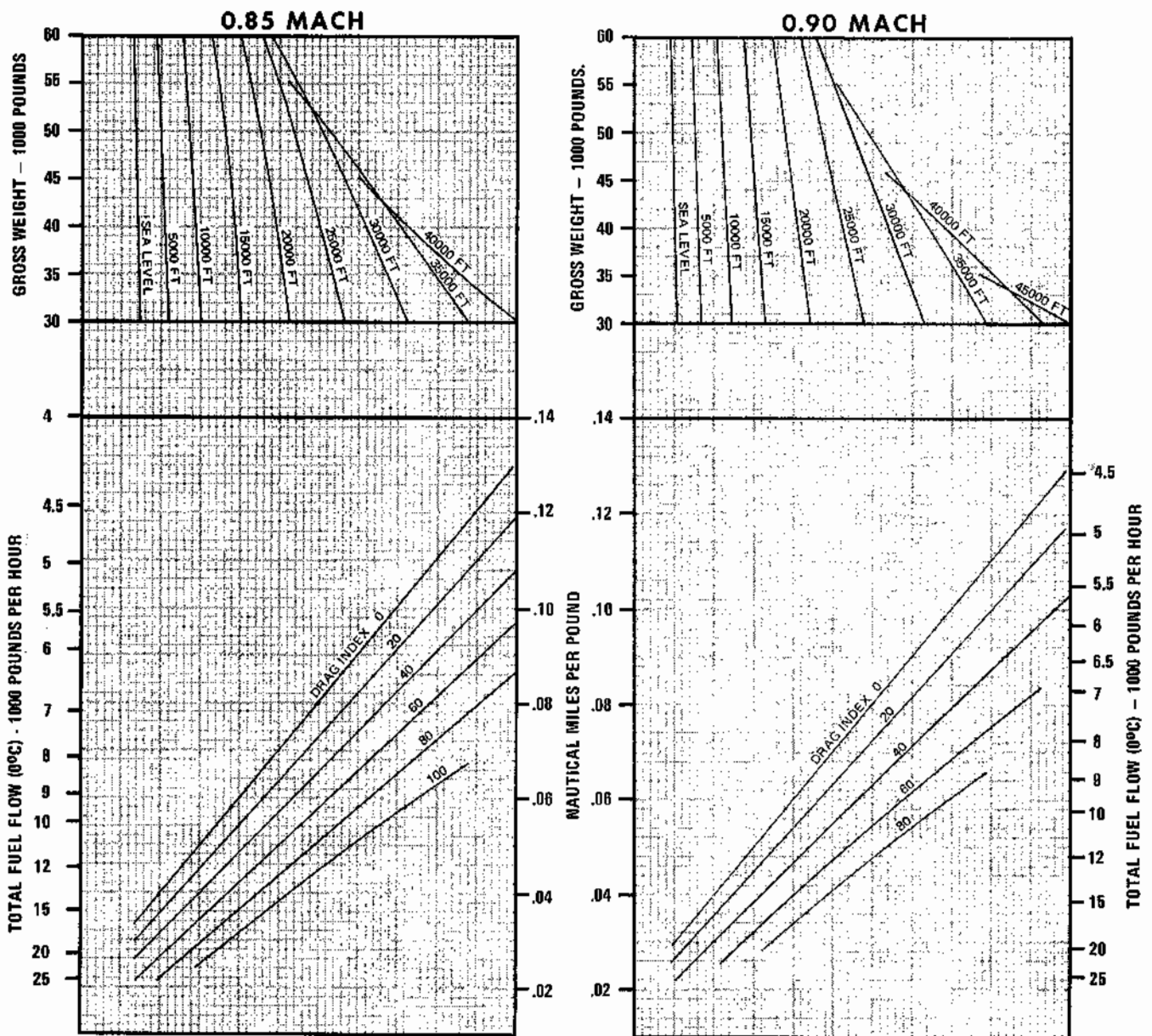

4E-1-(343)

Figure A4-17

# CONSTANT MACH / ALTITUDE CRUISE ONE ENGINE OPERATING

**AIRPLANE CONFIGURATION  
INDIVIDUAL DRAG INDEXES**

ICAO STANDARD DAY	
ALT. FT.	TEMP. °C
S.L.	15.0
5000	5.1
10,000	-4.8
15,000	-14.7
20,000	-24.6
25,000	-34.5
30,000	-44.4
35,000	-54.3
40,000	-56.5
45,000	-56.5
50,000	-56.5

DATE: 1 JANUARY 1973  
DATA BASIS: FLIGHT TEST

**REMARKS**  
ENGINE(S): (2) J79-GE-17  
INOPERATIVE ENGINE WINDMILLING  
ICAO STANDARD DAY

**NOTE**  
IF INOPERATIVE ENGINE IS NOT  
WINDMILLING, INCREASE DRAG INDEX  
BY 53 ADDITIONAL UNITS

GUIDE

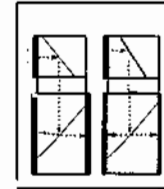

FUEL GRADE: JP-4  
FUEL DENSITY: 6.5 LB/GAL

**FUEL FLOW CORRECTION FACTORS**

TEMPERATURE °C	-60	-40	-20	0	20	40
FUEL FLOW FACTOR	0.88	0.92	0.96	1.00	1.04	1.07

**0.40 MACH**

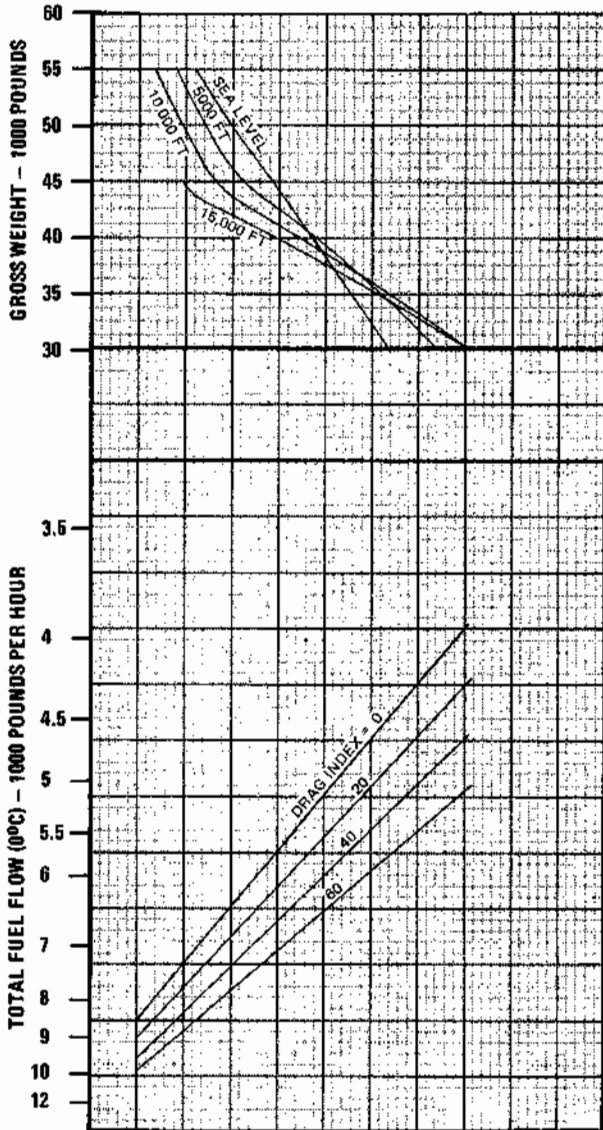

**0.45 MACH**

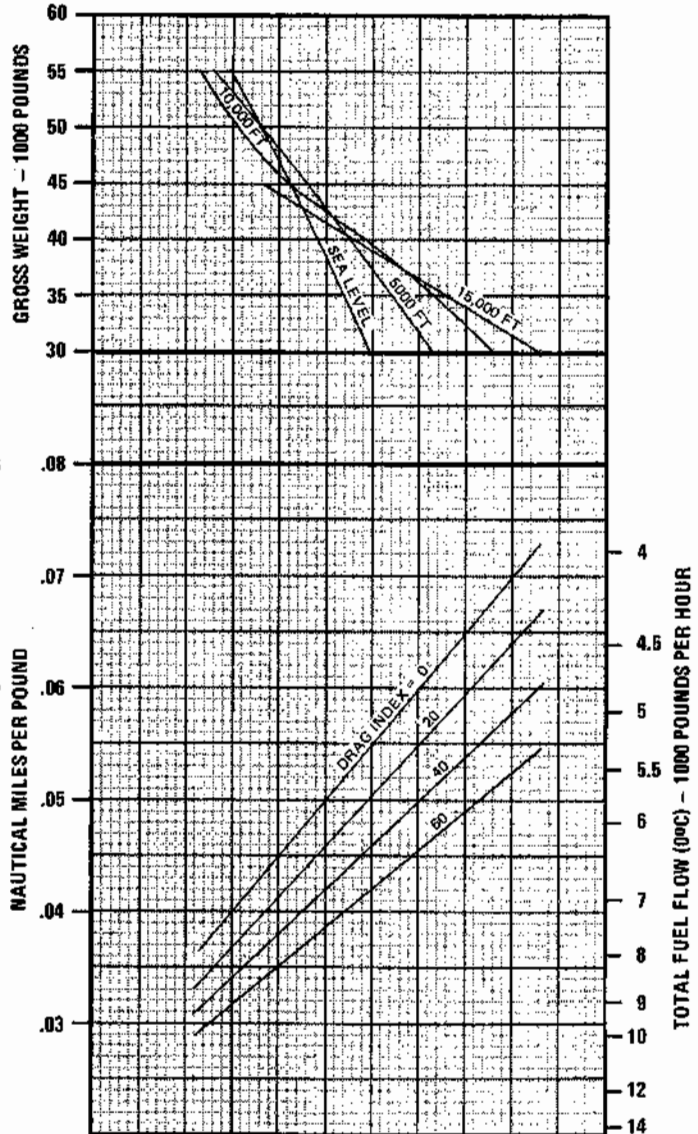

4E-1-(344)A

Figure A4-18



**F-4E**

# CONSTANT MACH/ALTITUDE CRUISE

## ONE ENGINE OPERATING

AIRPLANE CONFIGURATION  
INDIVIDUAL DRAG INDEXES

ICAO STANDARD DAY	
ALT. FT.	TEMP. °C
S.L.	15.0
5,000	5.1
10,000	-4.8
15,000	-14.7
20,000	-24.6
25,000	-34.5
30,000	-44.4
35,000	-54.3
40,000	-64.2
45,000	-74.1
50,000	-84.0

REMARKS  
ENGINE(S): (2) J79-GE-17  
INOPERATIVE ENGINE WINDMILLING  
ICAO STANDARD DAY

NOTE  
IF INOPERATIVE ENGINE IS NOT  
WINDMILLING, INCREASE DRAG  
INDEX BY 63 ADDITIONAL UNITS.

GUIDE

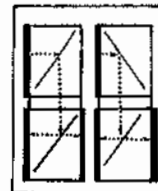

FUEL GRADE: JP-4  
FUEL DENSITY: 6.5 LB/GAL

DATE: 1 JANUARY 1973  
DATA BASIS: FLIGHT TEST

FUEL FLOW CORRECTION FACTORS

TEMPERATURE °C	-60	-40	-20	0	20	40
FUEL FLOW FACTOR	0.88	0.92	0.96	1.00	1.04	1.07

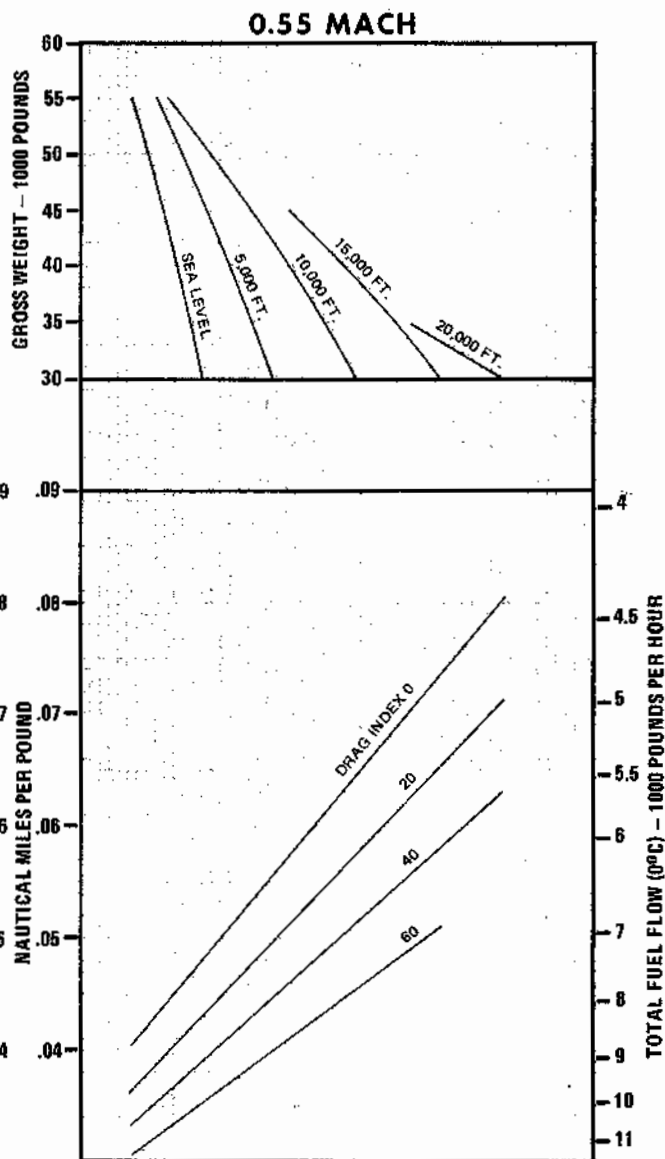
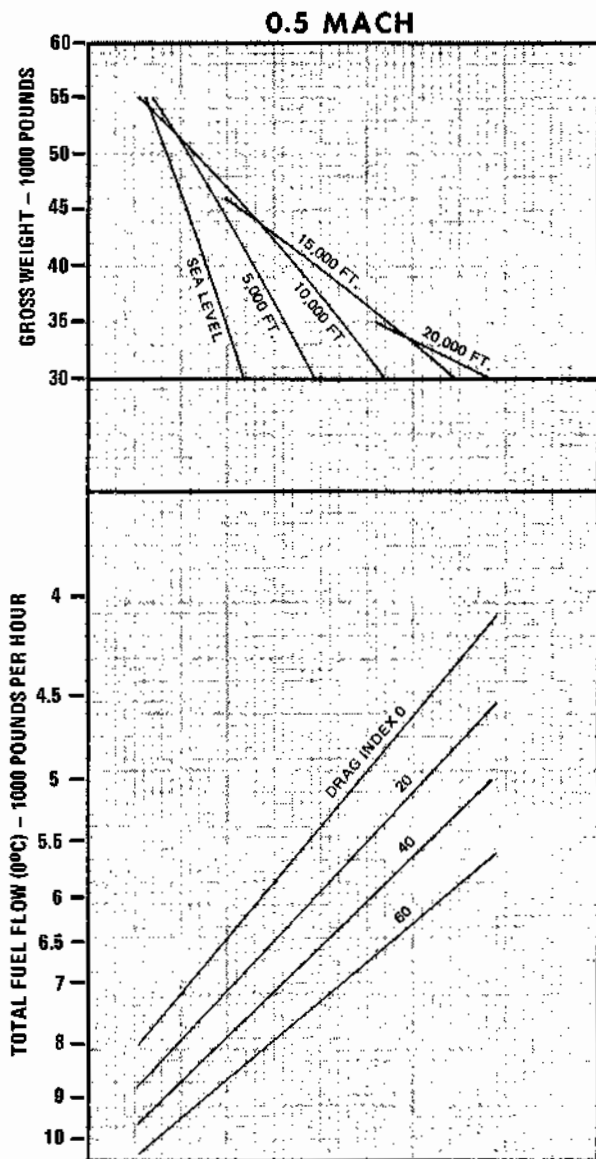

4E-1-(345)

Figure A4-19

**F-4E**

**CONSTANT MACH/ALTITUDE CRUISE  
ONE ENGINE OPERATING**

**AIRPLANE CONFIGURATION  
INDIVIDUAL DRAG INDEXES**

ICAO STANDARD DAY	
ALT. FT.	TEMP. °C
S.L.	15.0
5000	5.7
10,000	-4.8
15,000	-14.7
20,000	-24.6
25,000	-34.5
30,000	-44.4
35,000	-54.3
40,000	-56.5
45,000	-56.5
50,000	-56.5

DATE: 1 JANUARY 1973  
DATA BASIS: FLIGHT TEST

**REMARKS**  
ENGINE(S): (2) J79-GE-17  
INOPERATIVE ENGINE WINDMILLING  
ICAO STANDARD DAY

**NOTE**  
IF INOPERATIVE ENGINE IS NOT  
WINDMILLING, INCREASE DRAG  
INDEX BY 53 ADDITIONAL UNITS.

**GUIDE**

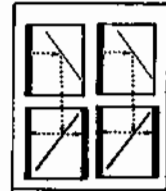

FUEL GRADE: JP-4  
FUEL DENSITY: 6.5 LB/GAL

FUEL FLOW CORRECTION FACTORS						
TEMPERATURE °C	-60	-40	-20	0	20	40
FUEL FLOW FACTOR	0.88	0.92	0.96	1.00	1.04	1.07

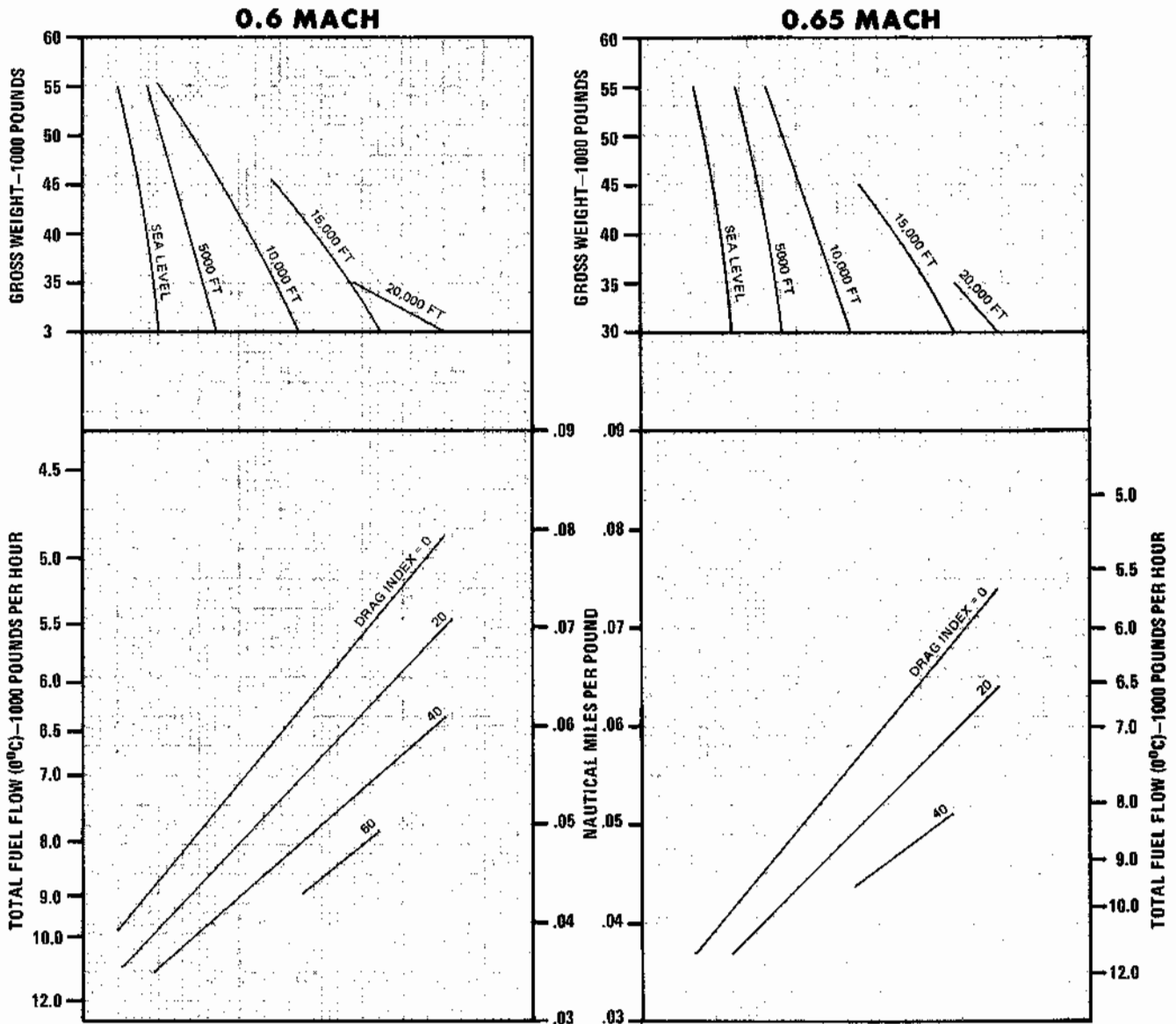

4E-1-(284)

Figure A4-20

**F-4E**

# CONSTANT MACH / ALTITUDE CRUISE ONE ENGINE OPERATING

**AIRPLANE CONFIGURATION  
INDIVIDUAL DRAG INDEXES**

ICAO STANDARD DAY	
ALT. FT.	TEMP. °C
S.L.	15.0
5000	5.7
10,000	-4.9
15,000	-14.7
20,000	-24.6
25,000	-34.3
30,000	-44.4
35,000	-54.3
40,000	-64.5
45,000	-74.5
50,000	-84.5

DATE: 1 JANUARY 1973  
DATA BASIS: FLIGHT TEST

**REMARKS**  
ENGINE(S), (2) J79-GE-17  
INOPERATIVE ENGINE WINDMILLING  
ICAO STANDARD DAY

**NOTE**  
IF INOPERATIVE ENGINE IS NOT  
WINDMILLING INCREASE DRAG INDEX  
BY 53 ADDITIONAL UNITS

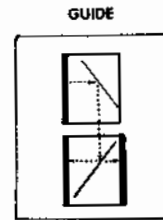

FUEL GRADE: JP-4  
FUEL DENSITY: 6.5 LB/GAL

FUEL FLOW CORRECTION FACTORS						
TEMPERATURE °C	-60	-40	-20	0	20	40
FUEL FLOW FACTOR	0.88	0.92	0.96	1.00	1.04	1.07

**0.7 MACH**

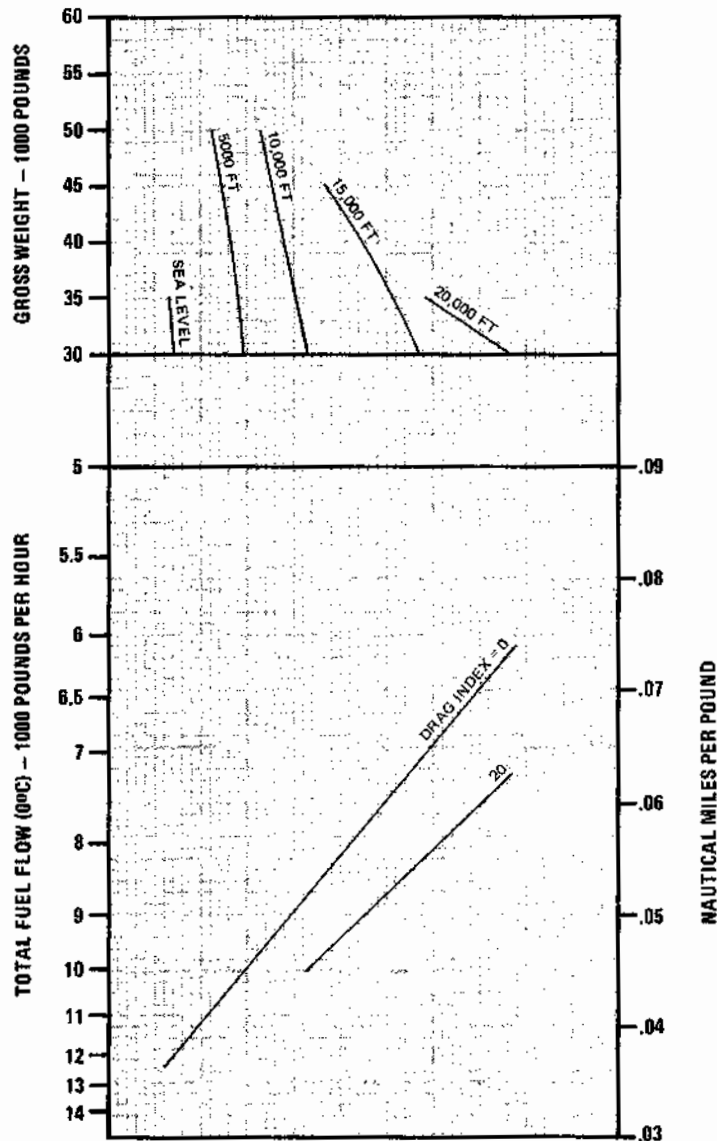

4E-1-(283)

Figure A4-21

**F-4E**

# CONSTANT ALTITUDE CRUISE

AIRPLANE CONFIGURATION  
INDIVIDUAL DRAG INDEXES

## LONG RANGE SPEED NAUTICAL MILES PER POUND AND MACH NUMBER

REMARKS  
ENGINE(S): (2) J79-GE-17  
ICAO STANDARD DAY

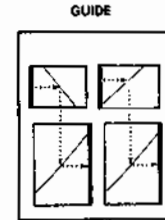

FUEL GRADE: JP-4  
FUEL DENSITY: 6.5 LB/GAL

DATE: 1 JANUARY 1973  
DATA BASIS: FLIGHT TEST

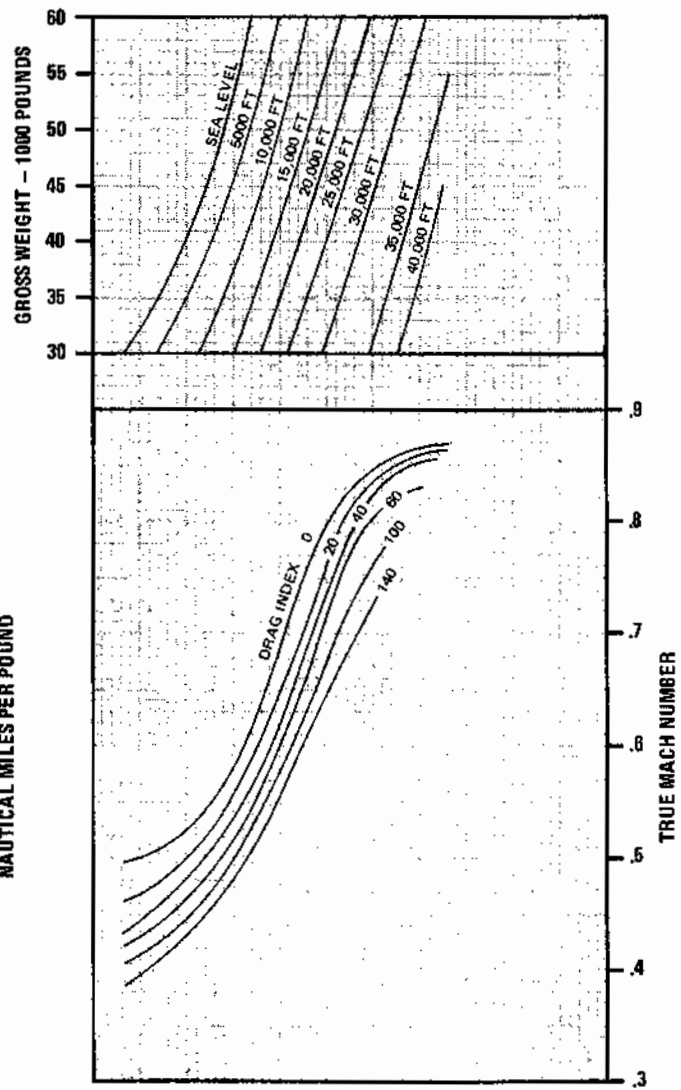
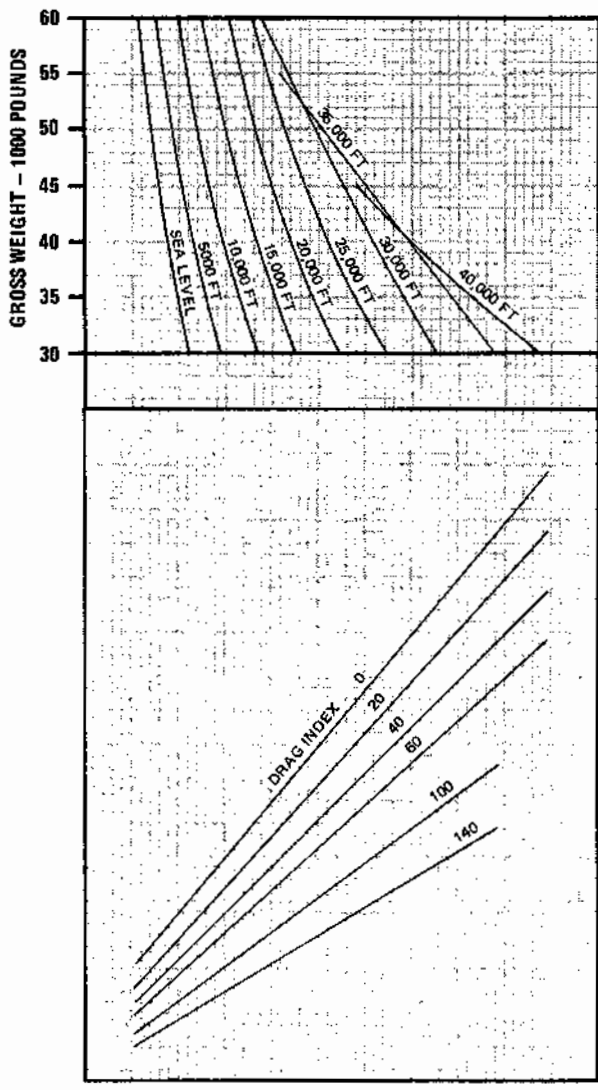

Figure A4-22 (Sheet 1 of 2)

**F-4E**

# CONSTANT ALTITUDE CRUISE

## LONG RANGE SPEED TRUE AIRSPEED AND FUEL FLOW

AIRPLANE CONFIGURATION  
INDIVIDUAL DRAG INDEXES

REMARKS  
ENGINE(S): (2) J79-GE-17  
ICAO STANDARD DAY

GUIDE

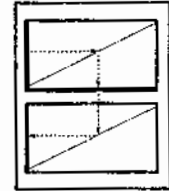

FUEL GRADE: JP-4  
FUEL DENSITY: 6.5 LB/GAL

DATE: 1 JANUARY 1973  
DATA BASIS: FLIGHT TEST

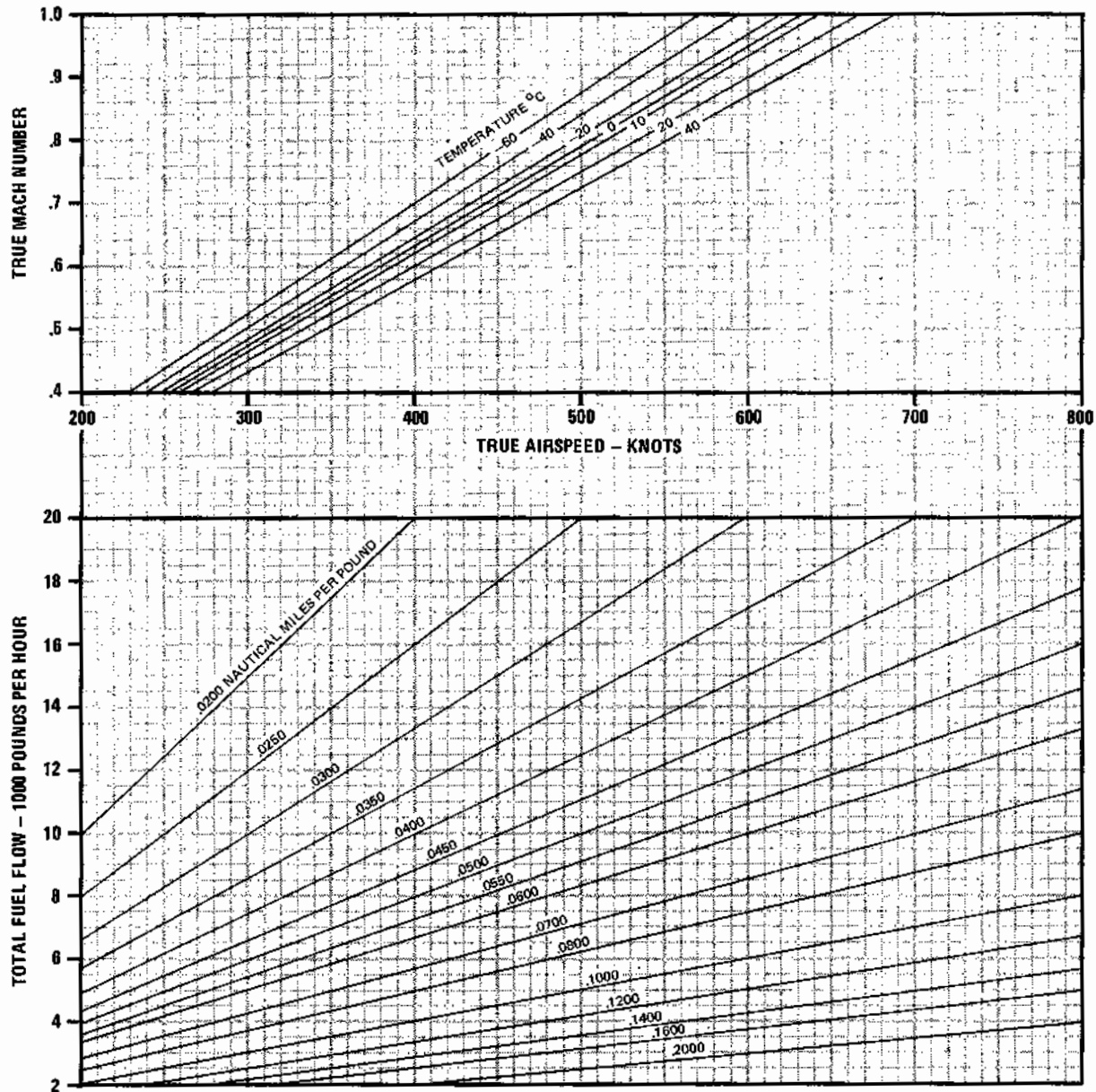

4E-1-(346-2)

Figure A4-22 (Sheet 2 of 2)

**F-4E**

**CONSTANT ALTITUDE CRUISE  
LONG RANGE SPEED  
NAUTICAL MILES PER POUND  
AND MACH NUMBER  
ONE ENGINE OPERATING**

AIRPLANE CONFIGURATION  
INDIVIDUAL DRAG INDEXES

GUIDE

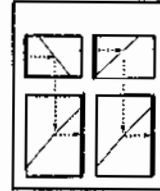

REMARKS  
ENGINE(S): (2) J79-GE-17  
INOPERATIVE ENGINE WINDMILLING  
ICAO STANDARD DAY

DATE: 1 JANUARY 1973  
DATA BASIS: FLIGHT TEST

FUEL GRADE: JP-4  
FUEL DENSITY: 6.5 LB/GAL

NOTE  
IF INOPERATIVE ENGINE IS NOT  
WINDMILLING, INCREASE DRAG  
INDEX BY 53 ADDITIONAL UNITS

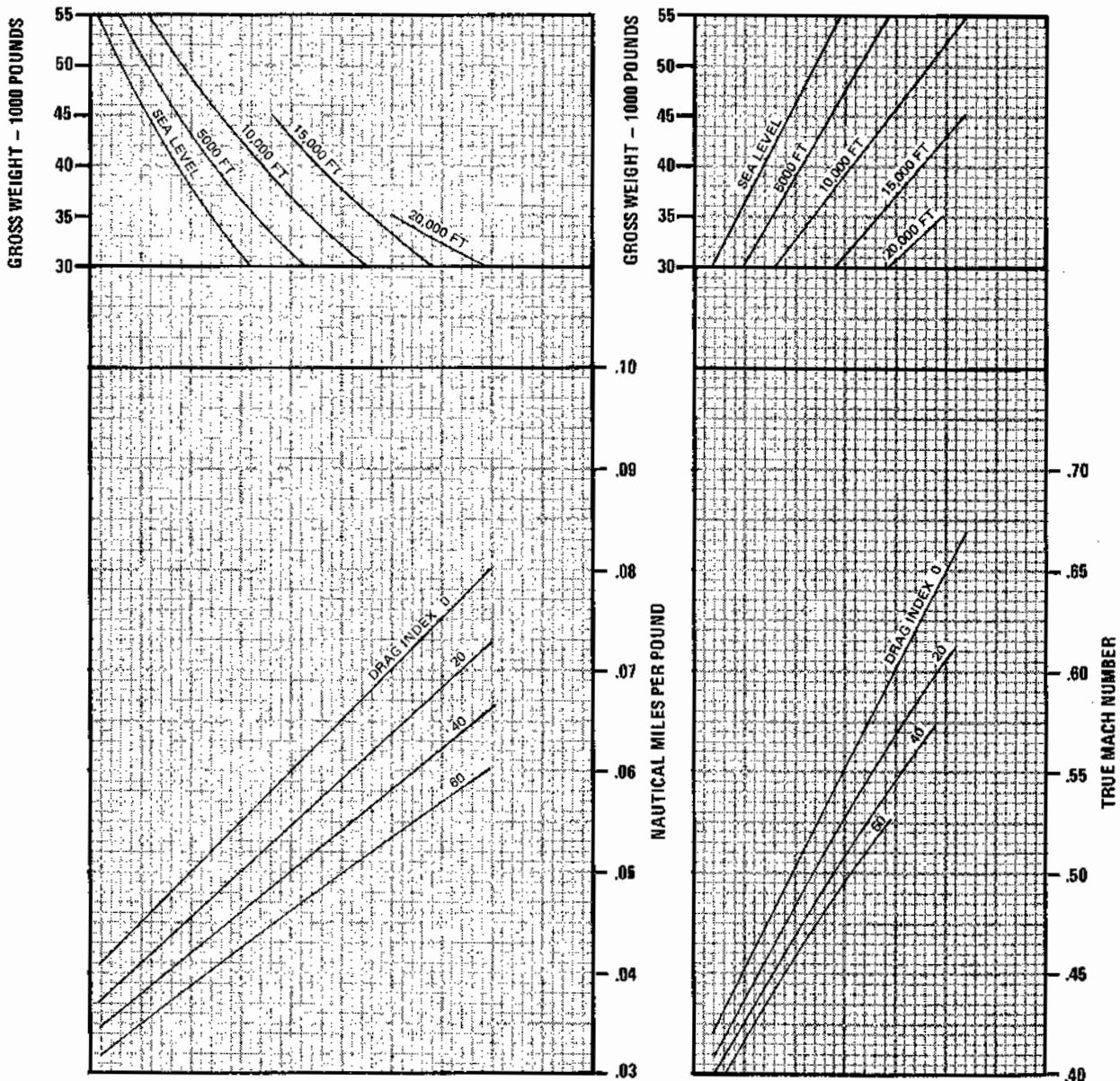

4E-1-(347-1)

Figure A4-23 (Sheet 1 of 2)

**F-4E**

**CONSTANT ALTITUDE CRUISE  
LONG RANGE SPEED  
TRUE AIRSPEED AND FUEL FLOW  
ONE ENGINE OPERATING**

AIRPLANE CONFIGURATION  
INDIVIDUAL DRAG INDEXES

REMARKS  
ENGINE(S): (2) J79-GE-17  
INOPERATIVE ENGINE WINDMILLING  
ICAO STANDARD DAY

NOTE  
IF INOPERATIVE ENGINE IS NOT  
WINDMILLING, INCREASE DRAG  
INDEX BY 53 ADDITIONAL UNITS

DATE: 1 JANUARY 1973  
DATA BASIS: FLIGHT TEST

GUIDE

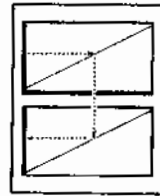

FUEL GRADE: JP-4  
FUEL DENSITY: 6.5 LB/GAL

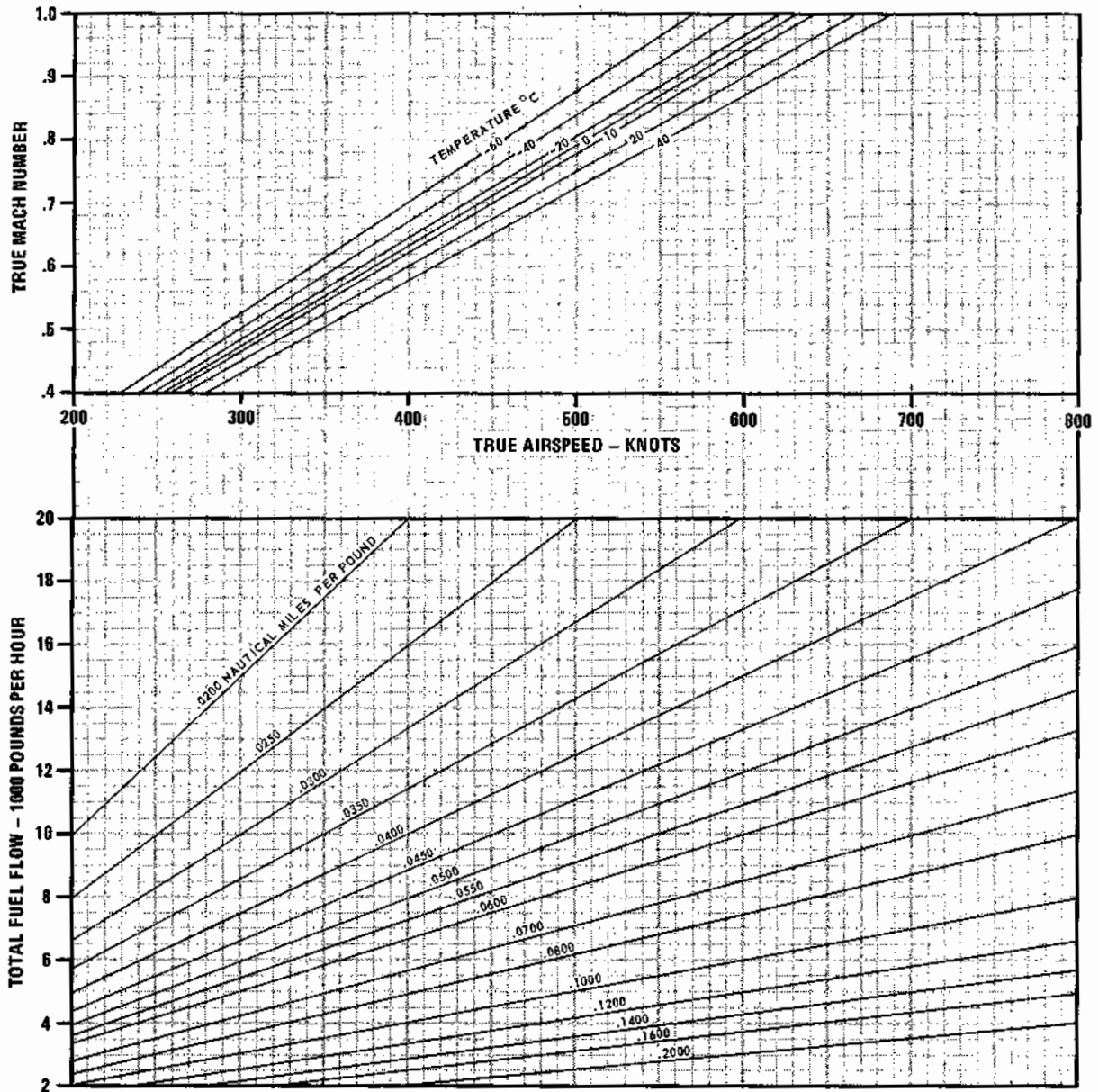

4E-1-(347-2)

Figure A4-23 (Sheet 2 of 2)

# PART 5 ENDURANCE

**NOTE**

For aircraft with TISEO scope housing (with or without scope) on the left wing and/or combat documentation cameras installed, additional units of drag must be applied to the computed drag index. Refer to the Airplane Loading chart in part 1.

## MAXIMUM ENDURANCE CHARTS

These charts (figures A5-1 thru A5-5) present optimum endurance altitude and maximum endurance specifics (fuel flow and Mach number) for all combinations of drag index, effective gross weight, and altitude. Separate charts are included for single engine operation.

**USE**

Enter the Altitude and Bank Angle chart with the average gross weight. If bank angles are to be considered, follow the gross weight curve until it intersects the bank angle to be used, then horizontally to the right to obtain effective gross weight. (If bank angles are not to be considered, enter the chart at the effective gross weight scale.) From this point proceed horizontally to the right and intersect the computed drag index. Reflect downward and read the optimum endurance altitude. Enter the Mach number plots with the effective gross weight, and proceed horizontally to intersect the optimum endurance altitude. Then descend downward and intersect the computed drag index and horizontally to read true Mach number. From the intersection of endurance altitude and drag index proceed horizontally to the right and intersect the optimum altitude. At this point read endurance airspeed. Enter the Fuel Flow plots with the effective gross weight, proceed horizontally to intersect the optimum endurance altitude. Reflect downward to the computed drag index, and then horizontally to read total fuel flow.

**Sample Problem**

**Altitude and Bank Angle**

A. Gross weight	45,000 Lb
B. Bank angle	20°
C. Effective gross weight	48,000 Lb
D. Drag index	40
E. Optimum endurance altitude	30,300 Ft

**Mach Number**

A. Effective gross weight	48,000 Lb
B. Endurance altitude	30,300 Ft
C. Drag index	40
D. Mach number	0.72
E. Endurance altitude	30,000 Ft
F. Airspeed IAS	265 Kt

**SAMPLE MAXIMUM ENDURANCE  
ALTITUDE AND BANK ANGLE**

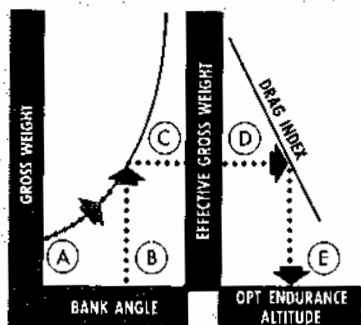

4E-1-(348)

**SAMPLE MAXIMUM ENDURANCE  
MACH NUMBER**

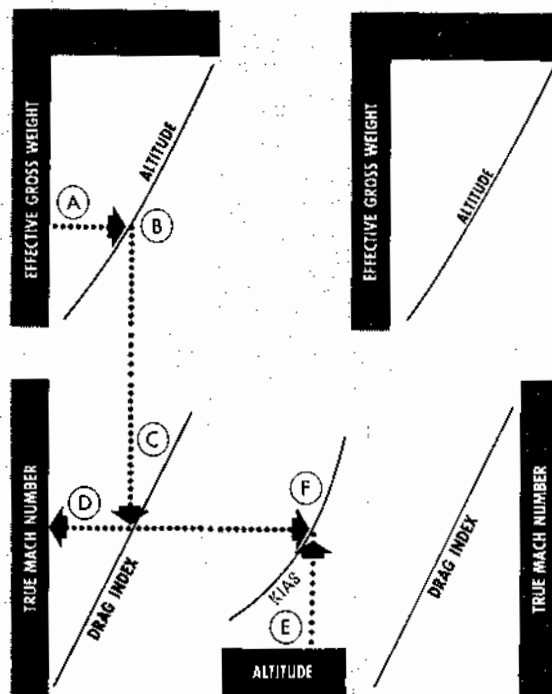

4E-1-(349)



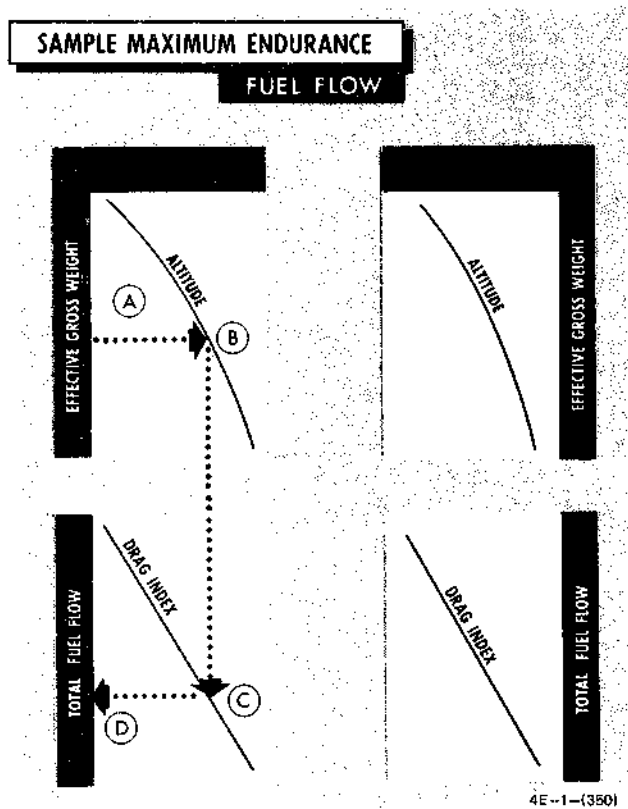

**Fuel Flow**

- A. Effective gross weight 48,000 Lb
- B. Endurance altitude 30,300 Ft
- C. Drag index 40
- D. Fuel flow 6500 PPH

**F-4E**

**MAXIMUM ENDURANCE  
ALTITUDE AND BANK ANGLE**

AIRPLANE CONFIGURATION  
INDIVIDUAL DRAG INDEXES

REMARKS  
ENGINE(S): (2) J79-GE-17  
ICAO STANDARD DAY

GUIDE



FUEL GRADE: JP-4  
FUEL DENSITY: 6.5 LB/GAL

DATE: 1 JANUARY 1973  
DATA BASIS: FLIGHT TEST

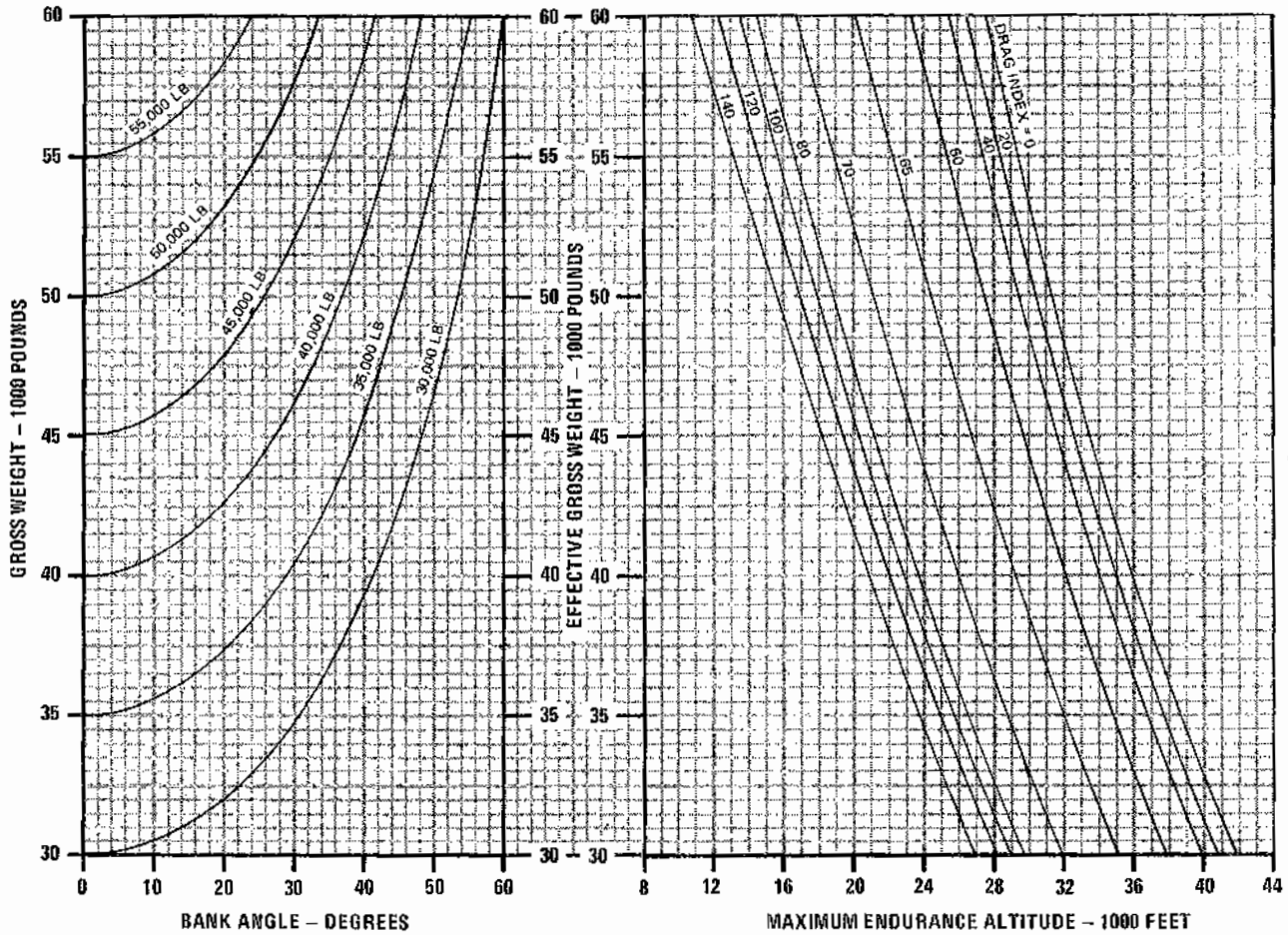

Figure A5-1

**F-4E**

# MAXIMUM ENDURANCE MACH NUMBER

AIRPLANE CONFIGURATION  
INDIVIDUAL DRAG INDEXES

REMARKS  
ENGINE(S): (2)J79-GE-17  
ICAO STANDARD DAY

GUIDE

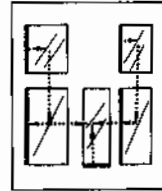

DATE: 1 JANUARY 1973  
DATA BASIS: FLIGHT TEST

FUEL GRADE: JP-4  
FUEL DENSITY: 6.5 LB/GAL

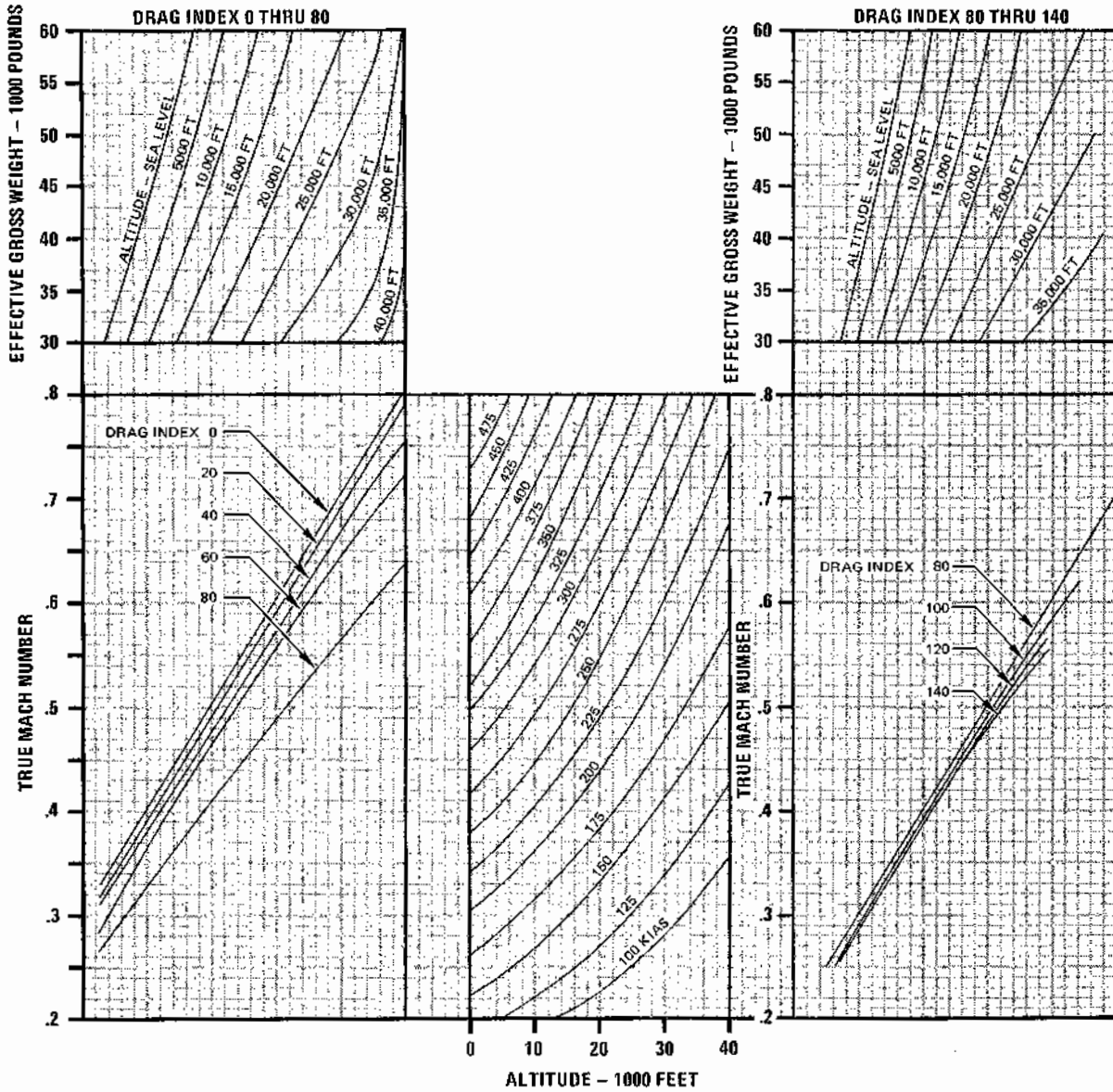

Figure A5-2

**F-4E**

# MAXIMUM ENDURANCE

AIRPLANE CONFIGURATION  
INDIVIDUAL DRAG INDEXES  
(0-80)

## FUEL FLOW

ICAO STANDARD DAY	
ALT. FT.	TEMP. °C
S.L.	15.0
5000	5.1
10,000	-4.8
15,000	-14.7
20,000	-24.6
25,000	-34.5
30,000	-44.4
35,000	-54.3
40,000	-56.5
45,000	-56.5
50,000	-56.5

REMARKS  
ENGINE(S): (2) J79-GE-17  
ICAO STANDARD DAY

**NOTE**

TOTAL FUEL FLOW IS DIRECTLY PROPORTIONAL TO TEMPERATURE CHANGE, INCREASING OR DECREASING 2% FOR EACH 10°C INCREMENT FROM STANDARD DAY.

GUIDE

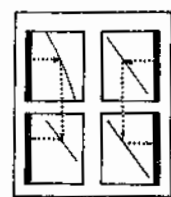

DATE: 1 JANUARY 1973  
DATA BASIS: FLIGHT TEST

FUEL GRADE: JP-4  
FUEL DENSITY: 6.5 LB/GAL

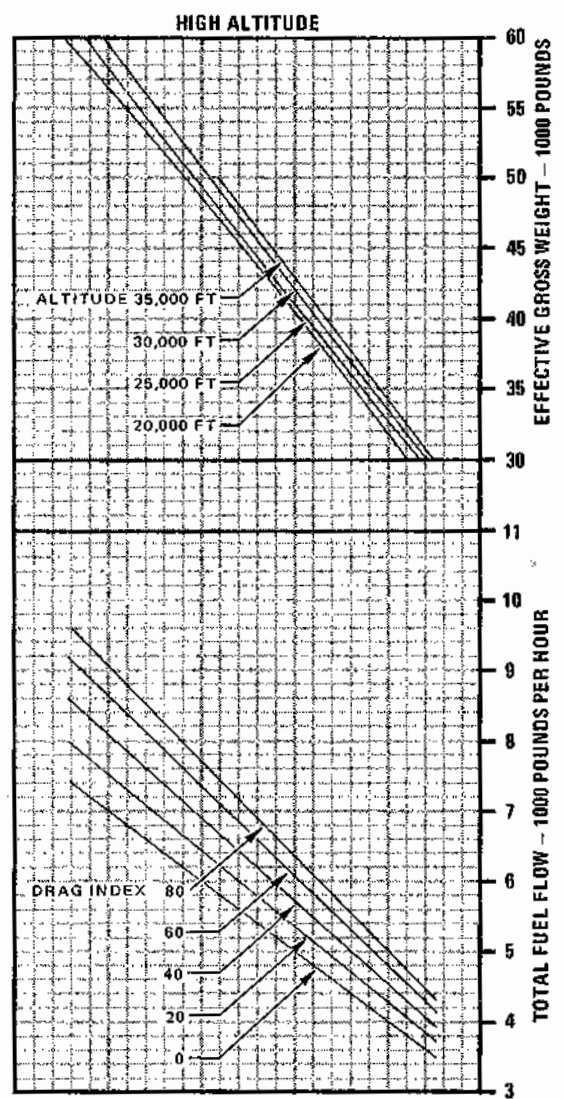
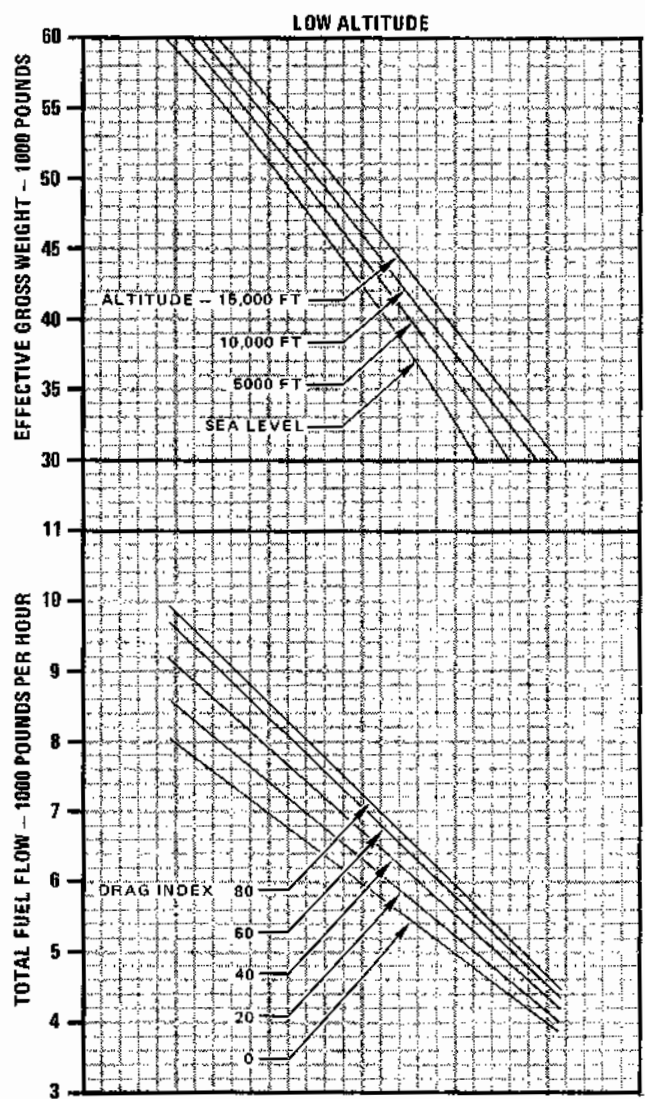

Figure A5-3 (Sheet 1 of 2)

**F-4E**

# MAXIMUM ENDURANCE

**AIRPLANE CONFIGURATION**  
INDIVIDUAL DRAG INDEXES  
(80 - 140)

ICAO STANDARD DAY	
ALT. FT.	TEMP. °C
S.L.	15.0
5000	5.1
10,000	-4.8
15,000	-14.7
20,000	-24.6
25,000	-34.5
30,000	-44.4
35,000	-54.3
40,000	-56.5
45,000	-56.5
50,000	-56.5

## FUEL FLOW

**REMARKS**  
ENGINE(S): (2) J79-GE-17  
ICAO STANDARD DAY

**NOTE**

TOTAL FUEL FLOW IS DIRECTLY PROPORTIONAL TO TEMPERATURE CHANGE, INCREASING OR DECREASING 2% FOR EACH 10°C INCREMENT FROM STANDARD DAY.

GUIDE

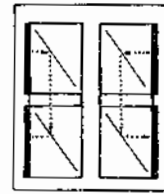

FUEL GRADE: JP-4  
FUEL DENSITY: 6.5 LB/GAL

DATE: 1 JANUARY 1973  
DATA BASIS: FLIGHT TEST

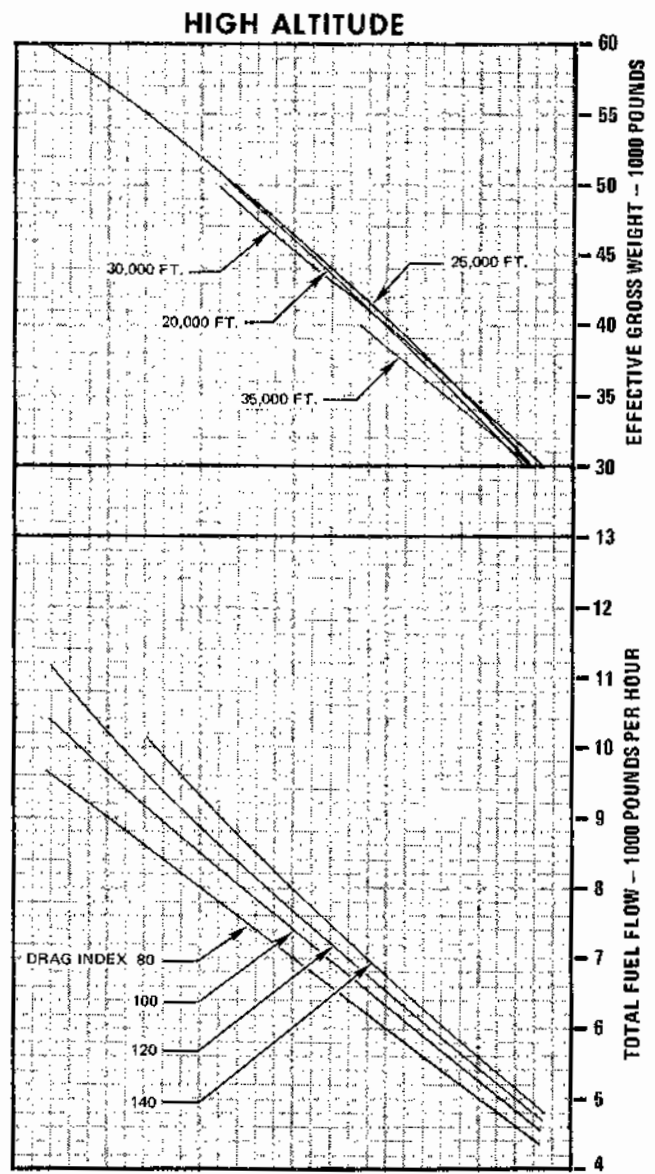
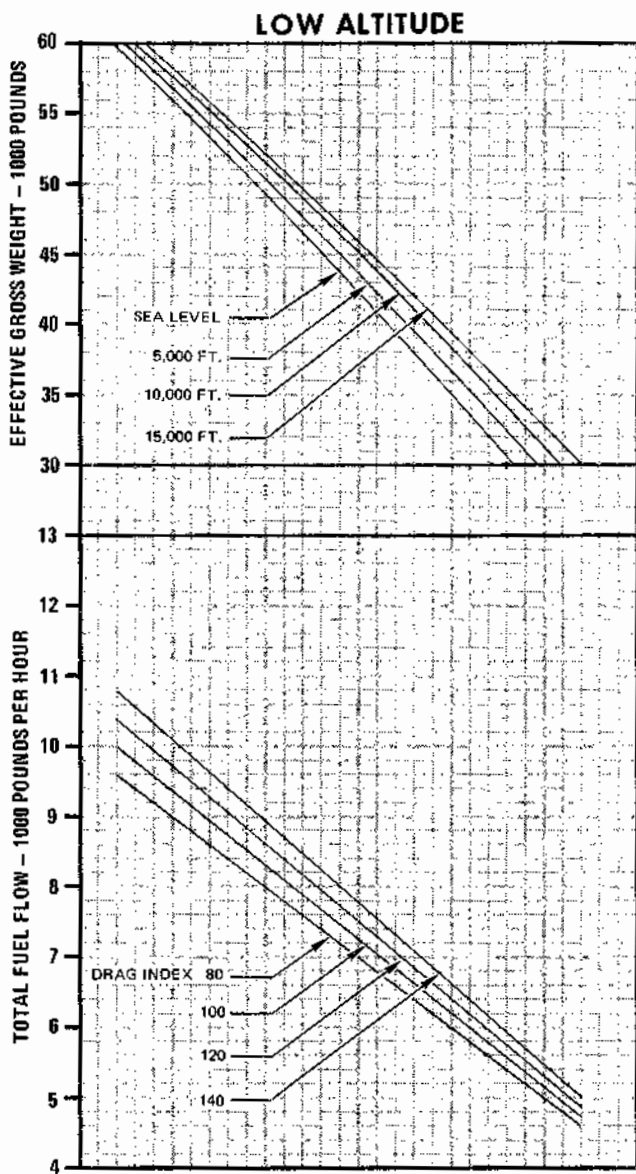

4E-1-(353-2)

Figure A5-3 (Sheet 2 of 2)

**F-4E**

# MAXIMUM ENDURANCE

## ALTITUDE AND BANK ANGLE ONE ENGINE OPERATING

REMARKS  
ENGINE (S): (2) J79-GE-17  
INOPERATIVE ENGINE WINDMILLING  
ICAO STANDARD DAY

AIRPLANE CONFIGURATION  
INDIVIDUAL DRAG INDEXES

GUIDE

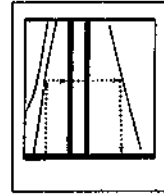

NOTE  
IF INOPERATIVE ENGINE IS NOT  
WINDMILLING, INCREASE DRAG INDEX  
BY 53 ADDITIONAL UNITS.

DATE: 1 JANUARY 1973  
DATA BASIS: FLIGHT TEST

FUEL GRADE: JP-4  
FUEL DENSITY: 6.5 LB/GAL

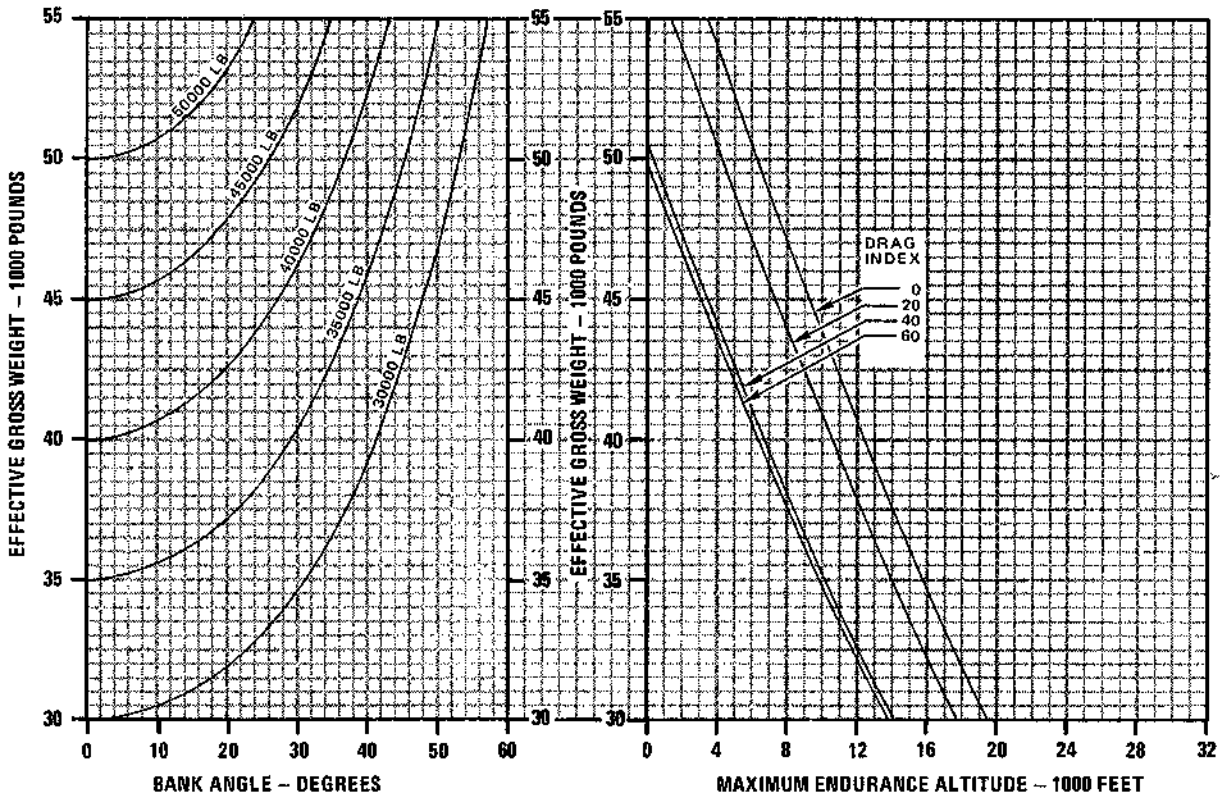

Figure A5-4

**F-4E**

# MAXIMUM ENDURANCE MACH NUMBER AND FUEL FLOW ONE ENGINE OPERATING

**AIRPLANE CONFIGURATION**  
INDIVIDUAL DRAG INDEXES

**REMARKS**  
ENGINE(S): (2) J79-GE-17  
ICAO STANDARD DAY  
INOPERATIVE ENGINE WINDMILLING

**NOTE**  
IF INOPERATIVE ENGINE IS NOT WINDMILLING,  
INCREASE DRAG INDEX BY 53 ADDITIONAL UNITS.  
• TOTAL FUEL FLOW IS DIRECTLY PROPORTIONAL TO  
TEMPERATURE CHANGE, INCREASING OR DECREASING  
2% FOR EACH 10°C INCREMENT FROM STANDARD DAY.

GUIDE

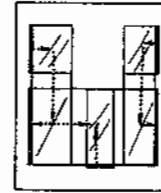

FUEL GRADE: JP-4  
FUEL DENSITY: 6.5 LB/GAL

DATE: 1 JANUARY 1973  
DATA BASIS: FLIGHT TEST

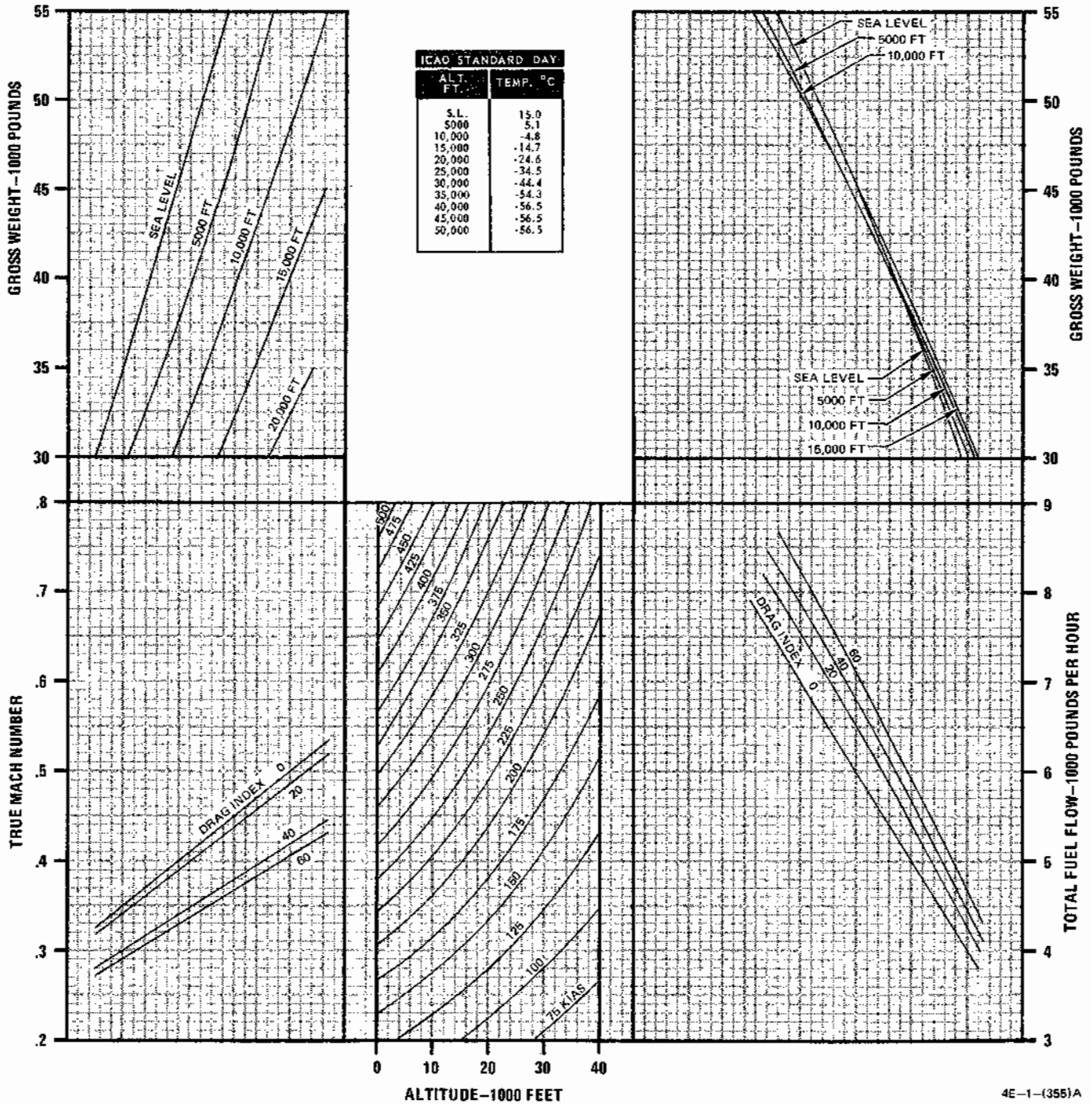

4E-1-(355)A

Figure A5-5

**PART 6**  
**AIR REFUELING**

---

Refer to Air Refueling Manual, TO 1-1C-1-8.



# PART 7

## DESCENT

### NOTE

For aircraft with TISEO scope housing (with or without scope) on the left wing and/or combat documentation cameras installed, additional units of drag must be applied to the computed drag index. Refer to the Airplane Loading chart in part 1.

D. Computed drag index	40.0
E. Time required	7.5 Min
F. Altitude	30,000 Ft
G. Computed drag index	40.0
H. Fuel required	180 Lb
J. Single drag reflector	
K. Mach number	0.67

## DESCENT

The descent charts (figures A7-1 thru A7-8) present distance, time, fuel used, and Mach number in the descent. Incremental data may be obtained for distance, time, and fuel by subtracting data corresponding to level off altitude from the data for the original cruising altitude.

### USE

Enter the upper plot of the appropriate chart at the cruising flight level, project horizontally to the right to intersect both drag reflectors at the applicable computed drag index. From the first intersection, project vertically downward to intersect and read the distance. From the second intersection, project vertically downward to intersect and read time to descend. Enter the lower plot with the cruising altitude and proceed horizontally to the right to intersect the drag reflector at the applicable computed drag index on the fuel graph. Continue horizontally to the right to intersect the single drag reflector on the Mach number graph. From the intersection on the fuel graph, project vertically downward to intersect and read fuel required. From the intersection at the single drag reflector on the Mach number graph, project vertically downward to intersect and read Mach number.

### Sample Problem

Descent (idle thrust), 250 KIAS

A. Altitude	30,000 Ft
B. Computed drag index	40.0
C. Distance	38 NM

### SAMPLE DESCENT

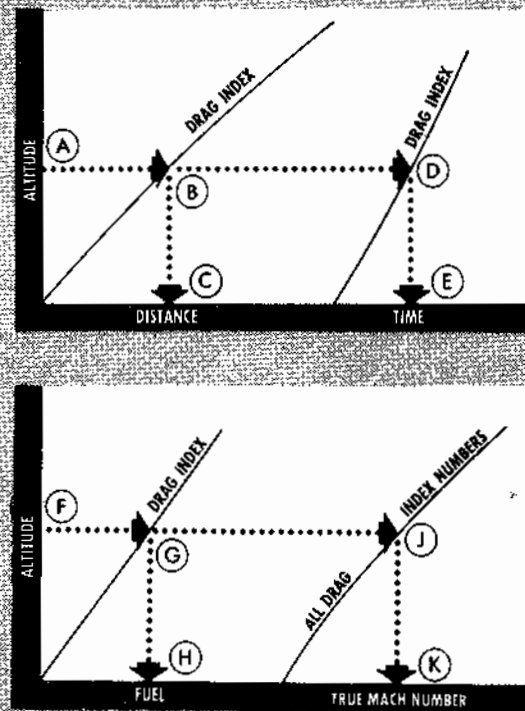

4E-1-1356

**F-4E**

**DESCENT**  
**250 KIAS- IDLE THRUST**  
**MAXIMUM RANGE**  
**SPEED BRAKES RETRACTED**

AIRPLANE CONFIGURATION  
 INDIVIDUAL DRAG INDEXES

REMARKS  
 ENGINE(S): (2) J79-GE-17  
 ALL GROSS WEIGHTS  
 ICAO STANDARD DAY

GUIDE

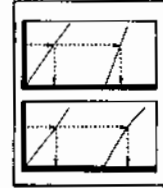

DATE: 1 JANUARY 1973  
 DATA BASIS: FLIGHT TEST

FUEL GRADE: JP-4  
 FUEL DENSITY: 6.5 LB/GAL

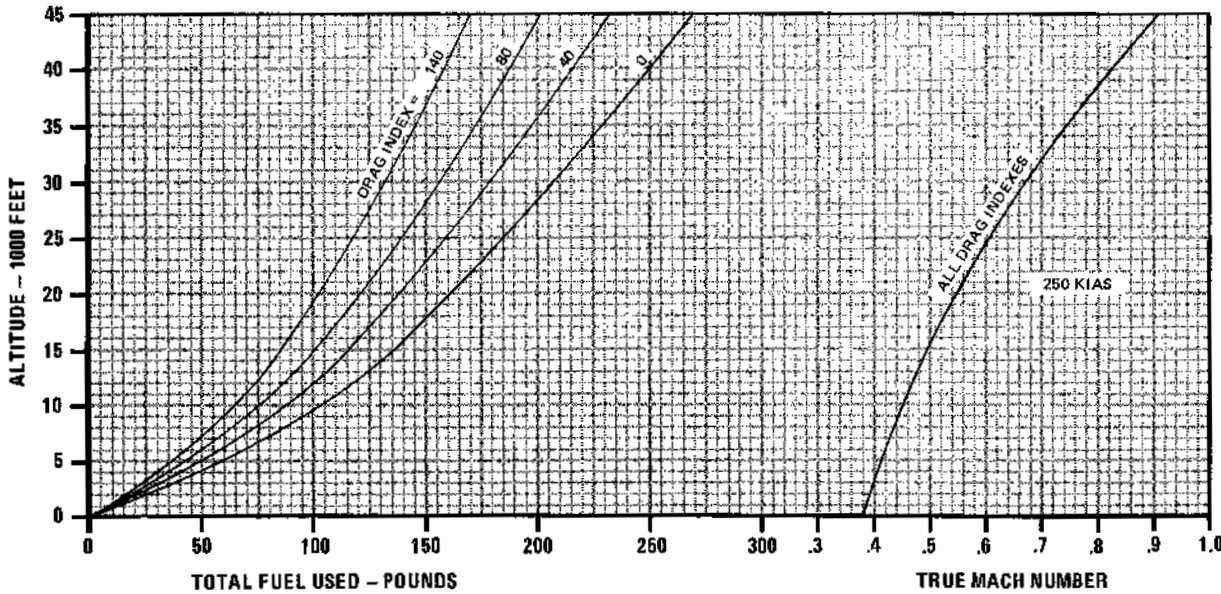
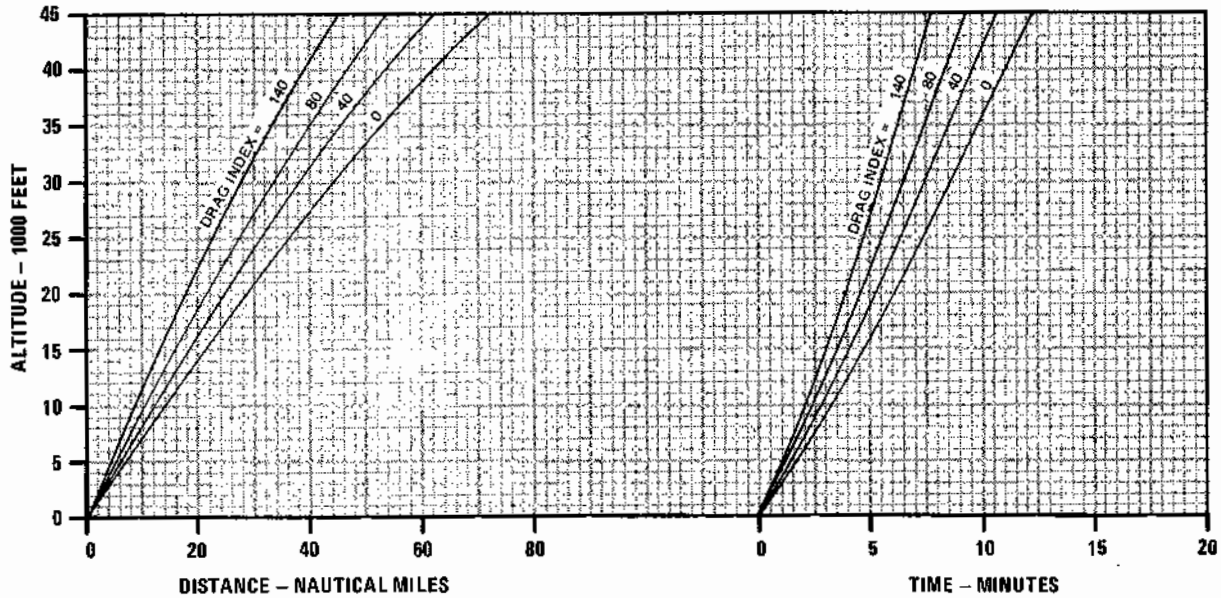

4E-1-(357)

Figure A7-1

**F-4E**

**DESCENT**  
**280 KIAS-80% RPM**  
**SPEED BRAKES EXTENDED**

AIRPLANE CONFIGURATION  
 INDIVIDUAL DRAG INDEXES

REMARKS  
 ENGINE(S): (2) J79-GE-17  
 ALL GROSS WEIGHTS  
 ICAO STANDARD DAY

GUIDE

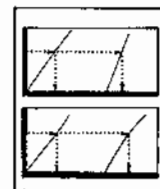

DATE: 1 JANUARY 1973  
 DATA BASIS: FLIGHT TEST

FUEL GRADE: JP-4  
 FUEL DENSITY: 6.5 LB/GAL

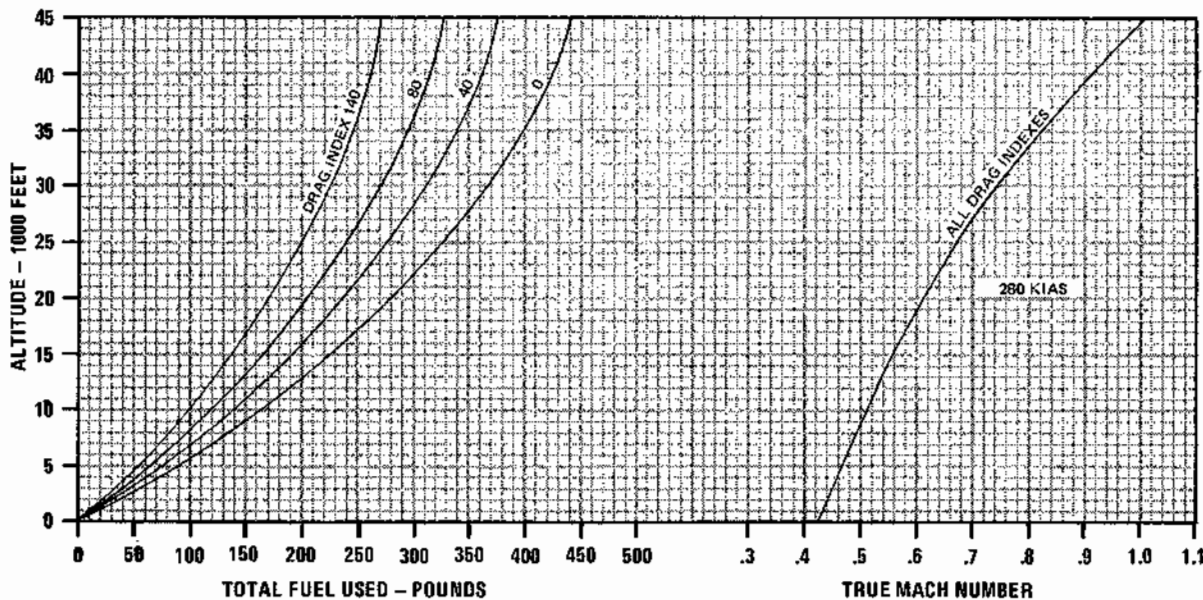
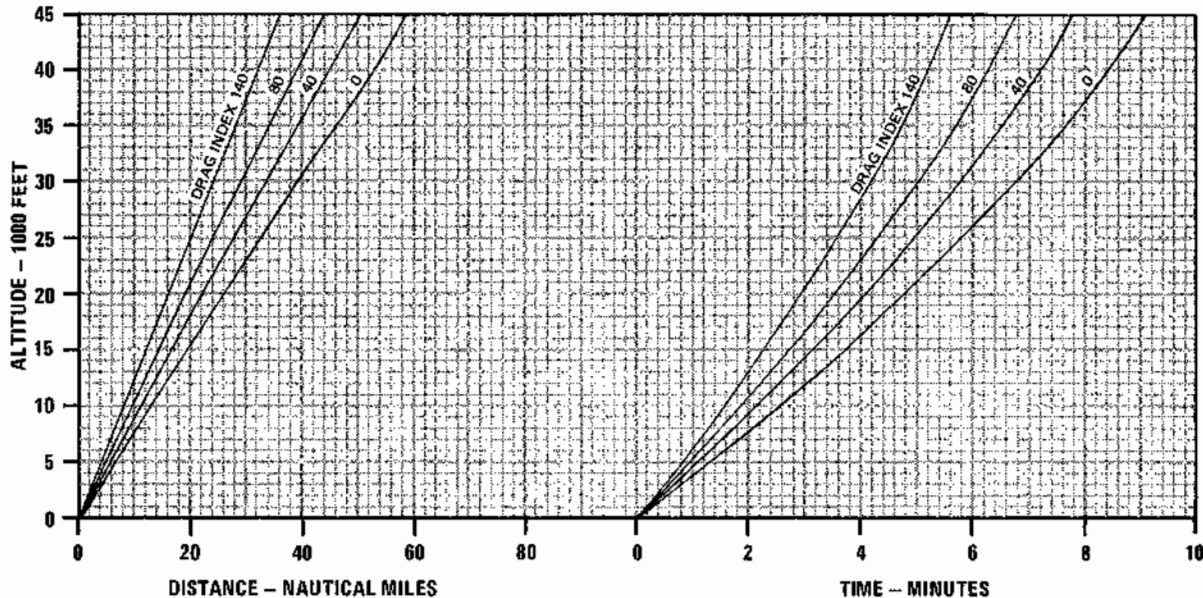

Figure A7-2

**F-4E**

**DESCENT**  
**0.8 MACH-IDLE THRUST**  
**SPEED BRAKES EXTENDED**

AIRPLANE CONFIGURATION  
 INDIVIDUAL DRAG INDEXES

REMARKS  
 ENGINE(S): (2) J79-GE-17  
 ALL GROSS WEIGHTS  
 ICAO STANDARD DAY

GUIDE

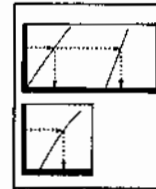

DATE: 1 JANUARY 1973  
 DATA BASIS: FLIGHT TEST

FUEL GRADE: JP-4  
 FUEL DENSITY: 6.5 LB/GAL

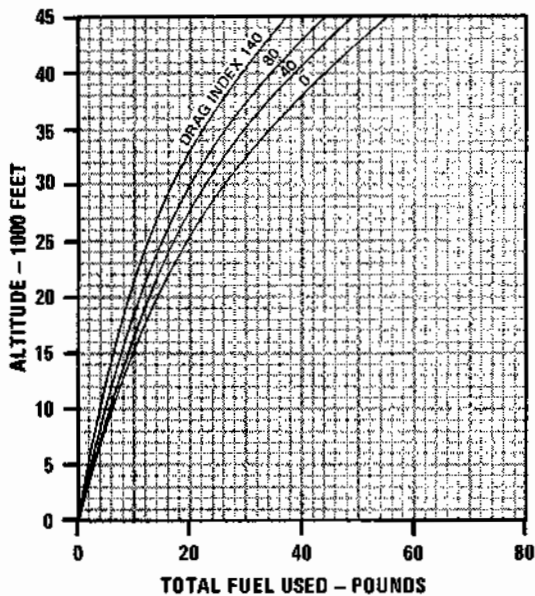
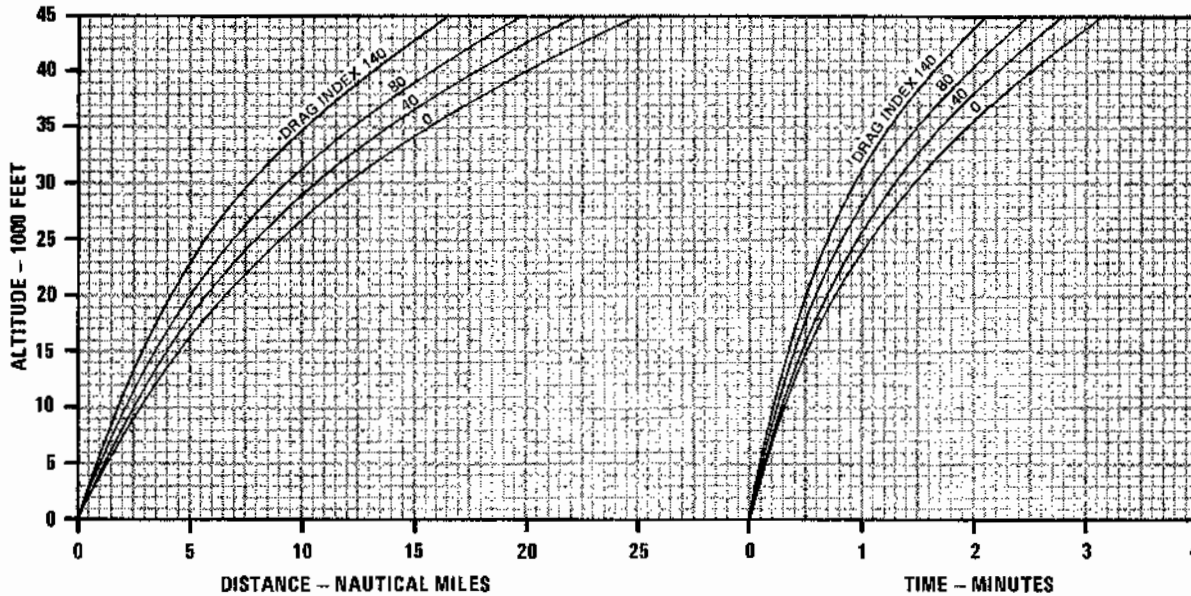

Figure A7-3

**F-4E**

**DESCENT**  
**0.8 MACH-IDLE THRUST**  
**SPEED BRAKES RETRACTED**

AIRPLANE CONFIGURATION  
 INDIVIDUAL DRAG INDEXES

REMARKS  
 ENGINE(S): (2) J79-GE-17  
 ALL GROSS WEIGHTS  
 ICAO STANDARD DAY

GUIDE

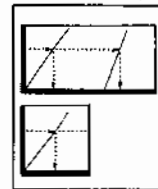

DATE: 1 JANUARY 1973  
 DATA BASIS: FLIGHT TEST

FUEL GRADE: JP-4  
 FUEL DENSITY: 6.5 LB/GAL

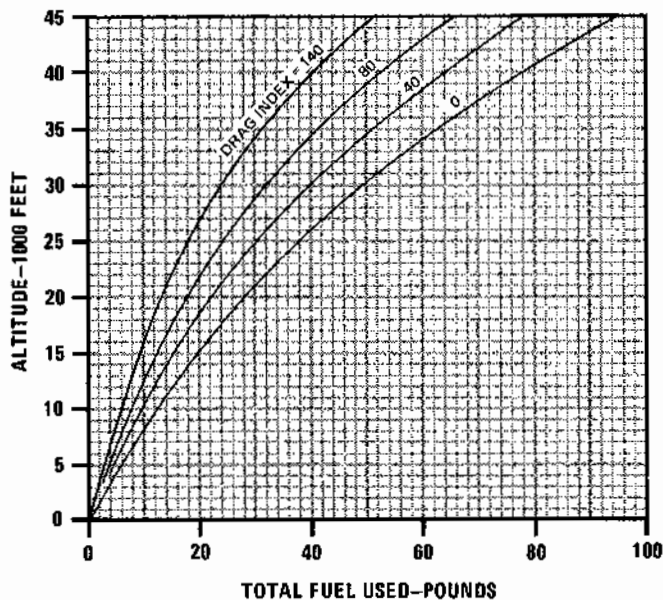
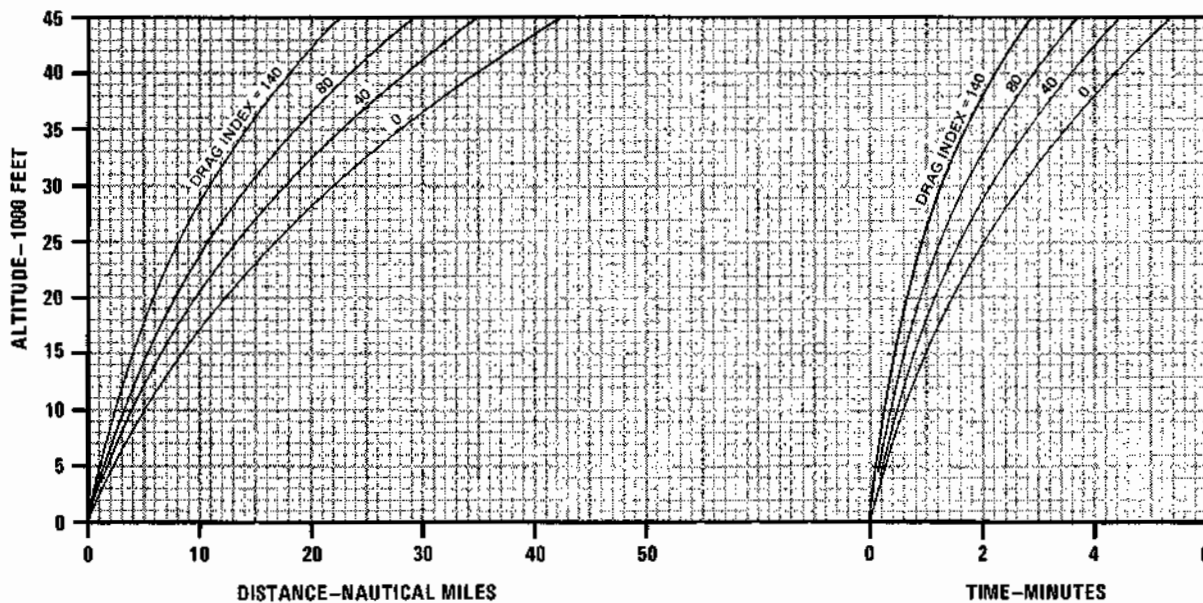

4E-1-(360)

Figure A7-4

**F-4E**

**DESCENT**  
**0.8 MACH - 80% RPM**  
**SPEED BRAKES EXTENDED**

AIRPLANE CONFIGURATION  
INDIVIDUAL DRAG INDEXES

REMARKS  
ENGINE(S): (2) J79-GE-17  
ALL GROSS WEIGHTS  
ICAO STANDARD DAY

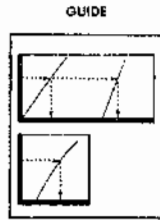

DATE: 1 JANUARY 1973  
DATA BASIS: FLIGHT TEST

FUEL GRADE: JP-4  
FUEL DENSITY: 6.5 LB/GAL

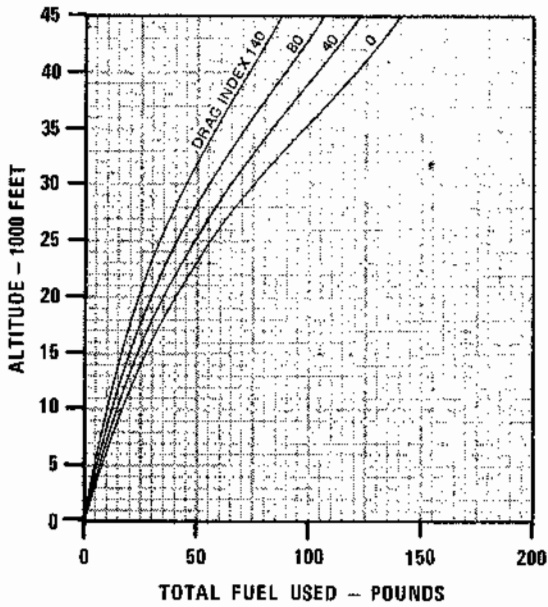
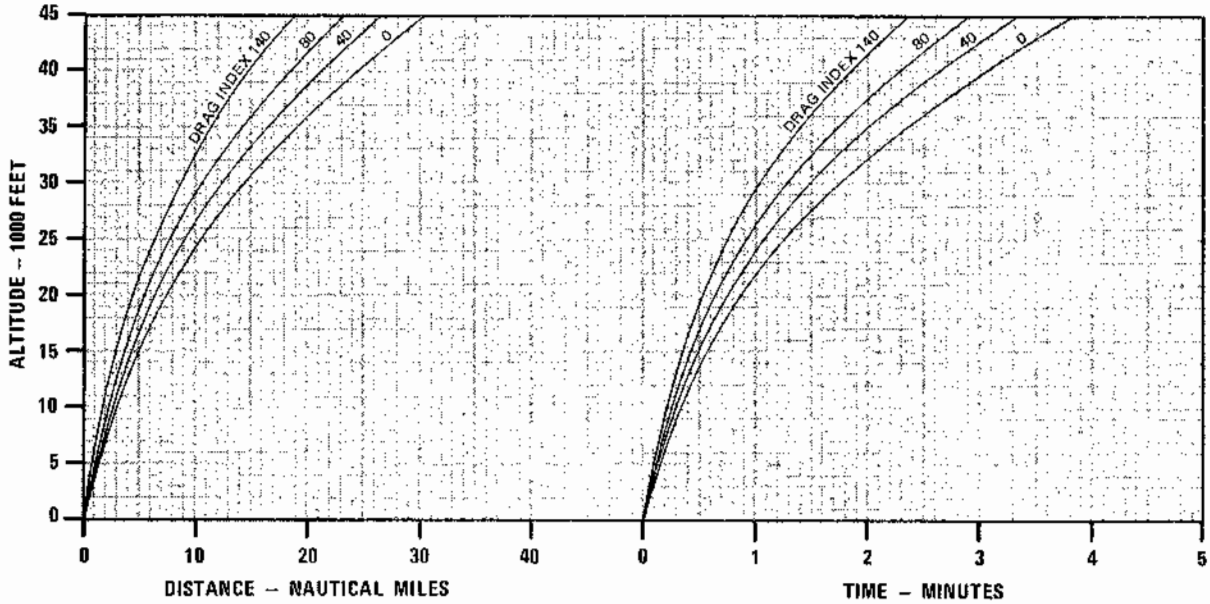

Figure A7-5

**F-4E**

**DESCENT**  
**0.8 MACH-80% RPM**  
**SPEED BRAKES RETRACTED**

AIRPLANE CONFIGURATION  
 INDIVIDUAL DRAG INDEXES

REMARKS  
 ENGINE(S): (2) J79-GE-17  
 ALL GROSS WEIGHTS  
 ICAO STANDARD DAY

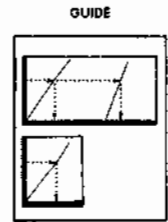

DATE: 1 JANUARY 1973  
 DATA BASIS: FLIGHT TEST

FUEL GRADE: JP-4  
 FUEL DENSITY: 6.5 LB/GAL

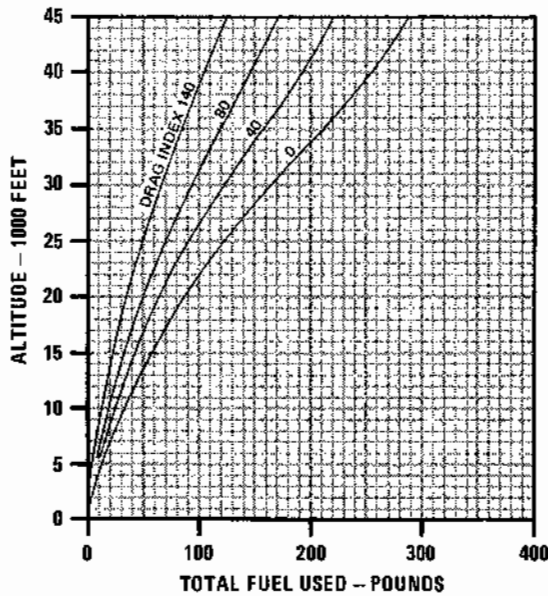
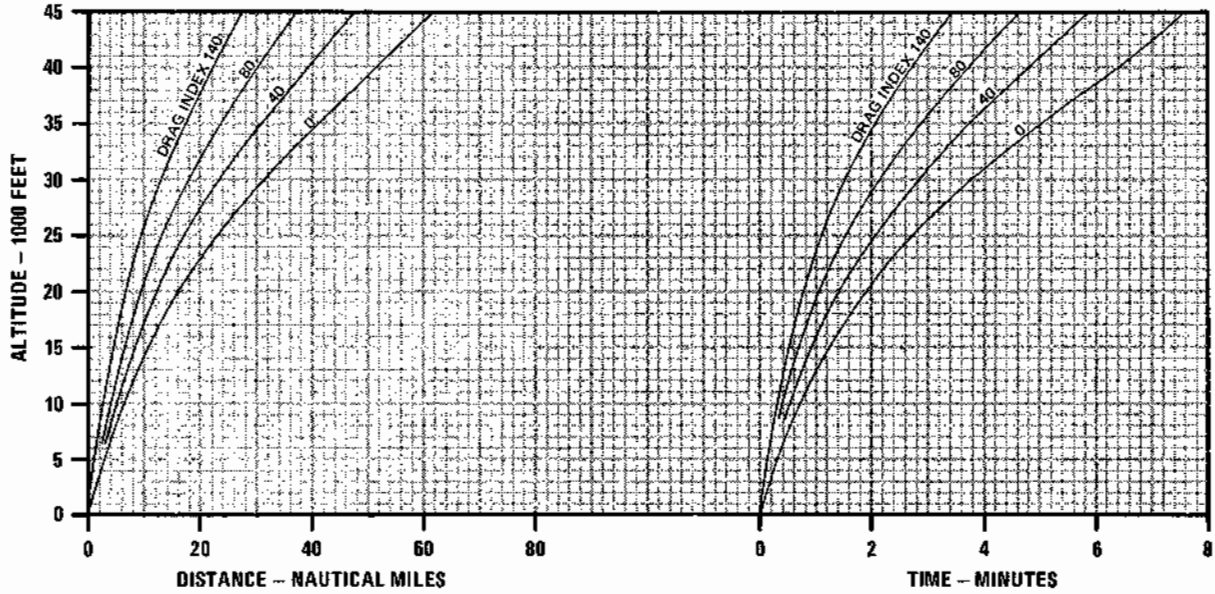

4E-1-(362)

Figure A7-6

**F-4E**

**DESCENT**  
**300 KIAS - 80% RPM**  
**SPEED BRAKE EXTENDED**

AIRPLANE CONFIGURATION  
 INDIVIDUAL DRAG INDEXES

REMARKS  
 ENGINE(S): (2) J79-GE-17  
 ICAO STANDARD DAY  
 ALL GROSS WEIGHTS

GUIDE

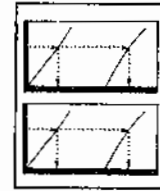

DATE: 1 JANUARY 1973  
 DATA BASIS: FLIGHT TEST

FUEL GRADE: JP-4  
 FUEL DENSITY: 6.5 LB/GAL

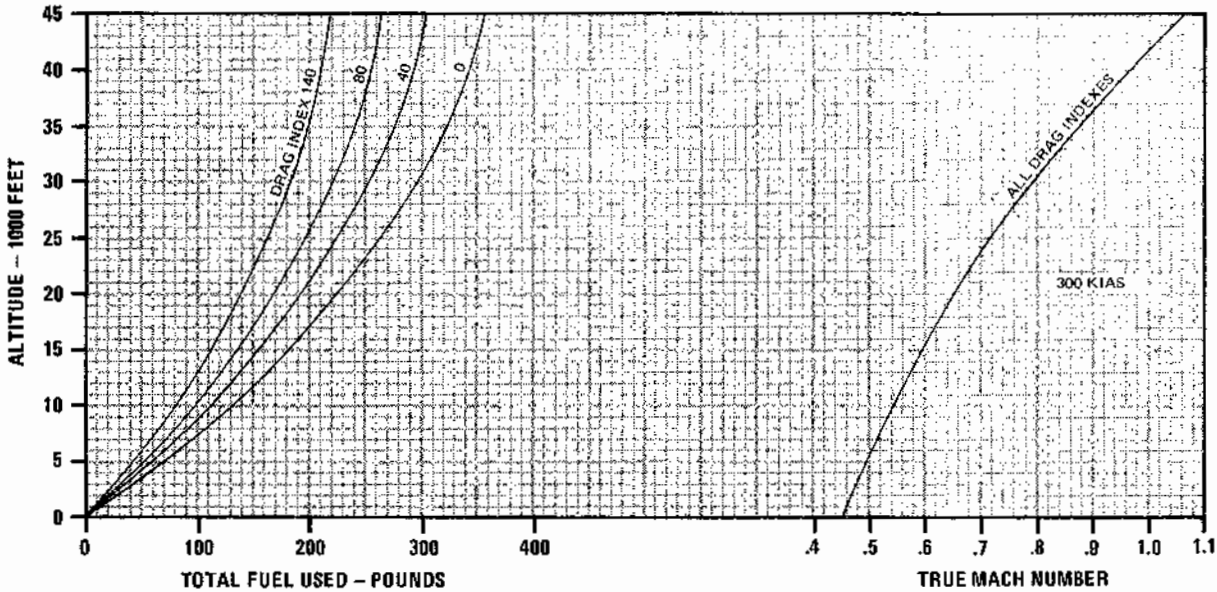
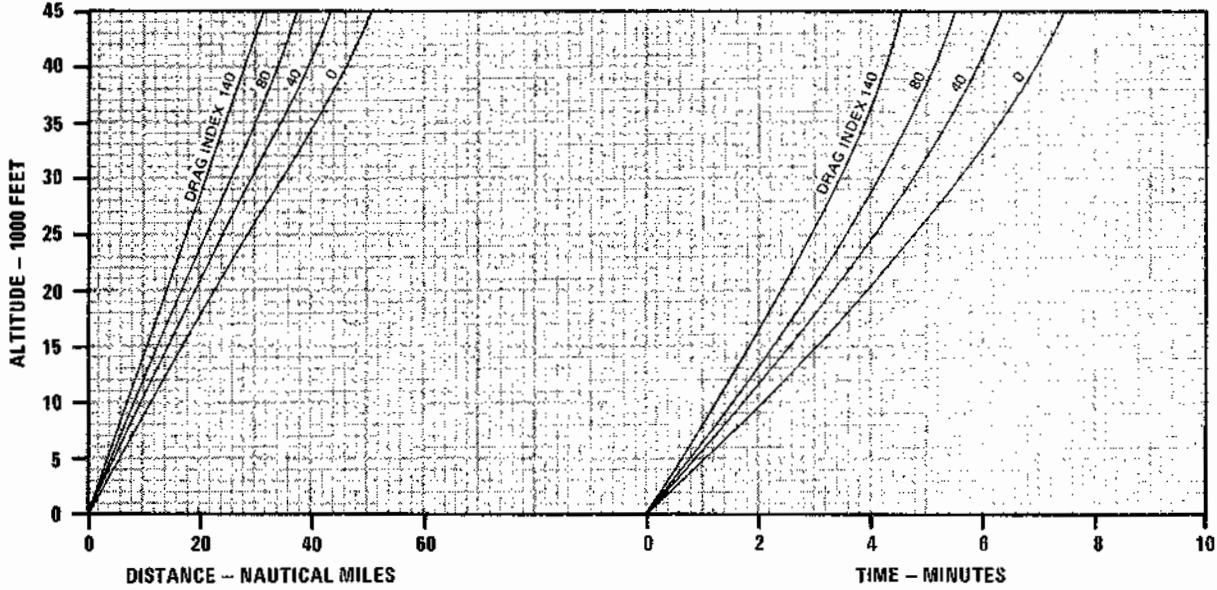

Figure A7-7



**F-4E**

# DESCENT

**300 KIAS - 80% RPM  
SPEED BRAKES RETRACTED**

AIRPLANE CONFIGURATION  
INDIVIDUAL DRAG INDEXES

REMARKS  
ENGINE(S): (2) J79-GE-17  
ALL GROSS WEIGHTS  
ICAO STANDARD DAY

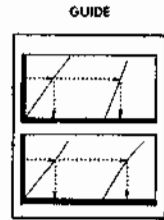

DATE: 1 OCTOBER 1976  
DATA BASIS: FLIGHT TEST

FUEL GRADE: JP-4  
FUEL DENSITY: 6.5 LB/GAL

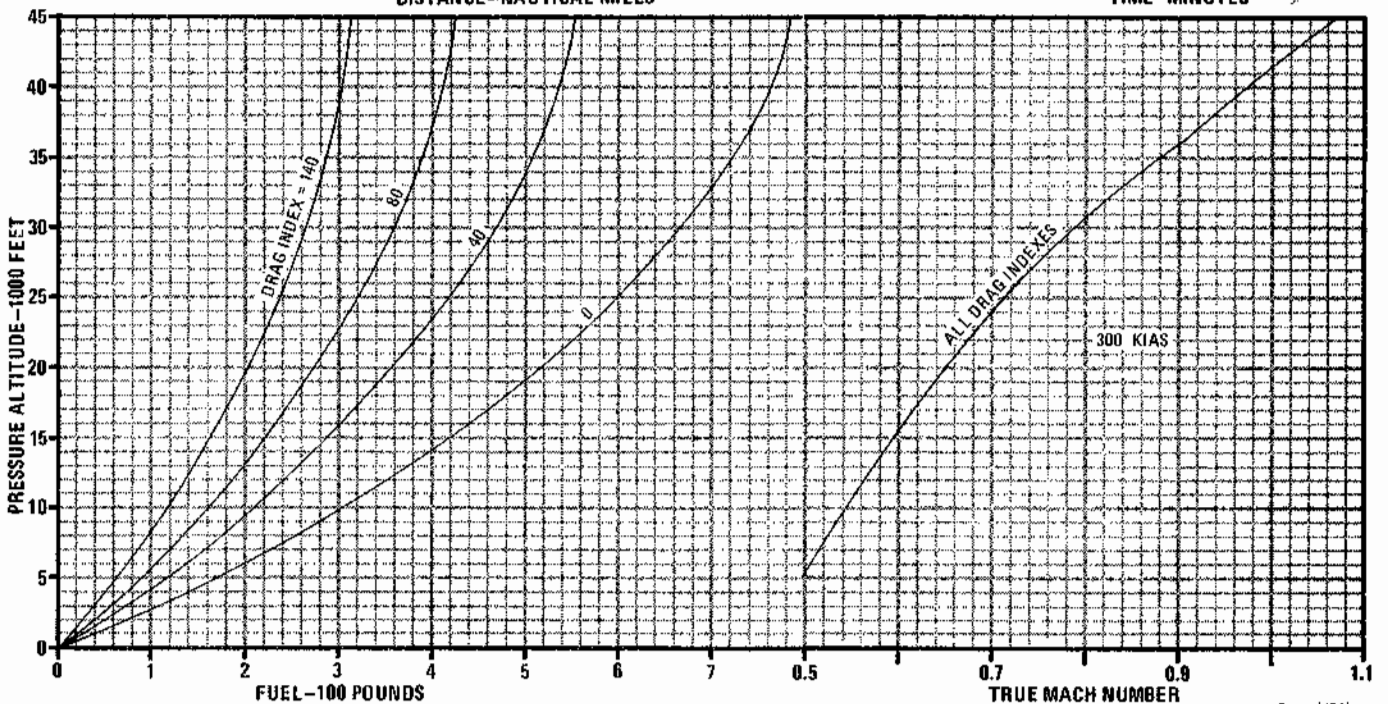
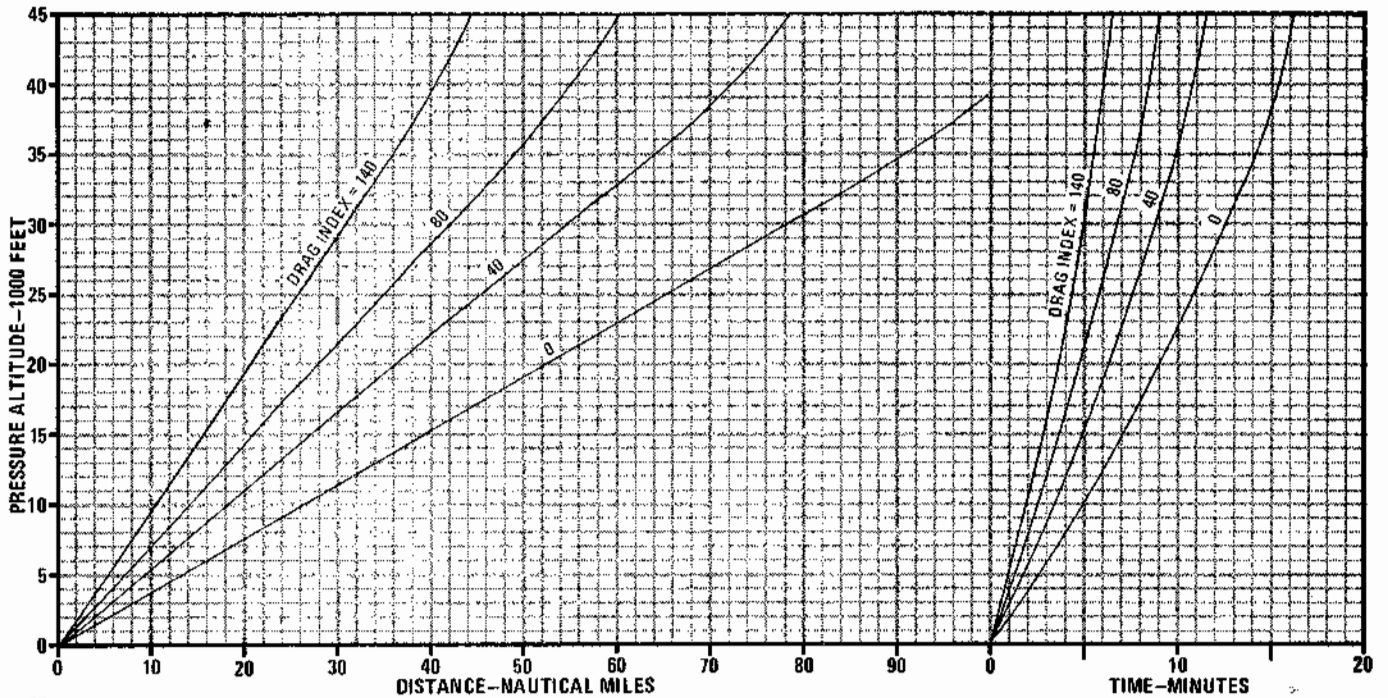

4E-1-(478)

Figure A7-8

# PART 8 LANDING

## FINAL APPROACH SPEEDS CHART

The Final Approach Speeds chart (figure A8-1) shows recommended approach speed curves for the various approach configurations, AOA and gross weights of the aircraft.

### USE

Enter the chart at estimated landing gross weight. Proceed vertically to the applicable configuration and AOA reflector line and project horizontally to the left scale to read recommended approach speed.

### Sample Problem

Configuration: Slats Out, Flaps Down, Gear Down

#### SAMPLE FINAL APPROACH SPEEDS

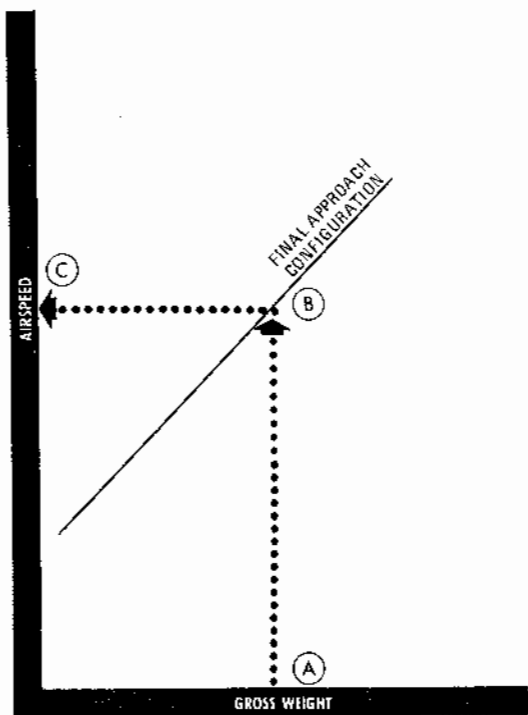

4E-1-(364)

- A. Estimated landing gross weight      36,000 Lb
- B. Intersect applicable reflector line
- C. Recommended approach speed (IAS) at 19.2 units (AOA)      149 Kt

## MINIMUM LANDING ROLL DISTANCE CHART

This chart (figure A8-2) provides landing roll distance information. Stopping distances are based on the anti-skid system operating and full brake pedal deflection applied. The variables of temperature, altitude, gross weight, effective wind, runway condition, and drag chute are taken into consideration.

### USE

Enter the chart with the runway temperature and project vertically upward to the correct pressure altitude. From this point, proceed horizontally to the right to the landing

#### SAMPLE MINIMUM LANDING ROLL DISTANCE

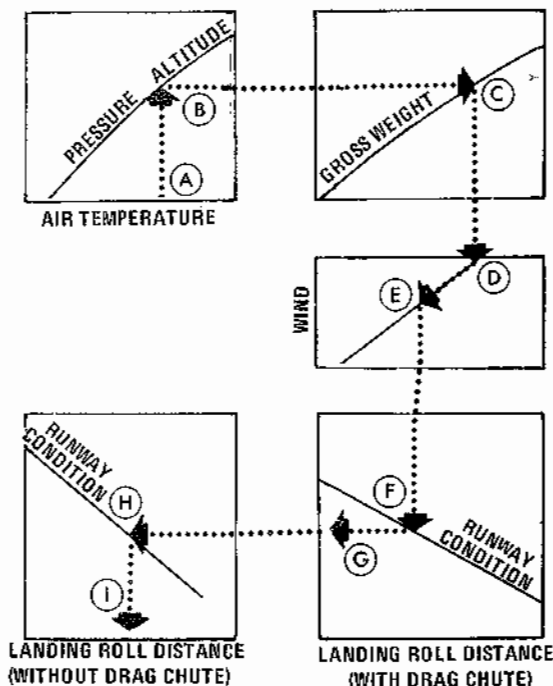

LANDING ROLL DISTANCE (WITHOUT DRAG CHUTE)

LANDING ROLL DISTANCE (WITH DRAG CHUTE)

4E-1-(365)A

gross weight. From this point, descend vertically to the wind baseline. Parallel the nearest guideline down to the effective headwind or tailwind. From this point, descend vertically to the appropriate runway condition reflector and then horizontally to the left to read landing roll distance with drag chute. If the landing is to be made without the drag chute, continue further to the left to the appropriate runway condition reflector and then proceed down to read the landing roll distance. If the landing is to be made over a 50-foot obstacle, allow 1900 feet for airborne distance required from the obstacle to the landing touchdown point.

**Sample Problem**

A. Temperature	15°C
B. Pressure altitude	Sea Level
C. Gross weight	35,000 Lb
D. Wind baseline	
E. Effective headwind	10 Kt
F. Runway condition wet	21
G. Landing roll distance	5000 Ft

If operating without drag chute:

H. Runway condition	Wet
I. Landing roll distance	9000 Ft

**F-4E**

# FINAL APPROACH SPEEDS

**AIRPLANE CONFIGURATION**  
 ALL DRAG INDEXES  
 FLAPS/SLATS AS NOTED  
 GEAR DOWN

**REMARKS**  
 ENGINE(S): (2)J79-GE-17  
 ICDA STANDARD DAY

**GUIDE**

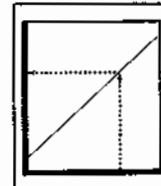

**Notes**

- DATA IS FOR A CG LOCATION OF 31% MAC. ADD 0.5 KNOTS FOR EACH PERCENT OF CG FORWARD OF 31% MAC.
- VARIATIONS IN AIRSPEED INDICATIONS OF UP TO 6 KNOTS CAN OCCUR BETWEEN INDIVIDUAL AIRSPEED SYSTEMS.

DATE: 1 AUGUST 1973  
 DATA BASIS: FLIGHT TEST

FUEL GRADE: JP-4  
 FUEL DENSITY: 6.5 LB/GAL

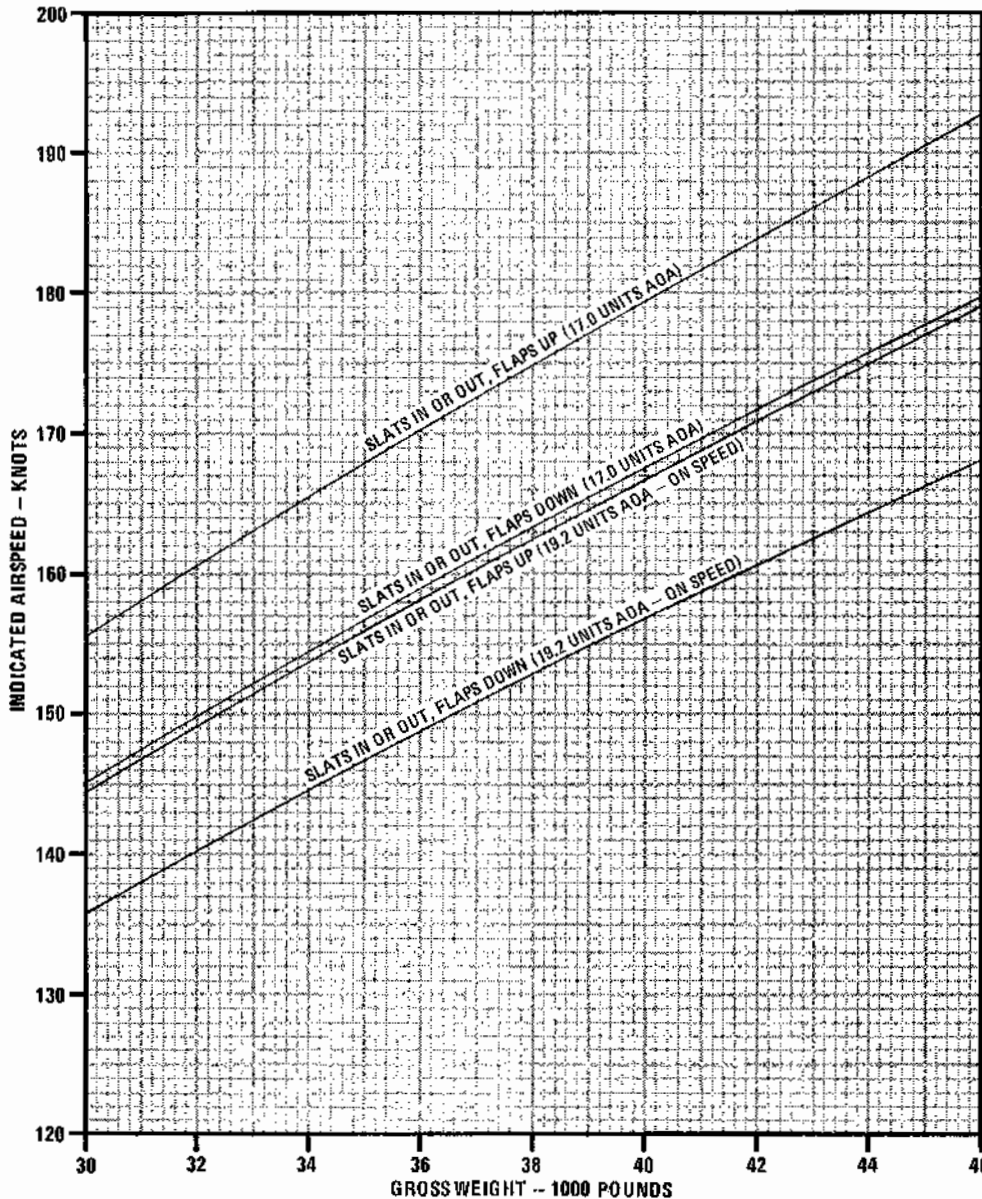

Figure A8-1

**F-4E**

# MINIMUM LANDING ROLL DISTANCE

**AIRPLANE CONFIGURATION**  
 ALL DRAG INDEXES  
 SLATS OUT  
 FLAPS DOWN  
 GEAR DOWN  
 DRAG CHUTE DEPLOYED  
 FULL BRAKE PEDAL DEFLECTION

**IDLE THRUST**  
**REMARKS**  
 ENGINE(S): (2) J79-GE-17

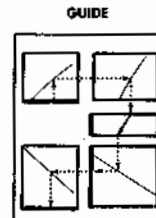

DATE: 1 JUNE 1977  
 DATA BASIS: **FLIGHT TEST**

FUEL GRADE: JP-4  
 FUEL DENSITY: 6.5 LB/GAL

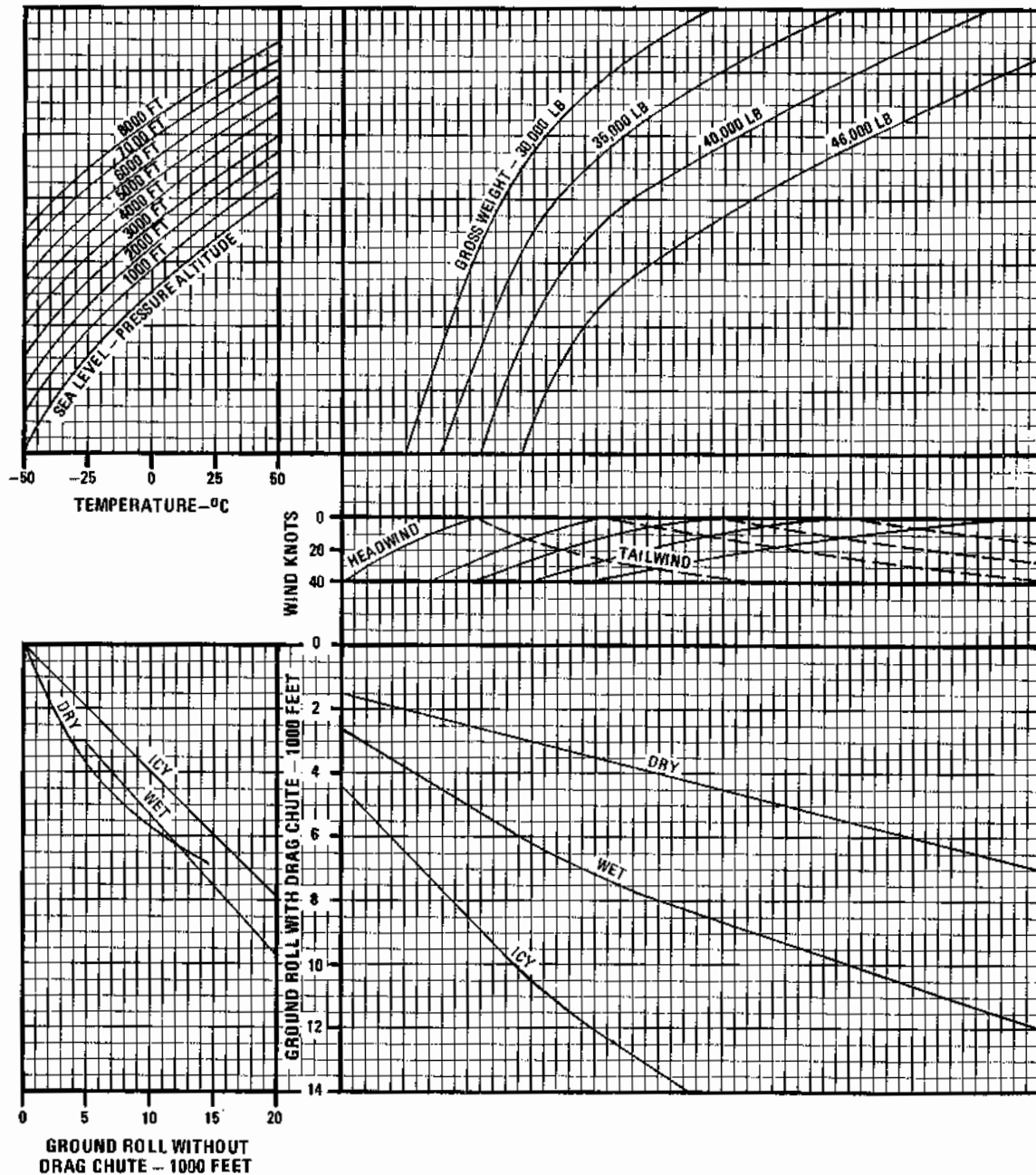

Figure A8-2

# PART 9

## COMBAT PERFORMANCE

### TABLE OF CONTENTS

#### Charts

Combat Fuel Flow .....	A9-8
Combat Specific Range .....	A9-11
Supersonic Maximum Thrust Climb .....	A9-14
Low Altitude Acceleration .....	A9-19
Maximum Thrust Acceleration Charts .....	A9-31
Military Thrust Acceleration Charts .....	A9-60
Level Flight Envelope .....	A9-84
V-N Envelope .....	A9-86
Dive Recovery Charts .....	A9-90
Temperature Effect on Maximum Speed ....	A9-94
Turn Capabilities .....	A9-95
Sustained G Turn Capabilities .....	A9-96

#### NOTE

For aircraft with Tiseo scope housing (with or without scope) on the left wing and combat documentation cameras, a degradation of combat performance will be noted. Additional information will be supplied when available.

### COMBAT FUEL FLOW CHARTS

These charts (figures A9-1 thru A9-3) present the specific fuel flow and general thrust setting to maintain a constant Mach number for an ICAO standard day and standard day +10°C at all altitudes between sea level and 50,000 feet. Each chart is plotted for a specific configuration. The fuel flow values are based on a stabilized level flight condition and do not represent the fuel flow required to accelerate to a given Mach number.

#### USE

Enter the chart corresponding to the aircraft configuration with the desired Mach number for stabilized level flight. Proceed vertically upward to the selected flight altitude. Note the general thrust setting required, and then project horizontally to the left to read specific fuel flow.

#### Sample Problem

Configuration: (4) AIM-7 Missiles

A. Desired Mach number	1.5
B. Altitude	25,000 Ft
C. Power setting required	Modulated Afterburners
D. Specific fuel flow	1010 PPM

### COMBAT SPECIFIC RANGE

These charts (figures A9-4 thru A9-6) present the specific range and the general power settings required to maintain a constant Mach number for an ICAO standard day and standard day +10°C at all altitudes from sea level to 50,000 feet. The specific range values are based on a stabilized level flight condition and do not represent the fuel flow required to accelerate to a given Mach number.

#### USE

Enter the chart corresponding to the aircraft configuration with the desired Mach number for stabilized level flight. Proceed vertically upward to the selected flight altitude. Note the general thrust setting required, and then project horizontally left to obtain the specific range.

#### SAMPLE COMBAT FUEL FLOW

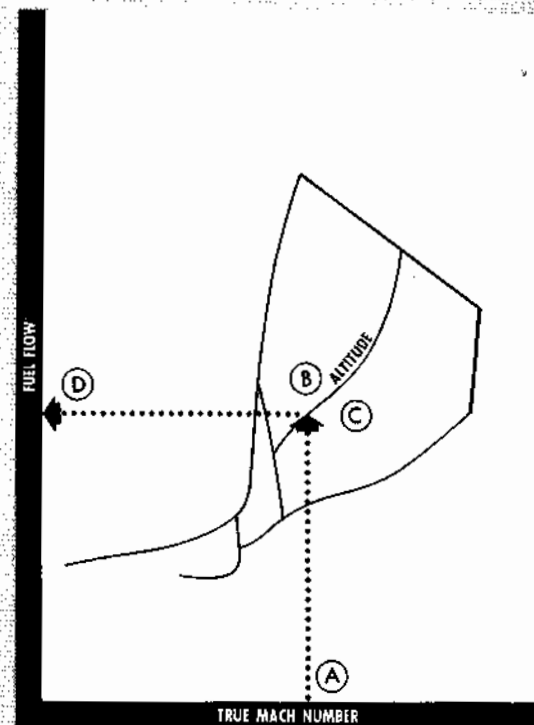

4E-1-(368)

**SAMPLE COMBAT SPECIFIC RANGE**

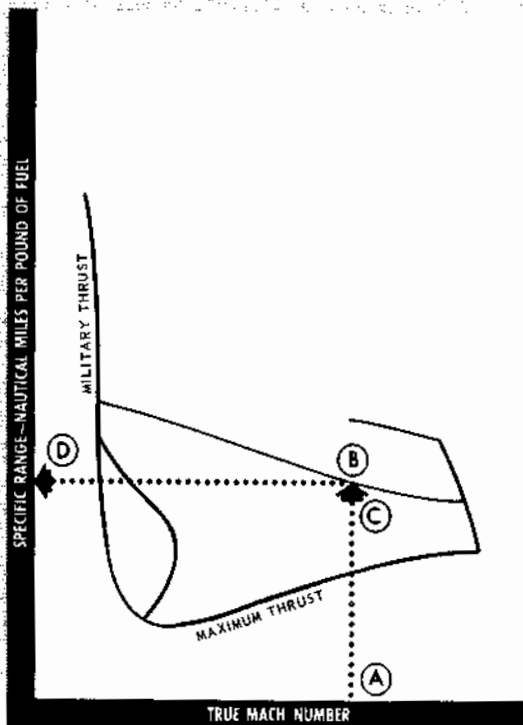

4E-1-(389)

**NOTE**

If ramp cycling occurs during supersonic climb, the climb schedule Mach number can be increased until the cycling stops. This produces an insignificant degradation in climb performance.

**USE**

Enter the chart with the gross weight and proceed vertically to the initial Mach number and note the corresponding distance and time. Proceed parallel to the guidelines to the desired supersonic climb Mach number (end of acceleration). Project both vertically downward and horizontally to the left from this point to read gross weight and distance traveled, also note the time. From these values, subtract the distance, weight, and time corresponding to the initial Mach number to determine the distance, fuel and time required to accelerate. From the climb Mach number gross weight intersection, (start of climb) proceed parallel along the guidelines to the desired altitude. Obtain the distance, gross weight, and time for this point. Subtract from this data the corresponding values at the start of climb to obtain the distance traveled, the weight change (fuel used), and the time required to complete the climb. If total distance, fuel, and time are desired, add the climb and acceleration values together.

**Sample Problem**

Configuration: (4) AIM-7 Missiles

**Sample Problem**

Configuration: (4) AIM-7 Missiles and (2) Wing Tanks

- A. Desired Mach number 1.3
- B. Altitude 30,000 Ft
- C. Thrust required Modulated Afterburners
- D. Specific range 0.018 NMPP

- A. Initial gross weight 40,000 Lb
- B. Initial Mach number 1.2
- C. Time corresponding to initial Mach number 0.7 Min
- D. Distance corresponding to initial Mach number 7.5 NM
- E. Climb Mach number 1.6
- F. Time at end of acceleration 1.9 Min
- G. Distance at end of acceleration 23.5 NM
- H. Gross weight at end of acceleration 38,900 Lb
- I. Time required for acceleration (F-C) 1.2 Min
- J. Fuel required for acceleration (A-H) 1100 Lb
- K. Distance required for acceleration (G-D) 16 NM
- L. Altitude at end of climb 52,000 Ft
- M. Time at end of climb 4.4 Min
- N. Distance at end of climb 61.4 NM
- O. Gross weight at end of climb 37,500 Lb
- P. Time required for climb (M-F) 2.5 Min
- Q. Distance required for climb (N-G) 37.9 NM
- R. Fuel required for climb (H-O) 1400 Lb
- S. Total time required to accelerate and climb (I+P) 3.7 Min
- T. Total distance required to accelerate and climb (K+Q) 53.9 NM
- U. Total fuel required to accelerate and climb (J+R) 2500 Lb

**SUPERSONIC MAXIMUM THRUST CLIMB CHARTS**

These charts (figures A9-7 thru A9-11) are plotted for supersonic maximum thrust climb from 35,000 feet to the supersonic combat ceiling. Distance traveled in the climb is plotted against gross weight, with guidelines provided to show the weight reduction as the climb progresses. The time to distance/altitude relationship is superimposed on the plot. Level flight acceleration data is provided which includes time, fuel used (gross weight change), and distance required to accelerate from the subsonic to the supersonic climb Mach number at 35,000 feet. If supersonic climb is contemplated, acceleration at 35,000 feet followed by the climb is recommended, since acceleration to supersonic Mach numbers at this altitude provides for the optimum performance capability.

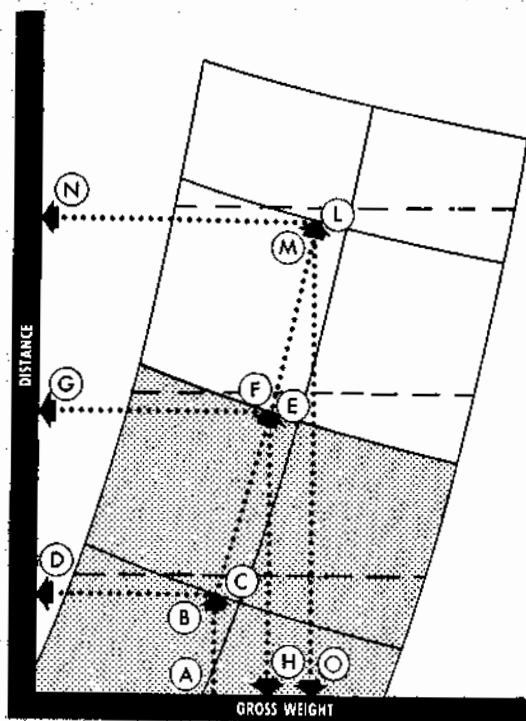
**SAMPLE SUPERSONIC MAXIMUM THRUST CLIMB**

4E-1-(370)

**LOW ALTITUDE ACCELERATIONS**

These charts (figures A9-12 thru A9-23) present time and fuel required to accelerate from 0.5 to 0.9 Mach at altitudes of Sea Level, 2000, 4000, and 6000 feet. Separate charts are provided for several gross weights and for both maximum and military thrust. The time and fuel values are tabulated for ICAO Standard Day conditions; however, correction factors are given for nonstandard temperatures.

**USE**

After selecting the applicable chart for thrust, gross weight, and altitude, enter with the Mach number desired at end of acceleration and project horizontally to the applicable drag index column. Read time/fuel required to accelerate from 0.5 Mach.

**ACCELERATION CHARTS**

These charts (figures A9-24 thru A9-76) show the relationship of time, distance, and fuel required for level flight maximum or military thrust accelerations. This data is presented for various altitudes and configurations.

**WARNING**

Refer to section V for external stores operating limitations.

**USE**

Enter the applicable chart with the aircraft gross weight. Proceed vertically upward to the initial Mach number and note the time. Project horizontally and note the distance. From the initial Mach number, proceed parallel to the guidelines to the Mach number desired at the end of acceleration. At this point note the time, then project horizontally and vertically and note the distance and gross weight. From this data, subtract the time, distance, and weight corresponding to the initial Mach number to determine the time, distance, and fuel required for acceleration.

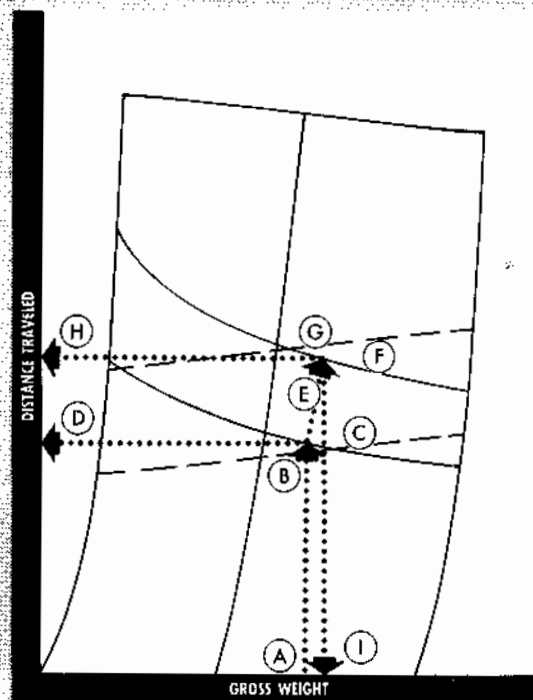
**SAMPLE ACCELERATION**

4E-1-(371)



**Sample Problem**

Configuration: (4) AIM-7 Missiles and (2) WING TANKS, 45,000 feet; Maximum thrust.

- A. Gross weight 45,000 Lb
- B. Initial Mach number 1.0
- C. Time 2 Min
- D. Distance 17 NM
- E. Parallel guidelines
- F. Desired Mach number 1.30
- G. Time corresponding to new Mach number 8.8 Min
- H. Distance corresponding to new Mach number 93 NM
- I. Gross Weight corresponding to new Mach number 41,950 Lb
- J. Time required for acceleration (G-C) 6.8 Min
- K. Distance required for acceleration (H-D) 76 NM
- L. Fuel required for acceleration (A-I) 3050 Lb

**LEVEL FLIGHT ENVELOPE**

These charts (figures A9-77 and A9-78) present the aircraft level flight speed envelope for various configurations and average combat gross weights. Parameters of the envelopes extend from buffet onset to  $V_{max}$  throughout the altitude range. Maximum Mach number curves for additional aircraft configurations are plotted within the envelopes.

**WARNING**

Refer to section V for external stores operating limitations.

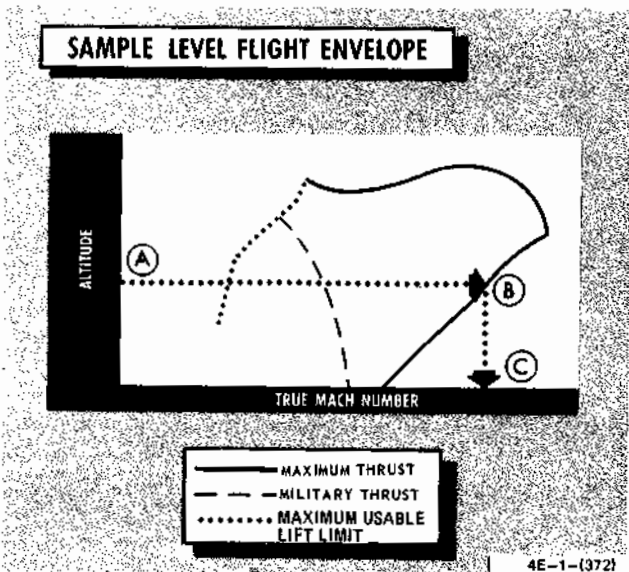

**USE**

Enter the appropriate chart with the desired combat altitude. Proceed horizontally to intersect the applicable configuration power curve. From this point proceed vertically downward to read the maximum attainable Mach number in level flight.

**Sample Problem**

Configuration: (4) AIM-7 Missiles

- A. Combat altitude 36,000 Ft
- B. Maximum attainable Mach number 2.04

**V-N ENVELOPE**

The Symmetrical Flight V-N Envelopes (figures A9-79 thru A9-82) are a graphical presentation of airspeed versus acceleration with lines of indicated angle of attack superimposed. Data is supplied for a gross weight of 37,500 pounds at four altitudes. The charts may be used to determine the allowable maximum symmetrical maneuvering capability of the airplane as well as the indicated angle of attack for any desired G. The charts may be considered to be linear between altitudes for all practical purposes, provided the interpolation is carried out for a constant airspeed.

**USE**

To find the allowable maximum symmetrical performance capability, enter the chart with the indicated airspeed and proceed vertically to the stall boundary (positive or negative G) or the maximum allowable acceleration (upper and lower) as applicable. From these intersections, project horizontally to the left to read the positive and negative G obtainable in the case of the stall boundaries, or the upper and lower maximum allowable G for the selected gross weight. To find the AOA for a given condition of G and airspeed, enter the appropriate chart with these parameters. Project horizontally to the right from the load factor and vertically upward from the airspeed. At the intersection of these two projections, read the indicated angle of attack.

**Sample Problem**

Altitude 5000 Feet; Gross Weight-37,500 pounds

- A. Speed (IAS) 500 Kt
- B. Load factor 6 G
- C. AOA 12 units

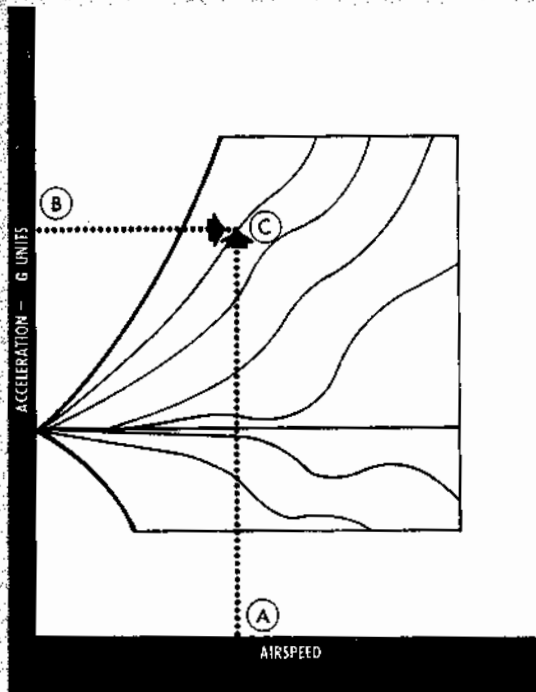
**SAMPLE V-N ENVELOPE**

4E-1-(373)

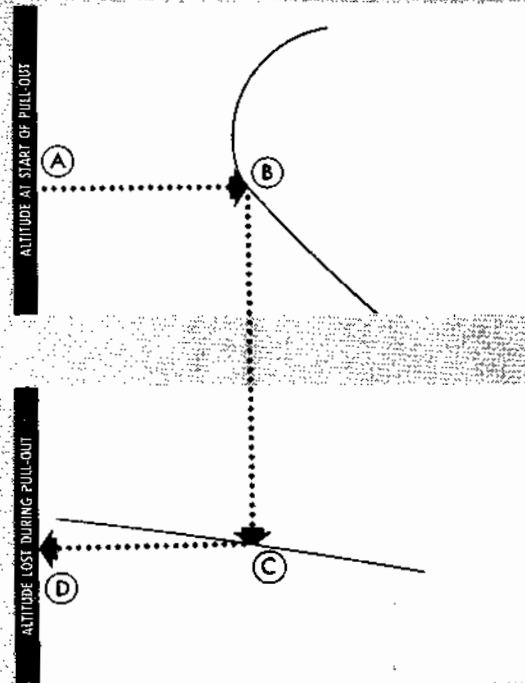
**SAMPLE DIVE RECOVERY**

4E-1-(374)

**DIVE RECOVERY CHARTS**

These charts (figures A9-83 thru A9-86) present the airplanes dive recovery capability for various speeds (subsonic and supersonic), altitudes and dive angles at 16 units and 25 units AOA.

**USE**

Enter the applicable chart at the start of the pull-out, and project horizontally to intersect the Mach number at the start of the pull-out. From this point, descend vertically and intersect the dive angle at the start of pull-out, then proceed horizontally to the left to read altitude lost during pull-out.

**Sample Problem**

Configuration: (4) AIM-7 Missiles; 16 Units AOA; Supersonic

A. Altitude at start of pull-out	40,000 Ft
B. Mach number at start of pull-out	1.5
C. Dive angle at start of pull-out	70°
D. Altitude loss during constant 16 unit AOA pull-out	13,500 Ft

**TEMPERATURE EFFECT ON MAXIMUM SPEED**

This chart (figure A9-87) shows the effect of nonstandard day temperatures on the maximum speed at maximum thrust. The speed variation is read out as the change in Mach number ( $\Delta$  Mach) for a 10°C variation in temperature (hot or cold) from standard day.

**USE**

Determine the temperature variation from standard day for the desired altitude.  $M_{\max}$  may be obtained from the Maximum Thrust Acceleration charts. Enter the chart at the standard day  $M_{\max}$  line. Proceed vertically into either the Hot or Cold Day plot depending on the temperature variation. Continue vertically to the selected altitude, then proceed horizontally to the left to read  $\Delta$  Mach. When the temperature variation differs from 10°C, simply divide the variation by 10 to reduce it to a decimal. Then multiply the  $\Delta$  Mach by the decimal to obtain the  $\Delta$  Mach for a specific situation.

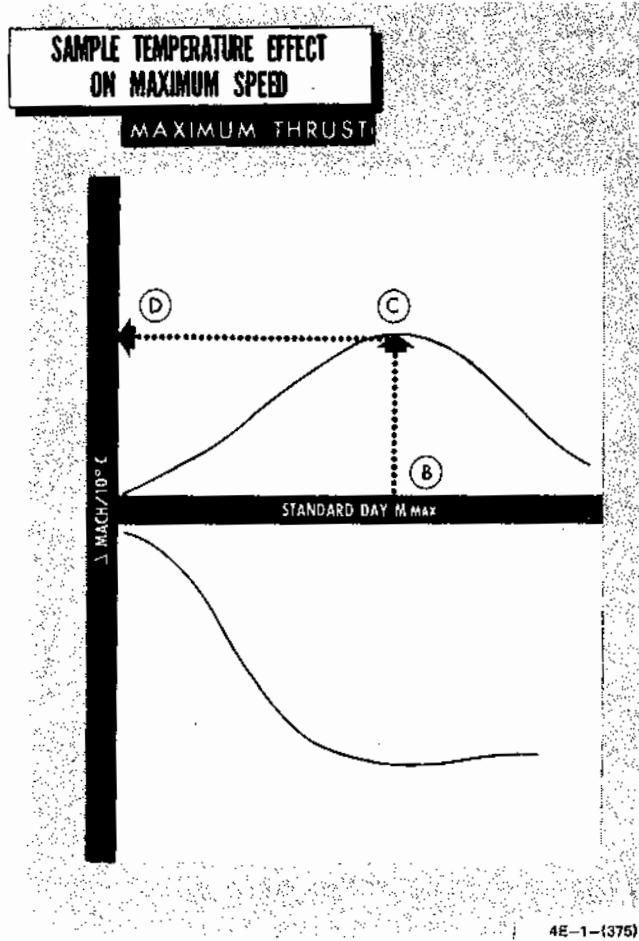

**Sample Problem**

Find  $\Delta$  Mach for a standard day  $M_{max}$  of 1.8 at 30,000 feet. Forecast flight level temperature is  $-46.8^{\circ}\text{C}$ .

- |  |                        |
|--|------------------------|
| A. Temperature variation                 | $-2.4^{\circ}\text{C}$ |
| B. Standard day $M_{max}$                | 1.8 Mach               |
| C. Altitude                              | 30,000 Ft              |
| D. Mach/ $10^{\circ}\text{C}$ variation  | 0.17                   |
| E. Mach/ $2.4^{\circ}\text{C}$ variation | 0.04                   |
| F. Mach number (B+E)                     | 1.84                   |

**TURN CAPABILITIES**

This chart (figure A9-88) presents the radius of turn and the rate of turn for a constant altitude, constant speed turn. Turn data is available for various speeds and bank angles. Load factor is also included for each bank angle.

**USE**

Enter the radius of turn plot with the true airspeed. Proceed horizontally to the right to the desired bank angle. Note the load factor, then proceed vertically downward and read the radius of turn. Enter the rate of turn plot with the true airspeed. Proceed horizontally to the right to the bank angle, note the load factor and then proceed vertically downward to read the rate of turn.

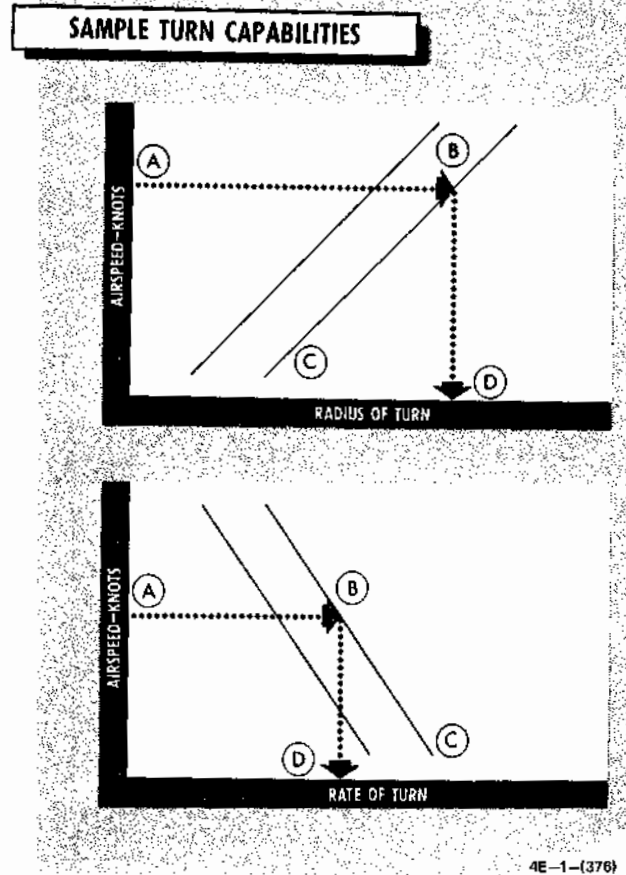

**Sample Problem**

**Radius of Turn**

- |                   |              |
|-------------------|--------------|
| A. True airspeed  | 420 Kt       |
| B. Bank angle     | $60^{\circ}$ |
| C. Load factor    | 2.0 G        |
| D. Radius of Turn | 9000 Ft      |

**Rate of Turn**

- |                  |                          |
|------------------|--------------------------|
| A. True airspeed | 420 Kt                   |
| B. Bank angle    | $60^{\circ}$             |
| C. Load factor   | 2.0 G                    |
| D. Rate of turn  | $4.5^{\circ}/\text{sec}$ |

## SUSTAINED G TURN CAPABILITIES

These charts (figures A9-89 and A9-90) present the minimum radius of turn and corresponding maximum rate of turn and load factor for two different configurations and combat gross weights. The charts are plotted for various constant airspeeds and altitudes from sea level to 45,000 feet. Bank angles are also shown with the corresponding load factor.

### USE

Enter the chart with the applicable airspeed or Mach number and proceed vertically to intersect the applicable altitude in each of the three plots. From these intersections, proceed horizontally to the left or right and read the minimum radius of turn, maximum rate of turn and maximum load factor attainable.

### Sample Problem

Configuration: (4) AIM-7 Missiles Gross Weight 42,777 Lb

A. Mach	0.80
B. Altitude	35,000 Ft
C. Minimum radius of turn	1.8 NM
D. Maximum rate of turn	4.1°/sec
E. Maximum sustained load factor	2.05 G
F. Bank angle	61°

### SAMPLE SUSTAINED G TURN CAPABILITIES

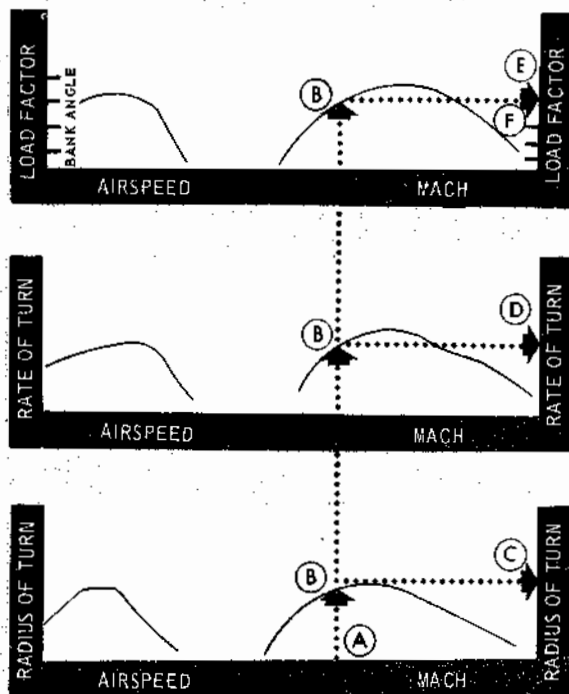

4E-1-(377)

**F-4E**

# COMBAT FUEL FLOW STABILIZED LEVEL FLIGHT

AIRPLANE CONFIGURATION  
(4) AIM 7

REMARKS  
ENGINE(S): (2) J79-GE-17

GUIDE



DATE: 1 FEBRUARY 1973  
DATA BASIS: FLIGHT TEST

FUEL GRADE: JP-4  
FUEL DENSITY: 6.5 LB/GAL

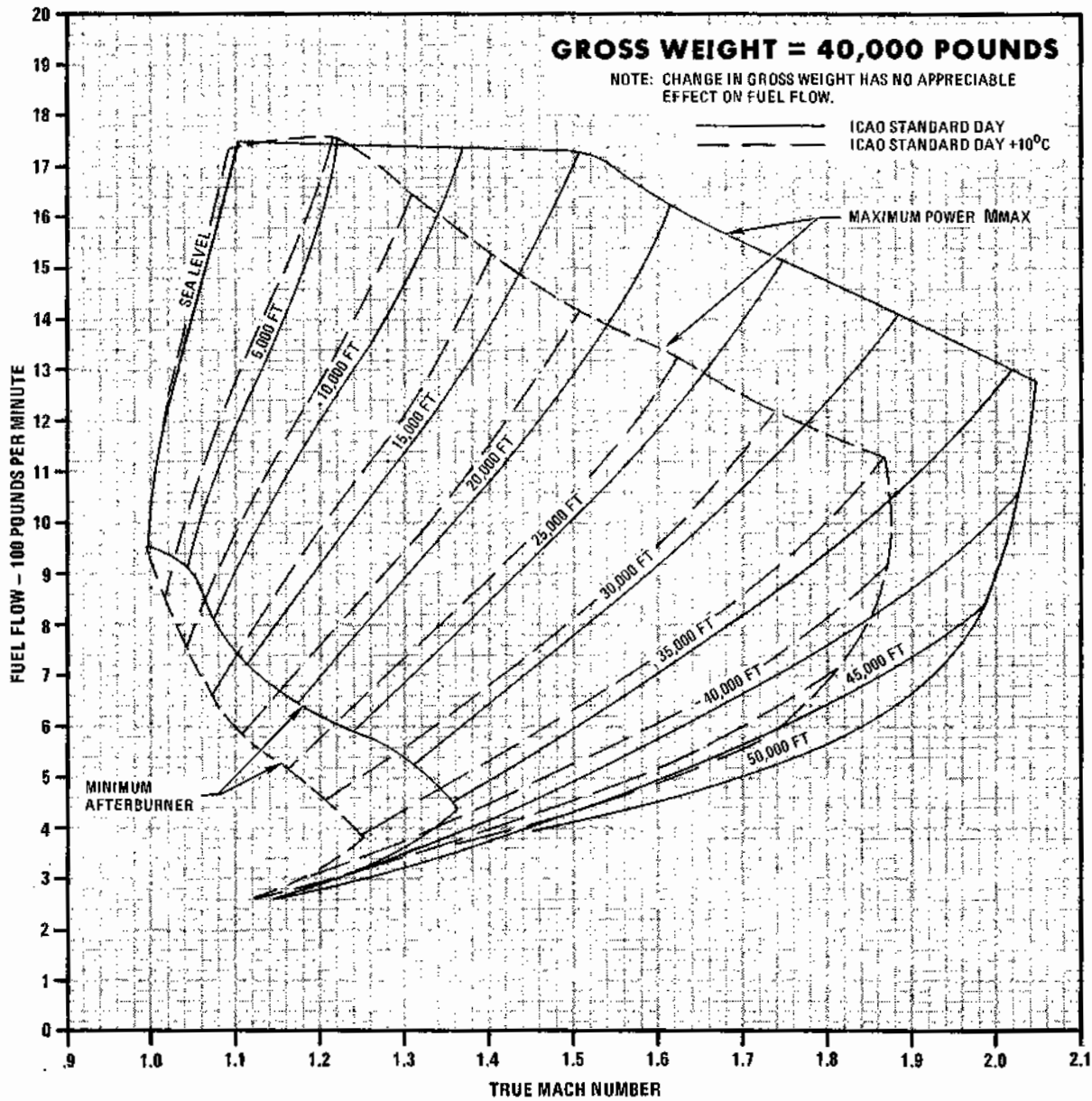

4E-1-(378)

Figure A9-1

**F-4E**

# COMBAT FUEL FLOW

## STABILIZED LEVEL FLIGHT

**AIRPLANE CONFIGURATION**  
(4)AIM-7 AND (1) Q TANK

**REMARKS**  
ENGINE(S): (2) J79-GE-17  
ICAO STANDARD DAY

GUIDE

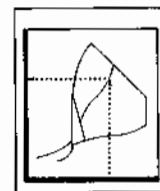

DATE: 1 FEBRUARY 1973  
DATA BASIS: FLIGHT TEST

FUEL GRADE: JP-4  
FUEL DENSITY: 6.5 LB/GAL

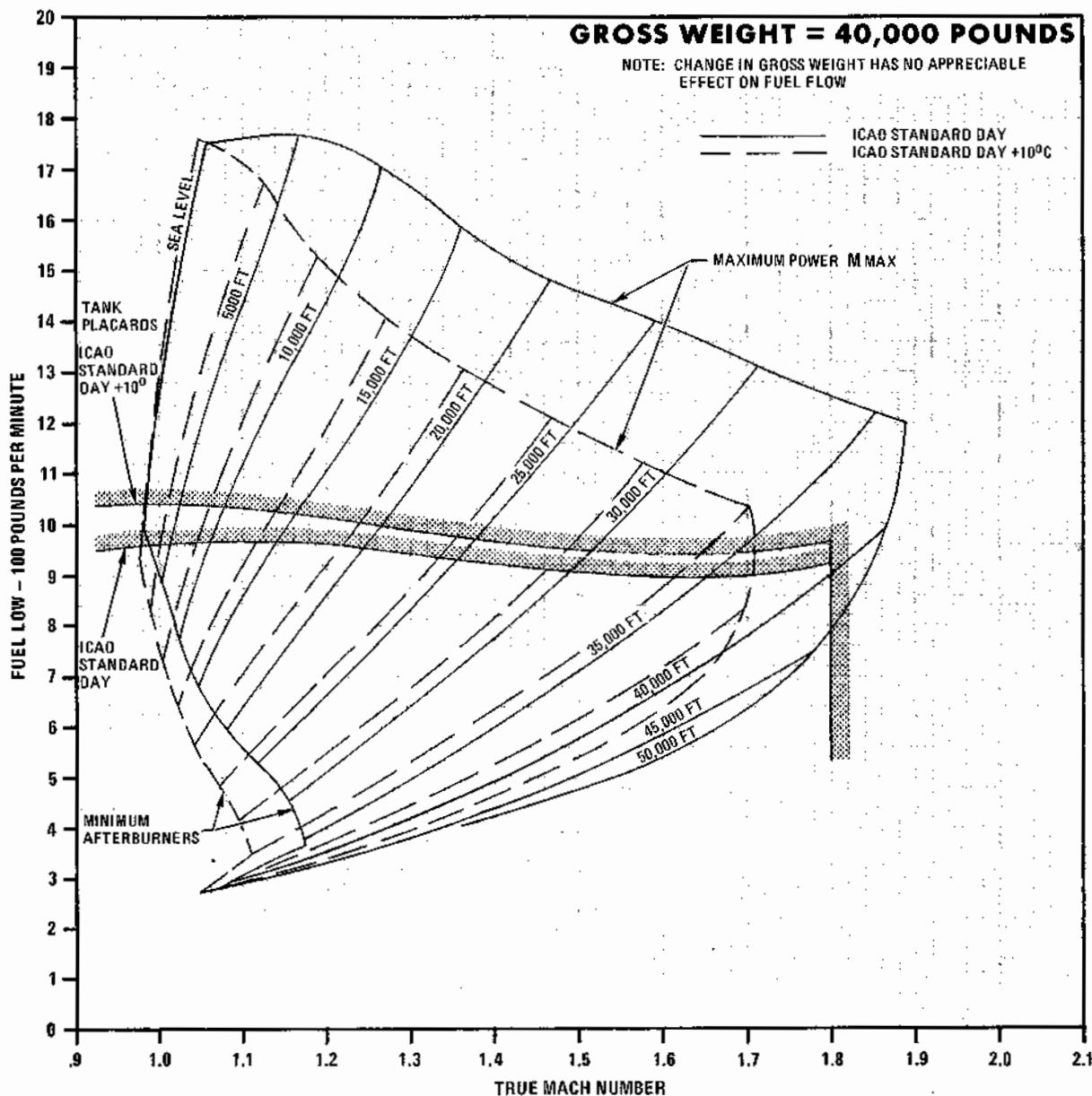

4E-1-(379)

Figure A9-2

**F-4E**

**COMBAT FUEL FLOW  
STABILIZED LEVEL FLIGHT**

**AIRPLANE CONFIGURATION**  
(4) AIM-7 AND (2) WING TANKS

**REMARKS**  
ENGINE(S): (2) J79-GE-17

GUIDE



DATE: 1 FEBRUARY 1973  
DATA BASIS: FLIGHT TEST

FUEL GRADE: JP-4  
FUEL DENSITY: 6.5 LB/GAL

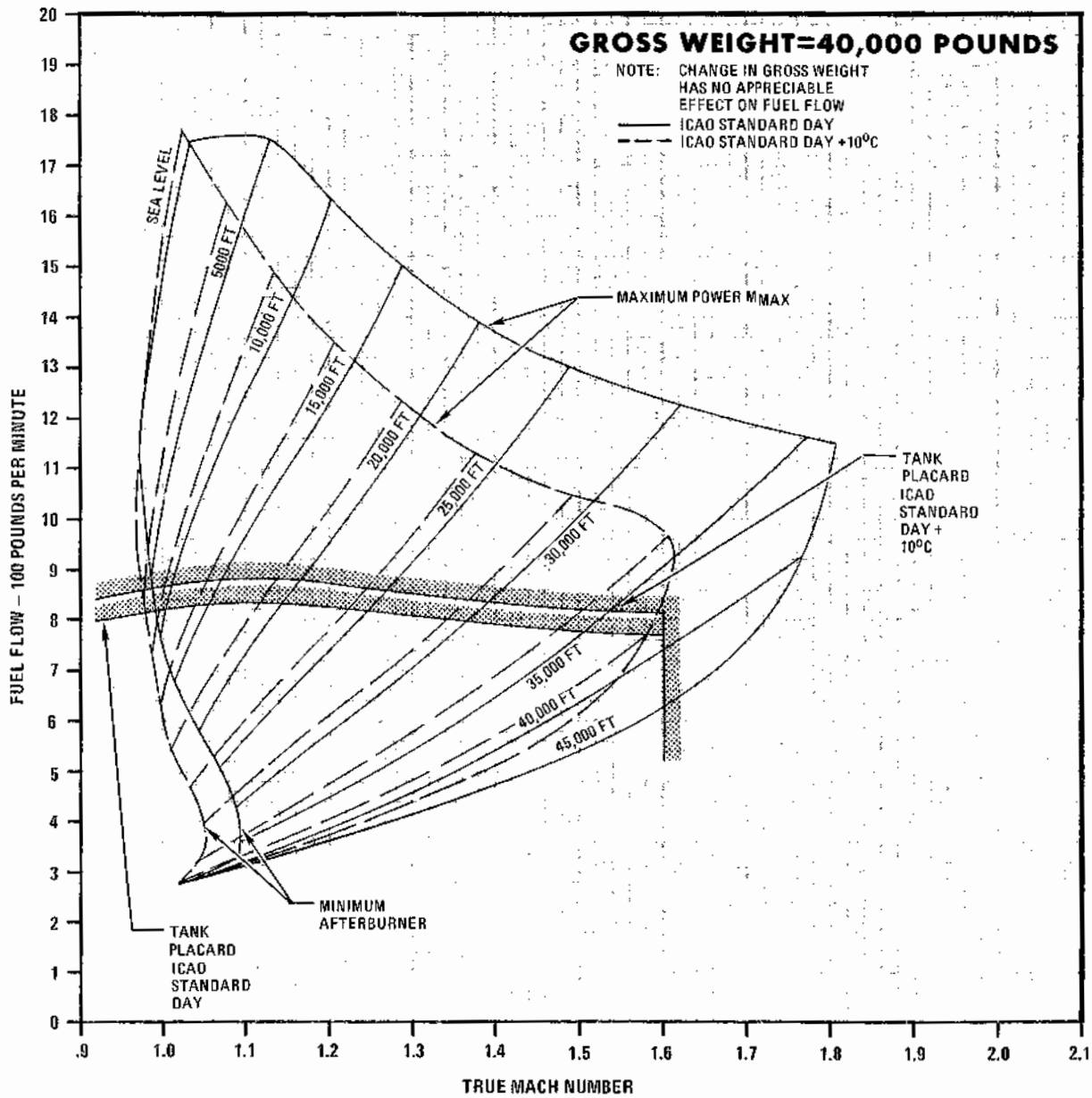

4E-1-(330)

Figure A9-3

F-4E

# COMBAT SPECIFIC RANGE STABILIZED LEVEL FLIGHT

AIRPLANE CONFIGURATION  
(4) AIM-7

REMARKS  
ENGINE(S): (2) J79-GE-17  
ICAO STANDARD DAY



DATE: 1 FEBRUARY 1973  
DATA BASIS: FLIGHT TEST

FUEL GRADE: JP-4  
FUEL DENSITY: 6.5 LB/GAL

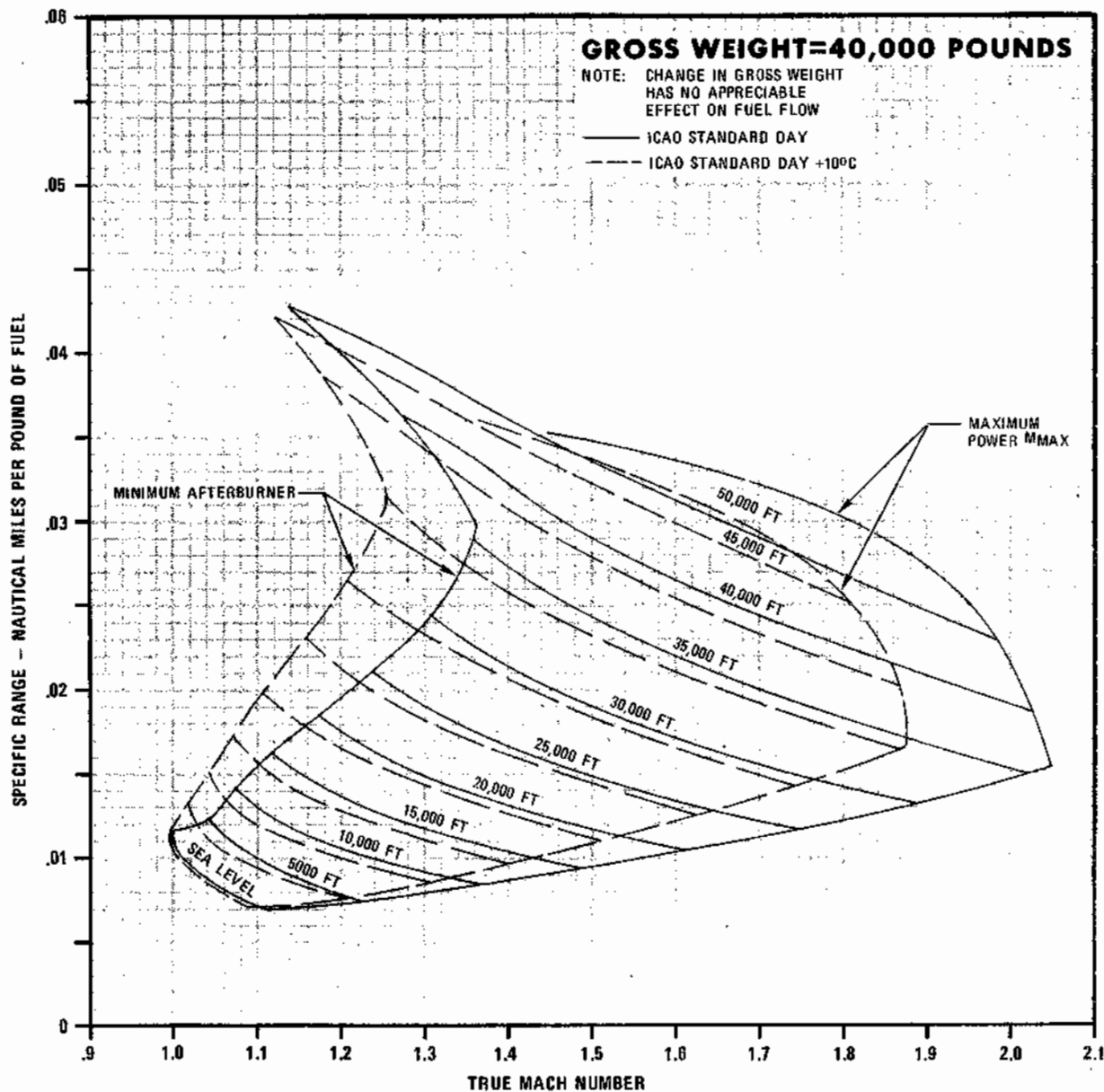

4E-1-(381)

Figure A9-4



**F-4E**

# COMBAT SPECIFIC RANGE STABILIZED LEVEL FLIGHT

**AIRPLANE CONFIGURATION**  
(4) AIM-7 AND (1)  $\zeta$  TANK

**REMARKS**  
ENGINE(S): (2) J79-GE-17  
ICAO STANDARD DAY

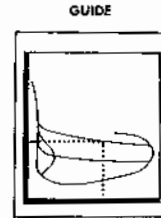

DATE: 1 FEBRUARY 1973  
DATA BASIS: FLIGHT TEST

FUEL GRADE: JP-4  
FUEL DENSITY: 6.5 LB/GAL

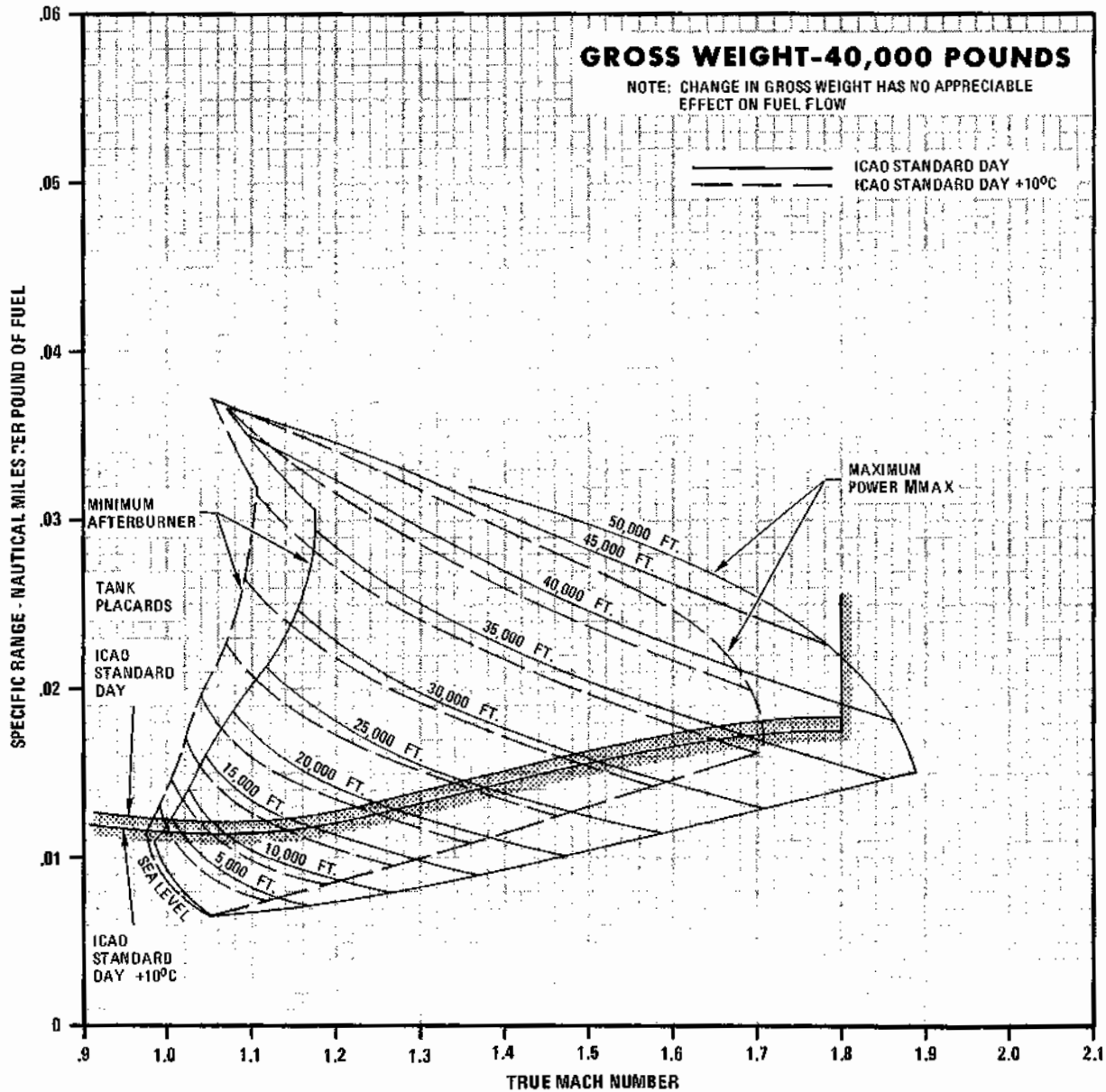

4E-1-(382)

Figure A9-5

**F-4E**  
**COMBAT SPECIFIC RANGE**  
**STABILIZED LEVEL FLIGHT**

AIRPLANE CONFIGURATION  
 (4) AIM-7 AND (2) WING TANKS

REMARKS  
 ENGINE(S): (2) J79-GE-17  
 ICAO STANDARD DAY

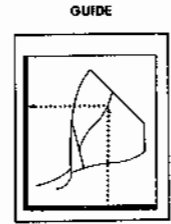

DATE: 1 FEBRUARY 1973  
 DATA BASIS: FLIGHT TEST

FUEL GRADE: JP-4  
 FUEL DENSITY: 6.5 LB/GAL

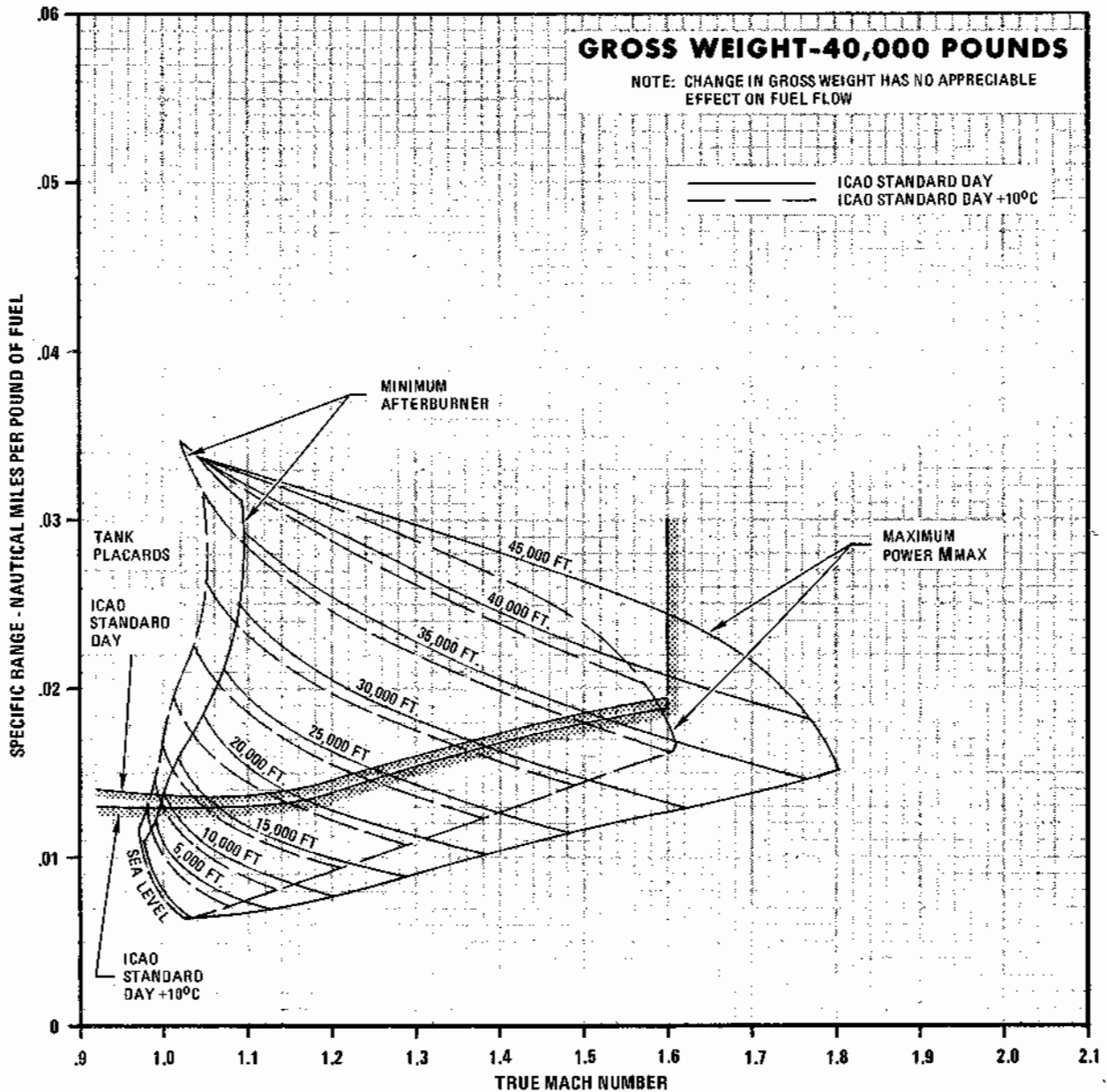

4E-1-(383)

Figure A9-6

**F-4E**

# SUPERSONIC MAXIMUM THRUST CLIMB

**AIRPLANE CONFIGURATION**

(4) AIM-7

**REMARKS**

ENGINE(S): (2)J79-GE-17  
ICAO STANDARD DAY

GUIDE

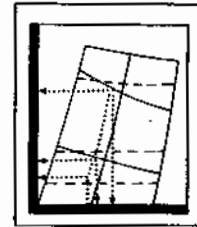

DATE: 1 FEBRUARY 1973  
DATE BASIS: FLIGHT TEST

FUEL GRADE: JP-4  
FUEL DENSITY: 6.5 LB/GAL

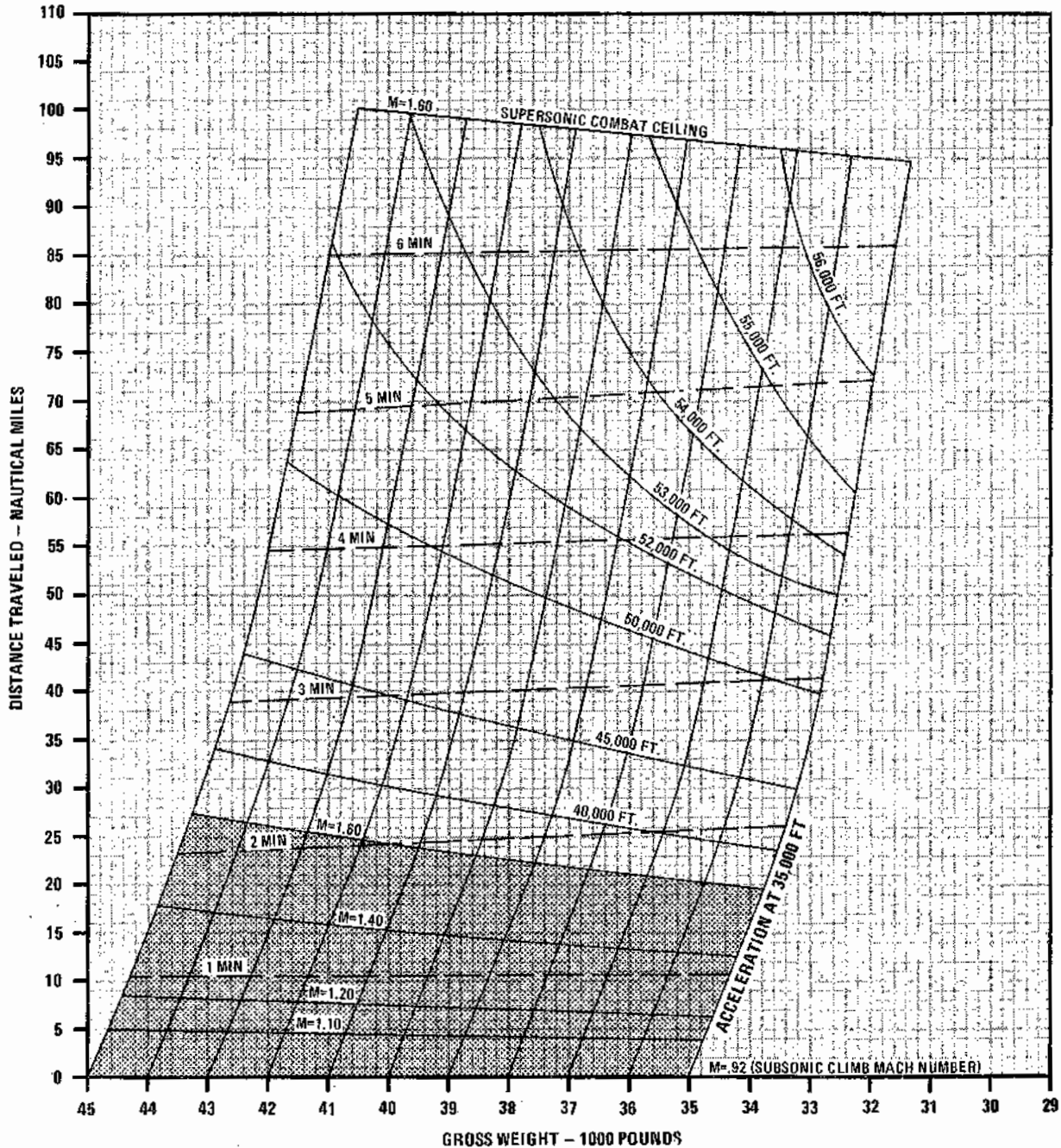

.4E-1-(384)

Figure A9-7

**F-4E**

# SUPERSONIC MAXIMUM THRUST CLIMB

**AIRPLANE CONFIGURATION**

(4) AIM-7 AND  
(1)  $Q_{L}$  TANK

**REMARKS**

ENGINE(S): I2IJ78-GE-17  
ICAO STANDARD DAY

**GUIDE**

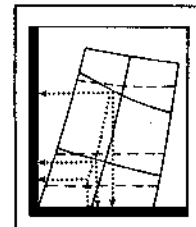

FUEL GRADE: JP-4  
FUEL DENSITY: 6.5 LB/GAL

DATE: 1 FEBRUARY 1973  
DATA BASIS: FLIGHT TEST

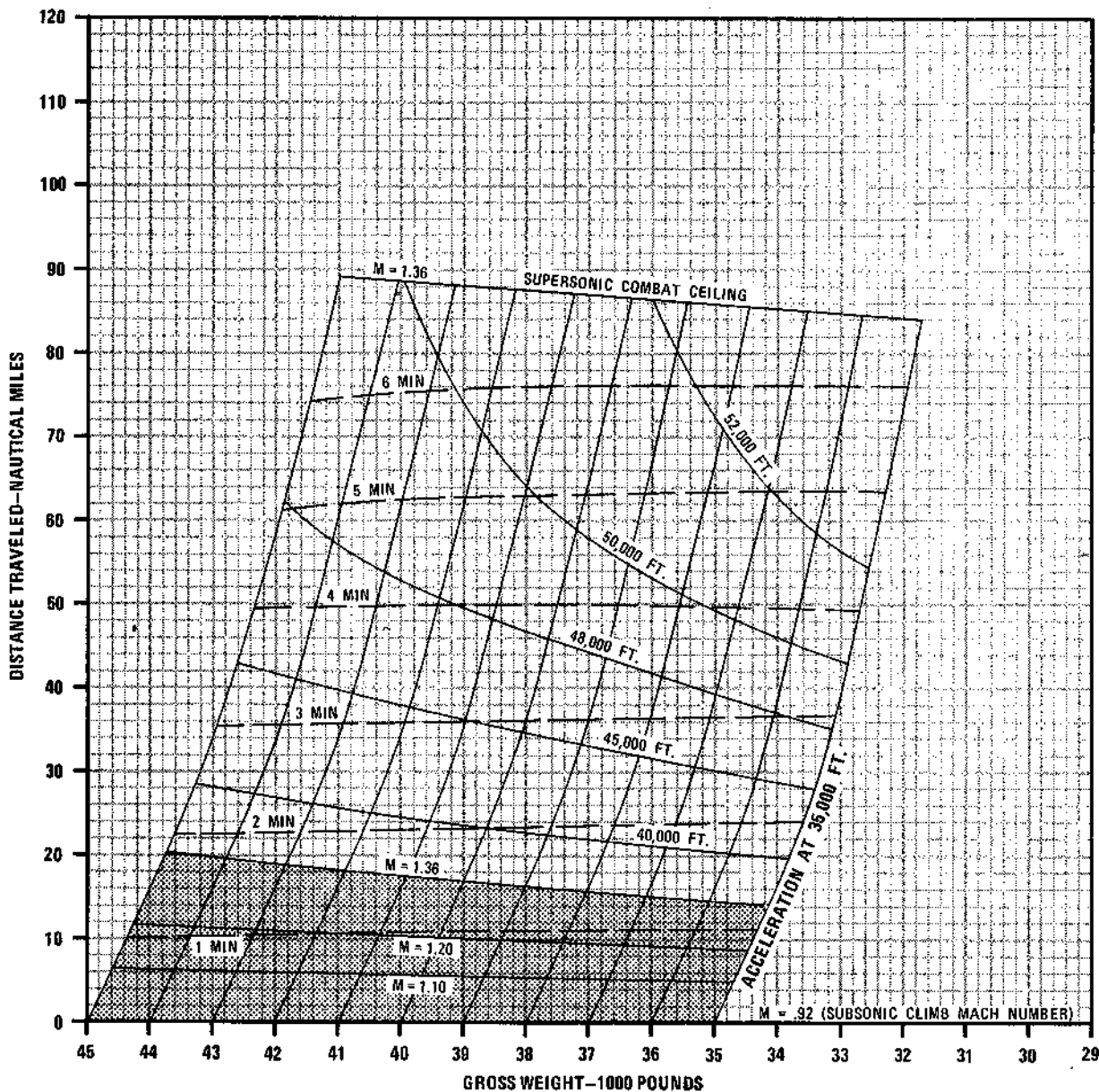

Figure A9-8

**F-4E**

# SUPERSONIC MAXIMUM THRUST CLIMB

**AIRPLANE CONFIGURATION**

(4) AIM-7 AND  
(2) WING TANKS

**REMARKS**

ENGINE(S): (2) J79-GE-17  
ICAO STANDARD DAY

**GUIDE**

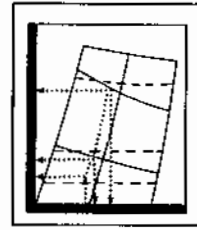

FUEL GRADE: JP-4  
FUEL DENSITY: 6.5 LB/GAL

DATE: 1 FEBRUARY 1973  
DATA BASIS: FLIGHT TEST

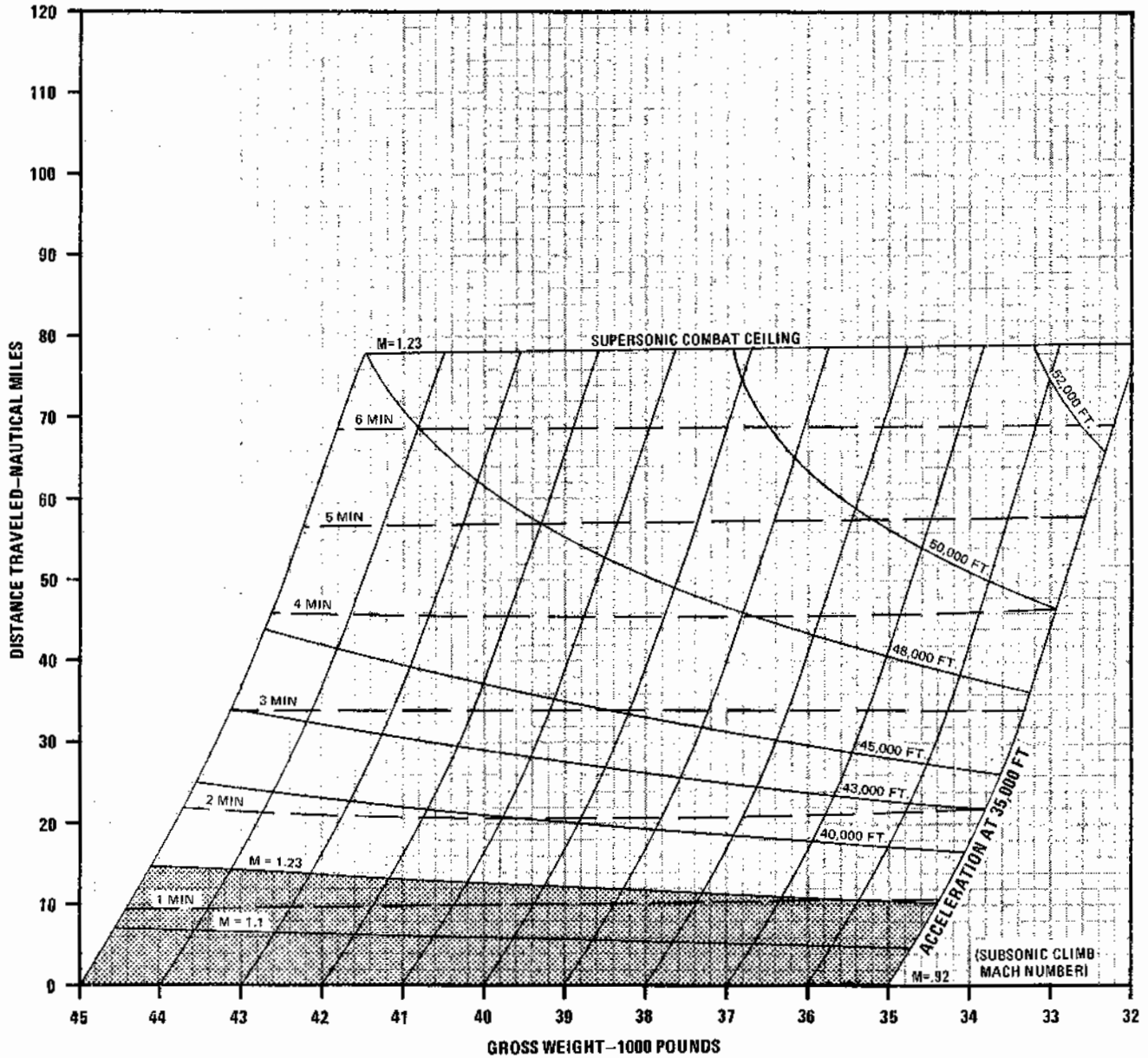

Figure A9-9

**F-4E**

# SUPERSONIC MAXIMUM THRUST CLIMB

**AIRPLANE CONFIGURATION**  
 (4) AIM-7 AND  
 (4) AIM-40

**REMARKS**  
 ENGINE(S): (2) J79-GE-17  
 ICAO STANDARD DAY

GUIDE



FUEL GRADE: JP-4  
 FUEL DENSITY: 6.5 LB/GAL

DATE: 1 FEBRUARY 1973  
 DATA BASIS: FLIGHT TEST

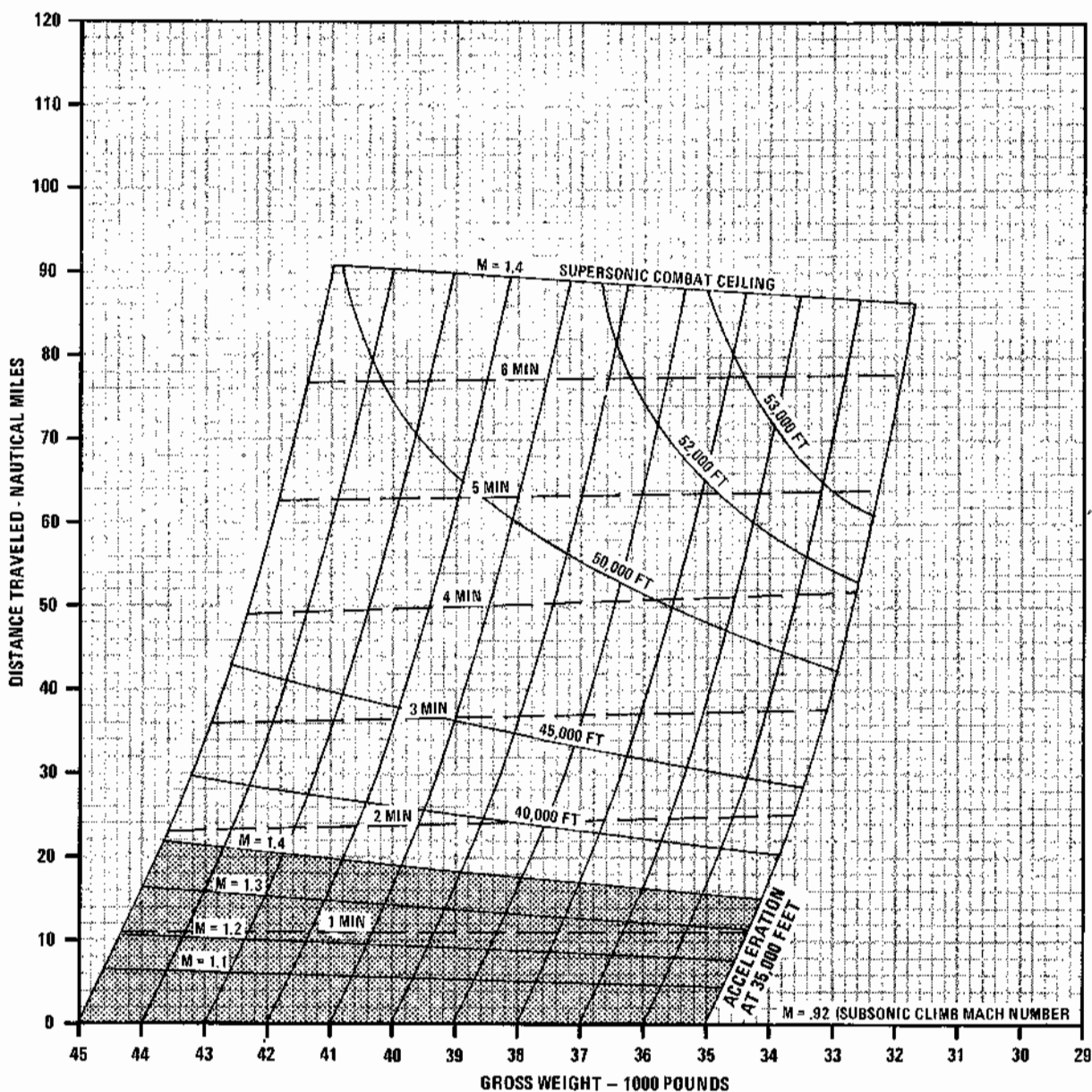

Figure A9-10

**F-4E**

**SUPERSONIC MAXIMUM THRUST CLIMB**

**AIRPLANE CONFIGURATION**  
 (4) AIM 7, (4) AIM-40  
 AND (1) Q TANK

**REMARKS**  
 ENGINE(S): (2) J79-GE-17  
 (ICAO STANDARD DAY)

GUIDE

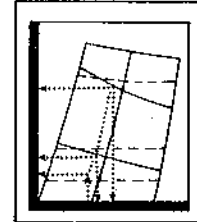

DATE: 1 FEBRUARY 1973  
 DATA BASIS: FLIGHT TEST

FUEL GRADE: JP-4  
 FUEL DENSITY: 6.5 LB/GAL

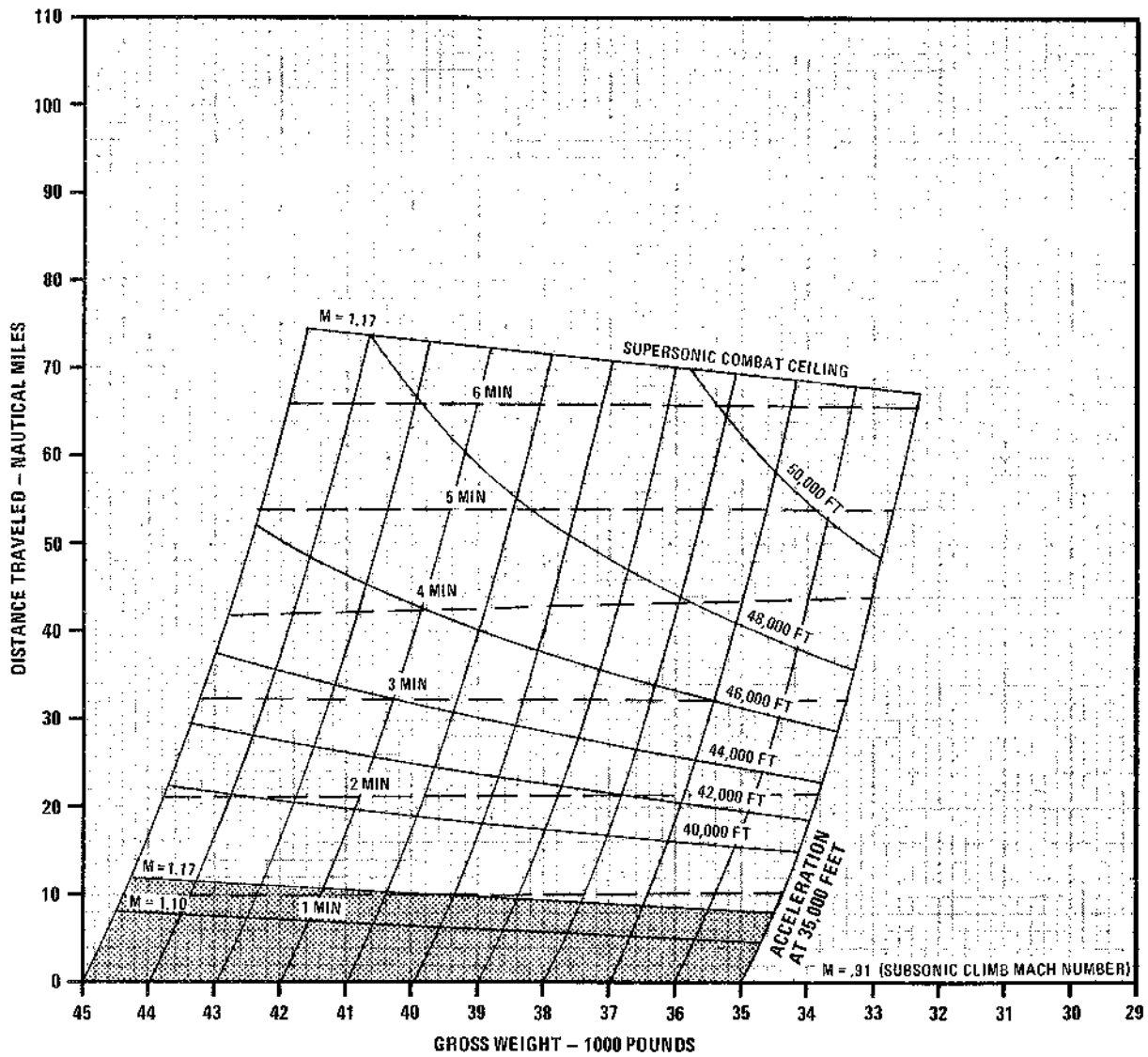

Figure A9-11

**F-4E**

**LOW ALTITUDE ACCELERATION  
MAXIMUM THRUST**

AIRPLANE CONFIGURATION  
INDIVIDUAL DRAG INDEXES

GROSS WEIGHT - 35,000 POUNDS

REMARKS

ENGINES: (2) J79-GE-17

DATE: 1 FEBRUARY 1973  
DATA BASIS: FLIGHT TEST

FUEL GRADE: JP-4  
FUEL DENSITY: 6.5 LB/GAL

	MACH	DRAG INDEX	TIME TO ACCELERATE (MIN.)/FUEL TO ACCELERATE (LB.)						TEMP EFFECTS FACTOR		
			0	20	40	60	80	100	120	+10°C	-10°C
SEA LEVEL (15°C)	.5	.0 / 0	.0 / 0	.0 / 0	.0 / 0	.0 / 0	.0 / 0	.0 / 0	.0 / 0	.0 / 0	.0 / 0
	.55	.04/48	.04/50	.04/51	.04/53	.04/55	.04/56	.04/58	1.10/1.07	.90/.93	
	.6	.07/98	.07/101	.08/105	.08/108	.08/112	.08/116	.09/121	1.10/1.07	.90/.93	
	.65	.11/149	.11/155	.11/161	.12/167	.12/174	.13/182	.14/190	1.10/1.07	.89/.92	
	.7	.14/202	.15/211	.15/219	.16/229	.17/239	.18/252	.19/266	1.11/1.08	.89/.92	
	.75	.18/257	.19/269	.19/282	.20/295	.21/312	.23/330	.24/352	1.11/1.08	.89/.91	
	.8	.21/313	.22/328	.23/346	.25/364	.26/389	.28/417	.30/451	1.11/1.08	.88/.91	
	.85	.25/371	.26/392	.28/414	.29/441	.31/475	.34/516	.38/571	1.12/1.09	.88/.90	
	.9	.28/432	.30/457	.32/486	.34/525	.37/573	.41/638	.47/733	1.14/1.10	.87/.90	
2000 FEET (11°C)	.5	.0 / 0	.0 / 0	.0 / 0	.0 / 0	.0 / 0	.0 / 0	.0 / 0	.0 / 0	.0 / 0	
	.55	.04/47	.04/49	.04/50	.04/52	.04/53	.04/55	.04/57	1.10/1.07	.90/.93	
	.6	.07/96	.08/100	.08/103	.08/106	.08/110	.09/113	.09/118	1.10/1.07	.90/.93	
	.65	.11/146	.11/152	.12/157	.12/163	.13/170	.13/177	.14/185	1.10/1.07	.89/.92	
	.7	.15/198	.15/206	.16/214	.17/224	.17/234	.18/245	.19/257	1.10/1.08	.89/.92	
	.75	.18/251	.19/263	.20/275	.21/288	.22/303	.28/320	.25/340	1.11/1.08	.89/.91	
	.8	.22/306	.23/320	.24/337	.25/355	.27/377	.29/400	.31/434	1.11/1.08	.88/.91	
	.85	.26/363	.27/382	.28/403	.30/428	.32/459	.35/497	.38/547	1.12/1.09	.88/.90	
	.9	.29/421	.31/445	.33/473	.35/508	.38/552	.42/611	.42/696	1.14/1.10	.87/.90	
4000 FEET (7°C)	.5	.0 / 0	.0 / 0	.0 / 0	.0 / 0	.0 / 0	.0 / 0	.0 / 0	.0 / 0	.0 / 0	
	.55	.04/47	.04/48	.04/49	.04/51	.04/52	.04/54	.05/56	1.10/1.07	.90/.93	
	.6	.08/94	.08/97	.08/101	.08/104	.09/107	.09/111	.09/115	1.10/1.07	.90/.93	
	.65	.11/143	.12/149	.12/154	.13/160	.13/166	.14/172	.14/180	1.10/1.07	.89/.92	
	.7	.15/194	.16/202	.16/209	.17/218	.18/228	.19/238	.20/250	1.10/1.08	.89/.92	
	.75	.19/246	.20/257	.21/268	.22/280	.23/294	.24/310	.25/328	1.11/1.08	.89/.91	
	.8	.23/299	.24/312	.25/328	.26/344	.28/365	.29/389	.31/418	1.11/1.08	.88/.91	
	.85	.26/354	.28/373	.29/392	.31/416	.33/444	.35/479	.39/524	1.12/1.09	.88/.90	
	.9	.30/411	.32/434	.34/459	.36/493	.39/534	.43/587	.48/661	1.14/1.10	.87/.90	
6000 FEET (3°C)	.5	.0 / 0	.0 / 0	.0 / 0	.0 / 0	.0 / 0	.0 / 0	.0 / 0	.0 / 0	.0 / 0	
	.55	.04/46	.04/47	.04/49	.04/50	.04/52	.05/53	.05/55	1.10/1.07	.90/.93	
	.6	.08/93	.08/96	.08/99	.09/102	.09/105	.09/109	.10/113	1.10/1.07	.90/.93	
	.65	.12/141	.12/146	.13/151	.13/156	.14/162	.14/168	.15/175	1.10/1.07	.89/.92	
	.7	.16/190	.16/198	.17/205	.18/213	.18/221	.19/232	.20/242	1.10/1.08	.89/.92	
	.75	.20/241	.21/251	.21/261	.22/273	.23/286	.25/301	.26/318	1.11/1.08	.89/.91	
	.8	.24/293	.25/305	.26/320	.27/336	.28/355	.30/375	.32/403	1.11/1.08	.88/.91	
	.85	.27/346	.29/364	.30/382	.32/404	.34/430	.36/462	.40/503	1.12/1.09	.88/.90	
	.9	.31/402	.33/423	.35/446	.37/478	.40/515	.43/564	.48/630	1.14/1.10	.87/.90	

4E-1-(389)

Figure A9-12



**F-4E**

**LOW ALTITUDE ACCELERATION  
MAXIMUM THRUST**

AIRPLANE CONFIGURATION  
INDIVIDUAL DRAG INDEXES

GROSS WEIGHT - 40,000 POUNDS

REMARKS  
ENGINES: (2) J79-GE-17

DATE: 1 FEBRUARY 1973  
DATA BASIS: FLIGHT TEST

FUEL GRADE: JP-4  
FUEL DENSITY: 6.5 LB/GAL

	MACH	DRAG INDEX	TIME TO ACCELERATE (MIN.) / FUEL TO ACCELERATE (LB.)						TEMP. EFFECTS FACTOR		
			0	20	40	60	80	100	120	+ 10°C	- 10°C
SEA LEVEL (15°C)	.5	.0 / 0	.0 / 0	.0 / 0	.0 / 0	.0 / 0	.0 / 0	.0 / 0	.0 / 0	0 / 0	0 / 0
	.55	.04/56	.04/57	.04/59	.04/61	.05/63	.05/65	.05/65	1.10/1.07	.90/93	
	.6	.08/113	.08/117	.09/121	.09/125	.09/130	.10/135	.10/140	1.10/1.07	.90/93	
	.65	.12/173	.13/179	.13/186	.14/193	.14/201	.15/210	.16/219	1.10/1.07	.89/92	
	.7	.16/234	.17/243	.18/253	.19/264	.19/277	.20/291	.21/307	1.10/1.08	.89/92	
	.75	.20/297	.21/310	.22/324	.23/340	.25/359	.26/380	.28/406	1.11/1.08	.89/91	
	.8	.25/362	.26/379	.27/398	.28/421	.30/448	.32/480	.35/520	1.11/1.08	.88/91	
	.85	.29/428	.30/451	.32/476	.34/508	.36/546	.39/595	.43/659	1.12/1.09	.88/90	
	.9	.33/497	.34/525	.37/559	.39/604	.43/660	.48/735	.54/845	1.14/1.10	.87/90	
2000 FEET (11°C)	.5	.0 / 0	.0 / 0	.0 / 0	.0 / 0	.0 / 0	.0 / 0	.0 / 0	0 / 0	0 / 0	
	.55	.04/55	.04/56	.05/58	.05/60	.05/62	.05/64	.05/66	1.10/1.07	.90/93	
	.6	.08/111	.09/115	.09/119	.09/123	.10/127	.10/132	.10/137	1.10/1.07	.90/93	
	.65	.13/169	.13/175	.14/182	.14/188	.15/196	.15/204	.16/213	1.10/1.07	.89/92	
	.7	.17/229	.18/238	.18/247	.19/258	.20/270	.21/283	.22/298	1.10/1.08	.89/92	
	.75	.21/291	.22/303	.23/316	.24/331	.25/349	.27/369	.28/392	1.11/1.08	.89/91	
	.8	.25/354	.26/370	.28/388	.29/409	.31/434	.33/464	.33/464	1.11/1.08	.88/91	
	.85	.29/419	.31/440	.33/464	.35/493	.37/529	.40/573	.44/631	1.12/1.09	.88/90	
	.9	.34/485	.35/512	.38/544	.40/585	.44/637	.48/704	.55/801	1.14/1.10	.87/90	
4000 FEET (7°C)	.5	.0 / 0	.0 / 0	.0 / 0	.0 / 0	.0 / 0	.0 / 0	.0 / 0	0 / 0	0 / 0	
	.55	.04/54	.05/55	.05/57	.05/59	.05/61	.05/62	.05/65	1.10/1.07	.90/93	
	.6	.09/109	.09/112	.09/116	.10/120	.10/124	.10/129	.11/133	1.10/1.07	.90/93	
	.65	.13/166	.14/172	.14/178	.15/184	.15/191	.16/199	.16/208	1.10/1.07	.89/92	
	.7	.18/224	.18/233	.19/242	.20/252	.21/263	.21/275	.23/289	1.10/1.08	.89/92	
	.75	.22/284	.23/296	.24/309	.25/323	.26/339	.27/358	.29/379	1.11/1.08	.89/91	
	.8	.26/346	.27/361	.29/378	.30/398	.32/421	.34/446	.36/482	1.11/1.08	.88/91	
	.85	.31/409	.32/429	.34/451	.36/479	.38/512	.41/553	.45/605	1.12/1.09	.88/90	
	.9	.35/474	.37/499	.39/529	.41/568	.45/615	.49/676	.55/763	1.14/1.10	.87/90	
6000 FEET (3°C)	.5	.0 / 0	.0 / 0	.0 / 0	.0 / 0	.0 / 0	.0 / 0	.0 / 0	0 / 0	0 / 0	
	.55	.05/53	.05/55	.05/56	.05/58	.05/60	.05/62	.06/63	1.10/1.07	.90/93	
	.6	.09/108	.09/111	.10/114	.10/118	.10/122	.11/126	.11/131	1.10/1.07	.90/93	
	.65	.14/163	.14/169	.15/175	.15/181	.16/187	.16/195	.17/203	1.10/1.07	.89/92	
	.7	.18/220	.19/228	.20/237	.20/246	.21/257	.22/268	.23/281	1.10/1.08	.89/92	
	.75	.23/279	.24/290	.25/302	.26/315	.27/330	.28/348	.30/368	1.11/1.08	.89/91	
	.8	.27/339	.28/353	.30/369	.31/388	.33/410	.35/435	.37/466	1.11/1.08	.88/91	
	.85	.32/400	.33/419	.36/440	.37/466	.39/496	.42/534	.42/531	1.12/1.09	.88/90	
	.9	.36/463	.38/487	.40/515	.43/551	.46/595	.50/650	.56/727	1.14/1.10	.87/90	

4E-1-(390)

Figure A9-13

**F-4E**

**LOW ALTITUDE ACCELERATION**

**MAXIMUM THRUST**

AIRPLANE CONFIGURATION  
INDIVIDUAL DRAG INDEXES

GROSS WEIGHT - 45,000 POUNDS

REMARKS

ENGINES: (2) J79-GE-17

DATE: 1 FEBRUARY 1973  
DATA BASIS: FLIGHT TEST

FUEL GRADE: JP-4  
FUEL DENSITY: 6.5 LB/GAL

	MACH	DRAG INDEX	TIME TO ACCELERATE (MIN) / FUEL TO ACCELERATE (LB.)						TEMP. EFFECTS FACTOR		
			0	20	40	60	80	100	120	+10°C	-10°C
SEA LEVEL (15°C)	.5	.0 / 0	.0 / 0	.0 / 0	.0 / 0	.0 / 0	.0 / 0	.0 / 0	.0 / 0	.0 / 0	.0 / 0
	.55	.05/63	.05/65	.05/67	.05/69	.05/72	.05/74	.06/77	1.10/1.07	.90/93	
	.6	.09/129	.10/133	.10/137	.10/142	.11/147	.11/153	.12/159	1.10/1.07	.90/93	
	.65	.14/196	.14/203	.15/211	.16/219	.16/228	.17/238	.18/250	1.10/1.07	.89/92	
	.7	.19/265	.19/276	.20/287	.21/300	.22/314	.23/331	.24/349	1.10/1.08	.89/92	
	.75	.23/336	.24/351	.25/368	.27/386	.28/407	.30/432	.32/461	1.11/1.08	.89/91	
	.8	.28/410	.29/430	.31/451	.32/477	.34/508	.37/545	.40/591	1.11/1.08	.88/91	
	.85	.32/485	.34/511	.36/540	.38/576	.41/620	.45/675	.49/748	1.12/1.09	.88/90	
	.9	.37/562	.39/595	.41/633	.45/684	.49/748	.54/834	.62/960	1.14/1.10	.87/90	
2000 FEET (11°C)	.5	.0 / 0	.0 / 0	.0 / 0	.0 / 0	.0 / 0	.0 / 0	.0 / 0	.0 / 0	.0 / 0	.0 / 0
	.55	.05/62	.05/64	.05/66	.05/68	.05/70	.06/73	.06/75	1.10/1.07	.90/93	
	.6	.10/126	.10/131	.10/135	.11/139	.11/144	.11/150	.12/156	1.10/1.07	.90/93	
	.65	.14/192	.15/199	.15/206	.16/214	.17/223	.17/232	.18/243	1.10/1.07	.89/92	
	.7	.19/260	.20/270	.21/281	.22/293	.23/306	.24/322	.25/339	1.10/1.08	.89/92	
	.75	.24/330	.25/344	.26/359	.27/376	.29/396	.30/419	.32/446	1.11/1.08	.89/91	
	.8	.29/401	.30/420	.31/440	.33/465	.35/493	.38/527	.40/569	1.11/1.08	.88/91	
	.85	.33/475	.35/499	.37/526	.39/559	.42/600	.45/651	.50/717	1.12/1.09	.88/90	
	.9	.38/549	.40/580	.43/616	.46/664	.50/721	.55/800	.62/911	1.14/1.10	.87/90	
4000 FEET (7°C)	.5	.0 / 0	.0 / 0	.0 / 0	.0 / 0	.0 / 0	.0 / 0	.0 / 0	.0 / 0	.0 / 0	.0 / 0
	.55	.05/61	.05/63	.05/65	.05/67	.06/69	.06/71	.06/74	1.10/1.07	.90/93	
	.6	.10/124	.10/128	.11/132	.11/137	.11/142	.12/147	.12/152	1.10/1.07	.90/93	
	.65	.15/189	.16/195	.16/202	.17/210	.17/218	.18/227	.19/237	1.10/1.07	.89/92	
	.7	.20/255	.21/264	.21/275	.22/286	.23/299	.24/313	.26/329	1.10/1.08	.89/92	
	.75	.25/323	.26/336	.27/351	.28/367	.30/386	.31/407	.33/432	1.11/1.08	.89/91	
	.8	.30/393	.31/410	.33/430	.34/452	.36/479	.39/511	.41/549	1.11/1.08	.88/91	
	.85	.35/464	.36/487	.38/512	.40/544	.43/582	.47/628	.51/688	1.12/1.09	.88/90	
	.9	.39/537	.41/566	.44/600	.47/644	.51/698	.56/769	.63/867	1.14/1.10	.87/90	
6000 FEET (3°C)	.5	.0 / 0	.0 / 0	.0 / 0	.0 / 0	.0 / 0	.0 / 0	.0 / 0	.0 / 0	.0 / 0	.0 / 0
	.55	.05/61	.05/62	.06/64	.06/66	.06/68	.06/70	.06/73	1.10/1.07	.90/93	
	.6	.10/123	.11/126	.11/130	.12/135	.12/139	.12/144	.13/149	1.10/1.07	.90/93	
	.65	.16/186	.16/192	.17/199	.17/206	.18/214	.19/222	.19/232	1.10/1.07	.89/92	
	.7	.21/251	.22/260	.22/270	.23/280	.24/292	.25/306	.27/321	1.10/1.08	.89/92	
	.75	.26/317	.27/329	.28/343	.29/359	.31/376	.32/396	.34/419	1.11/1.08	.89/91	
	.8	.31/385	.32/402	.34/420	.35/441	.37/466	.40/495	.42/531	1.11/1.08	.88/91	
	.85	.36/454	.38/476	.40/500	.42/529	.44/565	.48/607	.52/662	1.12/1.08	.88/90	
	.9	.41/526	.43/553	.45/585	.48/626	.52/676	.57/740	.63/828	1.14/1.10	.87/90	

-4E-1-(391)

Figure A9-14

**F-4E**

**LOW ALTITUDE ACCELERATION**

**MAXIMUM THRUST**

AIRPLANE CONFIGURATION  
INDIVIDUAL DRAG INDEXES

GROSS WEIGHT - 50,000 POUNDS

REMARKS

ENGINES: (2) J79-GE-17

DATE: 1 FEBRUARY 1973  
DATA BASIS: FLIGHT TEST

FUEL GRADE: JP-4  
FUEL DENSITY: 6.5 LB/GAL

MACH	DRAG INDEX	TIME TO ACCELERATE (MIN.)/FUEL TO ACCELERATE (LB.)						TEMP. EFFECTS FACTOR		
		0	20	40	60	80	100	120	+10°C	-10°C
SEA LEVEL (15°C)	.5	.0 / 0	.0 / 0	.0 / 0	.0 / 0	.0 / 0	.0 / 0	.0 / 0	.0 / 0	.0 / 0
	.55	.05/71	.05/73	.06/76	.06/78	.06/81	.06/83	.06/86	1.10/1.07	.90/.93
	.6	.10/144	.11/149	.11/154	.12/160	.12/166	.12/172	.13/179	1.10/1.07	.90/.93
	.65	.16/220	.16/228	.17/236	.17/246	.18/256	.19/268	.20/281	1.10/1.07	.89/.92
	.7	.21/297	.22/309	.23/322	.24/337	.25/353	.26/371	.27/392	1.10/1.08	.89/.92
	.75	.26/377	.27/394	.28/412	.30/433	.31/457	.33/485	.36/518	1.11/1.08	.89/.91
	.8	.31/459	.33/481	.34/506	.36/535	.38/570	.41/611	.45/663	1.11/1.08	.88/.91
	.85	.36/543	.38/572	.40/604	.43/645	.46/695	.50/757	.55/840	1.12/1.09	.88/.90
	.9	.41/629	.44/665	.46/709	.50/766	.54/838	.61/935	.69/1078	1.14/1.10	.87/.90

2000 FEET (11°C)	.5	.0 / 0	.0 / 0	.0 / 0	.0 / 0	.0 / 0	.0 / 0	.0 / 0	.0 / 0	.0 / 0
	.55	.05/70	.06/72	.06/74	.06/77	.06/79	.06/82	.07/85	1.10/1.07	.90/.93
	.6	.11/142	.11/147	.12/152	.12/157	.12/163	.13/169	.13/175	1.10/1.07	.90/.93
	.65	.16/216	.17/224	.17/232	.18/241	.19/251	.20/261	.20/274	1.10/1.07	.89/.92
	.7	.21/292	.22/303	.23/316	.24/329	.25/344	.27/362	.28/381	1.10/1.08	.89/.92
	.75	.27/370	.28/386	.29/403	.31/422	.32/445	.34/471	.36/502	1.11/1.08	.89/.91
	.8	.32/450	.34/471	.35/494	.37/521	.40/554	.42/592	.46/640	1.11/1.08	.88/.91
	.85	.37/532	.39/569	.41/589	.44/627	.47/673	.51/731	.56/806	1.12/1.09	.88/.90
	.9	.43/616	.45/650	.48/691	.51/744	.56/810	.61/893	.70/1024	1.14/1.10	.87/.90

4000 FEET (7°C)	.5	.0 / 0	.0 / 0	.0 / 0	.0 / 0	.0 / 0	.0 / 0	.0 / 0	.0 / 0	.0 / 0
	.55	.06/69	.06/71	.06/73	.06/75	.06/78	.07/80	.07/83	1.10/1.07	.90/.93
	.6	.11/140	.12/144	.12/149	.12/154	.13/159	.13/165	.14/172	1.10/1.07	.90/.93
	.65	.17/212	.17/219	.18/227	.19/236	.19/245	.20/255	.21/267	1.10/1.07	.89/.92
	.7	.22/286	.23/297	.24/309	.25/322	.26/336	.28/352	.29/371	1.10/1.08	.89/.92
	.75	.28/362	.29/377	.30/394	.32/412	.33/433	.35/458	.37/486	1.11/1.08	.89/.91
	.8	.33/440	.35/460	.37/482	.38/508	.41/538	.43/574	.47/618	1.11/1.08	.88/.91
	.85	.39/520	.41/546	.43/575	.45/610	.49/653	.52/706	.57/774	1.12/1.09	.88/.90
	.9	.44/602	.47/634	.49/673	.53/722	.57/784	.63/863	.70/975	1.14/1.10	.87/.90

6000 FEET (3°C)	.5	.0 / 0	.0 / 0	.0 / 0	.0 / 0	.0 / 0	.0 / 0	.0 / 0	.0 / 0	.0 / 0
	.55	.06/69	.06/70	.06/73	.06/75	.07/77	.07/79	.07/82	1.10/1.07	.90/.93
	.6	.12/138	.12/143	.13/147	.13/152	.13/157	.14/163	.14/169	1.10/1.07	.90/.93
	.65	.18/209	.18/216	.19/224	.20/232	.20/241	.21/251	.22/262	1.10/1.07	.89/.92
	.7	.23/282	.24/292	.25/304	.26/316	.27/329	.29/345	.30/362	1.10/1.08	.89/.92
	.75	.29/356	.30/370	.32/386	.33/404	.35/424	.36/446	.39/473	1.11/1.08	.89/.91
	.8	.35/432	.36/451	.38/472	.40/496	.42/525	.45/558	.48/598	1.11/1.08	.88/.91
	.85	.40/510	.42/534	.44/562	.47/595	.50/635	.54/684	.59/746	1.12/1.09	.88/.90
	.9	.46/590	.48/620	.51/656	.54/703	.59/760	.64/832	.71/933	1.14/1.10	.87/.90

4E-1-(392)

Figure A9-15

**F-4E**

**LOW ALTITUDE ACCELERATION**

**MAXIMUM THRUST**  
GROSS WEIGHT - 55,000 POUNDS

AIRPLANE CONFIGURATION  
INDIVIDUAL DRAG INDEXES

REMARKS

ENGINES: (2) J79-GE-17

DATE: 1 FEBRUARY 1973  
DATA BASIS: FLIGHT TEST

FUEL GRADE: JP-4  
FUEL DENSITY: 6.5 LB/GAL

	MACH	DRAG INDEX	TIME TO ACCELERATE (MIN) / FUEL TO ACCELERATE (LB.)						TEMP EFFECTS FACTOR		
			0	20	40	60	80	100	120	+ 10°C	- 10°C
SEA LEVEL (15°C)	.5	.0 / 0	.0 / 0	.0 / 0	.0 / 0	.0 / 0	.0 / 0	.0 / 0	.0 / 0	0 / 0	0 / 0
	.55	.06/78	.06/82	.06/84	.06/87	.07/90	.07/93	.07/96	1.10/1.07	.90/.93	
	.6	.12/161	.12/166	.12/172	.13/178	.13/185	.14/192	.14/200	1.10/1.07	.90/.93	
	.65	.17/244	.18/253	.19/263	.19/274	.20/285	.21/298	.22/313	1.10/1.07	.89/.92	
	.7	.23/330	.24/343	.25/358	.26/374	.27/393	.29/413	.30/435	1.10/1.08	.89/.92	
	.75	.29/418	.30/437	.32/458	.33/481	.35/508	.37/540	.40/577	1.11/1.08	.89/.91	
	.8	.35/509	.36/524	.38/562	.40/594	.43/633	.46/680	.50/738	1.11/1.08	.88/.91	
	.85	.40/602	.42/634	.46/671	.48/716	.51/772	.56/842	.62/935	1.12/1.09	.88/.90	
	.9	.46/697	.48/738	.51/786	.55/850	.61/930	.67/1039	.77/1201	1.14/1.10	.87/.90	
2000 FEET (11°C)	.5	.0 / 0	.0 / 0	.0 / 0	.0 / 0	.0 / 0	.0 / 0	.0 / 0	0 / 0	0 / 0	
	.55	.06/78	.06/80	.07/86	.07/86	.07/88	.07/91	.07/95	1.10/1.07	.90/.93	
	.6	.12/158	.12/163	.13/175	.13/175	.14/181	.14/188	.15/196	1.10/1.07	.90/.93	
	.65	.18/240	.19/249	.20/268	.20/268	.21/279	.22/292	.23/305	1.10/1.07	.89/.92	
	.7	.24/324	.25/337	.26/351	.27/366	.28/382	.30/403	.31/423	1.10/1.08	.89/.92	
	.75	.30/411	.31/428	.33/448	.34/470	.36/495	.38/524	.41/559	1.11/1.08	.89/.91	
	.8	.36/499	.37/523	.39/549	.41/580	.44/616	.47/659	.51/713	1.11/1.08	.88/.91	
	.85	.42/590	.44/620	.46/654	.49/697	.52/749	.57/813	.63/896	1.12/1.09	.88/.90	
	.9	.47/683	.50/721	.53/767	.57/826	.62/900	.68/998	.78/1140	1.14/1.10	.87/.90	
4000 FEET (7°C)	.5	.0 / 0	.0 / 0	.0 / 0	.0 / 0	.0 / 0	.0 / 0	.0 / 0	0 / 0	0 / 0	
	.55	.06/77	.07/80	.07/82	.07/84	.07/87	.07/90	.08/93	1.10/1.07	.90/.93	
	.6	.13/156	.13/161	.13/166	.14/172	.14/178	.15/185	.15/192	1.10/1.07	.90/.93	
	.65	.19/236	.19/245	.20/254	.21/263	.22/274	.23/285	.24/298	1.10/1.07	.89/.92	
	.7	.25/319	.26/331	.27/344	.28/359	.29/374	.31/393	.32/413	1.10/1.08	.89/.92	
	.75	.31/403	.32/420	.34/439	.35/459	.37/483	.39/510	.42/543	1.11/1.08	.89/.91	
	.8	.37/490	.39/512	.41/537	.43/566	.45/600	.48/640	.52/689	1.11/1.08	.88/.91	
	.85	.43/578	.45/607	.48/639	.51/679	.54/727	.58/787	.64/864	1.12/1.09	.88/.90	
	.9	.49/669	.52/705	.55/747	.59/803	.63/872	.70/962	.79/1089	1.14/1.10	.87/.90	
6000 FEET (3°C)	.5	.0 / 0	.0 / 0	.0 / 0	.0 / 0	.0 / 0	.0 / 0	.0 / 0	0 / 0	0 / 0	
	.55	.07/77	.07/79	.07/81	.07/84	.07/86	.08/89	.08/92	1.10/1.07	.90/.93	
	.6	.13/154	.14/159	.14/164	.15/170	.15/176	.16/183	.16/189	1.10/1.07	.90/.93	
	.65	.20/233	.20/242	.21/250	.22/259	.23/269	.24/281	.25/293	1.10/1.07	.89/.92	
	.7	.26/314	.27/326	.28/339	.29/352	.30/366	.32/385	.33/405	1.10/1.08	.89/.92	
	.75	.32/397	.34/413	.35/430	.37/450	.38/473	.41/498	.43/529	1.11/1.08	.89/.91	
	.8	.39/481	.40/501	.42/526	.44/553	.47/585	.50/623	.53/669	1.11/1.08	.88/.91	
	.85	.45/567	.47/595	.49/625	.54/663	.56/708	.60/763	.65/833	1.12/1.09	.88/.90	
	.9	.51/655	.54/690	.57/730	.61/782	.65/846	.71/928	.80/1042	1.14/1.10	.87/.90	

4E-1-(399)

Figure A9-16

**F-4E**

**LOW ALTITUDE ACCELERATION  
MAXIMUM THRUST**

AIRPLANE CONFIGURATION  
INDIVIDUAL DRAG INDEXES

GROSS WEIGHT - 60,000 POUNDS

REMARKS  
ENGINES: (2) J79-GE-17

DATE: 1 FEBRUARY 1973  
DATA BASIS: FLIGHT TEST

FUEL GRADE: JP-4  
FUEL DENSITY: 6.5 LB/GAL

	MACH	DRAG INDEX	TIME TO ACCELERATE (MIN) / FUEL TO ACCELERATE (LB.)						TEMP EFFECTS FACTOR		
			0	20	40	60	80	100	120	+10°C	-10°C
SEA LEVEL (15°C)	.5	.0 / 0	.0 / 0	.0 / 0	.0 / 0	.0 / 0	.0 / 0	.0 / 0	.0 / 0	.0 / 0	.0 / 0
	.55	.06/87	.07/90	.07/93	.07/96	.07/99	.08/103	.08/107	1.10/1.07	.90/.93	
	.6	.13/177	.13/183	.14/190	.14/197	.15/204	.15/212	.16/221	1.10/1.07	.90/.93	
	.65	.19/269	.20/279	.21/290	.21/302	.23/315	.23/330	.25/346	1.10/1.07	.89/.92	
	.7	.25/364	.27/379	.28/395	.29/413	.30/434	.33/457	.34/483	1.10/1.08	.89/.92	
	.75	.32/461	.33/482	.35/505	.37/531	.39/561	.41/596	.44/638	1.11/1.08	.89/.91	
	.8	.38/560	.40/588	.42/619	.44/655	.47/699	.51/751	.55/816	1.11/1.08	.88/.91	
	.85	.44/663	.47/698	.49/739	.52/789	.56/851	.61/929	.68/1033	1.12/1.09	.88/.90	
	.9	.50/767	.53/812	.56/866	.61/936	.67/1026	.74/1146	.85/1326	1.14/1.10	.87/.90	
2000 FEET (11°C)	.5	.0 / 0	.0 / 0	.0 / 0	.0 / 0	.0 / 0	.0 / 0	.0 / 0	.0 / 0	.0 / 0	
	.55	.07/87	.07/89	.07/92	.07/95	.08/98	.08/101	.08/105	1.10/1.07	.90/.93	
	.6	.13/175	.14/181	.14/187	.15/194	.15/201	.16/209	.17/217	1.10/1.07	.90/.93	
	.65	.20/265	.21/275	.21/285	.22/297	.23/309	.24/323	.25/338	1.10/1.07	.89/.92	
	.7	.26/358	.27/372	.29/388	.30/405	.31/424	.33/446	.35/471	1.10/1.08	.89/.92	
	.75	.33/453	.34/473	.36/495	.38/519	.40/547	.42/580	.45/619	1.11/1.08	.89/.91	
	.8	.29/550	.41/576	.43/606	.46/640	.49/680	.52/729	.56/789	1.11/1.08	.88/.91	
	.85	.46/650	.48/684	.51/722	.54/769	.58/827	.63/898	.69/993	1.12/1.09	.88/.90	
	.9	.52/752	.55/794	.58/845	.63/911	.68/993	.75/1103	.86/1261	1.14/1.10	.87/.90	
4000 FEET (7°C)	.5	.0 / 0	.0 / 0	.0 / 0	.0 / 0	.0 / 0	.0 / 0	.0 / 0	.0 / 0	.0 / 0	
	.55	.07/86	.07/88	.07/91	.08/94	.08/97	.08/100	.08/104	1.10/1.07	.90/.93	
	.6	.14/173	.14/178	.15/184	.15/191	.16/198	.16/205	.17/213	1.10/1.07	.90/.93	
	.65	.21/261	.21/271	.22/281	.23/292	.24/303	.25/316	.26/331	1.10/1.07	.89/.92	
	.7	.28/352	.29/366	.30/381	.31/397	.32/415	.34/436	.36/459	1.10/1.08	.89/.92	
	.75	.34/445	.36/464	.37/485	.39/508	.41/535	.43/565	.46/602	1.11/1.08	.89/.91	
	.8	.41/540	.43/565	.45/593	.47/625	.50/663	.53/708	.58/764	1.11/1.08	.88/.91	
	.85	.47/637	.50/670	.53/705	.56/750	.60/804	.64/870	.71/959	1.12/1.09	.88/.90	
	.9	.54/737	.57/777	.60/825	.65/887	.70/963	.77/1063	.87/1205	1.14/1.10	.87/.90	
6000 FEET (3°C)	.5	.0 / 0	.0 / 0	.0 / 0	.0 / 0	.0 / 0	.0 / 0	.0 / 0	.0 / 0	.0 / 0	
	.55	.07/85	.08/88	.08/91	.08/93	.08/96	.09/100	.09/103	1.10/1.07	.90/.93	
	.6	.15/177	.15/177	.16/183	.16/190	.17/196	.17/203	.18/211	1.10/1.07	.90/.93	
	.65	.22/259	.23/268	.25/278	.24/288	.25/300	.26/312	.27/326	1.10/1.07	.89/.92	
	.7	.29/348	.30/361	.31/376	.32/391	.34/409	.35/428	.37/450	1.10/1.08	.89/.92	
	.75	.36/439	.37/457	.39/477	.41/499	.43/524	.45/553	.48/587	1.11/1.08	.89/.91	
	.8	.43/532	.45/556	.47/582	.49/612	.52/648	.55/691	.59/742	1.11/1.08	.88/.91	
	.85	.50/627	.52/657	.55/691	.58/733	.62/784	.66/845	.73/925	1.12/1.09	.88/.90	
	.9	.56/723	.59/762	.63/807	.67/865	.72/936	.79/1028	.89/1156	1.14/1.10	.87/.90	

Figure A9-17

**F-4E**

# LOW ALTITUDE ACCELERATION MILITARY THRUST

AIRPLANE CONFIGURATION  
INDIVIDUAL DRAG INDEXES

GROSS WEIGHT - 35,000 POUNDS

REMARKS

ENGINES: (2) J79-GE-17

DATE: 1 FEBRUARY 1973  
DATA BASIS: FLIGHT TEST

FUEL GRADE: JP-4  
FUEL DENSITY: 6.5 LB/GAL

	MACH	DRAG INDEX	TIME TO ACCELERATE (MIN.)/FUEL TO ACCELERATE (LB.)						TEMP EFFECTS FACTOR		
			0	20	40	60	80	100	120	+ 10°C	- 10°C
SEA LEVEL (15°C)	.5	.0 / 0	.0 / 0	.0 / 0	.0 / 0	.0 / 0	.0 / 0	.0 / 0	.0 / 0	.0 / 0	.0 / 0
	.55	.07/25	.07/27	.07/28	.08/30	.08/32	.09/34	.10/37	1.17/1.11	.87/.93	
	.6	.14/52	.15/55	.16/59	.17/64	.18/69	.20/75	.22/83	1.18/1.11	.86/.91	
	.65	.21/81	.23/87	.24/94	.27/103	.29/113	.32/126	.37/143	1.19/1.13	.84/.90	
	.7	.29/113	.31/122	.34/134	.38/149	.43/168	.49/194	.60/237	1.23/1.16	.83/.88	
	.75	.37/147	.41/162	.45/180	.51/205	.61/242	.76/306	1.20/486	1.24/1.18	.79/.83	
	.8	.46/185	.51/207	.58/236	.69/290	.89/364	2.13/893		1.26/1.20	.80/.85	
	.85	.56/229	.64/261	.75/308	.99/410				1.30/1.24	.83/.87	
	.9	.68/283	.80/336	1.07/455					1.22/1.17	.81/.85	
2000 FEET (11°C)	.5	.0 / 0	.0 / 0	.0 / 0	.0 / 0	.0 / 0	.0 / 0	.0 / 0	.0 / 0	.0 / 0	
	.55	.07/25	.07/26	.08/28	.08/29	.09/31	.09/34	.10/36	1.17/1.11	.87/.93	
	.6	.14/51	.15/54	.16/58	.17/62	.18/67	.20/73	.22/80	1.18/1.11	.86/.91	
	.65	.22/80	.23/85	.25/92	.27/100	.29/109	.33/121	.37/136	1.19/1.13	.84/.90	
	.7	.30/110	.32/119	.35/130	.38/143	.43/160	.49/183	.58/218	1.23/1.16	.83/.88	
	.75	.38/143	.41/157	.46/174	.52/196	.60/228	.73/280	1.02/391	1.24/1.18	.79/.83	
	.8	.47/180	.52/200	.59/226	.68/264	.86/333	1.35/533		1.26/1.20	.80/.85	
	.85	.57/222	.64/251	.75/293	.95/374	2.26/925			1.30/1.24	.83/.87	
	.9	.69/273	.80/320	1.03/415					1.22/1.17	.81/.85	
4000 FEET (7°C)	.5	.0 / 0	.0 / 0	.0 / 0	.0 / 0	.0 / 0	.0 / 0	.0 / 0	.0 / 0	.0 / 0	
	.55	.07/25	.08/26	.08/27	.08/29	.09/31	.10/33	.10/35	1.17/1.11	.87/.93	
	.6	.15/51	.15/54	.16/57	.18/61	.19/65	.20/71	.22/77	1.18/1.11	.86/.91	
	.65	.22/78	.24/84	.26/90	.28/97	.30/106	.33/116	.37/130	1.19/1.13	.84/.90	
	.7	.30/108	.33/116	.35/126	.39/138	.43/154	.49/174	.57/204	1.23/1.16	.83/.88	
	.75	.39/140	.42/153	.47/168	.52/188	.60/216	.71/258	.93/340	1.24/1.18	.79/.83	
	.8	.48/175	.53/194	.59/217	.68/251	.83/307	1.18/437		1.26/1.20	.80/.85	
	.85	.58/215	.65/242	.75/279	.93/347	1.45/553			1.30/1.24	.83/.87	
	.9	.70/264	.81/306	1.01/385					1.22/1.17	.81/.85	
6000 FEET (3°C)	.5	.0 / 0	.0 / 0	.0 / 0	.0 / 0	.0 / 0	.0 / 0	.0 / 0	.0 / 0	.0 / 0	
	.55	.08/24	.08/26	.08/27	.09/29	.09/30	.10/32	.11/35	1.17/1.11	.87/.93	
	.6	.15/50	.16/53	.17/56	.18/60	.19/64	.21/69	.23/75	1.18/1.11	.86/.91	
	.65	.23/77	.25/82	.26/88	.28/95	.31/103	.34/113	.37/125	1.19/1.13	.84/.90	
	.7	.31/106	.34/114	.37/123	.40/135	.44/149	.49/167	.57/193	1.23/1.16	.83/.88	
	.75	.40/137	.44/149	.48/163	.53/182	.60/207	.71/243	.89/307	1.24/1.18	.79/.83	
	.8	.49/171	.54/188	.60/210	.69/240	.82/287	1.09/382		1.26/1.20	.80/.85	
	.85	.60/209	.67/234	.76/267	.92/324	1.29/402			1.30/1.24	.83/.87	
	.9	.72/255	.82/293	1.00/360					1.22/1.17	.81/.85	

4E-1-(395)

Figure A9-18

**F-4E**

**LOW ALTITUDE ACCELERATION  
MILITARY THRUST**

AIRPLANE CONFIGURATION  
INDIVIDUAL DRAG INDEXES

GROSS WEIGHT - 40,000 POUNDS

REMARKS

ENGINES: (2) J79-GE-17

DATE: 1 FEBRUARY 1973  
DATA BASIS: FLIGHT TEST

FUEL GRADE: JP-4  
FUEL DENSITY: 6.5 LB/GAL

	MACH	DRAG INDEX	TIME TO ACCELERATE (MIN.) / FUEL TO ACCELERATE (LB.)						TEMP EFFECTS FACTOR		
			0	20	40	60	80	100	120	+ 10°C	- 10°C
SEA LEVEL (15°C)	.5	.0 / 0	.0 / 0	.0 / 0	.0 / 0	.0 / 0	.0 / 0	.0 / 0	.0 / 0	.0 / 0	.0 / 0
	.55	.08/29	.08/31	.09/33	.09/35	.10/37	.11/40	.11/43	1.17/1.11	.87/93	
	.6	.16/60	.17/64	.18/69	.19/74	.21/80	.23/88	.25/97	1.18/1.11	.86/91	
	.65	.24/94	.26/101	.28/110	.31/119	.34/132	.38/147	.43/168	1.19/1.13	.84/90	
	.7	.33/131	.36/142	.40/156	.44/173	.50/196	.58/227	.75/298	1.23/1.16	.83/88	
	.75	.43/170	.47/188	.53/209	.60/238	.71/282	.90/359	1.44/582	1.24/1.18	.79/83	
	.8	.53/214	.59/240	.68/274	.80/325	1.04/424			1.26/1.20	.80/85	
	.85	.65/264	.74/302	.87/358	1.15/477				1.30/1.24	.83/87	
	.9	.78/327	.93/389	1.26/534					1.22/1.17	.81/85	
2000 FEET (11°C)	.5	.0 / 0	.0 / 0	.0 / 0	.0 / 0	.0 / 0	.0 / 0	.0 / 0	.0 / 0	.0 / 0	
	.55	.08/29	.08/31	.09/32	.10/34	.10/37	.11/39	.12/42	1.17/1.11	.87/93	
	.6	.16/60	.17/63	.19/68	.20/73	.21/78	.23/85	.26/94	1.18/1.11	.86/91	
	.65	.25/92	.27/99	.29/107	.31/116	.34/127	.38/141	.43/160	1.19/1.13	.84/90	
	.7	.34/128	.37/139	.40/151	.45/167	.50/188	.57/215	.69/258	1.23/1.16	.83/88	
	.75	.44/168	.48/182	.53/202	.60/228	.70/266	.86/329	1.22/468	1.24/1.18	.79/83	
	.8	.54/208	.60/232	.68/262	.80/308	1.00/390	1.62/638		1.26/1.20	.80/85	
	.85	.66/258	.75/291	.87/340	1.10/436				1.30/1.24	.83/87	
	.9	.80/316	.93/371	1.21/486					1.22/1.17	.81/85	
4000 FEET (7°C)	.5	.0 / 0	.0 / 0	.0 / 0	.0 / 0	.0 / 0	.0 / 0	.0 / 0	.0 / 0	.0 / 0	
	.55	.08/29	.09/30	.09/32	.10/34	.11/36	.11/39	.12/42	1.17/1.11	.87/93	
	.6	.17/59	.18/63	.19/67	.20/71	.22/77	.24/83	.26/91	1.18/1.11	.86/91	
	.65	.26/91	.28/97	.30/105	.32/113	.35/124	.39/137	.43/153	1.19/1.13	.84/90	
	.7	.35/125	.38/135	.41/147	.45/162	.51/180	.57/205	.67/240	1.23/1.16	.83/88	
	.75	.45/163	.49/178	.54/196	.61/219	.70/253	.85/307	1.11/406	1.24/1.18	.79/83	
	.8	.56/203	.62/225	.69/253	.80/293	.98/362	1.40/520		1.26/1.20	.80/85	
	.85	.67/249	.76/281	.87/325	1.09/408	1.74/663			1.30/1.24	.83/87	
	.9	.81/306	.94/355	1.18/450					1.22/1.17	.81/85	
6000 FEET (3°C)	.5	.0 / 0	.0 / 0	.0 / 0	.0 / 0	.0 / 0	.0 / 0	.0 / 0	.0 / 0	.0 / 0	
	.55	.09/29	.09/30	.10/32	.10/34	.11/36	.12/38	.13/41	1.17/1.11	.87/93	
	.6	.18/59	.19/62	.20/66	.21/70	.23/76	.25/82	.27/89	1.18/1.11	.86/91	
	.65	.27/90	.29/96	.31/103	.33/111	.36/121	.40/133	.44/138	1.19/1.13	.84/90	
	.7	.37/124	.39/133	.43/144	.47/158	.52/175	.58/197	.67/228	1.23/1.16	.83/88	
	.75	.47/160	.51/174	.56/191	.62/213	.71/243	.83/287	1.06/367	1.24/1.18	.79/83	
	.8	.58/199	.63/219	.71/245	.81/281	.98/341	1.29/455		1.26/1.20	.80/85	
	.85	.69/243	.77/272	.88/312	1.08/383	1.52/547			1.30/1.24	.83/87	
	.9	.83/297	.95/341	1.17/421					1.22/1.17	.81/85	

4E-1-(396)

Figure A9-19

**F-4E**

# LOW ALTITUDE ACCELERATION MILITARY THRUST

AIRPLANE CONFIGURATION  
INDIVIDUAL DRAG INDEXES

GROSS WEIGHT -- 45,000 POUNDS

REMARKS

ENGINES: (2) J79-GE-17

DATE: 1 FEBRUARY 1973  
DATA BASIS: FLIGHT TEST

FUEL GRADE: JP-4  
FUEL DENSITY: 6.5 LB/GAL

	MACH	DRAG INDEX	TIME TO ACCELERATE (MIN.)/FUEL TO ACCELERATE (LB.)						TEMP EFFECTS FACTOR		
			0	20	40	60	80	100	120	+10°C	-10°C
SEA LEVEL (15°C)	.5	.0 / 0	.0 / 0	.0 / 0	.0 / 0	.0 / 0	.0 / 0	.0 / 0	.0 / 0	.0 / 0	.0 / 0
	.55	.09/34	.09/36	.10/38	.11/40	.11/43	.12/46	.13/50	1.17/1.11	.87/93	
	.6	.18/69	.19/74	.21/79	.22/85	.24/93	.26/101	.29/112	1.18/1.11	.86/91	
	.65	.28/108	.30/116	.32/126	.35/137	.39/152	.44/170	.50/194	1.19/1.13	.84/90	
	.7	.38/149	.42/163	.46/179	.51/199	.57/226	.67/263	.82/325	1.23/1.16	.83/88	
	.75	.49/195	.54/215	.60/240	.69/274	.81/325	1.04/417	1.74/707	1.24/1.18	.79/83	
	.8	.61/244	.68/274	.78/313	.92/374	1.20/490			1.26/1.20	.80/85	
	.85	.74/301	.84/345	.99/410	1.32/550				1.30/1.24	.83/87	
	.9	.90/373	1.06/445	1.45/618					1.22/1.17	.81/85	
2000 FEET (11°C)	.5	.0 / 0	.0 / 0	.0 / 0	.0 / 0	.0 / 0	.0 / 0	.0 / 0	.0 / 0	.0 / 0	
	.55	.09/33	.10/36	.10/37	.11/40	.12/42	.13/46	.14/49	1.17/1.11	.87/93	
	.6	.19/68	.20/73	.21/78	.23/84	.25/91	.27/99	.30/109	1.18/1.11	.86/91	
	.65	.29/106	.31/114	.33/123	.36/134	.40/147	.44/164	.50/186	1.19/1.13	.84/90	
	.7	.39/146	.43/159	.46/174	.51/192	.58/216	.66/249	.85/320	1.23/1.16	.83/88	
	.75	.50/190	.55/209	.61/232	.69/263	.81/308	1.00/381	1.45/560	1.24/1.18	.79/83	
	.8	.62/238	.69/266	.78/301	.92/354	1.20/475	1.96/775		1.26/1.20	.80/85	
	.85	.75/293	.85/333	1.00/390	1.28/506				1.30/1.24	.83/87	
	.9	.91/361	1.07/425	1.39/560					1.22/1.17	.81/85	
4000 FEET (7°C)	.5	.0 / 0	.0 / 0	.0 / 0	.0 / 0	.0 / 0	.0 / 0	.0 / 0	.0 / 0	.0 / 0	
	.55	.10/33	.10/35	.11/37	.11/39	.12/42	.13/45	.14/49	1.17/1.11	.87/93	
	.6	.20/68	.21/72	.22/77	.24/83	.26/89	.28/97	.30/106	1.18/1.11	.86/91	
	.65	.30/106	.32/112	.34/121	.37/131	.41/143	.45/159	.51/178	1.19/1.13	.84/90	
	.7	.40/144	.44/156	.48/170	.52/187	.59/209	.67/238	.79/284	1.23/1.16	.83/88	
	.75	.52/186	.57/204	.63/225	.70/253	.81/293	.98/355	1.34/488	1.24/1.18	.79/83	
	.8	.64/233	.71/258	.79/291	.92/338	1.13/418	1.67/620		1.26/1.20	.80/85	
	.85	.77/285	.87/322	1.00/373	1.25/468	2.09/796			1.30/1.24	.83/87	
	.9	.93/349	1.08/407	1.36/519					1.22/1.17	.81/85	
6000 FEET (3°C)	.5	.0 / 0	.0 / 0	.0 / 0	.0 / 0	.0 / 0	.0 / 0	.0 / 0	.0 / 0	.0 / 0	
	.55	.10/33	.11/35	.11/37	.12/39	.13/42	.14/45	.13/41	1.17/1.11	.87/93	
	.6	.20/68	.22/72	.23/76	.25/82	.27/88	.29/95	.27/89	1.18/1.11	.86/91	
	.65	.31/104	.33/111	.36/119	.39/129	.42/141	.46/155	.44/148	1.19/1.13	.84/90	
	.7	.42/142	.45/154	.49/167	.54/183	.60/203	.68/230	.67/228	1.23/1.16	.83/88	
	.75	.54/184	.59/200	.64/220	.72/246	.82/282	.98/336	1.06/367	1.24/1.18	.79/83	
	.8	.66/229	.73/252	.81/282	.93/325	1.13/395	1.53/540		1.26/1.20	.80/85	
	.85	.79/279	.89/313	1.02/359	1.25/442	1.81/650			1.30/1.24	.83/87	
	.9	.95/340	1.09/392	1.35/486					1.22/1.17	.81/85	

4E-1-(397)

Figure A9-20



**F-4E**

**LOW ALTITUDE ACCELERATION  
MILITARY THRUST**

AIRPLANE CONFIGURATION  
INDIVIDUAL DRAG INDEXES

GROSS WEIGHT - 50,000 POUNDS

REMARKS

ENGINES: (2) J79-GE-17

DATE: 1 FEBRUARY 1973  
DATA BASIS: FLIGHT TEST

FUEL GRADE: JP-4  
FUEL DENSITY: 6.5 LB./GAL

MACH	DRAG INDEX	TIME TO ACCELERATE (MIN.)/FUEL TO ACCELERATE (LB.)						TEMP. EFFECTS FACTOR		
		0	20	40	60	80	100	120	+10°C	-10°C
<b>SEA LEVEL (15°C)</b>										
.5	.0 / 0	.0 / 0	.0 / 0	.0 / 0	.0 / 0	.0 / 0	.0 / 0	.0 / 0	.0 / .0	.0 / .0
.55	.10/38	.11/40	.11/43	.12/46	.13/49	.14/53	.15/58		1.17/1.11	.87/.93
.6	.21/79	.22/84	.24/90	.25/97	.28/106	.30/116	.34/129		1.18/1.11	.86/.91
.65	.32/122	.34/132	.37/143	.40/156	.45/173	.50/195	.58/224		1.19/1.13	.84/.90
.7	.43/169	.47/184	.52/203	.58/226	.66/257	.77/302	.96/378		1.23/1.16	.83/.88
.75	.55/220	.61/243	.68/272	.78/312	.93/372	1.20/482	2.18/888		1.24/1.18	.79/.83
.8	.69/276	.77/310	.88/355	1.05/426	1.39/566				1.26/1.20	.80/.85
.85	.83/340	.95/391	1.13/465	1.51/628					1.30/1.24	.83/.87
.9	1.01/421	1.20/504	1.66/708						1.22/1.17	.81/.85
<b>2000 FEET (11°C)</b>										
.5	.0 / 0	.0 / 0	.0 / 0	.0 / 0	.0 / 0	.0 / 0	.0 / 0		.0 / .0	.0 / .0
.55	.11/38	.11/40	.12/43	.13/46	.13/49	.15/53	.16/57		1.17/1.11	.87/.93
.6	.21/78	.23/83	.24/89	.26/96	.28/104	.31/114	.34/126		1.18/1.11	.86/.91
.65	.33/120	.35/130	.38/140	.41/153	.46/169	.51/188	.58/214		1.19/1.13	.84/.90
.7	.44/166	.48/181	.53/198	.59/219	.66/248	.76/287	.93/348		1.23/1.16	.83/.88
.75	.57/216	.63/237	.70/264	.79/300	.93/353	1.16/443	1.74/670		1.24/1.18	.79/.83
.8	.70/270	.78/301	.89/342	1.05/405	1.34/521	2.43/959			1.26/1.20	.80/.85
.85	.85/331	.97/377	1.13/443	1.47/581					1.30/1.24	.83/.87
.9	1.03/408	1.21/481	1.59/641						1.22/1.17	.81/.85
<b>4000 FEET (7°C)</b>										
.5	.0 / 0	.0 / 0	.0 / 0	.0 / 0	.0 / 0	.0 / 0	.0 / 0		.0 / .0	.0 / .0
.55	.11/38	.12/40	.12/42	.13/45	.14/48	.15/52	.16/56		1.17/1.11	.87/.93
.6	.22/77	.24/82	.25/88	.27/95	.29/102	.32/111	.35/123		1.18/1.11	.86/.91
.65	.34/119	.36/128	.39/138	.43/150	.47/165	.52/183	.59/207		1.19/1.13	.84/.90
.7	.46/164	.50/177	.54/194	.60/214	.67/240	.77/274	.91/327		1.23/1.16	.83/.88
.75	.59/212	.64/232	.71/257	.80/289	.93/336	1.14/412	1.56/571		1.24/1.18	.79/.83
.8	.72/264	.80/293	.91/331	1.05/387	1.31/484	1.99/741			1.26/1.20	.80/.85
.85	.87/323	.99/366	1.14/425	1.43/537	2.52/966				1.30/1.24	.83/.87
.9	1.05/396	1.22/462	1.55/593						1.22/1.17	.81/.85
<b>6000 FEET (3°C)</b>										
.5	.0 / 0	.0 / 0	.0 / 0	.0 / 0	.0 / 0	.0 / 0	.0 / 0		.0 / .0	.0 / .0
.55	.12/38	.12/40	.13/43	.14/45	.15/48	.16/52	.17/56		1.17/1.11	.87/.93
.6	.23/77	.25/82	.27/88	.29/94	.31/102	.33/111	.37/122		1.18/1.11	.86/.91
.65	.36/119	.38/127	.41/137	.44/149	.49/163	.54/180	.60/202		1.19/1.13	.84/.90
.7	.48/162	.52/176	.57/191	.62/210	.69/235	.79/267	.92/314		1.23/1.16	.83/.88
.75	.61/209	.67/228	.74/252	.82/282	.95/325	1.13/389	1.48/513		1.24/1.18	.79/.83
.8	.75/260	.83/288	.93/323	1.07/373	1.30/455	1.81/639			1.26/1.20	.80/.85
.85	.90/317	1.01/356	1.16/410	1.43/509	2.13/766				1.30/1.24	.83/.87
.9	1.08/386	1.25/446	1.54/557						1.22/1.17	.81/.85

4E-1-1398

Figure A9-21

**F-4E**

# LOW ALTITUDE ACCELERATION MILITARY THRUST

AIRPLANE CONFIGURATION  
INDIVIDUAL DRAG INDEXES

GROSS WEIGHT - 55,000 POUNDS

REMARKS

ENGINES: (2) J79-GE-17

DATE: 1 FEBRUARY 1973  
DATA BASIS: FLIGHT TEST

FUEL GRADE: JP-4  
FUEL DENSITY: 6.5 LB/GAL

	MACH	DRAG INDEX	TIME TO ACCELERATE (MIN.) / FUEL TO ACCELERATE (LB.)						TEMP. EFFECTS FACTOR		
			0	20	40	60	80	100	120	+10°C	-10°C
SEA LEVEL (15°C)	.5	.0 / 0	.0 / 0	.0 / 0	.0 / 0	.0 / 0	.0 / 0	.0 / 0	.0 / 0	.0 / 0	.0 / 0
	.55	.11/43	.12/46	.13/49	.14/52	.15/56	.16/61	.17/66	1.17/1.11	.87/.93	
	.6	.23/88	.25/95	.27/102	.29/110	.31/120	.35/132	.38/147	1.18/1.11	.86/.91	
	.65	.35/137	.38/148	.42/161	.46/177	.51/196	.57/222	.66/257	1.19/1.13	.84/.90	
	.7	.48/190	.53/207	.58/229	.65/256	.74/292	.87/346	1.10/435	1.23/1.16	.83/.88	
	.75	.62/247	.69/273	.77/307	.88/352	1.06/423	1.37/551	2.91/1191	1.24/1.18	.79/.83	
	.8	.77/309	.86/348	.99/400	1.19/484	1.58/646			1.26/1.20	.80/.85	
	.85	.93/381	1.07/438	1.28/526	1.71/713				1.30/1.24	.83/.87	
	.9	1.13/471	1.35/566	1.90/807					1.22/1.17	.81/.85	
2000 FEET (11°C)	.5	.0 / 0	.0 / 0	.0 / 0	.0 / 0	.0 / 0	.0 / 0	.0 / 0	.0 / 0	.0 / 0	
	.55	.12/43	.13/46	.13/48	.14/52	.15/56	.17/60	.18/65	1.17/1.11	.87/.93	
	.6	.24/88	.26/94	.28/101	.30/109	.32/118	.35/130	.39/144	1.18/1.11	.86/.91	
	.65	.37/136	.40/146	.43/159	.47/173	.52/192	.58/215	.67/246	1.19/1.13	.84/.90	
	.7	.50/187	.54/204	.60/224	.66/249	.75/282	.88/328	1.08/405	1.23/1.16	.83/.88	
	.75	.64/242	.71/267	.79/298	.89/340	1.06/402	1.33/508	2.08/804	1.24/1.18	.79/.83	
	.8	.79/303	.88/339	1.00/386	1.19/459	1.53/595	3.30/1312		1.26/1.20	.80/.85	
	.85	.95/372	1.09/424	1.28/501	1.67/659				1.30/1.24	.83/.87	
	.9	1.15/457	1.36/541	1.80/727					1.22/1.17	.81/.85	
4000 FEET (7°C)	.5	.0 / 0	.0 / 0	.0 / 0	.0 / 0	.0 / 0	.0 / 0	.0 / 0	.0 / 0	.0 / 0	
	.55	.13/43	.13/46	.14/49	.15/52	.16/56	.17/60	.19/65	1.17/1.11	.87/.93	
	.6	.25/88	.27/94	.29/101	.31/108	.34/117	.37/128	.41/142	1.18/1.11	.86/.91	
	.65	.38/135	.41/145	.45/157	.49/171	.53/188	.60/210	.68/239	1.19/1.13	.84/.90	
	.7	.52/185	.56/201	.62/220	.68/243	.77/274	.89/316	1.07/382	1.23/1.16	.83/.88	
	.75	.66/239	.73/262	.81/291	.91/329	1.06/385	1.31/476	1.85/677	1.24/1.18	.79/.83	
	.8	.82/297	.91/331	1.03/375	1.20/440	1.50/555	2.39/893		1.26/1.20	.80/.85	
	.85	.98/364	1.11/412	1.29/481	1.64/616	3.34/1285			1.30/1.24	.83/.87	
	.9	1.18/445	1.38/521	1.77/674					1.22/1.17	.81/.85	
6000 FEET (3°C)	.5	.0 / 0	.0 / 0	.0 / 0	.0 / 0	.0 / 0	.0 / 0	.0 / 0	.0 / 0	.0 / 0	
	.55	.13/44	.14/46	.15/49	.16/52	.17/56	.18/60	.20/66	1.17/1.11	.87/.93	
	.6	.27/88	.28/94	.30/101	.33/108	.35/117	.39/128	.43/141	1.18/1.11	.86/.91	
	.65	.40/135	.43/145	.47/156	.51/170	.56/187	.62/208	.70/235	1.19/1.13	.84/.90	
	.7	.55/184	.59/199	.64/218	.71/240	.79/269	.91/308	1.08/367	1.23/1.16	.83/.88	
	.75	.69/237	.76/259	.84/287	.94/322	1.09/373	1.32/453	1.76/609	1.24/1.18	.79/.83	
	.8	.85/294	.94/326	1.06/366	1.22/425	1.50/526	2.14/755		1.26/1.20	.80/.85	
	.85	1.02/357	1.15/403	1.32/466	1.66/588	2.54/914			1.30/1.24	.83/.87	
	.9	1.22/435	1.41/505	1.76/636					1.22/1.17	.81/.85	

4E-1-(389)

Figure A9-22

**F-4E**

# LOW ALTITUDE ACCELERATION MILITARY THRUST

AIRPLANE CONFIGURATION  
INDIVIDUAL DRAG INDEXES

GROSS WEIGHT - 60,000 POUNDS

REMARKS  
ENGINES: (2) J79-GE-17

DATE: 1 FEBRUARY 1973  
DATA BASIS: FLIGHT TEST

FUEL GRADE: JP-4  
FUEL DENSITY: 6.5 LB/GAL

	MACH	DRAG INDEX	TIME TO ACCELERATE (MIN.) / FUEL TO ACCELERATE (LB.)						TEMP. EFFECTS FACTOR		
			0	20	40	60	80	100	120	+10°C	-10°C
SEA LEVEL (15°C)	.5	.0 / 0	.0 / 0	.0 / 0	.0 / 0	.0 / 0	.0 / 0	.0 / 0	.0 / 0	.0 / 0	.0 / 0
	.55	.13/48	.14/51	.14/55	.16/59	.17/63	.18/69	.20/75	1.17/1.11	.87/.93	
	.6	.26/99	.28/106	.30/115	.32/124	.35/136	.39/150	.44/168	1.18/1.11	.86/.91	
	.65	.40/153	.43/166	.47/181	.51/199	.57/222	.65/252	.76/293	1.19/1.13	.84/.90	
	.7	.54/212	.59/232	.65/256	.73/288	.84/330	1.00/392	1.27/500	1.23/1.16	.83/.88	
	.75	.69/275	.77/305	.86/344	1.00/396	1.20/479	1.57/632		1.24/1.18	.79/.83	
	.8	.86/345	.96/389	1.11/448	1.34/543	1.80/737			1.26/1.26	.80/.85	
	.85	1.04/424	1.19/489	1.43/588	1.94/810				1.30/1.24	.83/.87	
	.9	1.26/524	1.51/631	2.15/915					1.22/1.17	.81/.85	
2000 FEET (11°C)	.5	.0 / 0	.0 / 0	.0 / 0	.0 / 0	.0 / 0	.0 / 0	.0 / 0	.0 / 0	.0 / 0	
	.55	.13/49	.14/52	.15/55	.16/59	.18/64	.19/69	.21/75	1.17/1.11	.87/.93	
	.6	.27/99	.29/106	.31/114	.34/124	.37/135	.41/148	.45/165	1.18/1.11	.86/.91	
	.65	.41/153	.45/165	.48/179	.53/196	.59/218	.66/246	.76/283	1.19/1.13	.84/.90	
	.7	.56/210	.61/229	.67/252	.75/281	.85/320	1.00/375	1.25/470	1.23/1.16	.83/.88	
	.75	.72/271	.79/300	.88/335	1.01/384	1.20/456	1.52/582	2.54/983	1.24/1.18	.79/.83	
	.8	.88/338	.99/380	1.13/434	1.34/518	1.74/677			1.26/1.20	.80/.85	
	.85	1.07/415	1.22/475	1.44/563	1.88/745				1.30/1.24	.83/.87	
	.9	1.29/510	1.52/606	2.04/825					1.22/1.17	.81/.85	
4000 FEET (7°C)	.5	.0 / 0	.0 / 0	.0 / 0	.0 / 0	.0 / 0	.0 / 0	.0 / 0	.0 / 0	.0 / 0	
	.55	.14/49	.15/52	.16/55	.17/59	.19/64	.20/69	.22/75	1.17/1.11	.87/.93	
	.6	.28/99	.30/106	.33/114	.35/123	.38/134	.42/147	.47/164	1.18/1.11	.86/.91	
	.65	.43/152	.47/164	.50/178	.55/194	.61/215	.68/241	.78/276	1.19/1.13	.84/.90	
	.7	.58/208	.64/226	.70/248	.77/276	.88/312	1.01/362	1.24/443	1.23/1.16	.83/.88	
	.75	.74/268	.82/295	.91/329	1.03/373	1.21/439	1.51/549	2.23/814	1.24/1.18	.79/.83	
	.8	.91/333	1.02/372	1.16/422	1.36/498	1.72/632	2.92/1093		1.26/1.20	.80/.85	
	.85	1.10/407	1.25/463	1.46/544	1.86/697				1.30/1.24	.83/.87	
	.9	1.32/497	1.55/585	2.01/768					1.22/1.17	.81/.85	
6000 FEET (3°C)	.5	.0 / 0	.0 / 0	.0 / 0	.0 / 0	.0 / 0	.0 / 0	.0 / 0	.0 / 0	.0 / 0	
	.55	.15/50	.16/53	.17/57	.19/61	.20/65	.22/71	.24/77	1.17/1.11	.87/.93	
	.6	.30/101	.33/108	.35/116	.38/125	.41/136	.45/149	.50/165	1.18/1.11	.86/.91	
	.65	.46/153	.49/165	.53/179	.58/195	.64/215	.72/241	.82/274	1.19/1.13	.84/.90	
	.7	.62/208	.67/226	.73/248	.81/274	.91/309	1.05/356	1.26/429	1.23/1.16	.83/.88	
	.75	.78/267	.86/293	.95/325	1.07/368	1.25/428	1.53/526	2.10/729	1.24/1.18	.79/.83	
	.8	.96/331	1.06/368	1.20/415	1.39/485	1.73/605	2.55/900		1.26/1.20	.80/.85	
	.85	1.14/402	1.29/454	1.50/529	1.86/661	3.05/1103			1.30/1.24	.83/.87	
	.9	1.37/488	1.59/569	2.00/724					1.22/1.17	.81/.85	

4E-1-(400)

Figure A9-23

**F-4E**

**MAXIMUM THRUST ACCELERATION  
10,000 FEET**

**AIRPLANE CONFIGURATION**  
(4) AIM-7

**REMARKS**  
ENGINE(S): (2) J79-GE-17  
ICAO STANDARD DAY

GUIDE

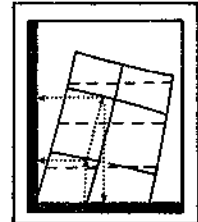

DATE: 1 FEBRUARY 1973  
DATA BASIS: FLIGHT TEST

FUEL GRADE: JP-4  
FUEL DENSITY: 6.5 LB/GAL

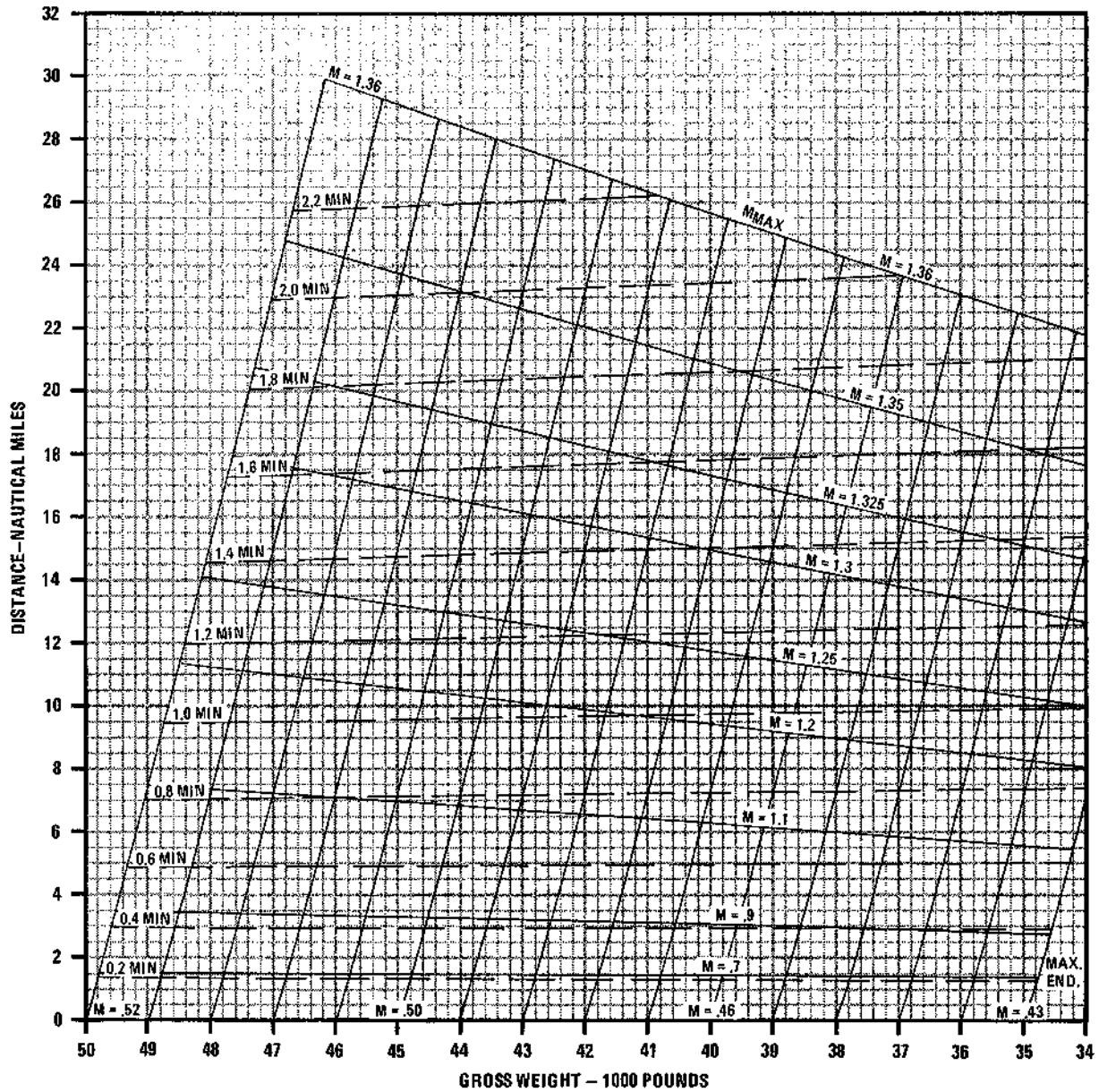

4E-1-(401)

Figure A9-24

**F-4E**

# MAXIMUM THRUST ACCELERATION

**30,000 FEET**

**AIRPLANE CONFIGURATION**  
(4) AIM-7

**REMARKS**  
ENGINE(S): (2) J79-GE-17  
ICAO STANDARD DAY

GUIDE

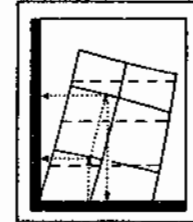

FUEL GRADE: JP-4  
FUEL DENSITY: 6.5 LB/GAL

DATE: 1 FEBRUARY 1973  
DATA BASIS: FLIGHT TEST

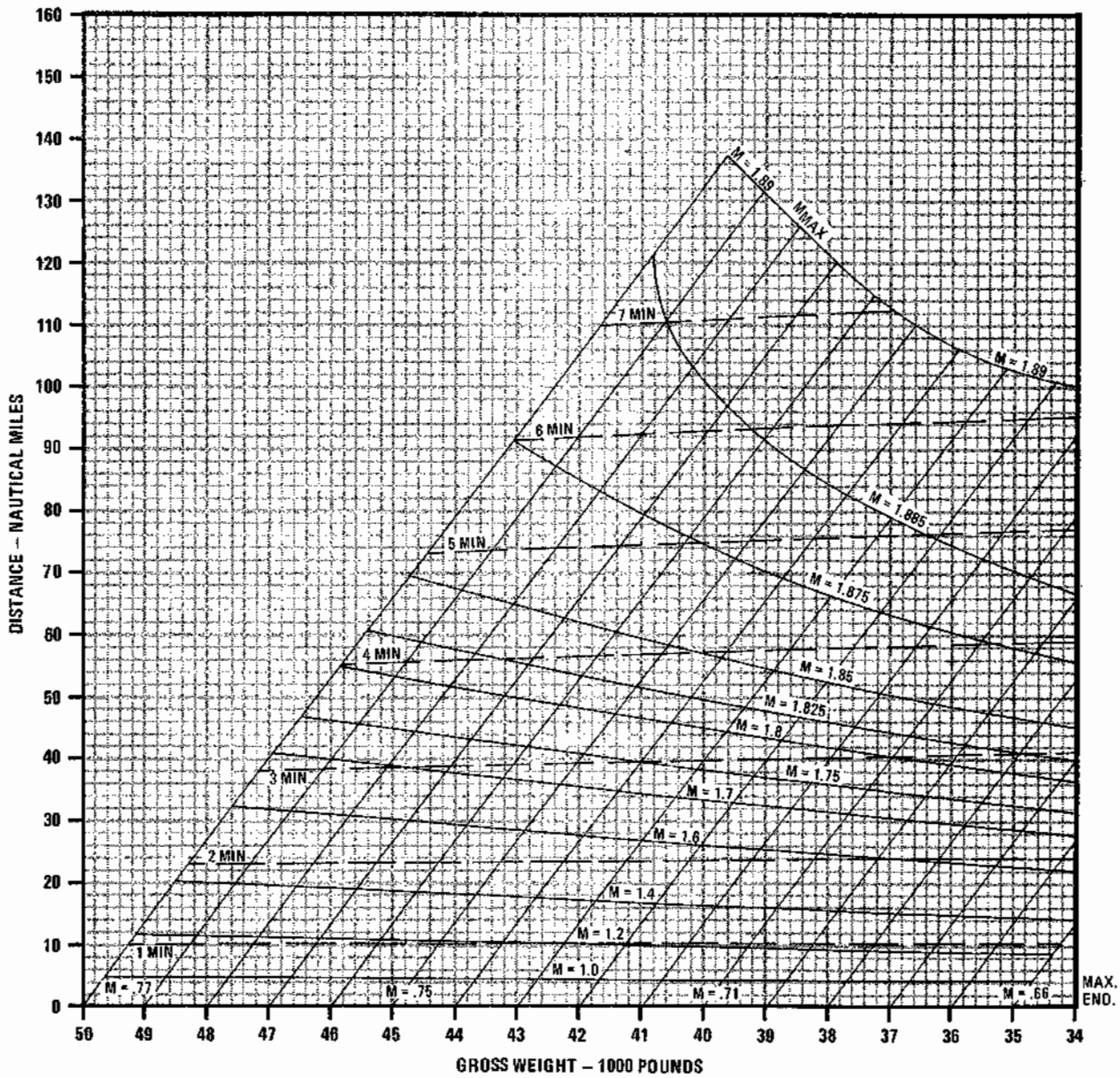

Figure A9-25

**F-4E**

# MAXIMUM THRUST ACCELERATION

**35,000 FEET**

**AIRPLANE CONFIGURATION**

(4) AIM-7

**REMARKS**

ENGINE(S): (2) J79-GE-17  
ICAO STANDARD DAY

**GUIDE**

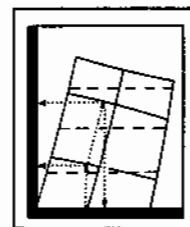

DATE: 1 FEBRUARY 1973  
DATA BASIS: FLIGHT TEST

FUEL GRADE: JP-4  
FUEL DENSITY: 6.5 LB/GAL

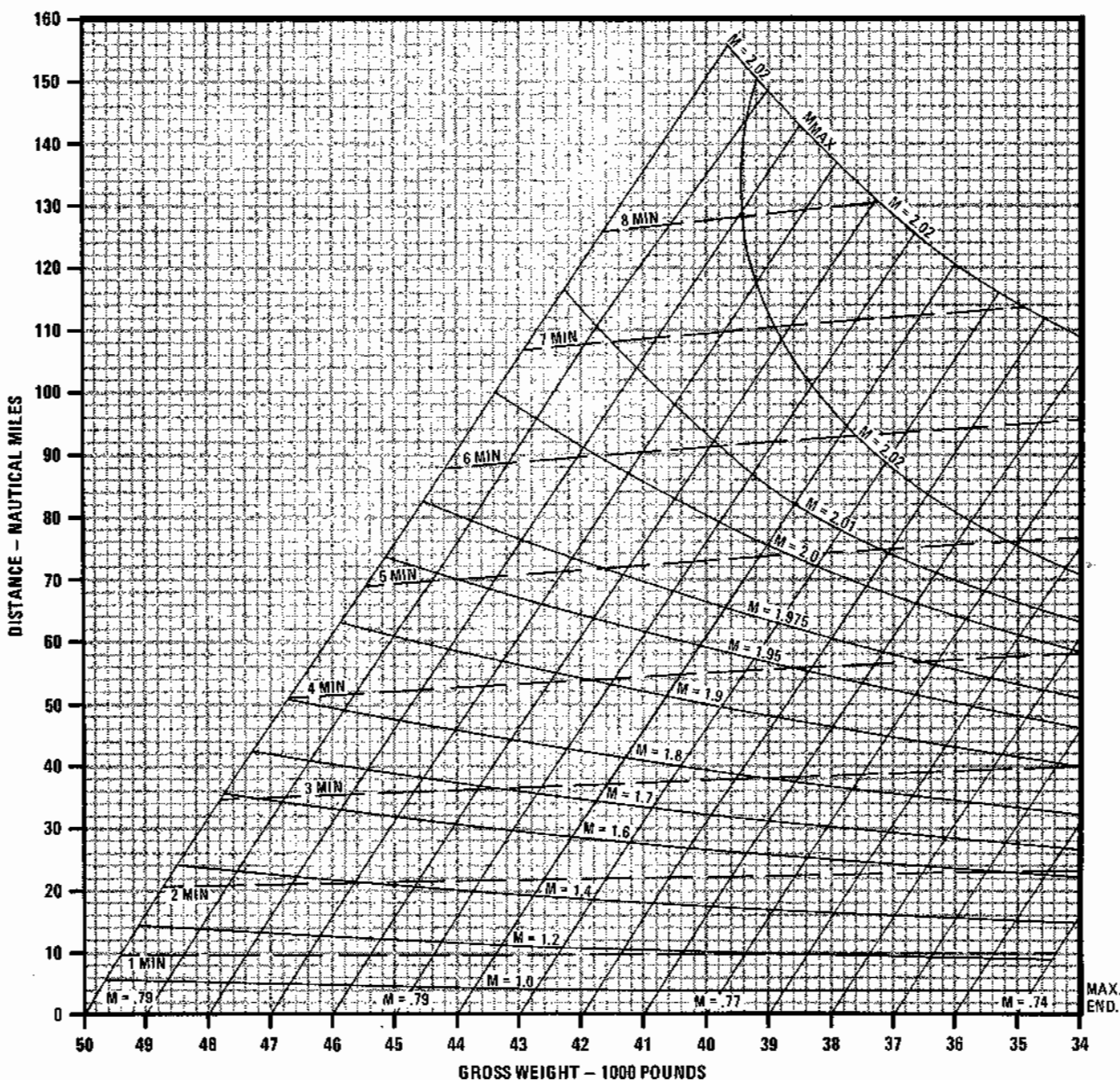

4E-1-(403)

Figure A9-26

**F-4E**

**MAXIMUM THRUST ACCELERATION  
40,000 FEET**

**AIRPLANE CONFIGURATION**  
(4) AIM-7

**REMARKS**  
ENGINE(S): (2) J79-GE-17  
ICAO STANDARD DAY

GUIDE



DATE: 1 FEBRUARY 1973  
DATA BASIS: FLIGHT TEST

FUEL GRADE: JP-4  
FUEL DENSITY: 6.5 LB/GAL

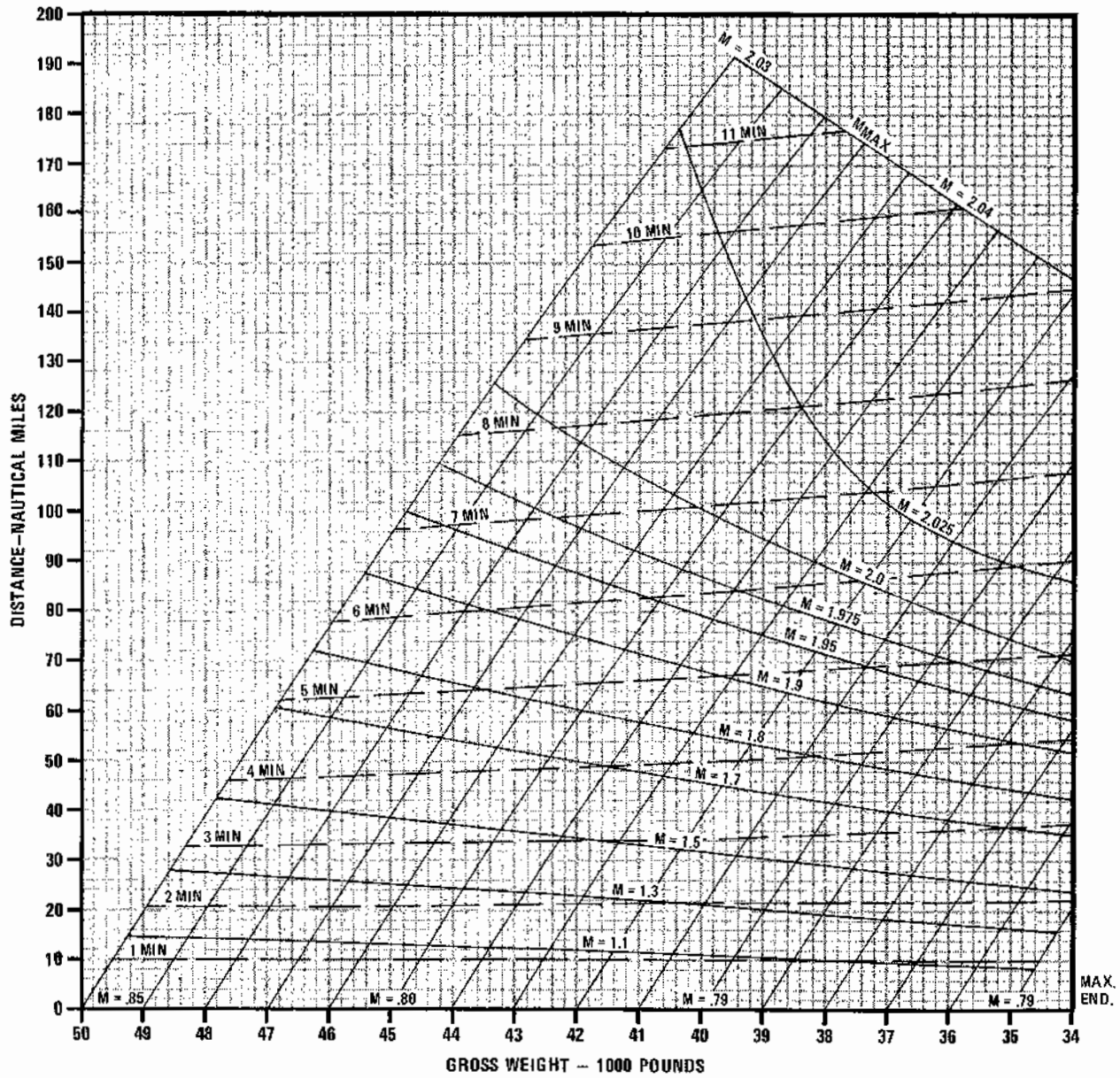

4E-1-(404)

Figure A9-27

**F-4E**

# MAXIMUM THRUST ACCELERATION

**45,000 FEET**

AIRPLANE CONFIGURATION  
(4) AIM-7

REMARKS  
ENGINE(S): (2) J79-GE-17  
ICAO STANDARD DAY

GUIDE

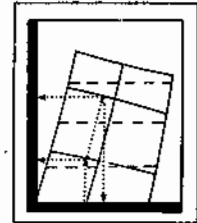

FUEL GRADE: JP-5  
FUEL DENSITY: 6.5 LB/GAL

DATE: 1 FEBRUARY 1973  
DATA BASIS: FLIGHT TEST

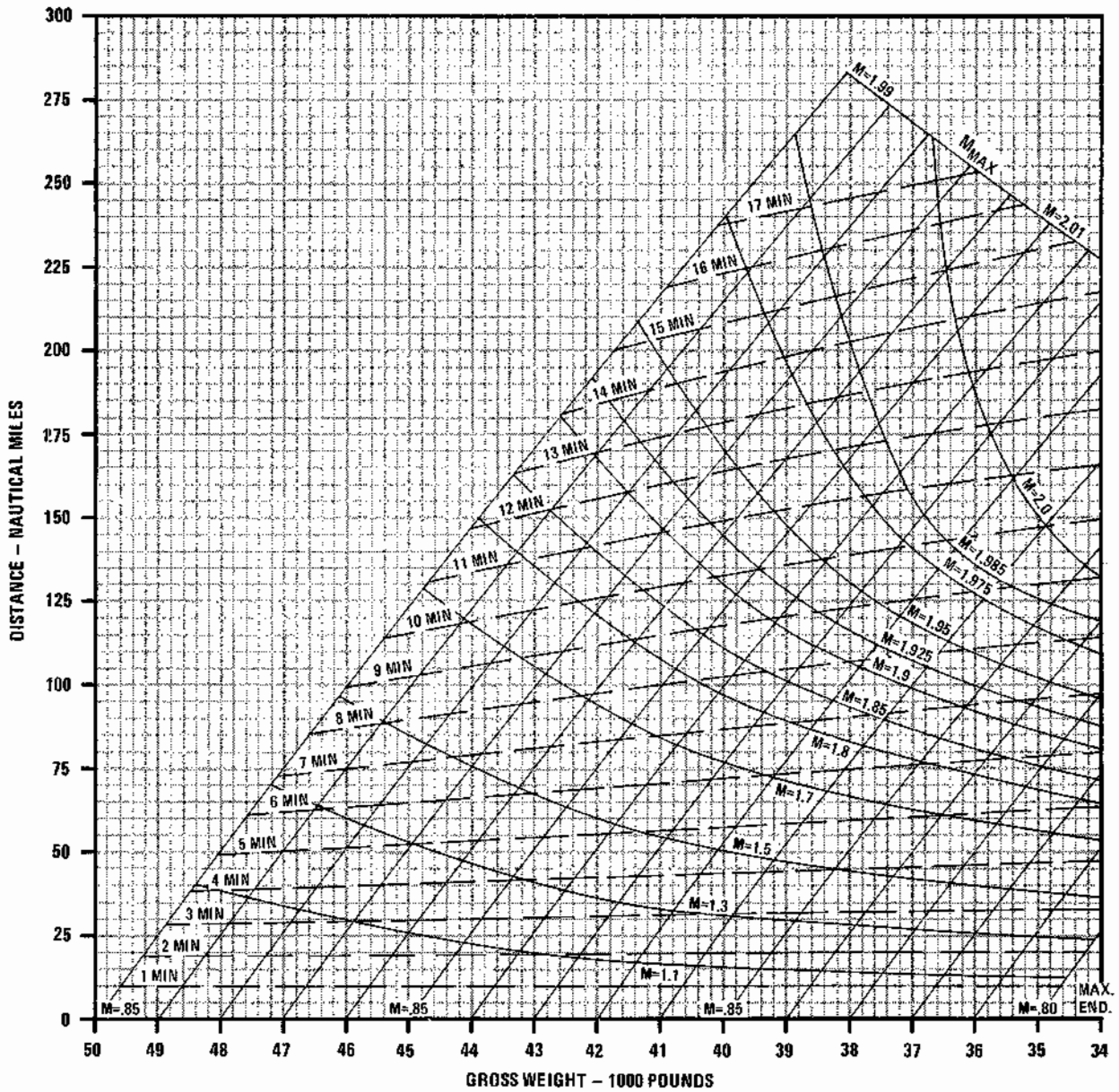

4E-1-(405)

Figure A9-28



**F-4E**

# MAXIMUM THRUST ACCELERATION

**30,000 FEET**

**AIRPLANE CONFIGURATION**  
(1) B28

**REMARKS**  
ENGINE(S): (2) J79-GE-17  
ICAO STANDARD DAY

GUIDE

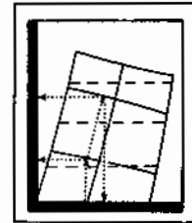

DATE: 1 FEBRUARY 1973  
DATA BASIS: FLIGHT TEST

FUEL GRADE: JP-4  
FUEL DENSITY: 6.5 LB/GAL

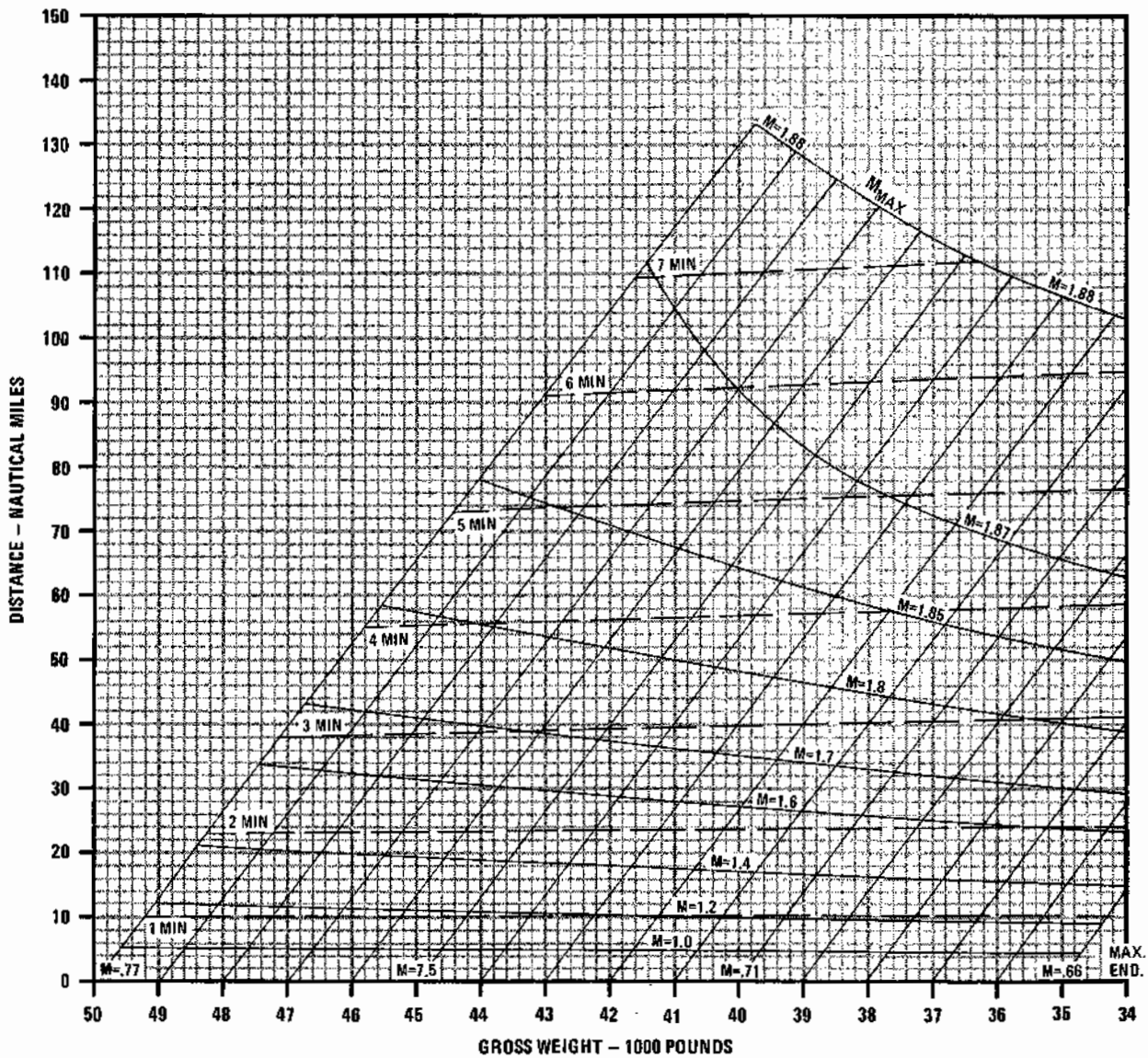

Figure A9-29

**F-4E**

# MAXIMUM THRUST ACCELERATION

**35,000 FEET**

AIRPLANE CONFIGURATION  
(1) B28

REMARKS  
ENGINE(S): (2) J79-GE-17  
ICAO STANDARD DAY

DATE: 1 FEBRUARY 1973  
DATA BASIS: FLIGHT TEST

GUIDE



FUEL GRADE: JP-4  
FUEL DENSITY: 6.5 LB/GAL

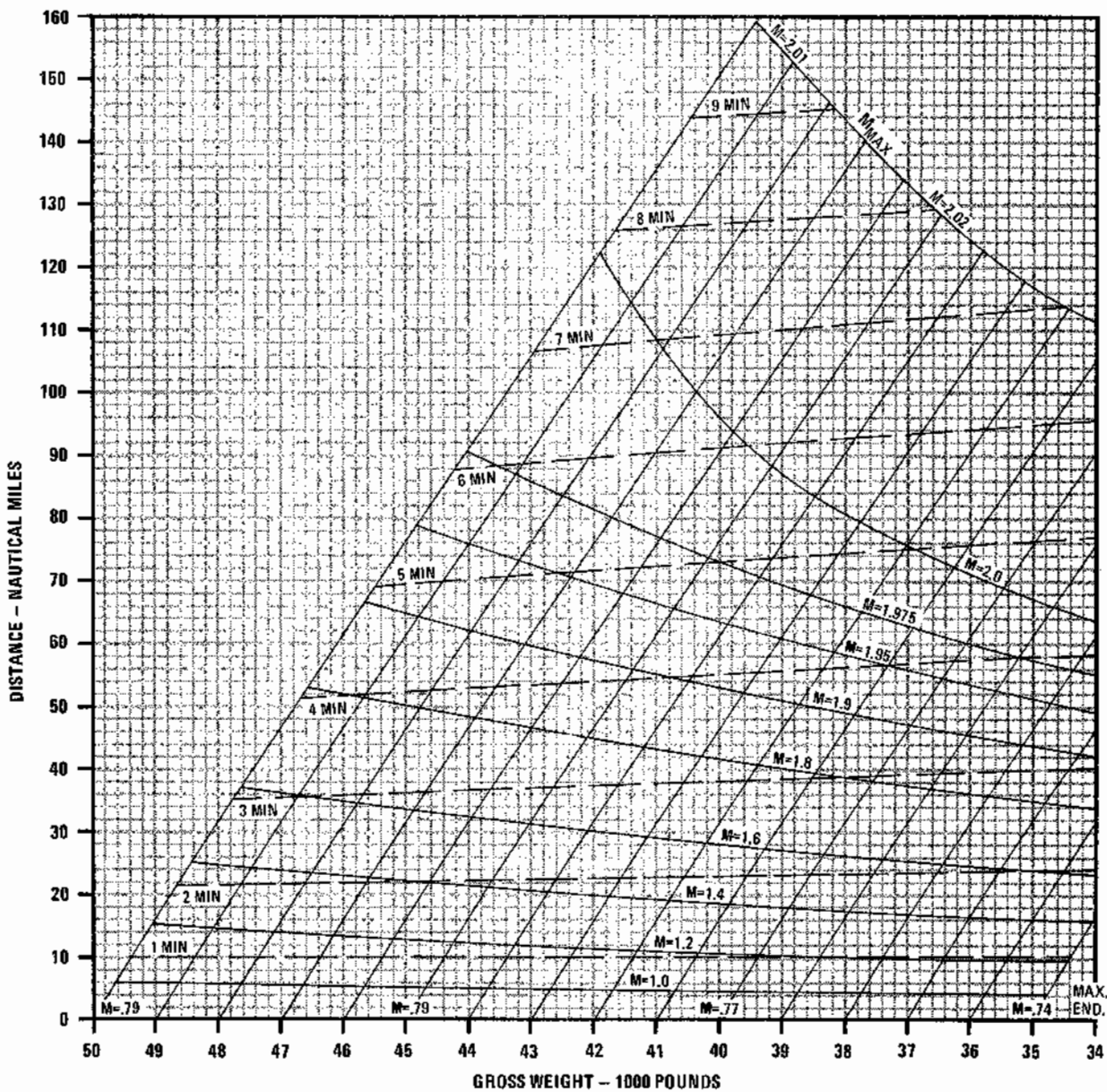

4E-1-(407)

Figure A9-30

**F-4E**

# MAXIMUM THRUST ACCELERATION

**40,000 FEET**

**AIRPLANE CONFIGURATION**  
(1) B28

**REMARKS**  
ENGINE(S): (2) J79-GE-17  
ICAO STANDARD DAY

**GUIDE**

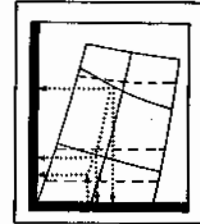

DATE: 1 FEBRUARY 1973  
DATA BASIS: FLIGHT TEST

FUEL GRADE: JP-4  
FUEL DENSITY: 6.5 LB/GAL

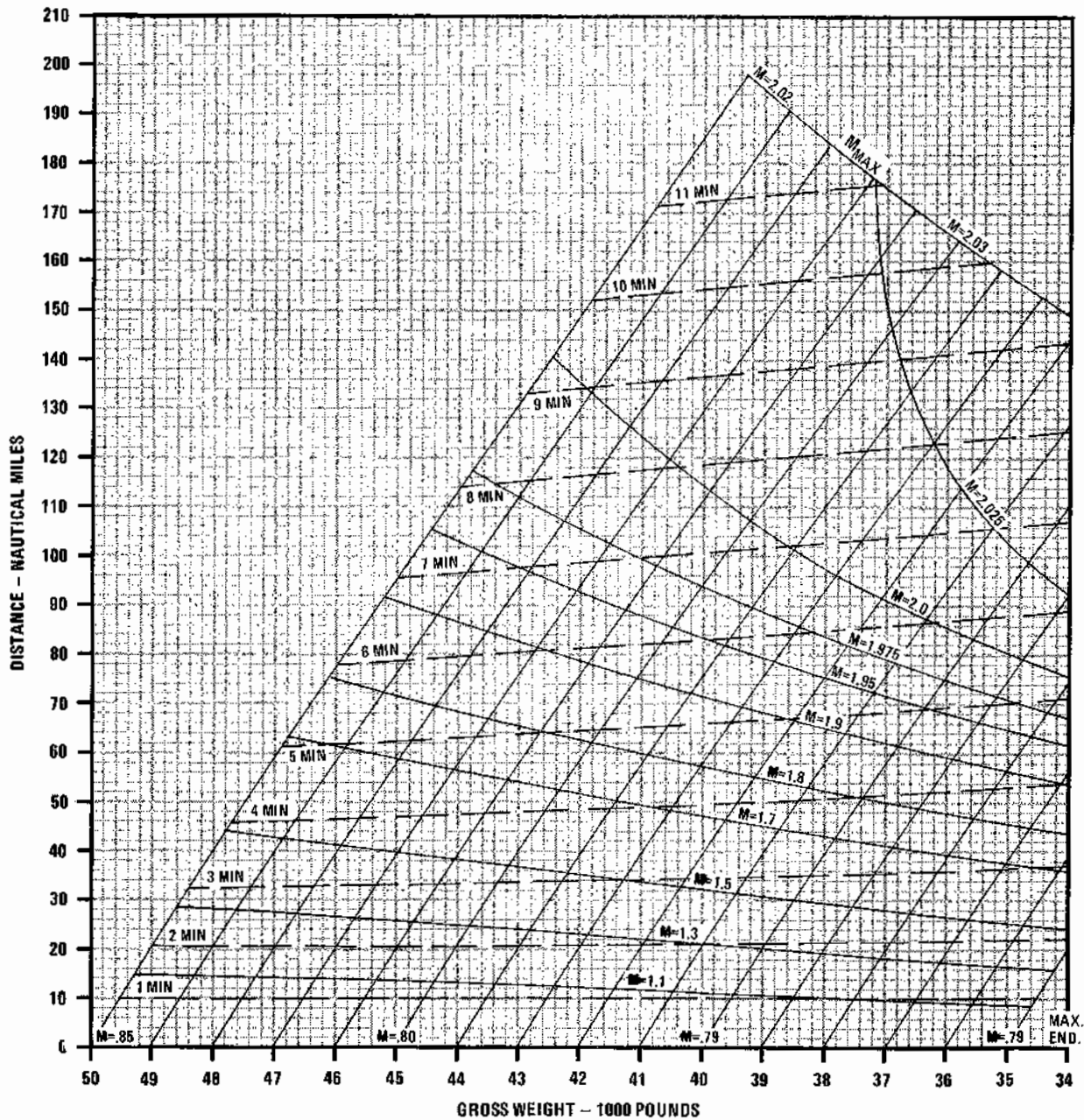

Figure A9-31

F-4E

# MAXIMUM THRUST ACCELERATION

## 45,000 FEET

AIRPLANE CONFIGURATION  
(1) B28

REMARKS  
ENGINE(S): (2) J79-GE-17  
ICAO STANDARD DAY

GUIDE

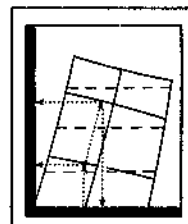

DATE: 1 FEBRUARY 1973  
DATA BASIS: FLIGHT TEST

FUEL GRADE: JP-4  
FUEL DENSITY: 6.5 LB/GAL

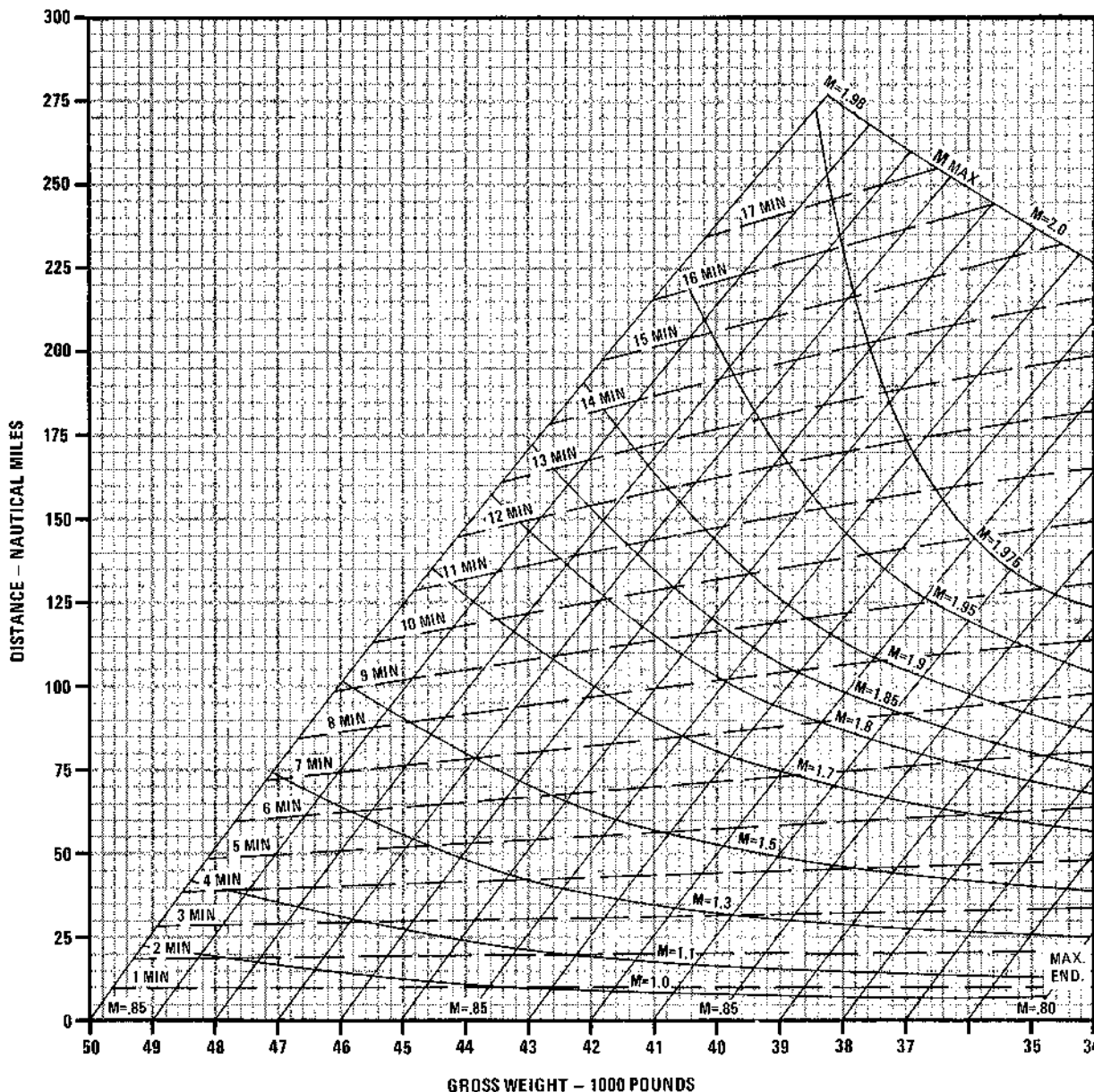

4E-1-(409)

Figure A9-32



**F-4E**

# MAXIMUM THRUST ACCELERATION

**35,000 FEET**

**AIRPLANE CONFIGURATION**

(4) AIM-4D AND (4) AIM-7

**REMARKS**

ENGINE(S): (2) J79-GE-17  
ICAO STANDARD DAY

DATE: 1 FEBRUARY 1973  
DATA BASIS: FLIGHT TEST

GUIDE

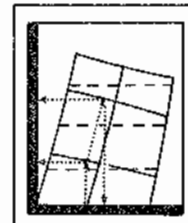

FUEL GRADE: JP-5  
FUEL DENSITY: 6.5 LB/GAL

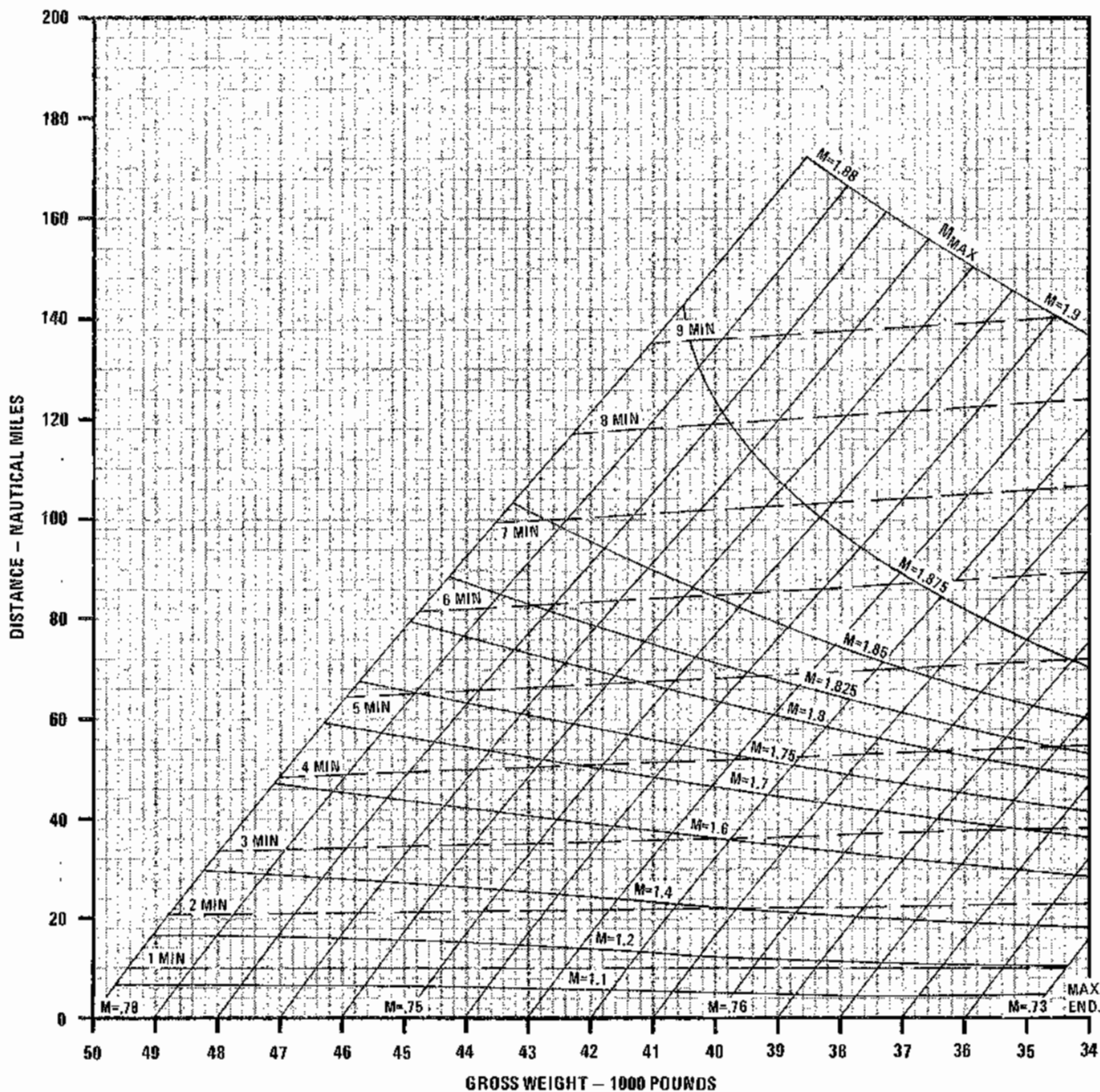

4E-1-(411)

Figure A9-34

**F-4E**

**MAXIMUM THRUST ACCELERATION  
40,000 FEET**

**AIRPLANE CONFIGURATION**  
(4)AIM-4D AND (4)AIM-7

**REMARKS**  
ENGINE(S): (2) J79-GE-17  
ICAO STANDARD DAY

GUIDE



DATE: 1 FEBRUARY 1973  
DATA BASIS: FLIGHT TEST

FUEL GRADE: JP-4  
FUEL DENSITY: 6.5 LB/GAL

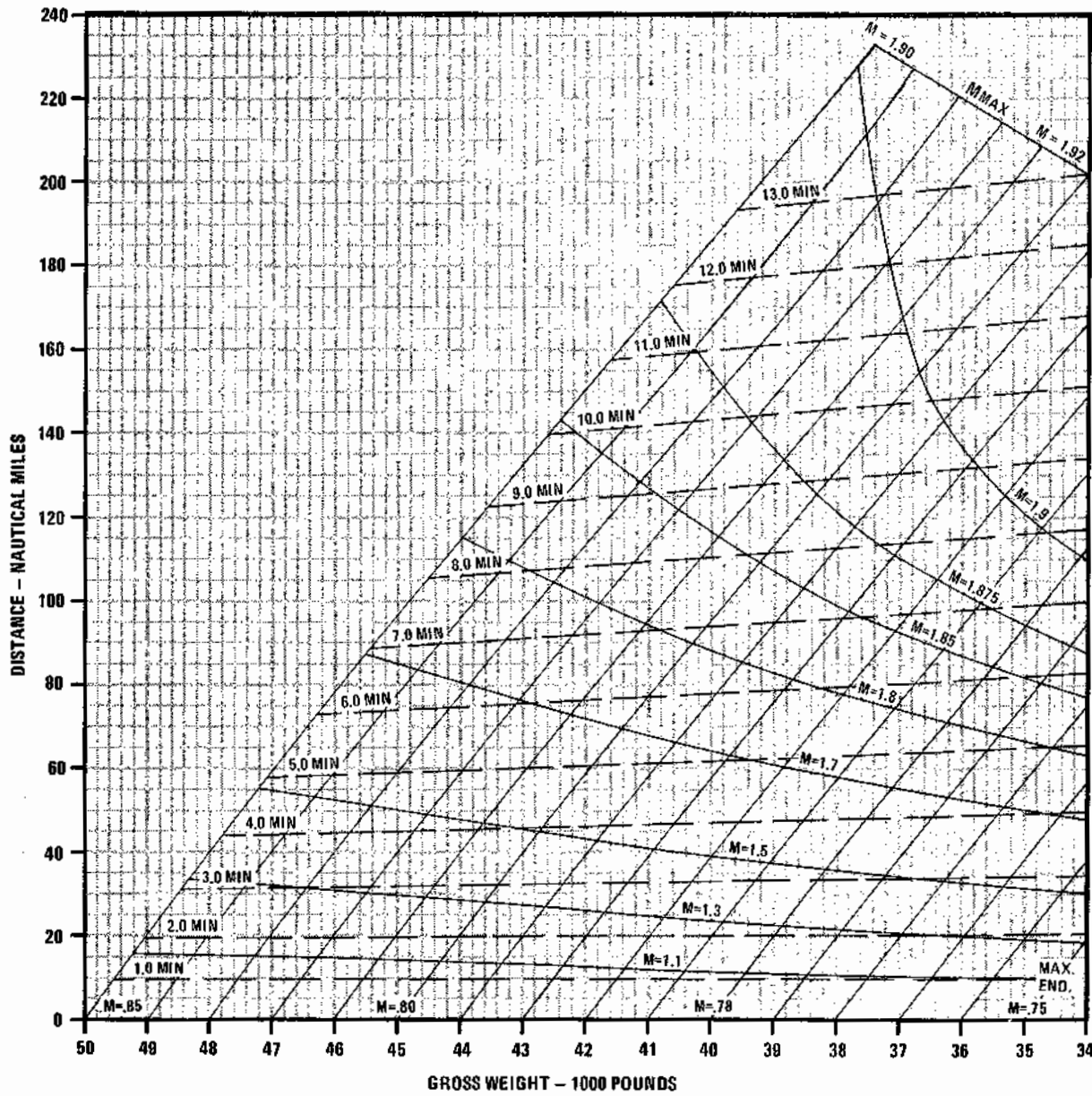

Figure A9-35

**F-4E**

# MAXIMUM THRUST ACCELERATION 45,000 FEET

**AIRPLANE CONFIGURATION**  
(4) AIM-4D AND (4) AIM-7

**REMARKS**  
ENGINE(S): (2) J79-GE-17  
ICAO STANDARD DAY

GUIDE

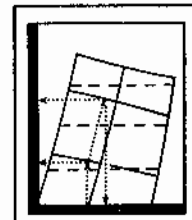

DATE: 1 FEBRUARY 1973  
DATA BASIS: FLIGHT TEST

FUEL GRADE: JP-4  
FUEL DENSITY: 6.5 L/GAL

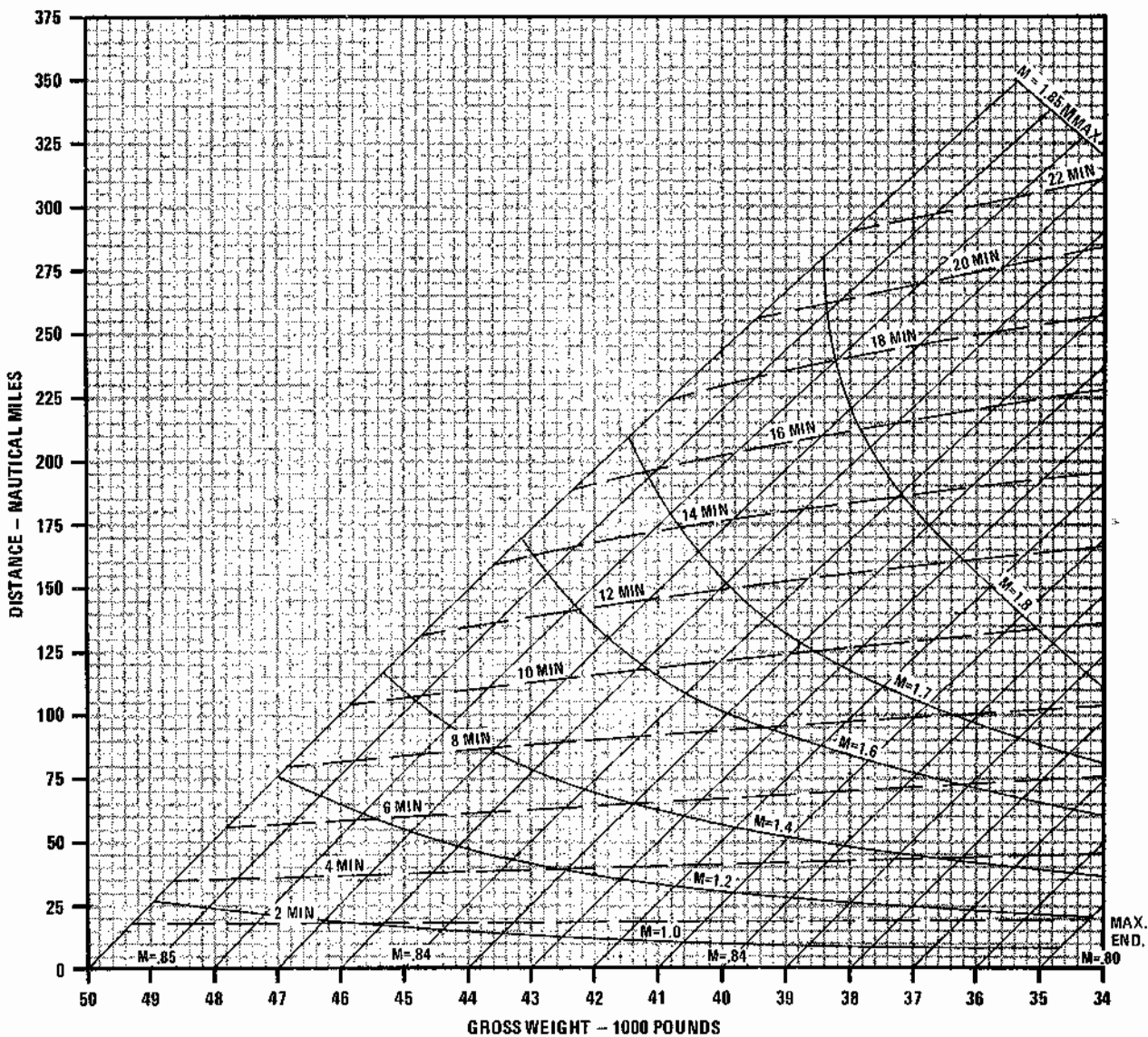

4E-1-(413)

Figure A9-36



**F-4E**

**MAXIMUM THRUST ACCELERATION**

**30,000 FEET**

**AIRPLANE CONFIGURATION**  
(4) AIM-7 AND (1) Q TANK

**REMARKS**  
ENGINE(S): (2) J79-GE-17  
ICAO STANDARD DAY

GUIDE

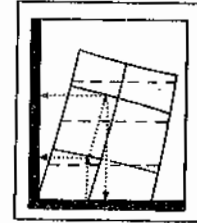

FUEL GRADE: JP-4  
DATA BASIS: 6.5 LB/GAL

DATE: 1 FEBRUARY 1973  
DATA BASIS: FLIGHT TEST

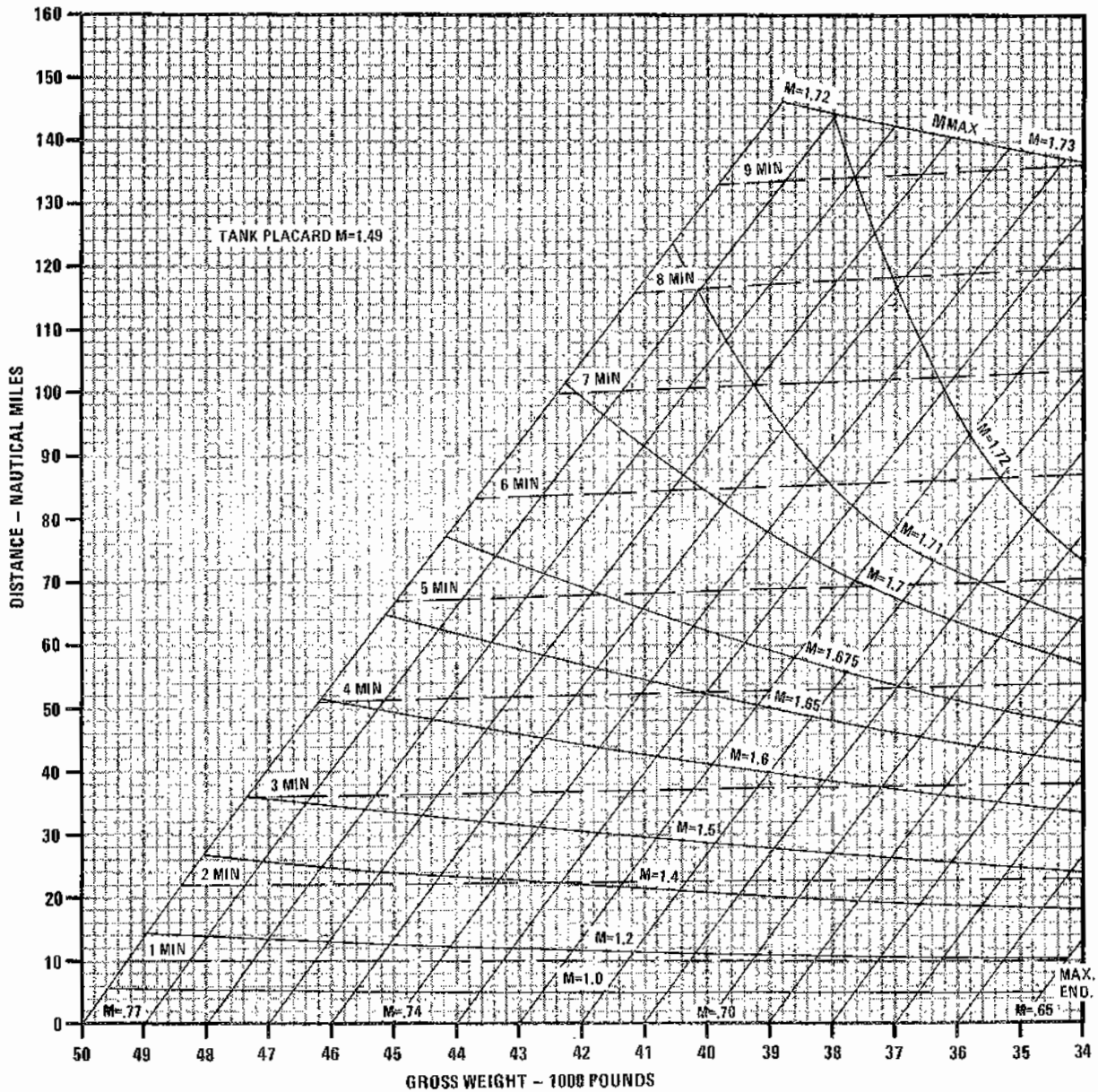

4E-1-(414)

Figure A9-37

**F-4E**

**MAXIMUM THRUST ACCELERATION**

**35,000 FEET**

AIRPLANE CONFIGURATION  
(4) AIM-7 AND (1) Q TANK

REMARKS  
ENGINE(S): (2) J79-GE-17  
ICAO STANDARD DAY

GUIDE



FUEL GRADE: JP-4  
FUEL DENSITY: 6.5 LB/GAL

DATE: 1 FEBRUARY 1973  
DATA BASIS: FLIGHT TEST

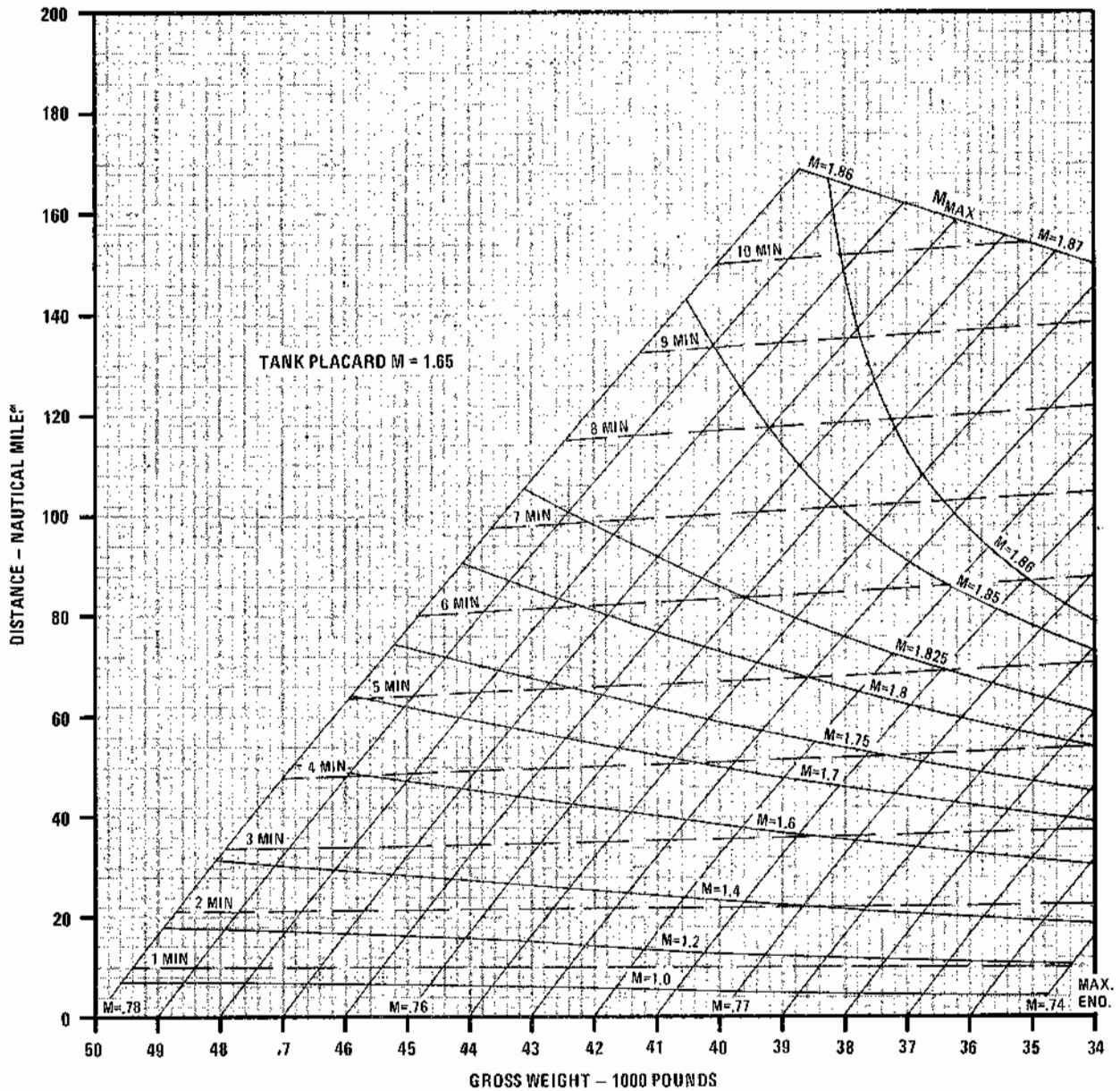

4E-1-(415)

Figure A9-38

**F-4E**

# MAXIMUM THRUST ACCELERATION

**40,000 FEET**

AIRPLANE CONFIGURATION  
(4) AIM-7 AND (1) Q TANK

REMARKS  
ENGINE(S): (2) J79-GE-17  
ICAO STANDARD DAY

GUIDE

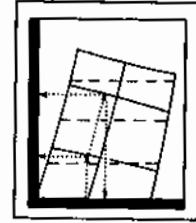

FUEL GRADE: JP-5  
FUEL DENSITY: 5.8 LB/GAL

DATE: 1 FEBRUARY 1973  
DATA BASIS: FLIGHT TEST

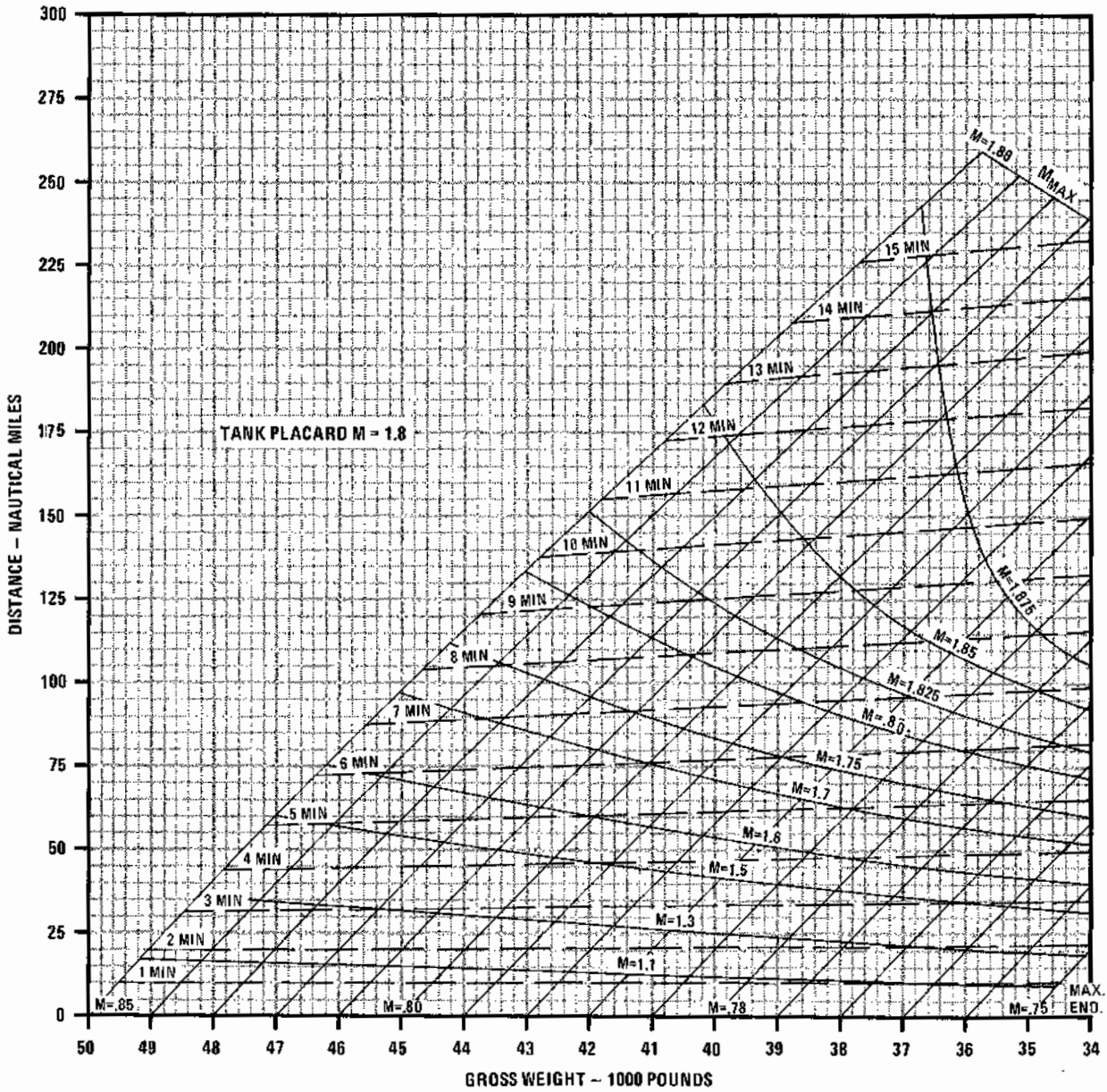

Figure A9-39

**F-4E**

# MAXIMUM THRUST ACCELERATION

**45,000 FEET**

**AIRPLANE CONFIGURATION**

(4) AIM-7 AND (1) Q TANK

**REMARKS**

ENGINE(S): (2) J79-GE-17  
ICAO STANDARD DAY

DATE: 1 FEBRUARY 1973  
DATA BASIS: FLIGHT TEST

GUIDE

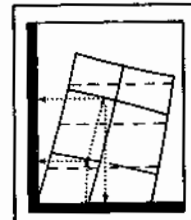

FUEL GRADE: JP-5  
FUEL DENSITY: 5.8 LB/GAL

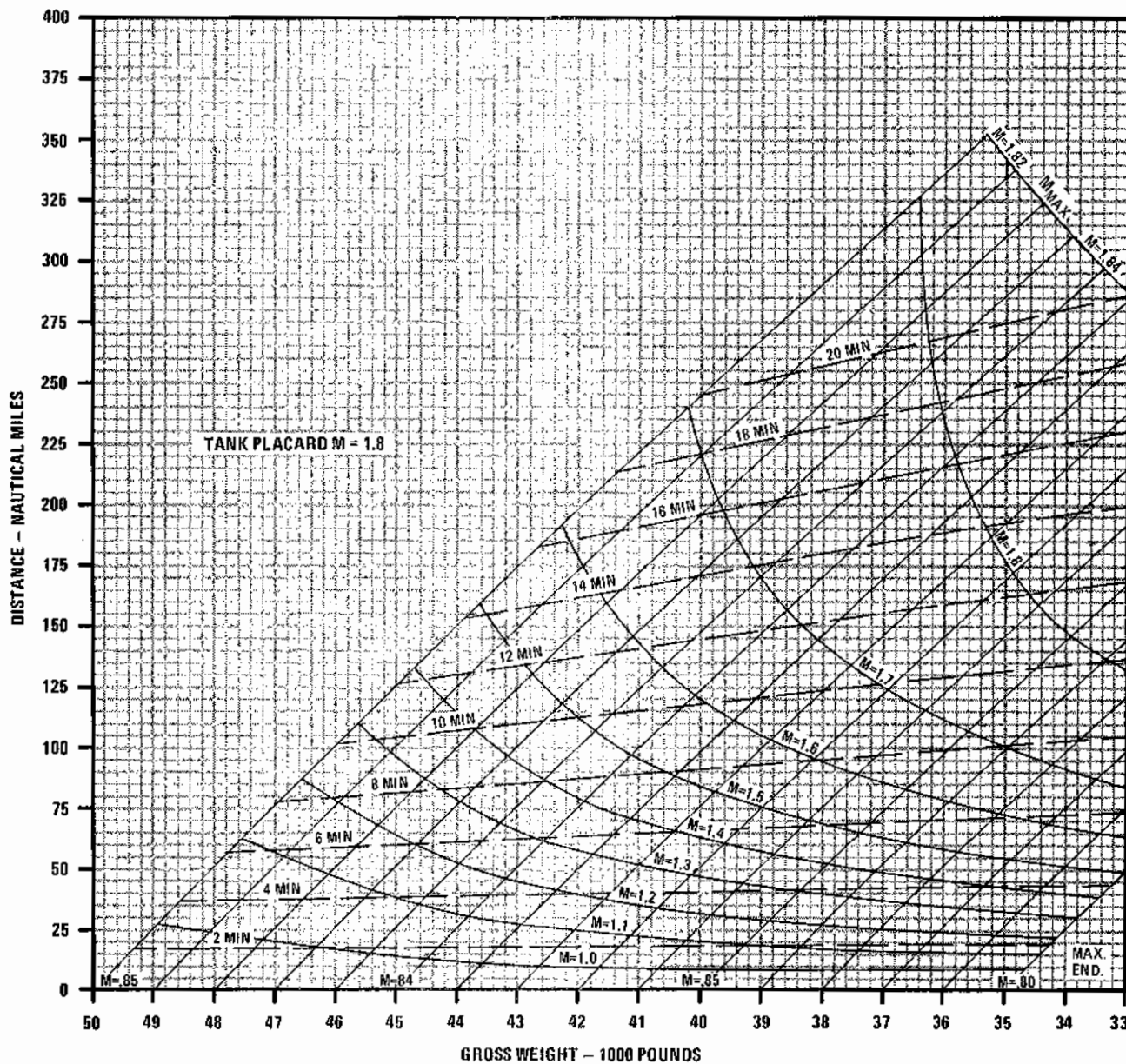

4E-1-(417)

Figure A9-40

**F-4E**

**MAXIMUM THRUST ACCELERATION**

**30,000 FEET**

**AIRPLANE CONFIGURATION**

(4) AIM-7 AND  
(2) WING TANKS

**REMARKS**

ENGINE(S): (2) J79-GE-17  
ICAO STANDARD DAY

GUIDE



DATE: 1 FEBRUARY 1973  
DATA BASIS: FLIGHT TEST

FUEL GRADE: JP-4  
FUEL DENSITY: 6.5 LB/GAL

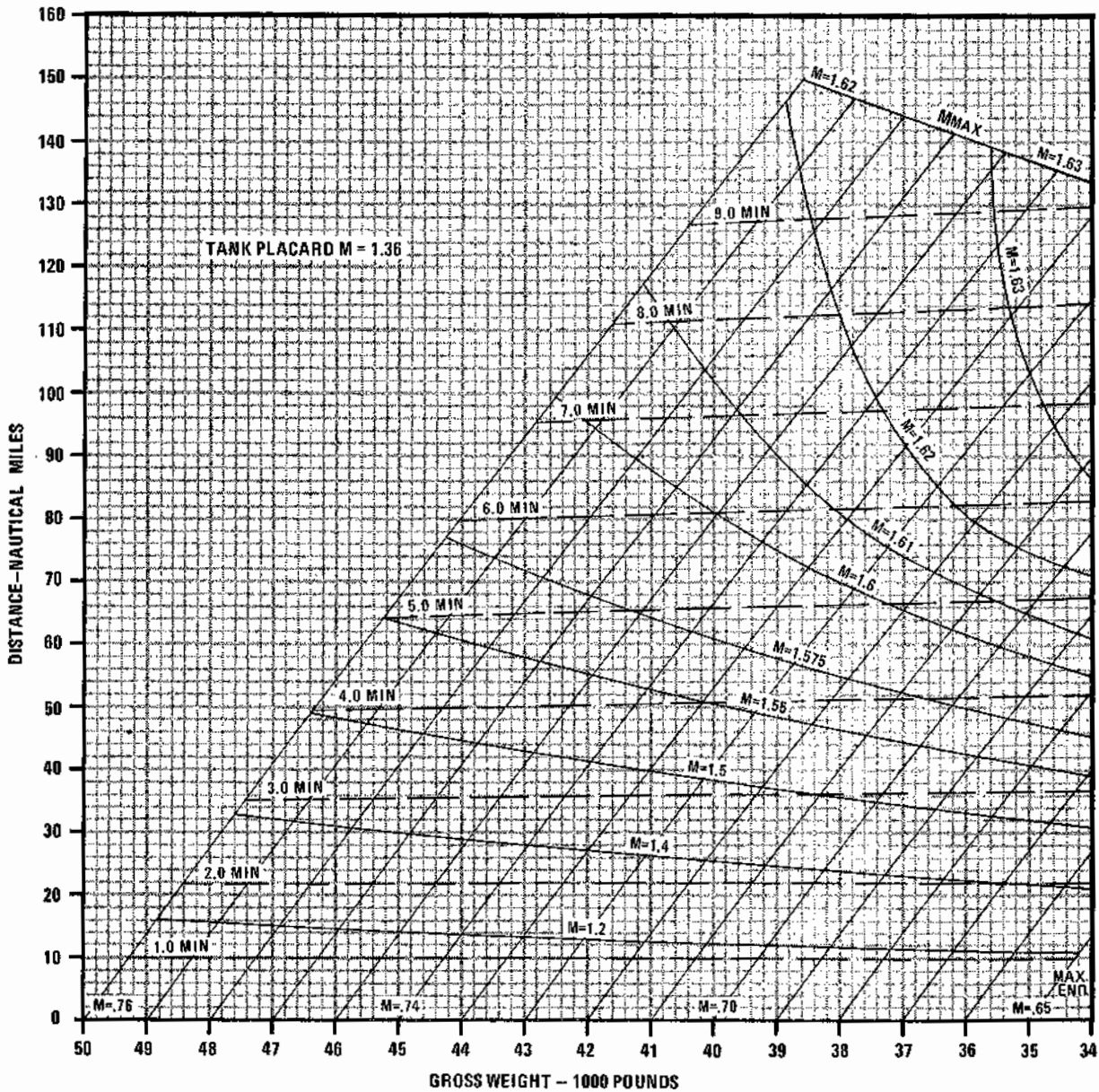

Figure A9-41

**F-4E**

# MAXIMUM THRUST ACCELERATION

**35,000 FEET**

**AIRPLANE CONFIGURATION**

- (4) AIM-7 AND
- (2) WING TANKS

**REMARKS**

ENGINE(S): (2) J79-GE-17  
ICAO STANDARD DAY

GUIDE

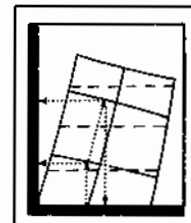

FUEL GRADE: JP-4  
FUEL DENSITY: 6.5 LB/GAL

DATE: 1 FEBRUARY 1973  
DATA BASIS: FLIGHT TEST

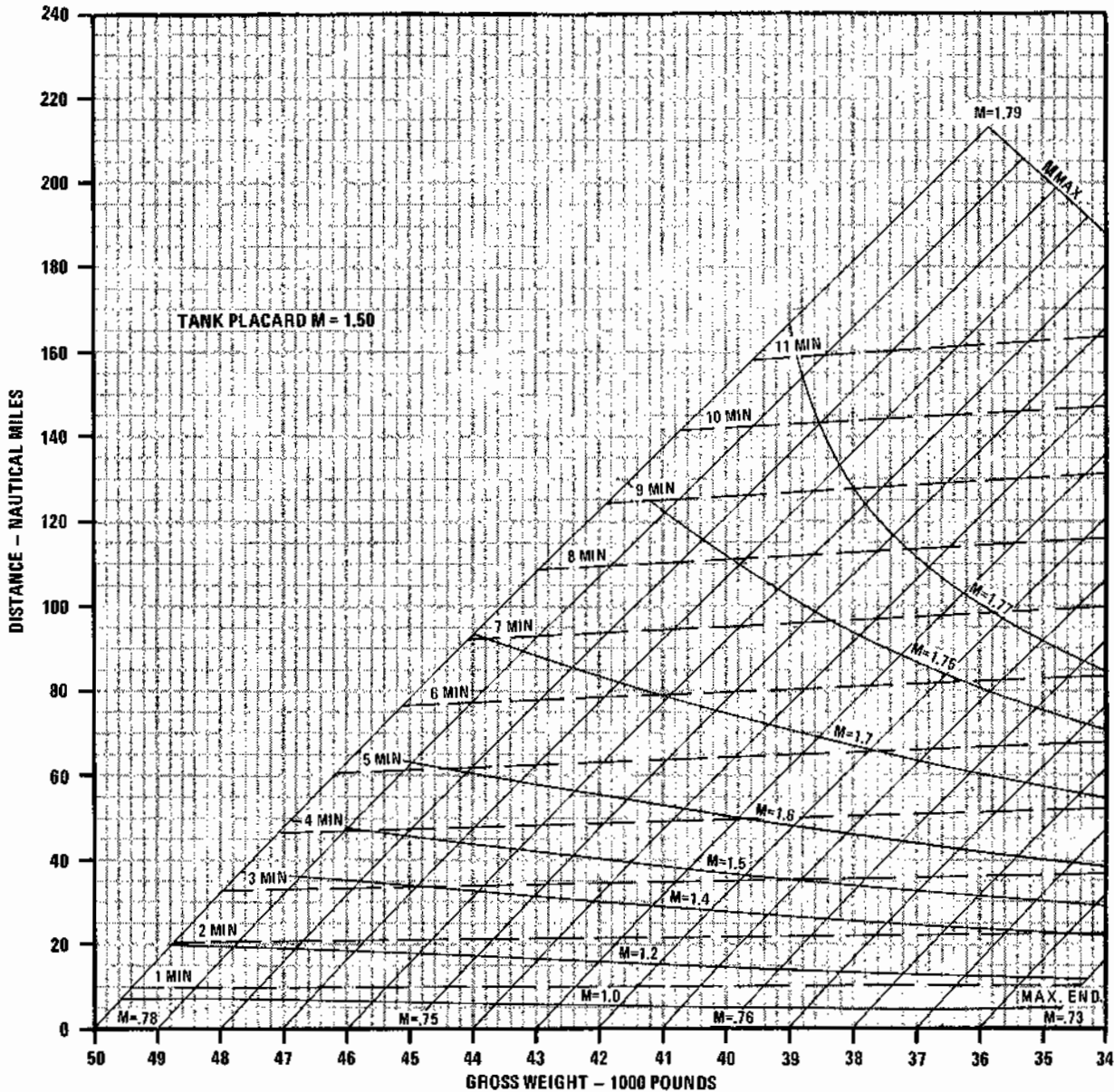

4E-1-(419)

Figure A9-42

F-4E

# MAXIMUM THRUST ACCELERATION 40,000 FEET

**AIRPLANE CONFIGURATION**  
(4) AIM-7 AND (2) WING TANKS

**REMARKS**  
ENGINE(S): (2) J79-GE-17  
ICAO STANDARD DAY

GUIDE



DATE: 1 FEBRUARY 1973  
DATA BASIS: FLIGHT TEST

FUEL GRADE: JP-5  
FUEL DENSITY: 5.8 LB/GAL

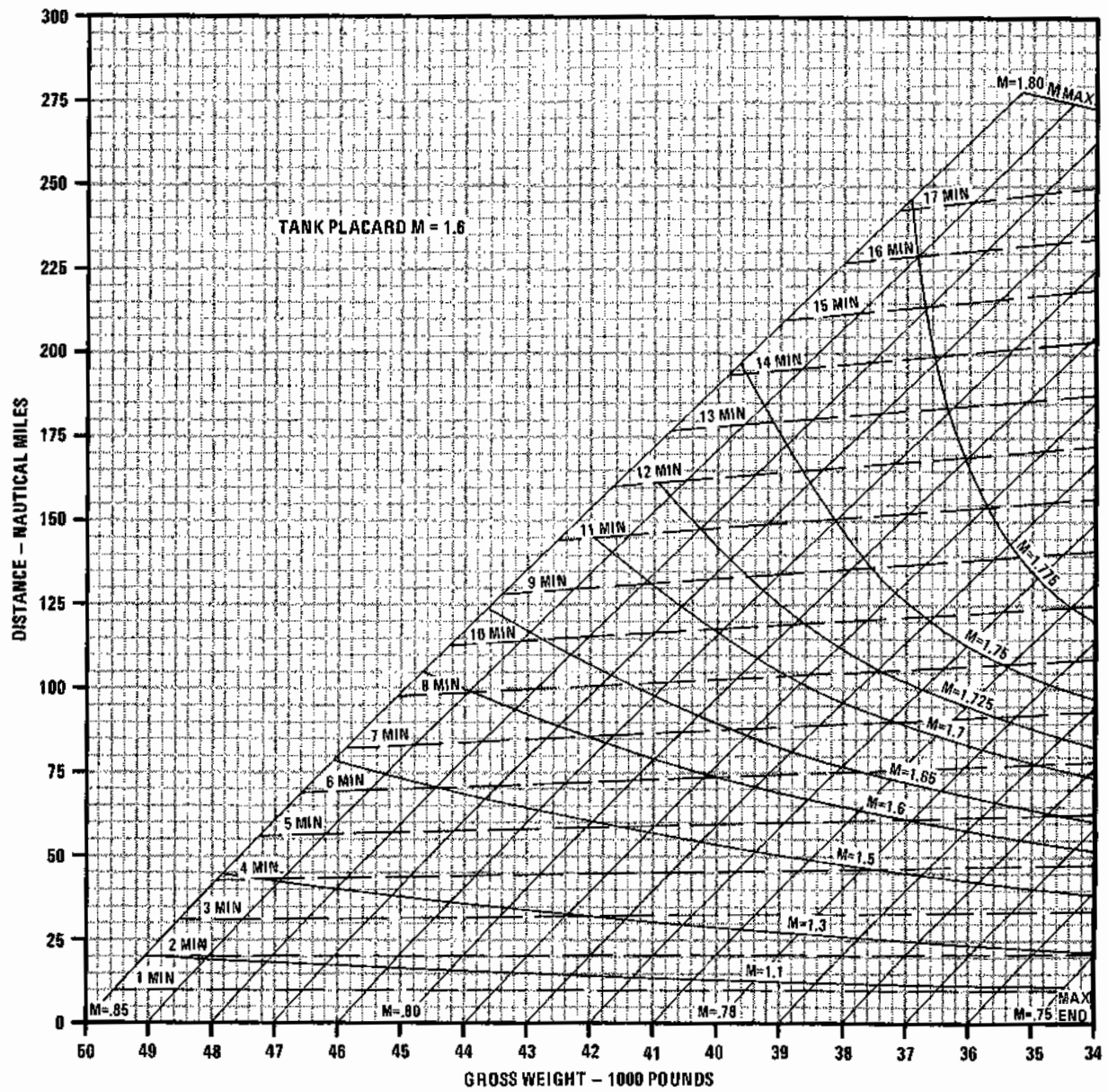

4E-1-(420)

Figure A9-43

**F-4E**

# MAXIMUM THRUST ACCELERATION

## 45,000 FEET

### AIRPLANE CONFIGURATION

- (4)AIM-7 AND
- (2)WING TANKS

### REMARKS

ENGINE(S): (2)J79-GE-17  
 ICAO STANDARD DAY

GUIDE

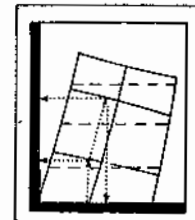

FUEL GRADE: JP-4  
 FUEL DENSITY: 6.5 LB/GAL

DATE: 1 FEBRUARY 1973  
 DATA BASIS: FLIGHT TEST

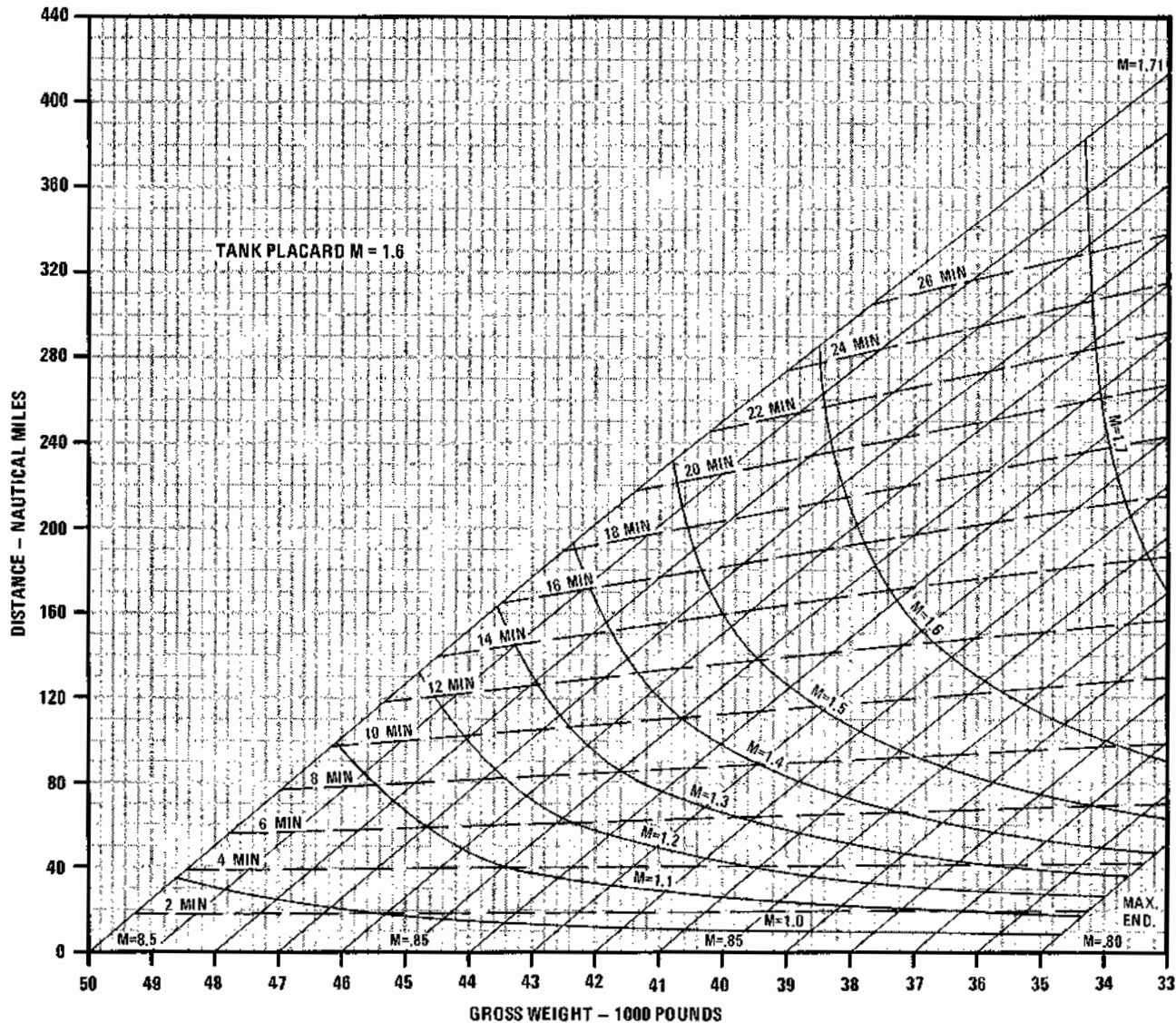

Figure A9-44



**F-4E**  
**MAXIMUM THRUST ACCELERATION**  
**30,000 FEET**

**AIRPLANE CONFIGURATION**  
 (1) B28 AND (2) WING TANKS

**REMARKS**  
 ENGINE(S): (2) J79-GE-17  
 ICAO STANDARD DAY

GUIDE

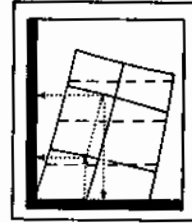

DATE: 1 FEBRUARY 1973  
 DATA BASIS: FLIGHT TEST

FUEL GRADE: JP-4  
 FUEL DENSITY: 6.5 LB/GAL

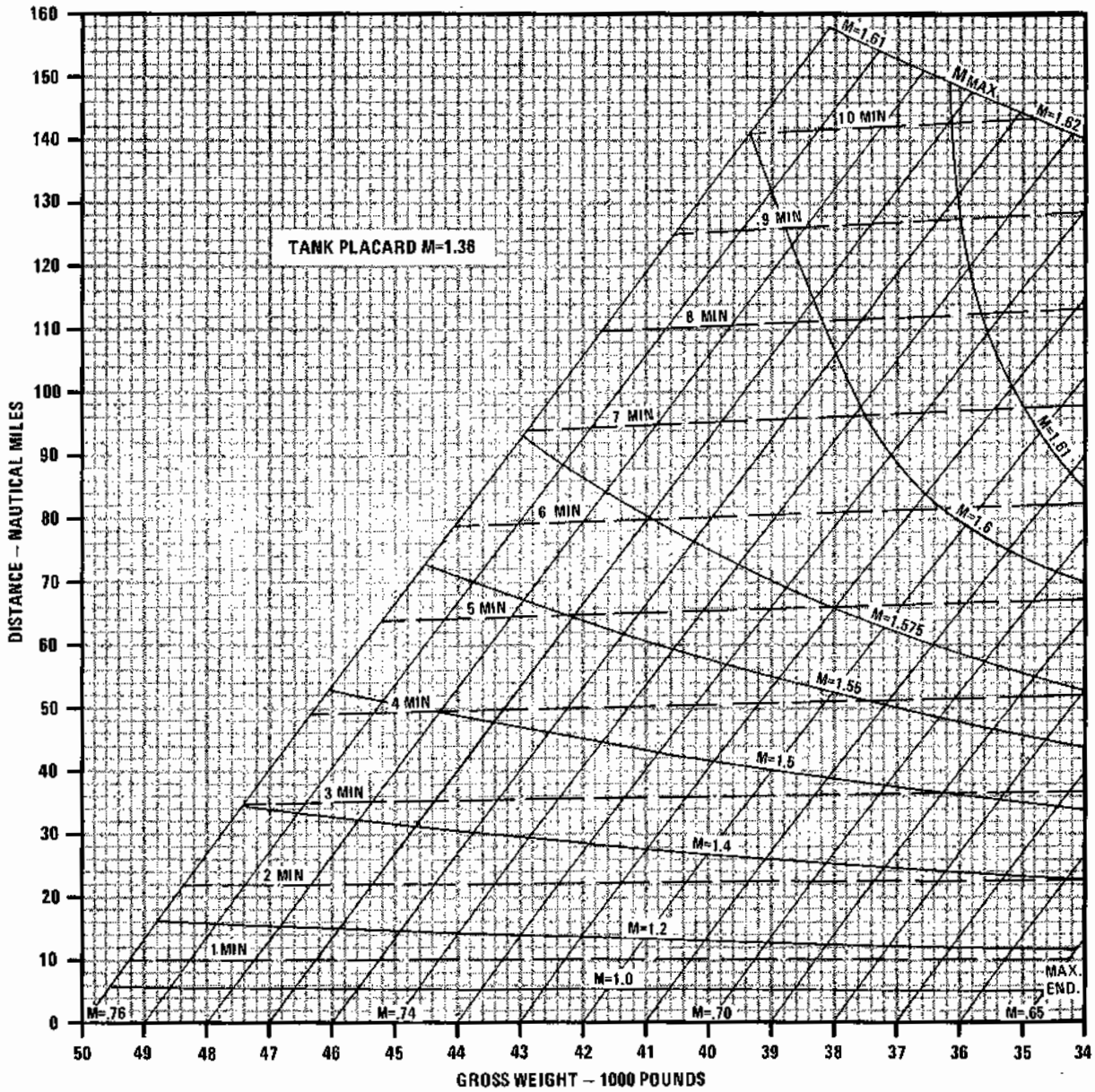

4E-1-(422)

Figure A9-45

**F-4E**  
**MAXIMUM THRUST ACCELERATION**  
**35,000 FEET**

**AIRPLANE CONFIGURATION**  
 (1) 828 AND (2) WING TANKS

**REMARKS**  
 ENGINE(S): (2) J79-GE-17  
 ICAO STANDARD DAY

GUIDE



DATE: 1 FEBRUARY 1973  
 DATA BASIS: FLIGHT TEST

FUEL GRADE: JP-4  
 FUEL DENSITY: 6.5 LB/GAL

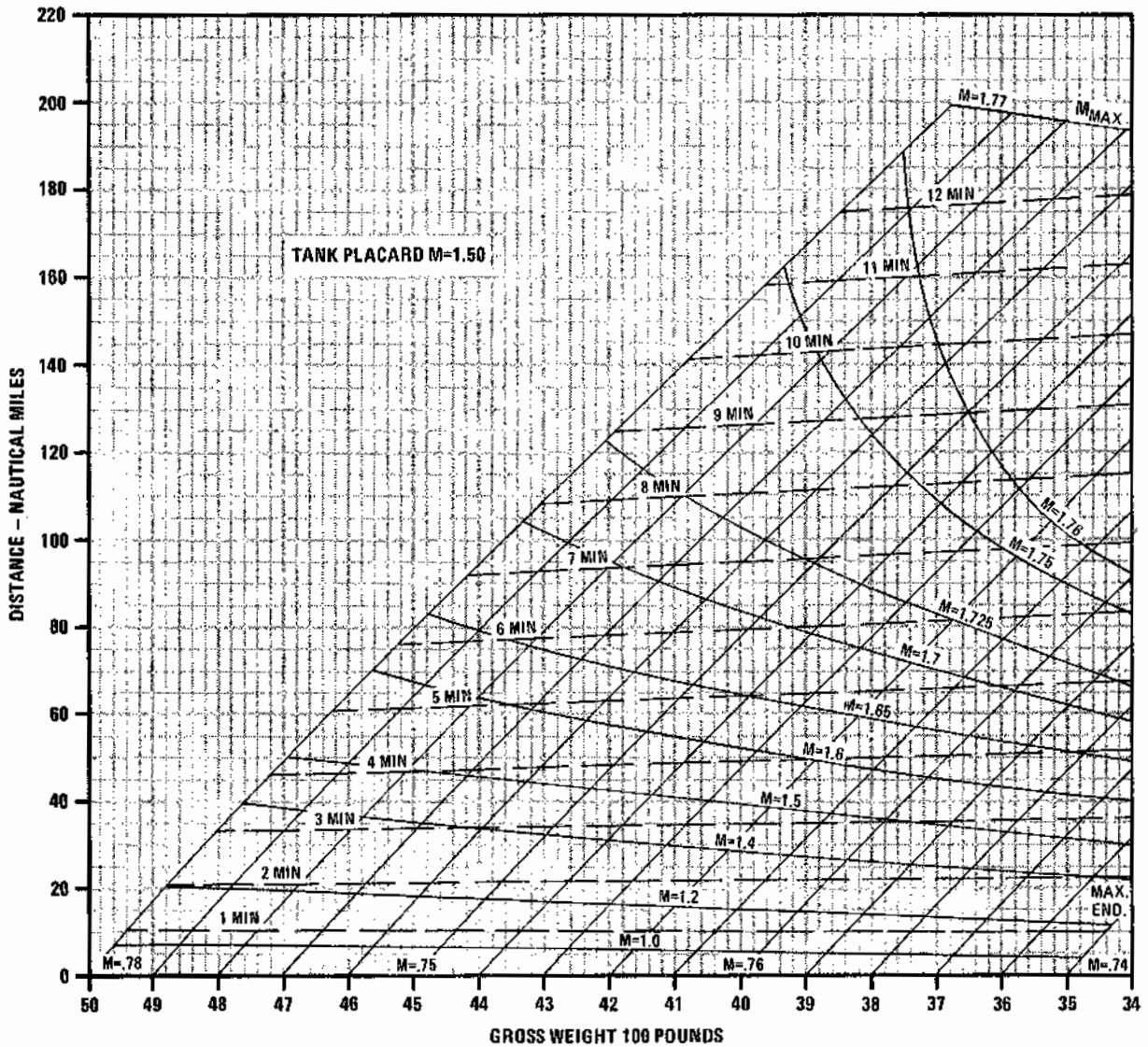

**F-4E**

**MAXIMUM THRUST ACCELERATION**

**40,000 FEET**

**AIRPLANE CONFIGURATION**  
(1) B20 AND (2) WING TANKS

**REMARKS**  
ENGINE(S): (2) J79-GE-17  
ICAO STANDARD DAY

GUIDE

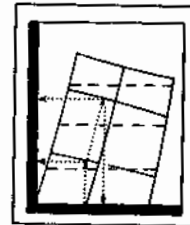

FUEL GRADE: JP-4  
FUEL DENSITY: 6.5 LB/GAL

DATE: 1 FEBRUARY 1973  
DATA BASIS: FLIGHT TEST

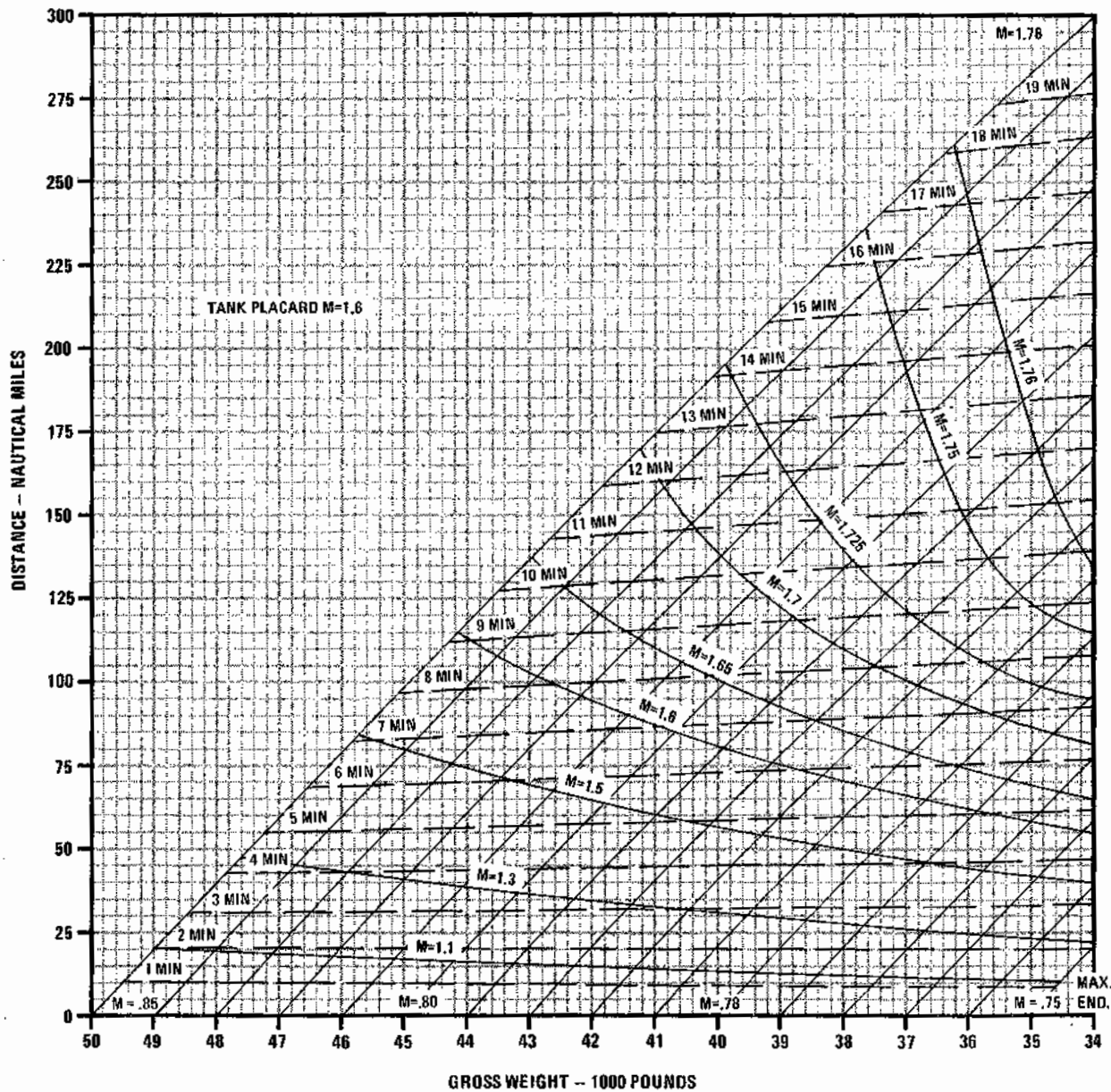

4E-1-(424)

Figure A9-47

**F-4E**

# MAXIMUM THRUST ACCELERATION

**45,000 FEET**

**AIRPLANE CONFIGURATION**  
(1) 028 AND (2) WING TANKS

**REMARKS**  
ENGINE(S): (2) J79-GE-17  
ICAO STANDARD DAY

GUIDE



DATE: 1 FEBRUARY 1973  
DATA BASIS: FLIGHT TEST

FUEL GRADE: JP-4  
FUEL DENSITY: 6.5 LB/GAL

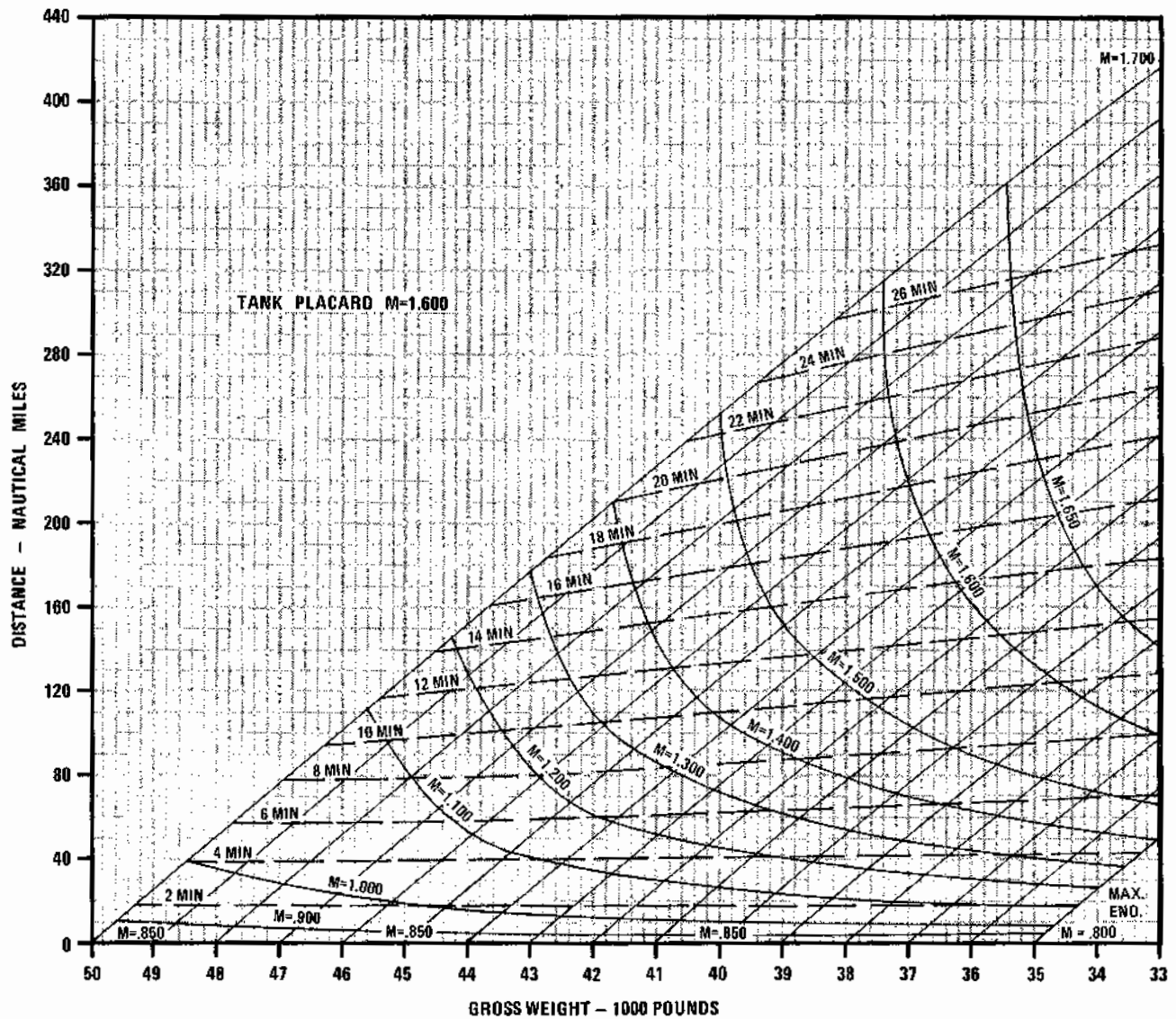

4E-1-(425)

Figure A9-48

**F-4E**

# MAXIMUM THRUST ACCELERATION

**30,000 FEET**

**AIRPLANE CONFIGURATION**  
 (4)AIM-40, (4)AIM-7  
 AND (1) CTANK

**REMARKS**  
 ENGINE(S): (2) J79-GE-17  
 (CAO STANDARD DAY)

GUIDE

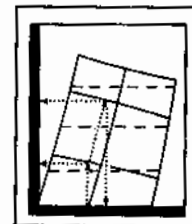

DATE: 1 FEBRUARY 1973  
 DATA BASIS: FLIGHT TEST

FUEL GRADE: JP-4  
 FUEL DENSITY: 6.5 LB/GAL

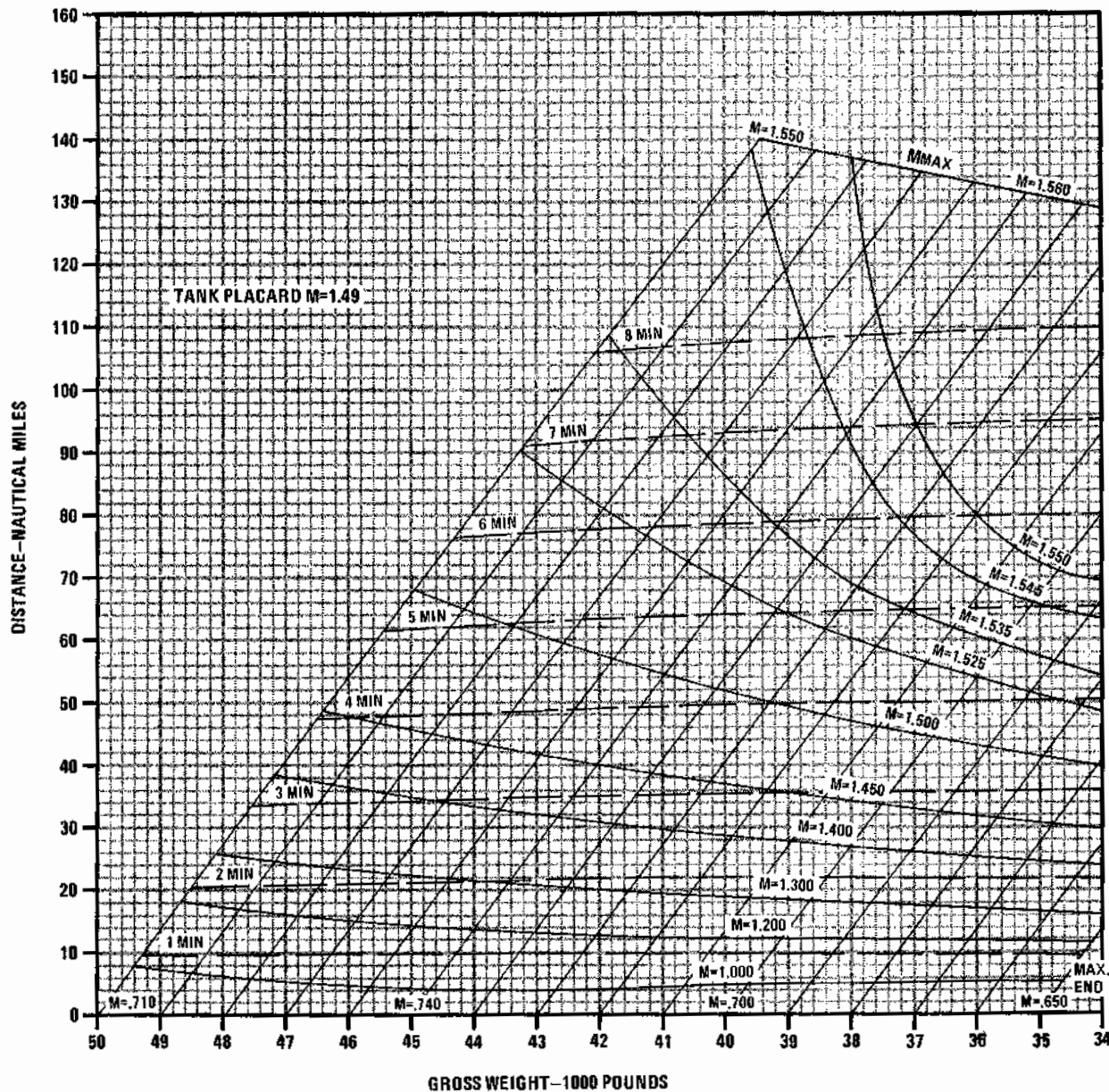
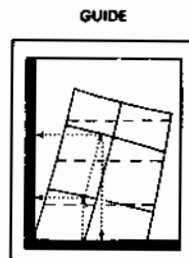

Figure A9-49

**F-4E**  
**MAXIMUM THRUST ACCELERATION**  
**35,000 FEET**

**AIRPLANE CONFIGURATION**  
 (4) AIM-4D, (4) AIM-7  
 AND (1)  $\epsilon$  TANK

**REMARKS**  
 ENGINE(S): (2) J79-GE-17  
 ICAO STANDARD DAY



FUEL GRADE: JP-4  
 FUEL DENSITY: 6.5 LB/GAL

DATE: 1 FEBRUARY 1973  
 DATA BASIS: FLIGHT TEST

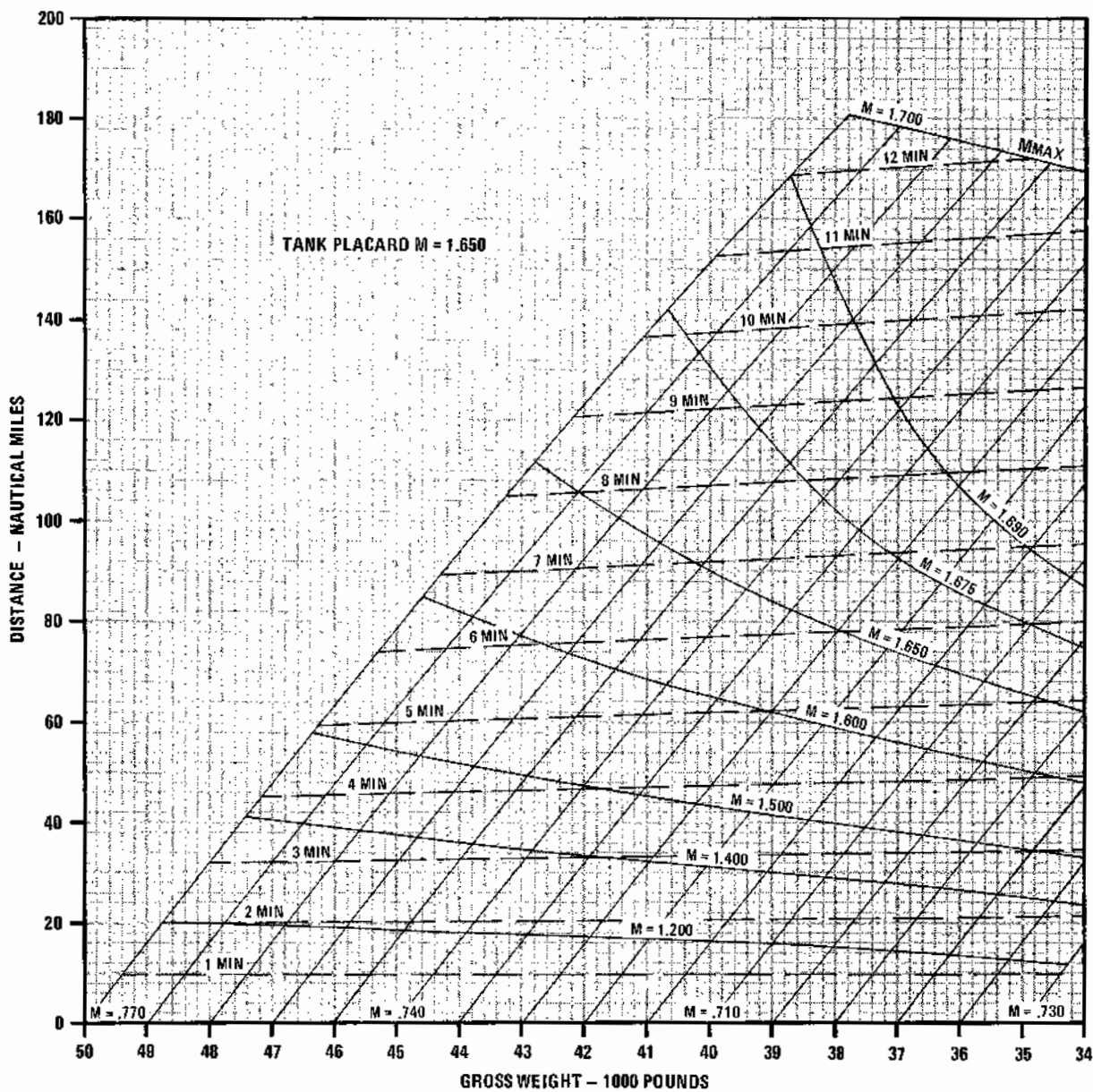

4E-1-(427)

Figure A9-50

**F-4E**

**MAXIMUM THRUST ACCELERATION  
40,000 FEET**

**AIRPLANE CONFIGURATION**

(4) AIM-4D, (4) AIM-7  
AND (1) C TANK

**REMARKS**

ENGINE(S): (2) J79-GE-17  
ICAO STANDARD DAY

GUIDE



FUEL GRADE: JP-4  
FUEL DENSITY: 6.5 LB/GAL

DATA: 1 FEBRUARY 1973  
DATA BASIS: FLIGHT TEST

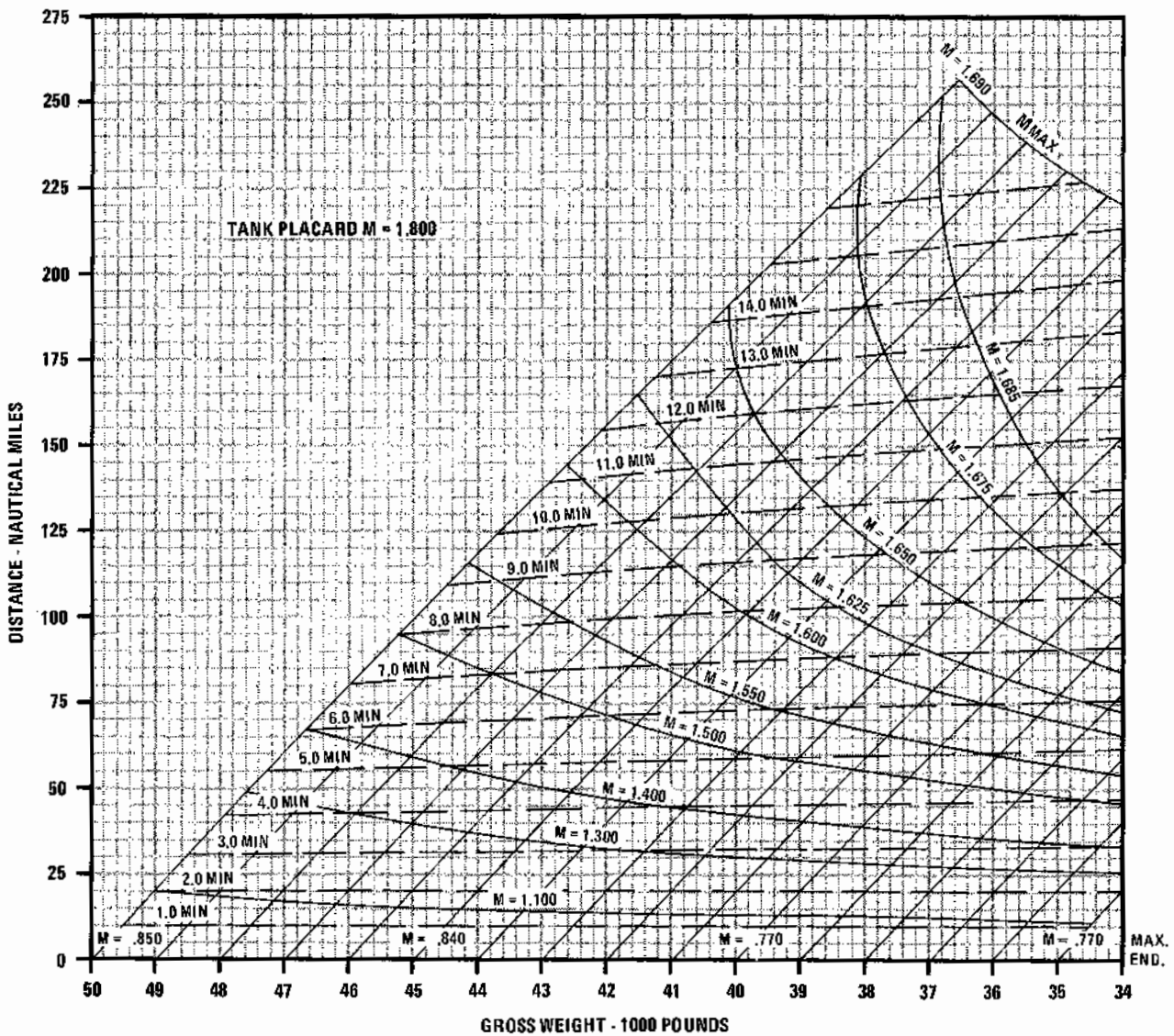

Figure A9-51

**F-4E**  
**MAXIMUM THRUST ACCELERATION**  
**45,000 FEET**

**AIRPLANE CONFIGURATION**

(4) AIM-4D, (4) AIM-7  
 AND (1) C TANK

**REMARKS**

ENGINE(S): (2) J79-GE-17  
 ICAD STANDARD DAY

**GUIDE**

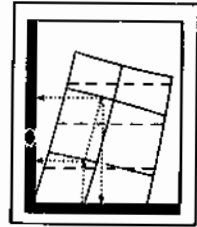

DATE: 1 FEBRUARY 1973  
 DATA BASIS: FLIGHT TEST

FUEL GRADE: JP-4  
 FUEL DENSITY: 6.5 LB/GAL

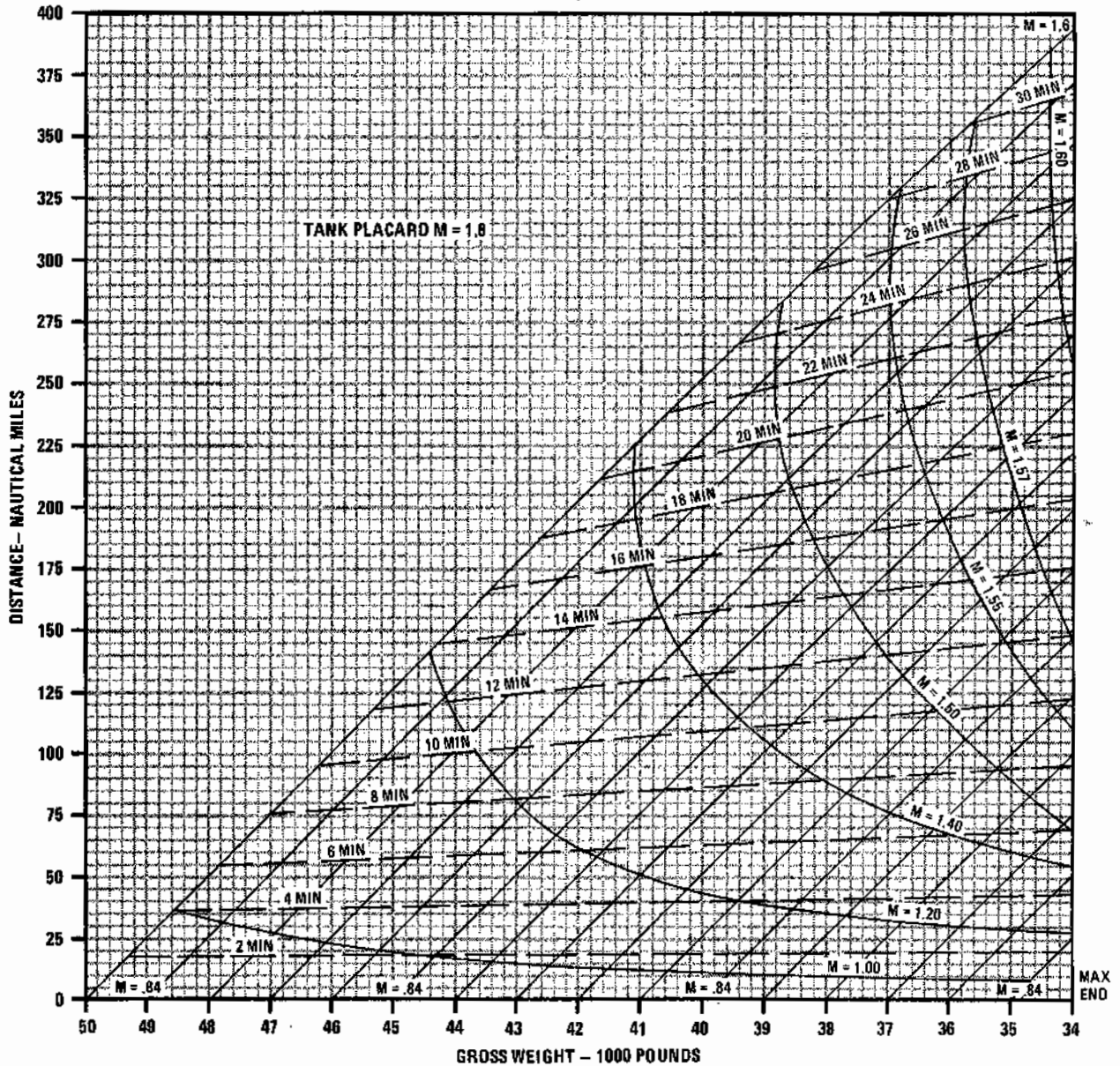

4E-1-(429)

Figure A9-52



**F-4E**

**MILITARY THRUST ACCELERATION**

**15,000 FEET**

**AIRPLANE CONFIGURATION**

(4) AIM-7

**REMARKS**  
ENGINE(S): (2) J79-GE-17  
ICAO STANDARD DAY

GUIDE



DATE: 1 FEBRUARY 1973  
DATA BASIS: FLIGHT TEST

FUEL GRADE: JP-4  
FUEL DENSITY: 6.5 LB/GAL

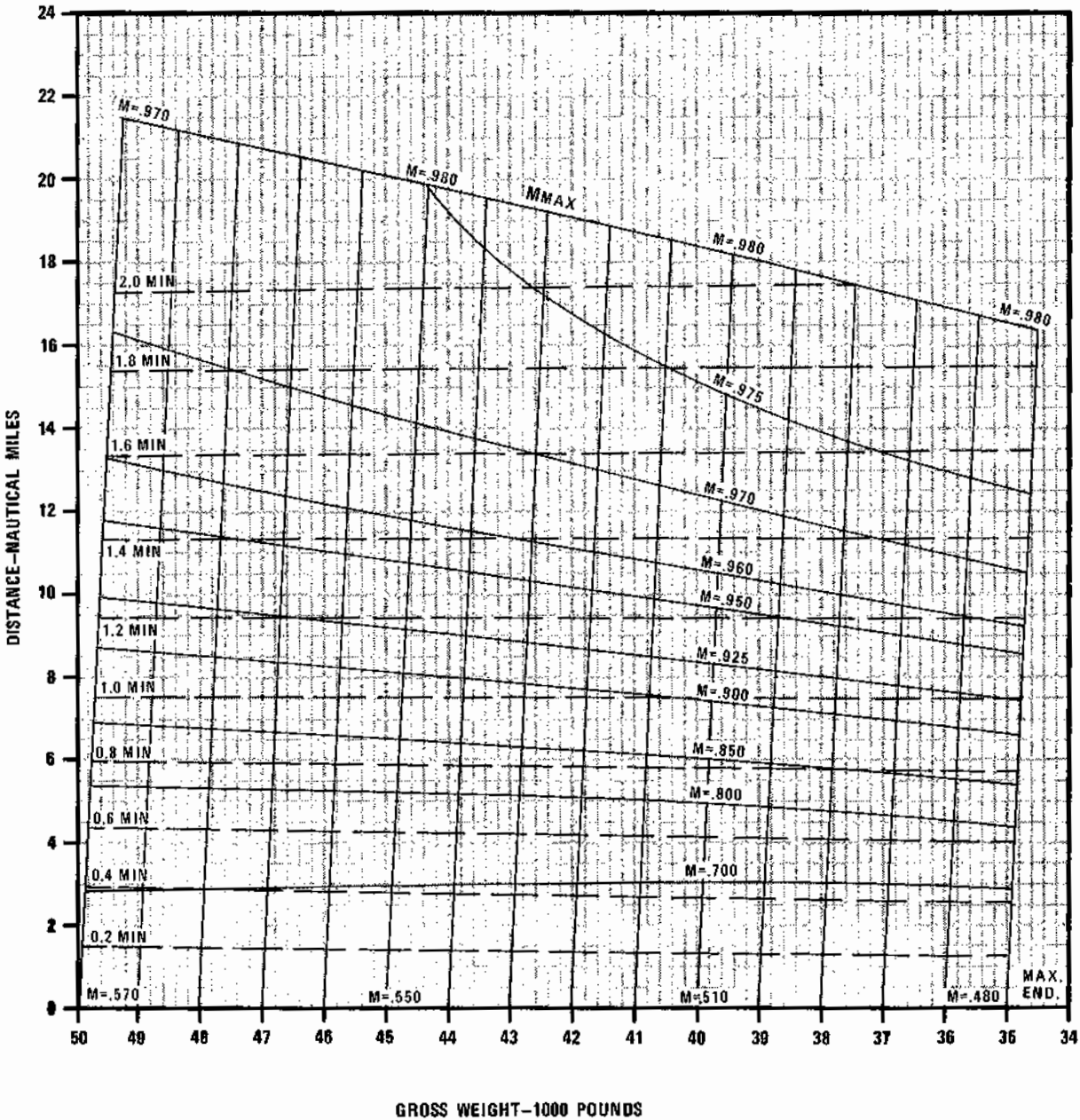

Figure A9-53

**F-4E**

**MILITARY THRUST ACCELERATION**

**25,000 FEET**

**AIRPLANE CONFIGURATION**  
(4) AIM-7

**REMARKS**  
ENGINES(S): (2) J79-GE-17  
ICAO STANDARD DAY

**GUIDE**

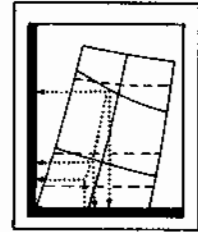

DATE: 1 FEBRUARY 1973  
DATA BASIS: FLIGHT TEST

FUEL GRADE: JP-4  
FUEL DENSITY: 6.6 LB/GAL.

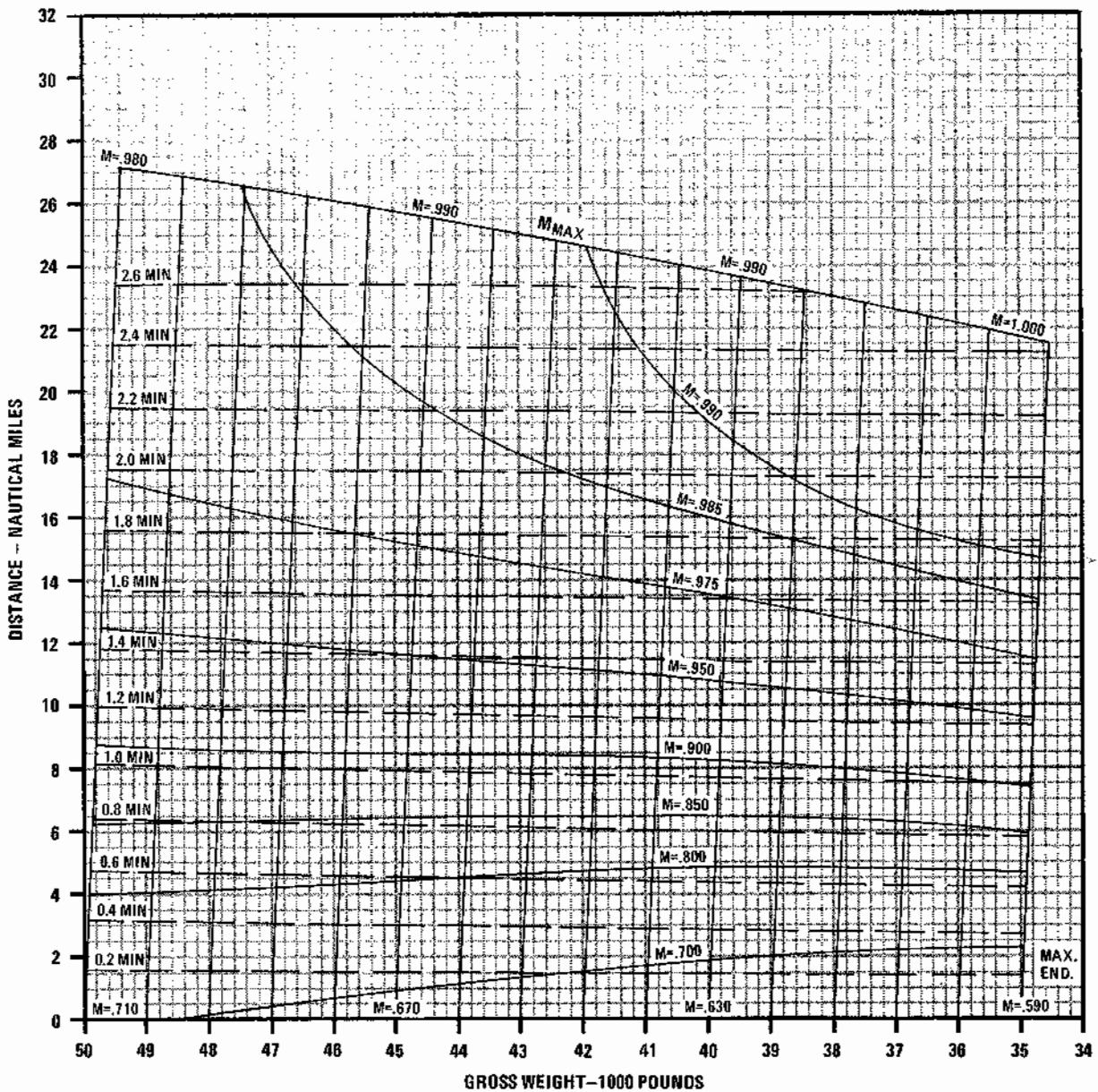

Figure A9-54

**F-4E**

**MILITARY THRUST ACCELERATION**  
**35,000 FEET**

AIRPLANE CONFIGURATION  
 (4) AIM-7

REMARKS  
 ENGINE(S): (2) J79-GE-17  
 ICAO STANDARD DAY

GUIDE

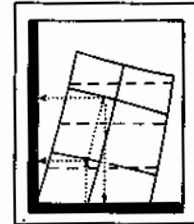

DATE: 1 FEBRUARY 1973  
 DATA BASIS: FLIGHT TEST

FUEL GRADE: JP-4  
 FUEL DENSITY: 6.5 LB/GAL

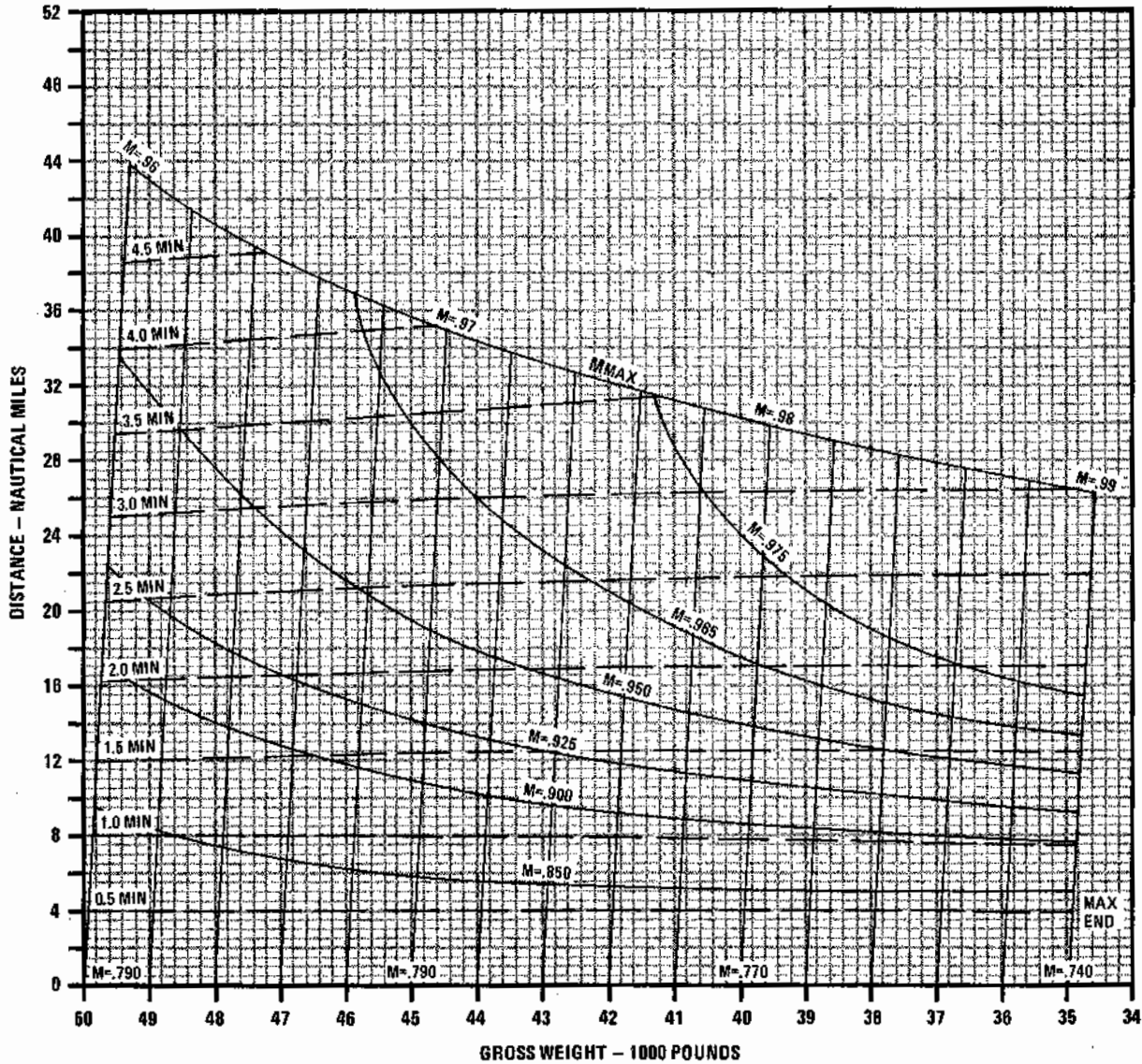

Figure A9-55

**F-4E**

**MILITARY THRUST ACCELERATION**

**15,000 FEET**

AIRPLANE CONFIGURATION  
(1) 9-28

REMARKS  
ENGINE(S): (2) J79-GE-17  
ICAO STANDARD DAY

GUIDE

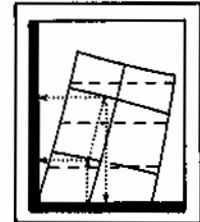

FUEL GRADE: JP-4  
FUEL DENSITY: 6.5 LB/GAL

DATE: 1 FEBRUARY 1973  
DATA BASIS: FLIGHT TEST

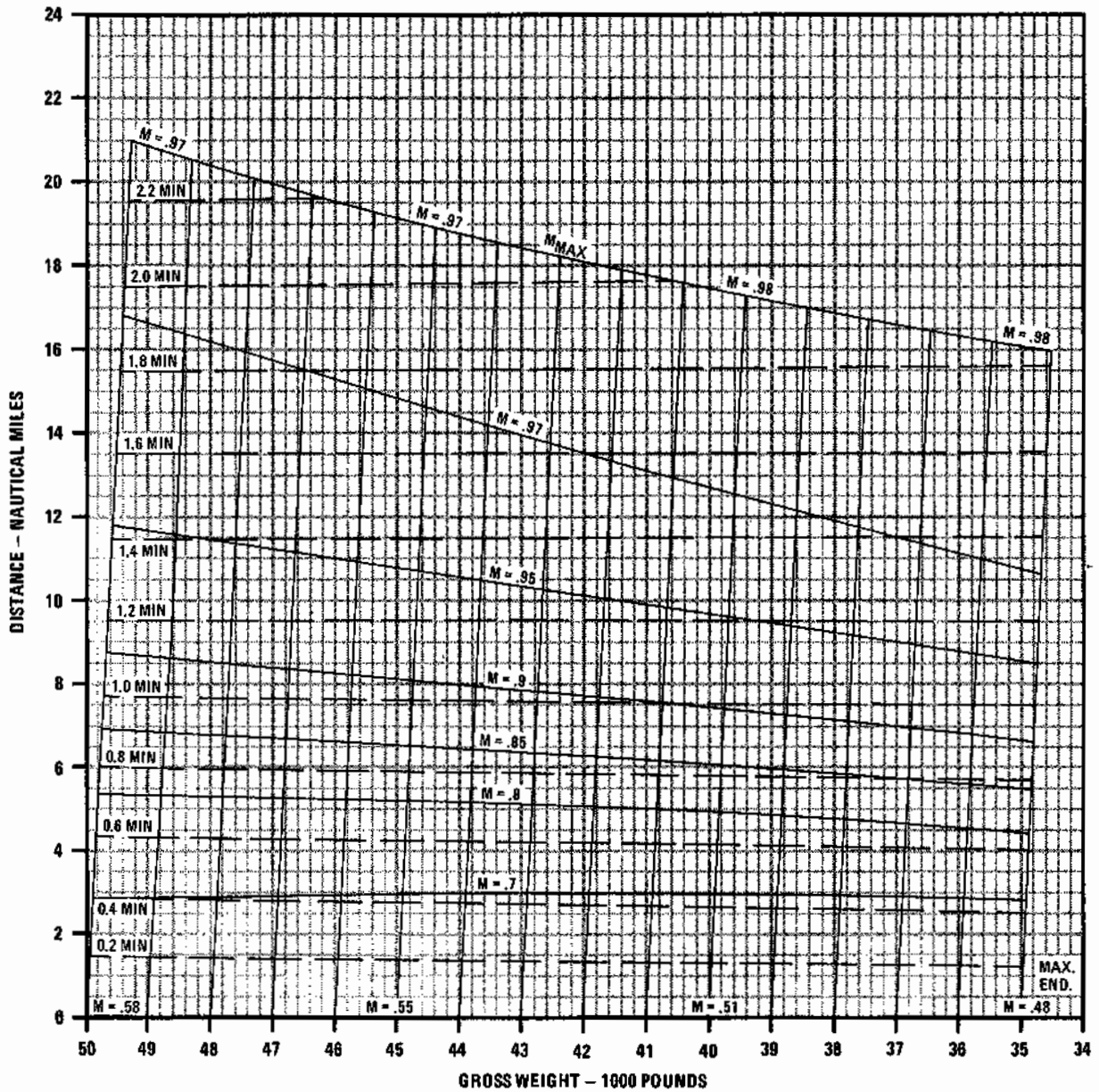

Figure A9-56



**F-4E**

**MILITARY THRUST ACCELERATION**

**35,000 FEET**

**AIRPLANE CONFIGURATION**

(1) B 28

**REMARKS**

ENGINE(S): (2) J79-GE-17  
ICAO STANDARD DAY

GUIDE



DATE: 1 FEBRUARY 1973  
DATA BASIS: FLIGHT TEST

FUEL GRADE: JP-4  
FUEL DENSITY: 6.5 LB/GAL

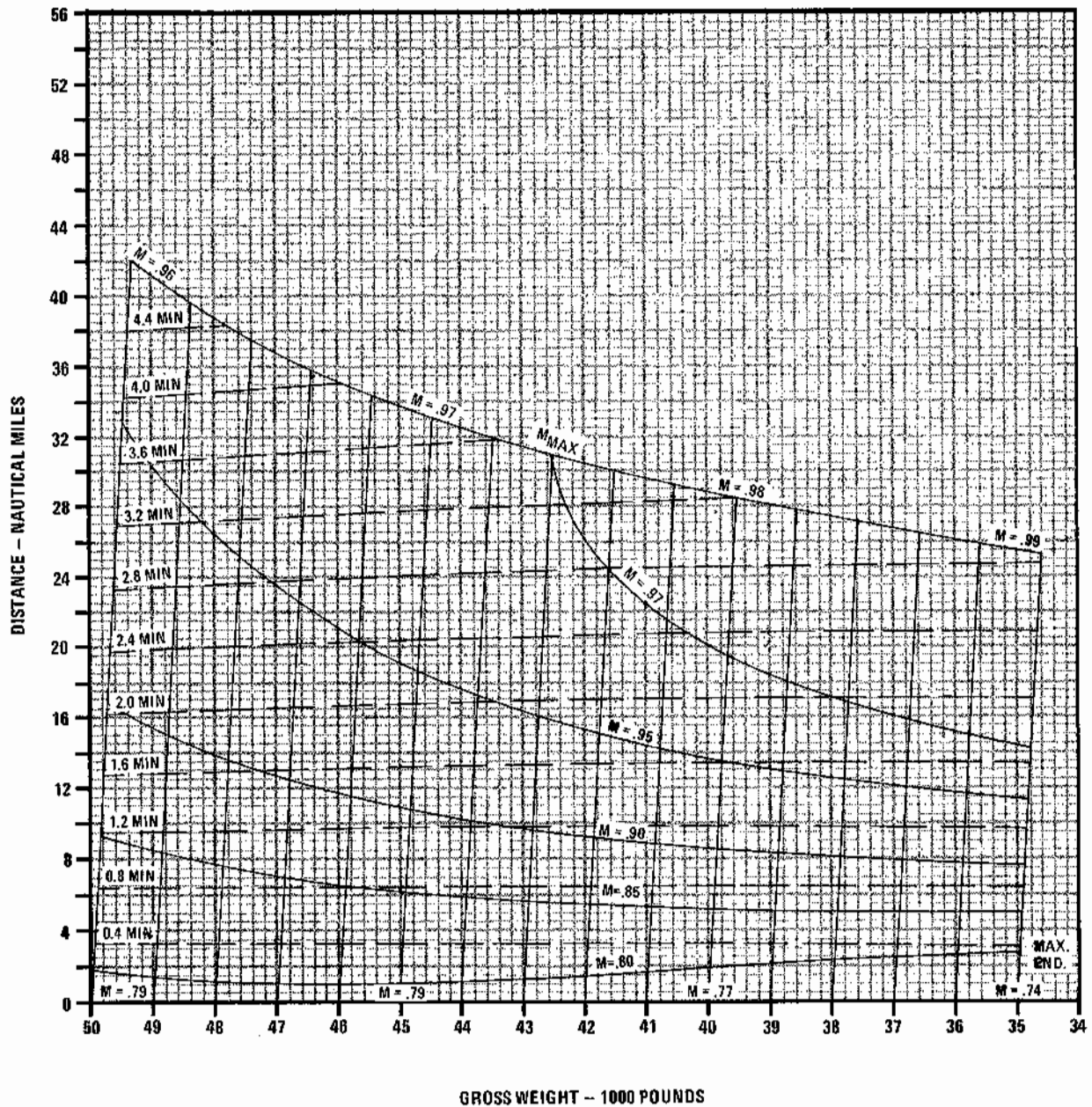

Figure A9-58

**F-4E**

**MILITARY THRUST ACCELERATION**

**15,000 FEET**

AIRPLANE CONFIGURATION  
 (4) AIM-7 AND (4) AIM-4D

REMARKS  
 ENGINE(S): (2) J79-GE-17  
 ICAO STANDARD DAY

GUIDE

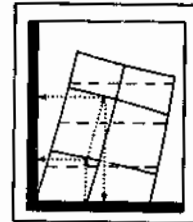

FUEL GRADE: JP-4  
 FUEL DENSITY: 6.5 LB/GAL

DATE: 1 FEBRUARY 1973  
 DATA BASIS: FLIGHT TEST

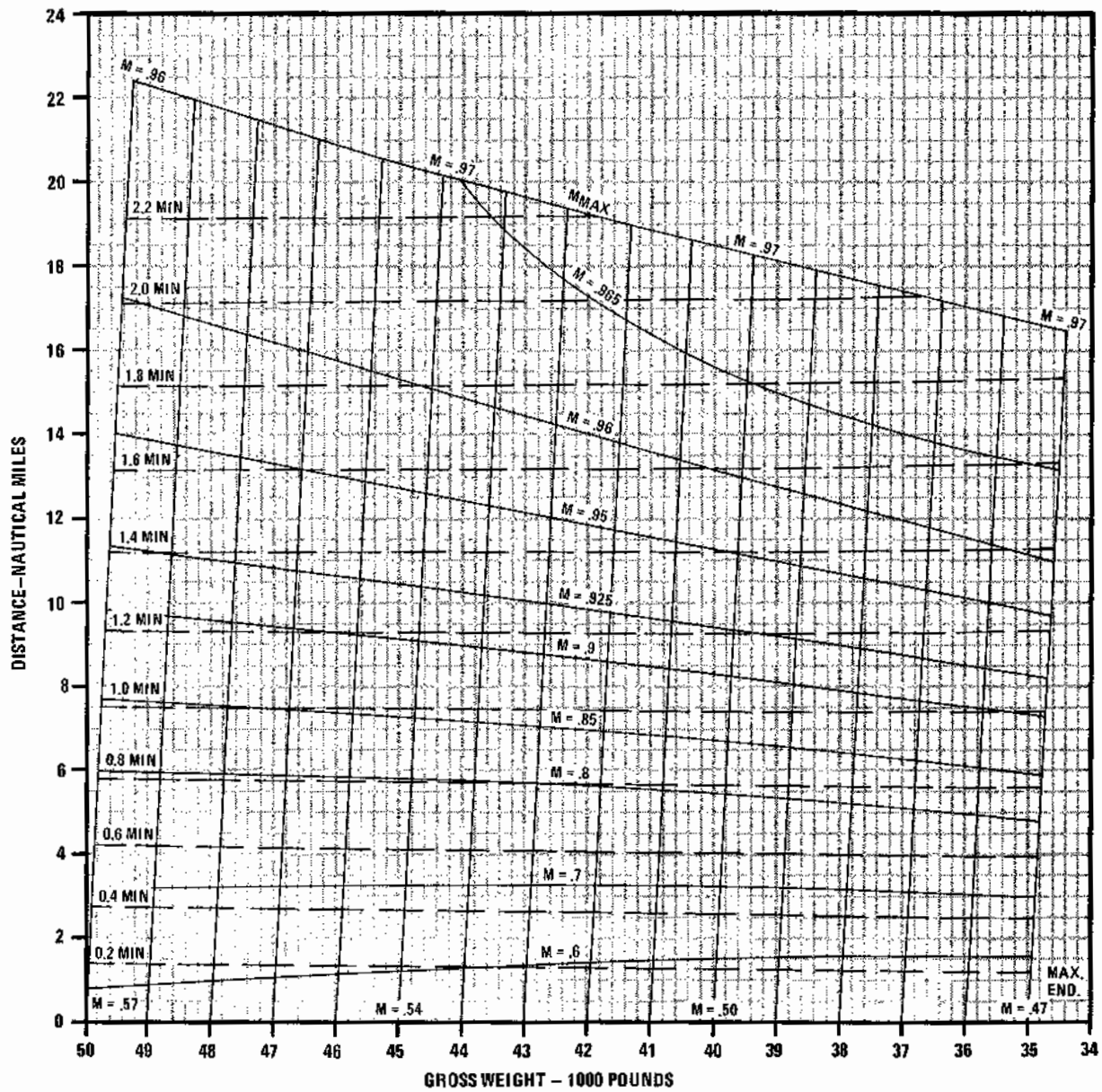

Figure A9-59





**F-4E**

**MILITARY THRUST ACCELERATION**

**35,000 FEET**

**AIRPLANE CONFIGURATION**  
(4) AIM-7 AND (4) AIM-4D

**REMARKS**  
ENGINE(S): (2) J79-GE-17  
ICAO STANDARD DAY

GUIDE



DATE: 1 FEBRUARY 1973  
DATA BASIS: FLIGHT TEST

FUEL GRADE: JP-4  
FUEL DENSITY: 6.5 LB/GAL

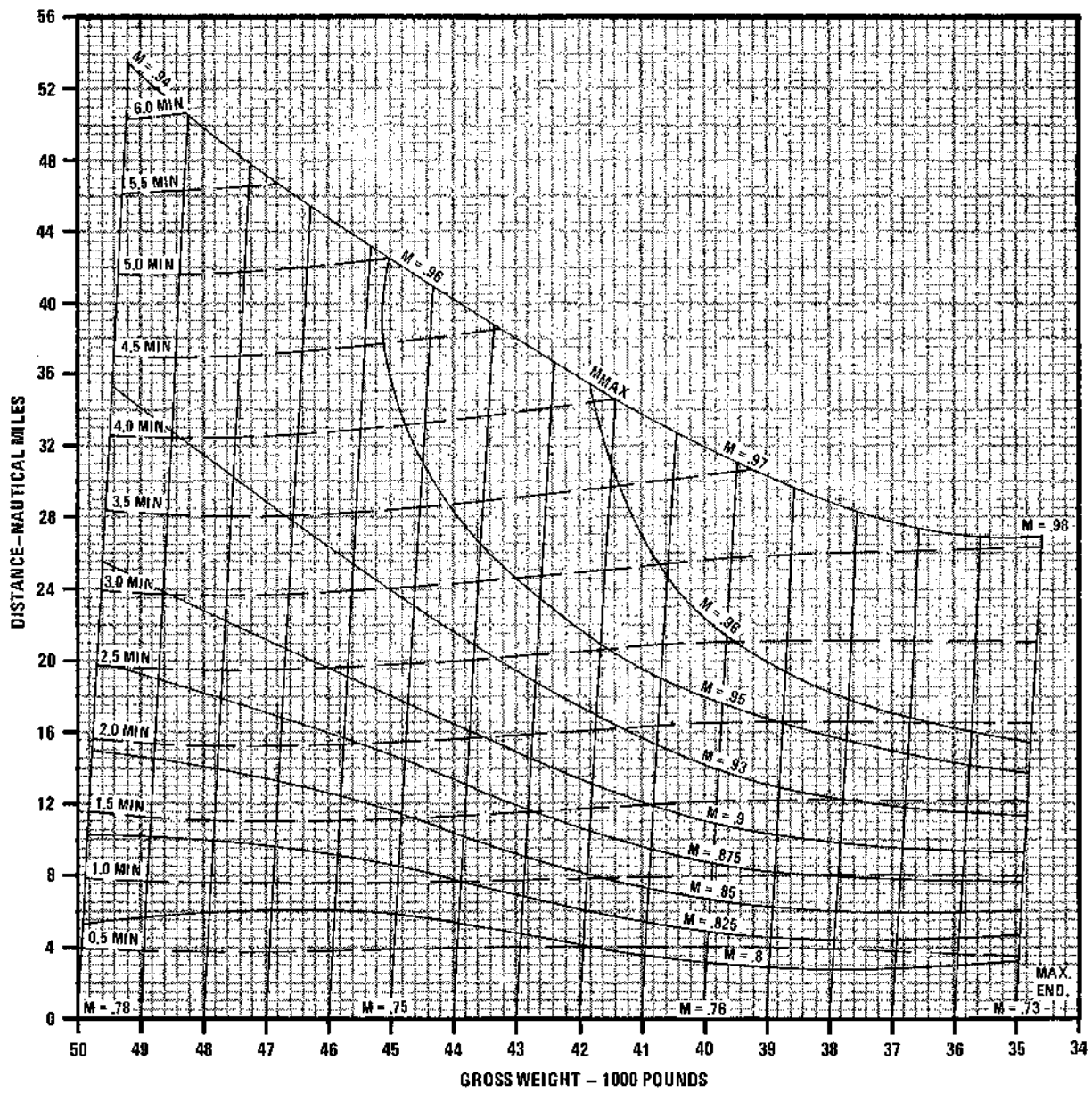

Figure A9-61

**F-4E**

# MILITARY THRUST ACCELERATION 15,000 FEET

**AIRPLANE CONFIGURATION**  
(4) AIM-7 AND (1) Q TANK

**REMARKS**  
ENGINE(S): (2) J79-GE-17  
ICAO STANDARD DAY

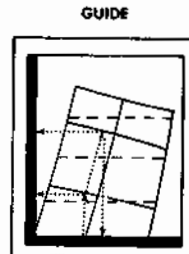

DATE: 1 FEBRUARY 1973  
DATA BASIS: FLIGHT TEST

FUEL GRADE: JP-4  
FUEL DENSITY: 6.5 LB/GAL

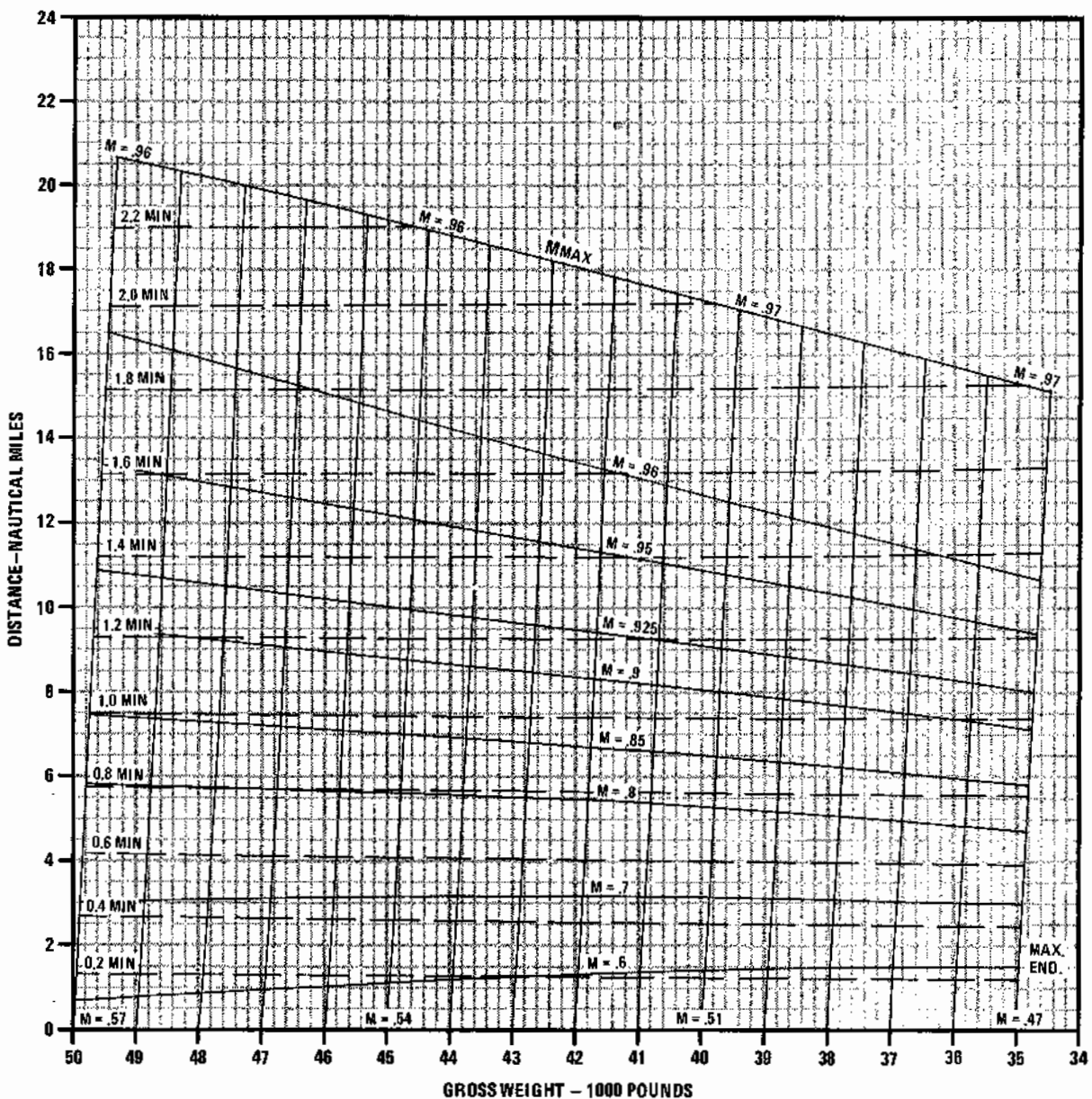

4E-1-(439)

Figure A9-62

**F-4E**

**MILITARY THRUST ACCELERATION**

**25,000 FEET**

**AIRPLANE CONFIGURATION**  
(4) AIM-7 AND (1)  $\xi$  TANK

**REMARKS**  
ENGINE(S): (2) J79-GE-17  
ICAO STANDARD DAY

**GUIDE**

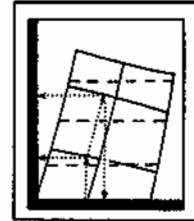

FUEL GRADE: JP-4  
FUEL DENSITY: 6.5 LB/GAL

DATE: 1 FEBRUARY 1973  
DATA BASIS: FLIGHT TEST

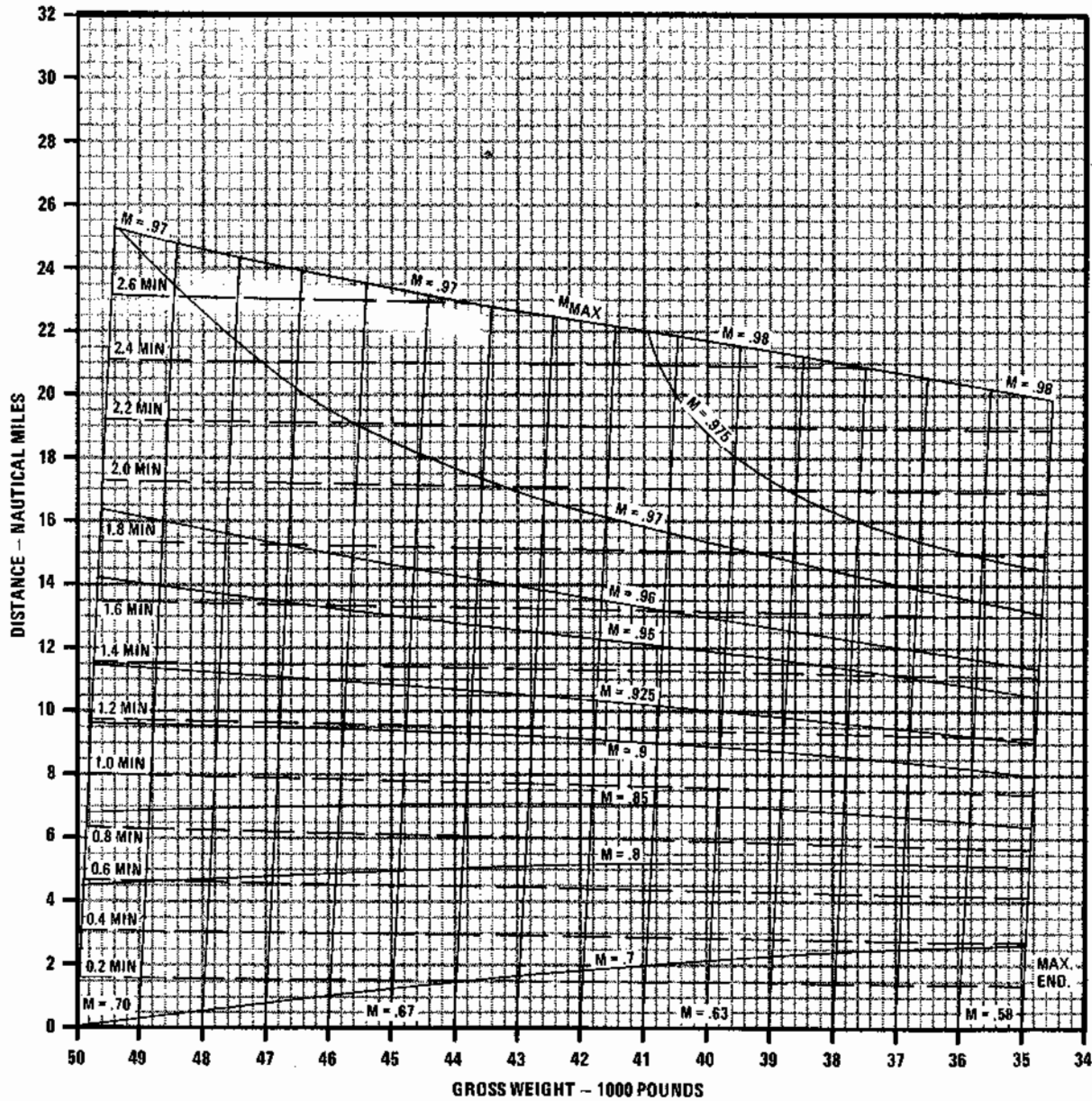

Figure A9-63

**F-4E**

**MILITARY THRUST ACCELERATION**

**35,000 FEET**

**AIRPLANE CONFIGURATION**  
 (4) AIM-7 AND (1) TANK

**REMARKS**  
 ENGINE(S): (2) J79-GE-17  
 ICAO STANDARD DAY

GUIDE

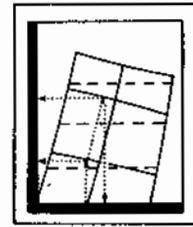

FUEL GRADE: JP-4

FUEL DENSITY: 6.5 LB/GAL

DATE: 1 FEBRUARY 1973  
 DATA BASIS: FLIGHT TEST

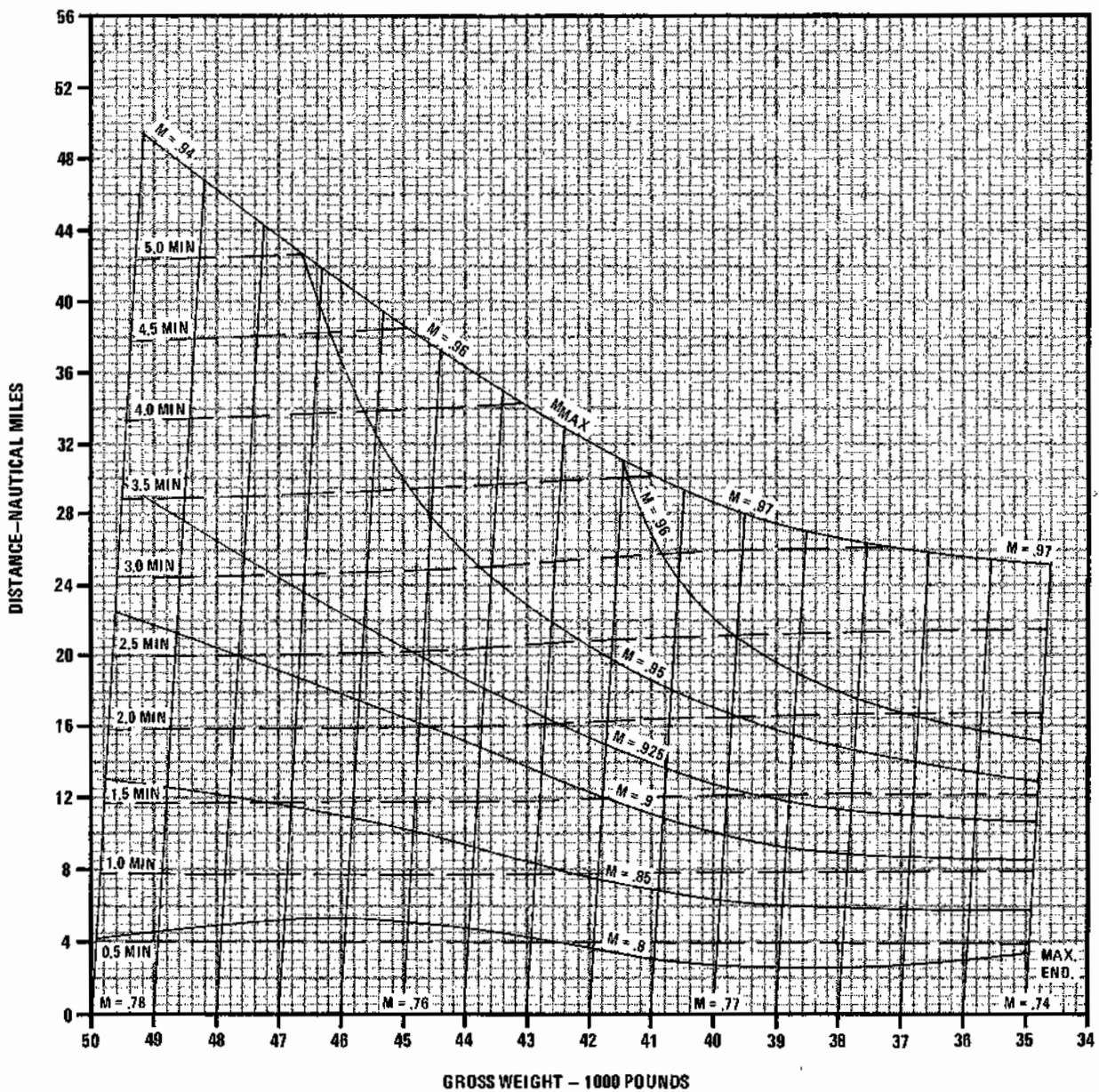

4E-1-(441)

Figure A9-64

**F-4E**

# MILITARY THRUST ACCELERATION

15,000 FEET

AIRPLANE CONFIGURATION  
(4) AIM-7 AND (2) WING TANKS

REMARKS  
ENGINE(S): (2) J79-GE-17  
ICAO STANDARD DAY

GUIDE

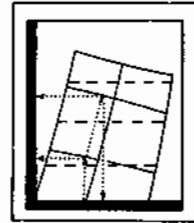

DATE: 1 FEBRUARY 1973  
DATA BASIS: FLIGHT TEST

FUEL GRADE: JP-4  
FUEL DENSITY: 6.5 LB/GAL

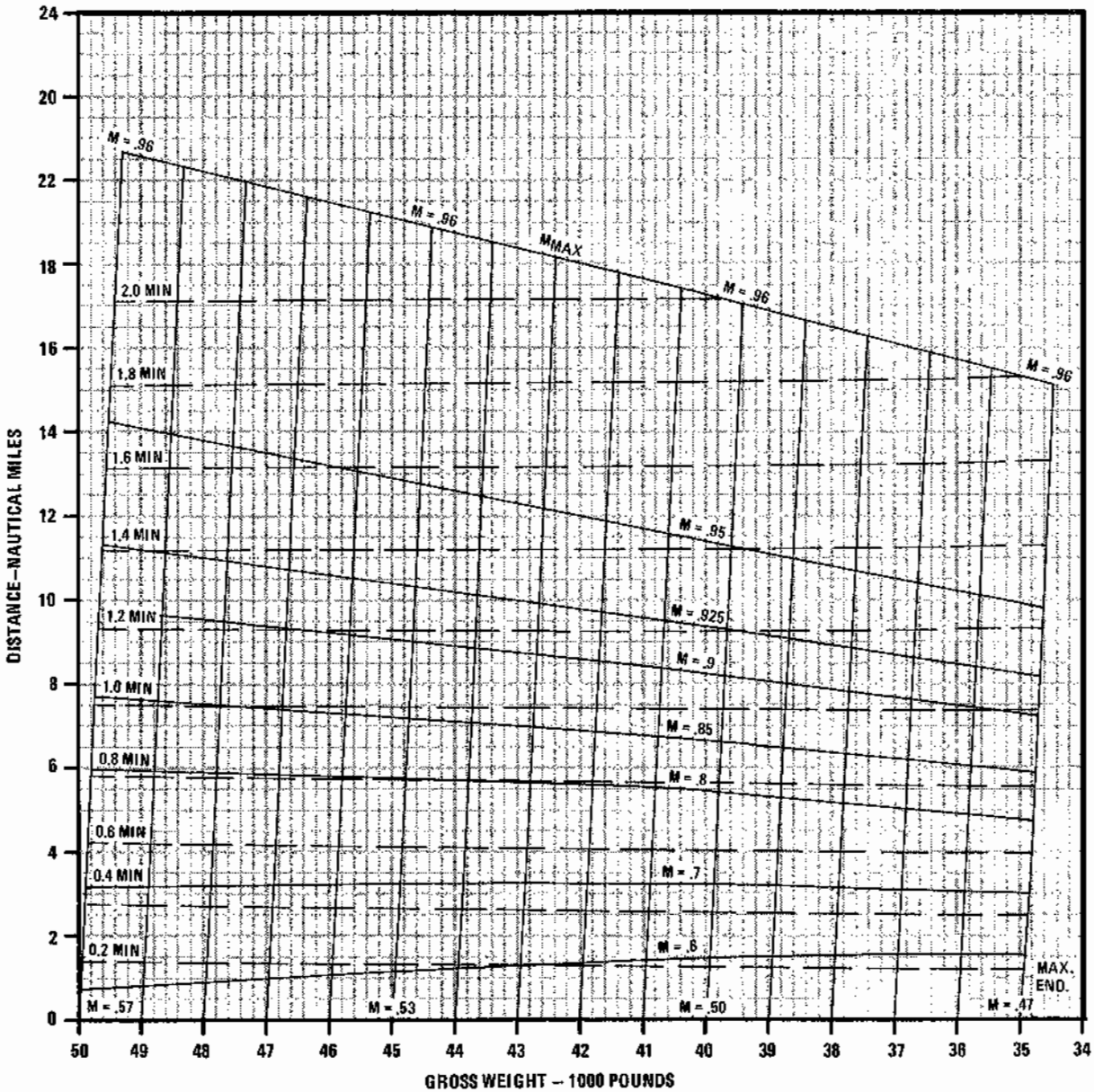

Figure A9-65

**F-4E**

**MILITARY THRUST ACCELERATION  
25,000 FEET**

**AIRPLANE CONFIGURATION**  
(4) AIM-7 AND (2) WING TANKS

**REMARKS**  
ENGINE(S): (2) J79-GE-17  
ICAO STANDARD DAY

GUIDE



DATE: 1 FEBRUARY 1973  
DATA BASIS: FLIGHT TEST

FUEL GRADE: JP-4  
FUEL DENSITY: 6.5 LB/GAL

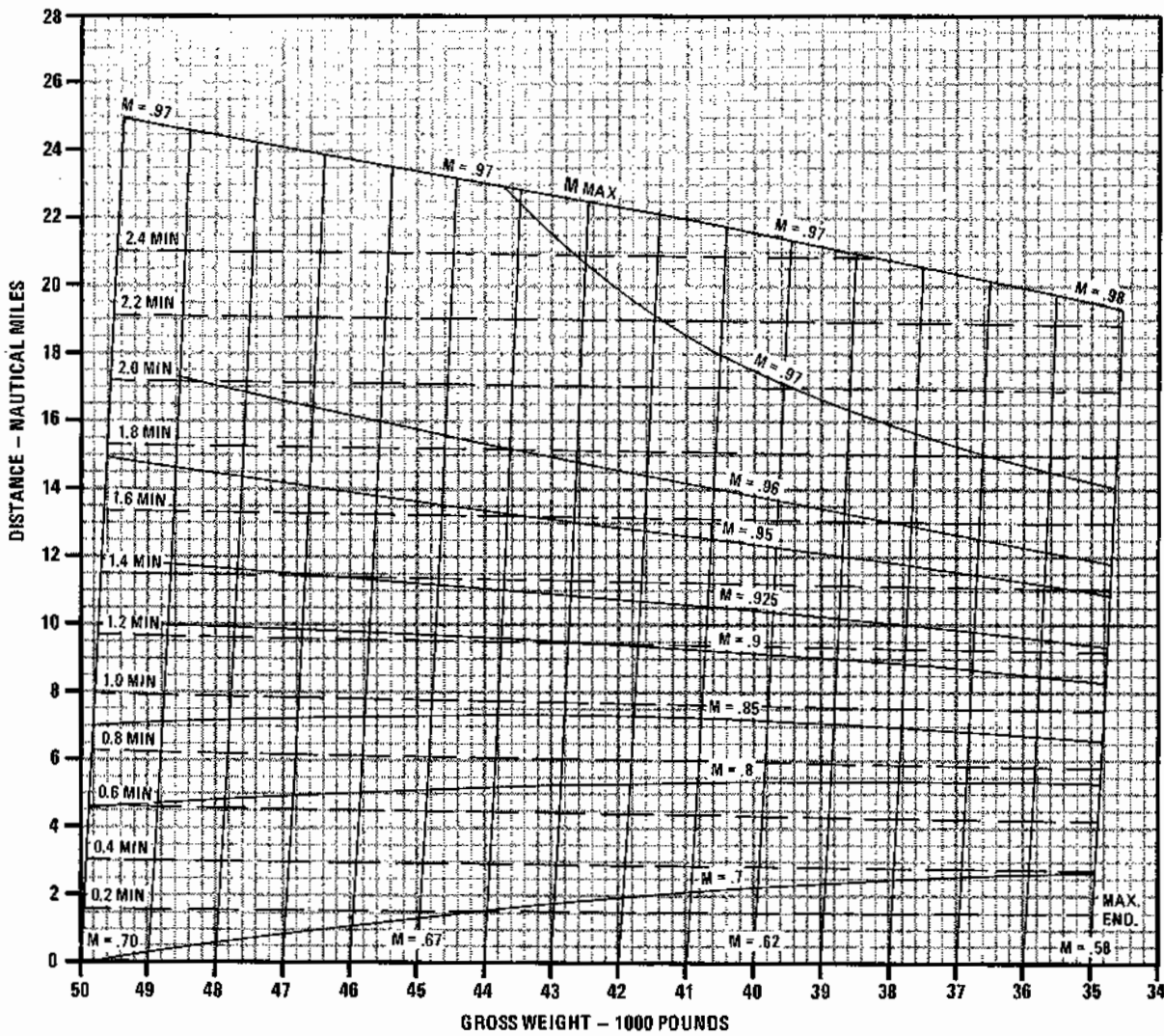

Figure A9-66

# F-4E

## MILITARY THRUST ACCELERATION

### 35,000 FEET

**AIRPLANE CONFIGURATION**  
 (4) AIM-7 AND (2) WING TANKS

**REMARKS**  
 ENGINE(S): (2) J79-GE-17  
 ICAO STANDARD DAY

GUIDE

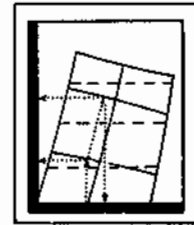

DATE: 1 FEBRUARY 1973  
 DATA BASIS: FLIGHT TEST

FUEL GRADE: JP-4  
 FUEL DENSITY: 6.5 LB/GAL

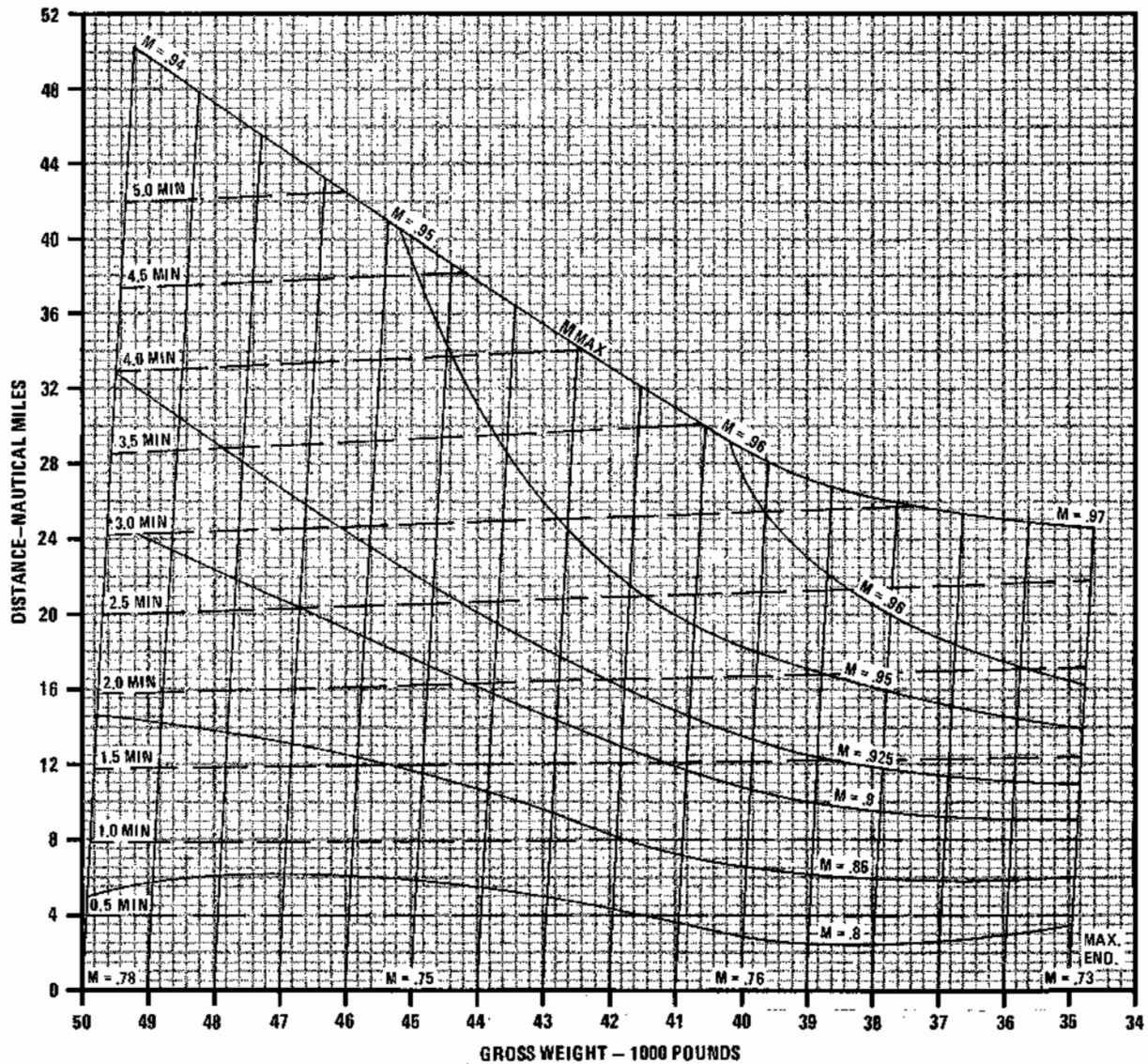

Figure A9-67

**F-4E**

**MILITARY THRUST ACCELERATION**

**15,000 FEET**

**AIRPLANE CONFIGURATION**  
(1) B-28 AND (2) WING TANKS

**REMARKS**  
ENGINE(S): (2) J79-GE-17  
ICAO STANDARD DAY

GUIDE



DATE: 1 FEBRUARY 1973  
DATA BASIS: FLIGHT TEST

FUEL GRADE: JP-4  
FUEL DENSITY: 6.5 LB/GAL

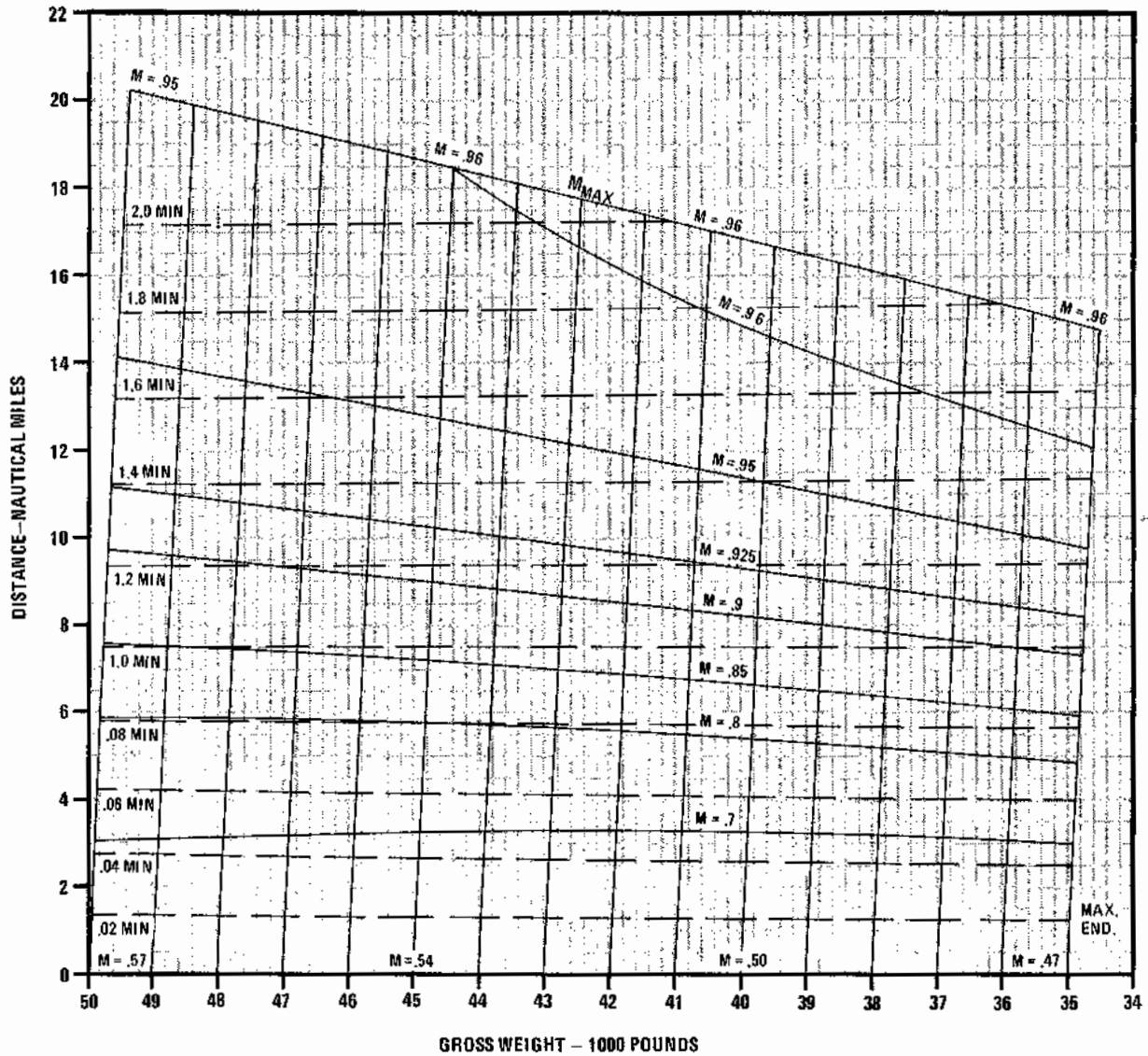

Figure A9-68



**F-4E**

# MILITARY THRUST ACCELERATION

25,000 FEET

**AIRPLANE CONFIGURATION**  
(1) B-28 AND (2) WING TANKS

**REMARKS**  
ENGINE(S): (2) J79-GE-17  
ICAO STANDARD DAY

GUIDE

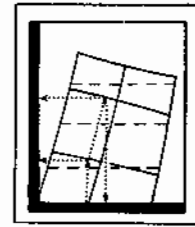

DATE: 1 FEBRUARY 1973  
DATA BASIS: FLIGHT TEST

FUEL GRADE: JP-4  
FUEL DENSITY: 6.5 LB/GAL

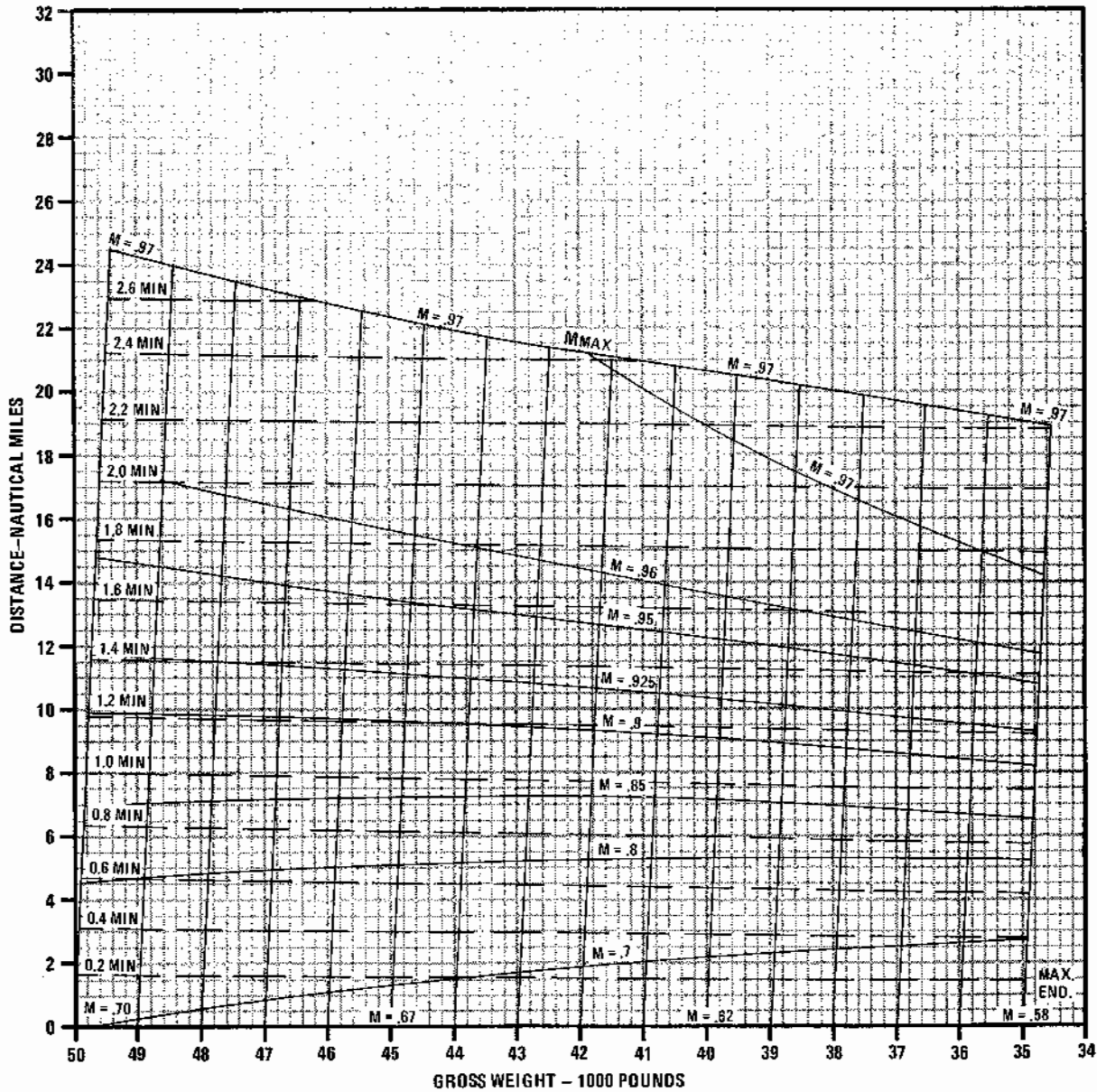

Figure A9-69

**F-4E**

**MILITARY THRUST ACCELERATION**

**35,000 FEET**

**AIRPLANE CONFIGURATION**

(1) B-28 AND (2) WING TANKS

**REMARKS**

ENGINE(S): (2) J79-GE-17  
ICAO STANDARD DAY

GUIDE

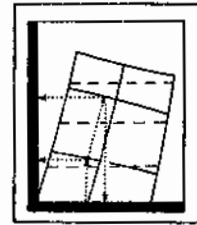

DATE: 1 FEBRUARY 1973  
DATA BASIS: FLIGHT TEST

FUEL GRADE: JP-4  
FUEL DENSITY: 6.5 LB/GAL

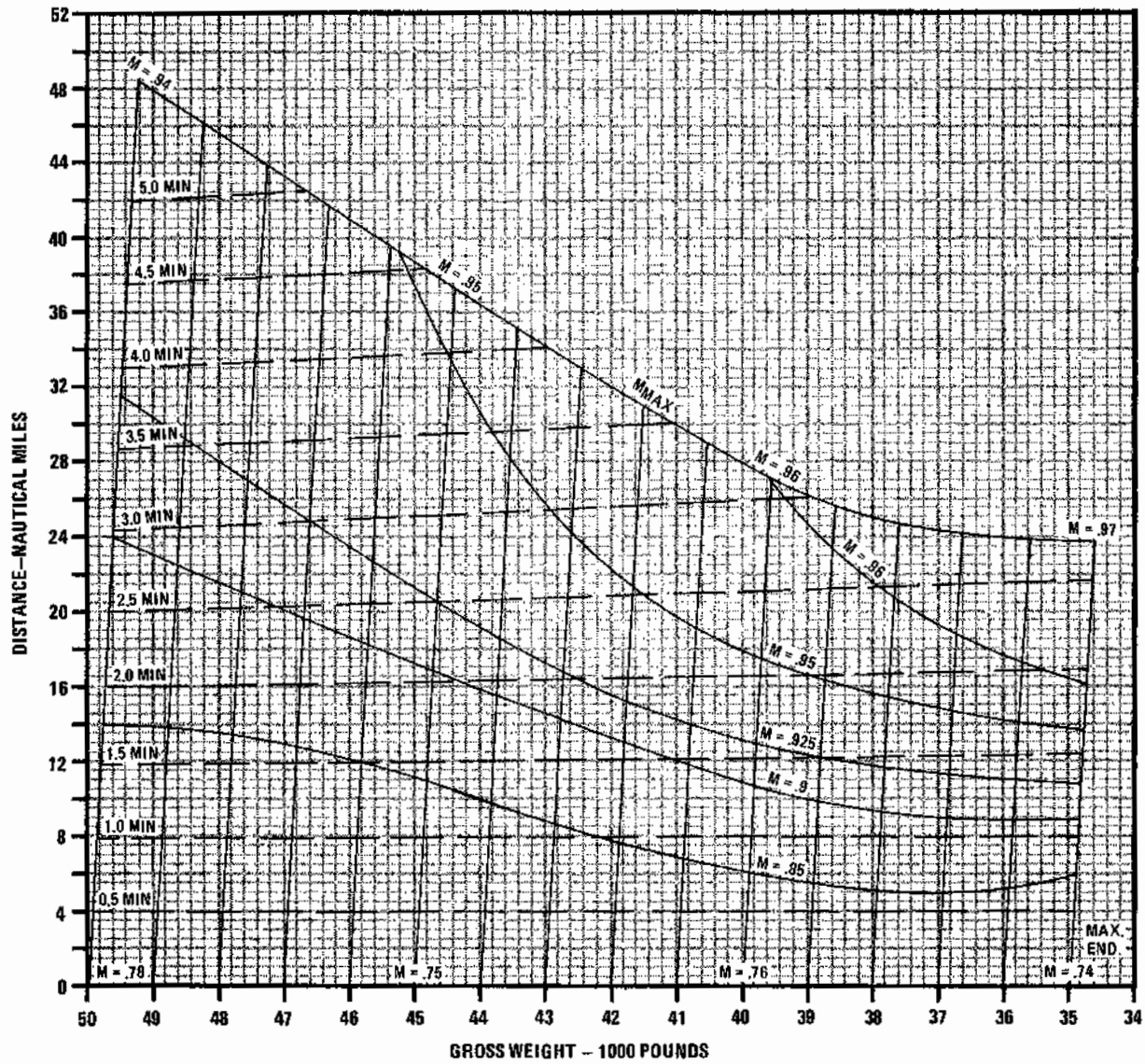

4E-1-(447)

Figure A9-70

# F-4E

## MILITARY THRUST ACCELERATION

### 15,000 FEET

**AIRPLANE CONFIGURATION**  
 (4) AIM-7, (1) Q TANK AND  
 (2) WING TANKS

**REMARKS**  
 ENGINE(S): (2) J79-GE-17  
 ICAO STANDARD DAY

GUIDE

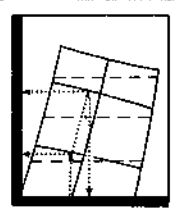

FUEL GRADE: JP-4  
 FUEL DENSITY: 6.5 LB/GAL

DATE: 1 FEBRUARY 1973  
 DATA BASIS: FLIGHT TEST

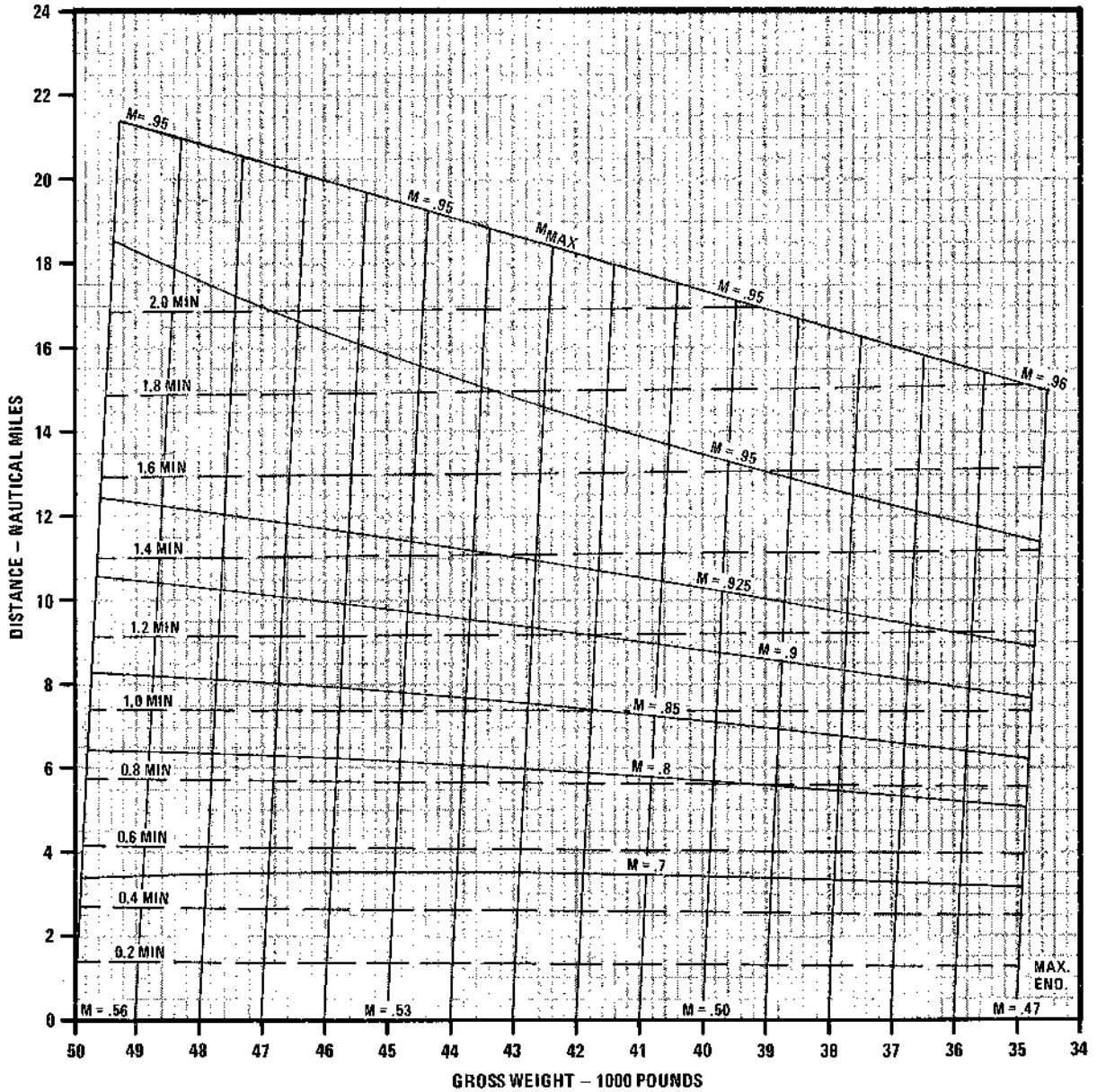

Figure A9-71

**F-4E**

**MILITARY THRUST ACCELERATION**

**25,000 FEET**

**AIRPLANE CONFIGURATION**

(4) AIM-7, (1) Q TANK  
AND (2) WING TANKS

**REMARKS**

ENGINE(S): (2) J79-GE-17  
ICAO STANDARD DAY

GUIDE

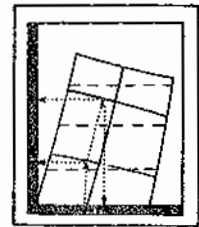

DATE: 1 FEBRUARY 1973  
DATA BASIS: FLIGHT TEST

FUEL GRADE: JP-4  
FUEL DENSITY: 6.5 LB/GAL

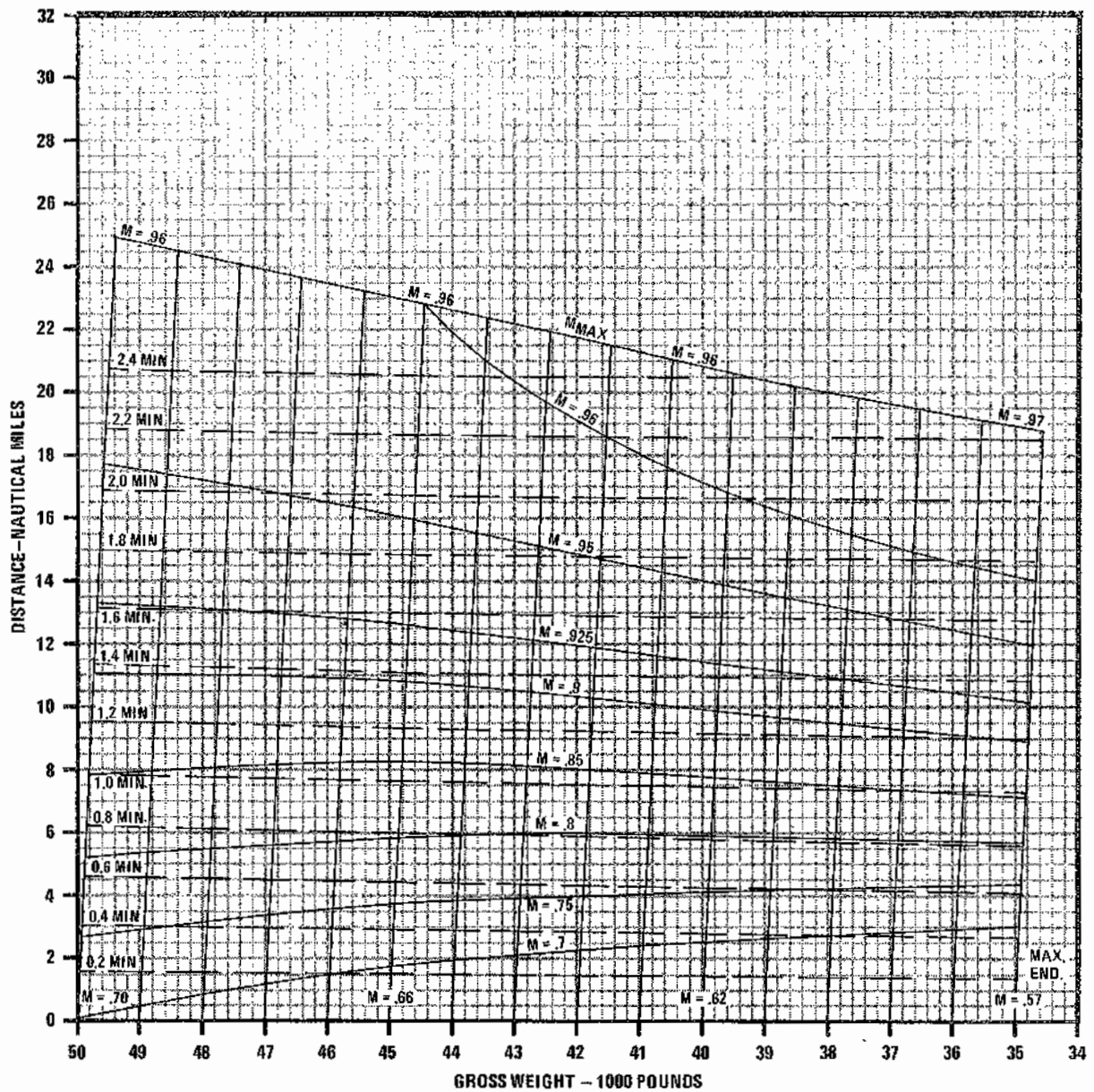

4E-1-(449)

Figure A9-72

**F-4E**

**MILITARY THRUST ACCELERATION**

**35,000 FEET**

**AIRPLANE CONFIGURATION**

(4) AIM-7, (1) G TANK  
AND (2) WING TANKS

**REMARKS**

ENGINE(S): (2) J79-GE-17  
ICAO STANDARD DAY

**GUIDE**



FUEL GRADE: JP-4  
FUEL DENSITY: 6.5 LB/GAL

DATE: 1 FEBRUARY 1973  
DATA BASIS: FLIGHT TEST

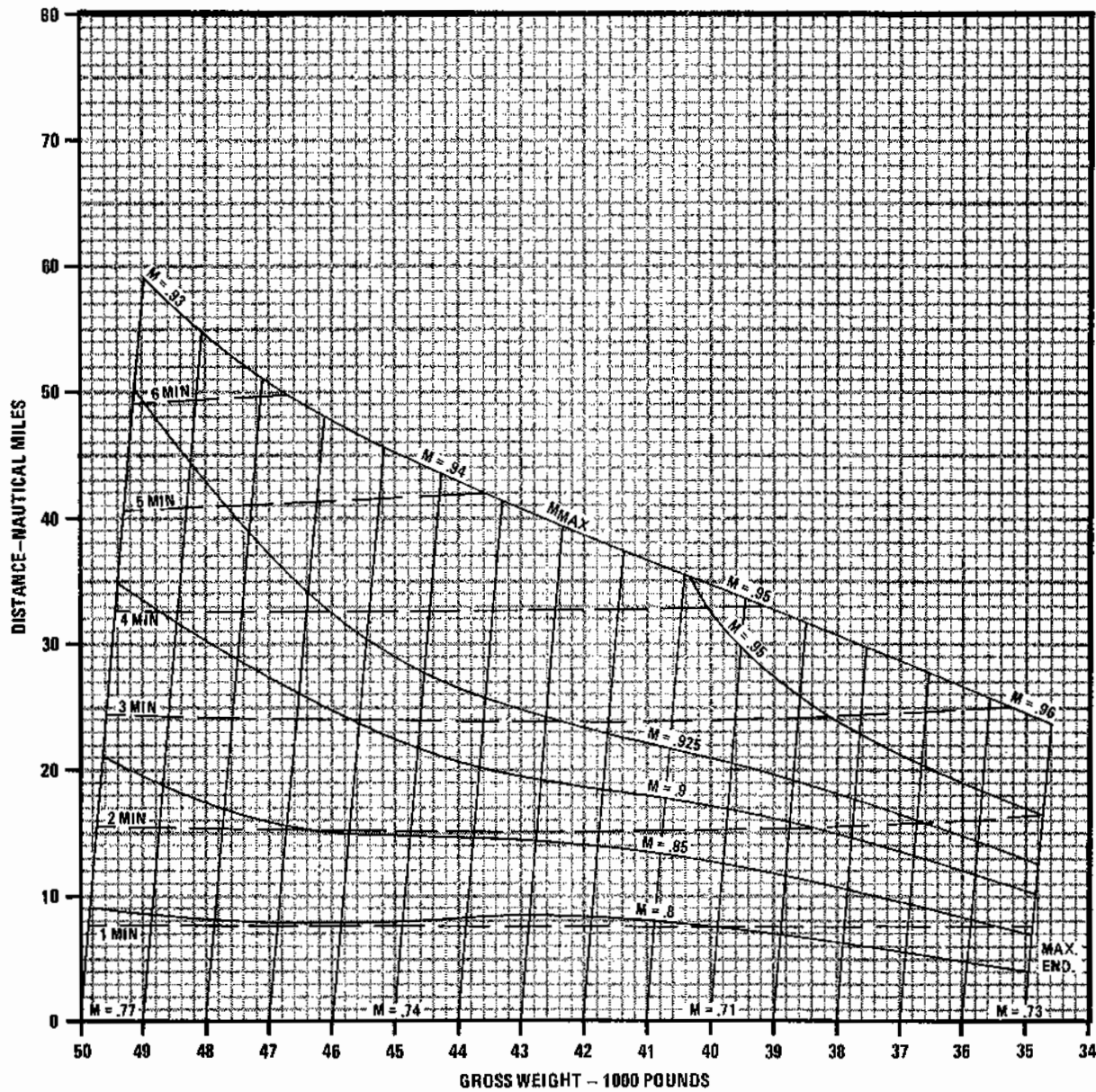

Figure A9-73

**F-4E**

# MILITARY THRUST ACCELERATION

**15,000 FEET**

**AIRPLANE CONFIGURATION**

(4) AIM-7, (4) AIM-40  
AND (1) Q TANK

**REMARKS**

ENGINE(S): (2) J79-GE-17  
ICAO STANDARD DAY

GUIDE



FUEL GRADE: JP-4  
FUEL DENSITY: 6.5 LB/GAL

DATE: 1 FEBRUARY 1973  
DATA BASIS: FLIGHT TEST

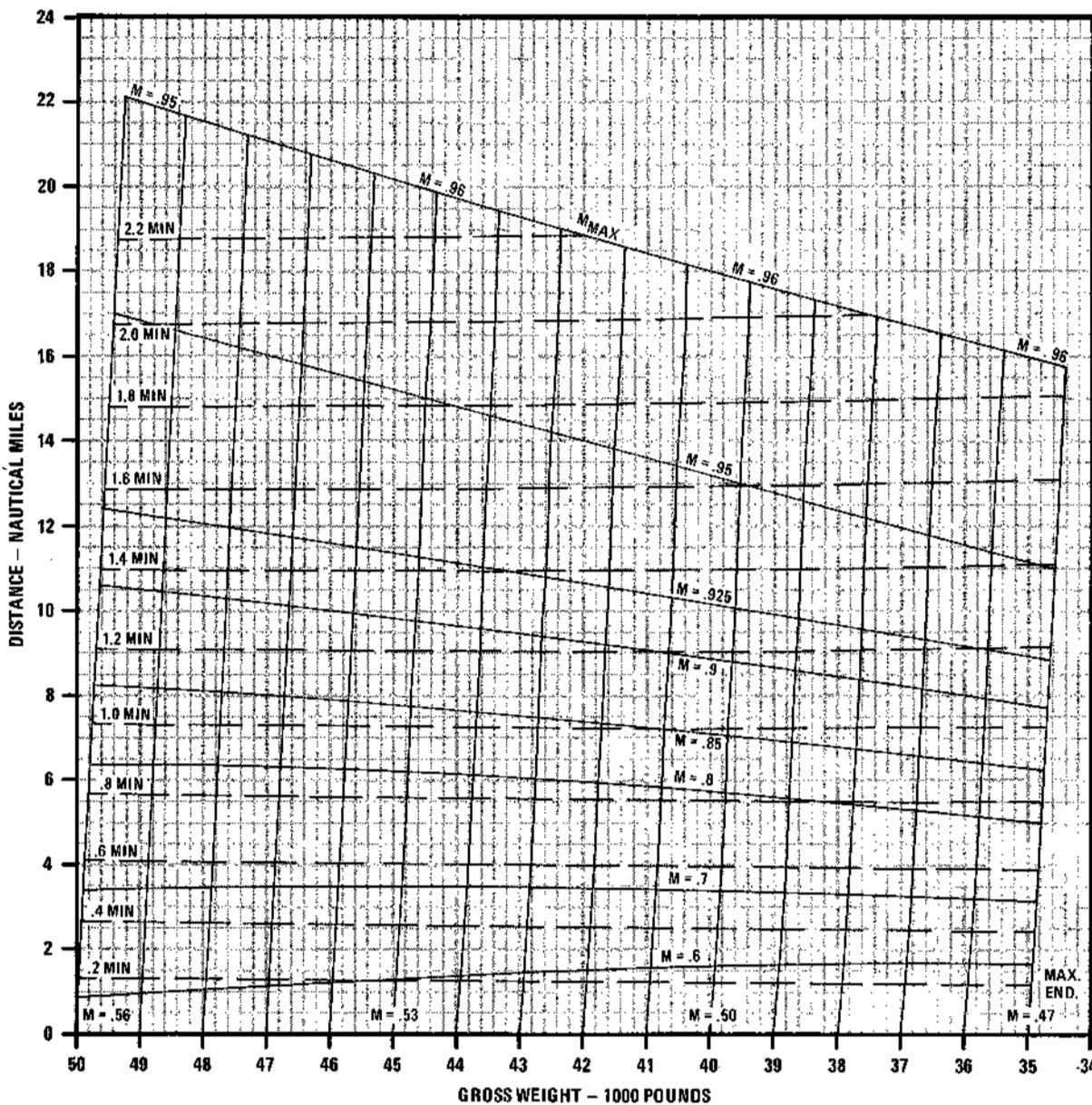

4E-1-(451)

Figure A9-74

**F-4E**  
**MILITARY THRUST ACCELERATION**  
**25,000 FEET**

**AIRPLANE CONFIGURATION**  
 (4) AIM-7, (4) AIM-4D  
 AND (1) TANK

**REMARKS**  
 ENGINE(S): (2) J79-GE-17  
 ICAO STANDARD DAY

GUIDE

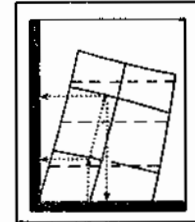

DATE: 1 FEBRUARY 1973  
 DATA BASIS: FLIGHT TEST

FUEL GRADE: JP-4  
 FUEL DENSITY: 6.5 LB/GAL

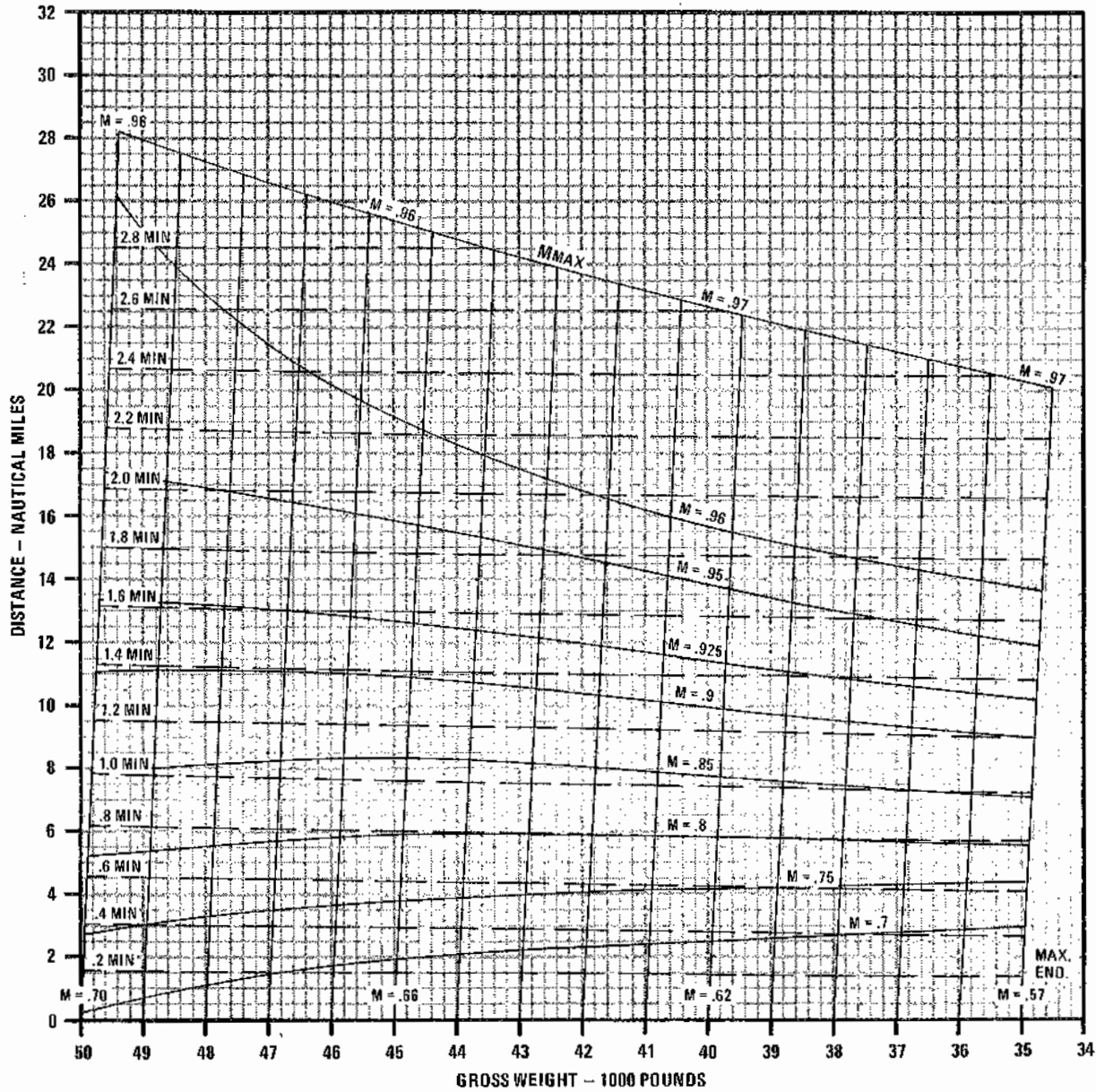

Figure A9-75

**F-4E**

# MILITARY THRUST ACCELERATION

**35,000 FEET**

**AIRPLANE CONFIGURATION**

(4) AIM-7, (4) AIM-40  
AND (1) Q TANK

**REMARKS**  
ENGINE(S): (2) J79-GE-17  
ICAO STANDARD DAY

GUIDE



DATE: 1 FEBRUARY 1973  
DATA BASIS: FLIGHT TEST

FUEL GRADE: JP-4  
FUEL DENSITY: 6.5 LB/GAL

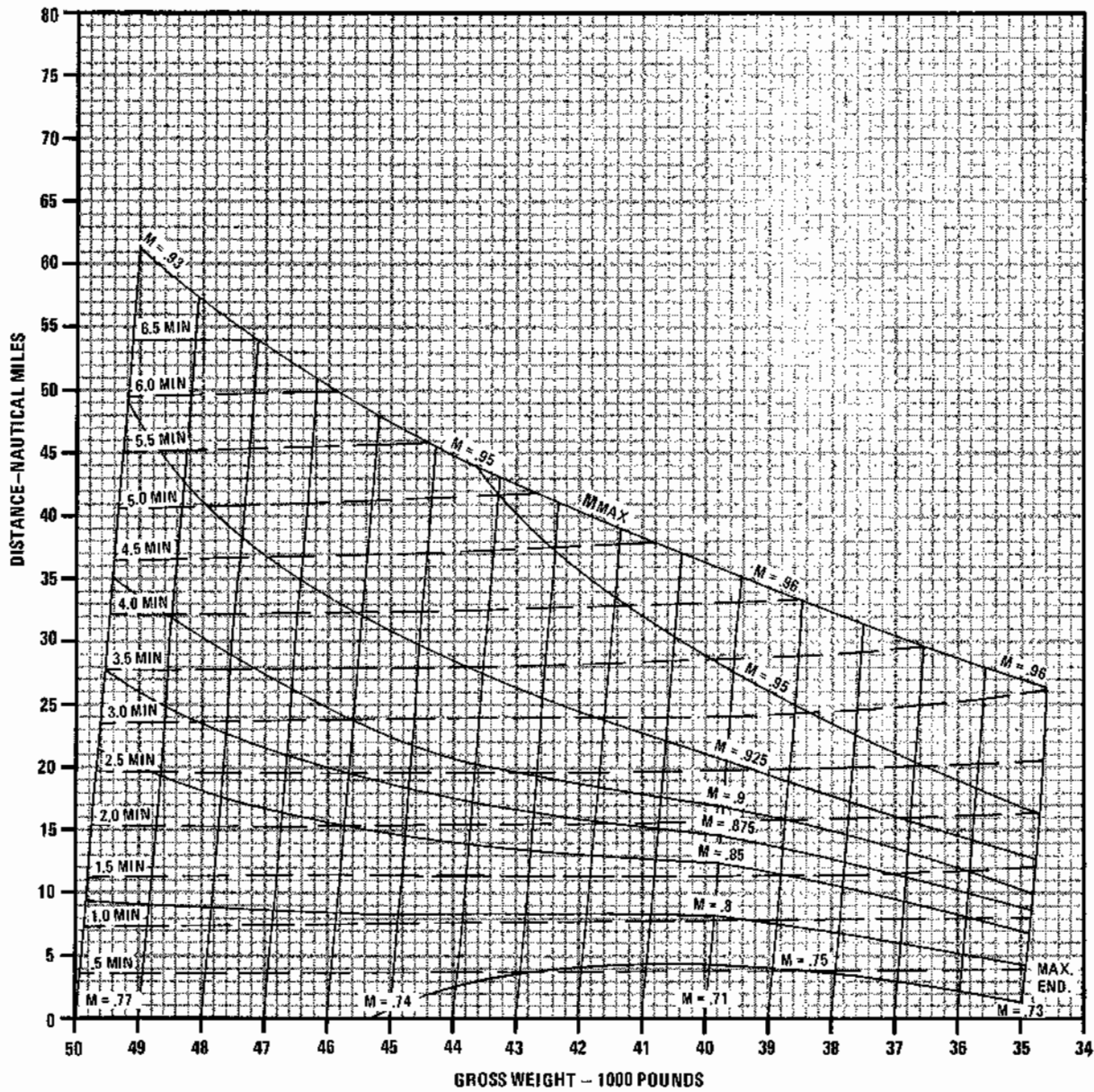

.4631

Figure A9-76



# F-4E LEVEL FLIGHT ENVELOPE

**REMARKS**  
ENGINE(S): (2) J79-GE-17  
ICAO STANDARD DAY  
COMBAT GROSS WEIGHTS

DATE: 1 FEBRUARY  
DATA BASIS: FLIGHT TEST

FUEL GRADE: JP-4  
FUEL DENSITY: 6.5 LB/GAL

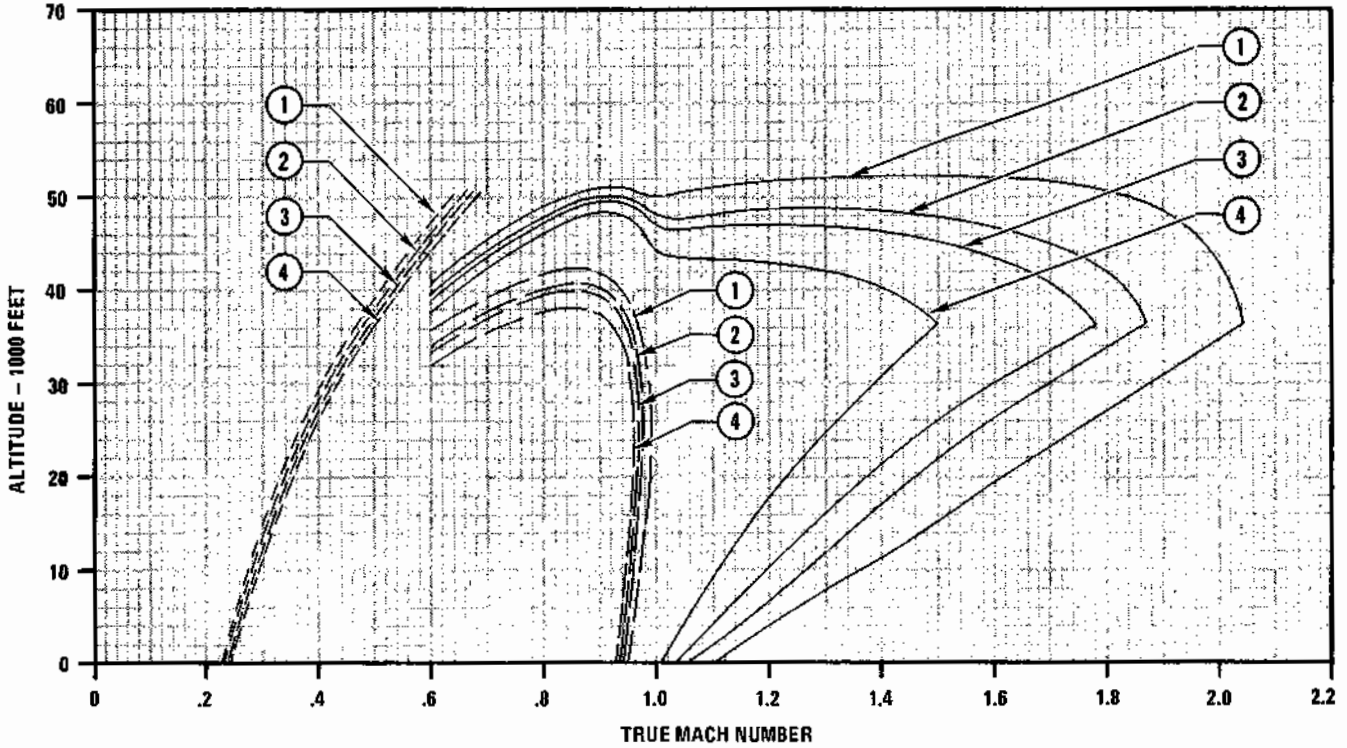

CURVE NO.	CONFIGURATION	GROSS WEIGHT	LEGEND
①	(4) AIM-7	42,777 LB	——— MAXIMUM THRUST - - - MILITARY THRUST - - - MAXIMUM USABLE LIFT LIMIT
②	(4) AIM-7 AND (1) G TANK	45,472 LB	
③	(4) AIM-7 AND (2) WING TANKS	46,279 LB	
④	(4) AIM-7, (1) G TANK AND (2) WING TANKS	48,974 LB	

Figure A9-77

# F-4E LEVEL FLIGHT ENVELOPE

ENGINE(S): (2) J79-GE-17  
ICAO STANDARD DAY  
COMBAT GROSS WEIGHTS

DATE: 1 FEBRUARY 1973  
DATA BASIS: FLIGHT TEST

FUEL GRADE: JP-4  
FUEL DENSITY: 6.5 LB/GAL

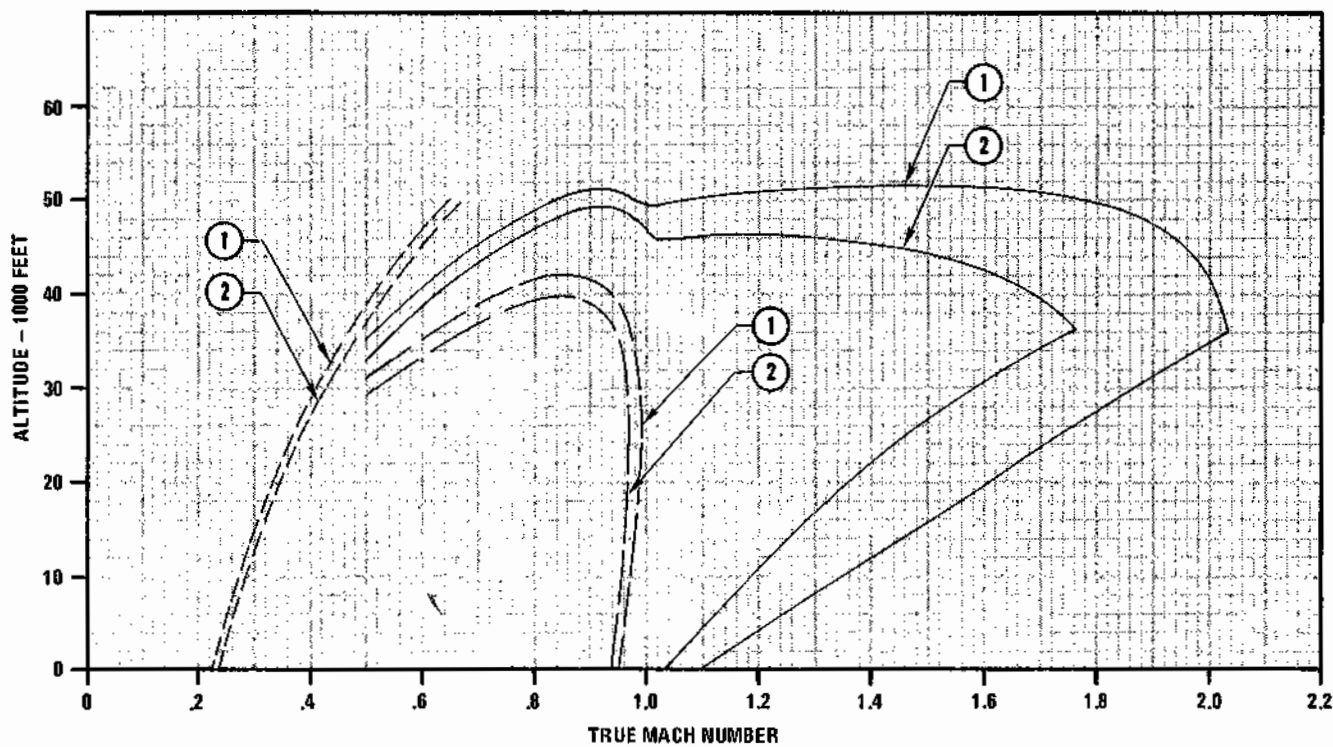

CURVE NO.	CONFIGURATION	GROSS WEIGHT
①	(1) 828	43,035 LB
②	(1) 828 AND 2 WING TANKS	46,537 LB

LEGEND	
———	MAXIMUM THRUST
- - - - -	MILITARY THRUST
- - - - -	MAXIMUM USABLE LIFT LIMIT

4E-1-(455)

Figure A9-78

**F-4E**

# V-N ENVELOPE SYMMETRICAL FLIGHT

AIRPLANE CONFIGURATION  
CLEAN OR (4) AIM-7

GROSS WEIGHT - 37,500 POUNDS

REMARKS  
ENGINE(S): (2) J79-GE-17  
ICAO STANDARD DAY

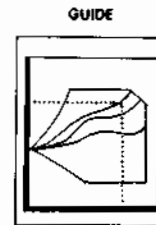

DATE: 1 NOVEMBER 1973  
DATA BASIS: FLIGHT TEST

FUEL GRADE: JP-4  
FUEL DENSITY: 6.5 LB/GAL

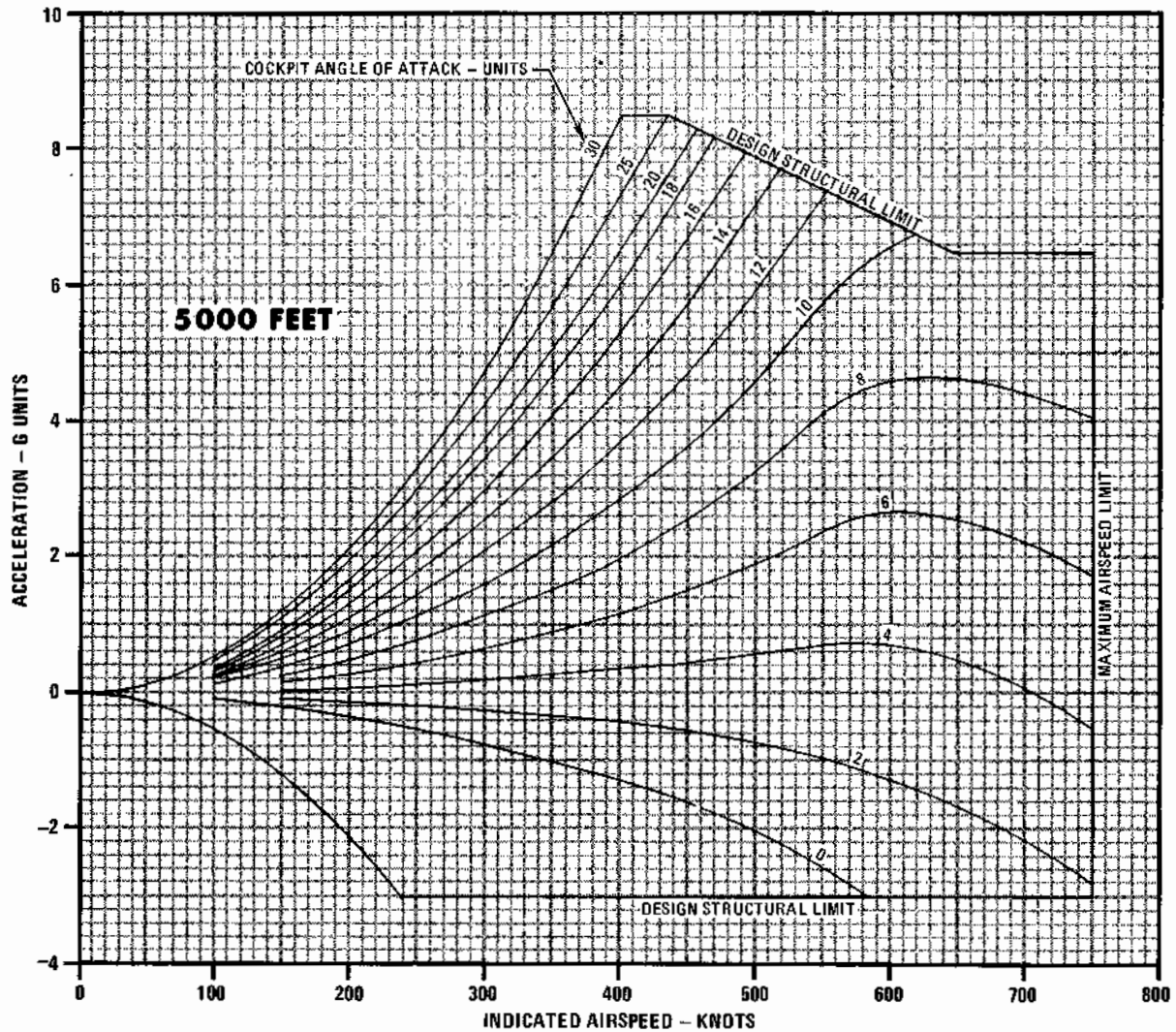

Figure A9-79

F-4E

# V-N ENVELOPE SYMMETRICAL FLIGHT

AIRPLANE CONFIGURATION  
CLEAN OR (4) AIM-7

GROSS WEIGHT - 37,500 POUNDS

REMARKS  
ENGINE(S): (2) J79-GE-17  
ICAO STANDARD DAY

GUIDE

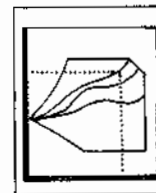

DATE: 1 NOVEMBER 1973  
DATA BASIS: FLIGHT TEST

FUEL GRADE: JP-4  
FUEL DENSITY: 6.5 LB/GAL

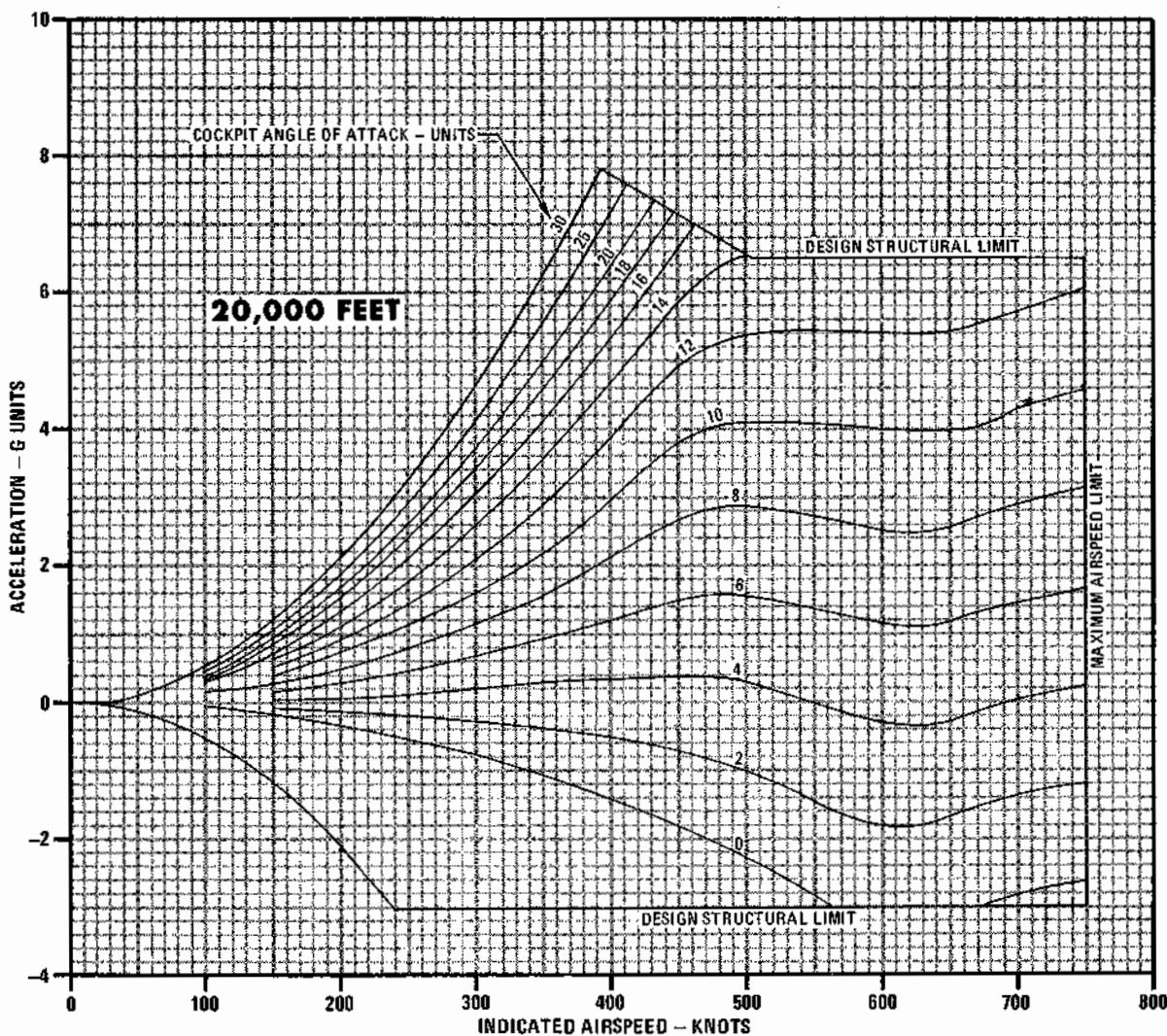

4E-1-1467)

Figure A9-80

**F-4E**

# V-N ENVELOPE SYMMETRICAL FLIGHT

AIRPLANE CONFIGURATION  
CLEAN OR (4) AIM-7

GROSS WEIGHT - 37,500 POUNDS

REMARKS  
ENGINE(S): (2) J79-GE-17  
ICAO STANDARD DAY

GUIDE

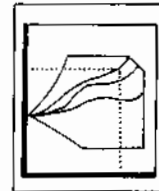

DATE: 1 NOVEMBER 1973  
DATA BASIS: FLIGHT TEST

FUEL GRADE: JP-4  
FUEL DENSITY: 6.5 LB/GAL

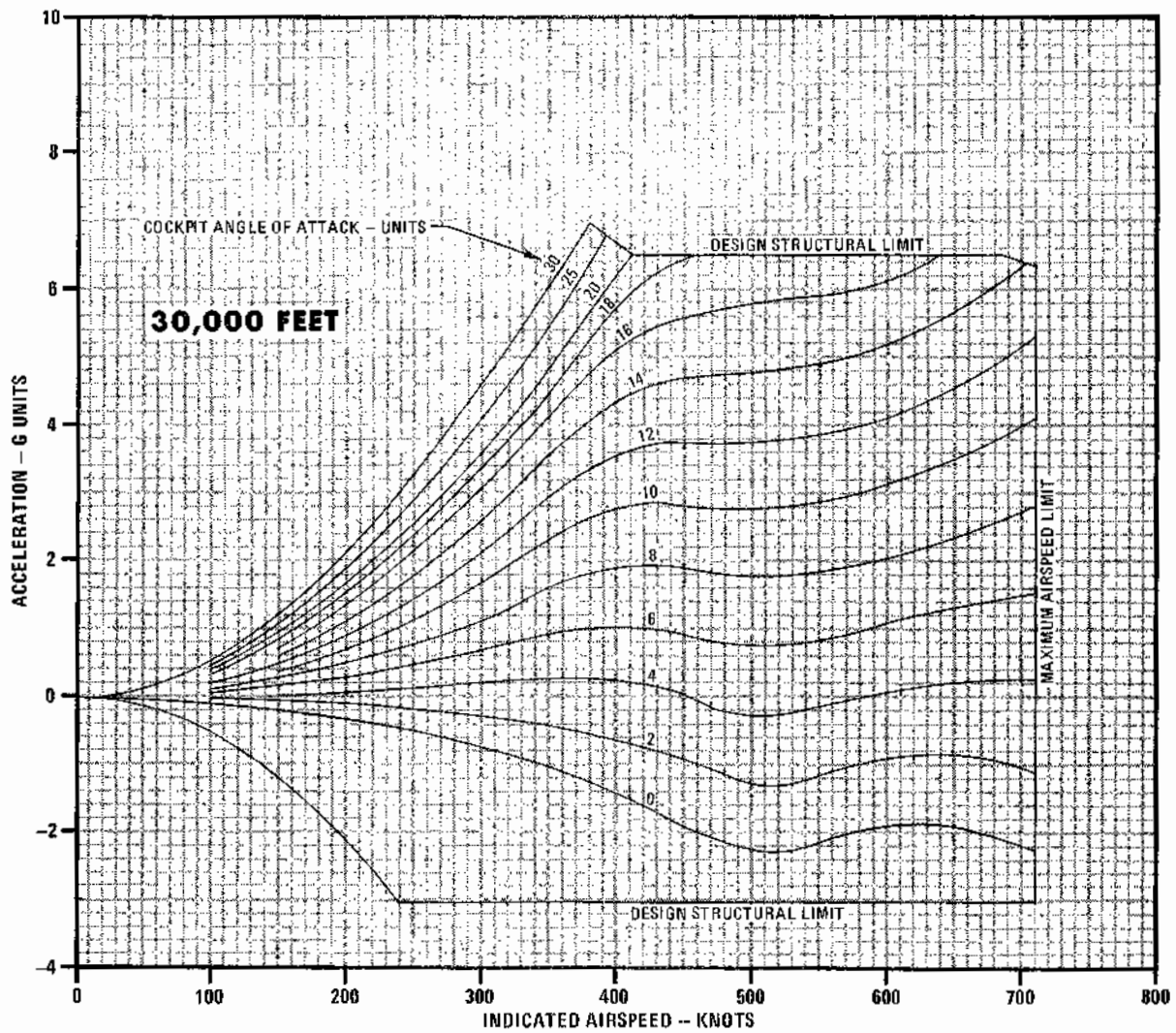

Figure A9-81

# F-4E V-N ENVELOPE SYMMETRICAL FLIGHT

AIRPLANE CONFIGURATION  
CLEAN OR (4) AIM-7

GROSS WEIGHT - 37,500 POUNDS

REMARKS  
ENGINE(S): (2) J79-GE-17  
ICAO STANDARD DAY



DATE: 1 NOVEMBER 1973  
DATA BASIS: FLIGHT TEST

FUEL GRADE: JP-4  
FUEL DENSITY: 6.5 LB/GAL

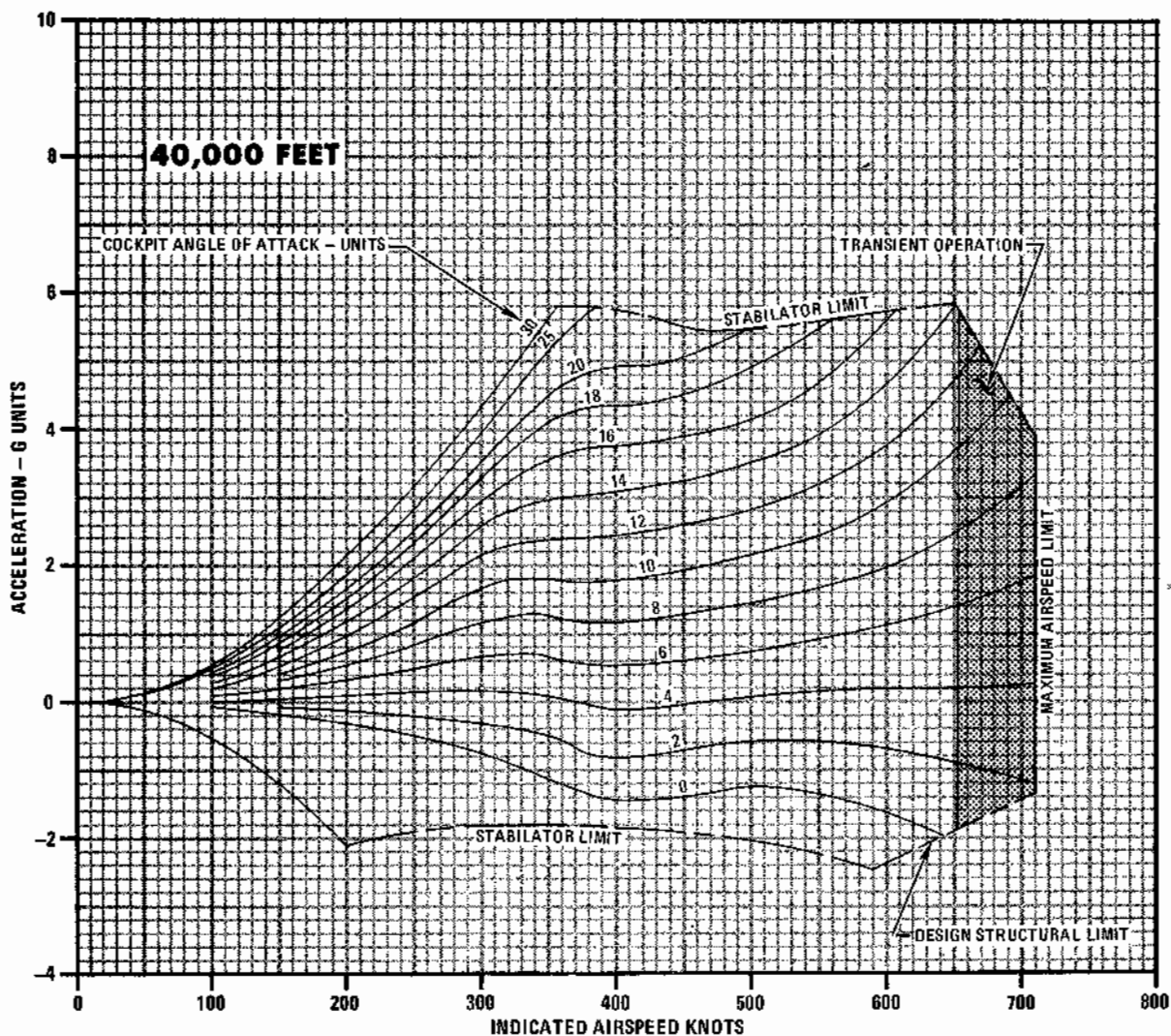

4E-1-(469)

Figure A9-82

**F-4E**

**DIVE RECOVERY -16 UNITS AOA**

**SUBSONIC-SPEED BRAKES RETRACTED**

GROSS WEIGHT 40,000 POUNDS

AIRPLANE CONFIGURATION  
(4)AIM-7

REMARKS  
ENGINE(S): (2) J79-GE-17  
ICAO STANDARD DAY

NOTES

1. ALTITUDE LOSS WITH MAXIMUM THRUST IS ESSENTIALLY THE SAME WITH MILITARY THRUST.
2. PULL-OUT BASED ON 1.0G PER SECOND ACCELERATION BUILDUP TO 16 UNITS (AOA), STABILATOR LIMIT OR 6.0G WHICHEVER OCCURS FIRST.

DATE: 1 NOVEMBER 1973  
DATA BASIS: FLIGHT TEST

GUIDE

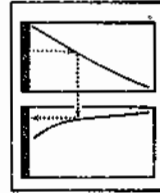

FUEL GRADE: JP-4  
FUEL DENSITY: 6.5 LB/GAL

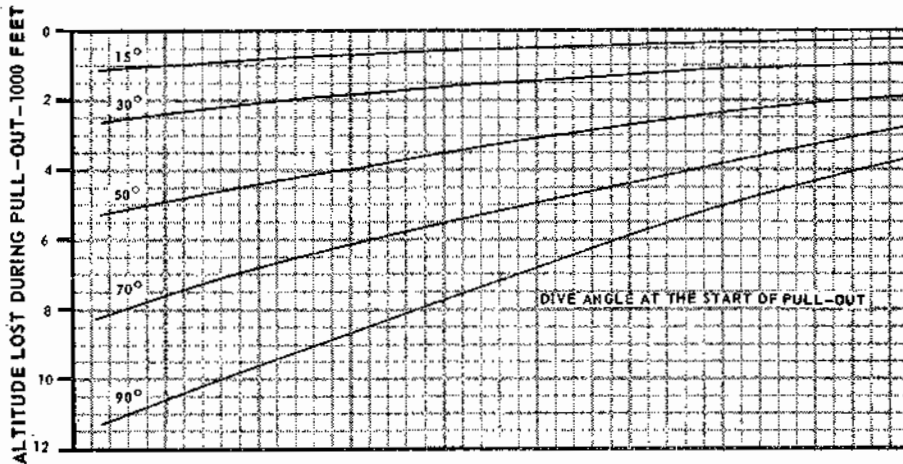
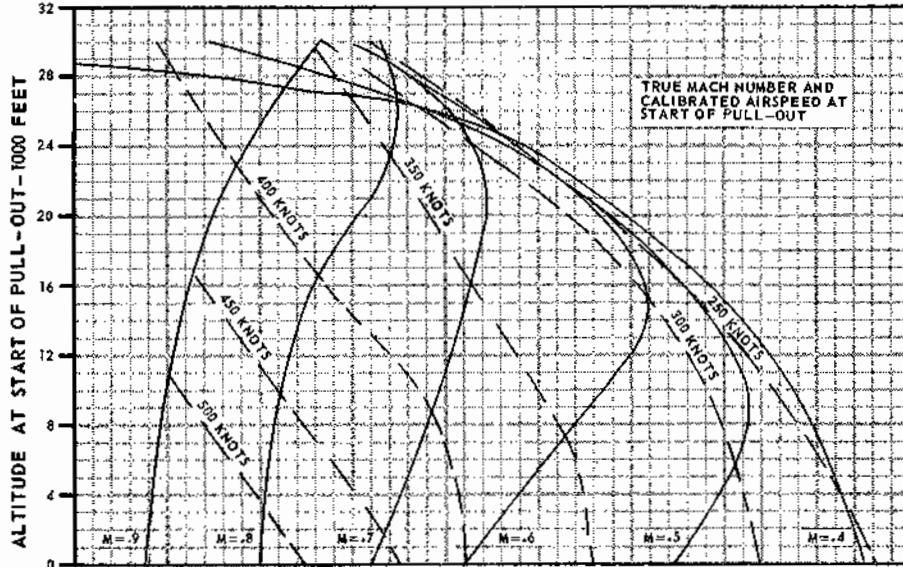

Figure A9-83

**F-4E**

**DIVE RECOVERY -25 UNITS AOA**  
**SUBSONIC-SPEED BRAKES RETRACTED**

AIRPLANE CONFIGURATION  
(4) AIM-7

GROSS WEIGHT 40,000 POUNDS

REMARKS

ENGINE(S): (2) J79-GE-17  
ICAD STANDARD DAY

NOTES

- 1. ALTITUDE LOSS WITH MAXIMUM THRUST IS ESSENTIALLY THE SAME WITH MILITARY THRUST.
- 2. PULLOUT BASED ON 1.0G PER SECOND ACCELERATION BUILDUP TO 25 UNITS (AOA), STABILATOR LIMIT OR 6.0G WHICHEVER OCCURS FIRST.

DATE: 1 NOVEMBER 1973  
DATA BASIS: FLIGHT TEST

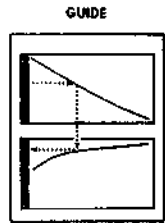

FUEL GRADE: JP-4  
FUEL DENSITY: 6.5 LB/GAL

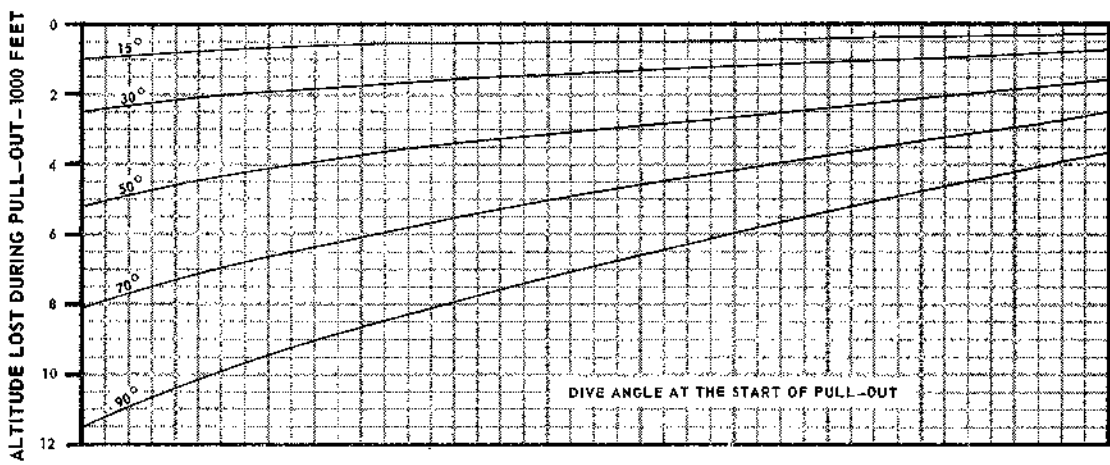
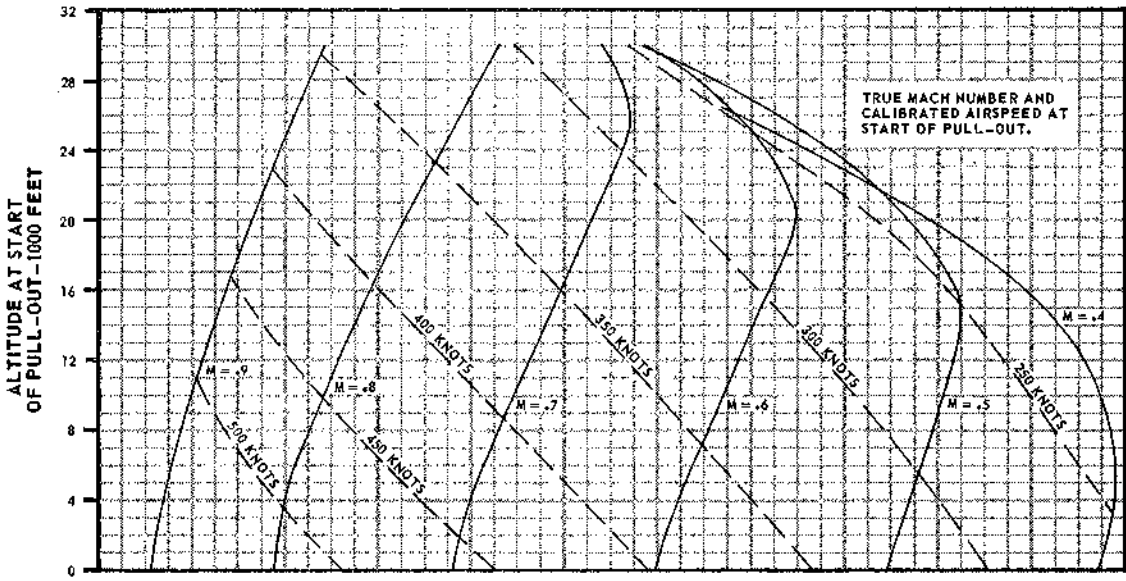

Figure A9-84



F-4E

# DIVE RECOVERY-16 UNITS AOA SUPERSONIC-SPEED BRAKES RETRACTED

AIRPLANE CONFIGURATION  
(4) AIM-7

GROSS WEIGHT - 40,000 POUNDS

REMARKS  
ENGINE(S): (2) J79-GE-17  
ICAO STANDARD DAY

### NOTES

1. ALTITUDE LOSS WITH MAXIMUM THRUST IS ESSENTIALLY THE SAME WITH MILITARY THRUST.
2. PULL-OUT BASED ON 1.0G PER SECOND ACCELERATION BUILDUP TO 16 UNITS (AOA), STABILATOR LIMIT OR 6.0G WHICHEVER OCCURS FIRST.

GUIDE



DATE: 7 NOVEMBER 1973  
DATA BASIS: FLIGHT TEST

FUEL GRADE: JP-4  
FUEL DENSITY: 6.5 LB/GAL

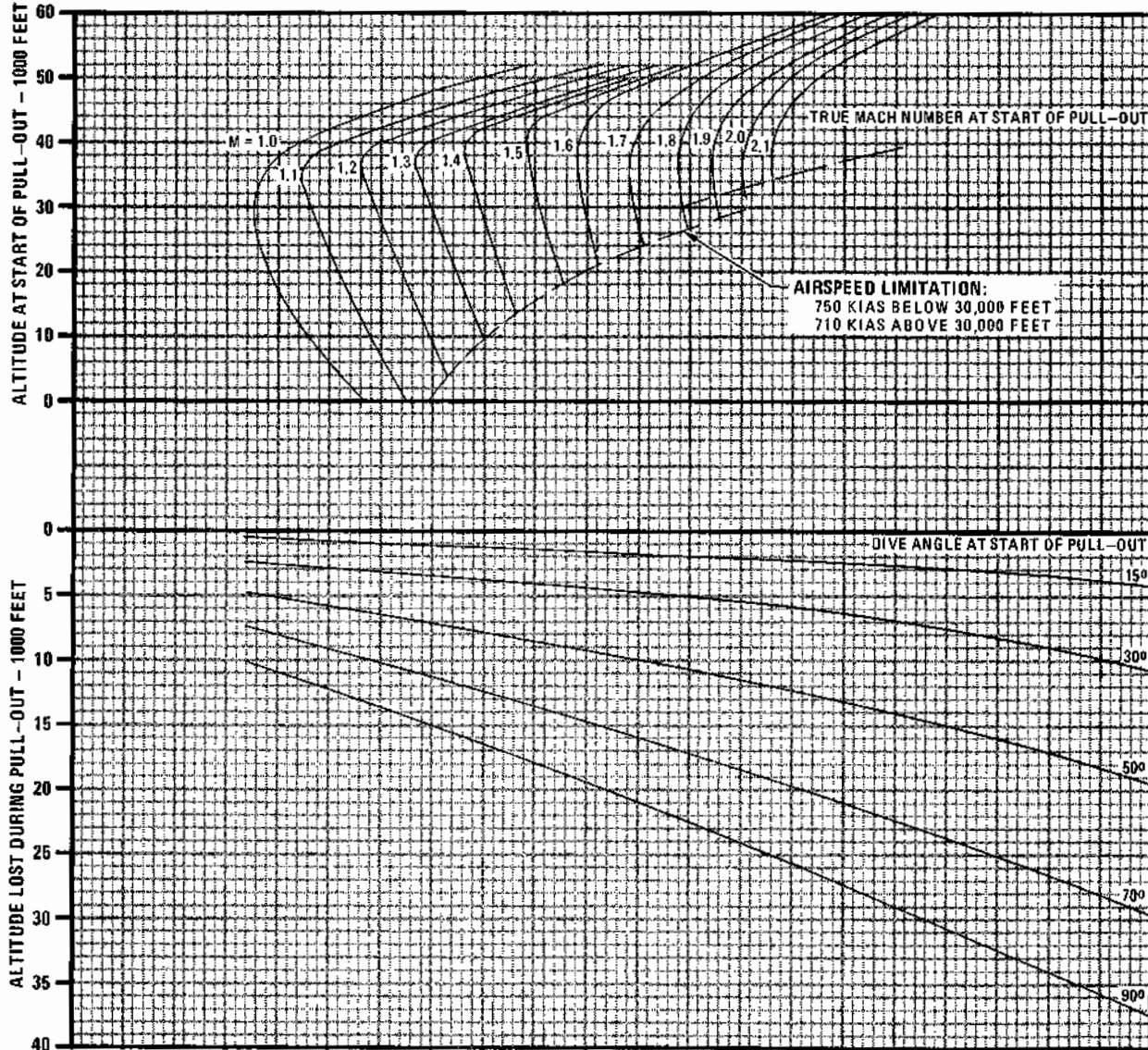

Figure A9-85

**F-4E**

**DIVE RECOVERY-25 UNITS AOA  
SUPERSONIC-SPEED BRAKES RETRACTED**

AIRPLANE CONFIGURATION  
(4) AIM-7

GROSS WEIGHT - 40,000 POUNDS

REMARKS  
ENGINE(S): (2) J79-GE-17  
ICAO STANDARD DAY

NOTES

1. ALTITUDE LOSS WITH MAXIMUM THRUST IS ESSENTIALLY THE SAME WITH MILITARY THRUST.
2. PULL-OUT BASED ON 1.0G PER SECOND ACCELERATION BUILDUP TO 25 UNITS (AOA), STABILATOR LIMIT OR 6.0G WHICHEVER OCCURS FIRST.

DATE: 1 NOVEMBER 1973  
DATA BASIS: FLIGHT TEST

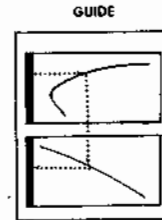

FUEL GRADE: JP-4  
FUEL DENSITY: 6.5 LB/GAL

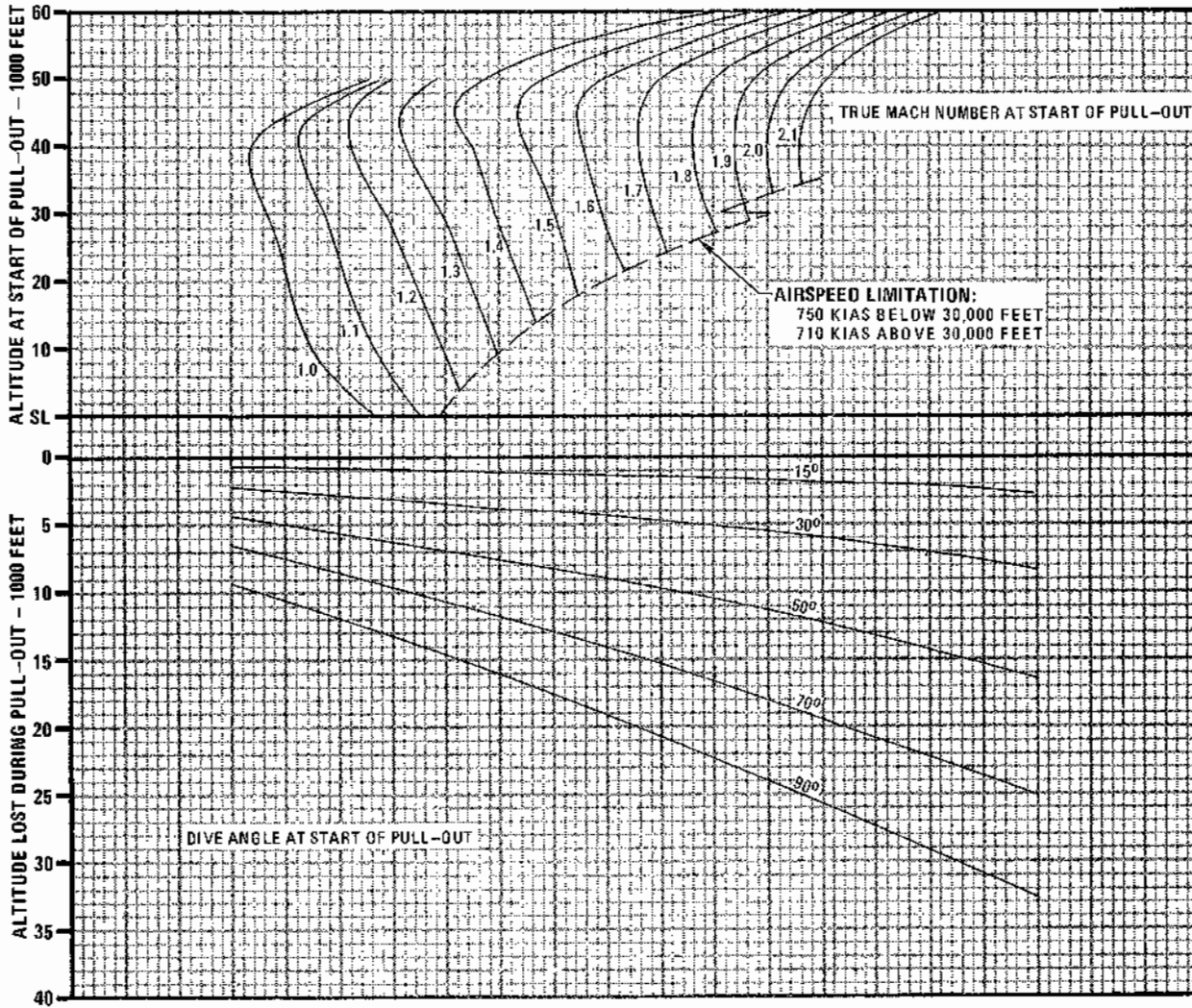

Figure A9-86

**F-4E**

# TEMPERATURE EFFECT ON MAXIMUM SPEED

## MAXIMUM THRUST

AIRPLANE CONFIGURATION  
ALL DRAG INDEXES

REMARKS  
ENGINE(S): (2) J79-GE-17

GUIDE

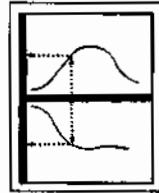

DATE: 1 FEBRUARY 1973  
DATA BASIS: FLIGHT TEST

FUEL GRADE: JP-4  
FUEL DENSITY: 6.5 LB/GAL

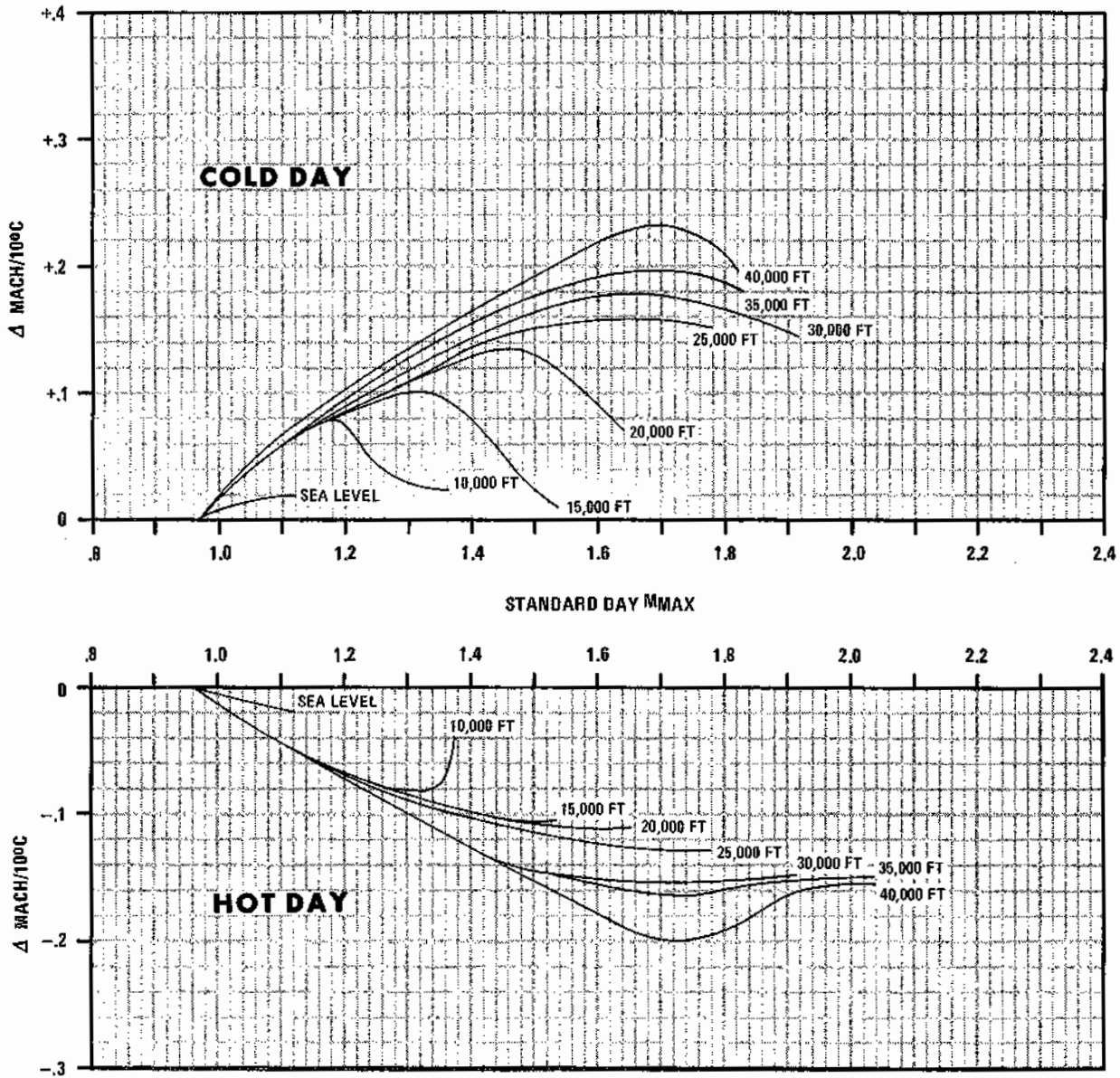

Figure A9-87

**F-4E**

# TURN CAPABILITIES CONSTANT SPEED AND ALTITUDE

REMARKS  
ENGINE(S): (2) J79-GE-17  
ICAO STANDARD DAY

GUIDE

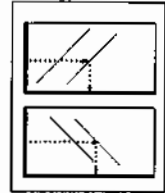

DATE: 1 FEBRUARY 1973  
DATA BASIS: FLIGHT TEST

FUEL GRADE: JP-4  
FUEL DENSITY: 6.5LB/GAL

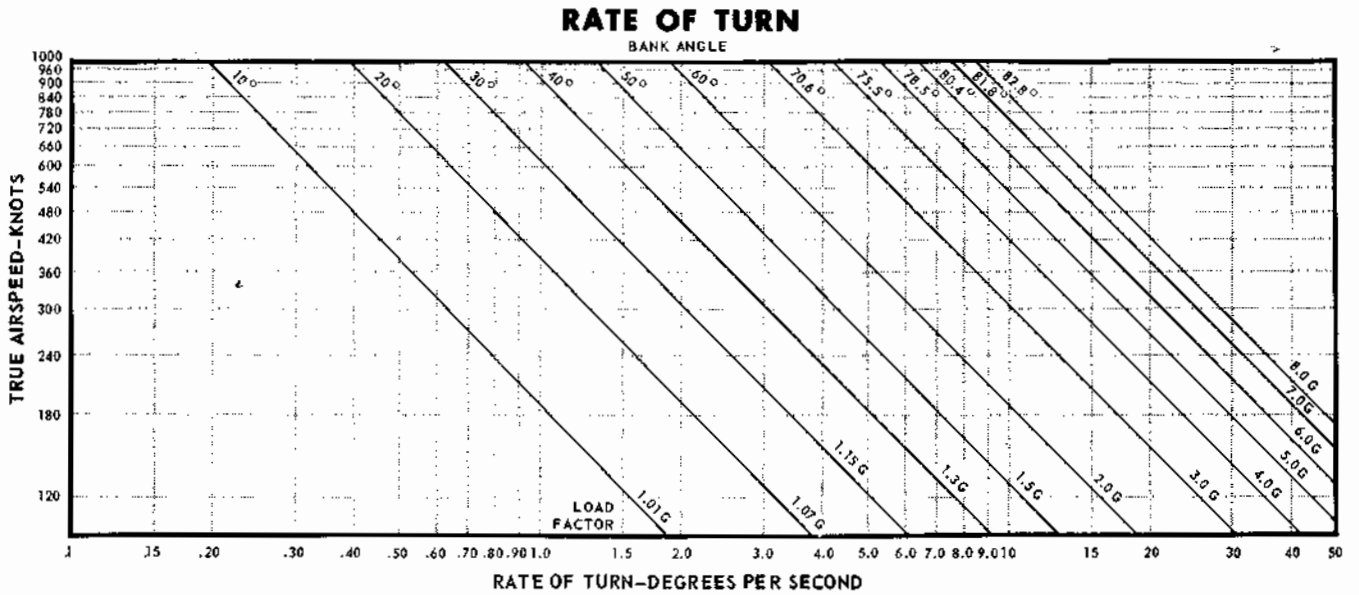
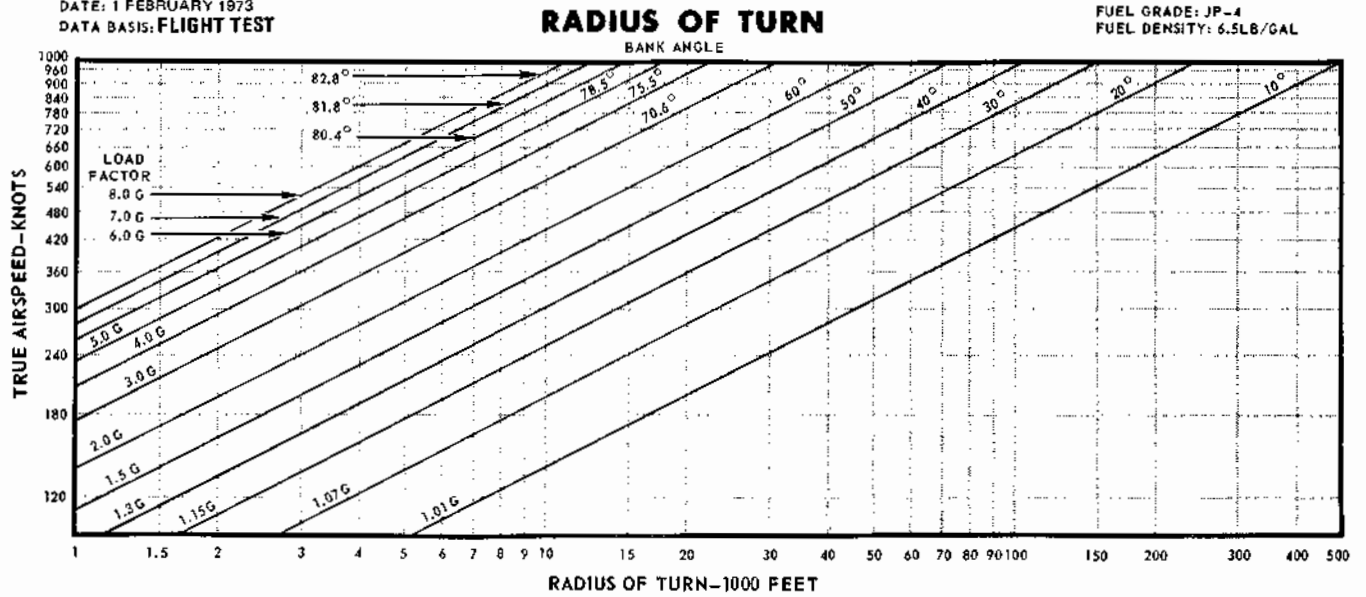

Figure A9-88

4E-1-(28)

**F-4E**

**SUSTAINED G TURN CAPABILITIES**

**GROSS WEIGHT-42,777 POUNDS**

**MAXIMUM THRUST**

**CONSTANT SPEED AND ALTITUDE**

AIRPLANE CONFIGURATION  
(4) AIM-7

REMARKS

ENGINE(S): (2) J79-GE-17  
ICAO STANDARD DAY

NOTE

MAXIMUM SPEED LIMITED  
BY ENGINE LIMIT

GUIDE

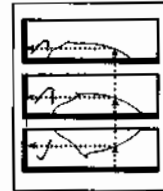

FUEL GRADE: JP-4  
FUEL DENSITY: 6.5 LB/GAL

DATE: 1 FEBRUARY 1973  
DATA BASIS: FLIGHT TEST

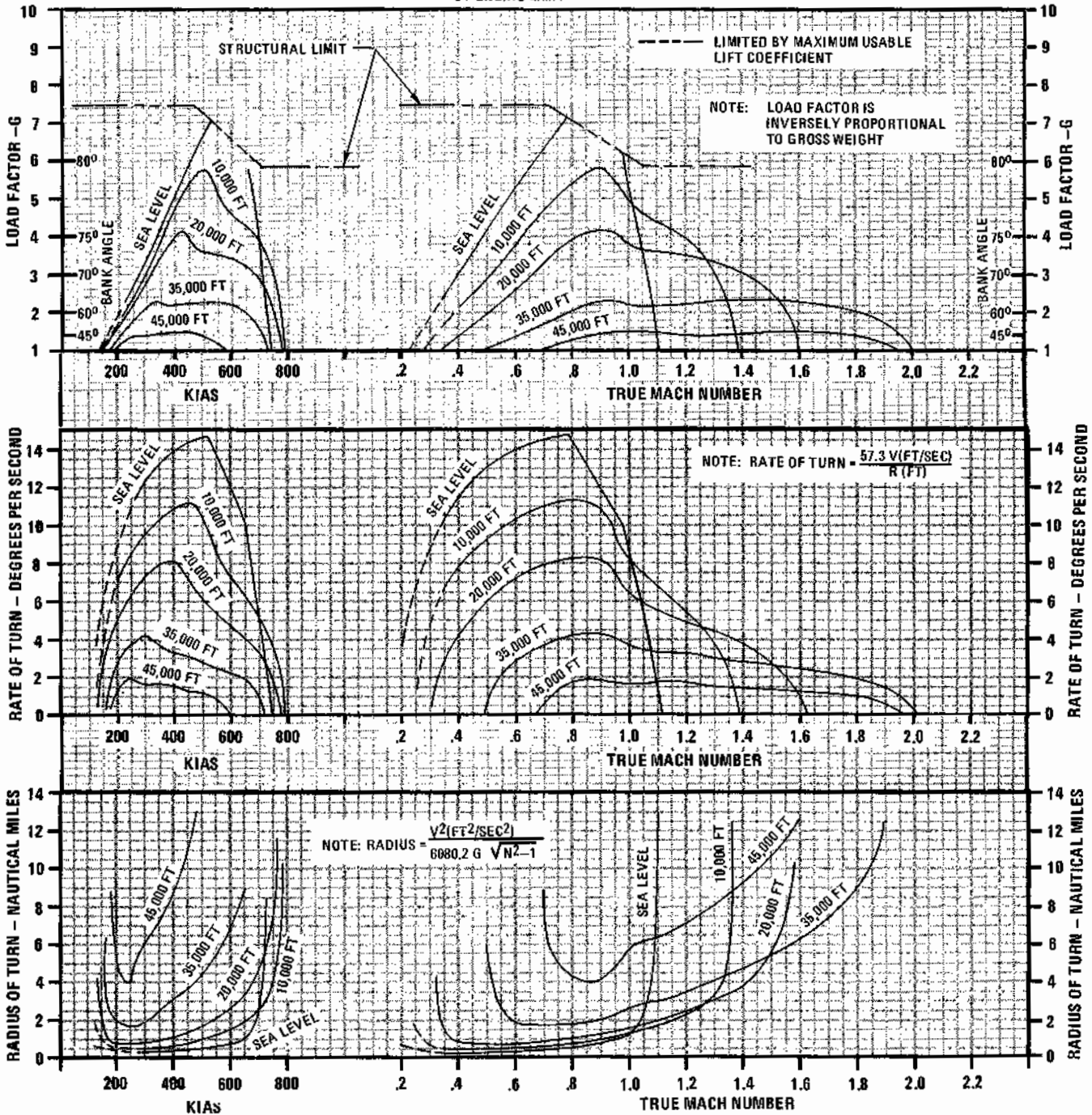

Figure A9-89

**F-4E**

# SUSTAINED G TURN CAPABILITIES

**GROSS WEIGHT-43,729 POUNDS  
MAXIMUM THRUST  
CONSTANT SPEED AND ALTITUDE**

**AIRPLANE CONFIGURATION**  
(4) AIM-7 AND (4) AIM-4  
OR  
(4) AIM-7 AND (1) SUU-16

**REMARKS**  
ENGINE(S): (2) J79-GE-17  
ICAO STANDARD DAY

**NOTE**  
ACCELERATION PLACARD FOR  
AIM-4 MISSILES = 6.0G

DATE: 1 FEBRUARY 1973  
DATA BASIS: FLIGHT TEST

GUIDE

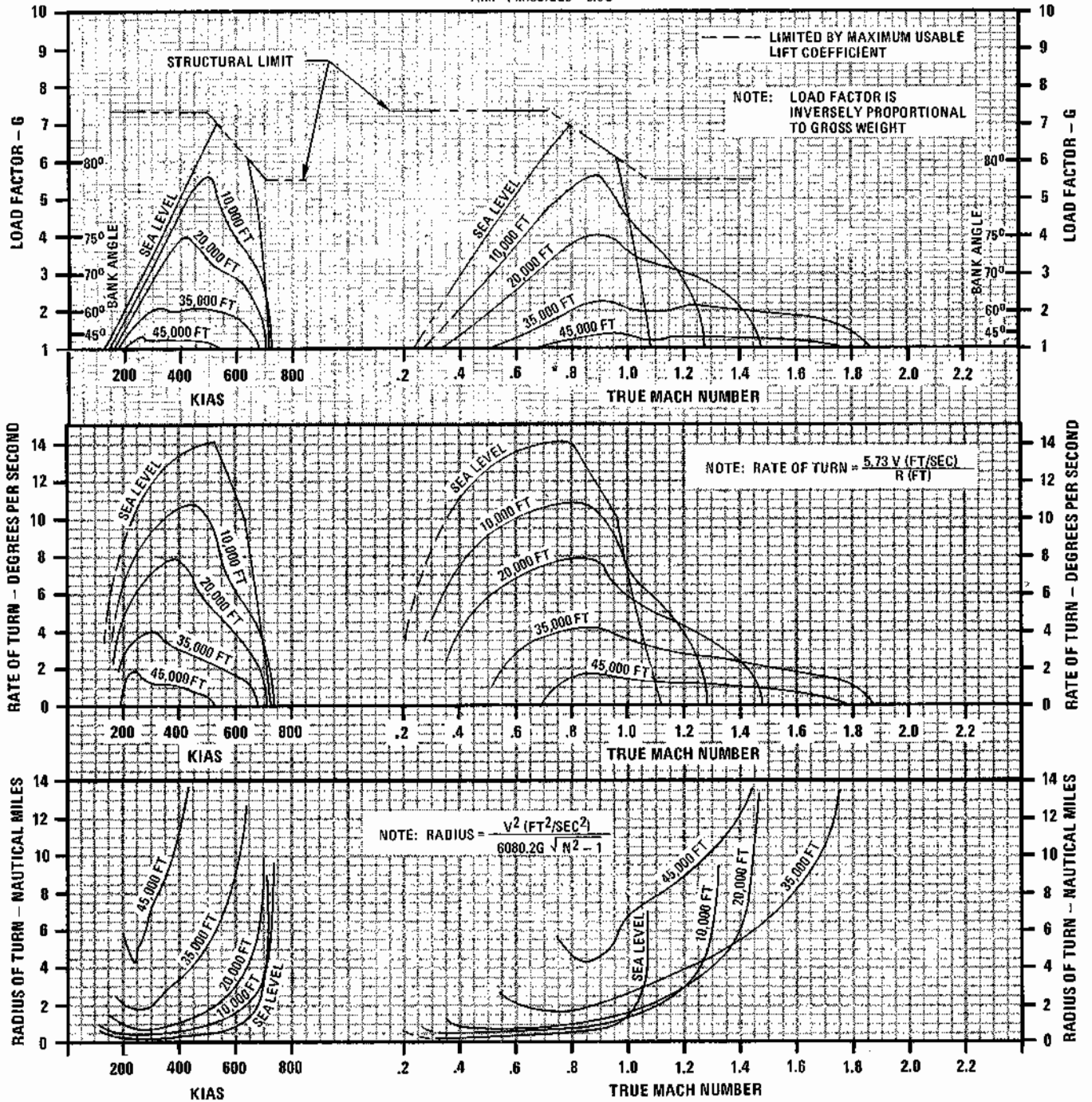
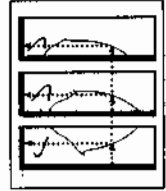

Figure A9-90

# PART 10

## MISSION PLANNING

---

### TABLE OF CONTENTS

Mission Overview .....	A10-2
Mission Fuel and Distance .....	A10-3
Cruise Back, Descent, and Landing .....	A10-3
Takeoff, Climb, and Cruise .....	A10-5
Mission Summary .....	A10-9

### MISSION PLANNING

Optimum use of the aircraft to obtain maximum performance with minimum fuel consumption requires careful preflight planning for the mission. The planning of a mission involves many things which are beyond the scope of this publication. As used here, mission planning will cover certain key phases of a mission and explain the use of performance charts.

The following sample Counter Air mission demonstrates features of performance data in Parts 1 thru 9. Although the sample problem does not cover the many mission capabilities of the aircraft, it familiarizes the aircrew with the use of performance data so that any mission may be preflight planned in a short time.

The sample problem illustrates, through a graphical solution, how performance charts can be integrated to form a complete mission flight plan. The steps used to develop such a plot are shown with the problem.

### COUNTER AIR MISSION PROFILE

Perform maximum thrust takeoff and climb at military thrust. Cruise at optimum altitude and maximum range speed to a combat zone 500 miles from the air base. Drop external tanks when empty. Perform combat maneuvering at maximum thrust for the full duration allowed by return and landing fuel requirements. Missiles and gun rounds are assumed to be expended at the end of the combat period. Return to the airfield at optimum altitude and airspeed. Descend at maximum range descent, arriving at the destination with 2000 pounds landing fuel reserve. The Counter Air Mission Overview (figure A10-1) and the Sample Mission Plan (figure A10-2) depict the overall mission plan.

### MISSION DATA

#### Configuration

- (4) AIM-4D Missiles, Pylons and Launchers
- (4) AIM-7D Missiles
- (1) Nosegun (639 rounds ammo)

(2) 370 Gallon External Wing Tanks

(1) 600 Gallon Centerline Tank

Useable Fuel (includes external tanks) 20,768 pounds

### MISSION FACTORS

#### Takeoff

Wind	Calm
Pressure altitude	2000 Ft
Temperature	+35°C
Runway	020°
Runway length	9000 Ft
Climb out wind (headwind)	20 Kt
Cruise out wind (headwind)	50 Kt
Cruise return wind (tailwind)	50 Kt
Descent wind (tailwind)	20 Kt

#### Landing

Wind	020°/10
Pressure altitude	2000 Ft
Temperature	+20°C
Runway	020°
Runway length	9000 Ft

### Sample Problem

The graphic solution of the problem is introduced in the Sample Mission Plan (figure A10-2) so that the pilot can see the complete picture before the actual solution is broken into parts. The problem is solved by plotting fuel remaining versus distance. Gross weight is also superimposed on the vertical scale.

### TAKEOFF AND LANDING DATA

The first step involves calculation of the aircraft gross weight, drag and stability indexes (refer to charts in Part 1) and completion of the checklist Takeoff and Landing Data card. The mission problem is then solved in incremental steps working backward from landing to the combat zone. Finally performance calculations are computed from takeoff to the combat zone. The weight difference between entering and leaving the combat area dictates the combat fuel availability.

Begin preflight planning by determining the aircraft gross weight, drag and stability indexes by using the Airplane Loading and Stability Numbers charts (Part 1).

# COUNTER AIR MISSION OVERVIEW

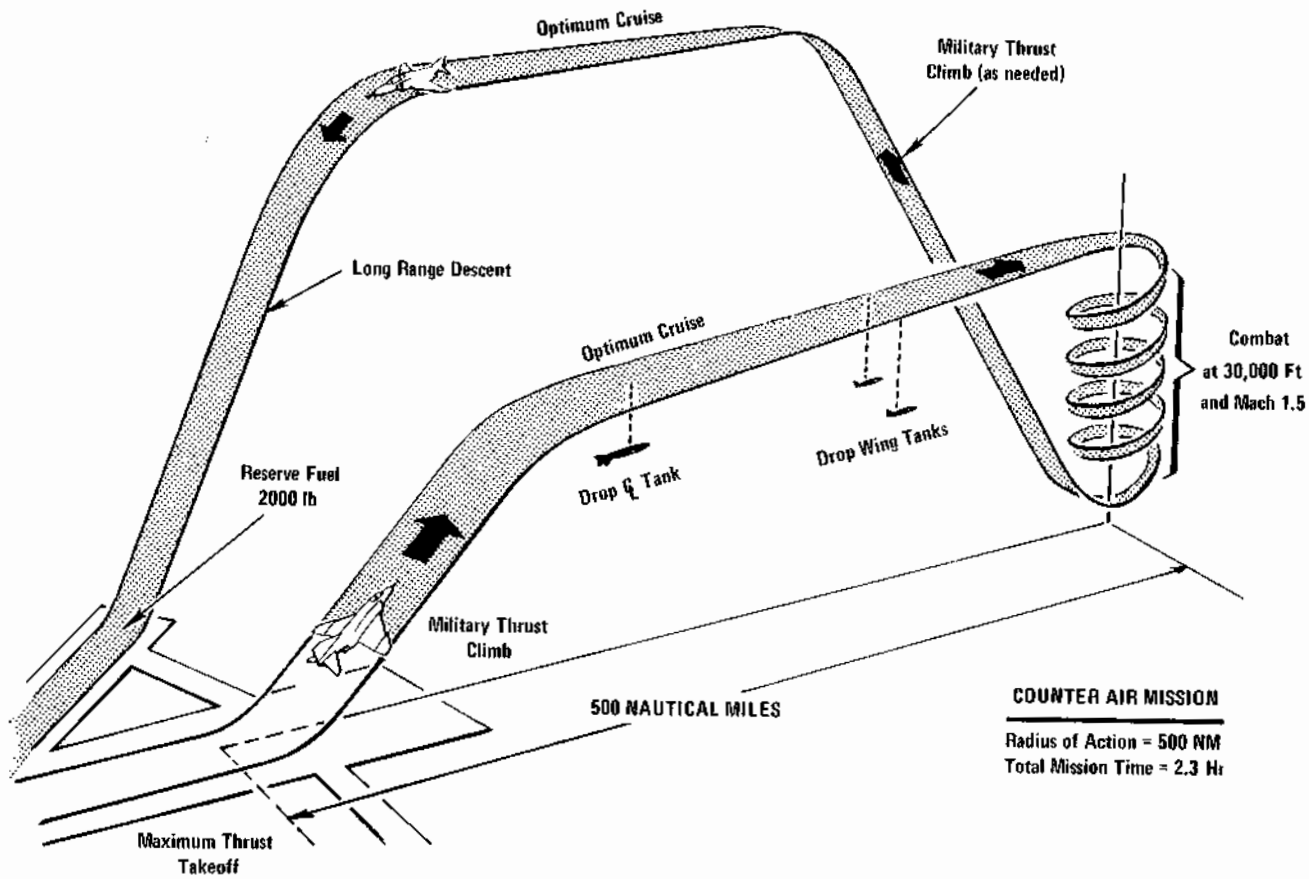

Figure A10-1

4E-1-(467)

Item	Wt (Lb)	Drag Index	Stab Index	Item	Wt (Lb)	Drag Index	Stab Index
(With slats) Basic Takeoff Weight (includes internal fuel)	45,160	0.0	0.0	(2) Inboard armament pylons and inboard and lower launchers	832	7.4	19.0
(1) Centerline tank rack	45	0.0	0.0	(1) Nose gun ammo (639 rounds prior to firing)	373	0.0	0.0
(1) Centerline tank (Royal Jet) (full)	4,204	9.6	0.0	(4) AIM-7D missiles	1,608	5.2	0.0
(2) Wing tanks (Sargent-Fletcher) (full)	5,426	12.8	88.0	<b>Start engine totals</b>	<b>58,184</b>	<b>41.0</b>	<b>115.0</b>
(4) AIM-4D missiles	536	6.0	8.0				

The allowable Aft CG Limit chart (Part 1) with the computed stability index of 115.0 is 33.0% MAC. Given a CG of 32.0% for this aircraft and configuration, the Aft CG Limit chart depicts operation in the CAUTION area since the proximity of the center of gravity to the aerodynamic center results in reduced static margin and flight stability.



## SAMPLE MISSION PLAN

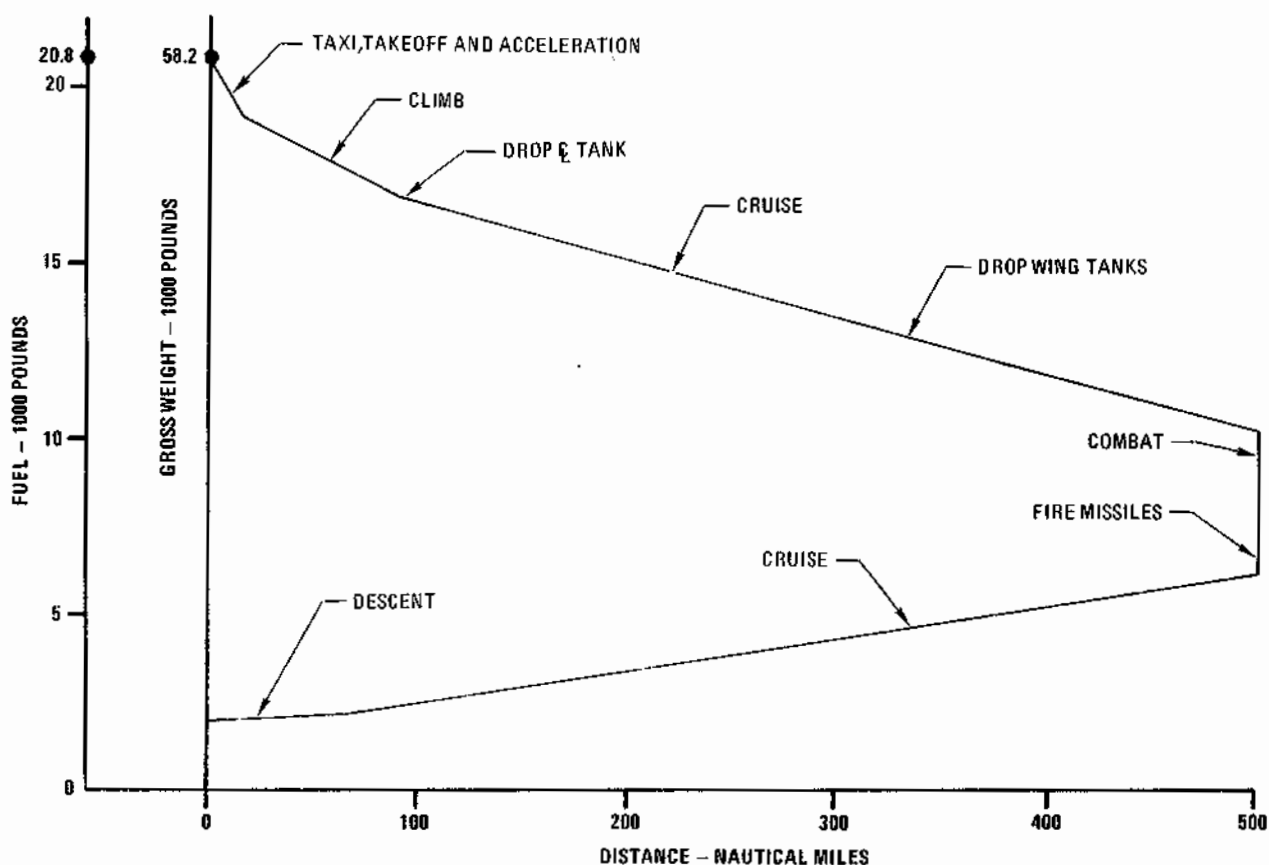

Figure A10-2

4E-1-(468)

### APPROACH AND LANDING RESERVE

Plan the mission by working backwards from the landing reserve. The planned landing fuel reserve for this mission is 2000 pounds which will permit landing pattern operation for 15 to 20 minutes.

Distance (no wind)	62 NM
Time	11.0 Min
Fuel	245 Lb
Speed (Mach number)	.84

Correct the descent distance for the 20 knot tailwind using the Rangewind Correction chart (Part 4).

### DESCENT FROM CRUISE ALTITUDE

The time, fuel, and descent distance can be determined from the descent charts (Part 7). The drag index for the cruise return leg configuration is 7.4. The airplane gross weight at end of letdown is 36,146 pounds (33,100 lb basic operating weight + 45 lb centerline tank rack + 832 lb inboard armament pylons and missile launcher + 169 lb ammo links + 2000 lb reserve fuel). The optimum cruise altitude for this weight and drag index is found on the Optimum Cruise Summary chart (Part 4) as 40,900 feet. Next enter the Maximum Range Descent chart (Part 7) and determine the descent data (assume descent to sea level).

Range factor	1.045
Distance (corrected)	64 NM

### RETURN AT OPTIMUM CRUISE ALTITUDE

The cruise data may be obtained from the Optimum Cruise Summary chart (Part 4). The drag index is 7.4 and end of cruise gross weight is 36,391 pounds (36,146 lb + 245 lb descent fuel). Assume arbitrary fuel increments and construct the return fuel-distance line as shown on the Sample Cruise Return and Descent chart (figure A10-3).

## SAMPLE CRUISE RETURN AND DESCENT

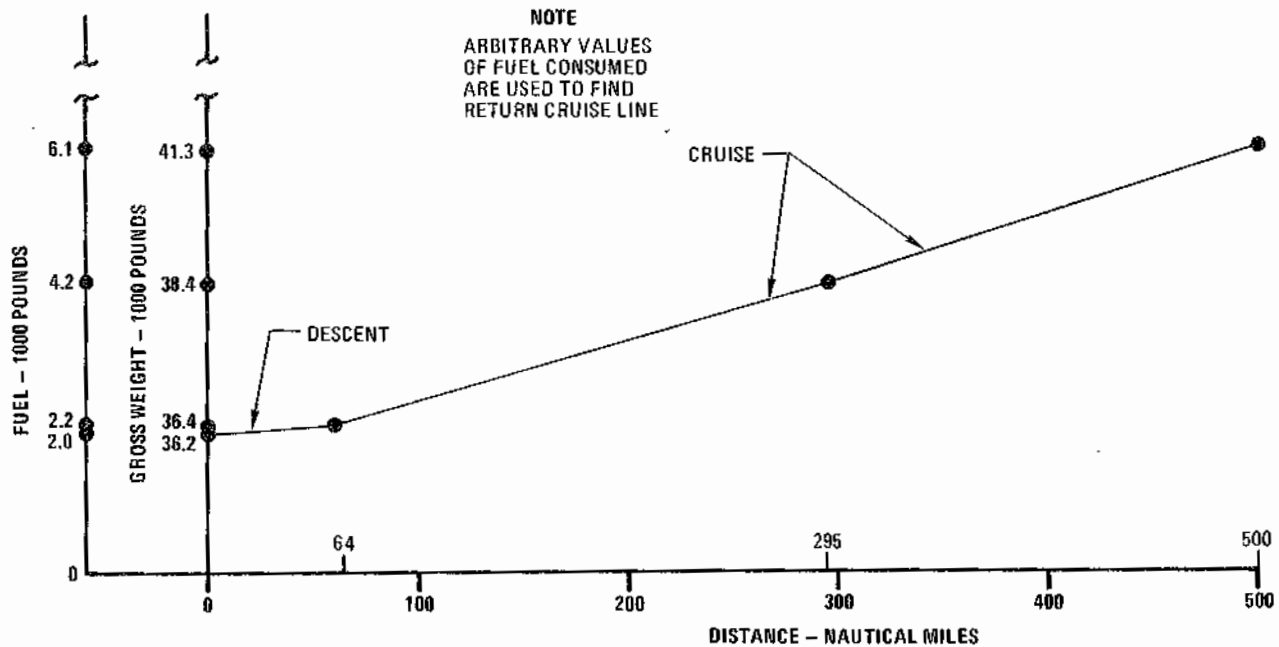

Figure A10-3

4E-1-(169)

# 3

Drag index	7.4
Fuel increment	2000Lb
Average weight	37,391 Lb
Optimum cruise altitude	40,000 Ft
Specific range	.105 NMPP
Distance (2000 lb × .105 NMPP)	210NM
Speed (Mach)	.865
Speed (TAS)	495 Kt
Time	25.4 Min
Range factor (50 Kt tailwind)	1.10
Ground distance	231 NM

Distance covered is 295 miles (64 NM + 231NM). Since the combat zone is 500 miles from base, cruise an additional 205 miles. Continue calculations using an average gross weight of 39,391 pounds.

Drag index	7.4
Average weight	39,391 Lb
Optimum cruise altitude	39,000 Ft
Specific range	.100 NMPP
Speed (Mach)	.865
Speed (TAS)	495 Kt
Ground speed	545 Kt
Distance (to go)	205 NM
Time	22.5 Min
Distance (no wind)	186 NM
Fuel used	1860 Lb

Total fuel needed when departing the combat area at cruise altitude for return to base is 6105 pounds (2000 lb + 245 lb + 2000 lb + 1860 lb). Gross weight when departing combat is 40,082 pounds (33,100 lb airplane operating weight + 45 lb centerline tank rack + 832 lb inboard pylons and launchers + 6105 lb fuel).

### TAXI, TAKEOFF AND ACCELERATION

The first portion of the mission fuel graph was constructed by working backwards from the landing reserve. The remainder of the plot is developed from the engine start condition. Takeoff gross weight is 57,534 pounds with a corresponding drag index of 41.0. This data was obtained from the Climb Speed Schedule (Part 3) using a start engine weight of 58,184 lb - 130 lb (start engines) - 420 lb (taxi at idle rpm for 10 min) - 100 lb (engine run-up). The Maximum Thrust takeoff and acceleration data (found in the Climb Speed Schedule, Part 3) is 925 lb (fuel), 0.8 min (time) and 3.0 NM (distance). This reduces initial climb weight to 56,609 pounds (57,534 lb - 925 lb).

The Takeoff and Landing Data Card, located in the normal procedures Checklist, TO 1F-4E-1CL-1, should be completed during the final mission planning phase. The format of the card (figure A10-4) provides a ready reference of: Known conditions (A thru F); Takeoff data (G thru L); and Landing data (M thru P). The Takeoff and Landing Data card should be filled out in the following sequence:

- Steps A thru F are known conditions and must be completed before takeoff calculations can be made. The takeoff gross weight is obtained by subtracting the engine start, run-up and acceleration fuel obtained from the Military Thrust Climb chart (Part 3) from the engine start gross weight.
- Step H is obtained from the Maximum Thrust Takeoff Distance chart (Part 2).
- Step G is obtained from the Velocity During Takeoff

A10-4

**SAMPLE TAKEOFF AND LANDING DATA CARD**

CONDITIONS			
	TAKEOFF	LANDING	
A	GROSS WEIGHT	<u>57,534 LB</u>	<u>36,146 LB</u>
B	RUNWAY LENGTH	<u>7500 FT</u>	<u>7500 FT</u>
C	WIND	<u>CALM</u>	<u>020/10</u>
D	RUNWAY TEMPERATURE	<u>+35 °C</u>	<u>+20 °C</u>
E	PRESSURE ALTITUDE	<u>2000 FT</u>	<u>2000 FT</u>
F	DENSITY RATIO	<u>0.87</u>	<u>0.915</u>

**TAKEOFF  
(MAXIMUM THRUST)**

G	ACCELERATION CHECK	<u>118 KT</u>	<u>2000 FT</u>
H	TAKEDOFF DISTANCE		<u>4500 FT</u>
I	MINIMUM GO SPEED		<u>155 KT</u>
J	MAXIMUM ABORT SPEED		<u>110 KT</u>
K	NOSEWHEEL LIFT-OFF SPEED		<u>136 KT</u>
L	TAKEDOFF SPEED		<u>176 KT</u>

**LANDING**

	IMMEDIATELY AFTER TAKEOFF	FINAL LANDING	
M	APPROACH SPEED	<u>168 KT</u>	<u>150 KT</u>
N	LANDING ROLL	<u>5000 FT</u>	<u>3600 FT</u>
O	NO DRAG CHUTE	<u>6200 FT</u>	<u>4500 FT</u>
P	NO FLAP APPROACH SPEED (ON SPEED)	<u>182 KT</u>	<u>162 KT</u>

Figure A10-4

4E-1-14701

Ground Run chart (Part 2). Establishment of an acceleration check is based on the availability of runway distance markers or other fixed points necessary to accurately relate distance traveled to the acceleration check point.

d. Step I is obtained from the Minimum Go Speed chart (Part 2).

e. Step J is obtained from the Maximum Abort Speed charts (Part 2). Since the Minimum Go Speed exceeds the Maximum Abort Speed in this problem, the warning on page A2-1 applies.

f. Steps K and L are obtained from the Takeoff Distance chart (Part 2).

g. Steps M and P are obtained from the Final Approach Speeds chart (Part 8), using the applicable configuration.

h. Steps N and O are obtained from the Minimum Landing Roll Distance chart (Part 8).

**CLIMB TO CRUISE ALTITUDE**

Determine the cruise altitude from the Optimum Cruise Summary chart (Part 4).

## TO 1F-4E-1

Drag index	41.0
Weight (estimated)	54,500 Lb
Cruise altitude	32,000 Ft

Determine the climb time, distance, and fuel data from the Military Thrust Climb charts (Part 3). Assume climb from sea level and standard temperature during climb.

Drag index	41.0
Initial Weight	56,609 Lb
Time	9.5 Min
Fuel	2200 Lb
Final Weight	54,409 Lb
Air distance	80 NM
Speed (average TAS)	480 Kt
Ground speed	460 Kt
Ground distance	72 NM

### CRUISE OUT AT OPTIMUM ALTITUDE

All cruise calculations are based on the Optimum Cruise Summary chart (Part 4). The useable fuel remaining in the 600 gallon centerline tank is 125 pounds (3900 lb - 130 lb - 420 lb - 100 lb - 925 lb - 2200 lb) which will be consumed during the initial portion of the first cruise leg. The average weight for this cruise leg is 54,347 pounds (54,409 lb - 125/2 lb). Determine the cruise altitude, speed, and specific range from the Optimum Cruise Summary chart (Part 4).

Drag index	41.0
Average weight	54,347 Lb
Cruise altitude	32,000 Ft
Specific range	.062 NMPP
Speed (Mach)	.85

The air distance traveled can now be calculated. The airspeed conversion chart (Part 1) is used to convert the cruise Mach to a true airspeed of 497 knots. The air distance traveled to consume the remaining centerline tank fuel is 8 NM (.062 NMPP x 125 lb). The no wind time to fly this cruise leg is calculated as 1 minute. The ground speed of 447 knots results in a ground distance of 7 miles. At this point the centerline fuel tank is jettisoned and the aircraft weight is 53,980 pounds (54,347 - 125/2 - 304 lb) at a drag index of 31.4 (41.0 - 9.6). Assume arbitrary cruise fuel increments and construct the Sample Takeoff, Climb and Cruise chart (figure A10-5).

The useable fuel in the Sargent-Fletcher external wing tanks is 4810 pounds (Part 1) and will be consumed next. The average weight for this cruise leg is 51,575 pounds (53,980 lb - 4810/2 lb). Enter the Optimum Cruise Summary chart (Part 4) to determine the cruise leg data.

Drag index	31.4
Average weight	51,575 Lb
Cruise altitude	33,600 Ft
Specific range	.069 NMPP
Speed (Mach)	0.855

The air distance traveled during this leg is 332 miles (.069 NMPP x 4810 lb). The cruise speed of Mach 0.855 converts to 500 knots (TAS). The time of flight for this leg is calculated as 39.5 minutes. At a ground speed of 450 knots the ground distance of this cruise leg is 296 miles. At this point the external wing tanks are jettisoned and the aircraft weight is 48,554 pounds (51,575 lb - 4810/2 lb

-616 lb) at a drag index of 18.6 (31.4 - 12.8). Since the distance to the combat zone is 500 miles, the distance remaining after external wing tanks are jettisoned is 122 miles (500 NM - 3 NM - 72 NM - 7 NM - 296 NM). The Optimum Cruise Summary chart provides the needed cruise data.

Drag index	18.6
Weight	47,554 Lb
Cruise altitude	34,800 Ft
Specific range	.076 NMPP
Mach	0.86
Speed (TAS)	494 Kt
Ground speed	444 Kt
Time	16.5 Min
Distance (air miles)	136 NM

The fuel consumed is 1790 pounds (136 NM/.076 NMPP).

### COMBAT OPERATIONS

The gross weight upon arrival at the combat zone is 46,764 pounds (48,554 lb - 1790 lb). Fuel available for combat is 4163 pounds (20,768 lb full fuel load - 10,500 lb start, taxi, accelerate, TO, climb, and cruise fuel to combat area - 6105 lb cruise return, descent, and landing reserve fuel).

The combat Fuel Flow charts (Part 9) are used to determine the fuel consumption during combat operations. Enter the applicable chart which most closely matches this configuration to determine the available combat time at maximum thrust. Assume combat operations reflect the pre-takeoff briefing requirements.

Combat Mach	1.5
Combat altitude	30,000 Ft
Maximum thrust (Standard Day)	
Fuel flow	920 PPM

With 4163 pounds of fuel available the combat time at these assumed combat conditions is 4.5 minutes. The remainder of the mission was predicated on departing the combat environment at 500 miles from the landing base at 39,000 feet altitude. As a conservative measure, calculations were based on weapon carriage throughout the entire combat period.

### POST COMBAT CLIMB - CONTINGENCY

In the event combat was completed at a lower altitude, climb fuel needed to reach return cruise altitude must be conserved by terminating combat earlier. Assuming that combat was completed at 10,000 feet altitude, use the climb charts (Part 3) to establish the climb fuel and distance needed to reach the return cruise altitude of 39,000 feet.

#### Military Thrust Climb

A. Gross weight	40,082 Lb
B. Cruise altitude	39,000 Ft
C. Start climb altitude	10,000 Ft
D. Drag index	7.4
E. Temperature deviation	0.0
F. Fuel required (to reach B)	1250 Lb

## SAMPLE TAKEOFF AND CRUISE

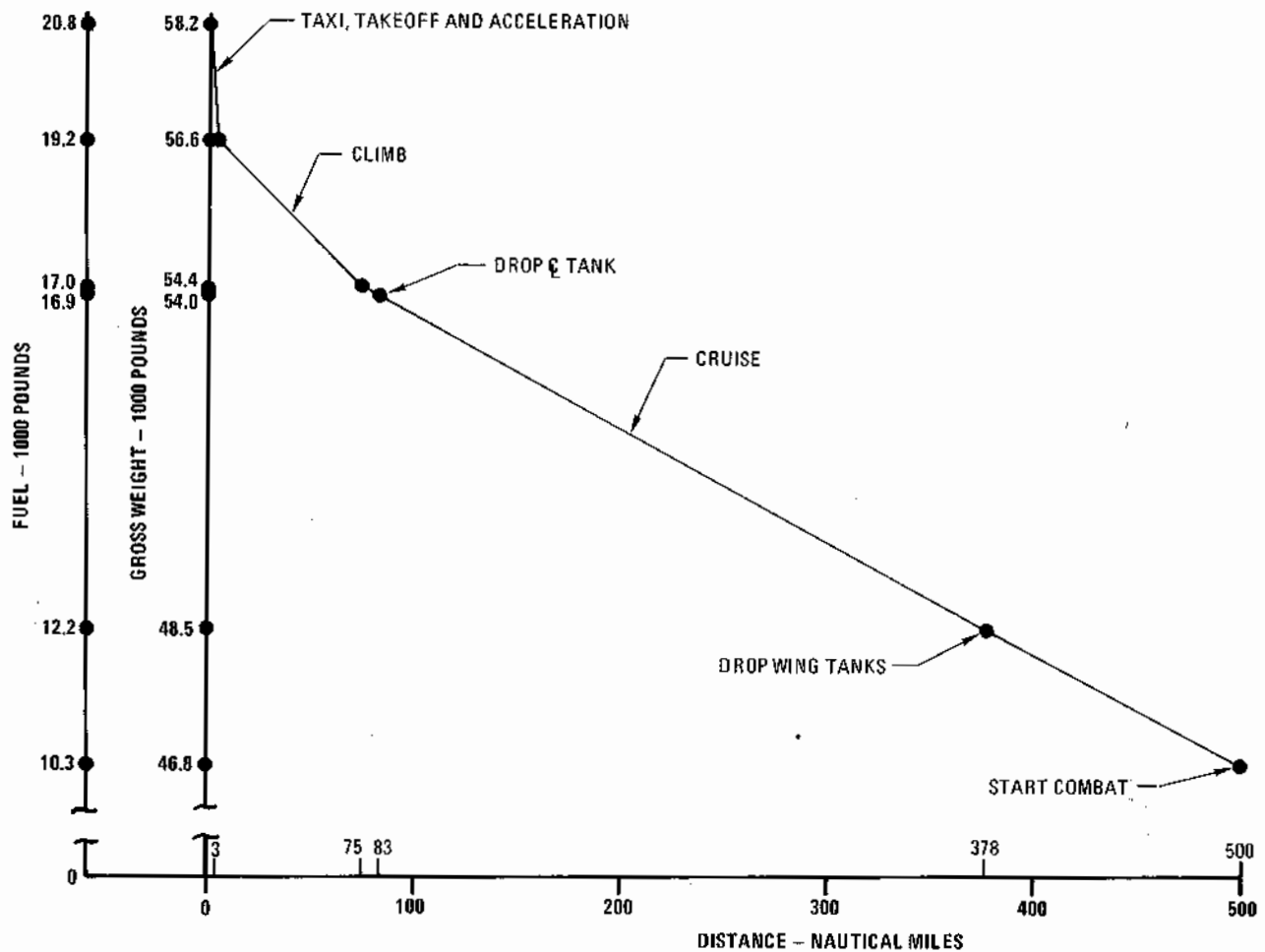

Figure A10-5

4E-1-(471)

G. Fuel required (to reach C)	300 Lb
H. Distance (to B)	55 NM
I. Distance (to C)	6 NM
J. Fuel needed to climb (F-G)	950 Lb
K. Distance during climb (H-I)	49 NM

Since cruise fuel consumption (previously computed) for this leg was .100 NMPP we can calculate the extra fuel needed by this change in the mission. Fuel required during the return cruise leg is 490 lb (49 NM/.100 NMPP). The revised return leg will require 660 lb (1150 lb - 490 lb) of additional fuel. Combat must be terminated 0.7 Min earlier (660/920) than originally planned to allow for this

contingency.

### MISSION PLANNING SUMMARY

A breakdown of the entire flight is shown in the Sample Mission Profile (figure A10-6), and Sample Mission Summary (figure A10-7). Any deviations from the planned mission factors (changes in headwind, excess combat time, and availability of air refueling) must be considered as the flight progresses to insure successful mission accomplishment.

# SAMPLE MISSION PROFILE

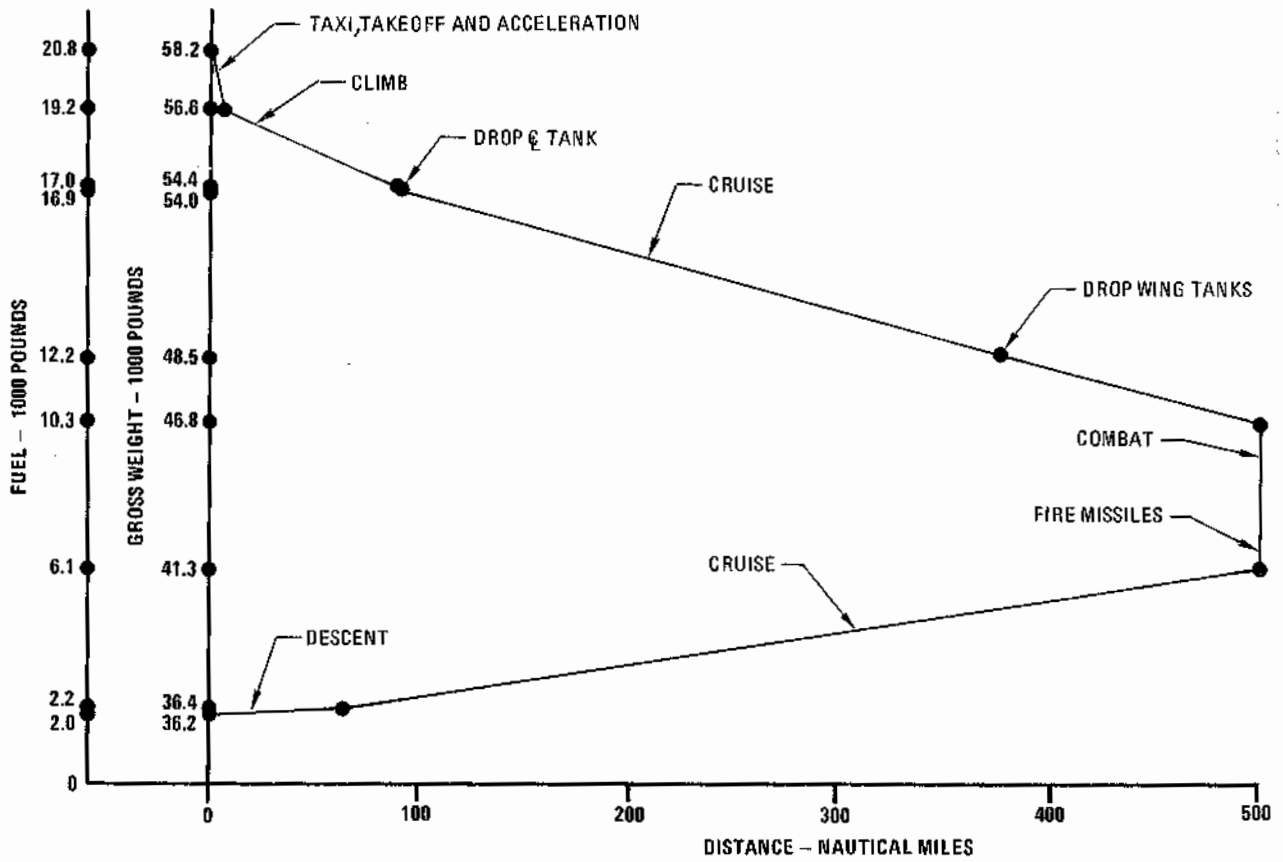

4E-1-(472)

Figure A10-6

**SAMPLE MISSION SUMMARY**

SEGMENT (CONFIGURATION)	INITIAL WEIGHT (LB)	DRAG INDEX	FUEL (LB)	TIME (MIN)	DISTANCE		ALTITUDE (FT)	SPEED MACH/TAS
					AIRNM	GROUNDNM		
MAXIMUM THRUST TAKEOFF	57,534	41.0	1575	0.8	3	3	SEA LEVEL	ACCELERATE
MILITARY THRUST CLIMB TO OPTIMUM	56,609	41.0	2200	9.5	80	72	32,000	CLIMBSCHEDULE
CRUISE AT OPTIMUM (3 EXTERNAL TANKS AND 8 MISSILES)	54,409	41.0	125	1.0	8	7	32,000	.85/497
CRUISE AT OPTIMUM (EXTERNAL WING TANKS AND 8 MISSILES)	53,980	31.4	4810	39.5	332	296	32,000-33,600	.855/500
CRUISE AT OPTIMUM (8 MISSILES)	48,554	18.6	1790	16.5	136	122	33,600-34,800	.86/494
COMBAT PERFORMANCE (8 MISSILES)	46,764	18.6	4163	4.5	-	-	30,000	1.5/-
CRUISE AT OPTIMUM (2 PYLONS AND MISSILE LAUNCHERS)	41,251	7.4	3860	47.9	396	436	39,000-40,900	.865/495
LONG RANGE DESCENT TO AIR BASE (2 PYLONS AND MISSILE LAUNCHERS)	36,391	7.4	245	11.0	62	64	40,900 TO SEA LEVEL	250 KIAS
APPROACH & LANDING RESERVE	36,146	7.4	2000	10.0	-	-	SEA LEVEL	-
<b>TOTAL</b>			20,768	140.7	(2 HR. 20.7 MIN.)			

4E-1-(473)

Figure A10-7

## SECTION XI

# FOLDOUT ILLUSTRATIONS

---

### TABLE OF CONTENTS

General Arrangement.....	F0-3	Flight Controls .....	F0-15
Airplane and Engine Fuel System.....	F0-5	Ejection Seats .....	F0-17
Electrical System .....	F0-7	Front Cockpit.....	F0-19
AC/DC Electrical Distribution .....	F0-9	Rear Cockpit .....	F0-21
Hydraulic System.....	F0-11	Circuit Breakers .....	F0-27
Pneumatic System .....	F0-13		



# GENERAL ARRANGEMENT

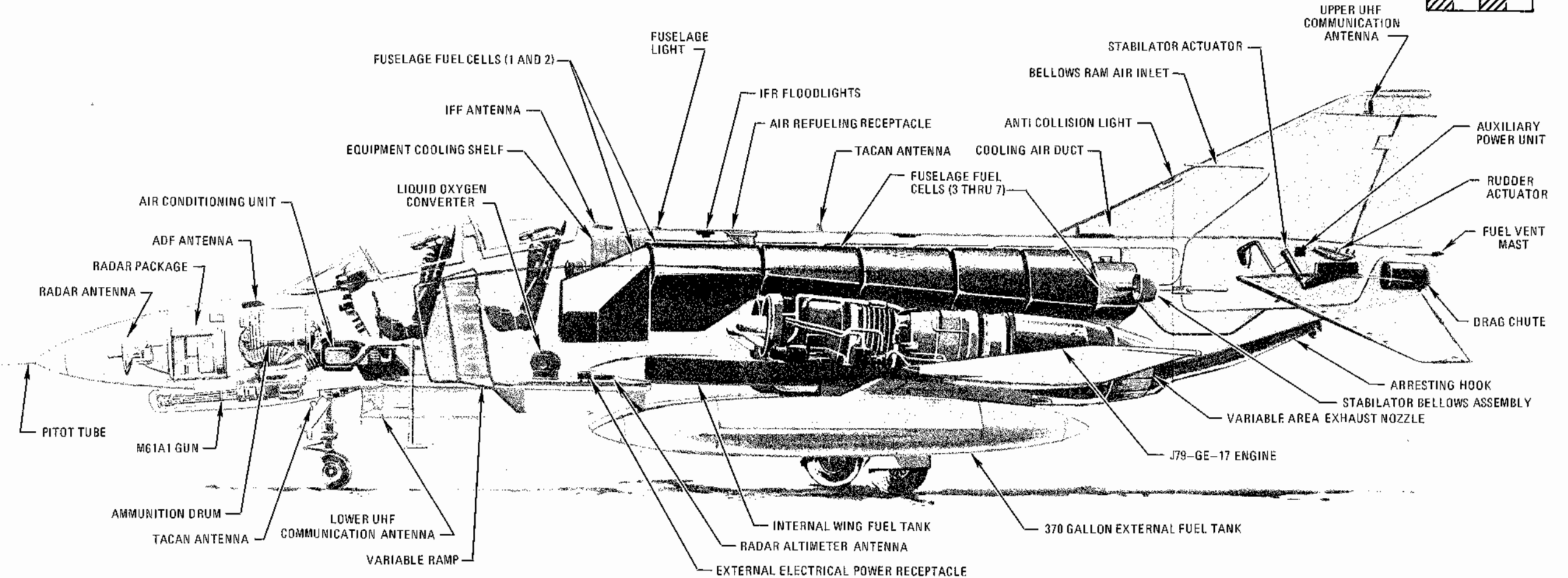
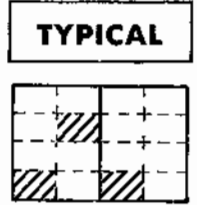

GENERAL ARRANGEMENT

4E-1 (17)A

Figure FO-1

Figure FO-1  
FO-3/(FO-4 blank)

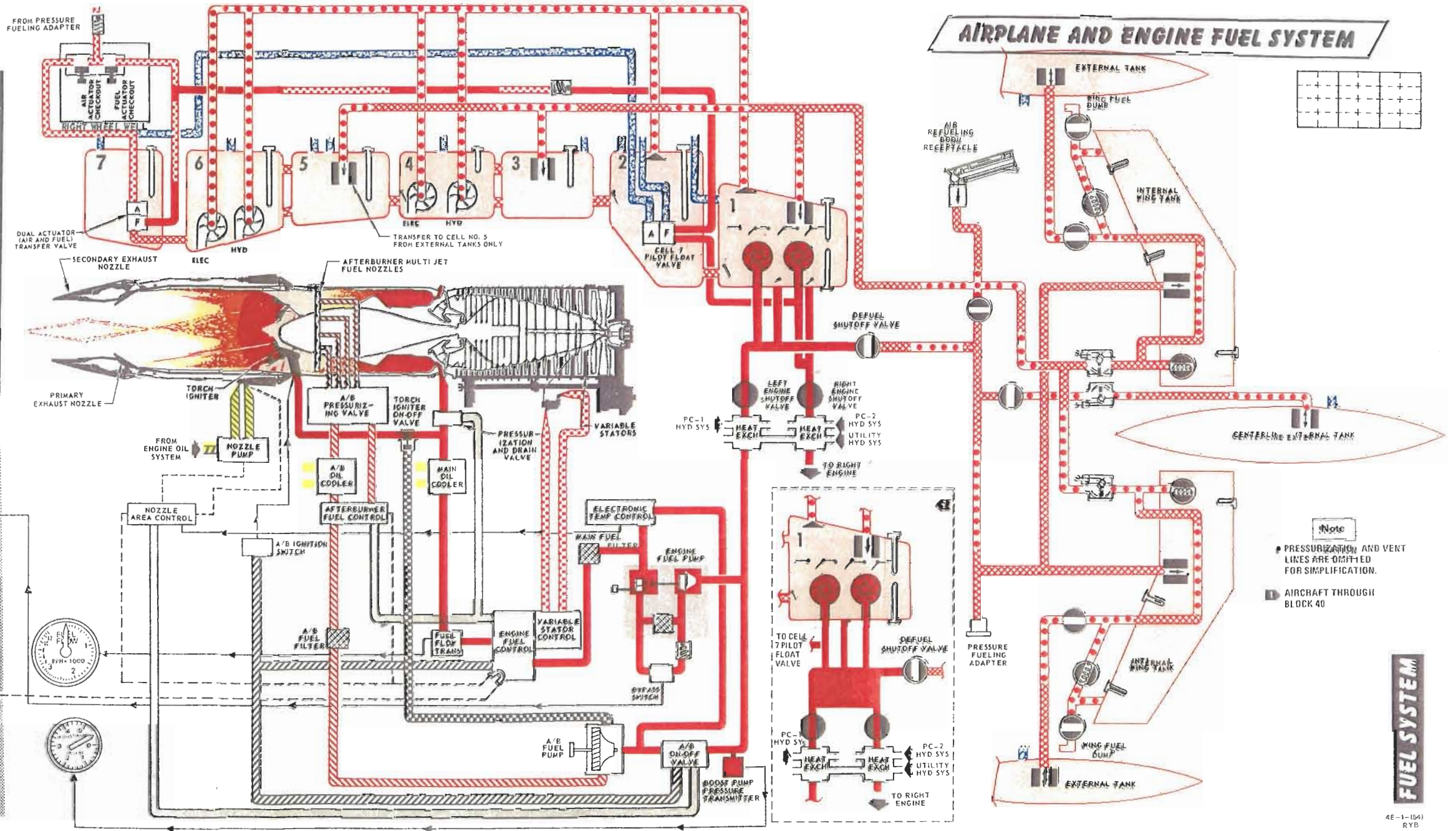
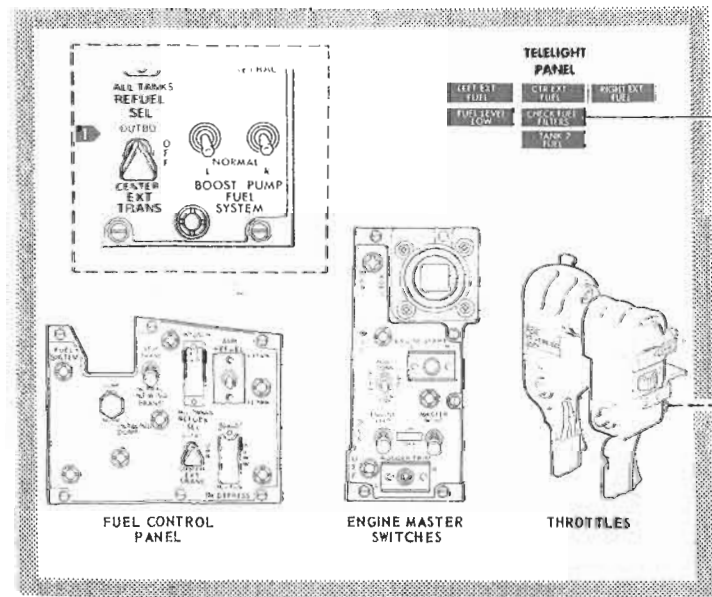
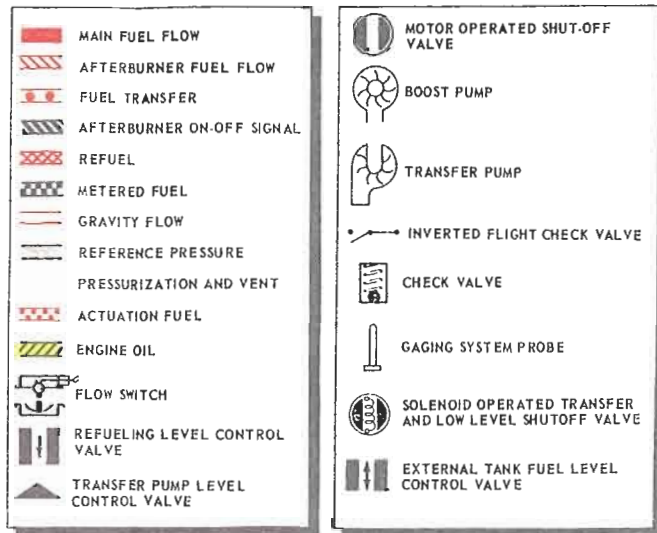

Figure FO-2

Figure FO-2  
FO-5/(FO-6 blank)



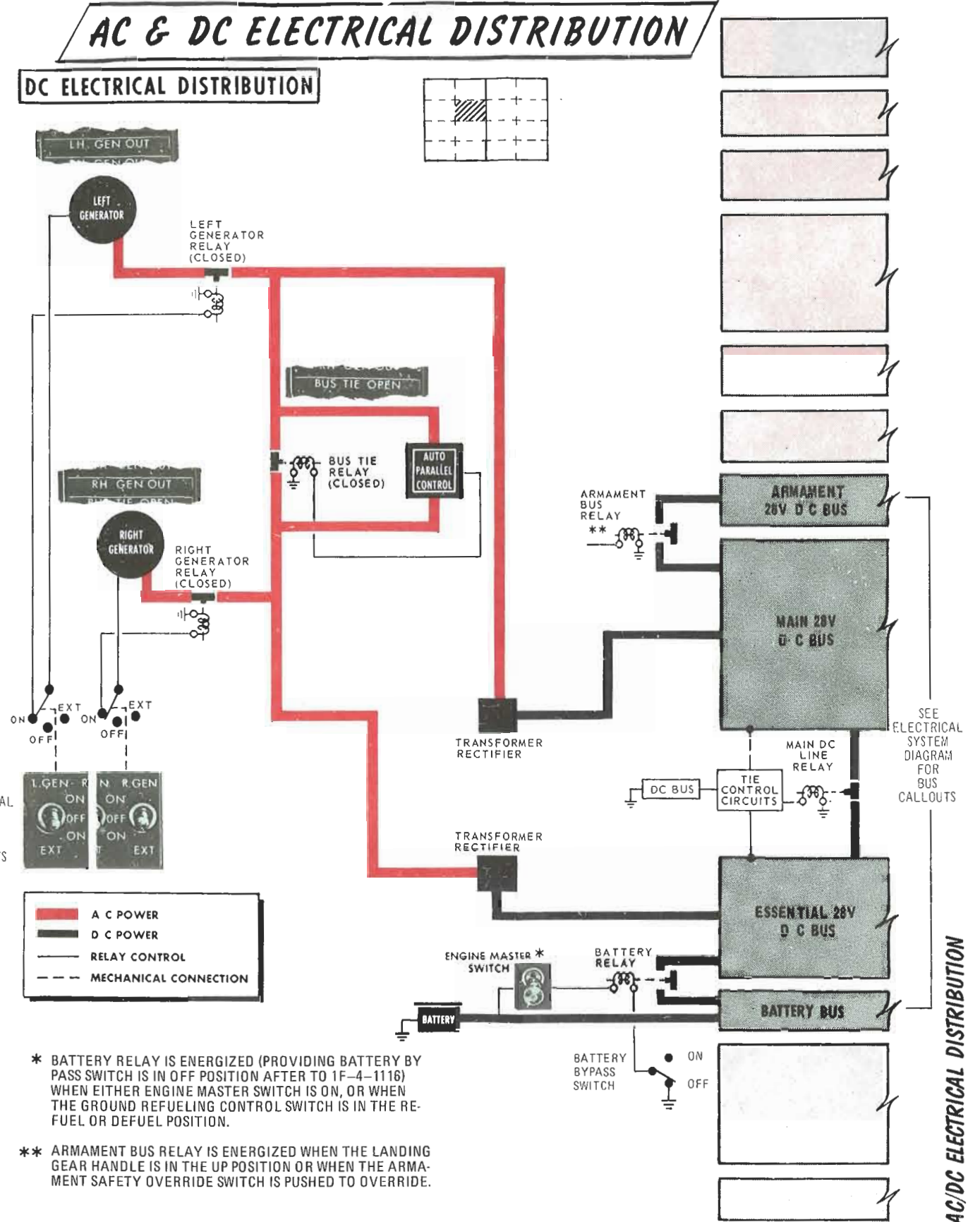
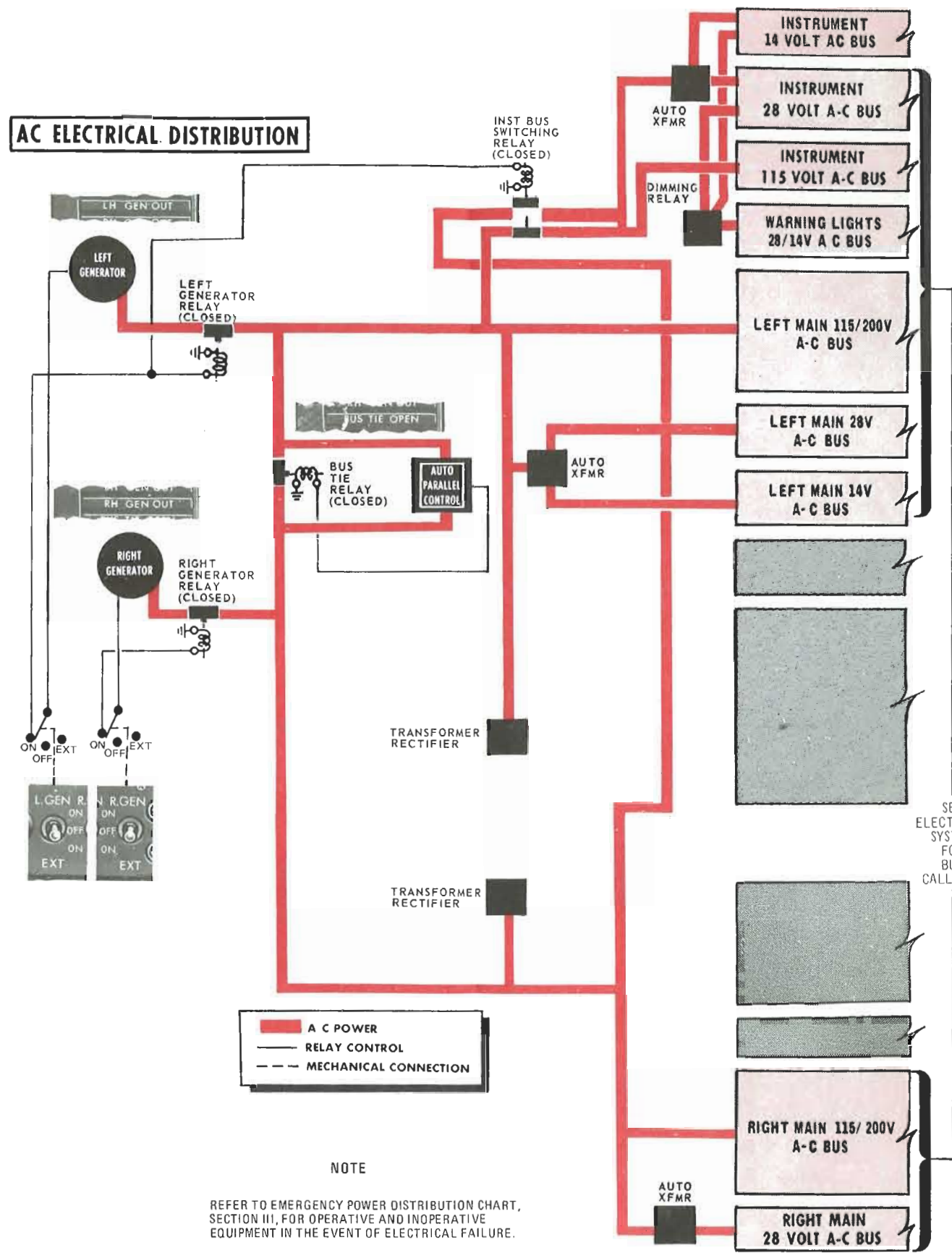

Figure FO-4

Figure FO-4  
 FO-9/(FO-10 blank)

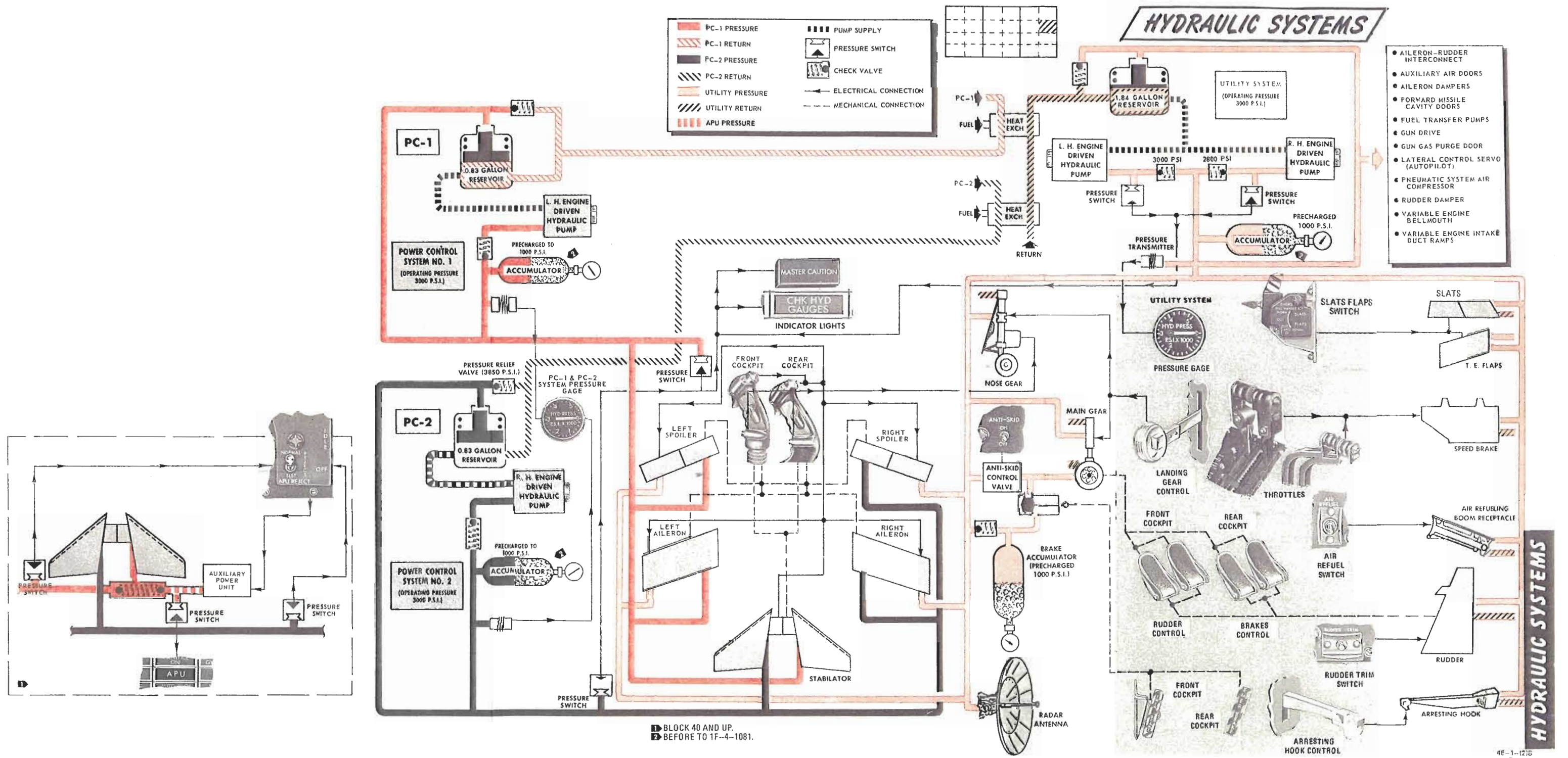

Figure FO-5

Figure FO-5  
FO-11/(FO-12 blank)

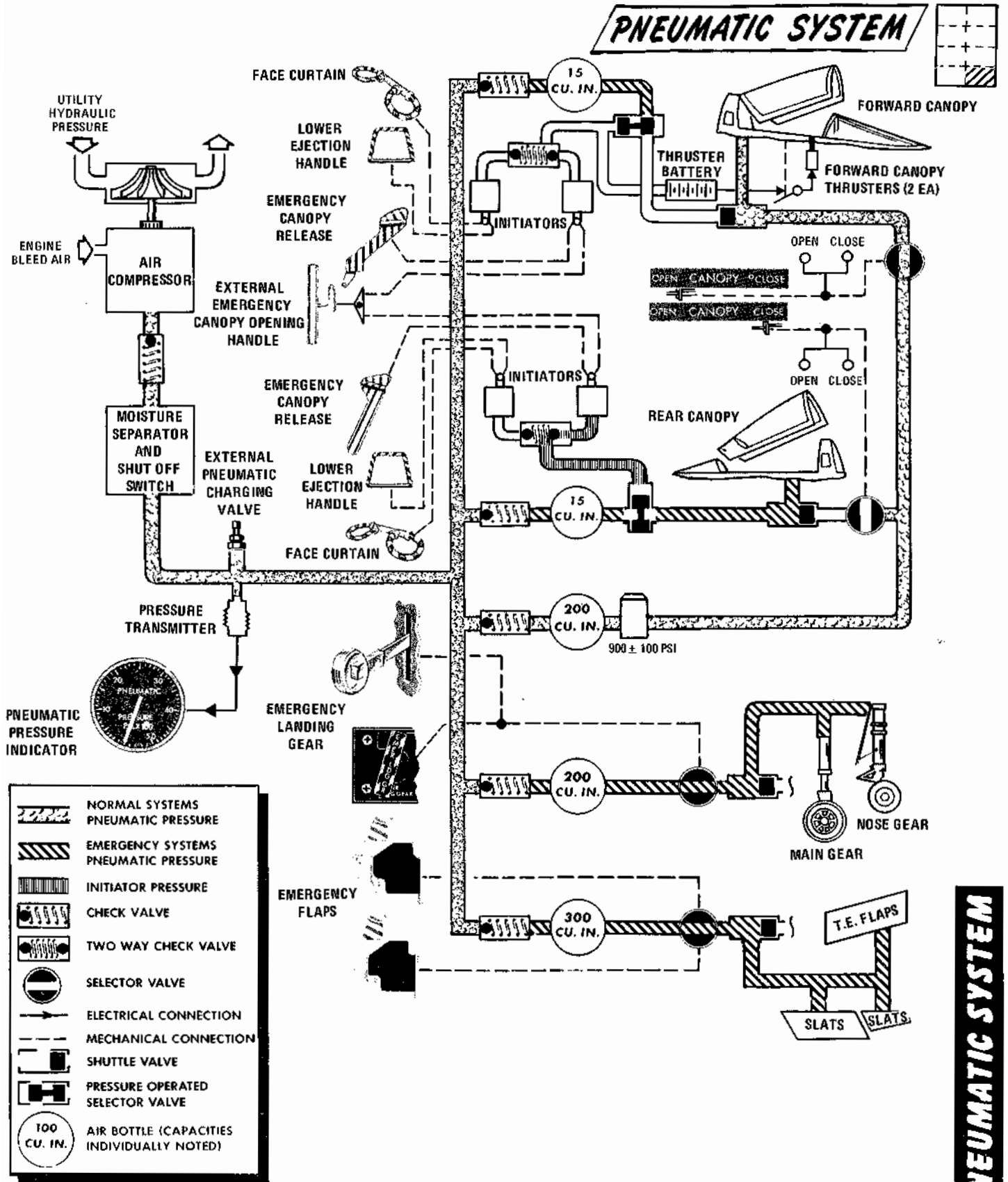
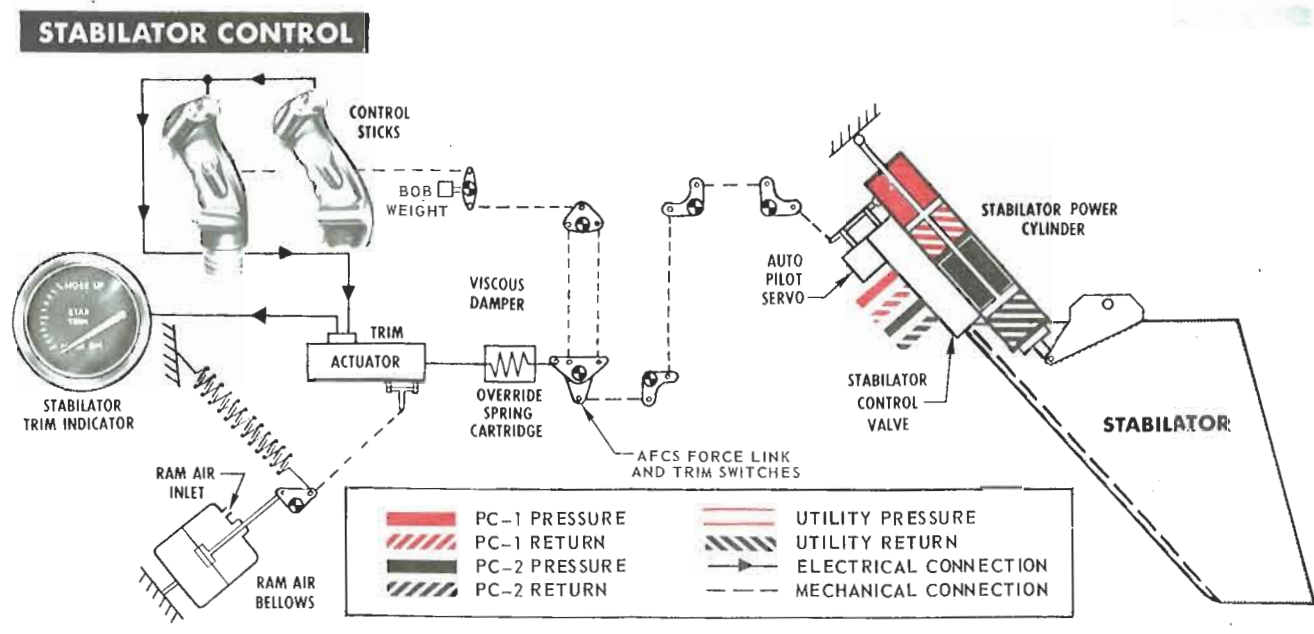
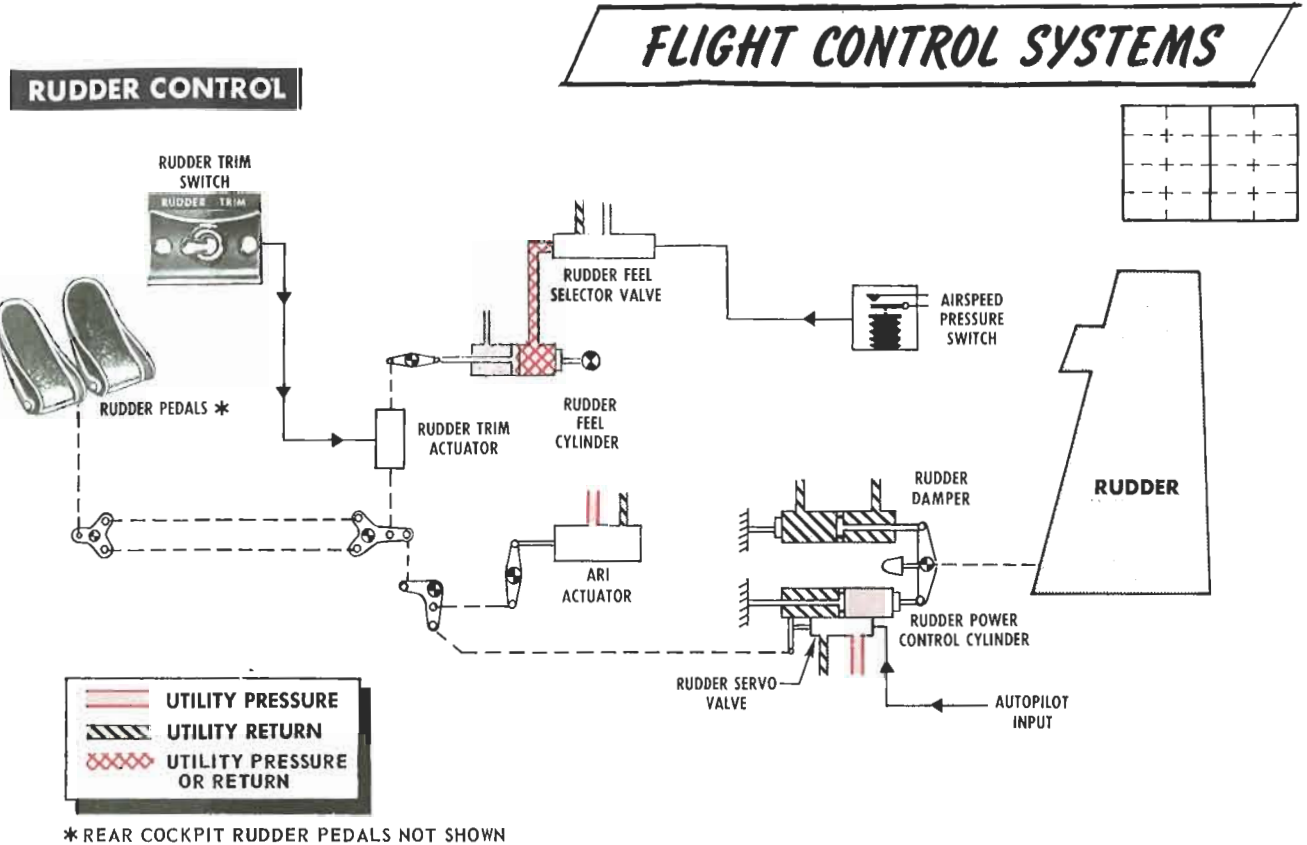
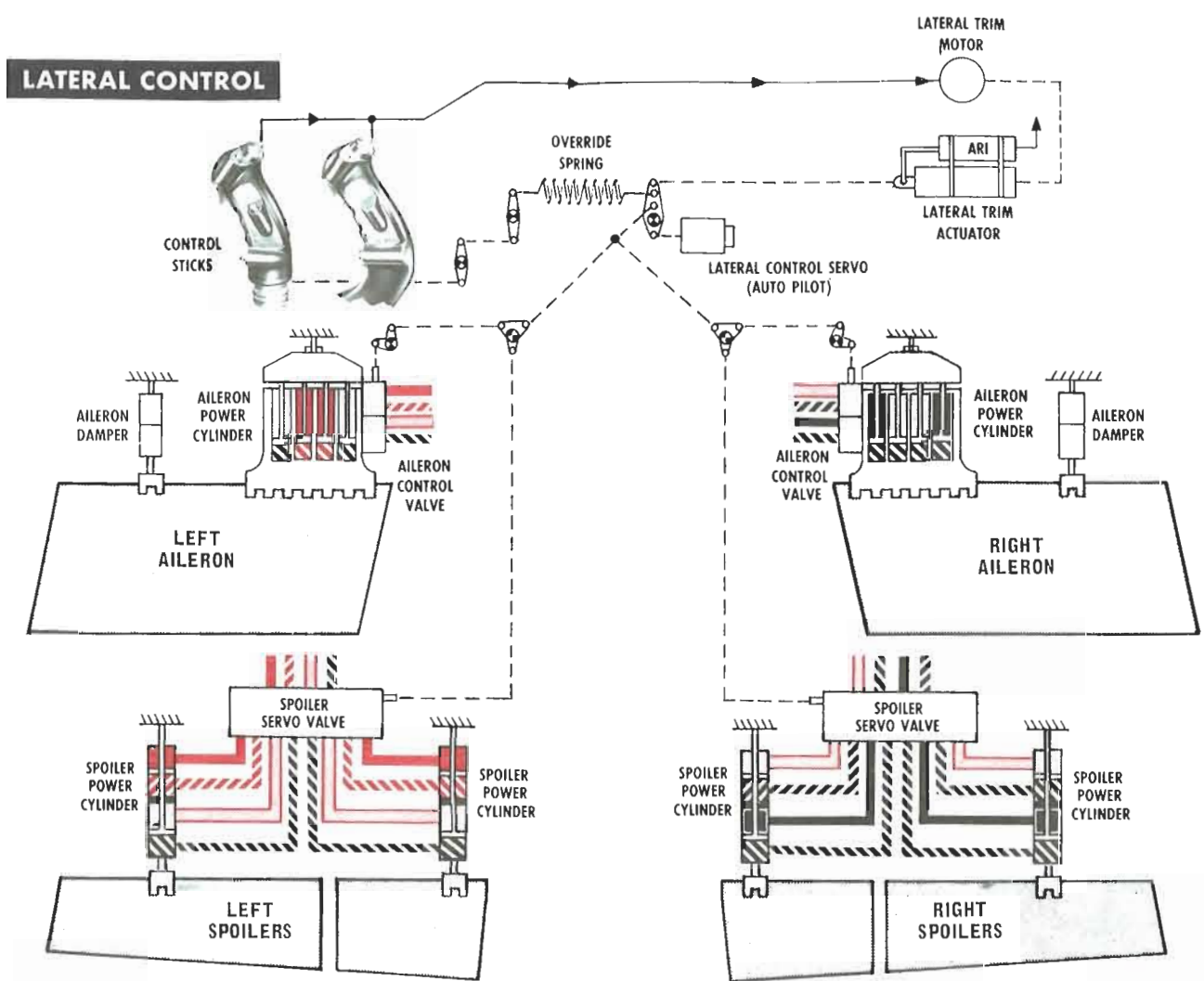

Figure FO-6

4E-1-(1)A

Figure FO-6

FO-13/(FO-14 blank)



# FLIGHT CONTROL SYSTEMS

**FLIGHT CONTROLS**

Figure FO-7

Figure FO-7  
FO-15/(FO-16 blank)





LEFT CONSOLE AREA

- 1 UTILITY PANEL (LEFT)
- 2 OXYGEN CONTROL PANEL
- 3 AGM CONTROL HANDLE
- 4 ENGINE CONTROL PANEL (INBOARD)
- 5 THROTTLES
- 6 ENGINE CONTROL PANEL (OUTBOARD)
- 7 EJECT LIGHT/SWITCH
- 8 FLAP/SLATS CONTROL PANEL
- 9 CANOPY SELECTOR
- 10 EXTRA PICTURE SWITCH
- 11 GUN CAMERA SWITCH
- 12 FUEL CONTROL PANEL
- 13 AUTOMATIC FLIGHT CONTROL SYSTEM CONTROL PANEL
- 14 DRAG CHUTE CONTROL HANDLE
- 15 INTERCOM SYSTEM CONTROL PANEL
- 16 SLATS OVERRIDE SWITCH
- 17 BOARDING STEPS POSITION INDICATOR
- 18 AUXILIARY ARMAMENT CONTROL PANEL
- 19 BLANK PANEL
- 20 ANTI-G SUIT CONTROL VALVE
- 21 ARMAMENT SAFETY OVERRIDE SWITCH

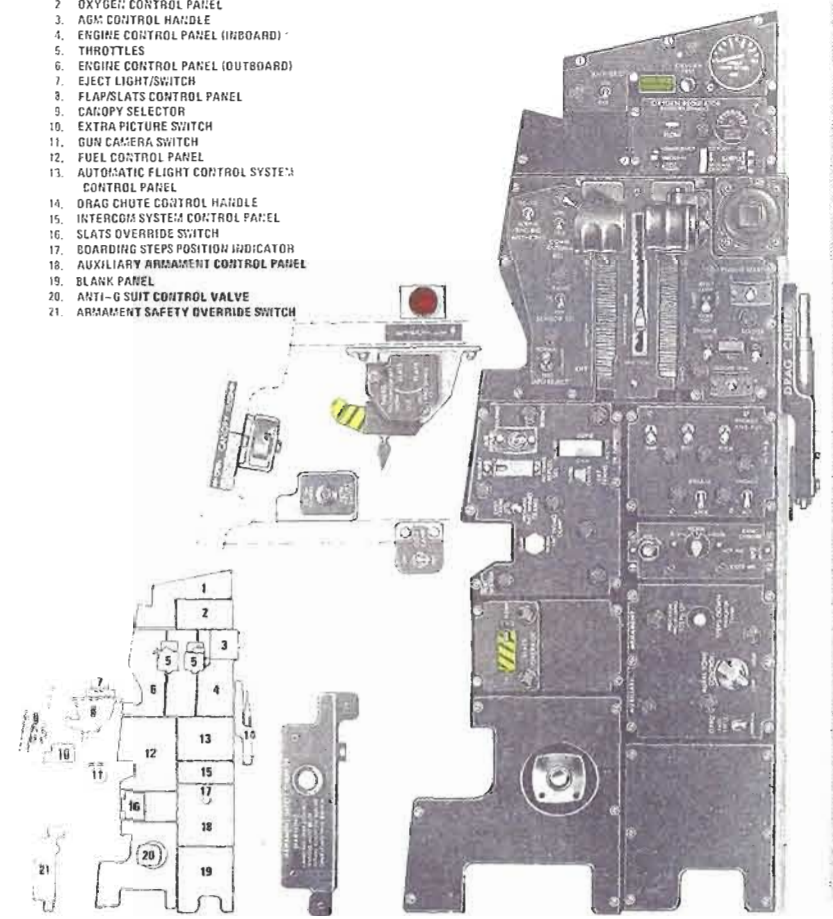

MAIN PANEL AREA

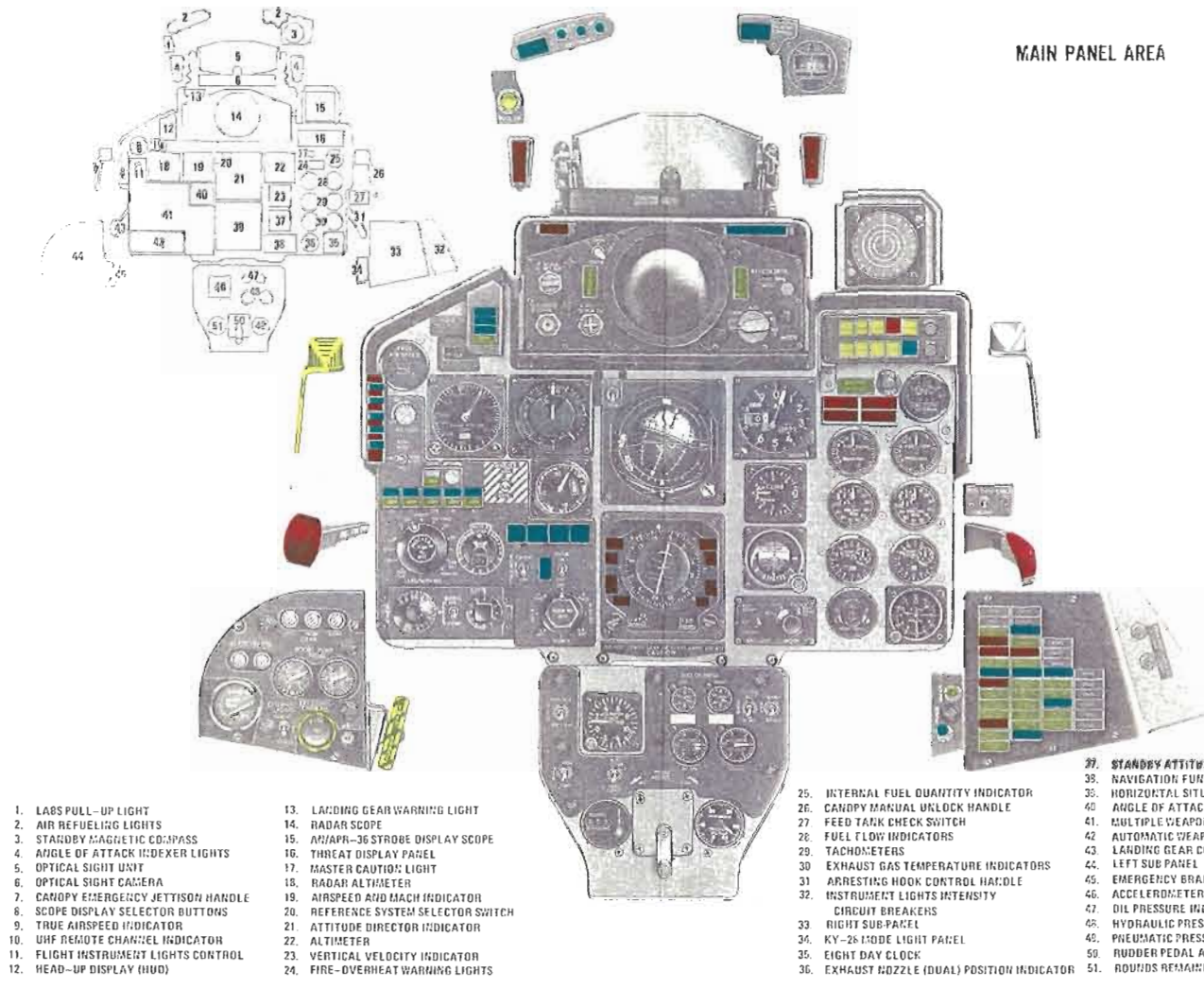

- 1. LABS PULL-UP LIGHT
- 2. AIR REFUELING LIGHTS
- 3. STANDBY MAGNETIC COMPASS
- 4. ANGLE OF ATTACK INDEXER LIGHTS
- 5. OPTICAL SIGHT UNIT
- 6. OPTICAL SIGHT CAMERA
- 7. CANOPY EMERGENCY JETTISON HANDLE
- 8. SCOPE DISPLAY SELECTOR BUTTONS
- 9. TRUE AIRSPEED INDICATOR
- 10. UHF REMOTE CHANNEL INDICATOR
- 11. FLIGHT INSTRUMENT LIGHTS CONTROL
- 12. HEAD-UP DISPLAY (HUD)
- 13. LANDING GEAR WARNING LIGHT
- 14. RADAR SCOPE
- 15. AN/APR-36 STROBE DISPLAY SCOPE
- 16. THREAT DISPLAY PANEL
- 17. MASTER CAUTION LIGHT
- 18. RADAR ALTIMETER
- 19. AIRSPEED AND MACH INDICATOR
- 20. REFERENCE SYSTEM SELECTOR SWITCH
- 21. ATTITUDE DIRECTOR INDICATOR
- 22. ALTIMETER
- 23. VERTICAL VELOCITY INDICATOR
- 24. FIRE-OVERHEAT WARNING LIGHTS
- 25. INTERNAL FUEL QUANTITY INDICATOR
- 26. CANOPY MANUAL UNLOCK HANDLE
- 27. FUEL TANK CHECK SWITCH
- 28. FUEL FLOW INDICATORS
- 29. TACHOMETERS
- 30. EXHAUST GAS TEMPERATURE INDICATORS
- 31. ARRESTING HOOK CONTROL HANDLE
- 32. INSTRUMENT LIGHTS INTENSITY CIRCUIT BREAKERS
- 33. RIGHT SUB-PANEL
- 34. KY-26-150DE LIGHT PANEL
- 35. EIGHT DAY CLOCK
- 36. EXHAUST NOZZLE (DUAL) POSITION INDICATOR
- 37. STANDBY ATTITUDE INDICATOR
- 38. NAVIGATION FUNCTION SELECTOR PANEL
- 39. HORIZONTAL SITUATION INDICATOR
- 40. ANGLE OF ATTACK INDICATOR
- 41. MULTIPLE WEAPONS SELECTOR PANEL
- 42. AUTOMATIC WEAPONS RELEASE UNIT
- 43. LANDING GEAR CONTROL HANDLE
- 44. LEFT SUB-PANEL
- 45. EMERGENCY BRAKE CONTROL HANDLE
- 46. ACCELEROMETER
- 47. OIL PRESSURE INDICATORS
- 48. HYDRAULIC PRESSURE INDICATORS
- 49. PNEUMATIC PRESSURE INDICATOR
- 50. RUDDER PEDAL ADJUSTMENT CRANK
- 51. ROUNDS REMAINING INDICATOR

RIGHT CONSOLE AREA

FRONT COCKPIT TYPICAL



- 1. GENERATOR CONTROL PANEL
- 2. COOLING INDICATION CONTROL PANEL
- 3. ONI EQUIPMENT COOLING RESET BUTTON
- 4. EMERGENCY VENT HANDLE
- 5. UTILITY PANEL (RIGHT)
- 6. DEFOG/FOOT HEAT CONTROL HANDLE
- 7. NAVIGATION CONTROL PANEL
- 8. CIRCUIT BREAKER PANEL
- 9. TEMPERATURE CONTROL PANEL
- 10. IFF CONTROL PANEL
- 11. DCU-94A BOMB CONTROL MONITOR PANEL
- 12. COMPASS CONTROL PANEL
- 13. COCKPIT LIGHTS CONTROL PANEL
- 14. KY-26 CONTROL PANEL
- 15. BLANK PANEL
- 16. EXTERIOR LIGHTS CONTROL PANEL
- 17. UTILITY ELECTRICAL RECEPTACLE
- 18. INSTRUMENT LIGHTS INTENSITY CONTROL PANEL
- 19. STANDBY ATTITUDE CIRCUIT BREAKER AND INTENSITY CONTROL PANEL
- 20. EMERGENCY FLOODLIGHTS PANEL

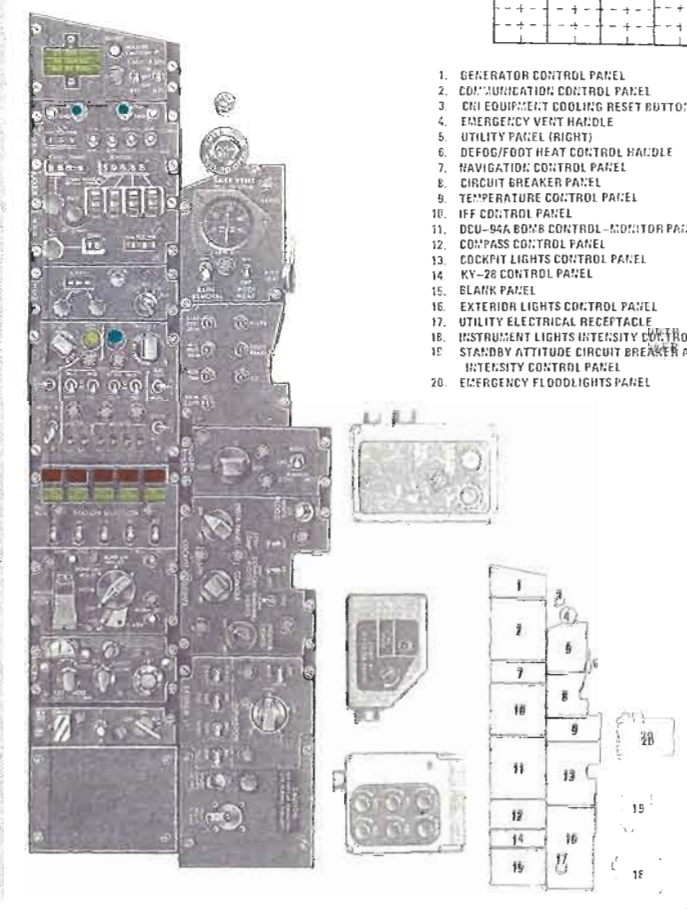

Figure FO-9

Figure FO-9 FO-19/(FO-20 blank)

FRONT COCKPIT F-4E

LEFT CONSOLE AREA

- 1. AGM-65 TRACKING MODE SWITCH
- 2. TISED CONTROL PANEL
- 3. INTERCOM CONTROL PANEL
- 4. RADAR CONTROL PANEL
- 5. COMMUNICATION CONTROL PANEL
- 6. NAVIGATION CONTROL PANEL
- 7. OXYGEN/CABIN ALTIMETER PANEL
- 8. ANTI-G SUIT CONTROL VALVE
- 9. EMERGENCY SLATS/FLAPS CONTROL PANEL
- 10. CANOPY SELECTOR
- 11. PULL UP TONE CUTOUT SWITCH
- 12. BLANK PANEL
- 13. THROTTLES
- 14. BLACK PANEL
- 15. BLACK PANEL

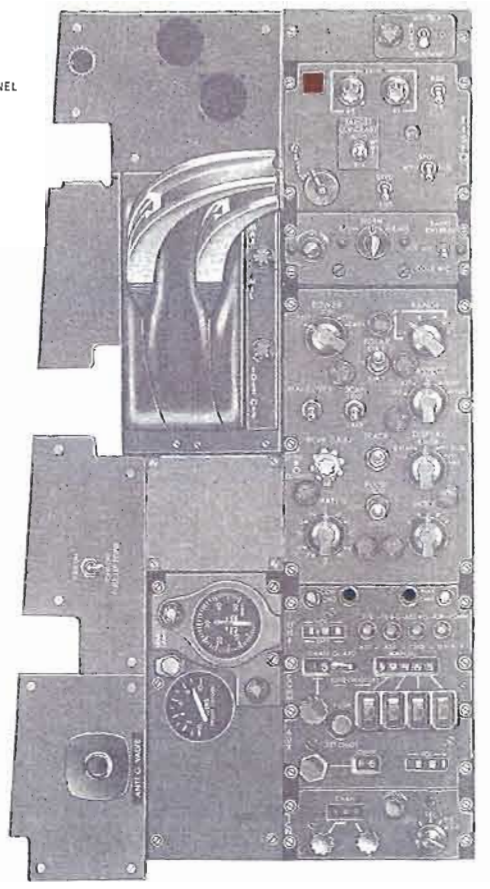

MAIN PANEL AREA



- 1. COMMAND SELECTOR VALVE
- 2. STANDBY MAGNETIC COMPASS
- 3. KY-28 MODE LIGHT PANEL (THRU BLK 45 ONLY)
- 4. THREAT DISPLAY PANEL
- 5. ANGLE OF ATTACK INDEXER & ACTIVITY LIGHTS
- 6. UHF CHANNEL REMOTE INDICATOR
- 7. VERTICAL VELOCITY INDICATOR
- 8. ANGLE OF ATTACK INDICATOR
- 9. ALTIMETER
- 10. RANGE INDICATOR
- 11. ALTITUDE INDICATOR
- 12. AIRSPEED-MACH INDICATOR
- 13. EIGHT DAY CLOCK
- 14. ACCELEROMETER
- 15. TURN AND SLIP INDICATOR

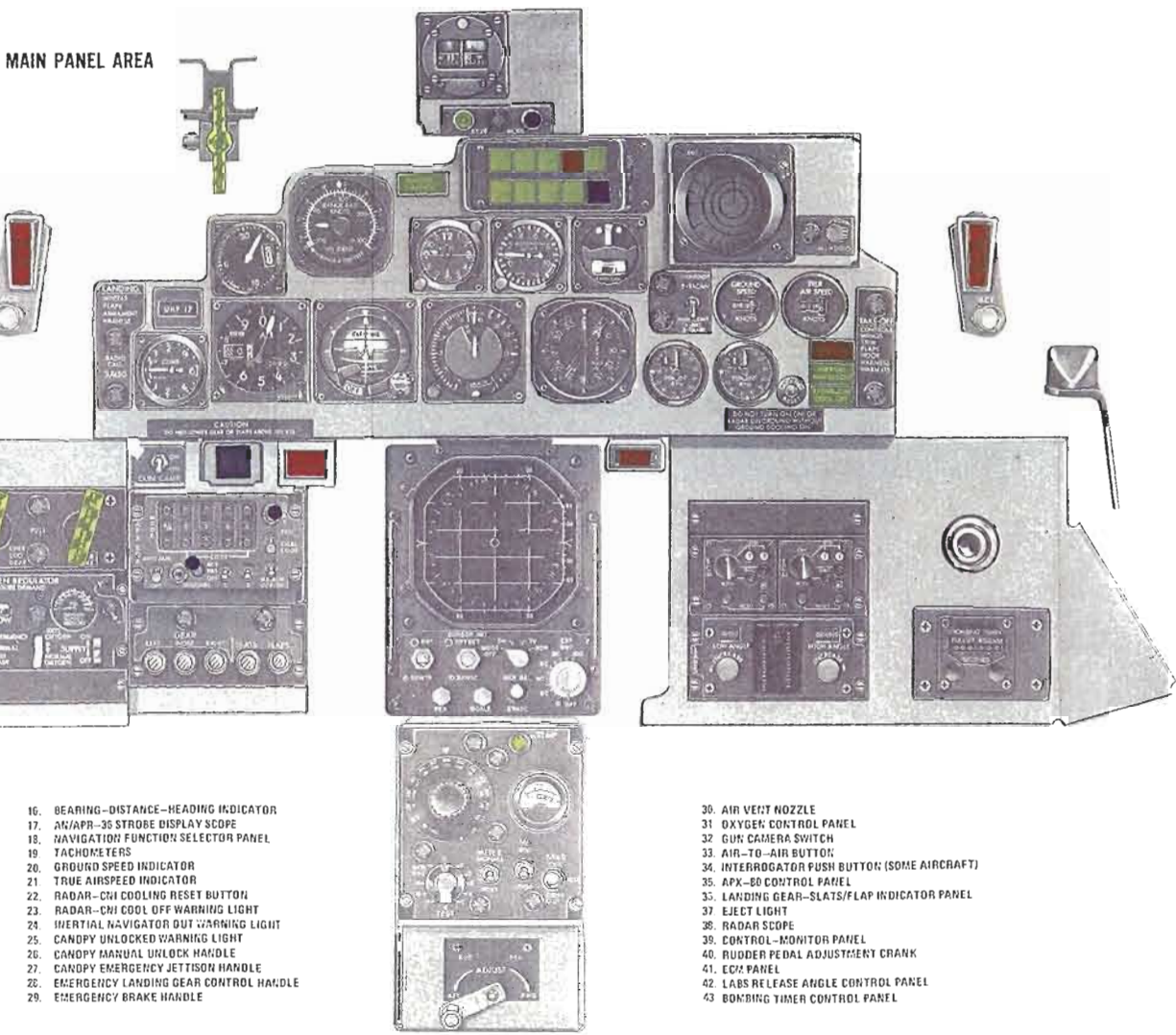

- 16. BEARING-DISTANCE-HEADING INDICATOR
- 17. AN/APR-35 STROBE DISPLAY SCOPE
- 18. NAVIGATION FUNCTION SELECTOR PANEL
- 19. TACHOMETERS
- 20. GROUND SPEED INDICATOR
- 21. TRUE AIRSPEED INDICATOR
- 22. RADAR-CRI COOLING RESET BUTTON
- 23. RADAR-CRI COOL OFF WARNING LIGHT
- 24. INERTIAL NAVIGATOR OUT WARNING LIGHT
- 25. CANOPY UNLOCKED WARNING LIGHT
- 26. CANOPY MANUAL UNLOCK HANDLE
- 27. CANOPY EMERGENCY JETTISON HANDLE
- 28. EMERGENCY LANDING GEAR CONTROL HANDLE
- 29. EMERGENCY BRAKE HANDLE

- 30. AIR VECT NOZZLE
- 31. OXYGEN CONTROL PANEL
- 32. GUN CAMERA SWITCH
- 33. AIR-TO-AIR BUTTON
- 34. INTERROGATOR PUSH BUTTON (SOME AIRCRAFT)
- 35. APX-80 CONTROL PANEL
- 36. LANDING GEAR-SLATS/FLAP INDICATOR PANEL
- 37. EJECT LIGHT
- 38. RADAR SCOPE
- 39. CONTROL-MONITOR PANEL
- 40. RUDDER PEDAL ADJUSTMENT CRANK
- 41. ECM PANEL
- 42. LABS RELEASE ANGLE CONTROL PANEL
- 43. BOMBING TIMER CONTROL PANEL

RIGHT CONSOLE AREA

REAR COCKPIT

TYPICAL

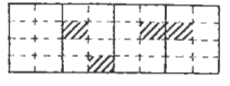

- 1. DIRECT RADAR SCOPE CAMERA CONTROL PANEL
- 2. INERTIAL NAVIGATOR CONTROL PANEL
- 3. RADAR ANTENNA CONTROL PANEL
- 4. STALL WARNING TONE CONTROL PANEL
- 5. EXTRA PICTURE SWITCH
- 6. CURSOR CONTROL PANEL
- 7. NUCLEAR STORE CONSENT SWITCH
- 8. SST-181X PULSE SELECTOR SWITCH
- 9. COCKPIT LIGHTS CONTROL PANEL
- 10. NAVIGATION CONTROL PANEL
- 11. WEAPONS RELEASE COMPUTER CONTROL PANEL
- 12. WEAPON DELIVERY PANEL

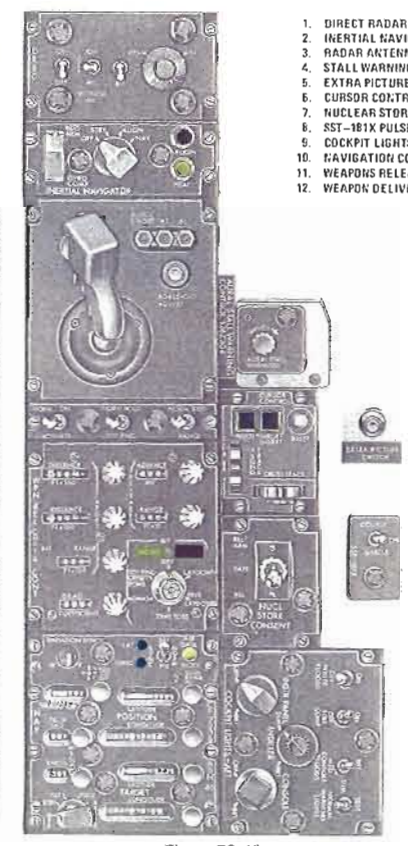
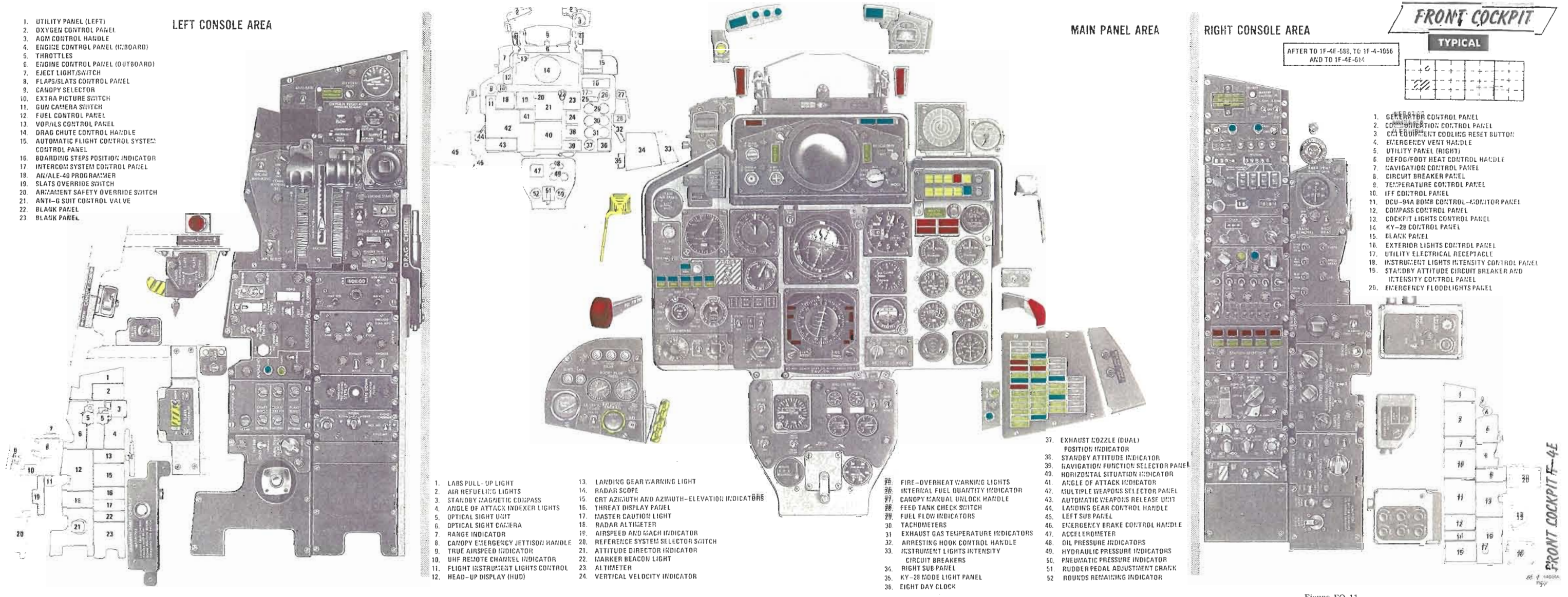

Figure FO-10

Figure FO-10  
FO-21/(FO-22 blank)

REAR COCKPIT F-4E



LEFT CONSOLE AREA

1. UTILITY PANEL (LEFT)
2. OXYGEN CONTROL PANEL
3. AGM CONTROL HANDLE
4. ENGINE CONTROL PANEL (INBOARD)
5. THROTTLES
6. ENGINE CONTROL PANEL (OUTBOARD)
7. EJECT LIGHT/SWITCH
8. FLAPS/SLATS CONTROL PANEL
9. CANOPY SELECTOR
10. EXTRA PICTURE SWITCH
11. GUN CAMERA SWITCH
12. FUEL CONTROL PANEL
13. VOR/LS CONTROL PANEL
14. DRAG CHUTE CONTROL HANDLE
15. AUTOMATIC FLIGHT CONTROL SYSTEM CONTROL PANEL
16. BOARDING STEPS POSITION INDICATOR
17. INTERCOM SYSTEM CONTROL PANEL
18. AN/ALE-40 PROGRAMMER
19. SLATS OVERRIDE SWITCH
20. ARGUMENT SAFETY OVERRIDE SWITCH
21. ANTI-G SUIT CONTROL VALVE
22. BLANK PANEL
23. BLANK PANEL

MAIN PANEL AREA

RIGHT CONSOLE AREA

FRONT COCKPIT

TYPICAL

AFTER TO 1F-4E-588, TO 1F-4-1056 AND TO 1F-4E-514

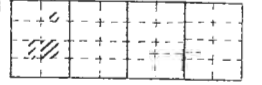

1. GENERATOR CONTROL PANEL
2. COMMUNICATION CONTROL PANEL
3. CEM EQUIPMENT COOLING RESET BUTTON
4. EMERGENCY VENT HANDLE
5. UTILITY PANEL (RIGHT)
6. DEFOG/FOOT HEAT CONTROL HANDLE
7. NAVIGATION CONTROL PANEL
8. CIRCUIT BREAKER PANEL
9. TEMPERATURE CONTROL PANEL
10. IFF CONTROL PANEL
11. DCU-94A BOMB CONTROL MONITOR PANEL
12. COMPASS CONTROL PANEL
13. COCKPIT LIGHTS CONTROL PANEL
14. KY-28 CONTROL PANEL
15. BLANK PANEL
16. EXTERIOR LIGHTS CONTROL PANEL
17. UTILITY ELECTRICAL RECEPTACLE
18. INSTRUMENT LIGHTS INTENSITY CONTROL PANEL
19. STANDBY ATTITUDE CIRCUIT BREAKER AND INTENSITY CONTROL PANEL
20. EMERGENCY FLOODLIGHTS PANEL

1. LABS PULL-UP LIGHT
2. AIR REFUELING LIGHTS
3. STANDBY MAGNETIC COMPASS
4. ANGLE OF ATTACK INDEXER LIGHTS
5. OPTICAL SIGHT UNIT
6. OPTICAL SIGHT CAMERA
7. RANGE INDICATOR
8. CANOPY EMERGENCY JETTISON HANDLE
9. TRUE AIRSPEED INDICATOR
10. UHF REMOTE CHANNEL INDICATOR
11. FLIGHT INSTRUMENT LIGHTS CONTROL
12. HEAD-UP DISPLAY (HUD)

13. LANDING GEAR WARNING LIGHT
14. RADAR SCOPE
15. CRT AZIMUTH AND AZIMUTH-ELEVATION INDICATORS
16. THREAT DISPLAY PANEL
17. MASTER CAUTION LIGHT
18. RADAR ALTIMETER
19. AIRSPEED AND GACH INDICATOR
20. REFERENCE SYSTEM SELECTOR SWITCH
21. ATTITUDE DIRECTOR INDICATOR
22. MARKER BEACON LIGHT
23. ALTIMETER
24. VERTICAL VELOCITY INDICATOR

25. FIRE-OVERHEAT WARNING LIGHTS
26. INTERNAL FUEL QUANTITY INDICATOR
27. CANOPY MANUAL UNLOCK HANDLE
28. FEED TANK CHECK SWITCH
29. FUEL FLOW INDICATORS
30. TACHOMETERS
31. EXHAUST GAS TEMPERATURE INDICATORS
32. ARRESTING HOOK CONTROL HANDLE
33. INSTRUMENT LIGHTS INTENSITY CIRCUIT BREAKERS
34. RIGHT SUB PANEL
35. KY-28 MODE LIGHT PANEL
36. EIGHT DAY CLOCK

37. EXHAUST NOZZLE (DUAL) POSITION INDICATOR
38. STANDBY ATTITUDE INDICATOR
39. NAVIGATION FUNCTION SELECTOR PANEL
40. HORIZONTAL SITUATION INDICATOR
41. ANGLE OF ATTACK INDICATOR
42. MULTIPLE WEAPONS SELECTOR PANEL
43. AUTOMATIC WEAPONS RELEASE UNIT
44. LANDING GEAR CONTROL HANDLE
45. LEFT SUB PANEL
46. EMERGENCY BRAKE CONTROL HANDLE
47. ACCELEROMETER
48. OIL PRESSURE INDICATORS
49. HYDRAULIC PRESSURE INDICATORS
50. PNEUMATIC PRESSURE INDICATOR
51. RUDDER PEDAL ADJUSTMENT CRANK
52. ROUNDS REMAINING INDICATOR

Figure FO-11

Figure FO-11  
FO-23/(FO-24 blank)

FRONT COCKPIT F-4E

LEFT CONSOLE AREA

1. INTERCOM CONTROL PANEL
2. CONTROL-MONITOR PANEL
3. RADAR CONTROL PANEL
4. COMMUNICATION CONTROL PANEL
5. NAVIGATION CONTROL PANEL
6. MARKER BEACON VOR/ILS AUDIO CONTROL
7. ANTI-G SUIT CONTROL VALVE
8. OXYGEN QUANTITY GAGE
9. CABIN ALTIMETER
10. PULL UP TONE CUTOUT SWITCH
11. EMERGENCY FLAP CONTROL PANEL
12. AM/ALE-40 PANEL
13. THROTTLES
14. CANOPY SELECTOR
15. BLANK PANEL

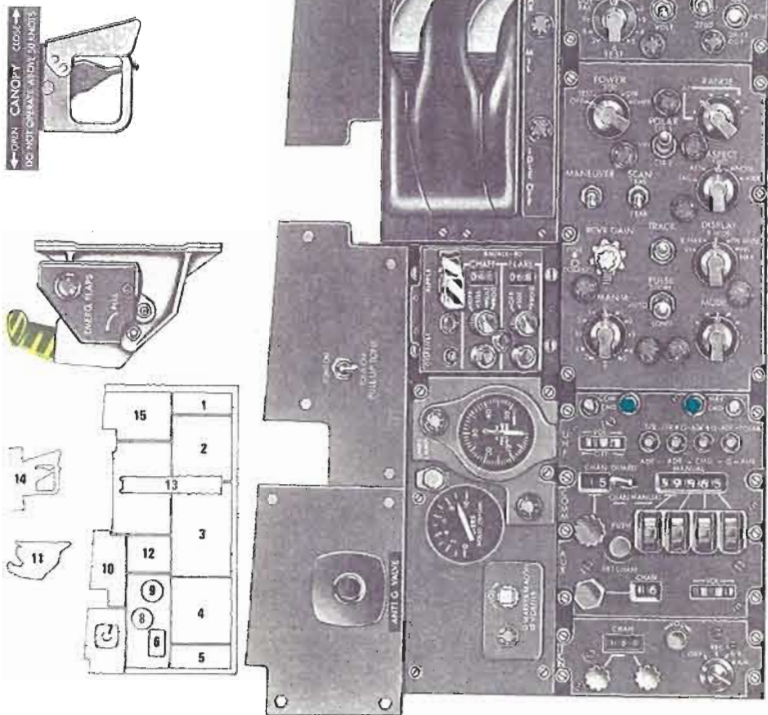

MAIN PANEL AREA

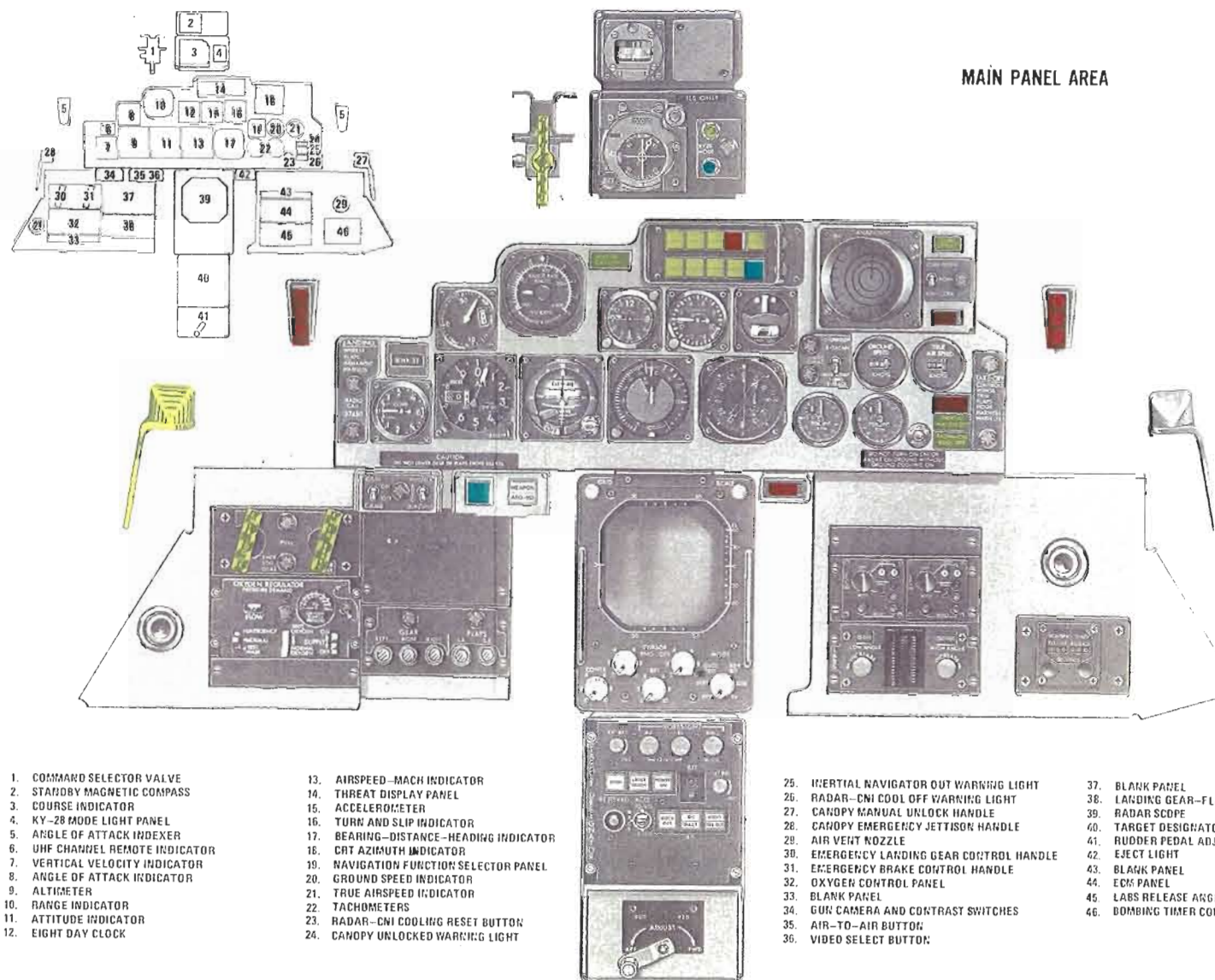

- |   |   |  |   |
|---|---|--|---|
| <ol style="list-style-type: none"> <li>1. COMMAND SELECTOR VALVE</li> <li>2. STANDBY MAGNETIC COMPASS</li> <li>3. COURSE INDICATOR</li> <li>4. KY-28 MODE LIGHT PANEL</li> <li>5. ANGLE OF ATTACK INDEXER</li> <li>6. UHF CHANNEL REMOTE INDICATOR</li> <li>7. VERTICAL VELOCITY INDICATOR</li> <li>8. ANGLE OF ATTACK INDICATOR</li> <li>9. ALTIMETER</li> <li>10. RANGE INDICATOR</li> <li>11. ATTITUDE INDICATOR</li> <li>12. EIGHT DAY CLOCK</li> </ol> | <ol style="list-style-type: none"> <li>13. AIRSPEED-MACH INDICATOR</li> <li>14. THREAT DISPLAY PANEL</li> <li>15. ACCELEROMETER</li> <li>16. TURN AND SLIP INDICATOR</li> <li>17. BEARING-DISTANCE-HEADING INDICATOR</li> <li>18. CRT AZIMUTH INDICATOR</li> <li>19. NAVIGATION FUNCTION SELECTOR PANEL</li> <li>20. GROUND SPEED INDICATOR</li> <li>21. TRUE AIRSPEED INDICATOR</li> <li>22. TACHOMETERS</li> <li>23. RADAR-CNI COOLING RESET BUTTON</li> <li>24. CANOPY UNLOCKED WARNING LIGHT</li> </ol> | <ol style="list-style-type: none"> <li>25. INERTIAL NAVIGATOR OUT WARNING LIGHT</li> <li>26. RADAR-CNI COOL OFF WARNING LIGHT</li> <li>27. CANOPY MANUAL UNLOCK HANDLE</li> <li>28. CANOPY EMERGENCY JETTISON HANDLE</li> <li>29. AIR VENT NOZZLE</li> <li>30. EMERGENCY LANDING GEAR CONTROL HANDLE</li> <li>31. EMERGENCY BRAKE CONTROL HANDLE</li> <li>32. OXYGEN CONTROL PANEL</li> <li>33. BLANK PANEL</li> <li>34. GUN CAMERA AND CONTRAST SWITCHES</li> <li>35. AIR-TO-AIR BUTTON</li> <li>36. VIDEO SELECT BUTTON</li> </ol> | <ol style="list-style-type: none"> <li>37. BLANK PANEL</li> <li>38. LANDING GEAR-FLAP INDICATOR PANEL</li> <li>39. RADAR SCOPE</li> <li>40. TARGET DESIGNATOR PANEL</li> <li>41. RUDDER PEDAL ADJUSTMENT CRANK</li> <li>42. EJECT LIGHT</li> <li>43. BLANK PANEL</li> <li>44. ECM PANEL</li> <li>45. LABS RELEASE ANGLE CONTROL PANEL</li> <li>46. BOMBING TIMER CONTROL</li> </ol> |
|---|---|--|---|

RIGHT CONSOLE AREA

REAR COCKPIT

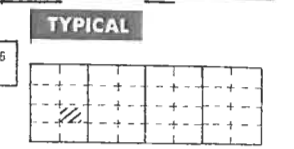

AFTER TO 1F-4E-588, TO 1F-4-1055 AND TO 1F-4E-514

1. CODER CONTROL
2. INERTIAL NAVIGATOR CONTROL PANEL
3. ANTENNA CONTROL PANEL
4. STALL WARNING TONE CONTROL PANEL
5. CURSOR CONTROL PANEL
6. EXTRA PICTURE SWITCH
7. NUCLEAR STORE CONSENT SWITCH
8. SST-181X PULSE SELECTOR SWITCH
9. COCKPIT LIGHTS CONTROL PANEL
10. NAVIGATION CONTROL PANEL
11. WEAPON RELEASE COMPUTER CONTROL PANEL
12. WEAPON DELIVERY PANEL

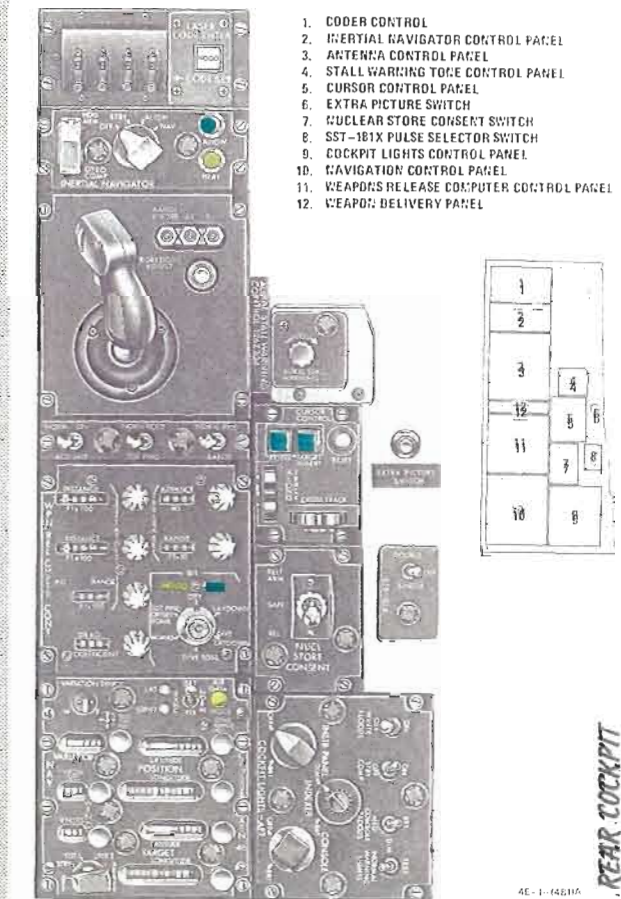
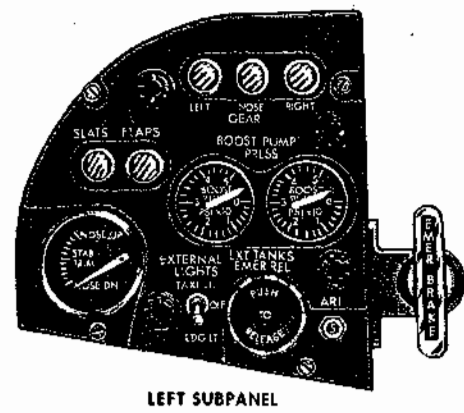

Figure FO-12

Figure FO-12  
FO-25/(FO-26 blank)

REAR COCKPIT



LEFT SUBPANEL

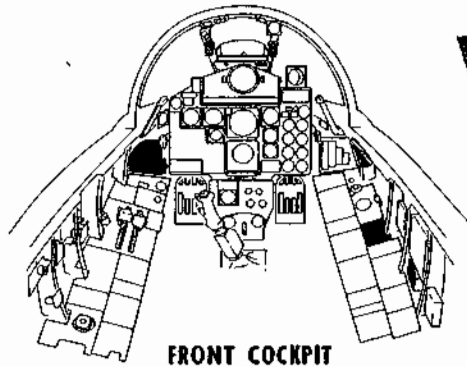

FRONT COCKPIT



INSTRUMENT LIGHTS INTENSITY CIRCUIT BREAKER PANEL

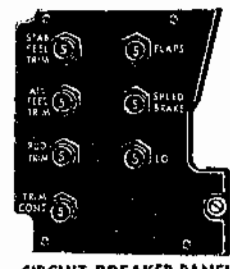

CIRCUIT BREAKER PANEL

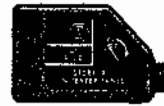

STANDBY ATTITUDE CIRCUIT BREAKER AND INTENSITY CONTROL PANEL

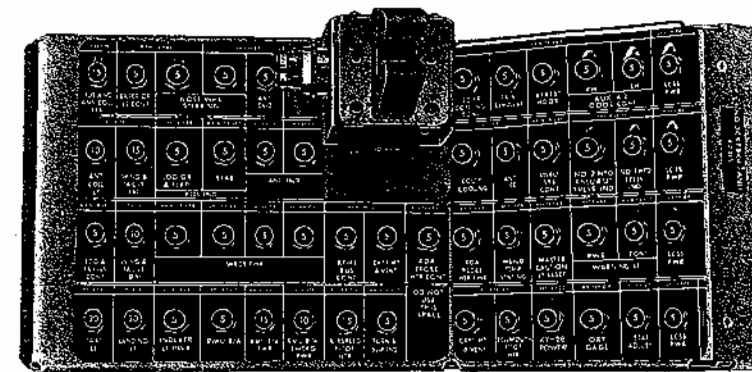

CIRCUIT BREAKER PANEL NO. 3

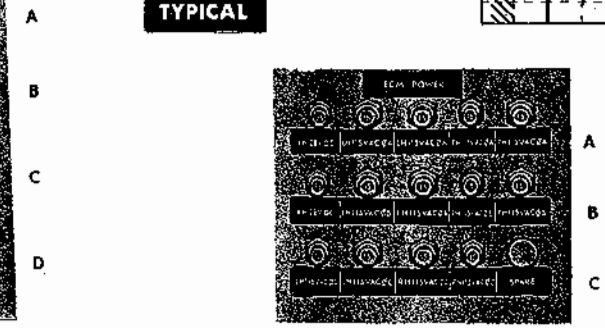

CIRCUIT BREAKER PANEL NO. 7

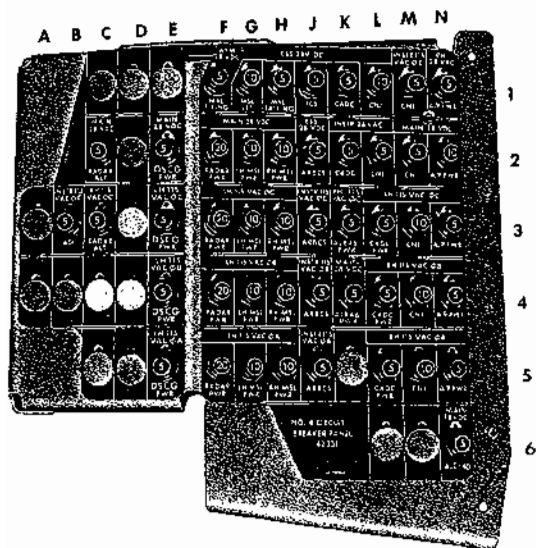

CIRCUIT BREAKER PANEL NO. 4

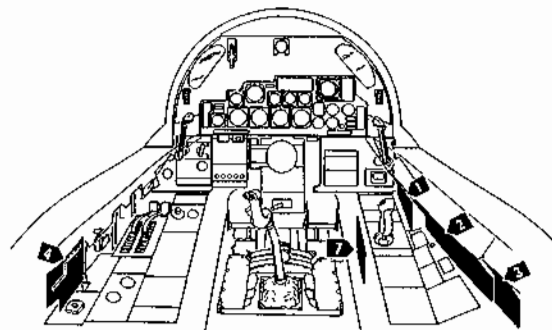

REAR COCKPIT

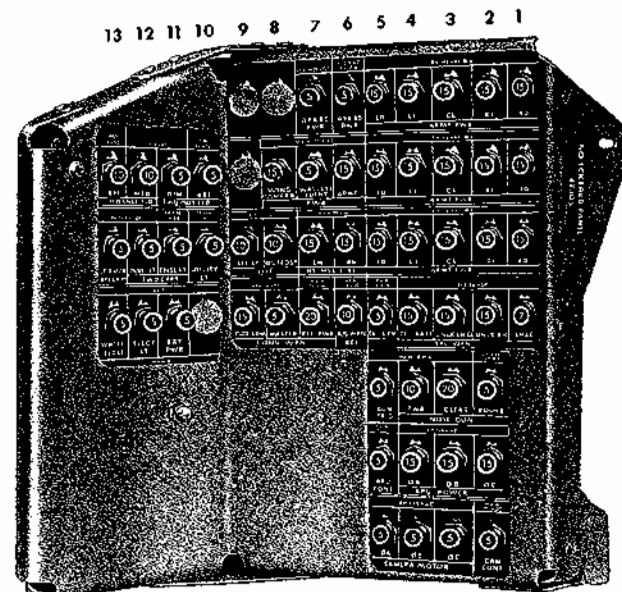

CIRCUIT BREAKER PANEL NO. 1

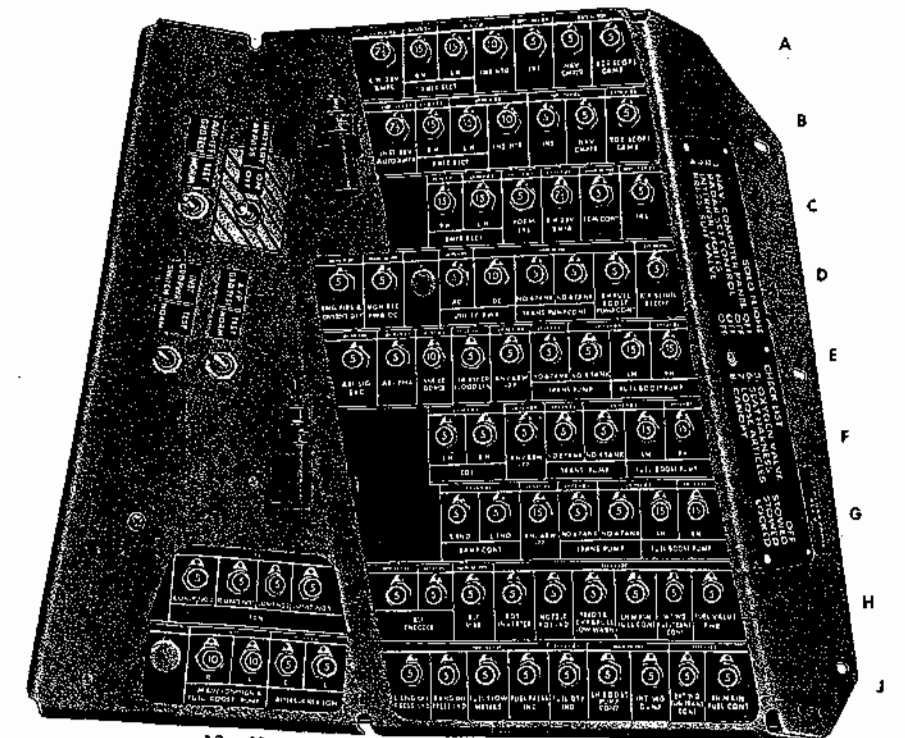

CIRCUIT BREAKER PANEL NO. 2

CIRCUIT BREAKERS

Figure FO-13

Figure FO-13  
FO-27/(FO-28 blank)

**GLOSSARY****A**

AC - Aerodynamic center  
ac - Alternating current  
ACP - Aircraft Communications Procedures  
ADCS - Air Data Computer Set  
ADI - Attitude Director Indicator  
ADIZ - Air Defense Identification Zone  
AFC - Automatic Frequency Control  
AFCS - Automatic Flight Control System  
AGC - Automatic Gain Control  
AHRS - Attitude Heading Reference System  
AI - Airborne Intercept  
AJB - Airborne, Electro-Mechanical, Bombing  
AMCS - Airborne Missile Control System  
AOA - Angle of Attack  
APA - Airborne, Radar, Auxiliary Assembly  
APN - Airborne, Radar, Navigational Aid  
APQ - Airborne, Radar, Special Purpose  
APU - Auxiliary Power Unit  
AR - Air Refueling  
ARI - Aileron Rudder Interconnect  
ARTC - Air Route Traffic Control  
ARC - Airborne, Radio, Control  
ASA - Airborne, Special Type, Auxiliary Assembly  
ASE - Allowable Steering Error  
ASN - Airborne, Special Type, Navigational Aid  
ASQ - Airborne, Special Type, Combination of Purposes  
ATC - Air Traffic Control  
AWW - Airborne, Armament, Control

**B**

BDHI - Bearing Distance Heading Indicator  
BINGO - Return to this channel (radio). Return fuel state

BIT - Built-In-Test  
BLC - Boundary Layer Control  
BST - Boresight  
Buster - Full Military Power

**C**

CAT - Clear Air Turbulence  
CADC - Central Air Data Computer  
CAP - Combat Air Patrol  
CAS - Calibrated Airspeed  
CG - Center of Gravity  
CIC - Combat Information Center  
CIT - Compressor Inlet Temperature  
CNI - Communication Navigation Identification  
COT - Cockpit Orientation Trainer  
CSD - Constant Speed Drive  
cw - Continuous Wave

**D**

dc - Direct current  
DCU - Douglas Control Unit  
DME - Distance Measuring Equipment  
DR - Dead Reckoning  
DVST - Direct View Storage Tube

**E**

EAS - Equivalent Airspeed  
EAT - Estimated Approach Time  
ECCM - Electronic Counter-Countermeasure(s)  
ECM - Electronic Countermeasure(s)  
EGT - Exhaust Gas Temperature

**F**

FAM - Familiarization  
FL - Flight Level

**G**

**GLOSSARY (CONT)**

G - Gravity

Gate - Maximum Power

GCA - Ground Control Approach

GCI - Ground Control Intercept

gpm - Gallon per minute

**H**

Hangfire - A delay or failure of an article of ordinance after being triggered

Hang Start - A start that results in a stagnated rpm and temperature

Hot Start - A start that exceeds normal starting temperatures

HSI - Horizontal Situation Indicator

Hz - Hertz

**I**

IP - Identification Point

IAS - Indicated Airspeed

IFF - Identification Friend or Foe

IFR - Instrument Flight Rules

ILS - Instrument Landing System

IMC - Instrument Meteorological Conditions

IR - Infrared

I/P - Identification of Position

**J**

JANAP - Joint Army Navy Air Force Publication

JP - Jet Propulsion

Judy - Radar contact with target, taking over intercept

**K**

KTS - Knots

**L**

LABS - Low Altitude Bombing System

LCOSS - Lead Computing Optical Sight

LE - Leading Edge

Glossary 2

LID - Limited Instrument Departure

LOX - Liquid Oxygen

Lpm - Liters per minute

**M**

MAC - Mean Aerodynamic Chord

MIL - Military

MIM - Maintenance Instruction Manual

Misfire - A permanent failure of an article of ordinance being triggered

MSDG - Multiple Sensor Display Group

MSL - Mean Sea Level

**N**

N/A - Not applicable

N/E - Not established

NMPP - Nautical Miles Per Pound

**O**

OAT - Outside Air Temperature

OMNI - Omni Directional Range

**P**

P - Pilot

PC - Power Control

PDVL - Pull Down Vent Line

Pigeons - Bearing and Distance

PLB - Personnel locator beacon

PMBR - Practice Multiple Bomb Rack

PPS - Pulses per seconds

prf - Pulse repetition frequency

psi - Pounds per square inch

Punch - Target detected, aircraft still under ground control

**Q**

q - Dynamic Pressure, psf

**R**

**GLOSSARY (CONT)**

RADAR - Radio Detection and Ranging

RAT - Ram Air Turbine

rf - Radio Frequency

RF - Reconnaissance - Fighter

rpm - Revolutions Per Minute

RWR - Radar Warning Receiver

**S**

SAR - Sea Air Rescue

SID - Standard Instrument Departure

SPC - Static Pressure Compensator

**T**

TACAN - Tactical Air Navigation

TAS - True Airspeed

TE - Trailing Edge

TISEO - Target Identification System Electro-Optical

TMN - True Mach Number

**U**

UHF - Ultra High Frequency

**V**

VFR - Visual Flight Rules

VHF - Very High Frequency

VMC - Visual Meteorological Conditions

Vn - Velocity Acceleration Relationship

VORTAC - Very High Frequency - Omni Range and Tactical Air Navigation

**W**

WSO - Weapons System Officer

WST - Weapons System Trainer



# ALPHABETICAL INDEX

## Note

All text and illustration numbers in this alphabetical index refer to page numbers, not paragraph or figure numbers.

	Page No.			Page	
	Text	Illus.		Text	Illus.
A			Airplane Loading . . . . .		A1-5
A/A IFF Ground Test Switch . . . . .	1-17		Air Refueling System . . . . .	4-17	
Accelerated Stalls . . . . .	6-9		Air Refuel Switch . . . . .	4-18	
Acceleration Charts . . . . .	9-3	9-31	Airspeed Conversion. . . . .	A1-2	A1-13
Acceleration Limitations. . . . .	5-6		Airspeed Limitations . . . . .	5-6	5-5
Accelerometers . . . . .	1-37		Airspeed/Mach Indicators . . . . .	1-37	
AC/DC Electrical Distribution . . . . .		FO-9	Airspeed Position Error Correction . . . . .	A1-2	A1-15
AC Electrical Power. . . . .	1-16		Alignment, Best Available True Heading . . . . .	4-12	
ADF Operation . . . . .	1-55		Alignment, Gyro Compass . . . . .	2-16	
ADI (Attitude Director Indicator) . . . . .	1-40		Alignment, Heading Memory . . . . .	2-16	
ADI/HSI Display. . . . .		1-44	Alignment Procedures . . . . .	4-11	
Adverse Yaw . . . . .	6-6		Alt Encoder Out Light . . . . .	1-33	
AFCS Controls . . . . .	4-8		Alternate Fuel . . . . .	5-4	
AFCS Mode . . . . .	4-7		Altimeter, Cockpit Pressure . . . . .	4-4	
AFCS Switch . . . . .	4-8		Altimeter Lag Chart. . . . .	A1-3	A1-18
Aft CG Limits . . . . .		5-10	Altimeter Position Error Correction . . . . .	A1-3	A1-17
		A1-9	Altimeter, Pressure. . . . .	1-37	
Afterburner Fuel Control . . . . .	1-7		Altimeter, Radar . . . . .	1-38	
Afterburner Fuel Distribution . . . . .	1-7		Altitude Encoder Unit . . . . .	1-33	
Afterburner Fuel Pump . . . . .	1-7		Altitude Hold Switch . . . . .	4-8	
Afterburner Fuel System . . . . .	1-7		Altitude Reporting Failure Indications . . . . .		1-38
Afterburner Ignition System . . . . .	1-7		AN/AJB-7 . . . . .	4-7	
Afterburner Shutdown Limitations . . . . .	5-4		AN/ASA-32 . . . . .	4-6	
Afterburner System . . . . .	1-7		AN/ASN-46A . . . . .	4-14	
After Electrical Power . . . . .	2-16		AN/ASQ-19A . . . . .	1-41	
After Landing . . . . .	2-28		AN/ASQ-91 . . . . .	4-19	
After Takeoff - Climb . . . . .	2-22		Angle of Attack . . . . .	6-6	
Aft Fuselage Overheat System . . . . .	1-35		Angle of Attack (AOA) System . . . . .	1-30	
Aileron Control . . . . .	1-20		Angle of Attack Aural Tone Indications . . . . .	1-30	1-32
Aileron Rudder Interconnect (ARI) . . . . .	1-23		Angle of Attack Displays . . . . .		1-31
Aileron-Spoiler Control System . . . . .	1-20		Anti-Collision Lights . . . . .	1-62	
AIM-9B, -9E, 9J, 9J-1 Airspeed Limitations . . . . .		5-37	Anti-G Suit System . . . . .	4-6	
Air Conditioning and Pressurization System . . . . .	4-1	4-2	Anti-Ice Indicator Light . . . . .	1-7	
Air Conditioning, Equipment . . . . .	4-5		Anti-Icing Switch . . . . .	1-7	
Aircraft . . . . .	1-1		Anti-Icing System . . . . .	1-5	
Aircraft Fuel System . . . . .	1-10		Anti-Ice System, Engine . . . . .	9-7	
Air Data Computer . . . . .	4-7		Anti-Skid Control Switch . . . . .	1-28	
Air Data Computer . . . . .	9-8		Anti-Skid Inoperative Light . . . . .	1-28	
Air Data Computer System . . . . .	1-33	1-34	Anti-Skid System . . . . .	1-28	
Air Induction System, Engine . . . . .	1-3		AOA (Angle of Attack) System. . . . .	1-30	
Airplane and Engine Fuel System . . . . .		FO-5	AOA Aural Tone System . . . . .	1-30	
			AOA Indexers . . . . .	1-30	
			AOA Indicators . . . . .	1-30	
			AOA Limitations . . . . .	5-6	

	Page			Page	
	Text	Illus		Text	Illus
APU Light . . . . .	1-19		Button, Armament Safety		
APU Reject Switch . . . . .	1-18		Override . . . . .	1-36	
APU, Stabilator . . . . .	1-18		Button, External Stores		
ARI (Aileron Rudder Interconnect . . . . .	1-23		Emergency Release . . . . .	1-36	
Armament . . . . .	1-2		Button, Fire Detector Check . . . . .	1-35	
Armament Safety Override			Button, Intercom Microphone . . . . .	1-46	
Button . . . . .	1-36		Button, Oxygen Quantity Gage		
Armor Plating . . . . .	1-2		Test . . . . .	1-65	
Arresting Hook light . . . . .	1-29		Buttons, Ignition . . . . .	1-5	
Arresting Hook System . . . . .	1-29				
Associated Systems, Bleed Air			C		
and . . . . .	1-6		Calibration Airspeed. . . . .	A1-2	
Attitude and Heading Displays . . . . .	1-46		Canopies . . . . .	1-61	
Attitude Director Indicator			Canopy Emergency Systems . . . . .	1-61	
(ADI) . . . . .	1-40		Canopy Initiator Safety Pins . . . . .		2-5
Attitude Indicator . . . . .	1-39		Canopy Interlock Mechanism . . . . .	1-70	
Attitude Reference And Bombing			Canopy Knife . . . . .	1-35	
Computer (AN/AJB-7) . . . . .	4-7		Canopy Unlock Warning Light. . . . .	1-61	
Attitude Reference System . . . . .	4-12		Cartridges, Starter . . . . .	7-2	
Aural Tone System (AOA) . . . . .	1-30		Cartridge Start . . . . .	2-11	
Auto - Acceleration . . . . .	7-1		Cartridge Starting . . . . .	1-5	
Automatic Flight Control System			Center of Gravity Limitations. . . . .	5-6	
(AN/ASA-32) . . . . .	4-6		CG Travel Due to Fuel		
Autopilot Ground Test Switch . . . . .	1-17		Consumption . . . . .	6-5	6-3
Autopilot Pitch Trim. . . . .	4-9		Circling Approach . . . . .	9-4	
Auxiliary Air Door Light. . . . .	1-5		Circuit Breakers . . . . .		FO-27
Auxiliary Air Doors . . . . .	1-5		Climb Charts . . . . .	A3-1	A3-3
Auxiliary Air System, Equipment . . . . .	4-6		Climb Speed Schedule . . . . .		A3-3, A3-7
Auxiliary Power Unit,					
Stabilator . . . . .	1-18		Climb Techniques . . . . .	2-23	
B			CNI (Communication-		
BDHI . . . . .	1-41	1-43	Navigation - Identification) . . . . .	1-41	
Battery . . . . .	1-16		CNI Equipment . . . . .		1-52
Battery Bypass Switch . . . . .	1-16		CNI Equipment Limitations . . . . .	5-8	
Beacon, Personnel Locator			Cockpit Air Conditioning . . . . .	4-1	
(PLB) . . . . .	1-79		Cockpit Entry . . . . .		2-2
Bearing-Distance-Heading			Cockpit Fogging . . . . .	4-3	
Indicator (BDHI) . . . . .	1-41	1-43	Cockpit Heating Procedure . . . . .	4-5	
Bearing/Distance Selector Switch . . . . .	1-41		Cockpit Pressure Altimeter . . . . .	4-4	
Before Electrical Power . . . . .	2-16		Cockpit Pressure Schedule . . . . .		4-4
Before Entering cockpit . . . . .	2-4		Cockpit Pressurization . . . . .	4-4	
Before Exterior Inspection . . . . .	2-1		Cockpit Temperature Schedule . . . . .		4-3
Before Landing/Descent . . . . .	2-24		Cockpit Turbine Overspeed		
Before Leaving Cockpit . . . . .	2-31		Indicator Light . . . . .	4-4	
Before Starting Engines . . . . .	2-8		Cold Weather Procedures . . . . .	9-4	
Before Takeoff . . . . .	2-20		Combat Ceiling Charts . . . . .	A3-2	A3-14
Before Taxiing . . . . .	2-13		Combat Fuel Flow Charts . . . . .	A9-1	A9-8
Bellmouth, Variable Bypass . . . . .	1-4		Combat Specific Range . . . . .	A9-1	A9-11
Best Available True Heading			Command Selector Valve Handle . . . . .	1-71	
Alignment. . . . .	4-12		Comm-Nav Control Panels . . . . .		1-53
Bleed Air and Associates			Comm Receiver-Transmitter		
Systems . . . . .	1-6		Operation . . . . .	1-54	
Bleed Air System . . . . .	1-5		Communication-Navigation -		
Boost Pump Check Switch . . . . .	1-11		Identification . . . . .	1-41	
Boost Pump Pressure			Compass Alignment, Gyro . . . . .	2-16	
Indicator . . . . .	1-11		Compass Controller . . . . .	4-12	
Brake, Emergency . . . . .	1-29		Compass, Magnetic . . . . .	1-38	
Brakes, Speed . . . . .	1-26		Computer, Air Data . . . . .	4-7	
Brake System . . . . .	1-28		Computer, Course and Distance		
Breakers, Circuit . . . . .	1-17		AN/ASN-46A) . . . . .	4-15	

	Page			Page	
	Text	Illus		Text	Illus
Computer, Attitude Reference and Bombing (AN/AJB-7) . . . . .	4-7		Drogue Gun . . . . .	1-70	
Computer, Flight Director . . . . .	1-39		Dual Ejection, Front Cockpit . . . . .	1-68	
Computer, Present Position (AN/ASN-46A). . . . .	4-15		Dual Ejection, Rear Cockpit . . . . .	1-68	
Console Lights . . . . .	1-63		Duct Temperature Light . . . . .	1-3	
Constant Altitude Cruise . . . . .	A4-3	A4-26	E		
Constant Mach/Altitude Cruise . . . . .	A4-2	A4-19	EGT Limitations . . . . .	5-1	
Control, Aileron . . . . .	1-20		Ejection, Dual From Front Cockpit . . . . .	1-68	
Control Engine Fuel . . . . .	1-2		Ejection, Dual From Rear Cockpit . . . . .	1-68	
Control Handle, Landing Gear . . . . .	1-27		Ejection Gun . . . . .	1-70	
Control, Rudder. . . . .	1-21		Ejection Seat . . . . .		FO-7
Controls, AFCS. . . . .	4-8		Ejection Seat and Canopy Initiator Safety Pins . . . . .		2-5
Controls and Indicators, Engine . . . . .	1-8		Ejection Seat Components . . . . .	1-68	
Controls, Electrical System . . . . .	1-17		Ejection Seat, MK-H7 . . . . .	1-66	
Controls, Engine . . . . .	1-8		Ejection Seat Sequencing . . . . .	1-66	
Controls, Flight. . . . .	1-20		Ejection, Single From Rear Cockpit . . . . .	1-68	
Control, Spoiler. . . . .	1-20		Eject Light . . . . .	1-35	
Control, Stabilator . . . . .	1-21		Electrical Power, AC . . . . .	1-16	
Controls, TACAN . . . . .	1-55	1-22	Electrical Power, DC . . . . .	1-16	
Control Sticks . . . . .	1-21		Electrical Power, External . . . . .	1-17	
Controls, UHF Radio . . . . .	1-51		Electrical Power Supply System . . . . .	1-15	
Control System, Aileron - Spoiler . . . . .	1-20		Electrical System Controls and Indicators . . . . .	1-17	
Control Unit, Exhaust Nozzle . . . . .	1-8	A10-2	Electrical System External Power Applied . . . . .		FO-7
Counter Air Mission Overview . . . . .			Electronic Countermeasures Pods (ALQ Series) . . . . .	4-19	
Countermeasures Dispenser Set AN/ALE-40 . . . . .	4-19		Emer. Flaps/Slats Extension . . . . .	1-26	
Course And Distance Computer (AN/ASN-46A). . . . .	4-15		Emergencies, Inflight . . . . .	3-7	
Crew Duties . . . . .	8-1		Emergencies, Landing . . . . .	3-33	3-41
Crosswind Landing, Dry . . . . .	2-27		Emergencies, Takeoff . . . . .	3-5	
Crosswind Takeoff . . . . .	2-22		Emergency Attitude Indicator . . . . .	4-14	
Cruise . . . . .	2-23		Emergency Attitude Reference System . . . . .	4-14	
Cruise Summary . . . . .	A4-1	A4-6	Emergency Brake System . . . . .	1-29	
D			Emergency Equipment . . . . .	1-33	
Danger Areas . . . . .		2-10	Emergency Fuel . . . . .	5-6	
DC Electrical Power . . . . .	1-16		Emergency, Ground Operation . . . . .	3-2	
Defogging Procedure, Windshield . . . . .	4-5		Emergency Procedures . . . . .	3-1	
Density Ratio Chart . . . . .	A2-1	A2-6	Emergency Quick Release Lever (AFCS) . . . . .	4-9	
Departures . . . . .	6-11		Emergency Quick Release Lever (Anti-Skid) . . . . .	1-29	
Depressurization Switch, Tank . . . . .	1-14		Emergency Release Button, External Stores . . . . .	1-36	
Descent/Before Landing . . . . .	2-24		Emergency Vent Knob . . . . .	4-5	
Descent Charts . . . . .	A7-1	A7-2	Encoder, Altitude . . . . .	1-33	
Descent, Instruments . . . . .	9-1		Encoder Out, Alt Light . . . . .	1-33	
Dihedral Effect . . . . .	6-6		Engine Air Induction System . . . . .	1-3	
Dimensions. . . . .	1-1		Engine Airspeed Limits . . . . .		5-5
Distance Required to Climb . . . . .		A3-6, A3-10, A3-13	Engine Anti-Ice System . . . . .	9-7	
Dive Recovery Charts . . . . .	A9-5	A9-90	Engine Anti-Icing System. . . . .	1-5	
Drag Chute System . . . . .	1-29		Engine, Before Starting . . . . .	2-8	
Drag Due to Asymmetric Loading . . . . .	A1-2	A1-10	Engine Bleed Air System. . . . .	1-5	
Drag Index System . . . . .	A1-1		Engine Controls and Indicators . . . . .	1-8	
Drain Valve, Fuel . . . . .	1-2		Engine Exhaust Temperature Limitations . . . . .	5-1	
Drogue Chute Scissors Mechanism . . . . .	1-70				

	Page			Page	
	Text	Illus		Text	Illus
Engine Fire and Overheat Detector System . . . . .	1-35		Flight Characteristics . . . . .	6-1	
Engine Fuel Control . . . . .	1-2		Flight Controls . . . . .	1-20	
Engine Fuel Pump . . . . .	1-2		Flight Control System . . . . .		FO-15
Engine Fuel System . . . . .	1-2		Flight Director Computer . . . . .	1-39	
Engine G Limitations . . . . .	5-4		Flight Director Group . . . . .	1-39	
Engine Ground Operation . . . . .	2-13		Flight Instrument Lights Control Panel . . . . .	1-63	
Engine Ignition System . . . . .	1-5		Flight Instrument Lights Intensity Control Panel . . . . .	1-63	
Engine Limitations . . . . .	5-1		Flight Strength Diagram . . . . .		5-13
Engine Master Switches . . . . .	1-8		Flood Lights . . . . .	1-62	
Engine Oil System . . . . .	1-3	1-4	Flood Lights, White . . . . .	1-63	
Engine Operating Characteristics . . . . .	7-1		Fluctuation, Fuel Flow . . . . .	5-1	
Engine Operating Envelope . . . . .	7-1	7-2	Fluctuation, RPM . . . . .	5-1	
Engines . . . . .	1-2		Force Transducer . . . . .	4-7	
Engine Shutdown . . . . .	2-30		Formation Lights . . . . .	1-62	
Engine Starter Operation . . . . .	7-2		Front Cockpit . . . . .		FO-19
Engines, Starting . . . . .	2-9		Front Cockpit Interior Check . . . . .	2-6	
Engine Starting System . . . . .	1-5		Fuel, Alternate . . . . .	5-4	
Engine Throttles . . . . .	1-8	1-8	Fuel Boost System . . . . .	1-11	
Equipment Air Conditioning System . . . . .	4-5		Fuel Control, Afterburner . . . . .	1-7	
Equipment Auxiliary Air System . . . . .	4-6		Fuel Control, Engine . . . . .	1-2	
Equipment, Emergency . . . . .	1-33		Fuel Distribution, Afterburner . . . . .	1-7	
Equivalent Airspeed . . . . .	A1-2		Fuel Distribution and Indication . . . . .		1-13
Exhaust Gas Temperature Indicator . . . . .	1-10		Fuel Drain Valve . . . . .	1-2	
Exhaust Nozzle Control Unit . . . . .	1-8		Fuel Dump System, Internal Wing . . . . .	1-15	
Exhaust Nozzle Limitations . . . . .	5-1		Fuel, Emergency . . . . .	5-6	
Exhaust Nozzle Position Indicator . . . . .	1-8		Fuel Filters Indicator Light . . . . .	1-3	
Exhaust Nozzle, Variable Area . . . . .	1-7		Fuel Flow Fluctuation . . . . .	5-1	
Exhaust Temperature Limitations . . . . .	5-1		Fuel Flow Indicators . . . . .	1-3	
Exterior Inspection . . . . .	2-3		Fuel Low Level Warning Light . . . . .	1-15	
Exterior Lighting . . . . .	1-62		Fuel Nozzles . . . . .	1-2	
External Electrical Power . . . . .	1-17		Fuel - Oil Heat Exchangers . . . . .	1-3	
External Stores Emergency Release Button . . . . .	1-36		Fuel Pressurization System . . . . .	1-11	
External Stores Limitations . . . . .		5-14	Fuel Pump, Afterburner . . . . .	1-7	
External Tank Fuel Light . . . . .	1-15		Fuel Pump, Engine . . . . .	1-2	
External Tank Jettison System . . . . .	1-15		Fuel Quantity Data Table . . . . .		1-12
External Tank Pressurization and Vent . . . . .	1-14		Fuel Quantity Indicating System . . . . .	1-14	
External Transfer Switch . . . . .	1-11		Fuel Quantity Indicator . . . . .	1-14	
			Fuel Required to Climb . . . . .		A3-5, A3-9, A3-12
<b>F</b>			Fuel System . . . . .	1-10	
Face Curtain Ejection Handle . . . . .	1-71		Fuel System, Afterburner . . . . .	1-7	
Feed Tank Check Switch . . . . .	1-14		Fuel System, Engine . . . . .	1-2	
Final Approach Speeds . . . . .	A8-1	A8-3	Fuel Vent System . . . . .	1-11	
Fire and Overheat Detector System . . . . .	1-35		Fuel Weight Variations . . . . .	7-2	
Fire Control System . . . . .	4-18		Fuselage Lights . . . . .	1-62	
Fire Detector Check Button . . . . .	1-35		Fuselage Pressurization . . . . .	1-14	
Fire Warning System . . . . .	1-35		Fuselage Vent . . . . .	1-14	
Firing Linkages and Canopy Interlock Mechanism . . . . .	1-70				
Flap/Slats Extension, Emer. . . . .	1-26		<b>G</b>		
Flaps/Slats Indicators . . . . .	1-26		Gear, Main . . . . .	1-27	
Flaps/Slats Selective . . . . .	1-24		Gear, Nose . . . . .	1-27	
Flaps/Slats Switch . . . . .	1-24		General Arrangement . . . . .		FO-3
Flaps/Slats System . . . . .	1-24		Generator Control Switches . . . . .	1-17	
Flight Characteristics . . . . .	2-24		Generator Indicator Light . . . . .	1-18	
			Generator Switching . . . . .	4-10	
			G - Limit Accelerometer . . . . .	4-8	
			Go-Around . . . . .		2-29

	Page No.			Page No.	
	Text	Illus.		Text	Illus.
Go-Around Technique . . . . .	2-28		Indicator, Bearing-Distance-Heading . . . . .	1-41	1-43
Gross Weight . . . . .	1-1		Indicator, Boost Pump Pressure . . . . .	1-11	
Ground Weight Limitations . . . . .	5-6		Indicator, EGT . . . . .	1-10	
Ground Operation Emergencies . . . . .	3-2		Indicator, Emergency Attitude . . . . .	4-14	
Ground Speed Indicator . . . . .	1-37		Indicator, Exhaust Nozzle Position . . . . .	1-8	
Guillotine Assembly . . . . .	1-70		Indicator, Fuel Quantity . . . . .	1-14	
Gun, Drogue . . . . .	1-70		Indicator, Ground Speed . . . . .	1-37	
Gun, Ejection . . . . .	1-70		Indicator, Horizontal Situation . . . . .	1-39	
Gyro Compass Alignment . . . . .	4-12		Indicator, Landing Gear Position . . . . .	1-27	
H			Indicator Lights . . . . .	1-33	
Handle, Command Selector Valve . . . . .	1-71		Indicator, Mach . . . . .	1-37	
Handle, Face Curtain Ejection . . . . .	1-71		Indicators, AOA . . . . .	1-30	
Handle, Landing Gear Control . . . . .	1-27		Indicators, Electrical System . . . . .	1-17	
Handle, Lower Ejection . . . . .	1-71		Indicators, Engine . . . . .	1-8	
Handles, Canopy Unlock . . . . .	1-61		Indicators Flap/Slats . . . . .	1-26	
Handle, Shoulder Harness Release . . . . .	1-72		Indicators, Fuel Flow . . . . .	1-3	
Handling Qualities . . . . .	6-7		Indicators, Hydraulic Pressure . . . . .	1-19	
Harness, Integrated . . . . .	1-73		Indicators, Oil Pressure . . . . .	1-3	
Heading Memory Alignment . . . . .	4-12		Indicator, True Airspeed . . . . .	1-37	
Heat Exchangers, Fuel-Oil . . . . .	1-3		Indicator, Turn and Slip . . . . .	1-39	
Heavy Gross Weight Landing . . . . .	2-28		Indicator, Vertical Velocity . . . . .	1-38	
Heavy Gross Weight Takeoff . . . . .	2-21		Inertial Navigation and Attitude-Heading Reference System . . . . .	4-11	
High Altitude Cruise Tables . . . . .	A4-2	A4-14	Inflight Emergencies . . . . .	3-7	
High AOA Maneuvering . . . . .	6-6		Instrument Climb . . . . .	9-1	
Holding/Loiter . . . . .	9-1		Instrument Descent . . . . .	9-1	
Hook, Arresting . . . . .	1-29		Instrument Flight Procedures . . . . .	9-1	
Horizontal Situation Indicator . . . . .	1-39		Instrument Fluctuation . . . . .	5-1	
Horizontal Situation Indicator Bearing and Distance Displays . . . . .		1-50	Instrument Ground Power Switch . . . . .	1-17	
Hot Refueling . . . . .	2-30		Instrument Markings . . . . .	5-1	5-2
Hot Weather Procedures . . . . .	9-6		Instrument Panel Lights . . . . .	1-63	
HSI . . . . .	1-39		Instruments . . . . .	1-37	
Hydraulic Power Supply System . . . . .	1-18		Instrument Takeoff . . . . .	9-1	
Hydraulic Pressure Indicators . . . . .	1-19		Integrated Harness . . . . .	1-73	
Hydraulic System . . . . .		FO-11	Intercom Control Panel . . . . .	1-43	
Hydraulic System Light . . . . .	1-19		Intercom Microphone Button . . . . .	1-46	
I			Intercom System . . . . .	1-43	
Ice and Rain . . . . .	9-7		Interior Check, Front Cockpit . . . . .	2-6	
Icy Runway, Landing . . . . .	2-27		Interior Check, Rear Cockpit . . . . .	2-17	
Identification System Control Panel . . . . .		1-59	Interior Lighting . . . . .	1-63	
Identification System (IFF) . . . . .	1-58	1-59	Interior Lighting . . . . .	1-64	
IFR Receptacle Light . . . . .	1-62		Interlock Mechanism, Canopy . . . . .	1-70	
Ignition Buttons . . . . .	1-5		Internal Wing Fuel Dump System . . . . .	1-15	
Ignition Limitations . . . . .	5-4		Internal Wing Transfer Switch . . . . .	1-11	
Ignition System, Afterburner . . . . .	1-7		Inverted Spins . . . . .	6-13	
Ignition System, Engine . . . . .	1-5		Inverted Stalls . . . . .	6-9	
Indexer Lights . . . . .	1-64		J		
Indexers, AOA . . . . .	1-30		Jet Penetration . . . . .		9-2
Indicated Airspeed . . . . .	A1-2		Jettison Control, Selective . . . . .	1-36	
Indicating System, Fuel Quantity . . . . .	1-14		Jettison System . . . . .	1-35	
Indicator, Airspeed/Mach . . . . .	1-37		Jettison System, External Tank . . . . .	1-15	
Indicator, Attitude . . . . .	1-39		Join - Up Lights . . . . .	1-62	
Indicator, Attitude Director . . . . .	1-40		K		
			Knife, Canopy . . . . .	1-35	

	Page			Page	
	Text	Illus		Text	Illus
L					
Landing	2-25		Lights Intensity Control Panel,		
Landing	6-7		Flight Instrument Lights	1-63	
Landing and Taxi Lights	1-62		Lights, Join-Up	1-62	
Landing Configuration Stalls	6-11		Lights, Landing and Taxi	1-62	
Landing, Crosswind Dry	2-27		Lights, Slats In	1-24	
Landing Emergencies	3-33		Light, Speed Brake Out	1-26	
Landing Gear Control Handle	1-27		Lights, Position	1-62	
Landing Gear Emer. Extension			Lights, Warning and Indicator	1-33	
Handle	1-27		Light, Tank 7 Fuel	1-15	
Landing Gear Position Indicators	1-27		Light, Taxi	1-62	
Landing Gear System	1-27		Light, Utility	1-64	
Landing Gear Warning Light	1-27		Limitations, Acceleration	5-6	
Landing, Heavy Gross Weight	2-28		Limitations, Afterburner Shut-		
Landing, Icy Runway	2-27		down	5-4	
Landing, No-Flap	2-25		Limitations, AIM-9B, -9E,		
Landing Pattern	2-25	2-26	9J, 9J-1		5-37
Landing, Short Field	2-25		Limitations, Airspeed	5-6	5-5
Landing Technique	2-25		Limitations, AOA	5-6	
Landing, Wet or Icy Runway	2-27		Limitations, Center of Gravity	5-6	
Landing, Wet Runway	2-27		Limitations, CNI Equipment	5-8	
Lateral Accelerometer	4-8		Limitations, EGT	5-1	
Lateral Control Feel System	1-20		Limitations, Engine	5-1	
Lateral Control Trim System	1-20		Limitations, Engine G	5-4	
Lead Computing Optical Sight	4-19		Limitations, Exhaust Nozzle	5-1	
Leg Restrainers	1-72	1-73	Limitations, External Stores	5-8	5-14
Level Flight Envelope	A9-4		Limitations, Gross Weight	5-6	
Light, Alt Encoder Unit	1-33		Limitations, Ignition	5-4	
Light, Anti-Ice Indicator	1-7		Limitations, Oil Pressure	5-1	
Light, Anti-Skid Inoperative	1-28		Limitations, Systems Operations		5-7
Light, APU	1-19		Limitations, Thrust	5-4	
Light, Arresting Hook	1-29		Limitations, Touchdown	5-6	
Light, Auxiliary Air Door	1-5		Limitations, Touchdown Sink		
Light, Canopy Unlock Warning	1-61		Rate		5-9
Light, Cockpit Turbine Overspeed			Limitations, Windmilling	5-4	
Indicator	4-4		Limits, Military Power Operating		5-4
Light, Duct Temperature	1-3		Locator Beacon, Personnel		
Light, Eject	1-35		(PLB)	1-74	
Light, External Tank Fuel	1-15		Loiter/Holding	9-1	
Light, Fuel Filter Indicator	1-3		Longitudinal Stability	6-1	
Light, Fuel Low Level Warning	1-15		Low Altitude Accelerations	A9-3	A9-19
Light, Generator Indicator	1-18		Low Altitude Bombing System		
Light, Hydraulic System	1-19		(LABS)	4-19	
Light, IFR Receptacle	1-62		Low Altitude Cruise Tables	A4-2	A4-8
Lighting Equipment	1-62		Low AOA, Maneuvering	6-6	
Lighting, Exterior	1-62		Lower Ejection Handle	1-71	
Lighting, Interior	1-63				
Light, Landing Gear Warning	1-27		M		
Light, Magnetic Compass	1-63		Mach Indicator	1-37	
Light, Master Caution	1-34		Magnetic Compass	1-38	
Lights, Anti-Collision	1-62		Magnetic Compass Light	1-63	
Lights, Console	1-63		Main Beam Assembly	1-68	
Lights Control Panel, Flight			Main Gear	1-27	
Instruments	1-63		Maneuvering, High AOA	6-6	
Lights Control, Station Select	1-64		Maneuvering, Low AOA	6-6	
Lights, Flood	1-62		Maneuvering, Max Performance	6-7	
Lights, Formation	1-62		Maneuvering, Medium AOA	6-6	
Lights, Fuselage	1-62		Maneuvering, Slats	1-24	
Lights, Indexer	1-64		Maneuvers, Prohibited	5-6	
Lights, Indicator	1-33		Master Caution Light	1-34	
Lights, Instrument Panel	1-63		Master Switches, Engine	1-8	

	Page No.			Page No.	
	Text	Illus.		Text	Illus.
Maximum Abort Speed Charts . . .	A2-3	A2-8	P		
Maximum Endurance Charts . . .	A5-1	A5-3			
Maximum Thrust Acceleration . . .		A9-31			
Max Performance Maneuvering . . .	6-7		Paddle Switch . . . . .	1-29	
Mechanism, Canopy Interlock . . .	1-70		Panel, IFF Control . . . . .	1-59	
Mechanism, Drogue Chute . . . . .			Panel, Navigation Function Selector . . . . .	1-41	
Scissors . . . . .	1-70		Parachute, Personnel . . . . .	1-71	
Mechanism, Time Release . . . . .	1-70		Penetration, Thunderstorms . . . . .	9-6	
Medium AOA Maneuvering . . . . .	6-6		Personnel Locator Beacon (PLB) . . . . .	1-74	
Military Power Operating Limits . . . . .		5-4	Pitch Trim, Autopilot . . . . .	4-9	
Military Thrust Acceleration . . . . .		A9-60	Pitot Heat Switch . . . . .	1-33	
Minimum Go Speed Chart . . . . .	A2-1	A2-7	Pitot - Static System . . . . .	1-31	
Minimum Landing Roll Distance . . . . .			Pneumatic Pressure Indicator . . . . .	1-20	
Chart . . . . .	A8-1	A8-4	Pneumatic Start . . . . .	2-9	
Minimum Run Takeoff . . . . .	2-21		Pneumatic, Starting . . . . .	1-5	
Miscellaneous Equipment . . . . .	4-19		Pneumatic System . . . . .	1-19	FO-13
Missed Approach Procedures . . . . .	9-4		Position Lights . . . . .	1-62	
Mission Planning . . . . .	A10-1		Power Control System . . . . .	1-18	
MK-H7 Ejection Seat . . . . .		FO-17	Power Supply System, Electrical . . . . .	1-15	
Multiple Weapons Control System . . . . .	4-18		Precision Approach . . . . .	9-1	9-3
			Preflight Check . . . . .	2-1	
N			Present Position Computer . . . . .		
Navigation Computer Displays . . . . .		1-48	(AN/ASN-46A) . . . . .	4-15	
Navigation Computer Set . . . . .			Pressure Altimeter . . . . .	1-37	
(AN/ASN-46) . . . . .	4-14		Pressure Indicator, Boost Pump . . . . .	1-11	
Navigation Computer Set . . . . .			Pressure Indicator, Oil . . . . .	1-3	
(AN/ASN-46A) . . . . .	4-14		Pressure Indicator, Pneumatic . . . . .	1-20	
Navigation Function Selector . . . . .			Pressure Indicators, Hydraulic . . . . .	1-19	
Panel . . . . .	1-41		Pressurization and Vent System, . . . . .		
Night Flying . . . . .	9-4		Fuel . . . . .	1-11	
No-Flap Landing . . . . .	2-25		Pressurization, Cockpit . . . . .	4-4	
No-Flap Takeoff . . . . .	2-21		Pressurization, Fuel . . . . .	1-11	
Normal Procedures . . . . .	2-1		Pressurization, Fuselage . . . . .	1-14	
Nose Gear . . . . .	1-27		Procedure, Cockpit Heating . . . . .	4-5	
Nose Gear Steering . . . . .	1-28		Procedures, Alignment . . . . .	4-11	
Nose Gun System, M61A1 . . . . .	4-19		Procedures, Cold Weather . . . . .	9-4	
Nozzle Control Unit, Exhaust . . . . .	1-8		Procedures, Emergency . . . . .	3-1	
Nozzle Limitations, Exhaust . . . . .	5-1		Procedures, Hot Weather . . . . .	9-6	
Nozzle Position Indicator . . . . .			Procedures, Instrument Flight . . . . .	9-1	
Exhaust . . . . .	1-8		Procedures, Normal . . . . .	2-1	
Nozzles, Fuel . . . . .	1-2		Procedure, Windshield Defogging . . . . .	4-5	
Nozzle, Variable Area Exhaust . . . . .	1-7		Prohibited Maneuvers . . . . .	5-6	
			Pump, Afterburner Fuel . . . . .	1-7	
O			Pump, Boost Check Switch . . . . .	1-11	
Oil Pressure Indicators . . . . .	1-3		Pump, Engine Fuel . . . . .	1-2	
Oil Pressure Limitations . . . . .	5-1		Pump, (Hydraulic Element) Oil . . . . .	1-3	
Oil Pump, Hydraulic . . . . .	1-3		Pump, Lubricating Oil . . . . .	1-3	
Oil Pump, Lubricating . . . . .	1-3				
Oil System, Engine . . . . .	1-3		Q		
One-G Stall . . . . .	6-9		Quantity Gage, Oxygen . . . . .	1-65	
Optimum Cruise Summary . . . . .		A4-6	Quick Release Lever (AFCS) . . . . .		
Out-of-Control Recovery . . . . .		6-12	Emergency . . . . .	4-9	
Oxygen Bottle, Emergency . . . . .	1-72		Quick Release Lever, Emergency . . . . .	1-29	
Oxygen Connection . . . . .	1-66		Quick Turn . . . . .	2-32	
Oxygen Duration Chart . . . . .		1-65			
Oxygen Knob, Emergency . . . . .	1-73		R		
Oxygen, Quantity Gage . . . . .	1-65		Radar Altimeter . . . . .	1-38	
Oxygen, Quantity Gage Test Button . . . . .	1-65		Radar Identification System . . . . .		
Oxygen Regulators . . . . .	1-64		Operation . . . . .		1-59
Oxygen Supply . . . . .	1-66		Radar Recording and Strike Camera . . . . .		
Oxygen System . . . . .	1-64		System . . . . .	4-18	
			Radar Warning Receiver . . . . .	4-19	

	Page No.			Page No.	
	Text	Illus.		Text	Illus.
Radar X-Band Transponder			Stabilator Auxiliary Power Unit . . .	1-18	
SST-181X . . . . .	4-19		Stabilator Control System . . . . .	1-21	
Radio, UHF . . . . .	1-50		Stabilator, Feel and Trim . . . . .	9-7	
Rain . . . . .	9-7		Stabilator Trim System . . . . .	1-21	
Rain Removal, Windshield . . . . .	4-5		Stability and Control . . . . .	6-1	
Ramp, Variable Duct . . . . .	1-3		Stability Augmentation . . . . .	1-23	
Rangewind Correction . . . . .	A4-1	A4-5	Stability Index System . . . . .	A1-1	
Rate Gyro Sensors . . . . .	4-8		Stall Characteristics . . . . .		6-10
Rear Cockpit . . . . .		FO-21			6-19
Rear Cockpit Interior Check . . . . .	2-17		Stalls . . . . .	6-9	
Rear View Mirrors . . . . .	4-19		Stalls, Accelerated . . . . .	6-9	
Refueling, Hot . . . . .	2-30		Stalls, Inverted . . . . .	6-9	
Refueling System, Air . . . . .	4-17		Stalls, Landing Configuration . . . . .	6-11	
Regulator, Oxygen . . . . .	1-64		Stalls, 1-G . . . . .	6-9	
Restrainers, Leg . . . . .	1-72	1-73	Stall Warning Vibrator . . . . .	1-23	
Rocket Motor (Seat) . . . . .	1-70		Standard Atmosphere Table . . . . .		A1-11
RPM Fluctuation . . . . .	5-1		Start, Cartridge . . . . .	2-11	
Rudder Control System . . . . .	1-21		Starter Cartridges . . . . .	7-2	
Rudder Feel Trim System . . . . .	1-22		Starting, Cartridge . . . . .	1-5	
Rudder Pedals . . . . .	1-23		Starting Engines . . . . .	2-9	
Rudder Trim Switch . . . . .	1-23		Starting, Pneumatic . . . . .	1-5	
			Starting System, Engine . . . . .	1-5	
S			Start Pneumatic . . . . .	2-9	
Safety Pins, Ejection Seat and			Start Switch . . . . .	1-5	
Canopy Initiator . . . . .		2-5	Static Pressure . . . . .	1-33	
Sample Mission Summary . . . . .		A-10-9	Station Select Lights Control . . . . .	1-64	
Scissors Mechanism, Drogue Chute . . . . .	1-70		Station Select Switches, Selective		
Scramble . . . . .	2-31		Jettison Control and . . . . .	1-36	
Seat, MK-H7 Ejection . . . . .	1-66		Steering, Nose Gear . . . . .	1-28	
Seat Positioning Switch . . . . .	1-71		Sticker Clips . . . . .	1-70	
Seat Sequencing, Ejection . . . . .	1-66		Subsonic Region . . . . .	6-7	
Selective Flaps/Slats . . . . .	1-24		Supersonic Maximum Thrust Climb		
Selective Jettison Control and			Charts . . . . .	A9-2	A9-14
Station Select Switches . . . . .	1-36		Supersonic Region . . . . .	6-8	
Select Switches, Station . . . . .	1-36		Survival Kit . . . . .	1-73	1-74
Self-Sealing Cells . . . . .	1-10		Sustained G Turn Capabilities . . . . .	A9-7	A9-96
Sequencing System, Automatic . . . . .		1-69	Switch, A/A IFF Ground Test . . . . .	1-17	
Servicing . . . . .	1-75	1-76	Switch, AFCS . . . . .	4-8	
Servos . . . . .	4-8		Switch, Air Refuel . . . . .	4-18	
Short Field Landing . . . . .	2-25		Switch, Altitude Hold . . . . .	4-8	
Shoulder Harness Release Handle . . . . .	1-72		Switch, Anti-Icing . . . . .	1-7	
Single Ejection, Rear Cockpit . . . . .	1-68		Switch, Anti-Skid Control . . . . .	1-28	
Single Engine Taxi . . . . .	2-30		Switch, APU Reject . . . . .	1-18	
Sink Rate, Touchdown Limits . . . . .		5-9	Switch, Autopilot Ground Test . . . . .	1-17	
Slats In Light . . . . .	1-24		Switch, Battery Bypass . . . . .	1-16	
Slats, Maneuvering . . . . .	1-24		Switch, Bearing/Distance Selector	1-41	
Slats Override Switch . . . . .	1-24		Switch, Boost Pump Check . . . . .	1-11	
Solo Flight Inspection . . . . .	2-32		Switches, Engine Master . . . . .	1-8	
Spare Lamps . . . . .	4-19		Switches, Generator Control . . . . .	1-17	
SPC . . . . .	1-33		Switches, Speed Brake . . . . .	1-26	
Special Weapons Delivery Systems . . . . .	4-19		Switch, External Transfer . . . . .	1-11	
Speech Security Unit (KY-28) . . . . .	4-19		Switch, Feed Tank Check . . . . .	1-14	
Speed Brake Operation, Emergency . . . . .	1-26		Switch, Flaps/Slats . . . . .	1-24	
Speed Brake Out Light . . . . .	1-26		Switch, Instrument Ground Power . . . . .	1-17	
Speed Brakes . . . . .	1-26		Switch, Internal Wing Transfer . . . . .	1-11	
Speed Brake Switches . . . . .	1-26		Switch, Paddle . . . . .	1-29	
Spin Recovery . . . . .		6-14	Switch, Pitot Heat . . . . .	1-33	
Spins . . . . .	6-11		Switch, Rudder Trim . . . . .	1-23	
Spins, Inverted . . . . .	6-13		Switch, Seat Positioning . . . . .	1-71	
Spins, Upright . . . . .	6-13		Switch, Slats Override . . . . .	1-24	
Spoiler Control . . . . .	1-20		Switch, Stag Aug . . . . .	4-8	
Stab Aug Switch . . . . .	4-8		Switch, Start . . . . .	1-5	
			Switch, Tank Depressurization . . . . .	1-14	



	Page No.			Page	
	Text	Illus.		Text	Illus.
System, Afterburner . . . . .	1-7		System, Oxygen . . . . .	1-64	
System, Afterburner Fuel . . . . .	1-7		System, Pitot-Static . . . . .	1-31	
System, Afterburner Ignition . . . . .	1-7		System, Pneumatic . . . . .	1-19	FO-13
System, Aft Fuselage Overheat . . . . .	1-35		System, Power Control . . . . .	1-18	
System, Aileron-Spoiler Control . . . . .	1-20		System, Radar Recording and Strike Camera . . . . .	4-18	
System, Air Conditioning and Pressurization . . . . .	4-1	4-2	System, Rudder Control . . . . .	1-21	
System, Air Data Computer . . . . .	1-33	1-34	System, Rudder Feel Trim . . . . .	1-22	
System, Airplane and Engine Fuel		FO-5	Systems, Bleed Air and Associated . . . . .		1-6
System, Air Refueling . . . . .	4-17		Systems, Canopy Emergency . . . . .	1-61	
System, AN/ASQ-19A . . . . .	1-41		Systems, Operation Limitations . . . . .		5-7
System, Angle of Attack (AOA) . . . . .	1-30		System, Stabilator Control . . . . .	1-21	
System, Anti-G Suit . . . . .	4-6		System, Stabilator Trim . . . . .	1-21	
System, Anti-Ice Engine . . . . .	9-7		System, TACAN . . . . .	1-55	
System, Anti-Skid . . . . .	1-28		System, Tow Targets . . . . .	4-19	
System, AOA Aural Tone . . . . .	1-30		System, Utility . . . . .	1-19	
System, Arresting Hook . . . . .	1-29		System, Wheel Brake . . . . .	1-28	
System, Attitude Reference . . . . .	4-12				
System, Automatic Flight Control (AN/ASA-32) . . . . .	4-6		T		
System, Drag Chute . . . . .	1-29		TACAN Displays . . . . .	1-49	
System, Electrical Power Supply . . . . .	1-15		TACAN System . . . . .	1-55	
System, Electrical External Power Applied . . . . .		FO-7	Tachometers . . . . .	1-9	
System, Emergency Attitude Reference . . . . .	4-14		Takeoff, Crosswind . . . . .	2-22	
System, Emergency Brake . . . . .	1-29		Takeoff Distance Charts . . . . .	A2-3	A2-10
System, Engine Air Induction . . . . .	1-3		Takeoff Emergencies . . . . .	3-5	
System, Engine Anti-Icing . . . . .	1-5		Takeoff, Heavy Gross Weight . . . . .	2-21	
System, Engine Bleed Air . . . . .	1-5		Takeoff, Minimum Run . . . . .	2-21	
System, Engine Fire and Overheat Detector . . . . .	1-35		Takeoff, No-Flap . . . . .	2-21	
System, Engine Fuel . . . . .	1-2		Takeoff, Normal . . . . .	2-21	
System, Engine Ignition . . . . .	1-5		Tank Depressurization Switch . . . . .	1-14	
System, Engine Oil . . . . .	1-3		Tank Jettison System . . . . .	1-15	
System, Engine Starting . . . . .	1-5		Tank 7 Fuel Light . . . . .	1-15	
System, Equipment Air Conditioning . . . . .	4-5		Taxiing . . . . .	2-18	
System, Equipment Auxiliary Air . . . . .	4-6		Taxi Lights . . . . .	1-62	
System, External Tank Jettison . . . . .	1-15		Taxi, Single Engine . . . . .	2-30	
System, Fire Control . . . . .	4-18		Telelight Panel . . . . .	1-34	
System, Fire Warning . . . . .	1-35		Temperature Conversion Chart . . . . .		A1-12
System, Flaps/Slats . . . . .	1-24		Temperature Effect On Maximum Speed . . . . .	A9-5	A9-94
System, Flight Control . . . . .		FO-15	Throttle Bursts . . . . .	5-4	
System, Fuel . . . . .	1-10		Throttles, Engine . . . . .	1-8	1-9
System, Fuel Boost . . . . .	1-11		Thrust Limitations . . . . .	5-4	
System, Fuel Quantity . . . . .	1-14		Thunderstorms . . . . .	9-6	
System, Fuel Transfer . . . . .	1-10		Time Release Mechanism . . . . .	1-70	
System, Hydraulic . . . . .		FO-11	Time To Climb . . . . .		A3-4, A3-8, A3-11
System, Hydraulic Power Supply . . . . .	1-18		Touch-And-Go Technique . . . . .	2-28	
System, Inertial Navigation And Attitude Heading Reference . . . . .	4-11		Touchdown Limitations . . . . .	5-6	
System, Intercom . . . . .	1-43		Touchdown Sink Rate Limits . . . . .		5-9
System, Internal Wing Fuel Dump . . . . .	1-15		Tow Target Systems . . . . .	4-18	
System, Jettison . . . . .	1-35		Transfer Switch, External . . . . .	1-11	
System, LABS . . . . .	4-19		Transfer Switch, Internal Wing . . . . .	1-11	
System, Landing Gear . . . . .	1-27		Transfer System, Fuel . . . . .	1-10	
System, Lateral Control Feel . . . . .	1-20		Trim, Stabilator . . . . .	9-7	
System, Lateral Control Trim . . . . .	1-20		Trim Switch, Rudder . . . . .	1-23	
System, Multiple Weapons Control . . . . .	4-18		Trim System, Lateral Control . . . . .	1-20	
			Trim System, Rudder Feel . . . . .	1-22	
			Trim System, Stabilator . . . . .	1-21	
			True Airspeed . . . . .	A1-2	
			True Airspeed Indicators . . . . .	1-37	

	Page No.			Page No.	
	Text	Illus.		Text	Illus.
Turbulence and Thunderstorms . . . . .	9-6		VOR/ILS And Heading Displays . . . . .		1-47
Turn and Slip Indicator . . . . .	1-39		VOR/ILS System . . . . .	1-57	
Turn Capabilities Chart . . . . .	A9-6	A9-95	W		
Turning Radius and Ground Clearance . . . . .		2-19	Warning and Indicator Lights . . . . .	1-33	
T2 Cutback . . . . .	7-1		Warning Lights Test Switch . . . . .	1-64	
T2 Reset . . . . .	7-1		Weapons Release Computer Set (AN/ASQ-91) . . . . .	4-19	
T5 Reset . . . . .	7-1		Weapon Suspension Equipment . . . . .	4-19	
U			Weight and Balance . . . . .	2-1	
UHF Radio . . . . .	1-50		Wet or Icy Runway Landing . . . . .	2-27	
UHF Radio Controls . . . . .	1-51		Wet Runway, Landing . . . . .	2-27	
Upright Spins . . . . .	6-13		Wheel Brake System . . . . .	1-28	
Utility Light . . . . .	1-64		Wind Component Chart . . . . .	A-14	A1-20
Utility System . . . . .	1-19		Windmilling Limitations . . . . .	5-4	
V			Windshield Defogging . . . . .	4-4	
Variable Area Exhaust Nozzle . . . . .	1-7		Windshield Defogging Procedure . . . . .	4-5	
Variable Bypass Bellmouth . . . . .	1-4		Windshield Rain Removal . . . . .	4-5	
Variable Duct Ramp . . . . .	1-3		Wing Fold . . . . .	1-26	
Velocity During Takeoff Ground Run Charts . . . . .	A2-4	A2-12	Wing Tank Pressurization and Vent . . . . .	1-14	
Vent Knob, Emergency . . . . .	4-5		Wing Transfer Switch, Internal . . . . .	1-11	
Vertical Velocity Indicator . . . . .	1-38		Z		
Vibrator, Stall Warning . . . . .	1-23		Zoom Climb . . . . .	6-15	
V-N Envelope . . . . .	A9-4	A9-86			