

Pilot's Handbook  
of  
Flight Operating Instructions

*NAVY MODEL*  
FM-2

*BRITISH MODEL*  
WILDCAT VI

Airplanes

Appendix I of this publication shall not be carried in aircraft on combat missions or when there is a reasonable chance of its falling into the hands of the enemy

THIS PUBLICATION SUPERSEDES AN 01-190FB-1 DATED 15 FEBRUARY 1945

*NOTICE.—This document contains information affecting the national defense of the United States within the meaning of the Espionage Act, 50 U. S. C., 31 and 32, as amended. Its transmission or the revelation of its contents in any manner to an unauthorized person is prohibited by law.*

15 June 1945

**THIS PUBLICATION MAY BE USED BY PERSONNEL RENDERING SERVICE TO THE UNITED STATES OR ITS ALLIES**

**Instructions Applicable to AAF Personnel.**

Paragraph 5.d. of Army Regulation 380-5 relative to the handling of restricted printed matter is quoted below:

"d. Dissemination of restricted matter.—The information contained in restricted documents and the essential characteristics of restricted material may be given to any person known to be in the service of the United States and to persons of undoubted loyalty and discretion who are cooperating in Government work, but will not be communicated to the public or to the press except by authorized military public relations agencies."

**Instructions Applicable to Navy Personnel.**

Navy Regulations, Article 75½, contains the following paragraphs relating to the handling of restricted matter:

"(b) Restricted matter may be disclosed to persons of discretion in the Government service when it appears to be in the public interest.

"(c) Restricted matter may be disclosed, under special circumstances, to persons not in the Government service when it appears to be in the public interest."

The Bureau of Aeronautics Circular Letter No. 12-43 further states:

"Therefore, it is requested that all naval activities check their own local regulations and procedures to make sure that handbooks, service instructions and other restricted technical publications are actually being made available to both civilian and enlisted personnel who have use for them."

**General.**

These instructions permit the issue of restricted publications to civilian contract and other accredited schools engaged in training personnel for Government work, to civilian concerns contracting for overhaul and repair of aircraft or aircraft accessories, and to similar commercial organizations.

**LIST OF REVISED PAGES ISSUED**

**NOTE:** A heavy black vertical line, to the left of the text on revised pages, indicates the extent of the revision. This line is omitted where more than 50 percent of the page is revised.

**ADDITIONAL COPIES OF THIS PUBLICATION MAY BE OBTAINED AS FOLLOWS:**

**AAF ACTIVITIES.**—Submit requisitions through the Air Inspector, Technical, whenever practicable, in accordance with T. O. No. 00-25-3 to the Commanding General, Fairfield Air Service Command, Patterson Field, Ohio. Attn: Publications Distribution Branch, as outlined in AAF Regulation 5-9. For details of Technical Order distribution, see T. O. No. 00-25-3.

**NAVY ACTIVITIES.**—Submit requests to the Chief, Bureau of Aeronautics, Navy Department, Washington, D. C. Also, see NavAer 00-500 for details on distribution of technical publications.

**BRITISH ACTIVITIES.**—Submit requirements on Form 294A, in duplicate, to the Air Publications and Forms Store, New College, Leadhall Lane, Harrogate, Yorkshire, England.

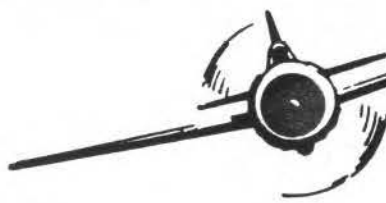

# Section 1 DESCRIPTION

## 1. DESCRIPTION.

*a. GENERAL.*—The FM-2 airplane, manufactured by Eastern Aircraft Division, General Motors Corporation, is a class VF, single engine, single place, folding mid-wing, monoplane, carrier fighter. It is designed to take off from the deck of an aircraft carrier with or without the aid of a catapult and to land on a carrier deck in an arresting gear or on an ordinary landing field. The overall dimensions of the airplane are: wing spread, 38 feet; length, 28 feet 7-7/32 inches; height at rest, 9 feet 11/2 inches. Equipped as a normal fighter its gross weight is approximately 7477 pounds.

*b. POWER PLANT.*—This airplane is powered with a nine cylinder, single bank, air cooled radial engine, Wright model R-1820-56, -56W, -56A or -56WA. The R-1820-56 engine has a take-off manifold pressure of 46.5 PSI at 2600 RPM at sea level and no water injection equipment. Model R-1820-56W has the same take-off setting, but has provision for water injection and therefore Combat Power rating. The R-1820-56A engine has a redesigned crankshaft allowing a take-off full throttle setting at 2700 RPM at sea level. It has no provisions for water injection and no Combat Power rating. The R-1820-56WA model has the features of both the -56W and the -56A engine. Its take-off setting is full throttle at 2700 RPM at sea level and a Combat Power rating of 2700 RPM at full throttle in low blower. None of these R-1820 engines must be operated above 2600 RPM in HIGH BLOWER.

Airplanes Serial Number 86422 and subsequent are equipped with R-1820-56WA engines. The R-1820-56A engine will be found only on airplanes which have had this model installed in the field.

All four engine models are equipped with an integral, single stage, two speed supercharger. The power plant is designed to operate on an AN-F-28, 100/130 octane fuel.

The Wright Water Injection System is installed on airplanes Serial Number 57044 and subsequent; earlier airplanes may have this installation. Airplanes equipped with Water Injection for Combat Power can be recognized by the limit switches on the supercharger and engine control quadrants.

*c. WINGS.*—The wings are folded and spread manually and are locked in spread position by locking pins actuated by a hand crank.

*d. ALIGHTING GEAR.*—The main landing gear is retracted mechanically by a handcrank operated by the pilot. The tail wheel is not retractable.

*e. FUSELAGE.*—All flight, engine and auxiliary controls are located in the pilot's cockpit. See figures 5, 6 and 7 for their arrangement. A baggage compartment aft of the cockpit is accessible through a hinged door on the right hand side of the airplane. This compartment houses the remote indicating compass, its transmitter and inverter, the radios and the battery and provides stowage space for auxiliary equipment and baggage.

*f. ARMAMENT.*—Two .50 caliber machine guns are mounted in the outer panel of each wing. Armor plate, a bullet proof windshield and the engine installation combine to protect the pilot from enemy fire from the front. Armor plate and structure protect him from rear fire.

## 2. SURFACE CONTROLS.

The ailerons and elevators are controlled by a standard type stick. The rudder is operated by standard under-rudder pedals. These pedals are adjustable by individual levers to four positions. To adjust the pedals, place the toes on the adjustment levers and push the pedals all the way forward, then with toes under the pedals, bring them aft one notch at a time until the desired position is attained. By aid of the position indicator, check that each pedal has ratcheted past the same number of notches.

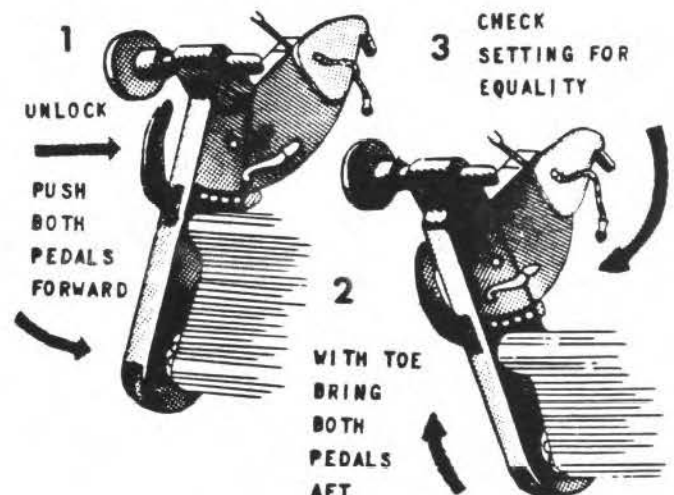
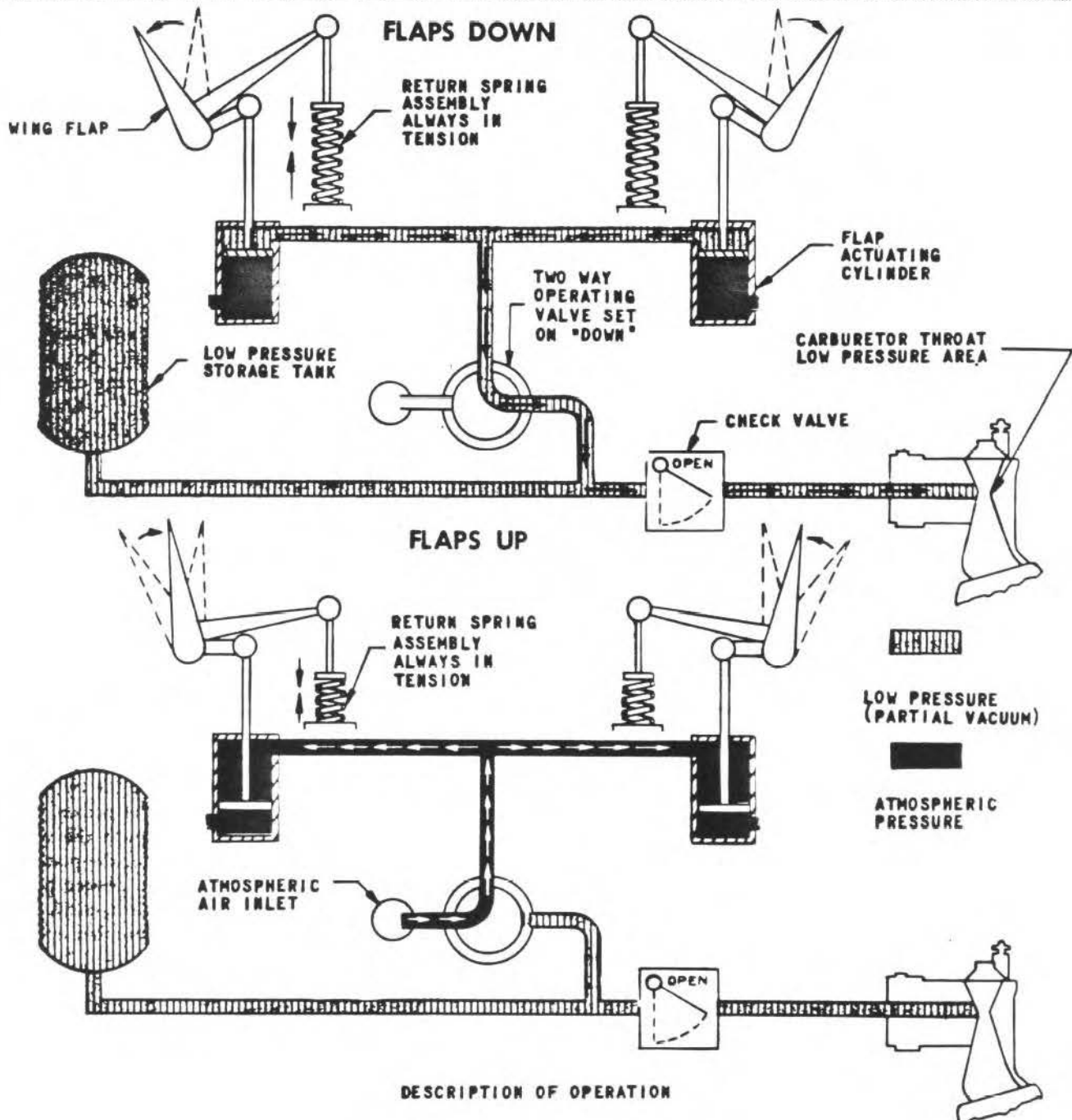

Figure 2—Pedal Adjustment Procedure

RESTRICTED  
AN 01-190FB-1



WITH VALVE IN "FLAPS DOWN" POSITION, THE LOW PRESSURE SIDE OF THE FLAP ACTUATING PISTON IS APPROXIMATELY 5.4 TO 6.8 LBS.SQ.IN AND THE PRESSURE ON THE OTHER SIDE IS ATMOSPHERIC (14.7 LBS.SQ.IN.). THIS DIFFERENTIAL IN PRESSURE PROVIDES THE FORCE TO MOVE THE PISTON AND THE FLAP TO "DOWN" POSITION.

WITH VALVE IN "FLAPS UP" POSITION, THE PRESSURE ON BOTH SIDES OF THE PISTON IS ATMOSPHERIC AND THEREFORE THERE IS NO OPERATING FORCE. AERODYNAMIC PRESSURE TOGETHER WITH THE FLAP RETURN SPRING, LOCATED IN THE STUB WING, RETURNS THE FLAP TO "UP" POSITION.

Figure 3 —Wing Flap Operation

### 3. TAB CONTROLS.

**NOTE**

The tab controls are rotated in the direction of the desired resultant motion of the airplane.

a. **AILERON TAB.**—A cockpit controlled trim tab is provided on the left aileron only. The control wheel, which is set into the left hand shelf, is rotated counter-clockwise to lower the left wing and clockwise to lower the right wing. The tab travel is 20° up and 20° down.

A fixed tab on the right aileron is adjusted by crimping to compensate for wing inequality. A single setting on leaving the factory or following wing repair is usually sufficient. Be careful not to crimp the tab too severely as a slight change in the tab angle will compensate for considerable wing heaviness.

b. **ELEVATOR TABS.**—The elevator tabs are controlled by a handcrank on the side of the left hand shelf. Rotation *aft* or *counter-clockwise* raises the nose. Rotation *forward* or *clockwise* lowers the nose.

Tab travel is through a range from 6° up to 11° down. These tabs have been found effective through all ranges of loadings. Trim about the lateral axis can be checked by means of the gyro horizon.

c. **RUDDER TAB.**—The rudder trim tab is controlled by a wheel mounted on the left hand cockpit shelf. Rotation *clockwise* turns the nose right. Rotation *counter-clockwise* turns the nose left.

Angular travel of the tab is from 22° left to 16°

right. On take-off, a basic setting at 2½ marks in the white segment of the dial is used.

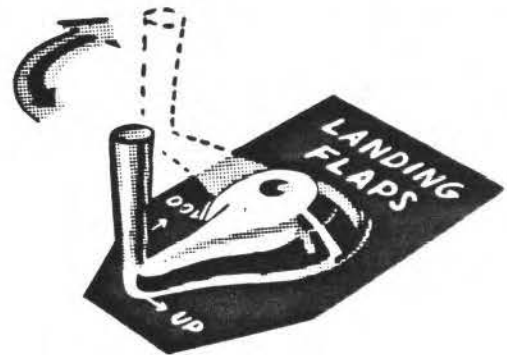

### 4. WING FLAP SYSTEM.

Split type wing flaps extend from the ailerons inboard to the fuselage but are divided into inboard and outboard flaps by the wing fold. Due to an overlap at the wing fold, the two sections operate as a unit capable of being drooped to a maximum of 43° by the action of a vacuum system.

The operating partial vacuum is obtained from the carburetor intake manifold and may be applied directly to the operating cylinder or stored in the vacuum tank located in the baggage compartment. This tank has sufficient capacity to operate the flaps at least twice with

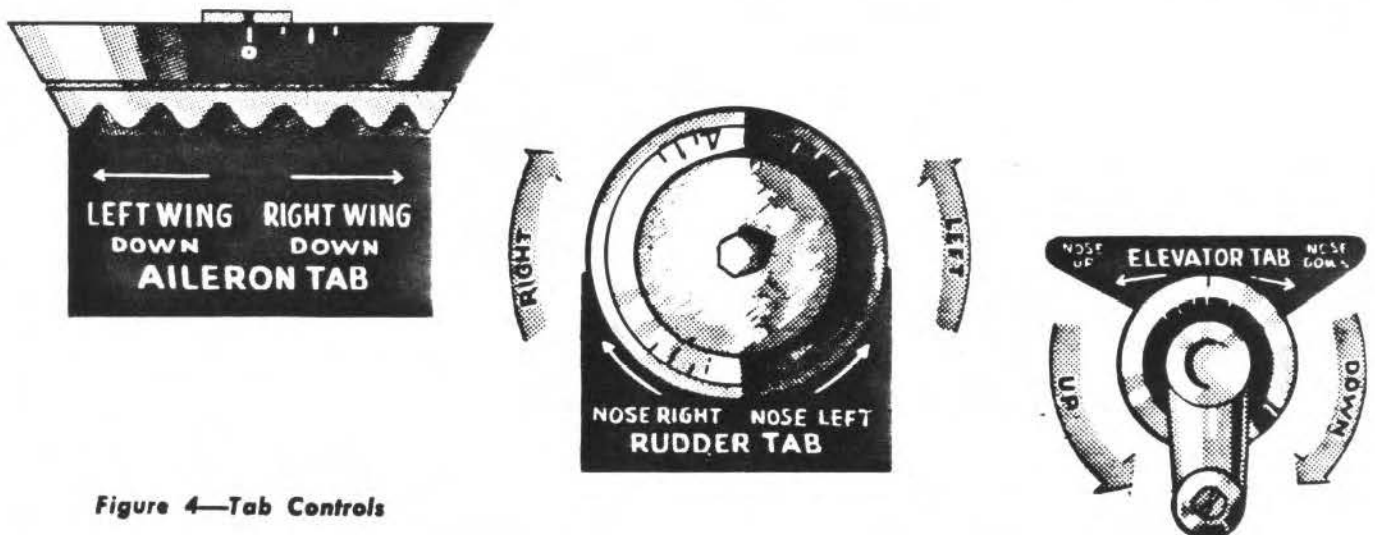

Figure 4—Tab Controls

the engine cut. Even though the switch is cut, the engine, unless it is completely stopped, will produce vacuum with the throttle closed.

The operating force on the flaps is sufficient to hold the flaps down when the engine is idled. In flight, as more power is applied and speed increases, the flaps will come up until, at about 130 knots (150 MPH), the angle of droop will be approximately 10°. If the power is then removed, the flaps will return to the *Down* position. This feature is very helpful when it is necessary to go around again after coming in for a landing.

In a take-off the flap valve can be left *Down* until ample speed and height are obtained for forcing flaps up. If the valve is then turned to *Up* position, any sinking effect is eliminated.

The detail operation of the system is described in the accompanying schematic diagram (Figure 3). With this vacuum system the operating efficiency of the flaps will be reduced with decreased atmospheric pressure at high altitudes.

The flap operating valve control is located on the left hand shelf of the cockpit. Rotation *clockwise* for a quarter turn of the handle lowers the flaps; *counter-clockwise* raises them.

## 5. POWER PLANT CONTROLS.

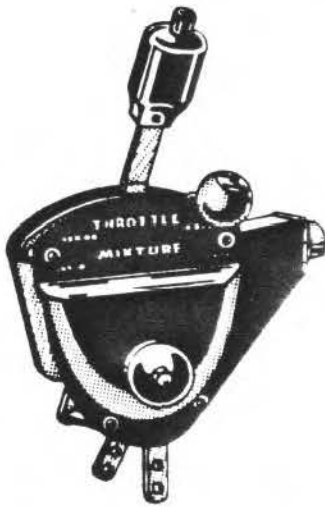

**a. THROTTLE AND MIXTURE CONTROLS.**—The throttle and mixture controls are united in an engine control quadrant mounted on the left hand cockpit shelf. A friction brake affecting the ease of movement of the control levers is adjusted by a knob on the face of the quadrant. The throttle is moved forward to open, aft to close. An adjustable joggle in the throttle rail marks the *Take-off* and *Military Power* position of the throttle control lever for the R-1820-W engine and the *Military*

*Power* throttle position for the R-1820-WA engine. This joggle should be set to provide the *Take-off* and *Military Power* determined for the operational area. Movement past the joggle places the throttle control in full boost position for *Combat Power*.

The mixture control is moved full forward for *Auto Rich* position. *Auto Lean* position is 45° aft, approximately in the center of the quadrant, and must be found by seating the control in the notched position. *Idle Cut-Off* position, marked in red on the quadrant, is located full aft.

Fuel will be discharged from the carburetor with the mixture control in any position except *Idle Cut-Off* whenever the fuel pressure is greater than five PSI whether the engine is running or stopped. Therefore, to prevent flooding through the inadvertent use of the electric emergency fuel pump, the mixture control should always be left in the *Idle Cut-Off* position when the engine is not running. If for any reason the engine should cut out during ground operation, the mixture control should be moved immediately into the *Idle Cut-Off* position in order to prevent flooding.

For landing, landing approach, take-off, all ground operation and during prolonged, steep dives, the mixture control should be set in auto rich. For all other flight operations the use of auto lean is recommended provided cylinder head temperature limits are not exceeded.

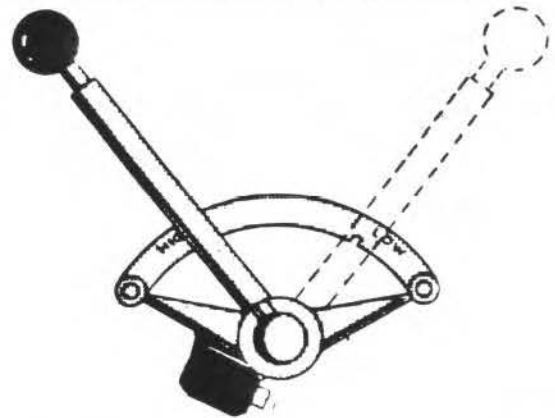

**b. SUPERCHARGER CONTROL.**—The two-speed

supercharger shift control is an arm mounted on a quadrant notched in two positions. To shift speed depress the knob on the top of the arm and move full forward for low blower; full aft for high blower. The control lever must be securely locked at the extremity of its travel in either *High* or *Low* position to insure complete and positive clutch engagement. Do not attempt to operate the engine with the supercharger control in any intermediate position.

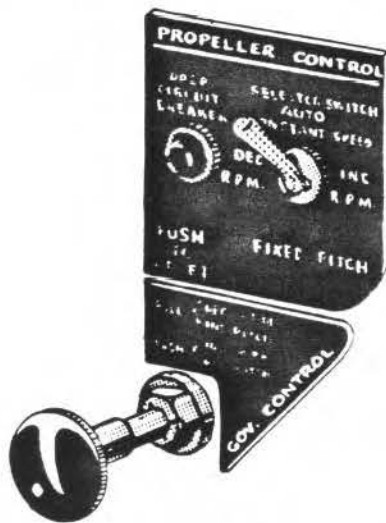

c. PROPELLER CONTROL.—The propeller is a three-blade Curtiss Electric Constant Speed type with a ten foot diameter. Basic pitch settings are at 18.5° low and 53.5° high.

Control is effected by an electric selector switch and a governor control push-pull knob.

With the selector switch in *Automatic* position, RPM is governed entirely by the operation of the push-pull knob on the left hand instrument panel. RPM is increased by pushing the knob in and decreased by pulling it out. Once an RPM is selected in this manner it will remain constant within the operating limits of the governor.

Always move the push-pull governor control knob slowly as a slight movement will cause a large change in engine RPM. For slight change in engine RPM, vernier control is recommended. This is obtained by rotating the control handle *clockwise* to increase engine RPM; *counter-clockwise* to decrease RPM.

When the selector switch is in *Fixed Pitch* position in the center of the three-way selector switch, the propeller will not be affected by movement of the control knob. For any desired manifold pressure, RPM can then be adjusted by holding the switch in either *Increase RPM* or *Decrease RPM* position until the desired RPM

is obtained. Immediately on release, the switch will automatically return to *Fixed Pitch* position. Hold this RPM switch on only momentarily until the desired RPM is indicated on the tachometer.

If the circuit breaker is opened by an overload, the propeller operates at fixed pitch at the pitch angle in effect at the moment the breaker is opened. Fixed pitch control cannot be used with this circuit breaker open; the propeller blade angle cannot be changed until the circuit breaker is reset.

#### AUTOMATIC CONTROL

##### To Increase RPM

Circuit Breaker.....On  
Selector Switch.....Automatic  
Propeller Governor Knob.....Push In

##### To Decrease RPM

Circuit Breaker.....On  
Selector Switch.....Automatic  
Propeller Governor Knob.....Pull Out

#### FIXED PITCH CONTROL

##### To Increase RPM

Circuit Breaker.....On  
Selector Switch.....Fixed Pitch  
Selector Switch.....Increase RPM

##### To Decrease RPM

Circuit Breaker.....On  
Selector Switch.....Fixed Pitch  
Selector Switch.....Decrease RPM



d. CARBURETOR AIR CONTROL.—The carburetor air control handle is located on the left hand instrument panel to the right of the propeller control. The full-in position allows direct cold air from the atmosphere to be taken in through the air scoop and enter the carburetor at the same time preventing warm air from entering the carburetor. The full-out position

prevents the direct cold air from entering the carburetor but allows the warm air to be taken in from the accessory section. This control operates a door whose action may be compared to a two-way valve.

Never use an intermediate position for this control. The control should be left in *Direct (Cold)* position at all times unless icing conditions are suspected or rain is encountered. Under these conditions the control should be pulled out to the *Alternate Hot* position.

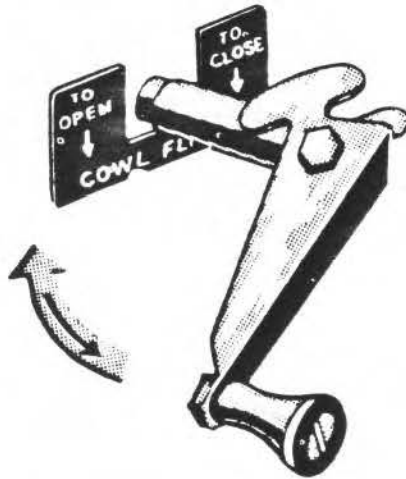

**e. COWL FLAP CONTROL AND CYLINDER HEAD TEMPERATURES.**—The cowl flaps are operated by a handcrank located on the right hand instrument panel. Rotation *clockwise* closes the flaps; rotation *counter-clockwise* opens them.

The full open setting of the cowl flaps is provided primarily for ground cooling. Intermediate settings should be used as needed so that the following cylinder head temperatures will not be exceeded:

Combat Power .....	248°C (5 min.)
Take-Off .....	248°C (5 min.)
Military Power .....	232°C (30 min.)
Normal Rated Power:	
.....	232°C (1 hour)
.....	218°C (Cont.)
Maximum Cruising Power and Below .....	205°C (Cont.)

**NOTE**

As the cowl flaps create a considerable drag when open as shown in the following table, they should be opened gradually in level flight as the temperature approaches the limit, rather than all the way when the limit is reached.

In a climb increase the airspeed by as much as 10 knots in preference to opening them more than half way.

**COWL FLAP DRAG  
IN KNOTS**

IAS	1/2 OPEN	FULL OPEN
120	8	15
140	7	14
160	7	13
180	7	13
200	6	12
220	5	11

Cylinder head temperatures can be reduced by:

1. Enriching the mixture.
2. Opening cowl flaps.
3. Reducing power.
4. Increasing climbing air speed.



**f. IGNITION SWITCH.**—The four position ignition switch is located on the left hand instrument panel. The *Left* and *Right* positions are used in checking the two magnetos during the engine warm-up period. The procedure is outlined in Section II, Paragraph 7c.

**g. PRIMING SYSTEM AND CONTROL.**—An electrically controlled priming system draws fuel from the carburetor and injects it into the diffuser section of the engine in two places. The primer switch is located on the pilot's distribution panel adjacent to the starter switch so that both may be operated with one hand. The primer switch is to be held down only momentarily, i.e. for not more than three to five seconds. Upon release it automatically returns to the *Off* position.

**b. STARTER AND CONTROL.**—A Breeze Type I cartridge starter is fired electrically by the starter switch. This switch is located on the pilot's distribution panel adjacent to the primer switch. To operate this switch, it is necessary to raise the guard and hold the switch in



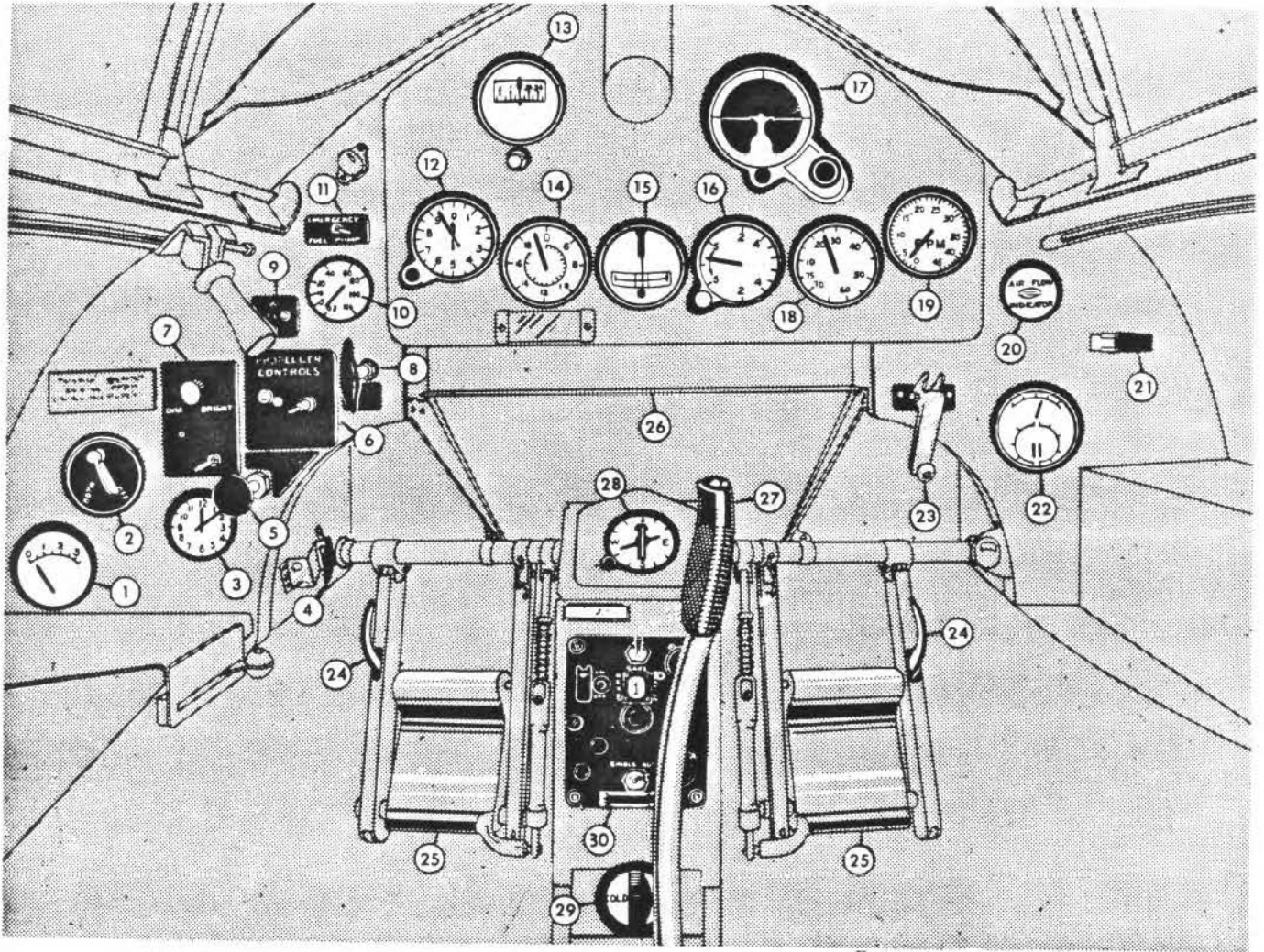

- |     |   |     |                            |
|-----|---|-----|----------------------------|
| 1.  | CYLINDER HEAD TEMPERATURE GAUGE               | 16. | CLIMB INDICATOR            |
| 2.  | IGNITION SWITCH                               | 17. | GYRO HORIZON               |
| 3.  | CLOCK   | 18. | MANIFOLD PRESSURE GAUGE    |
| 4.  | WINDSHIELD DEFROSTER CONTROL                  | 19. | TACHOMETER                 |
| 5.  | PROPELLER GOVERNOR CONTROL                    | 20. | OXYGEN FLOW METER          |
| 6.  | PROPELLER SELECTOR SWITCH AND CIRCUIT BREAKER | 21. | OIL DILUTION SWITCH        |
| 7.  | GUN SIGHT SWITCH AND RHEOSTAT                 | 22. | ENGINE GAUGE UNIT          |
| 8.  | CARBURETOR AIR CONTROL                        | 23. | COWL FLAP CONTROL HANDLE   |
| 9.  | LOW LEVEL FUEL WARNING LIGHT                  | 24. | PEDAL ADJUSTMENT LEVERS    |
| 10. | FUEL QUANTITY GAUGE                           | 25. | RUDDER PEDALS              |
| 11. | EMERGENCY FUEL PUMP SWITCH                    | 26. | CHART BOARD                |
| 12. | ALTIMETER                                     | 27. | CONTROL STICK              |
| 13. | DIRECTIONAL GYRO                              | 28. | COMPASS                    |
| 14. | AIRSPEED INDICATOR                            | 29. | CABIN AIR INTAKE CONTROL   |
| 15. | TURN AND BANK INDICATOR                       | 30. | MARK 3 STATION DISTRIBUTOR |

Figure 5—Instrument Panel

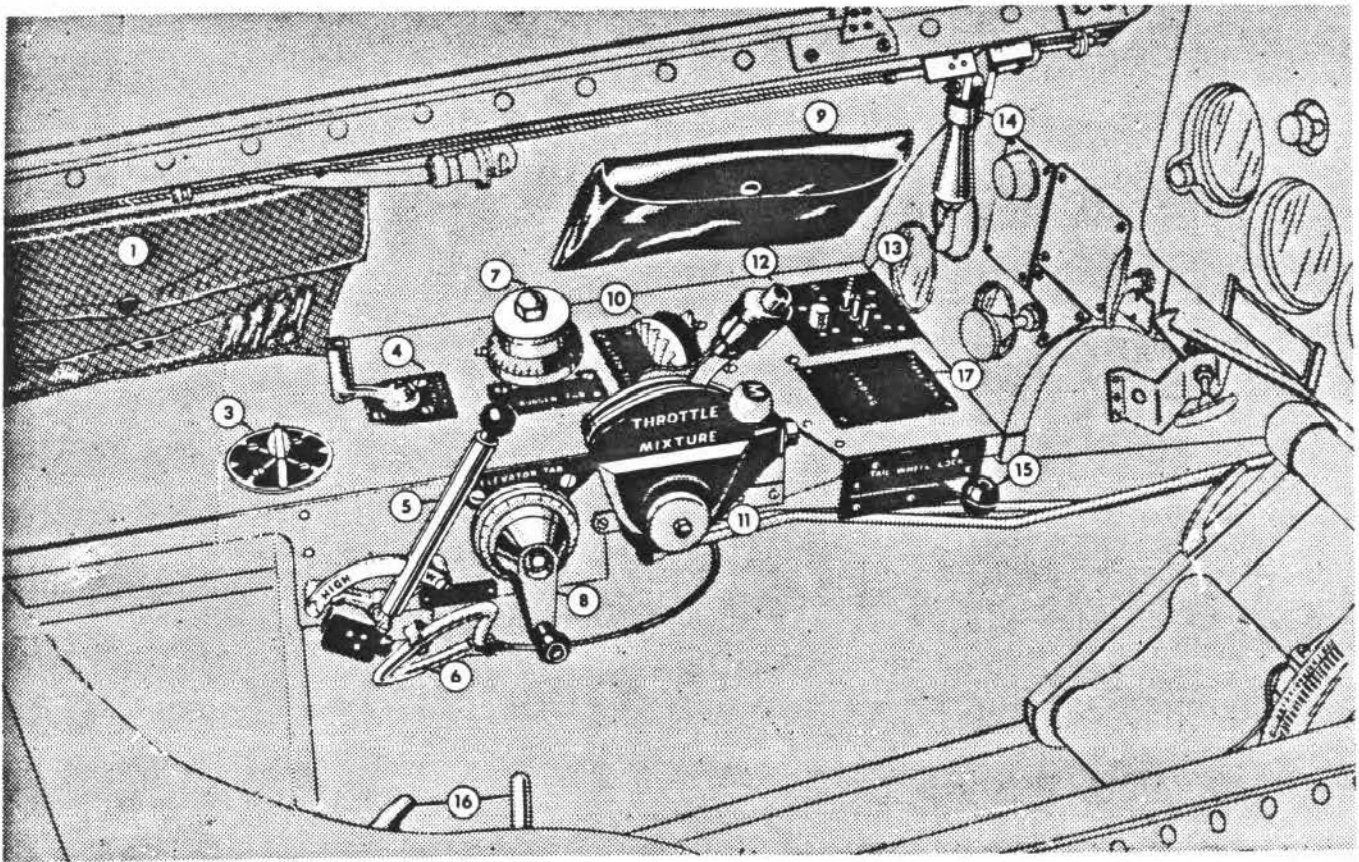

- |    |                                    |     |                                       |
|----|------------------------------------|-----|---------------------------------------|
| 1. | MAP CASE                           | 10. | AILERON TAB CONTROL                   |
| 3. | FUEL TANK SELECTOR VALVE           | 11. | THROTTLE AND MIXTURE CONTROL QUADRANT |
| 4. | LANDING FLAP CONTROL               | 12. | OXYGEN OR LIP MICROPHONE SWITCH       |
| 5. | SUPERCHARGER CONTROL QUADRANT      | 13. | RECOGNITION LIGHT SWITCHES            |
| 6. | DROPPABLE FUEL TANK RELEASE HANDLE | 14. | ARRESTING HOOK CONTROL HANDLE         |
| 7. | RUDDER TAB CONTROL                 | 15. | TAIL WHEEL LOCK CONTROL               |
| 8. | ELEVATOR TAB CONTROL               | 16. | GUN CHARGING HANDLES                  |
| 9. | WIRING DIAGRAM POCKET              | 17. | CHECK OFF LIST                        |

Figure 6—Left Hand Side of Cockpit

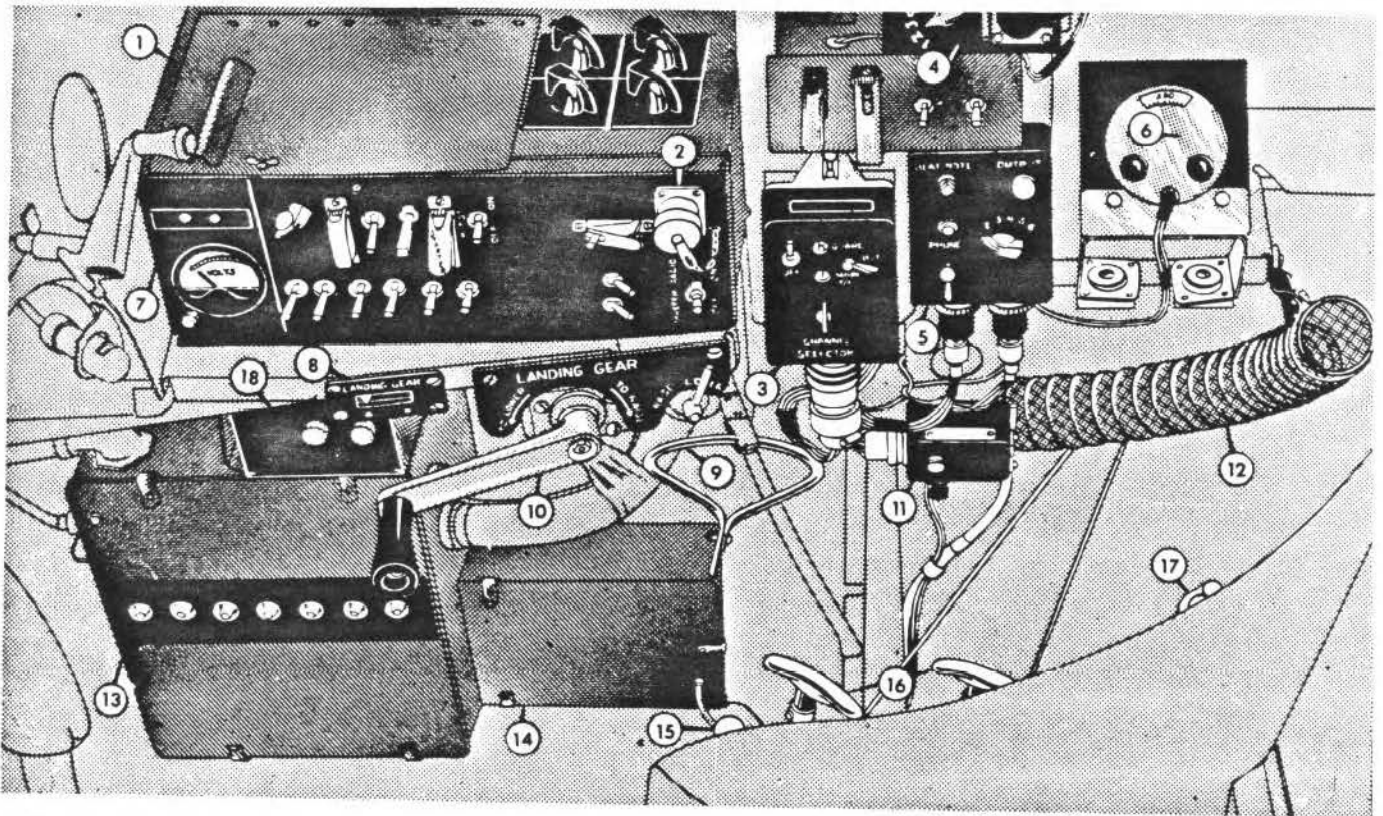

- |  |  |
|--|--|
| <ul style="list-style-type: none"> <li>1. PILOT'S DISTRIBUTION PANEL</li> <li>2. POWER RECEPTACLE (FOR ELECTRICALLY HEATED SUITS)</li> <li>3. COMMUNICATION EQUIPMENT CONTROL UNIT</li> <li>4. IFF CONTROL BOX AND SELECTOR SWITCH</li> <li>5. NAVIGATION EQUIPMENT CONTROL UNIT</li> <li>6. RANGE RECEIVER</li> <li>7. VOLTAMMETER OR VOLTMETER</li> <li>8. LANDING GEAR POSITION INDICATOR</li> <li>9. DROPPABLE FUEL TANK RELEASE HANDLE</li> </ul> | <ul style="list-style-type: none"> <li>10. LANDING GEAR HANDCRANK</li> <li>11. JACK BOX</li> <li>12. COCKPIT VENTILATOR</li> <li>13. MAIN JUNCTION BOX AND CIRCUIT BREAKER RESET BUTTONS</li> <li>14. GENERATOR CUT-OUT</li> <li>15. PILOT'S SEAT ADJUSTMENT HANDLE</li> <li>16. RIGHT HAND GUN CHARGING HANDLES</li> <li>17. OXYGEN BOTTLE SHUT-OFF VALVE</li> <li>18. CIRCUIT BREAKER BOX AND RESET BUTTONS FOR ROCKETS</li> </ul> |
|--|--|

Figure 7—Right Hand Side of Cockpit



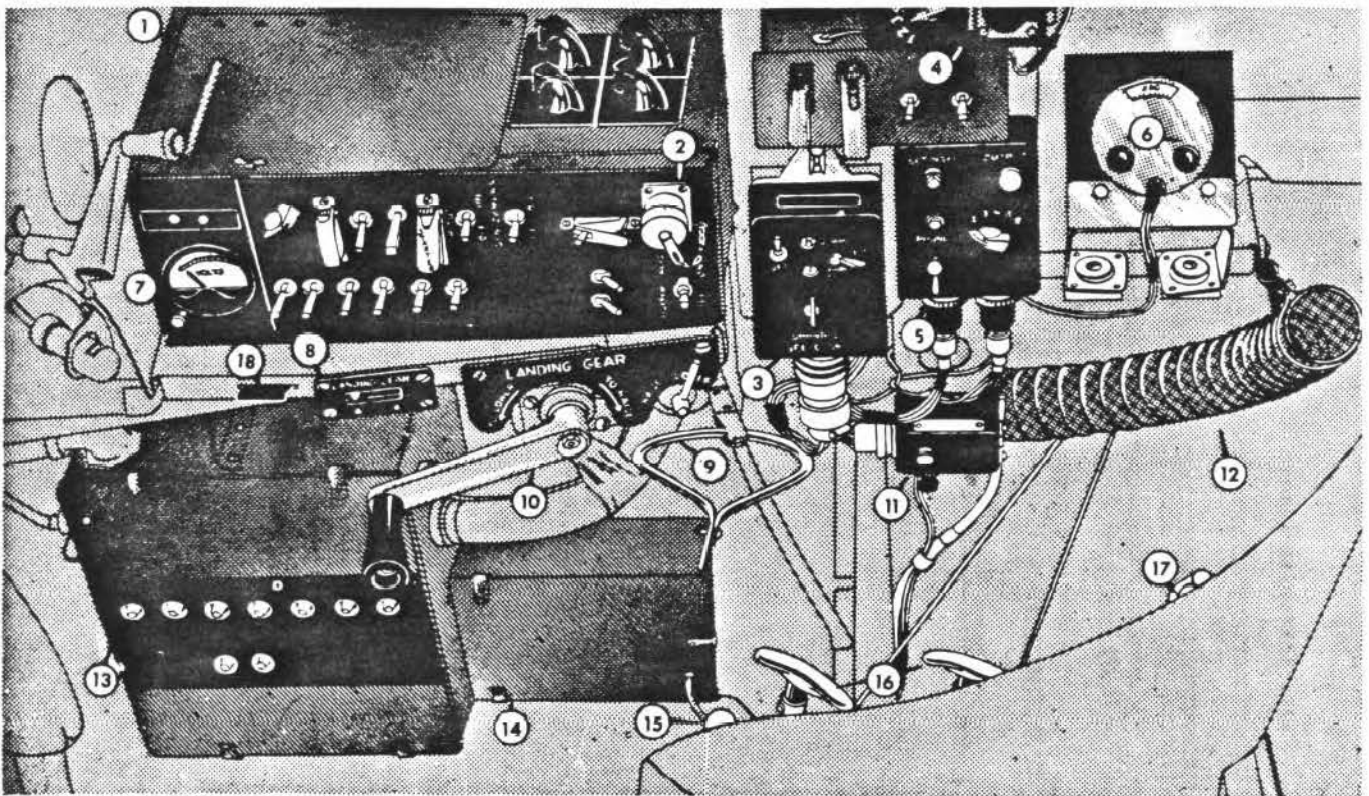

- |    |  |     |   |
|----|--|-----|---|
| 1. | PILOT'S DISTRIBUTION PANEL                       | 10. | LANDING GEAR HANDCRANK                              |
| 2. | POWER RECEPTACLE (FOR ELECTRICALLY HEATED SUITS) | 11. | JACK BOX  |
| 3. | COMMUNICATION EQUIPMENT CONTROL UNIT             | 12. | COCKPIT VENTILATOR                                  |
| 4. | IFF CONTROL BOX AND SELECTOR SWITCH              | 13. | MAIN JUNCTION BOX AND CIRCUIT BREAKER RESET BUTTONS |
| 5. | NAVIGATION EQUIPMENT CONTROL UNIT                | 14. | GENERATOR CUT-OUT                                   |
| 6. | RANGE RECEIVER                                   | 15. | PILOT'S SEAT ADJUSTMENT HANDLE                      |
| 7. | VOLTAMMETER OR VOLTMETER                         | 16. | RIGHT HAND GUN CHARGING HANDLES                     |
| 8. | LANDING GEAR POSITION INDICATOR                  | 17. | OXYGEN BOTTLE SHUT-OFF VALVE                        |
| 9. | DROPPABLE FUEL TANK RELEASE HANDLE               | 18. | LANDING GEAR POSITIVE-DOWN INDICATOR                |

Figure 7A—Right Hand Side of Cockpit

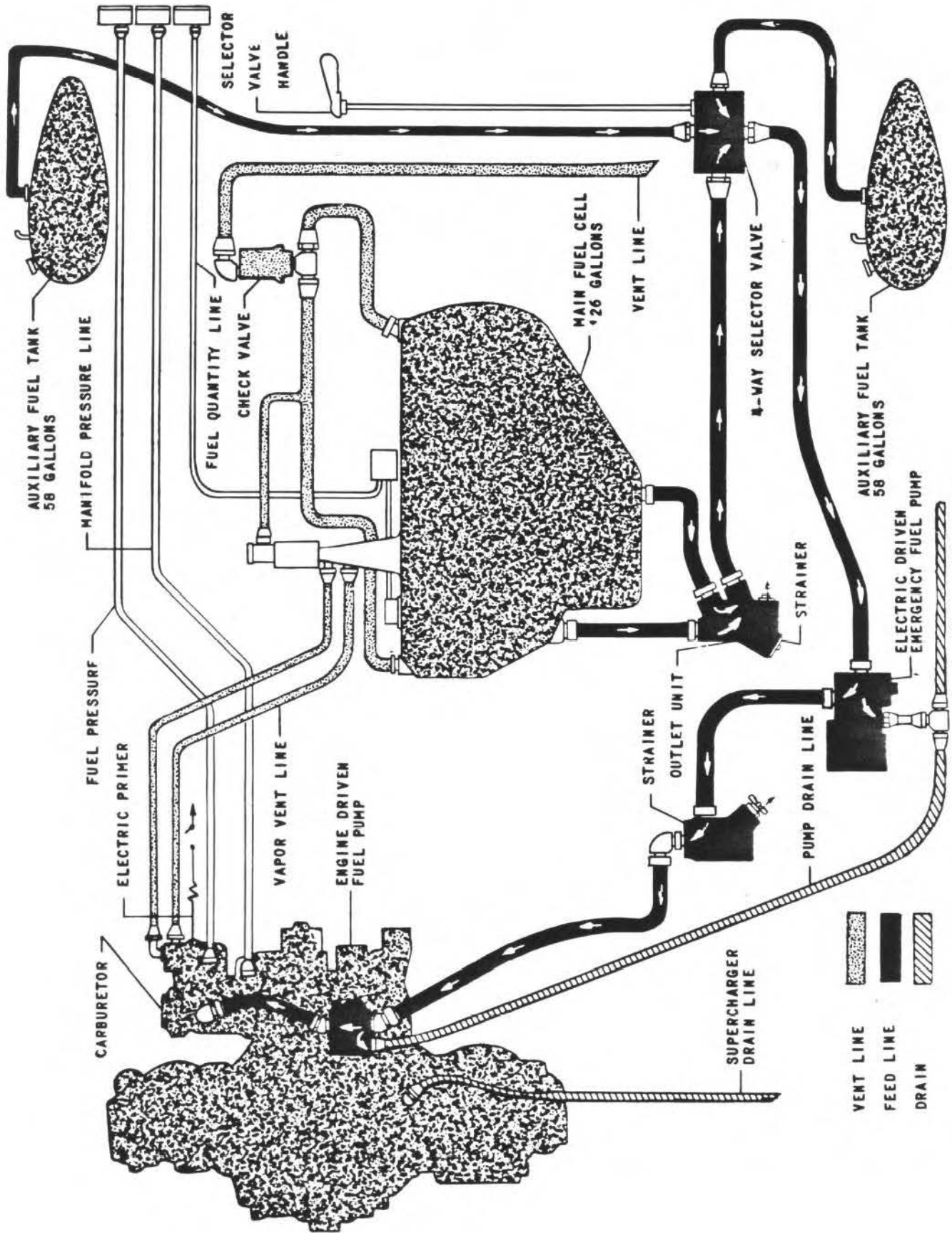
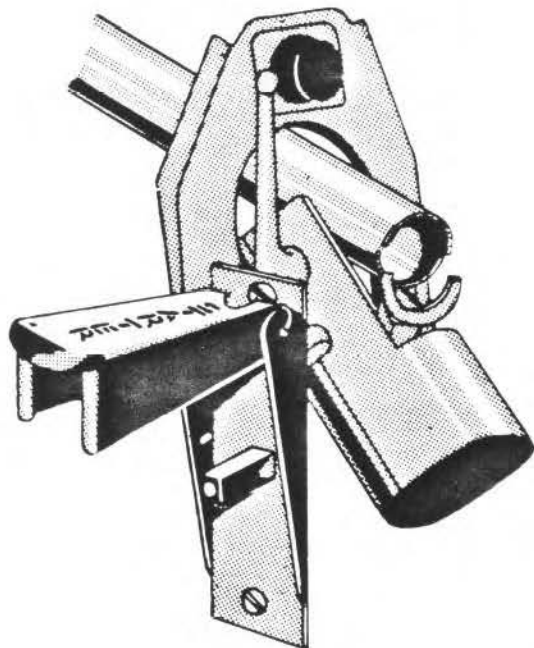

Figure 8—Fuel System Diagram



the "ON" position; it automatically returns to the "OFF" position upon release. The battery switch must be "ON" to operate the starter.

The starter breech is located on the right hand side of the engine mount structure and is accessible from the outside through the right hand landing gear well. Type C cartridges are to be used under all circumstances. A box containing extra cartridges is mounted in the engine accessory section on the engine mount support tubing.

**NOTE**

The starter switch need not be held ON after the cartridge is fired as there is no booster coil in this airplane.

**6. FUEL SYSTEM.**

a. DESCRIPTION.—The fuel system is basically a single tank pressure feed system with provisions for two auxiliary droppable tanks, one under each wing. The main tank, located in the fuselage below the cockpit; is equipped with a self-sealing liner. On airplane No. 57044 and subsequent the main tank although located in the same position consists only of a rigid self-sealing fuel cell without an aluminum shell.

Fuel grade 100/130, Specification AN-F-28, is specified.

**TANK CAPACITIES**

Main Tank.....	117 U.S. ( 97 Imp.) Gals. (with liner)
	130 U.S. (108 Imp.) Gals. (without liner)
Airplane No. 57044 and subsequent	
Main Cell.....	126 U.S. (105 Imp.) Gals.
Droppable, Right.....	58 U. S. (48 Imp.) Gals.
Droppable, Left.....	58 U. S. (48 Imp) Gals.

Fuel should be drawn from the main tank for a short time before switching to the droppable tanks. Fuel may be drawn from either droppable tank but the pilot should compensate for loss of weight on the one wing as the fuel is used by means of the trim tabs. Trim tab adjustment will compensate for a full tank on one wing and an empty tank on the other.

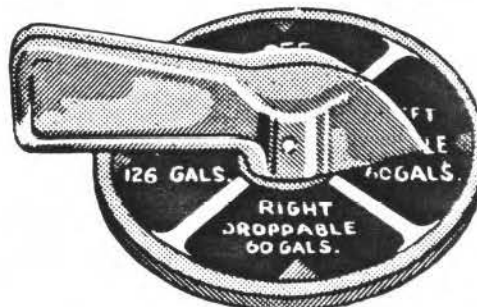

b. TANK SELECTOR VALVE.—The tank selector valve, located on the left hand cockpit shelf, has four positions: *Main*, *Left Droppable*, *Right Droppable*, and *Off*. The fuel tank selector should always be set on *Main* for take-off and landing. Always turn on the emergency fuel pump when changing fuel tanks.

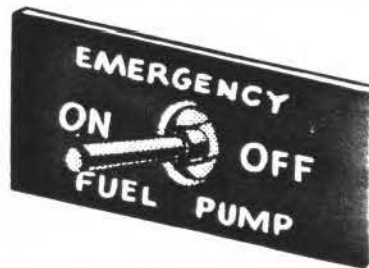

c. ELECTRIC EMERGENCY FUEL PUMP.—An electric emergency fuel pump is installed in the fuel system in place of the more common manually operated wobble pump. This emergency pump is controlled by an electric switch set in the left hand instrument panel. It should be used when starting, when changing fuel tanks, and when necessary to maintain fuel pressure in case of failure of the engine driven pump or of lowered fuel pressure at high altitudes.

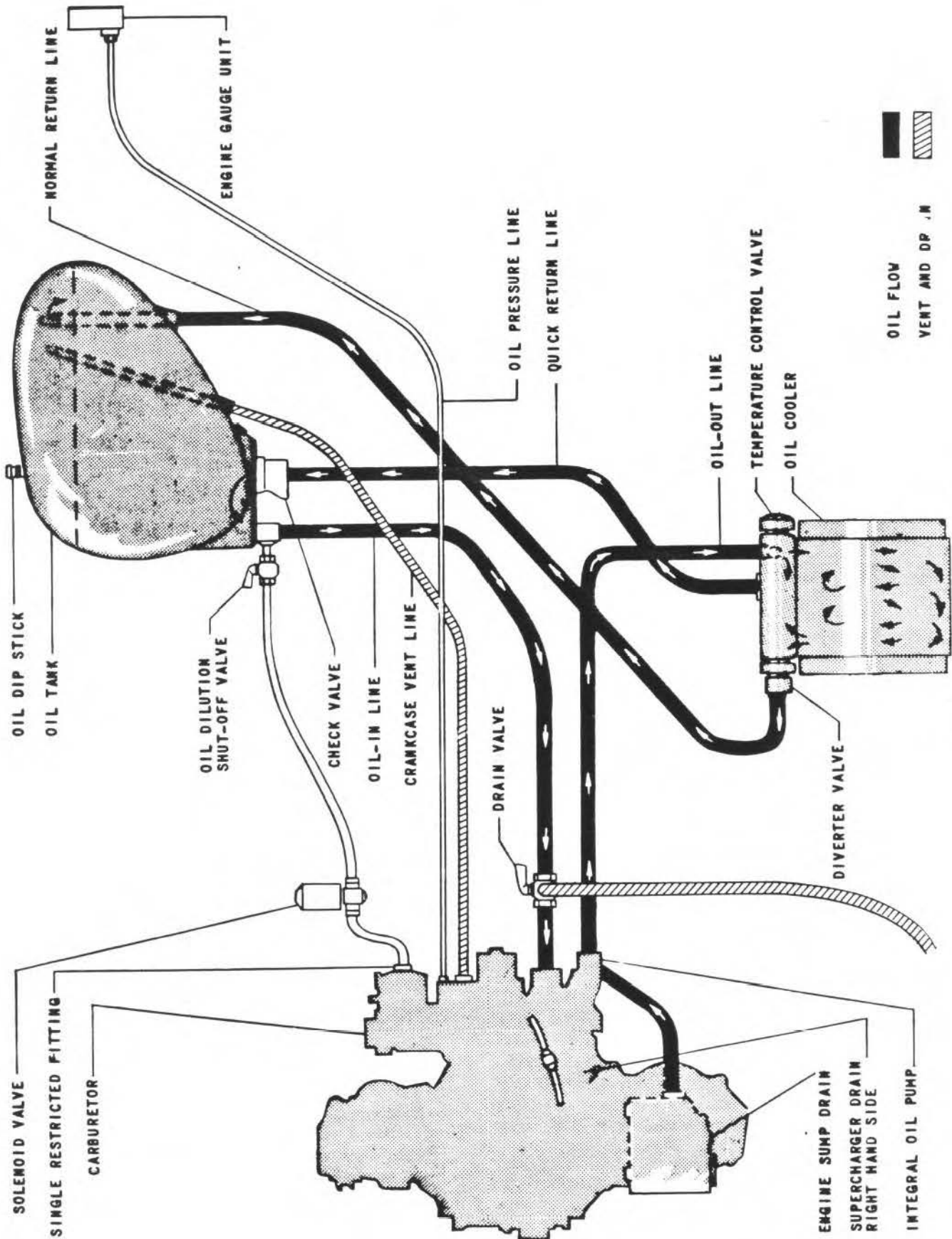

Figure 9—Oil System Diagram



*d. FUEL QUANTITY GAUGE.*—An electric fuel quantity gauge with the indicator mounted in the right hand panel shows the fuel level in the main tank only. No gauge is provided for the droppable tanks, therefore fuel consumption from these tanks must be determined from the lapsed time during which fuel is withdrawn.



*e. LOW FUEL LEVEL WARNING LIGHT.*—On airplane No. 57044 and subsequent, a low fuel level red warning light is installed on the left hand instrument panel next to the fuel quantity gage which is also installed on the left hand panel beginning with this installation. This light goes on when only 30 gallons of fuel (a minimum of one-half hour of flying time at Cruising Power) are left in the main tank.

*f. DROPPABLE FUEL TANK RELEASE.*—Droppable fuel tank release handles are red painted rings, one located on each side of the cockpit on the sides of the shelves. A sharp pull releases the tanks. The handles should then be clipped back to shelves in their former position to prevent them from fouling other controls.

*g. VAPOR RETURN.*—The vapor return line from the carburetor to the main tank may return as much as eight gallons of fuel per hour. Consequently, when operating with all tanks full, use about fifteen gallons of fuel from the main tank before turning the selector to one of the droppable tanks. This is necessary to make room for the returned fuel which otherwise would overflow out through the vent line.

## 7. OIL SYSTEM.

*a. DESCRIPTION.*—The oil supply is carried in a single tank attached to the upper engine mount. It is distributed by an engine driven oil pump and returned by scavenger pumps located in the engine nose sump and rear case.

### TANK CAPACITY

Normal .....	9 U.S. (7.5 Imp.) Gals.
Overload .....	11 U.S. (9.0 Imp.) Gals.

For most operations oil, Grade 1120, Specification AN-VV-O-446, should be used. However, the recom-

mended grade of oil varies with temperature. The latest service instructions and technical orders should be followed.

Oil returning from the engine passes through a thermostatic regulator valve mounted on the oil cooler. This valve causes the oil to by-pass the cooler until the oil-in temperature reaches 21°C at which time the valve starts to open and then maintains the desired oil-in temperature range of 75°C to 90°C. Cold oil by-passing the cooler is discharged into the tank adjacent to the suction outlet leading to the oil pump. Much of the same oil is thereby kept in circulation, hastening the rise of the oil-in temperature.

*b. OIL DILUTION SYSTEM.*—This airplane has provisions for the installation of an oil dilution system. When the equipment is installed, the system consists of a solenoid valve electrically operated by a momentary switch on the right hand instrument panel, a single restricted fitting, and a safety shut-off cock located in the dilution line between the carburetor and oil tank suction outlet leading to the oil pump.

The Oil Dilution switch is also connected to a second solenoid which simultaneously operates a diverter valve in the temperature regulator valve. This enables the diluted oil to by-pass the cooler and return to the bottom of the oil tank near the suction outlet.

Refer to Section II, Paragraph 20*b* for operational instructions for the oil dilution system.

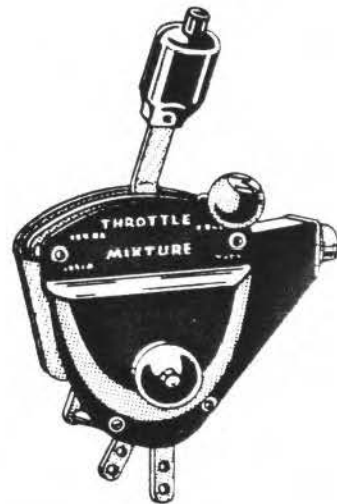

## 8. WATER INJECTION SYSTEM.

Figure 10 schematically outlines the general arrangement of the Water Injection system as installed in this airplane with the R1820-56W and R1820-56WA engines. The water tank, located in the accessory compartment, contains a ten minute supply of water, pressurized through a boost pressure supply line. A check valve incorporated in the line prevents loss of tank pressure when manifold pressure is reduced following take-off.

RESTRICTED  
AN 01-190FB-1

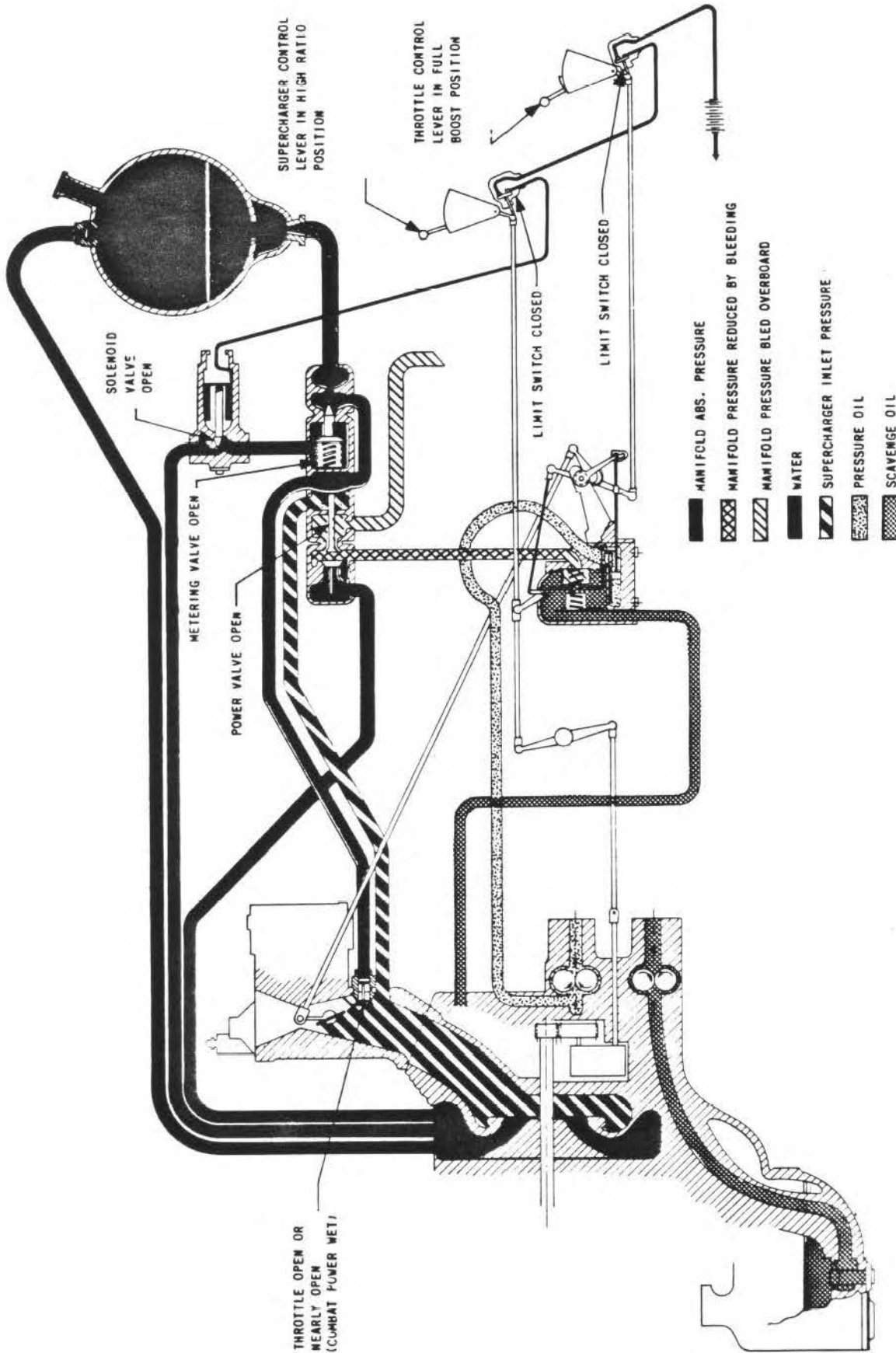
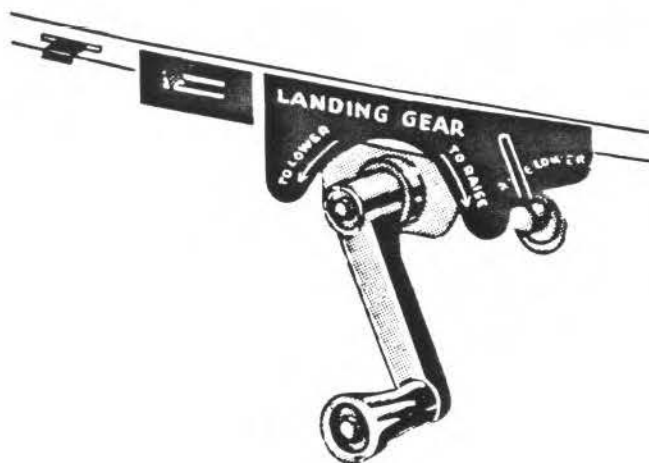

Figure 10—Water Injection System Schematic Diagram

The MP Regulator and Water Injection system Control Unit are mounted together on an assembly bracket. The solenoid valve, which controls the start of Water Injection operation, is actuated by two switches placed in series to prevent undesired water flow. One switch is mounted on the supercharger control quadrant so that movement of the lever into High Blower position closes this switch. The second switch is incorporated in the throttle control lever so that movement of the lever past the stop will close the switch completing the circuit to inaugurate water injection operation.



## 9. LANDING GEAR CONTROLS.

*a. RETRACTING MECHANISM.*—The landing gear is retracted or extended manually by means of a handcrank located on the right side of the cockpit. Approximately twenty-eight turns of the crank are required to raise or lower the landing gear. The crank is rotated *clockwise* to raise the gear and *counter-clockwise* to lower it.

### WARNING

While extending the wheels, a point is reached at which it becomes more difficult to rotate the crank handle and there may be a tendency for the pilot to stop and engage the ratchet lock. However, the pilot should continue to rotate the crank handle until it hits a stop indicating that the gear is fully down.

The handcrank is automatically latched by a ratchet acting on the crank while the wheels are being raised or lowered. The ratchet is released by operating a small lever just aft of the handcrank. After releasing the ratchet lever, the crank remains locked until pressure

is exerted on the crank opposite to the desired direction of rotation.

### WARNING

While extending the wheels, a point is reached at which it becomes more difficult to rotate the crank handle and there may be a tendency for the pilot to stop and engage the ratchet lock. However, the pilot must continue to rotate the crank handle until it hits a stop indicating that the gear is fully down.

*b. HANDCRANK BRAKE.*—The landing gear handcrank brake is installed on the operating shaft just forward of the handcrank gear box. This unit ratchets when the landing gear is being raised. When the gear is being lowered, a pawl engages the drum and the braking action retards the speed with which the wheels are lowered. The single adjusting nut which regulates the tension on the friction brake must be so adjusted that the lowering speed of the wheels will not tear the handcrank from the pilot's hand and possibly strip the gears. Proper adjustment will prevent this but as an additional precaution the pilot *must retain a firm grip* on the crank handle.

*c. POSITION OF WHEELS.*—A mechanical position indicator on the right hand cockpit shelf just forward of the handcrank registers the approximate position of the wheels as they are being raised or lowered and indicates the "Up" position.

*d. EXTENDED POSITION LOCK.*—With the wheels cranked to *Full-Down* position, sufficient locking force is exerted by the large operating chains, supplemented by a spring counterbalance unit, to prevent any possibility of wheels retracting during landing and take-off.

No adjustment is necessary on the counterbalance unit. It is so designed that it will always exert the proper force.



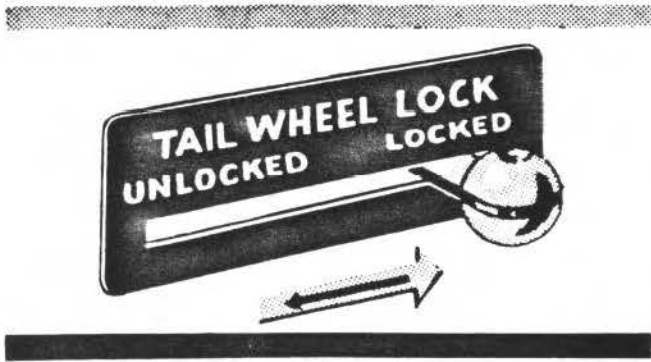

e. BRAKE CONTROL.—The duo-servo hydraulic brakes are operated by toe pressure on the upper part of the rudder pedals.

f. ARRESTING HOOK CONTROL.—The arresting hook located in the after fuselage is operated through a system of cables by a control mounted in a slide under the left hand cockpit rail.

To lower the hook rotate the handle up, pull it aft, and rotate the handle down. To raise the hook, reverse the procedure. About a twenty pound push is required to retract the hook.

**WARNING**

The pilot shall insure that the control handle is locked in the hook-down position prior to landing aboard a carrier.

The approach light automatically goes on when the arresting hook is lowered. A manual switch for the approach light is provided in the after fuselage for use in practicing carrier landings.

**g. TAIL WHEEL CASTER LOCK.**—The tail wheel drag link is equipped with a lock pin which locks the caster in the trailing position. This lock pin is controlled by a cable from the *Tail Wheel Lock* lever on the port cockpit shelf. With the lever in the forward position, the tail wheel is locked; in the aft position the tail wheel is free to swivel, i.e. unlocked.

The primary purpose of this lock is to reduce the possibility of ground looping on landing. Lock the tail wheel immediately after taxiing into position for take-off. The tail wheel will then remain locked during flight and during landing. Unlock the wheel after the landing run has been completed in order to facilitate taxiing.

For carrier operation, leave the tail wheel unlocked.

The tail wheel is a 360° swivel type equipped with a spring-loaded, self-centering device. The tire is a high-pressure type. Pressure should be kept at 110 pounds for normal operation and 175 pounds for carrier operation.

**10. WING FOLDING.**

**a. CONTROLS.**—The wings are folded and spread manually from the ground and are held in spread position by locking pins operated by handcranks. These handcranks are stowed in the leading edges of the wing at the folding axes and are reached through doors secured by latches.

**b. SAFETY INDICATOR.**—As the locking pins are withdrawn, red metal flags are raised above the upper surface of the stub panel in each wing. *The pilot should never take-off when any portion of either red flag shows above the wing surface without investigating the wing lock.*

**c. TO FOLD WINGS.**—Open the cover doors at the wing fold and set the handcranks. Turn the handcranks counter-clockwise to withdraw the locking pins. Move the wings to folded position and set the jury struts or cables into the fittings in the wing tips and outboard end of the stabilizers. The two sets of jury struts, cable and bar, are stowed in the baggage compartment of the airplane.

**d. TO SPREAD WINGS.**—Remove the jury struts. One man turns the locking pin crank handle fully counter-clockwise to make sure the locking pin is in the unlocked or fully out position. A second man then

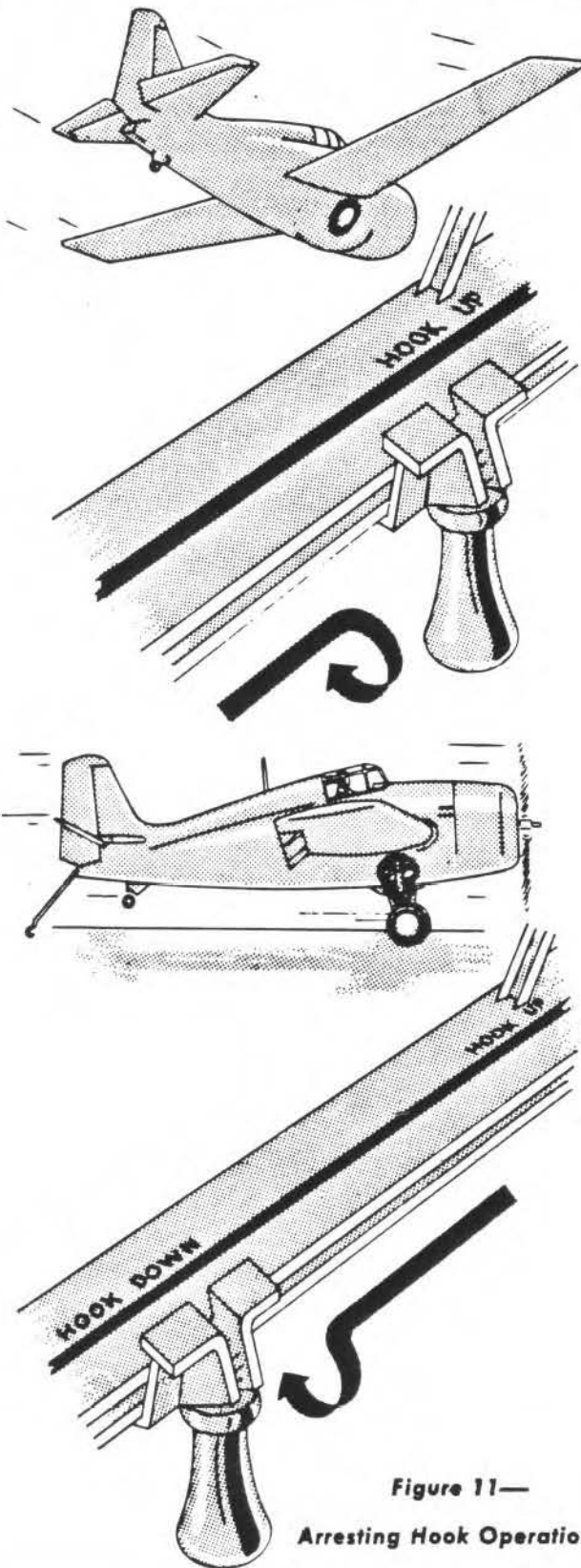

Figure 11—  
Arresting Hook Operation

moves the wing into a spread position by pushing on the wing tip. While the wing is being held in the full spread position, the first man advances the locking pin to a locked position by clockwise rotation of the handcrank. Continue cranking until the pin is in as far as it will go and no part of the red warning flag appears above the wing surface. Fold and stow the handcrank and snap the cover door closed.

**CAUTION**

When unlocking to fold the wings or releasing cables to spread wings, the wing will swing dangerously fast to a drooped position unless restraint is placed on the wing tip. If the wing is allowed to swing free and the arc is misjudged, damage may result to plane or personnel.

**11. ARMAMENT CONTROLS.**

**a. GUNNERY CONTROLS.**

(1)GENERAL DESCRIPTION.—Two .50 caliber machine guns and ammunition boxes are mounted in each wing outer panel. The guns are charged manually and fired electrically.

(2)GUN CHARGING.—Charging handle for each gun is located beside the pilot's seat, two each outboard of the right and left floor channels. Pull upward and return to load each gun. The shell is then under the hammer ready to fire. Guns need be charged manually only once after installing the boxes and catching the first shell behind the belt holding pawl.

By rotating the handle left or right while extended to charge position, the handle can be locked in full charge or an intermediate safety position to make it possible to operate safely with a shell in the chamber during catapulting or landing operations.

(3)GUN FIRING.—The guarded gun master switch marked *Guns* and the gun selector switches are mounted on the pilot's distribution panel on the right cockpit shelf. The trigger switch is incorporated in the control stick handle.

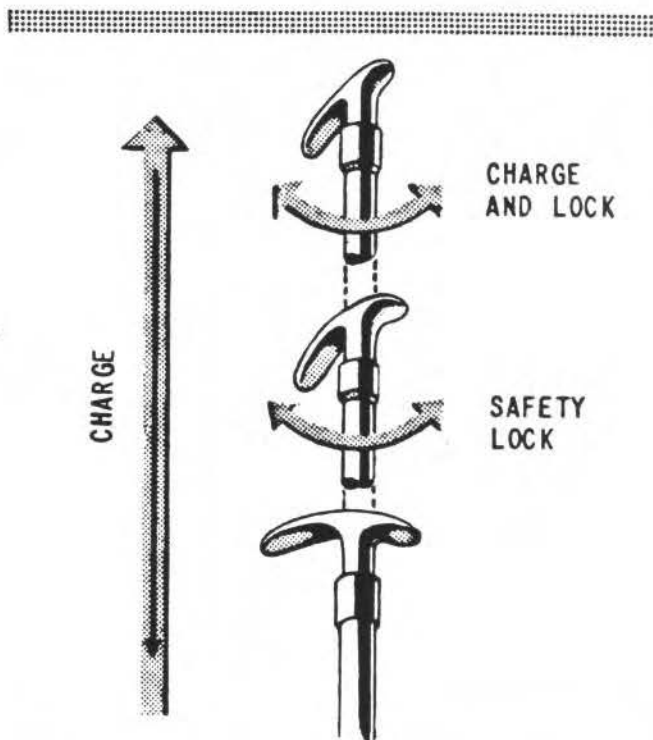

*The master switch must be on to fire the guns.* By use of the selector switches, the guns can be fired as a battery or in outboard and inboard pairs. Closing the trigger switch completes the firing circuit. Due to longer chutes and deeper boxes, the inboard guns carry slightly more ammunition than the outboard guns.

Individual fuses for each gun circuit are located in the top of the distribution panel. Spare fuses for replacement are contained in sockets directly under the active fuses.

(4)GUN SIGHTS.—The Mark VIII gun sight is controlled by a switch and rheostat mounted on the left

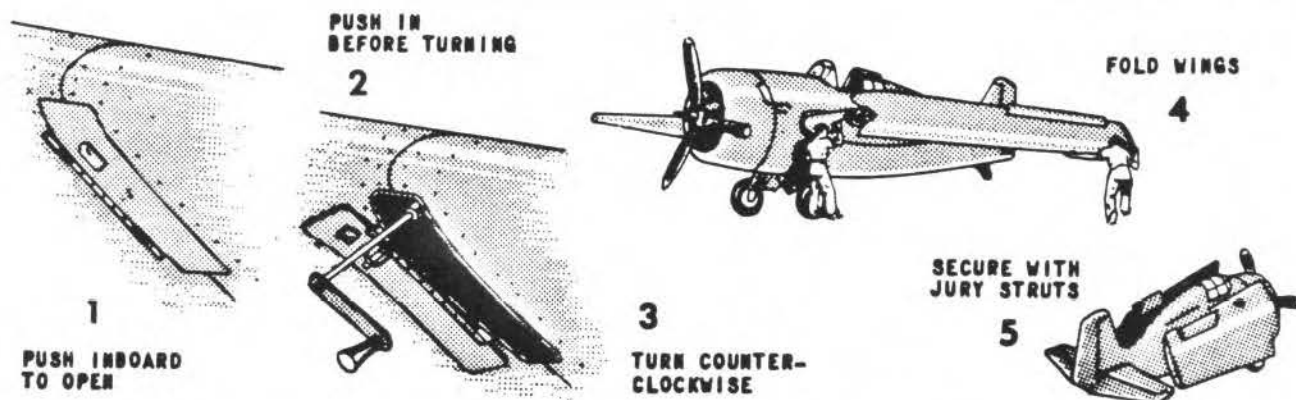

Figure 12—Wing Folding Procedure

instrument panel. The sight operates independently of the gun master switch.

To use the sight, set the switch *On* and turn on the rheostat. If the bulb does not illuminate, turn the switch to *On Alternate* to use the spare filament.

The gun sight circuit contains a circuit breaker with the reset button mounted in the main junction box cover just below the distribution panel. In case of overload, reset the circuit breaker by pushing the reset button.

(5) GUN CAMERA.—An electrically heated and operated gun camera, type AN-N-4, is mounted in the leading edge of the port stub wing. On airplanes through Serial Number 74358 a gun camera switch is installed on the pilot's distribution panel. This switch is independent of the gun master switch and must be *On* for the camera to operate. The gun camera heating element is always on when the camera is operated as it is controlled by the gun camera switch. Pictures are taken when the gun trigger switch is pressed.

The independent gun camera switch was eliminated coincidentally with the installation of the rockets. On airplanes Serial Number 74359 and subsequent, pictures are taken by the gun camera when either the trigger switch or the rocket switch is pressed and the Armament Master Switch is on.

Fuses for the gun camera circuit are located under the cover of the distribution panel.

(6) ELECTRIC GUN HEATERS.—Electric gun heaters of the pad type may be installed over each gun breech. A junction box is provided on the inboard side of the inboard gun compartment in each wing for this installation. The electric circuit is connected directly to the generator and the heaters are on at all times when the plug is connected to the junction box and the engine is running.

#### b. ROCKET INSTALLATION.

(1) Rockets are installed on FM-2 airplanes Serial Number 74359 and subsequent. The installation consists of three Mk. 5 Series Aircraft Rocket Launchers mounted on the undersurface of each wing. The wiring necessary includes a Mk. 3 or Mk. 3-1 Station Distributor and a firing switch. The latter is the button on the top of the control stick normally used for the bomb release circuit. The station distributor is located below the instrument panel forward of the control stick. Each launcher consists of 2 streamlined posts; the forward post contains a fuse arming control and the aft post contains both a receptacle for the rocket firing lead and a latch to restrain the rocket until the instant of firing.

### WARNING

If the pilot is in the airplane at the time the rocket firing leads are connected, he should be certain that the master armament switch is OFF and that the station distributor "safety" plug is removed.

(2) When the airplane is airborne and heading away from friendly territory or approaching a target range, the switches should be turned ON. The indicator light on the station distributor will glow when all switches are on; the intensity of the light may be varied by turning the knob on the light (which regulates a shutter). The station distributor switches should be turned off before the airplane returns to its base.

(3) The *SAFE-ARM* switch on the station distributor must be in the *ARM* position to allow the instantaneous nose fuse to arm and in the *SAFE* position to allow the short delay fuse to function. When the base fuse only is allowed to function, the rocket will penetrate the target before exploding.

(4) When the *SINGLE-AUTO* switch on the station distributor is set on *SINGLE*, a pair of rockets will be fired each time the trigger switch is depressed; when the switch is on the *AUTO* position, pairs of rockets will be fired at automatically spaced intervals (0.3 sec. with the Mk. 3, 0.1 sec. with the Mk. 3-1) while the switch is held closed.

c. TOW TARGET.—There is provision for the installation of a tow target release control on the right hand cockpit floor channel as marked by a name plate and for a release latch on the bottom of the fuselage. The tow target is released by an upward pull on the handle.

d. PYROTECHNICS.—Airplanes prior to Serial Number 74659 have a pyrotechnic installation consisting of a Mark VIII pyrotechnic pistol, a holster assembly and a holder for four extra cartridges. The pistol and cartridge holder are located on the cockpit left hand shelf. To fire the pistol, withdraw it from the holster and slide back the cockpit canopy. Fire overboard, directing the fire away from the airplane.

## 12. ELECTRICAL SYSTEM.

a. GENERAL DESCRIPTION.—The electrical system of this airplane is of the conventional single wire design. The active fuses, spare fuses and spare bulbs are stowed under the cover of the pilot's distribution panel. A standard receptacle is also provided in the rear upper corner of the distribution panel.

With three exceptions, all electrical equipment including the aforementioned receptacle, is connected to the positive bus bar in the distribution panel and therefore is hot whenever the engine is running, i.e. electricity is being generated by the generator and/or when the battery master switch is *On* or closed.

The three exceptions to the above are the gun heaters, the radio destructor switch, and the recognition lights. The gun heaters are connected to the generator side of the cut-out and therefore are only *On* when the engine is running and work independently of the battery. The radio destructor switch and the recognition light switch are connected to the battery side of the battery switch and therefore are always *Hot*.



On airplane Serial Number 57044 and subsequent a Generator Field switch is mounted on the distribution panel. This switch is normally *On* and is to be put *Off* only in emergency if the generator voltage regulator fails and it is desirable to cut out the generator field to prevent damage to the battery and possibly other equipment.

The generator cut-out is located aft of the main junction box under the distribution panel.

The voltammeter, or on later models, the voltmeter, is located on the forward face of the distribution panel on the right hand cockpit shelf. Two pin jacks for testing purposes are provided with the voltmeter.

b. ELECTRICAL CONTROLS.—The electrical controls, unless otherwise stated in a specific paragraph are all located on the distribution panel on the right hand cockpit shelf. The following controls are mounted on the panel:

#### SWITCHES

Section Light	Gun Camera
Flash	Pitot Tube Heater
Formation Lights	Starter
Wing Running Lights	Primer
Tail Running Light	Battery
Gun Selector (2)	Gun Master

Airplane Serial Number 57044 and subsequent:  
Generator Field                      Master Radio

Airplane Serial Number 74059 and subsequent:  
Master Exterior Light

Airplane Serial Number 74359 and subsequent:  
Gun Camera Switch                      Master Armament  
eliminated                                      (Replacing Gun  
Master)

#### RHEOSTATS

Electric Panel Light	Instrument Panel
Cockpit Lights	Lights
Compass Light	Chart Board Light

c. COCKPIT LIGHTING.—The cockpit and instruments are lighted by a right and left cockpit light, a compass light, a chartboard light, seven instrument panel lights, and a panel light. Spare bulbs are stowed as described above. The lights are controlled by rheostats with an *Off* position mounted on the pilot's distribution panel.

d. SPECIAL LIGHTING.—A master exterior light switch is installed on the distribution panel on airplanes Serial Number 74059 and subsequent. This switch controls all the exterior lights operated from this panel and must be on when the section light, formation light, tail or wing running lights are to be used. These lights are all extinguished simultaneously when this master switch is turned off.

The section and formation lights have individual *Bright-Off-Dim* switches and one common *Flash-Off-On* switch. To operate the lights the combined switch must be on *On* or *Flash*, and the individual switches set for either *Dim* or *Bright*.

An approach light manual switch is built into the approach light switch box just forward of Station 13 in the baggage compartment. This manual switch is in parallel with the automatic switch tripped by the arresting hook, and is used only for practice carrier landings



without actually letting the hook down. This switch must be turned on before taking off from the airport.

The recognition lights toggle switches and keying switch are on the forward end of the left hand cockpit shelf.

### 13. AUXILIARY CONTROLS.

#### a. SLIDING CANOPY.

(1) OPERATION.—The sliding canopy is operated by means of a large handle mounted in a slide on the right hand side of the cockpit under the cockpit rail. The handle is rotated upward and pulled aft to open the enclosure. By rotating downwards, the handle may be latched in any one of four positions: Closed,  $1\frac{1}{4}$  inches Open,  $5\frac{3}{8}$  inches Open, and Full Open. An angle clip on the lower left corner of the canopy may be used to assist in opening and in closing the canopy. A small door in the right hand side of the fuselage just below the windshield gives access to the cockpit from outside for the purpose of operating the handle when the canopy is closed.

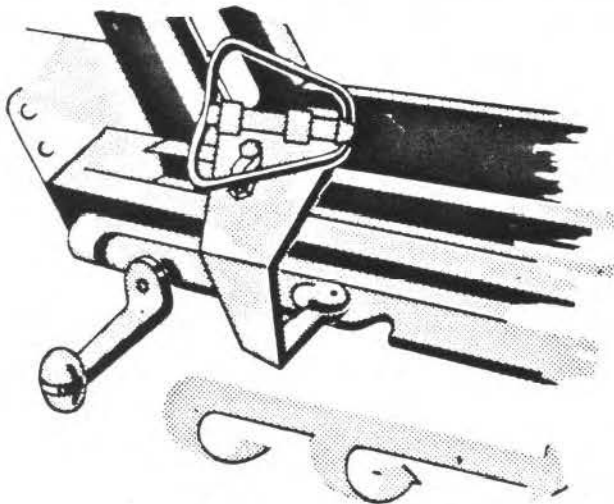

(2) EMERGENCY RELEASE.—The trolley slides at the forward end of the canopy are fastened to the canopy proper by quick release latches. These latches consist of pins joining the slide and the canopy. The release pins should be kept lubricated with a thin coating of grease at all times to permit easy removal. See Figure 31 and Section IV, Paragraph 1, for emergency release operating instructions.

b. WINDSHIELD DEFROSTER.—A T-handle control for the windshield heat defroster is located above the left rudder pedal just forward and below the instrument panel. To introduce heat into the air space between the double windshield, pull the handle aft and rotate clockwise to lock.

c. COCKPIT AIR INTAKE.—A toe operated valve located at the base of the compass mount forward of the

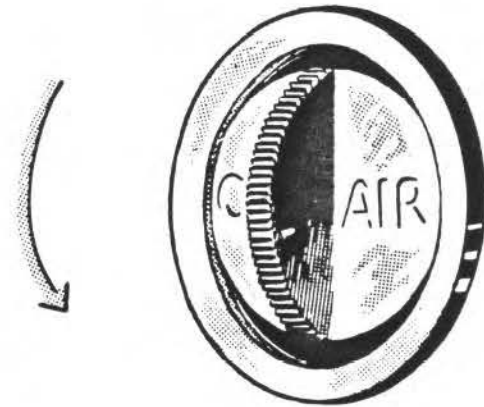

control stick introduces fresh air into the pilot's cockpit from an intake in the right hand stub wing.

d. PILOT'S SEAT ADJUSTMENT.—A control lever for the vertical adjustment of the pilot's seat is located on the right hand side of the seat. Movement aft releases the locking pin in the seat stanchion and allows the pilot to lower the seat by body weight, or raise it through the tension of the shock cords to any one of seven positions.

e. SHOULDER HARNESS.—The shoulder harness should be connected to the spring on the rear of the pilot's seat. The lever on the left hand side of the seat controls the spring. When this locking handle is in the aft position the spring allows the pilot unrestricted movement; in the forward position the handle locks the harness spring. To move the handle, the knob must first be depressed.

In installing the harness, pass the shoulder straps over the bar just below the pilot's headrest. This bar



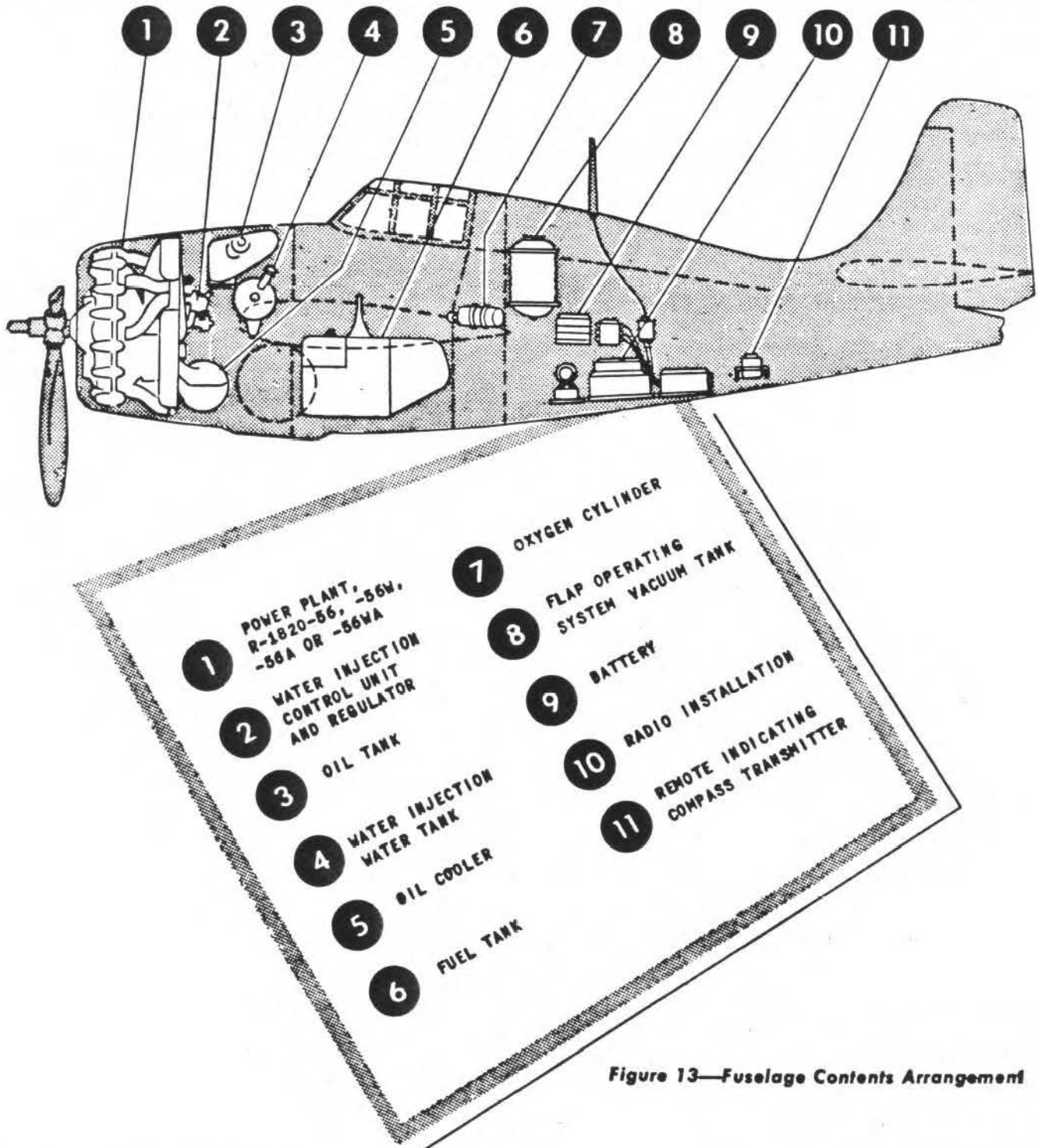

Figure 13—Fuselage Contents Arrangement

takes up the extra loads during arrested landings which might otherwise crush the pilot's seat.

f. MAP CASE.—A canvas map case including a pad and pencil holder is installed on the left hand side of the cockpit above the shelf under the cockpit rail.

g. CHART BOARD.—The chart board is located directly beneath the main instrument panel. It may be pulled aft provided the clasp on the left hand corner is released. This clasp is installed to hold the board in place when the airplane is catapulted.

# Section 2



## NORMAL OPERATING INSTRUCTIONS

### 1. BEFORE ENTERING THE PILOT'S COMPARTMENT.

#### a. FLIGHT LIMITATIONS AND RESTRICTIONS.

##### (1) MANEUVERS PROHIBITED.

(a) No standard maneuvers are prohibited when operating without droppable fuel tanks. Catapulting, field landings, and arrested landings are permissible with 100-pound class bombs on the wing racks.

(b) When carrying one or more droppable tanks the following maneuvers are not permitted:

- |            |                 |
|------------|-----------------|
| loops      | Immelman turns  |
| snap rolls | normal spins    |
| chandelles | prolonged spins |

When such tanks are carried the following maneuvers are permitted:

- wing overs
- vertical turns
- aileron rolls (only for entering a dive)
- inverted flight (only for entering a dive)

##### (2) PERMISSIBLE ACCELERATIONS

Gross Weight Pounds	Permissible Positive Acceleration
7700	7.5g*
7800	7.4g
8000	7.2g
8200	7.0g

\*When carrying filled droppable fuel tanks the maximum permissible positive acceleration is 4.0g.

##### (3) LIMITING AIRSPEEDS.

(a) DIVING.—Terminal velocity dives are permissible with the airplane equipped as a fighter or as a bomber with two 100-pound class bombs on the wing racks. Speed with droppable tanks is unrestricted provided the tank and sway braces are correctly installed, i.e., the forward sway brace shank is in the sway brace wing socket as far as possible so that slight tank deformation will not allow the brace to drop out of the socket.

(b) WING FLAPS.—There is no limiting airspeed for lowering the wing flaps. Regardless of the position of the flap control valve, the flaps will not come down if the airspeed is in excess of 130 knots (150 MPH) as air pressure holds the flaps up until the air speed has dropped below that point.

(c) LANDING GEAR.—There is no limiting airspeed for lowering the landing gear. However, if the gear is lowered above the airspeed of 150 knots (172 MPH), air loads on the gear will cause the handcrank to whip free and spin rapidly.

### NOTE

These limitations may be supplemented or superseded by instructions included in Service Publications.

b. EFFECT OF INITIAL GROSS WEIGHT.—Before entering the airplane for any flight the pilot should obtain the initial gross weight of the airplane and then consult flight charts included herein to determine the characteristics of the airplane at the given loading condition. For example, the difference in loading between normal fighter and overload fighter will necessitate an additional take-off distance of approximately 100 feet in a 15 knot wind. Also radically affected by weight changes are the rate of climb, landing distance and service ceiling.

c. AIRPLANE ENTRY.—Entry into the airplane when the canopy is closed should be from the starboard side. A step and hand hole are provided on each side of the fuselage. To open a closed canopy, unfasten the small door marked *Enclosure Release* located just below the windshield on the starboard side. Reaching inside, rotate the canopy handle upward and push aft.

### 2. PRE-FLIGHT CHECK LISTS.

#### a. PILOT'S STANDARD CHECK LIST.

(1) Adjust the harness, making certain that the

Figure 14—Pre-Flight Check List

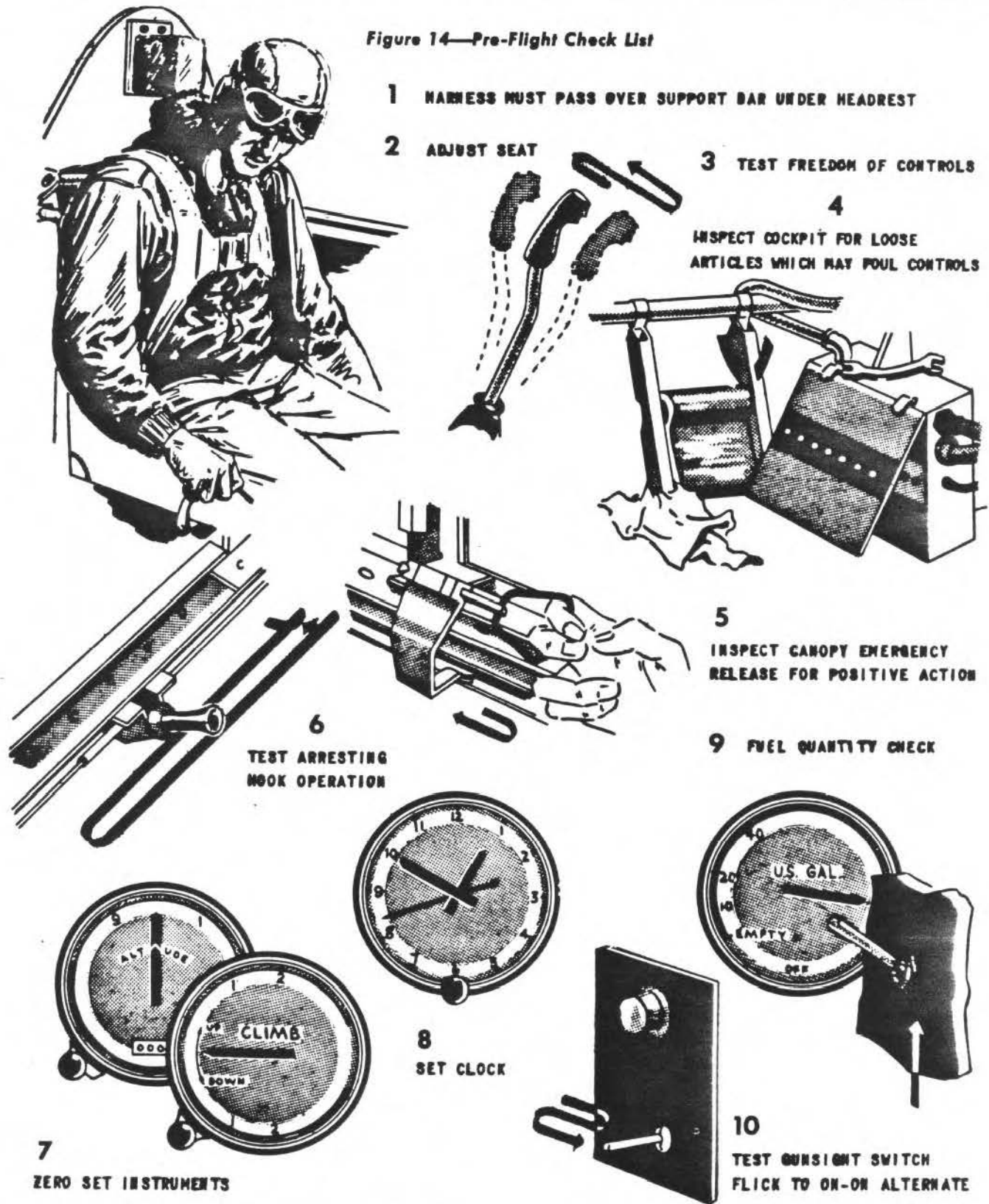

shoulder harness passes over the support bar under the headrest.

- (2) Adjust the seat to the desired level.
- (3) Test controls for freedom of movement.
- (4) Inspect cockpit for loose objects which may foul the controls.
- (5) Check each wing for visible red flag which would indicate that the wing fold locking pin is not securely locked.
- (6) Inspect the canopy emergency release pin to see that it is straight and lightly greased.
- (7) Test the freedom of operation of the arresting hook by lowering and raising, making certain that it locks in the extended position.
- (8) Uncage all instruments and check for zero settings. Test the setting knobs for freedom of movement.

**NOTE**

The gyro horizon and directional gyro indicators should be left uncaged at all times except

during maneuvers in which the operating limits of the indicators would be exceeded. The operating limits are:

	<i>Dive or Climb</i>	<i>Bank, Left or Right</i>
Gyro Horizon Indicator	70°	100°
Directional Gyro Indicator	55°	55°

(9) Wind the clock and set it to the operations' office time.

(10) Turn on the battery switch and check fuel quantity on the gauge.

(11) If a pyrotechnic pistol is installed, inspect the shells for proper colors.

(12) Check the oxygen equipment as outlined in Section V, Paragraph 1c.

(13) Test the operation of the gun sight by turning on the battery switch and, with the rheostat turned up, flicking the gun sight switch from *On* to *On Alternate*. Make sure that both filaments are working.





(14) There is no test for quantity of ammunition other than a visual inspection of the ammunition boxes. However, gun loading can be checked by operating the gun charging handles until a loaded shell is ejected from the bottom of the wing. As this operation leaves a loaded shell in the gun chamber, take-off should be accomplished with the gun charging handles locked in safety position.

(15) Check the radio equipment as outlined in Section V, Paragraph 2e.

#### b. SPECIAL NIGHT CHECK LIST.

(1) Complete check list indicated above.

(2) With the battery switch on, turn up the rheostats to test the cockpit lights, instrument panel lights, compass light, and chartboard light.

(3) Test the section and-formation lights by operating the switches.

(4) Have a ground crew member check the approach light operation when arresting gear test is made as outlined in Paragraph 2a(7).

(5) Check the operation of the recognition lights by use of toggle and keying switches.

### 3. FUEL SYSTEM MANAGEMENT.

Before starting a take-off, switch the fuel selector valve to the Main Tank using the emergency fuel pump to insure the proper system pressure. If droppable fuel tanks are carried, use about 15 gallons from the main tank to allow room for vapor return. Then switch to the droppable tanks, using that fuel first inasmuch as the tanks greatly increase drag and cause restrictions to be placed on maneuvers. When switching tanks, turn on the emergency fuel pump, move the selector switch to the proper tank, and check engine gauge unit for fuel pressure as the emergency fuel pump is turned off. If the pressure drops, turn on the emergency fuel pump again.

Fuel may be drawn from either droppable tank but the pilot should compensate by means of the trim tabs for the loss of weight on one wing as the fuel is used. Trim tab adjustment will compensate for a full tank on one wing and an empty tank on the other.

The emergency fuel pump is also used in case of failure of the engine driven pump or of lowered fuel pressure due to high altitudes.

Landing should always be attempted with fuel from the main tank and with the emergency fuel pump on.

### 4. FUNCTION OF THE MANIFOLD PRESSURE REGULATOR.

a. To obtain automatic regulation of manifold pressures necessary for Water Injection operation, a Delco Remy MP Regulator has been installed. This Regulator is adjusted by the pilot's throttle control lever. Movement of this lever selects the manifold pressure at which the pilot wishes to operate and sets that pressure on the Regulator. The Regulator then takes over to hold the

selected manifold pressure through all conditions of flight within the critical altitude of that MP-RPM setting. As the airplane is climbed the Regulator opens the carburetor throttle as necessary to maintain the selected pressure until at the critical altitude for that operational setting the carburetor throttle is wide open. If the climb continues and RPM is held constant, the Regulator holds the throttle wide open. Further advance of the throttle control lever will have no effect as the carburetor throttle is already wide open.

#### NOTE

Preliminary calculations suggest that the linkage between the Regulator and the carburetor throttle will not permit Regulator to fully open the throttle when in lower MP ranges. Until definite information is available, the pilot may consider the Regulator as fully automatic at operation above 60% power. When operating below 60% power and manifold pressure starts to fall off, again move the throttle control lever forward to reselect the desired MP. The Regulator will then hold the selected pressure until the critical altitude for that MP-RPM setting is reached.

b. Movement of the supercharger control lever from Low Blower position to High Blower position automatically lowers the throttle selected manifold pressure about 4 inches Hg to values approximately consistent with engine calibration curves.

### 5. COMBAT POWER.

a. A joggle in the throttle control quadrant rail marks the Take-off and Military Power position of the throttle control on airplanes equipped with R-1820-56W engines; it marks only the Military Power position on airplanes in which the R-1820-56WA engine is installed. When the throttle control lever is against the stop and the RPM is 2600, the pilot obtains Military Power, using Low blower below 13000 feet or High blower above 13000 feet. Movement of the throttle control lever past the joggle stop to the full forward position allows an additional boost (Combat Power) to a maximum of 50 inches Hg in Low blower, 52 inches Hg in High blower while the water is flowing and 46 inches Hg manifold pressure in High blower when the water is exhausted.

b. The water will flow only in High blower at Combat Power. The manifold pressure regulator will permit a maximum of 52 inches Hg while the water is flowing and will automatically reset the manifold pressure to a maximum of 46 inches Hg when the water is exhausted. When the manifold pressure drops to 43 inches Hg in High blower the regulator will stop the flow of water.

#### WARNING

Continuous operation at Combat Power is limited to 5 minutes. Maximum cylinder head temperature is 248C°.

Figure 15—Starting Check List



1  
IGNITION  
SWITCH OFF

2

THROTTLE OPEN  
MIXTURE IDLE  
CUT OFF



3

4 OR 5 REVOLU-  
TIONS IN NORMAL  
DIRECTION

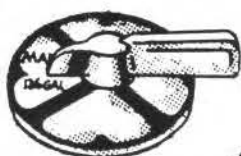

4

MAIN TANK

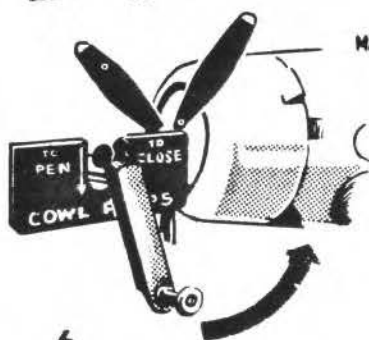

5

OPEN COWL FLAP

6

RESET CIRCUIT  
BREAKER



7

SELECTOR  
SWITCH  
AUTOMATIC



8

PUSH IN FOR  
TAKE-OFF RPM

9

PUSH IN FOR  
DIRECT AIR

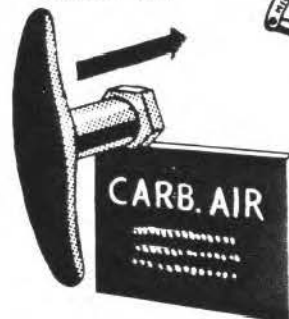

10

LOW  
BLOWER

## 6. STARTING.

### a. NORMAL STARTING CHECK-OFF LIST.

- (1) Leave the ignition switch on *Off*.
- (2) Set the mixture control in *Idle Cut-Off* position.
- (3) Move the throttle full forward.
- (4) Rotate the engine by hand for four or five revolutions in the normal direction. If an abnormal effort is required, remove the spark plugs from the lower cylinders to determine whether liquid has collected in the cylinder.

### CAUTION

This installation has a tendency for oil to collect in the cylinders when engine is not operating. If engine is not pulled through by hand before starting, "liquid locks" with bent and broken lower link rods will result.

- (5) Move the fuel selector valve handle to *Main Tank*.
- (6) Fully open the cowl flaps.
- (7) Push the propeller circuit breaker switch to insure that the circuit is closed.
- (8) Snap the propeller selector switch into *Auto-matic* position.
- (9) Push the propeller governor control knob full in for take-off RPM.
- (10) Push the carburetor air control knob full in for *Direct Air* position.
- (11) Lock the supercharger control in *Low* position.
- (12) Insert a cartridge into the starter breech and lock the breech.

(13) Set the throttle for 1000 RPM. Do not pump or move the throttle abruptly until the engine is running smoothly.

(14) Snap on the battery switch.

(15) Snap on the emergency fuel pump to build up a pressure of 14-16 PSI.

(16) Close the primer switch for three to five seconds immediately before firing the starter. The exact amount of priming will be varied as indicated by experience.

(17) Turn the ignition switch to *Both*.

(18) Snap the starter switch to fire the cartridge.

(19) Advance the mixture control to *Auto Rich* as the engine fires. If the engine stops immediately, return the mixture control to *Idle Cut-Off* position and switch off the emergency pump.

(20) Flick the primer switch intermittently until the engine runs smoothly.

(21) Idle the engine at 1000 RPM.

**CAUTION**

If in starting, oil pressure is not indicated in ten seconds, shut down the engine and investigate.

**b. HARD STARTING.**

(1) Follow the starting check-off list carefully. Wait a few minutes to allow any of the spilled fuel to drain out of the intake ducts and to permit the cartridge starter to cool before repeating the attempt.

(2) If it is suspected that the engine is over-primed, clear the cylinders and induction system of excess fuel by the following procedure:

(a) Mixture Control.....Idle Cut-Off

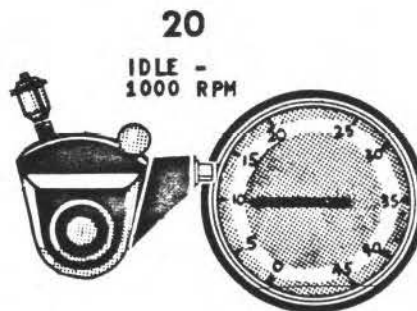

18  
ADVANCE TO AUTO RICH AS ENGINE FIRES



17  
IGNITION SWITCH ON BOTH



15  
CLOSE PRIMER FOR 3 TO 5 SECONDS IMMEDIATELY BEFORE FIRING STARTER

19  
FLICK PRIMER INTERMITTENTLY UNTIL ENGINE RUNS SMOOTHLY

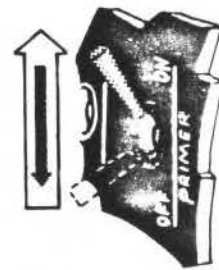

17  
ON TO FIRE CARTRIDGE.



14  
EMERGENCY FUEL PUMP ON



11  
INSERT CARTRIDGE

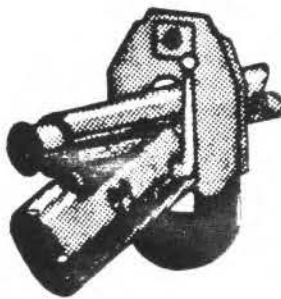

12  
SET FOR 1000 RPM

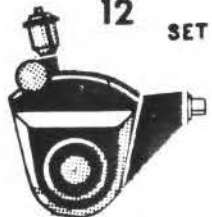

13  
BATTERY ON



Figure 16—Warm-Up Check List

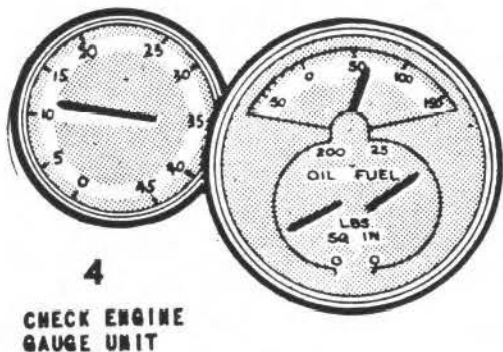
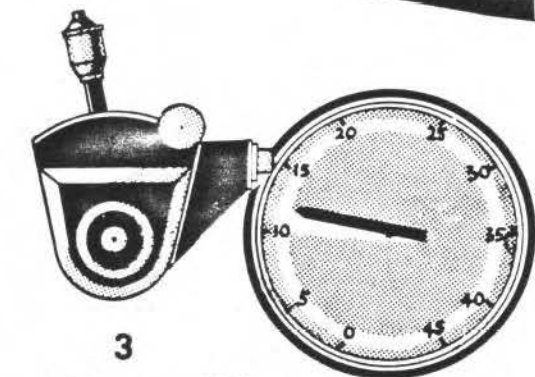
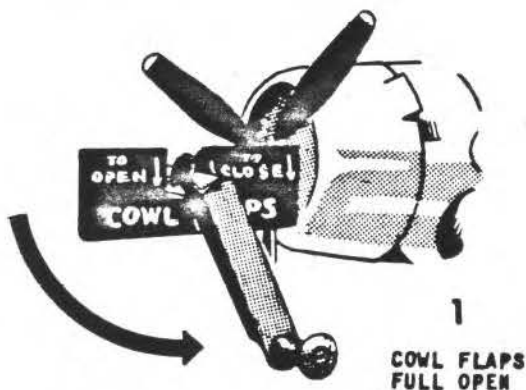

- (b) Auxiliary Fuel Pump.....Off
- (c) Ignition Switch.....Off
- (d) Throttle .....Full Open
- (e) Rotate engine by hand.....4 or 5 revolutions

(3) If the propeller turns over but the engine fails to start, do not fire more than three cartridges consecutively without allowing a period of at least five minutes for starter parts to cool. If the starting attempt fails to result in the normal rotation of the propeller, another cartridge should not be fired until the trouble has been determined and corrected. In the event of a safety disc failure, turn the engine propeller by hand to determine whether the engine is free. If the cartridge should fail to fire, do not remove the cartridge from the breech for at least five minutes.

**NOTE**

In all circumstances Type C cartridges should be used.

(4) After starting, if heavy viscous oil is indicated by oil pressure that is too high, fluctuates, or falls off when engine RPM is increased, the dilution valve may be operated intermittently (not continuously) to correct the condition. This is not considered good practice and should be used only in emergency. Allow adequate warm-up before taking off with diluted oil except in cases of extreme emergency.

c. EMERGENCY OPERATION OF CARTRIDGE STARTERS.—If the cartridge starter fails to fire because of an open circuit, the following emergency method can be used: Connect two flashlight batteries to a brass prod and a battery clamp. Insert a momentary contact toggle switch in the circuit between the batteries and the brass prod. Ground the battery clamp to the fuselage. Insert the prod directly against the electric contact strip in the lower part of the cartridge starter breech completing the circuit by closing the switch. This will fire the cartridge. Other controls are operated as in the normal starting procedure outlined above.

d. IN CASE OF FIRE.

(1) The pilot should visually check to ascertain that a member of the ground crew is on duty off his wing tip with a fire bottle before starting the engine.

(2) If an engine fire breaks out while starting, turn the fuel selector valve *Off*, switch the emergency fuel pump *Off*, increase the throttle setting but keep the ignition switch *On* until the propeller has stopped turning. This will suck any fuel and fire in the lines, ducts and carburetor into the engine where the fuel will be ignited, partially dissipated and passed out through the exhaust with the flames. If the fire continues or shows any signs of spreading the fire bottle should be employed by the ground crew.

7. GROUND CHECK.

a. WARM-UP.

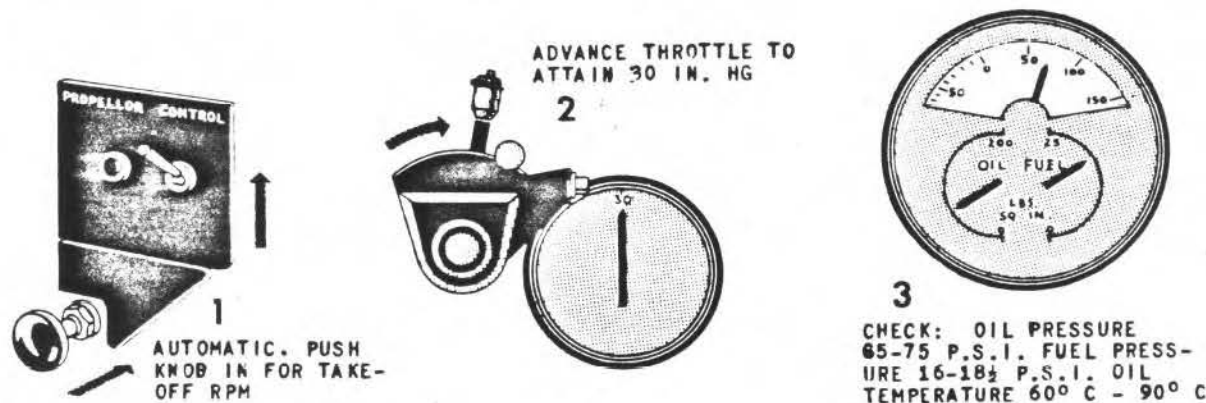

Figure 17—Engine Operation Check

(1) Fully open the cowl flaps.

(2) An oil pressure of 65-75 PSI is desired. If excessive pressure is obtained in cold weather, operate at 800 RPM until the oil pressure drops to the desired range.

(3) Push carburetor air control full in for *Direct* position.

(4) Idle the engine at 1000 RPM.

(5) When the engine fires smoothly, gradually open the throttle to 1200 RPM and run it at this speed until the oil inlet temperature reaches a minimum of 30°C (86°F).

**b. ENGINE CHECK.**

(1) Open the throttle to 30 in Hg with propeller set for take-off RPM.

(2) The oil pressure should maintain 65-75 PSI. If the oil pressure drops or fluctuates when the throttle is open, reduce speed and continue with the warm-up procedure.

**c. MAGNETO CHECK**

(1) With the propeller controls in the take-off position, advance the throttle to obtain approximately 2000 RPM.

(2) Move the magneto switch from *Both* to *Left*. The tachometer should show a drop of less than 100 RPM.

(3) Move the magneto switch from *Left* to *Both*. Wait until RPM stabilizes and move switch to *Right*. The tachometer should again show a drop of less than 100 RPM.

**d. CARBURETOR IDLE MIXTURE CHECK.**—Make idle mixture check with throttle set for 600 RPM and auxiliary fuel pump "ON". Move the mixture control lever smoothly and steadily into the *IDLE CUT-OFF* position and observe the tachometer for any change in RPM. Return the mixture control lever to *AUTO-RICH* position before the engine cuts out. The smallest noticeable rise in RPM during the check indicates a

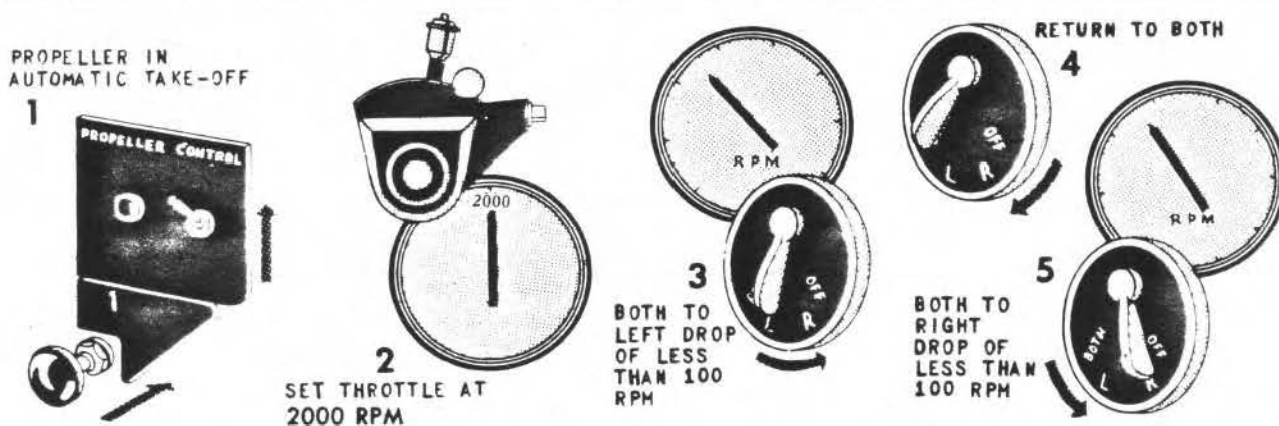

Figure 18—Magneto Operation Check

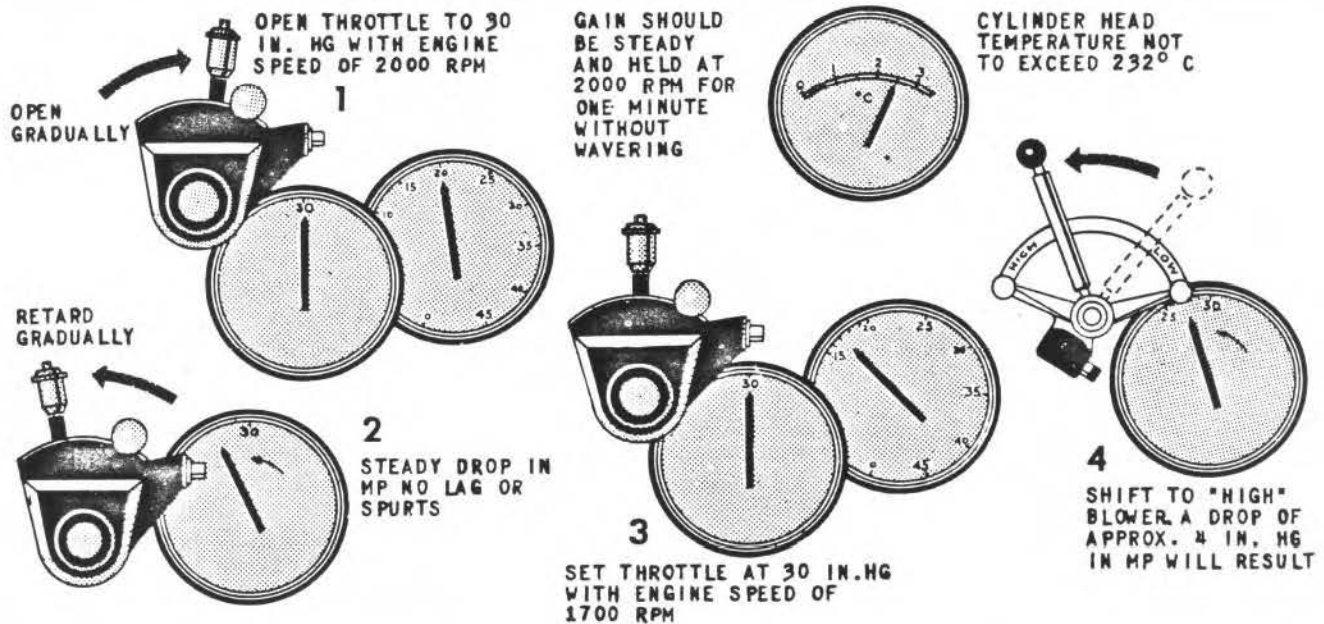

Figure 19—Manifold Pressure Regulator Check

satisfactory idle mixture adjustment, in order to permit idling at low speeds without danger of fouling plugs and at the same time to afford good acceleration characteristics. A rise in excess of 50 RPM indicates too rich a mixture. No rise or a drop in RPM indicates too lean a mixture.

e. MANIFOLD PRESSURE REGULATOR CHECK.

(1) With the propeller controls in the Take-Off position, open the throttle gradually to obtain 30 inches Hg manifold pressure. During this operation the RPM should climb steadily without lag or irregularities.

(2) Pull propeller governor control back to obtain 1700 RPM without changing the throttle and shift to high blower. A manifold pressure drop of 4 inches Hg should result. After the manifold pressure has stabilized return to low blower and note return of manifold pressure to 30 inches Hg.

(3) Return propeller governor control to Take-Off position and retard throttle to warm-up RPM.

f. PROPELLER OPERATION CHECK.

(1) MANUAL.

(a) Propeller circuit breaker "ON."

(b) Set Propeller selector switch in "Fixed Pitch."

(c) Hold selector switch in *Increase RPM* until a gain in RPM is noted on the tachometer then release switch (Return to *Fixed Pitch*).

(d) Hold selector switch in *Decrease RPM* until a drop in RPM is noted on the tachometer then release switch (Return to *Fixed Pitch*).

(2) AUTOMATIC.

(a) Set propeller selector switch in *Automatic*. Push propeller governor control knob all the way in for Take-Off RPM.

(b) Set throttle to obtain 1800 RPM.

(c) Pull out the propeller governor control knob until a decrease of approximately 200 RPM is obtained. A steady speed without surging should result.

(d) Return the propeller governor control knob to take-off RPM (full in). The original RPM (1800) should again be attained showing that the propeller is operating correctly in *Automatic*.

**NOTE**

With the Curtiss Electric Propeller, an adequate supply of electrical energy for *Automatic* control of propeller is essential for a safe take-off and operation in flight. Pilots should therefore form the habit of checking the ammeter or voltmeter during ground checks for an indication of current flow from the generator. The engine speed should be well above 1100 to 1300 RPM (at which speed the generator cuts out) when this check is made. If the generator is not supplying current to the electrical system, the reserve electrical energy of the battery is all that is available. To attempt a take-off and flight under these conditions may be disastrous.

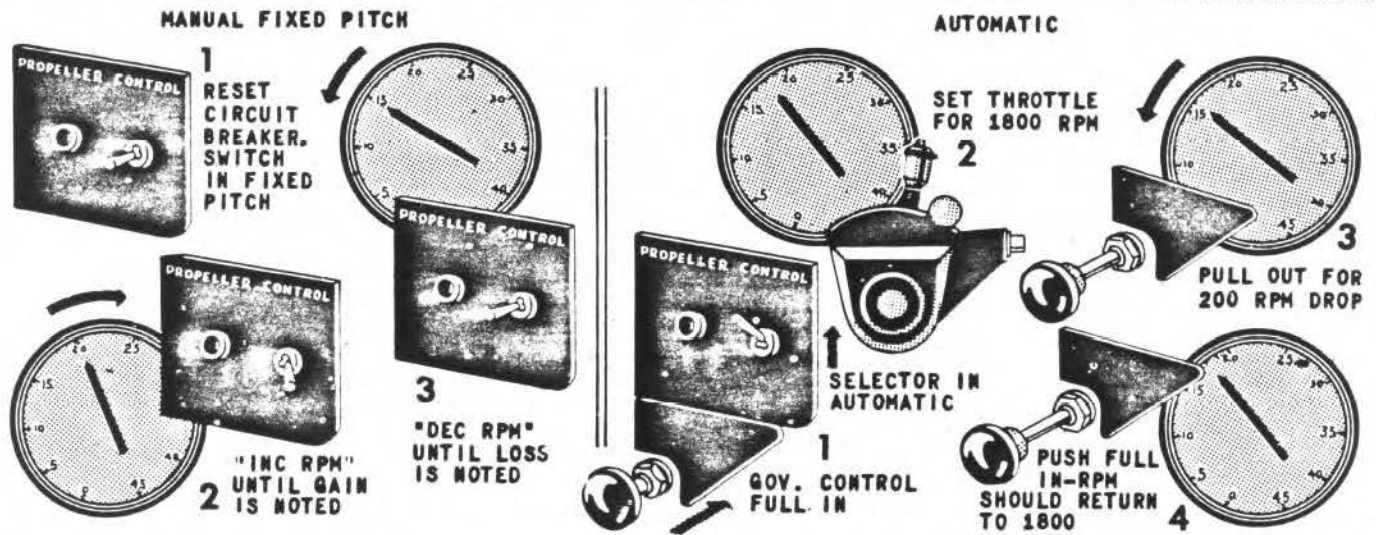

Figure 20—Propeller Operation Check

**g. SUPERCHARGER DESLUDGING OPERATION.**

(1) **BEFORE FLIGHT.**—During warm up prior to each flight, operate the supercharger in each blower position for two 30 second periods. Make these shifts with the engine turn up about 1000 RPM.

(2) **AFTER FLIGHT.**—To desludge the supercharger more completely, operate the engine in each blower position at about 1000 RPM for 30 seconds or more after each flight. The procedure of taxiing land based airplanes back to the line in high blower satisfies this requirement. Carrier based aircraft need not desludge after flight.

**b. SUPERCHARGER CHECK.**—Whenever it is desired to check the operation of the supercharger proceed as follows:

(1) With the propeller controls in the Take-off position open throttle to obtain 1700 RPM.

(2) Shift to high blower and open throttle further to obtain 30 inches Hg and note RPM.

(3) Close throttle completely. Shift to low blower and open throttle to 30 inches Hg again.

(4) If RPM is appreciably higher now than with 30 inches Hg in high blower the check is satisfactory.

**8. EMERGENCY TAKE-OFF.**

Emergency take-offs without full warm-up are not recommended. The engine has a tendency to run cool and to cool even further while taxiing. In an emergency, take-off may be made when oil-in temperature is 20°C and oil pressure remains steady after opening the throttle.

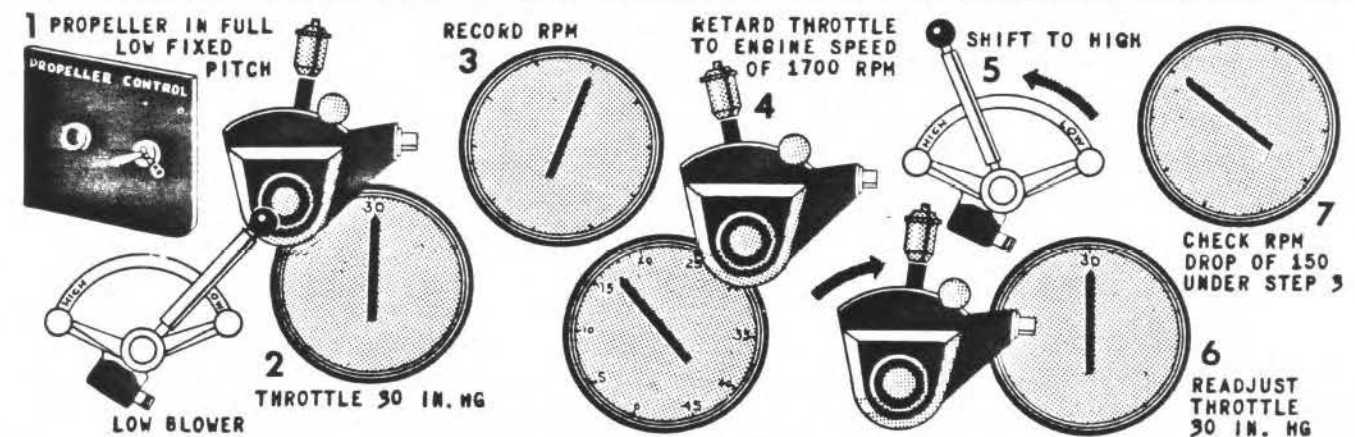
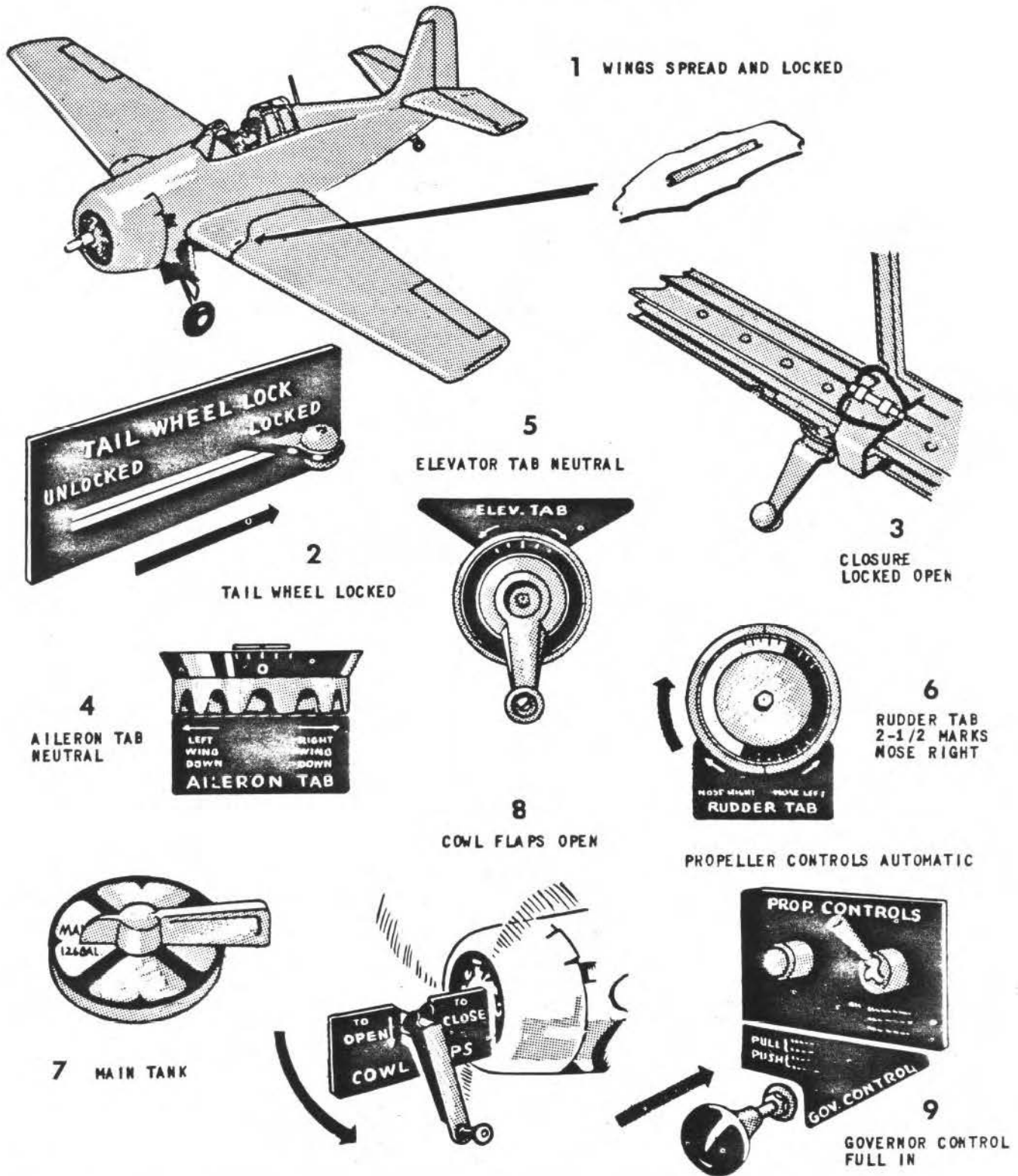
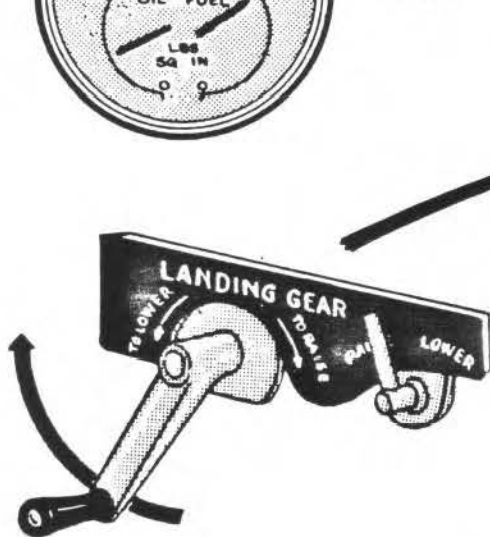
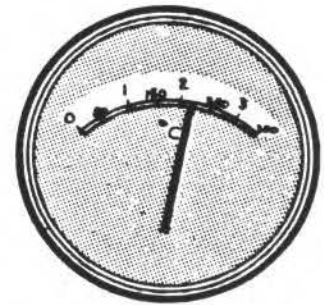
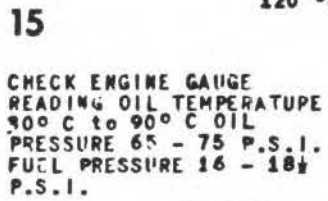
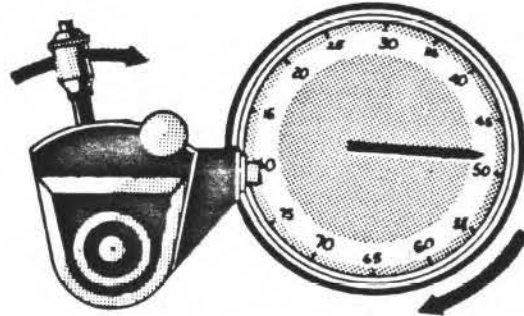
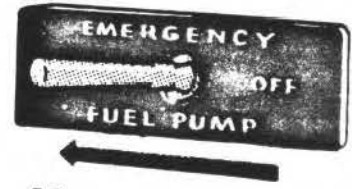
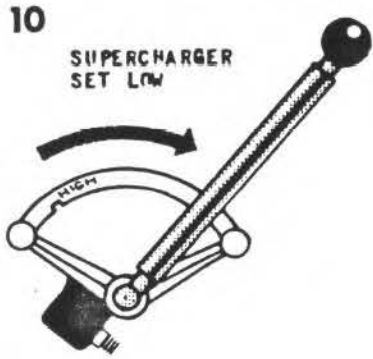

Figure 21—Supercharger Check

Figure 22—Take-Off Check List







## 9. TAXIING INSTRUCTIONS.

No unusual characteristics exist. Turns of 360° in either direction may be made with ease. Brakes should be carefully applied as the airplane has a tendency to nose over when the brakes are *jammed on*.

In all taxiing operations caution should be exercised to insure that the tail wheel is unlocked whether the plane is handled by a tractor or under its own power. The tail wheel locking pin may be sheared off otherwise.

As the engine cools during taxiing, further warm-up is usually required to bring the cylinder head temperature above minimum before entering the take-off run.

## 10. TAKE-OFF.

a. DISCUSSION.—*Before starting the take-off run see that the temperatures are above the low limits and not near the upper limits.*

Cylinder Head Temperature.....	248°C Maximum
Oil-in Temperature.....	30°C Minimum
	20°C Emergency
Oil Pressure.....	65.75 PSI
Fuel Pressure	

(With emergency pump on) 16-18½ PSI

For a rolling start, open the throttle gradually until a maximum of 46.5 in. Hg is obtained. The airplane will *take itself off* from a three-point position at about 70 to 75 knots.

In a standing start, gradually release the brakes when the manifold pressure reaches about 25 in. Hg. If the brakes are held, the tail begins to jump at about 30 in. Hg.

If it should be necessary to take-off in a cross wind make every attempt to keep the wind from the left. Adjust the rudder tab right in accordance with the strength of the cross wind.

### CAUTION

*Regardless of the altitude of the airport always take-off in low blower.*

### b. EXPANDED TAKE-OFF CHECK-OFF LIST.

(1) Visually check signal flags in wing to be certain that wings are spread and locked.

(2) Lock the tail wheel.

(3) Lock the cockpit enclosure in *Full Open* position.

(4) Set the aileron tab in neutral.

(5) Set the elevator tab in neutral.

(6) Set the rudder tab control at 2½ units nose right.

(7) Switch the fuel tank selector valve to *Main*.

(8) Open the cowl flaps.

(9) Set the propeller selector switch in *Automatic* with the push-pull knob full in for Take-off RPM.

(10) Set supercharger control in *Low*.

(11) Set the mixture control in *Auto Rich*.

(12) Flick on the emergency fuel pump.

(13) Move the carburetor air control to *Direct*.

(14) Advance the throttle to the stop to obtain 46.5 inches Hg manifold pressure (R-1820-56 and -56W engines).

Move the throttle past the stop to full forward position (R-1820-56A and -56WA engines).

### CAUTION

On airplanes powered by R-1820-56 and -56W engines, do not move the throttle control lever beyond the stop for take-off. The exact position of this stop should be adjusted to conform to the take-off power determined for the operational area.

## 11. ENGINE FAILURE DURING TAKE-OFF.

To provide greater safety in the event of a forced landing due to power failure, retract the landing gear as soon as the airplane is safely airborne.

### NOTE

On take-off the landing gear should be brought up immediately as high air loads caused by increased speed make the cranking operation much more difficult.

### WARNING

With power off or with low power this ship is excessively nose heavy and, in the event of an engine failure, will stall if a fairly good gliding angle is not immediately assumed.

## 12. CLIMB.

a. DISCUSSION.—The best climbing airspeed for this airplane is about 125 knots indicated. Speeds slightly higher than this have very little effect on the rate of climb but result in better cooling. At these relatively low speeds it should be noted that the resulting reduction in Ram brings about a lower airplane critical altitude. If after increasing airspeed, cooling is not improved, the cowl flaps must be adjusted to hold the temperature within the specified limits.

### NOTE

Above 20,500 ft. altitude do not exceed 2500 RPM. The use of 2600 RPM above this altitude results in a loss of propeller efficiency. The thrust, and consequently the airspeed, will be improved at 2500 RPM and the fuel consumption will be less than at 2600 RPM.

b. RATED POWER CLIMB.—Operate according to the Power Plant Chart and the Engine Calibration Curve. The following table shows the throttle and supercharger settings for this condition:

**TABLE I**

PRESS.	ALT.	MAN. PRESS., IN. HG	BLOWER RATIO
S.L.	—5700	43— Full Throttle	Low
	5700 —14000	Full Throttle	Low
	14000—20700	38— Full Throttle	High
	20700—Up	Full Throttle	High

Cylinder Head Temperature of 218°C can be maintained continuously or temperature up to 232°C for one hour.

c. **MILITARY POWER CLIMB.**—Operate in accordance with the Power Plant Charts and Engine Calibration Curve. The following table gives the throttle and supercharger settings for this condition:

**TABLE II**

PRESS.	ALT.	MAN. PRESS., IN. HG	BLOWER RATIO
S.L.	—3500	46.5— Full Throttle	Low
	3500 —13000	Full Throttle	Low
	13000—17800	43— Full Throttle	High
	17800—Up	Full Throttle	High

Cylinder Head Temperature of 232°C can be maintained for 30 minutes.

d. **COMBAT POWER CLIMB.**—The use of Water Injection in climb in low blower below 1000 feet gives very little advantage over climb with military power at the same altitude. While the following table gives the throttle and supercharger settings for a Combat Power climb it also shows the effect of Ram, as discussed in paragraph a, on the airplane critical altitudes by giving the airplane critical altitudes while climbing and in level flight. The Water Injection system (high blower) may be operated with definite gain in power between approximately 6,500 feet (where the manifold pressure drops to 42 inches Hg in low blower) and 17,800 feet (where the manifold pressure drops to 43 inches Hg in high blower).

**TABLE III**

BLOWER RATIO	MAP AT FULL THROTTLE	CRITICAL ALTITUDE CLIMB	CRITICAL ALTITUDE LEVEL FLIGHT
Low	50	—1200	1200
High	52 (Wet)	7800	10800
High	46 (Dry)	11800	14400

Cylinder Head Temperature of 248°C can be maintained for 5 minutes.

For maximum performance, shift blowers at the altitude where the manifold pressure is 42 inches Hg.

### 13. GENERAL FLYING CHARACTERISTICS.

a. **CRUISING BELOW NORMAL RATED POWER.**—The mixture control should be in *Auto Lean* for the cruising power operation as shown in the Engine Calibration Curve. If the head temperature cannot be kept below 205°C with the cowl flaps open, the mixture should be enriched.

The cruising manifold pressure-RPM relationships specified in the Engine Calibration Curve should not be exceeded.

Cruising operations can be carried on at any power below Normal Rated Power. The best fuel economy is realized at powers below Maximum Cruise.

Use the Flight Operating Instructions Chart to determine recommended cruising conditions based on fuel quantity and rate of consumption. Engine settings for cruising conditions are condensed in the Power Plant Chart.

#### b. CHANGING POWER CONDITIONS.

##### (1) TO INCREASE POWER.

(a) Set the desired RPM with the propeller governor control.

(b) Then adjust the throttle to obtain desired manifold pressure.

##### (2) TO DECREASE POWER.

(a) Set the desired manifold pressure with the throttle.

(b) Then set the desired RPM with the propeller governor. Readjust the throttle, if necessary.

#### c. SUPERCHARGER OPERATION.

(1) The supercharger high blower should be used above 14,000 feet pressure-altitude for normal rated and lower powers. The high blower should not be used for cruising at altitudes which cruising power is available in low blower since greater fuel economy is obtainable in low ratio.

(2) Shift from *Low* to *High* blower as follows:

(a) Set the mixture control in *Auto Rich* and switch the emergency fuel pump *On* to prevent the engine cutting out.

(b) Close the throttle as necessary to prevent exceeding the desired manifold pressure after shifting.

### NOTE

On those airplanes equipped with the Water Injection System the above step is not necessary to avoid exceeding the desired manifold pressure after shifting as the manifold pressure regulator will automatically reduce the throttle setting. If, however, the throttle setting is in the high brackets it should be retarded to approximately 50% to 60% throttle to avoid shifting at high power.

(c) Adjust the propeller governor to obtain 1700-1800 RPM (whenever possible). If many shifts are made above 1800 RPM or if any are made above 2500 RPM, failure of the supercharger clutch or drive may result.

(d) Move the supercharger control rapidly from *Low* to *High* and lock.

(e) Readjust the RPM and throttle setting as necessary to obtain the desired power.

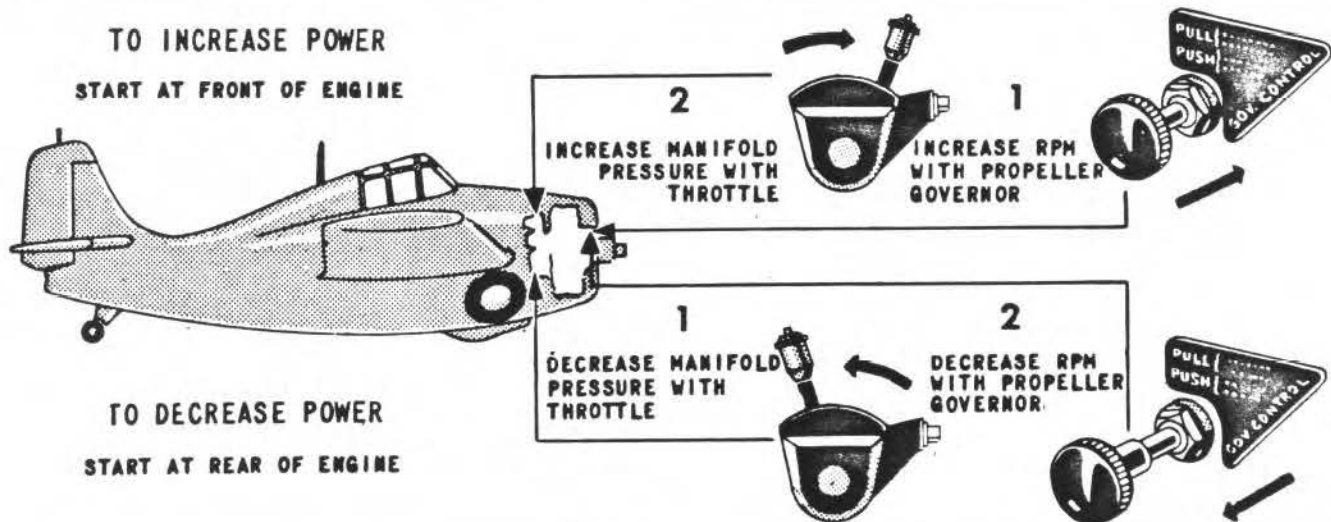

Figure 23—Changing Power

(f) Return the mixture control to *Auto Lean* and turn the emergency fuel pump off.

(3) Shift from *High* to *Low* blower as follows:

(a) Retard the throttle setting to 50% to 60% throttle.

(b) Adjust the propeller governor to obtain 1500 RPM or less.

(c) Shift rapidly from *High* to *Low* and lock the supercharger control in that position.

(d) Readjust the propeller governor, throttle and mixture control as necessary.

(4) Except in an emergency, do not shift more often than at five minute intervals while in flight in order to provide sufficient time for the dissipation of heat generated during the clutch engagement period. This restriction need not be observed during checking operations on the ground because of low clutch loads imposed at low engine RPM.

(5) The supercharger should be desludged before and after each flight. See paragraph 7g for details of the desludging operation.

d. STABILITY.—The trim tabs have sufficient range to maintain stability. After initial flight the fixed tab on the right aileron can be set to compensate for wing heaviness.

**NOTE**

This airplane is slightly nose heavy, especially at low power operation.

e. MANEUVERS WITH MANIFOLD PRESSURE REGULATOR.—During the slow rolls or entrance into dives or any maneuver producing a negative acceleration the resulting loss of oil pressure in the manifold pressure regulator on those airplanes equipped with the



Water Injection system (R-1820-56W or R-1820-56WA engine) causes a drop in manifold pressure. The amount of drop increases as the critical altitude for the particular engine operating condition is approached, attaining a magnitude that will almost cause the engine to cut out.

(1) This manifold pressure drop can be overcome by increasing the throttle setting as desired before going into any maneuver producing a negative acceleration. The throttle setting *must*, however, be returned to the original setting as the negative acceleration drops off (in most cases as the maneuver is completed) or a terrific surge of power will result.

(2) Due to the above condition, it is recommended that except during conditions where the original power is definitely required during the maneuver, the original throttle setting be retained and the power be allowed to drop off temporarily.

**WARNING**

If icing conditions are suspected on those airplanes incorporating a Manifold Pressure Regulator, switch immediately to alternate air. As the carburetor starts to ice the Regulator will automatically open the carburetor throttle to compensate for loss of manifold pressure. Therefore, the pilot receives no warning until the carburetor has heavily iced.

f. OPERATION OF WATER INJECTION SYSTEM FOR FAMILIARIZATION.—Full Combat Power is authorized only in combat areas under emergency con-

ditions. For the purpose of familiarizing the pilot with this equipment and checking its functioning without realizing full Combat Power, the following procedure is recommended:

(1) Climb to the altitude where the manifold pressure begins to fall below 43 inches Hg in high blower (approximately 17,800 feet, Military Power Critical Altitude) with the throttle open to the stop.

(2) Descend approximately 2,000 feet and at this altitude close the throttle limit switch by placing the throttle in full forward position. A momentary drop in power followed by an increase in MP above 43 inches indicates that water is flowing.

**NOTE**

There will be a slight increase in manifold pressure although full Combat Power manifold pressure will not be obtained as the altitude is above the "Wet" Combat Power critical altitude. Full Combat Power can be realized only at lower altitudes.

**14. STALLS.**

Stalls are fairly gentle with ample warning in clean, flapped or landing conditions. Warning appears as a shudder in the airplane just previous to the development of the full stall.

Stalling Speeds: Clean with power	68.5 knots
Flaps with power	61.0 knots
Landing condition with power	59.0 knots

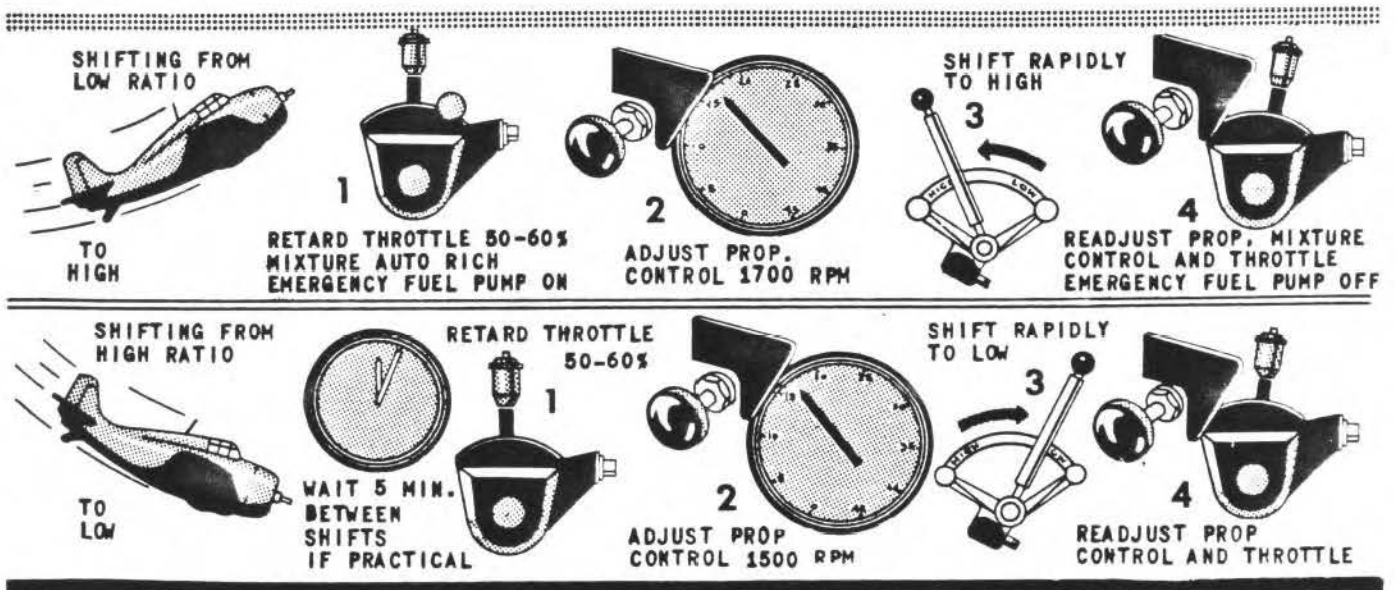

Figure 24—Supercharger Operation

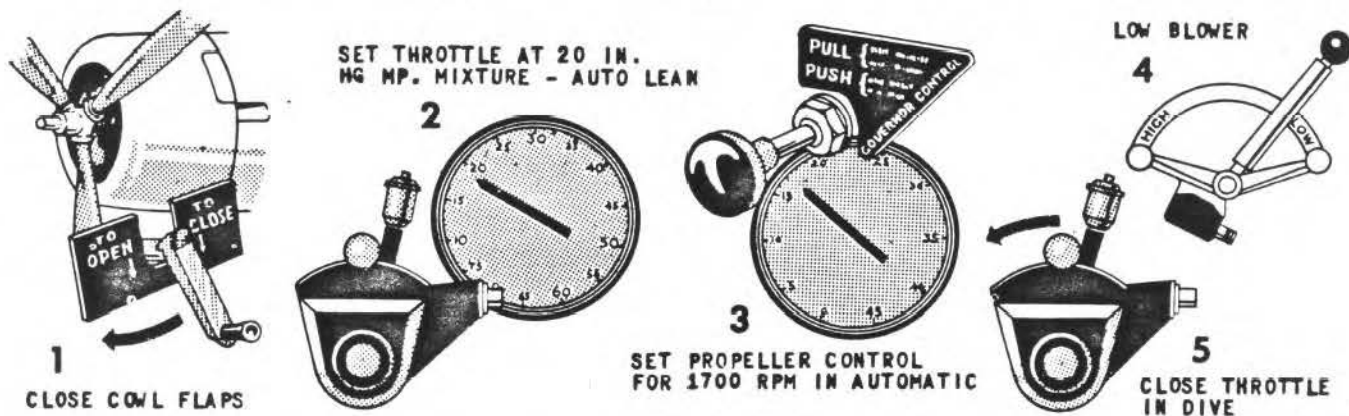

Figure 25—Diving Check List

Clean without power	74.5 knots
Flaps without power	67.0 knots
Landing condition without power	65.0 knots

The airplane tends to drop one wing or the other rather than mush after stall develops.

Aileron control is considered adequate at speeds five knots above stalling speed but not at the stall. The rudder, of course, may be used to raise a low wing after the ailerons become ineffective.

**15. SPINS.**

Recovery from normal fully developed spins to the left or right may be effected in 1½ to 2 turns by the application of full opposite rudder and forward stick.

Right spins have an erratic tendency at times and will eventually become normal; however, during the first five or six turns of the abnormal spin, recovery is difficult and requires approximately four turns. If the abnormal spin is allowed to continue it will become normal after five or six turns and recovery can be affected in two turns.

Inverted spins are normal and recovery is easy.

In the landing condition the airplane has a tendency to start its rotation gently and then after about one third of a turn whip into the spin. The spin is gentle enough but has this peculiar whip in the early stages of the rotation.

**16. PERMISSIBLE ACROBATICS.**

All the usual military maneuvers are permitted except when carrying one or more droppable fuel tanks. When such tanks are carried, wing overs, aileron rolls and vertical turns are permitted; inverted flight is permitted only for entering a dive.

**17. DIVING.**

a. DISCUSSION.—Stick forces in dives not approach-

ing a zero-lift dive are slightly aft, i.e. requiring a slight forward force. In a zero-lift dive there are no stick forces, i.e. the airplane tends to remain in the same attitude. The engine shall not be allowed to turn over 3100 RPM and the manifold pressure shall be kept below the limit for RPM and altitude. If the engine RPM does exceed 3100, close the throttle, shift the propeller to manual and full decrease RPM, and reduce the airspeed to the minimum speed for a safe glide.

During the dive the airplane has a tendency to droop the left wing and nose right. Correct this with the aileron tab and slight rudder pressure. This tendency increases as the diving speed increases and tab changes must be made accordingly. As the airplane comes out of the dive these tendencies drop off and trim should again be changed accordingly.

**NOTE**

If a high speed dive is anticipated, it is recommended that any tendencies the airplane may have to assume other attitudes than those desired be corrected with the stick and rudder pedals. This should be done in lieu of use of the trim tabs as slight changes in the angle of the tabs cause large changes in the airplane's attitude and subject the trim tabs to high structural loads.

The terminal velocity of this airplane is approximately 370 knots indicated at 15000 feet altitude and 7200 pounds gross weight. To recover from a terminal velocity dive a stick force of 75 to 100 pounds is required. There will also be a slight time lag between the application of the stick forces and the resulting change in the airplane's attitude.

b. EXPANDED DIVING CHECK-OFF LIST.

- (1) Close the cowl flaps.
- (2) Set throttle to attain 15 in. Hg. with mixture controls in AUTO RICH if a prolonged steep dive is to be undertaken. A shallow dive can be performed satisfactorily in AUTO LEAN since the automatic mixture control will not lag with a gradual loss of altitude.

**NOTE**

Any manifold pressure from 15 inches up to the maximum limiting manifold pressure for the RPM and altitude may be used. Any manifold pressure below 15 inches, if held in a prolonged dive, will foul up the engine in the same manner as do prolonged glides with a closed throttle. Care should be taken, however, not to let the manifold pressure build up over the limits as altitude is lost. THE GREATER THE MANIFOLD PRESSURE USED, THE GREATER WILL BE THE DIVING SPEED.

- (3) Set propeller control in "Automatic" at 2100 RPM.
- (4) Lock the supercharger in "Low" blower.
- (5) Retard throttle setting during dive in accordance with above note.

**18. NIGHT FLYING.** (No Special Instructions)

**19. APPROACH AND LANDING.**

*a.* EXPANDED LANDING CHECK-OFF LIST.

- (1) Crank the landing gear down.

**CAUTION**

Be sure the landing gear is fully down.

- (2) Lock the tail wheel caster for land operation. Unlock it for carrier operation.
- (3) Lower and lock the arresting hook in position for carrier landing. Leave the hook up for normal landing.
- (4) Open and lock the cockpit enclosure.
- (5) Set the carburetor air control full in for *Direct* position.
- (6) Set the propeller governor control for 2100 RPM.

**NOTE**

An approach speed of 85 knots is recommended. In slower approaches, the airplane has a tendency to nose down and lose stick control.

- (7) Lock the supercharger in *Low* regardless of the airport altitude.

- (8) Move the mixture control into *Auto Rich*.

- (9) Close the cowl flaps for a normal land approach. Open the cowl flaps for a *power on* carrier approach only as necessary to maintain recommended cylinder head temperatures.

- (10) Lower the wing flaps.

- (11) Move the propeller governor control full "IN" just prior to landing.

- (12) Open the cowl flaps wide just after landing.

**NOTE**

When lowering the landing flaps on this airplane the engine may "cough" and lose as much as 200 RPM during the operation. This drop is *normal and only temporary*. It is caused by a change in the mixture as the flaps are vacuum operated, the vacuum being created by the low pressure area in the carburetor venturi as shown in figure 3 and explained in Section I, paragraph 4.

*b.* CROSS WIND LANDING.—Follow the normal check-off list. Maintain a steep glide path to a position as close to the ground as possible. Do not attempt to hold the airplane off the ground any length of time. Allow the tail wheel to touch first with the caster locked. These instructions apply to cross wind or gusty conditions when holding off may give the wind a chance to pick up a wing while lateral control is sluggish.

*c.* WAVE-OFF CONDITION.—Power suddenly applied tends to raise the nose. Therefore, care should be exercised to push the stick forward or to use the nose-down tab when suddenly applying power in a *Wave-Off*. If this is not done a stall may develop.

Do not change flap settings. The flaps are forced up by the air stream as speed increases.

**20. STOPPING THE ENGINE.**

*a.* EXPANDED PILOT'S CHECK-OFF LIST.

- (1) Leave the cowl flaps fully open while idling and for at least ten minutes after stopping.
- (2) Leave the carburetor air control knob in for *Direct* position.
- (3) Set the propeller control knob full in for *Take-Off* RPM.
- (4) Leave the supercharger control in *Low*.
- (5) Leave the mixture control in *Auto Rich*.
- (6) Set the throttle for 800-1000 RPM to cool engine, and idle until head temperature drops below the desired 200°C before stopping the engine.

It is desirable to shift the blower control at least once while operating at this RPM. (High Blower will not engage but the driving mechanism will be flushed.)

(7) When engine has cooled sufficiently, increase the speed to 1000-1200 RPM for one-half minute to scavenge.

(8) Move the mixture control to *Idle Cut-Off*.

(9) When the propeller stops rotating, shut off the ignition switch.

(10) Snap off the battery switch.

(11) Turn Fuel Selector Switch to *Off*.

*b.* OIL DILUTION. — When temperatures below  $-5^{\circ}\text{C}$  ( $23^{\circ}\text{F}$ ) are forecast for the period before the next





Figure 26—Approach and Landing Check List

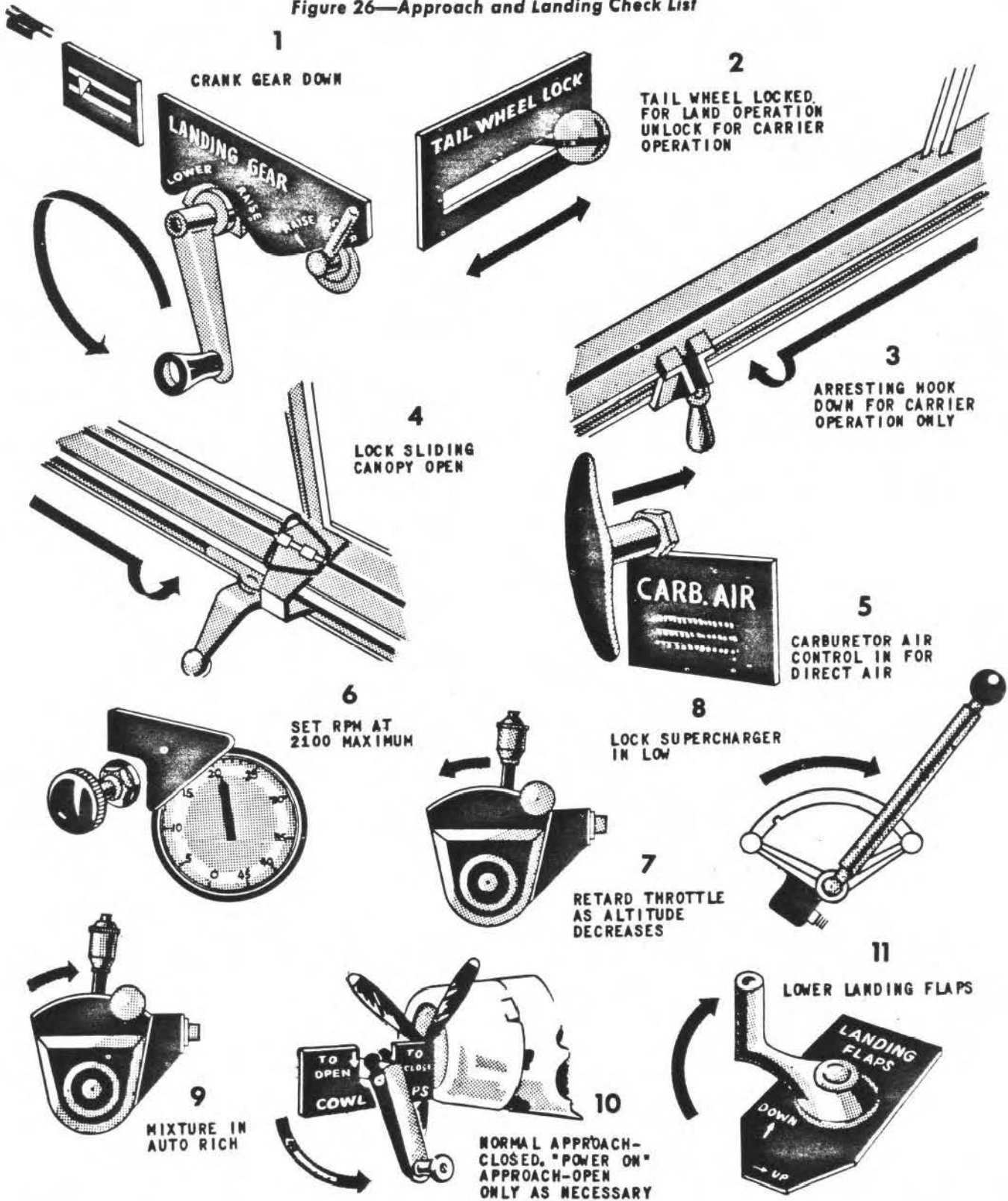

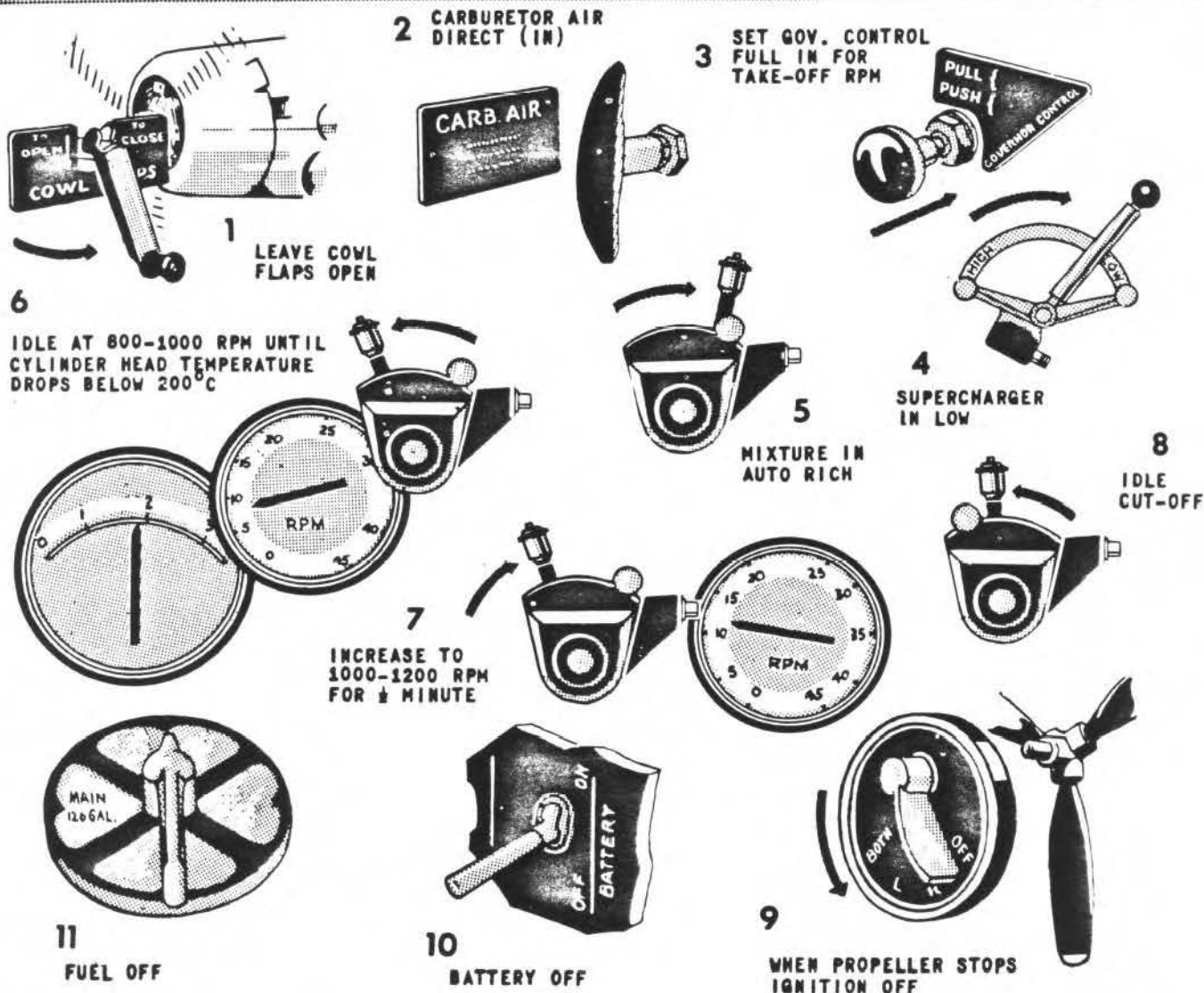

Figure 27—Stopping the Engine

start, the lubricating oil should be diluted immediately before stopping. If an oil dilution system is installed in the airplane use the following procedure when low temperatures are anticipated:

- (1) Open the shut-off cock in the oil dilution line.
- (2) Hold the engine speed constant at 1000 RPM.
- (3) Turn the oil dilution switch on and hold it for approximately two minutes.

**NOTE**

When the dilution switch is turned on, there will be a sharp drop in indicated fuel pressure. Fuel pressure should return to normal immediately when the switch is turned off. If it does not, stop the engine immediately and check the valve for leakage.

- (4) Still holding the dilution switch on, move the

mixture control to *Idle Cut-Off*. Hold the switch on until the engine stops.

- (5) Turn off the ignition switch when the propeller stops rotating.

- (6) Close the oil dilution shut-off cock. It should be closed except when actually diluting the oil.

**CAUTION**

Do not overdilute. Dilute only when justified by a forecast of temperature below  $-5^{\circ}\text{C}$ . Guard against fire. If the oil has been diluted at the last operating period, a normal start and warm up without rediluting should be made.

**21. TIEING DOWN.**

- a. **PARKING HARNESS.**—The control parking harness should be carried in the baggage compartment. To

Figure 28—Mooring Diagram

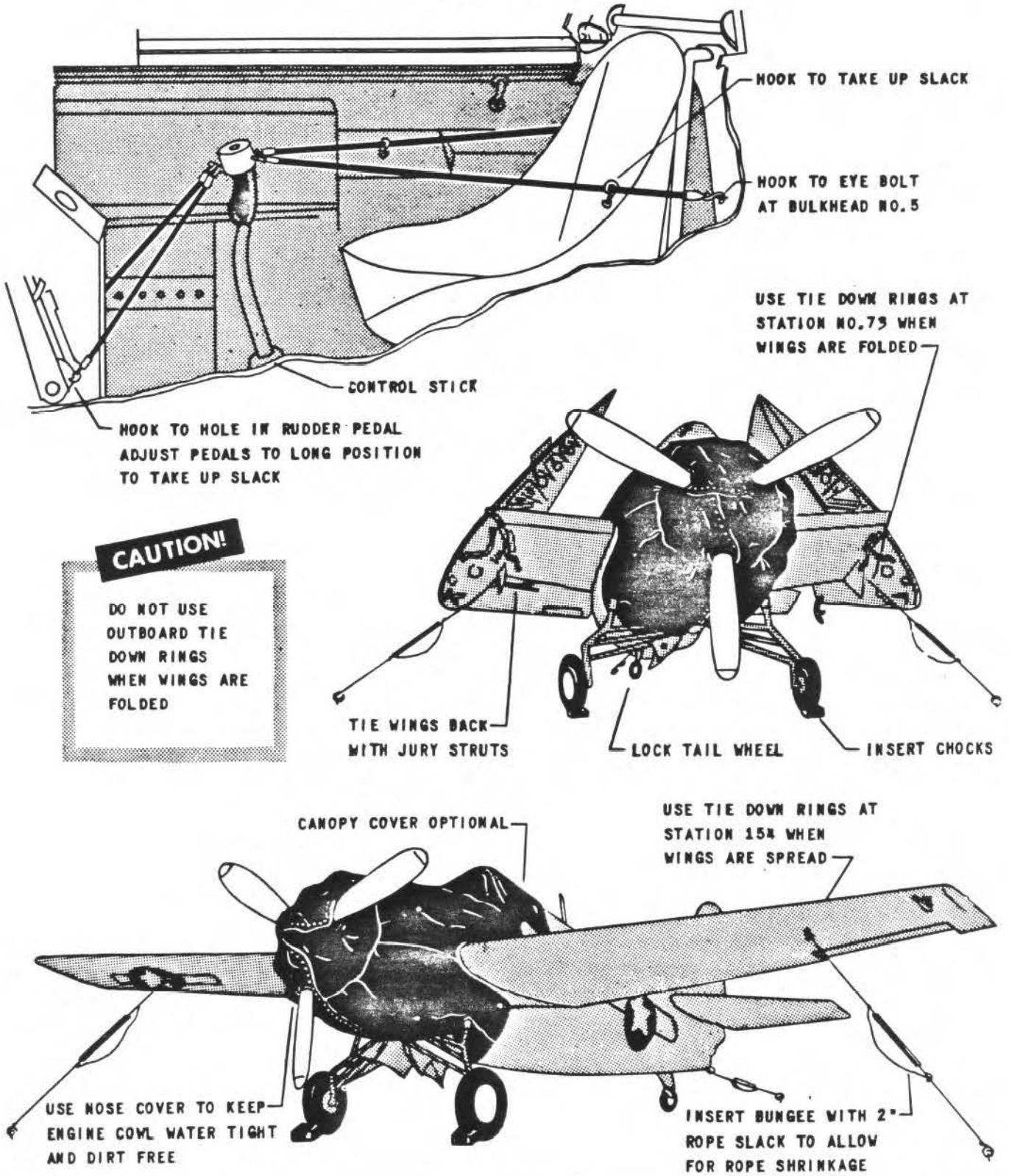

prevent whipping of the control surfaces when the plane must be parked outside, slide the cup of the device over the control stick handle. The two cables fastened to the same ring in the cup are brought forward and hooked into holes in the pedal support arms. The other cables are led aft and hooked into eye-bolts at either side of the pilot's seat and bulkhead No. 5. Slack can be taken up by moving the pedals forward to *Long* position. The spare hooks on the aft cables can be used to take up any additional slack.

*b.* MOORING.

(1) Lock the tail wheel.

- (2) Insert parking blocks.
- (3) Slip the nose cover over the engine cowling to keep the engine and accessories dry and dirt-free.
- (4) If the wings are folded, use the tie-down rings at Wing Station No. 73. Install the wing covers over the wing fold.
- (5) If the wings are spread, use the tie-down rings at Wing Station No. 154.
- (6) Attach the tail rope to catapult hold back bolt.
- (7) Spread the canvas cabin enclosure cover over the canopy and lash it down.







### 1. POWER PLANT CHART.

This chart is intended to summarize the specific characteristics and limitations of the engine and to provide additional instructions and information. The Engine Calibration Curve should be used to supplement the data given here. The definitions of the engine power ratings as shown on the chart are as follows:

*a.* TAKE-OFF.—Maximum recommended for take-off under a five minute time limit.

*b.* COMBAT POWER.— The limits established by the manufacturer and accepted by the Government specifically for combat use under the specified time limit,

limited to five minutes duration.

*c.* MILITARY.—Maximum recommended for operation limited to thirty minutes duration.

*d.* NORMAL RATED (Maximum Continuous).—Maximum recommended for continuous operation.

*e.* MAXIMUM CRUISE.—The maximum recommended economical power beyond which fuel consumption begins to increase at a rapid rate.

### 2. AIR SPEED CORRECTION TABLE.

Figure 30 is an Airspeed Indicator Calibration Chart showing the relationship between indicated and actual airspeed in knots.

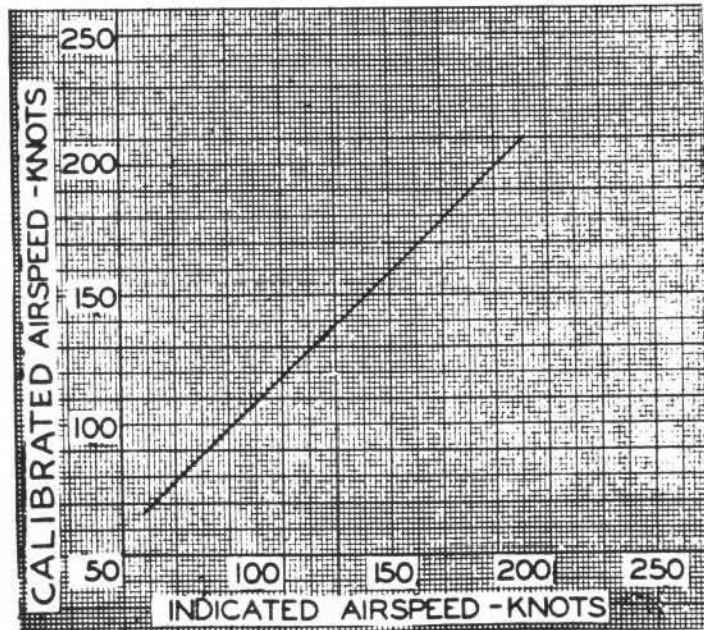

Figure 30—

Air Speed Correction Table

# Section A



## EMERGENCY OPERATING INSTRUCTIONS

### 1. SLIDING CANOPY EMERGENCY RELEASE.

To jettison the sliding canopy for emergency exit, grasp the red painted rings on both sides at the forward end of the canopy and pull aft. This removes the pins holding the canopy to the track slide allowing the slip-stream to tear the canopy free. It may be necessary to give the canopy a slight push up into the air stream if it is in a full closed position when the rings are pulled.

#### CAUTION

The pilot must pull the two emergency release pins simultaneously so that both sides of the canopy will be freed at approximately the same time. Should one pin be pulled before the other the pilot may be trapped or injured if the airstream jams the canopy on the remaining pin or whips it over as it is being torn free.

### 2. FIRES.

Open the canopy and gain as much altitude as possible.

a. ENGINE FIRES.—Although no absolute rule can

be made to control a fire in the engine section, the following procedure is offered as a guiding principle to be followed in the order listed in case of fire in flight or on the ground.

(1) Turn the fuel selector valve to the *Off* position, thus stopping the flow of fuel to the fire. Do not cut the ignition switch.

(2) Close the cowl flaps.

(3) Push the carburetor air control in for direct air supply.

(4) Increase the engine power as much as circumstances permit in order to consume the fuel that might otherwise feed the fire.

#### b. WING FIRES.

(1) If a fire is discovered in either wing turn off the following switches and rheostats controlling electrical units and wiring in the wing:

- Gun Camera Switch
- Gun Master Switch
- Formation Light Switch
- Wing Running Light Switch
- Pitot Tube Heater Switch



TO RELEASE CANOPY  
PULL BOTH RINGS  
SIMULTANEOUSLY

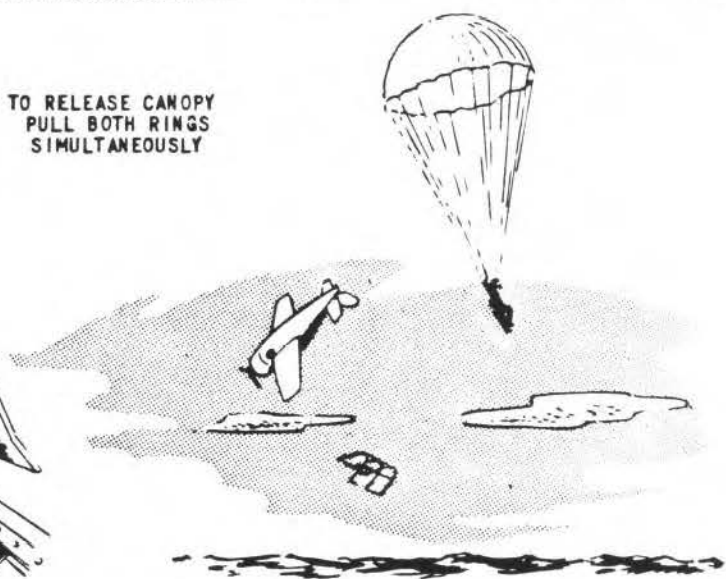

Figure 31—Cockpit Emergency Exit



(2) Attempt to extinguish the fire by sideslipping.

### 3. ENGINE FAILURE.

In case of engine failure with altitude, put the mixture control into *Auto Rich*, retard the throttle to a maximum of 20 in. Hg, throw on the emergency fuel pump switch, and hold the primer switch in *On*. Do not try to exceed 20 in. Hg manifold pressure while operating on the primer. Open the canopy.

Glide for flying speed. Further glide can be obtained with the flaps up. If the engine does not catch for a power landing and the location makes it possible to bring the airplane in, cut the ignition and turn the fuel selector valve to *Off* before landing. Lower the flaps when approaching for the landing.

### 4. WHEELS UP LANDING.

If the landing gear should fail to come down, land as slowly as possible with flaps down. Open the canopy. Level the airplane off about ten feet or less above the ground and let it drop in.

### 5. WATER LANDING—DITCHING.

If it becomes necessary to make a water landing, head for deep water. A landing in shallow water might cause the airplane to overturn and trap the pilot if the nose hits the bottom upon settling. Lock the canopy "OPEN". Keep the landing gear up and come in as for a wheels-up landing. As the airplane hits the water and loses forward momentum the nose will settle deeper and deeper and finally sink nose first. However, before the airplane makes its final plunge the pilot will have time to escape.

### 6. GENERATOR FAILURE.

If generator failure occurs in flight:

a. Turn off all electrically operated devices not essential to safety in order to conserve the battery.

b. With the Propeller Selector Switch on *Fixed Pitch* change the propeller pitch to the best fixed pitch for normal flight. Do not use the Automatic Setting.

c. Conserve the battery by:

(1) Using the radio sparingly.

(2) Turn off the battery switch as much as safe operation will permit. Turn it on only periodically as required to read the instruments and perform other necessary operations.

d. Turn on the battery switch before landing in order to have all electrical devices functioning normally during the landing. Set the propeller selector switch in *Automatic* position.

### 7. MP REGULATOR FAILURE.

Should the MP Regulator fail, approximately 90% of Normal Rated Power is available through the mechanical linkage between the throttle control lever and the carburetor throttle. The 10% lost represents that portion of the carburetor movement controlled by the automatic action of the Regulator.

In case of such failure operate the throttle control lever as though the Regulator was not installed in the linkage, advancing it to maintain the desired MP during a climb and retarding it during descent.

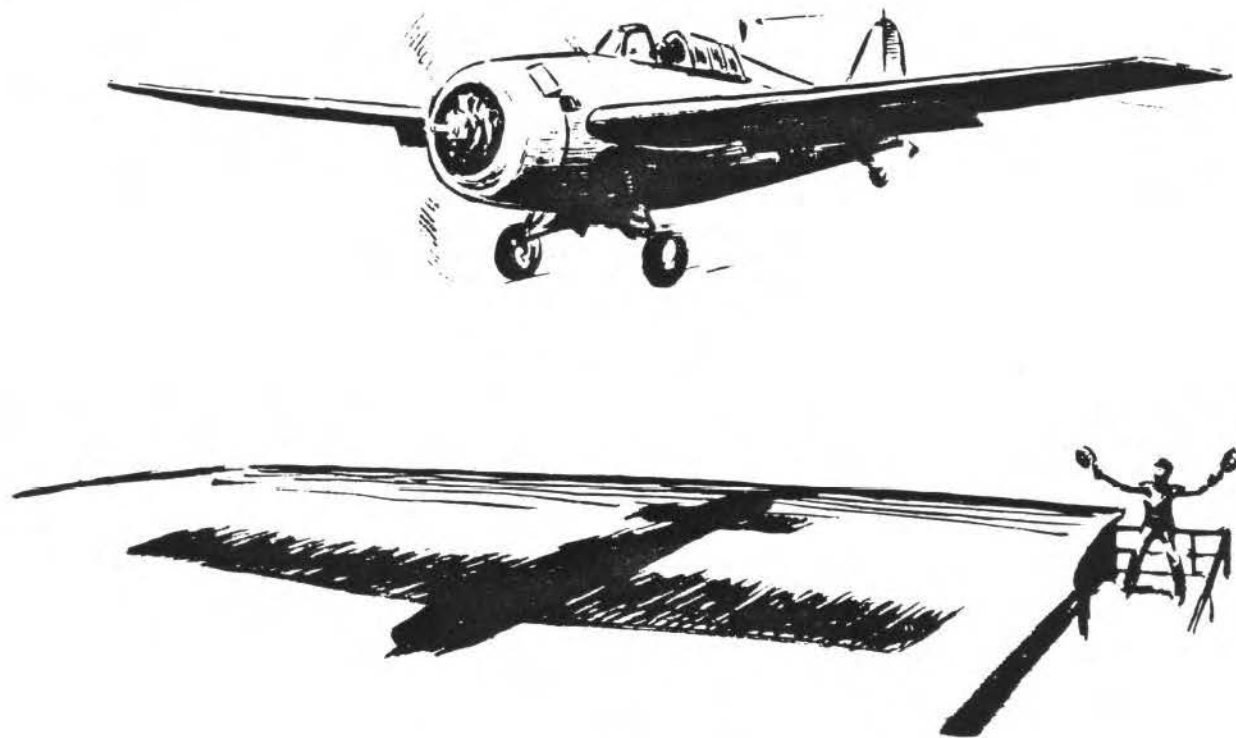
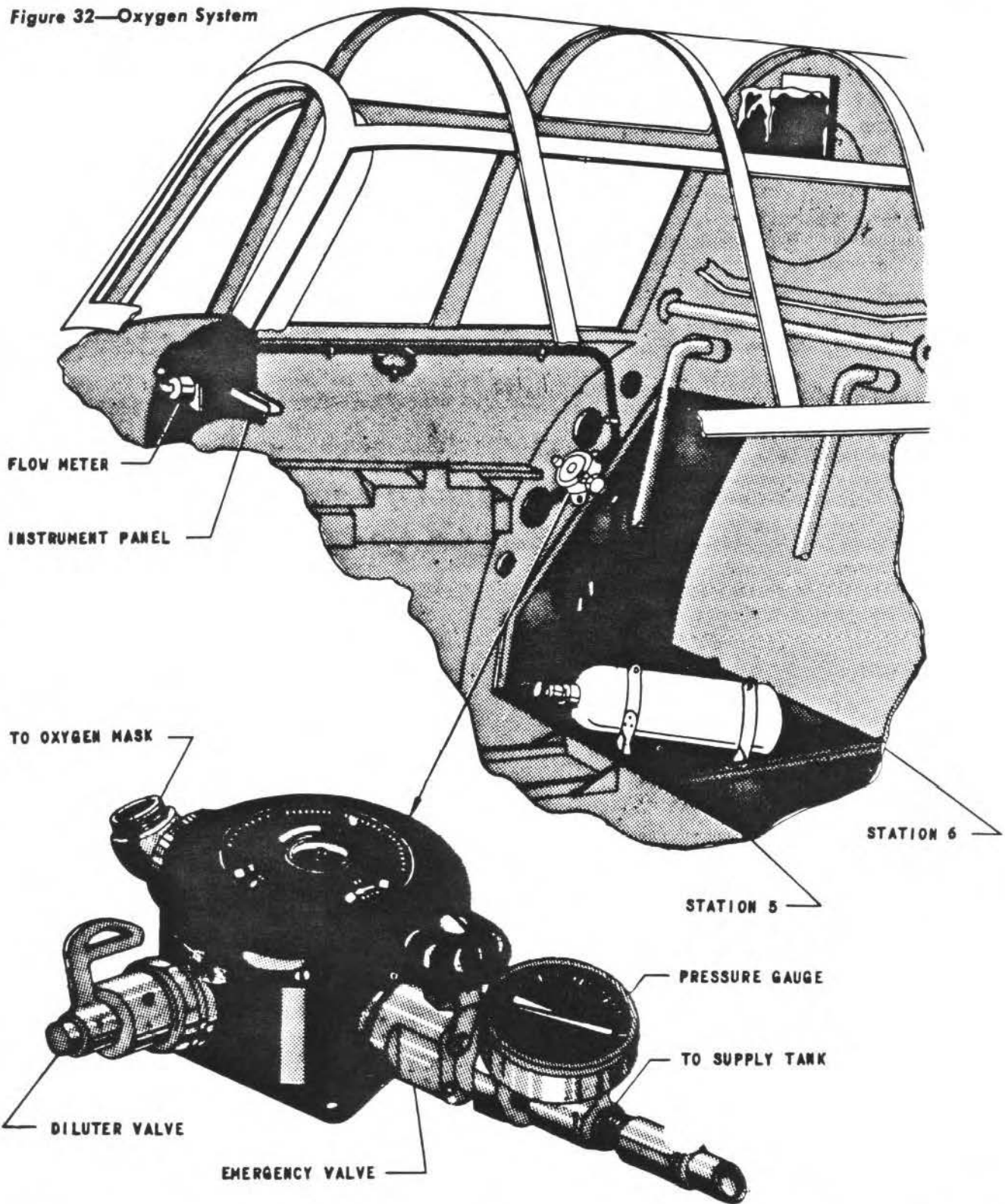
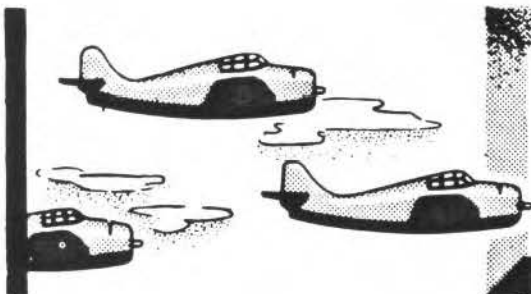

Figure 32—Oxygen System





# Section 5

## OPERATIONAL EQUIPMENT

### 1. OXYGEN SYSTEM.

a. DESCRIPTION.—This airplane has a diluter-demand oxygen system. The regulator is mounted on the bulkhead to the right and aft of the pilot. The pressure gage is mounted at the intake port of the regulator. The flowmeter is mounted in the right hand instrument panel facing the pilot. The tank itself is mounted in a cradle behind the pilot's seat. The main control handwheel is on the forward end of the oxygen cylinder to the right of the pilot's seat.

#### CAUTION

Oxygen equipment must be kept free from oil, grease and easily oxydized materials.

#### b. OPERATION.

(1) GENERAL.—The diluter-demand regulator opens a valve to provide a flow of oxygen during each inhalation. The emergency by-pass valve, incorporated in the regulator unit, provides a continuous flow of oxygen directly from the cylinder. The diluter valve allows air from the cockpit to enter the breathing system. The amount of air admitted by this valve is dependent upon the altitude up to approximately 30,000 feet beyond which 100 per cent oxygen is delivered.

During normal operations the diluter lever should be turned to the *On* position thus obtaining the maximum economy and endurance from the oxygen supply aboard the plane. However, if the presence of carbon monoxide in the cockpit is suspected as the result of the break-down of normal sealing of the fuselage or of damage by gunfire, the diluter lever should be turned to *Off* position. In this position 100% oxygen is supplied, but only during each inhalation. 100% oxygen is also supplied with the Emergency By-Pass valve *On*, but in a continuous flow regardless of the cycle of breathing.

All personnel using oxygen equipment should familiarize themselves thoroughly with the symptoms of anoxia so that they will at all times be on the alert to detect oxygen deficiencies before serious physical defects become evident.

(2) WHEN TO USE OXYGEN.—The pilot should use the oxygen equipment with the diluter valve

set to the *On* position, except as noted above:

(a) On all flights when above 10,000 feet.

(b) On flights of more than four hours duration between 8 to 10,000 feet for a minimum of fifteen minutes out of every hour.

(c) On *night* flights when above 5,000 feet.

c. PRE-FLIGHT CHECK.—To assure proper functioning of the oxygen system, the following items should be checked while the plane is on the ground prior to a flight in which oxygen is to be used or is likely to be used.

(1) Close the Emergency Valve.

(2) Open the cylinder valve. Allow at least ten seconds for the pressure in line to equalize. The pressure gage should then read  $1800 \pm 50$  p.s.i. if the cylinder is fully charged.

(3) Close the cylinder valve. If the pressure drops more than 100 pounds in five minutes there is excessive leakage. In such a case the oxygen system should be repaired prior to use.

(4) Check the mask fit by placing the thumb over the end of the mask tube and inhale lightly. If there is no leakage, the mask will adhere tightly to the face due to the suction created. If the mask leaks, tighten the mask suspension straps and/or adjust the nose wire and repeat the above test. *Do Not Use a Mask That Leaks.*

#### CAUTION

Never check mask fit by squeezing the mask tube *while the Emergency Valve is On.*

(5) Couple the mask securely to the breathing tube by means of the quick disconnect coupling.

#### CAUTION

Mating parts of coupling must not be "cocked" but must be fully engaged.

(6) Open the cylinder valve. Depress the diaphragm knob through the hole in the center of the regulator case and feel the flow of oxygen into the mask. Then release the diaphragm knob. Breathe several times observing the oxygen flow indicator for "blink", verifying the positive flow of oxygen.

**NOTE**

Since the amount of oxygen added is very small at sea level the oxygen flow meter may not operate while the airplane is on the ground. In this case turn the air-valve to *Off* or *100% Oxygen* and test again. If the oxygen flow indicator operation is now satisfactory, reset the air-valve to *On* or *Normal Oxygen*. In this setting adequate oxygen flow and "blinker" operation will be assured at oxygen altitudes.

(7) Check the Emergency Valve by slowly turning it counter-clockwise until the oxygen flows vigorously into the mask, then close the Emergency Valve.

**NOTE**

Upon completion of an oxygen check or an oxygen flight, close the cylinder valve.

d. RECHARGING CYLINDER.—To allow a safe margin of oxygen for maximum usage during a single flight, be sure that tank pressure is at 1800 PSI before any takeoff for an oxygen flight. At no time should the residual pressure in the tank be allowed to fall below 300 PSI.

The cylinder must be removed from the airplane to be recharged. Close the cylinder valve tightly, disconnect the tube at the valve and remove the cylinder from the cradle. *Be sure to close the valve before disconnecting the cylinder line.* High pressure oxygen escaping from a cylinder transforms it into a battering ram.

The cylinder is then connected to the recharge equipment by means of the sleeve nut on the valve. The cylinder valve is opened allowing the oxygen to cascade into the cylinder as the recharge equipment is operated until a pressure of 1900-1950 PSI is indicated. This pressure is necessary to insure 1800 PSI after the oxygen temperature in the cylinder has dropped from that caused by flow. Shut off the valve tightly and reinstall the cylinder in the airplane. The exact method of charging

the cylinder will vary with the recharging equipment used.

**CAUTION**

Exercise the greatest care to prevent oil, grease, white lead or any other easily oxidized material from coming in contact with the oxygen equipment. Contact of such materials with oxygen under pressure may cause explosion.

e. MAN-HOUR OXYGEN CONSUMPTION TABLE.—Figure 33 consists of a man-hour oxygen consumption table showing the endurance obtainable with the air-valve in the *On* and *Off* positions until the pressure falls to 300 PSI.

For example, if a flight of 5 hours duration at 18,500 feet is planned, reference to this table shows that sufficient oxygen is available for the flight only with the air valve set to the *On* position. If, however, a flight with droppable fuel tanks of 9.8 hours duration is planned at 18,500 feet, reference to this table shows that a flight of such a duration can only be made at 15,000 feet altitude.

In preparing his flight plan, the pilot should always check his proposed time of flight in altitudes above 10,000 feet against the accompanying chart to be certain sufficient oxygen is available for the flight.

**2. OPERATION OF RADIO EQUIPMENT.**

a. DESCRIPTION.

(1) GENERAL.—The FM-2 airplanes are equipped with three different radio installations. All the installations will eventually be changed in service to accommodate the AN/ARC-1 Communication Equipment, the AN/ARR-2 Navigation Equipment, and the BC1206 Range Receiver provided for ferry and training operations. This installation will be identical to the installation being incorporated in production on airplanes serial No. 57044 and subsequent with the exception of a slight difference in Navigation Equipment. The AN/ARR-2 Navigation Equipment incorporates a mechanical means

ENDURANCE WITH 514 CUBIC INCH CYLINDER		
Altitude	Diluter Demand Regulator—Set to <i>Off</i> or <i>100% Oxygen</i>	Diluter Demand Regulator—Set to <i>On</i> or <i>Normal Oxygen</i>
5,000 feet	1.8 hours	7.0 hours
10,000 feet	2.1 hours	8.3 hours
15,000 feet	2.6 hours	10.0 hours
20,000 feet	3.3 hours	8.8 hours
25,000 feet	4.1 hours	6.0 hours
30,000 feet	5.0 hours	5.0 hours
35,000 feet	6.5 hours	6.5 hours

Figure 33—  
Man-Hour Oxygen  
Consumption Table

of selecting the desired operating channels, while the AN/ARR-2a incorporates an automatic electrical selection of the channels.

In all installations, the radio controls are located on the starboard side of the cockpit aft of the Pilot's Distribution panel. A switch for a lip microphone is built in the throttle control. All other equipment is located in the baggage compartment.

**NOTE**

When the engine is running the battery switch need not be *On* to operate the radio equipment as the operating current is drawn from the generator and/or the battery when the engine is running. The battery switch *should* be turned *On*, however to care for the peak loads.

(2) Airplanes serial number 15952 to serial number 46942 inclusive are supplied with GF-12/RU-17 Communication Equipment, ZB-3(AN/ARR-1) Navigation Equipment, provision for ABD/ABE Navigation Equipment, provision for ABA-1 Identification Equipment, and provision for IFF/ABK Identification Equipment. Refer to figure 34 for a photograph of this equipment.

(3) Airplanes serial number 46943 to 57043 inclusive are supplied with AN/ARC-4 Communication Equipment, AN/ARR-2 Navigation Equipment, BC1206 Range Receiver, AN/APX-1 IFF Equipment and provision for ABA-1 Identification Equipment. Refer to figure 35 for a photograph of this equipment.

(4) Airplanes serial number 57044 and subsequent are supplied with AN/ARC-1 Communication Equipment, AN/ARR-2a Navigation Equipment, BC1206 Range equipment, AN/APX-1 IFF Equipment and provision for ABA-1 Identification Equipment. Beginning with airplane Serial Number 74809, the IFF Selector Switch is installed in the cockpit so the pilot may select the IFF channel during flight. This equipment is shown in figure 36.

**CAUTION**

Operation of this equipment involves use of high voltages which are dangerous and may result in fatal injuries. Operating personnel must, therefore, observe all safety regulations at all times.

**b. OPERATION OF COMMUNICATION EQUIPMENT.**

**(1) GF-12/RU-17 COMMUNICATION EQUIPMENT.**

**(a) TO RECEIVE.**

1. Set the Navigation Communication switch on *Communication*.
2. Set the ICS-Radio Switch on *Radio*.
3. Set the Auto-Off-Manual switch on *Auto* or *Manual*.

4. Turn the dual coil set remote control to the desired frequency band.
5. Tune and receive by means of the remote tuner.
6. If operating in *Manual*, adjust the volume with the *Increase-Output* knob.
7. If receiving voice or a modulated signal, use the *MCW* switch position.
8. If receiving an unmodulated signal, use the *CW* switch position.

**(b) TO TRANSMIT VOICE.**

1. Set the *ICS-Radio* switch on *Radio*.
2. Set the *Auto-Off-Manual* switch on *Manual* or *Auto*.
3. Set the *Voice-CW - MCW* switch on *Voice*.
4. Press the *Press to Talk* switch on the microphone or the switch in the throttle control arm if an oxygen mask is being worn.

**(c) TO TRANSMIT IN CODE.**

1. Set the *ICS-Radio* switch on *Radio*.
2. Set the *Auto-Off-Manual* switch on *Manual* or *Auto*.
3. Set the *Voice-CW - MCW* switch on *CW* or *MCW*.
4. Press the code key on the transmitter control box.

**(2) AN/ARC-4 COMMUNICATION EQUIPMENT.**

**(a) TO RECEIVE.**

1. Turn off the Output Control on the Navigation Receiver Control unit (full counter clockwise).
2. Set the Communication Control Unit *On-Off* switch to *On*.
3. Set the *Radio-Interphone* switch on *Radio*. (This position will always be maintained with this installation).
4. Set the *P-G, Both, P-P* switch for *P-P* (Plane to plane).
5. Advance the volume control (*Increase-Output* control knob) clockwise for desired reception. Channel 1 will now be received regardless of the position of the Channel Selector switch.

6. The following table lists receiving and transmitting channels for each position of the Channel Selector switch and the *P-G, Both, P-P* switch:

Channel Selection Position	Transmitter Channel	Receiver Channels for each Position of P-G, Both, P-P switch	
		P-P	Both P-G
1	1	1	1 & 2
2	2	1	1 & 2
3	3	1	1 & 3
4	4	1	1 & 4

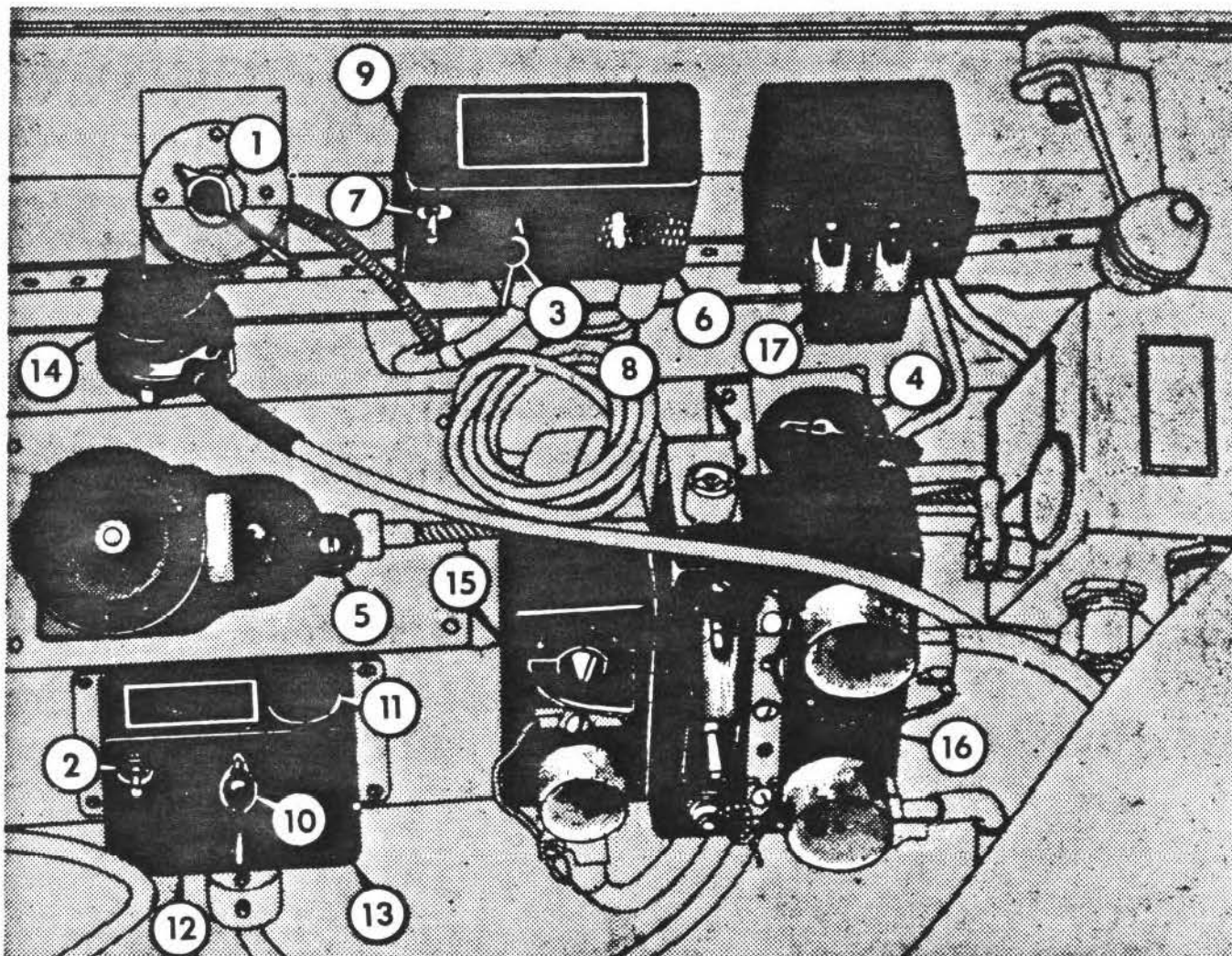

1. NAVIGATION-COMMUNICATION Switch
2. ICS-RADIO Switch
3. AUTO-OFF-MANUAL Switch
4. Dual Coil Remote Control
5. Remote Tuner
6. Volume INCREASE-OUTPUT Knob
7. CW-MCW Switch
8. Headphone Jack (On bottom)

9. Receiver Control Box
10. VOICE-CW-MCW Switch
11. Code Key
12. Microphone Jack (On bottom)
13. Transmitter Control Box
14. Microphone
15. IFF Selector Unit
16. IFF Control Unit
17. IFF Destruction Switches

Figure 34—GF-12/RU-17 and ZB-3 Radio Equipment

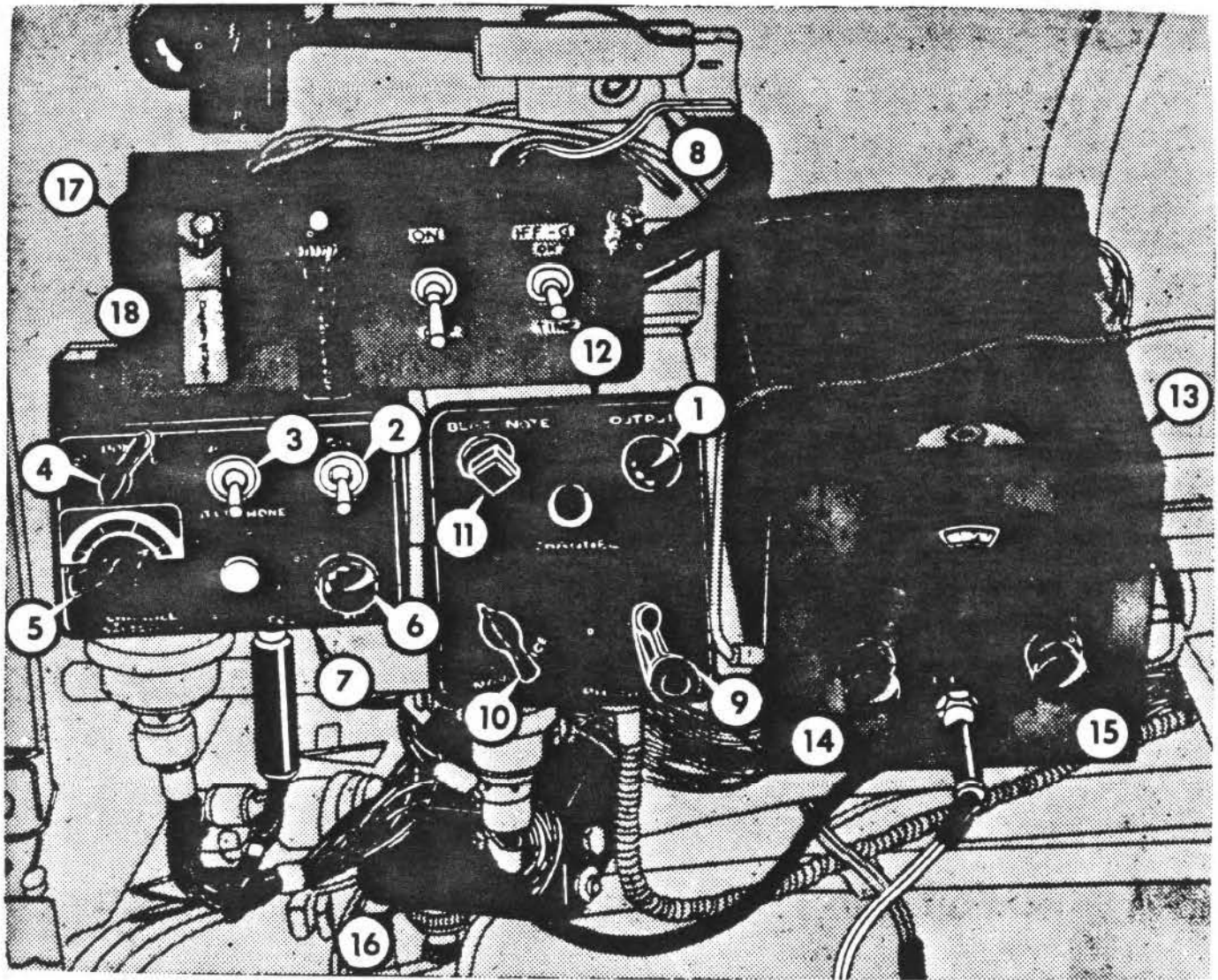

- 1. Volume INCREASE-OUTPUT Knob (Navigation)
- 2. ON-OFF Switch
- 3. RADIO-INTERPHONE Switch
- 4. PG-BOTH-PP Swithh
- 5. CHANNEL SELECTION Switch
- 6. Volume INCREASE-OUTPUT Knob (Communication)
- 7. Communication Control Unit
- 8. Microphone Bracket

- 9. Channel Crank Handle
- 10. NAVIGATION-VOICE Selector Switch
- 11. BEAT NOTE Knob
- 12. Navigation Control Unit
- 13. BC 1206 Range Receiver
- 14. ON-OFF Volume Control Switch
- 15. Tuner
- 16. Jack Box
- 17. IFF Control Box
- 18. IFF Destruction Switch

Figure 35—AN/ARC-4 and AN/ARR-2  
Radio Equipment

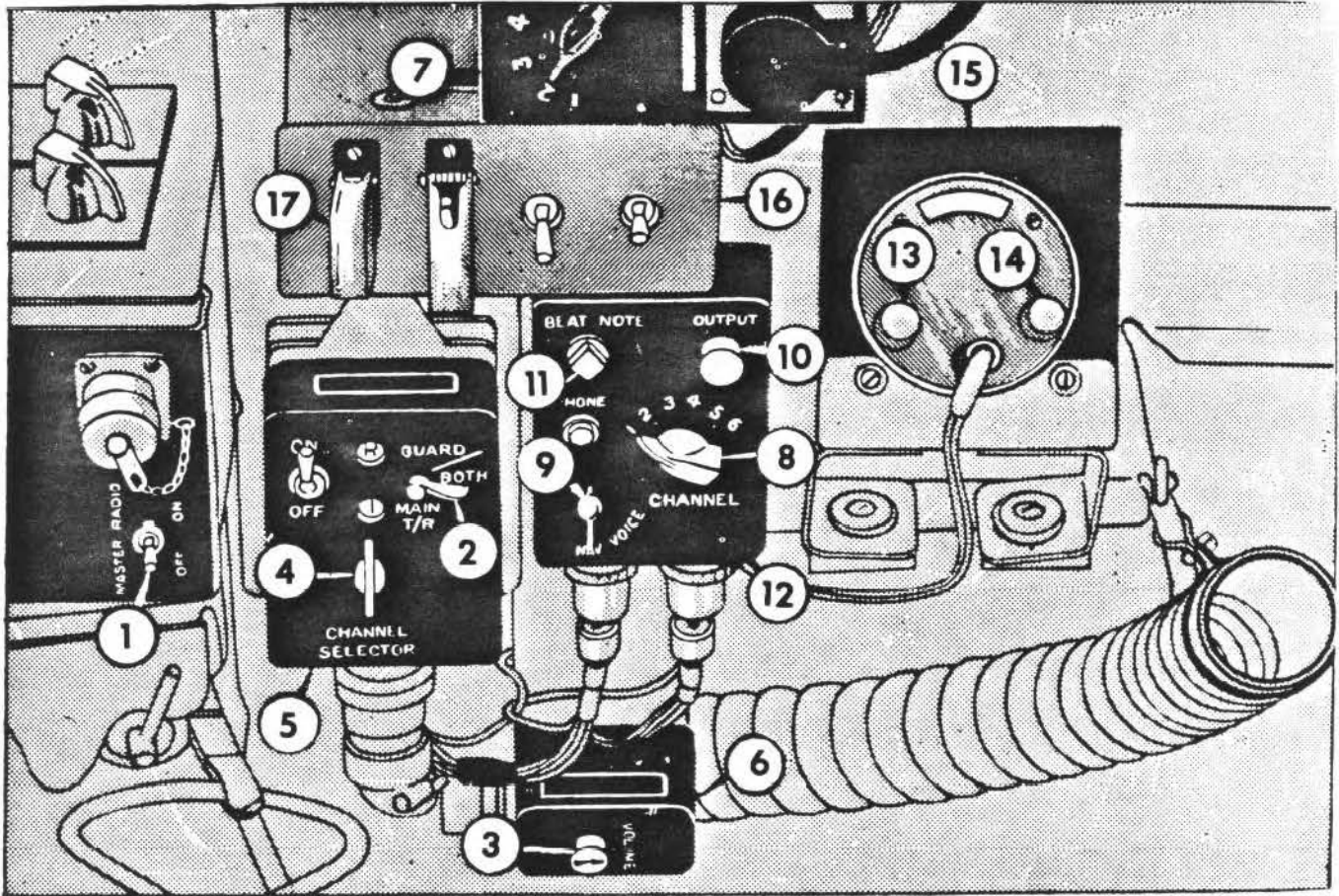

- |                                |                                    |
|--------------------------------|------------------------------------|
| 1. MASTER RADIO Switch         | 10. Volume INCREASE OUTPUT Control |
| 2. GUARD-BOTH-MAIN Switch      | 11. BEAT NOTE Knob                 |
| 3. Volume Control              | 12. Navigation Control Unit        |
| 4. Channel Selector Switch     | 13. On-Off Volume Control          |
| 5. Communications Control Unit | 14. Tuner Knob                     |
| 6. Jack Box                    | 15. BC-1206 Range Receiver         |
| 7. IFF Channel Selector Switch | 16. IFF Control Box                |
| 8. Channel Selector Switch     | 17. IFF Destruction Switch         |
| 9. NAVIGATION-VOICE Switch     |                                    |

Figure 36—AN/ARC-1 and AN/ARR-2a Radio Equipment



(b) TO TRANSMIT.

1. Obtain the desired operating channel in accordance with the above table. The transmitting channel is indicated directly by the channel indicator.

2. Press the *Press to Talk* switch on the microphone or the switch in the throttle control arm if an oxygen mask is being worn.

**NOTE**

Voice transmission only is possible with this equipment.

(3) AN/ARC-1 COMMUNICATION EQUIPMENT.

(a) TO RECEIVE.

1. Set the Radio Master Switch on the side of the Pilot's Distribution panel to *On*.

2. Select *Guard*, *Both* or *Main* channels.

3. Obtain desired volume by turning the volume control knob on the jack box clockwise.

4. The following table lists reception and transmitting channels for each position of the Channel Selector switch:

Channel Selection Position	Channels Available	
	Transmitting	Receiving
Guard	Guard	Guard
Both	1-9, incl.	Guard & 1-9, incl.
Main T/R	1-9, incl.	1-9, incl.

(b) TO TRANSMIT.

1. Set the Radio Master Switch to *On*.

2. Set the Channel Selector switch to the channel in which transmission is desired in accordance with the above table.

3. Press the *Press to Talk* switch on the microphone, or the switch in the throttle control arm if an oxygen mask is being worn.

**NOTE**

Voice transmission only is provided on this equipment.

c. OPERATION OF NAVIGATION EQUIPMENT.

(1) ZB-3 NAVIGATION EQUIPMENT.

(a) With Communication Equipment set for receiving as previously described under 2 b (1) (a), set the Communication-Navigation switch or selector on *Navigation*.

(b) Set the *CW-MCW* switch on the receiver switch box on *CW*.

(c) Set the *Auto-Off-Manual* switch on the Receiver switch box on *Manual*.

(d) Set the dual coil set remote control to the desired frequency band.

(e) Turn the Receiver Output control clockwise

to *Increase-Output* and adjust the volume as desired.

(2) AN/ARR-2 NAVIGATION EQUIPMENT.

(a) Turn the Output Control knob on the VHF Communication Control unit off (full counter clockwise).

(b) Operate the crank with the Navigation Receiver Control unit to obtain the desired operating channel indicated in the Channel Window.

(c) Set the *Nav-Voice* Selector switch on *Nav*.

(d) Set the Output control to obtain a usable weak signal (turn clockwise). If the desired signal cannot be heard, adjust to obtain a fairly strong background hiss.

(e) Adjust the Beat Note knob to produce a pleasing audible tone.

(f) Readjust the Output control to the minimum required for reception of signals to avoid inaccurate course indications.

(3) AN/ARR-2a NAVIGATION EQUIPMENT.—Operation of this equipment is the same as with the AN/ARR-2 equipment described above with the following exceptions:

(a) In lieu of the first step (step (a), Paragraph (2) above), turn down the volume control of the jack box. This volume control affects the AN/ARC-1 Communication Equipment only.

**NOTE**

The jack boxes, type J-22A/ARC-5, used with this installation have been modified to provide a direct circuit from the Navigation Equipment to the plug-in receptacle so that the volume control on the jack box regulates the volume of the AN/ARC-1 Communication Equipment only. Due to an electrical phenomenon, reception of the Navigation Equipment is also affected by the jack box volume control. Therefore, it may be necessary to turn the volume control up (clockwise) when using the Navigation Equipment.

(b) The desired channel is obtained by use of a channel selector switch in lieu of the crank.

(4) BC1206 RANGE RECEIVER.

(a) If used in conjunction with the installations referred to in paragraph 2 a (3), turn off VHF Communication Receiver by turning the *Increase-Output* control counter-clockwise.

(b) Turn up the volume control. This acts as an On-Off switch in a minimum position.

(c) Tune in the desired station and adjust the volume control. This control should be set to the minimum required for reception to avoid inaccurate course indications.

(d) When step (a) is required restore the Output control on the VHF Communication Receiver to a

previous setting if simultaneous monitoring is desired.

**NOTE**

The secret of accurately interpreting Navigation signals is attained by the lowest practical setting of the Output Control. Keep this control adjusted to receive only one character predominately. The lower the signal level, the better the reception.

**d. SIMULTANEOUS RECEPTION OF NAVIGATION AND COMMUNICATION EQUIPMENT.**

(1) GF-12/RU17 COMMUNICATION EQUIPMENT AND ZB-3 NAVIGATION EQUIPMENT.—With this installation simultaneous reception is not possible.

(2) AN/ARC-4 COMMUNICATION EQUIPMENT AND AN/ARR-2 NAVIGATION EQUIPMENT.

(a) Set the *On-Off* switch on Communication control unit to *On*.

(b) Turn the *Increase-Output* control clockwise to attain desired reception.

(c) Set the *P-G, Botb, P-P* switch on Communication Control unit to *Botb*.

(3) AN/ARC-1 COMMUNICATION EQUIP-

MENT AND AN/ARR-2a NAVIGATION EQUIPMENT.—This installation provides simultaneous reception at all times when Navigation Equipment is in operation.

**e. PRE-FLIGHT RADIO TEST.**

(1) On entering the cockpit, plug the head-set into the disconnect jack on the phone extension cord.

(2) Check to see that the microphone and head-set plugs are fully engaged in the jack box. If the use of an oxygen mask is anticipated, connect the mask microphone plug to the throttle microphone receptacle.

(3) Turn the battery switch to *On*.

(4) Test the VHF Communication Receiver by checking operation in all channels to be used.

**WARNING**

This test is subject to local limitations regarding Radio silence.

(5) Test the Navigation Equipment or Range Receiver, depending upon the mission assigned.

(6) When installations permit, set controls for simultaneous reception of Communication and Navigation Equipment.

(7) Select the desired transmitting channel and, if security instructions permit, make a test transmission with the base station and any other plane scheduled to same flight or mission.

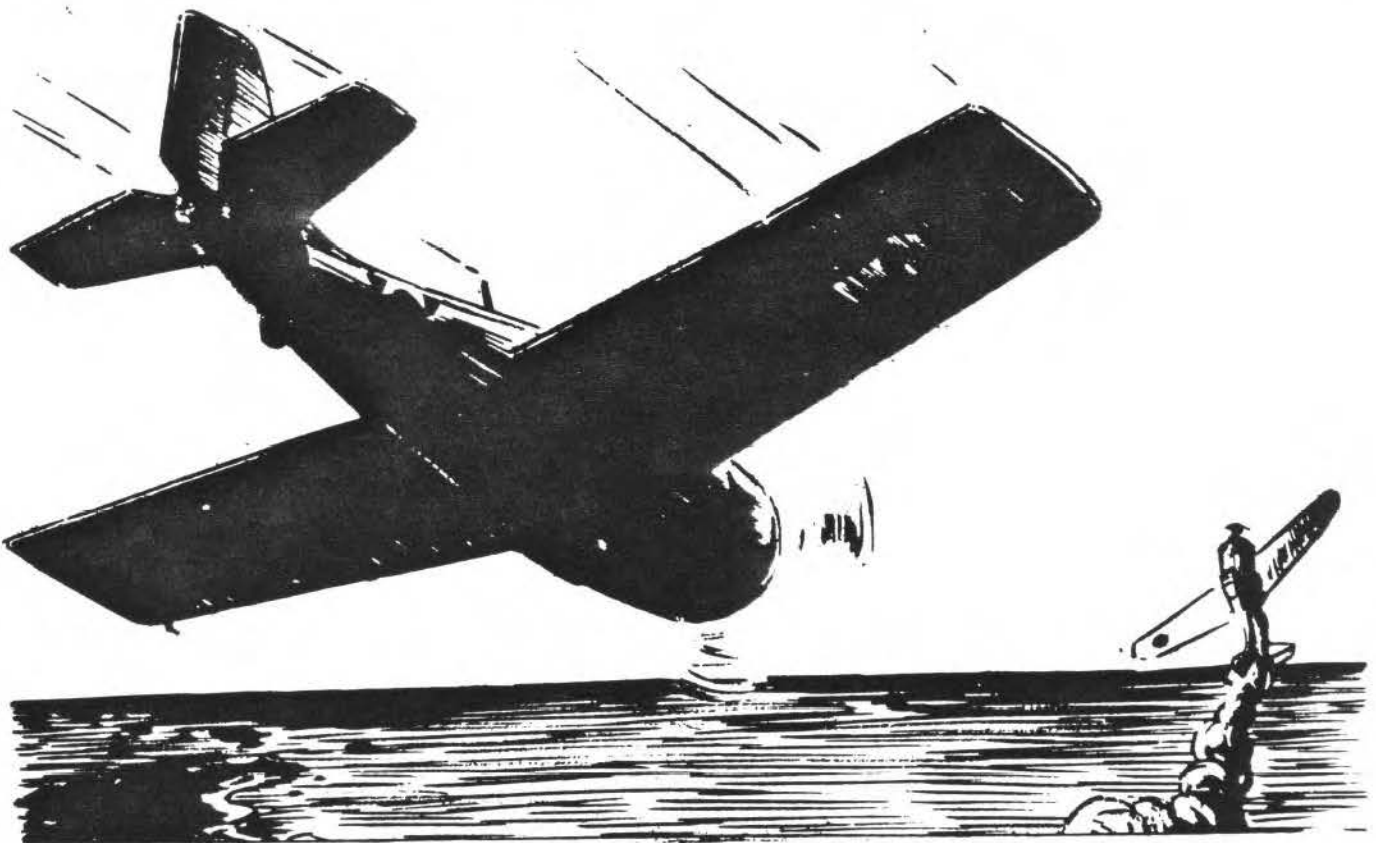



## 1. GENERAL DISCUSSION.

When operating in any locality where any extreme hot or cold weather conditions exist, or in desert or dry regions where there is an excessive amount of dust and sand in the air, certain precautions or additional operations are necessary to maintain normal and safe operation of this airplane. In extreme cold weather, precautions must be taken to prevent the formation of ice on certain parts of the airplane rendering flight impossible, just as in extreme hot weather steps must be taken to prevent overheating of the engine. The steps necessary for the operation of this airplane under these conditions are set forth in this section.

## 2. ARCTIC AND COLD WEATHER OPERATION.

*a.* WINDSHIELD DEFROSTER.—To defrost the windshield of this airplane, pull out the T handle control located above the left rudder pedal just forward of and below the instrument panel. This introduces heated air into the space between the double windshield thus removing and preventing any formation of frost on the windshield.

### *b.* OIL DILUTION.

(1) If temperatures below  $-5^{\circ}\text{C}$  ( $23^{\circ}\text{F}$ ) are forecast for the period just prior to the next expected operation, the lubricating oil should be diluted immediately before stopping the engine. (See Section II, Par. 20*b*)

*c.* PITOT TUBE HEATER.—The pitot tube is furnished with an electric heater which is controlled by a switch on the pilot's distribution panel. When icing conditions are encountered the pitot tube switch should be turned *On* to prevent ice formation on or inside the pitot tube resulting in erroneous airspeed indications.

*d.* ELECTRIC GUN HEATERS.—When operation of the guns is anticipated under icing conditions, the pilot should make sure that the gun heater is plugged in at the inboard gun compartment in each wing before taking off. When plugged in the gun heaters are connected directly to the generator and are *On* whenever the engine is running. Therefore, the pilot has no control of the gun heaters from the cockpit.

## 3. DESERT AND EXTREME DRY AND DUSTY CLIMATE OPERATION.

When operating under extremely dry and dusty conditions, the pilot should set the carburetor alternate air control for alternate air during landing, take-off, all ground operations and during flight at altitudes where there is an abnormal amount of dust and sand in the air. The alternate air duct of this airplane is provided with a filter that will remove all dust particles before entering the carburetor and engine where sand and dust would cause damage. The loss of ram which will accompany the shift from direct to alternate air supply will result in a drop in manifold pressure, but can always be compensated for by an increased throttle opening except when full throttle is already being used.

## 4. TROPIC AND EXTREME HOT WEATHER OPERATION.

When operating under extreme hot weather conditions the engine will have a greater tendency to overheat especially during all ground and low altitude operation. The pilot, therefore, must pay more attention to the engine cylinder head temperature and compensate for any overheating with the mixture and cowl flap control.

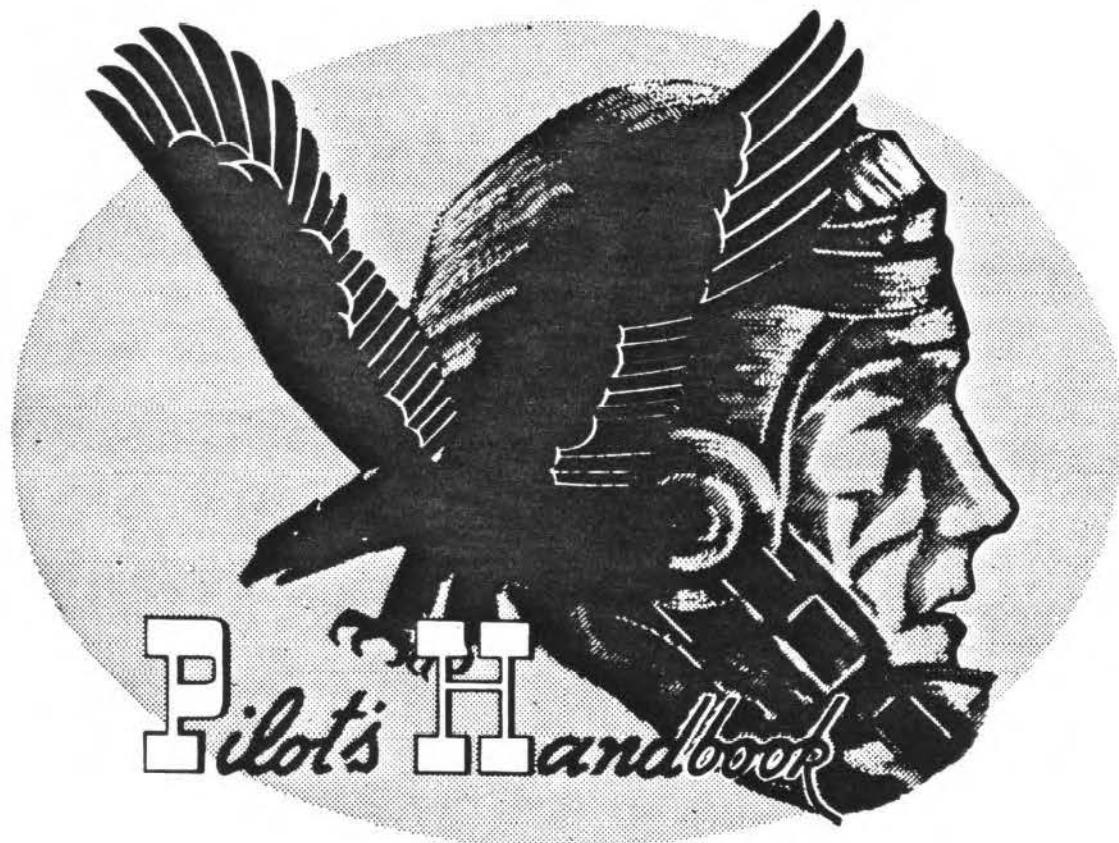

# APPENDIX I

## Operating Charts, Tables, Curves and Diagrams

**Appendix I of this publication shall not be carried in aircraft on combat missions or when there is a reasonable chance of it falling into the hands of the enemy.**

Figure 41—Personnel Protection Against Gunfire

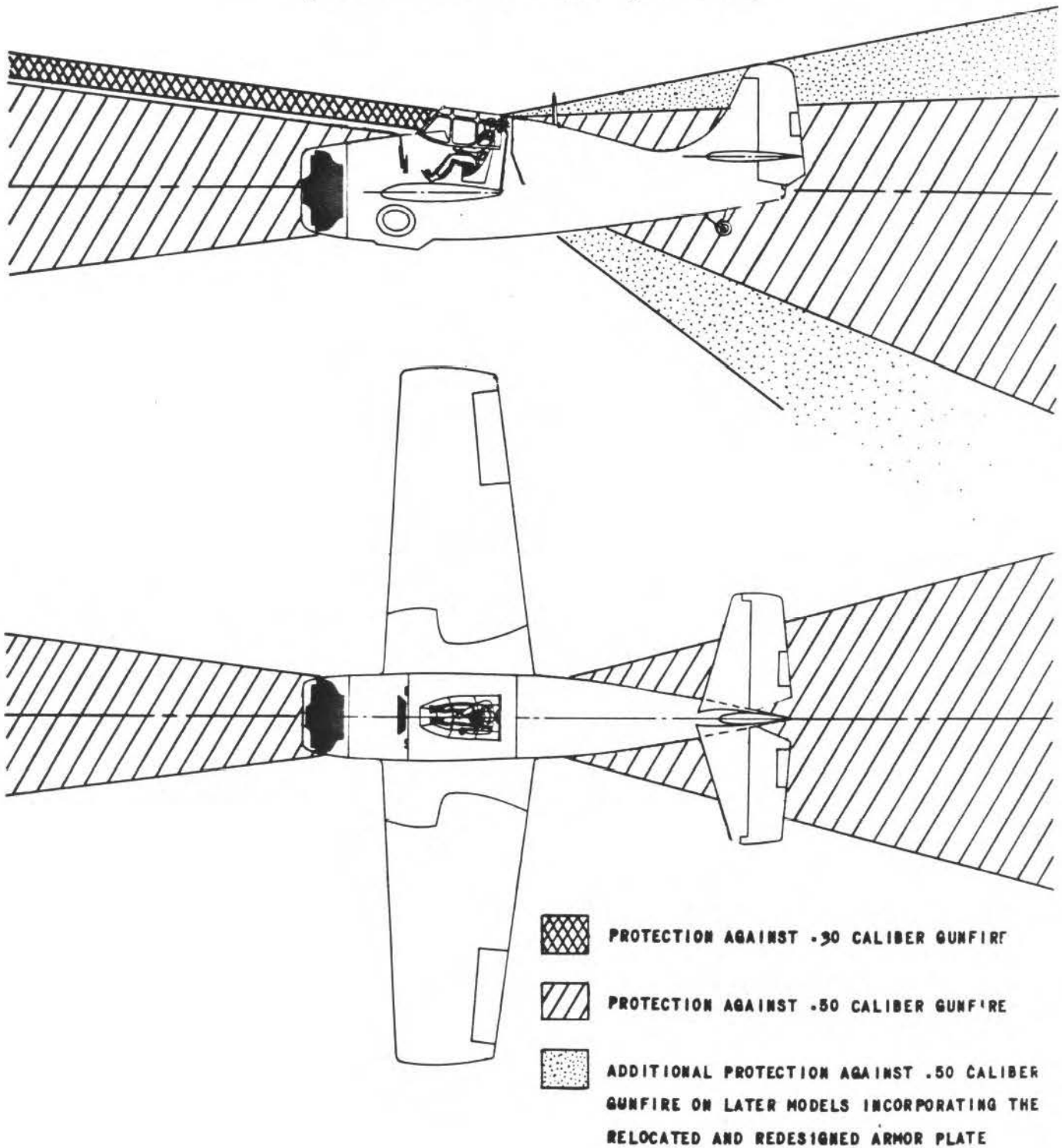

Appendix I of this publication shall not be carried in aircraft on combat missions or when there is reasonable chance of its falling into the hands of the enemy.

Appendix I of this publication shall not be carried in aircraft on combat missions or when there is reasonable chance of its falling into the hands of the enemy.

AIRCRAFT MODEL		TAKE-OFF, CLIMB & LANDING CHART																		ENGINE MODEL				
FM-2																				R-1820-56				
GROSS WEIGHT LB.		HEAD WIND		HARD SURFACE RUNWAY						SOD-TURF RUNWAY						SOFT SURFACE RUNWAY								
				AT SEA LEVEL		AT 3000 FEET		AT 6000 FEET		AT SEA LEVEL		AT 3000 FEET		AT 6000 FEET		AT SEA LEVEL		AT 3000 FEET		AT 6000 FEET				
				GROUND RUN	TO CLEAR 50' OBJ.	GROUND RUN	TO CLEAR 50' OBJ.	GROUND RUN	TO CLEAR 50' OBJ.	GROUND RUN	TO CLEAR 50' OBJ.	GROUND RUN	TO CLEAR 50' OBJ.	GROUND RUN	TO CLEAR 50' OBJ.	GROUND RUN	TO CLEAR 50' OBJ.	GROUND RUN	TO CLEAR 50' OBJ.	GROUND RUN	TO CLEAR 50' OBJ.			
M.P.H.		KTS.																						
7340		0	0	453	757	529	868	616	995	464	768	540	879	627	1006	481	785	555	894	644	1023			
		17	15	283	521	330	595	387	683	290	528	337	602	398	688	301	539	347	612	402	698			
		34	30	157	427	183	383	214	426	161	431	187	377	218	430	167	437	192	382	223	435			
		51	45	64	168	84	190	86	214	65	169	76	192	88	216	67	171	78	194	90	218			
8100		0	0	590	980	666	1078	753	1190	601	991	677	1089	764	1199	618	1008	694	1103	781	1216			
		17	15	369	678	431	761	499	853	376	685	439	769	506	860	386	695	449	779	517	817			
		34	30	204	432	240	489	296	567	207	435	244	493	301	572	213	441	250	499	305	578			
		51	45	83	230	108	275	139	328	85	232	110	277	142	331	87	234	112	279	145	334			
NOTE: INCREASE CHART DISTANCES AS FOLLOWS: 75°F + 10%; 100°F + 20%; 125°F + 30%; 150°F + 40%																		OPTIMUM TAKE-OFF WITH						
DATA AS OF 1/1/45																		BASED ON:						
CLIMB DATA																								
GROSS WEIGHT LB.	AT SEA LEVEL				AT 5000 FEET				AT 10,000 FEET				AT 15,000 FEET				AT 20,000 FEET				AT 25,000 FEET			
	BEST I.A.S.		RATE OF CLIMB F.P.M.	GAL. OF FUEL USED	BEST I.A.S.		RATE OF CLIMB F.P.M.	FROM SEA LEVEL TIME MIN.	FUEL USED	BEST I.A.S.		RATE OF CLIMB F.P.M.	FROM SEA LEVEL TIME MIN.	FUEL USED	BEST I.A.S.		RATE OF CLIMB F.P.M.	FROM SEA LEVEL TIME MIN.	FUEL USED	BEST I.A.S.		RATE OF CLIMB F.P.M.	FROM SEA LEVEL TIME MIN.	FUEL USED
	M.P.H.	KTS.			M.P.H.	KTS.				M.P.H.	KTS.				M.P.H.	KTS.				M.P.H.	KTS.			
OVERLOAD FIGHTER INFORMATION NOT AVAILABLE																								
POWER PLANT SETTINGS: (DETAILS ON FIG. SECTION III):																								
DATA AS OF												BASED ON:												
FUEL USED (U.S. GAL.) INCLUDES WARM-UP & TAKE-OFF ALLOWANCE																								
LANDING DISTANCE FEET																								
GROSS WEIGHT LB.	BEST IAS APPROACH				HARD DRY SURFACE						FIRM DRY SOD						WET OR SLIPPERY							
	POWER OFF		POWER ON		AT SEA LEVEL		AT 3000 FEET		AT 6000 FEET		AT SEA LEVEL		AT 3000 FEET		AT 6000 FEET		AT SEA LEVEL		AT 3000 FEET		AT 6000 FEET			
	M.P.H.	KTS.	M.P.H.	KTS.	GROUND ROLL	TO CLEAR 50' OBJ.	GROUND ROLL	TO CLEAR 50' OBJ.	GROUND ROLL	TO CLEAR 50' OBJ.	GROUND ROLL	TO CLEAR 50' OBJ.	GROUND ROLL	TO CLEAR 50' OBJ.	GROUND ROLL	TO CLEAR 50' OBJ.	GROUND ROLL	TO CLEAR 50' OBJ.	GROUND ROLL	TO CLEAR 50' OBJ.	GROUND ROLL	TO CLEAR 50' OBJ.		
6875		81	70		794	1355	866	1451	951	1560	875	1436	955	1540	1050	1659	1870	2431	2030	2615	2230	2839		
7360		83.5	72.5		835	1390	912	1496	1001	1577	921	1476	1010	1594	1109	1685	1946	2501	2035	2619	2350	2926		
DATA AS OF												BASED ON:												
REMARKS: TAKE OFF & LANDING DISTANCES ARE CALCULATED VALUES																		LEGEND						
NOTE: TO DETERMINE FUEL CONSUMPTION IN BRITISH IMPERIAL GALLONS, MULTIPLY BY 10, THEN DIVIDE BY 12																		I.A.S. : INDICATED AIRSPEED						
																		M.P.H. : MILES PER HOUR						
																		KTS. : KNOTS						
																		F.P.M. : FEET PER MINUTE						

RESTRICTED  
AN 01-190FB-1

Appendix I

Figure 38— Take-Off, Climb and Landing Chart





Appendix I of this publication shall not be carried in aircraft on combat missions or when there is reasonable chance of its falling into the hands of the enemy.

AIRCRAFT MODEL FM-2		FLIGHT OPERATION INSTRUCTION CHART										EXTERNAL LOAD ITEMS																			
ENGINE : R-1820-56		CHART WEIGHT LIMITS: 8100 TO POUNDS										2 Ext. Fuel Tanks (58 gals. each)																			
LIMITS		RPM.	M.P. IN. HG.	BLOWER POSITION	MIXTURE POSITION	TIME LIMIT	CYL. TEMP.	TOTAL G.P.H.	INSTRUCTIONS FOR USING CHART: SELECT FIGURE IN FUEL COLUMN EQUAL TO OR LESS THAN AMOUNT OF FUEL TO BE USED FOR CRUISING <sup>(1)</sup> MOVE HORIZONTALLY TO RIGHT OR LEFT AND SELECT RANGE VALUE EQUAL TO OR GREATER THAN THE STATUTE OR NAUTICAL AIR MILES TO BE FLOWN. VERTICALLY BELOW AND OPPOSITE VALUE NEAREST DESIRED CRUISING ALTITUDE (ALT.) READ RPM, MANIFOLD PRESSURE (M.P.) AND MIXTURE SETTING REQUIRED.			NOTES: COLUMN I IS FOR EMERGENCY HIGH SPEED CRUISING ONLY. COLUMNS II, III, IV AND V GIVE PROGRESSIVE INCREASE IN RANGE AT A SACRIFICE IN SPEED. AIR MILES PER GALLON (MI./GAL.) (NO WIND), GALLONS PER HR. (G.P.H.) AND TRUE AIRSPEED (T.A.S.) ARE APPROXIMATE VALUES FOR REFERENCE. RANGE VALUES ARE FOR AN AVERAGE AIRPLANE FLYING ALONE (NO WIND). <sup>(1)</sup> TO OBTAIN BRITISH IMPERIAL GAL. (OR G.P.H.): MULTIPLY U.S. GAL. (OR G.P.H.) BY 10 THEN DIVIDE BY 12.																			
WAR EMERG.																															
MILITARY POWER	2600	46.5	Low	Auto Lean	30 Min.		147																								
COLUMN I		FUEL			COLUMN II		COLUMN III		COLUMN IV		FUEL		COLUMN V																		
RANGE IN AIRMILES		U.S.			RANGE IN AIRMILES		RANGE IN AIRMILES		RANGE IN AIRMILES		U.S.		RANGE IN AIRMILES																		
STAUTE	NAUTICAL	GAL.			STATUTE	NAUTICAL	STATUTE	NAUTICAL	STATUTE	NAUTICAL	GAL.		STATUTE	NAUTICAL																	
670	583	210			600	551	800	695	945	820			1135	985																	
638	555	200			571	496	763	661	900	781			1080	938																	
574	500	180			515	447	686	595	810	702			973	844																	
510	444	160			457	397	610	529	720	625			865	750																	
447	389	140			400	347	534	463	630	546			756	656																	
384	334	120			343	298	457	396	540	468			648	562																	
320	278	100			286	248	381	331	450	390			550	477																	
255	222	80			228	198	305	264	360	312			432	375																	
192	167	60			171	148	229	198	270	234			324	281																	
127	110	40			104	99	152	132	180	156			216	187																	
64	55	20			57	49.6	76.3	66.2	90	78			108	93.8																	
MAXIMUM CONTINUOUS		PRESS			(2.86 STAT. (2.48 NAUT.) MI./GAL.)		(3.81 STAT. (3.31 NAUT.) MI./GAL.)		(4.5 STAT. (3.9 NAUT.) MI./GAL.)		PRESS		MAXIMUM AIR RANGE																		
R.P.M.	M.P. INCHES	MIX-TURE	APPROX.		ALT. FEET	R.P.M.	M.P. INCHES	MIX-TURE	APPROX.		R.P.M.	M.P. INCHES	MIX-TURE	APPROX.																	
			TOT.	T.A.S.		TOT.	T.A.S.	TOT.	T.A.S.	TOT.	T.A.S.				TOT.	T.A.S.															
			GPH.	MPH.	KTS.				GPH.	MPH.	KTS.				GPH.	MPH.	KTS.														
					40000																										
					35000																										
					30000																										
2500	38	A.L.	86	275	239	25000	2500	38	A.L.	86	274	238	2280	32.3	A.L.	68.5	264	229	2200	29.0	A.L.	56	252	220	25000	1970	29.0	A.L.	39.5	213	185
2500	38	A.L.	105	285	248	20000	2450	36	A.L.	98	280	243	2120	30.3	A.L.	67.0	258	224	1970	29.0	A.L.	54.3	245	213	20000	1820	29.0	A.L.	40.3	217	189
2500	38	A.L.	105	270	235	15000	2450	36	A.L.	92	262	228	2180	30.8	A.L.	64.0	245	213	2050	29.5	A.L.	52.0	236	205	15000	1650	29.0	A.L.	40.0	216	188
2500	43	A.L.	110	269	234	10000	2330	34.3	A.L.	92	262	228	2100	29.0	A.L.	53.0	244	212	1980	29.0	A.L.	51.0	230	206	10000	1660	29.0	A.L.	37.0	201	175
2500	43	A.L.	130	269	234	5000	2280	33.2	A.L.	85.6	244	212	2150	30.0	A.L.	59.5	228	198	2000	29.0	A.L.	47.5	215	187	5000	1500	29.0	A.L.	34.6	188	163
2500	43	A.L.	130	254	222	S.L.	2330	35	A.L.	80	229	199	2200	31.0	A.L.	55.7	214	186	2070	29.0	A.L.	44.8	201	175	S.L.	1500	29.0	A.L.	32.0	172	150
SPECIAL NOTES						EXAMPLE						LEGEND																			
(1) MAKE ALLOWANCE FOR WARM-UP, TAKE-OFF & CLIMB (SEE FIG. ) PLUS ALLOWANCE FOR WIND, RESERVE AND COMBAT AS REQUIRED.						AT 8100 LB. GROSS WEIGHT WITH 180 GAL. OF FUEL (AFTER DEDUCTING TOTAL ALLOWANCES OF 17 GAL.) TO FLY 515 STAT. AIRMILES AT 5000 FT. ALTITUDE MAINTAIN 2280 RPM AND 33.2 IN. MANIFOLD PRESSURE WITH MIXTURE SET: A.L.						ALT. : PRESSURE ALTITUDE M.P. : MANIFOLD PRESSURE GPH : U.S. GAL. PER HOUR TAS : TRUE AIRSPEED KTS. : KNOTS S.L. : SEA LEVEL F.R. : FULL RICH A.R. : AUTO-RICH A.L. : AUTO-LEAN C.L. : CRUISING LEAN M.L. : MANUAL LEAN F.T. : FULL THROTTLE																			
DATA AS OF 1 15 44						BASED ON: Patuxent River Report, Project TED No. PTR-2119						RED FIGURES ARE PRELIMINARY DATA, SUBJECT TO REVISION AFTER FLIGHT CHECK																			

RESTRICTED  
AN 01-190FB-1

Appendix I

Figure 39—Flight Operation Instruction Chart, Sheet 2 of 2

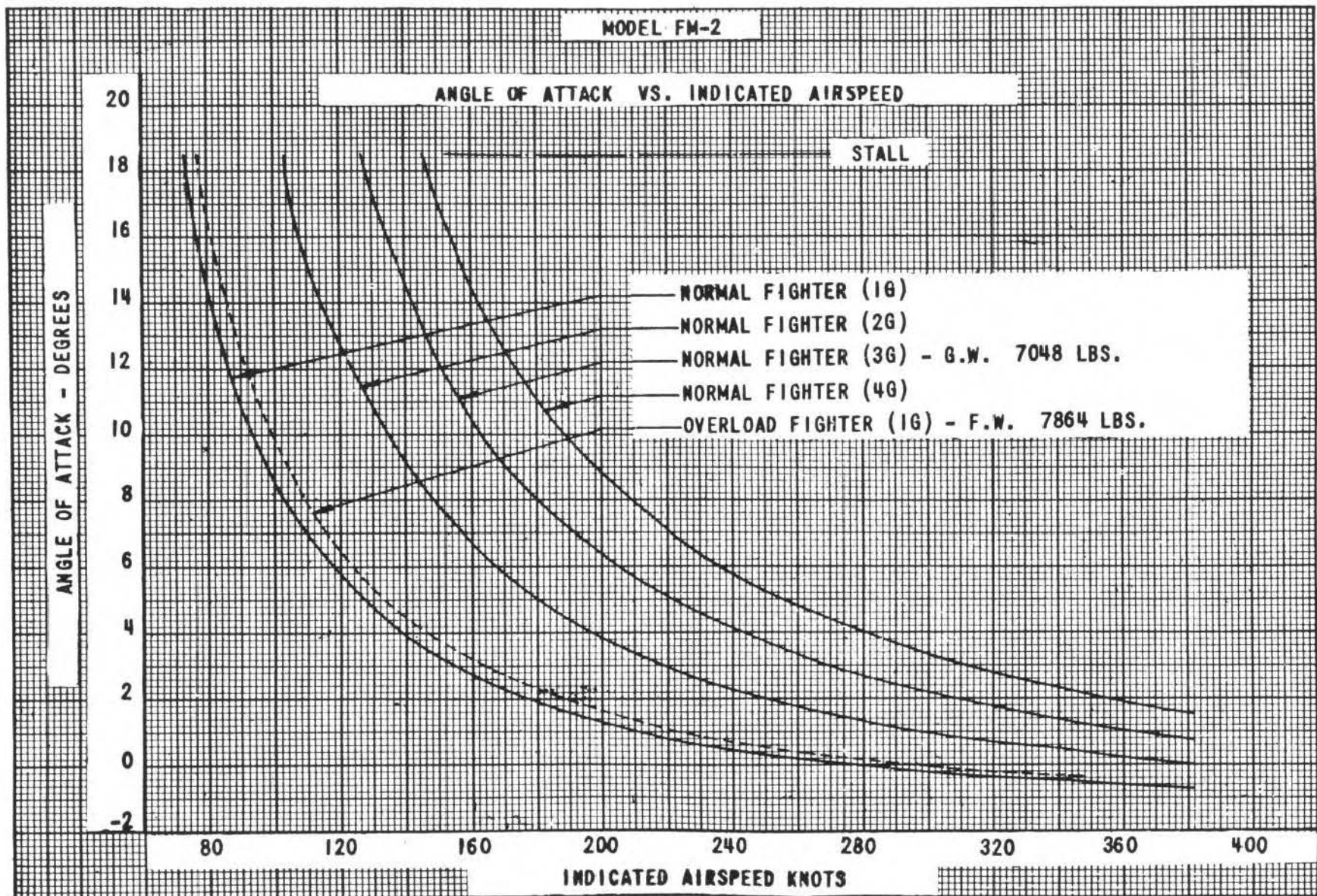

*Figure 40—Angle of Attack vs. Indicated Airspeed Curve*

*Appendix I of this publication shall not be carried in aircraft on combat missions or when there is reasonable chance of its falling into the hands of the enemy.*

RESTRICTED

Appendix I of this publication shall not be carried in aircraft on combat missions or when there is reasonable chance of its falling into the hands of the enemy.

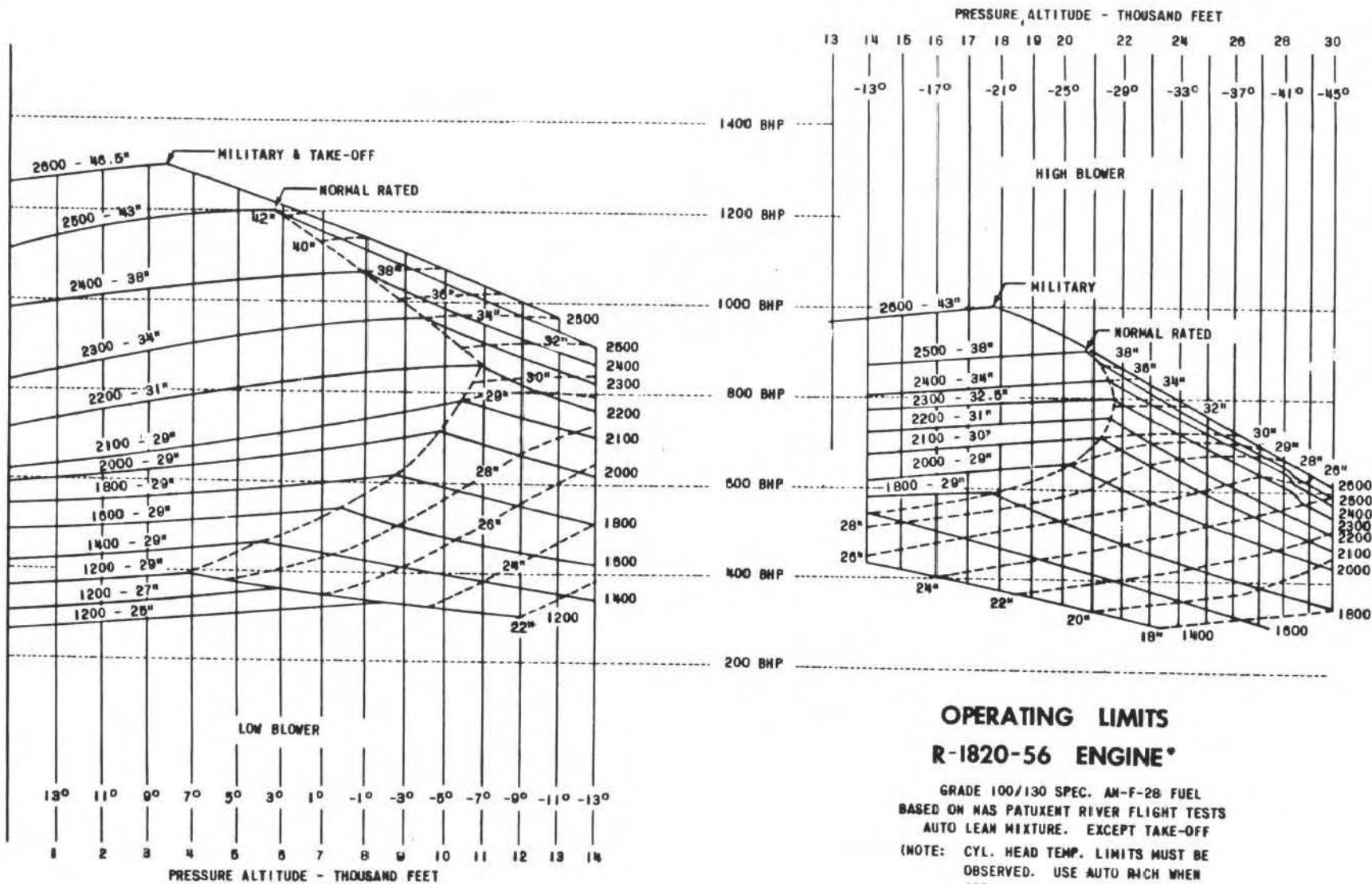

Figure 41—Engine Calibration Curve

RESTRICTED  
AN 01-190FB-1